

THE EXPERT'S VOICE® IN ORACLE



# Expert Oracle Database Architecture

THIRD EDITION

*TECHNIQUES AND SOLUTIONS  
FOR HIGH-PERFORMANCE  
AND PRODUCTIVITY*

Thomas Kyte and Darl Kuhn

**Apress®**

*For your convenience Apress has placed some of the front matter material after the index. Please use the Bookmarks and Contents at a Glance links to access them.*



**Apress®**

# Contents at a Glance

<b>About the Authors</b> .....	<b>xvii</b>
<b>About the Technical Reviewers</b> .....	<b>xix</b>
<b>Acknowledgments</b> .....	<b>xxi</b>
<b>Introduction</b> .....	<b>xxiii</b>
<b>Setting Up Your Environment</b> .....	<b>xxx</b>
■ <b>Chapter 1: Developing Successful Oracle Applications</b> .....	<b>1</b>
■ <b>Chapter 2: Architecture Overview</b> .....	<b>53</b>
■ <b>Chapter 3: Files</b> .....	<b>73</b>
■ <b>Chapter 4: Memory Structures</b> .....	<b>127</b>
■ <b>Chapter 5: Oracle Processes</b> .....	<b>173</b>
■ <b>Chapter 6: Locking and Latching</b> .....	<b>205</b>
■ <b>Chapter 7: Concurrency and Multiversioning</b> .....	<b>253</b>
■ <b>Chapter 8: Transactions</b> .....	<b>275</b>
■ <b>Chapter 9: Redo and Undo</b> .....	<b>307</b>
■ <b>Chapter 10: Database Tables</b> .....	<b>355</b>
■ <b>Chapter 11: Indexes</b> .....	<b>439</b>
■ <b>Chapter 12: Datatypes</b> .....	<b>511</b>
■ <b>Chapter 13: Partitioning</b> .....	<b>581</b>
■ <b>Chapter 14: Parallel Execution</b> .....	<b>659</b>
■ <b>Chapter 15: Data Loading and Unloading</b> .....	<b>697</b>
<b>Index</b> .....	<b>767</b>

# Introduction

The inspiration for the material contained in this book comes from my experiences developing Oracle software, and from working with fellow Oracle developers to help them build reliable and robust applications based on the Oracle database. The book is basically a reflection of what I do every day and of the issues I see people encountering each and every day.

I covered what I felt was most relevant, namely the Oracle database and its architecture. I could have written a similarly titled book explaining how to develop an application using a specific language and architecture—for example, one using JavaServer Pages that speaks to Enterprise JavaBeans, which in turn uses JDBC to communicate with Oracle. However, at the end of the day, you really do need to understand the topics covered in this book in order to build such an application successfully. This book deals with what I believe needs to be universally known to develop successfully with Oracle, whether you are a Visual Basic programmer using ODBC, a Java programmer using EJBs and JDBC, or a Perl programmer using DBI Perl. This book does not promote any specific application architecture; it does not compare three tier to client/server. Rather, it covers what the database can do and what you must understand about the way it works. Since the database is at the heart of any application architecture, the book should have a broad audience.

As the title suggests, *Expert Oracle Database Architecture* concentrates on the database architecture and how the database itself works. I cover the Oracle database architecture in depth: the files, memory structures, and processes that comprise an Oracle database and instance. I then move on to discuss important database topics such as locking, concurrency controls, how transactions work, and redo and undo, and why it is important for you to know about these things. Lastly, I examine the physical structures in the database such as tables, indexes, and datatypes, covering techniques for making optimal use of them.

## What This Book Is About

One of the problems with having plenty of development options is that it's sometimes hard to figure out which one might be the best choice for your particular needs. Everyone wants as much flexibility as possible (as many choices as they can possibly have), but they also want things to be very cut and dried—in other words, easy. Oracle presents developers with almost unlimited choice. No one ever says, "You can't do that in Oracle." Rather, they say, "How many different ways would you like to do that in Oracle?" I hope that this book will help you make the correct choice.

This book is aimed at those people who appreciate the choice but would also like some guidelines and practical implementation details on Oracle features and functions. For example, Oracle has a really neat feature called parallel execution. The Oracle documentation tells you how to use this feature and what it does. Oracle documentation does not, however, tell you when you should use this feature and, perhaps even more important, when you should not use this feature. It doesn't always tell you the implementation details of this feature, and if you're not aware of them, this can come back to haunt you (I'm not referring to bugs, but the way the feature is supposed to work and what it was really designed to do).

In this book I strove to not only describe how things work, but also explain when and why you would consider using a particular feature or implementation. I feel it is important to understand not only the "how" behind things, but also the "when" and "why" as well as the "when not" and "why not!"

## Who Should Read This Book

The target audience for this book is anyone who develops applications with Oracle as the database back end. It is a book for professional Oracle developers who need to know how to get things done in the database. The practical nature of the book means that many sections should also be very interesting to the DBA. Most of the examples in the book use SQL\*Plus to demonstrate the key features, so you won't find out how to develop a really cool GUI—but you will find out how the Oracle database works, what its key features can do, and when they should (and should not) be used.

This book is for anyone who wants to get more out of Oracle with less work. It is for anyone who wants to see new ways to use existing features. It is for anyone who wants to see how these features can be applied in the real world (not just examples of how to use the feature, but why the feature is relevant in the first place). Another category of people who would find this book of interest is technical managers in charge of the developers who work on Oracle projects. In some respects, it is just as important that they understand why knowing the database is crucial to success. This book can provide ammunition for managers who would like to get their personnel trained in the correct technologies or ensure that personnel already know what they need to know.

To get the most out of this book, the reader should have

- *Knowledge of SQL.* You don't have to be the best SQL coder ever, but a good working knowledge will help.
- *An understanding of PL/SQL.* This isn't a prerequisite, but it will help you to absorb the examples. This book will not, for example, teach you how to program a FOR loop or declare a record type; the Oracle documentation and numerous books cover this well. However, that's not to say that you won't learn a lot about PL/SQL by reading this book. You will. You'll become very intimate with many features of PL/SQL, you'll see new ways to do things, and you'll become aware of packages/features that perhaps you didn't know existed.
- *Exposure to some third-generation language (3GL), such as C or Java.* I believe that anyone who can read and write code in a 3GL language will be able to successfully read and understand the examples in this book.
- *Familiarity with the Oracle Database Concepts manual.*

A few words on that last point: due to the Oracle documentation set's vast size, many people find it to be somewhat intimidating. If you're just starting out or haven't read any of it as yet, I can tell you that the *Oracle Database Concepts* manual is exactly the right place to start. It's about 450 pages long (I know that because I wrote some of the pages and edited every one) and touches on many of the major Oracle concepts that you need to know about. It may not give you each and every technical detail (that's what the other 10,000 to 20,000 pages of documentation are for), but it will educate you on all the important concepts. This manual touches the following topics (to name a few):

- The structures in the database, and how data is organized and stored
- Distributed processing
- Oracle's memory architecture
- Oracle's process architecture
- Schema objects you will be using (tables, indexes, clusters, and so on)
- Built-in datatypes and user-defined datatypes
- SQL stored procedures
- How transactions work
- The optimizer
- Data integrity
- Concurrency control

I will come back to these topics myself time and time again. These are the fundamentals. Without knowledge of them, you will create Oracle applications that are prone to failure. I encourage you to read through the manual and get an understanding of some of these topics.

## How This Book Is Structured

To help you use this book, most chapters are organized into four general sections (described in the list that follows). These aren't rigid divisions, but they will help you navigate quickly to the area you need more information on. This book has 15 chapters, and each is like a "minibook"—a virtually stand-alone component. Occasionally, I refer to examples or features in other chapters, but you could pretty much pick a chapter out of the book and read it on its own. For example, you don't have to read Chapter 10 on database tables to understand or make use of Chapter 14 on parallelism.

The format and style of many of the chapters is virtually identical:

- An introduction to the feature or capability.
- Why you might want to use the feature or capability (or not). I outline when you would consider using this feature and when you would not want to use it.
- How to use this feature. The information here isn't just a copy of the material in the SQL reference; rather, it's presented in step-by-step manner: here is what you need, here is what you have to do, and these are the switches you need to go through to get started. Topics covered in this section will include:
  - How to implement the feature
  - Examples, examples, examples
  - How to debug this feature
  - Caveats of using this feature
  - How to handle errors (proactively)
  - A summary to bring it all together

There will be lots of examples and lots of code, all of which is available for download from the Source Code area of [www.apress.com](http://www.apress.com). The following sections present a detailed breakdown of the content of each chapter.

## Chapter 1: Developing Successful Oracle Applications

This chapter sets out my essential approach to database programming. All databases are not created equal, and in order to develop database-driven applications successfully and on time, you need to understand exactly what your particular database can do and how it does it. If you do not know what your database can do, you run the risk of continually reinventing the wheel—developing functionality that the database already provides. If you do not know how your database works, you are likely to develop applications that perform poorly and do not behave in a predictable manner.

The chapter takes an empirical look at some applications where a lack of basic understanding of the database has led to project failure. With this example-driven approach, the chapter discusses the basic features and functions of the database that you, the developer, need to understand. The bottom line is that you cannot afford to treat the database as a black box that will simply churn out the answers and take care of scalability and performance by itself.

## Chapter 2: Architecture Overview

This chapter covers the basics of Oracle architecture. We start with some clear definitions of two terms that are very misunderstood by many in the Oracle world, namely *instance* and *database*. We then cover two new types of databases introduced in Oracle 12c, namely *container database* and *pluggable database*. We also take a quick look at the System Global Area (SGA) and the processes behind the Oracle instance, and examine how the simple act of “connecting to Oracle” takes place.

## Chapter 3: Files

This chapter covers in depth the eight types of files that make up an Oracle database and instance. From the simple parameter file to the data and redo log files, we explore what they are, why they are there, and how we use them.

## Chapter 4: Memory Structures

This chapter covers how Oracle uses memory, both in the individual processes (Process Global Area, or PGA, memory) and shared memory (SGA). We explore the differences between manual and automatic PGA and, in Oracle 10g, automatic shared memory management, and in Oracle 11g, automatic memory management, and see when each is appropriate. After reading this chapter, you will have an understanding of exactly how Oracle uses and manages memory.

## Chapter 5: Oracle Processes

This chapter offers an overview of the types of Oracle processes (server processes versus background processes). It also goes into much more depth on the differences in connecting to the database via a shared server or dedicated server process. We’ll also take a look, process by process, at most of the background processes (such as LGWR, DBWR, PMON, SMON, and LREG) that we’ll see when starting an Oracle instance and discuss the functions of each.

## Chapter 6: Locking and Latching

Different databases have different ways of doing things (what works well in SQL Server may not work as well in Oracle), and understanding how Oracle implements locking and concurrency control is absolutely vital to the success of your application. This chapter discusses Oracle’s basic approach to these issues, the types of locks that can be applied (DML, DDL, and latches), and the problems that can arise if locking is not implemented carefully (deadlocking, blocking, and escalation).

## Chapter 7: Concurrency and Multiversioning

In this chapter, we’ll explore my favorite Oracle feature, multiversioning, and how it affects concurrency controls and the very design of an application. Here we will see that all databases are not created equal and that their very implementation can have an impact on the design of our applications. We’ll start by reviewing the various transaction isolation levels as defined by the ANSI SQL standard and see how they map to the Oracle implementation (as well as how the other databases map to this standard). Then we’ll take a look at what implications multiversioning, the feature that allows Oracle to provide nonblocking reads in the database, might have for us.

## Chapter 8: Transactions

Transactions are a fundamental feature of all databases—they are part of what distinguishes a database from a file system. And yet, they are often misunderstood and many developers do not even know that they are accidentally not using them. This chapter examines how transactions should be used in Oracle and also exposes some bad habits that may have been picked up when developing with other databases. In particular, we look at the implications of atomicity and how it affects statements in Oracle. We also discuss transaction control statements (COMMIT, SAVEPOINT, and ROLLBACK), integrity constraints, distributed transactions (the two-phase commit, or 2PC), and finally autonomous transactions.

## Chapter 9: Redo and Undo

It can be said that developers do not need to understand the detail of redo and undo as much as DBAs, but developers do need to know the role they play in the database. After first defining redo, we examine what exactly a COMMIT does. We discuss how to find out how much redo is being generated and how to significantly reduce the amount of redo generated by certain operations using the NOLOGGING clause. We also investigate redo generation in relation to issues such as block cleanout and log contention.

In the undo section of the chapter, we examine the role of undo data and the operations that generate the most/least undo. Finally, we investigate the infamous `ORA-01555: snapshot too old error`, its possible causes, and how to avoid it.

## Chapter 10: Database Tables

Oracle now supports numerous table types. This chapter looks at each different type—heap organized (i.e., the default, “normal” table), index organized, index clustered, hash clustered, nested, temporary, and object—and discusses when, how, and why you should use them. Most of time, the heap organized table is sufficient, but this chapter will help you recognize when one of the other types might be more appropriate.

## Chapter 11: Indexes

Indexes are a crucial aspect of your application design. Correct implementation requires an in-depth knowledge of the data, how it is distributed, and how it will be used. Too often, indexes are treated as an afterthought in application development, and performance suffers as a consequence.

This chapter examines in detail the different types of indexes, including B\*Tree, bitmap, function-based, and application domain indexes, and discusses where they should and should not be used. I’ll also answer some common queries in the “Frequently Asked Questions and Myths About Indexes” section, such as “Do indexes work on views?” and “Why isn’t my index getting used?”

## Chapter 12: Datatypes

There are a lot of datatypes to choose from. This chapter explores each of the 22 built-in datatypes, explaining how they are implemented, and how and when to use each one. First up is a brief overview of National Language Support (NLS), a basic knowledge of which is necessary to fully understand the simple string types in Oracle. We then move on to the ubiquitous NUMBER type. Next the LONG and LONG RAW types are covered, mostly from a historical perspective. The main objective here is to show how to deal with legacy LONG columns in applications and migrate them to the LOB type. Next, we delve into the various datatypes for storing dates and time, and investigating how to manipulate the various datatypes to get what we need from them. The ins and outs of time zone support are also covered.



Next up are the LOB datatypes. We'll cover how they are stored and what each of the many settings such as `IN ROW`, `CHUNK`, `RETENTION`, `CACHE`, and so on mean to us. When dealing with LOBs, it is important to understand how they are implemented and how they are stored by default—especially when it comes to tuning their retrieval and storage. We close the chapter by looking at the `ROWID` and `UROWID` types. These are special types, proprietary to Oracle, that represent the address of a row. We'll cover when to use them as a column datatype in a table (which is almost never).

## Chapter 13: Partitioning

Partitioning is designed to facilitate the management of very large tables and indexes by implementing a divide and conquer logic—basically breaking up a table or index into many smaller and more manageable pieces. It is an area where the DBA and developer must work together to maximize application availability and performance. Features introduced in Oracle 11g and Oracle 12c are also covered in detail.

This chapter covers both table and index partitioning. We look at partitioning using local indexes (common in data warehouses) and global indexes (common in OLTP systems).

## Chapter 14: Parallel Execution

This chapter introduces the concept of and uses for parallel execution in Oracle. We'll start by looking at when parallel processing is useful and should be considered, as well as when it should not be considered. After gaining that understanding, we move on to the mechanics of parallel query, the feature most people associate with parallel execution. Next, we cover parallel DML (PDML), which allows us to perform modifications using parallel execution. We'll see how PDML is physically implemented and why that implementation leads to a series of restrictions regarding PDML.

We then move on to parallel DDL. This, in my opinion, is where parallel execution really shines. Typically, DBAs have small maintenance windows in which to perform large operations. Parallel DDL gives DBAs the ability to fully exploit the machine resources they have available, permitting them to finish large, complex operations in a fraction of the time it would take to do them serially.

The chapter closes on procedural parallelism, the means by which we can execute application code in parallel. We cover two techniques here. The first is parallel pipelined functions, or the ability of Oracle to execute stored functions in parallel dynamically. The second is “do it yourself” (DIY) parallelism, whereby we design the application to run concurrently.

## Chapter 15: Data Loading and Unloading

The first half of the chapter focuses on external tables, a highly efficient means by which to bulk load and unload data. If you perform a lot of data loading, you should strongly consider using external tables. Also discussed in detail is the external table preprocessing feature that allows for operating system commands to be executed automatically as part of selecting from an external table.

The second half of this chapter focuses on SQL\*Loader (SQLLDR) and covers the various ways in which we can use this tool to load and modify data in the database. Issues discussed include loading delimited data, updating existing rows and inserting new ones, unloading data, and calling SQLLDR from a stored procedure. Again, SQLLDR is a well-established and crucial tool, but it is the source of many questions with regard to its practical use.

## Source Code and Updates

The best way to digest the material in this book is to thoroughly work through and understand the hands-on examples. As you work through the examples in this book, you may decide that you prefer to type in all the code by hand. Many readers choose to do this because it is a good way to get familiar with the coding techniques that are being used.

Whether you want to type the code in or not, all the source code for this book is available in the Source Code section of the Apress web site ([www.apress.com](http://www.apress.com)). If you like to type in the code, you can use the source code files to check the results you should be getting—they should be your first stop if you think you might have typed an error. If you don't like typing, then downloading the source code from the Apress web site is a must! Either way, the code files will help you with updates and debugging.

## Errata

Apress makes every effort to make sure that there are no errors in the text or the code. However, to err is human, and as such we recognize the need to keep you informed of any mistakes as they're discovered and corrected. Errata sheets are available for all our books at [www.apress.com](http://www.apress.com). If you find an error that hasn't already been reported, please let us know. The Apress web site acts as a focus for other information and support, including the code from all Apress books, sample chapters, previews of forthcoming titles, and articles on related topics.



# Developing Successful Oracle Applications

I spend the bulk of my time working with Oracle database software and, more to the point, with people who use this software. Over the last 25 years or so, I've worked on many projects—successful ones as well as complete failures—and if I were to encapsulate my experiences into a few broad statements, here's what they would be:

- An application built around the database—dependent on the database—will succeed or fail based on how it uses the database. As a corollary to this, all applications are built around databases; I can't think of a single useful application that doesn't store data persistently somewhere.
- Applications come, applications go. The *data*, however, lives forever. It is not about building applications; it really is about the data underneath these applications.
- A development team needs at its heart a core of database-savvy coders who are responsible for ensuring the database logic is sound and the system is built to perform from day one. Tuning after the fact—tuning after deployment—means you did not build it that way.

These may seem like surprisingly obvious statements, but in my experience, too many people approach the database as if it were a black box—something that they don't need to know about. Maybe they have a SQL generator that will save them from the hardship of having to learn SQL. Maybe they figure they'll just use it like a flat file and do “keyed reads.” Whatever they assume, I can tell you that thinking along these lines is most certainly misguided; you simply can't get away with not understanding the database. This chapter will discuss *why* you need to know about the database, specifically why you need to understand:

- The database architecture, how it works, and what it looks like.
- What concurrency controls are, and what they mean to you.
- How to tune your application from day one.
- How some things are implemented in the database, which is not necessarily the same as how you think they should be implemented.
- What features your database already provides and why it is generally better to use a provided feature than to build your own.
- Why you might want more than a cursory knowledge of SQL.
- That the DBA and developer staff are on the same team, not enemy camps trying to outsmart each other at every turn.

Now this may seem like a long list of things to learn before you start, but consider this analogy for a second: if you were developing a highly scalable, enterprise application on a brand-new operating system (OS), what is the first thing you'd do? Hopefully you answered, "Find out how this new OS works, how things will run on it, and so on." If that wasn't your answer, you'd most likely fail.

Consider, for example, Windows vs. UNIX/Linux. If you are a long-time Windows programmer and were asked to develop a new application on the UNIX/Linux platform, you'd have to relearn a couple of things. Memory management is done differently. Building a server process is considerably different—under Windows, you would develop a single process, a single executable with many threads. Under UNIX/Linux, you wouldn't develop a single stand-alone executable; you'd have many processes working together. It is true that both Windows and UNIX/Linux are operating systems. They both provide many of the same services to developers—file management, memory management, process management, security, and so on. However, they are very different architecturally—much of what you learned in the Windows environment won't apply to UNIX/Linux (and vice versa, to be fair). You have to unlearn to be successful. The same is true of your database environment.

What is true of applications running natively on operating systems is true of applications that will run on a database: understanding that database is crucial to your success. If you don't understand what your particular database does or how it does it, your application will fail. If you assume that because your application ran fine on SQL Server, it will necessarily run fine on Oracle, again your application is likely to fail. And, to be fair, the opposite is true—a scalable, well-developed Oracle application will not necessarily run on SQL Server without major architectural changes. Just as Windows and UNIX/Linux are both operating systems but fundamentally different, Oracle and SQL Server (pretty much any database could be noted here) are both databases but fundamentally different.

## My Approach

Before we begin, I feel it is only fair that you understand my approach to development. I tend to take a database-centric approach to problems. If I can do it in the database, I will. There are a couple of reasons for this—the first and foremost being that I know that if I build functionality in the database, I can *deploy* it anywhere. I am not aware of a popular, commercially viable server operating system on which Oracle is not available—from Windows to dozens of UNIX/Linux systems—the same exact Oracle software and options are available. I frequently build and test solutions on my laptop, running Oracle 12c, Oracle 11g, or Oracle 10g under UNIX/Linux or Windows on a virtual machine. I can then deploy them on a variety of servers running the same database software but different operating systems. When I have to implement a feature outside of the database, I find it extremely hard to deploy that feature anywhere I want. One of the main features that makes the Java language appealing to many people—the fact that their programs are always compiled in the same virtual environment, the Java Virtual Machine (JVM), and so are highly portable—is the exact same feature that make the database appealing to me. The database is *my* virtual machine. It is *my* virtual operating system.

So I try to do everything I can in the database. If my requirements go beyond what the database environment can offer, I do it in Java outside of the database. In this way, almost every operating system intricacy will be hidden from me. I still have to understand how *my* "virtual machines" work (Oracle, and occasionally a JVM)—you need to know the tools you are using—but they, in turn, worry about how best to do things on a given OS for me.

Thus, simply knowing the intricacies of this one "virtual OS" allows you to build applications that will perform and scale well on many operating systems. I don't mean to imply that you can be totally ignorant of your underlying OS, just that as a software developer building database applications you can be fairly well insulated from it, and you will not have to deal with many of its nuances. Your DBA, responsible for running the Oracle software, will be infinitely more in tune with the OS (if he or she is not, please get a new DBA!). If you develop client-server software and the bulk of your code is outside of the database and outside of a VM (Java virtual machines being perhaps the most popular VM), of course you'll have to be concerned about your OS once again.

I have a pretty simple mantra when it comes to developing database software, one that has been consistent for many years:

- You should do it in a single SQL statement if at all possible. And believe it or not, it is almost always possible. This statement is even truer as time goes on. SQL is an extremely powerful language.
- If you can't do it in a single SQL Statement, do it in PL/SQL—as little PL/SQL as possible! Follow the saying that goes “more code = more bugs, less code = less bugs.”
- If you can't do it in PL/SQL, try a Java stored procedure. The times this is necessary are extremely rare nowadays with Oracle9i and above. PL/SQL is an extremely competent, fully featured 3GL.
- If you can't do it in Java, do it in a C external procedure. This is most frequently the approach when raw speed or using a third-party API written in C is needed.
- If you can't do it in a C external routine, you might want to seriously think about why it is you need to do it.

Throughout this book, you will see the preceding philosophy implemented. We'll use PL/SQL—and object types in PL/SQL—to do things that SQL itself can't do or can't do efficiently. PL/SQL has been around for a very long time—over 26 years of tuning (as of 2014) has gone into it; in fact, way back in Oracle10g, the PL/SQL compiler itself was rewritten to be an optimizing compiler for the first time. You'll find no other language so tightly coupled with SQL, nor any as optimized to interact with SQL. Working with SQL in PL/SQL is a very natural thing—whereas in virtually every other language from Visual Basic to Java, using SQL can feel cumbersome. It never quite feels “natural”—it's not an extension of the language itself. When PL/SQL runs out of steam—which is exceedingly rare today with current database releases—we'll use Java. Occasionally, we'll do something in C, but typically only when C is the only choice, or when the raw speed offered by C is required. Often, this last reason goes away with native compilation of Java—the ability to convert your Java bytecode into operating system-specific object code on your platform. This lets Java run just as fast as C in many cases.

## The Black Box Approach

I have an idea, borne out by first-hand personal experience (meaning I made the mistake myself), as to why database-backed software development efforts so frequently fail. Let me be clear that I'm including here those projects that may not be documented as failures, but nevertheless take much longer to roll out and deploy than originally planned because of the need to perform a major rewrite, re-architecture, or tuning effort. Personally, I call such delayed projects failures: more often than not they could have been completed on schedule (or even faster).

The single most common reason for failure is a lack of practical knowledge of the database—a basic lack of understanding of the fundamental tool that is being used. The black box approach involves a conscious decision to protect the developers from the database. They are actually encouraged not to learn anything about it! In many cases, they are prevented from exploiting it. The reasons for this approach appear to be FUD-related (Fear, Uncertainty, and Doubt). Developers have heard that databases are “hard,” that SQL, transactions, and data integrity are “hard.” The solution: don't make anyone do anything hard. They treat the database as a black box and have some software tool generate all of the code. They try to insulate themselves with many layers of protection so that they don't have to touch this “hard” database.

This is an approach to database development that I've never been able to understand, in part because, for me, learning Java and C was a lot harder than learning the concepts behind the database. I'm now pretty good at Java and C but it took a lot more hands-on experience for me to become competent using them than it did to become competent using the database. With the database, you need to be aware of how it works but you don't have to know everything inside and out. When programming in C or Java/J2EE, you do need to know everything inside and out—and these are *huge* languages.

If you are building a database application, *the most important piece of software is the database*. A successful development team will appreciate this and will want its people to know about it, to concentrate on it. Many times I've walked into a project where almost the opposite was true.

A typical scenario would be as follows:

- The developers were fully trained in the GUI tool or the language they were using to build the front end (such as Java). In many cases, they had had weeks if not months of training in it.
- The team had zero hours of Oracle training and zero hours of Oracle experience. Most had no database experience whatsoever. They would also have a mandate to be “database independent”—a mandate (edict from management or learned through theoretical academic instruction) they couldn't hope to follow for many reasons. The most obvious one is they didn't know enough about what databases are or what they do to even find the lowest common denominator among them.
- The developers encountered massive performance problems, data integrity problems, hanging issues, and the like (but very pretty screens).

As a result of the inevitable performance problems, I now get called in to help solve the difficulties (in the past, as a learning developer I was sometimes the cause of such issues). On one particular occasion, I couldn't fully remember the syntax of a new command we needed to use. I asked for the *SQL Reference* manual—and I was handed an Oracle 6.0 document. The development was taking place on version 7.3, five years after the release of version 6.0! It was all they had to work with, but this did not seem to concern them at all. Never mind the fact that the tool they really needed to know about for tracing and tuning didn't really exist in version 6. Never mind the fact that features such as triggers, stored procedures, and many hundreds of others had been added in the five years since that documentation was written. It was very easy to determine why they needed help—fixing their problems was another issue all together.

---

■ **Note** Even today, I often find that the developers of database applications have spent no time reading the documentation. On my web site, [asktom.oracle.com](http://asktom.oracle.com), I frequently get questions along the lines of “what is the syntax for...” coupled with “we don't have the documentation so please just tell us.” I refuse to directly answer many of those questions, but rather point them to the online documentation freely available to anyone, anywhere in the world. In the last 15 years, the excuses like “We don't have documentation,” or “We don't have access to resources,” have virtually disappeared. The expansion of the Web and sites like [otn.oracle.com](http://otn.oracle.com) (the Oracle Technology Network) makes it inexcusable to not have a full set of documentation at your fingertips! Today, everyone has access to all of the documentation; they just have to read it or—even easier—search it.

---

The very idea that developers building a *database application* should be shielded from the database is amazing to me, but that attitude persists. Many people still insist that developers can't take the time to get trained in the database and, basically, that they shouldn't have to know anything about the database. Why? Well, more than once I've heard “... but Oracle is the most scalable database in the world, my people don't have to learn about it, it'll just work.” That's true; Oracle is the most scalable database in the world. However, I can write bad code that does not scale in Oracle as easily—if not more easily—as I can write good, scalable code in Oracle. You can replace Oracle with any piece of software and the same is true. This is a fact: it is easier to write applications that perform poorly than it is to write applications that perform well. It is sometimes too easy to build a single-user system in the world's most scalable database if you don't know what you are doing. The database is a tool and the improper use of any tool can lead to disaster. Would you take a nutcracker and smash walnuts with it as if it were a hammer? You could, but it wouldn't be a proper use of that tool and the result would be a mess (and probably some seriously hurt fingers). Similar effects can be achieved by remaining ignorant of your database.

I was called into a project that was in trouble. The developers were experiencing massive performance issues—it seemed their system was serializing many transactions, that is to say—so instead of many people working concurrently, everyone was getting into a really long line and waiting for everyone in front of them to complete. The application architects walked me through the architecture of their system—the classic three-tier approach. They would have a web browser talk to a middle tier application server running Java Server Pages (JSPs). The JSPs would in turn utilize another layer—Enterprise Java Beans (EJBs)—that did all of the SQL. The SQL in the EJBs was generated by a third-party tool and was done in a database-independent fashion.

Now, in this system it was very hard to diagnose anything, as none of the code was instrumented or traceable. Instrumenting code is the fine art of making every other line of developed code be debug code of some sort—so when you are faced with performance or capacity or even logic issues, you can track down exactly where the problem is. In this case, we could only locate the problem somewhere between the browser and the database—in other words, the entire system was suspect. The Oracle database is heavily instrumented, but the application needs to be able to turn the instrumentation on and off at appropriate points—something it was not designed to do.

So, we were faced with trying to diagnose a performance issue with not too many details, just what we could glean from the database itself. Fortunately, in this case it was fairly easy. When someone who knew the Oracle V\$ tables (the V\$ tables are one way Oracle exposes its instrumentation, its statistics, to us) reviewed them, it became apparent that the major contention was around a single table—a queue table of sorts. The application would place records into this table while another set of processes would pull the records out of this table and process them. Digging deeper, we found a bitmap index on a column in this table (see the later chapter on indexing for more information about bitmapped indexes). The reasoning was that this column, the processed-flag column, had only two values—Y and N. As records were inserted, they would have a value of N for not processed. As the other processes read and processed the record, they would update the N to Y to indicate that processing was done. The developers needed to find the N records rapidly and hence knew they wanted to index that column. They had read somewhere that bitmap indexes are for low-cardinality columns—columns that have but a few distinct values—so it seemed a natural fit. (Go ahead, use Google to search for *when to use bitmap indexes*; low-cardinality will be there over and over. Fortunately, there are also many articles refuting that too simple concept today.)

But that bitmap index was the cause of all of their problems. In a bitmap index, a single key entry points to many rows, hundreds or more of them. If you update a bitmap index key (and thus locking it), the hundreds of records that key points to are effectively locked as well. So, someone inserting the new record with N would lock the N record in the bitmap index, effectively locking hundreds of other N records as well. Meanwhile, the process trying to read this table and process the records would be prevented from modifying some N record to be a Y (processed) record, because in order for it to update this column from N to Y, it would need to lock that same bitmap index key. In fact, other sessions just trying to insert a new record into this table would be blocked as well, as they would be attempting to lock the same bitmap key entry. In short, the developers had created a table that at most one person would be able to insert or update against at a time! We can see this easily using a simple scenario.

---

■ **Note** I will use autonomous transactions throughout this book to demonstrate locking, blocking, and concurrency issues. It is my firm belief that autonomous transactions are a feature that Oracle should not have exposed to developers—for the simple reason that most developers do not know when and how to use them properly. The improper use of an autonomous transaction can and will lead to logical data-integrity corruption issues. Beyond using them as a demonstration tool, autonomous transactions have exactly one other use—as an error-logging mechanism. If you wish to log an error in an exception block, you need to log that error into a table and commit it—without committing anything else. That would be a valid use of an autonomous transaction. If you find yourself using an autonomous transaction outside the scope of logging an error or demonstrating a concept, you are almost surely doing something very wrong.

---

Here, I will use an autonomous transaction in the database to have two concurrent transactions in a single session. An autonomous transaction starts a “subtransaction” separate and distinct from any already established transaction in the session. The autonomous transaction behaves as if it were in an entirely different session—for all intents and purposes, the parent transaction is suspended. The autonomous transaction can be blocked by the parent transaction (as we’ll see) and, further, the autonomous transaction can’t see uncommitted modifications made by the parent transaction. For example:

```
EODA@ORA12CR1> create table t
  2 ( processed_flag varchar2(1)
  3 );
Table created.

EODA@ORA12CR1> create bitmap index
  2 t_idx on t(processed_flag);
Index created.

EODA@ORA12CR1> insert into t values ( 'N' );
1 row created.

EODA@ORA12CR1> declare
  2 pragma autonomous_transaction;
  3 begin
  4 insert into t values ( 'N' );
  5 commit;
  6 end;
  7 /
declare
*
ERROR at line 1:
ORA-00060: deadlock detected while waiting for resource
ORA-06512: at line 4
```

---

■ **Tip** See the “Setting Up Your Environment” section at the beginning of this book for details on how to set your SQL prompt to display environment information such as user name and database name.

---

Since I used an autonomous transaction and created a subtransaction, I received a deadlock—meaning my second insert was blocked by my first insert. Had I used two separate sessions, no deadlock would have occurred. Instead, the second insert would have just blocked and waited for the first transaction to commit or roll back. This symptom is exactly what the project in question was facing—the blocking, serialization issue.

So we had an issue whereby not understanding the database feature (bitmap indexes) and how it worked doomed the database to poor scalability from the start. To further compound the problem, there was no reason for the queuing code to ever have been written. The database has built-in queuing capabilities and has had them since version 8.0 of Oracle—which was released in 1997. This built-in queuing feature gives you the ability to have many producers (the sessions that insert the N, the unprocessed records) concurrently put messages into an inbound queue and have many consumers (the sessions that look for N records to process) concurrently receive these messages. That is, no special code should have been written in order to implement a queue in the database. The developers should have used the built-in feature. And they might have, except they were completely unaware of it.



Fortunately, once this issue was discovered, correcting the problem was easy. We did need an index on the processed-flag column, just not a bitmap index. We needed a conventional B\*Tree index. It took a bit of convincing to get one created. No one wanted to believe that conventionally indexing a column with two distinct values was a good idea. But after setting up a simulation (I am very much into simulations, testing, and experimenting), we were able to prove it was not only the correct approach but also that it would work very nicely.

---

■ **Note** We create indexes, indexes of any type, typically to find a small number of rows in a large set of data. In this case, the number of rows we wanted to find via an index was *one*. We needed to find one unprocessed record. One is a very small number of rows, therefore an index is appropriate. An index of any type would be appropriate. The B\*Tree index was very useful in finding a single record out of a large set of records.

---

When we created the index, we had to choose between the following approaches:

- Just create an index on the processed-flag column.
- Create an index only on the processed-flag column when the processed flag is N, that is, only index the values of interest. We typically don't want to use an index when the processed flag is Y since the vast majority of the records in the table have the value Y. Notice that I did not say "We never want to use..." You might want to very frequently count the number of processed records for some reason, and then an index on the processed records might well come in very handy.

In the chapter on indexing, we'll go into more detail on both types. In the end, we created a very small index on just the records where the processed flag was N. Access to those records was extremely fast and the vast majority of Y records did not contribute to this index at all. We used a function-based index on a function `decode( processed_flag, 'N', 'N' )` to return either N or NULL—since an entirely NULL key is not placed into a conventional B\*Tree index, we ended up only indexing the N records.

---

■ **Note** There is more information on NULLS and indexing in Chapter 11.

---

Was that the end of the story? No, not at all. My client still had a less than optimal solution on its hands. They still had to serialize on the "dequeue" of an unprocessed record. We could easily find the first unprocessed record—quickly—using `select * from queue_table where decode( processed_flag, 'N', 'N' ) = 'N' FOR UPDATE`, but only one session at a time could perform that operation. The project was using Oracle 10g and therefore could not yet make use of the relatively new `SKIP LOCKED` feature added in Oracle 11g Release 1. `SKIP LOCKED` would permit many sessions to concurrently find the first unlocked, unprocessed record, lock that record, and process it. Instead, we had to implement code to find the first unlocked record and lock it manually. Such code would generally look like the following in Oracle 10g and before. We begin by creating a table with the requisite index described earlier and populate it with some data, as follows:

```
EODA@ORA12CR1> create table t
 2 ( id          number primary key,
 3   processed_flag varchar2(1),
 4   payload     varchar2(20)
 5 );
Table created.
```

```
EODA@ORA12CR1> create index
 2 t_idx on
 3 t( decode( processed_flag, 'N', 'N' ) );
Index created.
```

```
EODA@ORA12CR1> insert into t
 2 select r,
 3     case when mod(r,2) = 0 then 'N' else 'Y' end,
 4     'payload ' || r
 5 from (select level r
 6       from dual
 7       connect by level <= 5)
 8 /
5 rows created.
```

```
EODA@ORA12CR1> select * from t;
```

```

      ID P PAYLOAD
-----
      1 Y payload 1
      2 N payload 2
      3 Y payload 3
      4 N payload 4
      5 Y payload 5
```

Then we basically need to find any and all unprocessed records. One by one we ask the database “Is this row locked already? If not, then lock it and give it to me.” That code would look like this:

```
EODA@ORA12CR1> create or replace
 2 function get_first_unlocked_row
 3 return t%rowtype
 4 as
 5     resource_busy exception;
 6     pragma exception_init( resource_busy, -54 );
 7     l_rec t%rowtype;
 8 begin
 9     for x in ( select rowid rid
10               from t
11               where decode(processed_flag,'N','N') = 'N')
12     loop
13     begin
14         select * into l_rec
15         from t
16         where rowid = x.rid and processed_flag='N'
17         for update nowait;
18         return l_rec;
19     exception
20         when resource_busy then null;
21         when no_data_found then null;
22     end;
23 end loop;
```

```

23     return null;
24 end;
25 /
Function created.

```

---

■ **Note** In the preceding code, I ran some DDL—the CREATE OR REPLACE FUNCTION. Right before DDL runs, it automatically commits, so there was an implicit COMMIT in there. The rows we’ve inserted are committed in the database—and that fact is necessary for the following examples to work correctly. In general, I’ll use that fact in the remainder of the book. If you run these examples without performing the CREATE OR REPLACE, make sure to COMMIT first!

---

Now, if we use two different transactions, we can see that both get different records. We also see that both get different records concurrently (using autonomous transactions once again to demonstrate the concurrency issues):

```

EODA@ORA12CR1> declare
2     l_rec t%rowtype;
3 begin
4     l_rec := get_first_unlocked_row;
5     dbms_output.put_line( 'I got row ' || l_rec.id || ', ' || l_rec.payload );
6 end;
7 /
I got row 2, payload 2

```

PL/SQL procedure successfully completed.

```

EODA@ORA12CR1> declare
2     pragma autonomous_transaction;
3     l_rec t%rowtype;
4 begin
5     l_rec := get_first_unlocked_row;
6     dbms_output.put_line( 'I got row ' || l_rec.id || ', ' || l_rec.payload );
7     commit;
8 end;
9 /
I got row 4, payload 4

```

PL/SQL procedure successfully completed.

Now, in Oracle 11g Release 1 and above, we can achieve the preceding logic using the SKIP LOCKED clause. In the following example we’ll do two concurrent transactions again, observing that they each find and lock separate records concurrently.

```

EODA@ORA12CR1> declare
2     l_rec t%rowtype;
3     cursor c
4     is
5     select *
6     from t
7     where decode(processed_flag, 'N', 'N') = 'N'

```

```

8      FOR UPDATE
9      SKIP LOCKED;
10 begin
11     open c;
12     fetch c into l_rec;
13     if ( c%found )
14     then
15         dbms_output.put_line( 'I got row ' || l_rec.id || ', ' || l_rec.payload );
16     end if;
17     close c;
18 end;
19 /
I got row 2, payload 2

```

PL/SQL procedure successfully completed.

```

EODA@ORA12CR1> declare
2     pragma autonomous_transaction;
3     l_rec t%rowtype;
4     cursor c
5     is
6     select *
7     from t
8     where decode(processed_flag, 'N', 'N') = 'N'
9     FOR UPDATE
10    SKIP LOCKED;
11 begin
12     open c;
13     fetch c into l_rec;
14     if ( c%found )
15     then
16         dbms_output.put_line( 'I got row ' || l_rec.id || ', ' || l_rec.payload );
17     end if;
18     close c;
19     commit;
20 end;
21 /

```

I got row 4, payload 4

PL/SQL procedure successfully completed.

Both of the preceding “solutions” would help to solve the second serialization problem my client was having when processing messages. But how much easier would the solution have been if my client had just used Advanced Queuing and invoked `DBMS_AQ.DEQUEUE`? To fix the serialization issue for the message producer, we had to implement a function-based index. To fix the serialization issue for the consumer, we had to use that function-based index to retrieve the records and write code. So we fixed their major problem, caused by not fully understanding the tools they were using and found only after lots of looking and study since the system was not nicely instrumented. What we hadn’t fixed yet were the following issues:

- The application was built without a single consideration for scaling at the database level.
- The application was performing functionality (the queue table) that the database *already supplied in a highly concurrent and scalable fashion*. I’m referring to the Advance Queuing (AQ) software that is burned into the database, functionality they were trying to reinvent.

- Experience shows that 80 to 90 percent (or more!) of *all* tuning should be done at the application level (typically the interface code reading and writing to the database), not at the database level.
- The developers had no idea what the beans did in the database or where to look for potential problems.

This was hardly the end of the problems on this project. We also had to figure out the following:

- How to tune SQL without changing the SQL. In general, that is very hard to do. Oracle10g and above do permit us to accomplish this magic feat for the first time to some degree with SQL Profiles (this option requires a license for the Oracle Tuning Pack), and 11g and above with extended statistics, and 12c and above with adaptive query optimization. But inefficient SQL will remain inefficient SQL.
- How to measure performance.
- How to see where the bottlenecks were.
- How and what to index. And so on.

At the end of the week the developers, who had been insulated from the database, were amazed at what the database could actually provide for them and how easy it was to get that information. Most importantly, they saw how big of a difference taking advantage of database features could make to the performance of their application. In the end, they were successful—just behind schedule by a couple of weeks.

My point about the power of database features is not a criticism of tools or technologies like Hibernate, EJBs, and container-managed persistence. It is a criticism of purposely remaining ignorant of the database and how it works and how to use it. The technologies used in this case worked well—after the developers got some insight into the database itself.

The bottom line is that the database is typically the cornerstone of your application. If it does not work well, nothing else really matters. If you have a black box and it does not work, what are you going to do about it? About the only thing you can do is look at it and wonder why it is not working very well. You can't fix it, you can't tune it. Quite simply, you do not understand how it works—and you made the decision to be in this position. The alternative is the approach that I advocate: understand your database, know how it works, know what it can do for you, and use it to its fullest potential.

## How (and How Not) to Develop Database Applications

That's enough hypothesizing, for now at least. In the remainder of this chapter, I will take a more empirical approach, discussing why knowledge of the database and its workings will definitely go a long way toward a successful implementation (without having to write the application twice!). Some problems are simple to fix as long as you understand how to find them. Others require drastic rewrites. One of the goals of this book is to help you avoid the problems in the first place.

---

■ **Note** In the following sections, I discuss certain core Oracle features without delving into exactly what these features are and all of the ramifications of using them. I will refer you either to a subsequent chapter in this book or to the relevant Oracle documentation for more information.

---

## Understanding Oracle Architecture

I have worked with many customers running large production applications—applications that had been “ported” from another database (for example, SQL Server) to Oracle. I quote “ported” simply because most ports I see reflect a “what is the least change we can make to have our SQL Server code compile and execute on Oracle” perspective. The applications that result from that line of thought are frankly the ones I see most often, because they are the ones that need the most help. I want to make clear, however, that I am not bashing SQL Server in this respect—the opposite is true! Taking an Oracle application and just plopping it down on top of SQL Server with as few changes as possible results in the same poorly performing code in reverse; the problem goes both ways.

In one particular case, however, the SQL Server architecture and how you use SQL Server really impacted the Oracle implementation. The stated goal was to scale up, but these folks did not want to really port to another database. They wanted to port with as little work as humanly possible, so they kept the architecture basically the same in the client and database layers. This decision had two important ramifications:

- The connection architecture was the same in Oracle as it had been in SQL Server.
- The developers used literal (nonbound) SQL.

These two ramifications resulted in a system that could not support the required user load (the database server simply ran out of available memory), and in a system that had abysmal performance.

## Use a Single Connection in Oracle

Now, in SQL Server it is a very common practice to open a connection to the database for each concurrent statement you want to execute. If you are going to do five queries, you might well see five connections in SQL Server. In Oracle, on the other hand, if you want to do five queries or five hundred, the maximum number of connections you want to open is one. So, a practice that is common in SQL Server is something that is not only not encouraged in Oracle, it is actively discouraged; having multiple connections to the database is just something you don’t want to do.

But do it they did. A simple web-based application would open 5, 10, 15, or more connections per web page, meaning that their server could support only 1/5, 1/10, or 1/15 the number of concurrent users that it should have been able to. Moreover, they were attempting to run the database on the Windows platform itself—just a plain Windows server without access to the “data center” version of Windows. This meant that the Windows single-process architecture limited the Oracle database server to about 1.75GB of RAM in total. Since each Oracle connection took at least a certain fixed amount of RAM, their ability to scale up the number of users using the application was severely limited. They had 8GB of RAM on the server, but could only use about 2GB of it.

---

■ **Note** There are ways to use more RAM in a 32-bit Windows environment, such as with the /AWE switch, but they required versions of the operating system that were not in use in this situation.

---

There were three approaches to correcting this problem, and all three entailed quite a bit of work—and this was after the “port” was complete! The options were as follows:

- Re-architect the application to allow it to take advantage of the fact that it was running “on” Oracle, and use a single connection to generate a page, not somewhere between 5 and 15 connections. This is the only solution that would actually solve the problem.
- Upgrade the operating system (no small chore) and utilize the larger memory model of the Windows Data Center version (itself not a small chore either as it involves a rather complicated database setup with indirect data buffers and other nonstandard settings).

- Migrate the database from a Windows-based OS to some other OS where multiple processes are used, effectively allowing the database to utilize all installed RAM. On a 32-bit Windows platform, you are limited to about 2GB of RAM for the combined PGA/SGA regions (2GB for both, together) since they are allocated by a single process. Using a multiprocess platform that was also 32-bit would limit you to about 2GB for the SGA and 2GB per process for the PGA, going much further than the 32-bit Windows platform.

As you can see, none of these are “OK, we’ll do that this afternoon” sort of solutions. Each is a complex solution to a problem that could have most easily been corrected during the database port phase, while you were in the code poking around and changing things in the first place. Furthermore, a simple test to scale before rolling out to production would have caught such issues prior to the end users feeling the pain.

## Use Bind Variables

If I were to write a book about how to build *nonscalable* Oracle applications, “Don’t Use Bind Variables” would be the first and last chapter. Not using bind variables is a major cause of performance issues and a major inhibitor of scalability—not to mention a security risk of huge proportions. The way the Oracle shared pool (a very important shared-memory data structure) operates is predicated on developers using bind variables in most cases. If you want to make a transactional Oracle implementation run slowly, even grind to a total halt, just refuse to use them.

A bind variable is a placeholder in a query. For example, to retrieve the record for employee 123, I can query:

```
select * from emp where empno = 123;
```

Alternatively, I can query:

```
select * from emp where empno = :empno;
```

In a typical system, you would query up employee 123 maybe once or twice and then never again for a long period of time. Later, you would query up employee 456, then 789, and so on. Or, foregoing SELECT statements, if you do not use bind variables in your insert statements, your primary key values will be hard-coded in them, and I know for a fact that these insert statements can’t ever be reused later!!! If you use literals (constants) in the query, then every query is a brand-new query, never before seen by the database. It will have to be parsed, qualified (names resolved), security-checked, optimized, and so on. In short, each and every unique statement you execute will have to be compiled every time it is executed.

The second query uses a bind variable, `:empno`, the value of which is supplied at query execution time. This query is compiled once and then the query plan is stored in a shared pool (the library cache), from which it can be retrieved and reused. The difference between the two in terms of performance and scalability is huge, dramatic even.

From the preceding description, it should be fairly obvious that parsing unique statements with hard-coded variables (called a *hard* parse) will take longer and consume many more resources than reusing an already parsed query plan (called a *soft* parse). What may not be so obvious is the extent to which the former will reduce the number of users your system can support. Obviously, this is due in part to the increased resource consumption, but an even more significant factor arises due to the latching mechanisms for the library cache. When you hard-parse a query, the database will spend more time holding certain low-level serialization devices called *latches* (see the chapter *Locking and Latching* for more details). These latches protect the data structures in Oracle’s shared memory from concurrent modifications by two sessions (otherwise Oracle would end up with corrupt data structures) and from someone reading a data structure while it is being modified. The longer and more frequently you have to latch these data structures, the longer the queue to get these latches will become. You will start to monopolize scarce resources. Your machine may appear to be underutilized at times, and yet everything in the database is running very slowly. The likelihood is that someone is holding one of these serialization mechanisms and a line is forming—you are not able to run at top speed. It only takes one ill-behaved application in your database to dramatically affect the performance of every other application. A single, small application that does not use bind variables will cause the relevant SQL of other well-tuned applications to get discarded from the shared pool over time. You only need one bad apple to spoil the entire barrel.

---

■ **Note** To see the difference between hard parsing and soft parsing live and in action, I recommend you review the demonstration hosted at <http://tinyurl.com/RWP-OLTP-PARSING>. This was put together by a team I work with, the Real World Performance team at Oracle. It clearly shows the difference between soft parsing and hard parsing—it is close to an order of magnitude difference! We can get ten times as much work performed on a transactional system architected to use bind variables as not. This short visual presentation is something you can use to convince other developers about the impact of bind variables (or the lack thereof) on performance!

---

If you use bind variables, then everyone who submits the same exact query that references the same object will use the compiled plan from the pool. You will compile your subroutine once and use it over and over again. This is very efficient and is the way the database intends you to work. Not only will you use fewer resources (a soft parse is much less resource-intensive), but also you will hold latches for less time and need them less frequently. This increases your performance and greatly increases your scalability.

Just to give you a tiny idea of how huge a difference this can make performance-wise, you only need to run a very small test. In this test, we'll just be inserting some rows into a table; the simple table we will use is:

```
EODA@ORA12CR1> create table t ( x int );
Table created.
```

Now we'll create two very simple stored procedures. They both will insert the numbers 1 through 10,000 into this table; however, the first procedure uses a single SQL statement with a bind variable:

```
EODA@ORA12CR1> create or replace procedure proc1
 2 as
 3 begin
 4     for i in 1 .. 10000
 5     loop
 6         execute immediate
 7         'insert into t values ( :x )' using i;
 8     end loop;
 9 end;
10 /
Procedure created.
```

The second procedure constructs a unique SQL statement for each row to be inserted:

```
EODA@ORA12CR1> create or replace procedure proc2
 2 as
 3 begin
 4     for i in 1 .. 10000
 5     loop
 6         execute immediate
 7         'insert into t values ( '||i||' )';
 8     end loop;
 9 end;
10 /
Procedure created.
```



Now, the only difference between the two is that one uses a bind variable and the other does not. Both are using dynamic SQL and the logic is otherwise identical. The only difference is the use of a bind variable in the first. We are ready to evaluate the two approaches and we'll use *runstats*, a simple tool I've developed, to compare the two in detail:

```
EODA@ORA12CR1> exec runstats_pkg.rs_start
PL/SQL procedure successfully completed.
```

```
EODA@ORA12CR1> exec proc1
PL/SQL procedure successfully completed.
```

```
EODA@ORA12CR1> exec runstats_pkg.rs_middle
PL/SQL procedure successfully completed.
```

```
EODA@ORA12CR1> exec proc2
PL/SQL procedure successfully completed.
```

```
EODA@ORA12CR1> exec runstats_pkg.rs_stop(9500)
Run1 ran in 34 cpu hsecs
Run2 ran in 432 cpu hsecs
run 1 ran in 7.87% of the time
```

---

■ **Note** For details on *runstats* and other utilities, see the “Setting Up Your Environment” section at the beginning of this book. You may not observe exactly the same values for CPU or any metric. Differences are caused by different Oracle versions, different operating systems, or different hardware platforms. The idea will be the same, but the exact numbers will undoubtedly be marginally different.

---

Now, the preceding result clearly shows that based on CPU time, it took significantly longer and significantly more resources to insert 10,000 rows without bind variables than it did with them. In fact, it took more than a magnitude more CPU time to insert the rows without bind variables. For every insert without bind variables, we spent the vast preponderance of the time to execute the statement simply *parsing* the statement! But it gets worse. When we look at other information, we can see a significant difference in the resources utilized by each approach:

Name	Run1	Run2	Diff
STAT...Cursor + sql area evic	2	9,965	9,963
STAT...enqueue requests	35	10,012	9,977
STAT...enqueue releases	34	10,012	9,978
STAT...execute count	10,020	20,005	9,985
STAT...opened cursors cumulati	10,019	20,005	9,986
STAT...table scans (short tabl	3	10,000	9,997
STAT...sorts (memory)	3	10,000	9,997
STAT...parse count (hard)	2	10,000	9,998
LATCH.session allocation	5	10,007	10,002
LATCH.session idle bit	17	10,025	10,008
STAT...db block gets	10,447	30,376	19,929
STAT...db block gets from cach	10,447	30,376	19,929
STAT...db block gets from cach	79	20,037	19,958
LATCH.shared pool simulator	8	19,980	19,972
STAT...calls to get snapshot s	22	20,003	19,981

STAT...parse count (total)	18	20,005	19,987
LATCH.call allocation	4	20,016	20,012
LATCH.enqueue hash chains	70	20,211	20,141
STAT...consistent gets	266	40,093	39,827
STAT...consistent gets from ca	266	40,093	39,827
STAT...consistent gets pin (fa	219	40,067	39,848
STAT...consistent gets pin	219	40,067	39,848
STAT...calls to kcmgcs	117	40,085	39,968
STAT...session logical reads	10,713	70,469	59,756
STAT...recursive calls	10,058	70,005	59,947
STAT...KTFB alloc space (block	196,608	131,072	-65,536
LATCH.cache buffers chains	51,835	171,570	119,735
LATCH.row cache objects	206	240,686	240,480
LATCH.shared pool	20,090	289,899	269,809
STAT...session pga memory	65,536	-262,144	-327,680
STAT...logical read bytes from	87,760,896	577,282,048	489,521,152

Run1 latches total versus runs -- difference and pct

Run1	Run2	Diff	Pct
73,620	784,913	711,293	9.38%

PL/SQL procedure successfully completed.

The runstats utility produces a report that shows differences in latch utilization as well as differences in statistics. Here I asked runstats to print out anything with a difference greater than 9,500. You can see that we *hard parsed* two times in the first approach using bind variables, and that we hard parsed 10,000 times without bind variables (once for each of the inserts). But that difference in hard parsing is just the tip of the iceberg. You can see here that we used an order of magnitude as many “latches” in the nonbind variable approach as we did with bind variables. That difference might beg the question “What is a latch?”

Let’s answer that question. A latch is a type of lock that is used to serialize access to shared data structures used by Oracle. The shared pool is an example; it’s a big, shared data structure found in the System Global Area (SGA), and this is where Oracle stores parsed, compiled SQL. When you modify anything in this shared structure, you must take care to allow only one process in at a time. (It is very bad if two processes or threads attempt to update the same in-memory data structure simultaneously—corruption would abound). So, Oracle employs a *latching* mechanism, a lightweight locking method to serialize access. Don’t be fooled by the word lightweight. Latches are serialization devices, allowing access (to a memory structure) one process at a time. The latches used by the hard-parsing implementation are some of the most used latches out there. These include the latches for the shared pool and for the library cache. Those are “big time” latches that people compete for frequently. What all this means is that as we increase the number of users attempting to hard parse statements simultaneously, our performance gets progressively worse over time. The more people parsing, the more people waiting in line to latch the shared pool, the longer the queues, the longer the wait.

Executing SQL statements without bind variables is very much like compiling a subroutine before each method call. Imagine shipping Java source code to your customers where, before calling a method in a class, they had to invoke the Java compiler, compile the class, run the method, and then throw away the bytecode. Next time they wanted to execute the same method, they would do the same thing: compile it, run it, and throw it away. You would never consider doing this in your application; you should never consider doing this in your database either.

Another impact of not using bind variables, for developers employing string concatenation, is security—specifically something called *SQL injection*. If you are not familiar with this term, I encourage you to put aside this book for a moment and, using the search engine of your choice, look up SQL injection. There are over five million hits returned for it as I write this edition. The problem of SQL injection is well documented.

---

■ **Note** SQL injection is a security hole whereby the developer accepts input from an end user and concatenates that input into a query, then compiles and executes that query. In effect, the developer accepts snippets of SQL code from the end user, then compiles and executes those snippets. That approach allows the end user to potentially modify the SQL statement so that it does something the application developer never intended. It's almost like leaving a terminal open with a SQL Plus session logged in and connected with SYSDBA privileges. You are just begging someone to come by and type in some command, compile it, and then execute it. The results can be disastrous.

---

It is a fact that if you do not use bind variables, that if you use the string concatenation technique in PROC2 shown earlier, your code is subject to SQL injection attacks and must be carefully reviewed. And it should be reviewed by people who don't actually like the developer who wrote the code—because the code must be reviewed critically and objectively. If the reviewers are peers of the code author, or worse, friends or subordinates, the review will not be as critical as it should be. Developed code that does not use bind variables must be viewed with suspicion—it should be the exceptional case where bind variables are not used, not the norm.

To demonstrate how insidious SQL injection can be, I present this small routine:

```
EODA@ORA12CR1> create or replace procedure inj( p_date in date )
 2  as
 3      l_username  all_users.username%type;
 4      c           sys_refcursor;
 5      l_query     varchar2(4000);
 6  begin
 7      l_query := '
 8      select username
 9          from all_users
10         where created = '' ||p_date ||'''';
11
12      dbms_output.put_line( l_query );
13      open c for l_query;
14
15      for i in 1 .. 5
16      loop
17          fetch c into l_username;
18          exit when c%notfound;
19          dbms_output.put_line( l_username || '.....' );
20      end loop;
21      close c;
22  end;
23  /
```

Procedure created.

---

■ **Note** This code prints out only five records at most. It was developed to be executed in an “empty” schema. A schema with lots of existing tables could cause various effects that differ from the results shown next. One effect could be that you don’t see the table I’m trying to show you in the example—that would be because we print out only five records. Another might be a numeric or value error—that would be due to a long table name. None of these facts invalidate the example; they could all be worked around by someone wanting to steal your data.

---

Now, most developers I know would look at that code and say that it’s safe from SQL injection. They would say this because the input to the routine must be an Oracle DATE variable, a 7-byte binary format representing a century, year, month, day, hour, minute, and second. There is no way that DATE variable could change the meaning of my SQL statement. As it turns out, they are very wrong. This code can be “injected”—modified at runtime, easily—by anyone who knows how (and, obviously, there are people who know how!). If you execute the procedure the way the developer “expects” the procedure to be executed, this is what you might expect to see:

```
EODA@ORA12CR1> exec inj( sysdate )

      select *
      from all_users
      where created = '12-MAR-14'
```

PL/SQL procedure successfully completed.

This result shows the SQL statement being safely constructed—as expected. So, how could someone use this routine in a nefarious way? Well, suppose you’ve got another developer in this project—the evil developer. The developers have access to execute that procedure, to see the users created in the database today, but they don’t have access to any of the other tables in the schema that owns this procedure. Now, they don’t know what tables exist in this schema—the security team has decided “security via obscurity” is good—so they don’t allow anyone to publish the table names anywhere. So, they don’t know that the following table in particular exists:

```
EODA@ORA12CR1> create table user_pw
 2 ( uname varchar2(30) primary key,
 3   pw   varchar2(30)
 4 );
Table created.
```

```
EODA@ORA12CR1> insert into user_pw
 2 ( uname, pw )
 3 values ( 'TKYTE', 'TOP SECRET' );
1 row created.
```

```
EODA@ORA12CR1> commit;
Commit complete.
```

The prior `USER_PW` table looks like a pretty important table, but remember, users do not know it exists. However, they (users with minimal privileges) do have access to the `INJ` routine:

```
EODA@ORA12CR1> create user devacct identified by foobar;
User created.
```

```
EODA@ORA12CR1> grant create session to devacct;
Grant succeeded.
```

```
EODA@ORA12CR1> grant execute on inj to devacct;
Grant succeeded.
```

So the evil developer/user, can simply execute:

```
EODA@ORA12CR1> connect devacct/foobar;
Connected.
```

```
DEVACCT@ORA12CR1> alter session set
 2  nls_date_format = '''union select tname from tab--'';
Session altered.
```

```
DEVACCT@ORA12CR1> exec eoda.inj( sysdate )
```

```
      select username
      from all_users
      where created =
''union select tname from tab--'
USER_PW.....
```

PL/SQL procedure successfully completed.

In the prior code, the `select` statement executes this statement (which returns no rows):

```
select username from all_users where created =''
```

And unions that with:

```
select tname from tab
```

Take a look at the last `--` bit. In `SQL*Plus`, a double dash is a comment; so this is commenting out the last quote mark, which is necessary to make the statement syntactically correct.

Now, that `NLS_DATE_FORMAT` is interesting—most people don't even know you can include character string literals with the `NLS_DATE_FORMAT`. (Heck, many people don't even know you can change the date format like that even without this “trick.” Nor do they know that you can alter your session (to set the `NLS_DATE_FORMAT`) even without the `ALTER SESSION` privilege!) What the malicious user did here was to trick *your* code into querying a table you did not intend him to query *using your set of privileges*. The `TAB` dictionary view limits its view to the set of tables the current schema can see. When users run the procedure, the current schema used for authorization is the owner of that

procedure (you, in short, not them). They can now see what tables reside in that schema. They see that table `USER_PW` and say, “Hmmm, sounds interesting.” So, they try to access that table:

```
DEVACCT@ORA12CR1> select * from eoda.user_pw;
select * from eoda.user_pw
*
```

```
ERROR at line 1:
ORA-00942: table or view does not exist
```

The malicious user can’t access the table directly; he lacks the `SELECT` privilege on the table. Not to worry, however, there is another way. The user wants to know about the columns in the table. Here’s one way to find out more about the table’s structure:

```
DEVACCT@ORA12CR1> alter session set
 2 nls_date_format = ''''union select tname||'/'||cname from col--'';
Session altered.
```

```
DEVACCT@ORA12CR1> exec eoda.inj( sysdate )
```

```
select username
  from all_users
  where created =
''union select tname||'/'||cname from col--'
USER_PW/PW....
USER_PW/UNAME.....
```

PL/SQL procedure successfully completed.

There we go, we know the column names. Now that we know the table names and the column names of tables in that schema, we can change the `NLS_DATE_FORMAT` one more time to query that table—not the dictionary tables. So the malicious user can next do the following:

```
DEVACCT@ORA12CR1> alter session set
 2 nls_date_format = ''''union select uname||'/'||pw from user_pw--'';
Session altered.
```

```
DEVACCT@ORA12CR1> exec eoda.inj( sysdate )
```

```
select username
  from all_users
  where created =
''union select uname||'/'||pw from user_pw--'
TKYTE/TOP SECRET.....
```

PL/SQL procedure successfully completed.

And there we go—that evil developer/user now has your sensitive username and password information. Going one step further, what if this developer has the `CREATE PROCEDURE` privilege? It is a safe assumption that he would (he is a developer after all). Could he go further with this example? Absolutely. That innocent-looking stored procedure gives guaranteed read access to everything the `EODA` schema has read access to, at a minimum; and if

the account exploiting this bug has `CREATE PROCEDURE`, that stored procedure allows him to execute any command that EODA could execute! To see this, we'll grant `CREATE PROCEDURE` to the schema, as follows:

```
DEVACCT@ORA12CR1> connect eoda/foo
Connected.
```

```
EODA@ORA12CR1> grant create procedure to devacct;
Grant succeeded.
```

```
EODA@ORA12CR1> connect devacct/foobar;
Connected.
```

---

■ **Note** This example assumes that the user EODA has been granted the DBA role with the `ADMIN OPTION`.

---

And then as the developer, we'll create a function that grants DBA. There are two important facts about this function: it is an *invoker rights routine*, meaning that it will execute with the privileges granted to the person executing the routine, and it is a *pragma autonomous\_transaction routine*, meaning that it creates a subtransaction that will commit or rollback before the routine returns, therefore making it eligible to be called from SQL. Here is that function:

```
DEVACCT@ORA12CR1> create or replace function foo
 2  return varchar2
 3  authid CURRENT_USER
 4  as
 5      pragma autonomous_transaction;
 6  begin
 7      execute immediate 'grant dba to devacct';
 8      return null;
 9  end;
10  /
```

Function created.

Now all we have to do is “trick” EODA (a DBA that can grant DBA to others) into running this function. Given what we've done to exploit the SQL injection flaw, this is easy. We'll set our `NLS_DATE_FORMAT` to include a reference to this function and grant execute on it to EODA:

```
DEVACCT@ORA12CR1> alter session set
 2  nls_date_format = ''''union select devacct.foo from dual--''';
Session altered.
```

```
DEVACCT@ORA12CR1> grant execute on foo to eoda;
Grant succeeded.
```

And voilà! We have DBA:

```
DEVACCT@ORA12CR1> select * from session_roles;
no rows selected
```

```
DEVACCT@ORA12CR1> exec eoda.inj( sysdate )
```

```
      select username
      from all_users
      where created =
''union select devacct.foo from dual--'
.....
```

PL/SQL procedure successfully completed.

```
DEVACCT@ORA12CR1> connect devacct/foobar
Connected.
```

```
DEVACCT@ORA12CR1> select * from session_roles;
```

```
ROLE
```

```
-----
DBA
SELECT_CATALOG_ROLE
...
XS_RESOURCE
OLAP_DBA
```

24 rows selected.

---

■ **Tip** Query `ROLE_ROLE_PRIVS` to view which roles are granted to other roles.

---

So, how could you have protected yourself? By using bind variables. For example:

```
EODA@ORA12CR1> create or replace procedure NOT_inj( p_date in date )
2 as
3     l_username  all_users.username%type;
4     c           sys_refcursor;
5     l_query     varchar2(4000);
6 begin
7     l_query := '
8     select username
9     from all_users
10    where created = :x';
11
12    dbms_output.put_line( l_query );
13    open c for l_query USING P_DATE;
14
```



```

15     for i in 1 .. 5
16     loop
17         fetch c into l_username;
18         exit when c%notfound;
19         dbms_output.put_line( l_username || '.....' );
20     end loop;
21     close c;
22 end;
23 /

```

Procedure created.

```
EODA@ORA12CR1> exec NOT_inj(sysdate)
```

```

select username
from all_users
where created = :x

```

PL/SQL procedure successfully completed.

It is a plain and simple fact that if you use bind variables you can't be subject to SQL injection. If you do *not* use bind variables, you have to meticulously inspect every single line of code and think like an evil genius (one who knows *everything* about Oracle, every single thing) and see if there is a way to attack that code. I don't know about you, but if I could be sure that 99.9999 percent of my code was not subject to SQL injection, and I only had to worry about the remaining 0.0001 percent (that couldn't use a bind variable for whatever reason), I'd sleep much better at night than if I had to worry about 100 percent of my code being subject to SQL injection.

In any case, on the particular project I began describing at the beginning of this section, rewriting the existing code to use bind variables was the only possible course of action. The resulting code ran orders of magnitude faster and increased many times the number of simultaneous users that the system could support. And the code was more secure—the entire codebase did not need to be reviewed for SQL injection issues. However, that security came at a high price in terms of time and effort, because my client had to code the system and then *code it again*. It is not that using bind variables is hard, or error-prone, it's just that they did not use them initially and thus were forced to go back and revisit virtually *all* of the code and change it. My client would not have paid this price if the developers had understood that it was vital to use bind variables in their application from day one.

## Understanding Concurrency Control

Concurrency control is one area where databases differentiate themselves. It is an area that sets a database apart from a file system and databases apart from each other. As a programmer, it is vital that your database application works correctly under concurrent access conditions, and yet time and time again this is something people fail to test. Techniques that work well if everything happens consecutively do not necessarily work so well when everyone does them simultaneously. If you don't have a good grasp of how your particular database implements concurrency control mechanisms, then you will:

- Corrupt the integrity of your data.
- Have applications run slower than they should with a small number of users.
- Decrease your applications' ability to scale to a large number of users.

Notice I don't say, "you might..." or "you run the risk of..." but rather that invariably you *will* do these things. You will do these things without even realizing it. Without correct concurrency control, you will corrupt the integrity of your database because something that works in isolation will not work as you expect in a multiuser situation. Your application will run slower than it should because you'll end up waiting for data. Your application will lose its ability to scale because of locking and contention issues. As the queues to access a resource get longer, the wait gets longer and longer.

An analogy here would be a backup at a tollbooth. If cars arrive in an orderly, predictable fashion, one after the other, there won't ever be a backup. If many cars arrive simultaneously, queues start to form. Furthermore, the waiting time does not increase linearly with the number of cars at the booth. After a certain point, considerable additional time is spent "managing" the people who are waiting in line, as well as servicing them (the parallel in the database would be context switching).

Concurrency issues are the hardest to track down; the problem is similar to debugging a multithreaded program. The program may work fine in the controlled, artificial environment of the debugger but crashes horribly in the real world. For example, under race conditions, you find that two threads can end up modifying the same data structure simultaneously. These kinds of bugs are terribly hard to track down and fix. If you only test your application in isolation and then deploy it to dozens of concurrent users, you are likely to be (painfully) exposed to an undetected concurrency issue.

Over the next two sections, I'll relate two small examples of how the lack of understanding concurrency control can ruin your data or inhibit performance and scalability.

## Implementing Locking

The database uses *locks* to ensure that, at most, one transaction is modifying a given piece of data at any given time. Basically, locks are the mechanism that allows for concurrency—without some locking model to prevent concurrent updates to the same row, for example, multiuser access would not be possible in a database. However, if overused or used improperly, locks can actually inhibit concurrency. If you or the database itself locks data unnecessarily, fewer people will be able to concurrently perform operations. Thus, understanding what locking is and how it works in your database is vital if you are to develop a scalable, correct application.

What is also vital is that you understand that each database implements locking differently. Some have page-level locking, others row-level; some implementations escalate locks from row level to page level, some do not; some use read locks, others don't; some implement serializable transactions via locking and others via read-consistent views of data (no locks). These small differences can balloon into huge performance issues or downright bugs in your application if you don't understand how they work.

The following points sum up Oracle's locking policy:

- Oracle locks data at the row level on modification. There is no lock escalation to a block or table level.
- Oracle never locks data just to read it. There are no locks placed on rows of data by simple reads.
- A writer of data does not block a reader of data. Let me repeat: *reads* are not blocked by *writes*. This is fundamentally different from many other databases, where reads are blocked by writes. While this sounds like an extremely positive attribute (and it generally is), if you do not understand this thoroughly and you attempt to enforce integrity constraints in your application via application logic, *you are most likely doing it incorrectly*.
- A writer of data is blocked only when another writer of data has already locked the row it was going after. A reader of data never blocks a writer of data.

You must take these facts into consideration when developing your application and you must also realize that this policy is unique to Oracle; every database has subtle differences in its approach to locking. Even if you go with lowest common denominator SQL in your applications, the locking and concurrency control models employed by each vendor assure something will be different. A developer who does not understand how his or her database handles concurrency will certainly encounter data integrity issues. (This is particularly common when a developer moves from another database to Oracle, or vice versa, and neglects to take the differing concurrency mechanisms into account in the application.)

## Preventing Lost Updates

One of the side effects of Oracle's nonblocking approach is that if you actually want to ensure that no more than one user has access to a row at once, then you, the developer, need to do a little work yourself.

A developer was demonstrating to me a resource-scheduling program (for conference rooms, projectors, etc.) that he had just developed and was in the process of deploying. The application implemented a business rule to prevent the allocation of a resource to more than one person for any given period of time. That is, the application contained code that specifically checked that no other user had previously allocated the time slot (at least the developer thought it did). This code queried the SCHEDULES table and, if no rows existed that overlapped that time slot, inserted the new row. So, the developer was basically concerned with two tables:

```
EODA@ORA12CR1> create table resources
 2 ( resource_name varchar2(25) primary key,
 3   other_data    varchar2(25)
 4 );
```

Table created.

```
EODA@ORA12CR1> create table schedules
 2 ( resource_name varchar2(25) references resources,
 3   start_time    date,
 4   end_time      date
 5 );
```

Table created.

And, right after inserting a room reservation into SCHEDULES, and before committing, the application would query:

```
EODA@ORA12CR1> select count(*)
 2   from schedules
 3  where resource_name = :resource_name
 4     and (start_time < :new_end_time)
 5     AND (end_time > :new_start_time)
 6 /
```

It looked simple and bulletproof (to the developer anyway); if the count came back as one, the room was yours. If it came back greater than one, you could not reserve it for that period. Once I knew what his logic was, I set up a very simple test to show him the error that would occur when the application went live—an error that would be incredibly hard to track down and diagnose after the fact. You'd be convinced it *must* be a database bug.

All I did was get someone else to use the terminal next to him. Both navigated to the same screen and, on the count of three, each hit the Go button and tried to reserve the same room for an overlapping time. Both got the reservation. The logic, which worked perfectly in isolation, failed in a multiuser environment. The problem in this case was caused in part by Oracle’s nonblocking reads. Neither session ever blocked the other session. Both sessions simply ran the query and then performed the logic to schedule the room. They could both run the query to look for a reservation, even if the other session had already started to modify the SCHEDULES table (the change wouldn’t be visible to the other session until commit, by which time it was too late). Since it would appear to each user they were never attempting to modify the same row in the SCHEDULES table, they would never block each other and, thus, the business rule could not enforce what it was intended to enforce.

This surprised the developer—a developer who had written many database applications—because his background was in a database that employed read locks. That is, a reader of data would be blocked by a writer of data, and a writer of data would be blocked by a concurrent read of that data. In his world, one of those transactions would have blocked the other—or perhaps the application would have deadlocked. But the transaction would ultimately fail.

So, the developer needed a method of enforcing the business rule in a multiuser environment—a way to ensure that exactly one person at a time made a reservation on a given resource. In this case, the solution was to impose a little serialization of his own. In addition to performing the preceding count (\*), the developer first performed the following:

```
select * from resources where resource_name = :resource_name FOR UPDATE;
```

What he did here was to lock the resource (the room) to be scheduled immediately *before* scheduling it, in other words before querying the SCHEDULES table for that resource. By locking the resource he is trying to schedule, the developer ensures that no one else is modifying the schedule for this resource simultaneously. Everyone wanting to execute that SELECT FOR UPDATE for the same resource must wait until the transaction commits, at which point they are able to see the schedule. The chance of overlapping schedules is removed.

Developers must understand that, in a multiuser environment, they must at times employ techniques similar to those used in multithreaded programming. The FOR UPDATE clause is working like a semaphore in this case. It serializes access to the RESOURCES tables for that particular row—ensuring no two people can schedule it simultaneously.

Using the FOR UPDATE approach is still highly concurrent as there are potentially thousands of resources to be reserved. What we have done is ensure that only one person modifies a resource at any time. This is a rare case where the manual locking of data we are not going to actually update is called for. You need to be able to recognize where you must manually lock and, perhaps as importantly, when not to (I’ll get to an example of this in a bit). Furthermore, the FOR UPDATE clause does not lock the resource from other people reading the data as it might in other databases. Hence the approach will scale very well.

Issues such as the ones I’ve described in this section have massive implications when you’re attempting to port an application from database to database (I return to this theme a little later in the chapter), and this trips people up time and time again. For example, if you are experienced in other databases where writers block readers and vice versa, you may have grown reliant on that fact to protect you from data integrity issues. The *lack* of concurrency is one way to protect yourself from this. That’s how it works in many non-Oracle databases. In Oracle, concurrency rules supreme and you must be aware that, as a result, things will happen differently (or suffer the consequences).

I have been in design sessions where the developers, even after being shown this sort of example, scoffed at the idea they would have to actually understand how it all works. Their response was “We just check the “transactional” box in our Hibernate application and it takes care of all transactional things for us. We don’t have to know this stuff.” I said to them, “So Hibernate will generate different code for SQL Server and DB2 and Oracle, entirely different code, different amounts of SQL statements, different logic?” They said no, but it will be transactional. This misses the point. Transactional in this context simply means that you support commit and rollback, not that your code is transactionally consistent (read that as “not that your code is correct”). Regardless of the tool or framework you are using to access the database, knowledge of concurrency controls is vital if you want to not corrupt your data.

Ninety-nine percent of the time, locking is totally transparent and you need not concern yourself with it. It's that other one percent you must be trained to recognize. There is no simple checklist of "if you do this, you need to do this" for this issue. Successful concurrency control is a matter of understanding how your application will behave in a multiuser environment and how it will behave in your database.

When we get to the chapters on locking and concurrency control, we'll delve into this topic in much more depth. There you'll learn that integrity constraint enforcement of the type presented in this section, where you must enforce a rule that crosses multiple rows in a single table or is between two or more tables (like a referential integrity constraint), are cases where you must always pay special attention and will most likely have to resort to manual locking or some other technique to ensure integrity in a multiuser environment.

## Multiversioning

This is a topic very closely related to concurrency control as it forms the foundation for Oracle's concurrency control mechanism. Oracle operates a multiversion, read-consistent concurrency model. In Chapter 7, we'll cover the technical aspects in more detail but, essentially, it is the mechanism by which Oracle provides for:

- *Read-consistent queries*: Queries that produce consistent results with respect to a point in time.
- *Nonblocking queries*: Queries are never blocked by writers of data, as they are in other databases.

These are two very important concepts in the Oracle database. The term *multiversioning* basically describes Oracle's ability to simultaneously maintain multiple versions of the data in the database (since version 3.0 in 1983!). The term *read consistency* reflects the fact that a query in Oracle will return results from a consistent point in time. Every block used by a query will be "as of" the same exact point in time—even if it was modified or locked while you performed your query (this has been true since version 4.0 of Oracle in 1984!). If you understand how multiversioning and read consistency work together, you will always understand the answers you get from the database. Before we explore in a little more detail how Oracle does this, here is the simplest way I know to *demonstrate* multiversioning in Oracle:

```
EODA@ORA12CR1> create table t
  2  as
  3  select username, created
  4  from all_users
  5  /
Table created.
```

```
EODA@ORA12CR1> set autoprint off
EODA@ORA12CR1> variable x refcursor;
EODA@ORA12CR1> begin
  2  open :x for select * from t;
  3  end;
  4  /
PL/SQL procedure successfully completed.
```

```
EODA@ORA12CR1> declare
  2  pragma autonomous_transaction;
  3  -- you could do this in another
  4  -- sqlplus session as well, the
  5  -- effect would be identical
```

```

6  begin
7      delete from t;
8      commit;
9  end;
10 /

```

PL/SQL procedure successfully completed.

```
EODA@ORA12CR1> print x
```

USERNAME	CREATED
-----	-----
DEVACCT	02-SEP-13
OPS\$MELANIE	17-JUL-13
SCOTT	03-JUL-13
OPS\$TKYTE	02-SEP-13
APEX_040200	28-JUN-13
APEX_PUBLIC_USER	28-JUN-13
...	
AUDSYS	28-JUN-13
SYS	28-JUN-13

36 rows selected.

In this example, we created a test table, T, and loaded it with some data from the ALL\_USERS table. We opened a cursor on that table. We fetched *no data* from that cursor: we just opened it and have kept it open.

---

■ **Note** Bear in mind that Oracle does not “pre-answer” the query. It does not copy the data anywhere when you open a cursor—imagine how long it would take to open a cursor on a one-billion-row table if it did. The cursor opens instantly and it answers the query as it goes along. In other words, the cursor just reads data from the table as you fetch from it.

---

In the same session (or maybe another session would do this; it would work as well), we proceed to delete all data from the table. We even go as far as to COMMIT work on that delete action. The rows are gone—but are they? In fact, they are retrievable via the cursor (or via a FLASHBACK query using the AS OF clause). The fact is that the resultset returned to us by the OPEN command was preordained at the point in time we opened it. We had touched not a single block of data in that table during the open, but the answer was already fixed in stone. We have no way of knowing what the answer will be until we fetch the data; however, the result is immutable from our cursor’s perspective. It is not that Oracle copied all of the preceding data to some other location when we opened the cursor; it was actually the DELETE command that preserved our data for us by placing it (the before image copies of rows as they existed before the DELETE) into a data area called an *undo* or *rollback segment*.

## Flashback

In the past, Oracle always decided the point in time at which our queries would be consistent. That is, Oracle made it such that any resultset we opened would be current with respect to one of two points in time:

- *The point in time the query was opened.* This is the default behavior in READ COMMITTED isolation (we'll be covering the differences between READ COMMITTED, READ ONLY, and SERIALIZABLE transaction levels in Chapter 7).
- *The point in time the transaction that the query is part of began.* This is the default behavior in READ ONLY and SERIALIZABLE transaction levels.

Starting with Oracle 9i's *flashback query* feature, however, we can tell Oracle to execute a query "as of" (with certain reasonable limitations on the length of time you can go back into the past, of course). With this, you can "see" read consistency and multiversioning even more directly.

---

■ **Note** The flashback data archive, used for long-term flashback queries (months or years into the past) and available with Oracle 11g Release 1 and above, does not use read consistency and multiversioning to produce the version of data that was in the database at some prior point in time. Instead, it uses before-image copies of the records it has placed into the archive. We'll come back to the flashback data archive in a later chapter. Note also that the flashback data archive is a *feature* of the database, starting with 11.2.0.4 and above. Previously, it was a separately priced option to the database; now it is a feature for all to use without additional license cost.

---

Consider the following example. We start by getting an SCN (System Change or System Commit number; the terms are interchangeable). This SCN is Oracle's internal clock: every time a commit occurs, this clock ticks upward (increments). We could use a date or timestamp as well, but here the SCN is readily available and very precise:

```
SCOTT@ORA12CR1> variable scn number
SCOTT@ORA12CR1> exec :scn := dbms_flashback.get_system_change_number;
```

PL/SQL procedure successfully completed.

```
SCOTT@ORA12CR1> print scn
```

```
          SCN
-----
13646156
```

---

■ **Note** The DBMS\_FLASHBACK package might have restricted access on your system. I granted execute on this package to SCOTT in my database; you may have to do the same.

---

We got the SCN so we can tell Oracle the point in time we'd like to query "as of"; we could also use a date or timestamp in place of an SCN. We want to be able to query Oracle later and see what was in this table at this precise moment in time. First, let's see what is in the EMP table right now:

```
SCOTT@ORA12CR1> select count(*) from emp;
```

```

COUNT(*)
-----
      14

```

Now let's delete all of this information and verify that it's "gone":

```
SCOTT@ORA12CR1> delete from emp;
14 rows deleted.
```

```
SCOTT@ORA12CR1> select count(*) from emp;
```

```

COUNT(*)
-----
         0

```

```
SCOTT@ORA12CR1> commit;
Commit complete.
```

However, using the flashback query, with either the AS OF SCN or AS OF TIMESTAMP clause, we can ask Oracle to reveal to us what was in the table as of that point in time:

```
SCOTT@ORA12CR1> select count(*),
2         :scn then_scn,
3         dbms_flashback.get_system_change_number now_scn
4   from emp as of scn :scn;
```

```

COUNT(*)  THEN_SCN    NOW_SCN
-----  -
      14    13646156    13646157

```

Finally, if you are using Oracle10g and above, you have a command called "flashback" that uses this underlying multiversioning technology to allow you to return objects to the state they were at some prior point in time. In this case, we can put EMP back the way it was before we deleted all of the information (as part of doing this, we'll need to enable row movement, which allows the rowid assigned to the row to change—a necessary prerequisite for flashing back a table):

```
SCOTT@ORA12CR1> alter table emp enable row movement;
Table altered.
```

```
SCOTT@ORA12CR1> flashback table emp to scn :scn;
Flashback complete.
```



```

SCOTT@ORA12CR1> select cnt_now, cnt_then,
2      :scn then_scn,
3      dbms_flashback.get_system_change_number now_scn
4  from (select count(*) cnt_now from emp),
5      (select count(*) cnt_then from emp as of scn :scn)
6  /

```

```

CNT_NOW  CNT_THEN  THEN_SCN  NOW_SCN
-----
      14      14  13646156  13646786

```

This is what read consistency and multiversioning are all about. If you don't understand how Oracle's multiversioning scheme works and what it implies, you won't be able to take full advantage of Oracle or write correct applications in Oracle (ones that will ensure data integrity).

---

■ **Note** Flashback table requires the Enterprise Edition of Oracle.

---

## Read Consistency and Nonblocking Reads

Let's look at the implications of multiversioning: read-consistent queries and nonblocking reads. If you are not familiar with multiversioning, what you see in the following code might be surprising. For the sake of simplicity, assume the table we are reading stores one row per database block (the smallest unit of storage in the database), and that we are full-scanning the table in this example.

The table we will query is a simple ACCOUNTS table. It holds balances in accounts for a bank. It has a very simple structure:

```

create table accounts
( account_number number primary key,
  account_balance number
);

```

In reality the ACCOUNTS table would have hundreds of thousands of rows in it, but for simplicity we're just going to consider a table with four rows, as shown in Table 1-1. (We will visit this example in more detail in Chapter 7.)

**Table 1-1.** Accounts Table Contents

Row	Account Number	Account Balance
1	123	\$500.00
2	234	\$250.00
3	345	\$400.00
4	456	\$100.00

We would like to run an end-of-day report that tells us how much money is in the bank. That’s an extremely simple query:

```
select sum(account_balance) from accounts;
```

And, of course, in this example the answer is obvious: \$1250. However, what happens if we read row 1, and while we’re reading rows 2 and 3, an automated teller machine (ATM) generates transactions against this table and moves \$400 from account 123 to account 456? Our query counts \$500 in row 4 and comes up with the answer of \$1650, doesn’t it? Well, of course, this is to be avoided, as it would be an error—at no time did this sum of money exist in the account balance column. Read consistency is the way Oracle avoids such occurrences. Oracle’s methods differ from those of most other databases, and you need to understand how.

In many other databases, if you wanted to get a “consistent” and “correct” answer to this query, you’d either have to lock the whole table while the sum was calculated *or* you’d have to lock the rows as you read them. This prevents people from changing the answer as you are getting it. If you lock the table up front, you get the answer that was in the database at the time the query began. If you lock the data as you read it (commonly referred to as a *shared read lock*, which prevents updates, but not other readers from accessing the data), you get the answer that was in the database at the point the query finished. Both of these methods inhibit concurrency a great deal. The table lock prevents any updates from taking place against the entire table for the duration of your query (for a table of four rows, this would only be a very short period, but for tables with hundreds of thousands of rows, it could be several minutes). The “lock as you go” method prevents updates on data you have read and already processed and could actually cause deadlocks between your query and other updates.

Now, I said earlier that you wouldn’t be able to take full advantage of Oracle if you didn’t understand the concept of multiversioning. Here is one reason why that is true. Oracle uses multiversioning to get the answer, as it existed at the point in time the query began, and the query will take place *without locking a single thing* (while our account transfer transaction updates rows 1 and 4, these rows will be locked to other writers, but not locked to other readers, such as our `SELECT SUM. . .` query). In fact, Oracle doesn’t have a “shared read” lock (a type of lock common in other databases)—it doesn’t need it. Everything inhibiting concurrency that can be removed has been removed.

I have seen actual cases where a report written by a developer who did not understand Oracle’s multiversioning capabilities would lock an entire system up as tight as could be. The reason: the developer wanted to have read-consistent (i.e., correct) results from his queries. In every other database the developer had worked with, this required locking the tables, or using a `SELECT . . . WITH HOLDLOCK` (a SQL Server mechanism for locking rows in a shared mode as you go along). So the developer would either lock the tables prior to running the report or use `SELECT . . . . FOR UPDATE` (the closest he could find to `WITH HOLDLOCK`). This would cause the system to basically stop processing transactions—needlessly.

So, how does Oracle get the correct, consistent answer (\$1250) during a read without locking any data—in other words, without decreasing concurrency? The secret lies in the transactional mechanisms that Oracle uses. Whenever you modify data, Oracle creates entries in two different locations (most other databases would put both entries in the same location; for them undo and redo are just “transaction data”). One entry goes to the redo logs where Oracle stores enough information to *redo* or “roll forward” the transaction. For an insert, this would be the row inserted. For a delete, it is conceptually a message to delete the row in file X, block Y, row slot Z. And so on. The other entry is an *undo* entry, written to an undo segment. If your transaction fails and needs to be undone, Oracle will read the “before” image from the undo segment and restore the data. In addition to using this undo segment data to undo transactions, Oracle uses it to undo changes to blocks as it is reading them—to restore the block to the point in time your query began. This gives you the ability to read right through a lock and to get consistent, correct answers without locking any data yourself.

So, as far as our example is concerned, Oracle arrives at its answer as shown in Table 1-2.

**Table 1-2.** *Multiversioning in Action*

Time	Query	Account Transfer Transaction
T1	Reads row 1; balance = \$500; sum = \$500 so far.	
T2		Updates row 1; puts an exclusive lock on row 1, preventing other updates (but not reads). Row 1 now has \$100.
T3	Reads row 2; balance = \$250; sum = \$750 so far.	
T4	Reads row 3 balance = \$400; sum = \$1150 so far.	
T5		Updates row 4; puts an exclusive lock on row 4, preventing other updates (but not reads). Row 4 now has \$500.
T6	Reads row 4; discovers that row 4 has been modified. It will actually roll back the block to make it appear as it did at time = T1. The query will read the value \$100 from this block.	
T7		Commits transaction.
T8	Presents \$1250 as the answer.	

At time T6, Oracle is effectively “reading through” the lock that our transaction placed on row 4. This is how nonblocking reads are implemented: Oracle only looks to see if the data changed; it doesn’t care if the data is currently locked (which implies that the data may have changed). Oracle simply retrieves the old value from the undo segment and proceeds to the next block of data.

This is another clear demonstration of multiversioning. Multiple versions of the same piece of information, all at different points in time, are available in the database. Oracle is able to use these snapshots of data at different points in time to provide us with read-consistent queries and nonblocking reads.

This read-consistent view of data is always performed at the SQL statement level. The results of any single SQL statement are consistent with respect to the point in time they began. This quality is what makes a statement like the following insert a predictable set of data:

```
for x in (select * from t)
loop
  insert into t values (x.username, x.user_id, x.created);
end loop;
```

The result of the `SELECT * FROM T` is preordained when the query begins execution. The `SELECT` will not see any of the new data generated by the `INSERT`. Imagine if it did—this statement might be a never-ending loop. If, as the `INSERT` generated more rows in `T`, the `SELECT` could “see” those newly inserted rows, the preceding code would create some unknown number of rows. If the table `T` started out with 10 rows, we might end up with 20, 21, 23, or an infinite number of rows in `T` when we finished. It would be totally unpredictable. This consistent read is provided to all statements so that an `INSERT` such as the following is predictable as well:

```
insert into t select * from t;
```

The INSERT statement will be provided a read-consistent view of T. It will not see the rows that it just inserted; rather, it will only insert the rows that existed at the time the SELECT began. Some databases won't even permit recursive statements such as the preceding because they can't tell how many rows might actually be inserted.

So, if you are used to the way other databases work with respect to query consistency and concurrency, or you never had to grapple with such concepts (i.e., you have no real database experience), you can now see how understanding how this works will be important to you. In order to maximize Oracle's potential, and to implement correct code, you *need* to understand these issues as they pertain to Oracle—not how they are implemented in other databases.

## Database Independence?

By now, you might be able to see where I'm going in this section. I have made references to other databases and how features are implemented differently in each. With the exception of some read-only applications, it is my contention that building a wholly database-independent application that is highly scalable is extremely hard—it is, in fact, quite impossible unless you know exactly how each database works in great detail. And, if you knew how each database worked in great detail, you'd understand that database independence is not something you really want to achieve (a very circular argument!).

To illustrate, let's revisit our initial resource scheduler example (prior to adding the FOR UPDATE clause). Let's say this application had been developed on a database with an entirely different locking/concurrency model from that of Oracle. What I'll show here is that if you migrate your application from one database to another, you'll have to verify that it still works correctly in these different environments and substantially change it as you do!

Let's assume that we had deployed the initial resource scheduler application in a database that employed blocking reads (reads are blocked by writes). Also consider that the business rule was implemented via a database trigger (*after* the INSERT had occurred but before the transaction committed, we would verify that only our row existed in the table for that time slot). In a blocking read system, due to this newly inserted data, it would be true that insertions into this table would serialize. The first person would insert her request for “room A” from 2:00 p.m. to 3:00 p.m. on Friday and then run a query looking for overlaps. The next person would try to insert an overlapping request and, upon looking for overlaps, would become blocked (waiting for the newly inserted data to become available for reading). In that blocking read database, our application would be apparently well behaved, though it could just as easily *deadlock* (a concept covered in the chapter on locking) if we both inserted our rows and then attempted to read each other's data. Our checks on overlapping resource allocations would have happened one after the other, never concurrently.

If we migrated this application to Oracle and simply assumed it would behave in the same way, we would be in for a shock. On Oracle, which does row-level locking and supplies nonblocking reads, it appears to be ill behaved. As we saw previously, we had to use the FOR UPDATE clause to serialize access. Without this clause, two users could schedule the same resource for the same times. This is a direct consequence of not understanding how the database we have works in a multiuser environment.

I have encountered issues such as this many times when an application is being moved from database A to database B. When an application that worked flawlessly in database A does not work or works in an apparently bizarre fashion on database B, the first thought is that database B is a “bad database.” The simple truth is that database B just works *differently*. Neither database is wrong or bad; they are just different. Knowing and understanding how they work will help you immensely in dealing with these issues. Taking an application from Oracle to SQL Server exposes SQL Server's blocking reads and deadlock issues—it goes both ways.

For example, I was asked to help convert some Transact SQL (the stored procedure language for SQL Server) into PL/SQL. The developer doing the conversion was complaining that the SQL queries in Oracle returned the “wrong” answer. The queries looked like this:

```

declare
  l_some_variable  varchar2(25);
begin
  if ( some_condition )
  then
    l_some_variable := f( ... );
  end if;

  for x in ( select * from T where x = l_some_variable )
  loop
    ...

```

The goal here was to find all of the rows in T where x was NULL if some condition was not met or where x equaled a specific value if some condition was met.

The complaint was that, in Oracle, this query would return no data when L\_SOME\_VARIABLE was not set to a specific value (when it was left as NULL). In Sybase or SQL Server, this was not the case—the query would find the rows where x was set to a NULL value. I see this on almost every conversion from Sybase or SQL Server to Oracle. SQL is supposed to operate under tri-valued logic and Oracle implements NULL comparisons the way ANSI SQL requires them to be implemented (where NULL signifies a state of unknown and not a value). Under those rules, comparing x to a NULL is neither true nor false—it is, in fact, *unknown*. The following snippet shows what I mean:

```

EODA@ORA12CR1> select * from dual where null=null;
no rows selected

```

```

EODA@ORA12CR1> select * from dual where null <> null;
no rows selected

```

```

EODA@ORA12CR1> select * from dual where null is null;

```

```

D
-
X

```

This can be confusing the first time you see it. It proves that, in Oracle, NULL is neither equal to nor not equal to NULL. SQL Server, by default, does not do it that way: in SQL Server and Sybase, NULL is equal to NULL (by default; in current releases of SQL Server, the default behavior may be modified to reflect the ANSI standard). None of the databases' processing is *wrong*—it is just *different*. And all of the databases are, in fact, ANSI compliant (ANSI compliance does not mean you support 100% of the standard, not by a long shot, see the next section “Impact of Standards” for details), but they still work differently. There are ambiguities, backward compatibility issues, and so on, to be overcome. For example, SQL Server supports the ANSI method of NULL comparison, just not by default (if it did, it would break thousands of existing legacy applications built on that database).

In this case, one solution to the problem is to write the query like this instead:

```

select *
  from t
 where ( x = l_some_variable OR (x is null and l_some_variable is NULL ) )

```

However, this leads to another problem. In SQL Server, this query would use an index on x. This might not be the case in Oracle since a B\*Tree index (more on indexing techniques in the chapter on indexes) will not index an entirely NULL entry. Hence, if you need to find NULL values, B\*Tree indexes are not always useful.

---

■ **Note** As long as at least one column of an Oracle B\*Tree index is defined as NOT NULL, all rows in the table will, in fact, appear in the index and the predicate where x is null can and will use an index to retrieve the rows.

---

What we did in this case, in order to minimize impact on the code, was to assign x some value that it could never in reality assume. Here, x, by definition, was a positive number, so we chose the number -1. Thus, the query became:

```
select * from t where nvl(x,-1) = nvl(l_some_variable,-1)
```

And we created a function-based index:

```
create index t_idx on t( nvl(x,-1) );
```

With minimal change, we achieved the same end result. The following are the important points to recognize from this example:

- Databases are different. Experience with one will, in part, carry over to another but you must be ready for some *fundamental* differences as well as some very minor differences.
- Minor differences (such as treatment of NULLs) can have as big an impact as fundamental differences (such as concurrency control mechanisms).
- Being aware of the database, how it works, and how its features are implemented is the only way to overcome these issues.

Developers frequently ask me (usually more than once a day) how to do something specific in the database, such as, “How do I create a temporary table in a stored procedure?” I don’t answer such questions directly. Instead, I respond with a question: “*Why* do you want to do that?” Many times, the answer that comes back is: “In SQL Server we created temporary tables in our stored procedures and we need to do this in Oracle.” That’s what I expected to hear. My response, then, is easy: “You don’t want to create temporary tables in a stored procedure in Oracle—you only think you do.” That would, in fact, be a very bad thing to do in Oracle. If you created the tables in a stored procedure in Oracle you would find that:

- Doing DDL is a scalability inhibitor.
- Doing DDL constantly is not fast.
- Doing DDL commits your transaction.
- You would have to use Dynamic SQL in all of your stored procedures in order to access this table—no static SQL (because the table wouldn’t exist at compile time).
- Dynamic SQL in PL/SQL is not as fast or as optimized as static SQL.

The bottom line is that you don’t want to do it exactly as you did it in SQL Server (if you even need the temporary table in Oracle at all). You want to do things as they are best done in Oracle. Just as if you were going the other way from Oracle to SQL Server, you would not want to create a single table for all users to share for temporary data (that is how Oracle does it). That would limit scalability and concurrency in those other databases. All databases are not created equal; they are all very different.

This is not to say that you can’t use temporary tables in Oracle. You can, you probably will. It is just that you will *use them differently in Oracle than you did in SQL Server* (and vice versa).

## The Impact of Standards

If all databases are SQL99-compliant, then they must be the same. At least that's often the assumption. In this section, I'd like to dispel that myth.

SQL99 is an ANSI/ISO standard for databases. It was the successor to the SQL92 ANSI/ISO standard, which in turn superseded the SQL89 ANSI/ISO standard. It has now been superseded itself by the SQL2003, SQL2008, and SQL2011 standards updates. The standard defines a language (SQL) and behavior (transactions, isolation levels, and so on) that tell you how a database will behave. Did you know that many commercially available databases are SQL99-compliant to at least some degree? Did you also know that it means very little as far as query and application portability goes?

Starting with the SQL92 standard, the standards have four levels:

- *Entry-level*: This is the level to which most vendors have complied. It is a minor enhancement of the predecessor standard, SQL89. *No database vendors have been certified higher* and, in fact, the National Institute of Standards and Technology (NIST), the agency that used to certify for SQL-compliance, does not even certify anymore. I was part of the team that got Oracle 7.0 NIST-certified for SQL92 entry-level compliance in 1993. An entry level-compliant database has a feature set that is a subset of Oracle 7.0's capabilities.
- *Transitional*: This level is approximately halfway between entry level and intermediate level as far as a feature set goes.
- *Intermediate*: This level adds many features including (this is not by any means an exhaustive list)
  - Dynamic SQL
  - Cascade DELETE for referential integrity
  - DATE and TIME data types
  - Domains
  - Variable length character strings
  - A CASE expression
  - CAST functions between data types
- *Full*: Adds provisions for (again, this list is not exhaustive)
  - Connection management
  - A BIT string data type
  - Deferrable integrity constraints
  - Derived tables in the FROM clause
  - Subqueries in CHECK constraint clauses
  - Temporary tables

The entry-level standard does not include features such as outer joins, the new inner join syntax, and so on. Transitional does specify outer join syntax and inner join syntax. Intermediate adds more, and Full is, of course all of SQL92. Most books on SQL92 do not differentiate between the various levels, which leads to confusion on the subject. They demonstrate what a theoretical database implementing SQL92 full would look like. It makes it impossible to pick up a SQL92 book, and apply what you see in the book to just any SQL92 database. The bottom line is that SQL92 will not go very far at the entry level and, if you use any of the features of intermediate or higher, you risk not being able to port your application.

SQL99 defines only two levels of conformance: Core and Enhanced. It attempted to go far beyond traditional SQL and introduced object relational constructs (arrays, collections, etc.). It covered a SQL MM (multimedia) type, object-relational types, and so on. No vendors are certifying databases to be SQL99 Core or Enhanced “compliant” and, in fact, I know of no vendor who is even claiming his product is fully compliant with either level of conformance.

You should not be afraid to make use of vendor-specific features—after all, you are paying a lot of money for them. Every database has its own bag of tricks, and you can always find a way to perform a given operation in each database. Use what is best for your current database, and reimplement components as you go to other databases. Use good programming techniques to isolate yourself from these changes. The same techniques are employed by people writing OS-portable applications—such as the Oracle kernel developers.

## Make Sure You Can Adapt

The goal is to fully use the facilities available to you, but ensure you can change the implementation on a case-by-case basis. As an analogy, Oracle is a portable application. It runs on many operating systems. On Windows, however, it runs the Windows way: using threads and other Windows-specific facilities. On UNIX/Linux, in contrast, Oracle runs as a multiprocess server, using individual processes to do what threads do on Windows—that’s the UNIX/Linux way. The “core Oracle” functionality is available on both platforms but it is implemented in very different ways under the covers. Your database applications that must function on multiple databases will be the same.

For example, a common function of many database applications is the generation of a unique key for each row. When you insert the row, the system should automatically generate a key for you. Oracle has implemented the database object called a SEQUENCE for this, SYS\_GUID() is another function that provides for unique keys as well. Informix has a SERIAL data type. Sybase and SQL Server have an IDENTITY type. Each database has a way to do this. However, the methods are different, both in how you do it, and the possible outcomes. So, to the knowledgeable developer, there are two paths that can be pursued:

- Develop a totally database-independent method of generating a unique key.
- Accommodate the different implementations and use different techniques when implementing keys in each database.

---

■ **Note** Oracle now also has an IDENTITY type, as of Oracle 12c. Under the covers it creates a sequence and defaults your column to that value—making it work very much like the SQL Server IDENTITY type.

---

The theoretical advantage of the first approach is that to move from database to database you need not change anything. I call it a “theoretical” advantage because the downside of this implementation is so huge that it makes this solution totally infeasible. What you’d have to do to develop a totally database-independent process is to create a table such as this:

```
EODA@ORA12CR1> create table id_table
  2 ( id_name varchar2(30) primary key,
  3   id_value number );
Table created.
```

```
EODA@ORA12CR1> insert into id_table values ( 'MY_KEY', 0 );
1 row created.
```

```
EODA@ORA12CR1> commit;
Commit complete.
```



Then, in order to get a new key, you'd have to execute the following code:

```
EODA@ORA12CR1> update id_table
 2   set id_value = id_value+1
 3   where id_name = 'MY_KEY';
1 row updated.
```

```
EODA@ORA12CR1> select id_value
 2   from id_table
 3   where id_name = 'MY_KEY';
```

```
ID_VALUE
-----
      1
```

Looks simple enough, but the outcomes (notice plural) are as follows:

- Only one user at a time may process a transaction row. You need to update that row to increment a counter, and this will cause your program to serialize on that operation. At best, one person at a time will generate a new value for this key.
- In Oracle (and the behavior might be different in other databases), all but the first user to attempt to concurrently perform this operation would receive the error “ORA-08177: can't serialize access for this transaction” in the SERIALIZABLE isolation level.

For example, using a serializable transaction (which is more common in the J2EE environment, where many tools automatically use this as the default mode of isolation, often unbeknownst to the developers), you would observe the following behavior. Notice that the SQL prompt contains information about which session is active in this example:

```
ops$tkyte session(419,269)> set transaction isolation level serializable;
Transaction set.
```

```
ops$tkyte session(419,269)> update id_table
 2   set id_value = id_value+1
 3   where id_name = 'MY_KEY';
1 row updated.
```

```
ops$tkyte session(419,269)> select id_value
 2   from id_table
 3   where id_name = 'MY_KEY';
```

```
ID_VALUE
-----
      7
```

Now, we'll go to another SQL\*Plus session and perform the same operation, a concurrent request for a unique id:

```
ops$tkyte session(6,479)> set transaction isolation level serializable;
Transaction set.
```

```
ops$tkyte session(6,479)> update id_table
 2   set id_value = id_value+1
 3   where id_name = 'MY_KEY';
```

This will block at this point, as only one transaction at a time can update the row. This demonstrates the first possible outcome—we would block and wait for the row. But since we’re using SERIALIZABLE in Oracle, we’ll observe the following behavior as we commit the first session’s transaction:

```
ops$tkyte session(419,269)> commit;
Commit complete.
```

The second session will immediately display the following error:

```
ops$tkyte session(6,479)> update id_table
 2   set id_value = id_value+1
 3   where id_name = 'MY_KEY';
update id_table
*
ERROR at line 1:
ORA-08177: can't serialize access for this transaction
```

That error would occur regardless of the ordering of the preceding commit statement. All it takes is for your transaction to attempt to modify any record that was modified by some other session since your transaction began.

So, that database-independent piece of logic really isn’t database independent at all. It may not even perform reliably in a single database, depending on the isolation level! Sometimes we block and wait; sometimes we get an error message. To say the end user would be upset in either case (wait long time, or wait long time to get error) is putting it mildly.

This issue is compounded by the fact that our transaction is much larger than just outlined. The UPDATE and SELECT in the example are only two statements of potentially many other statements that make up the transaction. We have yet to insert the row into the table with this key we just generated, and do whatever other work it takes to complete this transaction. This serialization will be a huge limiting factor in scaling. Think of the ramifications if this technique was used on web sites that processed orders, and this was how we generated order numbers. There would be no multiuser concurrency, so we would be forced to do everything sequentially.

The correct approach to this problem is to use the best code for each database. In Oracle 12c this is as follows (assuming the table that needs the generated primary key is T):

```
EODA@ORA12CR1> create sequence s;
Sequence created.

EODA@ORA12CR1> create table t
 2 ( x          number
 3          default s.nextval
 4          constraint t_pk primary key,
 5   other_data varchar2(20)
 6 )
 7 /
Table created.
```

Alternatively, you could use the IDENTITY attribute and skip the sequence generation:

```
EODA@ORA12CR1> create table t
 2 ( x          number
 3          generated as identity
 4          constraint t_pk primary key,
 5   other_data varchar2(20)
 6 )
 7 /
Table created.
```

---

■ **Note** An IDENTITY column must be of a numeric datatype.

---

But note that it did not really skip the sequence generation—the sequence was generated automatically by the database. In earlier releases of Oracle (11g and before), it would be typical to use the following logic to have an autogenerated surrogate primary key:

```
EODA@ORA12CR1> create table t
  2 ( pk number primary key,
  3   other_data varchar2(20)
  4 )
  5 /
```

Table created.

```
EODA@ORA12CR1> create sequence t_seq;
Sequence created.
```

```
EODA@ORA12CR1> create trigger t before insert on t
  2 for each row
  3 begin
  4     :new.pk := t_seq.nextval;
  5 end;
  6 /
```

Trigger created.

---

■ **Note** In releases before Oracle 11g, you will have to use `SELECT T_SEQ.NEXTVAL INTO :NEW.PK FROM DUAL;` in place of the assignment. Direct assignment of a sequence in PL/SQL was a new 11g feature.

---

This will have the effect of automatically—and transparently—assigning a unique key to each row inserted. A more performance-driven approach in Oracle Database 11g and before would be simply this:

```
Insert into t ( pk, .... ) values ( t_seq.NEXTVAL, .... );
```

That is, skip the overhead of the trigger altogether (this is *definitely* my preferred approach). You can achieve the same effect in the other databases using their types. The `CREATE TABLE` syntax will be different but the net results will be the same. Here, we've gone out of our way to use each database's feature to generate a *nonblocking*, highly concurrent unique key, and have introduced no real changes to the application code—all of the logic is contained in this case in the DDL.

## Layered Programming

Once you understand that each database *will implement features in a different way*, another example of defensive programming to allow for portability is to layer your access to the database when necessary. Let's say you are programming using JDBC. If all you use is straight SQL `SELECT`s, `INSERT`s, `UPDATE`s, and `DELETE`s, you probably don't need a layer of abstraction. You may very well be able to code the SQL directly in your application, as long as you limit the constructs you use to those supported by each of the databases you intend to support—and that you have verified work exactly the same (remember the `NULL= NULL` discussion!). This means you'll have poorly performing SQL,

though—and you’ll apparently have in your head more knowledge about more databases than most anyone I know of (after all, that’s the only way to know if something has a chance of working the same on all databases!). Another approach that is both more portable and offers better performance, would be to use stored procedures to return resultsets. You will discover that every vendor’s database can return resultsets from stored procedures, but how they are returned is different. The actual stored procedure source code you must write is different for different databases.

Your two choices here are to either not use stored procedures to return resultsets, or to implement different code for different databases. I would definitely follow the different-code-for-different-vendors method and use stored procedures heavily. This might seem as if it would increase the time it takes to implement on a different database. However, you’ll find it is actually easier to implement on multiple databases with this approach. Instead of having to find the perfect SQL that works on *all* databases (perhaps better on some than on others), you will implement the SQL that works best on that database. You can do this outside of the application itself, which gives you more flexibility in tuning the application. You can fix a poorly performing query in the database, and deploy that fix immediately, without having to patch the application. Additionally, you can take advantage of vendor extensions to SQL using this method freely. For example, Oracle supports a wide variety of SQL extensions, such as analytic functions, the SQL model clause, row pattern matching and more. In Oracle, you are free to use these extensions to SQL since they are “outside” of the application (i.e., hidden in the database). In other databases, you would use whatever features they provide to achieve the same results, perhaps. You paid for these features so you might as well use them.

Another argument for this approach—developing specialized code for the database you will deploy on—is that finding a single developer (let alone a team of developers) who is savvy enough to understand the nuances of the differences between Oracle, SQL Server, and DB2 (let’s limit the discussion to three databases in this case) is virtually impossible. I’ve worked mostly with Oracle for the last 20 years (mostly, not exclusively). I learn something new about Oracle *every single day I use it*. To suggest that I could be expert in three databases simultaneously and understand what the differences between all three are and how those differences will affect the “generic code” layer I’d have to build is highly questionable. I doubt I would be able to do that accurately or efficiently. Also, consider that we are talking about individuals here; how many developers actually fully understand or use the database they currently have, let alone three of them? Searching for the unique individual who can develop bulletproof, scalable, database-independent routines is like searching for the holy grail. Building a team of developers that can do this is impossible. Finding an Oracle expert, a DB2 expert, and a SQL Server expert and telling them “We need a transaction to do X, Y, and Z”—that’s relatively easy. They are told, “Here are your inputs, these are the outputs we need, and this is what this business process entails,” and from this they can produce transactional APIs (stored procedures) that fit the bill. Each will be implemented in the manner best for that particular database, according to that database’s unique set of capabilities. These developers are free to use the full power (or lack thereof, as the case may be) of the underlying database platform.

These are the same techniques developers who implement multiplatform code use. Oracle Corporation, for example, uses this technique in the development of its own database. There is a large amount of code (though a small percentage of the database code overall) called *OSD* (Operating System Dependent) code that is implemented specifically for each platform. Using this layer of abstraction, Oracle is able to make use of many native OS features for performance and integration, without having to rewrite the majority of the database itself. The fact that Oracle can run as a multithreaded application on Windows and a multiprocess application on UNIX/Linux attests to this feature. The mechanisms for inter-process communication are abstracted to such a level that they can be reimplemented on an OS-by-OS basis, allowing for radically different implementations that perform as well as an application written directly, and specifically, for that platform.

In addition to SQL syntactic differences, implementation differences, and differences in performance of the same query in different databases outlined earlier, there are the issues of concurrency controls, isolation levels, query consistency, and so on. We cover these items in some detail in Chapter 7 of this book, and you’ll see how their differences may affect you. SQL92/SQL99 attempted to provide a straightforward definition of how a transaction should work and how isolation levels should be implemented, but in the end, you’ll get different results from different databases. It is all due to the implementation. In one database an application will deadlock and block all over the place. In another database, the same exact application will run smoothly. In one database, the fact that you did block (physically serialize) was used to your advantage but when you deploy on another database and it does not block, you get the wrong answer. Picking an application up and dropping it on another database takes a lot of hard work and effort, even if you followed the standard 100 percent.

## Features and Functions

A natural extension of the argument that you shouldn't necessarily strive for database independence is the idea that you should understand exactly what your specific database has to offer and make full use of it. This is not a section on all of the features that Oracle 12c has to offer—that would be an extremely large book in itself. The new features of Oracle 9i, 10g, 11g, and 12c themselves fill a book in the Oracle documentation set. With over 10,000 pages of documentation provided by Oracle, covering every feature and function would be quite an undertaking. Rather, this section explores the benefits of gaining at least a cursory knowledge of what is provided.

As I've said before, I answer questions about Oracle on the Web. I'd say that 80 percent of my answers are simply URLs to the documentation (for every question you see that I've published—many of which are pointers into the documentation—there are two more questions I choose not to publish, almost all of which are “read this” answers). People ask how they might go about writing some complex piece of functionality in the database (or outside of it), and I just point them to the place in the documentation that tells them how Oracle has already implemented the feature they need and how to use it. Replication comes up frequently. Here's a typical example of what I am asked:

*Is there a view that will show the literal SQL run? What I mean is that when I select from V\$SQL, the SQL\_TEXT looks like this: INSERT INTO TABLE1 (COL1,COL2) VALUES (:1,:2). I need to see the actual data submitted. e.g. INSERT INTO TABLE1 (COL1,COL2) VALUES ('FirstVal',12). What I am trying to get is a list of insert, update, or delete statements run against one schema and run those same SQL statements against a second schema in the same order of execution. I am hopeful to be able to write something like this:*

```
Select SQL_FULLTEXT from V$SQL where FIRST_LOAD_TIME > SYSDATE-(1/24) AND
(SQL_TEXT like 'INSERT%'...) order by FIRST_LOAD_TIME
```

*This record set would be sent via a web service to schema2, which would process the statements. Is this possible?*

Here is someone trying to reinvent replication! He can't get the literal SQL (and thank goodness for that!), but even if he could, this approach would never work. You can't just take a concurrently executed set of SQL statements (what happens on a multi-CPU machine where two SQL statements are executed at exactly the same time?) and execute them serially (you may end up with different answers!). You'd need to replay them using the degree of concurrency you used on the originating system.

For example, if you and I both execute `INSERT INTO A_TABLE SELECT * FROM A_TABLE;` at about the same time, we'd end up with `A_TABLE` having three times as many rows as it did when we started. For example, if `A_TABLE` started with 100 rows and I did that insert, it would now have 200 rows. If you did the insert right after me (before I commit), you would not see my 200 rows and you'd insert 100 more rows into `A_TABLE`, which would end up with 300 rows. Now, if we change things so that a web service performs my insert (`A_TABLE` grows from 100 to 200 rows) and then your insert (`A_TABLE` grows from 200 to 400 rows)—you can see the problem here. Replication is not trivial, it is, in fact, quite difficult. Oracle (and other databases) has been doing replication for over two decades now; it takes a lot of effort to implement and maintain.

It's true you can write your own replication, and it might even be fun to do so, but at the end of the day, it's not the smartest thing to do. The database does a lot of stuff. In general, it can do it better than we can ourselves. Replication, for example, is internalized in the kernel, written in C. It's fast, it's fairly easy, and it's robust. It works across versions and across platforms. It is supported, so if you hit a problem, Oracle's support team will be there to help. If you upgrade, replication will be supported there as well, probably with some new features. Now, consider if you were to develop your own. You'd have to provide support for all of the versions you wanted to support. Interoperability between old and new releases? That'd be your job. If it “broke,” you wouldn't be calling support. At least, not until you could get a test case small enough to demonstrate your basic issue. When the new release of Oracle comes out, it would be up to you to migrate your replication code to that release.

## Knowing What's Out There

Not having a full understanding of what is available to you can come back to haunt you in the long run. I was working with some developers with years of experience developing database applications—on other databases. They built analysis software (trending, reporting, visualization software). It was to work on clinical data related to healthcare. They were not aware of SQL syntactical features like inline views, analytic functions, scalar subqueries. Their major problem was they needed to analyze data from a single parent table to two child tables; an Entity Relation Diagram (ERD) might look like Figure 1-1.

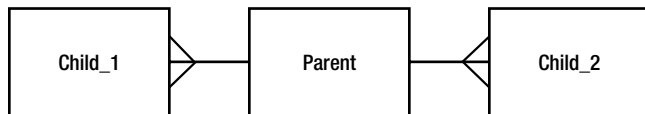

**Figure 1-1.** Simple ERD

The developers needed to be able to report on the parent record with aggregates from each of the child tables. The databases they worked with in the past did not support subquery factoring (WITH clause), nor did they support inline views—the ability to “query a query” instead of query a table. Not knowing these features existed, they wrote their own database of sorts in the middle tier. They would query the parent table and for each row returned run an aggregate query against each of the child tables. This resulted in their running thousands of tiny queries for each single query the end user wanted to run. Or, they would fetch the entire aggregated child tables into their middle tier into hash tables in memory—and do a hash join.

In short, they were reinventing the database, performing the functional equivalent of a nested loops join or a hash join, without the benefit of temporary tablespaces, sophisticated query optimizers, and the like. They were spending their time developing, designing, fine-tuning, and enhancing software that was trying to do the same thing the database they already bought did! Meanwhile, end users were asking for new features but not getting them, because the bulk of the development time was in this reporting “engine,” which really was a database engine in disguise.

I showed them that they could do things such as join two aggregations together in order to compare data that was stored at different levels of detail. Several approaches are possible, as illustrated in Listings 1-1 through 1-3.

### **Listing 1-1.** Inline Views to Query from a Query

```

select p.id, c1_sum1, c2_sum2
  from p,
       (select id, sum(q1) c1_sum1
        from c1
        group by id) c1,
       (select id, sum(q2) c2_sum2
        from c2
        group by id) c2
 where p.id = c1.id
       and p.id = c2.id
/
  
```

### **Listing 1-2.** Scalar Subqueries That Run Another Query per Row

```

select p.id,
       (select sum(q1) from c1 where c1.id = p.id) c1_sum1,
       (select sum(q2) from c2 where c2.id = p.id) c2_sum2
  from p
 where p.name = '1234'
/
  
```

**Listing 1-3.** Subquery Factoring via the WITH Clause

```

with c1_vw as
(select id, sum(q1) c1_sum1
   from c1
   group by id),
c2_vw as
(select id, sum(q2) c2_sum2
   from c2
   group by id),
c1_c2 as
(select c1.id, c1.c1_sum1, c2.c2_sum2
   from c1_vw c1, c2_vw c2
   where c1.id = c2.id )
select p.id, c1_sum1, c2_sum2
   from p, c1_c2
  where p.id = c1_c2.id
/

```

In addition to what you see in these listings, we can also do great things using the analytic functions like LAG, LEAD, ROW\_NUMBER, the ranking functions, and so much more. Rather than spending the rest of the day trying to figure out how to tune their middle tier database engine, we spent the day with the *SQL Reference Guide* projected on the screen (coupled with SQL\*Plus to create ad-hoc demonstrations of how things worked). The end goal was no longer tuning the middle tier; now it was turning off the middle tier as quickly as possible.

Here's another example: I have seen people set up daemon processes in an Oracle database that read messages off of pipes (a database IPC mechanism implemented via DBMS\_PIPE). These daemon processes execute the SQL contained within the pipe message and commit the work. They do this so they could execute auditing and error logging in a transaction that would not get rolled back if the bigger transaction did. Usually, if a trigger or something was used to audit an access to some data, but a statement failed later on, all of the work would be rolled back. So, by sending a message to another process, they could have a separate transaction do the work and commit it. The audit record would stay around, even if the parent transaction rolled back. In versions of Oracle before Oracle 8i, this was an appropriate (and pretty much the only) way to implement this functionality. When I told them of the database feature called *autonomous transactions*, they were quite upset with themselves. Autonomous transactions, implemented with a single line of code, do exactly what they were doing. On the bright side, this meant they could discard a lot of code and not have to maintain it. In addition, the system ran faster overall, and was easier to understand. Still, they were upset at the amount of time they had wasted reinventing the wheel. In particular, the developer who wrote the daemon processes was quite upset at having just written a bunch of "shelfware."

I see examples like these repeated time and time again—large complex solutions to problems that are already solved by the database itself. *I've been guilty of this myself.* I still remember the day when my Oracle sales consultant (I was the customer at the time) walked in and saw me surrounded by a ton of Oracle documentation. I looked up at him and just asked "Is this all true?" I spent the next couple of days just digging and reading. I had fallen into the trap that I knew all about databases because I had worked with SQL/DS, DB2, Ingress, Sybase, Informix, SQLBase, Oracle, and others. Rather than take the time to see what each had to offer, I would just apply what I knew from the others to whatever I was working on. (Moving to Sybase/SQL Server was the biggest shock to me—it worked nothing like the others at all.) Upon actually discovering what Oracle could do (and the others, to be fair), I started taking advantage of it and was able to move faster, with less code. This was in 1993. Imagine what you can do with the software today, almost two decades later.

Take the time to learn what is available. You miss so much by not doing that. I learn something new about Oracle pretty much every single day. It requires some keeping up with; I still read the documentation.

## Solving Problems Simply

There are always two ways to solve everything: the easy way and the hard way. Time and time again, I see people choosing the hard way. It is not always done consciously. More often, it is done out of ignorance. They never expected the database to be able to do “that.” I, on the other hand, expect the database to be capable of anything and only do it the hard way (by writing it myself) when I discover it can’t do something.

For example, I am frequently asked, “How can I make sure the end user has only one session in the database?” (There are hundreds of other examples I could have used here). This must be a requirement of many applications, but none I’ve ever worked on—I’ve not found a good reason for limiting people in this way. However, people want to do it and when they do, they usually do it the hard way. For example, they will have a batch job run by the operating system that will look at the `V$SESSION` table and arbitrarily kill sessions of users who have more than one session. Alternatively, they will create their own tables and have the application insert a row when a user logs in and remove the row when they log out. This implementation invariably leads to lots of calls to the help desk because when the application crashes, the row never gets removed. I’ve seen lots of other “creative” ways to do this, but none is as easy as this:

```
EODA@ORA12CR1> create profile one_session limit sessions_per_user 1;
Profile created.
```

```
EODA@ORA12CR1> alter user scott profile one_session;
User altered.
```

```
EODA@ORA12CR1> alter system set resource_limit=true;
System altered.
```

Now we’ll try to connect to SCOTT twice; the second attempt should fail:

```
EODA@ORA12CR1> connect scott/tiger
Connected.
```

```
SCOTT@ORA12CR1> host sqlplus scott/tiger
```

```
SQL*Plus: Release 12.1.0.1.0 Production on Fri Mar 14 11:12:04 2014
Copyright (c) 1982, 2013, Oracle. All rights reserved.
ERROR:
ORA-02391: exceeded simultaneous SESSIONS_PER_USER limit
```

That’s it—now any user with the `ONE_SESSION` profile can log on only once. When I bring up this solution, I can usually hear the smacking of a hand on the forehead followed by the statement “I never knew it could do that.” Taking the time to familiarize yourself with what the tools you have to work with are capable of doing can save you lots of time and energy in your development efforts.

The same “keep it simple” argument applies at the broader architecture level. I would urge people to think carefully before adopting very complex implementations. The more moving parts you have in your system, the more things you have that can go wrong, and tracking down exactly where that error is occurring in an overly complex architecture is not easy. It may be really “cool” to implement using umpteen tiers, but it’s not the right choice if a simple stored procedure can do it better, faster, and with less resources.

I’ve seen projects where application development has been going on for months, with no end in sight. The developers are using the latest and greatest technologies and languages, but development is not going very fast. It wasn’t that big of an application—and perhaps that was the problem. If you are building a doghouse (a small woodworking job), you wouldn’t bring in the heavy machinery. You’d use a few small power tools, but you wouldn’t have any use for the “big stuff.” On the other hand, if you were building an apartment complex, you’d have a cast of hundreds working on the project, you’d have the big machines—you’d use totally different tools to approach this problem. The same is true of application development. There is not a single “perfect architecture.” There is not a single “perfect language.” There is not one single “perfect approach.”



For example, to build my web site I used APEX (Application Express). It's a smallish application, there was a single developer (or two) working on it. It has maybe 20 screens. PL/SQL and APEX was the correct choice for this implementation—it did not need a cast of dozens, coding in Java, making EJBs, using Hibernate, and so on. It was a simple problem, solved simply. There are few complex, large-scale, huge applications (we buy most of those today: our HR systems, our ERP systems, and so on), but there are thousands of small applications. We need to use the proper approach and tools for the job.

I will always go with the simplest architecture that solves the problem completely over a complex one any day. The payback can be enormous. Every technology has its place. Not every problem is a nail, so we can use more than a hammer in our toolbox.

## Openness

I frequently see people doing things the hard way for another reason, and again it relates to the idea that we should strive for openness and database independence at all costs. The developers wish to avoid using closed, proprietary database features—even those as simple as stored procedures or sequences—because doing so will lock them into a database system. Well, let me put forth the idea that the instant you develop a read/write application, you are already somewhat locked in. You will find subtle (and sometimes not-so-subtle) differences between the databases as soon as you start running queries and modifications. For example, in one database you might find that your `SELECT COUNT(*) FROM T` deadlocks with a simple update of two rows. In Oracle, you'll find that the `SELECT COUNT(*)` never blocks on a writer of the data being counted. You've seen the case where a business rule appears to get enforced on one database, due to side effects of the database's locking model, and does not get enforced in another database. You'll find that, given the same exact transaction mix, reports come out with different answers in different databases, all because of fundamental implementation differences. You will find that it is a very rare application that can simply be picked up and moved from one database to another. Differences in the way the SQL is interpreted (for instance, the `NULL=NULL` example) and processed will always be there.

On one project, the developers were building a web-based product using Visual Basic, ActiveX Controls, IIS server, and the Oracle database. I was told that the development folks had expressed concern that since the business logic had been written in PL/SQL, the product had become database dependent and was asked, "How can we correct this?"

I was a little taken aback by this question. In looking at the list of chosen technologies I could not figure out how being database dependent was a "bad" thing:

- The developers had chosen a language that locked them into a single operating system supplied by a single vendor (they could have opted for Java).
- They had chosen a component technology that locked them into a single operating system and vendor (they could have opted for J2EE).
- They had chosen a web server that locked them into a single vendor and single platform (why not something more open?).

Every other technology choice they had made locked them into a very specific configuration—in fact, the *only* technology that offered them any choice in terms of operating systems was the database.

Regardless of this (they must have had good reasons to choose the technologies they did) we still have a group of developers making a conscious decision to not use the functionality of a critical component in their architecture, and doing so in the name of openness. It is my belief that you pick your technologies carefully and then you exploit them to the fullest extent possible. You paid a lot for these technologies—*isn't it in your best interest to exploit them fully?* I had to assume they were looking forward to using the full potential of the other technologies, so why was the database an exception? This was an even harder question to answer in light of the fact that it was crucial to their success.

We can put a slightly different spin on this argument if we consider it from the perspective of openness. You put all of your data into the database. The database is a very open tool. It supports data access via a large variety of open systems protocols and access mechanisms. Sounds great so far, the most open thing in the world.

Then, you put all of your application logic and more importantly, your *security* outside of the database. Perhaps in your beans that access the data. Perhaps in the JSPs that access the data. Perhaps in your Visual Basic code. Perhaps in your Hibernate-generated code. The end result is that you have just closed off your database—you have made it “non-open.” No longer can people hook in existing technologies to make use of this data; they *must* use your access methods (or bypass security altogether). This sounds all well and good today, but what you must remember is that the whiz-bang technology of today is yesterday’s concept, and tomorrow’s old, tired technology. What has persevered for over 30 years in the relational world (and probably most of the object implementations as well) is the database itself. The front ends to the data change almost yearly, and as they do, the applications that have all of the security built inside themselves, not in the database, become obstacles, roadblocks to future progress.

The Oracle database provides a feature called *fine-grained access control (FGAC)*. In a nutshell, this technology allows developers to embed procedures in the database that can modify queries as they are submitted to the database. This query modification is used to restrict the rows the client will receive or modify. The procedure can look at who is running the query, when they are running the query, what application is requesting the data, what terminal they are running the query from, and so on, and can constrain access to the data as appropriate. With FGAC, we can enforce security such that, for example:

- Any query executed outside of normal business hours by a certain class of users returns zero records.
- Any data can be returned to a terminal in a secure facility but only nonsensitive information can be returned to a remote client terminal.

Basically, FGAC allows us to locate access control in the database, *right next to the data*. It no longer matters if the user comes at the data from a bean, a JSP, a Visual Basic application using ODBC, or SQL\*Plus—the same security protocols will be enforced. You are well situated for the next technology that comes along.

Now I ask you, which implementation is more “open?” The one that makes all access to the data possible only through calls to the Visual Basic code and ActiveX controls (replace Visual Basic with Java and ActiveX with EJB if you like—I’m not picking on a particular technology but an implementation here) or the solution that allows access from anything that can talk to the database, over protocols as diverse as SSL, HTTP, and Oracle Net (and others) or using APIs such as ODBC, JDBC, OCI, and so on? I have yet to see an ad hoc reporting tool that will “query” your Visual Basic code. I know of dozens that can do SQL, though.

The decision to strive for database independence and total openness is one that people are absolutely free to take, and many try, but I believe it is the wrong decision. No matter what database you are using, you should exploit it fully, squeezing every last bit of functionality you can out of that product. You’ll find yourself doing that in the tuning phase (which again always seems to happen right after deployment) anyway. It is amazing how quickly the database independence requirement can be dropped when you can make the application run five times faster just by exploiting the database software’s capabilities.

## How Do I Make It Run Faster?

The question in the heading is one I get asked all the time. Everyone is looking for the fast = true switch, assuming “database tuning” means that you tune the database. In fact, it is my experience that more than 80 percent (frequently 100 percent) of all performance gains are to be realized at the application design and implementation level—not the database level. You can’t tune a database until you have tuned the applications that run on the database.

As time goes on, there are some switches we can throw at the database level to help lessen the impact of egregious programming blunders. For example, Oracle 8.1.6 added a new parameter, `CURSOR_SHARING=FORCE`. This feature implements an *auto binder*, if you will. It will silently take a query written as `SELECT * FROM EMP WHERE EMPNO = 1234` and rewrite it for us as `SELECT * FROM EMP WHERE EMPNO = :x`. This *can* dramatically decrease the

number of hard parses, and decrease the library latch waits we discussed in the Architecture sections—*but* (there is always a but) it can have some side effects. A common side effect with cursor sharing is something like this:

```
EODA@ORA12CR1> select /* TAG */ substr( username, 1, 1 )
  2   from all_users au1
  3   where rownum = 1;
```

```
S
-
S
```

```
EODA@ORA12CR1> alter session set cursor_sharing=force;
Session altered.
```

```
EODA@ORA12CR1> select /* TAG */ substr( username, 1, 1 )
  2   from all_users au2
  3   where rownum = 1;
```

```
SUBSTR(USERNAME,1,1)
```

```
-----
S
```

What happened there? Why is the column reported by SQL\*Plus suddenly so large for the second query, which is arguably the same query? If we look at what the cursor sharing setting did for us, it (and something else) will become obvious:

```
EODA@ORA12CR1> select sql_text from v$sql where sql_text like 'select /* TAG */ %';
```

```
SQL_TEXT
```

```
-----
select /* TAG */ substr( username, 1, 1 )
from all_users au1
where rownum = 1

select /* TAG */ substr( username, :SYS_B_0, :SYS_B_1" )
from all_users au2
where rownum = :SYS_B_2"
```

The cursor sharing removed information from the query. It found *every* literal, including the `substr` constants we were using. It removed them from the query and replaced them with bind variables. The SQL engine no longer knows that the column is a `substr` of length 1—it is of indeterminate length. Also, you can see that `where rownum = 1` is now bound as well. This seems like a good idea; however, the optimizer has just had some important information removed. It no longer knows that “this query will retrieve a single row;” it now believes “this query will return the first N rows and N could be any number at all.” This can have a negative impact on your generated query plans.

Additionally, I have shown that while `CURSOR_SHARING = FORCE` runs much faster than parsing and optimizing lots of unique queries (refer to the preceding section on bind variables), I have also found it to be slower than using queries where the developer did the binding. This arises not from any inefficiency in the cursor-sharing code, but rather in inefficiencies in the program itself. In many cases, an application that does not use bind variables is not efficiently parsing and reusing cursors either. Since the application believes each query is unique (it built them as unique statements), it will never use a cursor more than once. The fact is that if the programmer had used bind variables in the first place, she could have parsed a query once and reused it many times. It is this overhead of parsing that decreases the overall potential performance.

■ **Note** It is important to also point out that `CURSOR_SHARING=FORCE` will not fix SQL Injection bugs. The binding comes after the query was rewritten by your end user; the SQL Injection has already happened. `CURSOR_SHARING=FORCE` makes you no more secure than you were before. Only by using bind variables themselves can a developer implement a SQL Injection–proof application.

---

Basically, it is important to keep in mind that simply turning on `CURSOR_SHARING = FORCE` will not necessarily fix your problems. It may very well introduce new ones. `CURSOR_SHARING` is, in some cases, a very useful tool, but it is not a silver bullet. A well-developed application would never need it. In the long term, using bind variables where appropriate, and constants when needed, is the correct approach.

---

■ **Note** There are no silver bullets, none. If there were, they would be the default behavior and you would never hear about them.

---

Even if there are some switches that can be thrown at the database level, and they are truly few and far between, problems relating to concurrency issues and poorly executing queries (due to poorly written queries or poorly structured data) can't be fixed with a switch. These situations require rewrites (and frequently a re-architecture). Moving data files around, adjusting parameters, and other database-level switches frequently have a minor impact on the overall performance of an application. Definitely not anywhere near the two, three, ... *n* times increase in performance you need to achieve to make the application acceptable. How many times has your application been 10 percent too slow? 10 percent too slow, no one complains about. Five times too slow, people get upset. I repeat: you will not get a five times increase in performance by moving data files around. You will only achieve large increments in performance by fixing the application, perhaps by making it do significantly less I/O.

---

■ **Note** This is just to note how things change over time. I've often written that you will not get a five-times increase in performance by moving data files around. With the advent of hardware solutions such as Oracle Exadata (a storage area network device designed as an extension to the database), you can, in fact, get a five times, ten times, fifty times, or more decrease in response time (the time it takes to return data) by simply moving data files around. But that is more of a "we completely changed our hardware architecture" story than a "we reorganized some of our storage." Also, getting an application running only five or ten times faster on Exadata would be disappointing to me—I'd want it to be fifty times or more "faster"—and would require a rethinking of how the application is implemented.

---

Performance is something you have to design for, build to, and test for continuously throughout the development phase. It should never be something to be considered after the fact. I am amazed at how often people wait until the application has been shipped to the customer, put in place, and is actually running before they even start to tune it. I've seen implementations where applications are shipped with nothing more than primary keys—no other indexes whatsoever. The queries have never been tuned or stress-tested. The application has never been tried out with more than a handful of users. Tuning is considered to be part of the installation of the product. To me, that is an unacceptable approach. Your end users should be presented with a responsive, fully tuned system from day one. There will be enough "product issues" to deal with without having poor performance be the first thing users experience. Users expect a few bugs from a new application, but at least don't make the users wait a painfully long time for those bugs to appear on screen.

## The DBA-Developer Relationship

It's certainly true that the most successful information systems are based on a symbiotic relationship between the DBA and the application developer. In this section I just want to give a developer's perspective on the division of work between developer and DBA (assuming that every serious development effort has a DBA team).

As a developer, you should not necessarily have to know how to install and configure the software. That should be the role of the DBA and perhaps the system administrator (SA). Setting up Oracle Net, getting the listener going, configuring the shared server, enabling connection pooling, installing the database, creating the database, and so on—these are functions I place in the hands of the DBA/SA.

In general, a developer should not have to know how to tune the operating system. I myself generally leave this task to the SAs for the system. As a software developer for database applications, you will need to be competent in the use of your operating system of choice, but you shouldn't expect to have to tune it.

The single largest DBA responsibility is database recovery. Note I did not say “backup.” I said “recovery,” and I would say that this is the sole responsibility of the DBA. Understanding how rollback and redo work—yes, that is something a developer has to know. Knowing how to perform a tablespace point-in-time recovery is something a developer can skip over. Knowing that you can do it might come in handy, but actually having to do it—no.

Tuning at the database instance level and figuring out what the optimum `PGA_AGGREGATE_TARGET` should be—that's typically the job of the DBAs (and the database is quite willing and able to assist them in determining the correct figure). There are exceptional cases where a developer might need to change some setting for a session, but at the database level, the DBA is responsible for that. A typical database supports more than just a single developer's application. Only the DBA who supports all of the applications can make the right decision.

Allocating space and managing the files is the job of the DBA. Developers contribute their estimations for space (how much they feel they will need), but the DBA/SA takes care of the rest.

Basically, developers do not need to know how to run the database. They need to know how to run *in* the database. The developer and the DBA work together on different pieces of the same puzzle. The DBA will visit you, the developer, when your queries are consuming too many resources, and you will visit the DBA when you can't figure out how to make the system go any faster (that's when instance tuning can be done, when the application is fully tuned).

This all varies by environment, but I would like to think that there is a division. A good developer is usually a very bad DBA, and vice versa. They are two different skill sets, two different mind-sets, and two different personalities in my opinion.

## Summary

In this chapter, we have taken a somewhat anecdotal look at why you need to know the database. The examples I presented are not isolated—they happen every day, day in and day out. I observe a continuous cycle of such issues happening, over and over.

Let's quickly recap the key points. If you are developing with Oracle:

- You need to understand the Oracle architecture. You don't have to know it so well that you are able to rewrite the server, but you should know it well enough that you are aware of the implications of using a particular feature.
- You need to understand locking and concurrency control and that every database implements these features *differently*. If you don't, your database will give “wrong” answers and you will have large contention issues, leading to poor performance.
- Do not treat the database as a black box—something you need not understand. The database is the most critical piece of most applications. Trying to ignore it would be fatal.

- Do not reinvent the wheel. I've seen more than one development team get into trouble, not only technically but on a personal level, due to a lack of awareness as to what Oracle provides for free. This happens when someone points out that the feature they just spent the last couple of months implementing was actually a core feature of the database all along. Read the Oracle Database Concepts Guide—the New Features guide—the documentation that comes free with the software!
- Solve problems as simply as possible, using as much of Oracle's built-in functionality as possible. You paid a lot for it.
- Software projects come and go, as do programming languages and frameworks. We developers are expected to have systems up and running in weeks, maybe months, and then move on to the next problem. If you reinvent the wheel over and over, you will never come close to keeping up with the frantic pace of development. Just as you would never build your own hash table class in Java—since it comes with one—you should use the database functionality you have at your disposal. The first step to being able to do that, of course, is to understand what it is you have at your disposal. Read on.

And building on that last point, software projects and programming languages may come and go—but the *data* is here forever. We build applications that use data, and that data will be used by many applications over time. It is not about the application—it is about the data. Use techniques and implementations that permit the data to be used and reused. If you use the database as a bit bucket, making it so that all access to any data must come through your application, you have missed the point. You can't "ad hoc query" your application. You can't build a new application on top of your old application. But if you use the database, you'll find adding new applications, reports, or whatever to be much easier over time.



# Architecture Overview

Oracle is designed to be a very portable database—it is available on every platform of relevance, from Windows to UNIX/Linux to mainframes. However, the physical architecture of Oracle looks different on different operating systems. For example, on a UNIX/Linux operating system, you’ll see Oracle implemented as many different operating system processes, virtually a process per major function. On UNIX/Linux, this is the correct implementation, as it works on a multiprocess foundation. On Windows, however, this architecture would be inappropriate and would not work very well (it would be slow and nonscalable). On the Windows platform, Oracle is implemented as a single process with multiple threads. In the past, on IBM mainframe systems, running OS/390 and z/OS, the Oracle operating system–specific architecture exploits multiple OS/390 address spaces, all operating as a single Oracle instance. Up to 255 address spaces can be configured for a single database instance. Moreover, Oracle works together with OS/390 Workload Manager (WLM) to establish the execution priority of specific Oracle workloads relative to each other and relative to all other work in the OS/390 system. Even though the physical mechanisms used to implement Oracle from platform to platform vary, the architecture is sufficiently generalized that you can get a good understanding of how Oracle works on all platforms.

In this chapter, I present a broad picture of this architecture. We’ll take a look at the Oracle server and define some terms such as *database*, *pluggable database*, *container database*, and *instance* (terms that always seem to cause confusion). We’ll take a look at what happens when you “connect” to Oracle and, at a high level, how the server manages memory. In the subsequent three chapters, we’ll look in detail at the three major components of the Oracle architecture:

- Chapter 3 covers files. Here we’ll look at the five general categories of files that make up the database: parameter, data, temp, control, and redo log files. We’ll also cover other types of files, including trace, alert, dump (DMP), data pump, and simple flat files. We’ll look at the file area (in Oracle 10g and above) called the Fast Recovery Area, and we’ll also discuss the impact that Automatic Storage Management (ASM) has on file storage.
- Chapter 4 covers the Oracle memory structures referred to as the System Global Area (SGA), Process Global Area (PGA), and User Global Area (UGA). We’ll examine the relationships between these structures, and we’ll also discuss the shared pool, large pool, Java pool, and various other SGA components.
- Chapter 5 covers Oracle’s physical processes or threads. We’ll look at the three different types of processes that will be running on the database: server processes, background processes, and slave processes.

It was hard to decide which of these components to cover first. The processes use the SGA, so discussing the SGA before the processes might not make sense. On the other hand, when discussing the processes and what they do, I’ll need to make references to the SGA. These two components are closely tied: the files are acted on by the processes and won’t make sense without first understanding what the processes do.

What I'll do, then, is define some terms and give a general overview of what Oracle looks like (if you were to draw it on a whiteboard). There will be two architectures to consider. One is the architecture the Oracle database employed exclusively from version 6 through 11g (referred to now as *single tenant* in this book) and a new multitenant architecture available with Oracle 12c. You'll then be ready to get into some of the details.

## Defining Database and Instance

There are two terms that, when used in an Oracle context, seem to cause a great deal of confusion: *database* and *instance*. In Oracle terminology, the definitions of these terms are as follows:

- *Database*: A collection of physical operating system files or disks. When using Oracle Automatic Storage Management (ASM) or RAW partitions, the database may not appear as individual, separate files in the operating system, but the definition remains the same. There are three distinct types of databases in Oracle Database 12c.
  - *A single-tenant database*: This is a self-contained set of data files, control files, redo log files, parameter files, and so on, that include all of the Oracle metadata (the definition of ALL\_OBJECTS, for example), Oracle data, and Oracle code (such as the code for DBMS\_OUTPUT), in addition to all of the application metadata, data, and code. This is the only type of database in releases prior to version 12c.
  - *A container or root database*: This is a self-contained set of data files, control files, redo log files, parameter files, and so on, that only include the Oracle metadata, Oracle data, and Oracle code. There are no application objects or code in these data files—only Oracle-supplied metadata and Oracle-supplied code objects. This database is self-contained in that it can be mounted and opened without any other supporting physical structures.
  - *A pluggable database*: This is a set of data files only. It is not self-contained. A pluggable database needs a container database to be “plugged into” to be opened and accessible. These data files contain only metadata for application objects, application data, and code for those applications. There is no Oracle metadata or any Oracle code in these data files. There are no redo log files, control files, parameter files, and so on—only data files associated with a pluggable database. The pluggable database inherits these other types of files from the container database it is currently plugged into.
- *Instance*: A set of Oracle background processes or threads and a shared memory area, which is memory that is shared across those threads or processes running on a single computer. This is the place for volatile, nonpersistent stuff, some of which gets flushed to disk. A database instance can exist without any disk storage whatsoever. It might not be the most useful thing in the world, but thinking about it that way definitely helps draw the line between the instance and the database.

The two terms, *instance* and *database*, are sometimes used interchangeably, but they embrace very different concepts, especially now in the multitenant architecture. The relationship between them is that a single-tenant or container database (herein referred to simply as *database*, meaning either a single-tenant or container database; when discussing pluggable databases, *pluggable* will be explicitly referenced) may be mounted and opened by many instances. An instance may mount and open just a single database at any point in time. In fact, it is true to say that an instance will mount and open, at most, a single database in its entire lifetime! We'll look at an example of that in a moment.



A pluggable database will be associated with a single container database at a time and is only indirectly associated with an instance; it will share the instance created to mount and open the container database. So, like a container database, a pluggable database can be associated with one or more instances at any point in time. Unlike a single-tenant database, however, an instance may be providing access to many (up to around 250) pluggable databases simultaneously. That is, a single instance may be providing services for many pluggable databases, but only one container or single-tenant database.

Confused even more? Some further explanation should help clear up these concepts.

An instance is simply a set of operating system processes, or a single process with many threads, and some memory. These processes can operate on a single database, which is just a collection of files (data files, temporary files, redo log files, and control files). At any time, an instance will have only one set of files (one container or single-tenant database) associated with it. Multiple pluggable databases, subordinate to the container database, can be open and accessible simultaneously—but will all share the single instance created to open the container database.

In most cases, the opposite is true as well: a container or single-tenant database will have only one instance working on it. However, in the special case of Oracle Real Application Clusters (RAC), an Oracle option that allows it to function on many computers in a clustered environment, we may have many instances simultaneously mounting and opening this one database, which resides on a set of shared physical disks. This gives us access to this single database from many different computers at the same time. Oracle RAC provides for extremely highly available systems and has the potential to architect extremely scalable solutions.

Let's start by taking a look at a simple example. Let's say we've just installed Oracle 12c version 12.1.0.1 on our UNIX/Linux-based computer. We did a software-only installation. No starter databases, nothing—just the software.

The `pwd` command shows the current working directory, `db`s (on Windows, this would be the database directory) and the `ls -l` command shows that the directory is empty. There is no `init.ora` file and no SPFILEs (stored parameter files; these will be discussed in detail in Chapter 3).

```
[ora12cr1@dellpe dbs]$ pwd
/home/ora12cr1/app/ora12cr1/product/12.1.0/dbhome_1/dbs
[ora12cr1@dellpe dbs]$ ls -l
total 0
```

Using the `ps` (process status) command, we can see all processes being run by the user `ora12cr1` (the Oracle software owner in this case). There are no Oracle database processes whatsoever at this point.

```
[ora12cr1@dellpe dbs]$ ps -aef | grep ora12cr1
root      18392 15416  0 14:31 pts/1    00:00:00 su - ora12cr1
ora12cr1  18401 18392  0 14:31 pts/1    00:00:00 -bash
ora12cr1  18461 18401  0 14:34 pts/1    00:00:00 ps -aef
ora12cr1  18462 18401  0 14:34 pts/1    00:00:00 grep ora12cr1
```

We then enter the `ipcs` command, a UNIX/Linux command that is used to show interprocess communication devices, such as shared memory, semaphores, and the like. Currently, there are none in use on this system at all.

```
[ora12cr1@dellpe dbs]$ ipcs -a

----- Shared Memory Segments -----
key          shmid      owner      perms      bytes      nattch     status

----- Semaphore Arrays -----
key          semid      owner      perms      nsems

----- Message Queues -----
key          msqid      owner      perms      used-bytes  messages
```

We then start up SQL\*Plus (Oracle’s command-line interface) and connect as sysdba (the account that is allowed to do virtually anything in the database). Initially, assuming you haven’t yet set the environment variable ORACLE\_SID, you’ll see the following:

```
[ora12cr1@dellpe dbs]$ sqlplus / as sysdba

SQL*Plus: Release 12.1.0.1.0 Production on Mon Sep 2 14:35:52 2013

Copyright (c) 1982, 2013, Oracle. All rights reserved.

ERROR:
ORA-12162: TNS:net service name is incorrectly specified
```

This error occurs because the database software has no idea what to try to connect to. When you connect, the Oracle software will look for a TNS connect string (a network connection). If, as in our example, the connect string is not supplied, the Oracle software will look at the environment for a variable named ORACLE\_SID (on Windows, it would look also in the registry for the ORACLE\_SID variable). The ORACLE\_SID is the Oracle “site identifier;” it is sort of a key to gain access to an instance. If we set our ORACLE\_SID:

```
[ora12cr1@dellpe dbs]$ export ORACLE_SID=ora12c

the connection is successful and SQL*Plus reports we are connected to an idle instance:
```

```
[ora12cr1@dellpe dbs]$ sqlplus / as sysdba

SQL*Plus: Release 12.1.0.1.0 Production on Mon Sep 2 14:36:54 2013

Copyright (c) 1982, 2013, Oracle. All rights reserved.

Connected to an idle instance.

SQL>
```

Our “instance” right now consists solely of the Oracle server process shown in bold in the following output. There is no shared memory allocated yet and no other processes.

```
SQL> !ps -aef | grep ora12cr1
root      18392 15416  0 14:31 pts/1    00:00:00 su - ora12cr1
ora12cr1  18401 18392  0 14:31 pts/1    00:00:00 -bash
ora12cr1  18474 18473  0 14:36 pts/0    00:00:00 ../dbhome_1/bin/sqlplus  as sysdba
ora12cr1 18475 18474  0 14:36 ?          00:00:00 oracleora12c (DESCRIPTION=(LOCAL=YES)
(ADDRESS=(PROTOCOL=beq)))
ora12cr1  18482 18474  0 14:38 pts/0    00:00:00 /bin/bash -c ps -aef | grep ora12cr1
ora12cr1  18483 18482  0 14:38 pts/0    00:00:00 ps -aef
ora12cr1  18484 18482  0 14:38 pts/0    00:00:00 grep ora12cr1
```

```
SQL> !ipcs -a
```

```
----- Shared Memory Segments -----
key      shmids  owner    perms    bytes    nattch   status

----- Semaphore Arrays -----
key      semids  owner    perms    nsems

----- Message Queues -----
key      msqids  owner    perms    used-bytes  messages
```

---

■ **Note** On Windows, Oracle executes as a single process with threads; you won't see separate processes as on UNIX/Linux. Moreover, the Windows threads will not have the same names as the processes just shown. I am using UNIX/Linux specifically here so we can differentiate the individual processes and “see” them clearly.

---

One interesting thing to note from this `ps` output is the process named `oracleora12c`. No matter how hard you look on your system, you will not find an executable by that name. The Oracle binary that is executing is really the binary file `$ORACLE_HOME/bin/oracle`.

---

■ **Note** It is assumed that the environment variable (on UNIX/Linux) or registry setting (on Windows) named `ORACLE_HOME` has been set and represents the fully qualified path to where the Oracle software is installed.

---

The Oracle developers simply rename the process as it is loaded into memory. The name of the single Oracle process that is running right now (our *dedicated server process*; more on this later) is `oracle${ORACLE_SID}`. That naming convention makes it very easy to see what processes are associated with which instances and so on. So, let's try to start the instance now:

```
SQL> startup
ORA-01078: failure in processing system parameters
LRM-00109: could not open parameter file '/home/ora12cr1/app/ora12cr1/product/12.1.0/dbhome_1/dbs/
initora12c.ora'
```

Notice the error about a missing file named `initora12c.ora`. That file, referred to colloquially as an *init.ora file*, or more properly as a *parameter file*, is the sole file that must exist to start up an instance—we need either a parameter file (a simple flat file that I'll describe in more detail shortly) or a stored parameter file.

We'll create the parameter file now and put into it the minimal information we need to actually start a database instance. (Normally, we'd specify many more parameters, such as the database block size, control file locations, and so on). By default, this file is located in the `$ORACLE_HOME/dbs` directory and has the name `init${ORACLE_SID}.ora`:

```
[ora12cr1@dellpe dbs]$ cd $ORACLE_HOME/dbs
[ora12cr1@dellpe dbs]$ echo db_name=ora12c > initora12c.ora
[ora12cr1@dellpe dbs]$ cat initora12c.ora
db_name=ora12c
```

and then, once we get back into SQL\*Plus:

```
[ora12cr1@dellpe dbs]$ sqlplus / as sysdba
```

```
SQL*Plus: Release 12.1.0.1.0 Production on Mon Sep 2 14:42:27 2013
```

```
Copyright (c) 1982, 2013, Oracle. All rights reserved.
```

```
Connected to an idle instance.
```

```
SQL> startup nomount
ORACLE instance started.
```

```
Total System Global Area 329895936 bytes
Fixed Size                 2287960 bytes
Variable Size              272631464 bytes
Database Buffers          50331648 bytes
Redo Buffers               4644864 bytes
```

We used the `nomount` option to the `startup` command since we don't actually have a database to mount yet (the SQL\*Plus documentation includes all of the startup and shutdown options).

---

■ **Note** On Windows, prior to running the `startup` command, you'll need to execute a service creation statement using the `oradim.exe` utility.

---

Now we have what I'd call an instance. The background processes needed to actually run a database are all there, including process monitor (`pmon`), log writer (`lgwr`), and so on (these processes are covered in detail in Chapter 5). Let's take a look:

```
SQL> !ps -aef | grep ora12cr1
root      18392 15416  0 14:31 pts/1    00:00:00 su - ora12cr1
ora12cr1  18401 18392  0 14:31 pts/1    00:00:00 -bash
ora12cr1  18499 18401  0 14:42 pts/1    00:00:00 rlrwrap /home/ora12cr1/app/ora12cr1/product/12.1.0/
ora12cr1  18500 18499  0 14:42 pts/0    00:00:00 /home/ora12cr1/app/ora12cr1/product/12.1.0/dbhome_1/
ora12cr1  18508      1 0 14:43 ?        00:00:00 ora_pmon_ora12c
ora12cr1  18510      1 0 14:43 ?        00:00:00 ora_psp0_ora12c
ora12cr1  18512      1 0 14:43 ?        00:00:00 ora_vktm_ora12c
ora12cr1  18516      1 0 14:43 ?        00:00:00 ora_gen0_ora12c
ora12cr1  18518      1 0 14:43 ?        00:00:00 ora_mman_ora12c
ora12cr1  18522      1 0 14:43 ?        00:00:00 ora_diag_ora12c
ora12cr1  18524      1 0 14:43 ?        00:00:00 ora_dbrm_ora12c
ora12cr1  18526      1 0 14:43 ?        00:00:00 ora_dia0_ora12c
ora12cr1  18528      1 0 14:43 ?        00:00:00 ora_dbw0_ora12c
ora12cr1  18530      1 0 14:43 ?        00:00:00 ora_lgwr_ora12c
ora12cr1  18532      1 0 14:43 ?        00:00:00 ora_ckpt_ora12c
ora12cr1  18534      1 0 14:43 ?        00:00:00 ora_lg00_ora12c
ora12cr1  18536      1 0 14:43 ?        00:00:00 ora_lg01_ora12c
```

```

ora12cr1 18538      1 0 14:43 ?          00:00:00 ora_smon_ora12c
ora12cr1 18540      1 0 14:43 ?          00:00:00 ora_reco_ora12c
ora12cr1 18542      1 0 14:43 ?          00:00:00 ora_lreg_ora12c
ora12cr1 18544      1 0 14:43 ?          00:00:00 ora_mmon_ora12c
ora12cr1 18546      1 0 14:43 ?          00:00:00 ora_mml_ora12c
ora12cr1 18547 18500 0 14:43 ?          00:00:00 ora12cr1 (DESCRIPTION=(LOCAL=YES)
              (ADDRESS=(PROTOCOL=beq)))
ora12cr1 18566 18500 0 14:45 pts/0      00:00:00 /bin/bash -c ps -aef | grep ora12cr1
ora12cr1 18567 18566 0 14:45 pts/0      00:00:00 ps -aef
ora12cr1 18568 18566 0 14:45 pts/0      00:00:00 grep ora12cr1

```

Additionally, `ipcs`, for the first time, reports the use of shared memory and semaphores—two important interprocess communication devices on UNIX/Linux:

```
SQL> !ipcs -a
```

```

----- Shared Memory Segments -----
key          shmid      owner      perms      bytes      nattch     status
0x10d1c894  13074435   ora12cr1   660        10485760   38
0x00000000  13107204   ora12cr1   660        322961408  19

----- Semaphore Arrays -----
key          semid      owner      perms      nsems
0xfc46e83c  425986    ora12cr1   660        171
0xfc46e83d  458755    ora12cr1   660        171
0xfc46e83e  491524    ora12cr1   660        171
0xfc46e83f  524293    ora12cr1   660        171
0xfc46e840  557062    ora12cr1   660        171

----- Message Queues -----
key          msqid      owner      perms      used-bytes  messages

```

Note we have no “database” yet. We have the name of a database (in the parameter file we created), but no actual database. If we try to “mount” this database, it would fail because, quite simply, the database does not yet exist. Let’s create it. I’ve been told that creating an Oracle database involves quite a few steps, but let’s see:

```
SQL> create database;
Database created.
```

That is actually all there is to creating a database. In the real world, however, we’d use a slightly more complicated form of the `CREATE DATABASE` command because we would want to tell Oracle where to put the online redo log files, data files, control files, and so on. But we do now have a fully operational database. We still need to run the `$ORACLE_HOME/rdbms/admin/catalog.sql` script and other catalog scripts to build the rest of the data dictionary we use every day (the views we use such as `ALL_OBJECTS` are not yet present in this database), but we have an actual database here. We can use a simple query against some Oracle `V$` views, specifically `V$DATAFILE`, `V$LOGFILE`, and `V$CONTROLFILE`, to list the files that make up this database.

```
SQL> select name from v$datafile;
```

```
NAME
```

```
-----
/home/ora12cr1/app/ora12cr1/product/12.1.0/dbhome_1/dbs/dbs1ora12c.dbf
/home/ora12cr1/app/ora12cr1/product/12.1.0/dbhome_1/dbs/dbx1ora12c.dbf
/home/ora12cr1/app/ora12cr1/product/12.1.0/dbhome_1/dbs/dbu1ora12c.dbf
```

```
SQL> select member from v$logfile;
```

```
MEMBER
```

```
-----
/home/ora12cr1/app/ora12cr1/product/12.1.0/dbhome_1/dbs/log1ora12c.dbf
/home/ora12cr1/app/ora12cr1/product/12.1.0/dbhome_1/dbs/log2ora12c.dbf
```

```
SQL> select name from v$controlfile;
```

```
NAME
```

```
-----
/home/ora12cr1/app/ora12cr1/product/12.1.0/dbhome_1/dbs/cntrlora12c.dbf
```

Oracle used defaults to put everything together and created a database as a set of persistent files. If we close this database and try to open it again, we'll discover that we can't:

```
SQL> alter database close;
```

```
Database altered.
```

```
SQL> alter database open;
```

```
alter database open
```

```
*
```

```
ERROR at line 1:
```

```
ORA-16196: database has been previously opened and closed
```

An instance can mount and open, at most, one database—a single-tenant or container database—in its lifetime. Remember, the instance consists simply of the processes and shared memory. This is still up and running. All we did was close the database—that is, the physical files. We must discard this instance (shutdown) and create a new one (startup) to open this or any other database.

To recap:

- An instance is a set of background processes and shared memory.
- A (single-tenant or container) database is a self-contained collection of data stored on disk.
- An instance can mount and open only a single database, ever. As we'll see later, it may provide access to many pluggable databases and “open” and “close” them multiple times; however, it will only ever open a single self-contained database.
- A database may be mounted and opened by one or more instances (using RAC) and the number of instances mounting a single database can fluctuate over time.

As noted earlier, in most cases there's a one-to-one relationship between an instance and a database. This is probably why the confusion surrounding the terms arises. In most peoples' experiences, a database is an instance, and an instance is a database.

In many test environments, however, this is not the case. On my disk, I might have five separate databases. On the test machine, at any point in time there is only one instance of Oracle running, but the database it is accessing may be different from day to day or hour to hour, depending on my needs. By simply having many different parameter files, I can mount and open any one of these databases. Here, I have one instance at a time but many databases, only one of which is accessible at any time.

So now when people talk about an instance, you'll know they mean the processes and memory of Oracle. When they mention the database, they are talking about the physical files that hold the data. A database may be accessible from many instances, but an instance will provide access to exactly one database (single-tenant or container database) at a time.

## The SGA and Background Processes

You're probably ready now for an abstract picture of what an Oracle instance and database look like, so take a look at Figure 2-1.

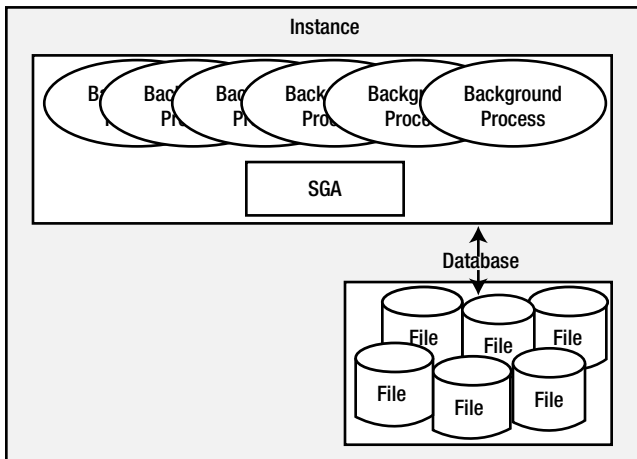

**Figure 2-1.** Oracle instance and database

Figure 2-1 shows an Oracle instance and database in their simplest form. Oracle has a large chunk of memory called the SGA that it uses, for example, to do the following:

- Maintain many internal data structures that all processes need access to.
- Cache data from disk; buffer redo data before writing it to disk.
- Hold parsed SQL plans.
- And so on.

Oracle has a set of processes that are “attached” to this SGA, and the mechanism by which they attach differs by operating system. In a UNIX/Linux environment, the processes will physically attach to a large shared memory segment, a chunk of memory allocated in the OS that may be accessed by many processes concurrently (generally using `shmget()` and `shmat()`).

Under Windows, these processes simply use the C call, `malloc()` to allocate the memory, since they are really threads in one big process and hence share the same virtual memory space.

Oracle also has a set of files that the database processes or threads read and write (and Oracle processes are the only ones allowed to read or write these files). In a single-tenant architecture, these files hold all of our table data, indexes, temporary space, redo logs, PL/SQL code, and so on. In a multitenant architecture, the container database will hold all of the Oracle-related metadata, data, and code; our application data will be separately contained in a pluggable database, which we have yet to create. The database we created earlier is a single-tenant database by default; it does not have pluggable databases enabled. The self-contained set of files includes data files that contain both the Oracle data, as well as the application data.

If you were to start up Oracle on a UNIX/Linux-based system and execute a `ps` command, you'd see that many physical processes are running, with various names. You saw an example of that earlier when you observed the `pmon`, `smon`, and other processes. I cover these processes in Chapter 5, so just be aware for now that they are commonly referred to as the *Oracle background processes*. They are persistent processes that make up the instance, and you'll see them from the time you start the instance until you shut it down.

It is interesting to note that these are processes, not individual programs. There is only one Oracle binary executable on UNIX/Linux; it has many “personalities,” depending on what it was told to do when it starts up. The same binary executable that was run to start `ora_pmon_ora12c` was also used to start the process `ora_ckpt_ora12c`. There is only one binary executable program, named simply `oracle`. It is just executed many times with different names.

On Windows, using the `psstat` tool (part of the Windows XP Resource Kit; search for “psstat download” using your favorite search engine if you don't have it), we'll find only one process, `oracle.exe`. Again, on Windows there is only one binary executable (`oracle.exe`). Within this process, we'll find many threads representing the Oracle background processes.

Using `psstat` (or any of a number of tools, such as `tasklist`, which comes with many Windows versions), we can see these processes:

```
C:\WINDOWS> psstat
```

```
Pstat version 0.3: memory: 523760 kb uptime: 0 1:37:54.375
```

```
PageFile: \\??\C:\pagefile.sys
```

```
Current Size: 678912 kb Total Used: 228316 kb Peak Used 605488 kb
```

```
Memory: 523760K Avail: 224492K TotalWs: 276932K InRam Kernel: 872K P:20540K
```

```
Commit: 418468K/ 372204K Limit:1169048K Peak:1187396K Pool N:10620K P:24588K
```

User Time	Kernel Time	Ws	Faults	Commit	Pri	Hnd	Thd	Pid	Name
		56860	2348193						File Cache
0:00:00.000	1:02:23.109	28	0	0	0	0	1	0	Idle Process
0:00:00.000	0:01:50.812	32	4385	28	8	694	52	4	System
0:00:00.015	0:00:00.109	60	224	172	11	19	3	332	smss.exe
0:00:33.234	0:00:32.046	2144	33467	1980	13	396	14	556	csrss.exe
0:00:00.343	0:00:01.750	3684	6811	7792	13	578	20	580	winlogon.exe
0:00:00.078	0:00:01.734	1948	3022	1680	9	275	16	624	services.exe
0:00:00.218	0:00:03.515	1896	5958	3932	9	363	25	636	lsass.exe
0:00:00.015	0:00:00.078	80	804	592	8	25	1	812	vmacthlp.exe
0:00:00.093	0:00:00.359	1416	2765	3016	8	195	17	828	svchost.exe
0:00:00.062	0:00:00.453	1340	3566	1764	8	244	10	896	svchost.exe
0:00:00.828	0:01:16.593	9632	36387	11708	8	1206	59	1024	svchost.exe
0:00:00.046	0:00:00.640	1020	2315	1300	8	81	6	1100	svchost.exe
0:00:00.015	0:00:00.234	736	2330	1492	8	165	11	1272	svchost.exe
0:00:00.015	0:00:00.218	128	1959	3788	8	117	10	1440	spoolsv.exe
0:00:01.312	0:00:19.828	13636	35525	14732	8	575	19	1952	explorer.exe
0:00:00.250	0:00:00.937	956	1705	856	8	29	1	228	VMwareTray.exe
0:00:00.812	0:00:04.562	1044	4619	3800	8	165	4	240	VMwareUser.exe



```

0:00:00.015  0:00:00.156      88    1049    1192    8    88    4    396  svchost.exe
0:00:00.109  0:00:04.640      744    1229    2432    8    81    3    460  cvpnd.exe
0:00:02.015  0:00:12.078     1476   17578   1904   13   139    3    600  VMwareService.exe
0:00:00.031  0:00:00.093      124    1004    1172    8   105    6    192  alg.exe
0:00:00.062  0:00:00.937     2648   13977   22656    8   101    3    720  TNSLSNR.EXE
0:04:00.359  0:02:57.734  164844  2009785  279168    8  550  29 1928  oracle.exe
0:00:00.093  0:00:00.437     6736    2316    2720    8   141    6  1224  msiexec.exe
0:00:00.015  0:00:00.031     2668    701    1992    8    34    1    804  cmd.exe
0:00:00.015  0:00:00.000     964     235     336    8    11    1  2856  pstat.exe

```

Here we can see there are 29 threads (Thd in the display) contained in the single Oracle process. These threads represent what were processes on UNIX/Linux—they are the `pmon`, `arch`, `lgwr`, and so on. They each represent a separate bit of the Oracle process. Paging down through the `pstat` report, we can see more details about each thread:

```

pid:788 pri: 8 Hnd: 550 Pf:2009785 Ws: 164844K oracle.exe
tid pri Ctx Swtch StrtAddr  User Time  Kernel Time State
498  9      651 7C810705  0:00:00.000  0:00:00.203 Wait:Executive
164  8      91 7C8106F9  0:00:00.000  0:00:00.000 Wait:UserRequest
...
a68  8      42 7C8106F9  0:00:00.000  0:00:00.031 Wait:UserRequest

```

We can't see the thread "names" like we could on UNIX/Linux (`ora_pmon_ora12c` and so on), but we can see the thread IDs (Tid), priorities (Pri), and other operating system accounting information about them.

## Connecting to Oracle

In this section, we'll take a look at the mechanics behind the two most common ways to have requests serviced by an Oracle server: *dedicated server* and *shared server* connections. We'll see what happens on the client and the server in order to establish connections, so we can log in and actually do work in the database. Lastly, we'll take a brief look at how to establish TCP/IP connections; TCP/IP is the primary networking protocol used to connect over the network to Oracle. And we'll look at how the listener process on our server, which is responsible for establishing the physical connection to the server, works differently in the cases of dedicated and shared server connections.

### Dedicated Server

Figure 2-1 and the following `ps` output present a picture of what an Oracle database named `ora12cr1` might look like immediately after starting.

```

[tkyte@dellpe]$ ps -aef | grep _$ORACLE_SID
ora12cr1 19607      1  0 15:16 ?          00:00:00 ora_pmon_ora12cr1
ora12cr1 19609      1  0 15:16 ?          00:00:00 ora_psp0_ora12cr1
ora12cr1 19611      1  0 15:16 ?          00:00:00 ora_vktm_ora12cr1
ora12cr1 19615      1  0 15:16 ?          00:00:00 ora_gen0_ora12cr1
ora12cr1 19617      1  1 15:16 ?          00:00:00 ora_mman_ora12cr1
ora12cr1 19621      1  0 15:16 ?          00:00:00 ora_diag_ora12cr1
ora12cr1 19623      1  0 15:16 ?          00:00:00 ora_dbwm_ora12cr1
ora12cr1 19625      1  0 15:16 ?          00:00:00 ora_dia0_ora12cr1
ora12cr1 19627      1  0 15:16 ?          00:00:00 ora_dbw0_ora12cr1
ora12cr1 19629      1  0 15:16 ?          00:00:00 ora_lgwr_ora12cr1
ora12cr1 19631      1  0 15:16 ?          00:00:00 ora_ckpt_ora12cr1

```

```

ora12cr1 19633      1 0 15:16 ?      00:00:00 ora_lg00_ora12cr1
ora12cr1 19635      1 0 15:16 ?      00:00:00 ora_lg01_ora12cr1
ora12cr1 19637      1 0 15:16 ?      00:00:00 ora_smon_ora12cr1
ora12cr1 19639      1 0 15:16 ?      00:00:00 ora_reco_ora12cr1
ora12cr1 19641      1 0 15:16 ?      00:00:00 ora_lreg_ora12cr1
ora12cr1 19643      1 1 15:16 ?      00:00:00 ora_mmon_ora12cr1
ora12cr1 19645      1 0 15:16 ?      00:00:00 ora_mml_ora12cr1
ora12cr1 19647      1 0 15:16 ?      00:00:00 ora_d000_ora12cr1
ora12cr1 19649      1 0 15:16 ?      00:00:00 ora_s000_ora12cr1
ora12cr1 19661      1 0 15:16 ?      00:00:00 ora_tmon_ora12cr1
ora12cr1 19663      1 0 15:16 ?      00:00:00 ora_tt00_ora12cr1
ora12cr1 19665      1 0 15:16 ?      00:00:00 ora_smco_ora12cr1
ora12cr1 19667      1 0 15:16 ?      00:00:00 ora_fbda_ora12cr1
ora12cr1 19671      1 0 15:16 ?      00:00:00 ora_aqpc_ora12cr1
ora12cr1 19675      1 0 15:16 ?      00:00:00 ora_cjq0_ora12cr1
ora12cr1 19705      1 0 15:16 ?      00:00:00 ora_w000_ora12cr1
ora12cr1 19708      1 0 15:16 ?      00:00:00 ora_qm02_ora12cr1
ora12cr1 19710      1 0 15:16 ?      00:00:00 ora_qm03_ora12cr1
ora12cr1 19712      1 0 15:16 ?      00:00:00 ora_q002_ora12cr1
ora12cr1 19714      1 0 15:16 ?      00:00:00 ora_q003_ora12cr1
tkyte    19720 15416 0 15:16 pts/1    00:00:00 grep_ora12cr1

```

If we were now to log into this database using a dedicated server, we would see a new process (or a thread on some other operating systems) get created just to service us:

```

OPS$TKYTE@ORA12CR1> !ps -aef | grep $ORACLE_SID
ora12cr1 19607      1 0 15:16 ?      00:00:00 ora_pmon_ora12cr1
ora12cr1 19609      1 0 15:16 ?      00:00:00 ora_psp0_ora12cr1
ora12cr1 19611      1 0 15:16 ?      00:00:00 ora_vktm_ora12cr1
ora12cr1 19615      1 0 15:16 ?      00:00:00 ora_gen0_ora12cr1
ora12cr1 19617      1 0 15:16 ?      00:00:00 ora_mman_ora12cr1
ora12cr1 19621      1 0 15:16 ?      00:00:00 ora_diag_ora12cr1
ora12cr1 19623      1 0 15:16 ?      00:00:00 ora_dbrm_ora12cr1
ora12cr1 19625      1 0 15:16 ?      00:00:00 ora_dia0_ora12cr1
ora12cr1 19627      1 0 15:16 ?      00:00:00 ora_dbw0_ora12cr1
ora12cr1 19629      1 0 15:16 ?      00:00:00 ora_lgwr_ora12cr1
ora12cr1 19631      1 0 15:16 ?      00:00:00 ora_ckpt_ora12cr1
ora12cr1 19633      1 0 15:16 ?      00:00:00 ora_lg00_ora12cr1
ora12cr1 19635      1 0 15:16 ?      00:00:00 ora_lg01_ora12cr1
ora12cr1 19637      1 0 15:16 ?      00:00:00 ora_smon_ora12cr1
ora12cr1 19639      1 0 15:16 ?      00:00:00 ora_reco_ora12cr1
ora12cr1 19641      1 0 15:16 ?      00:00:00 ora_lreg_ora12cr1
ora12cr1 19643      1 0 15:16 ?      00:00:00 ora_mmon_ora12cr1
ora12cr1 19645      1 0 15:16 ?      00:00:00 ora_mml_ora12cr1
ora12cr1 19647      1 0 15:16 ?      00:00:00 ora_d000_ora12cr1
ora12cr1 19649      1 0 15:16 ?      00:00:00 ora_s000_ora12cr1
ora12cr1 19661      1 0 15:16 ?      00:00:00 ora_tmon_ora12cr1
ora12cr1 19663      1 0 15:16 ?      00:00:00 ora_tt00_ora12cr1
ora12cr1 19665      1 0 15:16 ?      00:00:00 ora_smco_ora12cr1
ora12cr1 19667      1 0 15:16 ?      00:00:00 ora_fbda_ora12cr1
ora12cr1 19671      1 0 15:16 ?      00:00:00 ora_aqpc_ora12cr1

```

```

ora12cr1 19675      1 0 15:16 ?          00:00:00 ora_cjq0_ora12cr1
ora12cr1 19705      1 0 15:16 ?          00:00:00 ora_w000_ora12cr1
ora12cr1 19708      1 0 15:16 ?          00:00:00 ora_qm02_ora12cr1
ora12cr1 19712      1 0 15:16 ?          00:00:00 ora_q002_ora12cr1
ora12cr1 19714      1 0 15:16 ?          00:00:00 ora_q003_ora12cr1
tkyte    19732 19731  0 15:17 pts/0      00:00:00 /home/ora12cr1/app/ora12cr1/product/12.1.0/dbhome_1/
bin/sqlplus
ora12cr1 19733 19732  0 15:17 ?          00:00:00 oracleora12cr1 (DESCRIPTION=(LOCAL=YES)
(ADDRESS=(PROTOCOL=beq)))
tkyte    19744 19742  0 15:18 pts/0      00:00:00 grep ora12cr1

```

Now you can see that there is a new process, `oracleora12cr1`, created as our dedicated server process. When we log out, the extra thread/process will go away.

This brings us to the next iteration of our diagram. If we were to connect to Oracle in its most commonly used configuration, we would see something like Figure 2-2.

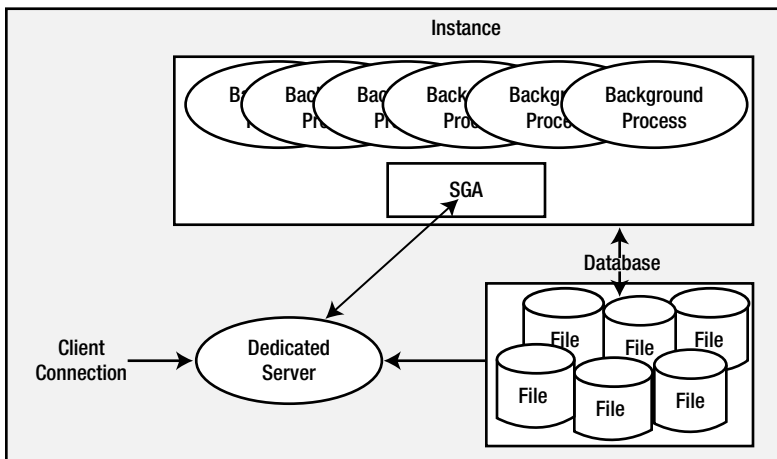

**Figure 2-2.** Typical dedicated server configuration

As noted, typically Oracle will create a new process for me when I log in. This is commonly referred to as the dedicated server configuration, since a server process will be dedicated to me for the life of my session. For each session, a new dedicated server will appear in a one-to-one mapping. This dedicated server process is not (by definition) part of the instance. My client process (whatever program is trying to connect to the database) will be in direct communication with this dedicated server over some networking conduit, such as a TCP/IP socket. It is this server process that will receive my SQL and execute it for me. It will read data files if necessary, and it will look in the database's cache for my data. It will perform my update statements. It will run my PL/SQL code. Its only goal is to respond to the SQL calls I submit to it.

## Shared Server

Oracle can also accept connections in a manner called *shared server*, in which you wouldn't see an additional thread created or a new UNIX/Linux process appear for each user connection.

■ **Note** In Version 7.x and 8.x of Oracle, shared server was known as *multithreaded server* or *MTS*. That legacy name is not in use anymore.

In a shared server, Oracle uses a pool of shared processes for a large community of users. Shared servers are simply a connection pooling mechanism. Instead of having 10,000 dedicated servers (that’s a lot of processes or threads) for 10,000 database sessions, a shared server lets us have a small percentage of these processes or threads, which are (as the name implies) shared by all sessions. This allows Oracle to connect many more users to the instance than would otherwise be possible. Our machine might crumble under the load of managing 10,000 processes, but managing 100 or 1,000 processes is doable. In shared server mode, the shared processes are generally started up with the database and appear in the ps list.

A big difference between shared and dedicated server connections is that the client process connected to the database never talks directly to a shared server, as it would to a dedicated server. It can’t talk to a shared server because that process is, in fact, shared. In order to share these processes, we need another mechanism through which to “talk.” Oracle employs a process (or set of processes) called a *dispatcher* for this purpose. The client process will talk to a dispatcher process over the network. The dispatcher process will put the client’s request into the request queue in the SGA (one of the many things the SGA is used for). The first shared server that is not busy will pick up this request and process it (e.g., the request could be `UPDATE T SET X = X+5 WHERE Y = 2`). Upon completion of this command, the shared server will place the response in the invoking dispatcher’s response queue. The dispatcher process monitors this queue and, upon seeing a result, will transmit it to the client. Conceptually, the flow of a shared server request looks like Figure 2-3.

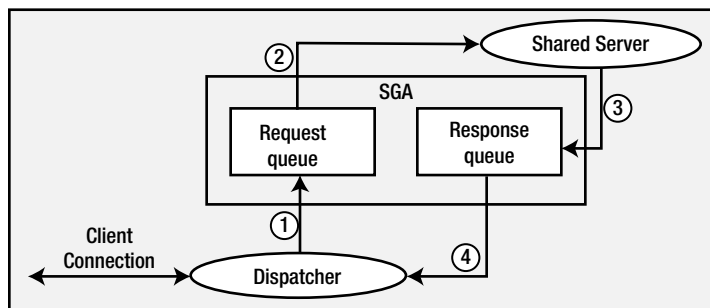

**Figure 2-3.** Steps in a shared server request

As shown in Figure 2-3, the client connection will send a request to the dispatcher. The dispatcher will first place this request onto the request queue in the SGA (1). The first available shared server will dequeue this request (2) and process it. When the shared server completes, the response (return codes, data, and so on) is placed into the response queue (3), subsequently picked up by the dispatcher (4), and transmitted back to the client.

As far as the developer is concerned, there is conceptually no difference between a shared server connection and a dedicated server connection. Architecturally they are quite different, but that’s not apparent to an application.

Now that you understand what dedicated server and shared server connections are, you may have the following questions:

- How do I get connected in the first place?
- What would start this dedicated server?
- How might I get in touch with a dispatcher?

The answers depend on your specific platform, but the sections that follow outline the process in general terms.

## Mechanics of Connecting over TCP/IP

We'll investigate the most common networking case: a network-based connection request over TCP/IP. In this case, the client is situated on one machine and the server resides on another, with the two connected on a TCP/IP network. It all starts with the client. The client makes a request using the Oracle client software (a set of provided application program interfaces, or APIs) to connect to a database. For example, the client issues the following:

```
[tkyte@dellpe ~]$ sqlplus scott/tiger@ora12cr1
SQL*Plus: Release 12.1.0.1.0 Production on Mon Sep 2 15:25:06 2013

Copyright (c) 1982, 2013, Oracle. All rights reserved.

Last Successful login time: Mon Sep 02 2013 13:44:49 -04:00

Connected to:
Oracle Database 12c Enterprise Edition Release 12.1.0.1.0 - 64bit Production
With the Partitioning, OLAP, Advanced Analytics and Real Application Testing options

SCOTT@ORA12CR1>
```

---

■ **Note** The string `ora12cr1` used here is unique to my configuration. I have a `tnsnames.ora` entry (more on that next) named `ora12cr1`. It is a TNS connect string that points to an existing, installed and configured Oracle 12c Release 1 instance on my network. You will be using your own TNS connect strings, unique to your installation.

---

Here, the client is the program SQL\*Plus, `scott/tiger` is the username and password, and `ora12cr1` is a TNS service name. TNS stands for Transparent Network Substrate and is “foundation” software built into the Oracle client that handles remote connections, allowing for peer-to-peer communication. The TNS connection string tells the Oracle software how to connect to the remote database. Generally, the client software running on your machine will read a file called `tnsnames.ora`. This is a plain-text configuration file commonly found in the `$ORACLE_HOME/network/admin` directory (`$ORACLE_HOME` represents the full path to your Oracle installation directory). It will have entries that look like this:

```
SCOTT@ORA12CR1> !cat $ORACLE_HOME/network/admin/tnsnames.ora
# tnsnames.ora Network Configuration File: /home/ora12cr1/app/ora12cr1/product/12.1.0/dbhome_1/
network/admin/tnsnames.ora
# Generated by Oracle configuration tools.

ORA12CR1 =
  (DESCRIPTION =
    (ADDRESS = (PROTOCOL = TCP)(HOST = somehost.somewhere.com)(PORT = 1521))
    (CONNECT_DATA =
      (SERVER = DEDICATED)
      (SERVICE_NAME = ora12cr1)
    )
  )
```

This configuration information allows the Oracle client software to map the TNS connection string we used, `ora12cr1`, into something useful—namely, a hostname, a port on that host on which a listener process will accept connections, the service name of the database on the host to which we wish to connect, and so on. A service name represents groups of applications with common attributes, service level thresholds, and priorities. The number of instances offering the service is transparent to the application, and each database instance may register with the listener as willing to provide many services. So, services are mapped to physical database instances and allow the DBA to associate certain thresholds and priorities with them.

This string, `ora12cr1`, could have been resolved in other ways. For example, it could have been resolved using a naming service provided by the Lightweight Directory Access Protocol (LDAP) server, similar in purpose to DNS for hostname resolution. However, use of the `tnsnames.ora` file is common in most small to medium installations (as measured by the number of hosts that need to connect to the database) where the number of copies of such a configuration file is manageable.

## EASY CONNECT

The easy connect method allows you to connect to a remote database without the need of a `tnsnames.ora` file (or other methods of resolving the location of the database). If you know the name of the host, server, port, and service name, you can directly enter those on the command line. The syntax is as follows:

```
sqlplus username@[//]host[:port][/service_name][:server][/instance_name]
```

For example, assuming the host name is `hesta`, the port is `1521`, and the service name is `ora12cr1`, then you can connect as follows:

```
$ sqlplus user/pass@hesta:1521/ora12cr1
```

The easy connect method is handy for situations in which you're troubleshooting connectivity issues or when you don't have a `tnsnames.ora` file available (or other ways to resolve the remote connection).

Now that the client software knows where to connect to, it will open a TCP/IP socket connection to the server with the hostname `somehost.somewhere.com` on port `1521` (this is the default listener port, and can be configured to run on other ports). If the DBA for our server has installed and configured Oracle Net, and has the listener listening on port `1521` for connection requests, this connection may be accepted. In a network environment, we will be running a process called the TNS listener on our server. This listener process is what will get us physically connected to our database. When it receives the inbound connection request, it inspects the request and, using its own configuration files, either rejects the request (because there is no such service, for example, or perhaps our IP address has been disallowed connections to this host) or accepts it and goes about getting us connected.

If we are making a dedicated server connection, the listener process will create a dedicated server for us. On UNIX/Linux, this is achieved via `fork()` and `exec()` system calls (the only way to create a new process after initialization in UNIX/Linux is via `fork()`). The new dedicated server process inherits the connection established by the listener, and we are now physically connected to the database. On Windows, the listener process requests the database process to create a new thread for a connection. Once this thread is created, the client is “redirected” to it, and we are physically connected. Diagrammatically in UNIX/Linux, it would look as shown in Figure 2-4.

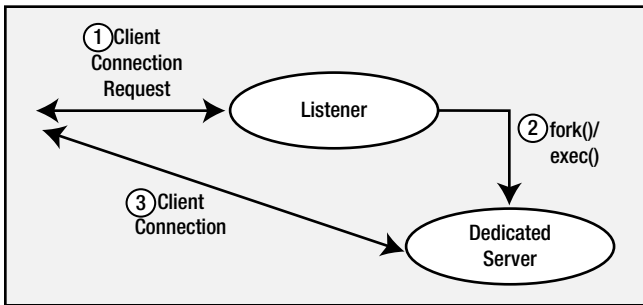

**Figure 2-4.** The listener process and dedicated server connections

However, the listener will behave differently if we are making a shared server connection request. This listener process knows the dispatcher(s) we have running in the instance. As connection requests are received, the listener will choose a dispatcher process from the pool of available dispatchers. The listener will either send back to the client the connection information describing how the client can connect to the dispatcher process or, if possible, hand off the connection to the dispatcher process (this is OS- and database version-dependent, but the net effect is the same). When the listener sends back the connection information, it is done because the listener is running on a well-known hostname and port on that host, but the dispatchers also accept connections on randomly assigned ports on that server. The listener is made aware of these random port assignments by the dispatcher and will pick a dispatcher for us. The client then disconnects from the listener and connects directly to the dispatcher. We now have a physical connection to the database. Figure 2-5 illustrates this process.

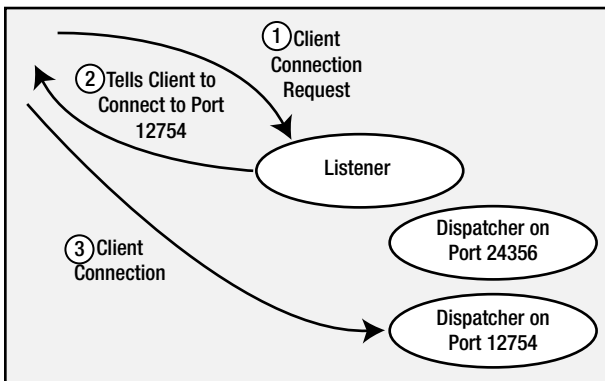

**Figure 2-5.** The listener process and shared server connections

## Pluggable Databases

Starting with Oracle Database 12c, a new approach to the concept of a “database” was introduced. So far in this chapter, we have concentrated on the single-tenant or container databases and their association with instances (a database may have one or more instances; an instance will mount and open, at most, a single database). We are now ready to look at the concept of a pluggable database—what it is and how it operates. Pluggable databases in the multitenant architecture are non-self-contained sets of data files that consist purely of application data and metadata. There is no Oracle-specific data/metadata in them; that information is in the container database that they are currently associated with. A pluggable database—in order to be used, to be queried—must be associated with a container database. That container database will only have Oracle data and metadata in it—just the information Oracle needs to “run.” The pluggable databases have the “rest” of the database metadata and data.

So, for example, the container database would have the definition of the “SYS” user (the metadata for the SYS user) and the compiled code and source code for objects like DBMS\_OUTPUT and UTL\_FILE. A pluggable database, on the other hand, would have the definition of an application schema like SCOTT, all of the metadata describing the tables in the SCOTT schema, all of the PL/SQL source code for the SCOTT schema, all of the GRANTS granted to the SCOTT schema, and so on. In short, a pluggable database has everything that describes a set of application schemas—the metadata for the accounts, the metadata for the tables in those accounts, and the actual data for those tables. A pluggable database is self-contained with respect to the application accounts it contains, but it needs a container database to be “opened” and queried. Therefore, you can say that a pluggable database is not “self-contained,” it needs something else in order to be opened and used.

A pluggable database is not directly opened by an instance, but rather an Oracle instance must be started and a container database mounted and opened by that instance. Once the container instance is up and running, and the container database is opened, that container database may open as many as 250 separate pluggable databases. Each of these pluggable databases acts as if it were a “stand-alone” database. That is, they appear to be self-contained, stand-alone “single tenant” databases. But they all share the same container database and container instance.

The main goals of the pluggable database, the multitenant architecture, are twofold:

- To measurably reduce the amount of resources it takes to host many databases—many applications—on a single host.
- To reduce the maintenance work performed by the DBA to manage many databases—many applications—on a single host.

## Reduced Resource Utilization

As you’ve already seen, when you start an Oracle instance, there are many processes associated with it. In Chapter 5 you’ll be introduced to each of them and see what they do; but as you can see, each instance is supported by some 20 to 40 processes. If you attempted to start up 50 single-tenant databases—where each database has an instance associated with it, or its own instance—you would have upward of 1,000 processes just to get the databases started! That is extremely taxing on the operating system, both to create that many processes and then to manage them.

Additionally, each instance would have its own SGA. Chapter 4 will cover what is in the SGA, but suffice it to say, there is a lot of duplication. Each SGA would have a cached copy of DBMS\_OUTPUT in its shared pool, and each SGA would have a redo log buffer and many other duplicative data structures.

With pluggable databases, you can have the separation of application metadata, users, data, code, and so on, but avoid the redundant instances. That is, you can have a single instance with a single container database (the Oracle metadata, code, and data) that provides access to as many as 250 pluggable databases, each hosting a separate application. Instead of 1,000 processes to start up 50 separate application databases, you can have 51 databases (one container and 50 application databases) sharing the same 20 to 40 processes. That’s a massive reduction in server resource utilization. Additionally, they all share a common SGA, allowing the repetitive parts of the 50 separate SGAs that would normally have to be shared. In general, the size of the single SGA you would allocate for these 50 application databases will be smaller than the sum of the 50 separate SGAs you would have to allocate otherwise.

## Reduced Maintenance

If a DBA were tasked with managing 50 separate databases using the single-tenant architecture, she would have 50 databases to backup, monitor, manage, patch, upgrade, and so on. Each database would be managed independent from every other database. In the multitenant architecture, there is a single “database” she would need to backup, monitor, manage, patch, upgrade and so on. For example, the act of patching an Oracle database involves updating the Oracle executables (updating the instance) and updating the Oracle metadata—the Oracle data dictionary. When a DBA patches a database, she does not touch any of the underlying application metadata, schemas, data, code, and so on—she only touches the Oracle instance and the Oracle metadata, data, and code.



Under the multitenant architecture, each of the 50 pluggable databases containing the application data share a common instance; hence when the DBA patches the instance, all 50 pluggable databases are patched instance wise. Likewise, when the DBA patches the container database, the self-contained set of files that hold the Oracle metadata, code, and data, all 50 pluggable databases inherit those updates. They share that Oracle metadata, code, and data. So the act of patching a single container database would, in fact, patch all of the underlying pluggable databases.

If that is not desirable (patching all 50 at once), an alternative approach can be applied. Instead of patching the existing container database, the DBA can just create a new container database that is patched. So now there are two Oracle instances with two container databases: one at version X and the other at version Y. In order to patch a pluggable database, the DBA “unplugs” it from the container database to which it is currently attached. Unplugging creates an XML manifest file that describes the files belonging to that pluggable database. Then, the DBA “plugs” that pluggable data into the new container database. The act of unplugging a pluggable database is very lightweight and fast—all that needs to be done is to create the XML manifest file. The act of plugging in a database is likewise lightweight and fast—the XML manifest file is read, the files associated with the pluggable database are registered with the container database, and the pluggable database can be used again. The pluggable database is patched or upgraded simply by plugging it into a container database that is patched. The DBA has one container database to manage, patch, upgrade, and so on. The pluggable databases just inherit that work.

## How Is a Pluggable Database Different?

From the perspective of a developer, a pluggable database is no different from a single-tenant database. The application connects to the database in exactly the same way it would connect to a single-tenant database in earlier releases. The earlier examples of creating connections, using shared servers, and using dedicated servers all still apply. The differences lie in the underlying architecture—that of a single instance for many pluggable databases, and the resulting reduced resource utilization on the server and the ease of management for the DBA.

From a DBA perspective, there are many changes in the way a database is administered—positive changes. For example, if a DBA configured a container database for RAC, every pluggable database under that container would be RAC enabled. The same with Data Guard, RMAN backups, and so on. The DBA has one instance to configure and work with, instead of one instance per application as in the past.

## Summary

This completes our overview of the Oracle architecture. In this chapter, we defined the terms *instance*, *database*, and *pluggable database*, and saw how to connect to the database through either a dedicated server connection or a shared server connection. Figure 2-6 sums up the material covered in the chapter and shows the interaction between a client using a shared server connection and a client using a dedicated server connection. It also shows that an Oracle instance may use both connection types simultaneously. (In fact, an Oracle database always supports dedicated server connections—even when configured for shared server.)

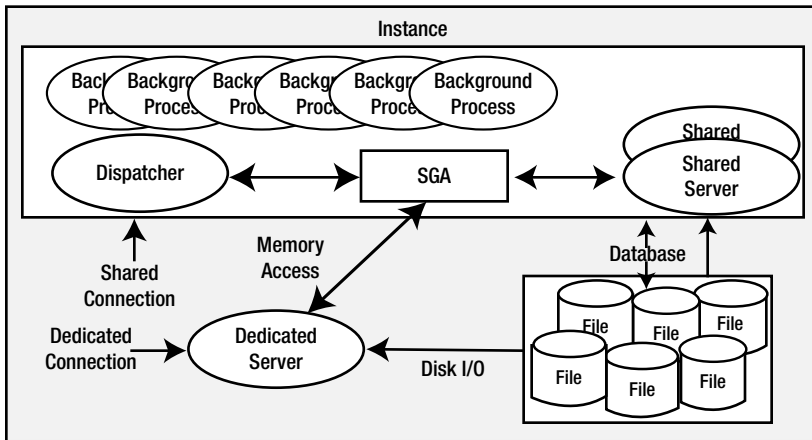

**Figure 2-6.** Connection overview

Now you're ready to take a more in-depth look at the files that comprise the database and the processes behind the server—what they do and how they interact with each other. You're also ready to look inside the SGA to see what it contains and what its purpose is. You'll start in the next chapter by looking at the types of files Oracle uses to manage the data, and the role of each file type.

## CHAPTER 3



# Files

In this chapter, we will examine the eight major file types that make up a database and instance. The files associated with an instance are simply

- *Parameter files*: These files tell the Oracle instance where to find the control files, and they also specify certain initialization parameters that define how big certain memory structures are, and so on. We will investigate the two options available for storing database parameter files.
- *Trace files*: These are diagnostic files created by a server process, generally in response to some exceptional error condition.
- *Alert files*: These are similar to trace files, but they contain information about “expected” events, and they also alert the DBA in a single, centralized file of many database events.

The files that make up the database are

- *Data files*: These are for the database; they hold your tables, indexes, and all other data segment types.
- *Temp files*: These are used for disk-based sorts and temporary storage.
- *Control files*: These tell you where the data files, temp files, and redo log files are, as well as other relevant metadata about their state. They also contain backup information maintained by RMAN (Recovery Manager, the backup and recovery tool).
- *Redo log files*: These are your transaction logs.
- *Password files*: These are used to authenticate users performing administrative activities over the network. We will not discuss these files in any great detail as they are not a necessary component of any Oracle database.

In Oracle 10g and above, there are a couple of optional file types that are used by Oracle to facilitate faster backup and faster recovery operations. These two files are

- *Change-tracking file*: This file facilitates a true incremental backup of Oracle data. It does not have to be located in the Fast Recovery Area, but as it relates purely to database backup and recovery, we’ll discuss it in the context of that area.
- *Flashback log files*: These files store “before images” of database blocks in order to facilitate the FLASHBACK DATABASE command.

We'll also take a look at other types of files commonly associated with the database, such as

- *Dump (DMP) files*: These files are generated by the Export database utility and consumed by the Import database utility. It should be noted that the Export utility is deprecated in current releases of Oracle—only Import is fully supported. Import is supported to facilitate the moving of data from older releases of Oracle (where Export was fully supported) into newer releases of the database.
- *Data Pump files*: These files are generated by the Oracle Data Pump Export process and consumed by the Data Pump Import process. This file format may also be created and consumed by external tables.
- *Flat files*: These are plain old files you can view in a text editor. You normally use these for loading data into the database.

The most important files in these lists are the data files and the redo log files, because they contain the data you worked so hard to accumulate. I can lose any and all of the remaining files and still get to my data. If I lose my redo log files, I may start to lose some data. If I lose my data files and all of their backups, I've definitely lost that data forever.

We will now take a look at the types of files, where they are usually located, how they are named, and what we might expect to find in them.

## Parameter Files

There are many different parameter files associated with an Oracle database, from a `tnsnames.ora` file on a client workstation (used to “find” a server on the network), to a `listener.ora` file on the server (for the network listener startup), to the `sqlnet.ora`, `cman.ora`, and `ldap.ora` files, to name a few. The most important parameter file, however, is the database's parameter file—without this, we can't even get an instance started, as demonstrated in Chapter 2. The remaining files are important; they are all related to networking and getting connected to the database. However, they are beyond the scope of our discussion. For information on their configuration and setup, I refer you to the *Net Services Administrator's Guide*. Since you're a developer, typically these files would be set up for you, not by you.

The parameter file for a database is commonly known as an init file, or an `init.ora` file. This is due to its historic default name, which is `init<ORACLE_SID>.ora`. I call it “historic” because starting with Oracle9i Release 1, a vastly improved method of storing parameter settings for the database was introduced: the server parameter file, or simply SPFILE. This file has the default name of `spfile<ORACLE_SID>.ora`. We'll take a look at both kinds of parameter files.

---

■ **Note** For those who are unfamiliar with the term SID or ORACLE\_SID, a full definition is called for. The SID is a *site identifier*. It and ORACLE\_HOME (where the Oracle software is installed) are hashed together in UNIX/Linux to create a unique key name for creating or attaching a Shared Global Area (SGA) memory region. If your ORACLE\_SID or ORACLE\_HOME is not set correctly and you are using a local (not network based) connection (see Chapter 2 for details on local/remote connections), you'll get the ORACLE NOT AVAILABLE error, since you can't attach to a shared memory segment that is identified by this unique key. On Windows, shared memory isn't used in the same fashion as on UNIX/Linux, but the SID is still important. You can have more than one database under the same ORACLE\_HOME, so you need a way to uniquely identify the instance associated with each one, along with their configuration files.

---

Without a parameter file, you can't start an Oracle database. This makes the parameter file fairly important, and as of Oracle9i Release 2 (versions 9.2 and above), the backup and recovery tool Recovery Manager (RMAN) recognizes this file's importance and will allow you to include the server parameter file (but not the legacy `init.ora` parameter file type) in your backup set. However, since the `init.ora` file is simply a plain text file that you can create

with any text editor, it is not a file you have to necessarily guard with your life. You can re-create it, as long as you know what was in it (e.g., you can retrieve that information from the database's alert log, if you have access to that, and reconstruct your entire `init.ora` parameter file).

We will now examine both types of database startup parameter files (`init.ora` and `SPFILE`) in turn, but before we do that, let's see what a database parameter file looks like.

## What Are Parameters?

In simple terms, a database parameter may be thought of as a key/value pair. You saw an important parameter, `db_name`, in the preceding chapter. The `db_name` parameter was stored as `db_name = ora12c`. The key here is `db_name` and the value is `ora12c`. This is our key/value pair. To see the current value of an instance parameter, you can query the `V$` view `V$PARAMETER`. Alternatively, in `SQL*Plus` you can use the `SHOW PARAMETER` command, for example:

```
EODA@ORA12CR1> select value
 2   from v$parameter
 3   where name = 'db_block_size'
 4   /
```

```
VALUE
-----
8192
```

```
EODA@ORA12CR1> show parameter db_block_s
```

NAME	TYPE	VALUE
db_block_size	integer	8192

Both outputs show basically the same information, although you can get more information from `V$PARAMETER` (there are many more columns to choose from than displayed in this example). But `SHOW PARAMETER` wins for me in ease of use and the fact that it “wildcards” automatically. Notice that I typed in only `db_block_s`; `SHOW PARAMETER` adds `%` to the front and back.

---

■ **Note** All `v$` views and all dictionary views are fully documented in the *Oracle Database Reference* manual. Please regard that manual as the definitive source of what is available in a given view.

---

If you were to execute the preceding example as a less-privileged user (EODA has been granted the DBA role for purposes of this book), you would see instead:

```
EODA@ORA12CR1> connect scott/tiger
Connected.
```

```
SCOTT@ORA12CR1> select value
 2   from v$parameter
 3   where name = 'db_block_size'
 4   /
from v$parameter
*
```

```
ERROR at line 2:
ORA-00942: table or view does not exist
```

```
SCOTT@ORA12CR1> show parameter db_block_s
ORA-00942: table or view does not exist
```

“Normal” accounts are not granted access to the V\$ performance views by default. Don’t let that get you down, however. There is a documented API typically available to all users that permits you to see the contents of V\$PARAMETER; this little helper function helps you see what is set as a parameter. For example:

```
SCOTT@ORA12CR1> create or replace
 2 function get_param( p_name in varchar2 )
 3 return varchar2
 4 as
 5     l_param_type number;
 6     l_intval     binary_integer;
 7     l_strval     varchar2(256);
 8     invalid_parameter exception;
 9     pragma exception_init( invalid_parameter, -20000 );
10 begin
11     begin
12         l_param_type :=
13             dbms_utility.get_parameter_value
14             ( parnam => p_name,
15               intval => l_intval,
16               strval => l_strval );
17     exception
18         when invalid_parameter
19         then
20             return '*access denied*';
21     end;
22     if ( l_param_type = 0 )
23     then
24         l_strval := to_char(l_intval);
25     end if;
26     return l_strval;
27 end get_param;
28 /
```

Function created.

---

■ **Note** If you’ve applied the latest security patch for 11g R2 or 12c, then you may need to grant select on v\_\$parameter or select\_catalog\_role to the user executing this function.

---

If you execute this function in SQL\*Plus, you’ll see:

```
SCOTT@ORA12CR1> exec dbms_output.put_line( get_param( 'db_block_size' ) );
8192
```

PL/SQL procedure successfully completed.

Not every parameter is available via the `dbms_utility.get_parameter_value` API call. Specifically, the memory-related parameters such as `sga_max_size`, `db_cache_size`, `pga_aggregate_target` and the like are not visible. We deal with that in the code on lines 17 through 21—we return `*access denied*` when we hit a parameter that we are not allowed to see. If you are curious about the entire list of restricted parameters, you can (as can any account that has been granted EXECUTE on this function) issue the following query:

```
EODA@ORA12CR1> select name, scott.get_param( name ) val
 2   from v$parameter
 3   where scott.get_param( name ) = '*access denied*';
```

NAME	VAL
sga_max_size	*access denied*
shared_pool_size	*access denied*
large_pool_size	*access denied*
java_pool_size	*access denied*
streams_pool_size	*access denied*
...	
client_result_cache_lag	*access denied*
olap_page_pool_size	*access denied*

25 rows selected.

---

■ **Note** You'll see different results for this query on different versions. You should expect the number and values of inaccessible parameters to go up and down over time as the number of parameters changes.

---

If you were to count the number of documented parameters you can set in each of the database versions—9i Release 2, 10g Release 2, 11g Release 1, 11g Release 2 and 12c Release 1—you'd probably find 258, 259, 294, 342 and 368 different parameters, respectively (I'm sure there could be additional parameters available on an operating system-specific basis). In other words, the number of parameters (and their names) varies by release. Most parameters, like `db_block_size`, are very long-lived (they won't go away from release to release), but over time many other parameters become obsolete as implementations change.

For example, in Oracle 9.0.1 and before—back to version 6 of Oracle—there was a `distributed_transactions` parameter that could be set to some positive integer and that controlled the number of concurrent distributed transactions the database could perform. It was available in prior releases, but it is not found in any release subsequent to 9.0.1. In fact, attempting to use that parameter with subsequent releases raises an error. For example:

```
EODA@ORA12CR1> alter system set distributed_transactions = 10;
alter system set distributed_transactions = 10
*
ERROR at line 1:
ORA-25138: DISTRIBUTED_TRANSACTIONS initialization parameter has been made
obsolete
```

If you would like to review the parameters and get a feeling for what is available and what each parameter does, refer to the *Oracle Database Reference* manual. The first chapter of this manual examines every documented parameter in detail. On the whole, the default value assigned to each parameter (or the derived value for parameters that obtain their default settings from other parameters) is sufficient for most systems. In general, the values of parameters such as the `control_files` parameter (which specifies the location of the control files on your system), `db_block_size`, various memory-related parameters, and so on, need to be set uniquely for each database.

Notice I used the term “documented” in the preceding paragraph. There are undocumented parameters as well. You can identify these because their names begin with an underscore (\_). There is a great deal of speculation about these parameters. Since they are undocumented, some people believe they must be “magical,” and many people assume that they are well known and used by Oracle insiders. In fact, I find the opposite to be true. They are not well known and they are hardly ever used. Most of these undocumented parameters are rather boring, actually, as they represent deprecated functionality and backward-compatibility flags. Others help in the recovery of data, not of the database itself; for example, some of them enable the database to start up in certain extreme circumstances, but only long enough to get data out. You have to rebuild after that.

Unless you are so directed by Oracle Support, there is no reason to have an undocumented parameter in your configuration. Many have side effects that could be devastating. In my production database, I don’t want to use any undocumented settings.

---

■ **Caution** Use undocumented parameters only at the request of Oracle Support. Their use can be damaging to a database, and their implementation can—and will—change from release to release.

---

You may set the various parameter values in one of two ways: either just for the current instance or persistently. It is up to you to make sure that the parameter files contain the values you want them to. When using legacy `init.ora` parameter files, this is a manual process. To change a parameter value persistently, to have that new setting be in place across server restarts, you must manually edit and modify the `init.ora` parameter file. With server parameter files, you’ll see that this has been more or less fully automated for you in a single command.

## Legacy `init.ora` Parameter Files

The legacy `init.ora` file is a very simple file in terms of its construction. It is a series of variable key/value pairs. A sample `init.ora` file might look like this:

```
control_files='/u01/dbfile/ORA12CR1/control01.ctl','/u02/dbfile/ORA12CR1/control02.ctl'
db_block_size=8192
db_name='ORA12CR1'
```

In fact, this is pretty close to the most basic `init.ora` file you could get away with in real life, though if the block size I was using was the default on my platform (the default block size varies by platform), I could remove that parameter. The parameter file is used at the very least to get the name of the database and the location of the control files. The control files tell Oracle the location of every other file, so they are very important to the “bootstrap” process that starts the instance.

Now that you know what these legacy database parameter files are and where to get more details about the valid parameters you can set, you also need to know where to find them on disk. The naming convention for this file by default is

```
init$ORACLE_SID.ora    (UNIX/Linux environment variable)
init%ORACLE_SID%.ora  (Windows environment variable)
```

and by default it will be found in

```
$ORACLE_HOME/dbs      (UNIX/Linux)
%ORACLE_HOME%\DATABASE (Windows)
```



It is interesting to note that, in many cases, you'll find the entire contents of this parameter file to be something like

```
IFILE= /some/path/to/somewhere/init.ora'
```

The `IFILE` directive works in a similar fashion to an `#include` file in C. It includes in the current file the contents of the named file. Here, this directive includes an `init.ora` file from a nondefault location.

It should be noted that the parameter file does not have to be in any particular location. When starting an instance, you can use the `pfile=filename` option to the startup command. This is most useful when you'd like to try out different `init.ora` parameters on your database to see the effects of different settings.

Legacy parameter files can be maintained by using any text editor. For example, on UNIX/Linux, I'd use `vi`; on the many Windows operating system versions, I'd use Notepad; and on a mainframe, I would perhaps use `Xedit`. It is important to note that you are fully responsible for editing and maintaining this file. There are no commands within the Oracle database itself that you can use to maintain the values in the `init.ora` file. For example, when you use the `init.ora` parameter file, issuing an `ALTER SYSTEM` command to change the size of an SGA component would not be reflected as a permanent change in that file. If you want that change to be made permanent—in other words, if you'd like it to be the default for subsequent restarts of the database—it's up to you to make sure all `init.ora` parameter files that might be used to start this database are manually updated.

The last interesting point of note is that the legacy parameter file is not necessarily located on the database server. One of the reasons the parameter file (that that we'll discuss shortly) was introduced was to remedy this situation. The legacy parameter file must be present on the client machine attempting to start the database, meaning that if you run a UNIX/Linux server but administer it using SQL\*Plus installed on your Windows desktop machine over the network, then you need the parameter file for the database on your desktop.

I still remember how I made the painful discovery that the parameter files are not stored on the server. This goes back many years to when a brand-new (now retired) tool called *SQL\*DBA* was introduced. This tool allowed us to perform remote operations, specifically, remote administrative operations. From my server (running SunOS at the time), I was able to connect remotely to a mainframe database server. I was also able to issue the shutdown command. However, it was at that point I realized I was in a bit of a jam—when I tried to start up the instance, *SQL\*DBA* would complain about not being able to find the parameter file. I learned that these parameter files—the `init.ora` plain text files—were located on the machine with the client; they had to exist on the *client* machine—not on the server. *SQL\*DBA* was looking for a parameter file on my local system to start the mainframe database. Not only did I not have any such file, I had no idea what to put into one to get the system started up again! I didn't know the `db_name` or control file locations (even just getting the correct naming convention for the mainframe files would have been a bit of a stretch), and I didn't have access to log into the mainframe system itself. I've not made that same mistake since; it was a painful lesson to learn.

When DBAs realized that the `init.ora` parameter file had to reside on the client's machine that starts the database, it led to a proliferation of these files. Every DBA wanted to run the administrative tools from his desktop, so every DBA needed a copy of the parameter file on his desktop machine. Tools such as Oracle Enterprise Manager (OEM) would add yet another parameter file to the mix. These tools would attempt to centralize the administration of all databases in an enterprise on a single machine, sometimes referred to as a *management server*. This single machine would run software that would be used by all DBAs to start up, shut down, back up, and otherwise administer a database. That sounds like a perfect solution: centralize all parameter files in one location and use the GUI tools to perform all operations. But the reality is that sometimes it's much more convenient to issue the administrative startup command from within SQL\*Plus on the database server machine itself during the course of some administrative task, so we ended up with multiple parameter files again: one on the management server and one on the database server. These parameter files would then get out of sync with each other and people would wonder why the parameter change they made last month might "disappear," then reappear in seemingly random manner.

Enter the server parameter file (`SPFILE`), which can now be a single source of truth for the database.

## Server Parameter Files (SPFILES)

SPFILES represent a fundamental change in the way Oracle accesses and maintains parameter settings for the instance. An SPFILE eliminates the two serious issues associated with legacy parameter files:

- *It stops the proliferation of parameter files.* An SPFILE is always stored on the database server; the SPFILE must exist on the server machine itself and can't be located on the client machine. This makes it practical to have a single source of “truth” with regard to parameter settings.
- *It removes the need (in fact, it removes the ability) to manually maintain parameter files outside of the database using a text editor.* The ALTER SYSTEM command lets you write values directly into the SPFILE. Administrators no longer have to find and maintain all of the parameter files by hand.

The naming convention for this file by default is

```
$ORACLE_HOME/dbs/spfile$ORACLE_SID.ora    (UNIX/Linux environment variable)
%ORACLE_HOME/database/spfile%ORACLE_SID%.ora  (Windows environment variable)
```

I strongly recommend using the default location; doing otherwise defeats the simplicity SPFILES represent. When an SPFILE is in its default location, everything is more or less done for you. Moving the SPFILE to a nondefault location means you have to tell Oracle where to find the SPFILE, leading to the original problems of legacy parameter files all over again!

## Converting to SPFILES

Suppose you have a database that is using a legacy parameter file. The move to an SPFILE is quite simple—you use the CREATE SPFILE command.

---

■ **Note** You can also use a “reverse” command to create a parameter file (PFILE) from an SPFILE. I'll explain shortly why you might want to do that.

---

So, assuming you have an init.ora parameter file and that init.ora parameter file is in the default location on the server, you simply issue the CREATE SPFILE command and restart your server instance:

```
EODA@ORA12CR1> show parameter spfile;
```

NAME	TYPE	VALUE
-----		
spfile	string	

```
EODA@ORA12CR1> create spfile from pfile;
```

```
create spfile from pfile
```

```
*
```

```
ERROR at line 1:
```

```
ORA-01031: insufficient privileges
```

Well, that `SHOW PARAMETER` command shows that we did not create an `SPFILE`: the value is blank. We are not privileged enough to create the `SPFILE`, even though I am logged in as a `DBA`. Creating an `SPFILE` is considered to be very privileged, and you can do it only if you are connected using credentials that allow you to startup and shutdown the database. So let's do that:

```
EODA@ORA12CR1> connect / as sysoper;
Connected.

PUBLIC@ORA12CR1> create spfile from pfile;
File created.

PUBLIC@ORA12CR1> startup force;
ORACLE instance started.
Database mounted.
Database opened.
```

I used the least privileged account I can to perform that operation, an account (mine) that uses the `SYSOPER` administrator privilege. `SYSOPER` is allowed to manage the parameter files, start and stop the database, but not much else; that's why the output of the startup command looks different—there is no `SGA` report, the memory settings are not visible, in fact:

```
PUBLIC@ORA12CR1> show parameter spfile;
ORA-00942: table or view does not exist
```

While the `SYSOPER` privilege can start and stop the database, it can't access `V$` views and so on. It is very limited in what it can do. We can verify that we are using the `SPFILE` by connecting as an account privileged enough to do so:

```
EODA@ORA12CR1> show parameter spfile;
```

NAME	TYPE	VALUE
spfile	string	/home/ora12cr1/app/ora12cr1/product/12.1.0/dbhome_1/dbs/spfileora12cr1.ora

To recap, we used the `SHOW PARAMETER` command here to show that initially we were not using an `SPFILE`, but after we created one and restarted the instance, we were using one and it had the default name.

---

■ **Note** In a clustered environment, using Oracle RAC, all instances share the same `SPFILE`, so this process of converting over to an `SPFILE` from a `PFILE` should be done in a controlled fashion. The single `SPFILE` can contain all of the parameter settings, even instance-specific settings, but you'll have to merge all of the necessary parameter files into a single `PFILE` using the format that follows.

---

In a clustered environment, in order to convert from individual `PFILES` to an `SPFILE` shared by all, you'd merge your individual `PFILES` into a single file resembling this:

```
*.cluster_database_instances=2
*.cluster_database=TRUE
*.cluster_interconnects='10.10.10.0'
```

```

*.compatible='12.1.0.0.0'
*.control_files='/u1/d1/012C/control01.ctl','/u1/d2/012C/control02.ctl'
*.db_name='012C'
...
*.processes=150
*.undo_management='AUTO'
012C1.instance_number=1
012C2.instance_number=2
012C1.local_listener='LISTENER_012C1'
012C2.local_listener='LISTENER_012C2'
012C1.remote_listener='LISTENER_012C2'
012C2.remote_listener='LISTENER_012C1'
012C1.thread=1
012C2.thread=2
012C1.undo_tablespace='UNDOTBS1'
012C2.undo_tablespace='UNDOTBS2'

```

That is, parameter settings that are common to all instances in the cluster would start with `*..` Parameter settings that are specific to a single instance, such as the `INSTANCE_NUMBER` and the `THREAD` of redo to be used, are prefixed with the instance name (the Oracle SID). In the preceding example,

- The `PFILE` would be for a two-node cluster with instances named `012C1` and `012C2`.
- The `*.db_name = '012C'` assignment indicates that all instances using this `SPFILE` will be mounting a database named `012C`.
- `012C1.undo_tablespace='UNDOTBS1'` indicates that the instance named `012C1` will use that specific undo tablespace, and so on.

## Setting Values in SPFILES

Once our database is up and running on the `SPFILE`, the next question relates to how we set and change values contained therein. Remember, `SPFILES` are binary files and we can't just edit them using a text editor. The answer is to use the `ALTER SYSTEM` command, which has the following syntax (portions in `<>` are optional, and the presence of the pipe symbol indicates “one of the list”):

```

Alter system set parameter=value <comment='text'> <deferred>
                <scope=memory|spfile|both> <sid='sid|*'>
                <container=current|all>

```

The `ALTER SYSTEM SET` command, by default, will update the currently running instance and make the change to the `SPFILE` for you—or in the case of a pluggable database, in the data dictionary of that pluggable database (see the following section on pluggable databases for more information). This greatly eases administration, and it eliminates the problems that arose when you used `ALTER SYSTEM` to add or modify parameter settings, but you forgot to update or missed an `init.ora` parameter file.

Let's take a look at each element of the command:

- The `parameter=value` assignment supplies the parameter name and the new value for the parameter. For example, `pga_aggregate_target = 1024m` would set the `pga_aggregate_target` parameter to a value of 1,024MB (1GB).

- `comment='text'` is an optional comment you can associate with this setting of the parameter. The comment will appear in the `UPDATE_COMMENT` field of the `V$PARAMETER` view. If you use the option to save the change to the `SPFILE`, the comment will be written into the `SPFILE` and preserved across server restarts as well, so future restarts of the database will see the comment.
- `deferred` specifies whether the system change takes place for subsequent sessions only (not currently established sessions, including the one making the change). By default, the `ALTER SYSTEM` command will take effect immediately, but some parameters can't be changed immediately—they can be changed only for newly established sessions. We can use the following query to see what parameters mandate the use of `deferred`:

```
EODA@ORA12CR1> select name
 2   from v$parameter
 3  where issys_modifiable='DEFERRED'
 4  /
```

```
NAME
```

```
-----
backup_tape_io_slaves
recyclebin
audit_file_dest
object_cache_optimal_size
object_cache_max_size_percent
sort_area_size
sort_area_retained_size
olap_page_pool_size
```

```
8 rows selected.
```

---

■ **Note** Your results may differ; from version to version, the list of which parameters may be set online—but must be deferred—can and will change.

---

The code shows that `SORT_AREA_SIZE` is modifiable at the system level, but only in a deferred manner. The following code shows what happens if we try to modify its value with and without the `deferred` option:

```
EODA@ORA12CR1> alter system set sort_area_size = 65536;
alter system set sort_area_size = 65536
                                     *
ERROR at line 1:
ORA-02096: specified initialization parameter is not modifiable with this
option
EODA@ORA12CR1> alter system set sort_area_size = 65536 deferred;
System altered.
```

- `SCOPE=MEMORY|SPFILE|BOTH` indicates the “scope” of this parameter setting. Here are our choices for setting the parameter value:
  - `SCOPE=MEMORY` changes the setting in the instance(s) only; it will not survive a database restart. The next time you start the database, the setting will be whatever was already recorded in the `SPFILE`.
  - `SCOPE=SPFILE` changes the value in the `SPFILE` only. The change will not take place until the database is restarted and the `SPFILE` is processed again. Some parameters can be changed only by using this option. For example, the `processes` parameter must use `SCOPE=SPFILE`, as you can’t change the active instance value.
  - `SCOPE=BOTH` means the parameter change takes place both in memory and in the `SPFILE`. The change will be reflected in the current instance and, the next time you start, this change will still be in effect. This is the default value for scope when using an `SPFILE`. With an `init.ora` parameter file, the default and only valid value is `SCOPE=MEMORY`.
- `sid='sid|*'` is useful mostly in a clustered environment; `sid='*'` is the default. This lets you specify a parameter setting uniquely for any given instance in the cluster. Unless you are using Oracle RAC, you will not need to specify the `sid=` setting.
- `container=current|all` is used in a multitenant database to determine the scope of the change. If the `ALTER SYSTEM` is executed in a root container database, the setting may be propagated down to every pluggable database by using the `all` option. Otherwise, by default, only the current container or pluggable database is affected by the change. Note that pluggable database–specific settings are not recorded in the `SPFILE` but are stored in the data dictionary of the pluggable database, so that when it is moved to another container, its specific settings will move with it.

A typical use of this command might be simply

```
EODA@ORA12CR1> alter system set pga_aggregate_target=512m;
System altered.
```

---

■ **Note** The preceding command—and in fact many of the `ALTER SYSTEM` commands in this book—may fail on your system. If you use other settings that are incompatible with my example (other memory parameters, for example), you may well receive an error. That doesn’t mean the command doesn’t work, but rather, the settings you attempted to use are not compatible with your overall setup.

---

Better yet, perhaps, would be using the `COMMENT=` assignment to document when and why a particular change was made:

```
EODA@ORA12CR1> alter system set pga_aggregate_target=512m
  2 comment = 'Changed 14-aug-2013, AWR recommendation';
```

System altered.

```
EODA@ORA12CR1> select value, update_comment
  2 from v$parameter
  3 where name = 'pga_aggregate_target'
  4 /
```

VALUE	UPDATE_COMMENT
-----	-----
536870912	Changed 14-aug-2013, AWR recommendation

## Unsetting Values in SPFILES

The next question that arises is, how do we unset a value that we previously set. In other words, we don't want that parameter setting in our SPFILE anymore. Since we can't edit the file using a text editor, how do we accomplish that? This, too, is done via the ALTER SYSTEM command, but using the RESET clause:

```
Alter system reset parameter <scope=memory|spfile|both> sid='sid|*'
```

So, for example, if we wanted to remove the sort\_area\_size parameter, to allow it to assume the default value we specified previously, we could do so as follows:

```
EODA@ORA12CR1> alter system reset sort_area_size scope=spfile ;
System altered.
```

---

■ **Note** In prior releases, specifically in Oracle 10g Release 2 and earlier, the SID= clause was not optional as it is now. In those releases, you'd include SID='\*' on the end of the ALTER SYSTEM command to reset the parameter for all instances in the SPFILE. Or you'd specify SID='some\_sid' to reset it for a single instance.

---

The sort\_area\_size is removed from the SPFILE, which you can verify by issuing the following:

```
EODA@ORA12CR1> connect / as sysoper;
Connected.
```

```
PUBLIC@ORA12CR1> create pfile='/tmp/pfile.tst' from spfile;
File created.
```

You can then review the contents of /tmp/pfile.tst, which will be generated on the database server. You'll find the sort\_area\_size parameter does not exist in the parameter file anymore.

## Creating PFILES from SPFILES

The CREATE PFILE...FROM SPFILE command we just saw is the opposite of CREATE SPFILE. It takes the binary SPFILE and creates a plain text file from it—one that can be edited in any text editor and subsequently used to start up the database. You might use this command for at least two things on a regular basis:

- To create a one-time parameter file with some special settings, to start up the database for maintenance. So, you'd issue CREATE PFILE...FROM SPFILE and edit the resulting text PFILE, modifying the required settings. You'd then start the database, using the PFILE=<FILENAME> option to specify your PFILE instead of the SPFILE. After you finished, you'd just start up normally without specifying the PFILE=<FILENAME>, and the database would use the SPFILE.

- To maintain a history of commented changes. In the past, many DBAs heavily commented their parameter files with a change history. If they changed the size of the buffer cache 20 times, for example, they would have 20 comments in front of the `db_cache_size` `init.ora` parameter setting, stating the date and reason for making the change. The SPFILE does not support this, but you can achieve the same effect if you get into the habit of doing the following:

```
PUBLIC@ORA12CR1> connect / as sysdba
Connected.
```

```
SYS@ORA12CR1> create pfile='init_14_aug_2013_ora12cr1.ora' from spfile;
File created.
```

```
SYS@ORA12CR1> alter system set pga_aggregate_target=512m
  2 comment = 'Changed 14-aug-2013, AWR recommendation';
System altered.
```

In this way, your history will be saved in the series of parameter files over time.

## Fixing Corrupted SPFILES

The last question that comes up with regard to SPFILES is, “SPFILES are binary files, so what happens if one gets corrupted and the database won’t start? At least the `init.ora` file was just text, so we could edit it and fix it.” Well, SPFILES shouldn’t go corrupt any more than should a data file, redo log file, control file, and so forth. However, in the event one does—or if you have set a value in your SPFILE that does not allow the database to start—you have a couple of options.

First, the amount of binary data in the SPFILE is very small. If you are on a UNIX/Linux platform, a simple `strings` command will extract all of your settings:

```
[ora12cr1@dellpe dbs]$ strings $ORACLE_HOME/dbs/spfile$ORACLE_SID.ora
*.audit_file_dest='/home/ora12cr1/app/ora12cr1/admin
/ora12cr1/adump'
*.audit_trail='db'
*.compatible='12.1.0.0.0'
...
```

On Windows, simply open the file with `write.exe` (WordPad). WordPad will display all of the clear text in the file, and by simply cutting and pasting into `init<ORACLE_SID>.ora`, you can create a PFILE to use to start your instance.

In the event that the SPFILE has just “gone missing” (for whatever reason—not that I’ve seen an SPFILE disappear), you can also resurrect the information for your parameter file from the database’s alert log (more on the alert log shortly). Every time you start the database, the alert log will contain a section like this:

```
Starting up:
Oracle Database 12c Enterprise Edition Release 12.1.0.1.0 - 64bit Production
With the Partitioning, OLAP, Advanced Analytics and Real Application Testing options.
ORACLE_HOME = /home/ora12cr1/app/ora12cr1/product/12.1.0/dbhome_1
System name:    Linux
Node name:     dellpe
Release:       2.6.39-400.109.1.el6uek.x86_64
Version:       #1 SMP Tue Jun 4 23:21:51 PDT 2013
Machine:       x86_64
```



Using parameter settings in server-side spfile /home/ora12cr1/app/ora12cr1/product/12.1.0/dbhome\_1/dbs/spfileora12cr1.ora

System parameters with non-default values:

```

processes                = 300
resource_limit           = TRUE
sga_target               = 4800M
control_files            = "/home/ora12cr1/oradata/ORAI2CR1/controlfile/o1_mf_8wvv2pml_.ctl"
control_files            = "/home/ora12cr1/app/ora12cr1/fast_recovery_area/ORAI2CR1/controlfile/
                          o1_mf_8wvv2ps2_.ctl"
db_block_size            = 8192
compatible               = "12.1.0.0.0"
db_create_file_dest      = "/home/ora12cr1/oradata"
db_recovery_file_dest    = "/home/ora12cr1/app/ora12cr1/fast_recovery_area"
db_recovery_file_dest_size = 4815M
undo_tablespace          = "UNDOTBS1"
remote_login_passwordfile = "EXCLUSIVE"
db_domain                = ""
dispatchers              = "(PROTOCOL=TCP) (SERVICE=ora12cr1XDB)"
local_listener           = "(ADDRESS=(PROTOCOL=tcp)(HOST=192.168.1.25)(PORT=1521))"
parallel_min_servers     = 0
parallel_max_servers     = 0
audit_file_dest          = "/home/ora12cr1/app/ora12cr1/admin/ora12cr1/adump"
audit_trail              = "DB"
db_name                  = "ora12cr1"
open_cursors             = 300
_column_tracking_level   = 1
pga_aggregate_target     = 1600M
diagnostic_dest          = "/home/ora12cr1/app/ora12cr1"

```

NOTE: remote asm mode is local (mode Ox1; from cluster type)

Starting background process PMON

Mon Sep 02 16:56:22 2013

PMON started with pid=2, OS id=21572

From this section, you can easily create a PFILE to be converted into a new SPFILE using the CREATE SPFILE command.

## Pluggable Databases

Pluggable databases are designed to be a set of files you can move from one root container database to another. That is, we can unplug a pluggable database, and upon plugging it back into either the same root container database or some other root container database, we would have our original pluggable database back—with all of the application schemas, users, metadata, grants, data, and even our pluggable database parameter settings (settings that were not inherited from the root container). This is achieved by storing pluggable database-specific parameter settings in a data dictionary table: SYS.PDB\_SPFILE\$. It is in this fashion that pluggable databases can override a parameter setting for some parameters (not every parameter can be set at the pluggable database level) in an SPFILE and have those parameter settings travel with them as they move from root container database to root container database.

## Parameter File Wrap-up

In this section, we covered the basics of managing Oracle initialization parameters and parameter files. We looked at how to set parameters, view parameter values, and have those settings persist across database restarts. We explored the two types of database parameter files: legacy PFILES (simple text files) and the newer SPFILES. For all existing databases, using SPFILES is recommended for the ease of administration and clarity they bring. The ability to have a single source of parameter “truth” for the database, along with the ability of the ALTER SYSTEM command to persist the parameter values, make SPFILES a compelling feature. I started using them the instant they became available and haven’t looked back.

## Trace Files

Trace files are a source of debugging information. When the server encounters a problem, it generates a trace file full of diagnostic information. When a developer executes DBMS\_MONITOR.SESSION\_TRACE\_ENABLE, the server generates a trace file full of performance-related information. Trace files are available to us because Oracle is a heavily instrumented piece of software. By “instrumented,” I mean that the programmers who wrote the database kernel put in debugging code—lots and lots of it. And they left it in, on purpose.

I’ve met many developers who consider debugging code to be overhead—something that must be ripped out before an application goes into production in a vain attempt to squeeze every ounce of performance out of the code. Later, of course, they discover that their code has a bug or it isn’t running as fast as it should (which end users tend to call a bug as well; to an end user, poor performance *is* a bug). At that point, they really wish that the debug code was still in the code (or had been in there if it never was), especially since you can’t drop debug code into the production system. You have to test any new code before putting it into a production environment, and that’s not something you do at the drop of a hat.

The Oracle database (and Application Server and Oracle applications and various tools such as Application Express (APEX)) is heavily instrumented. Signs of this instrumentation in the database are

- *V\$ views*: Most V\$ views contain “debug” information. V\$WAITSTAT, V\$SESSION\_EVENT, and many others exist solely to let us know what is going on deep in the kernel.
- *The AUDIT command*: This command allows you to specify what events the database should record for later analysis.
- *Resource Manager (DBMS\_RESOURCE\_MANAGER)*: This feature lets you micromanage resources (CPU, I/O, and the like) within the database. What makes a Resource Manager in the database possible is that it has access to all of the runtime statistics describing how the resources are being used.
- *Oracle events*: These enable you to ask Oracle to produce trace or diagnostic information as needed.
- *DBMS\_TRACE*: This facility within the PL/SQL engine exhaustively records the call tree of stored procedures, exceptions raised, and errors encountered.
- *Database event triggers*: These triggers, such as ON SERVERERROR, allow you to monitor and log any condition you feel is “exceptional” or out of the ordinary. For example, you can log the SQL that was running when an “out of temp space” error was raised.
- *SQL\_TRACE/DBMS\_MONITOR*: This is used to view the exact SQL, wait events and other performance/behavior related diagnostic information generated by running your application. The SQL Trace facility is also available in an extended fashion via the 10046 Oracle event.

among others. Instrumentation is vital in application design and development, and the Oracle database becomes better instrumented with each release. In fact, the amount of additional instrumentation in the database between Oracle9i Release 2 and Oracle 11g, and now Oracle 12c, is phenomenal. Oracle 10g took code instrumentation in the kernel to a whole new level with the introduction of the Automatic Workload Repository (AWR) and Active Session History (ASH) features. Oracle 11g took that further with options such as the Automatic Diagnostic Repository (ADR) and the SQL Performance Analyzer (SPA). Oracle 12c advanced even further with the addition of a DDL log to track all DDL operations in a database (something that shouldn't be happening in many typical production databases day to day) and the debug log to track exceptional conditions in the database.

In this section we're going to focus on the information you can find in various types of trace files. We'll cover what they are, where they are stored, and what we can do with them.

There are two general types of trace files, and what we do with each kind is very different:

- *Trace files you expected and want:* These are, for example, the result of enabling `DBMS_MONITOR.SESSION_TRACE_ENABLE`. They contain diagnostic information about your session and will help you tune your application to optimize its performance and diagnose any bottlenecks it is experiencing.
- *Trace files you were not expecting but the server generated as the result of an ORA-00600 "Internal Error", ORA-03113 "End of file on communication channel", or ORA-07445 "Exception Encountered" type of error.* These traces contain diagnostic information that is most useful to an Oracle Support analyst and, beyond showing where in our application the internal error was raised, are of limited use to us.

## Requested Trace Files

The trace files you typically expect to be generated as the result of enabling trace via `DBMS_MONITOR` (`ALTER SESSION SET SQL_TRACE=TRUE` in Oracle9i Release 2 and earlier), or using the extended trace facility via the 10046 event, might be as follows:

```
EODA@ORA12CR1> alter session set events
 2 '10046 trace name context forever, level 12'
 3 /
Session altered.
```

These trace files contain diagnostic and performance related information. They provide invaluable insights into the inner workings of your database application. You will see these trace files more often than any other kind of trace file in a normally operating database.

## File Locations

Whether you use `DBMS_MONITOR`, `SQL_TRACE` or the extended trace facility, Oracle will start generating a trace file on the database server machine in one of two locations:

- If you are using a dedicated server connection, the trace file will be generated in the directory specified by the `user_dump_dest` parameter.
- If you are using a shared server connection, the trace file will be generated in the directory specified by the `background_dump_dest` parameter.

To see where the trace files will go, you can issue the `show parameter dump_dest` command from SQL\*Plus, query the `V$PARAMETER` view, use the routine we created earlier (`SCOTT.GET_PARAM`), or query the new `V$DIAG_INFO` view. We'll demonstrate each in turn next.

```
EODA@ORA12CR1> show parameter dump_dest
```

NAME	TYPE	VALUE
background_dump_dest	string	/home/ora12cr1/app/ora12cr1/diag/rdbms/ora12cr1/ora12cr1/trace
core_dump_dest	string	/home/ora12cr1/app/ora12cr1/diag/rdbms/ora12cr1/ora12cr1/cdump
user_dump_dest	string	/home/ora12cr1/app/ora12cr1/diag/rdbms/ora12cr1/ora12cr1/trace

This shows the three dump (trace) destinations. The background dump destination is used by any “server” process (see Chapter 5 for a comprehensive list of Oracle background processes and their functions). The core dump destination is used for a “core dump” (very detailed process diagnostic information) when a serious problem arises, such as a process crash. The user dump destination is used by dedicated and shared server connections (covered in Chapter 2) when they generate a trace file.

To continue with the various methods of examining these dump destinations, let’s take a look at the V\$ tables available:

```
EODA@ORA12CR1> select name, value
 2   from v$parameter
 3  where name like '%dump_dest%';
```

NAME	VALUE
background_dump_dest	/home/ora12cr1/app/ora12cr1/diag/rdbms/ora12cr1/ora12cr1/trace
user_dump_dest	/home/ora12cr1/app/ora12cr1/diag/rdbms/ora12cr1/ora12cr1/trace
core_dump_dest	/home/ora12cr1/app/ora12cr1/diag/rdbms/ora12cr1/ora12cr1/cdump

We could, of course, use the DBMS\_UTILITY package we put in our earlier SCOTT.GET\_PARAM function to query the V\$PARAMETER table as well:

```
EODA@ORA12CR1> set serveroutput on
EODA@ORA12CR1> exec dbms_output.put_line( scott.get_param( 'user_dump_dest' ) )
/home/ora12cr1/app/ora12cr1/diag/rdbms/ora12cr1/ora12cr1/trace
```

PL/SQL procedure successfully completed.

In Oracle 11g, a new facility, the ADR, was added. As part of this new facility, there’s a new V\$ view—V\$DIAG\_INFO.

■ **Note** V\$DIAG\_INFO is a view available in Oracle 11g (and above) and is not available in older releases. It is an easier interface to the trace information used by the new ADR facility.

For readability purposes, in the following query against V\$DIAG\_INFO, I've factored out the long path name to the ADR Home directory, replacing it with \$home\$ in the output. This just makes it easier to read the output in the book; it is not something you need to do:

```
EODA@ORA12CR1> with home
```

```
 2 as
 3 (select value home
 4    from v$diag_info
 5    where name = 'ADR Home'
 6 )
 7 select name,
 8        case when value <> home.home
 9              then replace(value,home.home,'$home$')
10              else value
11        end value
12    from v$diag_info, home
13 /
```

NAME	VALUE
-----	-----
Diag Enabled	TRUE
ADR Base	/home/ora12cr1/app/ora12cr1
ADR Home	/home/ora12cr1/app/ora12cr1/di ag/rdbms/ora12cr1/ora12cr1
Diag Trace	\$home\$/trace
Diag Alert	\$home\$/alert
Diag Incident	\$home\$/incident
Diag Cdump	\$home\$/cdump
Health Monitor	\$home\$/hm
Default Trace File	\$home\$/trace/ora12cr1_ora_2231 9.trc
Active Problem Count	0
Active Incident Count	0

11 rows selected.

As you can see, the rows contain paths to the locations of various trace files. Oracle 11g revamped where many files are stored by default, organizing them a bit better to ease the support process when you log a service request with Oracle Support. The most important rows are

- *Diag Trace*: This is where the trace files—both background and user dump destinations—go to in Oracle 11g and above.
- *Default Trace File*: This is the name of your current session's trace file. In earlier releases, this file name could be tricky to figure out (we'll see how next). In Oracle 11g and above, a simple query against V\$DIAG\_INFO returns the fully qualified file name.

Prior to Oracle 11g and the addition of the Default Trace File information, you had to locate your trace file manually. If you use a shared server connection to Oracle, you are using a background process so the location of your trace files is defined by `background_dump_dest`. If you use a dedicated server connection, you are using a user or foreground process to interact with Oracle so your trace files will go in the directory specified by the `user_dump_dest` parameter. The `core_dump_dest` parameter defines where a “core” file would be generated in the event of a serious Oracle internal error (such as a segmentation fault on UNIX/Linux), or if Oracle Support had you generate one for additional debug information. In general, the two destinations of interest are the background and user dump destinations. Unless otherwise stated, we will be using dedicated server connections in the course of this book, so all of our trace files will be generated in the `user_dump_dest` location.

## Naming Convention

The trace file naming convention changes from time to time in Oracle, but if you have an example trace file name from your system, it is easy to see the template in use. For example, on my various UNIX/Linux servers, a trace file name looks like those in Table 3-1.

**Table 3-1.** Sample Trace File Names

Trace File Name	Database Version
ora_10583.trc	9i Release 1
ora9ir2_ora_1905.trc	9i Release 2
ora10gr2_ora_6793.trc	10g Release 2
ora11gr2_ora_1990.trc	11g Release 2
ora12cr1_ora_2344.trc	12c Release 1

On my servers, the trace file name can be broken down as follows:

- The first part of the file name is the `ORACLE_SID` (with the exception of Oracle9i Release 1, where Oracle decided to leave that off).
- The next bit of the file name is just `ora`.
- The number in the trace file name is the process ID of your dedicated server, available to you from the `V$PROCESS` view.

Therefore, prior to Oracle 11g, which has the easy to use `V$DIAG_INFO` view, in practice (assuming dedicated server mode) you need access to four views to determine your trace file name:

- `V$PARAMETER`, which is used to locate the trace file for `user_dump_dest` and to find the optional `tracefile_identifier` that might be used in your trace file name.
- `V$PROCESS`, which is used to find the process ID.
- `V$SESSION`, which is used to correctly identify your session’s information in the other views.
- `V$INSTANCE`, which is used to get the `ORACLE_SID`.

As noted earlier, you can use the `DBMS_UTILITY` to find the location, and often you simply “know” the `ORACLE_SID`, so technically you might only need access to `V$SESSION` and `V$PROCESS`, but for ease of use you’d want access to all four.

A query, then, to generate your trace file name could be:

```
EODA@ORA12CR1> column trace new_val TRACE format a100

EODA@ORA12CR1> select c.value || '/' || d.instance_name || '_ora_' || a.spid || '.trc' trace
 2   from v$process a, v$session b, v$parameter c, v$instance d
 3   where a.addr = b.paddr
 4         and b.audsid = userenv('sessionid')
 5         and c.name = 'user_dump_dest'
 6 /
```

TRACE

```
-----
/home/ora12cr1/app/ora12cr1/diag/rdbms/ora12cr1/ora12cr1/trace/ora12cr1_ora_22319.trc
```

And this just shows that if the file exists, you'll be able to access it via that name (assuming you have the permissions to read the trace directory). The following example generates a trace file, showing how the file is created once the trace is enabled:

```
EODA@ORA12CR1> !ls &TRACE
ls: cannot access /home/ora12cr1/app/ora12cr1/diag/rdbms/ora12cr1/ora12cr1/trace/ora12cr1_ora_22319.
trc: No such file or directory
```

```
EODA@ORA12CR1> exec dbms_monitor.session_trace_enable
PL/SQL procedure successfully completed.
```

```
EODA@ORA12CR1> !ls &TRACE
/home/ora12cr1/app/ora12cr1/diag/rdbms/ora12cr1/ora12cr1/trace/ora12cr1_ora_22319.trc
```

As you can see, before we enabled tracing in that session, no file existed; as soon as tracing is enabled, however, we are able to see it.

It should be obvious that on Windows you'd replace the / with \. If you are using 9i Release 1, instead of adding the instance name into the trace file name, you'd simply issue the following:

```
select c.value || 'ora_' || a.spid || '.trc'
```

## Tagging Trace Files

There is a way to “tag” your trace file so that you can find it even if you are not permitted access to V\$PROCESS and V\$SESSION. Assuming you have access to read the user\_dump\_dest directory, you can use the session parameter tracefile\_identifier. With this, you can add a uniquely identifiable string to the trace file name, for example:

```
EODA@ORA12CR1> alter session set tracefile_identifier = 'Look_For_Me';
Session altered.
```

```
EODA@ORA12CR1> !ls /home/ora12cr1/app/ora12cr1/diag/rdbms/ora12cr1/ora12cr1/trace/*Look_For_Me*
ls: cannot access /home/ora12cr1/app/ora12cr1/diag/rdbms/ora12cr1/ora12cr1/trace/*Look_For_Me*: No
such file or directory
```

```
EODA@ORA12CR1> exec dbms_monitor.session_trace_enable
PL/SQL procedure successfully completed.
```

```
EODA@ORA12CR1> !ls
/home/ora12cr1/app/ora12cr1/diag/rdbms/ora12cr1/ora12cr1/trace/*Look_For_Me*
```

The prior line of code didn't fit within the physical limitations of this page, so it displays as two lines when it should be on one line. The `ls` command is searching for files in this directory:

```
/home/ora12cr1/app/ora12cr1/diag/rdbms/ora12cr1/ora12cr1/trace
```

The `*` character is a wildcard instructing `ls` to look for any files with the string of `Look_For_Me` included in the file name. For this example, there are two files the prior `ls` command located:

```
/home/ora12cr1/app/ora12cr1/diag/rdbms/ora12cr1/ora12cr1/trace/ora12cr1_ora_22489_Look_For_Me.trc
/home/ora12cr1/app/ora12cr1/diag/rdbms/ora12cr1/ora12cr1/trace/ora12cr1_ora_22489_Look_For_Me.trm
```

As you can see, the trace file is now named in the standard `<ORACLE_SID>_ora_<PROCESS_ID>` format, but it also has the unique string we specified associated with it, making it easy to find “our” trace file name. The trace file ends with the extension of `.trc`. There's also a corresponding trace map file (with the extension of `.trm`) which contains structural information about the trace file. Usually you'll only be interested in the contents of the `.trc` file.

## Trace Files Generated in Response to Internal Errors

I'd like to close this section with a discussion about those other kinds of trace files—the ones we did not expect that were generated as a result of an `ORA-00600` or some other internal error. Is there anything we can do with them?

The short answer is that, in general, they are not for you and me. They are useful to Oracle Support. However, they can be helpful when we file a service request with Oracle Support. That point is crucial: if you are getting internal errors, the only way they will ever be corrected is if you file a service request. If you just ignore them, they will not get fixed by themselves, except by accident.

For example, in Oracle 10g Release 1, if you create the following table and run the query, you may well get an internal error (or not; it was filed as a bug and is corrected in later patch releases):

```
ops$tkyte@ORA10G> create table t ( x int primary key );
Table created.

ops$tkyte@ORA10G> insert into t values ( 1 );
1 row created.

ops$tkyte@ORA10G> exec dbms_stats.gather_table_stats( user, 'T' );
PL/SQL procedure successfully completed.

ops$tkyte@ORA10G> select count(x) over (
  2   from t;
  from t
  *
ERROR at line 2:
ORA-00600: internal error code, arguments: [12410], [], [], [], [], [], [], []
```

Now, suppose you are the DBA and all of a sudden this trace file pops up in the trace area. Or you are the developer and your application raises an `ORA-00600` error and you want to find out what happened. There is a lot of information in that trace file (some 35,000 lines, in fact), but in general it's not useful to you and me. We would generally just compress the trace file and upload it as part of our service request processing.



Starting in Oracle 11g and above, the process of gathering the trace information and uploading it to support has been modified (and made significantly easier). A new command-line tool, in conjunction with a user interface via Enterprise Manager, allows you to review the trace information in the ADR, and package and transmit it to Oracle Support.

The Automatic Diagnostic Repository Command Interpreter (ADRCI) utility allows you to review “problems” (critical errors in the database) and incidents (occurrences of those critical errors) and to package them up for transmission to support. The packaging step includes retrieving not only the trace information, but also details from the database alert log and other configuration/test case information. For example, I set up a situation in my database that raised a critical error. (No, I won’t say what it is. You have to generate your own critical errors.) I knew I had a “problem” in my database because the ADRCI tool told me so:

```
[ora12cr1@dellpe ~]$ adrci
```

```
ADRCI: Release 12.1.0.1.0 - Production on Mon Sep 2 17:45:38 2013
```

```
Copyright (c) 1982, 2013, Oracle and/or its affiliates. All rights reserved.
```

```
ADR base = "/home/ora12cr1/app/ora12cr1"
```

```
adrci> show problem
```

```
ADR Home = /home/ora12cr1/app/ora12cr1/diag/rdbms/ora12cr1/ora12cr1:
```

```
*****
```

PROBLEM_ID	PROBLEM_KEY	LAST_INCIDENT	LASTINC_TIME
1	ORA 7445 [qctcopn]	36281	2013-09-02 17:52:11.438000 -04:00

On September 2, 2013 I caused an ORA-7445, a serious problem, in the database (a bug was filed and fixed). I can now see what was affected by that error by issuing the `show incident` command:

```
adrci> show incident
```

```
ADR Home = /home/ora12cr1/app/ora12cr1/diag/rdbms/ora12cr1/ora12cr1:
```

```
*****
```

INCIDENT_ID	PROBLEM_KEY	CREATE_TIME
36249	ORA 7445 [qctcopn]	2013-09-02 17:45:06.791000 -04:00
36250	ORA 7445 [qctcopn]	2013-09-02 17:51:58.469000 -04:00
36281	ORA 7445 [qctcopn]	2013-09-02 17:52:11.438000 -04:00

I can see there three incidents, and I can identify the information related to each incident via the `show tracefile` command:

```
adrci> show tracefile -I 36250
```

```
diag/rdbms/ora12cr1/ora12cr1/incident/incdir_36250/ora12cr1_ora_22682_i36250.trc
```

This shows me the location of the trace file for incident number 36250. Further, I can see a lot of detail about the incident if I so choose:

```
adrci> show incident -mode detail -p "incident_id=36250"
```

```
ADR Home = /home/ora12cr1/app/ora12cr1/diag/rdbms/ora12cr1/ora12cr1:
```

```
*****
```

\*\*\*\*\*

## INCIDENT INFO RECORD 1

\*\*\*\*\*

INCIDENT_ID	36250
STATUS	ready
CREATE_TIME	2013-09-02 17:51:58.469000 -04:00
PROBLEM_ID	1
CLOSE_TIME	<NULL>
FLOOD_CONTROLLED	none
ERROR_FACILITY	ORA
ERROR_NUMBER	7445
ERROR_ARG1	qctcopn
ERROR_ARG2	SIGSEGV
ERROR_ARG3	ADDR:0x18
ERROR_ARG4	PC:0xB859512
ERROR_ARG5	Address not mapped to object
ERROR_ARG6	<NULL>
ERROR_ARG7	<NULL>
ERROR_ARG8	<NULL>
ERROR_ARG9	<NULL>
ERROR_ARG10	<NULL>
ERROR_ARG11	<NULL>
ERROR_ARG12	<NULL>
SIGNALLING_COMPONENT	<NULL>
SIGNALLING_SUBCOMPONENT	<NULL>
SUSPECT_COMPONENT	<NULL>
SUSPECT_SUBCOMPONENT	<NULL>
ECID	<NULL>
IMPACTS	0
PROBLEM_KEY	ORA 7445 [qctcopn]
FIRST_INCIDENT	36249
FIRSTINC_TIME	2013-09-02 17:45:06.791000 -04:00
LAST_INCIDENT	36281
LASTINC_TIME	2013-09-02 17:52:11.438000 -04:00
IMPACT1	0
IMPACT2	0
IMPACT3	0
IMPACT4	0
KEY_NAME	Client ProcId
KEY_VALUE	oracle@dellpe (TNS V1-V3).22682_140239502662112
KEY_NAME	SID
KEY_VALUE	416.23
KEY_NAME	ProcId
KEY_VALUE	31.41
KEY_NAME	PQ
KEY_VALUE	(0, 1378158717)
OWNER_ID	1
INCIDENT_FILE	/home/ora12cr1/app/ora12cr1/diag/rdbms/ora12cr1/ora12cr1/trace/ ora12cr1_ora_22682.trc
OWNER_ID	1
INCIDENT_FILE	/home/ora12cr1/app/ora12cr1/diag/rdbms/ora12cr1/ora12cr1/incident/ incdir_36250/ora12cr1_ora_22682_i36250.trc

And, finally, I can create a “package” of the incident that is useful for support. The package will contain everything a support analyst needs to begin working on the problem.

This section is not intended to be a full overview or introduction to the ADRCI utility, which is documented fully in the *Oracle Database Utilities* manual. Rather, I just wanted to introduce the existence of the tool—a tool that makes using trace files easy.

Prior to ADRCI in 11g, was there anything you could do with the unexpected trace files beyond sending them to support? Yes, there is some information in a trace file that can help you track down the who, what, and where of an error. The trace file can also help you find out if the problem is something others have experienced.

The previous example shows that ADRCI is an easy way to interrogate the trace files in Oracle 12c (I showed just a small fraction of the commands available). In 10g and before, you can do the same thing, albeit it a bit more manually. For example, a quick inspection of the very top of a trace file provides some useful information. Here’s an example:

```
/home/ora10gr1/admin/ora10gr1/udump/ora10gr1_ora_2578.trc
Oracle Database 10g Enterprise Edition Release 10.1.0.4.0 - Production
With the Partitioning, OLAP and Data Mining options
ORACLE_HOME = /home/ora10gr1
System name:   Linux
Node name:    dellpe
Release:     2.6.9-11.Elsm
Version:     #1 SMP Fri May 20 18:26:27 EDT 2005
Machine:     i686
Instance name: ora10gr1
Redo thread mounted by this instance: 1
Oracle process number: 16
Unix process pid: 2578, image: oracle@dellpe (TNS V1-V3)
```

The database information is important to have when you go to <http://support.oracle.com> to file the service request or to search to see if what you are experiencing is a known problem. In addition, you can see the Oracle instance on which the error occurred. It is quite common to have many instances running concurrently, so isolating the problem to a single instance is useful.

Here’s another section of the trace file to be aware of:

```
*** 2010-01-20 14:32:40.007
*** ACTION NAME:( ) 2010-01-20 14:32:39.988
*** MODULE NAME:(SQL*Plus) 2010-01-20 14:32:39.988
*** SERVICE NAME:(SYS$USERS) 2010-01-20 14:32:39.988
```

This part of the trace file is new with Oracle 10g and above and won’t be there in Oracle9i and before. It shows the session information available in the columns ACTION and MODULE from V\$SESSION. Here we can see that it was a SQL\*Plus session that caused the error to be raised (you and your developers can and should set the ACTION and MODULE information; some environments such as Oracle Forms and APEX already do this for you).

Additionally, we have the SERVICE NAME. This is the actual service name used to connect to the database—SYS\$USERS, in this case—indicating we didn’t connect via a TNS service. If we logged in using user/pass@ora10g.localdomain, we might see:

```
*** SERVICE NAME:(ORA10G) 2010-01-20 14:32:39.988
```

where ora10g is the service name (not the TNS connect string; rather, it’s the ultimate service registered in a TNS listener to which it connected). This is also useful in tracking down which process or module is affected by this error.

Lastly, before we get to the actual error, we can see the session ID (19 in this example), session serial number (27995 in this example), and related date/time information (all releases) as further identifying information:

```
*** SESSION ID:(19.27995) 2010-01-20 14:32:39.988
```

Now we are ready to get into the error itself:

```
ksedmp: internal or fatal error
ORA-00600: internal error code, arguments: [12410], [], [], [], [], [], [], []
Current SQL statement for this session:
select count(x) over ()
  from t
----- Call Stack Trace -----
_ksedmp+524
_ksfdmp.160+14
_kgeriv+139
_kgesiv+78
_ksesic0+59
_qerixAllocate+4155
_qknRwsAllocateTree+281
_qknRwsAllocateTree+252
_qknRwsAllocateTree+252
_qknRwsAllocateTree+252
_qknDoRwsAllocate+9
...
```

Here we see a couple of important pieces of information. First, we find the SQL statement that was executing when the internal error was raised, which is very useful for tracking down what application(s) was affected. Also, since we see the SQL here, we can start investigating possible workarounds—trying different ways to code the SQL see if we can quickly work around the issue while working on the bug. Furthermore, we can cut and paste the offending SQL into SQL\*Plus and see if we have a nicely reproducible test case for Oracle Support (these are the best kinds of test cases, of course).

The other important pieces of information are the error code (typically 600, 3113, or 7445) and other arguments associated with the error code. Using these, along with some of the stack trace information that shows the set of Oracle internal subroutines that were called in order, we might be able to find an existing bug (and workarounds, patches, and so on). For example, we might use the search string

```
ora-00600 12410 ksesic0 qerixAllocate qknRwsAllocateTree
```

Using My Oracle Support’s advanced search (using all of the words, search the bug database), we immediately find the bug 3800614, “ORA-600 [12410] ON SIMPLE QUERY WITH ANALYTIC FUNCTION”. If we go to <http://support.oracle.com> and search using that text, we will discover this bug, see that it is fixed in the next release, and note that patches are available—all of this information is available to us. I often find that the error I receive is one that has happened before and there are fixes or workarounds for it.

## Trace File Wrap-up

You now know the two types of general trace files, where they are located, and how to find them. Hopefully you’ll use trace files mostly for tuning and increasing the performance of your application, rather than for filing service requests. As a last note, Oracle Support does have access to many undocumented “events” that are very useful for dumping out tons of diagnostic information whenever the database hits any error. For example, if you are getting an ORA-01555

Snapshot Too Old that you absolutely feel you should not be getting, Oracle Support can guide you through the process of setting such diagnostic events to help you track down precisely why that error is getting raised, by creating a trace file every time that error is encountered.

## Alert File

The alert file (also known as the alert log) is the diary of the database. It is a simple text file written to from the day the database is “born” (created) to the end of time (when you erase it). In this file, you’ll find a chronological history of your database—the log switches; the internal errors that might be raised; when tablespaces were created, taken offline, put back online; and so on. It is an incredibly useful file for viewing the history of a database. I like to let mine grow fairly large before “rolling” (archiving) it. The more information the better, I believe, for this file.

I will not describe everything that goes into an alert log—that’s a fairly broad topic. I encourage you to take a look at yours, however, and see the wealth of information it holds. Instead, in this section we’ll take a look at a specific example of how to mine information from this alert log, in this case to create an uptime report.

In the past, I’ve used the alert log file for the <http://asktom.oracle.com> web site and to generate an uptime report for my database. Instead of poking through the file and figuring that out manually (the shutdown and startup times are in there), I decided to take advantage of the database and SQL to automate that work, thus creating a technique for generating a dynamic uptime report straight from the alert log.

Using an EXTERNAL TABLE (which is covered in much more detail in Chapter 10 and Chapter 15), we can actually query our alert log and see what is in there. I discovered that a pair of records was produced in my alert log every time I started the database:

```
Thu May 6 14:24:42 2004
Starting ORACLE instance (normal)
```

That is, I always saw a timestamp record, in that constant, fixed-width format, coupled with the message *Starting ORACLE instance*. I also noticed that before these records would be an ALTER DATABASE CLOSE message (during a clean shutdown), or a shutdown abort message, or nothing—no message, indicating a system crash. But any message would have some timestamp associated with it as well. So, as long as the system didn’t crash, some meaningful timestamp would be recorded in the alert log (and in the event of a system crash, some timestamp would be recorded shortly before the crash, as the alert log is written to quite frequently).

I discovered that I could easily generate an uptime report if I

- Collected all of the records like *Starting ORACLE instance %*.
- Collected all of the records that matched the date format (that were in fact dates).
- Associated with each *Starting ORACLE instance* record the prior two records (which would be dates).

The following code creates an external table to make it possible to query the alert log. (Note: replace `/background/dump/dest/` with your actual background dump destination and use your alert log name in the CREATE TABLE statement.)

```
EODA@ORA12CR1> create or replace
 2 directory data_dir
 3 as
 4 '/home/ora12cr1/app/ora12cr1/diag/rdbms/ora12cr1/ora12cr1/trace/'
 5 /
Directory created.
```

```

EODA@ORA12CR1> CREATE TABLE alert_log
 2 (
 3     text_line varchar2(4000)
 4 )
 5 ORGANIZATION EXTERNAL
 6 (
 7     TYPE ORACLE_LOADER
 8     DEFAULT DIRECTORY data_dir
 9     ACCESS PARAMETERS
10 (
11     records delimited by newline
12     fields
13 )
14 LOCATION
15 (
16     'alert_ora12cr1.log'
17 )
18 )
19 reject limit unlimited
20 /
Table created.

```

We can now query that information anytime:

```

EODA@ORA12CR1> select to_char(last_time,'dd-mon-yyyy hh24:mi') shutdown,
 2     to_char(start_time,'dd-mon-yyyy hh24:mi') startup,
 3     round((start_time-last_time)*24*60,2) mins_down,
 4     round((last_time-lag(start_time) over (order by r)),2) days_up,
 5     case when (lead(r) over (order by r) is null )
 6         then round((sysdate-start_time),2)
 7         end days_still_up
 8 from (
 9 select r,
10     to_date(last_time, 'Dy Mon DD HH24:MI:SS YYYY') last_time,
11     to_date(start_time,'Dy Mon DD HH24:MI:SS YYYY') start_time
12 from (
13 select r,
14     text_line,
15     lag(text_line,1) over (order by r) start_time,
16     lag(text_line,2) over (order by r) last_time
17 from (
18 select rownum r, text_line
19 from alert_log
20 where text_line like '___ __ __ __:__:__ 20__'
21     or text_line like 'Starting ORACLE instance %'
22     )
23     )
24 where text_line like 'Starting ORACLE instance %'
25     )
26 /

```

SHUTDOWN	STARTUP	MINS_DOWN	DAYS_UP	DAYS_STILL_UP
	28-jun-2013 16:04			
28-jun-2013 17:02	28-jun-2013 17:02	.03	.04	
29-jun-2013 06:00	01-jul-2013 09:42	3102.53	.54	
02-jul-2013 14:59	02-jul-2013 14:59	.03	1.22	
02-jul-2013 15:00	02-jul-2013 15:00	.03	0	
02-jul-2013 15:10	02-jul-2013 15:10	.03	.01	
02-jul-2013 17:01	02-jul-2013 17:02	1.55	.08	
18-jul-2013 02:00	18-jul-2013 11:31	571.37	15.37	
05-aug-2013 09:00	06-aug-2013 09:06	1445.62	17.9	
14-aug-2013 09:09	14-aug-2013 09:58	49.42	8	
31-aug-2013 14:08	02-sep-2013 10:51	2683.15	17.17	
02-sep-2013 14:32	02-sep-2013 14:51	18.93	.15	
02-sep-2013 15:13	02-sep-2013 15:13	.03	.02	
02-sep-2013 15:15	02-sep-2013 15:15	.05	0	
02-sep-2013 16:53	02-sep-2013 16:54	.03	.07	
02-sep-2013 16:56	02-sep-2013 16:56	.03	0	.07

16 rows selected.

I won't go into the nuances of the SQL query here, but the innermost query from lines 18 through 21 collects the "Starting" and date lines (remember, when using a LIKE clause, `_` matches precisely one character—at least one and at most one). That query also numbers the lines using `rownum`. Then, the next level of query uses the built-in `LAG()` analytic function to reach back one and two rows for each row, and slide that data up so the third row of this query has the data from rows 1, 2, and 3. Row 4 has the data from rows 2, 3, and 4, and so on. We end up keeping just the rows that were like `Starting ORACLE instance %`, which now have the two preceding timestamps associated with them. From there, computing downtime is easy: we just subtract the two dates. Computing the uptime is not much harder (now that you've seen the `LAG()` function): we just reach back to the prior row, get its startup time, and subtract that from this line's shutdown time.

My Oracle 12c database came into existence on 28-Jun-2013 and it has been shut down numerous times (and as of this writing it has been up for .07 days in a row).

If you are interested in seeing another example of mining the alert log for useful information, go to <http://tinyurl.com/y8wkhjt>. This page shows a demonstration of how to compute the average time it took to archive a given online redo log file. Once you understand what is in the alert log, generating these queries on your own becomes easy.

In addition to using an external table to query the alert log in 12c, you can easily view the alert log using the `ADRCI` tool. That tool lets you find, edit (review), and monitor (interactively display new records as they appear in the alert log). Also, the alert log in 11g and above is available in two versions—the old version we just used and an XML version:

```
EODA@ORA12CR1> column value new_val V
EODA@ORA12CR1> select value from v$diag_info where name = 'Diag Alert';
```

VALUE

```
-----
/home/ora12cr1/app/ora12cr1/diag/rdbms/ora12cr1/ora12cr1/alert
```

```
EODA@ORA12CR1> !ls &V/log.xml
/home/ora12cr1/app/ora12cr1/diag/rdbms/ora12cr1/ora12cr1/alert/log.xml
```

```
EODA@ORA12CR1> !head &V/log.xml
<msg time='2013-06-28T16:04:25.378-04:00' org_id='oracle' comp_id='rdbms'
```

```

msg_id='dbkr1CheckSuppressAlert:332:7003611' type='NOTIFICATION' group='startup'
level='16' host_id='localhost.localdomain' host_addr='::1'
pid='32628' version='1'>
<txt>Adjusting the default value of parameter parallel_max_servers
</txt>
</msg>
<msg time='2013-06-28T16:04:25.378-04:00' org_id='oracle' comp_id='rdbms'
msg_id='dbkr1CheckSuppressAlert:332:2000778772' type='NOTIFICATION' group='startup'
level='16' host_id='localhost.localdomain' host_addr='::1'

```

If you have utilities or tools to generate reports from XML (such as an Oracle database using XDB—XML DB—for example), you may query/report on that format as well.

Of course, Enterprise Manager also displays the important alert log information as well.

## Data Files

Data files, along with redo log files, are the most important type of files in the database. This is where all of your data will ultimately be stored. Every database has at least one data file associated with it, and typically has many more than one. Only the most simple “test” databases have one file. In fact, in Chapter 2 we saw that the simplest CREATE DATABASE command by default created a database with three data files, listed here for reference:

NAME

```

-----
/home/ora12cr1/app/ora12cr1/product/12.1.0/dbhome_1/dbs/dbs1ora12c.dbf
/home/ora12cr1/app/ora12cr1/product/12.1.0/dbhome_1/dbs/dbx1ora12c.dbf
/home/ora12cr1/app/ora12cr1/product/12.1.0/dbhome_1/dbs/dbu1ora12c.dbf

```

one for the SYSTEM tablespace (which houses the true Oracle data dictionary), and one for the SYSAUX tablespace (where other non-dictionary objects are stored in version 10g and above) one for the USER tablespace (tablespaces will be explained shortly in the “Tablespaces” section). Any real database will have at least these three data files.

After a brief review of file system types, we’ll discuss how Oracle organizes these files and how data is organized within them. To understand this, you need to know what tablespaces, segments, extents, and blocks are. These are the units of allocation that Oracle uses to hold objects in the database, and I describe them in detail shortly.

## A Brief Review of File System Mechanisms

There are four file system mechanisms (only three in Oracle 12c) in which to store your data in Oracle. By your data, I mean your data dictionary, redo, undo, tables, indexes, LOBs, and so on—the data you personally care about at the end of the day. Briefly, they are

- *“Cooked” operating system (OS) file systems:* These are files that appear in the file system just like your word processing documents do. You can see them in Windows Explorer; you can see them in UNIX/Linux as the result of an `ls` command. You can use simple OS utilities such as `xcopy` on Windows or `cp` on UNIX/Linux to move them around. Cooked OS files are historically the most popular method for storing data in Oracle, but I see that changing with the introduction of ASM (more on that in a moment). Cooked file systems are typically buffered as well, meaning that the OS will cache information for you as you read and, in some cases, write to disk.



- *Raw partitions*: These are not files—these are raw disks. You don't ls them; you don't review their contents in Windows Explorer. They are just big sections of disk without any sort of file system on them. The entire raw partition appears to Oracle as a single large file. This is in contrast to a cooked file system, where you might have many dozens or even hundreds of database data files. Currently, only a small percentage of Oracle installations use raw partitions due to their perceived administrative overhead. Raw partitions are not buffered devices—all I/O performed on them is direct I/O, without any OS buffering of data (which, for a database, is generally a positive attribute).

---

■ **Note** Raw partitions are deprecated in Oracle 11g and are no longer supported at all in Oracle 12c. If you have an existing database that uses raw partitions, you will have to data pump that data out, or use some other replication tool, such as Golden Gate, to move your data into a new database that uses one of the supported file systems. Alternatively, you can add new tablespaces utilizing a supported file system to your existing database, and move your data from raw partitions to this other file system. This approach will only work if your SYSTEM tablespace is not on a raw partition.

---

- *Automatic Storage Management (ASM)*: This is a new feature of Oracle 10g Release 1 (for both Standard and Enterprise editions). In releases prior to 11g Release 2, ASM is a file system designed exclusively for use by the database. An easy way to think about it is as a database file system. You won't store your shopping list in a text file on this particular file system—you'll store only database-related information here: tables, indexes, backups, control files, parameter files, redo logs, archives, and more. But even in ASM, the equivalent of a data file exists; conceptually, data is still stored in files, but the file system is ASM. ASM is designed to work in either a single machine or clustered environment. Since Oracle 11g Release 2, ASM provides not only this database file system but optionally a clustered file system as well, which is described next.
- *Clustered file system*: This is specifically for a RAC (clustered) environment and provides what looks like a cooked file system that is shared by many nodes (computers) in a clustered environment. A traditional cooked file system is usable by only one computer in a clustered environment. So, while it is true that you could NFS mount or Samba share (a method of sharing disks in a Windows/UNIX/Linux environment similar to NFS) a cooked file system among many nodes in a cluster, it represents a single point of failure. If the node owning the file system and performing the sharing failed, that file system would be unavailable. In releases of Oracle prior to 11g Release 2, the Oracle Cluster File System (OCFS) is Oracle's offering in this area and is currently available for Windows and UNIX/Linux only. Other third-party vendors provide certified clustered file systems that work with Oracle as well. Oracle 11g Release 2 provides another option in the form of the Oracle Automatic Storage Management Cluster File System (ACFS). A clustered file system brings the comfort of a cooked file system to a clustered environment.

The interesting thing is that a database might consist of files from any or all of the preceding file systems—you don't need to pick just one. You could have a database whereby portions of the data were stored in conventional cooked file systems, some on raw partitions, others in ASM, and yet other components in a clustered file system. This makes it rather easy to move from technology to technology, or to just get your feet wet in a new file system type without moving the entire database into it. Now, since a full discussion of file systems and all of their detailed attributes is beyond the scope of this book, we'll dive back into the Oracle file types. Regardless of whether the file is stored on cooked file systems, in raw partitions, within ASM, or on a clustered file system, the following concepts always apply.

## The Storage Hierarchy in an Oracle Database

A database is made up of one or more *tablespaces*. A tablespace is a logical storage container in Oracle that comes at the top of the storage hierarchy and is made up of one or more data files. These files might be cooked files in a file system, raw partitions, ASM-managed database files, or files on a clustered file system. A tablespace contains segments, as described next.

### Segments

*Segments* are the major organizational structure within a tablespace. Segments are simply your database objects that consume storage—typically objects such as tables, indexes, undo segments, and so on. Most times, when you create a table, you create a table segment. When you create a partitioned table, you are not creating a table segment, rather you create a segment per partition. When you create an index, you normally create an index segment, and so on. Every object that consumes storage is ultimately stored in a single segment. There are undo segments, temporary segments, cluster segments, index segments, and so on.

---

■ **Note** It might be confusing to read “Every object that consumes storage is ultimately stored in a single segment.” You will find many CREATE statements that create multisegment objects. The confusion lies in the fact that a single CREATE statement may ultimately create objects that consist of zero, one, or more segments! For example, CREATE TABLE T ( x int primary key, y clob ) will create four segments: one for the TABLE T, one for the index that will be created in support of the primary key, and two for the CLOB (one segment for the CLOB is the LOB index and the other segment is the LOB data itself). On the other hand, CREATE TABLE T ( x int, y date ) cluster MY\_CLUSTER will create *zero* segments (the cluster is the segment in this case). We’ll explore this concept further in Chapter 10.

---

### Extents

Segments consist of one or more *extents*. An extent is a logically contiguous allocation of space in a file. (Files themselves, in general, are not contiguous on disk; otherwise, we would never need a disk defragmentation tool! Also, with disk technologies such as Redundant Array of Independent Disks (RAID), you might find that a single file also spans many physical disks.) Traditionally, every segment starts with at least one extent. Oracle 11g Release 2 has introduced the concept of a “deferred” segment—a segment that will not immediately allocate an extent, so in that release and going forward, a segment might defer allocating its initial extent until data is inserted into it. When an object needs to grow beyond its initial extent, it will request another extent be allocated to it. This second extent will not necessarily be located right next to the first extent on disk—it may very well not even be allocated in the same file as the first extent. The second extent may be located very far away from the first extent, but the space within an extent is always logically contiguous in a file. Extents vary in size from one Oracle data block (explained shortly) to 2GB.

### Blocks

Extents, in turn, consist of *blocks*. A block is the smallest unit of space allocation in Oracle. Blocks are where your rows of data, or index entries, or temporary sort results are stored. A block is what Oracle typically reads from and writes to disk. Blocks in Oracle are generally one of four common sizes: 2KB, 4KB, 8KB, or 16KB (although 32KB is also permissible in some cases; there are restrictions in place as to the maximum size by operating system).

■ **Note** Here's a little-known fact: the default block size for a database does not have to be a power of two. Powers of two are just a commonly used convention. You can, in fact, create a database with a 5KB, 7KB, or  $n$ KB block size, where  $n$  is between 2KB and 32KB. I don't advise making use of this fact in real life, though—stick with the usual as your block size. Using nonstandard block sizes could easily become a support issue—if you are the only one using a 5KB block size, you may well encounter issues that other users would simply never see.

The relationship between segments, extents, and blocks is shown in Figure 3-1.

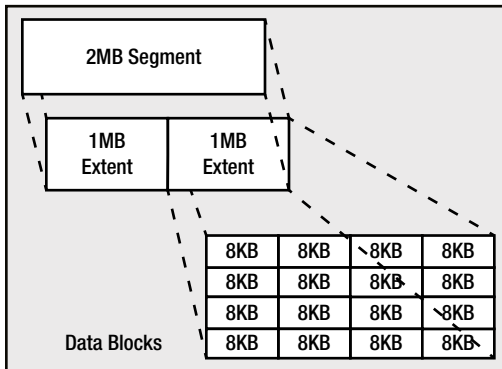

**Figure 3-1.** Segments, extents, and blocks

A segment is made up of one or more extents, and an extent is a logically contiguous allocation of blocks. Starting with Oracle9i Release 1, a database may have up to six different block sizes in it.

■ **Note** This feature of multiple block sizes was introduced for the purpose of making transportable tablespaces usable in more cases. The ability to transport a tablespace allows a DBA to move or copy the already formatted data files from one database and attach them to another—for example, to immediately copy all of the tables and indexes from an Online Transaction Processing (OLTP) database to a Data Warehouse (DW). However, in many cases, the OLTP database might be using a small block size, such as 2KB or 4KB, whereas the DW would be using a much larger one (8KB or 16KB). Without support for multiple block sizes in a single database, you wouldn't be able to transport this information. Tablespaces with multiple block sizes should be used to facilitate transporting tablespaces; they are not generally used for anything else.

There will be the database default block size, which is the size specified in the initialization file during the CREATE DATABASE command. The SYSTEM tablespace will have this default block size always, but you can then create other tablespaces with nondefault block sizes of 2KB, 4KB, 8KB, 16KB, and, depending on the operating system, 32KB. The total number of block sizes is six if and only if you specified a nonstandard block size (not a power of two) during database creation. Hence, for all practical purposes, a database will have at most five block sizes: the default size and then four other nondefault sizes.

Any given tablespace will have a consistent block size, meaning that every block in that tablespace will be the same size. A multisegment object, such as a table with a LOB column, may have each segment in a tablespace with a different block size, but any given segment (which is contained in a tablespace) will consist of blocks of exactly the same size.

Most blocks, regardless of their size, have the same general format, which looks something like Figure 3-2.

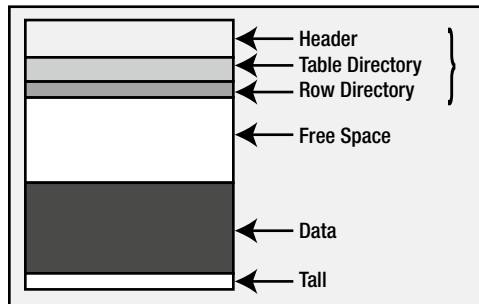

**Figure 3-2.** *The structure of a block*

Exceptions to this format include LOB segment blocks and hybrid columnar compressed blocks in Exadata storage, for example, but the vast majority of blocks in your database will resemble the format in Figure 3-2. The block header contains information about the type of block (table block, index block, and so on); transaction information when relevant (only blocks that are transaction-managed have this information—a temporary sort block would not, for example) regarding active and past transactions on the block; and the address (location) of the block on the disk.

The next two block components are found on the most common types of database blocks, those of HEAP-organized tables. We'll cover database table types in much more detail in Chapter 10, but suffice it to say that most tables are of this type.

The table directory, if present, contains information about the tables that store rows in this block (data from more than one table may be stored on the same block). The row directory contains information describing the rows that are to be found on the block. This is an array of pointers to where the rows are to be found in the data portion of the block. These three pieces of the block are collectively known as the block overhead, which is space used on the block that is not available for your data, but rather is used by Oracle to manage the block itself.

The remaining two pieces of the block are straightforward: there may be free space on a block, and then there will generally be used space that is currently storing data.

Now that you have a cursory understanding of segments, which consist of extents, which consist of blocks, let's take a closer look at tablespaces and then at exactly how files fit into the big picture.

## Tablespaces

As noted earlier, a tablespace is a container—it holds segments. Each segment belongs to exactly one tablespace. A tablespace may have many segments within it. All of the extents for a given segment will be found in the tablespace associated with that segment. Segments never cross tablespace boundaries. A tablespace itself has one or more data files associated with it. An extent for any given segment in a tablespace will be contained entirely within one data file. However, a segment may have extents from many different data files. Graphically, a tablespace might look like Figure 3-3.

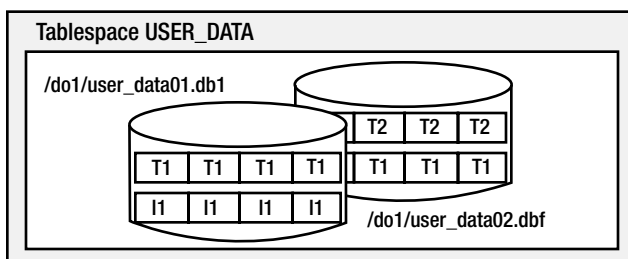

**Figure 3-3.** A tablespace containing two data files, three segments, and four extents

Figure 3-3 shows a tablespace named `USER_DATA`. It consists of two data files, `user_data01.dbf` and `user_data02.dbf`. It has three segments allocated to it: `T1`, `T2`, and `I1` (probably two tables and an index). The tablespace has four extents allocated in it, and each extent is depicted as a logically contiguous set of database blocks. Segment `T1` consists of two extents, one extent in each file. Segments `T2` and `I1` each have one extent depicted. If we need more space in this tablespace, we could either resize the data files already allocated to the tablespace or we could add a third data file to it.

A tablespace is a logical storage container in Oracle. As developers, we will create segments in tablespaces. We will never get down to the raw file level—we don't specify that we want our extents to be allocated in a specific file (we can, but in general we don't). Rather, we create objects in tablespaces and Oracle takes care of the rest. If at some point in the future, the DBA decides to move our data files around on disk to more evenly distribute I/O, that is OK with us. It will not affect our processing at all.

## Storage Hierarchy Summary

In summary, the hierarchy of storage in Oracle is as follows:

1. A *database* is made up of one or more tablespaces.
2. A *tablespace* is made up of one or more data files. These files might be cooked files in a file system, raw partitions, ASM managed database files, or a file on a clustered file system. A tablespace contains segments.
3. A *segment* (TABLE, INDEX, and so on) is made up of one or more extents. A segment exists in a tablespace, but may have data in many data files within that tablespace.
4. An *extent* is a logically contiguous set of blocks on disk. An extent is in a single tablespace and, furthermore, is always in a single file within that tablespace.
5. A *block* is the smallest unit of allocation in the database. A block is the smallest unit of I/O used by a database on data files.

## Dictionary-Managed and Locally-Managed Tablespaces

Before we move on, let's look at one more topic related to tablespaces: how extents are managed in a tablespace. Prior to Oracle 8.1.5, there was only one method for managing the allocation of extents within a tablespace: a dictionary-managed tablespace. That is, the space within a tablespace was managed in data dictionary tables, in much the same way you'd manage accounting data, perhaps with a DEBIT and CREDIT table. On the debit side, we have all of the extents allocated to objects. On the credit side, we have all of the free extents available for use. When an object needed another extent, it would ask the system for one. Oracle would then go to its data dictionary tables, run some queries, find the space (or not), and then update a row in one table (or remove it all together) and insert a row into another. Oracle managed space in very much the same way you write your applications: by modifying data and moving it around.

This SQL, executed on your behalf in the background to get the additional space, is referred to as recursive SQL. Your SQL INSERT statement caused other recursive SQL to be executed to get more space. This recursive SQL can be quite expensive if it is done frequently. Such updates to the data dictionary must be serialized; they can't be done simultaneously. They are something to be avoided.

In earlier releases of Oracle, we would see this space management issue—this recursive SQL overhead—most often in temporary tablespaces (this was before the introduction of “real” temporary tablespaces created via the CREATE TEMPORARY TABLESPACE command). Space would frequently be allocated (we would have to delete from one dictionary table and insert into another) and deallocated (we would put the rows we just moved back where they were initially). These operations would tend to serialize, dramatically decreasing concurrency and increasing wait times. In version 7.3 (way back in 1995), Oracle introduced the concept of a true temporary tablespace, a new tablespace type dedicated to just storing temporary data, to help alleviate this issue. Prior to this special tablespace type, temporary data was managed in the same tablespaces as persistent data and treated in much the same way as permanent data was.

A temporary tablespace was one in which you could create no permanent objects of your own. This was fundamentally the only difference; the space was still managed in the data dictionary tables. However, once an extent was allocated in a temporary tablespace, the system would hold on to it (i.e., it would not give the space back). The next time someone requested space in the temporary tablespace for any purpose, such as sorting, Oracle would look for an already allocated extent in its internal list of allocated extents. If it found one there, it would simply reuse it, or else it would allocate one the old-fashioned way. In this manner, once the database had been up and running for a while, the temporary segment would appear full but would actually just be “allocated.” The free extents were all there; they were just being managed differently. When someone needed temporary space, Oracle would look for that space in an in-memory data structure, instead of executing expensive, recursive SQL.

In Oracle 8.1.5 and later, Oracle went a step further in reducing this space management overhead. It introduced the concept of a locally-managed tablespace as opposed to a dictionary-managed one. Local management of space effectively did for all tablespaces what Oracle 7.3 did for temporary tablespaces: it removed the need to use the data dictionary to manage space in a tablespace. With a locally-managed tablespace, a bitmap stored in each data file is used to manage the extents. To get an extent, all the system needs to do is set a bit to 1 in the bitmap. To free up some space, the system sets a bit back to 0. Compared with using dictionary-managed tablespaces, this is incredibly fast. We no longer serialize for a long-running operation at the database level for space requests across all tablespaces. Rather, we serialize at the tablespace level for a very fast operation. Locally-managed tablespaces have other nice attributes as well, such as the enforcement of a uniform extent size, but that is starting to get heavily into the role of the DBA.

Going forward, the only storage management method you should be using is a locally-managed tablespace. In fact, in Oracle9i and above, if you create a database using the database configuration assistant (DBCA), it will create the SYSTEM tablespace as a locally-managed tablespace, and if the SYSTEM tablespace is locally managed, all other tablespaces in that database will be locally managed as well, and the legacy dictionary-managed method will not work. It's not that dictionary-managed tablespaces are not supported in a database where the SYSTEM tablespace is locally managed, it's that they simply can't be created:

```
EODA@ORA12CR1> create tablespace dmt
  2  datafile '/tmp/dmt.dbf' size 2m
  3  extent management dictionary;
create tablespace dmt
*
ERROR at line 1:
ORA-12913: Cannot create dictionary managed tablespace

EODA@ORA12CR1> !oerr ora 12913
12913, 00000, "Cannot create dictionary managed tablespace"
// *Cause: Attemp to create dictionary managed tablespace in database
//          which has system tablespace as locally managed
// *Action: Create a locally managed tablespace.
```

Note that `oerr` is a UNIX/Linux-only utility; on non-UNIX/Linux platforms, you'll need to refer to the *Oracle Database Error Messages* manual for the details on the error you receive.

---

■ **Note** You might wonder why I wrote “It’s not that dictionary-managed tablespaces are not supported in a database where the SYSTEM tablespace is locally managed, it’s that they simply can’t be created.” If they can’t be created, why would we need to support them? The answer lies in the transportable tablespace feature. You can transport a dictionary-managed tablespace into a database with a SYSTEM tablespace that is locally managed. You can plug that tablespace in and have a dictionary-managed tablespace in your database, but you can’t *create* one from scratch in that database.

---

The inability to create dictionary-managed tablespaces is a positive side effect, as it prohibits you from using the legacy storage mechanism, which was less efficient and dangerously prone to space fragmentation. Locally-managed tablespaces, in addition to being more efficient in space allocation and deallocation, also prevent tablespace fragmentation. We’ll take an in-depth look at this in Chapter 10.

## Temp Files

Temporary data files (temp files) in Oracle are a special type of data file. Oracle will use temporary files to store the intermediate results of large sort operations and hash operations, as well as to store global temporary table data, or resultset data, when there is insufficient memory to hold it all in RAM. In Oracle 12c and above, temporary tablespaces can also hold the UNDO generated by operations performed on global temporary tables. In earlier releases, the UNDO generated by global temporary tables was routed to the UNDO tablespace and hence would cause REDO to be generated; this is no longer the case. Permanent data objects, such as a table or an index, will never be stored in a temp file, but the contents of a temporary table and its indexes would be. So, you’ll never create your application tables in a temp file, but you might store data there when you use a temporary table.

Temp files are treated in a special way by Oracle. Normally, every change you make to an object will be recorded in the redo logs; these transaction logs can be replayed at a later date to “redo a transaction,” which you might do during recovery from failure. Temp files are excluded from this process. Specifically, transactions in global temporary tables (located in temp files) never have REDO generated for them, although they can have UNDO generated. Thus, *there may be REDO generated* working with temporary tables since UNDO is always protected by REDO, as you will see in detail in Chapter 9. The UNDO generated for global temporary tables is to support rolling back work you’ve done in your session, either due to an error processing data or because of some general transaction failure. A DBA never needs to back up a temporary data file, and, in fact, attempting to do so would be a waste of time, as you can never recover a temporary data file.

---

■ **Note** In Oracle 12c and above, the UNDO generated for global temporary tables may be stored in the temporary tablespace. By default, UNDO will be generated into the permanent UNDO tablespace, just like prior releases. An `init.ora` system-level setting, or a `TEMP_UNDO_ENABLED` session-level settable parameter, may be set to `TRUE` to enable the UNDO generated for global temporary tables to be stored in a temp file. In this manner, no REDO will be generated for these operations. We will investigate this further in Chapter 9.

---

It is recommended that your database be configured with locally-managed temporary tablespaces. You’ll want to make sure that as a DBA, you use a `CREATE TEMPORARY TABLESPACE` command. You don’t want to just alter a permanent tablespace to a temporary one, as you do not get the benefits of temp files that way.

One of the nuances of true temp files is that if the OS permits it, the temporary files will be created sparse—that is, they will not actually consume disk storage until they need to. You can see that easily in this example (on Oracle Linux):

```
EODA@ORA12CR1> !df -h /tmp
Filesystem          Size  Used Avail Use% Mounted on
/dev/mapper/VolGroup-lv_root
                    50G  6.5G  41G  14% /

EODA@ORA12CR1> create temporary tablespace temp_huge
  2 tempfile '/tmp/temp_huge.dbf' size 2g;

Tablespace created.

EODA@ORA12CR1> !df -h /tmp
Filesystem          Size  Used Avail Use% Mounted on
/dev/mapper/VolGroup-lv_root
                    50G  6.5G  41G  14% /

EODA@ORA12CR1> !ls -l /tmp/temp_huge.dbf
-rw-rw----. 1 ora12cr1 ora12cr1 2147491840 Sep  3 13:28 /tmp/temp_huge.dbf
```

---

■ **Note** The UNIX/Linux command `df` shows “disk free” space. This command showed that I have 41GB free in the file system containing `/tmp` before I added a 2GB temp file to the database. After I added that file, I *still* had 41GB free in the file system.

---

Apparently it didn’t take much storage to hold that file. If we look at the `ls` output, it appears to be a normal 2GB file, but it is, in fact, consuming only a few kilobytes of storage currently. So we could actually create hundreds of these 2GB temporary files, even though we have roughly 41GB of disk space free. Sounds great—free storage for all! The problem is, as we start to use these temp files and they start expanding out, we would rapidly hit errors stating “no more space.” Since the space is allocated or physically assigned to the file as needed by the OS, we stand a definite chance of running out of room (especially if after we create the temp files, someone else fills up the file system with other stuff).

How to solve this differs from OS to OS. On UNIX/Linux, you can use `dd` to fill the file with data, causing the OS to physically assign disk storage to the file, or use `cp` to create a nonsparse file, for example:

```
EODA@ORA12CR1> !cp --sparse=never /tmp/temp_huge.dbf /tmp/temp_huge_not_sparse.dbf

EODA@ORA12CR1> !df -h /tmp
Filesystem          Size  Used Avail Use% Mounted on
/dev/mapper/VolGroup-lv_root
                    50G  8.5G  39G  19% /

EODA@ORA12CR1> drop tablespace temp_huge including contents and datafiles;

Tablespace dropped.
```



```
EODA@ORA12CR1> create temporary tablespace temp_huge
  2 tempfile '/tmp/temp_huge_not_sparse.dbf' reuse;
```

Tablespace created.

After copying the sparse 2GB file to `/tmp/temp_huge_not_sparse.dbf` and creating the temporary tablespace using that temp file with the `REUSE` option, we are assured that temp file has allocated all of its file system space and our database actually has 2GB of temporary space to work with.

---

■ **Note** In my experience, Windows NTFS does not do sparse files, and this applies to UNIX/Linux variants. On the plus side, if you have to create a 15GB temporary tablespace on UNIX/Linux and have temp file support, you'll find it happens very fast (instantaneously); just make sure you have 15GB free and reserve it in your mind.

---

## Control Files

Control files are fairly small files (they can grow up to 64MB or so in extreme cases) that contain a directory of the other files Oracle needs. The parameter file tells the instance where the control files are, and the control files tell the instance where the database and online redo log files are.

The control files also tell Oracle other things, such as information about checkpoints that have taken place, the name of the database (which should match the `db_name` parameter in the parameter file), the timestamp of the database as it was created, an archive redo log history (this can make a control file large in some cases), `RMAN` information, and so on.

Control files should be multiplexed either by hardware (RAID) or by Oracle when RAID or mirroring is not available. More than one copy should exist, and the copies should be stored on separate disks to avoid losing them in case you have a disk failure. It is not fatal to lose your control files—it just makes recovery that much harder.

Control files are something a developer will probably never have to actually deal with. To a DBA, they are an important part of the database, but to a software developer they are not really relevant.

## Redo Log Files

Redo log files are crucial to the Oracle database. These are the transaction logs for the database. They are generally used only for recovery purposes, but they can be used for the following as well:

- Instance recovery after a system crash
- Media recovery after a data file restore from backup
- Standby database processing
- Input into “Streams,” or Golden Gate - redo log mining processes for information sharing (a fancy way of saying replication)
- Allow administrators to inspect historical database transactions through the Oracle LogMiner utility

Their main purpose in life is to be used in the event of an instance or media failure, or as a method of maintaining a standby database for failover. If the power goes off on your database machine, causing an instance failure, Oracle will use the online redo logs to restore the system to exactly the point it was at immediately prior to the power outage. If your disk drive containing your data file fails permanently, Oracle will use archived redo logs, as well as online redo logs, to recover a backup of that drive to the correct point in time. Additionally, if you “accidentally” drop a table or

remove some critical information and commit that operation, you can restore a backup and have Oracle restore it to the point just before the accident using these online and archived redo log files.

Virtually every operation you perform in Oracle generates some amount of redo to be written to the online redo log files. When you insert a row into a table, the end result of that insert is written to the redo logs. When you delete a row, the fact that you deleted that row is written. When you drop a table, the effects of that drop are written to the redo log. The data from the table you dropped is not written; however, the recursive SQL that Oracle performs to drop the table does generate redo. For example, Oracle will delete a row from the `SYS.OBJ$` table (and other internal dictionary objects), and this will generate redo, and if various modes of supplemental logging are enabled, the actual `DROP TABLE` statement will be written into the redo log stream.

Some operations may be performed in a mode that generates as little redo as possible. For example, I can create an index with the `NOLOGGING` attribute. This means that the initial creation of the index data will not be logged, but any recursive SQL Oracle performed on my behalf will be. For example, the insert of a row into `SYS.OBJ$` representing the existence of the index will be logged, as will all subsequent modifications of the index using SQL inserts, updates, and deletes. But the initial writing of the index structure to disk will not be logged.

I've referred to two types of redo log file: online and archived. We'll take a look at each in the sections that follow. In Chapter 9 we'll take another look at redo in conjunction with undo segments, to see what impact they have on you as a developer. For now, we'll just concentrate on what they are and what their purpose is.

## Online Redo Log

Every Oracle database has at least two online redo log file groups. Each redo log group consists of one or more redo log members (redo is managed in groups of members). The individual redo log file members of these groups are true mirror images of each other. These online redo log files are fixed in size and are used in a circular fashion. Oracle will write to log file group 1, and when it gets to the end of this set of files, it will switch to log file group 2 and overwrite the contents of those files from start to end. When it has filled log file group 2, it will switch back to log file group 1 (assuming we have only two redo log file groups; if we have three, it would, of course, proceed to the third group). This is shown in Figure 3-4.

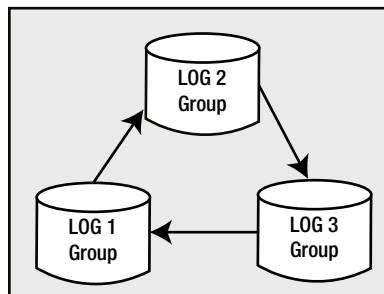

**Figure 3-4.** Writing to log file groups

The act of switching from one log file group to another is called a *log switch*. It is important to note that a log switch may cause a temporary “pause” in a poorly configured database. Since the redo logs are used to recover transactions in the event of a failure, we must be certain we won’t need the contents of a redo log file before we are able to use it. If Oracle isn’t sure that it won’t need the contents of a log file, it will suspend operations in the database momentarily and make sure that the data in the cache that this redo “protects” is safely written (checkpointed) onto disk. Once Oracle is sure of that, processing will resume and the redo file will be reused.

We’ve just started to talk about a key database concept: *checkpointing*. To understand how online redo logs are used, you’ll need to know something about checkpointing, how the database buffer cache works, and what a process called *Database Block Writer (DBWn)* does. The database buffer cache and DBWn are covered in more detail a later on, but we’ll skip ahead a little anyway and touch on them now.

The database buffer cache is where database blocks are stored temporarily. This is a structure in Oracle's SGA. As blocks are read, they are stored in this cache, hopefully so we won't have to physically reread them later. The buffer cache is first and foremost a performance-tuning device. It exists solely to make the very slow process of physical I/O appear to be much faster than it is. When we modify a block by updating a row on it, these modifications are done in memory to the blocks in the buffer cache. Enough information to redo, to replay this modification is stored in the redo log buffer, another SGA data structure. When we COMMIT our modifications, making them permanent, Oracle does not go to all of the blocks we modified in the SGA and write them to disk. Rather, it just writes the contents of the redo log buffer out to the online redo logs. As long as that modified block is in the buffer cache and not on disk, we need the contents of that online redo log in case the database fails. If, at the instant after we committed, the power was turned off, the database buffer cache would be wiped out.

If this happens, the only record of our change is in that redo log file. Upon restart of the database, Oracle will actually replay our transaction, modifying the block again in the same way we did and committing it for us. So, as long as that modified block is cached and not written to disk, we can't reuse (overwrite) that redo log file.

This is where DBWn comes into play. This Oracle background process is responsible for making space in the buffer cache when it fills up and, more important, for performing checkpoints. A checkpoint is the writing of dirty (modified) blocks from the buffer cache to disk. Oracle does this in the background for us. Many things can cause a checkpoint to occur, the most common being a redo log switch.

As we filled up log file 1 and switched to log file 2, Oracle initiated a checkpoint. At this point, DBWn started writing to disk all of the dirty blocks that are protected by log file group 1. Until DBWn flushes all of these blocks protected by that log file, Oracle can't reuse (overwrite) it. If we attempt to use it before DBWn has finished its checkpoint, we'll get a message like this in our database's ALERT log:

```
...
Thread 1 cannot allocate new log, sequence 66
Checkpoint not complete
  Current log# 2 seq# 65 mem# 0: /home/ora12cr1/app/ora12cr1/oradata/orcl/redo01.log
...
```

So, when this message appeared, processing was suspended in the database while DBWn hurriedly finished its checkpoint. Oracle gave all the processing power it could to DBWn at that point in the hope it would finish faster.

This is a message you never want to see in a nicely tuned database instance. If you do see it, you know for a fact that you have introduced artificial, unnecessary waits for your end users. This can always be avoided. The goal (and this is for the DBA, not the developer necessarily) is to have enough online redo log files allocated so that you never attempt to reuse a log file before the checkpoint (initiated by the log switch) completes. If you see this message frequently, it means a DBA has not allocated sufficient online redo logs for the application, or that DBWn needs to be tuned to work more efficiently.

Different applications will generate different amounts of redo log. A Decision Support System (DSS, query only) or DW system will naturally generate significantly less online redo logging than an OLTP (transaction processing) system would, day to day. A system that does a lot of image manipulation in Binary Large Objects (BLOBs) in the database may generate radically more redo than a simple order-entry system. An order-entry system with 100 users will probably generate a tenth the amount of redo 1,000 users would generate. Thus, there is no "right" size for your redo logs, although you do want to ensure they are large enough for your unique workload.

You must take many things into consideration when setting both the size of and the number of online redo logs. Many of them are beyond the scope of this book, but I'll list some of them to give you an idea:

- *Peak workloads:* You'd like your system to not have to wait for checkpoint-not-complete messages, to not get bottlenecked during your peak processing. You should size your redo logs not for average hourly throughput, but rather for your peak processing. If you generate 24GB of log per day, but 10GB of that log is generated between 9:00 am and 11:00 am, you'll want to size your redo logs large enough to carry you through that two-hour peak. Sizing them for an average of 1GB per hour would probably not be sufficient.

- *Lots of users modifying the same blocks:* Here you might want large redo log files. Since everyone is modifying the same blocks, you'd like to update them as many times as possible before writing them out to disk. Each log switch will fire a checkpoint, so you'd like to switch logs infrequently. This may, however, affect your recovery time.
- *Mean time to recover:* If you must ensure that a recovery takes as little time as possible, you may be swayed toward smaller redo log files, even if the previous point is true. It will take less time to process one or two small redo log files than a gargantuan one upon recovery. The overall system will run slower than it absolutely could day to day perhaps (due to excessive checkpointing), but the amount of time spent in recovery will be shorter. There are other database parameters that may also be used to reduce this recovery time, as an alternative to the use of small redo log files.

## Archived Redo Log

The Oracle database can run in one of two modes: ARCHIVELOG mode and NOARCHIVELOG mode. The difference between these two modes is simply what happens to a redo log file when Oracle goes to reuse it. “Will we keep a copy of that redo or should Oracle just overwrite it, losing it forever?” is an important question to answer. Unless you keep this file, you can't recover data from a backup to that point in time.

Say you take a backup once a week on Saturday. Now, on Friday afternoon, after you have generated hundreds of redo logs over the week, your hard disk fails. If you have not been running in ARCHIVELOG mode, the only choices you have right now are as follows:

- Drop the tablespace(s) associated with the failed disk. Any tablespace that had a file on that disk must be dropped, including the contents of that tablespace. If the SYSTEM tablespace (Oracle's data dictionary) or some other important system-related tablespace like your UNDO tablespace is affected, you can't do this. You will have to use the next option instead.
- Restore last Saturday's data and lose all of the work you did that week.

Neither option is very appealing. Both imply that you lose data. If you had been executing in ARCHIVELOG mode, on the other hand, you simply would have found another disk and restored the affected files from Saturday's backup onto it. Then, you would have applied the archived redo logs and, ultimately, the online redo logs to them (in effect replaying the week's worth of transactions in fast-forward mode). You lose nothing. The data is restored to the point of the failure.

People frequently tell me they don't need ARCHIVELOG mode for their production systems. I have yet to meet anyone who was correct in that statement. I believe that a system is not a production system unless it is in ARCHIVELOG mode. A database that is not in ARCHIVELOG mode will, someday, lose data. It is inevitable; *you will lose data* (not might, but *will*) if your database is not in ARCHIVELOG mode.

“We are using RAID-5, so we are totally protected” is a common excuse. I've seen cases where, due to a manufacturing error, all disks in a RAID set froze, all at about the same time. I've seen cases where the hardware controller introduced corruption into the data files, so people safely protected corrupt data with their RAID devices. RAID also does not do anything to protect you from operator error, one of the most common causes of data loss. RAID does not mean the data is safe, it might be more available, it might be *safer*, but data solely on a RAID device will be lost someday; it is a matter of time.

“If we had the backups from before the hardware or operator error and the archives were not affected, we could have recovered.” The bottom line is that there is no excuse for not being in ARCHIVELOG mode on a system where the data is of any value. Performance is no excuse; properly configured archiving adds little to no overhead. This, and the fact that a fast system that loses data is useless, means that even if archiving added 100 percent overhead, you still need to do it. A feature is overhead if you can remove it and lose nothing important; overhead is like icing on the cake. Preserving your data, and making sure you don't lose your data isn't overhead—it's the DBA's primary job!

Only a test or *maybe* a development system should execute in NOARCHIVELOG mode. Most development systems should be run in ARCHIVELOG mode for two reasons:

- This is how you will process the data in production; you want development to act and react as your production system would.
- In many cases, the developers pull their code out of the data dictionary, modify it, and compile it back into the database. The development database holds the current version of the code. If the development database suffers a disk failure in the afternoon, what happens to all of the code you compiled and recompiled all morning? It's lost.

Don't let anyone talk you out of being in ARCHIVELOG mode. You spent a long time developing your application, so you want people to trust it. Losing their data will not instill confidence in your system.

---

■ **Note** There are some cases in which a large DW could justify being in NOARCHIVELOG mode—if it made judicious use of READ ONLY tablespaces and was willing to fully rebuild any READ WRITE tablespace that suffered a failure by reloading the data.

---

## Password Files

The password file is an optional file that permits the remote SYSDBA or administrator access to the database.

When you attempt to start Oracle, there is no database available that can be consulted to verify passwords. When you start Oracle on the local system (i.e., not over the network, but from the machine the database instance will reside on), Oracle will use the OS to perform the authentication.

When Oracle was installed, the person performing the installation was asked to specify an OS group for the administrators. Normally, on UNIX/Linux, this group will be DBA by default, and ORA\_DBA on Windows. It can be any legitimate group name on that platform, however. That group is “special,” in that any user in that group can connect to Oracle “as SYSDBA” without specifying a username or password. For example, in my Oracle 12c Release 1 install, I specified an ora12cr1 group. Anyone in the ora12cr1 group may connect without a username/password:

```
[tkyte@dellpe ~]$ groups
tkyte ora12cr1 ora11gr2 ora10gr2
[tkyte@dellpe ~]$ sqlplus / as sysdba
```

```
SQL*Plus: Release 12.1.0.1.0 Production on Tue Sep 3 14:15:31 2013
```

```
Copyright (c) 1982, 2013, Oracle. All rights reserved.
```

```
Connected to:
```

```
Oracle Database 12c Enterprise Edition Release 12.1.0.1.0 - 64bit Production
With the Partitioning, OLAP, Advanced Analytics and Real Application Testing options
```

```
SYS@ORA12CR1> show user
USER is "SYS"
```

That worked. I'm connected and I could now start up this database, shut it down, or perform whatever administration I wanted to. But suppose I wanted to perform these operations from another machine, over the network. In that case, I would attempt to connect using @tns-connect-string. However, this would fail:

```
[tkyte@dellpe ~]$ sqlplus /@ora12cr1 as sysdba
```

SQL\*Plus: Release 12.1.0.1.0 Production on Tue Sep 3 14:16:22 2013

Copyright (c) 1982, 2013, Oracle. All rights reserved.

ERROR:

ORA-01017: invalid username/password; logon denied

OS authentication won't work over the network for SYSDBA, even if the very unsafe (for security reasons) parameter `REMOTE_OS_AUTHENT` is set to true. So, OS authentication won't work and, as discussed earlier, if you're trying to start up an instance to mount and open a database, then by definition there's no database yet in which to look up authentication details. It is the proverbial chicken and egg problem.

Enter the password file. The password file stores a list of usernames and passwords that are allowed to remotely authenticate as SYSDBA over the network. Oracle must use this file to authenticate them, not the normal list of passwords stored in the database.

So, let's correct our situation. First, verify that the `REMOTE_LOGIN_PASSWORDFILE` parameter is set to the default of `EXCLUSIVE`, meaning only one database uses a given password file:

```
EODA@ORA12CR1> show parameter remote_login_passwordfile
```

NAME	TYPE	VALUE
remote_login_passwordfile	string	EXCLUSIVE

---

■ **Note** Other valid values for this parameter are `NONE`, meaning there is no password file (there are no remote SYSDBA connections), and `SHARED` (more than one database can use the same password file).

---

The next step is to use the command-line tool (on UNIX/Linux and Windows) named `orapwd` to create and populate the initial password file:

```
[ora12cr1@dellpe ~]$ orapwd
Usage: orapwd file=<fname> entries=<users> force=<y/n> asm=<y/n>
       dbuniquename=<dbname> format=<legacy/12> sysbackup=<y/n> sysdgc=<y/n>
       syskm=<y/n> delete=<y/n> input_file=<input-fname>
```

```
Usage: orapwd describe file=<fname>
```

where

...

There must be no spaces around the equal-to (=) character.

The command we'll use when logged into the operating system account that owns the Oracle software is

```
[ora12cr1@dellpe dbs]$ orapwd file=orapw$ORACLE_SID password=bar entries=20
```

This creates a password file named `orapwora12cr1` in my case (my `ORACLE_SID` is `ora12cr1`). That's the naming convention for this file on most UNIX/Linux platforms (see your installation/OS admin guide for details on the naming of this file on your platform), and it resides in the `$ORACLE_HOME/dbs` directory. On Windows, this file is named `PW$ORACLE_SID%.ora` and it's located in the `%ORACLE_HOME%\database` directory. You should navigate to the correct directory prior to running the command to create that file, or move that file into the correct directory afterward.

Now, currently the only user in that file is SYS, even if there are other SYSDBA accounts on that database (they are not in the password file yet). Using that knowledge, however, we can for the first time connect as SYSDBA over the network:

```
[tkyte@dellpe ~]$ sqlplus sys/bar@ora12cr1 as sysdba
```

```
SQL*Plus: Release 12.1.0.1.0 Production on Tue Sep 3 14:21:08 2013
```

```
Copyright (c) 1982, 2013, Oracle. All rights reserved.
```

```
Connected to:
```

```
Oracle Database 12c Enterprise Edition Release 12.1.0.1.0 - 64bit Production
```

```
With the Partitioning, OLAP, Advanced Analytics and Real Application Testing options
```

```
SYS@ORA12CR1>
```

---

■ **Note** If you experience an ORA-12505 “TNS:listener does not currently know of SID given in connect Descriptor” error during this step, that means that the database listener is not configured with a static registration entry for this server. The DBA has not permitted remote SYSDBA connections when the database instance is not up. This will be the case for most Oracle installations for version 9i and above. You would need to configure static server registration in your `listener.ora` configuration file. Please search for “Configuring Static Service Information” (in quotes) on the OTN (Oracle Technology Network) documentation search page for the version of the database you are using for details on configuring this static service.

---

We have been authenticated, so we are in. We can now successfully start up, shut down, and remotely administer this database using the SYSDBA account. Now, we have another user, OPS\$TKYTE, who has been granted SYSDBA, but will not be able to connect remotely yet:

```
[tkyte@dellpe ~]$ sqlplus 'ops$tkyte/foobar'@ora12cr1 as sysdba
```

```
SQL*Plus: Release 12.1.0.1.0 Production on Tue Sep 3 14:22:21 2013
```

```
Copyright (c) 1982, 2013, Oracle. All rights reserved.
```

```
ERROR:
```

```
ORA-01017: invalid username/password; logon denied
```

The reason for this is that OPS\$TKYTE is not yet in the password file. In order to get OPS\$TKYTE into the password file, we need to “regrant” that account the SYSDBA privilege:

```
[tkyte@dellpe ~]$ sqlplus / as sysdba
```

```
SQL*Plus: Release 12.1.0.1.0 Production on Tue Sep 3 14:23:11 2013
```

```
Copyright (c) 1982, 2013, Oracle. All rights reserved.
```

Connected to:

Oracle Database 12c Enterprise Edition Release 12.1.0.1.0 - 64bit Production  
With the Partitioning, OLAP, Advanced Analytics and Real Application Testing options

```
SYS@ORA12CR1> grant sysdba to ops$tkyte;
```

Grant succeeded.

```
SYS@ORA12CR1> exit
```

Disconnected from Oracle Database 12c Enterprise Edition Release 12.1.0.1.0 - 64bit Production  
With the Partitioning, OLAP, Advanced Analytics and Real Application Testing options

```
[tkyte@dellpe ~]$ sqlplus 'ops$tkyte/foobar'@ora12cr1 as sysdba
```

SQL\*Plus: Release 12.1.0.1.0 Production on Tue Sep 3 14:23:25 2013

Copyright (c) 1982, 2013, Oracle. All rights reserved.

Connected to:

Oracle Database 12c Enterprise Edition Release 12.1.0.1.0 - 64bit Production  
With the Partitioning, OLAP, Advanced Analytics and Real Application Testing options

```
SYS@ORA12CR1>
```

This created an entry in the password file for us, and Oracle will now keep the password in sync. If OPS\$TKYTE alters his password, the old one will cease working for remote SYSDBA connections and the new one will start working. The same process is repeated for any user who was a SYSDBA but is not yet in the password file.

## Change Tracking File

The change-tracking file is an optional file for use with Oracle 10g Enterprise Edition and above. The sole purpose of this file is to track what blocks have modified since the last incremental backup. With this, the Recovery Manager (RMAN) tool can back up only the database blocks that have actually been modified without having to read the entire database.

In releases prior to Oracle 10g, an incremental backup would have had to read the entire set of database files to find blocks that had been modified since the last incremental backup. So, if you had a 1TB database to which you simply added 500MB of new data (e.g., a data warehouse load), the incremental backup would have read 1TB of data to find that 500MB of new information to back up. So, the incremental backup would have stored significantly less data in the backup, and it would have still read the entire database.

In Oracle 10g Enterprise Edition and up, that's no longer the case. As Oracle is running, and as blocks are modified, Oracle optionally maintains a file that tells RMAN what blocks have been changed. Creating this change-tracking file is rather simple and is accomplished via the ALTER DATABASE command:

```
SYS@ORA12CR1> alter database enable block change tracking using file
  2  '/home/ora12cr1/oradata/ORA12CR1/changed_blocks.bct';
Database altered.
```



---

■ **Caution** I'll say this from time to time throughout the book: please bear in mind that commands that set parameters, modify the database, or make fundamental changes should not be done lightly, and definitely should be tested prior to performing them on your “real” system. The preceding command will, in fact, cause the database to do more work. It will consume resources.

---

To turn off and remove the block change-tracking file, you'd use the ALTER DATABASE command once again:

```
SYS@ORA12CR1> alter database disable block change tracking;  
Database altered.
```

Note that this command will erase the block change-tracking file. It does not just disable the feature—it removes the file as well.

---

■ **Note** On certain operating systems, such as Windows, you might find that if you run my example—creating a block change-tracking file and then disabling it—the file appears to still exist. This is an OS-specific issue—it does not happen on many operating systems. It will happen only if you CREATE and DISABLE the change-tracking file from a single session. The session that created the block change-tracking file will leave that file open and some operating systems will not permit you to erase a file that has been opened by a previous process (for example, the session process that created the file). This is harmless; you just need to remove the file yourself later.

---

You can enable this new block change-tracking feature in either ARCHIVELOG or NOARCHIVELOG mode. But remember, a database in NOARCHIVELOG mode, where the redo log generated daily is not retained, can't recover all changes in the event of a media (disk or device) failure! A NOARCHIVELOG mode database will lose data some day. We will cover these two database modes in more detail in Chapter 9.

## Flashback Logs

Flashback logs were introduced in Oracle 10g in support of the FLASHBACK DATABASE command, a new feature of the Enterprise Edition of the database in that release. Flashback logs contain “before images” of modified database blocks that can be used to return the database to the way it was at some prior point in time.

## Flashback Database

The FLASHBACK DATABASE command was introduced to speed up the otherwise slow process of point-in-time database recovery. It can be used in place of a full database restore and a rolling forward using archive logs, and it is primarily designed to speed up the recovery from an “accident.” For example, let's take a look at what a DBA might do to recover from an accidentally dropped schema, in which the right schema was dropped, just in the wrong database (it was meant to be dropped in the test environment). The DBA immediately recognizes the mistake he has made and shuts down the database right away. Now what?

Prior to the FLASHBACK DATABASE capability, what would probably happen is this:

1. The DBA would shut down the database.
2. The DBA would restore the last full backup of database from tape (typically), generally a long process. Typically this would be initiated with RMAN via RESTORE DATABASE UNTIL <point in time>.
3. The DBA would restore all archive redo logs generated since the backup that were not available on the system.
4. Using the archive redo logs (and possibly information in the online redo logs), the DBA would roll the database forward and stop rolling forward at a point in time just before the erroneous DROP USER command. Steps 3 and 4 in this list would typically be initiated with RMAN via RECOVER DATABASE UNTIL <point in time>.
5. The database would be opened with the RESETLOGS option.

This was a nontrivial process with many steps and would generally consume a large piece of time (time when no one could access the database, of course). The causes of a point-in-time recovery like this are many: an upgrade script gone awry, an upgrade gone bad, an inadvertent command issued by someone with the privilege to issue it (a mistake, probably the most frequent cause), or some process introducing data integrity issues into a large database (again, an accident; maybe it was run twice instead of just once, or maybe it had a bug). Whatever the reason, the net effect was a large period of downtime.

The steps to recover in Oracle 10g Enterprise Edition and above, assuming you configured the flashback database capability, would be as follows:

1. The DBA shuts down the database.
2. The DBA startup-mounts the database and issues the flashback database command, using either an SCN (the Oracle internal clock), a restore point (which is a pointer to an SCN), or a timestamp (wall clock time), which would be accurate to within a couple of seconds.
3. The DBA opens the database with resetlogs.

To use this feature, the database must be in ARCHIVELOG mode and must have been set up to enable the FLASHBACK DATABASE command. What I'm trying to say is that you need to set up this capability before you ever need to use it. It is not something you can enable after the damage is done; you must make a conscious decision to use it, whether you have it on continuously or whether you use it to set restore points.

## Fast Recovery Area

The Fast Recovery Area is a new concept in Oracle 10g and above. Starting with 10g and for the first time in many years (over 25 years), the basic concept behind database backups has changed in Oracle. In the past, the design of backup and recovery in the database was built around the concept of a sequential medium, such as a tape device. That is, random access devices (disk drives) were always considered too expensive to waste for mere backups. You used relatively inexpensive tape devices with large storage capacities.

Today, however, you can buy terabytes of disk storage at a very low cost. In fact, my son Alan was the first kid on the block with a 1TB NAS (network-attached storage device). It cost \$125.00 USD. I remember my first hard drive on my personal computer: a whopping 40MB. I actually had to partition it into two logical disks because the OS I was using (MS-DOS at the time) could not recognize a disk larger than 32MB. Things have certainly changed in the last 25 years or so.

The Fast Recovery Area in Oracle is a location where the database will manage many of the files related to database backup and recovery. In this area (an *area* being a part of a disk set aside for this purpose; a directory, for example), you could find the following:

- RMAN backup pieces (full and/or incremental backups)
- RMAN image copies (byte-for-byte copies of data files and control files)
- Online redo logs
- Archived redo logs
- Multiplexed control files
- Flashback logs

Oracle uses this new area to manage these files, so the server will know what is on disk and what is not on disk (and perhaps on tape elsewhere). Using this information, the database can perform operations like a disk-to-disk restore of a damaged data file or the flashing back (a “rewind” operation) of the database to undo an operation that should not have taken place. For example, you could use the `FLASHBACK DATABASE` command to put the database back the way it was five minutes ago (without doing a full restore of the database and a point-in-time recovery). That would allow you to “undrop” that accidentally dropped user account.

The Fast Recovery Area is more of a logical concept. It is a holding area for the file types discussed in this chapter. Its use is optional—you don’t need to use it, but if you want to use some advanced features, such as the Flashback Database, you must use this area to store the information.

## DMP Files (EXP/IMP Files)

Export and Import are venerable Oracle data extraction and load tools that have been around for many versions. Export’s job is to create a platform-independent DMP file that contains all of the required metadata (in the form of `CREATE` and `ALTER` statements), and optionally the data itself to re-create tables, schemas, or even entire databases. Import’s sole job is to read these DMP files, and execute the DDL statements and load any data it finds.

---

■ **Note** Export is officially deprecated with Oracle 11g Release 2. It is supplied only for use with legacy database structures. New data types, new structures, new database features will not be supported by this tool. I strongly recommend using Data Pump, the export/import replacement tool introduced with Oracle 10g several years back.

---

DMP files are designed to be forward-compatible, meaning that newer releases can read older releases’ DMP files and process them successfully. I have heard of people exporting a version 5 database and successfully importing it into Oracle 10g (just as a test). So Import can read older version DMP files and process the data therein. The converse, however, is most definitely not true: the Import process that comes with Oracle9i Release 1 can’t—will not—successfully read a DMP file created by Oracle9i Release 2 or Oracle 10g Release 1. For example, I exported a simple table from Oracle 11g Release 2. Upon trying to use these DMP files in Oracle 10g Release 2, I soon discovered Oracle 10g Release 2 Import will not even attempt to process the Oracle 11g Release 2 DMP file:

```
$ imp userid=/ full=y
```

```
Import: Release 10.2.0.4.0 - Production on Wed Jan 20 18:21:03 2010
```

```
Copyright (c) 1982, 2007, Oracle. All rights reserved.
```

Connected to: Oracle Database 10g Enterprise Edition Release 10.2.0.4.0 - Production  
 With the Partitioning, OLAP, Data Mining and Real Application Testing options

```
IMP-00010: not a valid export file, header failed verification
IMP-00000: Import terminated unsuccessfully
```

Even in the cases where IMP was able to recognize the file, there would be a great chance that the DDL generated by the 11g Release 2 EXP tool would not be DDL that the earlier version of Oracle would recognize. For example, suppose you export from any release of Oracle version 9i Release 2 or above. You would find in the export file that every CREATE TABLE has a COMPRESS or NOCOMPRESS option added to it. Oracle9i Release 2 added basic table compression as a feature. If you were able to get any release of Oracle older than 9i Release 2 to read that export file, you'd find that the DDL it contains would fail—100 percent of the time. Not a single CREATE TABLE statement would work because the NOCOMPRESS/COMPRESS keywords would not be recognized by the older release.

DMP files are platform-independent, so you can safely take an export from any platform, transfer it to another, and import it (as long as the versions of Oracle permit). One caveat, however, with Windows and FTPing of files is that Windows will consider a DMP file a text file by default and will tend to convert linefeeds (the end-of-line marker on UNIX/Linux) into carriage return/linefeed pairs, thus totally corrupting the DMP file. When transferring a DMP file in Windows, make sure you're doing a binary transfer. If your subsequent import won't work, check the source and target file sizes to make sure they're the same. I can't recall how many times this issue has brought things to a screeching halt while the file had to be retransferred.

DMP files are binary files, meaning you won't be editing them to change them. You can extract a large amount of information from them—CREATE DDL and more—but you won't be editing them in a text editor (or any sort of editor, actually). In the book *Expert One-on-One Oracle* (Apress, 2003), I spent a great deal of time discussing the Import and Export utilities and working with DMP files. Because these tools are falling out of favor, in place of the infinitely more flexible Data Pump utilities, I'll defer a full discussion of how to manipulate them, extract data from them, and use them in general to the existing first edition of this book.

## Data Pump Files

Data Pump is a file format used by at least two tools in Oracle. External tables can load and unload data in the Data Pump format, and the new import/export tools IMPDP and EXPDP use this file format in much the same way IMP and EXP used the DMP file format.

---

■ **Note** The Data Pump format is exclusive to Oracle 10g Release 1 and above—it did not exist in any Oracle9i release, nor can it be used with that release.

---

Pretty much all of the same caveats that applied to DMP files mentioned previously will apply over time to Data Pump files as well. They are cross-platform (portable) binary files that contain metadata (not stored in CREATE/ALTER statements, but rather in XML) and possibly data. That they use XML as a metadata representation structure is actually relevant to you and me as end users of the tools. IMPDP and EXPDP have some sophisticated filtering and translation capabilities never seen in the IMP/EXP tools of old. This is in part due to the use of XML and to the fact that a CREATE TABLE statement is not stored as a CREATE TABLE, but rather as a marked-up document. This permits easy implementation of a request like “Please replace all references to tablespace FOO with tablespace BAR.” When the metadata was stored in the DMP file as CREATE/ALTER statements, the Import utility would have had to basically parse each SQL statement before executing it in order to accomplish the feat of changing tablespace names (something it does not do). IMPDP, however, just has to apply a simple XML transformation to accomplish the same. FOO, when it refers to a TABLESPACE, would be surrounded by <TABLESPACE>FOO</TABLESPACE> tags (or some other similar representation).

The fact that XML is used has allowed the EXPDP and IMPDP tools to literally leapfrog the old EXP and IMP tools with regard to their capabilities. In Chapter 15, we'll take a closer look at these tools. Before we get there, however, let's see how we can use this Data Pump format to quickly extract some data from database A and move it to database B. We'll be using an "external table in reverse" here.

External tables, originally introduced in Oracle9i Release 1, gave us the ability to read flat files—plain old text files—as if they were database tables. We had the full power of SQL to process them. They were read-only and designed to get data from outside Oracle in. External tables in Oracle 10g Release 1 and above can go the other way: they can be used to get data out of the database in the Data Pump format to facilitate moving the data to another machine or another platform. To start this exercise, we'll need a DIRECTORY object, telling Oracle the location to unload to:

```
EODA@ORA12CR1> create or replace directory tmp as '/tmp';
Directory created.
```

```
EODA@ORA12CR1> create table all_objects_unload
 2 organization external
 3 ( type oracle_datapump
 4   default directory TMP
 5   location( 'allobjects.dat' )
 6 )
 7 as
 8 select * from all_objects
 9 /
Table created.
```

And that literally is all there is to it: we have a file in /tmp named allobjects.dat that contains the contents of the query `select * from all_objects`. We can peek at this information:

```
EODA@ORA12CR1> !strings /tmp/allobjects.dat | head
"EODA". "U"
x86_64/Linux 2.4.xx
AL32UTF8
12.00.00.00.00
001:001:000001:000001
i<?xml version="1.0"?>
<ROWSET>
  <ROW>
    <STRMTABLE_T>
```

That's just the head, or top, of the file. Now, using a binary FTP (same caveat as for a DMP file), you can move that file to any other platform where you have Oracle 12c installed and by issuing a CREATE DIRECTORY statement (to tell the database where the file is) and a CREATE TABLE statement, such as this:

```
create table t
( OWNER          VARCHAR2(30),
  OBJECT_NAME    VARCHAR2(30),
  SUBOBJECT_NAME VARCHAR2(30),
  OBJECT_ID      NUMBER,
  DATA_OBJECT_ID NUMBER,
  OBJECT_TYPE    VARCHAR2(19),
  CREATED        DATE,
  LAST_DDL_TIME  DATE,
```

```

TIMESTAMP      VARCHAR2(19),
STATUS         VARCHAR2(7),
TEMPORARY      VARCHAR2(1),
GENERATED      VARCHAR2(1),
SECONDARY      VARCHAR2(1)
)
organization external
( type oracle_datapump
  default directory TMP
  location( 'allobjects.dat' )
);

```

You would be set to read that unloaded data using SQL immediately. That is the power of the Data Pump file format: immediate transfer of data from system to system, over “sneakernet” if need be. Think about that the next time you’d like to take a subset of data home to work with over the weekend while testing.

Even if the database character sets differ (they did not in this example), Oracle has the ability now to recognize the differing character sets due to the Data Pump format and deal with them. Character-set conversion can be performed on the fly as needed to make the data “correct” in each database’s representation.

Again, we’ll come back to the Data Pump file format in Chapter 15, but this section should give you an overall feel for what it is about and what might be contained in the file.

## Flat Files

Flat files have been around since the dawn of electronic data processing. We see them literally every day. The text alert log described previously is a flat file.

I found the following definition for “flat file” on the Web, and feel it pretty much wraps things up:

*“An electronic record that is stripped of all specific application (program) formats. This allows the data elements to be migrated into other applications for manipulation. This mode of stripping electronic data prevents data loss due to hardware and proprietary software obsolescence.”<sup>1</sup>*

A flat file is simply a file whereby each “line” is a “record,” and each line has some text delimited, typically by a comma or pipe (vertical bar). Flat files are easily read by Oracle using either the legacy data-loading tool SQLLDR or external tables. In fact, I will cover this in detail in Chapter 15 (External tables are also covered in Chapter 10).

However, flat files are not something produced so easily by Oracle. For whatever reason, there is no simple command-line tool to export information to a flat file. Tools such as APEX, SQL Developer, and Enterprise Manager facilitate this process, but there are no official command-line tools that are easily usable in scripts and such to perform this operation.

That’s one reason I decided to mention flat files in this chapter: to propose a set of tools capable of producing simple flat files. I have over the years developed three methods to accomplish this task, each appropriate in its own right. The first utility uses a combination of PL/SQL and UTL\_FILE with dynamic SQL to accomplish the job. With small volumes of data (hundreds or thousands of rows), this utility is sufficiently flexible and fast enough to get the job done. However, it must create its files on the database server machine, which is sometimes not the location we’d like for them. To that end, I have a SQL\*Plus utility that creates flat files on the machine that is running SQL\*Plus. Since SQL\*Plus can connect to an Oracle server anywhere on the network, this gives us the ability to unload to a flat file any

---

<sup>1</sup> See <http://osulibrary.oregonstate.edu/archives/handbook/definitions>

data from any database on the network. Lastly, when the need for total speed is there, nothing but C will do (if you ask me). So I also have a Pro\*C command-line unloading tool to generate flat files. All of these tools are freely available at <http://tkyte.blogspot.com/2009/10/httpasktomoraclecomtkyteflat.html>, and any new tools developed for unloading to flat files will appear there as well.

## Summary

In this chapter, we explored the important types of files used by the Oracle database, from lowly parameter files (without which you won't even be able to get started) to the all-important redo log and data files. We examined the storage structures of Oracle from tablespaces to segments and extents, and finally down to database blocks, the smallest unit of storage. We briefly reviewed how checkpointing works in the database, and we even started to look ahead at what some of the physical processes or threads of Oracle do. We also covered many optional file types such as password files, change-tracking files, Data Pump files, and more. In the next chapter we are ready to look at the Oracle memory structures.



# Memory Structures

In this chapter, we'll look at Oracle's three major memory structures:

- *System Global Area (SGA)*: This is a large, shared memory segment that virtually all Oracle processes will access at one point or another.
- *Process (or Program) Global Area (PGA)*: This is memory that is private to a single process or thread; it is not accessible from other processes/threads.
- *User Global Area (UGA)*: This is memory associated with your session. It is located either in the SGA or the PGA, depending whether you are connected to the database using a shared server (it will be in the SGA), or a dedicated server (it will be in the PGA).

---

■ **Note** In earlier releases of Oracle, shared server was referred to as Multi-Threaded Server or MTS. In this book, we will always use the term *shared server*.

---

When we discuss memory management in Oracle, we have five modes to investigate:

- *Automatic memory management (AMM)*, for the SGA and PGA, available only in Oracle 11g and above, the DBA sets just one parameter—the `MEMORY_TARGET` parameter—to allow the database to determine how to size all of the memory regions.
- *Automatic shared memory management (ASMM)*, for the SGA, where the DBA sets a target size for the SGA (via `SGA_TARGET`).
- *Manual shared memory management*, for the SGA, the DBA manually sizes individual memory areas of the SGA (via `DB_CACHE_SIZE`, `SHARED_POOL_SIZE`, and so on).
- *Automatic PGA memory management*, for the PGA, the DBA sets a target size for the PGA (via `PGA_AGGREGATE_TARGET`).
- *Manual PGA memory management*, for the PGA, the DBA manually sizes individual memory areas of the PGA (via `SORT_AREA_SIZE`, `HASH_AREA_SIZE`, and so on). Oracle strongly recommends not using this method, but we will discuss it to provide a foundation for other memory management concepts.

Looking at the prior bulleted list, which memory management method should you use? In an ideal environment, everybody would be using automatic memory management, right? Just set one parameter (`MEMORY_TARGET`) and you're done. However, in the real world it's not so black and white. Sometimes there are aspects of your environment where you know best what the target sizes of memory should be, and therefore decide to use one of the less automated memory management methods. This chapter's purpose is to help you become versed in all aspects of Oracle memory so that you can make intelligent decisions regarding how to enable memory management.



---

■ **Note** Some operating system configurations are incompatible with automatic memory management (for example, Linux HugePages). See the Oracle Database Administrator's Reference for Linux and UNIX-Based Operating Systems manual for details.

---

We'll attack all of the methods by first discussing PGA and UGA memory management, first manual and then automatic. We'll then move onto the SGA, again looking at manual and then automatic memory management methods. We'll close with a look at how to manage memory using just a single parameter to control both the SGA and PGA regions.

## The Process Global Area and User Global Area

The PGA is a process-specific piece of memory. In other words, it is memory specific to a single operating system process or thread. This memory is not accessible by any other process or thread in the system. It is typically allocated via either of the C runtime calls `malloc()` or `mmap()`, and it may grow (or even shrink) at runtime. The PGA is never allocated in Oracle's SGA; it is always allocated locally by the process or thread—the P in PGA stands for *process* or *program*; it is not shared.

The UGA is, in effect, your session's state. It is memory that your session must always be able to get to. The location of the UGA is dependent on how you connect to Oracle. If you connect via a shared server, the UGA must be stored in a memory structure that every shared server process has access to—and that's the SGA. In this way, your session can use any one of the shared servers, since any of them can read and write your session's data. On the other hand, if you are using a dedicated server connection, there's no need for universal access to your session state, and the UGA becomes virtually synonymous with the PGA; it will, in fact, be contained in the PGA of your dedicated server. When you look at the system statistics, you'll find the UGA reported in the PGA in dedicated server mode (the PGA will be greater than or equal to the UGA memory used; the PGA memory size will include the UGA size as well).

So, the PGA contains process memory and may include the UGA. The other areas of PGA memory are generally used for in-memory sorting, bitmap merging, and hashing. It would be safe to say that, besides the UGA memory, these are the largest contributors by far to the PGA.

Starting with Oracle9i Release 1, there are two ways to manage this other non-UGA memory in the PGA:

- *Manual PGA memory management*, where you tell Oracle how much memory it can use to sort and hash any time it needs to sort or hash in a specific process.
- *Automatic PGA memory management*, where you tell Oracle how much memory it should attempt to use system wide.

Starting with Oracle 11g Release 1, automatic PGA memory management can be implemented using one of the two following techniques:

- By setting the `PGA_AGGREGATE_TARGET` initialization parameter and telling Oracle how much PGA memory to attempt to use instance wide.
- By setting the `MEMORY_TARGET` initialization parameter and telling Oracle how much total memory the database instance should use for both the SGA and the PGA; the PGA size will be figured out by the instance itself from this parameter.

The manner in which memory is allocated and used differs greatly in each case, so we'll discuss each in turn.

---

■ **Note** It should be noted that in Oracle9i, when using a shared server connection, you only can use manual PGA memory management. This restriction was lifted with Oracle 10g Release 1 (and above). Since that release, you can use either automatic or manual PGA memory management with shared server connections. If you're using Oracle 10g Release 1 (and above) then you should be using automatic PGA memory management.

---

PGA memory management modes are controlled by the database initialization parameter `WORKAREA_SIZE_POLICY` and may be altered at the session level. This initialization parameter defaults to `AUTO`, which sets automatic PGA memory management when possible in Oracle9i Release 2 and above. In Oracle9i Release 1, the default setting was `MANUAL`.

In the sections that follow, we'll take a look at each approach.

## Manual PGA Memory Management

In manual PGA memory management, the following are the parameters that have the largest impact on the size of your PGA, outside of the memory allocated by your session for PL/SQL tables and other variables:

- `SORT_AREA_SIZE`: The total amount of RAM that will be used to sort information before swapping out to disk (using disk space in the temporary tablespace the user is assigned to).
- `SORT_AREA_RETAINED_SIZE`: The amount of memory that will be used to hold sorted data after the sort is complete. That is, if `SORT_AREA_SIZE` is 512KB and `SORT_AREA_RETAINED_SIZE` is 256KB, your server process would use up to 512KB of memory to sort data during the initial processing of the query. When the sort is complete, the sorting area would "shrink" down to 256KB, and any sorted data that does not fit in that 256KB would be written out to the temporary tablespace.
- `HASH_AREA_SIZE`: The amount of memory your server process can use to store hash tables in memory. These structures are used during a hash join, typically when joining a large set with another set. The smaller of the two sets would be hashed into memory and anything that didn't fit in the hash area region of memory would be stored in the temporary tablespace by the join key.

These parameters control the amount of space Oracle will use to sort or hash data in memory before using the temporary tablespace on disk, and how much of that memory segment will be retained after the sort is done. The `SORT_AREA_SIZE-SORT_AREA_RETAINED_SIZE` calculated value is generally allocated out of your PGA, and the `SORT_AREA_RETAINED_SIZE` value will be in your UGA. You can discover your current use of PGA and UGA memory and monitor its size by querying special Oracle V\$ views, also referred to as *dynamic performance views*.

For example, let's run a small test whereby in one session we'll sort lots of data and, from a second session, we'll monitor the UGA/PGA memory use in that first session. To do this in a predictable manner, we'll make a copy of the `ALL_OBJECTS` table, with about 72,000 rows in this case, without any indexes (so we know a sort has to happen when we use `ORDER BY` on this table):

```
EODA@ORA12CR1> create table t as select * from all_objects;
Table created.
```

```
EODA@ORA12CR1> exec dbms_stats.gather_table_stats( user, 'T' );
PL/SQL procedure successfully completed.
```

To remove any side effects from the initial hard parsing of queries, we'll run the following script three times, but for now ignore its output. We'll run the script again in a fresh session so as to see the effects on memory usage in a controlled environment. We'll use the sort area sizes of 64KB, 1MB, and 1GB in turn, so save this script as `run_query.sql` (this script assumes the username and password are `eoda/foo`, you'll have to modify it for your environment):

```
connect eoda/foo
set serveroutput off
set echo on
column sid new_val SID
select sid from v$mystat where rownum = 1;
alter session set workarea_size_policy=manual;
alter session set sort_area_size = &1;
prompt run @reset_stat &SID and @watch_stat in another session here!
pause
set termout off
select * from t order by 1, 2, 3, 4;
set termout on
prompt run @watch_stat in another session here!
pause
```

and then run:

```
@run_query 65536
@run_query 1048576
@run_query 1073741820
```

Just ignore the output for now; we are just warming up the shared pool and getting everything “even.”

---

■ **Note** When we process SQL in the database, we must first parse the SQL statement. There are two types of parses. The first is a hard parse, which is what happens the first time a query is parsed by the database instance and includes query plan generation and optimization. The second is a soft parse, which can skip many of the steps a hard parse must do, because it can reuse the result of that work. We hard parsed the previous queries so as to not measure the work performed by that operation in the following section.

---

I suggest logging out of that SQL\*Plus session and logging back in before continuing, in order to get a consistent environment, or one in which no work has been done yet. Now, we will want to be able to measure the session memory of the session running the big `ORDER BY` queries from a second separate session. If we used the same session, our query to see how much memory we are using for sorting might itself influence the very numbers we are looking at. To measure the memory from this second session, we'll use a small SQL\*Plus script I developed for this. It is actually a pair of scripts; you'll be told when to run them by the `run_query.sql` script. The one that resets a small table and sets a SQL\*Plus variable to the SID we want to watch is called `reset_stat.sql`:

```
drop table sess_stats;

create table sess_stats
( name varchar2(64), value number, diff number );

variable sid number
exec :sid := &1
```

---

■ **Note** Before using this script (or any script, for that matter), make sure you understand what the script does. This script drops and re-creates a table called `SESS_STATS`. If your schema already has such a table, you'll probably want to use a different name!

---

The other script is called `watch_stat.sql`, and for this case study, it uses the `MERGE` SQL statement so we can initially `INSERT` the statistic values for a session and then later come back and update them—without needing a separate `INSERT/UPDATE` script:

```
merge into sess_stats
using
(
select a.name, b.value
  from v$statname a, v$sesstat b
 where a.statistic# = b.statistic#
       and b.sid = :sid
       and (a.name like '%ga %'
           or a.name like '%direct temp%')
) curr_stats
on (sess_stats.name = curr_stats.name)
when matched then
  update set diff = curr_stats.value - sess_stats.value,
           value = curr_stats.value
when not matched then
  insert ( name, value, diff )
  values
  ( curr_stats.name, curr_stats.value, null )
/

select name,
       case when name like '%ga %'
           then round(value/1024,0)
           else value
       end kbytes_writes,
       case when name like '%ga %'
           then round(diff /1024,0)
           else value
       end diff_kbytes_writes
  from sess_stats
 order by name;
```

I emphasize the phrase “for this case study” because of the lines in bold—the names of the statistics we’re interested in looking at change from example to example. In this particular case, we’re interested in anything with `ga` in it (`pga` and `uga`), or anything with `direct temp`, which in Oracle 10g and above will show us the direct reads and writes against temporary space (how much I/O we did reading and writing to temp).

---

■ **Note** In Oracle9i, direct I/O to the temporary tablespace was not labeled as such, so we used a `WHERE` clause that included (`and a.name like '%ga %'` or `a.name like '%physical % direct%'`) in it.

---

When this `watch_stat.sql` script is run from the SQL\*Plus command line, we'll see a listing of the PGA and UGA memory statistics for the session, as well as temporary I/O. Now, if you run the script “@run\_query 65536” in a session, you'll see output like this:

```
EODA@ORA12CR1> @run_query 65536
Connected.
EODA@ORA12CR1> set serveroutput off
EODA@ORA12CR1> set echo on
EODA@ORA12CR1> column sid new_val SID
EODA@ORA12CR1> select sid from v$mystat where rownum = 1;

      SID
-----
      23

EODA@ORA12CR1> alter session set workarea_size_policy=manual;

Session altered.

EODA@ORA12CR1> alter session set sort_area_size = &1;
old  1: alter session set sort_area_size = &1
new  1: alter session set sort_area_size = 65536

Session altered.

EODA@ORA12CR1> prompt run @reset_stat &SID and @watch_stat in another session here!
run @reset_stat      23 and @watch_stat in another session here!
EODA@ORA12CR1> pause
```

We can see the SID of this new session (23), and we've set our PGA memory management to manual and our SORT\_AREA\_SIZE to 65,536 (64KB). Now the script tells us to run the two other scripts in another session, so we'll do that:

```
EODA@ORA12CR1> @reset_stat 23
Table dropped.

Table created.

PL/SQL procedure successfully completed.

EODA@ORA12CR1> @watch_stat

6 rows merged.
```

NAME	KBYTES_WRITES	DIFF_KBYTES_WRITES
physical reads direct temporary tablespace	0	0
physical writes direct temporary tablespace	0	0
session pga memory	876	0
session pga memory max	876	0
session uga memory	334	0
session uga memory max	334	0

```
6 rows selected.
```

---

■ **Note** The `watch_stat.sql` script must be run in the same session as the `reset_stat.sql` script; `reset_stat.sql` sets the `:sid` bind variable necessary for the `MERGE` statement. Alternatively, you can execute `exec :sid := <sid>`, where `<sid>` is the SID you observe in your testing.

---

So, before we begin we can see that we have about 334KB of data in the UGA and 876KB of data in the PGA. The first question is, “How much memory are we using between the PGA and UGA?” That is, are we using 334KB + 876KB of memory, or are we using some other amount? This is a trick question, and one that you can’t answer unless you know whether the monitored session with SID 23 was connected to the database via a dedicated server or a shared server—and even then it might be hard to figure out. In dedicated server mode, the UGA is totally contained within the PGA, in which case we would be consuming 876KB of memory in our process or thread.

In shared server mode, the UGA is allocated from the SGA, and the PGA is allocated in O/S memory private to the shared server process. So, in shared server mode, by the time we get the last row from the preceding query, the shared server process may be in use by someone else. That PGA isn’t “ours” anymore, so technically we are using 334KB of memory (except when we are actually running the query, at which point we are using 1210KB of memory between the combined PGA and UGA). In this case, I used a dedicated server (it would be impossible to do the test accurately otherwise) and we are using a grand total of 876KB of memory in the combined PGA and UGA. So, let’s now run the first big query in session 23, which is using manual PGA memory management in dedicated server mode. We just have to go back to that session where we ran `run_query.sql` and hit enter to start the query running:

---

■ **Note** Since we haven’t set a `SORT_AREA_RETAINED_SIZE`, its reported value will be zero, but its used value will match `SORT_AREA_SIZE`.

---

```
EODA@ORA12CR1> set termout off
EODA@ORA12CR1> prompt run @watch_stat in another session here!
run @watch_stat in another session here!
EODA@ORA12CR1> pause
```

The point where you see `set termout off` is the point where the large query is executing, we told SQL\*plus to run the query but not print on the screen (it would take a while for over 70,000 lines to be printed). Now if we run our `watch_stat.sql` script again in the second session, we’ll see something like the following:

```
EODA@ORA12CR1> @watch_stat
6 rows merged.
```

NAME	KBYTES_WRITES	DIFF_KBYTES_WRITES
physical reads direct temporary tablespace	3000	3000
physical writes direct temporary tablespace	3000	3000
session pga memory	1196	320
session pga memory max	1260	384
session uga memory	654	320
session uga memory max	718	384

6 rows selected.

Notice this time that the `session xxx memory` and `session xxx memory max` values don't match. The `session xxx memory` value represents how much memory we are using right now. The `session xxx memory max` value represents the peak value we used at some time during our session while processing the query.

---

■ **Note** In these examples, I wouldn't expect that you'd see exactly the same numbers I've printed here. The amount of memory used is affected by many things, such as Oracle version, the operating system and its features and capabilities, the amount of data placed into the table `T`, and so on. You should expect variations in memory amounts, but the overall picture will be the same.

---

As you can see, our memory usage went up—we've done some sorting of data. Our UGA memory increased from 334KB to 718KB during the processing (max value) of our query. To perform our query and the sorting, Oracle allocated a sort area for our session. Additionally, the PGA memory went from 876KB to 1196KB. Also, we can see that we did 3,000 writes and reads to and from temp (since the data we sorted could not have fit into 64KB, our `SORT_AREA_SIZE`).

By the time we finish our query and exhaust the result set, we can see that our PGA has shrunk somewhat (note that in Oracle8i and before, you wouldn't expect to see the PGA shrink back at all; this is a new feature with Oracle9i and later).

Let's retry that operation but play around with the size of our `SORT_AREA_SIZE` by increasing it to 1MB. We'll log out of the session we're monitoring and log back in, following the directions to increase our `SORT_AREA_SIZE` to 1MB. Remember that in the other session we are monitoring from, you must run the `reset_stat.sql` script to start over. As the beginning numbers are consistent (the output of the first `watch_stat.sql` should be the same in a new session), I don't display them here—only the final results:

NAME	KBYTES_WRITES	DIFF_KBYTES_WRITES
-----	-----	-----
physical reads direct temporary tablespace	1043	1043
physical writes direct temporary tablespace	1043	1043
session pga memory	1196	320
session pga memory max	2732	1856
session uga memory	718	384
session uga memory max	1756	1422
6 rows selected.		

As you can see, our UGA memory has grown considerably this time during the processing of our query. It temporarily grew to about 1,700KB (a bit more than 1MB, our `SORT_AREA_SIZE`), but the amount of physical I/O we had to do to sort this data dropped considerably as well (use more memory, swap to disk less often). We may have avoided a multipass sort as well, a condition that happens when there are so many little sets of sorted data to merge together that Oracle ends up writing the data to temp more than once. Now, let's go to an extreme here and use a 1GB `SORT_AREA_SIZE`:

NAME	KBYTES_WRITES	DIFF_KBYTES_WRITES
-----	-----	-----
physical reads direct temporary tablespace	0	0
physical writes direct temporary tablespace	0	0
session pga memory	1132	256
session pga memory max	11372	10496
session uga memory	654	320
session uga memory max	10631	10296
6 rows selected.		

We can observe that even though we allowed for up to 1GB of memory to the `SORT_AREA_SIZE`, we really only used about 10MB. This shows that the `SORT_AREA_SIZE` setting is an upper bound, not the default and only allocation size. Also, we only performed one sort again, but this time it was entirely in memory; there was no temporary space on disk used, as evidenced by the lack of physical I/O.

If you run this same test on various versions of Oracle, or perhaps even on different operating systems, you might see different behavior, and I would expect that your numbers in all cases would be a little different from mine. But the general behavior should be the same. In other words, as you increase the permitted sort area size and perform large sorts, the amount of memory used by your session will increase. You might notice the PGA memory going up and down, or it might remain constant over time, as just shown. For example, if you were to execute the previous test in Oracle8i, I'm sure you'd notice that PGA memory does not shrink back in size (i.e., the `SESSION PGA MEMORY` equals the `SESSION PGA MEMORY MAX` in all cases). This is to be expected, as the PGA is managed as a heap in 8i releases and is created via `malloc()`-ed memory. In 9i and above, new methods attach and release work areas as needed using operating system-specific memory allocation calls.

Here are the important things to remember about using the `*_AREA_SIZE` parameters:

- These parameters control the maximum amount of memory used by a SORT, HASH, or BITMAP MERGE operation.
- A single query may have many operations taking place that use this memory, and multiple sort/hash areas could be created. Remember that you may have many cursors opened simultaneously, each with its own `SORT_AREA_RETAINED` needs. So, if you set the sort area size to 10MB, you could use 10, 100, 1,000 or more megabytes of RAM in your session. These settings are not session limits; rather, they are limits on a single operation, and your session could have many sorts in a single query or many queries open that require a sort.
- The memory for these areas is allocated on an “as needed” basis. If you set the sort area size to 1GB as we did, it doesn't mean you'll allocate 1GB of RAM. It only means that you've given the Oracle process the permission to allocate that much memory for a sort/hash operation.

## Automatic PGA Memory Management

Starting with Oracle9i Release 1, a new way to manage PGA memory was introduced that avoids using the `SORT_AREA_SIZE`, `BITMAP_MERGE_AREA_SIZE`, and `HASH_AREA_SIZE` parameters. It was introduced to address a few issues:

- *Ease of use:* Much confusion surrounded how to set the proper `*_AREA_SIZE` parameters. There was also much confusion over how those parameters actually worked and how memory was allocated.
- *Manual allocation was a “one-size-fits-all” method:* Typically, as the number of users running similar applications against a database went up, the amount of memory used for sorting and hashing went up linearly as well. If 10 concurrent users with a sort area size of 1MB used 10MB of memory, 100 concurrent users would probably use 100MB, 1,000 would probably use 1000MB, and so on. Unless the DBA was sitting at the console continually adjusting the sort/hash area size settings, everyone would pretty much use the same values all day long. Consider the previous example, where you saw for yourself how the physical I/O to temp decreased as the amount of RAM we allowed ourselves to use went up. If you run that example for yourself, you will almost certainly see a decrease in response time as the amount of RAM available for sorting increases. Manual allocation fixes the amount of memory to be used for sorting at a more or less constant number, regardless of how much memory is actually available. Automatic memory management allows us to use the memory when it is available; it dynamically adjusts the amount of memory we use based on the workload.



- *Memory control:* As a result of the previous point, it was hard, if not impossible, to keep the Oracle instance inside a “box” memory-wise. You couldn’t control the amount of memory the instance was going to use, as you had no real control over the number of simultaneous sorts and hashes taking place. It was far too easy to attempt to use more real memory (actual physical free memory) than was available on the machine.

Enter automatic PGA memory management. Here, you first simply set up and size the SGA. The SGA is a fixed-size piece of memory so you can very accurately see how big it is, and that will be its total size (unless and until you change it). You then tell Oracle, “This is how much memory you should try to limit yourself to across all *work areas*” (a new umbrella term for the sorting and hashing areas you use). Now, you could in theory take a machine with 2GB of physical memory and allocate 768MB of memory to the SGA and 768MB of memory to the PGA, leaving 512MB of memory for the OS and other processes. I say “in theory” because it doesn’t work exactly that cleanly, but it’s close. Before I discuss why that’s true, let’s take a look at how to set up automatic PGA memory management and turn it on.

The process of setting this up involves deciding on the proper values for two instance initialization parameters:

- `WORKAREA_SIZE_POLICY`: This parameter may be set to either `MANUAL`, which will use the sort area and hash area size parameters to control the amount of memory allocated, or `AUTO`, in which case the amount of memory allocated will vary based on the currently allocated PGA memory to the instance. The default and recommended value is `AUTO`.
- `PGA_AGGREGATE_TARGET`: This parameter controls how much memory the instance should allocate, in total, for all work areas used to sort or hash data. Its default value varies by version and may be set by various tools such as the DBCA. In general, if you are using automatic PGA memory management, you should explicitly set this parameter.

---

■ **Note** In Oracle 11g Release 1 and above, instead of setting the `PGA_AGGREGATE_TARGET`, you can set the `MEMORY_TARGET` parameter. When the instance uses the `MEMORY_TARGET` parameter, it decides how much memory to allocate to the SGA and PGA respectively. It may also decide to reallocate these memory amounts while the database is up and running. This fact, however, doesn’t affect how automatic PGA memory management (described later in this chapter) works; rather it just decides the setting for the `PGA_AGGREGATE_TARGET`.

---

So, assuming that `WORKAREA_SIZE_POLICY` is set to `AUTO` (the default) and `PGA_AGGREGATE_TARGET` has a nonzero value, you will be using automatic PGA memory management. You can “turn it on” in your session via the `ALTER SESSION` command or at the system level via the `ALTER SYSTEM` command.

---

■ **Note** Bear in mind the previous caveat that in Oracle9i, shared server connections will not use automatic memory management; rather, they will use the `SORT_AREA_SIZE` and `HASH_AREA_SIZE` parameters to decide how much RAM to allocate for various operations. In Oracle 10g and up, automatic PGA memory management is available to both connection types. It is important to properly set the `SORT_AREA_SIZE` and `HASH_AREA_SIZE` parameters when using shared server connections with Oracle9i.

---

So, the entire goal of automatic PGA memory management is to maximize the use of RAM while at the same time not using more RAM than you want. Under manual memory management, this was a virtually impossible goal to achieve. If you set `SORT_AREA_SIZE` to 10MB, when one user was performing a sort operation that user would use up to 10MB for the sort work area. If 100 users were doing the same, they would use up to 1,000MB of memory. If you had 500MB of free memory, the single user performing a sort by himself could have used much more memory, and the 100 users should have used much less. That is what automatic PGA memory management was designed to do. Under a light workload, memory usage could be maximized as the load increases on the system, and as more users perform sort or hash operations, the amount of memory allocated to them would decrease—to reach the goal of using all available RAM, but not attempting to use more than physically exists.

## Determining How the Memory Is Allocated

Questions that come up frequently are “How is this memory allocated?” and “What will be the amount of RAM used by my session?” These are hard questions to answer for the simple reason that the algorithms for serving out memory under the automatic scheme are not documented and can and will change from release to release. When using things that begin with “A”—for automatic—you lose a degree of control, as the underlying algorithms decide what to do and how to control things.

We can make some observations based on information from MOS notes 147806.1 and 223730.1:

- The `PGA_AGGREGATE_TARGET` is a goal of an upper limit. *It is not a value that is preallocated when the database is started up.* You can observe this by setting the `PGA_AGGREGATE_TARGET` to a value much higher than the amount of physical memory you have available on your server. You will not see any large allocation of memory as a result (one caveat, if you’ve set `MEMORY_TARGET`, and then set `PGA_AGGREGATE_TARGET` to a value larger than `MEMORY_TARGET`, on instance startup Oracle throws an `ORA-00838` error and won’t let you start your instance).
- The amount of PGA memory available for a given session is derived from the setting of `PGA_AGGREGATE_TARGET`. The algorithm for determining the maximum size used by a process varies by database version. The amount of PGA memory a process is allocated is typically a function of the amount of memory available and the number of processes competing for space.
- As the workload on your instance goes up (more concurrent queries, concurrent users), the amount of PGA memory allocated to your work areas will go down. The database will try to keep the sum of all PGA allocations under the threshold set by `PGA_AGGREGATE_TARGET`. This is analogous to having a DBA sit at a console all day, setting the `SORT_AREA_SIZE` and `HASH_AREA_SIZE` parameters based on the amount of work being performed in the database. We will directly observe this behavior shortly in a test.

OK, so how can we observe the different work area sizes being allocated to our session? By applying the same technique we used earlier in the manual PGA memory management section to observe the memory used by our session and the amount of I/O to temp we performed. I performed the following test on an Oracle Linux machine with four CPUs using Oracle 12.1.0.1 and dedicated server connections. We begin by creating a table to hold the metrics we’d like to monitor (the following code is placed in a file named `stats.sql`):

```
create table sess_stats
as
select name, value, 0 active
from
(
select a.name, b.value
from v$statname a, v$sesstat b
```

```

where a.statistic# = b.statistic#
      and b.sid = (select sid from v$mystat where rownum=1)
      and (a.name like '%ga %'
           or a.name like '%direct temp%')
union all
select 'total: ' || a.name, sum(b.value)
from v$statname a, v$sesstat b, v$session c
where a.statistic# = b.statistic#
      and (a.name like '%ga %'
           or a.name like '%direct temp%')
      and b.sid = c.sid
      and c.username is not null
group by 'total: ' || a.name
);

```

The columns in this table we'll be using for the metrics represent:

- **NAME:** the name of the statistic we are gathering (PGA and UGA information from V\$SESSTAT for the current session, plus all of the memory information for the database instance as well as temporary tablespace writes).
- **VALUE:** the value of the given metric.
- **ACTIVE:** the number of other sessions doing work in the instance. Before we start, we assume an "idle" instance; we are the only user session right now, hence the value of zero.

I then ran the following SQL\*Plus script (stored in a file named `single_load.sql`) in an interactive session. The table T had been created beforehand with about 70,000 rows in it.

```

connect eoda/foo
set echo on
declare
    l_first_time boolean default true;
begin
    for x in ( select * from t order by 1, 2, 3, 4 )
    loop
        if ( l_first_time )
        then
            insert into sess_stats
            ( name, value, active )
            select name, value,
                   (select count(*)
                    from v$session
                    where status = 'ACTIVE'
                    and username is not null)
            from
            (
                select a.name, b.value
                from v$statname a, v$sesstat b
                where a.statistic# = b.statistic#
                    and b.sid = (select sid from v$mystat where rownum=1)
                    and (a.name like '%ga %'
                        or a.name like '%direct temp%')
                union all

```

```

select 'total: ' || a.name, sum(b.value)
  from v$statname a, v$sesstat b, v$session c
 where a.statistic# = b.statistic#
       and (a.name like '%ga %'
            or a.name like '%direct temp%')
       and b.sid = c.sid
       and c.username is not null
 group by 'total: ' || a.name
);
l_first_time := false;
end if;
end loop;
end;
/
commit;

```

This script sorts the big table T using PGA automatic memory management. Then, for that session, it captures all of the PGA/UGA memory settings as well as sort-to-disk activity. In addition, the UNION ALL adds system-level metrics about the same (total PGA memory, total UGA memory and so on). I ran that script against a database started with the following initialization settings:

```

*.compatible='12.1.0.1'
*.control_files='/u01/dbfile/ORA12CR1/control01.ctl', '/u02/dbfile/ORA12CR1/control02.ctl'
*.db_block_size=8192
*.db_name='ORA12CR1'
*.pga_aggregate_target=256m
*.sga_target=256m
*.open_cursors=300
*.processes=600
*.remote_login_passwordfile='EXCLUSIVE'
*.resource_limit=TRUE
*.undo_tablespace='UNDOTBS1'

```

These settings show I was using automatic PGA memory management with a PGA\_AGGREGATE\_TARGET of 256MB, meaning I wanted Oracle to use up to about 256MB of PGA memory for sorting.

I set up another script to be run in other sessions to generate a large sorting load on the machine. This script loops and uses a built-in package, DBMS\_ALERT, to see if it should continue processing. If it should, it runs the same big query, sorting the entire T table. When the simulation finished, a session could signal all of the sorting processes, the load generators, to “stop” and exit. Here’s the script (stored in a file named gen\_load.sql) used to perform the sort:

```

declare
  l_msg long;
  l_status number;
begin
  dbms_alert.register( 'WAITING' );
  for i in 1 .. 999999 loop
    dbms_application_info.set_client_info( i );
    dbms_alert.waitone( 'WAITING', l_msg, l_status, 0 );
    exit when l_status = 0;
    for x in ( select * from t order by 1, 2, 3, 4 )

```

```

        loop
            null;
        end loop;
    end loop;
end;
/
exit

```

and here's the script (stored in a file named `stop.sql`) to stop these processes from running:

```

begin
    dbms_alert.signal( 'WAITING', '' );
    commit;
end;
/

```

To observe the differing amounts of RAM allocated to the session I was measuring, I initially ran the `SELECT` in isolation—as the only session. I captured the statistics and saved them into the `SESS_STATS` table, along with the count of active sessions. Then I added 25 sessions to the system (i.e., I ran the preceding benchmark script (`gen_load.sql`) with the `for i in 1 .. 999999` loop in 25 new sessions). I waited a short period of time—one minute for the system to adjust to this new load—and then I created a new session and ran the single sort query from earlier, capturing of the metrics the first time through the loop. I did this repeatedly, for up to 500 concurrent users.

---

■ **Tip** On the Apress web site for this book, you can download the scripts used for this experiment. In the `ch04` directory, the `run.sql` script automates the test described in this section.

---

It should be noted that I asked the database instance to do an impossible thing here. As mentioned previously, based on the first time we ran `watch_stat.sql`, each connection to Oracle—before even doing a single sort—consumed a little more than .5MB of RAM. At 500 users, we would be very close to the `PGA_AGGREGATE_TARGET` setting just by having them all logged in, let alone actually doing any work! This drives home the point that the `PGA_AGGREGATE_TARGET` is just that: a target, not a directive. We can and will exceed this value for various reasons.

Now we are ready to report on the finding; for reasons of space, we'll stop the output at 275 users—since the data starts to get quite repetitive:

```

EODA@ORA12CR1> column active format 999
EODA@ORA12CR1> column pga format 999.9
EODA@ORA12CR1> column "tot PGA" format 999.9
EODA@ORA12CR1> column pga_diff format 999.99
EODA@ORA12CR1> column "temp write" format 9,999
EODA@ORA12CR1> column "tot writes temp" format 99,999,999
EODA@ORA12CR1> column writes_diff format 9,999,999
EODA@ORA12CR1> select active,
 2      pga,
 3      "tot PGA",
 4      "tot PGA"-lag( "tot PGA" ) over (order by active) pga_diff,
 5      "temp write",
 6      "tot writes temp",
 7      "tot writes temp"-lag( "tot writes temp" ) over (order by active) writes_diff

```

```

8   from (
9   select *
10  from (
11  select active,
12         name,
13         case when name like '%ga mem%' then round(value/1024/1024,1) else value end val
14   from sess_stats
15  where active < 275
16   )
17  pivot ( max(val) for name in (
18         'session pga memory' as "PGA",
19         'total: session pga memory' as "tot PGA",
20         'physical writes direct temporary tablespace' as "temp write",
21         'total: physical writes direct temporary tablespace' as "tot writes temp"
22   ) )
23   )
24  order by active
25 /

```

ACTIVE	PGA tot	PGA	PGA_DIFF	temp write	tot writes	temp WRITES_DIFF
0	3.5	7.6		0	0	
1	15.2	19.5	11.90	0	0	0
26	15.2	195.6	176.10	0	243,387	243,387
51	7.7	292.7	97.10	1,045	518,246	274,859
76	5.2	188.7	-104.00	3,066	941,324	423,078
101	5.2	232.6	43.90	6,323	1,834,035	892,711
126	5.2	291.8	59.20	6,351	3,021,485	1,187,450
151	5.1	345.0	53.20	6,326	4,783,879	1,762,394
177	5.0	403.3	58.30	6,321	8,603,295	3,819,416
201	5.2	453.2	49.90	6,327	12,848,568	4,245,273
226	4.8	507.5	54.30	6,333	15,225,399	2,376,831
251	5.1	562.2	54.70	6,315	17,579,502	2,354,103

12 rows selected.

Before we analyze the results, let's look at the query I used for reporting. My query uses a feature, available starting with Oracle 11g Release 1, called *pivot* to pivot a result set. Here's an alternate way to write lines 11 through 22 of that SQL query that would work in 10g Release 2 and before:

```

11  select active,
12         max( decode(name,'session pga memory',val) ) pga,
13         max( decode(name,'total: session pga memory',val) ) as "tot PGA",
14         max( decode(name,
15                'physical writes direct temporary tablespace',
16                val) ) as "temp write",
17         max( decode(name,
18                'total: physical writes direct temporary tablespace',
19                val) ) as "tot writes temp"

```

```

16   from (
17 select active,
18         name,
19         case when name like '%ga mem%' then round(value/1024/1024,1) else value end val
20   from sess_stats
21  where active < 275
22     )
23  group by active
24     ))

```

This part of the query retrieved the records from the table of metrics when there were less than 275 active sessions, converted the metrics for memory (UGA/PGA memory) from bytes into megabytes, and then pivoted—turned rows into columns—on the four interesting metrics. Once we got those four metrics in a single record, we used analytics (the LAG() function specifically) to add to each row the prior rows' total observed PGA and total observed I/O to temp so we could easily see the incremental differences in these values. Back to the data—as you can see, when I had a few active sessions, my sorts were performed entirely in memory. For an active session count of 1 to somewhere less than 50, I could sort entirely in memory. However, by the time I had 50 users logged in and actively sorting, the database started reining in the amount of memory I was allowed to use at a time. It would have taken a couple of minutes before the amount of PGA being used fell back within acceptable limits (the 256MB request), but eventually it would at these low concurrent user levels. The amount of PGA memory allocated to the session we were watching dropped from 15.2MB to 7.7MB and settled on around 5.2MB (remember, parts of that PGA are not for work area (sorting) allocations, but are for other operations; just the act of logging in created a .5MB PGA allocation). The total PGA in use by the system remained within tolerable limits until somewhere around 126 users. At that point, I started to exceed on a regular basis the PGA\_AGGREGATE\_TARGET, and continued to do so until the end of the test. I gave the database instance in this case an impossible task; the very act of having 126 users, most executing PL/SQL, plus the sort they were all requesting, just did not fit into the 256MB of RAM I had targeted. It simply could not be done. Each session therefore used as little memory as possible, but had to allocate as much memory as it needed. By the time I finished this test, the active sessions were using a total of about 560MB of PGA memory—as little as they could.

You should, however, consider what that output would look like under a manual memory management situation. Suppose the SORT\_AREA\_SIZE had been set to 5MB. The math is very straightforward: each session would be able to perform the sort in RAM (or virtual memory as the machine ran out of real RAM), and thus would consume 6MB to 7MB of RAM per session (the amount used without sorting to disk in the previous single-user case). The memory use would look something like this:

```

EODA@ORA12CR1> column total_pga format 9,999
EODA@ORA12CR1> with data(users)
 2 as
 3 (select 1 users from dual
 4   union all
 5   select users+25 from data where users+25 <= 275)
 6 select users, 7 my_pga, 7*users total_pga
 7   from data
 8   order by users
 9 /

```

USERS	MY_PGA	TOTAL_PGA
1	7	7
26	7	182
51	7	357
76	7	532
101	7	707
126	7	882
151	7	1,057
176	7	1,232
201	7	1,407
226	7	1,582
251	7	1,757

11 rows selected.

---

■ **Note** This query uses a technique—recursive subquery factoring—that is available only in Oracle 11g Release 2 and above. It will not work in earlier releases.

---

Had I run this test (I have 2GB of real memory on this server and my SGA is 256MB), by the time I got to 250 users, the machine would have begun paging and swapping to the point where it would have been impossible to continue; at 500 users I would have allocated around 3,514MB of RAM! So, the DBA would probably not set the `SORT_AREA_SIZE` to 5MB on this system, but rather to about 0.5 MB, in an attempt to keep the maximum PGA usage at a bearable level at peak. At 500 users, I would have had about 500MB of PGA allocated, perhaps similar to what we observed with automatic memory management, but even when there were fewer users, we would still have written to temp rather than performing the sort in memory.

Manual memory management represents a very predictable—but suboptimal—use of memory as the workload increases or decreases over time. Automatic PGA memory management was designed specifically to allow a small community of users to use as much RAM as possible when it was available, to back off on this allocation over time as the load increased, and increase the amount of RAM allocated for individual operations over time as the load decreased.

## Using `PGA_AGGREGATE_TARGET` to Control Memory Allocation

Earlier, I wrote that “in theory” we can use the `PGA_AGGREGATE_TARGET` to control the overall amount of PGA memory used by the instance. We saw in the last example that this is not a hard limit, however. The instance will attempt to stay within the bounds of the `PGA_AGGREGATE_TARGET`, but if it can’t, it won’t stop processing; rather, it will just be forced to exceed that threshold.

Another reason this limit is “theory” is because work areas, though large contributors to PGA memory, are not the only contributors to PGA memory. Many factors contribute to PGA memory allocation and only the work areas are under the control of the database instance. If you create and execute a PL/SQL block of code that fills in a large array with data in dedicated server mode where the UGA is in the PGA, Oracle can’t do anything but allow you to do it.



Consider the following quick example. We'll create a package that can hold some persistent (global) data in the server:

```
EODA@ORA12CR1> create or replace package demo_pkg
2 as
3     type array is table of char(2000) index by binary_integer;
4     g_data array;
5 end;
6 /
Package created.
```

Now we'll measure the amount of memory our session is currently using in the PGA/UGA (I used a dedicated server in this example, so the UGA is a subset of the PGA memory):

```
EODA@ORA12CR1> select a.name, to_char(b.value, '999,999,999') bytes,
2     to_char(round(b.value/1024/1024,1), '99,999.9' ) mbytes
3 from v$statname a, v$mystat b
4 where a.statistic# = b.statistic#
5 and a.name like '%ga memory%';
```

NAME	BYTES	MBYTES
-----	-----	-----
session uga memory	1,526,568	1.5
session uga memory max	1,526,568	1.5
session pga memory	2,208,088	2.1
session pga memory max	2,208,088	2.1

Initially we are using about 2.1MB of PGA memory in our session (as a result of compiling a PL/SQL package, running this query, etc.). Now, we'll run our query against T again using the same 256MB PGA\_AGGREGATE\_TARGET (this was done in an otherwise idle instance; we are the only session requiring memory right now):

```
EODA@ORA12CR1> set autotrace traceonly statistics;
EODA@ORA12CR1> select * from t order by 1,2,3,4;
```

72616 rows selected.

Statistics

```
-----
105 recursive calls
0 db block gets
1103 consistent gets
993 physical reads
0 redo size
3665844 bytes sent via SQL*Net to client
53795 bytes received via SQL*Net from client
4843 SQL*Net roundtrips to/from client
1 sorts (memory)
0 sorts (disk)
72616 rows processed
```

```
EODA@ORA12CR1> set autotrace off
```

As you can see, the sort was done entirely in memory, and in fact if we peek at our session's PGA/UGA usage, we can see how much we used:

```
EODA@ORA12CR1> select a.name, to_char(b.value, '999,999,999') bytes,
2      to_char(round(b.value/1024/1024,1), '99,999.9' ) mbytes
3      from v$statname a, v$mystat b
4      where a.statistic# = b.statistic#
5      and a.name like '%ga memory%';
```

NAME	BYTES	MBYTES
-----	-----	-----
session uga memory	1,854,008	1.8
session uga memory max	11,213,280	10.7
session pga memory	2,470,232	2.4
<b>session pga memory max</b>	<b>12,104,024</b>	<b>11.5</b>

We see 11.5MB of RAM being used, in the ballpark range of the 15MB we observed earlier in the prior test for sorting. Now we'll fill up that CHAR array we have in the package (a CHAR data type is blank-padded so each of these array elements is exactly 2,000 characters in length):

```
EODA@ORA12CR1> begin
2      for i in 1 .. 200000
3      loop
4          demo_pkg.g_data(i) := 'x';
5      end loop;
6 end;
7 /
```

PL/SQL procedure successfully completed.

If we then measure our session's current PGA utilization, we find something similar to the following:

```
EODA@ORA12CR1> select a.name, to_char(b.value, '999,999,999') bytes,
2      to_char(round(b.value/1024/1024,1), '99,999.9' ) mbytes
3      from v$statname a, v$mystat b
4      where a.statistic# = b.statistic#
5      and a.name like '%ga memory%';
```

NAME	BYTES	MBYTES
-----	-----	-----
session uga memory	469,569,304	447.8
session uga memory max	469,569,304	447.8
session pga memory	470,921,560	449.1
session pga memory max	470,921,560	449.1

Now, that is memory allocated in the PGA that the instance itself can't control. We already exceeded the PGA\_AGGREGATE\_TARGET set for the entire instance *in this single session*—and there is quite simply nothing the database can do about it. It would have to fail our request if it did anything, and it will do that only when the OS reports back that there is no more memory to give (ORA-04030). If we wanted, we could allocate more space in that array and place more data in it, and the instance would just have to do it for us.

However, the instance is aware of what we have done. It does not ignore the memory it can't control; it simply recognizes that the memory is being used and backs off the size of memory allocated for work areas accordingly. So if we rerun the same sort query, we see that this time we sorted to disk—the instance did not give us the 12MB or so of RAM needed to do this in memory since we had already exceeded the `PGA_AGGREGATE_TARGET`:

```
EODA@ORA12CR1> set autotrace traceonly statistics;
EODA@ORA12CR1> select * from t order by 1,2,3,4;
```

72616 rows selected.

Statistics

```
-----
          9 recursive calls
          8 db block gets
         986 consistent gets
        2025 physical reads
           0 redo size
    3665844 bytes sent via SQL*Net to client
        53795 bytes received via SQL*Net from client
         4843 SQL*Net roundtrips to/from client
           0 sorts (memory)
          1 sorts (disk)
        72616 rows processed
```

```
EODA@ORA12CR1> set autotrace off
```

So, because some PGA memory is outside of Oracle's control, it is easy to exceed the `PGA_AGGREGATE_TARGET` simply by allocating lots of really large data structures in our PL/SQL code. I am not recommending you do this by any means. I'm just pointing out that the `PGA_AGGREGATE_TARGET` is more of a request than a hard limit.

## Choosing Between Manual and Auto Memory Management

So, which method should you use, manual or automatic? My strong preference is to use the automatic PGA memory management by default.

---

■ **Caution** I'll repeat this from time to time in this book: please do not make any changes to a production system—a live system—without first testing for any side effects. For example, please do not read this chapter, check your system and find you are using manual memory management—and then just turn on automatic memory management. Query plans may change, and performance may be impacted. One of three things could happen:

- Things run exactly the same.
- Things run better than they did before.
- Things run much worse than they did before.

Exercise caution before making changes; test the proposed change first.

---

One of the most perplexing things for a DBA can be setting the individual parameters, especially parameters such as `SORT|HASH_AREA_SIZE` and so on. I often see systems running with incredibly small values for these parameters—values so small that system performance is massively impacted in a negative way. This is probably a result of the fact that the default values are very small themselves: 64KB for sorting and 128KB for hashing. There’s a lot of confusion over how big or small these values should be. Not only that, but the values you should use for them might vary over time, as the day goes by. At 8:00 a.m., with two users, a 50MB sort area size might be reasonable for the two users logged in. However, at 12:00 p.m. with 500 users, 50MB might not be appropriate. This is where the `WORKAREA_SIZE_POLICY = AUTO` setting and the corresponding `PGA_AGGREGATE_TARGET` come in handy. Setting the `PGA_AGGREGATE_TARGET`, the amount of memory you would like Oracle to feel free to use to sort and hash, is conceptually easier than trying to figure out the perfect `SORT|HASH_AREA_SIZE`, especially since there isn’t a perfect value for these parameters; the perfect value varies by workload.

Historically, DBAs configured the amount of memory Oracle would use by setting the size of the SGA (the buffer cache; the log buffer; and the shared, large, and Java pools). The remaining memory on the machine would then be used by the dedicated or shared servers in the PGA region. The DBA had little control over how much of this memory would or would not be used. She could set the `SORT_AREA_SIZE`, but if there were 10 concurrent sorts, Oracle could use as much as  $10 * \text{SORT\_AREA\_SIZE}$  bytes of RAM. If there were 100 concurrent sorts, Oracle would use  $100 * \text{SORT\_AREA\_SIZE}$  bytes; for 1,000 concurrent sorts,  $1,000 * \text{SORT\_AREA\_SIZE}$ ; and so on. Couple that with the fact that other things go into the PGA, and you really didn’t have good control over the maximal use of PGA memory on the system.

What you’d like to happen is for this memory to be allocated differently as the memory demands on the system grow and shrink. The more users, the less RAM each should use. The fewer users, the more RAM each should use. Setting `WORKAREA_SIZE_POLICY = AUTO` is just the way to achieve this. The DBA specifies a single size now, the `PGA_AGGREGATE_TARGET` or the maximum amount of PGA memory that the database should strive to use. Oracle then distributes this memory over the active sessions as it sees fit. Further, with Oracle9i Release 2 and up, there is even a PGA advisory (part of Statspack and AWR, available via a `V$` dynamic performance view and visible in Enterprise Manager), much like the buffer cache advisor. It will tell you over time what the optimal `PGA_AGGREGATE_TARGET` for your instance is to minimize physical I/O to your temporary tablespaces. You can use this information to either dynamically change the PGA size online (if you have sufficient RAM) or decide whether you need more RAM on your server to achieve optimal performance.

Are there times, however, when you won’t want to use it? Absolutely, but fortunately they seem to be the exception and not the rule. The automatic PGA memory management was designed to be multiuser “fair.” In anticipation of additional users joining the system, the automatic memory management will limit the amount of memory allocated as a percentage of the `PGA_AGGREGATE_TARGET`. But what happens when you don’t want to be fair, when you know that you should get all of the memory available? Well, that would be time to use the `ALTER SESSION` command to disable automatic memory management in your session (leaving it in place for all others) and to manually set your `SORT|HASH_AREA_SIZE` as needed. For example, that large batch process that takes place at 2:00 a.m. and does tremendously large hash joins, some index builds, and the like? It should be permitted to use all of the resources available to the instance. It does not want to be “fair” about memory use—it wants it all, as it knows it is the only thing happening in the database right now. That batch job can certainly issue the `ALTER SESSION` command and make use of all resources available.

So, in short, I prefer to use automatic PGA memory management for end-user sessions—for the applications that run day to day against my database. Manual memory management makes sense for large batch jobs that run during periods when they are the only activities in the instance.

## PGA and UGA Wrap-up

So far, we have looked at two memory structures: the PGA and the UGA. You should understand now that the PGA is private to a process. It is the set of variables that an Oracle dedicated or shared server needs to have independent of a session. The PGA is a “heap” of memory in which other structures may be allocated. The UGA is also a heap of memory in which various session-specific structures may be defined. The UGA is allocated from the PGA when you use a dedicated server to connect to Oracle, and from the SGA under a shared server connection. This implies that

when using a shared server, you must size your SGA's large pool to have enough space to cater to every possible user that will ever connect to your database concurrently. So, the SGA of a database supporting shared server connections is generally much larger than the SGA for a similarly configured dedicated server mode-only database. We'll cover the SGA in more detail next.

## The System Global Area

Every Oracle instance has one big memory structure referred to as the *System Global Area* (SGA). This is a large, shared memory structure that every Oracle process will access at one point or another. It varies in size from dozens of megabytes on small test systems, to a few gigabytes on medium-to-large systems, up to hundreds of gigabytes for really big systems.

On UNIX/Linux, the SGA is a physical entity you can “see” from the OS command line. It is physically implemented as a shared memory segment—a standalone piece of memory to which processes may attach. It is possible to have an SGA on a system without having any Oracle processes; the memory stands alone. It should be noted, however, that if you have an SGA without any Oracle processes, this is an indication that the database crashed in some fashion. It is an unusual situation, but it can happen. This is what an SGA “looks like” on Oracle Linux:

```
$ ipcs -m | grep ora
0x27ba944c 887324675 oracle 640 14680064 82
0x00000000 887357444 oracle 640 1061158912 41
0x749a2e08 887947269 oracle 640 14680064 72
0x00000000 887980038 oracle 640 511705088 36
0x00000000 888537095 oracle 640 8388608 16
0x00000000 888569864 oracle 640 260046848 16
0xc6e51dc4 888602633 oracle 640 2097152 16
```

---

■ **Note** I have multiple instances on my test/demo machine. I needed multiple instances to test the various concepts presented in this book on different releases. The only reasonable, correct number of instances on a production machine is *one*. In real life, never have more than one instance on a given production server. If you need more than one instance on a physical server, you should use virtualization to split that one server into many virtual servers—each with its own instance of Oracle.

---

Three SGAs are represented here and the report shows the OS account that owns the SGA (oracle for all of these in this example) and the size of the SGA—1G (the second line) for the first example. On Windows, you really can't see the SGA as a distinct entity the way you can in UNIX/Linux. Because on the Windows platform Oracle executes as a single process with a single address space, the SGA is allocated as private memory to the oracle.exe process. If you use the Windows Task Manager or some other performance tool, you can see how much memory oracle.exe has allocated, but you can't see the SGA versus any other piece of allocated memory.

---

■ **Note** Unless you have my parameter settings and you are running my exact same version of Oracle on my exact same OS, you will almost certainly see different numbers than I do. The SGA sizing is very version/OS/parameter-dependent.

---

Within Oracle itself, you can see the SGA regardless of platform, using another magic V\$ view called V\$SGASTAT. It might look as follows:

```
EODA@ORA12CR1> compute sum of bytes on pool
EODA@ORA12CR1> break on pool skip 1
EODA@ORA12CR1>
EODA@ORA12CR1> select pool, name, bytes
  2   from v$sgastat
  3   order by pool, name;
```

POOL	NAME	BYTES
java pool	free memory	4194304
*****		-----
sum		4194304
large pool	PX msg pool	491520
	free memory	3702784
*****		-----
sum		4194304
shared pool	1063.kgght	36784
	11G QMN so	4144
	177.kggfa	39840
...		
	zlllab Group Tree Heap De	160
*****		-----
sum		314572800
	buffer_cache	184549376
	fixed_sga	2290264
	log_buffer	7938048
	shared_io_pool	4194304
*****		-----
sum		198971992

1064 rows selected.

The SGA is broken up into various pools. Here are the major ones you'll see:

- *Java pool*: The Java pool is a fixed amount of memory allocated for the JVM running in the database. In Oracle10g and above, the Java pool may be resized online while the database is up and running.
- *Large pool*: The large pool is used by shared server connections for session memory, by parallel execution features for message buffers, and by RMAN backup for disk I/O buffers. This pool is resizable online.
- *Shared pool*: The shared pool contains shared cursors, stored procedures, state objects, dictionary caches, and many dozens of other bits of data. This pool is resizable online starting from Oracle version 9i.

- *Streams pool*: This is a pool of memory used by data-sharing tools such as Oracle GoldenGate, Oracle Streams, and so on. This pool is available in Oracle 10g and above and is resizable online. If the Streams pool is not configured and you use the Streams functionality, Oracle will use up to 10 percent of the shared pool for streams memory.
- *The “Null” pool*: This one doesn’t really have a name. It is the memory dedicated to block buffers (cached database blocks), the redo log buffer, and a “fixed SGA” area.

A typical SGA might look as shown in Figure 4-1.

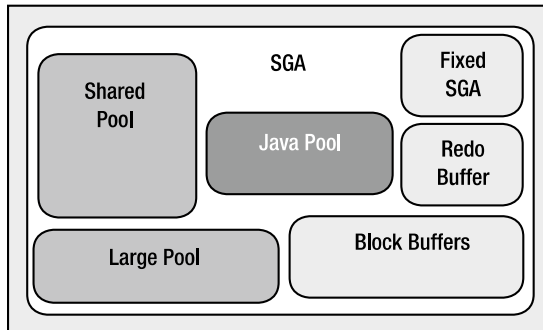

**Figure 4-1.** Typical SGA

The parameters that have the greatest effect on the overall size of the SGA are as follows:

- `JAVA_POOL_SIZE`: Controls the size of the Java pool.
- `SHARED_POOL_SIZE`: Controls the size of the shared pool (to some degree).
- `LARGE_POOL_SIZE`: Controls the size of the large pool.
- `STREAMS_POOL_SIZE`: Controls the size of the Streams pool.
- `DB_*_CACHE_SIZE`: Eight of these `CACHE_SIZE` parameters control the sizes of the various buffer caches available.
- `LOG_BUFFER`: Controls the size of the redo buffer (to some degree).
- `SGA_TARGET`: Used with automatic SGA memory management in Oracle 10g and above, can be changed online.
- `SGA_MAX_SIZE`: Used to control the size of the SGA.
- `MEMORY_TARGET`: Used with automatic memory management (both PGA and SGA automatic memory management) in Oracle 11g and above.
- `MEMORY_MAX_SIZE`: Used to control the maximum amount of memory Oracle should strive to use over both the PGA and SGA sizes under automatic memory management in Oracle 11g and above. This is really just a target; the PGA may exceed the optimum size if the number of users increases beyond some level or a session(s) allocates large untunable bits of memory as demonstrated earlier.

In Oracle9i, the various SGA components must be manually sized by the DBA. Starting in Oracle 10g and above, however, there is an option to consider: automatic shared memory management, whereby the database instance will allocate and reallocate the various SGA components at runtime in response to workload conditions. Moreover, starting in Oracle 11g, there's another option: automatic memory management, whereby the database instance will not only perform automatic SGA memory management and automatic PGA memory management, it will also decide the optimum size of the SGA and PGA for you—reallocating these allotments automatically when deemed reasonable.

Using the automatic shared memory management with Oracle 10g and above is simply a matter of setting the `SGA_TARGET` parameter to the desired SGA size, leaving out the other SGA-related parameters altogether. The database instance will take it from there, allocating memory to the various pools as needed and even taking memory away from one pool to give to another over time.

When using automatic memory management with Oracle 11g and above, you simply set the `MEMORY_TARGET`. The database instance will then decide the optimal SGA size and PGA size—and those components will be set up appropriately and do their own automatic memory management within their respective boundaries. Further, the database can and will resize the SGA and PGA allocations as the workload changes over time.

Regardless of whether you are using automatic or manual memory management, you'll find that memory is allocated to the various pools in the SGA in units called *granules*. A single granule is an area of memory of 4MB, 8MB, or 16MB in size. The granule is the smallest unit of allocation, so if you ask for a Java pool of 5MB and your granule size is 4MB, Oracle will actually allocate 8MB to the Java pool (8 being the smallest number greater than or equal to 5 that is a multiple of the granule size of 4). The size of a granule is determined by the size of your SGA (this sounds recursive to a degree, as the size of the SGA is dependent on the granule size). You can view the granule sizes used for each pool by querying `V$SGA_DYNAMIC_COMPONENTS`. In fact, we can use this view to see how the total SGA size might affect the size of the granules:

```
EODA@ORA12CR1> show parameter sga_target
```

NAME	TYPE	VALUE
sga_target	big integer	256M

```
EODA@ORA12CR1> select component, granule_size from v$sga_dynamic_components;
```

COMPONENT	GRANULE_SIZE
shared pool	4194304
large pool	4194304
java pool	4194304
streams pool	4194304
DEFAULT buffer cache	4194304
KEEP buffer cache	4194304
RECYCLE buffer cache	4194304
DEFAULT 2K buffer cache	4194304
DEFAULT 4K buffer cache	4194304
DEFAULT 8K buffer cache	4194304
DEFAULT 16K buffer cache	4194304
DEFAULT 32K buffer cache	4194304
Shared IO Pool	4194304
Data Transfer Cache	4194304
ASM Buffer Cache	4194304

15 rows selected.



---

■ **Note** This is the SGA information for the Oracle instance started with the initialization parameter file in the previous example. We specified the SGA and PGA sizes ourselves in that parameter file. Therefore we are using automatic shared memory management and automatic PGA memory management, but not the Oracle 11g (and above) “automatic memory management” setting, which would have sized and resized our PGA/SGA settings for us.

---

In this example, I used automatic shared memory management and controlled the size of the SGA via the single parameter `SGA_TARGET`. When my SGA size is under about 1GB, the granule is 4MB. When the SGA size is increased to some threshold over 1GB (it will vary slightly from operating system to operating system and even from release to release), I see an increased granule size. First we convert to using a stored parameter file to make altering the `SGA_TARGET` easier:

```
SYS@ORA12CR1> create spfile from pfile;
File created.
```

```
SYS@ORA12CR1> startup force;
ORACLE instance started.
```

```
Total System Global Area 267227136 bytes
Fixed Size                 2287336 bytes
Variable Size              180357400 bytes
Database Buffers          79691776 bytes
Redo Buffers               4890624 bytes
Database mounted.
Database opened.
```

---

■ **Note** If your instance is currently running, the `STARTUP FORCE` command will shut down the instance (abort mode) and restart it.

---

Then we modify the `SGA_TARGET`:

```
SYS@ORA12CR1> alter system set sga_target = 1512m scope=spfile;
System altered.
```

```
SYS@ORA12CR1> startup force
ORACLE instance started.
```

```
Total System Global Area 1586708480 bytes
Fixed Size                 2288824 bytes
Variable Size              402654024 bytes
Database Buffers          1174405120 bytes
Redo Buffers               7360512 bytes
Database mounted.
Database opened.
```

```
SYS@ORA12CR1> show parameter sga_target
```

NAME	TYPE	VALUE
sga_target	big integer	1520M

Now when we look at the SGA components:

```
SYS@ORA12CR1> select component, granule_size from v$sga_dynamic_components;
```

COMPONENT	GRANULE_SIZE
shared pool	16777216
large pool	16777216
java pool	16777216
streams pool	16777216
DEFAULT buffer cache	16777216
KEEP buffer cache	16777216
RECYCLE buffer cache	16777216
DEFAULT 2K buffer cache	16777216
DEFAULT 4K buffer cache	16777216
DEFAULT 8K buffer cache	16777216
DEFAULT 16K buffer cache	16777216
DEFAULT 32K buffer cache	16777216
Shared IO Pool	16777216
Data Transfer Cache	16777216
ASM Buffer Cache	16777216

15 rows selected.

As you can see, at 1.5GB of SGA, my pools will be allocated using 16MB granules, so any given pool size will be some multiple of 16MB.

With this in mind, let's look at each of the major SGA components in turn.

## Fixed SGA

The *fixed SGA* is a component of the SGA that varies in size from platform to platform and from release to release. It is “compiled” into the Oracle binary itself at installation time (hence the name “fixed”). The fixed SGA contains a set of variables that point to the other components of the SGA, as well as variables that contain the values of various parameters. The size of the fixed SGA is something over which we have no control, and it is generally very small. Think of this area as a “bootstrap” section of the SGA—something Oracle uses internally to find the other bits and pieces of the SGA.

## Redo Buffer

The *redo buffer* is where data that needs to be written to the online redo logs will be cached temporarily, before it is written to disk. Since a memory-to-memory transfer is much faster than a memory-to-disk transfer, use of the redo log buffer can speed up database operation. The data will not reside in the redo buffer for very long. In fact, LGWR initiates a flush to disk of this area in one of the following scenarios:

- Every three seconds
- Whenever a COMMIT or ROLLBACK is issued

- When LGWR is asked to switch log files
- When the redo buffer gets one-third full or contains 1MB of cached redo log data

For these reasons, it will be a very rare system that will benefit from a redo buffer of more than a couple of tens of megabytes in size. A large system with lots of concurrent transactions might benefit somewhat from a large redo log buffer because while LGWR (the process responsible for flushing the redo log buffer to disk) is writing a portion of the log buffer, other sessions could be filling it up. In general, a long-running transaction that generates a lot of redo will benefit the most from a larger than normal log buffer, as it will be continuously filling up part of the redo log buffer while LGWR is busy writing out some of it (we'll cover the phenomenon of writing uncommitted data at length in Chapter 9). The larger and longer the transaction, the more benefit it could receive from a generous log buffer.

The default size of the redo buffer, as controlled by the LOG\_BUFFER parameter, varies widely by operating system, database version, and other parameter settings. Rather than try to explain what the most common default size is (there isn't such a thing), I'll refer you to the documentation for your release of Oracle (the *Oracle Database Reference* guide). My default LOG\_BUFFER—given the instance we just started above with a 1.5GB SGA—is shown by the following query:

```
EODA@ORA12CR1> select value, isdefault
 2  from v$parameter
 3  where name = 'log_buffer'
 4  /
```

VALUE	ISDEFAULT
7036928	TRUE

The size is about 7MB. The minimum size of the default log buffer is OS-dependent. If you'd like to find out what that is, just set your LOG\_BUFFER to 1 byte and restart your database. For example, on my Oracle Linux instance I see the following:

```
EODA@ORA12CR1> alter system set log_buffer=1 scope=spfile;
System altered.
```

```
EODA@ORA12CR1> connect / as sysdba;
Connected.
```

```
SYS@ORA12CR1> startup force;
ORACLE instance started.
```

```
Total System Global Area 1586708480 bytes
Fixed Size                  2288824 bytes
Variable Size               402654024 bytes
Database Buffers           1174405120 bytes
Redo Buffers                 7360512 bytes
Database mounted.
Database opened.
SYS@ORA12CR1> show parameter log_buffer
```

NAME	TYPE	VALUE
log_buffer	integer	1703936

```

SYS@ORA12CR1> select 1703936/1024/1024 from dual;

1703936/1024/1024
-----
              1.625

```

The smallest log buffer I can really have, regardless of my settings, is going to be 1.625MB on this system.

---

■ **Note** For most database applications, the default value for the `LOG_BUFFER` parameter is sufficient. If you see a large number of waits associated with the `log buffer space` event, then consider increasing the `LOG_BUFFER` parameter.

---

## Block Buffer Cache

So far, we have looked at relatively small components of the SGA. Now we are going to look at one that is potentially huge in size. The block buffer cache is where Oracle stores database blocks before writing them to disk and after reading them in from disk. This is a crucial area of the SGA for us. Make it too small and our queries will take forever to run. Make it too big and we'll starve other processes (e.g., we won't leave enough room for a dedicated server to create its PGA, and we won't even get started).

In earlier releases of Oracle, there was a single block buffer cache, and all blocks from any segment went into this single area. Starting with Oracle 8.0, we had three places to store cached blocks from individual segments in the SGA:

- *Default pool*: The location where all segment blocks are normally cached. This is the original—and, previously, the only—buffer pool.
- *Keep pool*: An alternate buffer pool where by convention you assign segments that are accessed fairly frequently, but still get aged out of the default buffer pool due to other segments needing space.
- *Recycle pool*: An alternate buffer pool where by convention you assign large segments that you access very randomly, and which would therefore cause excessive buffer flushing of many blocks from many segments. There's no benefit to caching such segments because by the time you wanted the block again, it would have been aged out of the cache. You would separate these segments out from the segments in the default and keep pools so they would not cause those blocks to age out of the cache.

Note that in the keep and recycle pool descriptions I used the phrase “by convention.” There is nothing in place to ensure that you use either the keep pool or the recycle pool in the fashion described. In fact, the three pools manage blocks in a mostly identical fashion; *they do not have radically different algorithms for aging or caching blocks*. The goal here was to give the DBA the ability to segregate segments to hot, warm, and “do not care to cache” areas. The theory was that objects in the default pool would be hot enough (i.e., used enough) to warrant staying in the cache all by themselves. The cache would keep them in memory since they were very popular blocks. If you had some

segments that were fairly popular but not really hot, these would be considered the warm blocks. These segments' blocks could get flushed from the cache to make room for blocks you used infrequently (the “do not care to cache” blocks). To keep these warm segments' blocks cached, you could do one of the following:

- Assign these segments to the keep pool, in an attempt to let the warm blocks stay in the buffer cache longer.
- Assign the “do not care to cache” segments to the recycle pool, keeping the recycle pool fairly small so as to let the blocks come into the cache and leave the cache rapidly (decrease the overhead of managing them all).

Having to do one of these two things increased the management work the DBA had to perform, as there were three caches to think about, size, and assign objects to. Remember also that there is no sharing among them, so if the keep pool has lots of unused space, it won't give it to the overworked default or recycle pool. All in all, these pools were generally regarded as a very fine, low-level tuning device, only to be used after most other tuning alternatives had been looked at (if I could rewrite a query to do one-tenth the I/O rather than set up multiple buffer pools, that would be my choice).

Starting in Oracle9i, the DBA had up to four more optional caches, the `DB_nK_CACHE_SIZE`, to consider in addition to the default, keep, and recycle pools. These caches were added in support of multiple block sizes in the database. Prior to Oracle9i, a database would have a single block size (typically 2KB, 4KB, 8KB, 16KB, or 32KB). Starting with Oracle9i, however, a database can have a default block size, which is the size of the blocks stored in the default, keep, or recycle pool, as well as up to four nondefault block sizes, as explained in Chapter 3.

The blocks in these buffer caches are managed in the same way as the blocks in the original default pool—there are no special algorithm changes for them either. Let's now move on to see how the blocks are managed in these pools.

## Managing Blocks in the Buffer Cache

For simplicity, assume that there's just a single default pool. Because the other pools are managed in the same way, we need only discuss one of them.

The blocks in the buffer cache are basically managed in a single place with two different lists pointing at them:

- The list of *dirty* blocks that need to be written by the database block writer (DBWn; we'll take a look at that process a little later)
- A list of *nondirty* blocks

The list of nondirty blocks used to be a Least Recently Used (LRU) list in Oracle 8.0 and before. Blocks were listed in order of use. The algorithm has been modified slightly in Oracle8i and in later versions. Instead of maintaining the list of blocks in some physical order, Oracle employs a touch count algorithm, which effectively increments a counter associated with a block as you hit it in the cache. This count is not incremented every time you hit the block, but about once every three seconds if you hit it continuously. You can see this algorithm at work in one of the truly magic sets of tables: the X\$ tables. The X\$ tables are wholly undocumented by Oracle, but information about them leaks out from time to time.

---

■ **Note** I am using a user connected with the SYSDBA privilege in the following examples, because the X\$ tables are by default visible only to that account. You shouldn't in practice use an account with SYSDBA privileges to run queries. The need to query for information about blocks in the buffer cache is a rare exception to that rule.

---

The X\$BH table shows information about the blocks in the block buffer cache (which offers more information than the documented V\$BH view). Here, we can see the touch count get incremented as we hit blocks. We can run the following query against that view to find the five “currently hottest blocks” and join that information to the DBA\_OBJECTS view to see what segments they belong to. The query orders the rows in X\$BH by the TCH (touch count) column and keeps the first five. Then we join the X\$BH information to DBA\_OBJECTS by X\$BH.OBJ to DBA\_OBJECTS.DATA\_OBJECT\_ID:

```
SYS@ORA12CR1> select tch, file#, dbablk,
2         case when obj = 4294967295
3           then 'rbs/compat segment'
4           else (select max( '('||object_type||') ' ||
5                     owner || '.' || object_name ) ||
6                     decode( count(*), 1, '', ' maybe!' )
7           from dba_objects
8           where data_object_id = X.OBJ )
9         end what
10 from (
11 select tch, file#, dbablk, obj
12   from x$bh
13  where state <> 0
14  order by tch desc
15         ) x
16 where rownum <= 5
17 /
```

TCH	FILE#	DBABLK	WHAT
98	1	2825	(INDEX) SYS.I_JOB_NEXT
13	1	337	(INDEX) SYS.I_OBJ1
13	1	62117	(INDEX) SYS.I_OBJ1
11	1	4377	(INDEX) SYS.SYS_C00819
11	1	209	(TABLE) SYS.USER\$ maybe!

---

■ **Note** The  $(2^{32} - 1)$  or 4,294,967,295 referred to in the CASE statement is a magic number used to denote “special” blocks. If you’d like to understand what the underlying block in that instance is associated with, use the query `select * from dba_extents where file_id = <FILE#> and block_id <= <DBABLK> and block_id+blocks-1 >= <DBABLK>`.

---

You might be asking what is meant by the “maybe!” and the use of MAX() in the preceding scalar subquery. This is due to the fact that DATA\_OBJECT\_ID is not a “primary key” in the DBA\_OBJECTS view, as evidenced by the following:

```
SYS@ORA12CR1> select data_object_id, count(*)
2   from dba_objects
3  where data_object_id is not null
4  group by data_object_id
5  having count(*) > 1;
```

DATA_OBJECT_ID	COUNT(*)
337	2
6	3
29	3
620	7
2	18
781	3
8	3
750	3
64	2
10	3

10 rows selected.

This is due to clusters (discussed in Chapter 10), which may contain multiple tables. Therefore, when joining from X\$BH to DBA\_OBJECTS to print out a segment name, we would technically have to list all of the names of all of the objects in the cluster, as a database block does not belong to a single table all of the time.

We can even watch as Oracle increments the touch count on a block that we query repeatedly. We will use the magic table DUAL in this example—we know it is a one row, one column table.

---

■ **Note** Prior to Oracle 10g, querying DUAL would incur a full table scan of a real table named DUAL stored in the data dictionary. If you set autotrace on and query `SELECT DUMMY FROM DUAL`, you'll observe some I/O in all releases of Oracle (consistent gets). In 9i and earlier, if you query `SELECT SYSDATE FROM DUAL` or `variable := SYSDATE` in PL/SQL, you'll also see real I/O occur. However, in Oracle 10g, that `SELECT SYSDATE` is recognized as not needing to actually query the DUAL table (since you are not asking for the column or rowid from DUAL) and is done in a manner similar to calling a function. Therefore DUAL does not undergo a full table scan—only SYSDATE is returned to the application. This small change can dramatically decrease the number of consistent gets a system that uses DUAL heavily performs.

---

So every time we run the following query, we should be hitting the real DUAL table (since we explicitly reference the DUMMY column):

```

SYS@ORA12CR1> select tch, file#, dbablk, DUMMY
 2   from x$bh, (select dummy from dual)
 3   where obj = (select data_object_id
 4                 from dba_objects
 5                 where object_name = 'DUAL'
 6                 and data_object_id is not null)
 7 /

```

TCH	FILE#	DBABLK	D
1	1	929	X
2	1	928	X

```
SYS@ORA12CR1> exec dbms_lock.sleep(3.2);
```

```
PL/SQL procedure successfully completed.
```

```
SYS@ORA12CR1> /
```

TCH	FILE#	DBABLK	D
2	1	1416	X
2	1	1417	X

```
SYS@ORA12CR1> exec dbms_lock.sleep(3.2);
```

```
PL/SQL procedure successfully completed.
```

```
SYS@ORA12CR1> /
```

TCH	FILE#	DBABLK	D
4	1	1416	X
4	1	1417	X

```
SYS@ORA12CR1> exec dbms_lock.sleep(3.2);
```

```
PL/SQL procedure successfully completed.
```

```
SYS@ORA12CR1> /
```

TCH	FILE#	DBABLK	D
5	1	1416	X
5	1	1417	X

I expect output to vary by Oracle release; you may well see more than two rows returned. You might observe TCH not getting incremented every time. On a multiuser system, the results will be even more unpredictable. Oracle will attempt to increment the TCH once every three seconds (there is a TIM column that shows the last update time to the TCH column), but it is not considered important that the number be 100 percent accurate, as it is close. Also, Oracle will intentionally “cool” blocks and decrement the TCH count over time. So, if you run this query on your system, be prepared to see potentially different results.

So, in Oracle8i and above, a block buffer no longer moves to the head of the list as it used to; rather, it stays where it is in the list and has its touch count incremented. Blocks will naturally tend to “move” in the list over time, however. I put the word “move” in quotes because the block doesn’t physically move; rather, multiple lists are maintained that point to the blocks and the block will “move” from list to list. For example, modified blocks are pointed to by a dirty list (to be written to disk by DBWn). Also, as they are reused over time, when the buffer cache is effectively full, and some block with a small touch count is freed, it will be “placed” into approximately the middle of the list with the new data block.

The whole algorithm used to manage these lists is fairly complex and changes subtly from release to release of Oracle as improvements are made. The actual full details are not relevant to us as developers, beyond the fact that heavily used blocks will be cached, and blocks that are not used heavily will not be cached for long.



---

■ **Note** If you've been following along, running the examples in your database, take this opportunity to log out of the SYSDBA account and get back in with your own account!

---

## Multiple Block Sizes

Starting in Oracle9i, you can have multiple database block sizes in the same database. Previously, all blocks in a single database were the same size and in order to have a different block size, you had to rebuild the entire database. Now you can have a mixture of the “default” block size (the block size you used when you initially created the database; the size that is used for the SYSTEM and all TEMPORARY tablespaces) and up to four other block sizes. Each unique block size must have its own buffer cache area. The default, keep, and recycle pools will only cache blocks of the default size. In order to have a nondefault block size in your database, you need to have configured a buffer pool to hold them.

In this example, my default block size is 8KB. I will attempt to create a tablespace with a 16KB block size:

```
EODA@ORA12CR1> create tablespace ts_16k
  2 datafile '/tmp/ts_16k.dbf'
  3 size 5m
  4 blocksize 16k;
create tablespace ts_16k
*
ERROR at line 1:
ORA-29339: tablespace block size 16384 does not match configured block sizes
```

```
EODA@ORA12CR1> show parameter 16k
```

NAME	TYPE	VALUE
db_16k_cache_size	big integer	0

Right now, since I have not configured a 16KB cache, I can't create such a tablespace. I could do one of a couple of things right now to rectify this situation. I could set the DB\_16K\_CACHE\_SIZE parameter and restart the database. I could shrink one of my other SGA components in order to make room for a 16KB cache in the existing SGA. Or, I might be able to just allocate a 16KB cache if the SGA\_MAX\_SIZE parameter was larger than my current SGA size.

---

■ **Note** Starting in Oracle9i, you can resize various SGA components while the database is up and running. If you want to be able to “grow” the size of the SGA beyond its initial allocation, you must have set the SGA\_MAX\_SIZE parameter to some value larger than the allocated SGA. For example, if after startup your SGA size was 800MB and you wanted to add an additional 200MB to the buffer cache, you would have had to set the SGA\_MAX\_SIZE to 1GB or larger to allow for the growth.

---

In this example, I will set the `DB_16K_CACHE_SIZE` and restart, since I'm using automatic shared memory management and don't wish to set any of the other caches manually:

```
EODA@ORA12CR1> alter system set sga_target=300m scope=spfile;
System altered.

EODA@ORA12CR1> alter system set db_16k_cache_size = 16m scope=spfile;
System altered.

EODA@ORA12CR1> connect / as sysdba
Connected.

SYS@ORA12CR1> startup force
ORACLE instance started.

ORACLE instance started.

Total System Global Area  313159680 bytes
Fixed Size                 2287864 bytes
Variable Size             180356872 bytes
Database Buffers          125829120 bytes
Redo Buffers               4685824 bytes
Database mounted.
Database opened.
SYS@ORA12CR1> show parameter 16k
```

NAME	TYPE	VALUE
db_16k_cache_size	big integer	16M

So, now I have another buffer cache set up: one to cache any blocks that are 16KB in size. The default pool will consume the rest of the buffer cache space, as you can see by querying `V$SGASTAT`. These two buffer caches are mutually exclusive; if one “fills up,” it can't use space in the other. This gives the DBA a very fine degree of control over memory use, but it comes at a price. That price is complexity and management. These multiple block sizes were not intended as a performance or tuning feature (if you need multiple caches, you have the default, keep and recycle pools already), but rather came about in support of transportable tablespaces—the ability to take formatted data files from one database and transport or attach them to another database. They were implemented in order to take data files from a transactional system that was using an 8KB block size and transport that information to a data warehouse using a 16KB or 32KB block size.

The multiple block sizes do serve a good purpose, however, in testing theories. If you want to see how your database would operate with a different block size—how much space, for example, a certain table would consume if you used a 4KB block instead of an 8KB block—you can now test that easily without having to create an entirely new database instance.

You may also be able to use multiple block sizes as a very finely focused tuning tool for a specific set of segments, by giving them their own private buffer pools. Or, in a hybrid system, transactional users could use one set of data and reporting/warehouse users could query a separate set of data. The transactional data would benefit from the smaller block sizes due to less contention on the blocks (less data/rows per block means fewer people in general would go after the same block at the same time) as well as better buffer cache utilization (users read into the cache only the data they are interested in—the single row or small set of rows). The reporting/warehouse data, which might be based on the transactional data, would benefit from the larger block sizes due in part to less block overhead (it takes less storage overall) and larger logical I/O sizes perhaps. And since reporting/warehouse data does not

have the same update contention issues, the fact that there are more rows per block is not a concern but a benefit. Moreover, the transactional users get their own buffer cache in effect; they don't have to worry about the reporting queries overrunning their cache.

But in general, the default, keep, and recycle pools should be sufficient for fine-tuning the block buffer cache, and multiple block sizes would be used primarily for transporting data from database to database and perhaps for a hybrid reporting/transactional system.

## Shared Pool

The shared pool is one of the most critical pieces of memory in the SGA, especially with regard to performance and scalability. A shared pool that is too small can kill performance to the point that the system appears to hang. A shared pool that is too large can have the same effect. A shared pool that is used incorrectly will be a disaster as well.

What exactly is the shared pool? The shared pool is where Oracle caches many bits of “program” data. When we parse a query, the parsed representation is cached there. Before we go through the job of parsing an entire query, Oracle searches the shared pool to see if the work has already been done. PL/SQL code that you run is cached in the shared pool, so the next time you run it, Oracle doesn't have to read it in from disk again. PL/SQL code is not only cached here, it is shared here as well. If you have 1,000 sessions all executing the same code, only one copy of the code is loaded and shared among all sessions. Oracle stores the system parameters in the shared pool. The data dictionary cache (cached information about database objects) is stored here. In short, everything but the kitchen sink is stored in the shared pool.

The shared pool is characterized by lots of small (generally 4KB or less) chunks of memory. Bear in mind that 4KB is not a hard limit. There will be allocations that exceed that size, but in general the goal is to use small chunks of memory to prevent the fragmentation that would occur if memory chunks were allocated in radically different sizes, from very small to very large. The memory in the shared pool is managed on an LRU basis. It is similar to the buffer cache in that respect—if you don't use it, you'll lose it. A supplied package called `DBMS_SHARED_POOL` may be used to change this behavior—to forcibly pin objects in the shared pool. You can use this procedure to load up your frequently used procedures and packages at database startup time, and make it so they are not subject to aging out. Normally, though, if over time a piece of memory in the shared pool is not reused, it will become subject to aging out. Even PL/SQL code, which can be rather large, is managed in a paging mechanism so that when you execute code in a very large package, only the code that is needed is loaded into the shared pool in small chunks. If you don't use it for an extended period of time, it will be aged out if the shared pool fills up and space is needed for other objects.

The easiest way to break Oracle's shared pool is to not use bind variables. As you saw in Chapter 1, not using bind variables can bring a system to its knees for two reasons:

- The system spends an exorbitant amount of CPU time parsing queries.
- The system uses large amounts of resources managing the objects in the shared pool as a result of never reusing queries.

If every query submitted to Oracle is a unique query (because of unique values hard-coded in), the concept of the shared pool is substantially defeated. The shared pool was designed so that query plans would be used over and over again. If every query is a brand-new, never-before-seen query, then caching only adds overhead. The shared pool becomes something that inhibits performance. A common but misguided technique that many use to try to solve this issue is adding more space to the shared pool, which typically only makes things worse than before. As the shared pool inevitably fills up once again, it gets to be even more of an overhead than the smaller shared pool, for the simple reason that managing a big, full shared pool takes more work than managing a smaller, full shared pool.

The only true solution to this problem is to use shared SQL to reuse queries. Earlier, in Chapter 1, we briefly looked at the parameter `CURSOR_SHARING`, which can work as a short-term crutch in this area. The only real way to solve this issue, however, is to use reusable SQL in the first place. Even on the largest of large systems, I find that there are typically at most 10,000 to 20,000 unique SQL statements. Most systems execute only a few hundred unique queries.

The following real-world example demonstrates just how bad things can get if you use the shared pool poorly. I was asked to work on a system where the standard operating procedure was to shut down the database every night, to wipe out the SGA and restart it clean. The reason for doing this was that the system was having issues during the day whereby it was totally CPU-bound and, if the database were left to run for more than a day, performance really started to decline. They were using a 1GB shared pool inside of a 1.1GB SGA. This is true: 0.1GB dedicated to block buffer cache and other elements and 1GB dedicated to caching unique queries that would never be executed again. The reason for the cold start was that if they left the system running for more than a day, they would run out of free memory in the shared pool. At that point, the overhead of aging structures out (especially from a structure so large) was such that it overwhelmed the system and performance was massively degraded (not that performance was that great anyway, since they were managing a 1GB shared pool). Furthermore, the people working on this system constantly wanted to add more and more CPUs to the machine, as hard-parsing SQL is so CPU-intensive. By correcting the application and allowing it to use bind variables, not only did the physical machine requirements drop (they then had many times more CPU power than they needed), but also the allocation of memory to the various pools was reversed. Instead of a 1GB shared pool, they had less than 100MB allocated—and they never used it all over many weeks of continuous uptime.

One last comment about the shared pool and the parameter `SHARED_POOL_SIZE`. In Oracle9i and before, there is no direct relationship between the outcome of the query:

```
ops$tkyte@ORA9IR2> select sum(bytes) from v$sgastat where pool = 'shared pool';
```

```
SUM(BYTES)
-----
100663296
```

and the `SHARED_POOL_SIZE` parameter

```
ops$tkyte@ORA9IR2> show parameter shared_pool_size
```

NAME	TYPE	VALUE
shared_pool_size	big integer	83886080

other than the fact that the `SUM(BYTES) FROM V$SGASTAT` will always be larger than the `SHARED_POOL_SIZE`. The shared pool holds many other structures that are outside the scope of the corresponding parameter. The `SHARED_POOL_SIZE` is typically the largest contributor to the shared pool as reported by the `SUM(BYTES)`, but it is not the only contributor. For example, the parameter `CONTROL_FILES` contributes 264 bytes per file to the “miscellaneous” section of the shared pool. It is unfortunate that the “shared pool” in `V$SGASTAT` and the parameter `SHARED_POOL_SIZE` are named as they are, since the parameter contributes to the size of the shared pool, but it is not the only contributor.

In Oracle 10g and above, however, you should see a one-to-one correspondence between the two, assuming you are using manual shared memory management (i.e., you have set the `SHARED_POOL_SIZE` parameter yourself):

```
ops$tkyte@ORA10G> select sum(bytes)/1024/1024 mbytes from v$sgastat where pool = 'shared pool';
```

```
MBYTES
-----
128
```

```
ops$tkyte@ORA10G> show parameter shared_pool_size;
```

NAME	TYPE	VALUE
shared_pool_size	big integer	128M

---

■ **Note** I was using manual shared memory management in this example!

---

This is a relatively important change as you go from Oracle9i and before to 10g. In Oracle 10g, the `SHARED_POOL_SIZE` parameter controls the size of the shared pool, whereas in Oracle9i and before, it was just the largest contributor to the shared pool. You should review your 9i and before actual shared pool size (based on `V$SGASTAT`) and use that figure to set your `SHARED_POOL_SIZE` parameter in Oracle 10g and above. The various other components that used to add to the size of the shared pool now expect you to allocate that memory for them.

## Large Pool

The large pool is not so named because it is a “large” structure (although it may very well be large in size). It is so named because it is used for allocations of large pieces of memory that are bigger than the shared pool is designed to handle.

Prior to the introduction of the large pool in Oracle 8.0, all memory allocation took place in the shared pool. This was unfortunate if you were using features that made use of “large” memory allocations, such as shared server UGA memory allocations. This issue was further confounded by the fact that processing, which tended to need a lot of memory allocation, would use the memory in a manner different from the way the shared pool managed it. The shared pool manages memory on an LRU basis, which is perfect for caching and reusing data. Large memory allocations, however, tend to get a chunk of memory, use it, and then be done with it. There was no need to cache this memory.

What Oracle needed was something similar to the recycle and keep buffer pools implemented for the block buffer cache, and that’s exactly what the large pool and shared pool are now. The large pool is a recycle-style memory space, whereas the shared pool is more like the keep buffer pool—if people appear to be using something frequently, then you keep it cached.

Memory allocated in the large pool is managed in a heap, much in the way C manages memory via `malloc()` and `free()`. As soon as you “free” a chunk of memory, it can be used by other processes. In the shared pool, there really was no concept of freeing a chunk of memory. You would allocate memory, use it, and then stop using it. After a while, if that memory needed to be reused, Oracle would age out your chunk of memory. The problem with using only a shared pool is that one size doesn’t always fit all.

The large pool is used specifically by:

- *Shared server connections*, to allocate the UGA region in the SGA.
- *Parallel execution of statements*, to allow for the allocation of interprocess message buffers, which are used to coordinate the parallel query servers.
- *Backup* for RMAN disk I/O buffers in some cases.

As you can see, none of these memory allocations should be managed in an LRU buffer pool designed to manage small chunks of memory. With shared server connection memory, for example, once a session logs out, this memory is never going to be reused so it should be immediately returned to the pool. Also, shared server UGA memory allocation tends to be “large.” If you review the earlier examples with the `SORT_AREA_RETAINED_SIZE` or `PGA_AGGREGATE_TARGET`, you’ll remember that the UGA can grow very large and is definitely bigger than 4KB chunks. Putting shared server memory into the shared pool causes it to fragment into odd-sized pieces and, furthermore, you will find that large pieces of memory that will never be reused will age out memory that could be reused. This forces the database to do more work to rebuild that memory structure later.

The same is true for parallel query message buffers, since they are not LRU-manageable. They are allocated and can’t be freed until they are done being used. Once they have delivered their message, they are no longer needed and should be released immediately. With backup buffers, this applies to an even greater extent—they are large, and once Oracle is done using them, they should just “disappear.”

The large pool is not mandatory when using shared server connections, but it is highly recommended. If you don't have a large pool and use a shared server connection, the allocations come out of the shared pool as they always did in Oracle 7.3 and before. This will definitely lead to degraded performance over some period of time and should be avoided. The large pool will default to some size if the parameter `DBWR_IO_SLAVES` or `PARALLEL_MAX_SERVERS` is set to some positive value. You should set the size of the large pool manually if you are using a feature that employs it. The default value typically will not be appropriate for your situation.

## Java Pool

The Java pool was added in version 8.1.5 of Oracle to support running Java in the database. If you code a stored procedure in Java, Oracle will use this chunk of memory when processing that code. The parameter `JAVA_POOL_SIZE` is used to fix the amount of memory allocated to the Java pool for all session-specific Java code and data.

The Java pool is used in different ways, depending on the mode in which the Oracle server is running. In dedicated server mode, the Java pool includes the shared part of each Java class, which is actually used per session. These are basically the read-only parts (execution vectors, methods, etc.) and are about 4KB to 8KB per class. Thus, in dedicated server mode the total memory required for the Java pool is quite modest and can be determined based on the number of Java classes you'll be using. Note that none of the per-session state is stored in the SGA in dedicated server mode, as this information is stored in the UGA and, as you will recall, the UGA is included in the PGA in dedicated server mode.

When connecting to Oracle using a shared server connection, the Java pool includes both of the following:

- The shared part of each Java class.
- Some of the UGA used for per-session state of each session, which is allocated from the Java pool within the SGA. The remainder of the UGA will be located as usual in the shared pool, or if the large pool is configured, it will be located there instead.

As the total size of the Java pool is fixed in Oracle9i and before, application developers will need to estimate the total requirement of their applications and multiply this estimate by the number of concurrent sessions they need to support. This number will dictate the overall size of the Java pool. Each Java UGA will grow or shrink as needed, but bear in mind that the pool must be sized such that all UGAs combined can fit in it at the same time. In Oracle 10g and above, this parameter may be modified, and the Java pool may grow and shrink over time without the database being restarted.

## Streams Pool

The Streams pool is an SGA structure introduced in Oracle 10g. Oracle products that use the Streams pool include Oracle GoldenGate, XStream, Oracle Streams, Oracle Advanced Queuing, and Oracle Data Pump.

The size of the Streams pool is governed by setting the `STREAMS_POOL_SIZE` parameter. If `SGA_TARGET` is a non-zero value, then automatic SGA memory management will use the setting of `STREAMS_POOL_SIZE` as a minimum value for the Streams pool. If both the `SGA_TARGET` and `STREAMS_POOL_SIZE` are both set to zero, then up to 10 percent of the shared pool is used by the Streams pool.

Products that use the Streams pool will buffer queue messages. Instead of using permanent disk-based queues, with their attendant overhead, these features use in-memory queues. If these queues fill up, they eventually spill over to disk. If the Oracle instance with the memory queue fails for some reason, due to an instance failure (software crash), power failure, or whatever, these in-memory queues are rebuilt from the redo logs.

The Streams pool is only important in systems using features (such as GoldenGate, Streams, and so on) that need space in this memory area. In those environments, the `STREAMS_POOL_SIZE` should be set in order to avoid "stealing" 10 percent of the shared pool.

## SGA Memory Management

The SGA memory-related parameters are classified into one of two areas:

- *Auto-tuned SGA parameters:* Currently these are DB\_CACHE\_SIZE, SHARED\_POOL\_SIZE, LARGE\_POOL\_SIZE, JAVA\_POOL\_SIZE, and STREAMS\_POOL\_SIZE.
- *Manual SGA parameters:* These include LOG\_BUFFER, DB\_NK\_CACHE\_SIZE, DB\_KEEP\_CACHE\_SIZE, and DB\_RECYCLE\_CACHE\_SIZE.

At any time in Oracle 10g and above, you may query V\$SGAINFO to see which components of the SGA are resizable:

```
EODA@ORA12CR1> select * from V$SGAINFO;
```

NAME	BYTES	RES	CON_ID
Fixed SGA Size	2287336	No	0
Redo Buffers	4890624	No	0
Buffer Cache Size	67108864	Yes	0
Shared Pool Size	184549376	Yes	0
Large Pool Size	4194304	Yes	0
Java Pool Size	4194304	Yes	0
Streams Pool Size	0	Yes	0
Shared IO Pool Size	4194304	Yes	0
Data Transfer Cache Size	0	Yes	0
Granule Size	4194304	No	0
Maximum SGA Size	267227136	No	0
Startup overhead in Shared Pool	169940696	No	0
Free SGA Memory Available	0		0

13 rows selected.

For the SGA memory components that can be auto-tuned, there are three ways to manage these:

- *Manual shared memory management:* Setting all of the necessary pool and cache parameters.
- *Starting in Oracle 10g and above, automatic shared (or SGA) memory management:* Setting the SGA\_TARGET parameter. By setting the SGA\_TARGET parameter, you are allowing the instance to size and resize various SGA components.
- *Starting in Oracle 11g and above, automatic memory management:* Setting the MEMORY\_TARGET parameter. By setting the MEMORY\_TARGET parameter, you are allowing the instance to size and resize the SGA and PGA memory areas.

We will discuss each in turn.

## Manual Shared Memory Management

If you require some degree of control over the auto-tunable areas of the SGA memory, then set MEMORY\_TARGET and SGA\_TARGET to zero. When MEMORY\_TARGET is set to zero, this disables automatic memory management; when SGA\_TARGET is set to zero, this disables automatic shared memory management.

---

■ **Note** In Oracle9i and before, only manual shared memory management was available—the parameter `SGA_TARGET` did not exist and the parameter `SGA_MAX_SIZE` specified the maximum size of the SGA.

---

When automatic memory management is disabled, you can manually set the size of your SGA by specifying sizes for the following memory parameters: `DB_CACHE_SIZE`, `SHARED_POOL_SIZE`, `LARGE_POOL_SIZE`, `JAVA_POOL_SIZE`, and `STREAMS_POOL_SIZE`. Each of these parameters have a default value that Oracle will use in the event you don't explicitly set them. For example, the `DB_CACHE_SIZE` will be set to either 48MB or 4MB times the number of CPUs, whichever happens to be the largest for your system.

Here's an example of an initialization file that enables manual shared memory management:

```
*.compatible='12.1.0.1'
*.control_files='/u01/dbfile/ORA12CR1/control01.ctl','/u02/dbfile/ORA12CR1/control02.ctl'
*.db_block_size=8192
*.db_name='ORA12CR1'
*.memory_target=0
*.sga_target=0
*.db_cache_size=1G
*.shared_pool_size=256M
*.pga_aggregate_target=256m
*.open_cursors=300
*.processes=600
*.remote_login_passwordfile='EXCLUSIVE'
*.resource_limit=TRUE
*.undo_tablespace='UNDOTBS1'
```

One aspect to be aware of with manual shared memory management in Oracle 11g Release 2 and higher, is that even when you explicitly turn off all automatic memory management (by setting `MEMORY_TARGET` and `SGA_TARGET` to zero), Oracle may still do some automatic reallocation of memory from the database buffer cache to the shared pool. When running out of space in the shared pool, Oracle will automatically add space to the shared pool to avoid the ORA-04031 “Unable to allocate %s bytes of shared memory” error.

You can view the automatic resizing of SGA memory by querying the `V$MEMORY_RESIZE_OPS` view. The `OPER_MODE` column will contain the value of either `DEFERRED` or `IMMEDIATE` for any automatic SGA resizing operations. When using manual SGA memory management, SGA automatic resizing is disabled for `DEFERRED` mode requests, but allowed for `IMMEDIATE` mode requests. Therefore, when you're using manual shared memory management, you may see `GROW` and `SHRINK` operations (in the `OPER_TYPE` column) for `IMMEDIATE` auto-tuning requests for the `DB_CACHE_SIZE` and `SHARED_POOL` size memory areas.

A simple example will demonstrate what's described in the prior paragraphs. First, I'll create the `DBMS_SHARED_POOL` package so that I can pin objects in the shared pool:

```
SYS@ORA12CR1> @?/rdbs/admin/dbmspool
Session altered.
Package created.
Grant succeeded.
Session altered.
```

```
SYS@ORA12CR1> grant execute on dbms_shared_pool to eoda;
Grant succeeded.
```



Next, I'll run some code that will quickly start filling up the shared pool (by pinning multiple PL/SQL procedures in the shared pool):

```

SYS@ORA12CR1> conn eoda/foo
Connected.

EODA@ORA12CR1> declare
  2   k varchar2(30);
  3   ss varchar2(2000);
  4   begin
  5     for i in 1 .. 100000 loop
  6       ss := 'create or replace procedure SP' || i || ' is
  7         a number;
  8         begin
  9           a := 123456789012345678901234567890;
10          a := 123456789012345678901234567890;
11          a := 123456789012345678901234567890;
12          a := 123456789012345678901234567890;
13          a := 123456789012345678901234567890;
14          a := 123456789012345678901234567890;
15          a := 123456789012345678901234567890;
16          a := 123456789012345678901234567890;
17          a := 123456789012345678901234567890;
18          a := 123456789012345678901234567890;
19          a := 123456789012345678901234567890;
20          a := 123456789012345678901234567890;
21          a := 123456789012345678901234567890;
22          a := 123456789012345678901234567890;
23          a := 123456789012345678901234567890;
24         end;';
25     execute immediate ss;
26     k := 'SP' || i;
27     sys.dbms_shared_pool.keep(k);
28   end loop;
29 end;
30 /

```

Now, from another session, I'll query the data dictionary to view the memory resize operations as Oracle shifts memory to the shared pool:

```

EODA@ORA12CR1> select component, parameter, oper_type, oper_mode from v$memory_resize_ops;
...
DEFAULT buffer cache          db_cache_size          SHRINK          IMMEDIATE
shared pool                   shared_pool_size       GROW           IMMEDIATE
DEFAULT buffer cache          db_cache_size          SHRINK          IMMEDIATE
DEFAULT buffer cache          db_cache_size          SHRINK          IMMEDIATE
shared pool                   shared_pool_size       GROW           IMMEDIATE
DEFAULT buffer cache          db_cache_size          SHRINK          IMMEDIATE
shared pool                   shared_pool_size       GROW           IMMEDIATE

```

So just be aware of the possibility that in 11g Release 2 and higher, Oracle might perform some degree of automatic SGA memory reallocation, even when you've turned the feature off. As earlier noted, Oracle does this to keep processes from running out of space in the shared pool.

---

■ **Tip** See MOS note 1269139.1 for further details on automatic SGA resizing when using manual shared memory management.

---

## Automatic Shared Memory Management

Under automatic shared memory management, the primary parameter for sizing the total auto-tuned components is `SGA_TARGET`, which may be dynamically sized while the database is up and running, up to the setting of the `SGA_MAX_SIZE` parameter. This defaults to be equal to the `SGA_TARGET`, so if you plan on increasing the `SGA_TARGET`, you must have set the `SGA_MAX_SIZE` larger before starting the database instance. The database will use the `SGA_TARGET` value, minus the size of any of the other manually sized components such as the `DB_KEEP_CACHE_SIZE`, `DB_RECYCLE_CACHE_SIZE`, and so on, and use that amount of memory to size the default buffer pool, shared pool, large pool, and Java pool. Dynamically at runtime, the instance will allocate and reallocate memory among those four memory areas as needed. Instead of returning an ORA-04031 “Unable to allocate N bytes of shared memory” error to a user when the shared pool runs out of memory, the instance could instead choose to shrink the buffer cache by some number of megabytes (a granule size) and increase the shared pool by that amount.

---

■ **Note** To use automatic shared memory management, the parameter `STATISTICS_LEVEL` must be set to `TYPICAL` (default value) or `ALL`. If statistics collection is not enabled, the database will not have the historical information needed to make the necessary sizing decisions.

---

Over time, as the memory needs of the instance are ascertained, the size of the various SGA components would become more or less fixed in size. The database also remembers the sizes of these four components across database startup and shutdown so that it doesn't have to start all over again figuring out the right size for your instance each time. It does this via four double-underscore parameters: `__db_cache_size`, `__java_pool_size`, `__large_pool_size`, and `__shared_pool_size`. During a normal or immediate shutdown, the database will record these values to the *stored parameter file* and use them at startup to set the default sizes of each area.

---

■ **Note** This last feature, of storing the recommended values for the pools, only works if you are using stored parameter files (also known as *sfile*).

---

Additionally, if you know you want a certain minimum value to be used for one of the five areas, you may set that parameter in addition to setting the `SGA_TARGET`. The instance will use your setting as the lower bound, or the smallest size that particular area may be.

## Automatic Memory Management

Starting in Oracle 11g Release 1 and above, the database also offers automatic memory management—sort of a one stop shop for all of your memory settings. With Oracle 10g and automatic SGA memory management—the DBA could get away with just two major memory settings—the `PGA_AGGREGATE_TARGET` and the `SGA_TARGET`. The database would automatically allocate and reallocate memory chunks within each as described earlier. In Oracle 11g, the DBA can now get away with setting a single memory parameter—the `MEMORY_TARGET`. This `MEMORY_TARGET` represents the total amount of memory the combined SGA and PGA allocations should strive to stay within (remember, the PGA memory can be somewhat uncontrollable). The database will dynamically determine what the proper SGA size is and what the proper PGA size is, based on workload history). Over time, as the workload performed in the database changes, the allocations to the SGA and PGA will change as well. For example, if you are heavy OLTP (Online Transaction Processing) during the day and heavy batch processing at night, you might discover that the daytime SGA is much larger than the PGA and the nighttime SGA is much smaller than the PGA. This would reflect the different memory needs of these two application types.

---

■ **Note** Before implementing automatic memory management, consider checking for any MOS related operating system specific notes such as 749851.1 (for Linux) and 1399274.1 (for Solaris).

---

Just as with automatic SGA memory management, the DBA can set up lower bounds for the size of each memory area by setting the `SGA_TARGET` and `PGA_AGGREGATE_TARGET`, or the lower bound of each of the pools in the SGA by setting their values to that lower bound. The database will remember the optimal settings for the pools and the SGA and PGA in the stored parameter file if you are using one. For example, on one of my test systems I've set:

- `memory_target = 756m`
- `sga_target = 256m`
- `pga_aggregate_target = 256m`

The stored parameter file for that database currently has:

```
SYS@ORA12CR1> create pfile='/tmp/pfile' from spfile;
File created.
```

```
SYS@ORA12CR1> !cat /tmp/pfile;
ORA12CR1.__data_transfer_cache_size=0
ORA12CR1.__db_cache_size=67108864
ORA12CR1.__java_pool_size=4194304
ORA12CR1.__large_pool_size=4194304
ORA12CR1.__oracle_base='/orahome/app/oracle'#ORACLE_BASE set from environment
ORA12CR1.__pga_aggregate_target=520093696
ORA12CR1.__sga_target=272629760
ORA12CR1.__shared_io_pool_size=0
ORA12CR1.__shared_pool_size=184549376
ORA12CR1.__streams_pool_size=0
*.compatible='12.1.0.1'
*.control_files='/u01/dbfile/ORA12CR1/control01.ctl','/u02/dbfile/ORA12CR1/control02.ctl'
*.db_block_size=8192
*.db_name='ORA12CR1'
*.memory_target=792723456
*.open_cursors=300
```

```
*.pga_aggregate_target=268435456  
*.processes=600  
*.remote_login_passwordfile='EXCLUSIVE'  
*.resource_limit=TRUE  
*.sga_target=268435456  
*.undo_tablespace='UNDOTBS1'
```

As you can see, the double-underscore parameters in bold now include the `__sga_target` and `__pga_aggregate_target` settings as well as the various pools. These values are derived based on the last three memory parameters shown in bold, as well as the observed server workload. In this fashion, Oracle will remember your last optimal SGA/PGA settings and use them upon the next restart.

## Summary

In this chapter, we took a look at the Oracle memory structures. We started at the process and session level, examining the PGA and UGA and their relationship. We saw how the mode in which we connect to Oracle dictates how memory is organized. A dedicated server connection implies more memory used in the server process than under a shared server connection, but that use of a shared server connection implies there will be the need for a significantly larger SGA. Then we discussed the main structures of the SGA itself. We discovered the differences between the shared pool and the large pool, and looked at why we might want a large pool to “save” our shared pool. We covered the Java pool and how it is used under various conditions, and we looked at the block buffer cache and how that can be subdivided into smaller, more focused pools.

Now we are ready to move on to the physical processes that make up the rest of an Oracle instance.



# Oracle Processes

We've reached the last piece of the architecture puzzle. We've investigated the database and the set of physical files that constitute a database. In covering the memory used by Oracle, we've looked at one half of an instance. The last remaining architectural issue to cover is the set of *processes* that constitute the other half of the instance.

Each process in Oracle will perform a particular task or set of tasks, and each will have internal memory (PGA memory) allocated by it to perform its job. An Oracle instance has three broad classes of processes:

- *Server processes*: These perform work based on a client's request. We have already looked at dedicated and shared servers to some degree. These are the server processes.
- *Background processes*: These are the processes that start up with the database and perform various maintenance tasks, such as writing blocks to disk, maintaining the online redo log, cleaning up aborted processes, maintaining Automatic Workload Repository (AWR) and so on.
- *Slave processes*: These are similar to background processes, but they are processes that perform extra work on behalf of either a background or a server process.

Some of these processes, such as the database block writer (DBWn) and the log writer (LGWR), have cropped up already, but here we'll take a closer look at the function of each, and what each does and why.

---

■ **Note** When I use the term *process* in this chapter, consider it to be synonymous with the term *thread* on operating systems where Oracle is implemented with threads (such as Windows). In the context of this chapter, I use the term *process* to cover both processes and threads. If you are using an implementation of Oracle that is multiprocess, such as you see on UNIX/Linux, the term *process* is totally appropriate. If you are using a single-process implementation of Oracle, such as you see on Windows, the term *process* will actually mean *thread within the Oracle process*. So, for example, when I talk about the DBWn process, the equivalent on Windows is the DBWn thread within the Oracle process.

---

## Server Processes

Server processes are those that perform work on behalf of a client session. They are the processes that ultimately receive and act on the SQL statements our applications send to the database.

In Chapter 2, we briefly touched on the two main connection types to Oracle, namely the following:

- *Dedicated server*: There is a dedicated process on the server for your connection. There is a one-to-one mapping between a connection to the database and a server process or thread.
- *Shared server*: Many sessions share a pool of server processes spawned and managed by the Oracle instance. Your connection is to a database dispatcher, not to a dedicated server process created just for your connection.

---

■ **Note** It is important to understand the difference between a connection and a session in Oracle terminology.

A *connection* is just a physical path between a client process and an Oracle instance (e.g., a network connection between you and the instance). A *session*, on the other hand, is a logical entity in the database, where a client process can execute SQL and so on. Many independent sessions can be associated with a single connection, and these sessions can even exist independently of a connection. We will discuss this further shortly.

---

Both dedicated and shared server processes have the same job: they process all of the SQL you give to them. When you submit a `SELECT * FROM EMP` query to the database, an Oracle dedicated/shared server process parses the query and places it into the shared pool (or finds it in the shared pool already, hopefully). This process comes up with the query plan, if necessary, and executes the query plan, perhaps finding the necessary data in the buffer cache or reading the data from disk into the buffer cache.

These server processes are the workhorse processes. Often, you will find these processes to be the highest consumers of CPU time on your system, as they are the ones that do your sorting, your summing, your joining—pretty much everything.

## Dedicated Server Connections

In dedicated server mode, there will be a one-to-one mapping between a client connection and a server process (or thread, as the case may be). If you have 100 dedicated server connections on a UNIX/Linux machine, there will be 100 processes executing on their behalf. Graphically, it looks as shown in Figure 5-1.

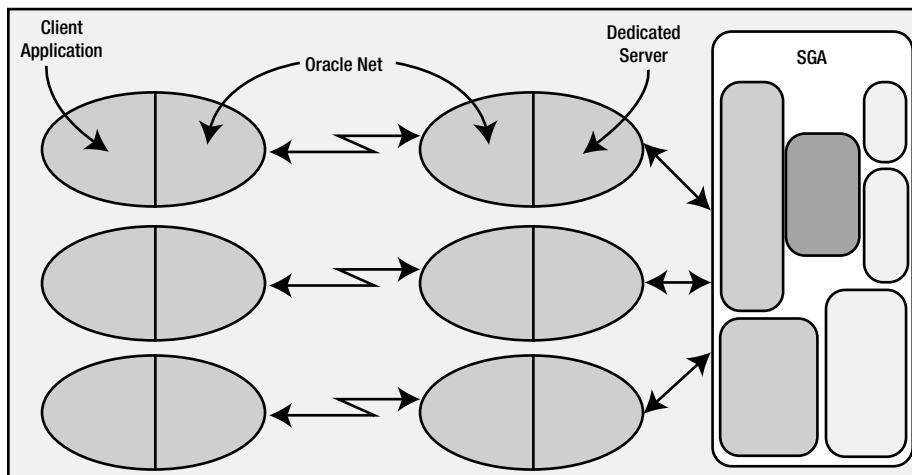

**Figure 5-1.** Typical dedicated server connection

Your client application will have Oracle libraries linked into it. These libraries provide the APIs you need in order to talk to the database. These APIs know how to submit a query to the database and process the cursor that is returned. They know how to bundle your requests into network calls that the dedicated server will know how to unbundle. This piece of software is called *Oracle Net*, although in prior releases you might have known it as *SQL\*Net* or *Net8*. This is the networking software/protocol that Oracle employs to allow for client/server processing (even in an *n*-tier architecture, there is a client/server program lurking). Oracle employs this same architecture even if Oracle Net is not technically involved in the picture. That is, even when the client and server are on the same machine this two-process (also known as *two-task*) architecture is still employed. This architecture provides two benefits:

- *Remote execution*: It is very natural for the client application to be executing on a machine other than the database itself.
- *Address space isolation*: The server process has read-write access to the SGA. An errant pointer in a client process could easily corrupt data structures in the SGA if the client process and server process were physically linked together.

In Chapter 2, we saw how these dedicated servers are *spawned* or created by the Oracle listener process. I won't cover that process again; rather, we'll quickly look at what happens when the listener isn't involved. The mechanism is much the same as it was with the listener, but instead of the listener creating the dedicated server via a `fork()/exec()` in UNIX/Linux or an interprocess communication (IPC) call in Windows, the client process itself creates it.

---

■ **Note** There are many variants of the `fork()` and `exec()` calls, such as `vfork()` and `execve()`. The call used by Oracle may vary by operating system and implementation, but the net effect is the same. `fork()` creates a new process that is a clone of the parent process; on UNIX/Linux, this is the only way to create a new process. `exec()` loads a new program image over the existing program image in memory, thus starting a new program. So, SQL\*Plus can *fork* (copy itself) and then *exec* the Oracle binary, the dedicated server, overlaying the copy of itself with this new program.

---

We can see this parent/child process creation clearly on UNIX/Linux when we run the client and server on the same machine:

```
$ sqlplus eoda/foo
SQL*Plus: Release 12.1.0.1.0 Production on Thu Mar 20 14:29:00 2014
Copyright (c) 1982, 2013, Oracle. All rights reserved.
Last Successful login time: Thu Mar 20 2014 13:47:01 -07:00
Connected to:
Oracle Database 12c Enterprise Edition Release 12.1.0.1.0 - 64bit Production
With the Partitioning, OLAP, Advanced Analytics and Real Application Testing options

EODA@ORA12CR1> select a.spid dedicated_server, b.process clientpid
 2 from v$process a, v$session b
 3 where a.addr = b.paddr
 4 and b.sid = sys_context('userenv','sid');
```

DEDICATED_SERVER	CLIENTPID
18571	18570

```
EODA@ORA12CR1> !/bin/ps -fp 18571 18570
UID      PID  PPID  C  STIME TTY          STAT      TIME CMD
oracle   18570 11782  0 15:17 pts/4    S+         0:00 sqlplus
oracle   18571 18570  0 15:17 ?          Ss         0:00 oracleORA12CR1(DESCRIPTION=(LOCAL=...
```

Here, I used a query to discover the process ID (PID) associated with my dedicated server (the SPID from `V$PROCESS` is the operating system PID of the process that was being used during the execution of that query). The output of `/bin/ps -fp` includes the parent process id (PPID) and shows the dedicated server process, 18571, is the child of my SQL\*Plus process: process id 18570.

## Shared Server Connections

Let's now take a look at the shared server process in more detail. This type of connection mandates the use of Oracle Net even if the client and server are on the same machine—you cannot use a shared server without using the Oracle TNS listener. As described earlier, the client application will connect to the Oracle TNS listener and will be redirected or handed off to a dispatcher. The dispatcher acts as the conduit between the client application and the shared server process. Figure 5-2 is a diagram of the architecture of a shared server connection to the database.

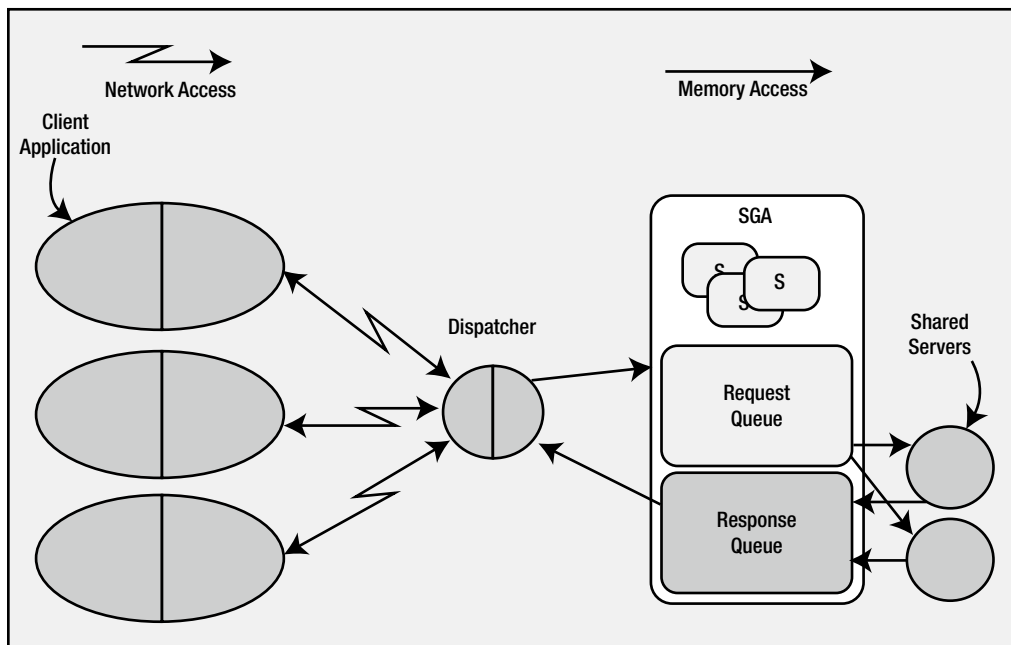

**Figure 5-2.** Typical shared server connection

Here, we can see that the client applications, with the Oracle libraries linked in, will be physically connected to a dispatcher process. We may have many dispatchers configured for any given instance, but it is not uncommon to have just one dispatcher for many hundreds—even thousands—of users. The dispatcher is simply responsible for receiving inbound requests from the client applications and putting them into a request queue in the SGA. The first available shared server process from the pool of pre-created shared server processes will pick up the request from the queue and attach the UGA of the associated session (the boxes labeled “S” in Figure 5-2). The shared server will process that request and place any output from it into the response queue. The dispatcher constantly monitors the response queue for results and transmits them back to the client application. As far as the client is concerned, it can't really tell if it is connected via a dedicated server or a shared connection—they appear to be the same. Only at the database level is the difference apparent.



## Database Resident Connection Pooling (DRCP)

Database Resident Connection Pooling (DRCP) is an optional method of connecting to the database and establishing a session. It is designed as a more efficient method of connection pooling for application interfaces that do not support efficient connection pooling natively—such as PHP, a general purpose web scripting language. DRCP is a mixture of dedicated server and shared server concepts. It inherits from a shared server the concept of server process pooling, only the processes being pooled will be dedicated servers, not shared servers; it inherits from the dedicated server the concept of—well—being dedicated.

In a shared server connection, the shared server process is shared among many sessions and a single session will tend to use many shared servers. With DRCP, this is not true; the dedicated server process that is selected from the pool will become dedicated to the client process for the life of its session. In a shared server, if I execute three statements against the database in my session, there is a good chance that the three statements will be executed by three different shared server processes. Using DRCP, those same three statements would be executed by the dedicated server assigned to me from the pool—that dedicated server would be mine until my session releases it back to the pool. So DRCP has the pooling capabilities of a shared server and the performance characteristics of a dedicated server. We'll explore performance of a dedicated versus a shared server more later in this chapter.

## Connections vs. Sessions

It surprises many people to discover that a connection is not synonymous with a session. In most people's eyes they are the same, but the reality is they do not have to be. A connection may have zero, one, or more sessions established on it. Each session is separate and independent, even though they all share the same physical connection to the database. A commit in one session does not affect any other session on that connection. In fact, each session using that connection could use different user identities!

In Oracle, a connection is simply a physical circuit between your client process and the database instance—a network connection, most commonly. The connection may be to a dedicated server process or to a dispatcher. As previously stated, a connection may have zero or more sessions, meaning that a connection may exist with no corresponding sessions. Additionally, a session *may or may not* have a connection. Using advanced Oracle Net features such as connection pooling, a physical connection may be dropped by a client, leaving the session intact (but idle). When the client wants to perform some operation in that *session*, it would reestablish the physical *connection*. Let's define these terms in more detail:

- **Connection:** A connection is a physical path from a client to an Oracle instance. A connection is established either over a network or over an IPC mechanism. A connection is typically between a client process and either a dedicated server or a dispatcher. However, using Oracle's Connection Manager (CMAN), a connection may be between a client and CMAN, and CMAN and the database. Coverage of CMAN is beyond the scope of this book, but *Oracle Database Net Services Administrator's Guide* (freely available from <http://otn.oracle.com>) covers it in some detail.
- **Session:** A session is a logical entity that exists in the instance. It is your *session state*, or a collection of data structures in memory that represents your unique session. It is what would come first to most people's minds when thinking of a database connection. It is your session on the server, where you execute SQL, commit transactions, and run stored procedures.

We can use SQL\*Plus to see connections and sessions in action, and also to recognize that it could be a very common thing indeed for a connection to have more than one session. We'll simply use the AUTOTRACE command and discover that we have two sessions! Over a single connection, using a single process, we'll establish two sessions. Here is the first:

```
EODA@ORA12CR1> select username, sid, serial#, server, paddr, status
 2   from v$session
 3   where username = USER
 4   /
```

USERNAME	SID	SERIAL#	SERVER	PADDR	STATUS
EODA	10	15	DEDICATED	00000000727FE9B0	ACTIVE

Now, that shows right now that we have one session: a single dedicated server-connected session. The PADDR column is the address of our sole dedicated server process. Next, we turn on AUTOTRACE to see the statistics of statements we execute in SQL\*Plus:

```
EODA@ORA12CR1> set autotrace on statistics
EODA@ORA12CR1> select username, sid, serial#, server, paddr, status
 2   from v$session
 3   where username = USER
 4   /
```

USERNAME	SID	SERIAL#	SERVER	PADDR	STATUS
EODA	10	15	DEDICATED	00000000727FE9B0	ACTIVE
EODA	21	721	DEDICATED	00000000727FE9B0	INACTIVE

#### Statistics

```
-----
      8 recursive calls
      0 db block gets
      2 consistent gets
      0 physical reads
      0 redo size
    1004 bytes sent via SQL*Net to client
     543 bytes received via SQL*Net from client
      2 SQL*Net roundtrips to/from client
      0 sorts (memory)
      0 sorts (disk)
      2 rows processed
```

```
EODA@ORA12CR1> set autotrace off
```

In doing so, we now have two sessions, but *both* are using the same single dedicated server process, as evidenced by them both having the same PADDR value. We can confirm in the operating system that no new processes were created and that we are using a single process—a single connection—for both sessions. Note that one of the sessions (the original session) has a status of ACTIVE. That makes sense: it is running the query to show this information, so of course it is active. But that INACTIVE session—what is that one for? That is the AUTOTRACE session. Its job is to watch our real session and report on what it does.

When we enable AUTOTRACE in SQL\*Plus, SQL\*Plus will perform the following actions when we execute DML operations (INSERT, UPDATE, DELETE, SELECT, and MERGE):

1. It will create a new session using the current connection, if the secondary session does not already exist.
2. It will ask this new session to query the V\$SESSTAT view to remember the initial statistics values for the session in which we will run the DML. This is very similar to the function the `watch_stat.sql` script performed for us in Chapter 4.
3. It will run the DML operation in the original session.
4. Upon completion of that DML statement, SQL\*Plus will request the other session to query V\$SESSTAT again and produce the report displayed previously showing the difference in the statistics for the session that executed the DML.

If you turn off AUTOTRACE, SQL\*Plus will terminate this additional session and you will no longer see it in V\$SESSION. Why does SQL\*Plus do this trick? The answer is fairly straightforward. SQL\*Plus does it for the same reason that we used a second SQL\*Plus session in Chapter 4 to monitor memory and temporary space usage: if we had used a single session to monitor memory usage, we would have been using memory to do the monitoring. By observing the statistics in a single session, we necessarily would change those statistics. If SQL\*Plus used a single session to report on the number of I/Os performed, how many bytes were transferred over the network, and how many sorts happened, then the queries used to find these details would be adding to the statistics themselves. They could be sorting, performing I/O, transferring data over the network (one would assume they would), and so on. Hence, we need to use another session to measure correctly.

So far, we've seen a connection with one or two sessions. Now we'd like to use SQL\*Plus to see a connection with no session. That one is pretty easy. In the same SQL\*Plus window used in the previous example, simply type the misleadingly named command, DISCONNECT:

```
EODA@ORA12CR1> disconnect
Disconnected from Oracle Database 12c Enterprise Edition Release 12.1.0.1.0 - 64bit Production
With the Partitioning, OLAP, Advanced Analytics and Real Application Testing options
```

Technically, that command should be called DESTROY\_ALL\_SESSIONS instead of DISCONNECT, since we haven't really disconnected physically.

---

■ **Note** The true disconnect in SQL\*Plus is “exit,” as you would have to exit to completely destroy the connection.

---

We have, however, closed all of our sessions. If we open another session using some other user account and query (replacing EODA with your account name, of course):

```
$ sqlplus / as sysdba
SQL*Plus: Release 12.1.0.1.0 Production on Thu Mar 20 15:57:56 2014
Copyright (c) 1982, 2013, Oracle. All rights reserved.
Connected to:
Oracle Database 12c Enterprise Edition Release 12.1.0.1.0 - 64bit Production
With the Partitioning, OLAP, Advanced Analytics and Real Application Testing options
```

```
SYS@ORA12CR1> select * from v$session where username = 'EODA';
no rows selected
```

We can see that we have no sessions—but we still have a process, a physical connection (using the previous ADDR value):

```
SYS@ORA12CR1> select username, program
 2   from v$process
 3  where addr = hextoraw( '00000000727FE9B0' );
```

USERNAME	PROGRAM
oracle	oracle@cs-xvm2 (TNS V1-V3)

So, here we have a connection with no sessions associated with it. We can use the also misnamed SQL\*Plus CONNECT command to create a new session in this existing process (the CONNECT command might be better named CREATE\_SESSION). Using the SQL\*Plus instance we disconnected in, we'll execute the following:

```
EODA@ORA12CR1> connect eoda/foo
Connected.
EODA@ORA12CR1> select username, sid, serial#, server, paddr, status
 2   from v$session
 3  where username = USER;
```

USERNAME	SID	SERIAL#	SERVER	PADDR	STATUS
EODA	10	25	DEDICATED	00000000727FE9B0	ACTIVE

Notice that we have the same PADDR as before, so we are using the same physical connection, but we have (potentially) a different SID. I say *potentially* because we could get assigned the same SID—it just depends on whether other people logged in while we were logged out and whether the original SID we had was available.

---

■ **Note** On Windows or other thread-based operating systems, you might see different results—the process address may change since you are connected to a threaded process, not just a single purpose process as you would on UNIX/Linux.

---

So far, these tests were performed using a dedicated server connection, so the PADDR was the process address of our dedicated server process. What happens if we use a shared server?

---

■ **Note** To connect via a shared server, your database instance would have to have been started with the necessary setup. Coverage of how to configure a shared server is beyond the scope of this book but is covered in detail in the *Oracle Database Net Services Administrator's Guide*.

---

Let's log in using a shared server and in that session query:

```
EODA@ORA12CR1> select a.username, a.sid, a.serial#, a.server,
2      a.paddr, a.status, b.program
3      from v$session a left join v$process b
4      on (a.paddr = b.addr)
5      where a.username = 'EODA'
6      /
```

USERNAME	SID	SERIAL#	SERVER	PADDR	STATUS	PROGRAM
EODA	485	1105	SHARED	000000071C4BE68	ACTIVE	oracle@cs-xvm2 (S004)

Our shared server connection is associated with a process—the PADDR is there and we can join to V\$PROCESS to pick up the name of this process. In this case, we see it is a shared server, as identified by the text S004.

However, if we use another SQL\*Plus window to query this same bit of information, while leaving our shared server session idle, we see something like this:

```
$ sqlplus / as sysdba
```

```
SYS@ORA12CR1> select a.username, a.sid, a.serial#, a.server,
2      a.paddr, a.status, b.program
3      from v$session a left join v$process b
4      on (a.paddr = b.addr)
5      where a.username = 'EODA'
6      /
```

USERNAME	SID	SERIAL#	SERVER	PADDR	STATUS	PROGRAM
EODA	485	1105	NONE	000000071C46788	INACTIVE	oracle@cs-xvm2 (D000)

Notice that our PADDR is different and the name of the process we are associated with has also changed. Our idle shared server connection is now associated with a dispatcher, D000. Hence we have yet another method for observing multiple sessions pointing to a single process. A dispatcher could have hundreds, or even thousands, of sessions pointing to it.

An interesting attribute of shared server connections is that the shared server process we use can change from call to call. If I were the only one using this system (as I am for these tests), running that query over and over as EODA would tend to produce the same PADDR of 000000071C4BE68 over and over. However, if I were to open more shared server connections and start to use those shared server connections in other sessions, then I might notice that the shared server I use varies.

Consider this example. I'll query my current session information, showing the shared server I'm using. Then in another shared server session, I'll perform a long-running operation (i.e., I'll monopolize that shared server). When I ask the database what shared server I'm using again, I'll (in my current session) most likely see a different one (if the original one is off servicing the other session). In the following example, the code in bold represents a second SQL\*Plus session that was connected via a shared server:

```
EODA@ORA12CR1> select a.username, a.sid, a.serial#, a.server,
2      a.paddr, a.status, b.program
3      from v$session a left join v$process b
4      on (a.paddr = b.addr)
5      where a.username = 'EODA'
6      /
```

USERNAME	SID	SERIAL#	SERVER	PADDR	STATUS	PROGRAM
EODA	485	1105	SHARED	0000000071C4BE68	ACTIVE	oracle@cs-xvm2 (S004)

From another terminal session, connect to the database as the user SCOTT (the shared text in the following connection string maps to an entry in the `tnsnames.ora` file that instructs SQL\*Plus to connect via a shared server connection):

```
$ sqlplus scott/tiger@shared
```

```
SCOTT@ORA12CR1> exec dbms_lock.sleep(20);
PL/SQL procedure successfully completed.
```

From the original connection as EODA, run the query to show the PROGRAM information again:

```
EODA@ORA12CR1> select a.username, a.sid, a.serial#, a.server,
2      a.paddr, a.status, b.program
3      from v$session a left join v$process b
4      on (a.paddr = b.addr)
5      where a.username = 'EODA'
6      /
```

USERNAME	SID	SERIAL#	SERVER	PADDR	STATUS	PROGRAM
EODA	485	1105	SHARED	0000000071C478E8	ACTIVE	oracle@cs-xvm2 (S000)

---

■ **Note** You need to use an account that has execute privileges on the `DBMS_LOCK` package. I granted my demo account SCOTT execute privileges on the `DBMS_LOCK` package to accomplish this: `SYS@ORA12CR1> grant execute on dbms_lock to scott;`

---

Notice that the first time I queried, I was using S004 as the shared server. Then, in another session (as SCOTT), I executed a long-running statement that monopolized the shared server, which just happened to be S004 this time. The first nonbusy shared server is the one that gets assigned to do the work, and in this case no one else was asking to use the S004 shared server, so the `DBMS_LOCK` command took it. When I queried again in the first SQL\*Plus session, I got assigned to another shared server process, S000, since the S004 shared server was busy.

It is interesting to note that the parse of a query (returns no rows yet) could be processed by shared server S000, the fetch of the first row by S001, the fetch of the second row by S002, and the closing of the cursor by S003. That is, an individual statement might be processed bit by bit by many shared servers.

So, what we have seen in this section is that a connection—a physical pathway from a client to a database instance—may have zero, one, or more sessions established on it. We have seen one use case of that when using SQL\*Plus's `AUTOTRACE` facility. Many other tools employ this ability as well. For example, Oracle Forms uses multiple sessions on a single connection to implement its debugging facilities. The *n*-tier proxy authentication feature of Oracle, used to provide end-to-end identification of users from the browser to the database, makes heavy use of the concept of a single connection with multiple sessions, but each session would use a potentially different user account. We have seen that sessions can use many processes over time, especially in a shared server environment. Also, if we are using connection pooling with Oracle Net, then our session might not be associated with any process at all; the client would drop the connection after an idle time and reestablish it transparently upon detecting activity.

In short, there is a many-to-many relationship between connections and sessions. However, the most common case, the one most of us see day to day, is a one-to-one relationship between a dedicated server and a single session.

## Dedicated Server vs. Shared Server vs. DRCP

Before we examine the rest of the processes, let's discuss why there are three main connection modes and when one might be more appropriate than the other.

### When to Use a Dedicated Server

As noted previously, in dedicated server mode there is a one-to-one mapping between the client connection and server process. This is by far the most common method of connection to the Oracle database for all SQL-based applications. It is the simplest to set up and provides the easiest way to establish connections. It requires little to no configuration.

Since there is a one-to-one mapping, you do not have to be concerned that a long-running transaction will block other transactions. Those other transactions will simply proceed via their own dedicated processes. Therefore, it is the only mode you should consider using in a non-OLTP environment where you may have long-running transactions. A dedicated server is the recommended configuration for Oracle, and it scales rather nicely. As long as your server has sufficient hardware (CPU and RAM) to service the number of dedicated server processes your system needs, a dedicated server may be used for thousands of concurrent connections.

Certain operations must be done in a dedicated server mode, such as database startup and shutdown, so every database will have either both or just a dedicated server set up.

### When to Use a Shared Server

A shared server setup and configuration, while not difficult, involves an extra step beyond a dedicated server setup. The main difference between the two is not, however, in their setup; it is in their mode of operation. With a dedicated server, there is a one-to-one mapping between client connections and server processes. With a shared server, there is a *many-to-one* relationship: many clients to a shared server.

As its name implies, a shared server is a shared resource, whereas a dedicated server is not. When using a shared resource, you must be careful to not monopolize it for long periods of time. As you saw previously, use of a simple `DBMS_LOCK.SLEEP(20)` in one session would monopolize a shared server process for 20 seconds. Monopolization of these shared server resources can lead to a system that appears to hang.

Figure 5-2 depicts two shared servers. If I have three clients and all of them attempt to run a 45-second process more or less at the same time, two of them will get their response in 45 seconds and the third will get its response in 90 seconds. This is rule number one for shared server: make sure your transactions are short in duration. They can be frequent, but they should be short (as characterized by OLTP systems). If they are not short, you will get what appears to be a total system slowdown due to shared resources being monopolized by a few processes. In extreme cases, if all of the shared servers are busy, the system will appear to hang for all users except the lucky few who are monopolizing the shared servers.

Another interesting situation that you may observe when using a shared server is that of an *artificial deadlock*. With a shared server, a number of server processes are being shared by a potentially large community of users. Consider a situation where you have five shared servers and one hundred user sessions established. At most, five of those user sessions can be active at any point in time. Suppose one of these user sessions updates a row and does not commit. While that user sits there and ponders his or her modification, five other user sessions try to lock that same row. They will, of course, become blocked and will patiently wait for that row to become available. Now the user session that holds the lock on this row attempts to commit its transaction (hence releasing the lock on the row). That user session will find that all of the shared servers are being monopolized by the five waiting sessions. We have an artificial deadlock situation here: the holder of the lock will never get a shared server to permit the commit, unless one of the waiting sessions gives up its shared server. But, unless the waiting sessions are waiting for the lock with a timeout, they will never give up their shared server (you could, of course, have an administrator kill their session via a dedicated server to release this logjam).

For these reasons, a shared server is only appropriate for an OLTP system characterized by short, frequent transactions. In an OLTP system, transactions are executed in milliseconds; nothing ever takes more than a fraction of a second. A shared server is highly inappropriate for a data warehouse. Here, you might execute a query that takes one, two, five, or more minutes. Under a shared server, this would be deadly. If you have a system that is 90 percent OLTP and 10 percent “not quite OLTP,” then you can mix and match dedicated servers and a shared server on the same instance. In this fashion, you can reduce the number of server processes on the machine dramatically for the OLTP users, and make it so that the “not quite OLTP” users do not monopolize their shared servers. In addition, the DBA can use the built-in Resource Manager to further control resource utilization.

Of course, a big reason to use a shared server is when you have no choice. Many advanced connection features require the use of a shared server. If you want to use Oracle Net connection pooling, you must use a shared server. If you want to use database link concentration between databases, then you must use a shared server for those connections.

---

■ **Note** If you are already using a connection pooling feature in your application (e.g., you are using the J2EE connection pool), and you have sized your connection pool appropriately, using a shared server will only be a performance inhibitor. You already sized your connection pool to cater for the number of concurrent connections that you will get at any point in time; you want each of those connections to be a direct dedicated server connection. Otherwise, you just have a connection pooling feature connecting to yet another connection pooling feature.

---

## Potential Benefits of a Shared Server

What are the benefits of a shared server, bearing in mind that you have to be somewhat careful about the transaction types you let use it? A shared server does three things: it reduces the number of operating system processes/threads, it artificially limits the degree of concurrency, and it reduces the memory needed on the system. Let’s discuss these points in more detail.

### Reduces the Number of Operating System Processes/Threads

On a system with thousands of users, the operating system may quickly become overwhelmed in trying to manage thousands of processes. In a typical system, only a fraction of the thousands of users are concurrently active at any point in time. For example, I’ve worked on systems with 5,000 concurrent users. At any one point in time, at most 50 were active. This system would work effectively with 50 shared server processes, reducing the number of processes the operating system has to manage by two orders of magnitude (100 times). The operating system can now, to a large degree, avoid context switching.

### Artificially Limits the Degree of Concurrency

Speaking as a person who has been involved in many benchmarks, the benefits of this seem obvious. When running benchmarks, people frequently ask to run as many users as possible until the system breaks. One of the outputs of these benchmarks is always a chart that shows the number of concurrent users versus the number of transactions (see Figure 5-3).



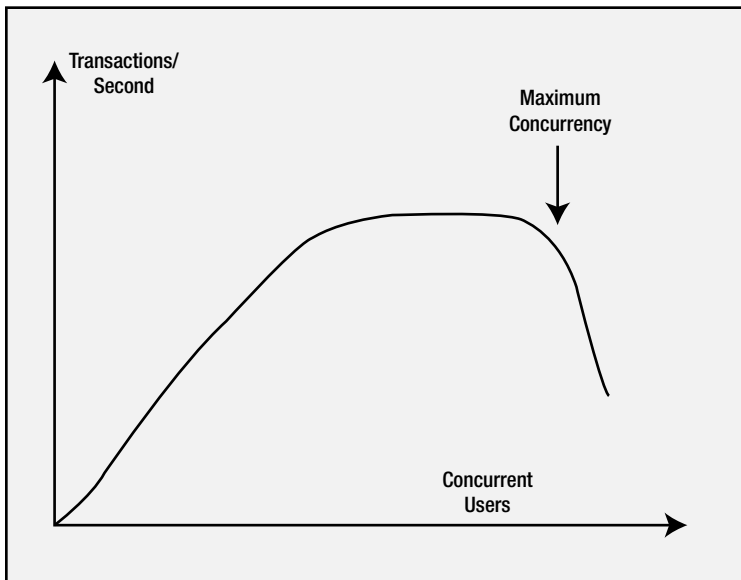

**Figure 5-3.** *Concurrent users vs. transactions per second*

Initially, as you add concurrent users, the number of transactions increases. At some point, however, adding additional users does not increase the number of transactions you can perform per second; the graph tends to flatten off. The throughput has peaked and now response time starts to increase. In other words, you are doing the same number of transactions per second, but the end users are observing slower response times. As you continue adding users, you will find that the throughput will actually start to decline. The concurrent user count before this drop-off is the maximum degree of concurrency you want to allow on the system. Beyond this point, the system becomes flooded and queues begin forming to perform work. Much like a backup at a tollbooth, the system can no longer keep up. Not only does response time rise dramatically at this point, but throughput from the system may fall, too, as the overhead of simply context switching and sharing resources between too many consumers takes additional resources itself. If we limit the maximum concurrency to the point right before this drop, we can sustain maximum throughput and minimize the increase in response time for most users. A shared server allows us to limit the maximum degree of concurrency on our system to this number.

An analogy for this process could be a simple door. The width of the door and the width of people limit the maximum people per minute throughput. At low load, there is no problem; however, as more people approach, some forced waiting occurs (CPU time slice). If a lot of people want to get through the door, we get the fallback effect—there are so many people saying “after you” and so many false starts that the throughput falls. Everybody gets delayed getting through. Using a queue means the throughput increases, some people get through the door almost as fast as if there was no queue, while others (the ones put at the end of the queue) experience the greatest delay and might fret that “this was a bad idea.” But when you measure how fast everybody (including the last person) gets through the door, the queued model (shared server) performs better than a free-for-all approach (even with polite people; but conjure up the image of the doors opening when a store has a large sale, with everybody pushing very hard to get through).

## Reduces the Memory Needed on the System

This is one of the most highly touted reasons for using a shared server: it reduces the amount of required memory. It does, but not as significantly as you might think, especially given the automatic PGA memory management discussed in Chapter 4, where work areas are allocated to a process, used, and released—and their size varies based on the concurrent workload. So, this was a fact that was *true* in older releases of Oracle but is not as meaningful today.

Also, remember that when you use a shared server, the UGA is located in the SGA. This means that when switching over to a shared server, you must be able to accurately determine your expected UGA memory needs and allocate appropriately in the SGA via the `LARGE_POOL_SIZE` parameter. The SGA requirements for the shared server configuration are typically very large. This memory must typically be preallocated and thus can only be used by the database instance.

---

■ **Note** It is true that with a resizable SGA, you may grow and shrink this memory over time, but for the most part, it will be owned by the database instance and will not be usable by other processes.

---

Contrast this with a dedicated server, where anyone can use any memory not allocated to the SGA. If the SGA is much larger due to the UGA being located in it, where does the memory savings come from? It comes from having that many fewer PGAs allocated. Each dedicated/shared server has a PGA. This is process information. It is sort areas, hash areas, and other process-related structures. It is this memory need that you are removing from the system by using a shared server. If you go from using 5,000 dedicated servers to 100 shared servers, it is the cumulative sizes of the 4,900 PGAs (excluding their UGAs) you no longer need that you are saving with a shared server.

## DRCP

So, what about DRCP, the feature (available with Oracle 11g and above)? It has many of the benefits of a shared server such as reduced processes (we are pooling), possible memory savings without the drawbacks. There is no chance of artificial deadlock; for example, the session that holds the lock on the resource in the earlier example would have its own dedicated server *dedicated* to it from the pool, and that session would be able to release the lock eventually. It doesn't have the multithreading capability of a shared server; when a client process gets a dedicated server from the pool, it *owns* that process until that client process releases it. Therefore, it is best suited for client applications that frequently connect, do some relatively short process, and disconnect—over and over and over again; in short, for client processes that have an API that do not have an efficient connection pool of their own.

## Dedicated/Shared Server Wrap-up

Unless your system is overloaded, or you need to use a shared server for a specific feature, a dedicated server will probably serve you best. A dedicated server is simple to set up (in fact, there is no setup) and makes tuning easier.

---

■ **Note** With shared server connections, a session's trace information (`SQL_TRACE=TRUE` output) may be spread across many individual trace files; thus, reconstructing what that session has done is more difficult. With the advent of the `DBMS_MONITOR` package in Oracle 10g and above, much of the difficulty has been removed, but it still complicates matters. Also, if you have multiple related trace files generated by a session, you can use the `TRCSESS` utility to combine the trace files.

---

If you have a very large user community and *know* that you will be deploying with a shared server, I would urge you to *develop and test* with a shared server. It will increase your likelihood of failure if you develop under just a dedicated server and never test on a shared server. Stress the system, benchmark it, and make sure that your application is well behaved under a shared server. That is, make sure it does not monopolize shared servers for too long. If you find that it does so during development, it is much easier to fix at that stage than during deployment.

You can use features such as the Advanced Queuing (AQ) to turn a long-running process into an apparently short one, but you have to *design* that into your application. These sorts of things are best done when you are developing. Also, historically, there have been differences between the feature set available to shared server connections versus dedicated server connections. We already discussed the lack of automatic PGA memory management in Oracle9i, for example, but also in the past, things as basic as a hash join between two tables were not available in shared server connections. (Hash joins are available in the current 9i and above releases with shared server!)

## Background Processes

The Oracle instance is made up of two things: the SGA and a set of background processes. The background processes perform the mundane maintenance tasks needed to keep the database running. For example, there is a process that maintains the block buffer cache for us, writing blocks out to the data files as needed. Another process is responsible for copying an online redo log file to an archive destination as it fills up. Yet another process is responsible for cleaning up after aborted processes, and so on. Each of these processes is pretty focused on its job, but works in concert with all of the others. For example, when the process responsible for writing to the log files fills one log and goes to the next, it will notify the process responsible for archiving that full log file that there is work to be done.

There is a V\$ view you can use to see all of the *possible* Oracle background processes and determine which ones are in use in your system currently:

```

EODA@ORA12CR1> select paddr, name, description
  2   from v$bgprocess
  3   order by paddr desc
  4   /

```

PADDR	NAME	DESCRIPTION
0000000072FD44C8	MMON	Manageability Monitor Process
00000000727FD850	MMNL	Manageability Monitor Process 2
00000000723FE138	LREG	Listener Registration
00000000723FCFD8	SMON	System Monitor Process
00000000723F9BB8	CKPT	checkpoint
00000000723F8A58	LGWR	Redo etc.
00000000723F78F8	DBW0	db writer process 0
...		
00	VMBO	Volume Membership 0
00	ACFS	ACFS CSS
00	SCRB	ASM Scrubbing Master
00	XDMG	cell automation manager
00	XDWK	cell automation worker actions

401 rows selected.

Rows in this view with a PADDR other than 00 are processes (threads) configured and running on your system.

---

■ **Tip** Another way to view currently running background processes is to query V\$PROCESS where PNAME is not null.

---

There are two classes of background processes: those that have a focused job to do (as just described) and those that do a variety of other jobs (i.e., utility processes). For example, there is a utility background process for the internal job queues accessible via the DBMS\_JOB/DBMS\_SCHEDULER packages. This process monitors the job queues and runs whatever is inside them. In many respects, it resembles a dedicated server process, but without a client connection. Let's examine each of these background processes, starting with the ones that have a focused job, and then look into the utility processes.

## Focused Background Processes

The number, names, and types of focused background processes varies by release. Figure 5-4 depicts a *typical set* of Oracle background processes that have a focused purpose:

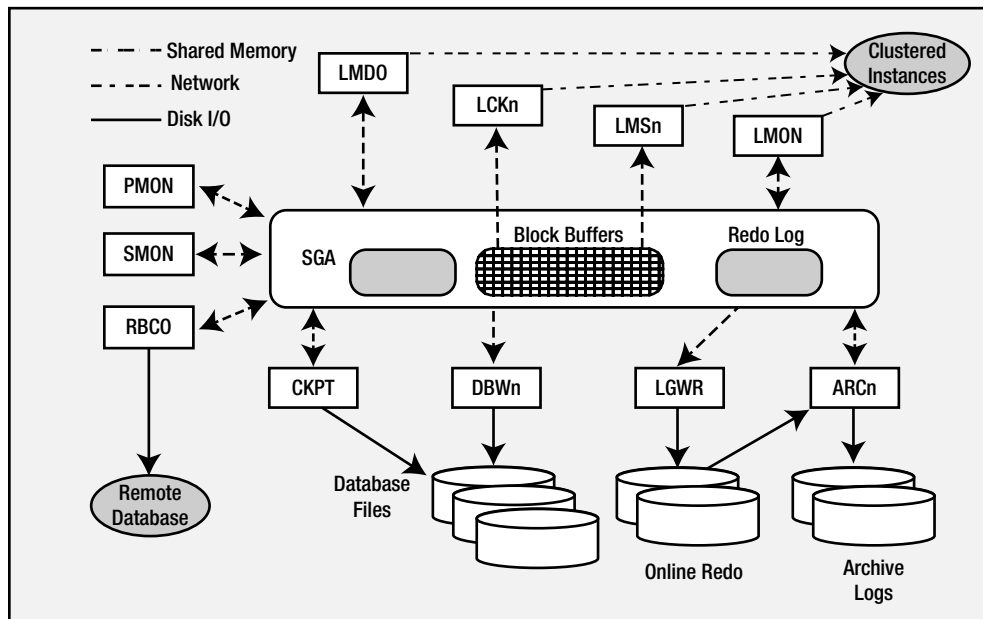

**Figure 5-4.** Focused background processes

■ **Tip** For a complete diagram showing all Oracle 12c background processes and memory structures, see the file at [www.oracle.com/technetwork/tutorials/posterfiles-1974103.pdf](http://www.oracle.com/technetwork/tutorials/posterfiles-1974103.pdf).

For example, in Oracle 12c Release 1, here's a database started using a minimum number of `init.ora` parameters.

```
SYS@ORA12CR1> create pfile='/tmp/pfile' from spfile;
File created.
```

```

SYS@ORA12CR1> !cat /tmp/pfile
...
*.compatible='12.1.0.1'
*.control_files='/u01/dbfile/ORA12CR1/control01.ctl','/u02/dbfile/ORA12CR1/control02.ctl'
*.db_block_size=8192
*.db_name='ORA12CR1'
*.memory_target=500M
*.undo_tablespace='UNDOTBS1'

```

In Oracle 12c Release 1, you would have about 22 background processes started up:

```

EODA@ORA12CR1> select paddr, name, description
 2   from v$bgprocess
 3  where paddr <> '00'
 4  order by paddr desc
 5  /

```

PADDR	NAME	DESCRIPTION
000000007F188558	VKRM	Virtual sKeduler for Resource Manager
000000007F17FA58	CJQO	Job Queue Coordinator
000000007F17E8F8	AQPC	AQ Process Coord
000000007F17D798	FBDA	Flashback Data Archiver Process
000000007F17C638	SMCO	Space Manager Process
000000007F17A378	TMON	Transport Monitor
000000007F175DF8	MMNL	Manageability Monitor Process 2
000000007F174C98	LREG	Listener Registration
000000007F173B38	RECO	distributed recovery
000000007F1729D8	SMON	System Monitor Process
000000007F16F5B8	CKPT	checkpoint
000000007F16E458	LGWR	Redo etc.
000000007F16D2F8	DBWO	db writer process 0
000000007F16C198	DIAO	diagnosibility process 0
000000007F16B038	DBRM	DataBase Resource Manager
000000007F169ED8	DIAG	diagnosibility process
000000007F168D78	MMON	Manageability Monitor Process
000000007F167C18	MMAN	Memory Manager
000000007F166AB8	GENO	generic0
000000007F165958	VKTM	Virtual Keeper of TiMe process
000000007F1647F8	PSPO	process spawner 0
000000007F163698	PMON	process cleanup

22 rows selected.

In Oracle 11g Release 2, with that same init.ora file, you would have about 17 background processes started up:

```

ops$tkyte@ORA11GR2> select paddr, name, description
 2   from v$bgprocess
 3  where paddr <> '00'
 4  order by paddr desc
 5  /

```

PADDR	NAME	DESCRIPTION
32AF0E64	CJQO	Job Queue Coordinator
32AEF8B4	QMNC	AQ Coordinator
32AEE304	MMNL	Manageability Monitor Process 2
32AED82C	MMON	Manageability Monitor Process
32AECD54	RECO	distributed recovery
32AEC27C	SMON	System Monitor Process
32AEB7A4	CKPT	checkpoint
32AEACCC	LGWR	Redo etc.
32AEA1F4	DBWO	db writer process 0
32AE971C	MMAN	Memory Manager
32AE8C44	DIAO	diagnosibility process 0
32AE816C	PSPO	process spawner 0
32AE7694	DBRM	DataBase Resource Manager
32AE6BBC	DIAG	diagnosibility process
32AE60E4	GENO	generic0
32AE560C	VKTM	Virtual Keeper of TiMe process
32AE4B34	PMON	process cleanup

17 rows selected.

Using the same `init.ora`, only replacing `MEMORY_TARGET` with `SGA_TARGET` and `PGA_AGGREGATE_TARGET`, in Oracle 10g Release 2, you might only see 12:

```
ops$tkyte@ORA10GR2> select paddr, name, description
 2   from v$bgsprocess
 3  where paddr <> '00'
 4  order by paddr desc
 5  /
```

PADDR	NAME	DESCRIPTION
23D27AC4	CJQO	Job Queue Coordinator
23D27508	QMNC	AQ Coordinator
23D26990	MMNL	Manageability Monitor Process 2
23D263D4	MMON	Manageability Monitor Process
23D25E18	RECO	distributed recovery
23D2585C	SMON	System Monitor Process
23D252A0	CKPT	checkpoint
23D24CE4	LGWR	Redo etc.
23D24728	DBWO	db writer process 0
23D2416C	MMAN	Memory Manager
23D23BB0	PSPO	process spawner 0
23D235F4	PMON	process cleanup

12 rows selected.

Note that you may not see all of these processes when you start your instance, but the majority of them will be present. You will only see `ARCn` (the archiver) if you are in `ARCHIVELOG` mode and have enabled automatic archiving. You will only see the `LMDO`, `LCKn`, `LMON`, and `LMSn` (more details on those processes shortly) processes if you are running Oracle RAC, a configuration of Oracle that allows many instances on different machines in a cluster to mount and open the same physical database.

■ **Note** Starting with Oracle 12c, on some UNIX/Linux platforms, you can use a mixture of processes and threads. This feature is enabled by setting the initialization `THREADED_EXECUTION` parameter to `TRUE` (the default is `FALSE`). Nothing has fundamentally changed—all of the “processes” are still there, you just might not see them via the operating system `ps` command because they are now running as a thread in a larger process.

So, Figure 5-4 depicts roughly what you might see if you started an Oracle instance, and mounted and opened a database. On an operating system where Oracle implements a multiprocess architecture, such as on a UNIX/Linux system, you can physically see these processes. After starting the instance, I observed the following:

```
$ ps -aef | grep ora_...._${ORACLE_SID} | grep -v grep
oracle  2276    1  0 10:33 ?        00:00:00 ora_pmon_ORA12CR1
oracle  2278    1  0 10:33 ?        00:00:00 ora_psp0_ORA12CR1
oracle  2280    1  0 10:33 ?        00:00:04 ora_vktn_ORA12CR1
oracle  2284    1  0 10:33 ?        00:00:00 ora_gen0_ORA12CR1
oracle  2286    1  0 10:33 ?        00:00:00 ora_mman_ORA12CR1
oracle  2290    1  0 10:33 ?        00:00:00 ora_diag_ORA12CR1
oracle  2292    1  0 10:33 ?        00:00:00 ora_dbrm_ORA12CR1
oracle  2294    1  0 10:33 ?        00:00:00 ora_dia0_ORA12CR1
oracle  2297    1  0 10:33 ?        00:00:00 ora_dbw0_ORA12CR1
oracle  2299    1  0 10:33 ?        00:00:00 ora_lgwr_ORA12CR1
oracle  2301    1  0 10:33 ?        00:00:00 ora_ckpt_ORA12CR1
oracle  2303    1  0 10:33 ?        00:00:00 ora_lg00_ORA12CR1
oracle  2305    1  0 10:33 ?        00:00:00 ora_lg01_ORA12CR1
oracle  2307    1  0 10:33 ?        00:00:00 ora_smon_ORA12CR1
oracle  2309    1  0 10:33 ?        00:00:00 ora_reco_ORA12CR1
oracle  2311    1  0 10:33 ?        00:00:00 ora_lreg_ORA12CR1
oracle  2313    1  0 10:33 ?        00:00:01 ora_mmon_ORA12CR1
oracle  2315    1  0 10:33 ?        00:00:00 ora_mmln_ORA12CR1
oracle  2327    1  0 10:33 ?        00:00:00 ora_p000_ORA12CR1
oracle  2329    1  0 10:33 ?        00:00:00 ora_p001_ORA12CR1
oracle  2331    1  0 10:33 ?        00:00:00 ora_tmon_ORA12CR1
oracle  2333    1  0 10:33 ?        00:00:00 ora_tt00_ORA12CR1
oracle  2335    1  0 10:33 ?        00:00:00 ora_smco_ORA12CR1
oracle  2337    1  0 10:33 ?        00:00:00 ora_fbda_ORA12CR1
oracle  2339    1  0 10:33 ?        00:00:00 ora_aqpc_ORA12CR1
oracle  2343    1  0 10:33 ?        00:00:00 ora_cjq0_ORA12CR1
oracle  2345    1  0 10:33 ?        00:00:00 ora_p002_ORA12CR1
oracle  2347    1  0 10:33 ?        00:00:00 ora_p003_ORA12CR1
oracle  2349    1  0 10:33 ?        00:00:00 ora_p004_ORA12CR1
oracle  2351    1  0 10:33 ?        00:00:00 ora_p005_ORA12CR1
oracle  2353    1  0 10:33 ?        00:00:00 ora_p006_ORA12CR1
oracle  2355    1  0 10:33 ?        00:00:00 ora_p007_ORA12CR1
oracle  2383    1  0 10:33 ?        00:00:00 ora_w000_ORA12CR1
oracle  2385    1  0 10:33 ?        00:00:00 ora_qm02_ORA12CR1
oracle  2389    1  0 10:33 ?        00:00:00 ora_q002_ORA12CR1
oracle  2391    1  0 10:33 ?        00:00:00 ora_q003_ORA12CR1
oracle  2465    1  0 10:38 ?        00:00:00 ora_w001_ORA12CR1
```

It is interesting to note the naming convention used by these processes. The process name starts with `ora_`. It is followed by four characters representing the actual name of the process, which are followed by `_ORA12CR1`. As it happens, my `ORACLE_SID` (site identifier) is `ORA12CR1`. On UNIX/Linux, this makes it very easy to identify the Oracle background processes and associate them with a particular instance (on Windows, there is no easy way to do this, as the backgrounds are threads in a larger, single process). What is perhaps most interesting, but not readily apparent from the preceding code, is that *they are all really the same exact binary executable program—there is not a separate executable for each “program.”* Search as hard as you like, but you will not find the `ora_pmon_ORA12CR1` binary executable on disk anywhere. You will not find `ora_lgwr_ORA12CR1` or `ora_reco_ORA12CR1`. These processes are all really `oracle` (that’s the name of the binary executable that is run). They just alias themselves upon startup to make it easier to identify which process is which. This enables a great deal of object code to be efficiently shared on the UNIX/Linux platform. On Windows, this is not nearly as interesting, as they are just threads within the process, so of course they are one big binary.

Let’s now take a look at the function performed by each *major* process of interest, starting with the primary Oracle background processes. For a complete listing of the possible background processes and a short synopsis of the function they perform, I will direct you to the appendix of the *Oracle Database Reference* manual available freely on <http://otn.oracle.com/>.

## PMON: The Process Monitor

This process is responsible for cleaning up after abnormally terminated connections. For example, if your dedicated server “fails” or is killed for some reason, PMON is the process responsible for fixing (recovering or undoing work) and releasing your resources. PMON will initiate the rollback of uncommitted work, release locks, and free SGA resources allocated to the failed process.

In addition to cleaning up after aborted connections, PMON is responsible for monitoring the other Oracle background processes and restarting them if necessary (and if possible). If a shared server or a dispatcher fails (crashes), PMON will step in and restart another one (after cleaning up for the failed process). PMON will watch all of the Oracle processes and either restart them or terminate the instance as appropriate. For example, it is appropriate to fail the instance in the event the database log writer process, LGWR, fails. This is a serious error, and the safest path of action is to terminate the instance immediately and let normal recovery fix the data. (Note that this is a rare occurrence and should be reported to Oracle Support immediately.)

---

■ **Note** Prior to Oracle 12c, PMON handled the listener registration tasks. Starting with Oracle 12c, the listener registration (LREG) background process registers instances and services with a listener.

---

## LREG: Listener Registration Process

The LREG process (available starting with Oracle 12c) is responsible for registering instances and services with the Oracle TNS listener. When an instance starts up, the LREG process polls the well-known port address, unless directed otherwise, to see whether or not a listener is up and running. The well-known/default port used by Oracle is 1521. Now, what happens if the listener is started on some different port? In this case, the mechanism is the same, except that the listener address needs to be explicitly specified by the `LOCAL_LISTENER` parameter setting. You can also use the `REMOTE_LISTENER` parameter to instruct LREG to register a service with a remote listener (which is common in Oracle RAC environments).

If the listener is running when the database instance is started, LREG communicates with the listener and passes to it relevant parameters, such as the service name and load metrics of the instance. If the listener was not started, LREG will periodically attempt (typically every 60 seconds) to contact it to register itself. You can also instruct LREG to immediately attempt to register a service with the listener via the `ALTER SYSTEM REGISTER` command (which is useful in high availability environments).



## SMON: The System Monitor

SMON is the process that gets to do all of the system-level jobs. Whereas PMON was interested in individual processes, SMON takes a system-level perspective of things and is a sort of garbage collector for the database. Some of the jobs it does include the following:

- *Cleans up temporary space:* With the advent of true temporary tablespaces, the chore of cleaning up temporary space has lessened, but it has not gone away. For example, when building an index, the extents allocated for the index during the creation are marked as TEMPORARY. If the CREATE INDEX session is aborted for some reason, SMON is responsible for cleaning them up. Other operations create temporary extents that SMON would be responsible for as well.
- *Coalesces free space:* If you are using dictionary-managed tablespaces, SMON is responsible for taking extents that are free in a tablespace and contiguous with respect to each other and coalescing them into one larger free extent. This occurs only on dictionary-managed tablespaces with a default storage clause that has PCTINCREASE set to a nonzero value.
- *Recovers transactions active against unavailable files:* This is similar to its role during database startup. Here, SMON recovers failed transactions that were skipped during instance/crash recovery due to a file(s) not being available to recover. For example, the file may have been on a disk that was unavailable or not mounted. When the file does become available, SMON will recover it.
- *Performs instance recovery of a failed node in RAC:* In an Oracle RAC configuration, when a database instance in the cluster fails (e.g., the machine the instance was executing on fails), some other node in the cluster will open that failed instance's redo log files and perform a recovery of all data for that failed instance.
- *Cleans up OBJ\$:OBJ\$:* OBJ\$ is a low-level data dictionary table that contains an entry for almost every object (table, index, trigger, view, and so on) in the database. Many times, there are entries in here that represent deleted objects, or objects that represent “not there” objects, used in Oracle's dependency mechanism. SMON is the process that removes these rows that are no longer needed.
- *Manage undo segments:* SMON will perform the automatic onlining, offlining, and shrinking of undo segments.
- *Offlines rollback segments:* When using manual rollback segment management (not recommended, you should be using automatic undo management), it is possible for the DBA to *offline*, or make unavailable, a rollback segment that has active transactions. It may be possible that active transactions are using this offlined rollback segment. In this case, the rollback is not really offlined; it is marked as “pending offline.” In the background, SMON will periodically try to truly take it offline, until it succeeds.

That should give you a flavor of what SMON does. It does many other things, such as flush the monitoring statistics that show up in the DBA\_TAB\_MODIFICATIONS view, flush the SCN to timestamp mapping information found in the SMON\_SCN\_TIME table, and so on. The SMON process can accumulate quite a lot of CPU over time, and this should be considered normal. SMON periodically wakes up (or is woken up by the other background processes) to perform these housekeeping chores.

## RECO: Distributed Database Recovery

RECO has a very focused job: it recovers transactions that are left in a prepared state because of a crash or loss of connection during a *two-phase commit* (2PC). A 2PC is a distributed protocol that allows for a modification that affects many disparate databases to be committed atomically. It attempts to close the window for distributed failure as much as possible before committing. In a 2PC between N databases, one of the databases—typically (but not always) the one the client logged into initially—will be the coordinator. This one site will ask the other N-1 sites if they are ready to commit. In effect, this one site will go to the N-1 sites and ask them to be prepared to commit. Each of the N-1 sites reports back its prepared state as YES or NO. If any one of the sites votes NO, the entire transaction is rolled back. If all sites vote YES, then the site coordinator broadcasts a message to make the commit permanent on each of the N-1 sites.

Say a site votes YES and is prepared to commit, but before it gets the directive from the coordinator to actually commit, the network fails or some other error occurs, then the transaction becomes an *in-doubt distributed transaction*. The 2PC tries to limit the window of time in which this can occur, but cannot remove it. If there is a failure right then and there, the transaction will become the responsibility of RECO. RECO will try to contact the coordinator of the transaction to discover its outcome. Until it does that, the transaction will remain in its uncommitted state. When the transaction coordinator can be reached again, RECO will either commit the transaction or roll it back.

It should be noted that if the outage is to persist for an extended period of time, and you have some outstanding transactions, you can commit/roll them back manually. You might want to do this since an in-doubt distributed transaction can cause *writers to block readers*—this is the one time this can happen in Oracle. Your DBA could call the DBA of the other database and ask her to query the status of those in-doubt transactions. Your DBA can then commit or roll them back, relieving RECO of this task.

## CKPT: Checkpoint Process

The checkpoint process doesn't, as its name implies, do a checkpoint (checkpoints were discussed in Chapter 3 in the section on redo logs)—that's mostly the job of DBWn. It simply assists with the checkpointing process by updating the file headers of the data files. It used to be that CKPT was an optional process, but starting with version 8.0 of the database, it is always started, so if you do a `ps` on UNIX/Linux, you'll normally see it there (I say "normally" because as of Oracle 12c, it's possible for the checkpoint process to run within an operating system thread, and therefore won't be displayed as a process).

The job of updating data files' headers with checkpoint information used to belong to the LGWR; however, as the number of files increased along with the size of a database over time, this additional task for LGWR became too much of a burden. If LGWR had to update dozens, or hundreds, or even thousands, of files, there would be a good chance sessions waiting to commit these transactions would have to wait far too long. CKPT removes this responsibility from LGWR.

## DBWn: Database Block Writer

The database block writer (DBWn) is the background process responsible for writing dirty blocks to disk. DBWn will write dirty blocks from the buffer cache, usually to make more room in the cache (to free buffers for reads of other data) or to advance a checkpoint (to move forward the position in an online redo log file from which Oracle would have to start reading, to recover the instance in the event of failure). As we discussed in Chapter 3 when Oracle switches log files, a checkpoint is signaled. Oracle needs to advance the checkpoint so that it no longer needs the online redo log file it just filled up. If it hasn't been able to do that by the time we need to reuse that redo log file, we get the "checkpoint not complete" message and we must wait.

---

■ **Note** Advancing log files is only one of many ways for checkpoint activity to occur. There are incremental checkpoints controlled by parameters such as `FAST_START_MTTR_TARGET` and other triggers that cause dirty blocks to be flushed to disk.

---

As you can see, the performance of DBWn can be crucial. If it does not write out blocks fast enough to free buffers (buffers that can be reused to cache some other blocks) for us, we will see both the number and duration of waits on Free Buffer Waits and Write Complete Waits start to grow.

We can configure more than one DBWn; in fact, in Oracle 11g, we can configure up to 36, and in Oracle 12c, up to 100, as evidenced by the following query:

```
EODA@ORA12CR1> select name, description from v$bgprocess
  2  where description like 'db writer process%';
```

```
NAME  DESCRIPTION
-----
```

```
DBW0  db writer process 0
DBW1  db writer process 1
DBW2  db writer process 2
...
BW97  db writer process 97
BW98  db writer process 98
BW99  db writer process 99
```

100 rows selected.

Most systems run with one database block writer, but larger, multi-CPU systems can make use of more than one. This is generally done to distribute the workload of keeping a large block buffer cache in the SGA clean, flushing the dirtied (modified) blocks to disk.

Optimally, the DBWn uses asynchronous I/O to write blocks to disk. With asynchronous I/O, DBWn gathers up a batch of blocks to be written and gives them to the operating system. DBWn does not wait for the operating system to actually write the blocks out; rather, it goes back and collects the next batch to be written. As the operating system completes the writes, it asynchronously notifies DBWn that it completed the writes. This allows DBWn to work much faster than if it had to do everything serially. We'll see later in the "Slave Processes" section how we can use I/O slaves to simulate asynchronous I/O on platforms or configurations that do not support it.

I would like to make one final point about DBWn. It will, almost by definition, write out blocks scattered all over disk—DBWn does lots of scattered writes. When you do an update, you'll be modifying index blocks that are stored here and there, and data blocks that are also randomly distributed on disk. LGWR, on the other hand, does lots of sequential writes to the redo log. This is an important distinction and one of the reasons that Oracle has a redo log and the LGWR process as well as the DBWn process. Scattered writes are significantly slower than sequential writes. By having the SGA buffer dirty blocks and the LGWR process do large sequential writes that can re-create these dirty buffers, we achieve an increase in performance. The fact that DBWn does its slow job in the background while LGWR does its faster job while the user waits gives us better overall performance. This is true even though Oracle may technically be doing more I/O than it needs to (writes to the log and to the data file); the writes to the online redo log could *in theory* be skipped if, during a commit, Oracle physically wrote the modified blocks out to disk instead. In practice, it does not happen this way. LGWR writes the redo information to the online redo logs for every transaction, and DBWn flushes the database blocks to disk in the background.

## LGWR: Log Writer

The LGWR process is responsible for flushing to disk the contents of the redo log buffer located in the SGA. It does this when one of the following is true:

- Every three seconds
- Whenever a COMMIT or ROLLBACK is issued
- When LGWR is asked to switch log files
- When the redo buffer gets one-third full or contains 1MB of cached redo log data

For these reasons, having an enormous (hundreds/thousands of megabytes) redo log buffer is not practical; Oracle will never be able to use it all since it pretty much continuously flushes it. The logs are written to with sequential writes as compared to the scattered I/O DBWn must perform. Doing large batch writes like this is much more efficient than doing many scattered writes to various parts of a file. This is one of the main reasons for having a LGWR and redo logs in the first place. The efficiency in just writing out the changed bytes using sequential I/O outweighs the additional I/O incurred. Oracle could just write database blocks directly to disk when you commit, but that would entail a lot of scattered I/O of full blocks, and this would be significantly slower than letting LGWR write the changes out sequentially.

---

■ **Note** Starting with Oracle 12c, Oracle will start additional Log Writer Worker (LGO) processes on multiprocessor machines to increase the performance of writing to the online redo log files.

---

## ARCn: Archive Process

The job of the ARCn process is to copy an online redo log file to another location when LGWR fills it up. These archived redo log files can then be used to perform media recovery. Whereas online redo log is used to fix the data files in the event of a power failure (when the instance is terminated), archived redo logs are used to fix data files in the event of a hard disk failure. If we lose the disk drive containing the data file, `/u01/dbfile/ORA12CR1/system01.dbf`, we can go to our backups from last week, restore that old copy of the file, and ask the database to apply all of the archived and online redo logs generated since that backup took place. This will catch up that file with the rest of the data files in our database, and we can continue processing with no loss of data.

ARCn typically copies online redo log files to at least two other locations (redundancy being a key to not losing data). These other locations may be disks on the local machine or, more appropriately, at least one will be located on another machine altogether, in the event of a catastrophic failure. In many cases, these archived redo log files are copied by some other process to some tertiary storage device, such as tape. They may also be sent to another machine to be applied to a standby database, a failover option offered by Oracle. We'll discuss the processes involved in that shortly.

## DIAG: Diagnosability Process

In past releases, the DIAG process was used exclusively in a RAC environment. As of Oracle 11g, with the ADR (Advanced Diagnostic Repository), it is responsible for monitoring the overall health of the instance, and it captures information needed in the processing of instance failures. This applies to both single instance configurations as well as multi-instance RAC configurations.

## FBDA: Flashback Data Archiver Process

This process available with Oracle 11g Release 1 and above. It is the key component of the flashback data archive capability—the ability to query data “as of” long periods of time ago (for example, to query data in a table as it appeared one year ago, five years ago, and so on). This long term historical query capability is achieved by maintaining a history of the row changes made to every row in a table over time. This history, in turn, is maintained by the FBDA process in the background. This process functions by working soon after a transaction commits. The FBDA process will read the UNDO generated by that transaction and roll back the changes made by the transaction. It will then record these rolled back (the original values) rows in the flashback data archive for us.

## DBRM: Database Resource Manager Process

This process implements the resource plans that may be configured for a database instance. It sets the resource plans in place and performs various operations related to enforcing/implementing those resource plans. The resource manager allows the administrators of a database to have fine grained control over the resources used by the database instance, by applications accessing the database, or by individual users accessing the database.

## GEN0: General Task Execution Process

This process provides, as expected by its name, a general task execution thread for the database. The main goal of this process is to offload potentially blocking processing (processing that would cause a process to stop while it occurs) from some other process and perform it in the background. For example, if the main ASM process needs to perform some blocking file operation, but that operation could safely be done in the background (ASM can safely continue processing before the operation completes), then the ASM process may request the GEN0 process to perform this operation and let GEN0 notify it upon completion. It is similar in nature to the slave processes described further later in this chapter.

## Remaining Common Focused Processes

Depending on the features of Oracle you are using, other focused processes may be visible. Some are listed here with a brief description of their function.

---

■ **Note** Appendix F (Background Processes) of the Oracle Database Reference manual, available on <http://otn.oracle.com/>, has a complete listing of the background processes and their functions.

---

Most of the processes described previously are nonnegotiable—you will have them if you have an Oracle instance running. (ARCn is technically optional but is, in my opinion, mandatory for all production databases!) The following processes are optional and will appear only if you make use of the specific feature. The following processes are unique to a database instance using ASM, as discussed in Chapter 3:

- *Automatic Storage Management Background (ASMB) process*: The ASMB process runs in a database instance that is making use of ASM. It is responsible for communicating to the ASM instance that is managing the storage, providing updated statistics to the ASM instance, and providing a heartbeat to the ASM instance, letting it know that it is still alive and functioning.
- *ReBALance (RBAL) process*: The RBAL process also runs in a database instance that is making use of ASM. It is responsible for processing a rebalance request (a redistribution request) as disks are added/removed to and from an ASM disk group.

The following processes are found in an Oracle RAC instance. RAC is a configuration of Oracle whereby multiple instances, each running on a separate node (typically a separate physical computer) in a cluster, may mount and open a single database. It gives you the ability to have more than one instance accessing, in a full read-write fashion, a single set of database files. The primary goals of RAC are twofold:

- *High availability*: With Oracle RAC, if one node/computer in the cluster fails due to a software, hardware, or human error, the other nodes may continue to function. The database will be accessible via the other nodes. You might lose some computing power, but you won't lose access to the database.

- *Scalability*: Instead of buying larger and larger machines to handle an increasing workload (known as *vertical scaling*), RAC allows you to add resources in the form of more machines in the cluster (known as *horizontal scaling*). Instead of trading your 4 CPU machine in for one that can grow to 8 or 16 CPUs, RAC gives you the option of adding another relatively inexpensive 4 CPU machine (or more than one).

The following processes are unique to a RAC environment. You will not see them otherwise.

- *Lock monitor (LMON) process*: The LMON process monitors all instances in a cluster to detect the failure of an instance. It then facilitates the recovery of the global locks held by the failed instance. It is also responsible for reconfiguring locks and other resources when instances leave or are added to the cluster (as they fail and come back online, or as new instances are added to the cluster in real time).
- *Lock manager daemon (LMD0) process*: The LMD process handles lock manager service requests for the global cache service (keeping the block buffers consistent between instances). It works primarily as a broker sending requests for resources to a queue that is handled by the LMSn processes. The LMD handles global deadlock detection/resolution and monitors for lock timeouts in the global environment. Also, starting with Oracle 12c, there may be LDDn slave processes spawned by the LMD0 process to assist with the workload.
- *Lock manager server (LMSn) process*: As noted earlier, in a RAC environment, each instance of Oracle is running on a different machine in a cluster, and they all access, in a read-write fashion, the same exact set of database files. To achieve this, the SGA block buffer caches must be kept consistent with respect to each other. This is one of the main goals of the LMSn process. In earlier releases of Oracle Parallel Server (OPS) this was accomplished via a *ping*. That is, if a node in the cluster needed a read-consistent view of a block that was locked in exclusive mode by another node, the exchange of data was done via a disk flush (the block was pinged). This was a very expensive operation just to read data. Now, with the LMSn, this exchange is done via very fast cache-to-cache exchange over the clusters' high-speed connection. You may have up to ten LMSn processes per instance.
- *Lock (LCK0) process*: This process is very similar in functionality to the LMD process described earlier, but it handles requests for all global resources other than database block buffers.

The following are common background processes seen with most single instance or RAC instances:

- *Process Spawner (PSP0) Process*: This process is responsible for spawning (starting/creating) the various background processes. It is the process that creates new processes/threads for the Oracle Instance. It does most of its work during instance startup.
- *Virtual Keeper of Time (VKTM) Process*: Implements a consistent, fine-grained clock for the Oracle instance. It is responsible for providing both wall clock time (human readable) as well as an extremely high resolution timer (not necessarily built using wall clock time, more of a ticker that increments for very small units of time) used to measure durations and intervals.
- *Virtual Sch(K)eduler for Resource Manager (VKRM) Process*: Scheduler for the resource manager. Manages CPU scheduling and managed processes with active resource plans.
- *Space Management Coordinator (SMCO) Process*: This process is part of the manageability infrastructure. It coordinates the proactive space management features of the database such as the processes that discover space that could be reclaimed and the processes that perform the reclamation.

## Utility Background Processes

These background processes are totally optional, based on your need for them. They provide facilities not necessary to run the database day to day, unless you are using them yourself, such as the job queues, or are making use of a feature that uses them, such as the diagnostic capabilities (starting with Oracle 10g and above).

These processes will be visible in UNIX/Linux as any other background process would be. If you do a `ps`, you will see them. In my `ps` listing from the beginning of the focused background processes section (reproduced in part here), you can see that I have

- Job queues configured. The `CJQ0` process is the job queue coordinator.
- Oracle AQ configured, as evidenced by the `Qnnn` (AQ queue process) and `QMNC` (AQ monitor process).
- Automatic memory management enabled, as evidenced by the Memory Manager (`MMAN`) process.
- Oracle manageability/diagnostic features enabled, as evidenced by the Manageability Monitor (`MMON`) and Manageability Monitor Light (`MMNL`) processes.

Let's take a look at the various processes you might see depending on the features you are using.

## CJQ0 and Jnnn Processes: Job Queues

In the first 7.0 release, Oracle provided replication in the form of a database object known as a *snapshot*. Job queues were the internal mechanism by which these snapshots were refreshed, or made current.

A job queue process monitored a job table that told it when it needed to refresh various snapshots in the system. In Oracle 7.1, Oracle Corporation exposed this facility for all to use via a database package called `DBMS_JOB`. So a process that was solely the domain of the snapshot in 7.0 became the "job queue" in 7.1 and later versions. Over time, the parameters for controlling the behavior of the job queue (how frequently it should be checked and how many queue processes there should be) changed in name from `SNAPSHOT_REFRESH_INTERVAL` and `SNAPSHOT_REFRESH_PROCESSES` to `JOB_QUEUE_INTERVAL` and `JOB_QUEUE_PROCESSES`. In current releases only the `JOB_QUEUE_PROCESSES` parameter is exposed as a user-tunable setting.

You may have up to 1,000 job queue processes. Their names will be `J000 . . . J999`. These processes are used heavily in replication as part of the materialized view refresh process. Streams-based replication (starting with Oracle9i Release 2 and above) uses AQ for replication and therefore does not use the job queue processes. Developers also frequently use the job queues in order to schedule one-off (background) jobs or recurring jobs such as sending an e-mail in the background or processing a long-running batch process in the background. By doing some work in the background, you can make a long task seem to take much less time to an impatient end user (he feels like it went faster, even though it might not be done yet). This is similar to what Oracle does with `LGWR` and `DBWn` processes; they do much of their work in the background, so you don't have to wait for them to complete all tasks in real time.

The `Jnnn`, where `nnn` represents a number, processes are very much like a shared server, but with aspects of a dedicated server. They are shared in the sense that they process one job after the other, but they manage memory more like a dedicated server would (their UGA memory is in the PGA, not the SGA). Each job queue process will run exactly one job at a time, one after the other, to completion. That is why we may need multiple processes if we wish to run jobs at the same time. There is no threading or preempting of a job. Once a job is running, it will run to completion (or failure).

You will notice that the `Jnnn` processes come and go over time. That is, if you configure up to 1,000 of them, you will not see 1,000 of them start up with the database. Rather, a sole process, the Job Queue Coordinator (`CJQ0`) will start up, and as it sees jobs that need to be run in the job queue table, it will start the `Jnnn` processes. As the `Jnnn` processes complete their work and discover no new jobs to process, they will start to exit, to go away. So, if you schedule most of your jobs to run at 2:00 AM when no one is around, you might well never actually see these `Jnnn` processes.

## QMNC and Qnnn: Advanced Queues

The QMNC process is to the AQ tables what the CJQ0 process is to the job table. It monitors the advanced queues and alerts waiting message *dequeueers* that a message has become available. QMNC and Qnnn are also responsible for queue *propagation*—that is, the ability of a message that was enqueued (added) in one database to be moved to a queue in another database for dequeuing.

The Qnnn processes are to the QMNC process what the Jnnn processes are to the CJQ0 process. They are notified by the QMNC process of work that needs to be performed, and they process the work.

The QMNC and Qnnn processes are optional background processes. The parameter AQ\_TM\_PROCESSES specifies creation of up to 40 of these processes named Qnnn, (where nn is a number 0..15 or a letter a..z) and a single QMNC process.

Unlike the Jnnn processes used by the job queues, the Qnnn processes are persistent. If you set AQ\_TM\_PROCESSES to 10, you will see ten Qnnn processes and the QMNC process at database startup and for the entire life of the instance.

Oracle automatically adjusts the number of queue processes and therefore rarely do you need to set AQ\_TM\_PROCESSES manually. If you do set this parameter, Oracle still automatically adjusts the number of processes spawned, and uses the value of AQ\_TM\_PROCESSES as a minimum number of processes to create.

---

■ **Note** Starting with Oracle 12c, there's an Advanced Queue Process Coordinator (AQPC) process. Its purpose is to create and manage master advanced queuing processes (starting, stopping, and so on). Statistics related to this process can be queried from the GV\$AQ\_BACKGROUND\_COORDINATOR view.

---

## EMNC: Event Monitor Processes

The EMNC process is part of the AQ architecture. It is used to notify queue subscribers of messages they would be interested in. This notification is performed asynchronously. There are Oracle Call Interface (OCI) functions available to register a callback for message notification. The callback is a function in the OCI program that will be invoked automatically whenever a message of interest is available in the queue. The EMNn background process is used to notify the subscriber. The EMNC process is started automatically when the first notification is issued for the instance. The application may then issue an explicit `message_receive(dequeue)` to retrieve the message.

## MMAN: Memory Manager

This process is available starting with Oracle 10g and above and is used by the automatic SGA sizing feature. The MMAN process coordinates the sizing and resizing of the shared memory components (the default buffer pool, the shared pool, the Java pool, and the large pool).

## MMON, MMNL, and Mnnn: Manageability Monitors

These processes are used to populate the Automatic Workload Repository (AWR), a feature available starting with Oracle 10g. The MMNL process flushes statistics from the SGA to database tables on a scheduled basis. The MMON process is used to auto-detect database performance issues and implement the self-tuning features. The Mnnn processes are similar to the Jnnn or Qnnn processes for the job queues; the MMON process will request these slave processes to perform work on its behalf. The Mnnn processes are transient in nature—they will come and go as needed.



## CTWR: Change Tracking Processes

This is an optional process starting with Oracle 10g database and above. The CTWR process is responsible for maintaining the change tracking file, as described in Chapter 3.

## RVWR: Recovery Writer

This process (available with Oracle 10g database and above), is responsible for maintaining the *before* images of blocks in the Fast Recovery Area (described in Chapter 3) used with the FLASHBACK DATABASE command.

## DMnn/DWnn: Data Pump Master/Worker Processes

Data Pump was a feature added in Oracle 10g Release 1 of the database. It was designed as a complete rewrite of the legacy export/import processes. Data Pump runs entirely in the server and the API to it is via PL/SQL. Since Data Pump runs in the server, support for performing the various Data Pump operations were added. The Data Pump master (DMnn) collects all inputs from client processes (it is the process that receives the API inputs) and then coordinates the worker processes (the DWnn) which perform the real work—the DMnn processes do the actual processing of the metadata and data.

## TMON/TT00: Transport Monitor and Redo Transport Slave

Starting with Oracle 12c, two Data Guard related processes are automatically started when your instance starts: a transport monitor process (TMON) and a redo transport slave (TT00). TMON will start and monitor a number of TT00 processes. The TT00 processes are used to inform the LGWR process if and when it needs to generate heartbeat redo. Even if you don't implement Data Guard, you may see the processes started. You don't need to worry about these processes, just be aware that they're there and will be used if you implement Data Guard.

If you do implement Data Guard, there will be a number of other processes started to facilitate the shipping of redo information from one database to another, and apply it. See the *Data Guard Concepts and Administration* manual from Oracle for full details.

## Remaining Utility Background Processes

So, is that the complete list? No, not by a long shot, there are many others depending on what features you implemented. For example, there are Streams apply and capture processes present when you implement products such as Oracle GoldenGate, Oracle XStream, Oracle Streams, and so on. However, the preceding list covers most of the common background processes you will encounter.

## Slave Processes

Now we are ready to look at the last class of Oracle processes: the *slave* processes. There are two types of slave processes with Oracle, I/O slaves and parallel query slaves.

## I/O Slaves

I/O slaves are used to emulate asynchronous I/O for systems or devices that do not support it. For example, tape devices (which are notoriously slow) do not support asynchronous I/O. By using I/O slaves, we can mimic for tape drives what the operating system normally provides for disk drives. Just as with true asynchronous I/O, the process writing to the device batches a large amount of data and hands it off to be written. When the data is successfully written, the writer (our I/O slave this time, *not* the operating system) signals the original invoker, who removes this batch of data from its list of data that needs to be written. In this fashion, we can achieve a much higher throughput, since the I/O slaves are the ones waiting for the slow device, while their caller is off doing other important work getting the data together for the next write.

I/O slaves are used in a couple of places in Oracle. DBWn and LGWR can make use of them to simulate asynchronous I/O, and RMAN will make use of them when writing to tape.

Two parameters control the use of I/O slaves:

- **BACKUP\_TAPE\_IO\_SLAVES:** This parameter specifies whether I/O slaves are used by RMAN to back up, copy, or restore data to tape. Since this parameter is designed around *tape* devices, and tape devices may be accessed by only one process at any time, this parameter is a Boolean, and not the number of slaves to use, as you might expect. RMAN will start up as many slaves as necessary for the number of physical devices being used. When `BACKUP_TAPE_IO_SLAVES = TRUE`, an I/O slave process is used to write to or read from a tape device. If this parameter is `FALSE` (the default), then I/O slaves are not used for backups. Instead, the dedicated server process engaged in the backup will access the tape device.
- **DBWR\_IO\_SLAVES:** This parameter specifies the number of I/O slaves used by the DBW0 process. The DBW0 process and its slaves always perform the writing to disk of dirty blocks in the buffer cache. By default, the value is 0 and I/O slaves are not used. Note that if you set this parameter to a nonzero value, LGWR and ARCn will use their own I/O slaves as well, up to four I/O slaves for LGWR and ARCn will be permitted.

The DBWn I/O slaves appear with the name I1nn, and the LGWR I/O slaves appear with the name I2nn.

## Pnnn: Parallel Query Execution Servers

Oracle 7.1.6 introduced the parallel query capability into the database. This is the capability to take a SQL statement such as a `SELECT`, `CREATE TABLE`, `CREATE INDEX`, `UPDATE`, and so on and create an execution plan that consists of *many* execution plans that can be done simultaneously. The outputs of each of these plans are merged together into one larger result. The goal is to do an operation in a fraction of the time it would take if you did it serially. For example, say you have a really large table spread across ten different files. You have 16 CPUs at your disposal, and you need to execute an ad hoc query on this table. It might be advantageous to break the query plan into 32 little pieces and really make use of that machine, as opposed to just using one process to read and process all of that data serially.

When using parallel query, you will see processes named Pnnn—these are the parallel query execution servers themselves. During the processing of a parallel statement, your server process will be known as the *Parallel Query Coordinator*. Its name won't change at the operating system level, but as you read documentation on parallel query, when you see references to the coordinator process, know that it is simply your original server process.

Prior to Oracle 12c, the default number of parallel execution servers started was zero. You could modify that behavior by specifying a non-zero value for the `PARALLEL_MIN_SERVERS` parameter. Starting with Oracle 12c, your instance will automatically create several parallel server processes. This occurs because the `PARALLEL_MIN_SERVERS`

parameter is set to a non-zero value (derived from `CPU_COUNT * PARALLEL_THREADS_PER_CPU * 2`). For example, on my two CPU box (`CPU_COUNT` parameter is 2 and `PARALLEL_THREADS_PER_CPU` parameter is 2), we see the following eight parallel execution servers running:

```
$ ps -ef | grep ora_p00 | grep -v grep

oracle  31086      1  0 Apr06 ?          00:00:03 ora_p000_ORA12CR1
oracle  31088      1  0 Apr06 ?          00:00:05 ora_p001_ORA12CR1
oracle  31104      1  0 Apr06 ?          00:00:02 ora_p002_ORA12CR1
oracle  31106      1  0 Apr06 ?          00:00:02 ora_p003_ORA12CR1
oracle  31108      1  0 Apr06 ?          00:00:02 ora_p004_ORA12CR1
oracle  31110      1  0 Apr06 ?          00:00:02 ora_p005_ORA12CR1
oracle  31112      1  0 Apr06 ?          00:00:02 ora_p006_ORA12CR1
oracle  31114      1  0 Apr06 ?          00:00:02 ora_p007_ORA12CR1
```

---

■ **Tip** See Chapter 14 for full details on parallel processing.

---

## Summary

We've covered the files used by Oracle, from the lowly but important parameter file to data files, redo log files, and so on. We've taken a look inside the memory structures used by Oracle, both in the server processes and the SGA. We've seen how different server configurations, such as shared server versus dedicated server mode for connections, will have a dramatic impact on how memory is used by the system. Lastly, we looked at the processes (or threads, depending on the operating system) that enable Oracle to do what it does. Now we are ready to look at the implementation of some other features of Oracle, such as locking, concurrency controls, and transactions.



# Locking and Latching

One of the key challenges in developing multiuser, database-driven applications is to maximize concurrent access and, at the same time, ensure that each user is able to read and modify the data in a consistent fashion. The locking mechanisms that allow this to happen are key features of any database, and Oracle excels in providing them. However, Oracle's implementation of these features is specific to Oracle—just as SQL Server's implementation is to SQL Server—and it is up to you, the application developer, to ensure that when your application performs data manipulation, it uses these mechanisms correctly. If you fail to do so, your application will behave in an unexpected way, and inevitably the integrity of your data will be compromised (as was demonstrated in Chapter 1).

In this chapter, we'll take a detailed look at how Oracle locks both data (e.g., rows in tables) and shared data structures (such as those found in the SGA). We'll investigate the granularity to which Oracle locks data and what that means to you, the developer. When appropriate, I'll contrast Oracle's locking scheme with other popular implementations, mostly to dispel the myth that row-level locking adds overhead; in reality, it adds overhead only if the implementation adds overhead. In the next chapter, we'll continue this discussion and investigate Oracle's multiversioning techniques and how locking strategies interact with them.

## What Are Locks?

*Locks* are mechanisms used to regulate concurrent access to a shared resource. Note how I used the term “shared resource” and not “database row.” It is true that Oracle locks table data at the row level, but it also uses locks at many other levels to provide concurrent access to various resources. For example, while a stored procedure is executing, the procedure itself is locked in a mode that allows others to execute it, but it will not permit another user to alter that instance of that stored procedure in any way. Locks are used in the database to permit concurrent access to these shared resources, while at the same time providing data integrity and consistency.

In a single-user database, locks are not necessary. There is, by definition, only one user modifying the information. However, when multiple users are accessing and modifying data or data structures, it is crucial to have a mechanism in place to prevent concurrent modification of the same piece of information. This is what locking is all about.

It is very important to understand that there are as many ways to implement locking in a database as there are databases. Just because you have experience with the locking model of one particular relational database management system (RDBMS) does not mean you know everything about locking. For example, before I got heavily involved with Oracle, I used other databases including Sybase, Microsoft SQL Server, and Informix. All three of these databases provide locking mechanisms for concurrency control, but there are deep and fundamental differences in the way locking is implemented in each one.

To demonstrate this, I'll outline my progression from a Sybase SQL Server developer to an Informix user and finally to an Oracle developer. This happened many years ago, and the SQL Server fans out there will tell me “But we have row-level locking now!” It is true: SQL Server may now use row-level locking, but the way it is implemented is totally different from the way it is done in Oracle. It is a comparison between apples and oranges, and that is the key point.

As a SQL Server programmer, I would hardly ever consider the possibility of multiple users inserting data into a table concurrently. It was something that just didn't often happen in that database. At that time, SQL Server provided only for page-level locking and, since all the data tended to be inserted into the last page of nonclustered tables, concurrent inserts by two users was simply not going to happen.

---

■ **Note** A SQL Server clustered table (a table that has a clustered index) is in some regard similar to, but very different from, an Oracle cluster. SQL Server used to only support page (block) level locking; if every row inserted was to go to the “end” of the table, you would never have had concurrent inserts or concurrent transactions in that database. The clustered index in SQL Server was used to insert rows all over the table, in sorted order by the cluster key, and as such improved concurrency in that database.

---

Exactly the same issue affected concurrent updates (since an UPDATE was really a DELETE followed by an INSERT in SQL Server). Perhaps this is why SQL Server, by default, commits or rolls back immediately after execution of each and every statement, compromising transactional integrity in an attempt to gain higher concurrency.

So in most cases, with page-level locking, multiple users could not simultaneously modify the same table. Compounding this was the fact that while a table modification was in progress, many queries were also effectively blocked against that table. If I tried to query a table and needed a page that was locked by an update, I waited (and waited and waited). The locking mechanism was so poor that providing support for transactions that took more than a second was deadly—the entire database would appear to freeze. I learned a lot of bad habits as a result. I learned that transactions were “bad” and that you ought to commit rapidly and never hold locks on data. Concurrency came at the expense of consistency. You either wanted to get it right or get it fast. I came to believe that you couldn't have both.

When I moved on to Informix, things were better, but not by much. As long as I remembered to create a table with row-level locking enabled, then I could actually have two people simultaneously insert data into that table. Unfortunately, this concurrency came at a high price. Row-level locks in the Informix implementation were expensive, both in terms of time and memory. It took time to acquire and unacquire (release) them, and each lock consumed real memory. Also, the total number of locks available to the system had to be computed prior to starting the database. If you exceeded that number, you were just out of luck. Consequently, most tables were created with page-level locking anyway, and, as with SQL Server, both row and page-level locks would stop a query in its tracks. As a result, I found that once again I would want to commit as fast as I could. The bad habits I picked up using SQL Server were simply reinforced and, furthermore, I learned to treat a lock as a very scarce resource—something to be coveted. I learned that you should manually escalate locks from row level to table level to try to avoid acquiring too many of them and bringing the system down, and bring it down I did—many times.

When I started using Oracle, I didn't really bother reading the manuals to find out how locking worked in this particular database. After all, I had been using databases for quite a while and was considered something of an expert in this field (in addition to Sybase, SQL Server, and Informix, I had used Ingress, DB2, Gupta SQLBase, and a variety of other databases). I had fallen into the trap of believing that I knew how things *should* work, so I thought of course they *would* work in that way. *I was wrong in a big way.*

It was during a benchmark that I discovered just how wrong I was. In the early days of these databases (around 1992/1993), it was common for the vendors to benchmark for really large procurements to see who could do the work the fastest, the easiest, and with the most features.

The benchmark was between Informix, Sybase SQL Server, and Oracle. Oracle went first. Their technical people came on-site, read through the benchmark specs, and started setting it up. The first thing I noticed was that the technicians from Oracle were going to use a database table to record their timings, even though we were going to have many dozens of connections doing work, each of which would frequently need to insert and update data in this log table. Not only that, but they were going to *read* the log table during the benchmark as well! Being a nice guy, I pulled one of the Oracle technicians aside to ask him if they were crazy. Why would they purposely introduce another point of contention into the system? Wouldn't the benchmark processes all tend to serialize around their operations on this single table? Would they jam the benchmark by trying to read from this table as others were heavily modifying

it? Why would they want to introduce all of these extra locks that they would need to manage? I had dozens of “Why would you even consider that?”-type questions. The technical folks from Oracle thought I was a little daft at that point. That is, until I pulled up a window into either Sybase SQL Server or Informix, and showed them the effects of two people inserting into a table, or someone trying to query a table with others inserting rows (the query returns zero rows per second). The differences between the way Oracle does it and the way almost every other database does it are phenomenal—they are night and day.

Needless to say, neither the Informix nor the SQL Server technicians were too keen on the database log table approach during their attempts. They preferred to record their timings to flat files in the operating system. The Oracle people left with a better understanding of exactly how to compete against Sybase SQL Server and Informix: just ask the audience “How many rows per second does your current database return when data is locked?” and take it from there.

The moral to this story is twofold. First, *all databases are fundamentally different*. Second, when designing an application for a new database platform, you must make no assumptions about how that database works. *You must approach each new database as if you had never used a database before*. Things you would do in one database are either not necessary or simply won’t work in another database.

In Oracle you will learn that:

- Transactions are what databases are all about. They are a good thing.
- You should defer committing until the correct moment. You should not do it quickly to avoid stressing the system, as it does not stress the system to have long or large transactions. The rule is *commit when you must, and not before*. Your transactions should only be as small or as large as your business logic dictates. (Interesting side note: I just wrote that rule for committing—“when you must, and not before”—on <http://asktom.oracle.com> just this morning, probably for the millionth time. Some things never change).
- You should hold locks on data as long as you need to. They are tools for you to use, not things to be avoided. Locks are not a scarce resource. Conversely, you should hold locks on data only as long as you need to. Locks may not be scarce, but they can prevent other sessions from modifying information.
- There is no overhead involved with row-level locking in Oracle—*none*. Whether you have 1 row lock or 1,000,000 row locks, the number of resources dedicated to locking this information will be the same. Sure, you’ll do a lot more work modifying 1,000,000 rows rather than 1 row, but the number of resources needed to lock 1,000,000 rows is the same as for 1 row; it is a fixed constant.
- You should never escalate a lock (e.g., use a table lock instead of row locks) because it would be “better for the system.” In Oracle, it won’t be better for the system—it will save no resources. There are times to use table locks, such as in a batch process, when you know you will update the entire table and you do not want other sessions to lock rows on you. But you are not using a table lock to make it easier for the system by avoiding having to allocate row locks; you are using a table lock to ensure you can gain access to all of the resources your batch program needs in this case.
- Concurrency and consistency can be achieved simultaneously. You can get it fast and correct, every time. Readers of data are *not* blocked by writers of data. Writers of data are *not* blocked by readers of data. This is one of the fundamental differences between Oracle and most other relational databases.

As we cover the remaining components in this chapter and the next, I’ll reinforce these points.

## Locking Issues

Before we discuss the various types of locks that Oracle uses, it is useful to look at some locking issues, many of which arise from badly designed applications that do not make correct use (or make no use) of the database's locking mechanisms.

### Lost Updates

A lost update is a classic database problem. Actually, it is a problem in all multiuser computer environments. Simply put, a lost update occurs when the following events occur, in the order presented here:

1. A transaction in Session1 retrieves (queries) a row of data into local memory and displays it to an end user, User1.
2. Another transaction in Session2 retrieves that same row, but displays the data to a different end user, User2.
3. User1, using the application, modifies that row and has the application update the database and commit. Session1's transaction is now complete.
4. User2 modifies that row also, and has the application update the database and commit. Session2's transaction is now complete.

This process is referred to as a *lost update* because all of the changes made in Step 3 will be lost. Consider, for example, an employee update screen that allows a user to change an address, work number, and so on. The application itself is very simple: a small search screen to generate a list of employees and then the ability to drill down into the details of each employee. This should be a piece of cake. So, we write the application with no locking on our part, just simple SELECT and UPDATE commands.

Then an end user (User1) navigates to the details screen, changes an address on the screen, clicks Save, and receives confirmation that the update was successful. Fine, except that when User1 checks the record the next day to send out a tax form, the old address is still listed. How could that have happened? Unfortunately, it can happen all too easily. In this case, another end user (User2) queried the same record just after User1 did—after User1 read the data, but before User1 modified it. Then, after User2 queried the data, User1 performed her update, received confirmation, and even re-queried to see the change for herself. However, User2 then updated the work telephone number field and clicked Save, blissfully unaware of the fact that he just overwrote User1's changes to the address field with the old data! The reason this can happen *in this case* is that the application developer wrote the program such that when one particular field is updated, all fields for that record are refreshed (simply because it's easier to update all the columns instead of figuring out exactly which columns changed and only updating those).

Note that for this to happen, User1 and User2 didn't even need to be working on the record at the exact same time. They simply needed to be working on the record at *about* the same time.

I've seen this database issue crop up time and again when GUI programmers with little or no database training are given the task of writing a database application. They get a working knowledge of SELECT, INSERT, UPDATE, and DELETE and set about writing the application. When the resulting application behaves in the manner just described, it completely destroys a user's confidence in it, especially since it seems so random, so sporadic, and totally irreproducible in a controlled environment (leading the developer to believe it must be user error).

Many tools, such as Oracle Forms and APEX (Application Express, the tool we used to create the AskTom web site), transparently protect you from this behavior by ensuring the record is unchanged from the time you query it, and locked before you make any changes to it (known as *optimistic locking*); but many others (such as a handwritten Visual Basic or a Java program) do not. What the tools that protect you do behind the scenes, or what the developers must do themselves, is use one of two types of locking strategies: *pessimistic* or *optimistic*.

## Pessimistic Locking

The pessimistic locking method would be put into action the instant before a user modifies a value on the screen. For example, a row lock would be placed as soon as the user indicates his intention to perform an update on a specific row that he has selected and has visible on the screen (by clicking a button on the screen, say). That row lock would *persist* until the application applied the users' modifications to the row in the database and committed.

Pessimistic locking is useful only in a stateful or connected environment—that is, one where your application has a continual connection to the database and you are the only one using that connection for at least the life of your transaction. This was the prevalent way of doing things in the early to mid 1990s with client/server applications. Every application would get a direct connection to the database to be used solely by that application instance. This method of connecting, in a stateful fashion, has become less common (though it is not extinct), especially with the advent of application servers in the mid to late 1990s.

Assuming you are using a stateful connection, you might have an application that queries the data without locking anything:

```
SCOTT@ORA12CR1> select empno, ename, sal from emp where deptno = 10;
```

EMPNO	ENAME	SAL
7782	CLARK	2450
7839	KING	5000
7934	MILLER	1300

Eventually, the user picks a row she would like to update. Let's say in this case, she chooses to update the MILLER row. Our application will, at that point, (before the user makes any changes on the screen but after the row has been out of the database for a while) bind the values the user selected so we can query the database and make sure the data hasn't been changed yet. In SQL\*Plus, to simulate the bind calls the application would make, we can issue the following:

```
SCOTT@ORA12CR1> variable empno number
SCOTT@ORA12CR1> variable ename varchar2(20)
SCOTT@ORA12CR1> variable sal number
SCOTT@ORA12CR1> exec :empno := 7934; :ename := 'MILLER'; :sal := 1300;
PL/SQL procedure successfully completed.
```

Now in addition to simply querying the values and verifying that they have not been changed, we are going to lock the row using FOR UPDATE NOWAIT. The application will execute the following query:

```
SCOTT@ORA12CR1> select empno, ename, sal
2   from emp
3   where empno = :empno
4     and decode( ename, :ename, 1 ) = 1
5     and decode( sal, :sal, 1 ) = 1
6     for update nowait
7 /
```

EMPNO	ENAME	SAL
7934	MILLER	1300



---

■ **Note** Why did we use "decode( column, :bind\_variable, 1 ) = 1"? It is simply a shorthand way of expressing "where (column = :bind\_variable OR (column is NULL and :bind\_variable is NULL)". You could code either approach, the decode() is just more compact in this case, and since NULL = NULL is never true (nor false!) in SQL, one of the two approaches would be necessary if either of the columns permitted NULLs.

---

The application supplies values for the bind variables from the data on the screen (in this case 7934, MILLER, and 1300) and re-queries this same row from the database, this time locking the row against updates by other sessions; hence this approach is called *pessimistic* locking. We lock the row before we attempt to update because we doubt—we *are pessimistic*—that the row will remain unchanged otherwise.

Since all tables *should* have a primary key (the preceding SELECT will retrieve at most one record since it includes the primary key, EMPNO) and primary keys should be immutable (we should never update them), we'll get one of three outcomes from this statement:

- If the underlying data has not changed, we will get our MILLER row back, and this row will be locked from updates (but not reads) by others.
- If another user is in the process of modifying that row, we will get an ORA-00054 resource busy error. We must wait for the other user to finish with it.
- If, in the time between selecting the data and indicating our intention to update, someone has already changed the row, then we will get zero rows back. That implies the data on our screen is stale. To avoid the lost update scenario previously described, the application needs to *re-query* and lock the data before allowing the end user to modify it. With pessimistic locking in place, when User2 attempts to update the telephone field, the application would now recognize that the address field had been changed and would *re-query* the data. Thus, User2 would not overwrite User1's change with the old data in that field.

Once we have locked the row successfully, the application will bind the new values, issue the update, and commit the changes:

```
SCOTT@ORA12CR1> update emp
 2   set ename = :ename, sal = :sal
 3   where empno = :empno;
```

1 row updated.

```
SCOTT@ORA12CR1> commit;
Commit complete.
```

We have now very safely changed that row. It is not possible for us to overwrite someone else's changes, as we verified the data did not change between when we initially read it out and when we locked it—our verification made sure no one else changed it before we did, and our lock ensures no one else can change it while we are working with it.

## Optimistic Locking

The second method, referred to as *optimistic* locking, defers all locking up to the point right before the update is performed. In other words, we will modify the information on the screen without a lock being acquired. We are *optimistic* that the data will not be changed by some other user; hence we wait until the very last moment to find out if we are right.

This locking method works in all environments, but it does increase the probability that a user performing an update will lose. That is, when that user goes to update her row, she finds that the data has been modified, and she has to start over.

One popular implementation of optimistic locking is to keep the old and new values in the application, and upon updating the data, use an update like this:

```
Update table
  Set column1 = :new_column1, column2 = :new_column2, ...
  Where primary_key = :primary_key
  And decode( column1, :old_column1, 1 ) = 1
  And decode( column2, :old_column2, 1 ) = 1
  ...
```

Here, we are optimistic that the data doesn't get changed. In this case, if our update updates one row, we got lucky; the data didn't change between the time we read it and the time we got around to submitting the update. If we update zero rows, we lose; someone else changed the data and now we must figure out what we want to do to continue in the application. Should we make the end user re-key the transaction after querying the new values for the row (potentially causing the user frustration, as there is a chance the row will have changed yet again)? Should we try to merge the values of the two updates by performing update conflict-resolution based on business rules (lots of code)?

The preceding UPDATE will, in fact, avoid a lost update, but it does stand a chance of being blocked, hanging while it waits for an UPDATE of that row by another session to complete. If all of your applications use optimistic locking, then using a straight UPDATE is generally OK since rows are locked for a very short duration as updates are applied and committed. However, if some of your applications use pessimistic locking, which will hold locks on rows for relatively long periods of time, or if there is any application (such as a batch process) that might lock rows for a long period of time (more than a second or two is considered long), then you should consider using a SELECT FOR UPDATE NOWAIT instead to verify the row was not changed, and lock it immediately prior to the UPDATE to avoid getting blocked by another session.

There are many methods of implementing optimistic concurrency control. We've discussed one whereby the application will store all of the before images of the row in the application itself. In the following sections, we'll explore two others, namely:

- Using a special column that is maintained by a database trigger or application code to tell us the "version" of the record.
- Using a checksum or hash that was computed using the original data.

## Optimistic Locking Using a Version Column

This is a simple implementation that involves adding a single column to each database table you wish to protect from lost updates. This column is generally either a NUMBER or DATE/TIMESTAMP column. It is typically maintained via a row trigger on the table, which is responsible for incrementing the NUMBER column or updating the DATE/TIMESTAMP column every time a row is modified.

---

■ **Note** I said it was typically maintained via a row trigger. I did not, however, say that was the best way or right way to maintain it. I would personally prefer this column be maintained by the UPDATE statement itself, not via a trigger because triggers that are not absolutely necessary (as this one is) should be avoided. For background on why I avoid triggers, refer to my "Trouble With Triggers" article from *Oracle Magazine*, found on the Oracle Technology Network at <http://www.oracle.com/technetwork/issue-archive/2008/08-sep/o58asktom-101055.html>.

---

The application you want to implement optimistic concurrency control would need only to save the value of this additional column, not all of the before images of the other columns. The application would only need to verify that the value of this column in the database at the point when the update is requested matches the value that was initially read out. If these values are the same, then the row has not been updated.

Let's look at an implementation of optimistic locking using a copy of the SCOTT.DEPT table. We could use the following Data Definition Language (DDL) to create the table:

```
EODA@ORA12CR1> create table dept
 2 ( deptno    number(2),
 3   dname     varchar2(14),
 4   loc       varchar2(13),
 5   last_mod  timestamp with time zone
 6             default systimestamp
 7             not null,
 8   constraint dept_pk primary key(deptno)
 9 )
10 /
Table created.
```

Then we INSERT a copy of the DEPT data into this table:

```
EODA@ORA12CR1> insert into dept( deptno, dname, loc )
 2 select deptno, dname, loc
 3   from scott.dept;
4 rows created.
```

```
EODA@ORA12CR1> commit;
Commit complete.
```

That code re-creates the DEPT table, but with an additional LAST\_MOD column that uses the TIMESTAMP WITH TIME ZONE data type. We have defined this column to be NOT NULL so that it must be populated, and its default value is the current system time.

This TIMESTAMP data type has the highest precision available in Oracle, typically going down to the microsecond (millionth of a second). For an application that involves user think time, this level of precision on the TIMESTAMP is more than sufficient, as it is highly unlikely that the process of the database retrieving a row and a human looking at it, modifying it, and issuing the update back to the database could take place within a fraction of a second. The odds of two people reading and modifying the same row in the same fraction of a second are very small indeed.

Next, we need a way of maintaining this value. We have two choices: either the application can maintain the LAST\_MOD column by setting its value to SYSTIMESTAMP when it updates a record, or a trigger/stored procedure can maintain it. Having the application maintain LAST\_MOD is definitely more performant than a trigger-based approach, since a trigger will add additional processing on top of that already done by Oracle. However, this does mean that you are relying on all of the applications to maintain LAST\_MOD consistently in all places that they modify this table. So, if each application is responsible for maintaining this field, it needs to consistently verify that the LAST\_MOD column was not changed and set the LAST\_MOD column to the current SYSTIMESTAMP. For example, if an application queries the row where DEPTNO=10:

```
EODA@ORA12CR1> variable deptno    number
EODA@ORA12CR1> variable dname     varchar2(14)
EODA@ORA12CR1> variable loc       varchar2(13)
EODA@ORA12CR1> variable last_mod  varchar2(50)
EODA@ORA12CR1>
```

```

EODA@ORA12CR1> begin
2   :deptno := 10;
3   select dname, loc, to_char( last_mod, 'DD-MON-YYYY HH.MI.SSXFF AM TZR' )
4     into :dname,:loc,:last_mod
5     from dept
6     where deptno = :deptno;
7 end;
8 /

```

PL/SQL procedure successfully completed.

which we can see is currently

```

EODA@ORA12CR1> select :deptno dno, :dname dname, :loc loc, :last_mod lm
2   from dual;

```

DNO	DNAME	LOC	LM
10	ACCOUNTING	NEW YORK	15-APR-2014 07.04.01.147094 PM -06:00

would use this next update statement to modify the information. The last line does the very important check to make sure the timestamp has not changed and uses the built-in function `TO_TIMESTAMP_TZ` (tz is short for time zone ) to convert the string we saved in from the `SELECT` statement back into the proper data type. Additionally, line 3 of the `UPDATE` statement updates the `LAST_MOD` column to be the current time if the row is found to be updated:

```

EODA@ORA12CR1> update dept
2   set dname = initcap(:dname),
3     last_mod = systimestamp
4   where deptno = :deptno
5     and last_mod = to_timestamp_tz(:last_mod, 'DD-MON-YYYY HH.MI.SSXFF AM TZR' );

```

1 row updated.

As you can see, one row was updated, the row of interest. We updated the row by primary key (`DEPTNO`) and verified that the `LAST_MOD` column had not been modified by any other session between the time we read it first and the time we did the update. If we were to try to update that same record again, using the same logic but without retrieving the new `LAST_MOD` value, we would observe the following:

```

EODA@ORA12CR1> update dept
2   set dname = upper(:dname),
3     last_mod = systimestamp
4   where deptno = :deptno
5     and last_mod = to_timestamp_tz(:last_mod, 'DD-MON-YYYY HH.MI.SSXFF AM TZR' );

```

0 rows updated.

Notice how 0 rows updated is reported this time because the predicate on `LAST_MOD` was not satisfied. While `DEPTNO 10` still exists, the value at the moment we wish to update no longer matches the timestamp value at the moment we queried the row. So, the application knows that the data has been changed in the database, based on the fact that no rows were modified—and it must now figure out what it wants to do about that.

You would not rely on each application to maintain this field for a number of reasons. For one, it adds code to an application, and it is code that must be repeated and correctly implemented anywhere this table is modified. In a large application, that could be in many places. Furthermore, every application developed in the future must also conform to these rules. There are many chances to miss a spot in the application code and thus not have this field properly used. So, if the application code itself isn't responsible for maintaining this `LAST_MOD` field, then I believe that the application shouldn't be responsible for checking this `LAST_MOD` field either (if it can do the check, it can certainly do the update). So, in this case, I suggest *encapsulating the update logic in a stored procedure* and not allowing the application to update the table directly at all. If it cannot be trusted to maintain the value in this field, then it cannot be trusted to check it properly either. So, the stored procedure would take as inputs the bind variables we used in the previous updates and do exactly the same update. Upon detecting that zero rows were updated, the stored procedure could raise an exception back to the client to let the client know the update had, in effect, failed.

An alternate implementation uses a trigger to maintain this `LAST_MOD` field, but for something as simple as this, my recommendation is to avoid the trigger and let the DML take care of it. Triggers introduce a measurable amount of overhead, and in this case they would be unnecessary. Furthermore, the trigger would not be able to confirm that the row has not been modified (it would only be able to supply the value for `LAST_MOD`, not check it during the update), hence the application has to be made painfully aware of this column and how to properly use it. So the trigger is not by itself sufficient.

## Optimistic Locking Using a Checksum

This is very similar to the previous version column method, but it uses the base data itself to compute a “virtual” version column. I'll quote the *Oracle Database PL/SQL Packages and Types Reference* manual (before showing how to use one of the supplied packages) to help explain the goal and concepts behind a checksum or hash function:

*“A one-way hash function takes a variable-length input string, the data, and converts it to a fixed-length (generally smaller) output string called a hash value. The hash value serves as a unique identifier (like a fingerprint) of the input data. You can use the hash value to verify whether data has been changed or not.*

*Note that a one-way hash function is a hash function that isn't easily reversible. It is easy to compute a hash value from the input data, but it is hard to generate data that hashes to a particular value.”*

We can use these hashes or checksums in the same way that we used our version column. We simply compare the hash or checksum value we obtain when we read data out of the database with that we obtain before modifying the data. If someone modified the row's values after we read it out, but before we updated it, then the hash or checksum will almost certainly be different.

There are many ways to compute a hash or checksum. I'll list several of these and demonstrate one in this section. All of these methods are based on supplied database functionality.

- `OWA_OPT_LOCK.CHECKSUM`: This method is available on Oracle8i version 8.1.5 and up. There is a function that, given a string, returns a 16-bit checksum, and another function that, given a ROWID, will compute the 16-bit checksum of that row and lock it at the same time. Possibilities of collision are 1 in 65,536 strings (the highest chance of a false positive).
- `DBMS_OBFUSCATION_TOOLKIT.MD5`: This method is available in Oracle8i version 8.1.7 and up. It computes a 128-bit message digest. The odds of a collision are about 1 in 3.4028E+38 (very small).
- `DBMS_CRYPTO.HASH`: This method is available in Oracle 10g Release 1 and up. It is capable of computing a Secure Hash Algorithm 1 (SHA-1) or MD4/MD5 message digests. It is recommended that you use the SHA-1 algorithm.

- `DBMS_SQLHASH.GETHASH`: This method is available in Oracle 10g Release 2 and up. It supports hash algorithms of SHA-1, MD4, and MD5. As a `SYSDBA` privileged user, you must grant execute on this package to a user before they can access it. This package is documented in the *Oracle Database Security Guide*.
- `STANDARD_HASH`: This method is available in Oracle 12c Release 1 and up. This is a built-in SQL function that computes a hash value on an expression using standard hash algorithms such as SHA1 (default), SHA256, SHA384, SHA512, and MD5. The returned value is a RAW data type.
- `ORA_HASH`: This method is available in Oracle 10g Release 1 and up. This is a built-in SQL function that takes a `VARCHAR2` value as input and (optionally) another pair of inputs that control the return value. The returned value is a number—by default a number between 0 and 4294967295.

---

■ **Note** An array of hash and checksum functions are available in many programming languages, so there may be others at your disposal outside the database. That said, if you use built-in database capabilities, you will have increased your portability (to new languages, new approaches) in the future.

---

The following example shows how you might use the `ORA_HASH` built-in function in Oracle 10g and above to compute these hashes/checksums. The technique would also be applicable for the other listed approaches; the logic would not be very much different, but the APIs you call would be. First, we'll start by removing the column we used in the previous example:

```
EODA@ORA12CR1> alter table dept drop column last_mod;
Table altered.
```

And then have our application query and display the information for department 10. Note that while we query the information, we compute the hash using the `ORA_HASH` built-in. This is the version information that we retain in our application. Following is our code to query and display:

```
EODA@ORA12CR1> variable deptno number
EODA@ORA12CR1> variable dname varchar2(14)
EODA@ORA12CR1> variable loc varchar2(13)
EODA@ORA12CR1> variable hash number

EODA@ORA12CR1> begin
  2  select deptno, dname, loc,
  3         ora_hash( dname || '/' || loc ) hash
  4  into :deptno, :dname, :loc, :hash
  5  from dept
  6  where deptno = 10;
  7  end;
  8  /
PL/SQL procedure successfully completed.
```

```
EODA@ORA12CR1> select :deptno, :dname, :loc, :hash
  2  from dual;
```

```

:DEPTNO :DNAME      :LOC      :HASH
-----
10 Accounting NEW YORK  2721972020
```

As you can see, the hash is just some number. It is the value we would want to use before updating. To update that row, we would lock the row in the database as it exists right now, and then compare the hash value of that row with the hash value we computed when we read the data out of the database. The logic for doing so could look like the following:

```
EODA@ORA12CR1> exec :dname := lower(:dname);
PL/SQL procedure successfully completed.
```

```
EODA@ORA12CR1> update dept
 2   set dname = :dname
 3   where deptno = :deptno
 4     and ora_hash( dname || '/' || loc ) = :hash
 5 /
1 row updated.
```

```
EODA@ORA12CR1> select dept.*,
 2     ora_hash( dname || '/' || loc ) hash
 3   from dept
 4   where deptno = :deptno;
```

DEPTNO	DNAME	LOC	HASH
10	accounting	NEW YORK	2818855829

Upon re-querying the data and computing the hash again after the update, we can see that the hash value is different. If someone had modified the row before we did, our hash values would not have compared. We can see this by attempting our update again, using the *old* hash value we read out the first time:

```
EODA@ORA12CR1> update dept
 2   set dname = :dname
 3   where deptno = :deptno
 4     and ora_hash( dname || '/' || loc ) = :hash
 5 /
0 rows updated.
```

As you see, there were zero rows updated, since our hash value did not match the data currently in the database.

In order for this hash-based approach to work properly, we must ensure every application uses the same approach when computing the hash, specifically they must concatenate *dname* with *'/'* with *loc* – in that order. To make that approach universal, I would suggest adding a virtual column to the table (in Oracle 11g Release 1 and above) or using a view to add a column, so that the function is hidden from the application itself. Adding a column would look like this in Oracle 11g Release 1 and above:

```
EODA@ORA12CR1> alter table dept
 2   add hash as
 3   ( ora_hash(dname || '/' || loc ) );
Table altered.
```

```
EODA@ORA12CR1> select *
 2   from dept
 3   where deptno = :deptno;
```

DEPTNO	DNAME	LOC	HASH
10	accounting	NEW YORK	2818855829

The added column is a virtual column and as such incurs no storage overhead. The value is not computed and stored on disk. Rather, it is computed upon retrieval of the data from the database.

This example showed how to implement optimistic locking with a hash or checksum. You should bear in mind that computing a hash or checksum is a somewhat CPU-intensive operation; it is computationally expensive. On a system where CPU bandwidth is a scarce resource, you must take this fact into consideration. However, this approach is much more network-friendly because the transmission of a relatively small hash instead of a before-and-after image of the row (to compare column by column) over the network will consume much less of that resource.

## Optimistic or Pessimistic Locking?

So which method is best? In my experience, pessimistic locking works very well in Oracle (but perhaps not so well in other databases) and has many advantages over optimistic locking. However, it requires a stateful connection to the database, like a client/server connection. This is because locks are not held across connections. This single fact makes pessimistic locking unrealistic in many cases today. In the past, with client/server applications and a couple dozen or hundred users, it would have been my first and only choice. Today, however, optimistic concurrency control is what I would recommend for most applications. Having a connection for the entire duration of a transaction is just too high a price to pay.

Of the methods available, which do I use? I tend to use the version column approach with a timestamp column. It gives me the extra update information in a long-term sense. Furthermore, it's less computationally expensive than a hash or checksum, and it doesn't run into the issues potentially encountered with a hash or checksum when processing LONG, LONG RAW, CLOB, BLOB, and other very large columns (LONG and LONG RAW are obsolete, I only mention them here because they're still used frequently in the Oracle data dictionary).

If I had to add optimistic concurrency controls to a table that was still being used with a pessimistic locking scheme (e.g., the table was accessed in both client/server applications and over the Web), I would opt for the ORA\_HASH approach. The reason is that the existing legacy application might not appreciate a new column appearing. Even if we took the additional step of hiding the extra column, the application might suffer from the overhead of the necessary trigger. The ORA\_HASH technique would be nonintrusive and lightweight in that respect. The hashing/checksum approach can be very database independent, especially if we compute the hashes or checksums outside of the database. However, by performing the computations in the middle tier rather than the database, we will incur higher resource usage penalties in terms of CPU usage and network transfers.

## Blocking

*Blocking* occurs when one session holds a lock on a resource that another session is requesting. As a result, the requesting session will be blocked—it will hang until the holding session gives up the locked resource. In almost every case, blocking is avoidable. In fact, if you do find that your session is blocked in an interactive application, then you have probably been suffering from the lost update bug as well, perhaps without realizing it. That is, your application logic is flawed and that is the cause of the blocking.

The five common DML statements that will block in the database are INSERT, UPDATE, DELETE, MERGE, and SELECT FOR UPDATE. The solution to a blocked SELECT FOR UPDATE is trivial: simply add the NOWAIT clause and it will no longer block. Instead, your application will report a message back to the end user that the row is already locked. The interesting cases are the remaining four DML statements. We'll look at each of them and see why they should not block and how to correct the situation if they do.



## Blocked Inserts

There are few times when an INSERT will block. The most common scenario is when you have a table with a primary key or unique constraint placed on it and two sessions attempt to insert a row with the same value. One of the sessions will block until the other session either commits (in which case the blocked session will receive an error about a duplicate value) or rolls back (in which case the blocked session succeeds). Another case involves tables linked together via referential integrity constraints. An INSERT into a child table may become blocked if the parent row it depends on is being created or deleted.

Blocked INSERTs typically happen with applications that allow the end user to generate the primary key/unique column value. This situation is most easily avoided by using a sequence or the SYS\_GUID() built-in function to generate the primary key/unique column value. Sequences/SYS\_GUID() were designed to be highly concurrent methods of generating unique keys in a multiuser environment. In the event that you cannot use either and must allow the end user to generate a key that might be duplicated, you can use the following technique, which avoids the issue by using manual locks implemented via the built-in DBMS\_LOCK package.

---

■ **Note** The following example demonstrates how to prevent a session from blocking on an insert statement due to a primary key or unique constraint. It should be stressed that the fix demonstrated here should be considered a short-term solution while the application architecture itself is inspected. This approach adds obvious overhead and should not be implemented lightly. A well-designed application would not encounter this issue (for example, you wouldn't have transactions that last for hours in a concurrent environment). This should be considered a last resort and is definitely not something you want to do to every table in your application "just in case."

---

With inserts, there's no existing row to select and lock; there's no way to prevent others from inserting a row with the same value, thus blocking our session and causing an indefinite wait. Here is where DBMS\_LOCK comes into play. To demonstrate this technique, we will create a table with a primary key and a trigger that will prevent two (or more) sessions from inserting the same values simultaneously. The trigger will use DBMS\_UTILITY.GET\_HASH\_VALUE to hash the primary key into some number between 0 and 1,073,741,823 (the range of lock ID numbers permitted for our use by Oracle). In this example, I've chosen a hash table of size 1,024, meaning we will hash our primary keys into one of 1,024 different lock IDs. Then we will use DBMS\_LOCK.REQUEST to allocate an exclusive lock based on that ID. Only one session at a time will be able to do that, so if someone else tries to insert a record into our table with the same primary key, that person's lock request will fail (and the error resource busy will be raised):

---

■ **Note** To successfully compile this trigger, execute permission on DBMS\_LOCK must be granted directly to your schema. The privilege to execute DBMS\_LOCK may not come from a role.

---

```
SCOTT@ORA12CR1> create table demo ( x int primary key );
Table created.
```

```
SCOTT@ORA12CR1> create or replace trigger demo_bifer
  2 before insert on demo
  3 for each row
  4 declare
  5     l_lock_id number;
  6     resource_busy exception;
  7     pragma exception_init( resource_busy, -54 );
```

```

8  begin
9      l_lock_id :=
10         dbms_utility.get_hash_value( to_char( :new.x ), 0, 1024 );
11      if ( dbms_lock.request
12          ( id          => l_lock_id,
13            lockmode    => dbms_lock.x_mode,
14            timeout     => 0,
15            release_on_commit => TRUE ) not in (0,4) )
16      then
17          raise resource_busy;
18      end if;
19  end;
20  /

```

Trigger created.

```

SCOTT@ORA12CR1> insert into demo(x) values (1);
1 row created.

```

Now, to demonstrate us catching this blocking INSERT problem in a single session, we'll use an `AUTONOMOUS_TRANSACTION` so that it seems as if this next block of code was executed in another SQL\*Plus session. In fact, if you use another session, the behavior will be the same. Here we go:

```

SCOTT@ORA12CR1> declare
  2      pragma autonomous_transaction;
  3  begin
  4      insert into demo(x) values (1);
  5      commit;
  6  end;
  7  /
declare
*
ERROR at line 1:
ORA-00054: resource busy and acquire with NOWAIT specified or timeout expired
ORA-06512: at "SCOTT.DEMO_BIFER", line 14
ORA-04088: error during execution of trigger 'SCOTT.DEMO_BIFER'
ORA-06512: at line 4

```

The concept here is to take the supplied primary key value of the table protected by the trigger and put it in a character string. We can then use `DBMS_UTILITY.GET_HASH_VALUE` to come up with a mostly unique hash value for the string. As long as we use a hash table smaller than 1,073,741,823, we can lock that value exclusively using `DBMS_LOCK`.

After hashing, we take that value and use `DBMS_LOCK` to request that lock ID to be exclusively locked with a timeout of ZERO (this returns immediately if someone else has locked that value). If we timeout or fail for any reason, we raise ORA-54 Resource Busy. Otherwise, we do nothing—it is OK to insert, we won't block. Upon committing our transaction, all locks, including those allocated by this `DBMS_LOCK` call, will be released.

Of course, if the primary key of your table is an `INTEGER` and you don't expect the key to go over 1 billion, you can skip the hash and just use the number as the lock ID.

You'll need to play with the size of the hash table (1,024 in this example) to avoid artificial resource busy messages due to different strings hashing to the same number. The size of the hash table will be application (data)-specific, and it will be influenced by the number of concurrent insertions as well. You might also add a flag to the trigger to allow people to turn the check on and off. If I were going to insert hundreds or thousands of records, for example, I might not want this check enabled.

## Blocked Merges, Updates, and Deletes

In an interactive application—one where you query some data out of the database, allow an end user to manipulate it, and then put it back into the database—a blocked UPDATE or DELETE indicates that you probably have a lost update problem in your code. (I'll call it a bug in your code if you do.) You are attempting to UPDATE a row that someone else is already updating (in other words, one that someone else already has locked). You can avoid the blocking issue by using the SELECT FOR UPDATE NOWAIT query to

- Verify the data has not changed since you queried it out (preventing lost updates).
- Lock the row (preventing the UPDATE or DELETE from blocking).

As discussed earlier, you can do this regardless of the locking approach you take. Both pessimistic and optimistic locking may employ the SELECT FOR UPDATE NOWAIT query to verify the row has not changed. Pessimistic locking would use that SELECT FOR UPDATE NOWAIT statement the instant the user indicated her intention to modify the data. Optimistic locking would use that statement immediately prior to updating the data in the database. Not only will this resolve the blocking issue in your application, but it'll also correct the data integrity issue.

Since a MERGE is simply an INSERT and UPDATE (and in 10g and above, with the enhanced MERGE syntax, it's a DELETE as well), you would use both techniques simultaneously.

## Deadlocks

*Deadlocks* occur when you have two sessions, each of which is holding a resource that the other wants. For example, if I have two tables, A and B, in my database, and each has a single row in it, I can demonstrate a deadlock easily. All I need to do is open two sessions (e.g., two SQL\*Plus sessions). In session A, I update table A. In session B, I update table B. Now, if I attempt to update table A in session B, I will become blocked. Session A has this row locked already. This is not a deadlock; it is just blocking. I have not yet deadlocked because there is a chance that session A will commit or roll back, and session B will simply continue at that point.

If I go back to session A and then try to update table B, I will cause a deadlock. One of the two sessions will be chosen as a victim and will have its statement rolled back. For example, the attempt by session B to update table A may be rolled back, with an error such as the following:

```
update a set x = x+1
*
ERROR at line 1:
ORA-00060: deadlock detected while waiting for resource
```

Session A's attempt to update table B will remain blocked—Oracle will not roll back the entire transaction. Only one of the statements that contributed to the deadlock is rolled back. Session B still has the row in table B locked, and session A is patiently waiting for the row to become available. After receiving the deadlock message, session B must decide whether to commit the outstanding work on table B, roll it back, or continue down an alternate path and commit later. As soon as this session does commit or roll back, the other blocked session will continue on as if nothing happened.

Oracle considers deadlocks to be so rare and unusual that it creates a trace file on the server each time one does occur. The contents of the trace file will look something like this:

```
*** 2014-04-16 18:58:26.602
*** SESSION ID:(31.18321) 2014-04-16 18:58:26.603
*** CLIENT ID:() 2014-04-16 18:58:26.603
*** SERVICE NAME:(SYS$USERS) 2014-04-16 18:58:26.603
*** MODULE NAME:(SQL*Plus) 2014-04-16 18:58:26.603
```

```

*** ACTION NAME:( ) 2014-04-16 18:58:26.603
*** 2014-04-16 18:58:26.603
DEADLOCK DETECTED ( ORA-00060 )

```

[Transaction Deadlock]

The following deadlock is not an ORACLE error. It is a deadlock due to user error in the design of an application or from issuing incorrect ad-hoc SQL. The following information may aid in determining the deadlock:

Obviously, Oracle considers these application deadlocks a self-induced error on the part of the application and, for the most part, Oracle is correct. Unlike in many other RDBMSs, deadlocks are so rare in Oracle they can be considered almost nonexistent. Typically, you must come up with artificial conditions to get one.

The number one cause of deadlocks in the Oracle database, in my experience, is unindexed foreign keys. (The number two cause is bitmap indexes on tables subject to concurrent updates, which we'll cover in Chapter 11). Oracle will place a full table lock on a child table after modification of the parent table in three scenarios:

- If you update the parent table's primary key (a very rare occurrence if you follow the rule of relational databases stating that primary keys should be immutable), the child table will be locked in the absence of an index on the foreign key.
- If you delete a parent table row, the entire child table will be locked (in the absence of an index on the foreign key) as well.
- If you merge into the parent table, the entire child table will be locked (in the absence of an index on the foreign key) as well. *Note this is only true in Oracle9i and 10g and is no longer true in Oracle 11g Release 1 and above.*

These full table locks are a short-term occurrence in Oracle9i and above, meaning they need to be taken for the duration of the DML operation, not the entire transaction. Even so, they can and do cause large locking issues. As a demonstration of the first point, if we have a pair of tables set up as follows, nothing untoward happens yet:

```

EODA@ORA12CR1> create table p ( x int primary key );
Table created.

```

```

EODA@ORA12CR1> create table c ( x references p );
Table created.

```

```

EODA@ORA12CR1> insert into p values ( 1 );
1 row created.

```

```

EODA@ORA12CR1> insert into p values ( 2 );
1 row created.

```

```

EODA@ORA12CR1> commit;
Commit complete.

```

```

EODA@ORA12CR1> insert into c values ( 2 );
1 row created.

```

But if we go into another session and attempt to delete the first parent record, we'll find that session gets immediately blocked.

```
EODA@ORA12CR1> delete from p where x = 1;
```

It is attempting to gain a full table lock on table C before it does the delete. Now no other session can initiate a DELETE, INSERT, or UPDATE of any rows in C (the sessions that had already started may continue, but no new sessions may start to modify C).

This blocking would happen with an update of the primary key value as well. Because updating a primary key is a huge no-no in a relational database, this is generally not an issue with updates. However, I have seen this updating of the primary key become a serious issue when developers use tools that generate SQL for them, and those tools update every single column, regardless of whether the end user actually modified that column or not. For example, say that we use Oracle Forms and create a default layout on any table. Oracle Forms by default will generate an update that modifies every single column in the table we choose to display. If we build a default layout on the DEPT table and include all three fields, Oracle Forms will execute the following command whenever we modify any of the columns of the DEPT table:

```
update dept set deptno=:1,dname=:2,loc=:3 where rowid=:4
```

In this case, if the EMP table has a foreign key to DEPT and there is no index on the DEPTNO column in the EMP table, then the entire EMP table will be locked during an update to DEPT. This is something to watch out for carefully if you are using any tools that generate SQL for you. Even though the value of the primary key does not change, the child table EMP will be locked after the execution of the preceding SQL statement. In the case of Oracle Forms, the solution is to set that table's UPDATE CHANGED COLUMNS ONLY property to YES. Oracle Forms will generate an UPDATE statement that includes only the changed columns (not the primary key).

Problems arising from deletion of a row in a parent table are far more common. As I demonstrated, if I delete a row in table P, then the child table, C, will become locked during the DML operation, thus preventing other updates against C from taking place for the duration of the transaction (assuming no one else was modifying C, of course; in which case the delete will wait). This is where the blocking and deadlock issues come in. By locking the entire table C, I have seriously decreased the concurrency in my database to the point where no one will be able to modify anything in C. In addition, I have increased the probability of a deadlock, since I now own lots of data until I commit. The probability that some other session will become blocked on C is now much higher; any session that tries to modify C will get blocked. Therefore, I'll start seeing lots of sessions that hold some preexisting locks on other resources getting blocked in the database. If any of these blocked sessions are, in fact, locking a resource that my session also needs, we will have a deadlock. The deadlock in this case is caused by my session preventing access to many more resources (in this case, all of the rows in a single table) than it ever needed. When someone complains of deadlocks in the database, I have them run a script that finds unindexed foreign keys; 99 percent of the time we locate an offending table. By simply indexing that foreign key, the deadlocks—and lots of other contention issues—go away. The following example demonstrates the use of this script to locate the unindexed foreign key in table C:

```
EODA@ORA12CR1> column columns format a30 word_wrapped
EODA@ORA12CR1> column table_name format a15 word_wrapped
EODA@ORA12CR1> column constraint_name format a15 word_wrapped
```

```
EODA@ORA12CR1> select table_name, constraint_name,
 2      cname1 || nvl2(cname2, ',' || cname2, null) ||
 3      nvl2(cname3, ',' || cname3, null) || nvl2(cname4, ',' || cname4, null) ||
 4      nvl2(cname5, ',' || cname5, null) || nvl2(cname6, ',' || cname6, null) ||
 5      nvl2(cname7, ',' || cname7, null) || nvl2(cname8, ',' || cname8, null)
 6      columns
```

```

7   from ( select b.table_name,
8           b.constraint_name,
9           max(decode( position, 1, column_name, null )) cname1,
10          max(decode( position, 2, column_name, null )) cname2,
11          max(decode( position, 3, column_name, null )) cname3,
12          max(decode( position, 4, column_name, null )) cname4,
13          max(decode( position, 5, column_name, null )) cname5,
14          max(decode( position, 6, column_name, null )) cname6,
15          max(decode( position, 7, column_name, null )) cname7,
16          max(decode( position, 8, column_name, null )) cname8,
17          count(*) col_cnt
18         from (select substr(table_name,1,30) table_name,
19                 substr(constraint_name,1,30) constraint_name,
20                 substr(column_name,1,30) column_name,
21                 position
22                from user_cons_columns ) a,
23                user_constraints b
24        where a.constraint_name = b.constraint_name
25              and b.constraint_type = 'R'
26        group by b.table_name, b.constraint_name
27       ) cons
28  where col_cnt > ALL
29         ( select count(*)
30           from user_ind_columns i,
31               user_indexes      ui
32          where i.table_name = cons.table_name
33                and i.column_name in (cname1, cname2, cname3, cname4,
34                                     cname5, cname6, cname7, cname8 )
35                and i.column_position <= cons.col_cnt
36                and ui.table_name = i.table_name
37                and ui.index_name = i.index_name
38                and ui.index_type IN ('NORMAL', 'NORMAL/REV')
39          group by i.index_name
40         )
41 /

```

TABLE_NAME	CONSTRAINT_NAME	COLUMNS
C	SYS_C0061427	X

This script works on foreign key constraints that have up to eight columns in them (if you have more than that, you probably want to rethink your design). It starts by building an inline view named `CONS` in the previous query. This inline view transposes the appropriate column names in the constraint from rows into columns, with the result being a row per constraint and up to eight columns that have the names of the columns in the constraint. Additionally, there is a column, `COL_CNT`, which contains the number of columns in the foreign key constraint itself. For each row returned from the inline view, we execute a correlated subquery that checks all of the indexes on the table currently being processed. It counts the columns in that index that match columns in the foreign key constraint and then groups them by index name. So, it generates a set of numbers, each of which is a count of matching columns in some index on that table. If the original `COL_CNT` is greater than all of these numbers, then there is no index on that table that supports that constraint. If `COL_CNT` is less than all of these numbers, then there is at least one index that supports that constraint. Note the use of the `NVL2` function, which we used to “glue” the list of column names into a

comma-separated list. This function takes three arguments: A, B, C. If argument A is not null, then it returns argument B; otherwise, it returns argument C. This query assumes that the owner of the constraint is the owner of the table and index as well. If another user indexed the table or the table is in another schema (both rare events), it will not work correctly.

The prior script also checks to see if the index type is a B\*Tree index (NORMAL or NORMAL/REV). We're checking to see if it's a B\*Tree index because a bitmap index on a foreign key column does not prevent the locking issue.

---

■ **Note** In data warehouse environments, it's common to create bitmap indexes on a fact table's foreign key columns. However, in data warehouse environments, usually the loading of data is done in an orderly manner through scheduled ETL processes and, therefore, would not encounter the situation of inserting into a child table as one process while concurrently deleting from a parent table from another process (like you might encounter in an OLTP application).

---

So, the prior script shows that table C has a foreign key on the column X but no index. By creating a B\*Tree index on X, we can remove this locking issue all together. In addition to this table lock, an unindexed foreign key can also be problematic in the following cases:

- When you have an ON DELETE CASCADE and have not indexed the child table. For example, EMP is child of DEPT. DELETE DEPTNO = 10 should CASCADE to EMP. If DEPTNO in EMP is not indexed, you will get a full table scan of EMP for each row deleted from the DEPT table. This full scan is probably undesirable, and if you delete many rows from the parent table, the child table will be scanned once for each parent row deleted.
- When you query from the parent to the child. Consider the EMP/DEPT example again. It is very common to query the EMP table in the context of a DEPTNO. If you frequently run the following query (say, to generate a report), you'll find that not having the index in place will slow down the queries:

```
select * from dept, emp
where emp.deptno = dept.deptno and dept.deptno = :X;
```

When do you not need to index a foreign key? The answer is, in general, when the following conditions are met:

- You do not delete from the parent table.
- You do not update the parent table's unique/primary key value (watch for unintended updates to the primary key by tools).
- You do not join from the parent to the child (like DEPT to EMP).

If you satisfy all three conditions, feel free to skip the index; it's not needed. If you meet any of the preceding conditions, be aware of the consequences. This is the one rare instance when Oracle tends to overlock data.

## Lock Escalation

When lock escalation occurs, the system is decreasing the granularity of your locks. An example would be the database system turning your 100 row-level locks against a table into a single table-level lock. You are now using one lock to lock everything and, typically, you are also locking a whole lot more data than you were before. Lock escalation is used frequently in databases that consider a lock to be a scarce resource and overhead to be avoided.

---

■ **Note** Oracle will never escalate a lock. Never.

---

Oracle never escalates locks, but it does practice lock conversion or lock promotion, terms that are often confused with lock escalation.

---

■ **Note** The terms *lock conversion* and *lock promotion* are synonymous. Oracle typically refers to the process as *lock conversion*.

---

Oracle will take a lock at the lowest level possible (i.e., the least restrictive lock possible) and convert that lock to a more restrictive level if necessary. For example, if you select a row from a table with the `FOR UPDATE` clause, two locks will be created. One lock is placed on the row(s) you selected (and this will be an exclusive lock; no one else can lock that specific row in exclusive mode). The other lock, a `ROW SHARE TABLE` lock, is placed on the table itself. This will prevent other sessions from placing an exclusive lock on the table and thus prevent them from altering the structure of the table, for example. Another session can modify any other row in this table without conflict. As many commands as possible that could execute successfully given there is a locked row in the table will be permitted.

Lock escalation is not a database “feature.” It is not a desired attribute. The fact that a database supports lock escalation implies there is some inherent overhead in its locking mechanism and significant work is performed to manage hundreds of locks. In Oracle, the overhead to have 1 lock or 1 million locks is the same: none.

## Lock Types

The three general classes of locks in Oracle are as follows:

- *DML locks*: DML stands for *Data Manipulation Language*. In general this means `SELECT`, `INSERT`, `UPDATE`, `MERGE`, and `DELETE` statements. DML locks are the mechanism that allows for concurrent data modifications. DML locks will be, for example, locks on a specific row of data or a lock at the table level that locks every row in the table.
- *DDL locks*: DDL stands for *Data Definition Language*, (`CREATE` and `ALTER` statements, and so on). DDL locks protect the definition of the structure of objects.
- *Internal locks and latches*: Oracle uses these locks to protect its internal data structures. For example, when Oracle parses a query and generates an optimized query plan, it will latch the library cache to put that plan in there for other sessions to use. A latch is a lightweight, low-level serialization device employed by Oracle, similar in function to a lock. Do not confuse or be misled by the term *lightweight*; latches are a common cause of contention in the database, as you will see. They are lightweight in their implementation, but not their effect.

We will now take a more detailed look at the specific types of locks within each of these general classes and the implications of their use. There are more lock types than I can cover here. The ones I cover in the sections that follow are the most common and are held for a long duration. The other types of locks are generally held for very short periods of time.

## DML Locks

DML locks are used to ensure that only one person at a time modifies a row and that no one can drop a table upon which you are working. Oracle will place these locks for you, more or less transparently, as you do work.



## TX (Transaction) Locks

A *TX lock* is acquired when a transaction initiates its first change. The transaction is automatically initiated at this point (you don't explicitly start a transaction in Oracle). The lock is held until the transaction performs a `COMMIT` or `ROLLBACK`. It is used as a queuing mechanism so that other sessions can wait for the transaction to complete. Each and every row you modify or `SELECT FOR UPDATE` in a transaction will point to an associated TX lock for that transaction. While this sounds expensive, it is not. To understand why this is, you need a conceptual understanding of where locks live and how they are managed. In Oracle, locks are stored as an attribute of the data (see Chapter 10 for an overview of the Oracle block format). Oracle does not have a traditional lock manager that keeps a long list of every row that is locked in the system. Many other databases do it that way because, for them, locks are a scarce resource, the use of which needs to be monitored. The more locks are in use, the more these systems have to manage, so it is a concern in these systems if too many locks are being used.

In a database with a traditional memory-based lock manager, the process of locking a row would resemble the following:

1. Find the address of the row you want to lock.
2. Get in line at the lock manager (which must be serialized, as it is a common in-memory structure).
3. Lock the list.
4. Search through the list to see if anyone else has locked this row.
5. Create a new entry in the list to establish the fact that you have locked the row.
6. Unlock the list.

Now that you have the row locked, you can modify it. Later, as you commit your changes, you must continue the procedure as follows:

1. Get in line again.
2. Lock the list of locks.
3. Search through the list and release all of your locks.
4. Unlock the list.

As you can see, the more locks acquired, the more time spent on this operation, both before and after modifying the data. Oracle does not do it that way. Oracle's process looks like this:

1. Find the address of the row you want to lock.
2. Go to the row.
3. Lock the row right there, right then—at the location of the row, not in a big list somewhere (waiting for the transaction that has it locked to end if it is already locked, unless you are using the `NOWAIT` option).

That's it. Since the lock is stored as an attribute of the data, Oracle does not need a traditional lock manager. The transaction will simply go to the data and lock it (if it is not locked already). The interesting thing is that the data may appear locked when you get to it, even if it's not. When you lock rows of data in Oracle, the row points to a copy of the transaction ID that is stored with the block containing the data, and when the lock is released that transaction ID is left behind. This transaction ID is unique to your transaction and represents the undo segment number, slot, and sequence number. You leave that on the block that contains your row to tell other sessions that you own this data (not all of the data on the block—just the one row you are modifying). When another session comes along, it sees the transaction ID and, using the fact that it represents a transaction, it can quickly see if the transaction holding the lock

is still active. If the lock is not active, the session is allowed access to the data. If the lock is still active, that session will ask to be notified as soon as the lock is released. Hence, you have a queuing mechanism: the session requesting the lock will be queued up waiting for that transaction to complete, and then it will get the data.

Here is a small example showing how this happens, using three V\$ tables:

- V\$TRANSACTION, which contains an entry for every active transaction.
- V\$SESSION, which shows the sessions logged in.
- V\$LOCK, which contains an entry for all enqueue locks being held as well as for sessions that are waiting on locks. You will not see a row in this view for each row locked by a session. As stated earlier, that master list of locks at the row level doesn't exist. If a session has one row in the EMP table locked, there will be one row in this view for that session indicating that fact. If a session has millions of rows in the EMP table locked, there will still be just one row in this view. This view shows what enqueue locks individual sessions have.

First, let's get a copy of the EMP and DEPT tables. If you already have them in your schema, replace them with the following definitions:

```
EODA@ORA12CR1> create table dept
  2 as select * from scott.dept;
Table created.
```

```
EODA@ORA12CR1> create table emp
  2 as select * from scott.emp;
Table created.
```

```
EODA@ORA12CR1> alter table dept
  2 add constraint dept_pk
  3 primary key(deptno);
Table altered.
```

```
EODA@ORA12CR1> alter table emp
  2 add constraint emp_pk
  3 primary key(empno);
Table altered.
```

```
EODA@ORA12CR1> alter table emp
  2 add constraint emp_fk_dept
  3 foreign key (deptno)
  4 references dept(deptno);
Table altered.
```

```
EODA@ORA12CR1> create index emp_deptno_idx
  2 on emp(deptno);
Index created.
```

Let's start a transaction now:

```
EODA@ORA12CR1> update dept
  2 set dname = initcap(dname);
4 rows updated.
```

Now, let's look at the state of the system at this point. This example assumes a single-user system; otherwise, you may see many rows in V\$TRANSACTION. Even in a single-user system, do not be surprised to see more than one row in V\$TRANSACTION, as many of the background Oracle processes may be performing a transaction as well.

```
EODA@ORA12CR1> select username,
2      v$lock.sid,
3      trunc(id1/power(2,16)) rbs,
4      bitand(id1,to_number('ffff','xxxx')+0 slot,
5      id2 seq,
6      lmode,
7      request
8  from v$lock, v$session
9  where v$lock.type = 'TX'
10     and v$lock.sid = v$session.sid
11     and v$session.username = USER;
```

USERNAME	SID	RBS	SLOT	SEQ	LMODE	REQUEST
EODA	22	2	27	21201	6	0

```
EODA@ORA12CR1> select XIDUSN, XIDSLOT, XIDSQN from v$transaction;
```

XIDUSN	XIDSLOT	XIDSQN
2	27	21201

The interesting points to note here are as follows:

- The LMODE is 6 in the V\$LOCK table and the REQUEST is 0. If you refer to the definition of the V\$LOCK table in the *Oracle Database Reference* manual, you will find that LMODE=6 is an exclusive lock. A value of 0 in the request means you are not making a request; you have the lock.
- There is only one row in this table. This V\$LOCK table is more of a queuing table than a lock table. Many people expect four rows in V\$LOCK since we have four rows locked. Remember, however, that Oracle does not store a master list of every row locked anywhere. To find out if a row is locked, we must go to that row.
- I took the ID1 and ID2 columns and performed some manipulation on them. Oracle needed to save three 16-bit numbers, but only had two columns in order to do it. So, the first column ID1 holds two of these numbers. By dividing by  $2^{16}$  with `trunc(id1/power(2,16)) rbs`, and by masking out the high bits with `bitand(id1,to_number('ffff','xxxx')+0 slot`, I am able to get back the two numbers that are hiding in that one number.
- The RBS, SLOT, and SEQ values match the V\$TRANSACTION information. This is my transaction ID.

Now we'll start another session using the same username, update some rows in EMP, and then try to update DEPT:

```
EODA@ORA12CR1> update emp set ename = upper(ename);
14 rows updated.
```

```
EODA@ORA12CR1> update dept set deptno = deptno-10;
```

We're now blocked in this session. If we run the V\$ queries again, we see the following:

```
EODA@ORA12CR1> select username,
2      v$lock.sid,
3      trunc(id1/power(2,16)) rbs,
4      bitand(id1,to_number('ffff','xxxx'))+0 slot,
5      id2 seq,
6      lmode,
7      request
8 from v$lock, v$session
9 where v$lock.type = 'TX'
10 and v$lock.sid = v$session.sid
11 and v$session.username = USER;
```

USERNAME	SID	RBS	SLOT	SEQ	LMODE	REQUEST
EODA	17	2	27	21201	0	6
EODA	22	2	27	21201	6	0
EODA	17	8	17	21403	6	0

```
EODA@ORA12CR1> select XIDUSN, XIDSLOT, XIDSQN from v$transaction;
```

XIDUSN	XIDSLOT	XIDSQN
2	27	21201
8	17	21403

What we see here is that a new transaction has begun, with a transaction ID of (8,17,21403). Our new session, SID=17, has two rows in V\$LOCK this time. One row represents the locks that it owns (where LMODE=6). It also has a row that shows a REQUEST with a value of 6. This is a request for an exclusive lock. The interesting thing to note here is that the RBS/SLOT/SEQ values of this request row are the transaction ID of the *holder* of the lock. The transaction with SID=22 is blocking the transaction with SID=17. We can see this more explicitly simply by doing a self-join of V\$LOCK:

```
EODA@ORA12CR1> select
2      (select username from v$session where sid=a.sid) blocker,
3      a.sid,
4      ' is blocking ',
5      (select username from v$session where sid=b.sid) blockee,
6      b.sid
7 from v$lock a, v$lock b
8 where a.block = 1
9 and b.request > 0
10 and a.id1 = b.id1
11 and a.id2 = b.id2;
```

BLOCKER	SID 'ISBLOCKING'	BLOCKEE	SID
EODA	22 is blocking	EODA	17

Now, if we commit our original transaction, SID=22, and rerun our lock query, we find that the request row has gone:

```
EODA@ORA12CR1> select username,
2      v$lock.sid,
3      trunc(id1/power(2,16)) rbs,
4      bitand(id1,to_number('ffff','xxxx')+0) slot,
5      id2 seq,
6      lmode,
7      request
8  from v$lock, v$session
9  where v$lock.type = 'TX'
10     and v$lock.sid = v$session.sid
11     and v$session.username = USER;
```

USERNAME	SID	RBS	SLOT	SEQ	LMODE	REQUEST
EODA	17	8	17	21403	6	0

```
EODA@ORA12CR1> select XIDUSN, XIDSLOT, XIDSQN from v$transaction;
```

XIDUSN	XIDSLOT	XIDSQN
8	17	21403

The request row disappeared the instant the other session gave up its lock. That request row was the queuing mechanism. The database is able to wake up the blocked sessions the instant the transaction is completed. There are prettier displays with various GUI tools, but in a pinch, having knowledge of the tables you need to look at is very useful.

However, before we can say that we have a good understanding of how the row locking in Oracle works, we must look at one last topic: how the locking and transaction information is managed with the data itself. It is part of the block overhead. In Chapter 10, we'll get into the details of the block format, but suffice it to say that at the top of a database block is some leading overhead space in which to store a transaction table for that block. This transaction table contains an entry for each real transaction that has locked some data in that block. The size of this structure is controlled by two physical attribute parameters on the CREATE statement for an object:

- **INITTRANS:** The initial, preallocated size of this structure. This defaults to 2 for indexes and tables.
- **MAXTRANS:** The maximum size to which this structure may grow. It defaults to 255 and has a minimum of 2 practically. In Oracle 10g and above, *this setting has been deprecated*, so it no longer applies. MAXTRANS is always 255 in that release and later.

Each block starts life with, by default, two transaction slots. The number of simultaneous active transactions that a block can ever have is constrained by the value of MAXTRANS and by the availability of space on the block. You may not be able to achieve 255 concurrent transactions on the block if there is not sufficient space to grow this structure.

We can artificially demonstrate how this works by creating a table with lots of rows packed into a single block such that the block is very full from the start; there will be very little room left on the block after we initially load our data. The presence of these rows will limit how large the transaction table can grow, due to the lack of space. I was using an 8KB block size and I tested this particular example in all versions of Oracle from 9i Release 2 through 12c

Release 1 with the same results (so, if you have an 8KB blocksize, you should be able to reproduce this). We'll start by creating our packed table. I played around with different lengths of data until I arrived at this very special size:

```
EODA@ORA12CR1> create table t
  2 ( x int primary key,
  3   y varchar2(4000)
  4 )
  5 /
```

Table created.

```
EODA@ORA12CR1> insert into t (x,y)
  2 select rownum, rpad('*',148, '*')
  3   from dual
  4   connect by level <= 46;
46 rows created.
```

```
EODA@ORA12CR1> select length(y),
  2         dbms_rowid.rowid_block_number(rowid) blk,
  3         count(*), min(x), max(x)
  4   from t
  5   group by length(y), dbms_rowid.rowid_block_number(rowid);
```

LENGTH(Y)	BLK	COUNT(*)	MIN(X)	MAX(X)
148	23470	46	1	46

So, our table has 46 rows, all on the same block. I chose 148 characters because if it was one character more, we'd need two blocks to hold these same 46 records. Now, we need a way to see what happens when many transactions try to lock data on this single block simultaneously. For that, we'll use an AUTONOMOUS\_TRANSACTION again, just so we can use a single session and not have to run lots of concurrent SQL\*Plus sessions. Our stored procedure will lock a row in the table by the primary key starting with a primary key value of 1 (the first record inserted). If our procedure gets the lock on this row without having to wait (without getting blocked), it will simply increase the primary key value by 1 and, using recursion, do it all over again. So, the second call will try to lock record 2, the third call record 3, and so on. If the procedure is made to wait, it will raise an ORA-54 resource busy error and we'll print out "locked out trying to select row <primary key value>". That will indicate we ran out of transaction slots on this block before we ran out of rows to lock. On the other hand, if we find no row to lock, that means we've already locked every row on this block and we print out success (meaning, the transaction table in the block header was able to grow to accommodate all of the transactions). Here is that stored procedure:

```
EODA@ORA12CR1> create or replace procedure do_update( p_n in number )
  2 as
  3   pragma autonomous_transaction;
  4   l_rec t%rowtype;
  5   resource_busy exception;
  6   pragma exception_init( resource_busy, -54 );
  7 begin
  8   select *
  9     into l_rec
 10    from t
 11   where x = p_n
 12     for update NOWAIT;
 13
```

```

14     do_update( p_n+1 );
15     commit;
16 exception
17 when resource_busy
18 then
19     dbms_output.put_line( 'locked out trying to select row ' || p_n );
20     commit;
21 when no_data_found
22 then
23     dbms_output.put_line( 'we finished - no problems' );
24     commit;
25 end;
26 /

```

Procedure created.

The magic is on line 14 where we recursively call ourselves with a new primary key value to lock over and over. If you run the procedure after populating the table with 148 character strings, you should observe:

```

EODA@ORA12CR1> exec do_update(1);
locked out trying to select row 38
PL/SQL procedure successfully completed.

```

This output shows that we were able to lock 37 rows but ran out of transaction slots for the 38th row. For this given block, a maximum of 37 transactions can concurrently access it. If we redo the example with a slightly smaller string we'll see that it finishes with no problems:

```

EODA@ORA12CR1> truncate table t;
Table truncated.

```

```

EODA@ORA12CR1> insert into t (x,y)
 2  select rownum, rpad('*',147, '*')
 3  from dual
 4  connect by level <= 46;
46 rows created.

```

```

EODA@ORA12CR1> select length(y),
 2      dbms_rowid.rowid_block_number(rowid) blk,
 3      count(*), min(x), max(x)
 4  from t
 5  group by length(y), dbms_rowid.rowid_block_number(rowid);

```

LENGTH(Y)	BLK	COUNT(*)	MIN(X)	MAX(X)
147	23470	46	1	46

```

EODA@ORA12CR1> exec do_update(1);
we finished - no problems
PL/SQL procedure successfully completed.

```

This time we completed successfully—the difference a single byte makes! In this case, having the extra 46 bytes of space free on the block (each of the 46 strings was just one byte smaller) allowed us to have at least 9 more transactions active on the block.

This example demonstrates what happens when many transactions attempt to access the same block simultaneously—a wait on the transaction table may occur if there is an extremely high number of concurrent transactions. Blocking may occur if the `INITRANS` is set low and there is not enough space on a block to dynamically expand the transaction. In most cases, the default of 2 for `INITRANS` is sufficient, as the transaction table will dynamically grow (space permitting), but in some environments you may need to increase this setting (to reserve more room for slots) to increase concurrency and decrease waits.

An example of when you might need to increase the setting would be on a table or, even more frequently, on an index (since index blocks can get many more rows on them than a table can typically hold) that is frequently modified and has a lot of rows per block on average. You may need to increase either `PCTFREE` (discussed in Chapter 10) or `INITRANS` to set aside ahead of time sufficient space on the block for the number of expected concurrent transactions. This is especially true if you anticipate the blocks will be nearly full to begin with, meaning there is no room for the dynamic expansion of the transaction structure on the block.

One last note on `INITRANS`. A couple of times I've stated that the default value for this attribute is 2. However, if you examine the data dictionary after creating a table, you'll notice that `INITRANS` displays a value of 1:

```
EODA@ORA12CR1> create table t ( x int );
EODA@ORA12CR1> select ini_trans from user_tables where table_name = 'T';

INI_TRANS
-----
         1
```

So is the default number of transaction slots 1 or 2? Even though the data dictionary is showing a value of 1, we can demonstrate that it really is 2. Consider this experiment. First generate one transaction for table T by inserting a single record:

```
EODA@ORA12CR1> insert into t values ( 1 );
```

Now verify that one block is consumed by table T:

```
EODA@ORA12CR1> select dbms_rowid.ROWID_BLOCK_NUMBER(rowid) from t;
DBMS_ROWID.ROWID_BLOCK_NUMBER(ROWID)
-----
                               57715
```

Next, place into the variables—B and F—the block number and the data file number of the block used by table T:

```
EODA@ORA12CR1> column b new_val B
EODA@ORA12CR1> column f new_val F
EODA@ORA12CR1> select dbms_rowid.ROWID_BLOCK_NUMBER(rowid) B,
   2      dbms_rowid.ROWID_TO_ABSOLUTE_FNO( rowid, user, 'T' ) F
   3      from t;
```

Now dump the block being used by table T:

```
EODA@ORA12CR1> alter system dump datafile &F block &B;
```



Next, place into a variable named TRACE the location and name of the trace file containing the dump information for the block:

```
EODA@ORA12CR1> column trace new_val TRACE

EODA@ORA12CR1> select c.value || '/' || d.instance_name || '_ora_' || a.spid || '.trc' trace
 2   from v$process a, v$session b, v$parameter c, v$instance d
 3   where a.addr = b.paddr
 4         and b.audsid = userenv('sessionid')
 5         and c.name = 'user_dump_dest';
```

Now terminate the session and edit the trace file:

```
EODA@ORA12CR1> disconnect
EODA@ORA12CR1> edit &TRACE
```

Searching the trace file for the value of Itl, we see there are two transaction slots that have been initialized (even though there has only been one transaction issued for this table):

Itl	Xid	Uba	Flag	Lck	Scn/Fsc
0x01	0x0013.00e.000024be	0x00c000bf.039e.2d	--U-	1	fsc 0x0000.01cfa56a
0x02	0x0000.000.00000000	0x00000000.0000.00	----	0	fsc 0x0000.00000000

The INITRANS value of 1 reported in the data dictionary is most likely a legacy value and it really should display a value of 2 for more current versions of Oracle.

## TM (DML Enqueue) Locks

TM locks are used to ensure that the structure of a table is not altered while you are modifying its contents. For example, if you have updated a table, you will acquire a TM lock on that table. This will prevent another user from executing DROP or ALTER commands on that table. If another user attempts to perform DDL on the table while you have a TM lock on it, he'll receive the following error message:

```
drop table dept
      *
ERROR at line 1:
ORA-00054: resource busy and acquire with NOWAIT specified
```

---

■ **Note** In Oracle 11g Release 2 and above, you may set DDL\_LOCK\_TIMEOUT in order to have DDL wait. This is achieved typically via the ALTER SESSION command. For example, you could issue ALTER SESSION SET DDL\_LOCK\_TIMEOUT=60; before issuing the DROP TABLE command. The DROP TABLE command issued would then wait 60 seconds before returning an error (or it could succeed, of course, as well).

---

The ORA-00054 message is a confusing message at first, since there is no direct method to specify NOWAIT or WAIT on a DROP TABLE at all. It is just the generic message you get when you attempt to perform an operation that would be blocked, but the operation does not permit blocking. As you've seen before, it's the same message you get if you issue a SELECT FOR UPDATE NOWAIT against a locked row.

The following shows how these locks would appear in the V\$LOCK table:

```
EODA@ORA12CR1> create table t1 ( x int );
Table created.

EODA@ORA12CR1> create table t2 ( x int );
Table created.

EODA@ORA12CR1> insert into t1 values ( 1 );
1 row created.

EODA@ORA12CR1> insert into t2 values ( 1 );
1 row created.

EODA@ORA12CR1> select (select username
2      from v$session
3      where sid = v$lock.sid) username,
4      sid,
5      id1,
6      id2,
7      lmode,
8      request, block, v$lock.type
9  from v$lock
10 where sid = sys_context('userenv','sid');
```

USERNAME	SID	ID1	ID2	LMODE	REQUEST	BLOCK TY
EODA	22	133	0	4	0	0 AE
<b>EODA</b>	<b>22</b>	<b>244271</b>	<b>0</b>	<b>3</b>	<b>0</b>	<b>0 TM</b>
<b>EODA</b>	<b>22</b>	<b>244270</b>	<b>0</b>	<b>3</b>	<b>0</b>	<b>0 TM</b>
EODA	22	1966095	152	6	0	0 TX

```
EODA@ORA12CR1> select object_name, object_id
2  from user_objects
3  where object_id in (244271,244270);
```

OBJECT_NAM	OBJECT_ID
T2	244271
T1	244270

---

■ **Note** The AE lock is an edition lock, available in Oracle 11g and above. It is part of the Edition Based Redefinition feature (not covered in this particular book). ID1 is the object id of the edition that SID is using currently. This edition lock protects the referenced edition from modification (dropping of the edition, for example) in much the same way the TM locks protect the tables they point to from structural modification.

---

Whereas we get only one TX lock per transaction, we can get as many TM locks as the objects we modify. Here, the interesting thing is that the ID1 column for the TM lock is the object ID of the DML-locked object, so it is easy to find the object on which the lock is being held.

An interesting aside to the TM lock: the total number of TM locks allowed in the system is configurable by you (for details, see the DML\_LOCKS parameter definition in the *Oracle Database Reference* manual). It may, in fact, be set to zero. This does not mean that your database becomes a read-only database (no locks), but rather that DDL is not permitted. This is useful in very specialized applications, such as RAC implementations, to reduce the amount of intra-instance coordination that would otherwise take place. You can also remove the ability to gain TM locks on an object-by-object basis using the ALTER TABLE <TABLENAME> DISABLE TABLE LOCK command. This is a quick way to make it harder to accidentally drop a table, as you will have to reenable the table lock before dropping the table. It can also be used to detect a full table lock as a result of the unindexed foreign key we discussed previously.

## DDL Locks

DDL locks are automatically placed against objects during a DDL operation to protect them from changes by other sessions. For example, if I perform the DDL operation ALTER TABLE T, the table T will *in general* have an exclusive DDL lock placed against it, preventing other sessions from getting DDL locks and TM locks on this table.

---

■ **Note** Oracle 11g has modified what used to be a rule. In the past, ALTER TABLE T would have an exclusive DDL lock placed against it. In this example, table T prevents other sessions from performing DDL and acquiring TM locks (used to modify the contents of the table). Now, many ALTER commands can be performed online—without preventing modifications.

---

DDL locks are held for the duration of the DDL statement and are released immediately afterward. This is done, in effect, by always wrapping DDL statements in implicit commits (or a commit/rollback pair). For this reason, DDL always commits in Oracle. Every CREATE, ALTER, and so on statement is really executed as shown in this pseudo-code:

```
Begin
  Commit;
  DDL-STATEMENT
  Commit;
Exception
  When others then rollback;
End;
```

So, DDL will always commit, even if it is unsuccessful. DDL starts by committing; be aware of this. It commits first so that if it has to roll back, it will not roll back your transaction. If you execute DDL, it will make permanent any outstanding work you have performed, even if the DDL is not successful. If you need to execute DDL, but you do not want it to commit your existing transaction, you may use an autonomous transaction.

There are three types of DDL locks:

- *Exclusive DDL locks*: These prevent other sessions from gaining a DDL lock or TM (DML) lock themselves. This means that you may query a table during a DDL operation, but you may not modify it in any way.
- *Share DDL locks*: These protect the structure of the referenced object against modification by other sessions, but allow modifications to the data.
- *Breakable parse locks*: These allow an object, such as a query plan cached in the shared pool, to register its reliance on some other object. If you perform DDL against that object, Oracle will review the list of objects that have registered their dependence and invalidate them. Hence, these locks are breakable—they do not prevent the DDL from occurring.

Most DDL takes an exclusive DDL lock. If you issue a statement such as

```
Alter table t move;
```

the table T will be unavailable for modifications during the execution of that statement. The table may be queried using SELECT during this time, but most other operations will be prevented, including all other DDL statements. In Oracle, some DDL operations may now take place without DDL locks. For example, I can issue the following:

```
Create index t_idx on t(x) ONLINE;
```

The ONLINE keyword modifies the method by which the index is actually built. Instead of taking an exclusive DDL lock, preventing modifications of data, Oracle will only attempt to acquire a low-level (mode 2) TM lock on the table. This will effectively prevent other DDL from taking place, but it will allow DML to occur normally. Oracle accomplishes this feat by keeping a record of modifications made to the table during the DDL statement and applying these changes to the new index as it finishes the CREATE action. This greatly increases the availability of data. To see this for yourself, you could create a table of some size:

```
EODA@ORA12CR1> create table t as select * from all_objects;
Table created.
```

```
EODA@ORA12CR1> select object_id from user_objects where object_name = 'T';
```

```
OBJECT_ID
-----
244277
```

And then run the create index against that table:

```
EODA@ORA12CR1> create index t_idx on t(owner,object_type,object_name) ONLINE;
```

While at the same time running this query in another session to see the locks taken against that newly created table (remember, ID1=244277 is specific to my example, you'll want to use *your* object ID).

```
EODA@ORA12CR1> select (select username
2      from v$session
3      where sid = v$lock.sid) username,
4      sid,
5      id1,
6      id2,
7      lmode,
8      request, block, v$lock.type
9  from v$lock
10 where id1 = 244277
11 /
```

USERNAME	SID	ID1	ID2	LMODE	REQUEST	BLOCK TY
EODA	22	244277	0	3	0	0 DL
EODA	22	244277	0	3	0	0 DL
EODA	22	244277	0	2	0	0 TM
EODA	22	244277	0	4	0	0 OD

So, here we see four locks taken out against our object. The two DL locks are *direct load* locks. They are used to prevent a direct path load into our base table while the index creation is taking place (which implies, of course, that you cannot directly path load the table AND create the index simultaneously). The OD lock is a lock type first appeared with Oracle 11g (you would not see that lock in 10g or 9i) that permits truly online DDL. In the past (10g and before), online DDL such as CREATE INDEX ONLINE was not 100 percent online. It would take a lock at the beginning and end of the CREATE statement—preventing other concurrent activities (modifications of the base table data). It was *mostly online* but not *completely online*. Starting with 11g, the CREATE INDEX ONLINE command is completely online; it does not require exclusionary locks at the beginning/end of the command. Part of the implementation to accomplish this feat was the introduction of the OD (Online DDL) lock; it is used internally to allow truly online DDL operations.

Other types of DDL take share DDL locks. These are taken out against dependent objects when you create stored, compiled objects, such as procedures and views. For example, if you execute the following, share DDL locks will be placed against both EMP and DEPT while the CREATE VIEW command is being processed:

```
Create view MyView
as
select emp.empno, emp.ename, dept.deptno, dept.dname
   from emp, dept
  where emp.deptno = dept.deptno;
```

You can modify the contents of these tables, but you cannot modify their structure.

The last type of DDL lock is a breakable parse lock. When your session parses a statement, a parse lock is taken against every object referenced by that statement. These locks are taken in order to allow the parsed, cached statement to be invalidated (flushed) in the shared pool if a referenced object is dropped or altered in some way.

A view that is invaluable for looking at this information is DBA\_DDL\_LOCKS. There is no V\$ view. The DBA\_DDL\_LOCKS view is built on the more mysterious X\$ tables and, by default, it might not be installed in your database. You can install this and other locking views by running the catblock.sql script found in the directory [ORACLE\_HOME]/rdbms/admin. This script must be executed as the user SYS in order to succeed. Once you have executed this script, you can run a query against the view. For example, in a freshly connected session, I might see the following:

```
EODA@ORA12CR1> connect eoda/foo
Connected.
EODA@ORA12CR1> set linesize 1000
EODA@ORA12CR1> select session_id sid, owner, name, type,
 2      mode_held held, mode_requested request
 3      from dba_ddl_locks
 4      where session_id = (select sid from v$mystat where rownum=1)
 5      /
```

SID	OWNER	NAME	TYPE	HELD	REQUEST
22	SYS	DBMS_OUTPUT	Body	Null	None
22	SYS	DBMS_OUTPUT	Table/Procedure/Type	Null	None
22	EODA	EODA	18	Null	None
22	SYS	DBMS_APPLICATION_INFO	Body	Null	None
22	SYS	PLITBLM	Table/Procedure/Type	Null	None
22	SYS	DBMS_APPLICATION_INFO	Table/Procedure/Type	Null	None
22		EODA	73	Share	None
22	SYS	DATABASE	18	Null	None

8 rows selected.

These are all the objects that my session is locking. I have breakable parse locks on a couple of the DBMS\_\* packages. These are a side effect of using SQL\*Plus; it might call DBMS\_APPLICATION\_INFO, for example, when you initially log in (to enable/disable DBMS\_OUTPUT via the SET SERVEROUTPUT command). I may see more than one copy of various objects here; this is normal, and it just means I have more than one thing I'm using in the shared pool that references these objects. Note that in the view, the OWNER column is not the owner of the lock; rather, it is the owner of the object being locked. This is why you see many SYS rows. SYS owns these packages, but they all *belong* to my session.

To see a breakable parse lock in action, let's first create and run a stored procedure, P:

```
EODA@ORA12CR1> create or replace procedure p
2 as
3 begin
4 null;
5 end;
6 /
```

Procedure created.

```
EODA@ORA12CR1> exec p
PL/SQL procedure successfully completed.
```

The procedure, P, will now show up in the DBA\_DDL\_LOCKS view. We have a parse lock on it:

```
EODA@ORA12CR1> select session_id sid, owner, name, type,
2 mode_held held, mode_requested request
3 from dba_ddl_locks
4 where session_id = (select sid from v$mystat where rownum=1)
5 /
```

SID	OWNER	NAME	TYPE	HELD	REQUEST
22	EODA	P	Table/Procedure/Type	Null	None
...					
22	SYS	DATABASE	18	Null	None

9 rows selected.

We then recompile our procedure and query the view again:

```
EODA@ORA12CR1> alter procedure p compile;
Procedure altered.
```

```
EODA@ORA12CR1> select session_id sid, owner, name, type,
2 mode_held held, mode_requested request
3 from dba_ddl_locks
4 where session_id = (select sid from v$mystat where rownum=1)
5 /
```

SID	OWNER	NAME	TYPE	HELD	REQUEST
22	SYS	DBMS_OUTPUT	Body	Null	None
22	SYS	DBMS_OUTPUT	Table/Procedure/Type	Null	None
22	EODA	EODA	18	Null	None
22	SYS	DBMS_APPLICATION_INFO	Body	Null	None
22	SYS	PLITBLM	Table/Procedure/Type	Null	None
22	SYS	DBMS_APPLICATION_INFO	Table/Procedure/Type	Null	None
22		EODA	73	Share	None
22	SYS	DATABASE	18	Null	None

8 rows selected.

We find that P is now missing from the view. Our parse lock has been broken.

This view is useful to you, as a developer, when it is found that some piece of code won't compile in the test or development system—it hangs and eventually times out. This indicates that someone else is using it (actually running it), and you can use this view to see who that might be. The same will happen with GRANT statements and other types of DDL against the object. You cannot grant EXECUTE on a procedure that is running, for example. You can use the same method to discover the potential blockers and waiters.

---

■ **Note** Oracle 11g Release 2 and above introduces the *feature* Edition-based redefinition (EBR). With EBR, you can, in fact, grant EXECUTE and/or recompile code in the database without interfering with users currently executing the code. EBR allows you to have multiple versions of the same stored procedure in a schema at once. This allows you to work on a copy of the procedure in a new edition (version) without contending with the current version of the procedure being used by other users. We will not be covering EBR in this book, however, just mentioning it when it changes the rules.

---

## Latches

*Latches* are lightweight serialization devices used to coordinate multiuser access to shared data structures, objects, and files.

Latches are locks designed to be held for extremely short periods of time—for example, the time it takes to modify an in-memory data structure. They are used to protect certain memory structures, such as the database block buffer cache or the library cache in the shared pool. Latches are typically requested internally in a *willing to wait* mode. This means that if the latch is not available, the requesting session will sleep for a short period of time and retry the operation later. Other latches may be requested in an immediate mode, which is similar in concept to a SELECT FOR UPDATE NOWAIT, meaning that the process will go do something else, such as try to grab an equivalent sibling latch that may be free, rather than sit and wait for this latch to become available. Since many requestors may be waiting for a latch at the same time, you may see some processes waiting longer than others. Latches are assigned rather randomly, based on the luck of the draw, if you will. Whichever session asks for a latch right after it was released will get it. There is no line of latch waiters—just a mob of waiters constantly retrying.

Oracle uses atomic instructions like “test and set” and “compare and swap” for operating on latches. Since the instructions to set and free latches are atomic, the operating system itself guarantees that only one process gets to test and set the latch even though many processes may be going for it simultaneously. Since the instruction is only one instruction, it can be quite fast (but the overall latching algorithm itself is many CPU instructions). Latches are held for short periods of time and provide a mechanism for cleanup in case a latch holder dies abnormally while holding it. This cleanup process would be performed by PMON.

Enqueues, which we discussed earlier, are another, more sophisticated serialization device used when updating rows in a database table, for example. They differ from latches in that they allow the requestor to queue up and wait for the resource. With a latch request, the requestor session is told right away whether or not it got the latch. With an enqueue lock, the requestor session will be blocked until it can actually attain it.

---

■ **Note** Using `SELECT FOR UPDATE NOWAIT` or `WAIT [n]`, you can optionally decide not to wait for an enqueue lock if your session would be blocked, but if you do block and wait, you will wait in a queue.

---

As such, an enqueue is not as fast as a latch can be, but it does provide functionality over and above what a latch can offer. Enqueues may be obtained at various levels, so you can have many share locks and locks with various degrees of shareability.

## Latch “Spinning”

One thing I’d like to drive home with regard to latches is this: latches are a type of lock, locks are serialization devices, and serialization devices inhibit scalability. If your goal is to construct an application that scales well in an Oracle environment, you must look for approaches and solutions that minimize the amount of latching you need to perform.

Even seemingly simple activities, such as parsing a SQL statement, acquire and release hundreds or thousands of latches on the library cache and related structures in the shared pool. If we have a latch, then someone else might be waiting for it. When we go to get a latch, we may well have to wait for it ourselves.

Waiting for a latch can be an expensive operation. If the latch is not available immediately and we are willing to wait for it, as we likely are most of the time, then on a multi-CPU machine our session will spin, trying over and over, in a loop, to get the latch. The reasoning behind this is that context switching (i.e., getting kicked off the CPU and having to get back on the CPU) is expensive. So, if the process cannot get a latch immediately, we’ll stay on the CPU and try again immediately rather than just going to sleep, giving up the CPU, and trying later when we’ll have to get scheduled back on the CPU. The hope is that the holder of the latch is busy processing on the other CPU (and since latches are designed to be held for very short periods of time, this is likely) and will give it up soon. If after spinning and constantly trying to get the latch, we still fail to obtain it, only then will our process sleep, or take itself off of the CPU, and let some other work take place. This sleep action is usually the result of many sessions concurrently requesting the same latch; it is not that a single session is holding it for a long time, but rather that so many sessions want it at the same time and each hold it for a short duration. If you do something short (fast) often enough, it adds up! The pseudo-code for a latch get might look like this:

```

Loop
    for i in 1 .. 2000
    loop
        try to get latch
        if got latch, return
        if i = 1 then misses=misses+1
    end loop
    INCREMENT WAIT COUNT
    sleep
    Add WAIT TIME
End loop;
```



The logic is to try to get the latch and, failing that, to increment the miss count, a statistic we can see in a Statspack report or by querying the V\$LATCH view directly. Once the process misses, it will loop some number of times (an undocumented parameter controls the number of times and is typically set to 2,000), attempting to get the latch over and over. If one of these get attempts succeeds, then it returns and we continue processing. If they all fail, the process will go to sleep for a short duration of time, after incrementing the sleep count for that latch. Upon waking up, the process begins all over again. This implies that the cost of getting a latch is not just the “test and set”-type operation that takes place, but also a considerable amount of CPU while we try to get the latch. Our system will appear to be very busy (with much CPU being consumed), but not much work is getting done.

## Measuring the Cost of Latching a Shared Resource

As an example, we'll study the cost of latching the shared pool. We'll compare a well-written program (one that uses bind variables) and a program that is not so well written (it uses literal SQL, or unique SQL for each statement). To do this, we'll use a very small Java program that simply logs into Oracle, turns off auto-commit (as all Java programs should do immediately after connecting to a database), and executes 25,000 unique INSERT statements in a loop. We'll perform two sets of tests: our program will not use bind variables in the first set, and in the second set it will.

To evaluate these programs and their behavior in a multiuser environment, I opted to use Statspack to gather the metrics, as follows:

1. Execute a Statspack snapshot to gather the current state of the system.
2. Run N copies of the program, having each program INSERT into its own database table so as to avoid the contention associated with having all programs trying to insert into a single table.
3. Take another snapshot immediately after the last copy of the program finishes.

Then it is a simple matter of printing out the Statspack report and finding out how long it took N copies of the program to complete, how much CPU was used, what major wait events occurred, and so on.

---

■ **Note** Why not use AWR (Automatic Workload Repository) to perform this analysis? The answer to that is because everyone has access to Statspack, everyone. It might have to be installed by your DBA, but every Oracle customer has access to it. I want to present results that are reproducible by everyone.

---

These tests were performed on a dual-CPU machine with hyperthreading enabled (making it appear as if there were four CPUs). Given that there were two physical CPUs, you might expect very linear scaling here—that is, if one user uses 1 unit of CPU to process her inserts, then you might expect that two users would require 2 units of CPU. You'll discover that this premise, while sounding plausible, may well be inaccurate (just how inaccurate depends on your programming technique, as you'll see). It would be correct if the processing we were performing needed no shared resource, but our process will use a shared resource, namely the shared pool. We need to latch the shared pool to parse SQL statements, and we need to latch the shared pool because it is a shared data structure, and we cannot modify it while others are reading it and we cannot read it while it is being modified.

---

■ **Note** I've performed these tests using Java, PL/SQL, Pro\*C, and other languages. The end results are very much the same every time. This demonstration and discussion applies to all languages and all interfaces to the database. I chose Java for this example as I find Java and Visual Basic applications are most likely to not use bind variables when working with the Oracle database.

---

## Setting Up for the Test

In order to test, we'll need a schema (set of tables) to work with. We'll be testing with multiple users and want to measure the contention due to latching most of all, meaning that we're not interested in measuring the contention you might observe due to multiple sessions inserting into the same database table. So, we'll want a table per user to be created and we'll name these tables T1 . . . T10. For example:

```
SCOTT@ORA12CR1> connect scott/tiger
Connected.
```

```
SCOTT@ORA12CR1> begin
 2     for i in 1 .. 10
 3     loop
 4         for x in (select * from user_tables where table_name = 'T' || i )
 5         loop
 6             execute immediate 'drop table ' || x.table_name;
 7         end loop;
 8         execute immediate 'create table t' || i || ' ( x int )';
 9     end loop;
10 end;
11 /
```

PL/SQL procedure successfully completed.

We'll run this script before each iteration of the test to follow in order to reset our schema and to force hard parsing to take place if we run a test more than once. During our testing, we'll follow these steps:

1. Run `statspack.snap`.
2. Immediately start N of our Java routines, where N will vary from 1 to 10, representing 1 to 10 concurrent users.
3. Wait for all N to complete.
4. Run `statspack.snap`.
5. Generate the Statspack report for the last two Statspack IDs.

The numbers presented for the following test runs were collected using this technique.

---

■ **Tip** The scripts to automate the test described in this section are available for download from the Apress web site for this book. In the `cho6` folder there are two subdirectories: `nobinds` and `binds`. Within those directories the `run.sql` script calls the required code to execute this test. You'll need to modify the code to reflect your database connection information, where appropriate. And, of course, you'll also have to compile the Java program on your server.

---

## Without Bind Variables

In the first instance, our program will not use bind variables, but rather will use string concatenation to insert data (you will obviously have to use your own connect string for your system):

```
import java.sql.*;
public class instest
{
    static public void main(String args[]) throws Exception
    {
        DriverManager.registerDriver(new oracle.jdbc.driver.OracleDriver());
        Connection
            conn = DriverManager.getConnection
                ("jdbc:oracle:thin:@heesta:1521:ORA12CR1", "scott", "tiger");
        conn.setAutoCommit( false );
        Statement stmt = conn.createStatement();
        for( int i = 0; i < 25000; i++ )
        {
            stmt.execute
                ("insert into "+ args[0] +
                 " (x) values(" + i + ")" );
        }
        conn.commit();
        conn.close();
    }
}
```

I ran the test in single user mode (that is, by itself with no other active database sessions), and the Statspack report came back with this information:

<b>Elapsed:</b>	<b>0.25 (mins)</b>	<b>Av Act Sess:</b>	<b>0.9</b>
DB time:	0.22 (mins)	DB CPU:	0.20 (mins)

Cache Sizes	Begin	End		
Buffer Cache:	2,656M		Std Block Size:	8K
Shared Pool:	640M		Log Buffer:	14,808K

Load Profile	Per Second	Per Transaction	Per Exec	Per Call
...				
Parses:	3,342.1	25,066.0		
Hard parses:	1,667.2	12,504.0		
...				

Instance Efficiency Indicators			
Buffer Nowait %:	100.00	Redo Nowait %:	100.00
Buffer Hit %:	99.99	Optimal W/A Exec %:	100.00
Library Hit %:	60.05	Soft Parse %:	50.12
Execute to Parse %:	0.11	Latch Hit %:	100.00
Parse CPU to Parse Elapsd %:	108.72	% Non-Parse CPU:	16.29
...			

Event	Waits	Time (s)	Avg wait (ms)	%Total Call Time
AQPC idle	1	30	30010	36.1
heartbeat redo informer	15	15	1004	18.1
LGWR worker group idle	14	15	1055	17.8
lreg timer	4	12	3001	14.4
<b>CPU time</b>		<b>11</b>		<b>13.4</b>

I included the SGA configuration for reference, but the relevant statistics are as follows:

- Elapsed (DB time) time of approximately 15 seconds (0.25 of a minute)
- 1,667 hard parses per second
- 11 CPU seconds used

Now, if we were to run two of these programs simultaneously, we might expect the hard parsing to jump to about 3,300 per second (we have two CPUs available, after all) and the CPU time to double to perhaps 22 CPU seconds. Let's take a look:

```

Elapsed:      0.27 (mins) Av Act Sess:      1.6
DB time:     0.44 (mins)   DB CPU:      0.41 (mins)
...
Load Profile
~~~~~
...
      Parses:      6,259.8      33,385.3
      Hard parses: 3,125.6      16,669.7
...
Instance Efficiency Indicators
~~~~~
      Buffer Nowait %: 100.00      Redo Nowait %: 100.00
      Buffer Hit %: 99.99      Optimal W/A Exec %: 100.00
      Library Hit %: 60.03      Soft Parse %: 50.07
      Execute to Parse %: 0.06      Latch Hit %: 98.41
      Parse CPU to Parse Elapsd %: 96.28      % Non-Parse CPU: 15.06
...
Top 5 Timed Events
~~~~~
Event
-----
CPU time
23
32.7
LGWR worker group idle      18      16      876      22.8
heartbeat redo informer     15      15      1005     21.8
lreg timer                   5       15      3001     21.7
latch: shared pool
15,076
0
0
.6

```

What we discover is that the hard parsing goes up somewhat, and the CPU time more than doubles. How could that be? The answer lies in Oracle's implementation of latching. On this multi-CPU machine, when we could not immediately get a latch, we spun. The act of spinning itself consumes CPU. Process 1 attempted many times to get a latch onto the shared pool only to discover that process 2 held that latch, so process 1 had to spin and wait for it (consuming CPU). The converse would be true for process 2; many times it would find that process 1 was holding

the latch to the resource it needed. So, much of our processing time was spent not doing real work, but waiting for a resource to become available. If we page down through the Statspack report to the “Latch Sleep Breakdown” report, we discover the following:

Latch Name	Requests	Misses	Sleeps	Gets
shared pool	2,296,041	75,240	15,267	60,165

Note how the number 15,267 appears in the SLEEPS column here? That number corresponds very closely to the number of WAITS reported in the preceding “Top 5 Timed Events” report.

---

■ **Note** The number of sleeps corresponds *closely* to the number of waits; this might raise an eyebrow. Why not *exactly*? The reason is that the act of taking a snapshot is not atomic; a series of queries are executed gathering statistics into tables during a Statspack snapshot, and each query is *as of* a slightly different point in time. So, the wait event metrics were gathered at a time slightly before the latching details were.

---

Our “Latch Sleep Breakdown” report shows us the number of times we tried to get a latch and failed in the spin loop. That means the Top 5 report is showing us only the tip of the iceberg with regard to latching issues—the 75,240 misses (which means we spun trying to get the latch) are not revealed in the Top 5 report for us. After examination of the Top 5 report, we might not be inclined to think we have a hard parse problem here, even though we have a very serious one. To perform 2 units of work, we needed to use more than 2 units of CPU. This was due entirely to the fact that we need that shared resource, the shared pool. Such is the nature of latching.

You can see that it can be very hard to diagnose a latching-related issue, unless you understand the mechanics of how they are implemented. A quick glance at a Statspack report, using the Top 5 section, might cause us to miss the fact that we have a fairly bad scaling issue on our hands. Only by deeper investigation in the latching section of the Statspack report will we see the problem at hand.

Additionally, it is not normally possible to determine how much of the CPU time used by the system is due to this spinning—all we know in looking at the two-user test is that we used 23 seconds of CPU time and that we missed getting a latch on the shared pool 75,240 times. We don’t know how many times we spun trying to get the latch each time we missed, so we have no real way of gauging how much of the CPU time was spent spinning and how much was spent processing. We need multiple data points to derive that information.

In our tests, because we have the single-user example for comparison, we can conclude that about 1 CPU seconds or so was spent spinning on the latch, waiting for that resource. We can come to this conclusion because we know that a single user needs only 11 seconds of CPU time so two single users would need 22 seconds, and 23 (total CPU seconds) minus 22 is 1.

## With Bind Variables

Now I’d like to look at the same situation as presented in the previous section, but this time using a program that uses significantly less latches during its processing. We’ll take that Java program and code it using bind variables. To accomplish this, we’ll change the Statement into a PreparedStatement, parse a single INSERT statement, and then bind and execute that PreparedStatement repeatedly in the loop:

```
import java.sql.*;
public class instest
{
    static public void main(String args[]) throws Exception
    {
        System.out.println( "start" );
        DriverManager.registerDriver(new oracle.jdbc.driver.OracleDriver());
    }
}
```

```

Connection
  conn = DriverManager.getConnection
    ("jdbc:oracle:thin:@heesta:1521:ORA12CR1", "scott","tiger");
conn.setAutoCommit( false );
PreparedStatement pstmt =
  conn.prepareStatement
    ("insert into "+ args[0] + " (x) values(?)" );
for( int i = 0; i < 25000; i++ )
{
  pstmt.setInt( 1, i );
  pstmt.executeUpdate();
}
conn.commit();
conn.close();
System.out.println( "done" );
}
}

```

Let's look at the single and dual user Statspack reports, as we did for the no bind variable example. We'll see dramatic differences here. Here is the single-user report:

```

Elapsed:          0.07 (mins) Av Act Sess:          0.6
DB time:          0.04 (mins)      DB CPU:          0.03 (mins)

Cache Sizes
-----
      Buffer Cache:    2,656M          Std Block Size:      8K
      Shared Pool:    640M           Log Buffer:          14,808K

Load Profile
-----
...
      Parses:          158.5          317.0
Hard parses:        29.8           59.5
...

Instance Efficiency Indicators
-----
      Buffer Nowait %: 100.00          Redo NoWait %: 100.00
      Buffer Hit %:    98.99          Optimal W/A Exec %: 100.00
      Library Hit %:  96.14          Soft Parse %: 81.23
      Execute to Parse %: 97.72       Latch Hit %: 100.00
Parse CPU to Parse Elapsd %: 87.10   % Non-Parse CPU: 71.58
...

Top 5 Timed Events
-----
Event                               Waits      Time (s)      Avg %Total
                                       wait      Time          wait   Call
                                       (ms)      Time          Time
-----
AQPC idle                            1          30          30004    66.6
lreg timer                            2           6           3004    13.3
heartbeat redo informer                4           4           1006     8.9
LGWR worker group idle                12           4            331     8.8
CPU time                          1           1           2.1

```

That is quite dramatic: from 11 CPU seconds in the no bind variables example to 1 CPU second here. From 1,667 hard parses per second to about 29 per second (and based on my knowledge of how Stats pack works, most of those were from running Statspack). Even the elapsed time was dramatically reduced from about 15 seconds down to 4 seconds (0.07 minutes). When not using bind variables, we spent ten-elevenths of our CPU time parsing SQL (1 second versus 11). This was not entirely latch related, as much of the CPU time incurred without bind variables was spent parsing and optimizing the SQL. Parsing SQL is very CPU intensive, but to expend ten-elevenths of our CPU doing something (parsing) that doesn't really do useful work for us—work we didn't need to perform—is pretty expensive.

When we get to the two-user test, the results continue to look better:

```

Elapsed:      0.08 (mins) Av Act Sess:      0.9
DB time:     0.07 (mins)   DB CPU:      0.07 (mins)
...
Load Profile
~~~~~
          Per Second   Per Transaction   Per Exec   Per Call
...
      Parses:          25.6             42.7
Hard parses:      0.8             1.3
...
Instance Efficiency Indicators
~~~~~
      Buffer Nowait %: 100.00      Redo NoWait %: 100.00
      Buffer Hit %: 99.93      Optimal W/A Exec %: 100.00
      Library Hit %: 99.97      Soft Parse %: 96.88
      Execute to Parse %: 99.74      Latch Hit %: 99.99
Parse CPU to Parse Elapsed %: 100.00      % Non-Parse CPU: 99.66
...
Top 5 Timed Events
~~~~~
Event                               Waits    Time (s)    Avg %Total
                                       wait    Time (ms)    Call
-----
AQPC idle                            1         30    30012    74.6
heartbeat redo informer              4          4    1010    10.0
lreg timer                            1          3    3000     7.5
CPU time                              3          3         7.3
log file parallel write              22         0         5     .3

```

The amount of CPU time is about 2 to 3 times the amount reported by the single-user test case.

---

■ **Note** Due to rounding, the 1 CPU seconds is really anywhere from 0 to 2, and the 3 is really anywhere from 2 to 4 seconds.

---

Further, the amount of CPU used by two users with bind variables is *far* less than half the amount of CPU a single user not using bind variables required! When I looked at the latch report in this Statspack report, I found there was so little contention for the shared pool and library cache that it was not even worth reporting. In fact, digging deeper turned up the fact that the shared pool latch was requested 50,511 times versus well over 2.2 million times in the preceding two-user test without binds:

```

Latch Name                Requests    Misses    Sleeps    Gets
-----
shared pool                50,511      48         1         47

```

## Performance/Scalability Comparison

Table 6-1 summarizes the CPU usage by each implementation, as well as the latching results as we increase the number of users beyond two. As you can see, the solution using fewer latches (binds) will scale much better as the user load goes up.

**Table 6-1.** CPU Usage Comparison with and Without Bind Variables

Users	CPU (sec)/Elapsed Time (min.)		Shared Pool Latch Requests		Latch Wait Count/Latch Wait Time (sec.)	
	No Binds	Binds	No Binds	Binds	No Binds*	Binds
1	11/0.22	1/0.04	0	0	0/0	0/0
2	23/0.44	3/0.07	>2.2 million	>50 thousand	15.0k/0	0/0
3	35/0.65	4/0.10	>3.5 million	>75 thousand	19.1k/1	0/0
4	47/0.89	4/0.13	>4.7 million	>95 thousand	33.9k/1	0/0
5	58/1.13	4/0.15	>5.9 million	>126 thousand	55.8k/3	10/0
6	70/1.35	6/0.18	>7.1 million	>152 thousand	61.1k/3	22/0
7	82/1.56	7/0.21	>8.3 million	>176 thousand	70.0k/3	23/0
8	90/2.55	7/0.23	>9.5 million	>201 thousand	121.3k/42	28/0
9	105/2.21	8/0.27	>10.7 million	>226 thousand	111.6k/13	25/0
10	115/2.49	8/0.28	>11.9 million	>252 thousand	123.1k/17	41/0

\*Note: Latch wait count is in thousands for No Binds, but not for Binds.

The interesting observation is that 10 users using bind variables (and very few latch requests as a result) use the same amount of hardware resources (CPU) as 1 user that does not use bind variables (i.e., that overuse a latch or process more than they need to). When you examine the results for 10 users, you see that nonuse of bind variables results in the use of over 14 times the CPU and takes almost 9 times the execution time when compared to the bind variable solution. The more users are added over time, the longer each user spends waiting for these latches. We went from an average of 0.6 seconds/session (3 seconds of wait/5 sessions) of wait time for latches with 5 users to an average of 1.7 seconds/session of wait time with 10 users. However, the implementation that avoided overuse of the latch suffered no ill effects as it scaled up.

## Mutexes

A *mutex* is a serialization device much like a latch is, in fact, the name mutex stands for *mutual exclusion*. It is another serialization tool used by the database; it was introduced in Oracle 10g Release 1 and is used in place of traditional latches in many places in the server. A mutex differs from a latch in that it is even more lightweight in its implementation. It requires less code to implement, approximately one-fifth of the instructions (which results in less CPU to request in general) and it requires less memory, approximately one-seventh of the size, to implement. A mutex, in addition to being lighter weight, is a little less functional in some respects. Just like an enqueue lock is much heavier than a latch, a latch is heavier than a mutex. But, like the enqueue to latch comparison, the latch can do more than a mutex in some cases (like an enqueue can do more than a latch in some cases). This means that not every latch will be, or should be, replaced by a mutex, just as every enqueue lock will not be, or should not be, replaced by a latch.



When reading about mutexes in various reports, just remember that they are lighter-weight serialization devices. They enable possibly more scalability than a latch (just as latches are more scalable than enqueues), but they are still *a serialization device*. If you can avoid doing something that requires a mutex, in general, you should, for the same reason you would avoid requesting a latch if possible.

## Manual Locking and User-Defined Locks

So far, we have looked mostly at locks that Oracle places for us transparently. When we update a table, Oracle places a TM lock on it to prevent other sessions from dropping that table (or performing most DDL, in fact). We have TX locks that are left on the various blocks we modify so others can tell what data we own. The database employs DDL locks to protect objects from change while we ourselves are changing them. It uses latches and locks internally to protect its own structure.

Next, let's take a look at how we can get involved in some of this locking action. Our options are as follows:

- Manually lock data via a SQL statement.
- Create our own locks via the `DBMS_LOCK` package.

The following sections briefly discuss why you might want to do each of these.

### Manual Locking

We have, in fact, already seen a couple of cases where we might want to use manual locking. The `SELECT . . . FOR UPDATE` statement is the predominant method of manually locking data. We used it in previous examples to avoid the lost update issue whereby one session would overwrite another session's changes. We've seen it used as a method to serialize access to detail records to enforce business rules (e.g., the resource scheduler example from Chapter 1).

We can also manually lock data using the `LOCK TABLE` statement. This statement is used rarely, because of the coarseness of the lock. It simply locks the table, not the rows in the table. If you start modifying the rows, they will be locked as normal. So, this is not a method to save on resources (as it might be in other RDBMSs). You might use the `LOCK TABLE IN EXCLUSIVE MODE` statement if you were writing a large batch update that would affect most of the rows in a given table and you wanted to be sure that no one would block you. By locking the table in this manner, you can be assured that your update will be able to do all of its work without getting blocked by other transactions. It would be the rare application, however, that has a `LOCK TABLE` statement in it.

### Creating Your Own Locks

Oracle actually exposes to developers the enqueue lock mechanism that it uses internally, via the `DBMS_LOCK` package. You might be wondering why you would want to create your own locks. The answer is typically application specific. For example, you might use this package to serialize access to some resource external to Oracle. Say you are using the `UTL_FILE` routine that allows you to write to a file on the server's file system. You might have developed a common message routine that every application calls to record messages. Since the file is external, Oracle won't coordinate the many users trying to modify it simultaneously. In comes the `DBMS_LOCK` package. Now, before you open, write, and close the file, you will request a lock named after the file in exclusive mode, and after you close the file, you will manually release the lock. In this fashion, only one person at a time will be able to write a message to this file. Everyone else will queue up. The `DBMS_LOCK` package allows you to manually release a lock when you are done with it, or to give it up automatically when you commit, or even to keep it as long as you are logged in.

## Summary

This chapter covered a lot of material that, at times, may have made you scratch your head. While locking is rather straightforward, some of its side effects are not. However, it is vital that you understand these issues. For example, if you were not aware of the table lock Oracle uses to enforce a foreign key relationship when the foreign key is not indexed, then your application would suffer from poor performance. If you did not understand how to review the data dictionary to see who was locking whom, you might never figure that one out. You would just assume that the database hangs sometimes. I sometimes wish I had a dollar for every time I was able to solve the insolvable hanging issue by simply running the query to detect unindexed foreign keys and suggesting that we index the one causing the problem. I would be very rich.



# Concurrency and Multiversioning

As stated in the last chapter, one of the key challenges in developing multiuser, database-driven applications is to maximize concurrent access but, at the same time, ensure that each user is able to read and modify the data in a consistent fashion. In this chapter, we're going to take a detailed look at how Oracle achieves *multiversion read consistency* and what that means to you, the developer. I will also introduce a new term, *write consistency*, and use it to describe how Oracle works not only in a read environment with read consistency, but also in a mixed read and write environment.

## What Are Concurrency Controls?

*Concurrency controls* are the collection of functions that the database provides to allow many people to access and modify data simultaneously. As noted in the previous chapter, the *lock* is one of the core mechanisms by which Oracle regulates concurrent access to shared database resources and prevents interference between concurrent database transactions. To briefly summarize, Oracle uses a variety of locks, including the following:

- *TX (Transaction) locks*: These locks are acquired for the duration of a data-modifying transaction.
- *TM (DML Enqueue) and DDL locks*: These locks ensure that the structure of an object is not altered while you are modifying its contents (TM lock) or the object itself (DDL lock).
- *Latches and Mutexes*: These are internal locks that Oracle employs to mediate access to its shared data structures. We'll refer to both as Latches in this chapter, although they might be implemented by a Mutex on your operating system, depending on the Oracle version.

In each case, there is minimal overhead associated with lock acquisition. TX transaction locks are extremely scalable both in terms of performance and cardinality. TM and DDL locks are applied in the least restrictive mode whenever possible. Latches and enqueues are both very lightweight and fast (enqueues are slightly the heavier of the two, though more feature-rich). Problems only arise from poorly designed applications that hold locks for *longer than necessary* and cause blocking in the database. If you design your code well, Oracle's locking mechanisms will allow for scalable, highly concurrent applications.

---

■ **Note** I used the phrase “longer than necessary.” That does not mean you should attempt to commit (end your transaction) as soon as possible. Transactions should be exactly as long as they need to be—and no longer than that. That is, your transaction is your unit of work; it is all or nothing. You should commit when your unit of work is complete and not before—and not any later either!

---

But Oracle's support for concurrency goes beyond efficient locking. It implements a *multiversioning* architecture (introduced in Chapter 1) that provides controlled yet highly concurrent access to data. Multiversioning describes Oracle's ability to simultaneously materialize multiple versions of the data and is the mechanism by which Oracle provides read-consistent views of data (i.e., consistent results with respect to a point in time). A rather pleasant side effect of multiversioning is that a reader of data will never be blocked by a writer of data. In other words, writes do not block reads. This is one of the fundamental differences between Oracle and other databases. A query that only reads information in Oracle will never be blocked; it will never deadlock with another session, and it will never get an answer that didn't exist in the database.

---

■ **Note** There is a short period of time during the processing of a distributed *Two Phase Commit* where Oracle will prevent read access to information. As this processing is somewhat rare and exceptional (the problem applies only to queries that start between the prepare and the commit phases and try to read the data before the commit arrives), I will not cover it in detail.

---

Oracle's multiversioning model for read consistency is applied by default at the *statement level* (for each and every query) and can also be applied at the *transaction level*. This means that each and every SQL statement submitted to the database sees a read-consistent view of the database, at least—and if you would like this read-consistent view of the database to be at the level of a transaction (a set of SQL statements), you may do that as well, as we'll see in the “Serializable” section in this chapter.

The basic purpose of a transaction in the database is to take the database from one consistent state to the next. The ISO SQL standard specifies various *transaction isolation levels*, which define how *sensitive* one transaction is to changes made by another. The greater the level of sensitivity, the greater the degree of isolation the database must provide between transactions executed by your application. In the following section, we'll look at how, via its multiversioning architecture and with absolutely minimal locking, Oracle can support each of the defined isolation levels.

## Transaction Isolation Levels

The ANSI/ISO SQL standard defines four levels of transaction isolation, with different possible outcomes for the same transaction scenario. That is, the same work performed in the same fashion with the same inputs may result in different answers, depending on your isolation level. These isolation levels are defined in terms of three “phenomena” that are either permitted or not at a given isolation level:

- *Dirty read*: The meaning of this term is as bad as it sounds. You are permitted to read uncommitted, or *dirty*, data. You would achieve this effect by just opening an OS file that someone else is writing and reading whatever data happens to be there. Data integrity is compromised, foreign keys are violated, and unique constraints are ignored.
- *Nonrepeatable read*: This simply means that if you read a row at time T1 and attempt to reread that row at time T2, the row may have changed, or it may have disappeared, or it may have been updated, and so on.
- *Phantom read*: This means that if you execute a query at time T1 and re-execute it at time T2, additional rows may have been added to the database, which will affect your results. This differs from the nonrepeatable read in that with a phantom read, data you already read has not been changed, but rather that *more* data satisfies your query criteria than before.

---

■ **Note** The ANSI/ISO SQL standard defines *transaction*-level characteristics, not just individual statement-by-statement-level characteristics. In the following pages, we'll examine transaction-level isolation, not just statement-level isolation.

---

The SQL isolation levels are defined based on whether or not they allow each of the preceding phenomena. I find it interesting to note that the SQL standard does not impose a specific locking scheme or mandate particular behaviors, but rather describes these isolation levels in terms of these phenomena, allowing for many different locking/concurrency mechanisms to exist (see Table 7-1).

**Table 7-1.** ANSI Isolation Levels

Isolation Level	Dirty Read	Nonrepeatable Read	Phantom Read
READ UNCOMMITTED	Permitted	Permitted	Permitted
READ COMMITTED	--	Permitted	Permitted
REPEATABLE READ	--	--	Permitted
SERIALIZABLE	--	--	--

Oracle explicitly supports the READ COMMITTED and SERIALIZABLE isolation levels as they are defined in the standard. However, this doesn't tell the whole story. The SQL standard was attempting to set up isolation levels that would permit various degrees of consistency for queries performed in each level. REPEATABLE READ is the isolation level that the SQL standard claims will guarantee a read-consistent result from a query. In their definition, READ COMMITTED does not give you consistent results, and READ UNCOMMITTED is the level to use to get nonblocking reads.

However, in Oracle, READ COMMITTED has all of the attributes required to achieve read-consistent queries. In many other databases, READ COMMITTED queries can and will return answers that never existed in the database at any point in time. Moreover, Oracle also supports the *spirit* of READ UNCOMMITTED. The goal of providing a dirty read is to supply a nonblocking read, whereby queries are not blocked by, and do not block, updates of the same data. However, Oracle does not need dirty reads to achieve this goal, nor does it support them. Dirty reads are an implementation other databases must use in order to provide nonblocking reads.

In addition to the four defined SQL isolation levels, Oracle provides another level, namely READ ONLY. A READ ONLY transaction is equivalent to a REPEATABLE READ or SERIALIZABLE transaction that can't perform any modifications in SQL. A transaction using a READ ONLY isolation level only sees those changes that were committed *at the time the transaction began*, but inserts, updates, and deletes are not permitted in this mode (other sessions may update data, but not the READ ONLY transaction). Using this mode, you can achieve REPEATABLE READ and SERIALIZABLE levels of isolation.

Let's now move on to discuss exactly how multiversioning and read consistency fit into the isolation scheme and how databases that do not support multiversioning achieve the same results. This information is instructive for anyone who has used another database and believes she understands how the isolation levels must work. It is also interesting to see how a standard that was supposed to remove the differences between the databases, ANSI/ISO SQL, actually allows for them. The standard, while very detailed, can be implemented in very different ways.

## READ UNCOMMITTED

The READ UNCOMMITTED isolation level allows dirty reads. Oracle does not make use of dirty reads, nor does it even allow for them. The basic goal of a READ UNCOMMITTED isolation level is to provide a standards-based definition that caters for nonblocking reads. As we have seen, Oracle provides for nonblocking reads by default. You would be hard-pressed to make a SELECT query block in the database (as noted earlier, there is the special case of a distributed transaction). Every single query, be it a SELECT, INSERT, UPDATE, MERGE, or DELETE, executes in a read-consistent fashion. It might seem funny to refer to an UPDATE statement as a query, but it is. UPDATE statements have two components: a read component as defined by the WHERE clause and a write component as defined by the SET clause. UPDATE statements read and write to the database; all DML statements have this ability. The case of a single row INSERT using the VALUES clause is the only exception, as such statements have no read component, just the write component.

In Chapter 1, Oracle's method of obtaining read consistency was demonstrated by way of a simple single table query that retrieved rows that were deleted *after* the cursor was opened. We're now going to explore a real-world example to see what happens in Oracle using multiversioning, as well as what happens in any number of other databases.

Let's start with the same basic table and query:

```
create table accounts
( account_number number primary key,
  account_balance number not null
);

select sum(account_balance) from accounts;
```

Before the query begins, assume we have the data shown in Table 7-2.

**Table 7-2.** ACCOUNTS Table Before Modifications

Row	Account Number	Account Balance
1	123	\$500.00
2	456	\$240.25
...	...	...
342,023	987	\$100.00

Now, our select statement starts executing and reads row 1, row 2, and so on.

---

■ **Note** I do not mean to imply that rows have any sort of physical ordering on disk in this example. There really is not a first row, second row, or last row in a table. There is just a set of rows. We are assuming here that row 1 really means “the first row we happened to read” and row 2 is the second row we happened to read and so on.

---

At some point while we are in the middle of the query, a transaction moves \$400.00 from account 123 to account 987. This transaction does the two updates but does not commit. The table now looks as shown in Table 7-3.

**Table 7-3.** ACCOUNTS Table During Modifications

Row	Account Number	Account Balance	Locked?
1	123	(\$500.00) changed to \$100.00	X
2	456	\$240.25	--
...	...	...	--
342,023	987	(\$100.00) changed to \$500.00	X

So, two of those rows are locked. If anyone tried to update them, that user would be blocked. So far, the behavior we are seeing is more or less consistent across all databases. The difference will be in what happens when the query gets to the locked data.

When the query we are executing gets to the block containing the locked row (row 342,023) at the bottom of the table, it will notice that the data in it has changed since the time at which it started execution. To provide a consistent (correct) answer, Oracle will at this point create a copy of the block containing this row *as it existed when the query began*. That is, it will read a value of \$100.00, the value that existed at the time the query began. Effectively, Oracle takes a detour around the modified data; it reads around it, reconstructing it from the undo segment (also known as a *rollback segment*; discussed in detail in Chapter 9). A consistent and correct answer comes back without waiting for the transaction to commit.

Now, a database that allowed a dirty read would simply return the value it saw in account 987 at the time it read it, in this case \$500.00. The query would count the transferred \$400 twice. Therefore, not only does it return the wrong answer, but also it returns a total that never existed in the table at any committed point in time. In a multiuser database, a dirty read can be a dangerous feature and, personally, I have never seen the usefulness of it. Say that, rather than transferring, the transaction was actually just depositing \$400.00 in account 987. The dirty read would count the \$400.00 and get the “right” answer, wouldn’t it? Well, suppose the uncommitted transaction was rolled back. We have just counted \$400.00 that was never actually in the database.

The point here is that dirty read is not a feature; rather, it is a liability. In Oracle, it is just not needed. You get all of the advantages of a dirty read (no blocking) without any of the incorrect results.

## READ COMMITTED

The READ COMMITTED isolation level states that a transaction may only read data that has been committed in the database. There are no dirty reads. There may be nonrepeatable reads (i.e., rereads of the same row may return a different answer in the same transaction) and phantom reads (i.e., newly inserted and committed rows become visible to a query that were not visible earlier in the transaction). READ COMMITTED is perhaps the most commonly used isolation level in database applications everywhere, and it is the default mode for Oracle databases, it is rare to see a different isolation level used.

However, achieving READ COMMITTED isolation is not as cut-and-dried as it sounds. If you look at Table 7-1, it looks straightforward. Obviously, given the earlier rules, a query executed in any database using the READ COMMITTED isolation will behave in the same way, will it not? *It will not*. If you query multiple rows in a single statement, in almost every other database, READ COMMITTED isolation can be as bad as a dirty read, depending on the implementation.

In Oracle, using multiversioning and read-consistent queries, the answer we get from the ACCOUNTS query is the same in READ COMMITTED as it was in the READ UNCOMMITTED example. Oracle will reconstruct the modified data as it appeared when the query began, returning the answer that was in the database when the query started.

Let's now take a look at how our previous example might work in READ COMMITTED mode in other databases—you might find the answer surprising. We'll pick up our example at the point described in the previous table:

- We are in the middle of the table. We have read and summed the first N rows.
- The other transaction has moved \$400.00 from account 123 to account 987.
- The transaction has not yet committed, so rows containing the information for accounts 123 and 987 are locked.

We know what happens in Oracle when it gets to account 987—it will read around the modified data, find out it should be \$100.00, and complete. Table 7-4 shows how another database, running in some default READ COMMITTED mode, might arrive at the answer.

**Table 7-4.** *Timeline in a Non-Oracle Database Using READ COMMITTED Isolation*

Time	Query	Account Transfer Transaction
T1	Reads row 1, account 123, value=\$500. Sum=\$500.00 so far.	--
T2	Reads row 2, account 456, value=\$240.25. Sum=\$740.25 so far.	--
T3	--	Updates row 1 (account 123) and puts an exclusive lock on row 1, preventing other updates and reads. Row 1 had \$500.00, now it has \$100.00.
T4	Reads row N. Sum = . . .	--
T5	--	Updates row 342,023 (account 987) and puts an exclusive lock on this row. This row had \$100, now it has \$500.00.
T6	Tries to read row 342,023, account 987. Discovers that it is locked. This session will block and wait for this row's block to become available. <i>All processing on this query stops.</i>	--
T7	--	Commits transaction.
T8	Reads row 342,023, account 987, sees \$500.00, and presents a final answer that includes the \$400.00 double-counted.	--

The first thing to notice is that this other database, upon getting to account 987, will block our query. This session must wait on that row until the transaction holding the exclusive lock commits. This is one reason why many people have a bad habit of committing every statement, instead of processing well-formed transactions consisting of all of the statements needed to take the database from one consistent state to the next. *Updates interfere with reads in most other databases.* The really bad news in this scenario is that we are making the end user wait for the *wrong* answer. We still receive an answer that never existed in the committed database state at any point in time, as with the dirty read, but this time we made the user wait for the wrong answer. In the next section, we'll look at what these other databases need to do to achieve read-consistent, correct results.

The important lesson here is that various databases executing in the same, apparently safe isolation level can and will return very different answers under the exact same circumstances. It is important to understand that, in Oracle, nonblocking reads are not had at the expense of correct answers. You can have your cake and eat it too, sometimes.



## REPEATABLE READ

The goal of REPEATABLE READ is to provide an isolation level that gives consistent, correct answers and prevents lost updates. We'll take a look at examples of both, see what we have to do in Oracle to achieve these goals, and examine what happens in other systems.

### Getting a Consistent Answer

If we have a REPEATABLE READ isolation, the results from a given query must be consistent with respect to some point in time. Most databases (not Oracle) achieve repeatable reads via the use of row-level shared read locks. A shared read lock prevents other sessions from modifying data that we have read. This, of course, decreases concurrency. Oracle opted for the more concurrent, multiversioning model to provide read-consistent answers.

In Oracle, using multiversioning, we get an answer that is consistent with respect to the point in time the query began execution. In other databases, using shared read locks, we get an answer that is consistent with respect to the point in time the query completes—that is, when we can get the answer at all (more on this in a moment).

In a system that employs a shared read lock to provide repeatable reads, we would observe rows in a table getting locked as the query processed them. So, using the earlier example, as our query reads the ACCOUNTS table, it would leave shared read locks on each row, as shown in Table 7-5.

**Table 7-5.** *Timeline 1 in Non-Oracle Database Using READ REPEATABLE Isolation*

Time	Query	Account Transfer Transaction
T1	Reads row 1. Sum=\$500.00 so far. Row 1 has a shared read lock on it.	--
T2	Reads row 2. Sum=\$740.25 so far. Row 2 has a shared read lock on it.	--
T3	--	Attempts to update row 1 but is blocked. Transaction is suspended until it can obtain an exclusive lock.
T4	Reads row N. Sum = . . .	--
T5	Reads row 342,023, sees \$100.00, and presents final answer.	--
T6	Commits transaction.	--
T7	--	Updates row 1 and puts an exclusive lock on this row. Row now has \$100.00.
T8	--	Updates row 342,023 and puts an exclusive lock on this row. Row now has \$500.00. Commits transaction.

Table 7-5 shows that we now get the correct answer, but at the cost of physically blocking one transaction and executing the two transactions sequentially. This is one of the side effects of shared read locks for consistent answers: *readers of data will block writers of data*. This is in addition to the fact that, in these systems, writers of data will block readers of data. Imagine if automatic teller machines (ATMs) worked this way in real life.

So, you can see how shared read locks would inhibit concurrency, but they can also cause spurious errors to occur. In Table 7-6, we start with our original table, but this time with the goal of transferring \$50.00 from account 987 to account 123.

**Table 7-6.** *Timeline 2 in Non-Oracle Database Using READ REPEATABLE Isolation*

Time	Query	Account Transfer Transaction
T1	Reads row 1. Sum=\$500.00 so far. Row 1 has a shared read lock on it.	--
T2	Reads row 2. Sum=\$740.25 so far. Row 2 has a shared read lock on it.	--
T3	--	Updates row 342,023 and puts an exclusive lock on row 342,023, preventing other updates and shared read locks. This row now has \$50.00.
T4	Reads row N. Sum = . . .	--
T5	--	Attempts to update row 1 but is blocked. Transaction is suspended until it can obtain an exclusive lock.
T6	Attempts to read row 342,023 but can't as an exclusive lock is already in place.	--

We have just reached the classic deadlock condition. Our query holds resources the update needs and vice versa. Our query has just deadlocked with our update transaction. One of them will be chosen as the victim and will be killed. We just spent a long time and a lot of resources only to fail and get rolled back at the end. This is the second side effect of shared read locks: *readers and writers of data can and frequently will deadlock each other.*

In Oracle, we have statement-level read consistency without reads blocking writes or deadlocks. Oracle never uses shared read locks—*ever*. Oracle has chosen the harder-to-implement but infinitely more concurrent multiversioning scheme.

## Lost Updates: Another Portability Issue

A common use of REPEATABLE READ in databases that employ the shared read locks could be for lost update prevention.

---

■ **Note** Lost update detection and solutions to the lost update problem are discussed in Chapter 6.

---

If we have REPEATABLE READ enabled in a database *that employs shared read locks* (and not multiversioning), lost update errors can't happen. The reason lost updates will not happen in those databases is because the simple act of selecting the data *leaves a lock on it, and once read by our transaction, that data cannot be modified by any other transaction.* Now, if your application assumes that REPEATABLE READ implies “lost updates can't happen,” you are in for a painful surprise when you move your application to a database that does not use shared read locks as an underlying concurrency control mechanism.

---

■ **Note** In a stateless environment, such as a web-based application, lost updates would likely be a cause for concern—even in REPEATABLE READ isolation. This is because a single database session is used by many clients via a connection pool and locks are not held across calls. REPEATABLE READ isolation only prevents lost updates in a stateful environment, such as that observed with a client-server application.

---

While this sounds good, you must remember that leaving the shared read locks behind on all data as it is read will, of course, severely limit concurrent reads and modifications. So, while this isolation level in those databases provides for lost update prevention, it does so by removing the ability to perform concurrent operations! You can't always have your cake and eat it too.

## SERIALIZABLE

This is generally considered the most restrictive level of transaction isolation, but it provides the highest degree of isolation. A `SERIALIZABLE` transaction operates in an environment that makes it appear as if there are no other users modifying data in the database. Any row we read is assured to be the same upon a reread, and any query we execute is guaranteed to return the same results for the life of a transaction. For example, if we execute the following, the answers returned from T would be the same, even though we just slept for 24 hours (or we might get an `ORA-01555, snapshot too old` error, which is discussed in Chapter 8):

```
Select * from T;
Begin dbms_lock.sleep( 60*60*24 ); end;
Select * from T;
```

The isolation level `SERIALIZABLE` assures us these two queries will always return the same results. Side effects (changes) made by other transactions are not visible to the query regardless of how long it has been running.

In Oracle, a `SERIALIZABLE` transaction is implemented so that the read consistency we normally get at the statement level is extended to the transaction.

---

■ **Note** As noted earlier, there is also an isolation level in Oracle denoted `READ ONLY`. It has all of the qualities of the `SERIALIZABLE` isolation level, but it prohibits modifications. It should be noted that the `SYS` user (or users connected with the `SYSDBA` privilege) *can't* have a `READ ONLY` or `SERIALIZABLE` transaction. `SYS` is special in this regard.

---

Instead of results being consistent with respect to the start of a statement, they are preordained at the time you begin the transaction. In other words, Oracle uses the undo segments to reconstruct the data as it existed when our transaction began, instead of just when our statement began.

That's a pretty deep thought there: the database already knows the answer to any question you might ask it, before you ask it.

This degree of isolation comes with a price, and that price is the following possible error:

```
ERROR at line 1:
ORA-08177: can't serialize access for this transaction
```

You will get this message whenever you attempt to update a row that has changed since your transaction began.

---

■ **Note** Oracle attempts to do this purely at the row level, but you may receive an `ORA-08177` error even when the row you are interested in modifying has not been modified. The `ORA-08177` error may happen due to some other row(s) being modified on the block that contains your row.

---

Oracle takes an optimistic approach to serialization—it gambles on the fact that the data your transaction wants to update won't be updated by any other transaction. This is typically the way it happens, and usually the gamble pays off, especially in quick-transaction, OLTP-type systems. If no one else updates your data during your transaction, this isolation level, which will generally decrease concurrency in other systems, will provide the same degree of concurrency as it would without `SERIALIZABLE` transactions. The downside to this is that you may get the `ORA-08177` error if the gamble doesn't pay off. If you think about it, however, it's worth the risk. If you're using `SERIALIZABLE` transactions, you shouldn't expect to update the same information as other transactions. If you do, you should use the `SELECT . . . FOR UPDATE` as described in Chapter 1, and this will serialize the access. So, using an isolation level of `SERIALIZABLE` will be achievable and effective if you:

- Have a high probability of no one else modifying the same data.
- Need transaction-level read consistency.
- Will be doing short transactions (to help make the first bullet point a reality).

Oracle finds this method scalable enough to run all of their TPC-Cs (an industry standard OLTP benchmark; see <http://www.tpc.org> for details). In many other implementations, you will find this being achieved with shared read locks and their corresponding deadlocks, and blocking. In Oracle, we do not get any blocking, but we will get the `ORA-08177` error if other sessions change the data we want to change as well. However, we will not get the error as frequently as we will get deadlocks and blocks in the other systems.

But—there is always a “but”—you must take care to understand these different isolation levels and their implications. Remember, with isolation set to `SERIALIZABLE`, you will not see any changes made in the database after the start of your transaction, until you commit. Applications that attempt to enforce their own data integrity constraints, such as the resource scheduler described in Chapter 1, must take extra care in this regard. If you recall, the problem in Chapter 1 was that we could not enforce our integrity constraint in a multiuser system since we could not see changes made by other uncommitted sessions. Using `SERIALIZABLE`, we would still not see the uncommitted changes, but we would also not see the committed changes made after our transaction began!

As a final point, be aware that `SERIALIZABLE` *does not* mean that all transactions executed by users will behave as if they were executed one right after another in a serial fashion. It does not imply that there is some serial ordering of the transactions that will result in the same outcome. The phenomena previously described by the SQL standard do not make this happen. This last point is a frequently misunderstood concept, and a small demonstration will clear it up. The following table represents two sessions performing work over time. The database tables A and B start out empty and are created as follows:

```
EODA@ORA12CR1> create table a ( x int );
Table created.
```

```
EODA@ORA12CR1> create table b ( x int );
Table created.
```

Now we have the series of events shown in Table 7-7.

**Table 7-7.** SERIALIZABLE Transaction Example

Time	Session 1 Executes	Session 2 Executes
T1	Alter session set isolation_level=serializable;	--
T2	--	Alter session set isolation_level=serializable;
T3	Insert into a select count(*) from b;	--
T4	--	Insert into b select count(*) from a;
T5	Commit;	--
T6	--	Commit;

Now, when this is all said and done, tables A and B will each have a row with the value 0 in it. If there were some serial ordering of the transactions, we could not possibly have both tables containing the value 0 in them. If session 1 executed *in its entirety* before session 2, then table B would have a row with the value 1 in it. If session 2 executed *in its entirety* before session 1, then table A would have a row with the value 1 in it. As executed here, however, both tables will have rows with a value of 0. They just executed as if they were the only transaction in the database at that point in time. No matter how many times session 1 queries table B and no matter the committed state of session 2, the count will be the count that was committed in the database at time T1. Likewise, no matter how many times session 2 queries table A, the count will be the same as it was at time T2.

## READ ONLY

READ ONLY transactions are very similar to SERIALIZABLE transactions, the only difference being that they do not allow modifications, so they are not susceptible to the ORA-08177 error. READ ONLY transactions are intended to support reporting needs where the contents of the report need to be consistent with respect to a single point in time. In other systems, you would use REPEATABLE READ and suffer the associated effects of the shared read lock. In Oracle, you will use the READ ONLY transaction. In this mode, the output you produce in a report that uses 50 SELECT statements to gather the data will be consistent with respect to a single point in time—the time the transaction began. You will be able to do this without locking a single piece of data anywhere.

This aim is achieved by using the same multiversioning as used for individual statements. The data is reconstructed as needed from the undo segments and presented to you as it existed when the report began. READ ONLY transactions are not trouble-free, however. Whereas you might see an ORA-08177 error in a SERIALIZABLE transaction, you expect to see an ORA-01555 snapshot too old error with READ ONLY transactions. This will happen on a system where other people are actively modifying the information you are reading. The changes (undo) made to this information are recorded in the undo segments. But undo segments are used in a circular fashion in much the same manner as redo logs. The longer the report takes to run, the better the chance that some undo you need to reconstruct your data won't be there anymore. The undo segment will have wrapped around, and the portion of it you need would be reused by some other transaction. At this point, you will receive the ORA-01555 error and have to start over again.

The only solution to this sticky issue is to have the undo tablespace sized correctly for your system. Time and time again, I see people trying to save a few megabytes of disk space by having the smallest possible undo tablespace ("Why 'waste' space on something I don't really need?" is the thought). The problem is that the undo tablespace is a key component of the way the database works, and unless it is sized correctly, you will hit this error. In many years of using Oracle 6, 7, 8, 9, 10, 11, and 12, I can say I have never hit an ORA-01555 error outside of a testing or development system. In such a case, you know you have not sized the undo tablespace correctly and you fix it. We will revisit this issue in Chapter 9.

## Implications of Multiversion Read Consistency

So far, we've seen how multiversioning provides us with nonblocking reads, and I have stressed that this is a good thing: consistent (correct) answers with a high degree of concurrency. What could be wrong with that? Well, unless you understand that it exists and what it implies, then you are probably doing some of your transactions incorrectly. Recall from Chapter 1 the scheduling resources example whereby we had to employ some manual locking techniques (via `SELECT FOR UPDATE` to serialize modifications to the `SCHEDULES` table by resource). But can it affect us in other ways? The answer to that is definitely yes. We'll go into the specifics in the sections that follow.

### A Common Data Warehousing Technique That Fails

A common data warehousing technique I've seen people employ goes like this:

1. They use a trigger to maintain a `LAST_UPDATED` column in the source table, much like the method described in the last chapter in the "Optimistic Locking" section.
2. To initially populate a data warehouse table, they remember what time it is *right now* by selecting out `SYSDATE` on the source system. For example, suppose it is exactly 9:00 a.m. right now.
3. They then pull all of the rows from the transactional system—a full `SELECT * FROM TABLE`—to get the data warehouse initially populated.
4. To refresh the data warehouse, they remember what time it is *right now* again. For example, suppose an hour has gone by—it is now 10:00 a.m. on the source system. They will remember that fact. They then pull all changed records since 9:00 a.m. (the moment before they started the first pull) and merge them in.

---

■ **Note** This technique may *pull* the same record twice in two consecutive refreshes. This is unavoidable due to the granularity of the clock. A `MERGE` operation will not be affected by this (i.e., update existing record in the data warehouse or insert a new record).

---

They believe that they now have all of the records in the data warehouse that were modified since they did the initial pull. They may actually have all of the records, but just as likely they may not. This technique does work on some other databases—ones that employ a locking system whereby reads are blocked by writes and vice versa. But in a system where you have nonblocking reads, the logic is flawed.

To see the flaw in this example, all we need to do is assume that at 9:00 a.m. there was at least one open, uncommitted transaction. At 8:59:30 a.m., it had updated a row in the table we were to copy. At 9:00 a.m., when we started pulling the data and thus reading the data in this table, we would not see the modifications to that row; we would see the last committed version of it. If it was locked when we got to it in our query, we would read around the lock. If it was committed by the time we got to it, we would still read around it since read consistency permits us to read only data that was committed in the database when our statement began. We would *not* read that new version of the row during the 9:00 a.m. initial pull, nor would we read the modified row during the 10:00 a.m. refresh. The reason? The 10:00 a.m. refresh would only pull records modified since 9:00 a.m. that morning, but this record was modified at 8:59:30 a.m. We would never pull this changed record.

In many other databases where reads are blocked by writes and a committed but inconsistent read is implemented, this refresh process would work perfectly. If at 9:00 a.m. when we did the initial pull of data, we hit that row and it was locked, we would have blocked and waited for it, and read the committed version. If it were not locked, we would just read whatever was there, committed.

So, does this mean the preceding logic just cannot be used? No, it means that we need to get the “right now” time a little differently. We need to query `V$TRANSACTION` and find out which is the earliest of the current time and the time recorded in `START_TIME` column of this view. We will need to pull all records changed since the start time of the oldest transaction (or the current `SYSDATE` value if there are no active transactions):

```
select nvl( min(to_date(start_time,'mm/dd/rr hh24:mi:ss')),sysdate)
  from v$transaction;
```

---

■ **Note** The preceding query works regardless of the presence of any data in `V$TRANSACTION`. That is, even if `V$TRANSACTION` is empty (because there are no transactions currently), this query returns a record. A query that has an aggregate with no `WHERE` clause always returns *at least* one row and *at most* one row.

---

In this example, that would be 8:59:30 a.m. when the transaction that modified the row started. When we go to refresh the data at 10:00 a.m., we pull all of the changes that had occurred since that time; when we merge these into the data warehouse, we’ll have everything we need.

## An Explanation for Higher Than Expected I/O on Hot Tables

Another situation where it is vital that you understand read consistency and multiversioning is when you are faced with a query that in production, under a heavy load, uses many more I/Os than you observe in your test or development systems, and you have no way to account for it. You review the I/O performed by the query and note that it is much higher than you have ever seen—much higher than seems possible. You restore the production instance on test and discover that the I/O is way down. But in production, it is still very high (but seems to vary: sometimes it is high, sometimes it is low, and sometimes it is in the middle). The reason, as we’ll see, is that in your test system, in isolation, you do not have to undo other transactions’ changes. In production, however, when you read a given block, you might have to undo (roll back) the changes of many transactions, and each rollback could involve I/O to retrieve the undo and apply it.

This is probably a query against a table that has many concurrent modifications taking place; you are seeing the reads to the undo segment taking place, the work that Oracle is performing to restore the block back the way it was when your query began. You can see the effects of this easily in a single session, just to understand what is happening. We’ll start with a very small table:

```
EODA@ORA12CR1> create table t ( x int );
Table created.
```

```
EODA@ORA12CR1> insert into t values ( 1 );
1 row created.
```

```
EODA@ORA12CR1> exec dbms_stats.gather_table_stats( user, 'T' );
PL/SQL procedure successfully completed.
```

```
EODA@ORA12CR1> select * from t;
```

```

      X
-----
      1
```

Now we'll set our session to use the SERIALIZABLE isolation level, so that no matter how many times we run a query in our session, the results will be "as of" that transaction's start time:

```
EODA@ORA12CR1> alter session set isolation_level=serializable;
Session altered.
```

Now, we'll query that small table and observe the amount of I/O performed:

```
EODA@ORA12CR1> set autotrace on statistics
EODA@ORA12CR1> select * from t;
```

```

          X
-----
         1

Statistics
-----
          0 recursive calls
          0 db block gets
          7 consistent gets
...

```

So, that query took seven I/Os (consistent gets) in order to complete. In *another session*, we'll modify this table repeatedly:

```
EODA@ORA12CR1> begin
  2 for i in 1 .. 10000
  3 loop
  4 update t set x = x+1;
  5 commit;
  6 end loop;
  7 end;
  8 /
PL/SQL procedure successfully completed.
```

And returning to our SERIALIZABLE session, we'll rerun the same query:

```
EODA@ORA12CR1> select * from t;

          X
-----
         1

Statistics
-----
          0 recursive calls
          0 db block gets
       10004 consistent gets
...

```



It did 10,004 I/Os that time—a marked difference. So, where did all of the I/O come from? That was Oracle rolling back the changes made to that database block. When we ran the second query, Oracle knew that all of the blocks retrieved and processed by that query had to be “as of” the start time of the transaction. When we got to the buffer cache, we discovered that the block in the cache was simply “too new”—the other session had modified it some 10,000 times. Our query could not see those changes, so it started walking the undo information and undid the last change. It discovered this rolled back block was still too new and did another rollback of the block. It did this repeatedly until finally it found the version of the block that was committed in the database when our transaction began. That was the block we may use—and did use.

---

■ **Note** Interestingly, if you were to rerun the `SELECT * FROM T`, you would likely see the I/O go back down to 7 or so again; it would not be 10,004. The reason? Oracle has the ability to store multiple versions of the same block in the buffer cache. When you undid the changes to this block for the query that did 10,004 I/Os, you left that version in the cache, and subsequent executions of your query are able to access it.

---

So, do we only encounter this problem when using the `SERIALIZABLE` isolation level? No, not at all. Consider a query that runs for five minutes. During the five minutes the query is running, it is retrieving blocks from the buffer cache. Every time it retrieves a block from the buffer cache, it will perform this check: “Is the block too new? If so, roll it back.” And remember, the longer the query runs, the higher the chance that a block it needs has been modified over time.

Now, the database is expecting this check to happen (i.e., to see if a block is “too new” and the subsequent rolling back of the changes), and for just such a reason, the buffer cache may actually contain multiple versions of the same block in memory. In that fashion, chances are that a version you require will be there, ready and waiting to go, instead of having to be materialized using the undo information. A query such as the following may be used to view these blocks:

```
select file#, block#, count(*)
from v$dbh
group by file#, block#
having count(*) > 3
order by 3
/
```

In general, you will find no more than about six versions of a block in the cache at any point in time, but these versions can be used by any query that needs them.

It is generally these small *hot* tables that run into the issue of inflated I/Os due to read consistency. Other queries most often affected by this issue are long-running queries against volatile tables. The longer they run, the longer they run, because over time they may have to perform more work to retrieve a block from the buffer cache.

## Write Consistency

So far, we’ve looked at read consistency: Oracle’s ability to use undo information to provide nonblocking query and consistent (correct) reads. We understand that as Oracle reads blocks for queries out of the buffer cache, it will ensure that the version of the block is “old” enough to be seen by that query.

But that begs the following questions: What about writes/modifications? What happens when you run an `UPDATE` statement, as follows, and while that statement is running, someone updates a row it has yet to read from `Y=5` to `Y=6` and commits?

```
Update t Set x = 2 Where y = 5;
```

That is, when your UPDATE began, some row had the value Y=5. As your UPDATE reads the table using consistent reads, it sees that the row was Y=5 when the UPDATE began. But, the current value for Y is now 6 (it's not 5 anymore) and before updating the value of X, Oracle will check to see that Y is still 5. Now what happens? How are the updates affected by this?

Obviously, we can't modify an old version of a block; when we go to modify a row, we must modify the current version of that block. Additionally, Oracle can't just simply skip this row, as that would be an inconsistent read and unpredictable. What we'll discover is that in such cases, Oracle will restart the write modification from scratch.

## Consistent Reads and Current Reads

Oracle does do two types of block gets when processing a modification statement. It performs

- *Consistent reads*: When “finding” the rows to modify
- *Current reads*: When getting the block to actually update the row of interest

We can see this easily using TKPROF. Consider this small one row example, which reads and updates the single row in table T from earlier:

```
EODA@ORA12CR1> exec dbms_monitor.session_trace_enable
PL/SQL procedure successfully completed.
```

```
EODA@ORA12CR1> select * from t;
```

```

      X
-----
    1001
```

```
EODA@ORA12CR1> update t t1 set x = x+1;
1 row updated.
```

```
EODA@ORA12CR1> update t t2 set x = x+1;
1 row updated.
```

When we run TKPROF and view the results, we'll see something like this (note that I removed the ELAPSED, CPU, and DISK columns from this report):

```
select * from t
```

call	count	query	current	rows
Parse	1	0	0	0
Execute	1	0	0	0
Fetch	2	7	0	1
total	4	7	0	1

```
update t t1 set x = x+1
```

call	count	query	current	rows
Parse	1	0	0	0
Execute	1	7	3	1
Fetch	0	0	0	0
total	2	7	3	1

```
update t t2 set x = x+1
```

call	count	query	current	rows
Parse	1	0	0	0
Execute	1	7	1	1
Fetch	0	0	0	0
total	2	7	1	1

So, during just a normal query, we incur seven *query (consistent) mode gets*. During the first UPDATE, we incur the same seven I/Os (the search component of the update involves finding all of the rows that are in the table when the update began, in this case) and three *current mode gets* as well. The current mode gets are performed in order to retrieve the *table block* as it exists right now, the one with the row on it, to get an *undo segment block* to begin our transaction, and an *undo block*. The second update has exactly one current mode get; since we did not have to do the undo work again, we had only the one current get on the block with the row we want to update. The very presence of the current mode gets tells us that a modification of some sort took place. Before Oracle will modify a block with new information, it must get the most current copy of it.

So, how does read consistency affect a modification? Well, imagine you were executing the following UPDATE statement against some database table:

```
Update t Set x = x+1 Where y = 5;
```

We understand that the WHERE Y=5 component, the read-consistent phase of the query, will be processed using a consistent read (query mode gets in the TKPROF report). The set of WHERE Y=5 records that was committed in the table at the beginning of the statement's execution are the records it will see (assuming READ COMMITTED isolation; if the isolation is SERIALIZABLE, it would be the set of WHERE Y=5 records that existed when the transaction began). This means if that UPDATE statement were to take five minutes to process from start to finish, and someone added and committed a new record to the table with a value of 5 in the Y column, then that UPDATE would not see it because the consistent read would not see it. This is expected and normal. But, the question is, what happens if two sessions execute the following statements in order:

```
Update t Set y = 10 Where y = 5;
Update t Set x = x+1 Where y = 5;
```

Table 7-8 demonstrates the timeline.

**Table 7-8.** *Sequence of Updates*

Time	Session 1	Session 2	Comment
T1	Update t Set y=10 Where y=5;		This updates the one row that matches the criteria.
T2		Update t Set x=x+1 Where y=5;	Using consistent reads, this will find the record session 1 modified, but it won't be able to update it since session 1 has it locked. Session 2 will block and wait for this row.
T3	Commit;		This releases session 2; session 2 becomes unblocked. It can finally do the current read on the block containing this row, where Y was equal to 5 when session 1 began its update. The current read will show that Y is now equal to 10, not 5 anymore.

So the record that was  $Y=5$  when you began the UPDATE is no longer  $Y=5$ . The consistent read component of the UPDATE says, "You want to update this record because  $Y$  was 5 when we began," but the current version of the block makes you think, "Oh, no, I can't update this row because  $Y$  isn't 5 anymore. It would be wrong."

If we just skipped this record at this point and ignored it, then we would have a nondeterministic update. It would be throwing data consistency and integrity out the window. The outcome of the update (how many and which rows were modified) would depend on the order in which rows got hit in the table and what other activity just happened to be going on. You could take the same exact set of rows and in two different databases, each one running the transactions in exactly the same mix, and you could observe different results, just because the rows were in different places on the disk.

In this case, Oracle will choose to *restart* the update. When the row that was  $Y=5$  when you started is found to contain the value  $Y=10$ , Oracle will silently roll back your update (just the update, not any other part of the transaction) and restart it, assuming you are using READ COMMITTED isolation. If you are using SERIALIZABLE isolation, then at this point you would receive an ORA-08177: can't serialize access for this transaction error. In READ COMMITTED mode, after the transaction rolls back your update, the database will restart the update (i.e., change the point in time at which the update is "as of"), and instead of updating the data again, it will go into SELECT FOR UPDATE mode and attempt to lock all of the rows WHERE  $Y=5$  for your session. Once it does this, it will run the UPDATE against that locked set of data, thus ensuring this time that it can complete without restarting.

But to continue on with the "but what happens if . ." train of thought, what happens if, after restarting the update and going into SELECT FOR UPDATE mode (which has the same read-consistent and read-current block gets going on as an update does), a row that was  $Y=5$  when you started the SELECT FOR UPDATE is found to be  $Y=11$  when you go to get the current version of it? That SELECT FOR UPDATE will restart and the cycle begins again.

This raises several interesting questions. Can we observe this? Can we see this actually happen? And if so, so what? What does this mean to us as developers? We'll address these questions in turn now.

## Seeing a Restart

It is easier to see a restart than you might, at first, think. We'll be able to observe one, in fact, using a simple one-row table. This is the table we'll use to test with:

```
EODA@ORA12CR1> create table t ( x int, y int );
Table created.
```

```
EODA@ORA12CR1> insert into t values ( 1, 1 );
1 row created.
```

```
EODA@ORA12CR1> commit;
Commit complete.
```

To observe the restart, all we need is a trigger to print out some information. We'll use a `BEFORE UPDATE FOR EACH ROW` trigger to print out the before and after image of the row as the result of an update:

```
EODA@ORA12CR1> create or replace trigger t_bufer
 2 before update on t for each row
 3 begin
 4     dbms_output.put_line
 5     ( 'old.x = ' || :old.x ||
 6       ', old.y = ' || :old.y );
 7     dbms_output.put_line
 8     ( 'new.x = ' || :new.x ||
 9       ', new.y = ' || :new.y );
10 end;
11 /
Trigger created.
```

Now we'll update that row:

```
EODA@ORA12CR1> set serveroutput on
EODA@ORA12CR1> update t set x = x+1;
old.x = 1, old.y = 1
new.x = 2, new.y = 1
1 row updated.
```

So far, everything is as we expect: the trigger fired once, and we see the old and new values. Note that we have not yet committed, however—the row is still locked. In another session, we'll execute this update:

```
EODA@ORA12CR1> set serveroutput on
EODA@ORA12CR1> update t set x = x+1 where x > 0;
```

This will immediately block, of course, since the first session has that row locked. If we now go back to the first session and commit, we'll see this output (the update is repeated for clarity) in the second session:

```
EODA@ORA12CR1> update t set x = x+1 where x > 0;
old.x = 1, old.y = 1
new.x = 2, new.y = 1
old.x = 2, old.y = 1
new.x = 3, new.y = 1
1 row updated.
```

As you can see, that row trigger saw two versions of that row here. The row trigger was fired two times: once with the original version of the row and what we tried to modify that original version to, and again with the final row that was actually updated. Since this was a `BEFORE FOR EACH ROW` trigger, Oracle saw the read-consistent version of the record and the modifications we would like to have made to it. However, Oracle retrieved the block in current mode to actually perform the update *after* the `BEFORE FOR EACH ROW` trigger fired. It waits until after this trigger fires to get the block in current mode, because the trigger can modify the `:NEW` values. So Oracle can't modify the block until *after* this trigger executes, and the trigger could take a very long time to execute. Since only one session at a time can hold a block in current mode, Oracle needs to limit the time we have it in that mode.

After this trigger fired, Oracle retrieved the block in current mode and noticed that the column used to find this row, `X`, had been modified. Since `X` was used to locate this record and `X` was modified, the database decided to restart our query. Notice that the update of `X` from 1 to 2 did not put this row out of scope; we'll still be updating it with

this UPDATE statement. Rather, it is the fact that X was used to locate the row, and the consistent read value of X (1 in this case) differs from the current mode read of X (2). Now, upon restart, the trigger sees the value of X=2 (following modification by the other session) as the :OLD value and X=3 as the :NEW value.

So, this shows that these restarts happen. It takes a trigger to see them in action; otherwise, they are generally *undetectable*. That does not mean you can't see other symptoms—such as a large UPDATE statement rolling back work after updating many rows and then discovering a row that causes it to restart—just that it is hard to definitively say, “This symptom is caused by a restart.”

An interesting observation is that triggers themselves may cause restarts to occur even when the statement itself doesn't warrant them. Normally, the columns referenced in the WHERE clause of the UPDATE or DELETE statement are used to determine whether or not the modification needs to restart. Oracle will perform a consistent read using these columns and, upon retrieving the block in current mode, it will restart the statement if it detects that any of them have changed. Normally, the other columns in the row are not inspected. For example, let's simply rerun the previous example and use WHERE Y>0 to find the rows in both sessions, the output we'll see in the first session (the one that gets blocked) would be:

```
EODA@ORA12CR1> update t set x = x+1 where y > 0;
old.x = 1, old.y = 1
new.x = 2, new.y = 1
old.x = 2, old.y = 1
new.x = 3, new.y = 1
1 row updated.
```

So why did Oracle fire the trigger twice when it was looking at the Y value? Does it examine the whole row? As you can see from the output, the update was, in fact, restarted and the trigger again fired twice, even though we were searching on Y>0 and did not modify Y at all. But, if we re-create the trigger to simply print out the fact that it fired, rather than reference the :OLD and :NEW values, as follows, and go into that second session again and run the update, we observe it gets blocked (of course):

```
EODA@ORA12CR1> create or replace trigger t_bufer
  2 before update on t for each row
  3 begin
  4     dbms_output.put_line( 'fired' );
  5 end;
  6 /
Trigger created.
```

```
EODA@ORA12CR1> update t set x = x+1;
fired
1 row updated.
```

After committing the blocking session, we'll see the following:

```
EODA@ORA12CR1> update t set x = x+1 where y > 0;
fired
1 row updated.
```

The trigger fired just once this time, not twice. Thus, the :NEW and :OLD column values, when referenced in the trigger, are also used by Oracle to do the restart checking. When we referenced :NEW.X and :OLD.X in the trigger, X's consistent read and current read values were compared and found to be different. A restart ensued. When we removed the reference to that column from the trigger, there was no restart.

So the rule is that the set of columns used in the WHERE clause to find the rows plus the columns referenced in the row triggers will be compared. The consistent read version of the row will be compared to the current read version of the row; if any of them are different, the modification will restart.

---

■ **Note** You can use this bit of information to further understand why using an AFTER FOR EACH ROW trigger is more efficient than using a BEFORE FOR EACH ROW. The AFTER trigger won't have the same effect—we've already retrieved the block in current mode by then.

---

Which leads us to the “Why do we care?” question.

## Why Is a Restart Important to Us?

The first thing that pops out should be “Our trigger fired twice!” We had a one-row table with a BEFORE FOR EACH ROW trigger on it. We updated one row, yet the trigger fired two times.

Think of the potential implications of this. If you have a trigger that does anything nontransactional, this could be a fairly serious issue. For example, consider a trigger that sends an update where the body of the e-mail is “This is what the data used to look like. It has been modified to look like this now.” If you sent the e-mail directly from the trigger, using UTL\_SMTP in Oracle9i or UTL\_MAIL in Oracle 10g and above, then the user would receive two e-mails, with one of them reporting an update that never actually happened.

Anything you do in a trigger that is nontransactional will be impacted by a restart. Consider the following implications:

- Consider a trigger that maintains some PL/SQL global variables, such as for the number of rows processed. When a statement that restarts rolls back, the modifications to PL/SQL variables won't roll back.
- Virtually any function that starts with UTL\_ (UTL\_FILE, UTL\_HTTP, UTL\_SMTP, and so on) should be considered susceptible to a statement restart. When the statement restarts, UTL\_FILE won't *un-write* to the file it was writing to.
- Any trigger that is part of an autonomous transaction must be suspect. When the statement restarts and rolls back, the autonomous transaction can't be rolled back.

All of these consequences must be handled with care in the belief that they may be fired more than once per row or be fired for a row that won't be updated by the statement after all.

The second reason you should care about potential restarts is performance related. We have been using a single-row example, but what happens if you start a large batch update and it is restarted after processing the first 100,000 records? It will roll back the 100,000 row changes, restart in SELECT FOR UPDATE mode, and do the 100,000 row changes again after that.

You might notice, after putting in that simple audit trail trigger (the one that reads the :NEW and :OLD values), that performance is much worse than you can explain, even though nothing else has changed except the new triggers. It could be that you are restarting queries you never used in the past. Or the addition of a tiny program that updates just a single row here and there makes a batch process that used to run in an hour suddenly run in many hours due to restarts that never used to take place.

This is not a new feature of Oracle—it has been in the database since version 4.0, when read consistency was introduced. I myself was not totally aware of how it worked until the summer of 2003 and, after I discovered what it implied, I was able to answer a lot of “How could that have happened?” questions from my own past. It has made me swear off using autonomous transactions in triggers almost entirely, and it has made me rethink the way some of my applications have been implemented. For example, I'll never send e-mail from a trigger directly; rather, I'll always use

DBMS\_JOB or something similar to send the e-mail after my transaction commits. This makes the sending of the e-mail *transactional*; that is, if the statement that caused the trigger to fire and send the e-mail is restarted, the rollback it performs will roll back the DBMS\_JOB request. Most everything nontransactional that I did in triggers was modified to be done in a job after the fact, making it all transactionally consistent.

## Summary

In this chapter, we covered a lot of material that, at times, might not have been obvious. However, it is vital that you understand these issues. For example, if you were not aware of the statement-level restart, you might not be able to figure out how a certain set of circumstances could have taken place. That is, you would not be able to explain some of the daily empirical observations you make. In fact, if you were not aware of the restarts, you might wrongly suspect the actual fault to be due to the circumstances or end user error. It would be one of those unreproducible issues, as it takes many things happening in a specific order to observe.

We took a look at the meaning of the isolation levels set out in the SQL standard and at how Oracle implements them; at times, we contrasted Oracle's implementation with that of other databases. We saw that in other implementations (i.e., ones that employ read locks to provide consistent data), there is a huge trade-off between concurrency and consistency. To get highly concurrent access to data, you would have to decrease your need for consistent answers. To get consistent, correct answers, you would need to live with decreased concurrency. In Oracle that is not the case, due to its multiversioning feature.

Table 7-9 sums up what you might expect in a database that employs read locking versus Oracle's multiversioning approach.

**Table 7-9.** A Comparison of Transaction Isolation Levels and Locking Behavior in Oracle vs. Databases That Employ Read Locking

Isolation Level	Implementation	Writes Block Reads	Reads Block Writes	Deadlock-Sensitive Reads	Incorrect Query Results	Lost Updates	Lock Escalation or Limits
READ UNCOMMITTED	Not Oracle	No	No	No	Yes	Yes	Yes
READ COMMITTED	Not Oracle	Yes	No	No	Yes	Yes	Yes
READ COMMITTED	Oracle	No	No	No	No	No*	No
REPEATABLE READ	Not Oracle	Yes	Yes	Yes	No	No	Yes
SERIALIZABLE	Not Oracle	Yes	Yes	Yes	No	No	Yes
SERIALIZABLE	Oracle	No	No	No	No	No	No

\* With *SELECT FOR UPDATE NOWAIT*.

Concurrency controls and how the database implements them are definitely things you want to understand. I've been singing the praises of multiversioning and read consistency, but like everything else in the world, they are double-edged swords. If you don't understand that multiversioning is there and how it works, you will make errors in application design. Consider the resource scheduler example from Chapter 1. In a database without multiversioning and its associated nonblocking reads, the original logic employed by the program may very well have worked. However, this logic would fall apart when implemented in Oracle. It would allow data integrity to be compromised. Unless you know how multiversioning works, you will write programs that corrupt data. It is that simple.





# Transactions

Transactions are one of the features that set databases apart from file systems. In a file system, if you are in the middle of writing a file and the operating system crashes, that file will probably be corrupted, though there are “journaled” file systems and the like that may be able to recover your file to some point in time. However, if you need to keep two files synchronized, such a system won’t help—if you update one file and the system fails before you finish updating the second, your files won’t be synchronized.

This is the main purpose of *transactions*—they take the database from one consistent state to the next. That is their function. When you commit work in the database, you are assured that either all of your changes, or none of them, have been saved. Furthermore, you are assured that the various rules and checks that protect data integrity were implemented.

In the previous chapter, we discussed transactions in terms of concurrency control and how, as a result of Oracle’s multiversioning, read-consistent model, Oracle transactions can provide consistent data every time, under highly concurrent data access conditions. Transactions in Oracle exhibit all of the required ACID characteristics:

- *Atomicity*: Either all of a transaction happens or none of it happens.
- *Consistency*: A transaction takes the database from one consistent state to the next.
- *Isolation*: The effects of a transaction may not be visible to other transactions until the transaction has committed.
- *Durability*: Once the transaction is committed, it is permanent.

In particular, we discussed how Oracle obtains *consistency* and *isolation* in the previous chapter. Here we’ll focus most of our attention on the concept of *atomicity* and how that is applied in Oracle.

In this chapter, we’ll discuss the implications of atomicity and how it affects statements in Oracle. We’ll cover transaction control statements such as `COMMIT`, `SAVEPOINT`, and `ROLLBACK`, and we’ll discuss how integrity constraints are enforced in a transaction. We’ll also look at why you may have some bad transaction habits if you’ve been developing in other databases. We’ll look at distributed transactions and the two-phase commit (2PC). Lastly, we’ll examine autonomous transactions, what they are, and the role they play.

## Transaction Control Statements

You don’t need a “begin transaction” statement in Oracle. A transaction implicitly begins with the first statement that modifies data (the first statement that gets a TX lock). You can explicitly begin a transaction using `SET TRANSACTION` or the `DBMS_TRANSACTION` package, but it is not a necessary step, unlike in some other databases. Issuing either a `COMMIT` or `ROLLBACK` statement explicitly ends a transaction.

---

■ **Note** Not all ROLLBACK statements are created equal. It should be noted that a ROLLBACK TO SAVEPOINT command will not end a transaction! Only a full, proper ROLLBACK will.

---

You should always explicitly terminate your transactions with a COMMIT or ROLLBACK; otherwise, the tool or environment you're using will pick one or the other for you. If you exit your SQL\*Plus session normally, without committing or rolling back, SQL\*Plus assumes you wish to commit your work and it does so. If you just exit from a Pro\*C program, on the other hand, an implicit rollback takes place. Never rely on implicit behavior, as it could change in the future. Always explicitly COMMIT or ROLLBACK your transactions.

---

■ **Note** As an example of something changing in the future, SQL\*Plus in Oracle 11g Release 2 and above contains a setting, "exitcommit." This setting controls whether SQL\*Plus issues a COMMIT or ROLLBACK upon exit. So when you use 11g Release 2, the default behavior that has been in place since SQL\*Plus was invented may well be different!

---

Transactions are *atomic* in Oracle, meaning that either every statement that comprises the transaction is committed (made permanent) or all of the statements are rolled back. This protection is extended to individual statements as well. Either a statement entirely succeeds or the statement is entirely rolled back. Note that I said the "statement" is rolled back. The failure of one statement does not cause previously executed statements to be automatically rolled back. Their work is preserved and must either be committed or rolled back by you. Before we get into the details of exactly what it means for a statement and transaction to be atomic, let's take a look at the various transaction control statements available to us:

- **COMMIT:** To use this statement's simplest form, you just issue COMMIT. You could be more verbose and say COMMIT WORK, but the two are equivalent. A COMMIT ends your transaction and makes any changes permanent (durable). There are extensions to the COMMIT statement used in distributed transactions that allow you to label a COMMIT (label a transaction) with some meaningful comment and force the commit of an in-doubt distributed transaction. There are also extensions that allow you to perform an asynchronous commit—a commit that actually breaks the *durability* concept. We'll take a look at this in a bit and see when it might be appropriate to use.
- **ROLLBACK:** To use this statement's simplest form, you just issue ROLLBACK. Again, you could be more verbose and say ROLLBACK WORK, but the two are equivalent. A rollback ends your transaction and undoes any uncommitted changes. It does this by reading information stored in the rollback/undo segments (going forward I'll refer to these exclusively as *undo segments*, the favored terminology for Oracle 10g and later) and restoring the database blocks to the state they were before your transaction began.
- **SAVEPOINT:** A SAVEPOINT allows you to create a marked point within a transaction. You may have multiple SAVEPOINTS within a single transaction.
- **ROLLBACK TO <SAVEPOINT>:** This statement is used with the SAVEPOINT command. You can roll back your transaction to that marked point without rolling back any of the work that preceded it. So, you could issue two UPDATE statements, followed by a SAVEPOINT and then two DELETE statements. If an error or some sort of exceptional condition occurs during execution of the DELETE statements, and you catch that exception and issue the ROLLBACK TO SAVEPOINT command, the transaction will roll back to the named SAVEPOINT, undoing any work performed by the DELETES but leaving the work performed by the UPDATE statements intact.

- **SET TRANSACTION:** This statement allows you to set various transaction attributes, such as the transaction's isolation level and whether it is read-only or read-write. You can also use this statement to instruct the transaction to use a specific undo segment when using manual undo management, but this is not recommended. We'll discuss manual and automatic undo management in more detail in Chapter 9.

That's it—there are no other transaction control statements. The most frequently used control statements are **COMMIT** and **ROLLBACK**. The **SAVEPOINT** statement has a somewhat special purpose. Internally, Oracle uses it frequently; in fact Oracle uses it every time you execute any SQL or PL/SQL statement, and you may find some use for it in your applications as well.

## Atomicity

Now we're ready to see what's meant by statement, procedure, and transaction atomicity.

### Statement-Level Atomicity

Consider the following statement:

```
Insert into t values ( 1 );
```

It seems fairly clear that if the statement were to fail due to a constraint violation, the row would not be inserted. However, consider the following example, where an **INSERT** or **DELETE** on table **T** fires a trigger that adjusts the **CNT** column in table **T2** appropriately:

```
EODA@ORA12CR1> create table t2 ( cnt int );
Table created.
```

```
EODA@ORA12CR1> insert into t2 values ( 0 );
1 row created.
```

```
EODA@ORA12CR1> commit;
Commit complete.
```

```
EODA@ORA12CR1> create table t ( x int check ( x>0 ) );
Table created.
```

```
EODA@ORA12CR1> create trigger t_trigger
 2 before insert or delete on t for each row
 3 begin
 4   if ( inserting ) then
 5     update t2 set cnt = cnt +1;
 6   else
 7     update t2 set cnt = cnt -1;
 8   end if;
 9   dbms_output.put_line( 'I fired and updated ' ||
10                        sql%rowcount || ' rows' );
11 end;
12 /
Trigger created.
```

In this situation, it is less clear what should happen. If the error occurs *after* the trigger has fired, should the effects of the trigger persist, or not? That is, if the trigger fired and updated T2, but the row was not inserted into T, what should the outcome be? Clearly the answer is that we don't want the CNT column in T2 to be incremented if a row is not actually inserted into T. Fortunately in Oracle, the original statement from the client—INSERT INTO T, in this case—either entirely succeeds or entirely fails. This statement is atomic. We can confirm this, as follows:

```
EODA@ORA12CR1> set serveroutput on
EODA@ORA12CR1> insert into t values (1);
I fired and updated 1 rows

1 row created.

EODA@ORA12CR1> insert into t values(-1);
I fired and updated 1 rows
insert into t values(-1)
*
ERROR at line 1:
ORA-02290: check constraint (EODA.SYS_C0061484) violated

EODA@ORA12CR1> select * from t2;

      CNT
-----
       1
```

---

■ **Note** When using SQL\*Plus from Oracle9i Release 2 and before, in order to see that the trigger fired, you need to add a line of code, EXEC NULL, after the second INSERT. This is because SQL\*Plus does not retrieve and display the DBMS\_OUTPUT information after a failed DML statement in those releases. In Oracle 10g and above it does.

---

So, one row was successfully inserted into T and we duly received the message I fired and updated 1 rows. The next INSERT statement violates the integrity constraint we have on T. The DBMS\_OUTPUT message appeared—the trigger on T in fact did fire and we have evidence of that. The trigger performed its updates of T2 successfully. We might expect T2 to have a value of 2 now, but we see it has a value of 1. Oracle made the *original* INSERT atomic—the original INSERT INTO T is the statement, and any side effects of that original INSERT INTO T are considered part of that statement.

Oracle achieves this statement-level atomicity by silently wrapping a SAVEPOINT around each of our calls to the database. The preceding two INSERTs were really treated like this:

```
Savepoint statement1;
  Insert into t values ( 1 );
If error then rollback to statement1;
Savepoint statement2;
  Insert into t values ( -1 );
If error then rollback to statement2;
```

For programmers used to Sybase or SQL Server, this may be confusing at first. In those databases *exactly the opposite is true*. The triggers in those systems execute independently of the firing statement. If they encounter an error, the triggers must explicitly roll back their own work and then raise another error to roll back the triggering statement. Otherwise, the work done by a trigger could persist even if the triggering statement, or some other part of the statement, ultimately fails.

In Oracle, this statement-level atomicity extends as deep as it needs to. In the preceding example, if the `INSERT INTO T` fires a trigger that updates another table, and that table has a trigger that deletes from another table (and so on, and so on), either *all* of the work succeeds or *none* of it does. You don't need to code anything special to ensure this; it's just the way it works.

## Procedure-Level Atomicity

It is interesting to note that Oracle considers PL/SQL blocks to be statements as well. Consider the following stored procedure and reset of the example tables:

```
EODA@ORA12CR1> create or replace procedure p
 2 as
 3 begin
 4     insert into t values ( 1 );
 5     insert into t values (-1 );
 6 end;
 7 /
```

Procedure created.

```
EODA@ORA12CR1> delete from t;
0 rows deleted.
```

```
EODA@ORA12CR1> update t2 set cnt = 0;
1 row updated.
```

```
EODA@ORA12CR1> commit;
Commit complete.
```

```
EODA@ORA12CR1> select * from t;
no rows selected
```

```
EODA@ORA12CR1> select * from t2;
```

```
      CNT
-----
      0
```

So, we have a procedure we know will fail, and the second `INSERT` will always fail in this case. Let's see what happens if we run that stored procedure:

```
EODA@ORA12CR1> begin
 2     p;
 3 end;
 4 /
```

```
I fired and updated 1 rows
I fired and updated 1 rows
```

```
begin
*
ERROR at line 1:
ORA-02290: check constraint (EODA.SYS_C0061484) violated
ORA-06512: at "EODA.P", line 5
ORA-06512: at line 2
```

```
EODA@ORA12CR1> select * from t;
no rows selected
```

```
EODA@ORA12CR1> select * from t2;
```

```
      CNT
-----
      0
```

As you can see, Oracle treated the stored procedure call as an atomic statement. The client submitted a block of code—BEGIN P; END;—and Oracle wrapped a SAVEPOINT around it. Since P failed, Oracle restored the database back to the point right before it was called.

---

■ **Note** The preceding behavior—statement-level atomicity—relies on the PL/SQL routine not performing any commits or rollbacks. It is my opinion that COMMIT and ROLLBACK should not be used in general in PL/SQL; the invoker of the PL/SQL stored procedure is the only one that knows when a transaction is complete. It is a bad programming practice to issue a COMMIT or ROLLBACK in your developed PL/SQL routines.

---

Now, if we submit a slightly different block, we will get entirely different results:

```
EODA@ORA12CR1> begin
 2      p;
 3  exception
 4      when others then
 5          dbms_output.put_line( 'Error!!!! ' || sqlerrm );
 6  end;
 7  /
```

**I fired and updated 1 rows**  
**I fired and updated 1 rows**  
I fired and updated 1 rows  
Error!!!! ORA-02290: check constraint (EODA.SYS\_C0061484) violated  
PL/SQL procedure successfully completed.

```
EODA@ORA12CR1> select * from t;
```

```
      X
-----
      1
```

```
EODA@ORA12CR1> select * from t2;
```

```

      CNT
-----
      1

```

```
EODA@ORA12CR1> rollback;
Rollback complete.
```

Here, we ran a block of code that ignored any and all errors, and the difference in outcome is huge. Whereas the first call to P effected no changes, this time the first INSERT succeeds and the CNT column in T2 is incremented accordingly.

Oracle considered the “statement” to be the block that the client submitted. This statement succeeded by catching and ignoring the error itself, so the `If error then rollback...` didn’t come into effect and Oracle didn’t roll back to the SAVEPOINT after execution. Hence, the partial work performed by P was preserved. The reason this partial work is preserved in the first place is that we have statement-level atomicity within P: each statement in P is atomic. P becomes the client of Oracle when it submits its two INSERT statements. Each INSERT either succeeds or fails entirely. This is evidenced by the fact that we can see that the trigger on T fired twice and updated T2 twice, yet the count in T2 reflects only one UPDATE. The second INSERT executed in P had an implicit SAVEPOINT wrapped around it.

## THE “WHEN OTHERS” CLAUSE

I consider virtually all code that contains a WHEN OTHERS exception handler that does not also include a RAISE or RAISE\_APPLICATION\_ERROR to re-raise the exception to be a bug. It silently ignores the error and it changes the transaction semantics. Catching WHEN OTHERS and translating the exception into an old-fashioned return code changes the way the database is supposed to behave.

In fact, when Oracle 11g Release 1 was still on the drawing board, I was permitted to submit three requests for new features in PL/SQL. I jumped at the chance, and my first suggestion was simply “remove the WHEN OTHERS clause from the language.” My reasoning was simple: the most common cause of developer-introduced bugs I see—the *most common cause*—is a WHEN OTHERS not followed by a RAISE or RAISE\_APPLICATION\_ERROR. I felt the world would be a safer place without this language feature. The PL/SQL implementation team could not do this, of course, but they did the next best thing. They made it so that PL/SQL will generate a compiler warning if you have a WHEN OTHERS that is not followed by a RAISE or RAISE\_APPLICATION\_ERROR call. For example:

```
EODA@ORA12CR1> alter session set
 2 PLSQL_Warnings = 'enable:all'
 3 /
Session altered.
```

```
EODA@ORA12CR1> create or replace procedure some_proc( p_str in varchar2 )
 2 as
 3 begin
 4     dbms_output.put_line( p_str );
 5 exception
 6     when others
```

```

7   then
8     -- call some log_error() routine
9     null;
10  end;
11  /

```

SP2-0804: Procedure created with compilation warnings

```

EODA@ORA12CR1> show errors procedure some_proc
Errors for PROCEDURE P:

```

LINE/COL ERROR

```

-----
1/1      PLW-05018: unit SOME_PROC omitted optional AUTHID clause; default
         value DEFINER used

6/10     PLW-06009: procedure "SOME_PROC" OTHERS handler does not end in
         RAISE or RAISE_APPLICATION_ERROR

```

So, if you include `WHEN OTHERS` in your code and it is not followed by a `RAISE` or `RAISE_APPLICATION_ERROR`, be aware that you are *almost certainly* looking at a bug in your developed code, a bug placed there by you.

The difference between the two blocks of code, one with a `WHEN OTHERS` exception block and one without, is subtle, and something you must consider in your applications. Adding an exception handler to a block of PL/SQL code can radically change its behavior. A different way to code this—one that restores the statement-level atomicity to the entire PL/SQL block—is as follows:

```

EODA@ORA12CR1> begin
2   savepoint sp;
3   p;
4   exception
5     when others then
6       rollback to sp;
7       dbms_output.put_line( 'Error!!!! ' || sqlerrm );
8   end;
9   /

```

**I fired and updated 1 rows**

**I fired and updated 1 rows**

```

Error!!!! ORA-02290: check constraint (EODA.SYS_C0061484) violated
PL/SQL procedure successfully completed.

```

```

EODA@ORA12CR1> select * from t;
no rows selected

```

```

EODA@ORA12CR1> select * from t2;

```

```

      CNT
-----
      0

```



---

■ **Caution** The preceding code represents an exceedingly bad practice. In general, you should neither catch a `WHEN OTHERS` nor explicitly code what Oracle already provides as far as transaction semantics is concerned.

---

Here, by mimicking the work Oracle normally does for us with the `SAVEPOINT`, we are able to restore the original behavior while still catching and “ignoring” the error. I provide this example for illustration only; this is an exceedingly bad coding practice.

## Transaction-Level Atomicity

The entire goal of a transaction, a set of SQL statements executed together as a unit of work, is to take the database from one consistent state to another consistent state. To accomplish this goal, transactions are atomic as well—the entire set of successful work performed by a transaction is either entirely committed and made permanent or rolled back and undone. Just like a statement, the transaction is an atomic unit of work. Upon receipt of “success” from the database after committing a transaction, you know that all of the work performed by the transaction has been made persistent.

## DDL and Atomicity

It is worth noting that there is a certain class of statements in Oracle that are atomic—but only at the statement level. Data Definition Language (DDL) statements are implemented in a manner such that:

1. They begin by committing any outstanding work, ending any transaction you might already have in place.
2. They perform the DDL operation, such as a `CREATE TABLE`.
3. They commit the DDL operation if it was successful, or roll back the DDL operation otherwise.

This means that any time you issue a DDL statement such as `CREATE`, `ALTER` and so on, you must expect your existing transaction to be immediately committed and the subsequent DDL command to be performed and either committed and made durable or rolled back in the event of any error. DDL does not break the ACID concepts in any way, but the fact that it commits is something you definitely need to be aware of.

## Durability

Normally, when a transaction is committed, its changes are permanent; you can rely on those changes being in the database, even if the database crashed the instant after the commit completed. This is not true, however, in two specific cases:

- You use the `WRITE` extensions (available in Oracle 10g Release 2 and above) available in the `COMMIT` statement.
- You issue `COMMITs` in a nondistributed (accesses only a single database, no database links) PL/SQL block of code.

We'll look at each in turn.

## WRITE Extensions to COMMIT

Starting with Oracle 10g Release 2 and above, you may add a `WRITE` clause to your `COMMIT` statements. The `WRITE` clause allows the commit to either `WAIT` for the redo you generated to be written to disk (the default) or `NOWAIT`—to not wait—for the redo to be written. The `NOWAIT` option is the capability—a capability that must be used carefully, with forethought, and with understanding of exactly what it means.

Normally, a `COMMIT` is a synchronous process. Your application invokes `COMMIT` and then your application *waits* for the entire `COMMIT` processing to be complete (what that entails exactly will be covered in detail in Chapter 9). This is the behavior of `COMMIT` in all the database releases before Oracle 10g Release 2 and is the default behavior in Oracle 10g Release 2 and above.

In current releases of the database, instead of waiting for the commit to complete, which may take measurable time since a commit involves a physical write—a physical I/O—to the redo log files stored on disk, you may have the commit performed in the background, without waiting for it. That comes with the side-effect that *your commit is no longer assured to be durable*. That is, your application may get a response back from the database that the asynchronous commit you submitted was received, other sessions may be able to see your changes, but later find that the transaction you thought was committed was not. This situation will occur only in very rare cases and will always involve a serious failure of the hardware or software. It requires the database to be shutdown abnormally in order for an asynchronous commit to not be durable, meaning the database instance or computer the database instance is running on would have to suffer a complete failure.

So, if transactions are meant to be durable, what is the potential use of a feature that might make them possibly not durable? Raw performance. When you issue a `COMMIT` in your application, you are asking the LGWR process to take the redo you've generated and ensure that it is written to the online redo log files. Performing physical I/O, which this process involves, is measurably slow; it takes a long time, relatively speaking, to write data to disk. So, a `COMMIT` may well take longer than the DML statements in the transaction itself! If you make the `COMMIT` asynchronous, you remove the need to wait for that physical I/O in the client application, perhaps making the client application appear faster—especially if it does lots of `COMMIT`s.

This might suggest that you'd want to use this `COMMIT WRITE NOWAIT` all of the time—after all isn't performance the most important thing in the world? No, it is not. Most of the time, you need the durability achieved by default with `COMMIT`. When you `COMMIT` and report back to an end user “we have committed,” you need to be sure that the change is permanent. It will be recorded in the database even if the database/hardware failed right after the `COMMIT`. If you report to an end user that “Order 12352 has been placed,” you need to make sure that Order 12352 was truly placed and persistent. So, for most every application, the default `COMMIT WRITE WAIT` is the only correct option (note that you only need say `COMMIT`—the default setting is `WRITE WAIT`).

When would you want to use this capability to commit without waiting then? Three scenarios come to mind:

- A custom data load program. It must be custom, since it will have additional logic to deal with the fact that a commit might not persist a system failure.
- An application that processes a live data feed of some sort, say a stock quote feed from the stock markets that inserts massive amounts of time-sensitive information into the database. If the database goes offline, the data stream keeps on going and the data generated during the system failure will never be processed (Nasdaq does not shut down because your database crashed, after all!). That this data is not processed is OK, because the stock data is so time-sensitive, after a few seconds it would be overwritten by new data anyway.
- An application that implements its own “queuing” mechanism, for example one that has data in a table with a `PROCESSED_FLAG` column. As new data arrives, it is inserted with a value of `PROCESSED_FLAG='N'` (unprocessed). Another routine is tasked with reading the `PROCESSED_FLAG='N'` records, performing some small, fast transaction and updating the `PROCESSED_FLAG='N'` to 'Y'. If it commits but that commit is later undone (by a system failure), it is OK because the application that processes these records will just process the record again—it is “restartable.”

If you look at these application categories, you'll notice that all three of them are background, noninteractive applications. They do not interact with a human being directly. Any application that does interact with a person—that reports to the person “Commit complete”—should use the synchronous commit. Asynchronous commits are not a tuning device for your online customer-facing applications. Asynchronous commits are applicable only to batch-oriented applications, those that are automatically restartable upon failure. Interactive applications are not restartable automatically upon failure—a human being must redo the transaction. Therefore, you have another flag that tells you whether this capability can be considered—do you have a batch application or an interactive one? Unless it is batch-oriented, synchronous commit is the way to go.

So, outside of those three categories of batch applications, this capability—`COMMIT WRITE NOWAIT`—should probably not be used. If you do use it, you need to ask yourself what would happen if your application is told *commit processed*, but later, the commit is undone. You need to be able to answer that question and come to the conclusion that it will be OK if that happens. If you can't answer that question, or if a committed change being lost would have serious repercussions, you should not use the asynchronous commit capability.

## COMMITTS in a Nondistributed PL/SQL Block

Since PL/SQL was first introduced in version 6 of Oracle, it has been transparently using an asynchronous commit. That approach has worked because all PL/SQL is like a batch program in a way—the end user does not know the outcome of the procedure until it is completely finished. That's also why this asynchronous commit is used only in nondistributed PL/SQL blocks of code; if we involve more than one database, then there are two things—two databases—relying on the commit being durable. When two databases are relying on the commit being durable, we have to utilize synchronous protocols or a change might be committed in one database but not the other.

---

■ **Note** Of course, pipelined PL/SQL functions deviate from “normal” PL/SQL functions. In normal PL/SQL functions, the outcome is not known until the end of the stored procedure call. Pipelined functions in general are able to return data to a client long before they complete (they return “chunks” of data to the client, a bit at a time). But since pipelined functions are called from `SELECT` statements and would not be committing anyway, they do not come into play in this discussion.

---

Therefore, PL/SQL was developed to utilize an asynchronous commit, allowing the `COMMIT` statement in PL/SQL to not have to wait for the physical I/O to complete (avoiding the “log file sync” wait). That does not mean that you can't rely on a PL/SQL routine that commits and returns control to your application to not be durable with respect to its changes—PL/SQL will wait for the redo it generated to be written to disk before returning to the client application—but it will only wait once, right before it returns.

---

■ **Note** The following example demonstrates a bad practice—one that I call “slow-by-slow processing” or “row-by-row processing,” as row-by-row is synonymous with slow-by-slow in a relational database. It is meant just to illustrate how PL/SQL processes a `COMMIT` statement.

---

First let's create table T:

```
EODA@ORA12CR1> create table t
 2 as
 3 select *
 4   from all_objects
 5  where 1=0
 6  /
```

Table created.

Now consider this PL/SQL procedure:

```
EODA@ORA12CR1> create or replace procedure p
 2 as
 3 begin
 4   for x in ( select * from all_objects )
 5   loop
 6     insert into t values X;
 7     commit;
 8   end loop;
 9 end;
10 /
```

Procedure created.

That PL/SQL code reads a record at a time from ALL\_OBJECTS, inserts the record into table T and commits each record as it is inserted. Logically, that code is the same as this:

```
EODA@ORA12CR1> create or replace procedure p
 2 as
 3 begin
 4   for x in ( select * from all_objects )
 5   loop
 6     insert into t values X;
 7     commit write NOWAIT;
 8   end loop;
 9
10   -- make internal call here to ensure
11   -- redo was written by LGWR
12 end;
13 /
```

Procedure created.

So, the commits performed in the routine are done with `WRITE NOWAIT` and before the PL/SQL block of code returns to the client application, PL/SQL makes sure that the last bit of redo it generated was safely recorded to disk—making the PL/SQL block of code and its changes durable.

In Chapter 11, we'll see the salient effects of this feature of PL/SQL when measuring the performance of reverse key indexes. If you'd like to see how PL/SQL performs in the manner described earlier, skip there for a moment to review the reverse key index benchmark.

# Integrity Constraints and Transactions

It is interesting to note exactly when integrity constraints are checked. By default, integrity constraints are checked after the entire SQL statement has been processed. There are also deferrable constraints that permit the validation of integrity constraints to be postponed until either the application requests they be validated by issuing a `SET CONSTRAINTS ALL IMMEDIATE` command or upon issuing a `COMMIT`.

## IMMEDIATE Constraints

For the first part of this discussion, we'll assume that constraints are in `IMMEDIATE` mode, which is the norm. In this case, the integrity constraints are checked immediately after the entire SQL statement has been processed. Note that I used the term "SQL statement," not just "statement." If I have many SQL statements in a PL/SQL stored procedure, each SQL statement will have its integrity constraints validated immediately after its individual execution, not after the stored procedure completes.

So, why are constraints validated *after* the SQL statement executes? Why not *during*? This is because it is very natural for a single statement to make individual rows in a table momentarily inconsistent. Taking a look at the partial work by a statement would result in Oracle rejecting the results, even if the end result would be OK. For example, suppose we have a table like this:

```
EODA@ORA12CR1> create table t ( x int unique );
Table created.
```

```
EODA@ORA12CR1> insert into t values ( 1 );
1 row created.
```

```
EODA@ORA12CR1> insert into t values ( 2 );
1 row created.
```

```
EODA@ORA12CR1> commit;
Commit complete.
```

And we want to execute a multiple-row `UPDATE`:

```
EODA@ORA12CR1> update t set x=x-1;
2 rows updated.
```

If Oracle checked the constraint after each row was updated, on any given day we would stand a 50-50 chance of having the `UPDATE` fail. The rows in `T` are accessed in *some* order, and if Oracle updated the `X=1` row first, we would momentarily have a duplicate value for `X` and it would reject the `UPDATE`. Since Oracle waits patiently until the end of the statement, the statement succeeds because by the time it is done, there are no duplicates.

## DEFERRABLE Constraints and Cascading Updates

Starting with Oracle 8.0, we also have the ability to *defer* constraint checking, which can be quite advantageous for various operations. The one that immediately jumps to mind is the requirement to cascade an `UPDATE` of a primary key to the child keys. Many people claim you should never need to do this—that primary keys are immutable (I am one of those people), but many others persist in their desire to have a cascading `UPDATE`. Deferrable constraints make this possible.

---

■ **Note** It is considered an extremely bad practice to perform update cascades to modify a primary key. It violates the intent of the primary key. If you have to do it once to correct bad information, that's one thing, but if you find you are constantly doing it as part of your application, you will want to go back and rethink that process—you have chosen the wrong attributes to be the key!

---

In early releases of Oracle, it was possible to do a `CASCADE UPDATE`, but doing so involved a tremendous amount of work and had certain limitations. With deferrable constraints, it becomes almost trivial. The code could look like this:

```
EODA@ORA12CR1> create table parent
  2 ( pk int primary key )
  3 /
Table created.
```

```
EODA@ORA12CR1> create table child
  2 ( fk constraint child_fk_parent
  3     references parent(pk)
  4     deferrable
  5     initially immediate
  6 )
  7 /
Table created.
```

```
EODA@ORA12CR1> insert into parent values ( 1 );
1 row created.
```

```
EODA@ORA12CR1> insert into child values ( 1 );
1 row created.
```

We have a parent table, `PARENT`, and a child table, `CHILD`. Table `CHILD` references table `PARENT`, and the constraint used to enforce that rule is called `CHILD_FK_PARENT` (child foreign key to parent). This constraint was created as `DEFERRABLE`, but it is set to `INITIALLY IMMEDIATE`. This means we can defer that constraint until `COMMIT` or to some other time. By default, however, it will be validated at the statement level. This is the most common use of the deferrable constraints. Most existing applications won't check for constraint violations on a `COMMIT` statement, and it is best not to surprise them with that. As defined, table `CHILD` behaves in the fashion tables always have, but it gives us the ability to explicitly change its behavior. Now let's try some DML on the tables and see what happens:

```
EODA@ORA12CR1> update parent set pk = 2;
update parent set pk = 2
*
ERROR at line 1:
ORA-02292: integrity constraint (EODA.CHILD_FK_PARENT) violated - child record found
```

Since the constraint is in IMMEDIATE mode, this UPDATE fails. We'll change the mode and try again:

```
EODA@ORA12CR1> set constraint child_fk_parent deferred;
Constraint set.
```

```
EODA@ORA12CR1> update parent set pk = 2;
1 row updated.
```

Now it succeeds. For illustration purposes, I'll show how to check a deferred constraint explicitly before committing, to see if the modifications we made are in agreement with the business rules (in other words, to check that the constraint isn't currently being violated). It's a good idea to do this before committing or releasing control to some other part of the program (which may not be expecting the deferred constraints):

```
EODA@ORA12CR1> set constraint child_fk_parent immediate;
set constraint child_fk_parent immediate
*
ERROR at line 1:
ORA-02291: integrity constraint (EODA.CHILD_FK_PARENT) violated - parent key not found
```

It fails and returns an error immediately as expected, since we knew that the constraint had been violated. The UPDATE to PARENT was not rolled back (that would violate the statement-level atomicity); it is still outstanding. Also note that our transaction is still working with the CHILD\_FK\_PARENT constraint deferred because the SET CONSTRAINT command failed. Let's continue now by cascading the UPDATE to CHILD:

```
EODA@ORA12CR1> update child set fk = 2;
1 row updated.
```

```
EODA@ORA12CR1> set constraint child_fk_parent immediate;
Constraint set.
```

```
EODA@ORA12CR1> commit;
Commit complete.
```

And that's the way it works. Note that to defer a constraint, you must create it that way—you have to drop and re-create the constraint to change it from nondeferrable to deferrable. That might lead you to believe that you should create all of your constraints as “deferrable initially immediate,” just in case you wanted to defer them at some point. In general, that is *not* true. You want to allow constraints to be deferred only if you have a real need to do so. By creating deferred constraints, you introduce differences in the physical implementation (in the structure of your data) that might not be obvious. For example, if you create a deferrable UNIQUE or PRIMARY KEY constraint, the index that Oracle creates to support the enforcement of that constraint will be a non-unique index. Normally, you expect a unique index to enforce a unique constraint, but since you have specified that the constraint could temporarily be ignored, it can't use that unique index. Other subtle changes will be observed, for example, with NOT NULL constraints. In Chapter 11, we'll see how an index on a NOT NULL column can be used in many cases where a similar index on a NULL column can't be. If you allow your NOT NULL constraints to be deferrable, the optimizer will start treating the column as if it supports NULLs—because it in fact *does* support NULLs during your transaction. For example, suppose you have a table with the following columns and data:

```
EODA@ORA12CR1> create table t
  2 ( x int constraint x_not_null not null deferrable,
  3   y int constraint y_not_null not null,
  4   z varchar2(30)
  5 );
Table created.
```

```
EODA@ORA12CR1> insert into t(x,y,z)
  2  select rownum, rownum, rpad('x',30,'x')
  3  from all_users;
45 rows created.
```

```
EODA@ORA12CR1> exec dbms_stats.gather_table_stats( user, 'T' );
PL/SQL procedure successfully completed.
```

In this example, column X is created such that when you COMMIT, X will not be null. However, during your transaction X is allowed to be null since the constraint is deferrable. Column Y, on the other hand, is always NOT NULL. Let's say you were to index column Y:

```
EODA@ORA12CR1> create index t_idx on t(y);
Index created.
```

And you then ran a query that could make use of this index on Y—but only if Y is NOT NULL, as in following query:

```
EODA@ORA12CR1> explain plan for select count(*) from t;
Explained.

EODA@ORA12CR1> select * from table(dbms_xplan.display(null,null,'BASIC'));
```

```
-----
| Id | Operation          | Name |
-----
|  0 | SELECT STATEMENT   |      |
|  1 |   SORT AGGREGATE   |      |
|  2 |    INDEX FULL SCAN| T_IDX|
-----
```

You would be happy to see the optimizer chose to use the small index on Y to count the rows rather than to full-scan the entire table T. However, let's say that you drop that index and index column X instead:

```
EODA@ORA12CR1> drop index t_idx;
Index dropped.

EODA@ORA12CR1> create index t_idx on t(x);
Index created.
```

And you then ran the query to count the rows once more, you would discover that the database does not, in fact cannot, use your index:

```
EODA@ORA12CR1> explain plan for select count(*) from t;
Explained.
```



```
EODA@ORA12CR1> select * from table(dbms_xplan.display(null,null,'BASIC'));
```

Id	Operation	Name
0	SELECT STATEMENT	
1	SORT AGGREGATE	
2	TABLE ACCESS FULL	T

It full-scanned the table. It had to full-scan the table in order to count the rows. This is due to the fact that in an Oracle B\*Tree index, index key entries that are entirely null are not made. That is, the index will not contain an entry for any row in the table T, such that all of the columns in the index are null. Since X is allowed to be null *temporarily*, the optimizer has to assume that X might be null and therefore would not be in the index on X. Hence a count returned from the index might be different (wrong) from a count against the table.

We can see that if X had a nondeferrable constraint placed on it, this limitation is removed; that is, column X is in fact as good as column Y *if* the NOT NULL constraint is not deferrable:

```
EODA@ORA12CR1> alter table t drop constraint x_not_null;
Table altered.
```

```
EODA@ORA12CR1> alter table t modify x constraint x_not_null not null;
Table altered.
```

```
EODA@ORA12CR1> explain plan for select count(*) from t;
Explained.
```

```
EODA@ORA12CR1> select * from table(dbms_xplan.display(null,null,'BASIC'));
```

Id	Operation	Name
0	SELECT STATEMENT	
1	SORT AGGREGATE	
2	INDEX FULL SCAN	T_IDX

So, the bottom line is, only use deferrable constraints where you have an identified need to use them. They introduce subtle side effects that could cause differences in your physical implementation (non-unique vs. unique indexes) or in your query plans—as just demonstrated!

## Bad Transaction Habits

Many developers have some bad habits when it comes to transactions. I see this frequently with developers who have worked with a database that “supports” but does not “promote” the use of transactions. For example, in Informix (by default), Sybase, and SQL Server, you must explicitly BEGIN a transaction; otherwise, each individual statement is a transaction all by itself. In a similar manner to the way in which Oracle wraps a SAVEPOINT around discrete statements, these databases wrap a BEGIN WORK/COMMIT or ROLLBACK around each statement. This is because, in these databases, locks are precious resources, and readers block writers and vice versa. In an attempt to increase concurrency, these databases want you to make the transaction as short as possible—sometimes at the expense of data integrity.

Oracle takes the opposite approach. Transactions are always implicit, and there is no way to have an “autocommit” unless an application implements it (see the “Using Autocommit” section later in this chapter for more details). In Oracle, every transaction should be committed when it must and never before. Transactions should be as

large as they need to be. Issues such as locks, blocking, and so on should not really be considered the driving forces behind transaction size—data integrity is *the driving* force behind the size of your transaction. Locks are not a scarce resource, and there are no contention issues between concurrent readers and writers of data. This allows you to have robust transactions in the database. These transactions do not have to be short in duration—they should be exactly as long as they need to be (but no longer). Transactions are not for the convenience of the computer and its software; they are to protect your data.

## Committing in a Loop

Faced with the task of updating many rows, most programmers will try to figure out some procedural way to do it in a loop, so that they can commit every so many rows. I've heard two (*false!*) reasons for doing it this way:

- It is faster and more efficient to frequently commit lots of small transactions than it is to process and commit one big transaction.
- We don't have enough undo space.

Both of these reasons are misguided. Furthermore, committing too frequently leaves you prone to the danger of leaving your database in an “unknown” state should your update fail halfway through. It requires complex logic to write a process that is smoothly restartable in the event of failure. By far the best option is to commit only as frequently as your business processes dictate and to size your undo segments accordingly.

Let's take a look at these issues in more detail.

## Performance Implications

It is generally not faster to commit frequently—it is almost always faster to do the work in a single SQL statement. By way of a small example, say we have a table, T, with lots of rows, and we want to update a column value for every row in that table. We'll use this to set up such a table (run these four setup steps before each of the following three cases):

```
EODA@ORA12CR1> drop table t;
Table dropped.
```

```
EODA@ORA12CR1> create table t as select * from all_objects;
Table created.
```

```
EODA@ORA12CR1> exec dbms_stats.gather_table_stats( user, 'T' );
PL/SQL procedure successfully completed.
```

```
EODA@ORA12CR1> variable n number
```

Well, when we go to update, we could simply do it in a single UPDATE statement, like this:

```
EODA@ORA12CR1> exec :n := dbms_utility.get_cpu_time;
PL/SQL procedure successfully completed.
```

```
EODA@ORA12CR1> update t set object_name = lower(object_name);
72614 rows updated.
```

```
EODA@ORA12CR1> exec dbms_output.put_line((dbms_utility.get_cpu_time-:n)|| ' cpu hsecs...');
49 cpu hsecs...
```

Many people, for whatever reason, feel compelled to do it like this—slow-by-slow/row-by-row—in order to have a commit every N records:

```
EODA@ORA12CR1> exec :n := dbms_utility.get_cpu_time;
PL/SQL procedure successfully completed.
```

```
EODA@ORA12CR1> begin
2   for x in ( select rowid rid, object_name, rownum r
3               from t )
4   loop
5       update t
6           set object_name = lower(x.object_name)
7           where rowid = x.rid;
8       if ( mod(x.r,100) = 0 ) then
9           commit;
10      end if;
11  end loop;
12  commit;
13 end;
14 /
PL/SQL procedure successfully completed.
```

```
EODA@ORA12CR1> exec dbms_output.put_line((dbms_utility.get_cpu_time-:n)||' cpu hsecs...' );
275 cpu hsecs...
```

In this simple example, it is many times *slower* to loop in order to commit frequently. If you can do it in a *single* SQL statement, do it that way, as it is almost certainly faster. Even if we “optimize” the procedural code, using bulk processing for the updates (as follows), it is in fact much faster, but still much slower than it could be.

```
EODA@ORA12CR1> exec :n := dbms_utility.get_cpu_time;
PL/SQL procedure successfully completed.
```

```
EODA@ORA12CR1> declare
2   type ridArray is table of rowid;
3   type vcArray is table of t.object_name%type;
4
5   l_rids ridArray;
6   l_names vcArray;
7
8   cursor c is select rowid, object_name from t;
9 begin
10  open c;
11  loop
12      fetch c bulk collect into l_rids, l_names LIMIT 100;
13      forall i in 1 .. l_rids.count
14          update t
15              set object_name = lower(l_names(i))
16              where rowid = l_rids(i);
```

```

17         commit;
18         exit when c%notfound;
19     end loop;
20     close c;
21 end;
22 /

```

PL/SQL procedure successfully completed.

```

EODA@ORA12CR1> exec dbms_output.put_line((dbms_utility.get_cpu_time-:n)||' cpu hsecs...' );
67 cpu hsecs...

```

PL/SQL procedure successfully completed.

Not only that, but you should notice that the code is getting more and more complex. From the sheer simplicity of a single UPDATE statement, to procedural code, to even more complex procedural code—we are going in the wrong direction! Furthermore (yes, there is more to complain about), the preceding procedural code is not done yet. It doesn't deal with “what happens when we fail” (not *if we* but rather *when we*). What happens if this code gets halfway done and then the system fails? How do you restart the procedural code with a commit? You'd have to add yet more code so you knew where to pick up and continue processing. With the single UPDATE statement, we just reissue the UPDATE. We know that it will entirely succeed or entirely fail; there will not be partial work to worry about. We visit this point more in the section “Restartable Processes Require Complex Logic.”

Now, just to supply a counterpoint to this discussion, recall in Chapter 7 when we discussed the concept of write consistency and how an UPDATE statement, for example, could be made to restart. In the event that the preceding UPDATE statement was to be performed against a subset of the rows (it had a WHERE clause, and other users were modifying the columns this UPDATE was using in the WHERE clause), then there would be a case either for using a series of smaller transactions rather than one large transaction or for locking the table prior to performing the mass update. The goal here would be to reduce the opportunity for restarts to occur.

If we were to UPDATE the vast majority of the rows in the table, that would lead us toward using the LOCK TABLE command. In my experience, however, these sorts of large mass updates or mass deletes (the only statement types really that would be subject to the restart) are done in isolation. That large, one-time bulk update or the purge of old data generally is not done during a period of high activity. Indeed, the purge of data should not be affected by this at all, since you would typically use some date field to locate the information to purge, and other applications would not modify this data.

## Snapshot Too Old Error

Let's now look at the second reason developers are tempted to commit updates in a procedural loop, which arises from their (misguided) attempts to use a “limited resource” (undo segments) sparingly. This is a configuration issue; you *need* to ensure that you have enough undo space to size your transactions correctly. Committing in a loop, apart from generally being slower, is also the most common cause of the dreaded ORA-01555 error. Let's look at this in more detail.

As you will appreciate after reading Chapters 1 and 7, Oracle's multiversioning model uses undo segment data to reconstruct blocks as they appeared at the beginning of your statement or transaction (depending on the isolation mode). If the necessary undo information no longer exists, you will receive an ORA-01555: snapshot too old error message and your query will not complete. So, if you are modifying the table that you are reading (as in the previous example), you are generating undo information required for your query. Your UPDATE generates undo information that your query will probably be making use of to get the read-consistent view of the data it needs to update. If you commit, you are allowing the system to reuse the undo segment space you just filled up. If it does reuse the undo, wiping out old undo data that your query subsequently needs, you are in big trouble. Your SELECT will fail and your UPDATE will stop partway through. You have a partly finished logical transaction and probably no good way to restart it (more about this in a moment).

Let's see this concept in action with a small demonstration. In a small test database, I set up a table:

```
EODA@ORA12CR1> create table t as select * from all_objects;
Table created.
```

```
EODA@ORA12CR1> create index t_idx on t(object_name);
Index created.
```

```
EODA@ORA12CR1> exec dbms_stats.gather_table_stats( user, 'T', cascade=>true );
PL/SQL procedure successfully completed.
```

I then created a very small undo tablespace and altered the system to use it. Note that by setting AUTOEXTEND off, I have limited the size of all UNDO to be 10MB or less in this system:

```
EODA@ORA12CR1> create undo tablespace undo_small
 2   datafile '/u01/dbfile/ORA12CR1/undo_small.dbf'
 3   size 10m reuse
 4   autoextend off
 5 /
Tablespace created.
EODA@ORA12CR1> alter system set undo_tablespace = undo_small;
System altered.
```

Now, with only the small undo tablespace in use, I ran this block of code to do the UPDATE:

```
EODA@ORA12CR1> begin
 2   for x in ( select /*+ INDEX(t t_idx) */ rowid rid, object_name, rownum r
 3             from t
 4             where object_name > ' ' )
 5   loop
 6     update t
 7       set object_name = lower(x.object_name)
 8       where rowid = x.rid;
 9     if ( mod(x.r,100) = 0 ) then
10       commit;
11     end if;
12   end loop;
13   commit;
14 end;
15 /
begin
*
ERROR at line 1:
ORA-01555: snapshot too old: rollback segment number  with name "" too small
ORA-06512: at line 2
```

I get the error. I should point out that I added an index hint to the query and a WHERE clause to make sure I was reading the table randomly (together, they caused the cost-based optimizer to read the table “sorted” by the index key). When we process a table via an index, we tend to read a block for a single row, and then the next row we want will be on a different block. Ultimately, we will process all of the rows on block 1, just not all at the same time. Block 1 might hold, say, the data for all rows with OBJECT\_NAMEs starting with the letters A, M, N, Q, and Z. So we would hit the block many times, since we are reading the data sorted by OBJECT\_NAME and presumably many OBJECT\_NAMEs start with letters between A and M. Since we are committing frequently and reusing undo space, we eventually revisit a block where we can simply no longer roll back to the point our query began, and at that point we get the error.

This was a very artificial example just to show how it happens in a reliable manner. My UPDATE statement was generating undo. I had a very small undo tablespace to play with (10MB). I wrapped around in my undo segments many times, since they are used in a circular fashion. Every time I committed, I allowed Oracle to overwrite the undo data I generated. Eventually, I needed some piece of data I had generated, but it no longer existed and I received the ORA-01555 error.

You would be right to point out that in this case, if I had not committed on line 10, I would have received the following error:

```
begin
*
ERROR at line 1:
ORA-30036: unable to extend segment by 8 in undo tablespace 'UNDO_SMALL'
ORA-06512: at line 6
```

The major differences between the two errors are as follows:

- The ORA-01555 example *left my update in a totally unknown state*. Some of the work had been done; some had not.
- There is absolutely *nothing I can do to avoid the ORA-01555 error*, given that I committed in the cursor FOR loop.
- *The ORA-30036 error can be avoided* by allocating appropriate resources in the system. This error is avoidable by correct sizing; the first error is not. Further, even if I don’t avoid this error, at least the update is rolled back and the database is left in a known, consistent state—not halfway through some large update.

The bottom line here is that you can’t “save” on undo space by committing frequently—you need that undo. I was in a single-user system when I received the ORA-01555 error. It takes only one session to cause that error, and many times even in real life it is a single session causing its own ORA-01555 errors. Developers and DBAs need to work together to size these segments adequately for the jobs that need to be done. There can be no short-changing here. You must discover, through analysis of your system, what your biggest transactions are and size appropriately for them. The dynamic performance view V\$UNDOSTAT can be very useful to monitor the amount of undo you are generating and the duration of your longest running queries. Many people consider things like temp, undo, and redo as overhead—things to allocate as little storage to as possible. This is reminiscent of a problem the computer industry had on January 1, 2000, which was all caused by trying to save 2 bytes in a date field. These components of the database are not overhead, but rather are key components of the system. They must be sized appropriately (not too big and not too small).

---

■ **Note** Speaking of UNDO segments being too small, make sure to set your undo tablespace back to your regular one after running these examples, otherwise you’ll be hitting ORA-30036 errors for the rest of the book!

---

## Restartable Processes Require Complex Logic

The most serious problem with the “commit before the logical transaction is over” approach is the fact that it frequently leaves your database in an unknown state if the UPDATE fails halfway through. Unless you planned for this ahead of time, it is very hard to restart the failed process, allowing it to pick up where it left off. For example, say we were not applying the LOWER() function to the column, as in the previous example, but rather some other function of the column, such as this:

```
last_ddl_time = last_ddl_time + 1;
```

If we halted the UPDATE loop partway through, how would we restart it? We could not just rerun it, as we would end up adding 2 to some dates, and 1 to others. If we fail again, we would add 3 to some, 2 to others, 1 to the rest, and so on. We need yet more complex logic—some way to “partition” the data. For example, we could process every OBJECT\_NAME that starts with A, and then B, and so on:

```
EODA@ORA12CR1> create table to_do
 2  as
 3  select distinct substr( object_name, 1,1 ) first_char
 4  from T
 5  /
Table created.

EODA@ORA12CR1> begin
 2      for x in ( select * from to_do )
 3      loop
 4          update t set last_ddl_time = last_ddl_time+1
 5              where object_name like x.first_char || '%';
 6
 7          dbms_output.put_line( sql%rowcount || ' rows updated' );
 8          delete from to_do where first_char = x.first_char;
 9
10      commit;
11  end loop;
12 end;
13 /
238 rows updated
5730 rows updated
1428 rows updated
...
262 rows updated
1687 rows updated
PL/SQL procedure successfully completed.
```

Now, we could restart this process if it fails, since we would not process any object name that had already been processed successfully. The problem with this approach, however, is that unless we have some attribute that evenly partitions the data, we will end up having a very wide distribution of rows. The second UPDATE did more work than all of the others combined. Additionally, if other sessions are accessing this table and modifying the data, they might update the OBJECT\_NAME field as well. Suppose that some other session updates the object named Z to be A, *after* we

already processed the As. We would miss that record. Furthermore, this is a very inefficient process compared to `UPDATE T SET LAST_DDL_TIME = LAST_DDL_TIME+1`. We are probably using an index to read every row in the table, or we are full-scanning it  $n$  times, both of which are undesirable. There are so many bad things to be said about this approach.

---

■ **Note** In Chapter 14, we'll visit a feature available starting with Oracle 11g Release 2—the `DBMS_PARALLEL_EXECUTE` package. There we'll revisit this restartable approach and deal with the non-uniform update patterns as well.

---

The best approach is the one I advocated at the beginning of Chapter 1: do it simply. If it can be done in SQL, do it in SQL. What can't be done in SQL, do in PL/SQL. Do it using the least amount of code you can. Have sufficient resources allocated. Always think about what happens in the event of an error. So many times, I've seen people code update loops that worked great on the test data but then failed halfway through when applied to the real data. Then they are really stuck, as they have no idea where the loop stopped processing. It's a lot easier to size undo correctly than to write a restartable program. If you have truly large tables that need to be updated, you should be using partitions (more on that in Chapter 10), which you can update each individually. You can even use parallel DML to perform the update, or in Oracle 11g Release 2 and above, the `DBMS_PARALLEL_EXECUTE` package.

## Using Autocommit

My final words on bad transaction habits concern the one that arises from using the popular programming APIs ODBC and JDBC. These APIs “autocommit” by default. Consider the following statements, which transfer \$1,000 from a checking account to a savings account:

```
update accounts set balance = balance - 1000 where account_id = 123;
update accounts set balance = balance + 1000 where account_id = 456;
```

If your program is using ODBC or JDBC when you submit these statements, they (silently) inject a commit after *each* UPDATE. Consider the impact of this if the system fails after the first UPDATE and before the second. You've just lost \$1,000!

I can sort of understand why ODBC does this. The developers of SQL Server designed ODBC, and this database demands that you use very short transactions due to its concurrency model (writes block reads, reads block writes, and locks are a scarce resource). What I can't understand is how this got carried over into JDBC, an API that is supposed to support “the enterprise.” It is my belief that the very next line of code after opening a connection in JDBC should always be this:

```
Connection conn = DriverManager.getConnection
    ("jdbc:oracle:oci:@database","scott","tiger");

conn.setAutoCommit (false);
```

This returns control over the transaction back to you, the developer, which is where it belongs. You can then safely code your account transfer transaction and commit it after both statements have succeeded. Lack of knowledge of your API can be deadly in this case. I've seen more than one developer unaware of this autocommit “feature” get into big trouble with his application when an error occurred.



## Distributed Transactions

One of the really nice features of Oracle is its ability to transparently handle distributed transactions. I can update data in many different databases in the scope of a single transaction. When I commit, either I commit the updates in all of the instances or I commit none of them (they will all be rolled back). I need no extra code to achieve this; I simply “commit.”

A key to distributed transactions in Oracle is the *database link*. A database link is a database object that describes how to log into another instance from your instance. However, the purpose of this section is not to cover the syntax of the database link command (it is fully documented in the *Oracle Database SQL Language Reference* manual), but rather to expose you to its very existence. Once you have a database link set up, accessing remote objects is as easy as this:

```
select * from T@another_database;
```

This would select from the table T in the database instance defined by the database link ANOTHER\_DATABASE. Typically, you would “hide” the fact that T is a remote table by creating a view of it, or a synonym. For example, I can issue the following and then access T as if it were a local table:

```
create synonym T for T@another_database;
```

Now that I have this database link set up and can read some tables, I am also able to modify them (assuming I have the appropriate privileges, of course). Performing a distributed transaction is now no different from a local transaction. All I would do is this:

```
update local_table set x = 5;
update remote_table@another_database set y = 10;
commit;
```

That’s it. Oracle will commit either in both databases or in neither. It uses a two-phase commit protocol (2PC) to do this. 2PC is a distributed protocol that allows for a modification that affects many disparate databases to be committed atomically. It attempts to close the window for distributed failure as much as possible before committing. In a 2PC between many databases, one of the databases—typically the one the client is logged into initially—will be the coordinator for the distributed transaction. This one site will ask the other sites if they are ready to commit. In effect, this site will go to the other sites and ask them to be prepared to commit. Each of the other sites reports back its “prepared state” as YES or NO. If any one of the sites votes NO, the entire transaction is rolled back. If all sites vote YES, the site coordinator broadcasts a message to make the commit permanent on each of the sites.

This limits the window in which a serious error could occur. Prior to the “voting” on the 2PC, any distributed error would result in all of the sites rolling back. There would be no doubt as to the outcome of the transaction. After the order to commit or rollback, there again is no doubt as to the outcome of the distributed transaction. It is only during the very short window when the coordinator is collecting the votes that the outcome might be in doubt, after a failure.

Assume, for example, we have three sites participating in the transaction with Site 1 being the coordinator. Site 1 has asked Site 2 to prepare to commit, and Site 2 has done so. Site 1 then asks Site 3 to prepare to commit, and it does so. At this point, Site 1 is the only site that knows the outcome of the transaction, and it is now responsible for broadcasting the outcome to the other sites. If an error occurs right now—the network fails, Site 1 loses power, whatever—Sites 2 and 3 will be left hanging. They will have what is known as an *in-doubt distributed transaction*. The 2PC protocol attempts to close the window of error as much as possible, but it can’t close it entirely. Sites 2 and 3 must keep that transaction open, awaiting notification of the outcome from Site 1.

If you recall from the architecture discussion in Chapter 5, it is the function of the RECO process to resolve this issue. This is also where COMMIT and ROLLBACK with the FORCE option come into play. If the cause of the problem was a network failure between Sites 1, 2, and 3, then the DBAs at Sites 2 and 3 could actually call the DBA at Site 1, ask him for the outcome, and apply the commit or rollback manually, as appropriate.

There are some, but not many, limitations to what you can do in a distributed transaction, and they are reasonable (to me, anyway, they seem reasonable). The big ones are as follows:

- You can't issue a `COMMIT` over a database link. That is, you can't issue a `COMMIT@remote_site`. You may commit only from the site that initiated the transaction.
- You can't do DDL over a database link. This is a direct result of the preceding issue. DDL commits. You can't commit from any site other than the initiating site, hence you can't do DDL over a database link.
- You can't issue a `SAVEPOINT` over a database link. In short, you can't issue any transaction control statements over a database link. All transaction control is inherited from the session that opened the database link in the first place; you can't have different transaction controls in place in the distributed instances in your transaction.

The lack of transaction control over a database link is reasonable, since the initiating site is the only one that has a list of everyone involved in the transaction. If in our three-site configuration, Site 2 attempted to commit, it would have no way of knowing that Site 3 was involved. In Oracle, only Site 1 can issue the commit command. At that point, it is permissible for Site 1 to delegate responsibility for distributed transaction control to another site.

We can influence which site will be the actual commit site by setting the `COMMIT_POINT_STRENGTH` (a parameter) of the site. A `COMMIT_POINT_STRENGTH` associates a relative level of importance to a server in a distributed transaction. The more important the server (the more available the data needs to be), the more probable that it will coordinate the distributed transaction. You might want to do this if you need to perform a distributed transaction between your production machine and a test machine. Since the transaction coordinator is *never* in doubt as to the outcome of a transaction, it's best if the production machine coordinated the distributed transaction. You don't care so much if your test machine has some open transactions and locked resources. You certainly do care if your production machine does.

The inability to do DDL over a database link is actually not so bad at all. First, DDL is rare. You do it once at installation or during an upgrade. Production systems don't do DDL (well, they *shouldn't* do DDL). Second, there is a method to do DDL over a database link, in a fashion, using the job queue facility, `DBMS_JOB` or, in Oracle 10g and higher, the scheduler package, `DBMS_SCHEDULER`. Instead of trying to do DDL over the link, you use the link to schedule a remote job to be executed as soon as you commit. In that fashion, the job runs on the remote machine, is not a distributed transaction, and can do the DDL. In fact, this is the method by which the Oracle Replication Services perform distributed DDL to do schema replication.

## Autonomous Transactions

Autonomous transactions allow you to create a “transaction within a transaction” that will commit or roll back changes independently of its parent transaction. They allow you to suspend the currently executing transaction, start a new one, do some work, and commit or roll back—all without affecting the currently executing transaction state. Autonomous transactions provide a new method of controlling transactions in PL/SQL and may be used in

- Top-level anonymous blocks
- Local (a procedure in a procedure), stand-alone, or packaged functions and procedures
- Methods of object types
- Database triggers

Before we take a look at how autonomous transactions work, I'd like to emphasize that this type of transaction is a powerful and therefore dangerous tool when used improperly. The true need for an autonomous transaction is very rare indeed. I would be very suspicious of any code that makes use of them—that code would get extra examination. It is far too easy to accidentally introduce logical data integrity issues into a system using them. In the sections that follow, we'll discuss when they may safely be used after seeing how they work.

## How Autonomous Transactions Work

The best way to demonstrate the actions and consequences of an autonomous transaction is by example. We'll create a simple table to hold a message:

```
EODA@ORA12CR1> create table t ( msg varchar2(25) );
Table created.
```

Next, we'll create two procedures, each of which simply INSERTs its name into the message table and commits. However, one of these procedures is a normal procedure and the other is coded as an autonomous transaction. We'll use these objects to show what work persists (is committed) in the database under various circumstances.

First, here's the `AUTONOMOUS_INSERT` procedure:

```
EODA@ORA12CR1> create or replace procedure Autonomous_Insert
2 as
3     pragma autonomous_transaction;
4 begin
5     insert into t values ( 'Autonomous Insert' );
6     commit;
7 end;
8 /
Procedure created.
```

Note the use of the `pragma AUTONOMOUS_TRANSACTION`. This directive tells the database that this procedure, when executed, is to be executed as a new autonomous transaction, independent from its parent transaction.

---

■ **Note** A *pragma* is simply a compiler directive, a method to instruct the compiler to perform some compilation option. Other pragmas are available. Refer to the *Oracle Database PL/SQL Language Reference* manual; you'll find a list of them in its index.

---

And here's the “normal” `NONAUTONOMOUS_INSERT` procedure:

```
EODA@ORA12CR1> create or replace procedure NonAutonomous_Insert
2 as
3 begin
4     insert into t values ( 'NonAutonomous Insert' );
5     commit;
6 end;
7 /
Procedure created.
```

Now let's observe the behavior of the *nonautonomous* transaction in an anonymous block of PL/SQL code:

```
EODA@ORA12CR1> begin
  2      insert into t values ( 'Anonymous Block' );
  3      NonAutonomous_Insert;
  4      rollback;
  5 end;
  6 /
```

PL/SQL procedure successfully completed.

```
EODA@ORA12CR1> select * from t;
```

MSG

```
-----
Anonymous Block
NonAutonomous Insert
```

As you can see, the work performed by the anonymous block, its INSERT, was *committed* by the NONAUTONOMOUS\_INSERT procedure. Both rows of data were committed, so the ROLLBACK command had nothing to roll back. Compare this to the behavior of the autonomous transaction procedure:

```
EODA@ORA12CR1> delete from t;
2 rows deleted.
```

```
EODA@ORA12CR1> commit;
Commit complete.
```

```
EODA@ORA12CR1> begin
  2      insert into t values ( 'Anonymous Block' );
  3      Autonomous_Insert;
  4      rollback;
  5 end;
  6 /
```

PL/SQL procedure successfully completed.

```
EODA@ORA12CR1> select * from t;
```

MSG

```
-----
Autonomous Insert
```

Here, only the work done by and committed in the autonomous transaction persists. The INSERT done in the anonymous block was rolled back by the ROLLBACK statement on line 4. The autonomous transaction procedure's COMMIT has no effect on the parent transaction started in the anonymous block. In a nutshell, this captures the essence of autonomous transactions and what they do.

To summarize, if you COMMIT inside a "normal" procedure, it will make durable not only its own work but also any outstanding work performed in that session. However, a COMMIT performed in a procedure with an autonomous transaction will make durable only that procedure's work.

## When to Use Autonomous Transactions

The Oracle database has supported autonomous transactions internally for quite a while. We see them all of the time in the form of recursive SQL. For example, a recursive transaction may be performed when selecting from a sequence, in order for you to increment the sequence immediately in the `SYS.SEQ$` table. The update of the `SYS.SEQ$` table in support of your sequence is immediately committed and visible to other transactions, but your transaction is not yet committed. Additionally, if you roll back your transaction, the increment to the sequence remains in place; it is not rolled back with your transaction, as it has already been committed. Space management, auditing, and other internal operations are performed in a similar recursive fashion.

This feature has now been exposed for all to use. However, I have found that the legitimate real-world use of autonomous transactions is *very limited*. Time after time, I see them used as a workaround to such problems as a mutating table constraint in a trigger. This almost always leads to data integrity issues, however, since the cause of the mutating table is an attempt to read the table upon which the trigger is firing. Well, by using an autonomous transaction you can query the table, but you are querying the table now without being able to see your changes (which is what the mutating table constraint was trying to do in the first place; the table is in the middle of a modification, so query results would be inconsistent). Any decisions you make based on a query from that trigger would be questionable—you are reading “old” data at that point in time.

A potentially valid use for an autonomous transaction is in custom auditing, but I stress the words “potentially valid.” There are more efficient ways to audit information in the database than via a custom-written trigger. For example, you can use the `DBMS_FGA` package or just the `AUDIT` command itself.

A question that application developers often pose to me is, “How can I log errors in my PL/SQL routines in a manner that will persist, even when my PL/SQL routines’ work is rolled back?” Earlier, we described how PL/SQL statements are *atomic*—they either completely succeed or completely fail. If we logged an error in our PL/SQL routines, by default our logged error information would roll back when Oracle rolled back our statement. Autonomous transactions allow us to change that behavior, to have our error logging information persist even while the rest of the partial work is rolled back.

Let’s start by setting up a simple error logging table to use; we’ll record the timestamp of the error, the error message, and the PL/SQL error stack (for pinpointing where the error emanated from):

```
EODA@ORA12CR1> create table error_log
 2 ( ts timestamp,
 3   err1 clob,
 4   err2 clob )
 5 /
Table created.
```

Now we need the PL/SQL routine to log errors into this table. We can use this small example:

```
EODA@ORA12CR1> create or replace
 2 procedure log_error
 3 ( p_err1 in varchar2, p_err2 in varchar2 )
 4 as
 5   pragma autonomous_transaction;
 6 begin
 7   insert into error_log( ts, err1, err2 )
 8     values ( systimestamp, p_err1, p_err2 );
 9   commit;
10 end;
11 /
Procedure created.
```

The “magic” of this routine is on line 5 where we used the `pragma autonomous_transaction` directive to inform PL/SQL that we want this subroutine to start a new transaction, perform some work in it, and commit it—without affecting any other transaction currently in process. The `COMMIT` on line 9 can affect only the SQL performed by this `LOG_ERROR` procedure.

Now let’s test it out. To make it interesting, we’ll create a couple of procedures that will call each other:

```
EODA@ORA12CR1> create table t ( x int check (x>0) );
Table created.
```

```
EODA@ORA12CR1> create or replace procedure p1( p_n in number )
  2 as
  3 begin
  4     -- some code here
  5     insert into t (x) values ( p_n );
  6 end;
  7 /
```

Procedure created.

```
EODA@ORA12CR1> create or replace procedure p2( p_n in number )
  2 as
  3 begin
  4     -- code
  5     -- code
  6     p1(p_n);
  7 end;
  8 /
```

Procedure created.

And then we’ll invoke those routines from an anonymous block:

```
EODA@ORA12CR1> begin
  2     p2( 1 );
  3     p2( 2 );
  4     p2( -1);
  5 exception
  6     when others
  7     then
  8         log_error( sqlerrm, dbms_utility.format_error_backtrace );
  9         RAISE;
 10 end;
 11 /
```

begin

\*

```
ERROR at line 1:
ORA-02290: check constraint (EODA.SYS_C0061527) violated
ORA-06512: at line 9
```

Now, we can see the code failed (you want that error returned, hence the RAISE on line 9). We can verify that Oracle undid our work (we know that the first two calls to procedure P2 succeeded; the values 1 and 2 are successfully inserted into our table T):

```
EODA@ORA12CR1> select * from t;
no rows selected
```

But we can also verify that our error log information has persisted, and in fact is committed:

```
EODA@ORA12CR1> rollback;
Rollback complete.

EODA@ORA12CR1> select * from error_log;

TS
-----
ERR1
-----
ERR2
-----
09-MAY-14 05.11.03.818918 PM
ORA-02290: check constraint (EODA.SYS_C00204351) violated
ORA-06512: at "EODA.P1", line 5
ORA-06512: at "EODA.P2", line 6
ORA-06512: at line 4
```

In my experience, that is the only truly valid use of an autonomous transaction—to log errors or informational messages in a manner that can be committed independently of the parent transaction.

## Summary

In this chapter, we looked at many aspects of transaction management in Oracle. Transactions are among the major features that set a database apart from a file system. Understanding how they work and how to use them is necessary to implement applications correctly in any database. Understanding that in Oracle all statements are atomic (including their side effects) and that this atomicity is extended to stored procedures is crucial. We saw how the placement of a WHEN OTHERS exception handler in a PL/SQL block could radically affect what changes took place in the database. As database developers, having a good understanding of how transactions work is crucial.

We took a look at the somewhat complex interaction between integrity constraints (unique keys, check constraints, and the like) and transactions in Oracle. We discussed how Oracle typically processes integrity constraints immediately after a statement executes, but that we can defer this constraint validation until the end of the transaction if we wish. This feature is key in implementing complex multitable updates when the tables being modified are all dependent on each other—the cascading update is an example of that.

We moved on to consider some of the bad transaction habits that people tend to pick up from working with databases that “support” rather than “promote” the use of transactions. We looked at the cardinal rule of transactions: they should be as short as they can be but as long as they need to be. *Data integrity drives the transaction size*—that is a key concept to take away from this chapter. The only things that should drive the size of your transactions are the business rules that govern your system. Not undo space, not locks—business rules.

We covered distributed transactions and how they differ from single database transactions. We explored the limitations imposed upon us in a distributed transaction and discussed why they exist. Before you build a distributed system, you need to understand these limitations. What works in a single instance might not work in a distributed database.

The chapter closed with a look at autonomous transactions and covered what they are and, more important, when they should and should not be used. I would like to emphasize once again that the legitimate real-world use of autonomous transactions is exceedingly rare. If you find them to be a feature you are using constantly, you'll want to take a long, hard look at why.



## CHAPTER 9



# Redo and Undo

This chapter describes two of the most important pieces of data in an Oracle database: redo and undo. *Redo* is the information Oracle records in online (and archived) redo log files in order to “replay” your transaction in the event of a failure. *Undo* is the information Oracle records in the undo segments in order to reverse, or roll back, your transaction.

In this chapter, we will discuss topics such as how redo and undo (rollback) are generated, and how they fit into transactions, recovery, and so on. We’ll start off with a high-level overview of what redo and undo are and how they work together. We’ll then drill down into each topic, covering each in more depth and discussing what you, the developer, need to know about them.

The chapter is slanted toward the developer perspective in that we will not cover issues that a DBA should be exclusively in charge of figuring out and tuning. For example, we won’t cover how to find the optimum setting for `RECOVERY_PARALLELISM` or the `FAST_START_MTTR_TARGET` parameters. Nevertheless, redo and undo are topics that bridge the DBA and developer roles. Both need a good fundamental understanding of the purpose of redo and undo, how they work, and how to avoid potential issues with regard to their use. Knowledge of redo and undo also helps both DBAs and developers better understand how the database operates, in general.

In this chapter, I will present the pseudo-code for these mechanisms in Oracle and a conceptual explanation of what actually takes place. I will not cover every internal detail of what files get updated with what bytes of data. What actually takes place is a little more involved, but having a good understanding of the flow of how it works is valuable and will help you to understand the ramifications of your actions.

---

■ **Note** Time and time again, I get questions regarding the exact bits and bytes of redo and undo. People seem to want to have a very detailed specification of exactly, precisely, what is in there. I never answer those questions. Instead, I focus on the intent of redo and undo, the concepts behind redo and undo. I focus on the use of redo and undo—not on the bits and bytes. I myself do not “dump” redo log files or undo segments. I do use the supplied tools, such as LogMiner to read redo and flashback transaction history to read undo, but that presents the information to me in a human-readable format. So, we won’t be doing internals in this chapter but rather building a strong foundation.

---

## What Is Redo?

Redo log files are crucial to the Oracle database. These are the transaction logs for the database. Oracle maintains two types of redo log files: *online* and *archived*. They are used for recovery purposes; their main purpose in life is to be used in the event of an instance or media failure.

If the power goes off on your database machine, causing an instance failure, Oracle will use the online redo logs to restore the system to exactly the committed point it was at immediately prior to the power outage. If your disk drive

fails (a media failure), Oracle will use both archived redo logs and online redo logs to recover a backup of the data that was on that drive to the correct point in time. Moreover, if you “accidentally” truncate a table or remove some critical information and commit the operation, you can restore a backup of the affected data and recover it to the point in time immediately prior to the “accident” using online and archived redo log files.

Archived redo log files are simply copies of old, full online redo log files. As the system fills up log files, the ARCn process makes a copy of the online redo log file in another location, and optionally puts several other copies into local and remote locations as well. These archived redo log files are used to perform media recovery when a failure is caused by a disk drive going bad or some other physical fault. Oracle can take these archived redo log files and apply them to backups of the data files to catch them up to the rest of the database. They are the transaction history of the database.

---

■ **Note** With the advent of Oracle 10g, we now have flashback technology. This allows us to perform flashback queries (query the data as of some point in time in the past), un-drop a database table, put a table back the way it was some time ago, and so on. As a result, the number of occasions in which we need to perform a conventional recovery using backups and archived redo logs has decreased. However, the ability to perform a recovery is the DBA’s most important job. Database recovery is the one thing a DBA is not allowed to get wrong.

---

Every Oracle database has at least two online redo log groups with at least a single member (redo log file) in each group. These online redo log groups are written to in a circular fashion. Oracle will write to the log files in group 1, and when it gets to the end of the files in group 1, it will switch to log file group 2 and begin writing to that one. When it has filled log file group 2, it will switch back to log file group 1 (assuming you have only two redo log file groups; if you have three, Oracle would, of course, proceed to the third group).

Redo logs, or transaction logs, are one of the major features that make a database a database. They are perhaps its most important recovery structure, although without the other pieces such as undo segments, distributed transaction recovery, and so on, nothing works. They are a major component of what sets a database apart from a conventional file system. The online redo logs allow us to effectively recover from a power outage—one that might happen while Oracle is in the middle of a write. The archived redo logs let us recover from media failures when, for instance, the hard disk goes bad or human error causes data loss. Without redo logs, the database would not offer any more protection than a file system.

## What Is Undo?

Undo is conceptually the opposite of redo. Undo information is generated by the database as you make modifications to data so that the data can be put back the way it was before the modifications took place. This might be done in support of multiversioning as we learn in Chapter 7, or in the event the transaction or statement you are executing fails for any reason, or if we request it with a ROLLBACK statement. Whereas redo is used to replay a transaction in the event of failure—to recover the transaction—undo is used to reverse the effects of a statement or set of statements. Undo, unlike redo, is stored internally in the database in a special set of segments known as undo segments.

---

■ **Note** “Rollback segment” and “undo segment” are considered synonymous terms. Using manual undo management, the DBA will create “rollback segments.” Using automatic undo management, the system will automatically create and destroy “undo segments” as necessary. These terms should be considered the same for all intents and purposes in this discussion.

---

It is a common misconception that undo is used to restore the database *physically* to the way it was before the statement or transaction executed, but this is not so. The database is *logically* restored to the way it was—any changes are logically undone—but the data structures, the database blocks themselves, may well be different after a rollback. The reason for this lies in the fact that, in any multiuser system, there will be tens or hundreds or thousands of concurrent transactions. One of the primary functions of a database is to mediate concurrent access to its data. The blocks that our transaction modifies are, in general, being modified by many other transactions as well. Therefore, we can't just put a block back exactly the way it was at the start of our transaction—that could undo someone else's work!

For example, suppose our transaction executed an INSERT statement that caused the allocation of a new extent (i.e., it caused the table to grow). Our INSERT would cause us to get a new block, format it for use, and put some data into it. At that point, some other transaction might come along and insert data into this block. If we roll back our transaction, obviously we can't unformat and unallocate this block. Therefore, when Oracle rolls back, it is really doing the logical equivalent of the opposite of what we did in the first place. For every INSERT, Oracle will do a DELETE. For every DELETE, Oracle will do an INSERT. For every UPDATE, Oracle will do an “anti-UPDATE,” or an UPDATE that puts the row back the way it was prior to our modification.

---

■ **Note** This undo generation is not true for direct-path operations, which have the ability to bypass undo generation on the table. We'll discuss these operations in more detail shortly.

---

How can we see this in action? Perhaps the easiest way is to follow these steps:

1. Create an empty table.
2. Full-scan the table and observe the amount of I/O performed to read it.
3. Fill the table with many rows (no commit).
4. Roll back that work and undo it.
5. Full-scan the table a second time and observe the amount of I/O performed.

So, let's create an empty table:

```
EODA@ORA12CR1> create table t
 2 as
 3 select *
 4   from all_objects
 5   where 1=0;
Table created.
```

And now we'll query it, with AUTOTRACE enabled in SQL\*Plus to measure the I/O.

---

■ **Note** In this example, we will full-scan the table twice each time. The goal is to only measure the I/O performed the second time in each case. This avoids counting additional I/Os performed by the optimizer during any parsing and optimization that may occur.

---

The query initially takes *no* I/Os to full-scan the table:

```
EODA@ORA12CR1> select * from t;
no rows selected
```

```
EODA@ORA12CR1> set autotrace traceonly statistics
EODA@ORA12CR1> select * from t;
no rows selected
```

Statistics

```
-----
0 recursive calls
0 db block gets
0 consistent gets
0 physical reads
```

```
EODA@ORA12CR1> set autotrace off
```

Now, that might surprise you at first—especially if you are an Oracle user dating back to versions before Oracle 11g Release 2—that there are *zero* I/Os against the table. This is due to a new Oracle 11g Release 2 feature—deferred segment creation.

---

■ **Note** The deferred segment creation feature is available only with the Enterprise Edition of Oracle. This feature is enabled by default in Oracle 11g Release 2 and higher. You can override this default behavior when creating the table. See Chapter 10 for further details.

---

If you run this example in older releases, you’ll likely see three or so I/O’s performed. We’ll discuss that in a moment, but for now let’s continue this example. Next, we’ll add lots of data to the table. We’ll make it “grow,” then roll it all back:

```
EODA@ORA12CR1> insert into t select * from all_objects;
18371 rows created.
```

```
EODA@ORA12CR1> rollback;
Rollback complete.
```

Now, if we query the table again, we’ll discover that it takes considerably more I/Os to read the table this time:

```
EODA@ORA12CR1> select * from t;
no rows selected
```

```
EODA@ORA12CR1> set autotrace traceonly statistics
EODA@ORA12CR1> select * from t;
no rows selected
```

## Statistics

```
-----
      0 recursive calls
      0 db block gets
    317 consistent gets
      0 physical reads
```

```
EODA@ORA12CR1> set autotrace off
```

The blocks that our INSERT caused to be added under the table’s high-water mark (HWM) are still there—formatted, but empty. Our full scan had to read them to see if they contained any rows. Moreover, the first time we ran the query, we observed *zero* I/Os. That was due to the default mode of table creation in Oracle 11g Release 2—using deferred segment creation. When we issued that CREATE TABLE, no storage, not a single extent, was allocated. The segment creation was deferred until the INSERT took place, and when we rolled back, the segment persisted. You can see this easily with a smaller example, I’ll explicitly request deferred segment creation this time although it is enabled by default in 11g Release 2:

```
EODA@ORA12CR1> drop table t purge;
Table dropped.
```

```
EODA@ORA12CR1> create table t ( x int )
  2 segment creation deferred;
Table created.
```

```
EODA@ORA12CR1> select extent_id, bytes, blocks
  2   from user_extents
  3   where segment_name = 'T'
  4   order by extent_id;
no rows selected
```

```
EODA@ORA12CR1> insert into t(x) values (1);
1 row created.
```

```
EODA@ORA12CR1> rollback;
Rollback complete.
```

```
EODA@ORA12CR1> select extent_id, bytes, blocks
  2   from user_extents
  3   where segment_name = 'T'
  4   order by extent_id;
```

EXTENT_ID	BYTES	BLOCKS
0	65536	8

As you can see, after the table was initially created there was no allocated storage—no extents were used by this table. Upon performing an INSERT, followed immediately by ROLLBACK, we can see the INSERT allocated storage—but the ROLLBACK does not “release” it.

Those two things together—that the segment was actually created by the INSERT but not “uncreated” by the ROLLBACK, and that the new formatted blocks created by the INSERT were scanned the second time around—show that a rollback is a logical “put the database back the way it was” operation. The database will not be exactly the way it was, just logically the same.

## How Redo and Undo Work Together

Now let's take a look at how redo and undo work together in various scenarios. We will discuss, for example, what happens during the processing of an INSERT with regard to redo and undo generation, and how Oracle uses this information in the event of failures at various points in time.

An interesting point to note is that undo information, stored in undo tablespaces or undo segments, is protected by redo as well. In other words, undo data is treated just like table data or index data—changes to undo generates some redo, which is logged (to the log buffer and then the redo log file). Why this is so will become clear in a moment when we discuss what happens when a system crashes. Undo data is added to the undo segment and is cached in the buffer cache, just like any other piece of data would be.

### Example INSERT-UPDATE-DELETE-COMMIT Scenario

For this example, assume we've created a table with an index as follows:

```
create table t(x int, y int);
create index ti on t(x);
```

And then we will investigate what might happen with a set of statements like this:

```
insert into t (x,y) values (1,1);
update t set x = x+1 where x = 1;
delete from t where x = 2;
```

We will follow this transaction down different paths and discover the answers to the following questions:

- What happens if the system fails at various points in the processing of these statements?
- What happens if the buffer cache fills up?
- What happens if we ROLLBACK at any point?
- What happens if we succeed and COMMIT?

### The INSERT

The initial INSERT INTO T statement will generate both redo and undo. The undo generated will be enough information to make the INSERT “go away.” The redo generated by the INSERT INTO T will be enough information to make the INSERT “happen again.”

After the INSERT has occurred, we have the scenario illustrated in Figure 9-1.

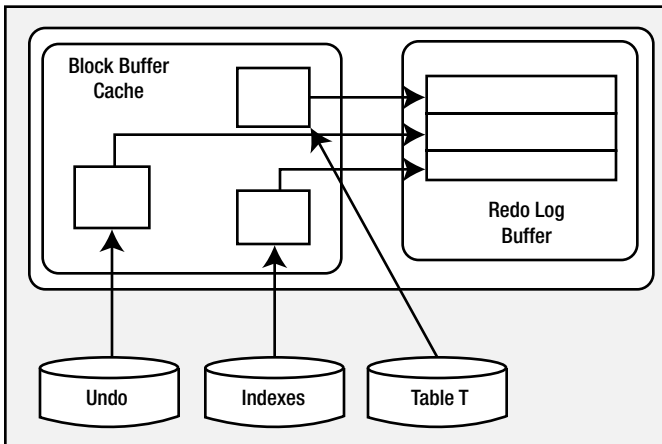

**Figure 9-1.** State of the system after an INSERT

There are some cached, modified undo blocks, index blocks, and table data blocks. Each of these blocks is protected by entries in the redo log buffer.

## Hypothetical Scenario: The System Crashes Right Now

In this scenario, the system crashes before a COMMIT is issued or before the redo entries are written to disk (see Chapter 4 for details on mechanisms that cause redo to be written to disk). Everything is OK. The SGA is wiped out, but we don't need anything that was in the SGA. It will be as if this transaction never happened when we restart. None of the blocks with changes got flushed to disk, and none of the redo got flushed to disk. We have no need of any of this undo or redo to recover from an instance failure.

## Hypothetical Scenario: The Buffer Cache Fills Up Right Now

The situation is such that DBWn must make room and our modified blocks are to be flushed from the cache. In this case, DBWn will start by asking LGWR to flush the redo entries that protect these database blocks. Before DBWn can write any of the blocks that are changed to disk, LGWR must flush (to disk) the redo information related to these blocks. This makes sense: if we were to flush the modified blocks for table T (but not the undo blocks associated with the modifications) without flushing the redo entries associated with the undo blocks, and the system failed, we would have a modified table T block with no undo information associated with it. We need to flush the redo log buffers before writing these blocks out so that we can redo all of the changes necessary to get the SGA back into the state it is in right now, so that a rollback can take place.

This second scenario shows some of the foresight that has gone into all of this. The set of conditions described by “If we flushed table T blocks *and* did not flush the redo for the undo blocks *and* the system failed” is starting to get complex. It only gets more complex as we add users, and more objects, and concurrent processing, and so on.

At this point, we have the situation depicted in Figure 9-1. We have generated some modified table and index blocks. These have associated undo segment blocks, and all three types of blocks have generated redo to protect them. If you recall from our discussion of the redo log buffer in Chapter 4, it is flushed *at least* every three seconds, when it is one-third full or contains 1MB of buffered data, or whenever a COMMIT or ROLLBACK takes place. It is very possible that at some point during our processing, the redo log buffer will be flushed. In that case, the picture will look like Figure 9-2.

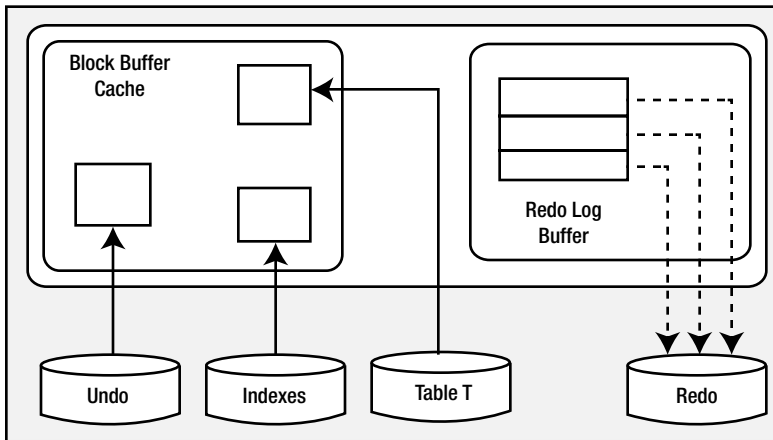
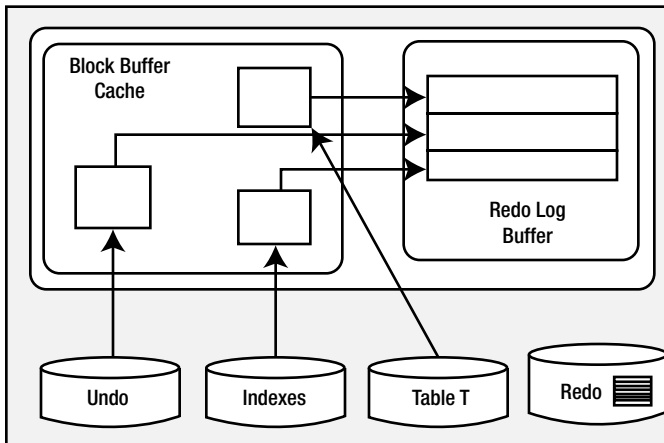

**Figure 9-2.** State of the system after a redo log buffer flush

That is, we'll have modified blocks representing uncommitted changes in the buffer cache and redo for those uncommitted changes on disk. This is a very normal scenario that happens frequently.

## The UPDATE

The UPDATE will cause much of the same work as the INSERT to take place. This time, the amount of undo will be larger; we have some “before” images to save as a result of the UPDATE. Now we have the picture shown in Figure 9-3 (the dark rectangle in the redo log file represents the redo generated by the INSERT, the redo for the UPDATE is still in the SGA and has not yet been written to disk).



**Figure 9-3.** State of the system after the UPDATE



We have more new undo segment blocks in the block buffer cache. To undo the UPDATE, if necessary, we have modified database table and index blocks in the cache. We have also generated more redo log buffer entries. Let's assume that our redo generated from the INSERT statement (discussed in the prior section) is on disk (in the redo log file) and redo generated from the UPDATE is in cache.

## Hypothetical Scenario: The System Crashes Right Now

Upon startup, Oracle would read the redo log files and find some redo log entries for our transaction. Given the state in which we left the system, we have the redo entries generated by the INSERT in the redo log files (which includes redo for undo segments associated with the INSERT). However, the redo for the UPDATE was only in the log buffer and never made it to disk (and was wiped out when the system crashed). That's okay, the transaction was never committed and the data files on disk reflect the state of the system before the UPDATE took place.

However, the redo for the INSERT was written to the redo log file. Therefore Oracle would “roll forward” the INSERT. We would end up with a picture much like Figure 9-1, with modified undo blocks (information on how to undo the INSERT), modified table blocks (right after the INSERT), and modified index blocks (right after the INSERT). Oracle will discover that our transaction never committed and will roll it back since the system is doing crash recovery and, of course, our session is no longer connected.

To roll back the uncommitted INSERT, Oracle will use the undo it just rolled forward (from the redo and now in the buffer cache) and apply it to the data and index blocks, making them look as they did before the INSERT took place. Now everything is back the way it was. The blocks that are on disk may or may not reflect the INSERT (it depends on whether or not our blocks got flushed before the crash). If the blocks on disk do reflect the INSERT, then the INSERT will be undone when the blocks are flushed from the buffer cache. If they do not reflect the undone INSERT, so be it—they will be overwritten later anyway.

---

■ **Note** See Chapter 3 for a full discussion on checkpointing and when modified (dirty) buffers are written from the buffer cache to disk.

---

This scenario covers the rudimentary details of a crash recovery. The system performs this as a two-step process. First it rolls forward, bringing the system right to the point of failure, and then it proceeds to roll back everything that had not yet committed. This action will resynchronize the data files. It replays the work that was in progress and undoes anything that has not yet completed.

## Hypothetical Scenario: The Application Rolls Back the Transaction

At this point, Oracle will find the undo information for this transaction either in the cached undo segment blocks (most likely) or on disk if they have been flushed (more likely for very large transactions). It will apply the undo information to the data and index blocks in the buffer cache, or if they are no longer in the cache request, they are read from disk into the cache to have the undo applied to them. These blocks will later be flushed to the data files with their original row values restored.

This scenario is much more common than the system crash. It is useful to note that during the rollback process, the redo logs are never involved. The only time redo logs are read for recovery purposes is during recovery and archival. This is a key tuning concept: redo logs are written to. Oracle does not read them during normal processing. As long as you have sufficient devices so that when ARCn is reading a file, LGWR is writing to a different device, there is no contention for redo logs. Many other databases treat the log files as “transaction logs.” They do not have this separation of redo and undo. For those systems, the act of rolling back can be disastrous—the rollback process must read the logs their log writer is trying to write to. They introduce contention into the part of the system that can least stand it. Oracle's goal is to make it so that redo logs are written sequentially, and no one ever reads them while they are being written.

## The DELETE

Again, undo is generated as a result of the DELETE, blocks are modified, and redo is sent over to the redo log buffer. This is not very different from before. In fact, it is so similar to the UPDATE that we are going to move right on to the COMMIT.

## The COMMIT

We've looked at various failure scenarios and different paths, and now we've finally made it to the COMMIT. Here, Oracle will flush the redo log buffer to disk, and the picture will look like Figure 9-4.

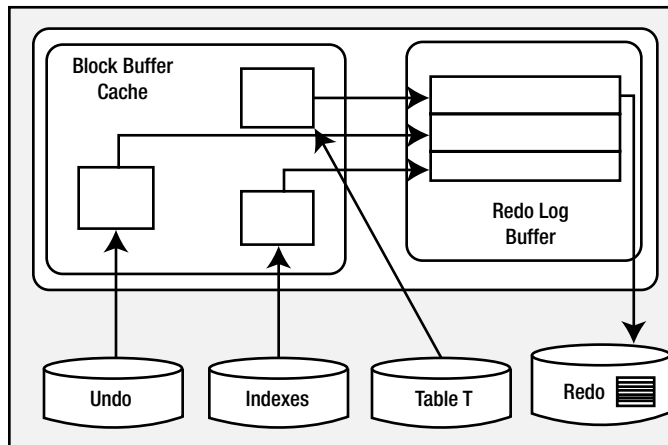

**Figure 9-4.** State of the system after a COMMIT

The modified blocks are in the buffer cache; maybe some of them have been flushed to disk. *All of the redo* necessary to replay this transaction is safely on disk and the changes are now permanent. If we were to read the data directly from the data files, we probably would see the blocks as they existed *before* the transaction took place, as DBWn most likely has not yet written them. That's OK—the redo log files can be used to bring those blocks up to date in the event of a failure. The undo information will hang around until the undo segment wraps around and reuses those blocks. Oracle will use that undo to provide for consistent reads of the affected objects for any session that needs them.

## Commit and Rollback Processing

It is important to understand how redo log files might impact us as developers. We will look at how the different ways we can write our code affect redo log utilization. We've already seen the mechanics of redo earlier in the chapter, and now we'll look at some specific issues. You might detect many of these scenarios, but they would be fixed by the DBA as they affect the database instance as a whole. We'll start with what happens during a COMMIT, and then get into commonly asked questions and issues surrounding the online redo logs.

### What Does a COMMIT Do?

As a developer, you should have a good understanding of exactly what goes on during a COMMIT. In this section, we'll investigate what happens during the processing of the COMMIT statement in Oracle. A COMMIT is generally a very fast operation, regardless of the transaction size. You might think that the bigger a transaction (in other words, the more

data it affects), the longer a COMMIT would take. This is not true. The response time of a COMMIT is generally “flat,” regardless of the transaction size. This is because a COMMIT does not really have too much work to do, but what it does do is vital.

One of the reasons this is an important fact to understand and embrace is that it will lead to letting your transactions be as big as they should be. As we discussed in the previous chapter, many developers artificially constrain the size of their transactions, committing every so many rows, instead of committing when a logical unit of work has been performed. They do this in the mistaken belief that they are preserving scarce system resources, when in fact they are increasing them. If a COMMIT of one row takes X units of time, and the COMMIT of 1,000 rows takes the same X units of time, then performing work in a manner that does 1,000 one-row COMMITs will take an additional 1,000\*X units of time to perform. By committing only when you have to (when the logical unit of work is complete), you will not only increase performance, you’ll also reduce contention for shared resources (log files, various internal latches, and the like). A simple example demonstrates that it necessarily takes longer. We’ll use a Java application, although you can expect similar results from most any client—except, in this case, PL/SQL (we’ll discuss why that is after the example). To start, here is the sample table we’ll be inserting into:

```
SCOTT@ORA12CR1> create table test
 2 ( id          number,
 3   code        varchar2(20),
 4   descr       varchar2(20),
 5   insert_user varchar2(30),
 6   insert_date date
 7 )
 8 /
```

Table created.

Our Java program (stored in a file named `perfTest.java`) will accept two inputs: the number of rows to INSERT (`iters`) and how many rows between commits (`commitCnt`). It starts by connecting to the database, setting autocommit *off* (which should be done in all Java code), and then calling a `doInserts()` method a total of two times:

- Once just to warm up the routine (make sure all of the classes are loaded)
- A second time, with SQL Tracing on, specifying the number of rows to INSERT along with how many rows to commit at a time (i.e., commit every N rows)

It then closes the connection and exits. The main method is as follows :

```
import java.sql.*;

public class perfTest
{
    public static void main (String arr[]) throws Exception
    {
        DriverManager.registerDriver(new oracle.jdbc.OracleDriver());
        Connection con = DriverManager.getConnection
            ("jdbc:oracle:thin:@csxdev:1521:ORA12CR1", "scott", "tiger");
        Integer iters = new Integer(arr[0]);
        Integer commitCnt = new Integer(arr[1]);

        con.setAutoCommit(false);

        doInserts( con, 1, 1 );

        Statement stmt = con.createStatement ();
```

```

    stmt.execute( "begin dbms_monitor.session_trace_enable(waits=>true); end;" );

    doInserts( con, iters.intValue(), commitCnt.intValue() );

    con.close();
}

```

---

■ **Note** The SCOTT account or whatever account you use to test this with will need to have the EXECUTE privilege granted on the DBMS\_MONITOR package.

---

Now, the method `doInserts()` is fairly straightforward. It starts by preparing (parsing) an INSERT statement so we can repeatedly bind/execute it over and over:

```

static void doInserts(Connection con, int count, int commitCount )
throws Exception
{
    PreparedStatement ps =
        con.prepareStatement
        ("insert into test " +
         " (id, code, descr, insert_user, insert_date)"
         + " values (?,?=?, user, sysdate)");
}

```

It then loops over the number of rows to insert, binding and executing the INSERT over and over. Additionally, it checks a row counter to see if it needs to COMMIT or not inside the loop :

```

int rowcnt = 0;
int committed = 0;

for (int i = 0; i < count; i++ )
{
    ps.setInt(1,i);
    ps.setString(2,"PS - code" + i);
    ps.setString(3,"PS - desc" + i);
    ps.executeUpdate();
    rowcnt++;
    if ( rowcnt == commitCount )
    {
        con.commit();
        rowcnt = 0;
        committed++;
    }
}
con.commit();

System.out.println
("pstatement rows/commitcnt = " + count + " / " + committed );
}
}

```

Now we'll run this code repeatedly with different inputs and review the resulting TKPROF file. We'll run with 100,000 row inserts—committing 1 row at a time, then 10, and so on. The resulting TKPROF files produced the results in Table 9-1.

**Table 9-1.** Results from Inserting 100,000 Rows

Number of Rows to Insert	Commit Every N Rows, N=	CPU for Insert Statement (Seconds)	Wait Time for Log File Sync (Seconds)
100,000	1	2.30	31.17
100,000	10	2.16	3.48
100,000	100	2.20	0.62
100,000	1,000	2.02	0.08
100,000	10,000	1.46	0.02
100,000	100,000	2.01	0.00

As you can see, the more often you commit, the longer you wait (your mileage will vary on this). And the amount of time you wait is more or less directly proportional to the number of times you commit. Remember, this is just a single-user scenario; with multiple users doing the same work, all committing too frequently, the numbers will go up rapidly.

We've heard the same story, time and time again, with similar situations. For example, we've seen how not using bind variables and performing hard parses often severely reduces concurrency due to library cache contention and excessive CPU utilization. Even when we switch to using bind variables, soft parsing too frequently—caused by closing cursors even though we are going to reuse them shortly—incurs massive overhead. We must perform operations only when we need to—a COMMIT is just another such operation. It is best to size our transactions based on business need, not based on misguided attempts to lessen resource usage on the database.

There are two factors contributing to the expense of the COMMIT in this example:

- We've obviously increased the round-trips to and from the database. If we commit every record, we are generating that much more traffic back and forth. I didn't even measure that, which would add to the overall runtime.
- Every time we commit, we must wait for our redo to be written to disk. This will result in a "wait." In this case, the wait is named "log file sync."

So, we committed after every INSERT, we waited every time for a short period of time—and if you wait a little bit of time but you wait often, it all adds up. Fully thirty seconds of our runtime was spent waiting for a COMMIT to complete when we committed 100,000 times—in other words, waiting for LGWR to write the redo to disk. In stark contrast, when we committed once, we didn't wait very long (not a measurable amount of time actually). This proves that a COMMIT is a fast operation; we expect the response time to be more or less flat, not a function of the amount of work we've done.

So, why is a COMMIT's response time fairly flat, regardless of the transaction size? It is because before we even go to COMMIT in the database, we've already done the really hard work. We've already modified the data in the database, so we've already done 99.9 percent of the work. For example, operations such as the following have already taken place:

- Undo blocks have been generated in the SGA.
- Modified data blocks have been generated in the SGA.
- Buffered redo for the preceding two items has been generated in the SGA.

- Depending on the size of the preceding three items and the amount of time spent, some combination of the previous data may be flushed onto disk already.
- All locks have been acquired.

When we COMMIT, all that is left to happen is the following:

- A System Change Number (SCN) is generated for our transaction. In case you are not familiar with it, the SCN is a simple timing mechanism Oracle uses to guarantee the ordering of transactions and to enable recovery from failure. It is also used to guarantee read-consistency and checkpointing in the database. Think of the SCN as a ticker; every time someone COMMITs, the SCN is incremented by one.
- LGWR writes all of our *remaining* buffered redo log entries to disk and records the SCN in the online redo log files as well. This step is actually the COMMIT. If this step occurs, we have committed. Our transaction entry is “removed” from V\$TRANSACTION—this shows that we have committed.
- All locks recorded in V\$LOCK held by our session are released, and everyone who was enqueued waiting on locks we held will be woken up and allowed to proceed with their work.
- Some of the blocks our transaction modified will be visited and “cleaned out” in a fast mode if they are still in the buffer cache. *Block cleanout* refers to the lock-related information we store in the database block header. Basically, we are cleaning out our transaction information on the block, so the next person who visits the block won’t have to. We are doing this in a way that need not generate redo log information, saving considerable work later (this is discussed more fully in the upcoming “Block Cleanout” section).

As you can see, there is very little to do to process a COMMIT. The lengthiest operation is, and always will be, the activity performed by LGWR, as this is physical disk I/O. The amount of time spent by LGWR here will be greatly reduced by the fact that it has already been flushing the contents of the redo log buffer on a recurring basis. LGWR will not buffer all of the work you do for as long as you do it. Rather, it will incrementally flush the contents of the redo log buffer in the background as you are going along. This is to avoid having a COMMIT wait for a very long time in order to flush all of your redo at once.

So, even if we have a long-running transaction, much of the buffered redo log it generates would have been flushed to disk, prior to committing. On the flip side is the fact that when we COMMIT, we must typically wait until *all* buffered redo that has not been written yet is safely on disk. That is, our call to LGWR is by default a *synchronous* one. While LGWR may use asynchronous I/O to write in parallel to our log files, our transaction will normally wait for LGWR to complete all writes and receive confirmation that the data exists on disk before returning.

---

■ **Note** Oracle 11g Release 1 and above have an asynchronous wait as described in Chapter 8. However, that style of commit has limited general-purpose use, as discussed. Commits in any end-user-facing application should be synchronous.

---

Now, earlier I mentioned that we were using a Java program and not PL/SQL for a reason—and that reason is a PL/SQL commit-time optimization as discussed in Chapter 8. I said that our call to LGWR is by default a synchronous one and that we wait for it to complete its write. That is true in Oracle 12c Release 1 and before for every programmatic language *except PL/SQL*. The PL/SQL engine, realizing that the client does not know whether or not a COMMIT has happened in the PL/SQL routine until the PL/SQL routine is completed, does an asynchronous commit. It does not wait for LGWR to complete; rather, it returns from the COMMIT call immediately. However, when the PL/SQL routine is completed, when we return from the database to the client, the PL/SQL routine will wait for LGWR to complete any of the outstanding COMMITs. So, if you commit 100 times in PL/SQL and then return to the client, you will likely find you

waited for LGWR once—not 100 times—due to this optimization. Does this imply that committing frequently in PL/SQL is a good or OK idea? No, not at all—just that it is not *as bad an idea* as it is in other languages. The guiding rule is to commit when your logical unit of work is complete—not before.

---

■ **Note** This commit-time optimization in PL/SQL may be suspended when you are performing distributed transactions or Data Guard in maximum availability mode. Since there are two participants, PL/SQL must wait for the commit to actually be complete before continuing. Also, it can be suspended by directly invoking `COMMIT WORK WRITE WAIT` in PL/SQL with database version Oracle 11g Release 1 and above.

---

To demonstrate that a `COMMIT` is a “flat response time” operation, we’ll generate varying amounts of redo and time the `INSERTs` and `COMMITs`. As we do these `INSERTs` and `COMMITs`, we’ll measure the amount of redo our session generates using this small utility function:

```
EODA@ORA12CR1> create or replace function get_stat_val( p_name in varchar2 ) return number
 2 as
 3     l_val number;
 4 begin
 5     select b.value
 6         into l_val
 7         from v$statname a, v$mystat b
 8         where a.statistic# = b.statistic#
 9              and a.name = p_name;
10
11     return l_val;
12 end;
13 /
Function created.
```

---

■ **Note** The owner of the previous function will need to have been directly granted the `SELECT` privilege on the `V$` views `V_$STATNAME` and `V_$MYSTAT`.

---

Drop the table `T` (if it exists) and create an empty table `T` of the same structure as `BIG_TABLE`:

```
EODA@ORA12CR1> drop table t purge;

EODA@ORA12CR1> create table t
 2 as
 3 select *
 4 from big_table
 5 where 1=0;
Table created.
```

■ **Note** Directions on how to create and populate the `BIG_TABLE` table used in many examples is in the “Setting Up Your Environment” section at the very front of this book.

And we’ll measure the CPU and Elapsed time used to commit our transaction using the `DBMS_UTILITY` package routines `GET_CPU_TIME` and `GET_TIME`. The actual PL/SQL block used to generate the workload and report on it is:

```
EODA@ORA12CR1> declare
2     l_redo number;
3     l_cpu  number;
4     l_ela  number;
5 begin
6     dbms_output.put_line
7     ( '- ' || '          Rows' || '          Redo' ||
8       '      CPU' || ' Elapsed' );
9     for i in 1 .. 6
10    loop
11        l_redo := get_stat_val( 'redo size' );
12        insert into t select * from big_table where rownum <= power(10,i);
13        l_cpu  := dbms_utility.get_cpu_time;
14        l_ela  := dbms_utility.get_time;
15        commit work write wait;
16        dbms_output.put_line
17        ( '- ' ||
18          to_char( power( 10, i ), '9,999,999' ) ||
19          to_char( (get_stat_val('redo size')-l_redo), '999,999,999' ) ||
20          to_char( (dbms_utility.get_cpu_time-l_cpu), '999,999' ) ||
21          to_char( (dbms_utility.get_time-l_ela), '999,999' ) );
22    end loop;
23 end;
24 /
```

-	Rows	Redo	CPU	Elapsed
-	10	7,072	0	1
-	100	10,248	0	0
-	1,000	114,080	0	0
-	10,000	1,146,484	0	2
-	100,000	11,368,512	0	2
-	1,000,000	113,800,488	1	2

PL/SQL procedure successfully completed.

*\* This test was performed on a single-user machine with a 1.7 MB log buffer and three 500MB online redo log files. Times are in hundredths of seconds.*

As you can see, as we generate varying amount of redo from 7,072 bytes to 113MB, the difference in time to COMMIT is not measurable using a timer with a one hundredth of a second resolution. As we were processing and generating the redo log, LGWR was constantly flushing our buffered redo information to disk in the background. So, when we generated 113MB of redo log information, LGWR was busy flushing every 1MB, or so. When it came to the COMMIT, there wasn’t much left to do—not much more than when we created ten rows of data. You should expect to see similar (but not exactly the same) results, regardless of the amount of redo generated.



## What Does a ROLLBACK Do?

By changing the COMMIT to ROLLBACK, we can expect a totally different result. The time to roll back is definitely a function of the amount of data modified. I changed the script developed in the previous section to perform a ROLLBACK instead (simply change the COMMIT to ROLLBACK) and the timings are very different. Look at the results now:

```
EODA@ORA12CR1> declare
  2     l_redo number;
  3     l_cpu  number;
  4     l_ela  number;
  5 begin
  6     dbms_output.put_line
  7     ( '-' || '      Rows' || '      Redo' ||
  8     '      CPU' || ' Elapsed' );
  9     for i in 1 .. 6
 10     loop
 11         l_redo := get_stat_val( 'redo size' );
 12         insert into t select * from big_table where rownum <= power(10,i);
 13         l_cpu  := dbms_utility.get_cpu_time;
 14         l_ela  := dbms_utility.get_time;
 15         --commit work write wait;
 16         rollback;
 17         dbms_output.put_line
 18         ( '-' ||
 19         to_char( power( 10, i ), '9,999,999' ) ||
 20         to_char( (get_stat_val('redo size')-l_redo), '999,999,999' ) ||
 21         to_char( (dbms_utility.get_cpu_time-l_cpu), '999,999' ) ||
 22         to_char( (dbms_utility.get_time-l_ela), '999,999' ) );
 23     end loop;
 24 end;
 25 /
```

-	Rows	Redo	CPU	Elapsed
-	10	7,180	0	0
-	100	10,872	0	0
-	1,000	121,880	0	0
-	10,000	1,224,864	0	0
-	100,000	12,148,416	2	4
-	1,000,000	121,733,580	25	36

PL/SQL procedure successfully completed.

This difference in CPU and Elapsed timings is to be expected, as a ROLLBACK has to undo the work we've done. Similar to a COMMIT, a series of operations must be performed. Before we even get to the ROLLBACK, the database has already done a lot of work. To recap, the following would have happened:

- Undo segment records have been generated in the SGA.
- Modified data blocks have been generated in the SGA.
- A buffered redo log for the preceding two items has been generated in the SGA.

- Depending on the size of the preceding three items and the amount of time spent, some combination of the previous data may be flushed onto disk already.
- All locks have been acquired.

When we ROLLBACK,

- We undo all of the changes made. This is accomplished by reading the data back from the undo segment and, in effect, reversing our operation and then marking the undo entry as applied. If we inserted a row, a ROLLBACK will delete it. If we updated a row, a rollback will reverse the update. If we deleted a row, a rollback will reinsert it again.
- All locks held by our session are released, and everyone who was enqueued waiting on locks we held will be released.

A COMMIT, on the other hand, just flushes any remaining data in the redo log buffers. It does very little work compared to a ROLLBACK. The point here is that you don't want to roll back unless you have to. It is expensive since you spend a lot of time doing the work, and you'll also spend a lot of time undoing the work. Don't do work unless you're sure you are going to want to COMMIT it. This sounds like common sense—of course I wouldn't do all of the work unless I wanted to COMMIT it. However, I've often seen a developer use a “real” table as a temporary table, fill it up with data, report on it, and then roll back to get rid of the temporary data. Later we'll talk about true temporary tables and how to avoid this issue.

## Investigating Redo

As a developer, it's often important to be able to measure how much redo your operations generate. The more redo you generate, the longer your operations may take, and the slower the entire system might be. You are not just affecting *your* session, but *every* session. Redo management is a point of serialization within the database. There is just one LGWR in any Oracle instance, and eventually all transactions end up at LGWR, asking it to manage their redo and COMMIT their transaction. The more it has to do, the slower the system will be. By seeing how much redo an operation tends to generate, and testing more than one approach to a problem, you can find the best way to do things.

---

■ **Note** Starting with Oracle 12c (on multiprocessor systems) log writer worker processes (LG00) are automatically started to improve the performance of writing to the redo log file.

---

## Measuring Redo

It is pretty straightforward to see how much redo is being generated, as shown earlier in the chapter. I've used the AUTOTRACE built-in feature of SQL\*Plus. But AUTOTRACE works only with simple DML—it can't, for example, be used to view what a stored procedure call did. I've also used my utility function presented earlier, GET\_STAT\_VAL, to retrieve the “redo size” value from V\$ tables. We'll continue to use that function for the following exercise.

Let's take a look at the difference in redo generated by conventional path INSERTs (the normal INSERTs you and I do every day) and direct-path INSERTs—used when loading large amounts of data into the database. We'll use AUTOTRACE and the previously created tables T and BIG\_TABLE for this simple example. First we'll load the table using a conventional-path INSERT:

```
EODA@ORA12CR1> set autotrace traceonly statistics;
EODA@ORA12CR1> truncate table t;
Table truncated.
```

```
EODA@ORA12CR1> insert into t
  2 select * from big_table;
1000000 rows created.
```

#### Statistics

```
-----
      90 recursive calls
    123808 db block gets
     39407 consistent gets
     13847 physical reads
113875056 redo size
     1177 bytes sent via SQL*Net to client
     1354 bytes received via SQL*Net from client
         4 SQL*Net roundtrips to/from client
         2 sorts (memory)
         0 sorts (disk)
    1000000 rows processed
```

As you can see, that INSERT generated about 113MB of redo; we were expecting that because of the prior example in PL/SQL.

---

■ **Note** The example in this section was performed on a NOARCHIVELOG-mode database. If you are in ARCHIVELOG mode, the table would have to be created or set as NOLOGGING to observe this dramatic change. We will investigate the NOLOGGING attribute in more detail shortly in the section “Setting NOLOGGING in SQL.” Please make sure to coordinate all nonlogged operations with your DBA on a “real” system.

---

When we use a direct-path load in a NOARCHIVELOG-mode database, we get the following results:

```
EODA@ORA12CR1> truncate table t;
Table truncated.

EODA@ORA12CR1> insert /*+ APPEND */ into t
  2 select * from big_table;
1000000 rows created.
```

#### Statistics

```
-----
      551 recursive calls
    16645 db block gets
    15242 consistent gets
    13873 physical reads
220504 redo size
     1160 bytes sent via SQL*Net to client
     1368 bytes received via SQL*Net from client
         4 SQL*Net roundtrips to/from client
        86 sorts (memory)
         0 sorts (disk)
    1000000 rows processed
```

```
EODA@ORA12CR1> set autotrace off
```

That INSERT generated only about 220KB—*kilobytes, not megabytes*—of redo. The method I outline using the V\$MYSTAT view is useful in general for seeing the side effects of various options. The GET\_STAT\_VAL script is useful for small tests, with one or two operations.

## Can I Turn Off Redo Log Generation?

This question is often asked. The simple short answer is no, since redo logging is crucial for the database; it is not overhead and it is not a waste. You do need it, regardless of whether you believe you do or not. It is a fact of life, and it is the way the database works. If you turned off redo, then any temporary failure of disk drives, power, or a software crash, would render the entire database unusable and unrecoverable. That said, however, there are some operations that can be done without generating redo log in some cases.

---

■ **Note** As of Oracle9i Release 2, a DBA can place the database into FORCE LOGGING mode. In that case, *all* operations are logged. The query SELECT FORCE\_LOGGING FROM V\$DATABASE may be used to see if logging is going to be forced or not. This feature is in support of Data Guard, a disaster-recovery feature of Oracle that relies on redo to maintain a standby database copy.

---

## Setting NOLOGGING in SQL

Some SQL statements and operations support the use of a NOLOGGING clause. This does not mean that all operations against the object will be performed without generating redo, just that some very *specific* operations will generate *significantly less* redo than normal. Note that I said “significantly less redo,” not “no redo.” All operations will generate some redo—all data dictionary operations will be logged regardless of the logging mode. The amount of redo generated can be significantly less, however. For this example of the NOLOGGING clause, I ran the following in a database running in ARCHIVELOG mode:

```
EODA@ORA12CR1> select log_mode from v$database;
```

```
LOG_MODE
-----
ARCHIVELOG
```

```
EODA@ORA12CR1> drop table t purge;
Table dropped.
```

```
EODA@ORA12CR1> variable redo number
EODA@ORA12CR1> exec :redo := get_stat_val( 'redo size' );
PL/SQL procedure successfully completed.
```

```
EODA@ORA12CR1> create table t
  2 as
  3 select * from all_objects;
Table created.
```

```
EODA@ORA12CR1> exec dbms_output.put_line( (get_stat_val('redo size')-:redo) ➔
|| ' bytes of redo generated...' );
4487796 bytes of redo generated...
PL/SQL procedure successfully completed.
```

That CREATE TABLE generated about 4MB of redo information (your results will vary depending on how many rows are inserted into table T). We'll drop and re-create the table, in NOLOGGING mode this time:

```
EODA@ORA12CR1> drop table t;
Table dropped.
```

```
EODA@ORA12CR1> variable redo number
EODA@ORA12CR1> exec :redo := get_stat_val( 'redo size' );
PL/SQL procedure successfully completed.
```

```
EODA@ORA12CR1> create table t
  2 NOLOGGING
  3 as
  4 select * from all_objects;
Table created.
```

```
EODA@ORA12CR1> exec dbms_output.put_line( (get_stat_val('redo size')-:redo) ➔
|| ' bytes of redo generated...' );
90108 bytes of redo generated...
PL/SQL procedure successfully completed.
```

This time, we generated only 90KB of redo. As you can see, this makes a tremendous difference—4MB of redo vs. 90KB. The 4MB written in the first example is a copy of the actual table data itself; it was written to the redo log when the table was created without the NOLOGGING clause.

If you test this on a NOARCHIVELOG-mode database, you will not see any differences between the two. The CREATE TABLE will not be logged, with the exception of the data dictionary modifications, in a NOARCHIVELOG-mode database. That fact also points out a valuable tip: test your system in the mode it will be run in production, *as the behavior may be different*. Your production system will be running in ARCHIVELOG mode; if you perform lots of operations that generate redo in this mode, but not in NOARCHIVELOG mode, you'll want to discover this during testing, not during rollout to the users!

Of course, it is now obvious that you will do everything you can with NOLOGGING, right? In fact, the answer is a resounding *no*. You must use this mode very carefully, and only after discussing the issues with the person in charge of backup and recovery. Let's say you create this table and it is now part of your application (e.g., you used a CREATE TABLE AS SELECT NOLOGGING as part of an upgrade script). Your users modify this table over the course of the day. That night, the disk that the table is on fails. "No problem," the DBA says. "We are running in ARCHIVELOG mode and we can perform media recovery." The problem is, however, that the initially created table, since it was not logged, is not recoverable from the archived redo log. This table is unrecoverable and this brings out the most important point about NOLOGGING operations: they must be coordinated with your DBA and the system as a whole. If you use them and others are not aware of that fact, you may compromise the ability of your DBA to recover your database fully after a media failure. NOLOGGING operations must be used judiciously and carefully.

The important things to note about NOLOGGING operations are as follows:

- *Some amount of redo will be generated*, as a matter of fact. This redo is to protect the data dictionary. There is no avoiding this at all. It could be of a significantly lesser amount than before, but there will be some.
- *NOLOGGING does not prevent redo from being generated by all subsequent operations*. In the preceding example, I did not create a table that is never logged. Only the single, individual operation of creating the table was not logged. All subsequent “normal” operations such as INSERTs, UPDATEs, DELETEs, and MERGEs will be logged. Other special operations, such as a direct-path load using SQL\*Loader, or a direct-path INSERT using the INSERT /\*+ APPEND \*/ syntax, will not be logged (unless and until you ALTER the table and enable full logging again). In general, however, the operations your application performs against this table *will be logged*.
- After performing NOLOGGING operations in an ARCHIVELOG-mode database, *you must take a new baseline backup of the affected data files as soon as possible*, in order to avoid losing the data created by the NOLOGGING operation due to media failure. Since the data created by the NOLOGGING operation is not in the redo log files, and is not yet in the backups, you have no way of recovering it!

## Setting NOLOGGING on an Index

There are two ways to use the NOLOGGING option. You have already seen one method—embedding the NOLOGGING keyword in the SQL command. The other method, which involves setting the NOLOGGING attribute on the segment (index or table), allows *certain* operations to be performed implicitly in a NOLOGGING mode. For example, I can alter an index or table to be NOLOGGING by default. This means for the index that subsequent rebuilds of this index will not be logged (the index will not generate redo; other indexes and the table itself might, but this index will not). Using the table T we just created, we can observe:

```
EODA@ORA12CR1> select log_mode from v$database;

LOG_MODE
-----
ARCHIVELOG

EODA@ORA12CR1> create index t_idx on t(object_name);
Index created.

EODA@ORA12CR1> variable redo number
EODA@ORA12CR1> exec :redo := get_stat_val( 'redo size' );
PL/SQL procedure successfully completed.

EODA@ORA12CR1> alter index t_idx rebuild;
Index altered.

EODA@ORA12CR1> exec dbms_output.put_line( (get_stat_val('redo size')-:redo)
|| ' bytes of redo generated...');
672264 bytes of redo generated...
PL/SQL procedure successfully completed.
```

---

■ **Note** Again, this example was performed in an ARCHIVELOG-mode database. You would not see the differences in redo size in a NOARCHIVELOG mode database as the index CREATE and REBUILD operations are not logged in NOARCHIVELOG mode.

---

When the index is in LOGGING mode (the default), a rebuild of it generated about 600KB of redo. However, we can alter the index:

```
EODA@ORA12CR1> alter index t_idx nologging;
Index altered.
```

```
EODA@ORA12CR1> exec :redo := get_stat_val( 'redo size' );
PL/SQL procedure successfully completed.
```

```
EODA@ORA12CR1> alter index t_idx rebuild;
Index altered.
```

```
EODA@ORA12CR1> exec dbms_output.put_line( (get_stat_val('redo size')-:redo)
|| ' bytes of redo generated...');
```

**39352 bytes of redo generated...**

```
PL/SQL procedure successfully completed.
```

And now it generates a mere 39KB of redo. But that index is “unprotected” now. If the data files it was located in failed and had to be restored from a backup, we would lose that index data. Understanding that fact is crucial. The index is not recoverable right now—we need a backup to take place. Alternatively, the DBA could just re-create the index as we can re-create the index directly from the table data as well.

## NOLOGGING Wrap-up

The operations that may be performed in a NOLOGGING mode are as follows:

- Index creations and ALTERs (rebuids).
- Bulk INSERTs into a table using a direct-path INSERT such as that available via the /\*+ APPEND \*/ hint or SQL\*Loader direct-path loads. The table data will not generate redo, but all index modifications will (the indexes on this nonlogged table will generate redo).
- LOB operations (updates to large objects do not have to be logged).
- Table creations via CREATE TABLE AS SELECT.
- Various ALTER TABLE operations such as MOVE and SPLIT.

Used appropriately on an ARCHIVELOG-mode database, NOLOGGING can speed up many operations by dramatically reducing the amount of redo log generated. Suppose you have a table you need to move from one tablespace to another. You can schedule this operation to take place immediately before a backup occurs—you would ALTER the table to be NOLOGGING, move it, rebuild the indexes (without logging as well), and then ALTER the table back to logging mode. Now, an operation that might have taken X hours can happen in X/2 hours perhaps (I’m not promising a 50-percent reduction in runtime!). The appropriate use of this feature includes involving the DBA, or whoever is responsible for database backup and recovery or any standby databases. If that person is not aware that you’re using this feature and a media failure occurs, you may lose data, or the integrity of the standby database might be compromised. This is something to seriously consider.

## Why Can't I Allocate a New Log?

I get this question all of the time. You are getting warning messages to this effect (this will be found in `alert.log` on your server):

```
Thread 1 cannot allocate new log, sequence 1466
Checkpoint not complete
Current log# 3 seq# 1465 mem# 0: /.../...redo03.log
```

It might say `Archival required` instead of `Checkpoint not complete`, but the effect is pretty much the same. This is really something the DBA should be looking out for. This message will be written to `alert.log` on the server whenever the database attempts to reuse an online redo log file and finds that it can't. This happens when `DBWn` has not yet finished checkpointing the data protected by the redo log or `ARCn` has not finished copying the redo log file to the archive destination. At this point, the database effectively *halts* as far as the end user is concerned. It stops cold. `DBWn` or `ARCn` will be given priority to flush the blocks to disk. Upon completion of the checkpoint or archival, everything goes back to normal. The reason the database suspends user activity is that there is simply no place to record the changes the users are making. Oracle is attempting to reuse an online redo log file, but because either the file would be needed to recover the database in the event of a failure (`Checkpoint not complete`), or the archiver has not yet finished copying it (`Archival required`), Oracle must wait (and the end users will wait) until the redo log file can safely be reused.

If you see that your sessions spend a lot of time waiting on a “log file switch,” “log buffer space,” or “log file switch checkpoint or archival incomplete,” you are most likely hitting this. You will notice it during prolonged periods of database modifications if your log files are sized incorrectly, or because `DBWn` and `ARCn` need to be tuned by the DBA or system administrator. I frequently see this issue with the “starter” database that has not been customized. The “starter” database typically sizes the redo logs far too small for any significant amount of work (including the initial database build of the data dictionary itself). As soon as you start loading up the database, you will notice that the first 1,000 rows go fast, and then things start going in spurts: 1,000 go fast, then hang, then go fast, then hang, and so on. These are the indications you are hitting this condition.

There are a couple of things you can do to solve this issue:

- *Make DBWn faster.* Have your DBA tune `DBWn` by enabling `ASYNCR`, using `DBWn` I/O slaves, or using multiple `DBWn` processes. Look at the I/O on the system and see if one disk or a set of disks is “hot” and you need to therefore spread the data out. The same general advice applies for `ARCn` as well. The pros of this are that you get “something for nothing” here—increased performance without really changing any logic/structures/code. There really are no downsides to this approach.
- *Add more redo log files.* This will postpone the `Checkpoint not complete` in some cases and, after a while, it will postpone the `Checkpoint not complete` so long that it perhaps doesn't happen (because you gave `DBWn` enough breathing room to checkpoint). The same applies to the `Archival required` message. The benefit of this approach is the removal of the “pauses” in your system. The downside is it consumes more disk, but the benefit far outweighs any downside here.
- *Re-create the log files with a larger size.* This will extend the amount of time between the time you fill the online redo log and the time you need to reuse it. The same applies to the `Archival required` message, if the redo log file usage is “bursty.” If you have a period of massive log generation (nightly loads, batch processes) followed by periods of relative calm, then having larger online redo logs can buy enough time for `ARCn` to catch up during the calm periods. The pros and cons are identical to the preceding approach of adding more files. Additionally, it may postpone a checkpoint from happening until later, since checkpoints happen at each log switch (at least), and the log switches will now be further apart.



- *Make checkpointing happen more frequently and more continuously.* Use a smaller block buffer cache (not entirely desirable) or various parameter settings such as `FAST_START_MTTR_TARGET`, `LOG_CHECKPOINT_INTERVAL`, and `LOG_CHECKPOINT_TIMEOUT`. This will force DBWn to flush dirty blocks more frequently. The benefit to this approach is that recovery time from a failure is reduced. There will always be less work in the online redo logs to be applied. The downside is that blocks may be written to disk more frequently if they are modified often. The buffer cache will not be as effective as it could be, and it can defeat the block cleanout mechanism discussed in the next section.

The approach you take will depend on your circumstances. This is something that must be fixed at the database level, taking the entire instance into consideration.

## Block Cleanout

In this section, we'll discuss *block cleanouts*, or the removal of "locking"-related information on the database blocks we've modified. This concept is important to understand when we talk about the infamous `ORA-01555: snapshot too old` error in a subsequent section.

If you recall from Chapter 6, we talked about data locks and how they are managed. I described how they are actually attributes of the data, stored on the block header. A side effect of this is that the next time that block is accessed, we may have to clean it out—in other words, remove the transaction information. This action generates redo and causes the block to become *dirty* if it wasn't already, meaning that a simple `SELECT` may generate redo and may cause lots of blocks to be written to disk with the next checkpoint. Under most normal circumstances, however, this will not happen. If you have mostly small- to medium-sized transactions (OLTP), or you have a data warehouse that performs direct-path loads or uses `DBMS_STATS` to analyze tables after load operations, you'll find the blocks are generally cleaned for you. If you recall from the earlier section titled "What Does a COMMIT Do?" one of the steps of COMMIT-time processing is to revisit some blocks if they are still in the SGA and if they are accessible (no one else is modifying them), and then clean them out. This activity is known as a *commit clean out* and is the activity that cleans out the transaction information on our modified block. Optimally, our COMMIT can clean out the blocks so that a subsequent `SELECT` (read) will not have to clean it out. Only an `UPDATE` of this block would truly clean out our residual transaction information, and since the `UPDATE` is already generating redo, the cleanout is not noticeable.

We can force a cleanout to *not* happen, and therefore observe its side effects, by understanding how the commit cleanout works. In a commit list associated with our transaction, Oracle will record lists of blocks we have modified. Each of these lists is 20 blocks long, and Oracle will allocate as many of these lists as it needs—up to a point. If the sum of the blocks we modify exceeds 10 percent of the block buffer cache size, Oracle will stop allocating new lists. For example, if our buffer cache is set to cache 3,000 blocks, Oracle will maintain a list of up to 300 blocks (10 percent of 3,000). Upon COMMIT, Oracle will process each of these lists of 20 block pointers, and if the block is still available, it will perform a fast cleanout. So, as long as the number of blocks we modify does not exceed 10 percent of the number of blocks in the cache *and* our blocks are still in the cache and available to us, Oracle will clean them out upon COMMIT. Otherwise, it just skips them (i.e., does not clean them out).

With this understanding, we can set up artificial conditions to see how the cleanout works. I set my `DB_CACHE_SIZE` to a low value of 16MB, which is sufficient to hold 2,048 8KB blocks (my blocksize is 8KB). Next I create a table such that a row fits on exactly one block—I'll never have two rows per block. Then I fill this table up with 10,000 rows and COMMIT. We know that 10,000 blocks far exceeds 10% of 2048, so the database will not be able to clean out all of these dirty blocks upon commit—most of them will not even be in the buffer cache anymore. I'll measure the amount of redo I've generated so far, run a `SELECT` that will visit each block, and then measure the amount of redo that `SELECT` generated.

---

■ **Note** In order for this example to be reproducible and predictable, you'll need to disable SGA automatic memory management. If that is enabled, there is a chance that the database will increase the size of your buffer cache—defeating the "math" I've worked out.

---

Surprisingly to many people, the SELECT will have generated redo. Not only that, but it will also have “dirtied” these modified blocks, causing DBWn to write them again. This is due to the block cleanout. Next, I’ll run the SELECT to visit every block once again and see that no redo is generated. This is expected, as the blocks are all “clean” at this point. We’ll start by creating our table:

```
EODA@ORA12CR1> create table t
  2 ( id number primary key,
  3   x char(2000),
  4   y char(2000),
  5   z char(2000)
  6 )
  7 /
```

Table created.

```
EODA@ORA12CR1> exec dbms_stats.set_table_stats( user, 'T',
                                                numRows=>10000, numblks=>10000 );
```

PL/SQL procedure successfully completed.

I used DBMS\_STATS to set table statistics so as to avoid any side effects from hard parsing later (Oracle tends to scan objects that have no statistics during a hard parse and this side effect would interfere with my example!). So, this is my table with one row per block (in my 8KB blocksize database). Next, we’ll inspect the block of code we’ll be executing against this table:

```
EODA@ORA12CR1> declare
  2   l_rec t%rowtype;
  3   begin
  4     for i in 1 .. 10000
  5     loop
  6       select * into l_rec from t where id=i;
  7     end loop;
  8   end;
  9   /
declare
*
```

ERROR at line 1:  
ORA-01403: no data found  
ORA-06512: at line 6

That block failed, but that’s OK—we knew it would since there is no data in the table yet. I ran that block simply to get the hard parse of the SQL and PL/SQL performed so when we run it later, we won’t have to worry about side effects from hard parsing being counted. Now we are ready to load the data into our table and commit:

```
EODA@ORA12CR1> insert into t
  2 select rownum, 'x', 'y', 'z'
  3   from all_objects
  4   where rownum <= 10000;
10000 rows created.
```

```
EODA@ORA12CR1> commit;
Commit complete.
```

And, finally, I'm ready to measure the amount of redo generated during the first read of the data:

```
EODA@ORA12CR1> variable redo number
EODA@ORA12CR1> exec :redo := get_stat_val( 'redo size' );
PL/SQL procedure successfully completed.
```

```
EODA@ORA12CR1> declare
  2     l_rec t%rowtype;
  3 begin
  4     for i in 1 .. 10000
  5     loop
  6         select * into l_rec from t where id=i;
  7     end loop;
  8 end;
  9 /
```

PL/SQL procedure successfully completed.

```
EODA@ORA12CR1> exec dbms_output.put_line( (get_stat_val('redo size')-:redo)
                                           || ' bytes of redo generated...');
```

**802632 bytes of redo generated...**

PL/SQL procedure successfully completed.

So, this SELECT generated about 802KB of redo during its processing. This represents the block headers it modified during the index read of the primary key index and the subsequent table read of T. DBWn will be writing these modified blocks back out to disk at some point in the future (actually, since the table doesn't fit into the cache, we know that DBWn has already written out at least some of them). Now, if I run the query again

```
EODA@ORA12CR1> exec :redo := get_stat_val( 'redo size' );
PL/SQL procedure successfully completed.
```

```
EODA@ORA12CR1> declare
  2     l_rec t%rowtype;
  3 begin
  4     for i in 1 .. 10000
  5     loop
  6         select * into l_rec from t where id=i;
  7     end loop;
  8 end;
  9 /
```

PL/SQL procedure successfully completed.

```
EODA@ORA12CR1> exec dbms_output.put_line( (get_stat_val('redo size')-:redo)
                                           || ' bytes of redo generated...');
```

**0 bytes of redo generated...**

PL/SQL procedure successfully completed.

I see that no redo is generated—the blocks are all clean.

If we were to rerun the preceding example with the buffer cache set to hold a little more than 100,000 blocks, we'd find that we generate little to no redo on any of the SELECTs—we will not have to clean dirty blocks during either of our SELECT statements. This is because the 10,000-plus (remember the index was modified as well) blocks we modified fit comfortably into 10 percent of our buffer cache, and we are the only users. There is no one else mucking around with the data, and no one else is causing our data to be flushed to disk or accessing those blocks. In a live system, it would be normal for at least some of the blocks to not be cleaned out sometimes.

This behavior will most affect you after a large INSERT (as just demonstrated), UPDATE, or DELETE—one that affects many blocks in the database (anything more than 10 percent of the size of the cache will definitely do it). You'll notice that the first query to touch the block after this will generate a little redo and dirty the block, possibly causing it to be rewritten if DBWn had already flushed it or the instance had been shut down, clearing out the buffer cache altogether. There is not too much you can do about it. It is normal and to be expected. If Oracle didn't do this deferred cleanout of a block, a COMMIT could take as long to process as the transaction itself. The COMMIT would have to revisit each and every block, possibly reading them in from disk again (they could have been flushed).

If you are not aware of block cleanouts and how they work, they will be one of those mysterious things that just seem to happen for no reason. For example, say you UPDATE a lot of data and COMMIT. Now you run a query against that data to verify the results. The query appears to generate tons of write I/O and redo. It seems impossible if you are unaware of block cleanouts; it was to me the first time I saw it. You go and get someone to observe this behavior with you, but it is not reproducible as the blocks are now “clean” on the second query. You simply write it off as one of those database mysteries—a mystery that only happens when you are alone.

In an OLTP system, you'll probably never see a block cleanout happening, since those systems are characterized by small, short transactions that affect only a few blocks. By design, all or most of the transactions are short and sweet. Modify a couple of blocks and they all get cleaned out. In a warehouse where you make massive UPDATES to the data after a load, block cleanouts may be a factor in your design. Some operations will create data on “clean” blocks. For example, CREATE TABLE AS SELECT, direct-path loaded data, and direct-path inserted (using the /\* +APPEND \*/ hint) data will all create clean blocks. An UPDATE, normal INSERT, or DELETE may create blocks that need to be cleaned with the first read. This could really affect you if your processing consists of

- Bulk-loading lots of new data into the data warehouse
- Running UPDATES on all of the data you just loaded (producing blocks that need to be cleaned out)
- Letting people query the data

You have to realize that the first query to touch the data will incur some additional processing if the block needs to be cleaned. Realizing this, you yourself should “touch” the data after the UPDATE. You just loaded or modified a ton of data—you need to analyze it at the very least. Perhaps you need to run some reports to validate the load. This will clean the block out and make it so the next query doesn't have to. Better yet, since you just bulk-loaded the data, you now need to refresh the statistics anyway. Running the DBMS\_STATS utility to gather statistics may well clean out all of the blocks as it just uses SQL to query the information and would naturally clean the blocks out as it goes along.

## Log Contention

This, like the cannot allocate new log message, is something the DBA must fix, typically in conjunction with the system administrator. However, it is something a developer might detect as well if the DBA isn't watching closely enough.

If you are faced with log contention, what you might observe is a large wait time on the “log file sync” event and long write times evidenced in the “log file parallel write” event in a Statspack report. If you see this, you may be experiencing contention on the redo logs; they are not being written fast enough. This can happen for many reasons. One application reason (one the DBA can't fix, but the developer must) is that you are committing too frequently—committing inside of a loop doing INSERTs, for example. As demonstrated in the “What Does a COMMIT Do?” section, committing too frequently, aside from being a bad programming practice, is a surefire way to introduce lots of log file sync waits. Assuming all of your transactions are correctly sized (you are not committing more frequently than your business rules dictate), the most common causes for log file waits that I've seen are as follows:

- *Putting redo on a slow device:* The disks are just performing poorly. It is time to buy faster disks.
- *Putting redo on the same device as other files that are accessed frequently:* Redo is designed to be written with sequential writes and to be on dedicated devices. If other components of your system—even other Oracle components—are attempting to read and write to this device at the same time as LGWR, you will experience some degree of contention. Here, you want to ensure LGWR has exclusive access to these devices if at all possible.

- *Mounting the log devices in a buffered manner:* Here, you are using a “cooked” file system (not RAW disks). The operating system is buffering the data, and the database is also buffering the data (redo log buffer). Double-buffering slows things down. If possible, mount the devices in a “direct” fashion. How to do this varies by operating system and device, but it is usually possible.
- *Putting redo on a slow technology, such as RAID-5:* RAID-5 is great for reads, but it is generally terrible for writes. As we saw earlier regarding what happens during a COMMIT, we must wait for LGWR to ensure the data is on disk. Using any technology that slows this down is not a good idea.

If at all possible, you really want at least five dedicated devices for logging and optimally six to mirror your archives as well. In these days of 200GB, 300GB, 1TB and larger disks, this is getting harder, but if you can set aside four of the smallest, fastest disks you can find and one or two big ones, you can affect LGWR and ARCn in a positive fashion. To lay out the disks, you would break them into three groups (see Figure 9-5):

- *Redo log group 1:* Disks 1 and 3
- *Redo log group 2:* Disks 2 and 4
- *Archive:* Disk 5 and optionally disk 6 (the big disks)

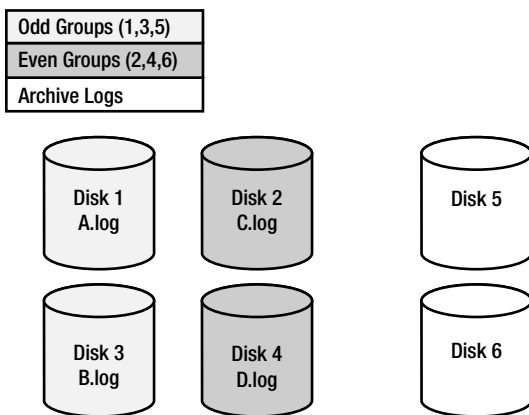

**Figure 9-5.** Optimal redo log configuration

You would place redo log group 1 with members A and B onto disks 1 and 3. You would place redo log group 2 with members C and D onto disks 2 and 4. If you have groups 3, 4, and so on, they’d go onto the odd and even groups of disks respectively. The effect of this is that LGWR, when the database is currently using group 1, will write to disks 1 and 3 simultaneously. When this group fills up, LGWR will move to disks 2 and 4. When they fill up, LGWR will go back to disks 1 and 3. Meanwhile, ARCn will be processing the full online redo logs and writing them to disks 5 and 6, the big disks. The net effect is neither ARCn nor LGWR is ever reading a disk being written to, or writing to a disk being read from, so there is no contention (see Figure 9-6).

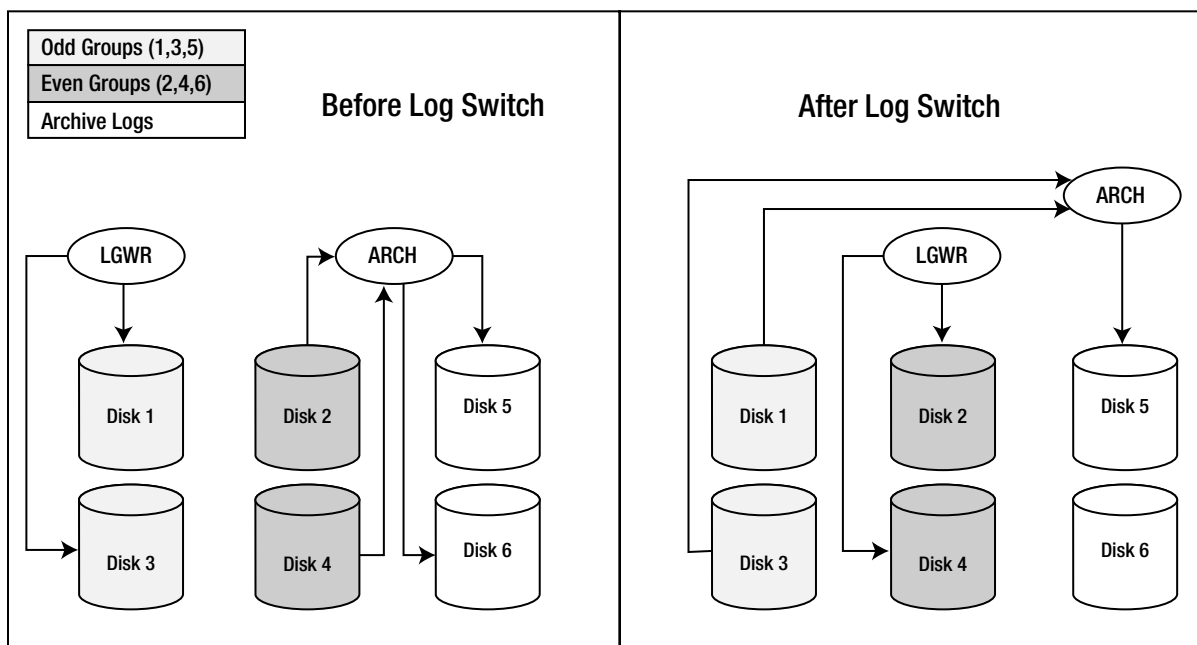

**Figure 9-6.** Redo log flow

So, when LGWR is writing group 1, ARCN is reading group 2 and writing to the archive disks. When LGWR is writing group 2, ARCN is reading group 1 and writing to the archive disks. In this fashion, LGWR and ARCN each have their own dedicated devices and will not be contending with anyone, not even each other.

## Temporary Tables and Redo/Undo

Temporary tables have been a feature within Oracle for several releases now (introduced in Oracle8i version 8.1.5). Even though temporary tables have been around for a while, there is still some confusion surrounding them, in particular in the area of logging. In Chapter 10, we will cover how and why you might use temporary tables. In this section, we'll explore only the question "How do temporary tables work with respect to logging of changes?"

In Oracle 12c, the processing of undo for temporary tables is significantly enhanced. Therefore I'll break this topic into two sections: Prior to 12c and Starting with 12c.

### Prior to 12c

Temporary tables generate no redo for their blocks. Therefore, an operation on a temporary table is not recoverable. When you modify a block in a temporary table, no record of this change will be made in the redo log files. However, temporary tables do generate undo, *and the undo is logged*. Hence, temporary tables will generate some redo. At first glance, this doesn't seem to make total sense: Why would they need to generate undo? This is because you can roll back to a SAVEPOINT within a transaction. You might erase the last 50 INSERTs into a temporary table, leaving the first 50. Temporary tables can have constraints and everything else a normal table can have. They might fail a statement on the five-hundredth row of a 500-row INSERT, necessitating a rollback of that statement. Since temporary tables behave in general just like normal tables, temporary tables must generate undo. Since undo data must be logged, temporary tables will generate some redo log for the undo they generate.

This is not nearly as ominous as it seems. The primary SQL statements used against temporary tables are INSERTs and SELECTs. Fortunately, INSERTs generate very little undo (you need to restore the block to “nothing,” and it doesn’t take very much room to store “nothing”), and SELECTs generate no undo. Hence, if you use temporary tables for INSERTs and SELECTs exclusively, this section means nothing to you. It is only if you UPDATE or DELETE that you might be concerned about this.

I set up a small test to demonstrate the amount of redo generated while working with temporary tables, an indication therefore of the amount of undo generated for temporary tables, since only the undo is logged for them. To demonstrate, I’ll take identically configured permanent and temporary tables, and then perform the same operations on each, measuring the amount of redo generated each time. The tables I’ll use are as follows:

```
EODA@ORA11GR2> create table perm
 2 ( x char(2000) ,
 3   y char(2000) ,
 4   z char(2000) )
 5 /
Table created.
```

```
EODA@ORA11GR2> create global temporary table temp
 2 ( x char(2000) ,
 3   y char(2000) ,
 4   z char(2000) )
 5 on commit preserve rows
 6 /
Table created.
```

I set up a small stored procedure to allow me to perform arbitrary SQL and report the amount of redo generated by that SQL. I’ll use this routine to perform INSERTs, UPDATEs, and DELETEs against both the temporary and permanent tables:

```
EODA@ORA11GR2> create or replace procedure do_sql( p_sql in varchar2 )
 2 as
 3   l_start_redo   number;
 4   l_redo         number;
 5 begin
 6   l_start_redo := get_stat_val( 'redo size' );
 7
 8   execute immediate p_sql;
 9   commit;
10
11   l_redo := get_stat_val( 'redo size' ) - l_start_redo;
12
13   dbms_output.put_line
14   ( to_char(l_redo, '99,999,999') || ' bytes of redo generated for "' ||
15     substr( replace( p_sql, chr(10), ' ' ), 1, 25 ) || '"...' );
16 end;
17 /
Procedure created.
```

Then I ran equivalent INSERTs, UPDATEs, and DELETEs against both the PERM and TEMP tables:

```
EODA@ORA11GR2> set serveroutput on format wrapped
EODA@ORA11GR2> begin
 2     do_sql( 'insert into perm
 3             select 1,1,1
 4             from all_objects
 5             where rownum <= 500' );
 6
 7     do_sql( 'insert into temp
 8             select 1,1,1
 9             from all_objects
10             where rownum <= 500' );
11     dbms_output.new_line;
12
13     do_sql( 'update perm set x = 2' );
14     do_sql( 'update temp set x = 2' );
15     dbms_output.new_line;
16
17     do_sql( 'delete from perm' );
18     do_sql( 'delete from temp' );
19 end;
20 /

3,313,088 bytes of redo generated for "insert into perm      "...
 72,584 bytes of redo generated for "insert into temp      "...

3,268,384 bytes of redo generated for "update perm set x = 2"...
1,946,432 bytes of redo generated for "update temp set x = 2"...

3,245,112 bytes of redo generated for "delete from perm"...
3,224,460 bytes of redo generated for "delete from temp"...
```

PL/SQL procedure successfully completed.

As you can see,

- The INSERT into the “real” table generated a lot of redo, while almost no redo was generated for the temporary table. This makes sense—there is very little undo data generated for INSERTs and only undo data is logged for temporary tables.
- The UPDATE of the real table generated about twice the amount of redo as the temporary table. Again, this makes sense. About half of that UPDATE, the “before image,” had to be saved. The “after image” (redo) for the temporary table did not have to be saved.
- The DELETEs each took about the same amount of redo space. This makes sense, because the undo for a DELETE is big, but the redo for the modified blocks is very small. Hence, a DELETE against a temporary table takes place very much in the same fashion as a DELETE against a permanent table.



---

■ **Note** If you see the temporary table generating more redo than the permanent table with the INSERT statement, you are observing a product issue in the database that is fixed in at least Oracle 9.2.0.6 and 10.1.0.4 patch releases and above.

---

Therefore, the following generalizations can be made regarding DML activity on temporary tables:

- An INSERT will generate little to no undo/redo activity.
- An UPDATE will generate about half the redo as with a permanent table.
- A DELETE will generate the same amount of redo as with a permanent table.

There are notable exceptions to the next to last statement. For example, if I UPDATE a column that is entirely NULL with 2,000 bytes of data, there will be very little undo data generated. This UPDATE will behave like the INSERT. On the other hand, if I UPDATE a column with 2,000 bytes of data to be NULL, it will behave like the DELETE as far as redo generation is concerned. On average, you can expect an UPDATE against a temporary table to produce about 50 percent of the undo/redo you'd experience with a permanent table.

In addition, you must consider any indexes in place on your temporary tables. Index modifications will also generate undo—which in turn generates redo. If you rerun the above example with these two indexes in place:

```
EODA@ORA11GR2> create index perm_idx on perm(x);
Index created.
```

```
EODA@ORA11GR2> create index temp_idx on temp(x);
Index created.
```

You will find redo generated in the order of (for brevity, all of the code from the previous example is not repeated here):

```
...
19 end;
20 /

11,735,576 bytes of redo generated for "insert into perm      "...
 3,351,864 bytes of redo generated for "insert into temp    "...

 9,257,748 bytes of redo generated for "update perm set x = 2"...
 5,465,868 bytes of redo generated for "update temp set x = 2"...

 4,434,992 bytes of redo generated for "delete from perm"...
 4,371,620 bytes of redo generated for "delete from temp"...
```

PL/SQL procedure successfully completed.

The numbers hold true from what we saw before—but you can see that the index definitely added to the redo generated. The INSERT into the global temporary table went from generating almost no redo to generating 3.3MB of redo. All of this additional redo was related to the undo produced for the index maintenance.

---

■ **Note** This is an exaggerated example. The index in question was on a CHAR(2000) column; the index key is much larger than you'll normally see in real life. Don't expect this much additional redo typically.

---

In general, common sense prevails in estimating the amount of redo created. If the operation you perform causes undo data to be created, then determine how easy or hard it will be to reverse (undo) the effect of your operation. If you INSERT 2,000 bytes, the reverse of this is easy. You simply go back to no bytes. If you DELETE 2,000 bytes, the reverse is INSERTing 2,000 bytes. In this case, the redo is substantial.

Armed with this knowledge, you will avoid deleting from temporary tables. You can use TRUNCATE, bearing in mind, of course, that TRUNCATE is DDL that will commit your transaction, and in Oracle9i and before invalidate your cursors. Or just let the temporary tables empty themselves automatically after a COMMIT or when your session terminates. All of these methods generate no undo and, therefore, no redo. You should try to avoid updating a temporary table unless you really have to for some reason. You should use temporary tables mostly as something to be INSERTed into and SELECTed from. In this fashion, you'll make optimum use of their unique ability to not generate redo.

## Starting with 12c

As you saw in the previous section, when issuing INSERT, UPDATE, and DELETE statements in a temporary table, the undo for those changes is recorded in the undo tablespace, which in turn will generate redo. With the advent of Oracle 12c, you can instruct Oracle to store the undo for a temporary table in a temporary tablespace via the TEMP\_UNDO\_ENABLED parameter. When blocks are modified in a temporary tablespace, no redo is generated. Therefore, when TEMP\_UNDO\_ENABLED is set to TRUE, any DML issued against a temporary table will generate little or no redo.

---

■ **Note** By default, TEMP\_UNDO\_ENABLED is set to FALSE. So unless otherwise configured, temporary tables will generate the same amount of redo in 12c as in prior releases.

---

The TEMP\_UNDO\_ENABLED parameter can be set at the session or system level. Here's an example of setting it to TRUE at the session level:

```
EODA@ORA12CR1> alter session set temp_undo_enabled=true;
```

Once enabled for a session, any modifications to data in a temporary table in that session will have a subsequent undo logged to the temporary tablespace. Any modifications to permanent tables will still have undo logged to the undo tablespace. To see the impact of this, I'll rerun the exact same code (from the "Prior to 12c" section) that displays the amount of redo generated when issuing transactions against a permanent table and a temporary table—with the only addition being that TEMP\_UNDO\_ENABLED is set to TRUE. Here is the output:

```
3,312,148 bytes of redo generated for "insert into perm      "...
   376 bytes of redo generated for "insert into temp      "...

2,203,788 bytes of redo generated for "update perm set x = 2"...
   376 bytes of redo generated for "update temp set x = 2"...

3,243,412 bytes of redo generated for "delete from perm"...
   376 bytes of redo generated for "delete from temp"...
```

The results are dramatic: a trivial amount of redo is generated by the INSERT, UPDATE, and DELETE statements in a temporary table. For environments where you perform large batch operations that transact against temporary tables, you can expect to see a significant reduction in the amount of redo generated.

---

■ **Note** You may be wondering why there were 376 bytes of redo generated in the prior example’s output. As processes consume space within the database, Oracle does some internal housekeeping. These changes are recorded in the data dictionary, which in turn generates some redo and undo.

---

Starting with Oracle12c, in an Oracle Active Data Guard configuration, you can issue DML statements directly on a temporary table that exists in a standby database. We can view the amount of redo generated for a temporary table in a standby database by running the same code (from the “Prior to 12c” section) against a standby database. The only difference being the statements issuing transactions against permanent tables must be removed (because you cannot issue DML on a permanent table in a standby database). Here is the output showing that 0 bytes of redo are generated:

```
0 bytes of redo generated for "insert into temp          "...
0 bytes of redo generated for "update temp set x = 2"...
0 bytes of redo generated for "delete from temp"...
```

---

■ **Note** There’s no need to set `TEMP_UNDO_ENABLED` in the standby database. This is because temporary undo is always enabled in an Oracle Active Data Guard standby database.

---

Global temporary tables are often used for reporting purposes—like generating and storing intermediate query results. Oracle Active Data Guard is often used to offload reporting applications to the standby database. Couple global temporary tables with Oracle Active Data Guard, and you have a more powerful tool to address your reporting requirements.

## Investigating Undo

We’ve already discussed a lot of undo segment topics. We’ve seen how they are used during recovery, how they interact with the redo logs, and how they are used for consistent, nonblocking reads of data. In this section, we’ll look at the most frequently raised issues with undo segments.

The bulk of our time will be spent on the infamous `ORA-01555: snapshot too old` error, as this single issue causes more confusion than any other topic in the entire set of database topics. Before we do this, however, we’ll investigate one other undo-related issue: the question of what type of DML operation generates the most and least undo (you might already be able to answer that yourself, given the preceding examples with temporary tables).

### What Generates the Most and Least Undo?

This is a frequently asked but easily answered question. The presence of indexes (or the fact that a table is an index-organized table) may affect the amount of undo generated dramatically, as indexes are complex data structures and may generate copious amounts of undo information.

That said, an `INSERT` will, in general, generate the least amount of undo, since all Oracle needs to record for this is a rowid to “delete.” An `UPDATE` is typically second in the race (in most cases). All that needs to be recorded are the changed bytes. It is most common that you `UPDATE` some small fraction of the entire row’s data. Therefore, a small fraction of the row must be remembered in the undo. Many of the previous examples run counter to this rule of thumb, but that’s because they update large, fixed-sized rows and they update the entire row. It is much more common to `UPDATE` a row and change a small percentage of the total row. A `DELETE` will, in general, generate the most undo. For a `DELETE`, Oracle must record the entire row’s before image into the undo segment. The previous temporary table example, with regard to redo generation, demonstrated that fact: the `DELETE` generated the most redo, and since

the only logged element of the DML operation on a temporary table is the undo, we in fact observed that the DELETE generated the most undo. The INSERT generated very little undo that needed to be logged. The UPDATE generated an amount equal to the before image of the data that was changed, and the DELETE generated the entire set of data written to the undo segment.

As previously mentioned, you must also take into consideration the work performed on an index. You'll find that an update of an unindexed column not only executes much faster, it also tends to generate significantly less undo than an update of an indexed column. For example, we'll create a table with two columns, both containing the same information, and index one of them:

```
EODA@ORA12CR1> create table t
 2 as
 3 select object_name unindexed,
 4        object_name indexed
 5 from all_objects
 6 /
```

Table created.

```
EODA@ORA12CR1> create index t_idx on t(indexed);
Index created.
```

```
EODA@ORA12CR1> exec dbms_stats.gather_table_stats(user,'T');
PL/SQL procedure successfully completed.
```

Now we'll update the table, first updating the unindexed column and then the indexed column. We'll need a new V\$ query to measure the amount of undo we've generated in each case. The following query accomplishes this for us. It works by getting our session ID (SID) from V\$MYSTAT, using that to find our record in the V\$SESSION view, and retrieving the transaction address (TADDR). It uses the TADDR to pull up our V\$TRANSACTION record (if any) and selects the USED\_UBLK column—the number of used undo blocks. Since we currently are not in a transaction, we expect it to return zero rows right now:

```
EODA@ORA12CR1> select used_ublk
 2 from v$transaction
 3 where addr = (select taddr
 4               from v$session
 5               where sid = (select sid
 6                             from v$mystat
 7                             where rownum = 1
 8                             )
 9               )
10 /
no rows selected
```

But the query will return a row after the UPDATE starts a transaction:

```
EODA@ORA12CR1> update t set unindexed = lower(unindexed);
72077 rows updated.
```

```

EODA@ORA12CR1> select used_ublk
 2   from v$transaction
 3   where addr = (select taddr
 4                   from v$session
 5                   where sid = (select sid
 6                                   from v$mystat
 7                                   where rownum = 1
 8                                   )
 9                   )
10 /

```

```
USED_UBLK
```

```
-----
      151
```

```

EODA@ORA12CR1> commit;
Commit complete.

```

That UPDATE used 151 blocks to store its undo. The commit would free that up, or release it, so if we rerun the query against V\$TRANSACTION, it would once again show us no rows selected. When we update the same data—only indexed this time—we’ll observe the following:

```

EODA@ORA12CR1> update t set indexed = lower(indexed);
72077 rows updated.

```

```

EODA@ORA12CR1> select used_ublk
 2   from v$transaction
 3   where addr = (select taddr
 4                   from v$session
 5                   where sid = (select sid
 6                                   from v$mystat
 7                                   where rownum = 1
 8                                   )
 9                   )
10 /

```

```
USED_UBLK
```

```
-----
      854
```

As you can see, updating that indexed column in this example generated several times as much undo. This is due to the inherent complexity of the index structure itself and the fact that we updated every single row in the table—moving every single index key value in this structure.

## ORA-01555: Snapshot Too Old Error

In the last chapter, we briefly investigated the ORA-01555 error and looked at one cause of it: committing too frequently. Here we’ll take a much more detailed look at the causes and solutions for the ORA-01555 error. ORA-01555 is one of those errors that confound people. It is the foundation for many myths, inaccuracies, and suppositions.

---

■ **Note** ORA-01555 is not related to data corruption or data loss at all. It is a “safe” error in that regard; the only outcome is that the query that received this error is unable to continue processing.

---

The error is actually straightforward and has only two real causes, but since there’s a special case of one of them that happens so frequently, I’ll say that there are three:

- The undo segments are too small for the work you perform on your system.
- Your programs fetch across COMMITs (actually a variation on the preceding point). We covered this in Chapter 8.
- Block cleanout.

The first two points are directly related to Oracle’s read-consistency model. As you recall from Chapter 7, the results of your query are *preordained*, meaning they are well-defined before Oracle goes to retrieve even the first row. Oracle provides this consistent point in time “snapshot” of the database by using the undo segments to roll back blocks that have changed since your query began. Every statement you execute, such as the following:

```
update t set x = 5 where x = 2;
insert into t select * from t where x = 2;
delete from t where x = 2;
select * from t where x = 2;
```

will see a read-consistent view of T and the set of rows where X=2, regardless of any other concurrent activity in the database.

---

■ **Note** The four statements presented here are just examples of the types of statements that would see a read-consistent view of T. They are not meant to be run as a single transaction in the database, as the first update would cause the following three statements to see no records. They are purely illustrative.

---

All statements that “read” the table take advantage of this read consistency. In the example just shown, the UPDATE reads the table to find rows where x=2 (and then UPDATES them). The INSERT reads the table to find rows where X=2, and then INSERTs them, and so on. It is this dual use of the undo segments, both to roll back failed transactions and to provide for read consistency that results in the ORA-01555 error.

The third item in the previous list is a more insidious cause of ORA-01555 in that it can happen in a database where there is a single session, and this session is not modifying the tables that are being queried when the ORA-01555 error is raised! This doesn’t seem possible—why would we need undo data for a table we can guarantee is not being modified? We’ll find out shortly.

Before we take a look at all three cases with illustrations, I’d like to share with you the solutions to the ORA-01555 error, in general:

- Set the parameter UNDO\_RETENTION properly (larger than the amount of time it takes to execute your longest-running transaction). V\$UNDOSTAT can be used to determine the duration of your long-running queries. Also, ensure sufficient space on disk has been set aside so the undo segments are allowed to grow to the size they need to be based on the requested UNDO\_RETENTION.
- Increase the size of or add more undo segments when using manual undo management. This decreases the likelihood of undo data being overwritten during the course of your long-running query. This method goes toward solving all three of the previous points. *Note that this is definitely not the preferred method; automatic undo management is highly recommended.*

- Reduce the runtime of your query (tune it). This is always a good thing if possible, so it might be the first thing you try. It reduces the need for larger undo segments. This method goes toward solving all three of the previous points.
- Gather statistics on related objects. This helps avoid the third point listed earlier. Since the block cleanout is the result of a very large mass UPDATE or INSERT, statistics-gathering needs to be done anyway after a mass UPDATE or large load.

We'll come back to these solutions, as they are important to know. It seemed appropriate to display them prominently before we begin.

## Undo Segments Are in Fact Too Small

The scenario is this: you have a system where the transactions are small. As a result, you need very little undo segment space allocated. Say, for example, the following is true:

- Each transaction generates 8KB of undo on average.
- You do five of these transactions per second on average (40KB of undo per second, 2,400KB per minute).
- You have a transaction that generates 1MB of undo that occurs once per minute on average. In total, you generate about 3.5MB of undo per minute.
- You have 15MB of undo configured for the system.

That is more than sufficient undo for this database when processing transactions. The undo segments will wrap around and reuse space about every three to four minutes or so, on average. If you sized undo segments based on your transactions that do modifications, you did all right.

In this same environment, however, you have some reporting needs. Some of these queries take a really long time to run—five minutes, perhaps. Here is where the problem comes in. If these queries take five minutes to execute *and* they need a view of the data as it existed when the query began, you have a very good probability of the ORA-01555 error occurring. Since your undo segments will wrap during this query execution, you know that some undo information generated since your query began is gone—it has been overwritten. If you hit a block that was modified near the time you started your query, the undo information for this block will be missing, and you will receive the ORA-01555 error.

Here's a small example. Let's say we have a table with blocks 1, 2, 3, . . . 1,000,000 in it. Table 9-2 shows a sequence of events that could occur.

**Table 9-2.** Long-Running Query Timeline

Time (Minutes:Seconds)	Action
0:00	Our query begins.
0:01	Another session UPDATES block 1,000,000. Undo information for this is recorded into some undo segment.
0:01	This UPDATE session COMMITS. The undo data it generated is still there, but is now subject to being overwritten if we need the space.
1:00	Our query is still chugging along. It is at block 200,000.
1:01	Lots of activity going on. We have generated a little over 14MB of undo by now.
3:00	Our query is still going strong. We are at block 600,000 or so by now.
4:00	Our undo segments start to wrap around and reuse the space that was active when our query began at time 0:00. Specifically, we have just reused the undo segment space that the UPDATE to block 1,000,000 used back at time 0:01.
5:00	Our query finally gets to block 1,000,000. It finds it has been modified since the query began. It goes to the undo segment and attempts to find the undo for that block to get a consistent read on it. At this point, it discovers the information it needs no longer exists. ORA-01555 is raised and the query fails.

This is all it takes. If your undo segments are sized such that they have a good chance of being reused during the execution of your queries, and your queries access data that will probably be modified, you stand a very good chance of hitting the ORA-01555 error on a recurring basis. If this is the case, you must set your `UNDO_RETENTION` parameter higher and let Oracle take care of figuring out how much undo to retain (this is the suggested approach; it's much easier than trying to figure out the perfect undo size yourself) or resize your undo segments and make them larger (or have more of them). You need enough undo configured to last as long as your long-running queries. The system was sized for the transactions that modify data—you forgot to size for the other components of the system.

With Oracle9i and above, there are two methods to manage undo in the system:

- *Automatic undo management:* Here, Oracle is told how long to retain undo for, via the `UNDO_RETENTION` parameter. Oracle will determine how many undo segments to create based on concurrent workload and how big each should be. The database can even reallocate extents between individual undo segments at runtime to meet the `UNDO_RETENTION` goal set by the DBA. This is the recommended approach for undo management.
- *Manual undo management:* Here, the DBA does the work. The DBA determines how many undo segments to manually create, based on the estimated or observed workload. The DBA determines how big the segments should be based on transaction volume (how much undo is generated) and the length of the long-running queries.

Manual undo management, where a DBA figures out how many undo segments to have and how big each should be, is where one of the points of confusion comes into play. People say, “Well, we have XMB of undo configured, but this can grow. We have `MAXEXTENTS` set at 500 and each extent is 1MB, so the undo can get quite large.” The problem is that the manually managed undo segments will never grow due to a query; they will grow only due to `INSERTs`, `UPDATEs`, and `DELETEs`. The fact that a long-running query is executing does not cause Oracle to grow a manual undo segment to retain the data in case it might need it. Only a long-running `UPDATE` transaction would do this. In the preceding example, even if the manual undo segments had the potential to grow, they will not. What you need to do for this system is have manual undo segments that are already big. You need to permanently allocate space to the undo segments, not give them the opportunity to grow on their own.



The only solutions to this problem are to either make it so that the manual undo segments are sized so that they wrap only every six to ten minutes, or make it so your queries never take more than two to three minutes to execute. The first suggestion is based on the fact that you have queries that take five minutes to execute. In this case, the DBA needs to make the amount of permanently allocated undo two to three times larger. The second (perfectly valid) suggestion is equally appropriate. Any time you can make the queries go faster, you should. If the undo generated since the time your query began is never overwritten, you'll avoid ORA-01555.

Under automatic undo management, things are much easier from the ORA-01555 perspective. Rather than having to figure out how big the undo space needs to be and then preallocating it, the DBA tells the database how long the longest-running query is and sets that value in the `UNDO_RETENTION` parameter. Oracle will attempt to preserve undo for at least that duration of time. If sufficient space to grow has been allocated, Oracle will extend an undo segment and not wrap around—in trying to obey the `UNDO_RETENTION` period. This is in direct contrast to manually managed undo, which will wrap around and reuse undo space as soon as it can. It is primarily for this reason, the support of the `UNDO_RETENTION` parameter, that I highly recommend *automatic undo management* whenever possible. That single parameter reduces the possibility of an ORA-01555 error greatly (when it is set appropriately).

When using manual undo management, it is also important to remember that the probability of an ORA-01555 error is dictated by the *smallest* undo segment in your system, not the largest and not the average. Adding one “big” undo segment will not make this problem go away. It only takes the smallest undo segment to wrap around while a query is processing, and this query stands a chance of an ORA-01555 error. This is why I was a big fan of equi-sized rollback segments when using the legacy rollback segments. In this fashion, each undo segment is both the smallest and the largest. This is also why I avoid using “optimally” sized undo segments. If you shrink an undo segment that was forced to grow, you are throwing away a lot of undo that may be needed right after that. It discards the oldest undo data when it does this, minimizing the risk, but still the risk is there. I prefer to manually shrink undo segments during off-peak times if at all.

I am getting a little too deep into the DBA role at this point, so we'll move on to the next case. It's just important that you understand that the ORA-01555 error in this case is due to the system not being sized correctly for your workload. The only solution is to size correctly for your workload. It is not your fault, but it is your problem since you hit it. It's the same as if you run out of temporary space during a query. You either configure sufficient temporary space for the system, or you rewrite the queries so they use a plan that does not require temporary space.

To demonstrate this effect, we can set up a small, but somewhat artificial test. We'll create a very small undo tablespace with one session that will generate many small transactions, virtually assuring us that it will wrap around and reuse its allocated space many times—regardless of the `UNDO_RETENTION` setting, since we are not permitting the undo tablespace to grow. The session that uses this undo segment will be modifying a table, T. It will use a full scan of T and read it from “top” to “bottom.” In another session, we will execute a query that will read the table T via an index. In this fashion, it will read the table somewhat randomly: it will read row 1, then row 1,000, then row 500, then row 20,001, and so on. In this way, we will tend to visit blocks very randomly and perhaps many times during the processing of our query. The odds of getting an ORA-01555 error in this case are virtually 100 percent. So, in one session we start with the following:

```
EODA@ORA12CR1> create undo tablespace undo_small
 2 datafile '/tmp/undo.dbf' size 2m
 3 autoextend off
 4 /
Tablespace created.
```

```
EODA@ORA12CR1> alter system set undo_tablespace = undo_small;
System altered.
```

Now, we'll set up the table T to query and modify. Note that we are ordering the data randomly in this table. The CREATE TABLE AS SELECT tends to put the rows in the blocks in the order it fetches them from the query. We'll just scramble the rows up so they are not artificially sorted in any order, randomizing their distribution:

```
EODA@ORA12CR1> drop table t purge;
Table dropped.
```

```
EODA@ORA12CR1> create table t
  2 as
  3 select *
  4   from all_objects
  5   order by dbms_random.random;
Table created.
```

```
EODA@ORA12CR1> alter table t add constraint t_pk primary key(object_id);
Table altered.
```

```
EODA@ORA12CR1> exec dbms_stats.gather_table_stats( user, 'T', cascade=> true );
PL/SQL procedure successfully completed.
```

And now we are ready to do our modifications:

```
EODA@ORA12CR1> begin
  2   for x in ( select rowid rid from t )
  3   loop
  4       update t set object_name = lower(object_name) where rowid = x.rid;
  5       commit;
  6   end loop;
  7 end;
  8 /
```

Now, while that PL/SQL block of code is running, we will run a query in another session. That other query will read table T and process each record. It will spend about 1/100 of a second processing each record before fetching the next (simulated using DBMS\_LOCK.SLEEP(0.01)). We will use the FIRST\_ROWS hint in the query to have it use the index we created to read the rows out of the table via the index sorted by OBJECT\_ID. Since the data was randomly inserted into the table, we would tend to query blocks in the table rather randomly. This block will only run for a couple of seconds before failing:

```
EODA@ORA12CR1> declare
  2   cursor c is
  3   select /*+ first_rows */ object_name
  4     from t
  5     order by object_id;
  6
  7   l_object_name t.object_name%type;
  8   l_rowcnt      number := 0;
  9 begin
 10   open c;
 11   loop
 12       fetch c into l_object_name;
 13       exit when c%notfound;
 14       dbms_lock.sleep( 0.01 );
```

```

15         l_rowcnt := l_rowcnt+1;
16     end loop;
17     close c;
18 exception
19     when others then
20         dbms_output.put_line( 'rows fetched = ' || l_rowcnt );
21         raise;
22 end;
23 /
rows fetched = 159
declare
*
ERROR at line 1:
ORA-01555: snapshot too old: rollback segment number 16 with name
"_SYSSMU16_587457654$" too small
ORA-06512: at line 21

```

As you can see, it got to process only 159 records before failing with the ORA-01555: snapshot too old error. To correct this, we want to make sure two things are done:

- UNDO\_RETENTION is set in the database to be at least long enough for this read process to complete. That will allow the database to grow the undo tablespace to hold sufficient undo for us to complete.
- The undo tablespace is allowed to grow or you manually allocate more disk space to it.

For this example, I have determined my long-running process takes about 720 seconds to complete (I have about 72,000 records in the table, so at 0.01 seconds per row we have 720 seconds). My UNDO\_RETENTION is set to 900 (this is in seconds, so the undo retention is about 15 minutes). I altered the undo tablespace's data file to permit it to grow by 1MB at a time, up to 2GB in size:

```

EODA@ORA12CR1> alter database
 2 datafile '/tmp/undo.dbf'
 3 autoextend on
 4 next 1m
 5 maxsize 2048m;
Database altered.

```

When I ran the processes concurrently again, both ran to completion. The undo tablespace's data file grew this time, because it was allowed to and the undo retention I set up said to.

```

EODA@ORA12CR1> select bytes/1024/1024
 2 from dba_data_files
 3 where tablespace_name = 'UNDO_SMALL';

```

```

BYTES/1024/1024
-----

```

```

21

```

So, instead of receiving an error, we completed successfully, and the undo grew to be large enough to accommodate our needs. It is true that in this example, getting the error was purely due to the fact that we read the table T via the index and performed random reads all over the table. If we had rapidly full-scanned the table instead, there is a good chance we would not have received the ORA-01555 error *in this particular case*. This is because both the SELECT and UPDATE would have been full-scanning T, and the SELECT could most likely race ahead of the UPDATE during its scan (the SELECT just has to read, but the UPDATE must read and update and therefore could go slower). By doing the random reads, we increase the probability that the SELECT will need to read a block, which the UPDATE modified and committed many rows ago. This just demonstrates the somewhat insidious nature of the ORA-01555 error. Its occurrence depends on how concurrent sessions access and manipulate the underlying tables.

## Delayed Block Cleanout

This cause of the ORA-01555 error is hard to eliminate entirely, but it is rare anyway, as the circumstances under which it occurs do not happen frequently (at least not in Oracle8i and above anymore). We have already discussed the block cleanout mechanism, but to summarize, it is the process whereby the next session to access a block after it has been modified may have to check to see if the transaction that last modified the block is still active. Once the process determines that the transaction is not active, it cleans out the block so that the next session to access it does not have to go through the same process again. To clean out the block, Oracle determines the undo segment used for the previous transaction (from the block's header) and then determines whether the undo header indicates that the transaction has been committed and, if so, when it committed. This confirmation is accomplished in one of two ways. One way is that Oracle can determine that the transaction committed a long time ago, even though its transaction slot has been overwritten in the undo segment transaction table. The other way is that the COMMIT SCN is still in the transaction table of the undo segment, meaning the transaction committed a short time ago, and its transaction slot hasn't been overwritten.

To receive the ORA-01555 error from a delayed block cleanout, all of the following conditions must be met:

- A modification is made and COMMITed, and the blocks are not cleaned out automatically (e.g., the transaction modified more blocks than can fit in 10 percent of the SGA block buffer cache).
- These blocks are not touched by another session and will not be touched until our unfortunate query (displayed shortly) hits it.
- A long-running query begins. This query will ultimately read some of those blocks from earlier. This query starts at SCN  $t_1$ , the read-consistent SCN it must roll data back to in order to achieve read consistency. The transaction entry for the modification transaction is still in the undo segment transaction table when we begin.
- During the query, many commits are made in the system. These transactions don't touch the blocks in question (if they did, we wouldn't have the impending problem as they would clean out the old transaction—solving the clean-out issue).
- The transaction tables in the undo segments roll around and reuse slots due to the high degree of COMMITs. Most important, the transaction entry for the original modification transaction is cycled over and reused. In addition, the system has reused undo segment extents, preventing a consistent read on the undo segment header block itself.
- Additionally, the lowest SCN recorded in the undo segment now exceeds  $t_1$  (it is higher than the read-consistent SCN of the query), due to the large number of commits.

When our query gets to the block that was modified and committed before it began, it is in trouble. Normally, it would go to the undo segment pointed to by the block and find the status of the transaction that modified it (in other words, it would find the COMMIT SCN of that transaction). If the COMMIT SCN is less than  $t_1$ , our query can use this block. If the COMMIT SCN is greater than  $t_1$ , our query must roll back that block. The problem is, however, that our query is unable to determine in this particular case if the COMMIT SCN of the block is greater than or less than  $t_1$ . It is unsure as to whether it can use that block image or not. The ORA-01555 error then results.

To see this, we will create many blocks in a table that need to be cleaned out. We will then open a cursor on that table and allow many small transactions to take place against some other table—not the table we just updated and opened the cursor on. Finally, we will attempt to fetch the data for the cursor. Now, we *know* that the data required by the cursor will be “OK”—we should be able to see all of it since the modifications to the table would have taken place and been committed *before* we open the cursor. When we get an ORA-01555 error this time, it will be because of the previously described issue with delayed block cleanout. To set up for this example, we’ll use

- The 4MB UNDO\_SMALL undo tablespace.
- A 16MB buffer cache, which is enough to hold about 2,000 blocks. This is so we can get some dirty blocks flushed to disk to observe this phenomenon.

Before we start, we’ll create the undo tablespace and the “big” table we’ll be querying:

```
EODA@ORA12CR1> create undo tablespace undo_small
 2 datafile '/tmp/undo.dbf' size 4m
 3 autoextend off
 4 /
Tablespace created.
```

```
EODA@ORA12CR1> create table big
 2 as
 3 select a.*, rpad('*',1000, '*') data
 4 from all_objects a;
Table created.
```

```
EODA@ORA12CR1> alter table big add constraint big_pk
 2 primary key(object_id);
Table altered.
```

```
EODA@ORA12CR1> exec dbms_stats.gather_table_stats( user, 'BIG' );
PL/SQL procedure successfully completed.
```

---

■ **Note** You might wonder why I didn’t use `CASCADE=>TRUE` on the gather-statistics call to gather statistics on the index created by default by the primary key constraint. That is because since Oracle 10g, a `CREATE INDEX` or `ALTER INDEX REBUILD` has implicit compute statistics added to it already whenever the table it is indexing is not empty. So, the very act of creating the index has the side effect of gathering statistics on itself. There’s no need to regather the statistics we already have.

---

The previous table will have lots of blocks as we get about six or seven rows per block using that big data field, and my ALL\_OBJECTS table has over 70,000 rows. Next, we’ll create the small table the many little transactions will modify:

```
EODA@ORA12CR1> create table small ( x int, y char(500) );
Table created.
```

```
EODA@ORA12CR1> insert into small select rownum, 'x' from all_users;
25 rows created.
```

```
EODA@ORA12CR1> commit;
Commit complete.
```

```
EODA@ORA12CR1> exec dbms_stats.gather_table_stats( user, 'SMALL' );
PL/SQL procedure successfully completed.
```

Now, we'll dirty up that big table. We have a very small undo tablespace, so we'll want to update as many blocks of this big table as possible, all while generating the least amount of undo possible. We'll use a fancy UPDATE statement to do that. Basically, the following subquery is finding the "first" rowid of a row on every block. That subquery will return a rowid for every database block identifying a single row on it. We'll update that row, setting a VARCHAR2(1) field. This will let us update all of the blocks in the table (some 8,000 plus in the example), flooding the buffer cache with dirty blocks that will have to be written out (we have room for only 500 right now). We'll make sure we are using that small undo tablespace as well. To accomplish this and not exceed the capacity of our undo tablespace, we'll craft an UPDATE statement that will update just the "first row" on each block. The ROW\_NUMBER() built-in analytic function is instrumental in this operation; it assigns the number 1 to the "first row" by database block in the table, which would be the single row on the block we would update:

```
EODA@ORA12CR1> alter system set undo_tablespace = undo_small;
System altered.
```

```
EODA@ORA12CR1> update big
  2   set temporary = temporary
  3   where rowid in
  4   (
  5   select r
  6   from (
  7   select rowid r, row_number() over
  8   (partition by dbms_rowid.rowid_block_number(rowid) order by rowid) rn
  9   from big
 10   )
 11  where rn = 1
 12  )
 13 /
3064 rows updated.
```

```
EODA@ORA12CR1> commit;
Commit complete.
```

OK, so now we know that we have lots of dirty blocks on disk. We definitely wrote some of them out, because we just didn't have the room to hold them all. Next, we will open a cursor, but it won't yet fetch a single row. Remember, when we open the cursor, the resultset is preordained, so even though Oracle did not actually process a row of data, the act of opening that resultset fixed the point in time the results must be "as of." Now since we'll be fetching the data we just updated and committed, and we know no one else is modifying the data, we should be able to retrieve the rows without needing any undo at all. But that's where the delayed block cleanout rears its head. The transaction that modified these blocks is so new that Oracle will be obliged to verify that it committed before we begin, and if we overwrite that information (also stored in the undo tablespace), the query will fail. So, here is the opening of the cursor:

```
EODA@ORA12CR1> variable x refcursor
EODA@ORA12CR1> exec open :x for select * from big where object_id < 100;
PL/SQL procedure successfully completed.
```

```
EODA@ORA12CR1>
EODA@ORA12CR1> !./run.sh
```

`run.sh` is a shell script; it simply fired off nine SQL\*Plus sessions using a command:

```
$ORACLE_HOME/bin/sqlplus eoda/foo @test2 1 &
$ORACLE_HOME/bin/sqlplus eoda/foo @test2 2 &
... (3-8 would go here )...
$ORACLE_HOME/bin/sqlplus eoda/foo @test2 9 &
```

where each SQL\*Plus session was passed a different number (that was number 1; there was a 2, 3, and so on). In the prior script, ensure you replace the `eoda/foo` with the username and password for your environment. The script `test2.sql` they each ran is as follows:

```
begin
  for i in 1 .. 5000
  loop
    update small set y = i where x= &1;
    commit;
  end loop;
end;
/
exit
```

---

■ **Note** All of the scripts used in this example are available for download from the Apress web site for this book. In the `ch09` folder, the `demo11.sql` script automates this example.

---

So, we had nine sessions inside of a tight loop initiate many transactions. The `run.sh` script waited for the nine SQL\*Plus sessions to complete their work, and then we returned to our session, the one with the open cursor. Upon attempting to print it out, we observe the following:

```
EODA@ORA12CR1> print x
ERROR:
ORA-01555: snapshot too old: rollback segment number 17 with name
"_SYSSMU17_452567810$" too small
no rows selected
```

As I said, the preceding is a rare case. It took a lot of conditions, all of which must exist simultaneously to occur. We needed blocks that were in need of a cleanout to exist, and these blocks are rare in Oracle8i and above. A `DBMS_STATS` call to collect statistics gets rid of them so the most common causes—large mass updates and bulk loads—should not be a concern, since the tables need to be analyzed after such operations anyway. Most transactions tend to touch less than 10 percent of the blocks in the buffer cache; hence, they do not generate blocks that need to be cleaned out. If you believe you’ve encountered this issue, in which a `SELECT` against a table that has no other DML applied to it is raising the `ORA-01555` error, try the following solutions:

- Ensure you are using “right-sized” transactions in the first place. Make sure you are not committing more frequently than you should.
- Use `DBMS_STATS` to scan the related objects, cleaning them out after the load. Since the block cleanout is the result of a very large mass `UPDATE` or `INSERT`, this needs to be done anyway.

- Allow the undo tablespace to grow by giving it the room to extend and increasing the undo retention. This decreases the likelihood of an undo segment transaction table slot being overwritten during the course of your long-running query. This is the same as the solution for the other cause of an ORA-01555 error (the two are very much related; you experience undo segment reuse during the processing of your query). In fact, I reran the preceding example with the undo tablespace set to autoextend 1MB at a time, with an undo retention of 900 seconds. The query against the table BIG completed successfully.
- Reduce the runtime of your query—tune it. This is always good if possible, so it might be the first thing you try.

## Summary

In this chapter, we explored redo and undo and took a look at what they mean to the developer. I've mostly presented here situations or conditions you should be on the lookout for, since it is actually the DBAs or SAs who must correct these issues. The key point to take away from this chapter is the importance of redo and undo, and the fact that they are not overhead—they are integral components of the database and are necessary and mandatory. Once you have a good understanding of how they work and what they do, you'll be able to make better use of them. Understanding that you are not "saving" anything by committing more frequently than you should (you are actually wasting resources, as it takes more CPU, more disk, and more programming) is probably the most important point of all. Be aware of what the database needs to do, and then let the database do it.





# Database Tables

In this chapter, we will discuss the various types of database tables and cover when you might want to use each type (i.e., when one type of table is more appropriate than another). We will concentrate on the physical storage characteristics of the tables: how the data is organized and stored.

Once upon a time, there was only one type of table, really: a *normal* table. It was managed in the same way a *heap of stuff* is managed (the definition of which appears in the next section). Over time, Oracle added more sophisticated types of tables. Now, in addition to the heap organized table, there are clustered tables (three types of those), index organized tables, nested tables, temporary tables, external tables, and object tables. Each type of table has different characteristics that make it suitable for use in different application areas.

## Types of Tables

We will define each type of table before getting into the details. There are nine major types of tables in Oracle, as follows:

- *Heap organized tables*: These are normal, standard database tables. Data is managed in a heap-like fashion. As data is added, the first free space found in the segment that can fit the data will be used. As data is removed from the table, it allows space to become available for reuse by subsequent INSERTs and UPDATEs. This is the origin of the name “heap” as it refers to this type of table. A *heap* is a bunch of space, and it is used in a somewhat random fashion.
- *Index organized tables*: These tables are stored in an index structure. This imposes physical order on the rows themselves. Whereas in a heap the data is stuffed wherever it might fit, in index-organized tables (IOTs) the data is stored in sorted order, according to the primary key.
- *Index clustered tables*: *Clusters* are groups of one or more tables, physically stored on the same database blocks, with all rows that share a common cluster key value being stored physically near each other. Two goals are achieved in this structure. First, many tables may be stored physically joined together. Normally, you would expect data from only one table to be found on a database block, but with clustered tables, data from many tables may be stored on the same block. Second, all data that contains the same cluster key value, such as `DEPTNO = 10`, will be physically stored together. The data is clustered around the cluster key value. A cluster key is built using a B\*Tree index. The advantage to index clustered tables is that disk I/O is reduced and query performance is improved when accessing tables that are frequently joined on the cluster key.
- *Hash clustered tables*: These tables are similar to index clustered tables, but instead of using a B\*Tree index to locate the data by cluster key, the hash cluster hashes the key to the cluster to arrive at the database block the data should be on. In a hash cluster, the data is the index (metaphorically speaking). These tables are appropriate for data that is read frequently via an equality comparison on the key.

- *Sorted hash clustered tables:* This table type was introduced in Oracle 10g and combines some aspects of a hash-clustered table with those of an IOT. The concept is as follows: you have some key value that rows will be hashed by (say, CUSTOMER\_ID), and then a series of records related to that key that arrive in sorted order (timestamp-based records) and are processed in that sorted order. For example, a customer places orders in your order entry system, and these orders are retrieved and processed in a first in, first out (FIFO) manner. In such a system, a sorted hash cluster may be the right data structure for you.
- *Nested tables:* These are part of the object-relational extensions to Oracle. They are simply system-generated and maintained child tables in a parent/child relationship. They work much in the same way as EMP and DEPT in the SCOTT schema with the EMP table being the nested table. EMP is considered to be a child of the DEPT table, since the EMP table has a foreign key—DEPTNO—that points to DEPT. The main difference is that they are not stand-alone heap organized tables.
- *Temporary tables:* These tables store scratch data for the life of a transaction or the life of a session. These tables allocate temporary extents, as needed, from the current user's temporary tablespace. Each session will see only the extents that session allocates; it will never see any of the data created in any other session. Temporary tables allow you to temporarily persist data with the benefit of generating much less redo (and less undo as of Oracle 12c) than a regular heap organized table (see Chapter 9 for a complete discussion on the redo and undo behavior of temporary tables).
- *Object tables:* These tables are created based on an object type. They have special attributes not associated with nonobject tables, such as a system-generated REF (object identifier) for each row. Object tables are really special cases of heap, index organized, and temporary tables, and they may include nested tables as part of their structure as well.
- *External tables:* The data in these tables are not stored in the database itself; rather, they reside outside of the database in ordinary operating system files (with the columns of data in the file usually demarcated by a delimiter or position). External tables in Oracle9i and above give you the ability to query a file residing outside the database as if it were a normal heap organized table inside the database. They are most useful as a means of getting data into the database (they are a very powerful data-loading tool). Furthermore, as of Oracle 10g, introduced an external table unload capability, they provide an easy way to move data between Oracle databases without using database links. We will look at external tables in some detail in Chapter 15.

Here is some general information about tables, regardless of their type:

- A table can have up to 1,000 columns, although I recommend against a design that does contain the maximum number of columns, unless there is some pressing need. Tables are most efficient with far fewer than 1,000 columns. Oracle will internally store a row with more than 254 columns in separate row pieces that point to each other and must be reassembled to produce the entire row image.
- A table can have a virtually unlimited number of rows, although you will hit other limits that prevent this from happening. For example, typically a tablespace can have at most 1,022 files (although there are BIGFILE tablespaces in Oracle 10g and above that will get you beyond these file size limits, too). Say you have a typical tablespace and are using files that are 32GB in size—that is to say, 32,704GB (1,022 files times 32GB) in total size. This would be 2,143,289,344 blocks, each of which is 16KB in size. You might be able to fit 160 rows of between 80 to 100 bytes per block. This would give you 342,926,295,040 rows. If you partition the table, though, you can easily multiply this number many times. For example, consider a table with 1,024 hash partitions—that would be 1024 \* 342,926,295,040 rows. There are limits, but you'll hit other practical limitations before even coming close to having three hundred fifty-one trillion, one hundred fifty-six billion, five hundred twenty-six million, one hundred twenty thousand, nine hundred sixty rows in a table.

- A table can have as many indexes as there are permutations of columns (and permutations of functions on those columns and permutations of any unique expression you can dream of). With the advent of function-based indexes, the true number of indexes you could create theoretically becomes infinite! Once again, however, practical restrictions, such as overall performance (every index you add will add overhead to an INSERT into that table) will limit the actual number of indexes you will create and maintain.
- There is no limit to the number of tables you may have, even within a single database. Yet again, practical limits will keep this number within reasonable bounds. You will not have millions of tables (as this many is impractical to create and manage), but you may have thousands of tables.

In the next section, we'll look at some of the parameters and terminology relevant to tables. After that, we'll jump into a discussion of the basic heap-organized table and then move on to examine the other types.

## Terminology

In this section, we will cover the various storage parameters and terminology associated with tables. Not all parameters are used for every table type. For example, the PCTUSED parameter is not meaningful in the context of an IOT (the reason for this will become obvious in Chapter 11). We'll cover the relevant parameters as part of the discussion of each individual table type. The goal is to introduce the terms and define them. As appropriate, more information on using specific parameters is covered in subsequent sections.

## Segment

A *segment* in Oracle is an object that consumes storage on disk. While there are many segment types, the most popular are as follows:

- *Cluster*: This segment type is capable of storing tables. There are two types of clusters: B\*Tree and hash. Clusters are commonly used to store related data from multiple tables prejoined on the same database block and to store related information from a single table together. The name “cluster” refers to this segment’s ability to cluster related information physically together.
- *Table*: A table segment holds data for a database table and is perhaps the most common segment type used in conjunction with an index segment.
- *Table partition or subpartition*: This segment type is used in partitioning and is very similar to a table segment. A table partition or subpartition segment holds just a slice of the data from a table. A partitioned table is made up of one or more table partition segments, and a composite partitioned table is made up of one or more table subpartition segments.
- *Index*: This segment type holds an index structure.
- *Index partition*: Similar to a table partition, this segment type contains some slice of an index. A partitioned index consists of one or more index partition segments.
- *Lob partition, lob subpartition, lobindex, and lobsegment*: The lobindex and lobsegment segments hold the structure of a *large object*, or *LOB*. When a table containing a LOB is partitioned, the lobsegment will be partitioned as well—the lob partition segment is used for that. It is interesting to note that there is not a lobindex partition segment type—for whatever reason, Oracle marks the partitioned lob index as an index partition (one wonders why a lobindex is given a special name). LOBs are discussed in full detail in Chapter 12.

- *Nested table*: This is the segment type assigned to nested tables, a special kind of child table in a master/detail relationship that we'll discuss later.
- *Rollback and Type2 undo*: This is where undo data is stored. Rollback segments are those manually created by the DBA. Type2 undo segments are automatically created and managed by Oracle.

So, for example, a table *may be* a segment. An index *may be* a segment. I stress the words “may be” because we can partition an index into separate segments. So, the index object itself would just be a definition, not a physical segment—and the index would be made up of many index partitions, and each *index partition* would be a segment. A table may be a segment or not. For the same reason, we might have many table segments due to partitioning, or we might create a table in a segment called a *cluster*. Here the table will reside, perhaps with other tables in the same cluster segment.

The most common case, however, is that a table will be a segment and an index will be a segment. This is the easiest way to think of it for now. When you create a table, you are normally creating a new table segment and, as discussed in Chapter 3, that segment consists of extents, and extents consist of blocks. This is the normal storage hierarchy. But it is important to note that only the common case has this one-to-one relationship. For example, consider this simple CREATE TABLE statement:

```
EODA@ORA12CR1> create table t ( x int primary key, y clob, z blob );
```

This statement creates six segments, assuming Oracle 11g Release 1 and before; in Oracle 11g Release 2 and above, segment creation is deferred until the first row is inserted by default (we'll use syntax to have the segments created immediately below). If you issue this CREATE TABLE statement in a schema that owns nothing, you'll observe the following:

```
EODA@ORA12CR1> select segment_name, segment_type from user_segments;
```

no rows selected

```
EODA@ORA12CR1> create table t
 2 ( x int primary key,
 3   y clob,
 4   z blob )
 5 SEGMENT CREATION IMMEDIATE
 6 /
```

Table created.

```
EODA@ORA12CR1> select segment_name, segment_type from user_segments;
```

SEGMENT_NAME	SEGMENT_TYPE
T	TABLE
SYS_LOB0000021096C00003\$\$	LOBSEGMENT
SYS_LOB0000021096C00002\$\$	LOBSEGMENT
SYS_IL0000021096C00003\$\$	LOBINDEX
SYS_IL0000021096C00002\$\$	LOBINDEX
SYS_C005958	INDEX

6 rows selected.

The table itself created a segment in this example: the first row in the output. Also, the primary key constraint created an index segment in this case in order to enforce uniqueness.

---

■ **Note** A unique or primary key constraint may or may not create a new index. If there is an existing index on the constrained columns, and these columns are on the leading edge of the index, the constraint can and will use them.

---

Additionally, each of the LOB columns created two segments: one segment to store the actual chunks of data pointed to by the character large object (CLOB) or binary large object (BLOB) pointer, and one segment to organize them. LOBs provide support for very large chunks of information, up to many gigabytes in size. They are stored in chunks in the lobsegment, and the lobindex is used to keep track of where the LOB chunks are and the order in which they should be accessed.

Note that on line 5 of the CREATE TABLE statement I used syntax specific to Oracle 11g Release 2 and above—the SEGMENT CREATION IMMEDIATE clause. If you attempt to use that syntax in earlier releases you will receive:

```
ops$tkyte%ORA11GR1> Create table t
 2 ( x int primary key,
 3   y clob,
 4   z blob )
 5 SEGMENT CREATION IMMEDIATE
 6 /
SEGMENT CREATION IMMEDIATE
*
ERROR at line 5:
ORA-00922: missing or invalid option
```

---

■ **Note** The deferred segment creation feature is available only in the Enterprise Edition of Oracle. If you work in an environment that has a mixture of Enterprise Edition and Standard Edition databases, then be careful when exporting objects from an EE database to an SE database. If you attempt to export objects that have no segments created or attempt to import into an SE database, you may receive this error : ORA-00439 feature not enabled. One workaround for this is to initially create the tables in the EE database with SEGMENT CREATION IMMEDIATE. See MOS note 1087325.1 for further details.

---

## Segment Space Management

Starting with Oracle9i, there are two methods for managing space in segments:

- *Manual Segment Space Management*: You set various parameters such as FREELISTS, FREELIST GROUPS, PCTUSED, and others to control how space is allocated, used, and reused in a segment over time. I will refer to this space management method in this chapter as *MSSM*, but bear in mind that that is a made-up abbreviation that you will not find widely in the Oracle documentation.
- *Automatic Segment Space Management (ASSM)*: You control one parameter relating to how space is used: PCTFREE. The others are accepted when the segment is created, but they are ignored.

MSSM is the legacy implementation in Oracle. It has been around for many years, over many versions. ASSM was first introduced in Oracle9i Release 1 and its design intention was to eliminate the need to fine tune the myriad parameters used to control space allocation and provide high concurrency. For example, by having the FREELISTS parameter set to the default of 1, you might find that your insert/update intensive segments may be suffering from contention on free space allocation. When Oracle goes to insert a row into a table, update an index key entry, or update a row causing the row to migrate (more on that in a moment), it may need to get a block from the list of free blocks associated with the segment. If there is only one list, only one transaction at a time may review and modify this list—they would have to wait for each other. Multiple FREELISTS and FREELIST GROUPS serve the purpose of increasing concurrency in such a case, as the transactions may each be looking at different lists and not contending with each other.

When I discuss the storage settings shortly, I will mention which are for manual and which are for automatic segment space management, but in the area of storage/segment characteristics, the only storage settings that apply to ASSM segments are as follows:

- BUFFER\_POOL
- PCTFREE
- INITRANS
- MAXTRANS (only in 9i; in 10g and above this is ignored for all segments)

The remaining storage and physical attribute parameters do not apply to ASSM segments.

Segment space management is an attribute inherited from the tablespace in which a segment is contained (and segments never span tablespaces). For a segment to use ASSM, it would have to reside in a tablespace that supported that method of space management.

## High-water Mark

This is a term used with table segments stored in the database. If you envision a table, for example, as a flat structure or as a series of blocks laid one after the other in a line from left to right, the *high-water mark (HWM)* would be the rightmost block that ever contained data, as illustrated in Figure 10-1.

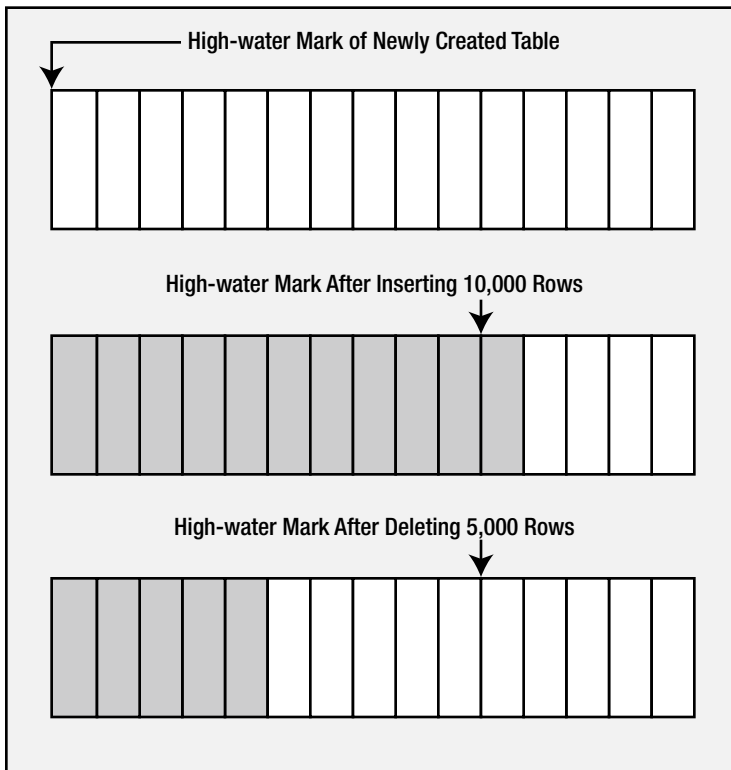

**Figure 10-1.** Depiction of an HWM

Figure 10-1 shows that the HWM starts at the first block of a newly created table. As data is placed into the table over time and more blocks get used, the HWM rises. If we delete some (or even *all*) of the rows in the table, we might have many blocks that no longer contain data, but they are still *under* the HWM, and they will remain under the HWM until the object is rebuilt, truncated, or shrunk (shrinking of a segment is a feature introduced in Oracle 10g that is supported only if the segment is in an ASSM tablespace).

The HWM is relevant since Oracle will scan all blocks under the HWM, even when they contain *no* data, during a full scan. This will impact the performance of a full scan—especially if most of the blocks under the HWM are empty. To see this, just create a table with 1,000,000 rows (or create any table with a large number of rows), and then execute a `SELECT COUNT(*)` from this table. Now, `DELETE` every row in the table and you will find that the `SELECT COUNT(*)` takes just as long to count 0 rows as it did to count 1,000,000 (or longer, depending on if you need to clean out the block, refer to the “Block Cleanout” section of Chapter 9). This is because Oracle is busy reading all of the blocks below the HWM to see if they contain data. You should compare this to what happens if you used `TRUNCATE` on the table instead of deleting each individual row. `TRUNCATE` will reset the HWM of a table back to zero and will truncate the associated indexes on the table as well. If you plan on deleting every row in a table, `TRUNCATE`—if it can be used—would be the method of choice for this reason.

---

■ **Caution** Keep in mind that a `TRUNCATE` statement cannot be rolled back, nor will any triggers fire (if they exist) on the table. Therefore, before truncating, ensure you permanently want to remove the data since it can’t be undone.

---

In an MSSM tablespace, segments have a definite HWM. In an ASSM tablespace, however, there is an HWM *and* a low HWM. In MSSM, when the HWM is advanced (e.g., as rows are inserted), all of the blocks are formatted and valid, and Oracle can read them safely. With ASSM, however, when the HWM is advanced Oracle doesn't format *all* of the blocks immediately—they are only formatted and made safe to read upon their first actual use. The first actual use will be when the database decides to insert a record into a given block. Under ASSM, the data is inserted in any of the blocks between the low HWM) and the HWM, so many of the blocks between these two points might not be formatted. The low HWM is defined to be the point below which all blocks are formatted (because they currently contain data or previously contained data).

So, when full scanning a segment, we have to know if the blocks to be read are safe or unformatted (meaning they contain nothing of interest and we do not process them). To make it so that not every block in the table needs go through this safe/not safe check, Oracle maintains a low HWM and a HWM. Oracle will full scan the table up to the HWM—and for all of the blocks below the low HWM, it will just read and process them. For blocks between the low HWM and the HWM (see Figure 10-2), it must be more careful and refer to the ASSM bitmap information used to manage these blocks in order to see which of them it should read and which it should just ignore.

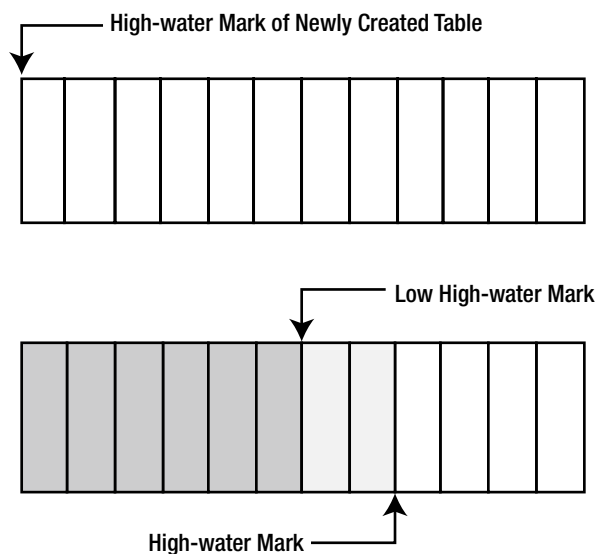

**Figure 10-2.** Depiction of a low HWM

## FREELISTS

When you use an MSSM tablespace, the FREELIST is where Oracle keeps track of blocks under the HWM for objects that have free space on them.

---

■ **Note** FREELISTS and FREELIST GROUPS do not pertain to ASSM tablespaces at all; only MSSM tablespaces use this technique.

---



Each object will have at least one FREELIST associated with it, and as blocks are used, they will be placed on or taken off of the FREELIST as needed. It is important to note that only blocks under the HWM of an object will be found on the FREELIST. The blocks that remain above the HWM will be used only when the FREELISTS are empty, at which point Oracle advances the HWM and adds these blocks to the FREELIST. In this fashion, Oracle postpones increasing the HWM for an object until it has to.

An object may have more than one FREELIST. If you anticipate heavy INSERT or UPDATE activity on an object by many concurrent users, then configuring more than one FREELIST can have a major positive impact on performance (at the cost of possible additional storage). Having sufficient FREELISTS for your needs is crucial.

FREELISTS can be a huge positive performance influence (or inhibitor) in an environment with many concurrent inserts and updates. An extremely simple test can show the benefits of setting FREELISTS correctly. First create a tablespace that uses MSSM. You must specify the `SEGMENT SPACE MANAGEMENT MANUAL` clause. This example creates an MSSM tablespace (named `mssm`) and then creates a table named `T` within that tablespace:

```
EODA@ORA12CR1> create tablespace mssm
 2 datafile size 1m autoextend on next 1m
 3 segment space management manual;
```

Tablespace created.

Now consider this relatively simple table:

```
EODA@ORA12CR1> create table t ( x int, y char(50) ) tablespace mssm;
Table created.
```

---

■ **Note** `mssm` in the preceding example is the name of a tablespace, not a keyword. You may replace it with the name of any tablespace you have that uses manual segment space management.

---

Using five concurrent sessions, we start inserting into this table like wild. If we measure the system-wide wait events for block-related waits both before and after inserting, we will find large waits, especially on data blocks (trying to insert data). This is frequently caused by insufficient FREELISTS on tables (and on indexes, but we'll cover that in detail in the next chapter "Indexes"). I used Statspack for this—I took a `statspack.snap`, executed a script that started the five concurrent SQL\*Plus sessions, and waited for them to exit, before taking another `statspack.snap`. The script these sessions ran was simply:

```
begin
  for i in 1 .. 1000000
  loop
    insert into t values ( i, 'x' );
  end loop;
  commit;
end;
/
exit;
```

Now, this is a very simple block of code, and I'm the only user in the database here. I should get the best possible performance. I have plenty of buffer cache configured, my redo logs are sized appropriately, indexes won't be slowing things down, I'm running on a machine with two hyperthreaded Xeon CPUs—this should run fast. What I discovered afterward, however, is the following:

```

Snapshot          Snap Id    Snap Time          Sessions Curs/Sess Comment
~~~~~
Begin Snap:      195 27-Jan-14 11:58:12      36      1.0
End Snap:       196 27-Jan-14 11:58:23      36      1.0
Elapsed:        0.18 (mins) Av Act Sess:    4.7
DB time:        0.87 (mins)      DB CPU:    0.31 (mins)
...
Top 5 Timed Events
~~~~~
Event                               Waits    Time (s)    Avg %Total
                                         wait    Call
                                         (ms)    Time
-----
AQPC idle                            1         30    30009    23.3
buffer busy waits                    51,262    28         1    21.5
LGWR worker group idle                599       20         33    15.5
CPU time                              18         18         14.2
lreg timer                            4         12    3000     9.3
-----

```

I collectively waited 28 seconds, or a little less than 6 seconds per session on average, on `buffer busy waits`. These waits are caused entirely by the fact that there are not enough `FREELISTS` configured on my table for the type of concurrent activity that is taking place. I can eliminate most of that wait time easily, just by creating the table with multiple `FREELISTS`

```

EODA@ORA12CR1> create table t ( x int, y char(50) )
  2 storage ( freelists 5 ) tablespace MSSM;
Table created.

```

or by altering the object

```

EODA@ORA12CR1> alter table t storage ( FREELISTS 5 );
Table altered.

```

You will find that the `buffer busy waits` goes way down, and the amount of CPU needed (since you are doing less work here; competing for a latched data structure can really burn CPU) also goes down along with the elapsed time:

```

Snapshot          Snap Id    Snap Time          Sessions Curs/Sess Comment
~~~~~
Begin Snap:      197 27-Jan-14 12:07:05      36      1.0
End Snap:       198 27-Jan-14 12:07:14      36      1.0
Elapsed:        0.15 (mins) Av Act Sess:    4.2
DB time:        0.64 (mins)      DB CPU:    0.25 (mins)
...

```

Top 5 Timed Events		Avg %Total		
Event	Waits	Time (s)	wait (ms)	Call Time
LGWR worker group idle	346	279	806	85.9
CPU time		15		4.5
log file parallel write	344	9	27	2.9
lreg timer	3	9	3000	2.8
heartbeat redo informer	8	8	1000	2.5

What you want to do for a table is try to determine the maximum number of concurrent (truly concurrent) inserts or updates that will require more space. What I mean by *truly concurrent* is how often you expect two people at exactly the same instant to request a free block for that table. This is not a measure of overlapping transactions; it is a measure of how many sessions are doing inserts at the same time, regardless of transaction boundaries. You want to have about as many FREELISTS as concurrent inserts into the table to increase concurrency.

You should just set FREELISTS really high and then not worry about it, right? Wrong—of course, that would be too easy. When you use multiple FREELISTS, there is a master FREELIST and there are process FREELISTS. If a segment has a single FREELIST, then the master and process FREELISTS are one and the same thing. If you have two FREELISTS, you'll really have one master FREELIST and two process FREELISTS. A given session will be assigned to a single process FREELIST based on a hash of its session ID. Now, each process FREELIST will have very few blocks on it—the remaining free blocks are on the master FREELIST. As a process FREELIST is used, it will pull a few blocks from the master FREELIST as needed. If the master FREELIST cannot satisfy the space requirement, then Oracle will advance the HWM and add empty blocks to the master FREELIST. So, over time, the master FREELIST will fan out its storage over the many process FREELISTS (again, each of which has only a few blocks on it). So, each process will use a single process FREELIST. It will not go from process FREELIST to process FREELIST to find space. This means that if you have ten process FREELISTS on a table and the one your process is using exhausts the free buffers on its list, it will not go to another process FREELIST for space—so even if the other nine process FREELISTS have five blocks each (45 blocks in total), it will go to the master FREELIST. Assuming the master FREELIST cannot satisfy the request for a free block, it would cause the table to advance the HWM or, if the table's HWM cannot be advanced (all the space is used), to extend (to get another extent). It will then continue to use the space on its FREELIST only (which is no longer empty). There is a tradeoff to be made with multiple FREELISTS. On one hand, use of multiple FREELISTS is a huge performance booster. On the other hand, it will probably cause the table to use slightly more disk space than absolutely necessary. You will have to decide which is less bothersome in your environment.

Do not underestimate the usefulness of the FREELISTS parameter, especially since you can alter it up and down at will with Oracle 8.1.6 and later. What you might do is alter it to a large number to perform some load of data in parallel with the conventional path mode of SQL\*Loader. You will achieve a high degree of concurrency for the load with minimum waits. After the load, you can reduce the value to some more reasonable day-to-day number. The blocks on the many existing FREELISTS will be merged into the one master FREELIST when you alter the space down.

Another way to solve the previously mentioned issue of buffer busy waits is to use an ASSM managed tablespace. Take the preceding example and create the table T in an ASSM managed tablespace, as follows:

```
EODA@ORA12CR1> create tablespace assm
  2 datafile size 1m autoextend on next 1m
  3 segment space management auto;
Tablespace created.
```

```
EODA@ORA12CR1> create table t ( x int, y char(50) ) tablespace ASSM;
Table created.
```

You'll find the buffer busy waits, CPU time, and elapsed time to have decreased for this case as well, similar to when we configured the perfect number of FREELISTS for a segment using MSSM—without having to figure out the optimum number of required FREELISTS:

```

Snapshot          Snap Id    Snap Time          Sessions Curs/Sess Comment
-----
Begin Snap:      199 27-Jan-14 12:16:30      33      1.0
End Snap:        200 27-Jan-14 12:16:37      33      1.0
Elapsed:         0.12 (mins) Av Act Sess:    5.3
DB time:         0.62 (mins)   DB CPU:         0.25 (mins)
...
Top 5 Timed Events                               Avg %Total
-----
Event                                             Waits    Time (s)    wait Call
                                                (ms)    Time
-----
LGWR worker group idle                          341         562    1647    92.9
CPU time                                         15          15         2.4
log file parallel write                         341         10         29     1.6
heartbeat redo informer                          8           8     1000    1.3
lreg timer                                       2           6     3000    1.0
-----

```

This is one of ASSM's main purposes: to remove the need to manually determine the correct settings for many key storage parameters. ASSM uses additional space when compared to MSSM in some cases as it attempts to spread inserts out over many blocks, but in most all cases, the nominal extra storage utilized is far outweighed by the decrease in concurrency issues. An environment where storage utilization is crucial and concurrency is not (a data warehouse pops into mind) would not necessarily benefit from ASSM managed storage for that reason.

## PCTFREE and PCTUSED

In general, the PCTFREE parameter tells Oracle how much space should be reserved on a block for future updates. By default, this is 10 percent. If there is a higher percentage of free space than the value specified in PCTFREE, then the block is considered to be *free*. PCTUSED tells Oracle the percentage of free space that needs to be present on a block that is not currently free in order for it to become free again. The default value is 40 percent.

As noted earlier, when used with a table (but not an IOT, as we'll see), PCTFREE tells Oracle how much space should be reserved on a block for future updates. This means if we use an 8KB block size, as soon as the addition of a new row onto a block causes the free space on the block to drop below about 800 bytes, Oracle will use another block from the FREELIST instead of the existing block. This 10 percent of the data space on the block is set aside for updates to the rows on that block.

---

■ **Note** PCTFREE and PCTUSED are implemented differently for different table types. Some table types employ both, whereas others only use PCTFREE, and even then only when the object is created. IOTs use PCTFREE upon creation to set aside space in the table for future updates, but do not use PCTFREE to decide when to stop inserting rows into a given block, for example.

---

The exact effect of these two parameters varies depending on whether you are using ASSM or MSSM tablespaces. When you are using MSSM, these parameter settings control when the block will be put on and taken off the FREELIST. If you are using the default values for PCTFREE (10) and PCTUSED (40), then a block will remain on the FREELIST until it is 90 percent full (10 percent free space). Once it hits 90 percent, it will be taken off the FREELIST and remain off the FREELIST until the free space on the block exceeds 60 percent of the block.

When you are using ASSM, PCTFREE still limits if a new row may be inserted into a block, but it does not control whether a block is on a FREELIST or not, as ASSM does not use FREELISTS at all. In ASSM, PCTUSED is simply ignored.

There are three settings for PCTFREE: too high, too low, and just about right. If you set PCTFREE for blocks too high, you will waste space. If you set PCTFREE to 50 percent and you never update the data, you have just wasted 50 percent of every block. On another table, however, 50 percent may be very reasonable. If the rows start out small and tend to double in size, setting PCTFREE too small will cause row migration as you update the rows.

## Row Migration

What is row migration? *Row migration* is when a row is forced to leave the block it was created on because it grew too large to fit on that block with the rest of the rows. To illustrate row migration, we start with a block that looks like Figure 10-3.

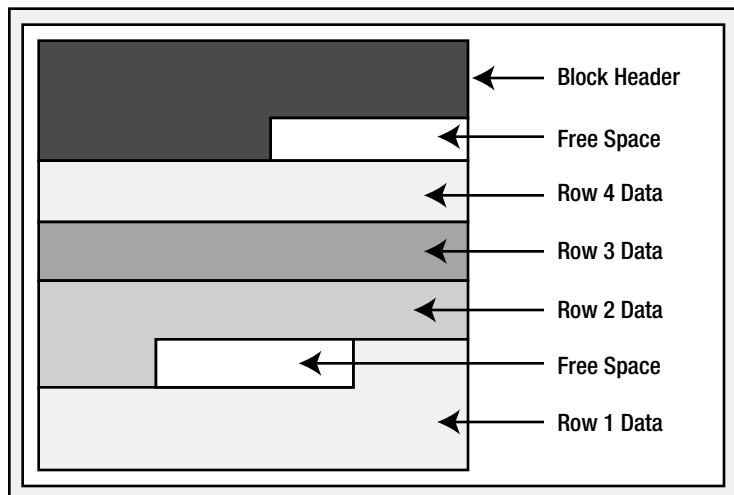

**Figure 10-3.** Data block before update

Approximately one-seventh of the block is free space. However, we would like to more than double the amount of space used by row 4 via an UPDATE (it currently consumes one-seventh of the block). In this case, even if Oracle coalesced the space on the block as shown in Figure 10-4, there is still insufficient room to double the size of row 4, because the size of the free space is less than the current size of row 4.

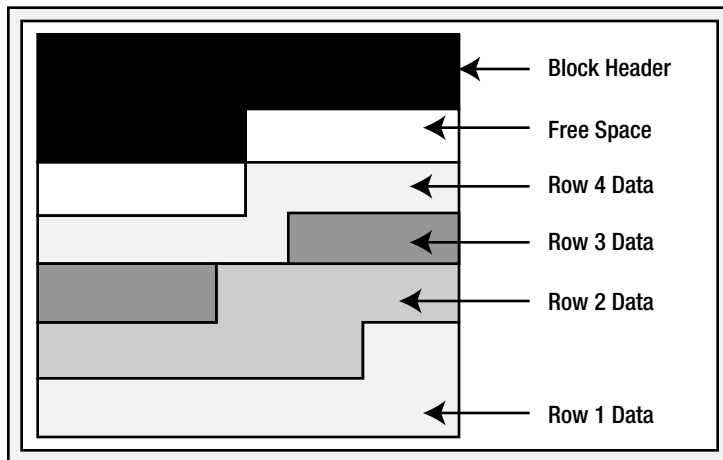

**Figure 10-4.** Data block as it would appear after coalescing free space

If the row fit into the coalesced space, it would have happened. This time, however, Oracle will not perform this coalescing and the block will remain as it is. Since row 4 would have to span more than one block if it stayed on this block, Oracle will move, or migrate, the row. However, Oracle cannot just move the row; it must leave behind a forwarding address. There may be indexes that physically point to this address for row 4. A simple update will not modify the indexes as well.

---

■ **Note** There is a special case with partitioned tables that a rowid, the address of a row, will change. We will look at this case in Chapter 13. Additionally, other administrative operations such as `FLASHBACK TABLE` and `ALTER TABLE SHRINK` may change rowids assigned to rows as well.

---

Therefore, when Oracle migrates the row, it will leave behind a pointer to where the row really is. After the update, the blocks might look as shown in Figure 10-5.

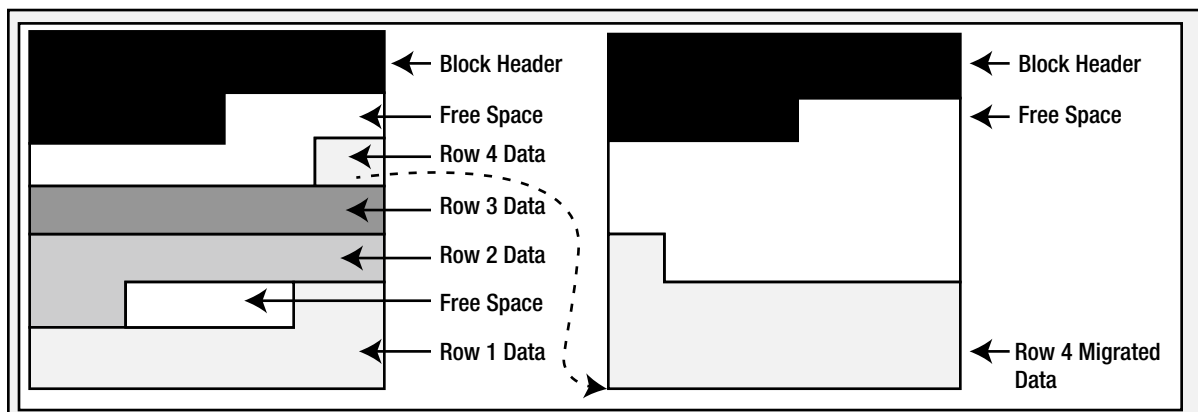

**Figure 10-5.** Migrated row depiction

So, a *migrated row* is a row that had to move from the block it was inserted into onto some other block. Why is this an issue? Your application will never know; the SQL you use is no different. It only matters for performance reasons. If you go to read this row via an index, the index will point to the original block. That block will point to the new block. Instead of doing the two or so I/Os to read the index plus one I/O to read the table, you'll need to do yet one more I/O to get to the actual row data. In isolation, this is no big deal—you won't even notice it. However, when you have a sizable percentage of your rows in this state, with many users accessing them, you'll begin to notice this side effect. Access to this data will start to slow down (additional I/Os and the associated latching that goes with the I/O add to the access time), your buffer cache efficiency goes down (you need to buffer two blocks instead of just the one you would if the rows were not migrated), and your table grows in size and complexity. For these reasons, you generally do not want migrated rows (but do not lose sleep if a couple hundred/thousand rows in a table of thousands or more rows are migrated).

It is interesting to note what Oracle will do if the row that was migrated from the block on the left to the block on the right in Figure 10-5 has to migrate *again* at some future point in time. This would be due to other rows being added to the block it was migrated to and then updating this row to make it even larger. Oracle will actually migrate the row *back* to the original block and, if there is sufficient space, leave it there (the row might become *unmigrated*). If there isn't sufficient space, Oracle will migrate the row to another block altogether and change the forwarding address on the *original* block. As such, row migrations will always involve one level of indirection.

So, now we are back to PCTFREE and what it is used for: it is the setting that will help you to minimize row migration when set properly.

## Setting PCTFREE and PCTUSED Values

Setting PCTFREE and PCTUSED is an important—and greatly overlooked—topic. In summary, PCTUSED and PCTFREE are both *crucial* when using MSSM; with ASSM, only PCTFREE is. On the one hand, you need to use them to avoid too many rows from migrating. On the other hand, you use them to avoid wasting too much space. You need to look at your objects and describe how they will be used, and then you can come up with a logical plan for setting these values. Rules of thumb may very well fail you on these settings; they really need to be set based on usage. You might consider the following (keeping in mind that “high” and “low” are *relative* terms, and that when using ASSM, only PCTFREE applies):

- *High PCTFREE, low PCTUSED*: This setting is for when you insert lots of data that will be updated, and the updates will increase the size of the rows frequently. This setting reserves a lot of space on the block after inserts (high PCTFREE) and makes it so that the block must almost be empty before getting back onto the FREELIST (low PCTUSED).
- *Low PCTFREE, high PCTUSED*: This setting is for if you tend to only ever INSERT or DELETE from the table, or if you do UPDATE, the UPDATE tends to shrink the row in size.

Again there are no hard and fast rules as to what is high and low with these parameters. You'll have to consider the behavior of your application when setting PCTFREE and PCTUSED. The PCTFREE value can range from 0 to 99. A high setting of PCTFREE might be something like 70 which means that 70% of the block will be reserved for updates. A low value of PCTFREE might be something like 5, meaning you leave little space on the block for future updates (that make the row grow in size). And the PCTUSED parameter can contain values between 0 and 99. A high setting of PCTFREE might be in the range of 70 to 80. A low setting of PCTFREE would be somewhere around 10.

## LOGGING and NOLOGGING

Normally, objects are created in a LOGGING fashion, meaning all operations performed against them that can generate redo will generate it. NOLOGGING allows certain operations to be performed against that object without the generation of redo; we covered this in the Chapter 9 in some detail. NOLOGGING affects only a few specific operations, such as the initial creation of the object, direct-path loads using SQL\*Loader, or rebuilds (see the *Oracle Database SQL Language Reference* manual for the database object you are working with to see which operations apply).

This option does not disable redo log generation for the object in general—only for very specific operations. For example, if I create a table as `SELECT NOLOGGING` and then `INSERT INTO THAT_TABLE VALUES ( 1 )`, the `INSERT` will be logged, but the table creation might not have been (the DBA can force logging at the database or tablespace level).

## INITRANS and MAXTRANS

Each block in a segment has a block header. Part of this block header is a transaction table. Entries will be made in the transaction table to describe which transactions have what rows/elements on the block locked. The initial size of this transaction table is specified by the `INITRANS` setting for the object (for tables and indexes this defaults to 2). This transaction table will grow dynamically as needed up to `MAXTRANS` entries in size (given sufficient free space on the block, that is). Each allocated transaction entry consumes 23 to 24 bytes of storage in the block header. Note that as of Oracle 10g, `MAXTRANS` is ignored—all segments have a `MAXTRANS` of 255.

## Heap Organized Tables

A heap organized table is probably used 99 percent (or more) of the time in applications. A heap organized table is the type of table you get by default when you issue the `CREATE TABLE` statement. If you want any other type of table structure, you need to specify that in the `CREATE` statement itself.

A *heap* is a classic data structure studied in computer science. It is basically a big area of space, disk, or memory (disk in the case of a database table, of course) that is managed in an apparently random fashion. Data will be placed where it fits best, rather than in any specific sort of order. Many people expect data to come back out of a table in the same order it was put into it, but with a heap, this is definitely not assured. In fact, rather the opposite is guaranteed: the rows will come out in a wholly unpredictable order. This is quite easy to demonstrate.

In this example, I will set up a table such that in my database I can fit one full row per block (I am using an 8KB block size). You do not need to have the case where you only have one row per block— I am just taking advantage of this to demonstrate a predictable sequence of events. The following sort of behavior (that rows have no order) will be observed on tables of all sizes, in databases with any block size:

```
EODA@ORA12CR1> create table t
 2 ( a int,
 3   b varchar2(4000) default rpad('*',4000,'*'),
 4   c varchar2(3000) default rpad('*',3000,'*')
 5 )
 6 /
```

Table created.

```
EODA@ORA12CR1> insert into t (a) values ( 1);
1 row created.
```

```
EODA@ORA12CR1> insert into t (a) values ( 2);
1 row created.
```

```
EODA@ORA12CR1> insert into t (a) values ( 3);
1 row created.
```

```
EODA@ORA12CR1> delete from t where a = 2 ;
1 row deleted.
```

```
EODA@ORA12CR1> insert into t (a) values ( 4);
1 row created.
```



```
EODA@ORA12CR1> select a from t;
```

```

      A
-----
      1
      4
      3

```

Adjust columns B and C to be appropriate for your block size if you would like to reproduce this. For example, if you have a 2KB block size, you do not need column C, and column B should be a VARCHAR2(1500) with a default of 1,500 asterisks. Since data is managed in a heap in a table like this, as space becomes available, it will be reused.

---

■ **Note** When using ASSM or MSSM, you’ll find rows end up in different places. The underlying space management routines are very different; the same operations executed against a table in ASSM and MSSM may well result in different physical order. The data will logically be the same, but it will be stored in different ways.

---

A full scan of the table will retrieve the data as it hits it, not in the order of insertion. This is a key concept to understand about database tables: in general, they are inherently unordered collections of data. You should also note that I do not need to use a DELETE in order to observe this effect; I could achieve the same results using *only* INSERTs. If I insert a small row, followed by a very large row that will not fit on the block with the small row, and then a small row again, I may very well observe that the rows come out by default in the order “small row, small row, large row.” They will not be retrieved in the order of insertion—Oracle will place the data where it fits, not in any order by date or transaction.

If your query needs to retrieve data in order of insertion, you must add a column to the table that you can use to order the data when retrieving it. This column could be a number column, for example, maintained with an increasing sequence (using the Oracle SEQUENCE object). You could then *approximate* the insertion order using a SELECT that did an ORDER BY on this column. It will be an approximation because the row with sequence number 55 may very well have committed before the row with sequence 54, therefore it was officially first in the database.

You should think of a heap organized table as a big unordered collection of rows. These rows will come out in a seemingly random order, and depending on other options being used (parallel query, different optimizer modes, and so on), they may come out in a different order with the same query. Do not ever count on the order of rows from a query unless you have an ORDER BY statement on your query!

That aside, what is important to know about heap tables? Well, the CREATE TABLE syntax spans some 87 pages in the *Oracle Database SQL Language Reference* manual provided by Oracle, so there are lots of options that go along with them. There are so many options that getting a hold on all of them is pretty difficult. The wire diagrams (or *train track* diagrams) alone take 20 pages to cover. One trick I use to see most of the options available to me in the CREATE TABLE statement for a given table is to create the table as simply as possible, for example:

```
EODA@ORA12CR1> create table t
  2 ( x int primary key,
  3   y date,
  4   z clob
  5 )
  6 /
Table created.
```

Then, using the standard supplied package `DBMS_METADATA`, I query the definition of it and see the verbose syntax:

```
EODA@ORA12CR1> select dbms_metadata.get_ddl( 'TABLE', 'T' ) from dual;
```

```
DBMS_METADATA.GET_DDL('TABLE','T')
```

```
-----
CREATE TABLE "EODA"."T"
  (   "X" NUMBER(*,0),
      "Y" DATE,
      "Z" CLOB,
      PRIMARY KEY ("X")
  USING INDEX PCTFREE 10 INITRANS 2 MAXTRANS 255
  TABLESPACE "USERS" ENABLE
  ) SEGMENT CREATION DEFERRED
  PCTFREE 10 PCTUSED 40 INITRANS 1 MAXTRANS 255
  NOCOMPRESS LOGGING
  TABLESPACE "USERS"
  LOB ("Z") STORE AS SECUREFILE (
  TABLESPACE "USERS" ENABLE STORAGE IN ROW CHUNK 8192
  NOCACHE LOGGING NOCOMPRESS KEEP_DUPLICATES )
```

The nice thing about this trick is that it shows many of the options for my `CREATE TABLE` statement. I just have to pick data types and such; Oracle will produce the verbose version for me. I can now customize this verbose version, perhaps changing the `ENABLE STORAGE IN ROW` to `DISABLE STORAGE IN ROW`, which would disable the storage of the LOB data in the row with the structured data, causing it to be stored in another segment. I use this trick myself all of the time to avoid having to decipher the huge wire diagrams. I also use this technique to learn what options are available to me on the `CREATE TABLE` statement under different circumstances.

Now that you know how to see most of the options available to you on a given `CREATE TABLE` statement, which are the important ones you need to be aware of for heap tables? In my opinion, there are three with ASSM and five with MSSM:

- **FREELIST:** MSSM only. Every table manages the blocks it has allocated in the heap on a `FREELIST`. A table may have more than one `FREELIST`. If you anticipate heavy insertion into a table by many concurrent users, configuring more than one `FREELIST` can have a major positive impact on performance (at the cost of possible additional storage). Refer to the previous discussion and example in the section “`FREELISTS`” for the sort of impact this setting can have on performance.
- **PCTFREE:** Both ASSM and MSSM. A measure of how full a block can be is made during the `INSERT` process. As shown earlier, this is used to control whether a row may be added to a block or not based on how full the block currently is. This option is also used to control row migrations caused by subsequent updates and needs to be set based on how you use the table.
- **PCTUSED:** MSSM only. A measure of how empty a block must become before it can be a candidate for insertion again. A block that has less than `PCTUSED` space used is a candidate for insertion of new rows. Again, like `PCTFREE`, you must consider how you will be using your table to set this option appropriately.
- **INITRANS:** Both ASSM and MSSM. The number of transaction slots initially allocated to a block. If set too low (defaults to 2, this option can cause concurrency issues in a block that is accessed by many users. If a database block is nearly full and the transaction list cannot be dynamically expanded, sessions will queue up for this block, as each concurrent transaction needs a transaction slot. If you believe you will have many concurrent updates to the same blocks, consider increasing this value.

- **COMPRESS/NOCOMPRESS:** Both ASSM and MSSM. Enables or disables compression of table data during either direct-path operations or during conventional path (“normal,” if you will) operations such as INSERT. Prior to Oracle9i Release 2, this option was not available. Starting with Oracle9i Release 2 through Oracle 10g Release 2, the option was COMPRESS or NOCOMPRESS to either use or not use table compression during direct-path operations only. In those releases, only direct-path operations such as CREATE TABLE AS SELECT, INSERT /\*+ APPEND \*/ , ALTER TABLE T MOVE, and SQL\*Loader direct-path loads could take advantage of compression. Starting with Oracle 11g Release 1 and above, the options are NOLOGGING, COMPRESS FOR OLTP, and COMPRESS BASIC. NOLOGGING disables any compression, COMPRESS FOR OLTP enables compression for all operations (direct or conventional path), and COMPRESS BASIC enables compression for direct-path operations only. Starting with Oracle 12c Release 1, these compression options are now specified syntactically as ROW STORE COMPRESS BASIC (enables compression during direct-path operations), and ROW STORE COMPRESS ADVANCED (enables compression for all operations).

---

■ **Note** LOB data that is stored out of line in the LOB segment does not make use of the PCTFREE/PCTUSED parameters set for the table. These LOB blocks are managed differently: they are always filled to capacity and returned to the FREELIST only when completely empty.

---

These are the parameters you want to pay particularly close attention to. With the introduction of locally managed tablespaces, which are highly recommended, I find that the rest of the storage parameters (such as PCTINCREASE, NEXT, and so on) are simply not relevant anymore.

## Index Organized Tables

*Index organized tables (IOTs)* are quite simply tables stored in an index structure. Whereas a table stored in a heap is unorganized (i.e., data goes wherever there is available space), data in an IOT is stored and sorted by primary key. IOTs behave just like “regular” tables do as far as your application is concerned; you use SQL to access them as normal. They are especially useful for information retrieval, spatial, and OLAP applications.

What is the point of an IOT? You might ask the converse, actually: what is the point of a heap organized table? Since all tables in a relational database are supposed to have a primary key anyway, isn’t a heap organized table just a waste of space? We have to make room for both the table and the index on the primary key of the table when using a heap organized table. With an IOT, the space overhead of the primary key index is removed, as the index is the data, and the data is the index. The fact is that an index is a complex data structure that requires a lot of work to manage and maintain, and the maintenance requirements increase as the width of the row to store increases. A heap, on the other hand, is trivial to manage by comparison. There are efficiencies in a heap organized table over an IOT. That said, IOTs have some definite advantages over their heap counterparts. For example, I once built an inverted list index on some textual data (this predated the introduction of interMedia and related technologies). I had a table full of documents, and I would parse the documents and find words within them. My table looked like this:

```
create table keywords
( word varchar2(50),
  position int,
  doc_id int,
  primary key(word,position,doc_id)
);
```

Here I had a table that consisted solely of columns of the primary key. I had *over* 100 percent overhead; the size of my table and primary key index were comparable (actually, the primary key index was larger since it physically stored the rowid of the row it pointed to, whereas a rowid is not stored in the table—it is inferred). I only used this table with a WHERE clause on the WORD or WORD and POSITION columns. That is, I never used the table—I used only the index on the table. The table itself was no more than overhead. I wanted to find all documents containing a given word (or near another word, and so on). The KEYWORDS heap table was useless, and it just slowed down the application during maintenance of the KEYWORDS table and doubled the storage requirements. This is a perfect application for an IOT.

Another implementation that begs for an IOT is a code lookup table. Here you might have ZIP\_CODE to STATE lookup, for example. You can now do away with the heap table and just use an IOT itself. Anytime you have a table that you access via its primary key exclusively, it is a possible candidate for an IOT.

When you want to enforce co-location of data or you want data to be physically stored in a specific order, the IOT is the structure for you. For users of Sybase and SQL Server, this is where you would have used a clustered index, but IOTs go one better. A clustered index in those databases may have up to a 110 percent overhead (similar to the previous KEYWORDS table example). Here, we have a 0 percent overhead since the data is stored only once. A classic example of when you might want this physically co-located data would be in a parent/child relationship. Let's say the EMP table had a child table containing addresses. You might have a home address entered into the system when the employee is initially sent an offer letter for a job. Later, he adds his work address. Over time, he moves and changes the home address to a previous address and adds a new home address. Then he has a school address he added when he went back for a degree, and so on. That is, the employee has three or four (or more) detail records, but these details arrive randomly over time. In a normal heap based table, they just go anywhere. The odds that two or more of the address records would be on the same database block in the heap table are very near zero. However, when you query an employee's information, you always pull the address detail records as well. The rows that arrive over time are always retrieved together. To make the retrieval more efficient, you can use an IOT for the child table to put all of the records for a given employee near each other upon insertion, so when you retrieve them over and over again, you do less work.

An example will easily show the effects of using an IOT to physically co-locate the child table information. Let's create and populate an EMP table:

```
EODA@ORA12CR1> create table emp
 2 as
 3 select object_id empno,
 4        object_name ename,
 5        created hiredate,
 6        owner job
 7 from all_objects
 8 /
```

Table created.

```
EODA@ORA12CR1> alter table emp add constraint emp_pk primary key(empno);
```

Table altered.

```
EODA@ORA12CR1> begin
 2   dbms_stats.gather_table_stats( user, 'EMP', cascade=>true );
 3 end;
 4 /
```

PL/SQL procedure successfully completed.

Next, we'll implement the child table two times, once as a conventional heap table and again as an IOT:

```
EODA@ORA12CR1> create table heap_addresses
 2 ( empno      references emp(empno) on delete cascade,
 3   addr_type  varchar2(10),
 4   street    varchar2(20),
 5   city      varchar2(20),
 6   state     varchar2(2),
 7   zip       number,
 8   primary key (empno,addr_type)
 9 )
10 /
```

Table created.

```
EODA@ORA12CR1> create table iot_addresses
 2 ( empno      references emp(empno) on delete cascade,
 3   addr_type  varchar2(10),
 4   street    varchar2(20),
 5   city      varchar2(20),
 6   state     varchar2(2),
 7   zip       number,
 8   primary key (empno,addr_type)
 9 )
10 ORGANIZATION INDEX
11 /
```

Table created.

I populated these tables by inserting into them a work address for each employee, then a home address, then a previous address, and finally a school address. A heap table would tend to place the data at the end of the table; as the data arrives, the heap table would simply add it to the end, due to the fact that the data is just arriving and no data is being deleted. Over time, if addresses are deleted, the inserts would become more random throughout the table. Suffice it to say, the chance an employee's work address would be on the same block as his home address in the heap table is near zero. For the IOT, however, since the key is on EMPNO, ADDR\_TYPE, we'll be pretty sure that all of the addresses for a given EMPNO are located on one or maybe two index blocks together. The inserts used to populate this data were:

```
EODA@ORA12CR1> insert into heap_addresses
 2 select empno, 'WORK', '123 main street', 'Washington', 'DC', 20123
 3 from emp;
72075 rows created.
```

```
EODA@ORA12CR1> insert into iot_addresses
 2 select empno, 'WORK', '123 main street', 'Washington', 'DC', 20123
 3 from emp;
72075 rows created.
```

I did that three more times, changing WORK to HOME, PREV, and SCHOOL in turn. Then I gathered statistics:

```
EODA@ORA12CR1> exec dbms_stats.gather_table_stats( user, 'HEAP_ADDRESSES' );
PL/SQL procedure successfully completed.
```

```
EODA@ORA12CR1> exec dbms_stats.gather_table_stats( user, 'IOT_ADDRESSES' );
PL/SQL procedure successfully completed.
```

Now we are ready to see what measurable difference we could expect to see. Using AUTOTRACE, we'll get a feeling for the change:

```
EODA@ORA12CR1> set autotrace traceonly
EODA@ORA12CR1> select *
  2   from emp, heap_addresses
  3   where emp.empno = heap_addresses.empno
  4   and emp.empno = 42;
```

#### Execution Plan

Plan hash value: 775524973

Id	Operation	Name	Rows	Bytes	Cost (%CPU)
0	SELECT STATEMENT		4	292	8 (0)
1	NESTED LOOPS		4	292	8 (0)
2	TABLE ACCESS BY INDEX ROWID	EMP	1	27	2 (0)
* 3	INDEX UNIQUE SCAN	EMP_PK	1		1 (0)
4	TABLE ACCESS BY INDEX ROWID BATCHED	HEAP_ADDRESSES	4	184	...
* 5	INDEX RANGE SCAN	SYS_C0032863	4		2 (0)

#### Predicate Information (identified by operation id):

```
3 - access("EMP"."EMPNO"=42)
5 - access("HEAP_ADDRESSES"."EMPNO"=42)
```

#### Statistics

```
1 recursive calls
0 db block gets
11 consistent gets
0 physical reads
0 redo size
1361 bytes sent via SQL*Net to client
543 bytes received via SQL*Net from client
2 SQL*Net roundtrips to/from client
0 sorts (memory)
0 sorts (disk)
4 rows processed
```

That is a pretty common plan: go to the EMP table by primary key; get the row; then using that EMPNO, go to the address table; and using the index, pick up the child records. We did 11 I/Os to retrieve this data. Now run the same query, but use the IOT for the addresses:

```
EODA@ORA12CR1> select *
  2   from emp, iot_addresses
  3   where emp.empno = iot_addresses.empno
  4   and emp.empno = 42;
```

#### Execution Plan

Plan hash value: 252066017

Id	Operation	Name	Rows	Bytes	Cost (%CPU)	Time
0	SELECT STATEMENT		4	292	4 (0)	00:00:01
1	NESTED LOOPS		4	292	4 (0)	00:00:01
2	TABLE ACCESS BY INDEX ROWID	EMP	1	27	2 (0)	00:00:01
* 3	INDEX UNIQUE SCAN	EMP_PK	1		1 (0)	00:00:01
* 4	INDEX RANGE SCAN	SYS_IOT_TOP_182459	4	184	2 (0)	00:00:01

Predicate Information (identified by operation id):

```
  3 - access("EMP"."EMPNO"=42)
  4 - access("IOT_ADDRESSES"."EMPNO"=42)
```

#### Statistics

```
  1 recursive calls
  0 db block gets
  7 consistent gets
  0 physical reads
  0 redo size
1361 bytes sent via SQL*Net to client
 543 bytes received via SQL*Net from client
   2 SQL*Net roundtrips to/from client
   0 sorts (memory)
   0 sorts (disk)
   4 rows processed
```

We did four fewer I/Os (the four should have been guessable); we skipped four TABLE ACCESS (BY INDEX ROWID BATCHED) steps. The more child records we have, the more I/Os we would anticipate skipping.

So, what is four I/Os? Well, in this case it was over one-third of the I/O performed for the query, and if we execute this query repeatedly, it would add up. Each I/O and each consistent get requires an access to the buffer cache, and while it is true that reading data out of the buffer cache is faster than disk, it is also true that the buffer cache gets are *not free and not totally cheap*. Each will require many latches of the buffer cache, and latches are serialization devices that will inhibit our ability to scale. We can measure both the I/O reduction as well as latching reduction by running a PL/SQL block such as this:

```
EODA@ORA12CR1> begin
  2   for x in ( select empno from emp )
  3   loop
  4       for y in ( select emp.ename, a.street, a.city, a.state, a.zip
```

```

5          from emp, heap_addresses a
6          where emp.empno = a.empno
7             and emp.empno = x.empno )
8      loop
9          null;
10     end loop;
11 end loop;
12 end;
13 /

```

PL/SQL procedure successfully completed.

Here, we are just emulating a busy period and running the query some 72,000 times, once for each EMPNO. If we run that for the HEAP\_ADDRESSES and IOT\_ADDRESSES tables, TKPROF shows us the following:

```

SELECT EMP.ENAME, A.STREET, A.CITY, A.STATE, A.ZIP
FROM EMP, HEAP_ADDRESSES A WHERE EMP.EMPNO = A.EMPNO AND EMP.EMPNO = :B1

```

call	count	cpu	elapsed	disk	query	current	rows
Parse	1	0.00	0.00	0	0	0	0
Execute	72110	1.02	1.01	0	0	0	0
Fetch	72110	2.16	2.11	0	722532	0	288440
total	144221	3.18	3.12	0	722532	0	288440

```

...
Rows (1st) Rows (avg) Rows (max) Row Source Operation
-----
4          4          4 NESTED LOOPS (cr=10 pr=0 pw=0 time=40 us cost=8 size=228 card=4)
1          1          1 TABLE ACCESS BY INDEX ROWID EMP (cr=3 pr=0 pw=0 time=11 us cost=2...
1          1          1 INDEX UNIQUE SCAN EMP_PK (cr=2 pr=0 pw=0 time=7 us cost=1 size=0...
4          4          4 TABLE ACCESS BY INDEX ROWID BATCHED HEAP_ADDRESSES (cr=7...
4          4          4 INDEX RANGE SCAN SYS_C0032863 (cr=3 pr=0 pw=0 time=10 us cost=2...

```

\*\*\*\*\*

```

SELECT EMP.ENAME, A.STREET, A.CITY, A.STATE, A.ZIP
FROM EMP, IOT_ADDRESSES A WHERE EMP.EMPNO = A.EMPNO AND EMP.EMPNO = :B1

```

call	count	cpu	elapsed	disk	query	current	rows
Parse	1	0.00	0.00	0	0	0	0
Execute	72110	1.04	1.01	0	0	0	0
Fetch	72110	1.64	1.63	0	437360	0	288440
total	144221	2.69	2.64	0	437360	0	288440

...



```

Rows (1st) Rows (avg) Rows (max) Row Source Operation
-----
      4          4          4 NESTED LOOPS (cr=7 pr=0 pw=0 time=28 us cost=4 size=228 card=4)
      1          1          1 TABLE ACCESS BY INDEX ROWID EMP (cr=3 pr=0 pw=0 time=11 us cost=2...
      1          1          1 INDEX UNIQUE SCAN EMP_PK (cr=2 pr=0 pw=0 time=7 us cost=1 size=0...
      4          4          4 INDEX RANGE SCAN SYS_IOT_TOP_182459 (cr=4 pr=0 pw=0 time=15 us...
Rows      Row Source Operation
-----
      4 NESTED LOOPS (cr=7 pr=3 pw=0 time=9 us cost=4 size=280 card=4)
      1 TABLE ACCESS BY INDEX ROWID EMP (cr=3 pr=0 pw=0 time=0 us cost=2 size=30...)
      1 INDEX UNIQUE SCAN EMP_PK (cr=2 pr=0 pw=0 time=0 us cost=1 size=0 ...)
      4 INDEX RANGE SCAN SYS_IOT_TOP_93124 (cr=4 pr=3 pw=0 time=3 us cost=2 ...)

```

Both queries fetched exactly the same number of rows, but the HEAP table performed considerably more logical I/O. As the degree of concurrency on the system goes up, we would likewise expect the CPU used by the HEAP table to go up more rapidly as well, while the query possibly waits for latches into the buffer cache. Using runstats (a utility of my own design; refer to the introductory section of this book “Setting Up Your Environment” for details), we can measure the difference in latching. On my system, I observed the following

Name	Run1	Run2	Diff
STAT...buffer is pinned count	216,342	0	-216,342
STAT...consistent gets	723,461	438,275	-285,186
STAT...consistent gets from ca	723,461	438,275	-285,186
STAT...consistent gets pin (fa	362,888	77,700	-285,188
STAT...consistent gets pin	362,888	77,700	-285,188
STAT...no work - consistent re	362,870	77,682	-285,188
STAT...session logical reads	723,538	438,332	-285,206
STAT...table fetch by rowid	360,570	72,114	-288,456
STAT...buffer is not pinned co	649,026	288,456	-360,570
STAT...session pga memory	393,216	0	-393,216
STAT...session pga memory max	393,216	0	-393,216
LATCH.cache buffers chains	1,091,314	518,788	-572,526
STAT...logical read bytes from	5,927,223,296	3,590,815,744	-2,336,407,552

```

Run1 latches total versus runs -- difference and pct
Run1          Run2          Diff          Pct
1,235,153     620,581         -614,572     199.03%

```

where Run1 was the HEAP\_ADDRESSES table and Run2 was the IOT\_ADDRESSES table. As you can see, there was a dramatic and repeatable decrease in the latching taking place, mostly due to the cache buffers chains latch (the one that protects the buffer cache). The IOT in this case would provide the following benefits:

- Increased buffer cache efficiency, as any given query needs to have fewer blocks in the cache.
- Decreased buffer cache access, which increases scalability.
- Less overall work to retrieve our data, as it is faster.
- Less physical I/O per query possibly, as fewer distinct blocks are needed for any given query and a single physical I/O of the addresses most likely retrieves all of them (not just one of them, as the heap table implementation does).

The same would be true if you frequently use BETWEEN queries on a primary or unique key. Having the data stored physically sorted will increase the performance of those queries as well. For example, I maintain a table of stock quotes in my database. Every day, for hundreds of stocks, I gather together the stock ticker, date, closing price, day's high, day's low, volume, and other related information. The table looks like this:

```
EODA@ORA12CR1> create table stocks
 2 ( ticker      varchar2(10),
 3   day         date,
 4   value       number,
 5   change      number,
 6   high        number,
 7   low         number,
 8   vol         number,
 9   primary key(ticker,day)
10 )
11 organization index
12 /
Table created.
```

I frequently look at one stock at a time for some range of days (e.g., computing a moving average). If I were to use a heap organized table, the probability of two rows for the stock ticker ORCL existing on the same database block are almost zero. This is because every night, I insert the records for the day for all of the stocks. This fills up at least one database block (actually, many of them). Therefore, every day I add a new ORCL record, but it is on a block different from every other ORCL record already in the table. If I query as follows

```
Select * from stocks
where ticker = 'ORCL'
and day between sysdate-100 and sysdate;
```

Oracle would read the index and then perform table access by rowid to get the rest of the row data. Each of the 100 rows I retrieve would be on a different database block due to the way I load the table—each would probably be a physical I/O. Now consider that I have this same data in an IOT. That same query only needs to read the relevant index blocks, and it already has all of the data. Not only is the table access removed, but all of the rows for ORCL in a given range of dates are physically stored near each other as well. Less logical I/O and less physical I/O is incurred.

Now you understand when you might want to use IOTs and how to use them. What you need to understand next is what the options are with these tables. What are the caveats? The options are very similar to the options for a heap organized table. Once again, we'll use DBMS\_METADATA to show us the details. Let's start with the three basic variations of the IOT:

```
EODA@ORA12CR1> create table t1
 2 ( x int primary key,
 3   y varchar2(25),
 4   z date
 5 )
 6 organization index;
Table created.
```

```
EODA@ORA12CR1> create table t2
 2 ( x int primary key,
 3   y varchar2(25),
 4   z date
```

```

5 )
6 organization index
7 OVERFLOW;
Table created.

```

```

EODA@ORA12CR1> create table t3
2 ( x int primary key,
3   y varchar2(25),
4   z date
5 )
6 organization index
7 overflow INCLUDING y;

```

Table created.

We'll get into what OVERFLOW and INCLUDING do for us, but first let's look at the detailed SQL required for the first table:

```

EODA@ORA12CR1> select dbms_metadata.get_ddl( 'TABLE', 'T1' ) from dual;

```

```

DBMS_METADATA.GET_DDL('TABLE','T1')
-----

```

```

CREATE TABLE "EODA"."T1"
(
  "X" NUMBER(*,0),
  "Y" VARCHAR2(25),
  "Z" DATE,
  PRIMARY KEY ("X") ENABLE
) ORGANIZATION INDEX NOCOMPRESS PCTFREE 10 INITRANS 2 MAXTRANS 255 LOGGING
STORAGE(INITIAL 65536 NEXT 1048576 MINEXTENTS 1 MAXEXTENTS 2147483645
PCTINCREASE 0 FREELISTS 1 FREELIST GROUPS 1
BUFFER_POOL DEFAULT FLASH_CACHE DEFAULT CELL_FLASH_CACHE DEFAULT)
TABLESPACE "USERS"
PCTTHRESHOLD 50

```

This table introduces a new option, PCTTHRESHOLD, which we'll look at in a moment. You might have noticed that something is missing from the preceding CREATE TABLE syntax: there is no PCTUSED clause, but there is a PCTFREE. This is because an index is a complex data structure that isn't randomly organized like a heap, so data must go where it belongs. Unlike a heap, where blocks are sometimes available for inserts, blocks are always available for new entries in an index. If the data belongs on a given block because of its values, it will go there regardless of how full or empty the block is. Additionally, PCTFREE is used only when the object is created and populated with data in an index structure. It is not used like it is in the heap organized table. PCTFREE will reserve space on a newly created index, but not for subsequent operations on it. The same considerations for FREELISTS we had on heap organized tables apply in whole to IOTs.

First, let's look at the NOCOMPRESS option. This option is different in implementation from the table compression discussed earlier. It works for any operation on the index organized table (as opposed to the table compression which may or may not be in effect for conventional path operations). Using NOCOMPRESS, it tells Oracle to store each and every value in an index entry (i.e., do not compress). If the primary key of the object were on columns A, B, and C, every occurrence of A, B, and C would physically be stored. The converse to NOCOMPRESS is COMPRESS N, where N is an

integer that represents the number of columns to compress. This removes repeating values and factors them out at the block level, so that the values of A and perhaps B that repeat over and over are no longer physically stored. Consider, for example, a table created like this:

```
EODA@ORA12CR1> create table iot
 2 ( owner, object_type, object_name,
 3   primary key(owner,object_type,object_name)
 4 )
 5 organization index
 6 NOCOMPRESS
 7 as
 8 select distinct owner, object_type, object_name from all_objects
/
```

Table created.

If you think about it, the value of OWNER is repeated many hundreds of times. Each schema (OWNER) tends to own lots of objects. Even the value pair of OWNER, OBJECT\_TYPE repeats many times, so a given schema will have dozens of tables, dozens of packages, and so on. Only all three columns together do not repeat. We can have Oracle suppress these repeating values. Instead of having an index block with values shown in Table 10-1, we could use COMPRESS 2 (factor out the leading two columns) and have a block with the values shown in Table 10-2.

**Table 10-1.** Index Leaf Block, NOCOMPRESS

Sys,table,t1	Sys,table,t2	Sys,table,t3	Sys,table,t4
Sys,table,t5	Sys,table,t6	Sys,table,t7	Sys,table,t8
...	...	...	...
Sys,table,t100	Sys,table,t101	Sys,table,t102	Sys,table,t103

**Table 10-2.** Index Leaf Block, COMPRESS 2

Sys,table	t1	t2	t3
t4	t5	...	...
...	t103	t104	...
t300	t301	t302	t303

That is, the values SYS and TABLE appear once, and then the third column is stored. In this fashion, we can get many more entries per index block than we could otherwise. This does not decrease concurrency—we are still operating at the row level in all cases—or functionality at all. It *may* use slightly more CPU horsepower, as Oracle has to do more work to put together the keys again. On the other hand, it may significantly reduce I/O and allow more data to be cached in the buffer cache, since we get more data per block. That is a pretty good tradeoff.

Let's demonstrate the savings by doing a quick test of the preceding CREATE TABLE as SELECT with NOCOMPRESS, COMPRESS 1, and COMPRESS 2. We'll start by creating our IOT without compression:

```
EODA@ORA12CR1> create table iot
 2 ( owner, object_type, object_name,
 3   constraint iot_pk primary key(owner,object_type,object_name)
 4 )
```

```

5 organization index
6 NOCOMPRESS
7 as
8 select distinct owner, object_type, object_name
9   from all_objects
10 /
Table created.

```

Now we can measure the space used. We'll use the `ANALYZE INDEX VALIDATE STRUCTURE` command for this. This command populates a dynamic performance view named `INDEX_STATS`, which will contain only one row at most with the information from the last execution of that `ANALYZE` command:

```

EODA@ORA12CR1> analyze index iot_pk validate structure;
Index analyzed.

```

```

EODA@ORA12CR1> select lf_blks, br_blks, used_space,
2      opt_cmp_r_count, opt_cmp_r_pctsave
3      from index_stats;

```

LF_BKLS	BR_BKLS	USED_SPACE	OPT_CMPR_COUNT	OPT_CMPR_PCTSAVE
240	1	1726727	2	37

This shows our index is currently using 240 leaf blocks (where our data is) and 1 branch block (blocks Oracle uses to navigate the index structure) to find the leaf blocks. The space used is about 1.7MB (1,726,727 bytes). The other two oddly named columns are trying to tell us something. The `OPT_CMPR_COUNT` (optimum compression count) column is trying to say, "If you made this index `COMPRESS 2`, you would achieve the best compression." The `OPT_CMPR_PCTSAVE` (optimum compression percentage saved) is telling us if we did the `COMPRESS 2`, we would save about one-third of the storage and the index would consume just two-thirds the disk space it is now.

---

■ **Note** The next chapter, "Indexes," covers the index structure in more detail.

---

To test that theory, we'll rebuild the IOT with `COMPRESS 1` first:

```

EODA@ORA12CR1> alter table iot move compress 1;
Table altered.

```

```

EODA@ORA12CR1> analyze index iot_pk validate structure;
Index analyzed.

```

```

EODA@ORA12CR1> select lf_blks, br_blks, used_space,
2      opt_cmp_r_count, opt_cmp_r_pctsave
3      from index_stats;

```

LF_BKLS	BR_BKLS	USED_SPACE	OPT_CMPR_COUNT	OPT_CMPR_PCTSAVE
213	1	1529506	2	28

As you can see, the index is in fact smaller: about 1.5MB, with fewer leaf blocks. But now it is saying, “You can still get another 28% off,” as we didn’t chop off that much yet. Let’s rebuild with COMPRESS 2:

```
EODA@ORA12CR1> alter table iot move compress 2;
Table altered.
```

```
EODA@ORA12CR1> analyze index iot_pk validate structure;
Index analyzed.
```

```
EODA@ORA12CR1> select lf_blks, br_blks, used_space,
2      opt_cmpr_count, opt_cmpr_pctsave
3      from index_stats;
```

LF_BKLS	BR_BKLS	USED_SPACE	OPT_CMPR_COUNT	OPT_CMPR_PCTSAVE
151	1	1086483	2	0

Now we are significantly reduced in size, both by the number of leaf blocks as well as overall used space, by about 1MB. If we go back to the original numbers

```
EODA@ORA12CR1> select (1-.37)* 1726727 from dual;
```

```
(1-.37)*1726727
-----
1087838.01
```

we can see the OPT\_CMPR\_PCTSAVE was pretty much dead-on accurate. The preceding example points out an interesting fact with IOTs. They are tables, but only in name. Their segment is truly an index segment.

I am going to defer discussion of the PCTTHRESHOLD option at this point, as it is related to the next two options for IOTs: OVERFLOW and INCLUDING. If we look at the full SQL for the next two sets of tables, T2 and T3, we see the following (I’ve used a DBMS\_METADATA routine to suppress the storage clauses, as they are not relevant to the example):

```
EODA@ORA12CR1> begin
2  dbms_metadata.set_transform_param
3  ( DBMS_METADATA.SESSION_TRANSFORM, 'STORAGE', false );
4  end;
5  /
```

PL/SQL procedure successfully completed.

```
EODA@ORA12CR1> select dbms_metadata.get_ddl( 'TABLE', 'T2' ) from dual;
```

```
DBMS_METADATA.GET_DDL('TABLE','T2')
```

```
-----
CREATE TABLE "EODA"."T2"
(
  "X" NUMBER(*,0),
  "Y" VARCHAR2(25),
  "Z" DATE,
  PRIMARY KEY ("X") ENABLE
) ORGANIZATION INDEX NOCOMPRESS PCTFREE 10 INITRANS 2 MAXTRANS 255 LOGGING
TABLESPACE "USERS"
```

```
PCTTHRESHOLD 50 OVERFLOW
PCTFREE 10 PCTUSED 40 INITRANS 1 MAXTRANS 255 LOGGING
TABLESPACE "USERS"
```

```
EODA@ORA12CR1> select dbms_metadata.get_ddl( 'TABLE', 'T3' ) from dual;
```

```
DBMS_METADATA.GET_DDL('TABLE','T3')
```

```
-----
CREATE TABLE "EODA"."T3"
(
  "X" NUMBER(*,0),
  "Y" VARCHAR2(25),
  "Z" DATE,
  PRIMARY KEY ("X") ENABLE
) ORGANIZATION INDEX NOCOMPRESS PCTFREE 10 INITRANS 2 MAXTRANS 255 LOGGING
TABLESPACE "USERS"
PCTTHRESHOLD 50 INCLUDING "Y" OVERFLOW
PCTFREE 10 PCTUSED 40 INITRANS 1 MAXTRANS 255 LOGGING
TABLESPACE "USERS"
```

So, now we have PCTTHRESHOLD, OVERFLOW, and INCLUDING left to discuss. These three items are intertwined, and their goal is to make the index leaf blocks (the blocks that hold the actual index data) able to efficiently store data. An index is typically on a subset of columns. You will generally find many more times the number of row entries on an index block than you would on a heap table block. An index counts on being able to get many rows per block. Oracle would spend large amounts of time maintaining an index otherwise, as each INSERT or UPDATE would probably cause an index block to split in order to accommodate the new data.

The OVERFLOW clause allows you to set up another segment (making an IOT a multisegment object, much like having a CLOB column does) where the row data for the IOT can overflow onto when it gets too large.

---

■ **Note** The columns making up the primary key cannot overflow—they must be placed on the leaf blocks directly.

---

Notice that an OVERFLOW reintroduces the PCTUSED clause to an IOT when using MSSM. PCTFREE and PCTUSED have the same meanings for an OVERFLOW segment as they do for a heap organized table. The conditions for using an overflow segment can be specified in one of two ways:

- **PCTTHRESHOLD:** When the amount of data in the row exceeds that percentage of the block, the trailing columns of that row will be stored in the overflow. So, if PCTTHRESHOLD was 10 percent and your block size was 8KB, any row that was greater than about 800 bytes in length would have part of it stored elsewhere, off the index block.
- **INCLUDING:** All of the columns in the row up to and including the one specified in the INCLUDING clause are stored on the index block, and the remaining columns are stored in the overflow.

Given the following table with a 2KB block size:

```
EODA@ORA12CR1> create table iot
2 ( x      int,
3   y      date,
4   z      varchar2(2000),
```

```

5   constraint iot_pk primary key (x)
6 )
7 organization index
8 pctthreshold 10
9 overflow
10 /
Table created.

```

Graphically, it could look like Figure 10-6.

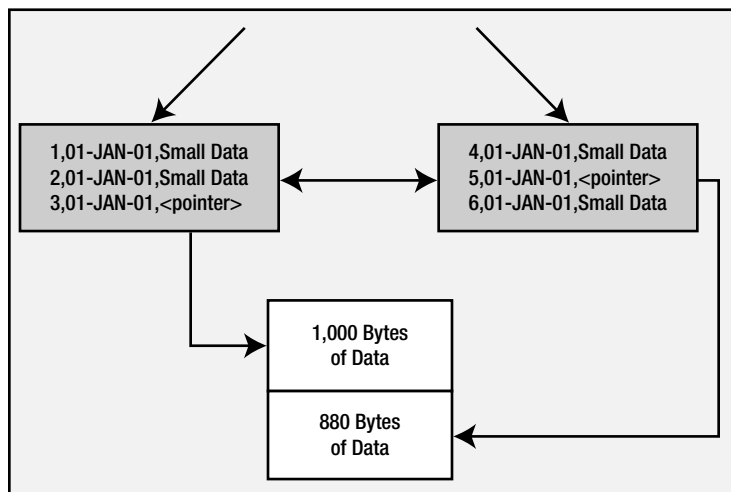

**Figure 10-6.** IOT with overflow segment, PCTTHRESHOLD clause

The gray boxes are the index entries, part of a larger index structure (in Chapter 11 you'll see a larger picture of what an index looks like). Briefly, the index structure is a tree, and the leaf blocks (where the data is stored) are, in effect, a doubly linked list to make it easier to traverse the nodes in order once we've found where we want to start in the index. The white box represents an OVERFLOW segment. This is where data that exceeds our PCTTHRESHOLD setting will be stored. Oracle will work backward from the last column up to but not including the last column of the primary key to find out what columns need to be stored in the overflow segment. In this example, the number column X and the date column Y will always fit in the index block. The last column, Z, is of varying length. When it is less than about 190 bytes or so (10 percent of a 2KB block is about 200 bytes; subtract 7 bytes for the date and 3 to 5 for the number), it will be stored on the index block. When it exceeds 190 bytes, Oracle will store the data for Z in the overflow segment and set up a pointer (a rowid, in fact) to it.

The other option is to use the INCLUDING clause. Here we are stating explicitly what columns we want stored on the index block and which should be stored in the overflow. Given a CREATE TABLE statement like this

```

EODA@ORA12CR1> create table iot
2 ( x int,
3 y date,
4 z varchar2(2000),
5 constraint iot_pk primary key (x)
6 )
7 organization index

```



```

8 including y
9 overflow
10 /
Table created.

```

what we can expect to find is illustrated in Figure 10-7.

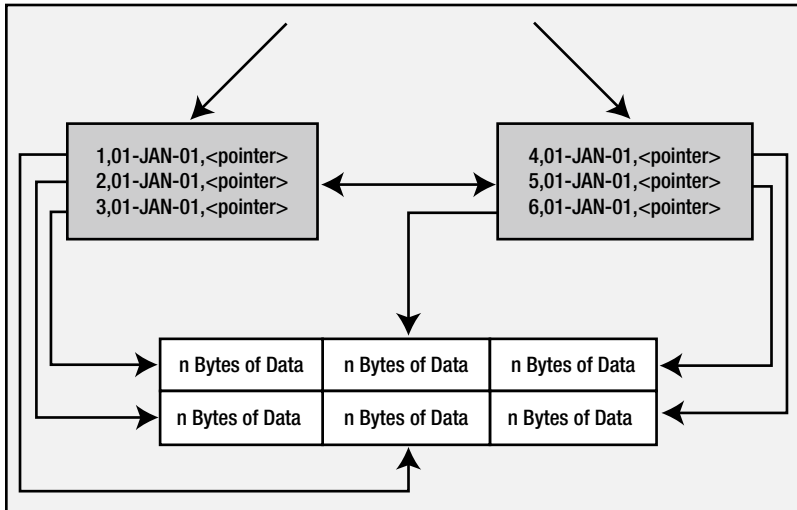

**Figure 10-7.** IOT with OVERFLOW segment, INCLUDING clause

In this situation, regardless of the size of the data stored in it, Z will be stored out of line in the overflow segment (all nonprimary key columns that follow the column specified in the INCLUDING clause are stored in the overflow segment).

Which is better then: PCTTHRESHOLD, INCLUDING, or some combination of both? It depends on your needs. If you have an application that always, or almost always, uses the first four columns of a table and rarely accesses the last five columns, using INCLUDING would be appropriate. You would include up to the fourth column and let the other five be stored out of line. At runtime, if you need them, the columns will be retrieved in much the same way as a chained row would be. Oracle will read the head of the row, find the pointer to the rest of the row, and then read that. If, on the other hand, you cannot say that you almost always access these columns and hardly ever access those columns, you should give some consideration to PCTTHRESHOLD. Setting PCTTHRESHOLD is easy once you determine the number of rows you would like to store per index block on average. Suppose you wanted 20 rows per index block. Well, that means each row should be one-twentieth (5 percent). Your PCTTHRESHOLD would be 5, and each chunk of the row that stays on the index leaf block should consume no more than 5 percent of the block.

The last thing to consider with IOTs is indexing. You can have an index on IOTs themselves—sort of like having an index *on* an index. These are called *secondary indexes*. Normally, an index contains the physical address of the row it points to, the rowid. An IOT secondary index cannot do this; it must use some other way to address the row. This is because a row in an IOT can move around a lot, and it does not migrate in the way a row in a heap organized table would. A row in an IOT is expected to be at some position in the index structure, based on its primary key value; it will only be moving because the size and shape of the index itself is changing. (We'll cover more about how index structures are maintained in the next chapter.) To accommodate this, Oracle introduced a *logical rowid*. These logical rowids are based on the IOT's primary key. They may also contain a guess as to the current location of the row, although this guess is almost always wrong because after a short while, data in an IOT tends to move. The guess is the physical address of the row in the IOT when it was first placed into the secondary index structure. If the row in

the IOT has to move to another block, the guess in the secondary index becomes stale. Therefore, an index on an IOT is slightly less efficient than an index on a regular heap organized table. On a regular table, an index access typically requires the I/O to scan the index structure and then a single read to read the table data. With an IOT, typically two scans are performed: one on the secondary structure and the other on the IOT itself. That aside, indexes on IOTs provide fast and efficient access to the data in the IOT using columns other than the primary key.

## Index Organized Tables Wrap-up

Getting the right mix of data on the index block versus data in the overflow segment is the most critical part of the IOT setup. Benchmark various scenarios with different overflow conditions, and see how they will affect your INSERTs, UPDATEs, DELETEs, and SELECTs. If you have a structure that is built once and read frequently, stuff as much of the data onto the index block as you can. If you frequently modify the structure, you will have to achieve some balance between having all of the data on the index block (great for retrieval) versus reorganizing data in the index frequently (bad for modifications). The FREELIST consideration you have for heap tables applies to IOTs as well. PCTFREE and PCTUSED play two roles in an IOT. PCTFREE is not nearly as important for an IOT as for a heap table, and PCTUSED doesn't come into play normally. When considering an OVERFLOW segment, however, PCTFREE and PCTUSED have the same interpretation as they do for a heap table; set them for an overflow segment using the same logic as you would for a heap table.

## Index Clustered Tables

I generally find people's understanding of what a cluster is in Oracle to be inaccurate. Many people tend to confuse a cluster with a SQL Server or Sybase "clustered index." They are not the same. A cluster is a way to store a group of tables that share some common column(s) in the same database blocks and to store related data together on the same block. A clustered index in SQL Server forces the rows to be stored in sorted order according to the index key, similar to an IOT as just described. With a cluster, a single block of data may contain data from many tables. Conceptually, you are storing the data "prejoined." It can also be used with single tables where you are storing data together grouped by some column. For example, all of the employees in department 10 will be stored on the same block (or as few blocks as possible, if they all don't fit). It is not storing the data sorted—that is the role of the IOT. It is storing the data clustered by some key, but in a heap. So, department 100 might be right next to department 1, and very far away (physically on disk) from departments 101 and 99.

Graphically, you might think of it as shown in Figure 10-8. On the left side of the image, we are using conventional tables. EMP will be stored in its segment. DEPT will be stored on its own. They may be in different files and different tablespaces, and they are definitely in separate extents. On the right side of the image, we see what would happen if we clustered these two tables together. The square boxes represent database blocks. We now have the value 10 factored out and stored once. Then, all of the data from all of the tables in the cluster for department 10 is stored in that block. If all of the data for department 10 does not fit on the block, then additional blocks will be chained to the original block to contain the overflow, in the same fashion as the overflow blocks for an IOT.

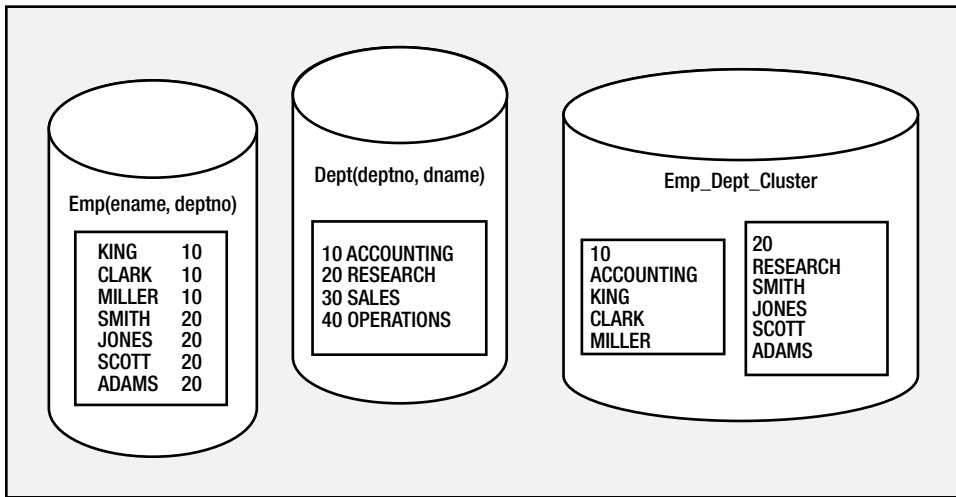

**Figure 10-8.** Index clustered data

So, let's look at how we might go about creating a clustered object. Creating a cluster of tables in the object is straightforward. The definition of the storage of the object (PCTFREE, PCTUSED, INITIAL, and so on) is associated with the CLUSTER, not the tables. This makes sense since there will be many tables in the cluster, and they will be on the same block. Having different PCTFREEs would not make sense. Therefore, a CREATE CLUSTER statement looks a lot like a CREATE TABLE statement with a small number of columns (just the cluster key columns):

```
EODA@ORA12CR1> create cluster emp_dept_cluster
 2 ( deptno number(2) )
 3 size 1024
 4 /
Cluster created.
```

Here, we have created an *index cluster* (the other type being a *hash cluster*, which we'll look at in a coming section "Hash Clustered Tables"). The clustering column for this cluster will be the DEPTNO column. The columns in the tables do not have to be called DEPTNO but they *must* be NUMBER(2) to match this definition. We have, on the cluster definition, a SIZE 1024 option. This is used to tell Oracle that we expect about 1,024 bytes of data to be associated with each cluster key value. Oracle will use that to compute the *maximum* number of cluster keys that could fit per block. Given that we have an 8KB block size, Oracle will fit up to seven cluster keys (but maybe less if the data is larger than expected) per database block. For example, the data for departments 10, 20, 30, 40, 50, 60, and 70 would tend to go onto one block, and as soon as we insert department 80, a new block will be used. This does not mean that the data is stored in a sorted manner; it just means that if we inserted the departments in that order, they would naturally tend to be put together. If we inserted the departments in the order 10, 80, 20, 30, 40, 50, 60, and then 70, the final department (70) would tend to be on the newly added block. As we'll see next, both the size of the data and the order in which the data is inserted will affect the number of keys we can store per block.

The SIZE parameter therefore controls the maximum number of cluster keys per block. It is the single largest influence on the space utilization of our cluster. Set the size too high, and we'll get very few keys per block and we'll use more space than we need. Set the size too low, and we'll get excessive chaining of data, which offsets the purpose of the cluster to store all of the data together on a single block. It is the most important parameter for a cluster.

Next, we need to index the cluster before we can put data in it. We could create tables in the cluster right now, but we're going to create and populate the tables simultaneously, and we need a cluster index *before* we can have any data. The cluster index's job is to take a cluster key value and return the block address of the block that contains that

key. It is a primary key, in effect, where each cluster key value points to a single block in the cluster itself. So, when we ask for the data in department 10, Oracle will read the cluster key, determine the block address for that, and then read the data. The cluster key index is created as follows:

```
EODA@ORA12CR1> create index emp_dept_cluster_idx
  2  on cluster emp_dept_cluster
  3  /
Index created.
```

It can have all of the normal storage parameters of an index and can be stored in another tablespace. It is just a regular index, so it can be on multiple columns; it just happens to index into a cluster and can also include an entry for a completely null value (see Chapter 11 for the reason why this is interesting). Note that we do *not* specify a list of columns in this CREATE INDEX statement—that is derived from the CLUSTER definition itself. Now we are ready to create our tables in the cluster:

```
EODA@ORA12CR1> create table dept
  2  ( deptno number(2) primary key,
  3    dname  varchar2(14),
  4    loc    varchar2(13)
  5  )
  6  cluster emp_dept_cluster(deptno)
  7  /
Table created.
```

```
EODA@ORA12CR1> create table emp
  2  ( empno   number primary key,
  3    ename   varchar2(10),
  4    job     varchar2(9),
  5    mgr     number,
  6    hiredate date,
  7    sal     number,
  8    comm    number,
  9    deptno number(2) references dept(deptno)
 10  )
 11  cluster emp_dept_cluster(deptno)
 12  /
Table created.
```

Here, the only difference from a normal table is that we used the CLUSTER keyword and told Oracle which column of the base table will map to the cluster key in the cluster itself. Remember, the cluster is the segment here, therefore this table will never have segment attributes such as TABLESPACE, PCTFREE, and so on—they are attributes of the cluster segment, not the table we just created. We can now load them up with the initial set of data:

```
EODA@ORA12CR1> insert into dept
  2  ( deptno, dname, loc )
  3  select deptno+r, dname, loc
  4     from scott.dept,
  5        (select level r from dual connect by level < 10);
36 rows created.
```

```
EODA@ORA12CR1> insert into emp
 2 (empno, ename, job, mgr, hiredate, sal, comm, deptno)
 3 select rownum, ename, job, mgr, hiredate, sal, comm, deptno+r
 4   from scott.emp,
 5      (select level r from dual connect by level < 10);
```

126 rows created.

---

■ **Note** I used a SQL trick to generate data in this example. I wanted more than seven departments to demonstrate that Oracle will limit the number of department keys per block based on my `SIZE` parameter. Therefore, I needed more than the four department rows found in `SCOTT.DEPT`. I generated nine rows using the “connect by level” trick against `DUAL` and performed a Cartesian join of those nine rows with the four in `DEPT` resulting in 36 unique rows. I did a similar trick with `EMP` to fabricate data for these departments.

---

Now that the data is loaded, let’s look at the organization of it on disk. We’ll use the `DBMS_ROWID` package to peek into the rowid and see what blocks data is stored on. Let’s first look at the `DEPT` table and see how many `DEPT` rows per block we have:

```
EODA@ORA12CR1> select min(count(*)), max(count(*)), avg(count(*))
 2   from dept
 3   group by dbms_rowid.rowid_block_number(rowid)
 4  /
```

```
MIN(COUNT(*)) MAX(COUNT(*)) AVG(COUNT(*))
-----
          1             7             6
```

So, even though we loaded `DEPT` first—and the `DEPT` rows are very small (hundreds of them could fit on an 8k block normally)—we find that the maximum number of `DEPT` rows on a block in this table is only seven. That fits in with what we anticipated when we set the `SIZE` to 1024. We estimated that with an 8k block and 1024 bytes of data per cluster key for the combined `EMP` and `DEPT` records, we would see approximately seven unique cluster key values per block, and that is exactly what we are seeing here. Next, let’s look at the `EMP` and `DEPT` tables together. We’ll look at the rowids of each and compare the block numbers after joining by `DEPTNO`. If the block numbers are the same, we’ll know that the `EMP` row and the `DEPT` row are stored on the same physical database block together if they differ we’ll know they are not. In this case, we observe that all of our data is perfectly stored. There are no cases where a record for the `EMP` table is stored on a block separate from its corresponding `DEPT` record:

```
EODA@ORA12CR1> select *
 2   from (
 3   select dept_blk, emp_blk,
 4          case when dept_blk <> emp_blk then '*' end flag,
 5          deptno
 6   from (
 7   select dbms_rowid.rowid_block_number(dept.rowid) dept_blk,
 8          dbms_rowid.rowid_block_number(emp.rowid) emp_blk,
 9          dept.deptno
10   from emp, dept
11  where emp.deptno = dept.deptno
```

```

12      )
13      )
14  where flag = '*'
15  order by deptno
16  /
no rows selected

```

That was exactly our goal—to get every row in the EMP table stored on the same block as the corresponding DEPT row. But what would have happened if we estimated incorrectly, what if 1024 was insufficient? What if some of our departments were close to 1024 and others exceeded that value? Then, obviously, the data could not fit on the same block and we’d have to place some of the EMP records on a block separate from the DEPT record. We can see this easily by resetting our prior example (I’m starting with the tables as they were before the load, right after creating them). When I load this time, we’ll load every EMP record eight times, to multiply the number of employee records per each department:

```

EODA@ORA12CR1> insert into dept
  2  ( deptno, dname, loc )
  3  select deptno+r, dname, loc
  4  from scott.dept,
  5  (select level r from dual connect by level < 10);

```

36 rows created.

```

EODA@ORA12CR1> insert into emp
  2  (empno, ename, job, mgr, hiredate, sal, comm, deptno)
  3  select rownum, ename, job, mgr, hiredate, sal, comm, deptno+r
  4  from scott.emp,
  5  (select level r from dual connect by level < 10),
  6  (select level r2 from dual connect by level < 8);

```

882 rows created.

```

EODA@ORA12CR1> select min(count(*)), max(count(*)), avg(count(*))
  2  from dept
  3  group by dbms_rowid.rowid_block_number(rowid)
  4  /

```

```

MIN(COUNT(*)) MAX(COUNT(*)) AVG(COUNT(*))
-----
          1             7             6

```

So far, it looks just like the prior example, but let’s compare the blocks the EMP records are on to the blocks the DEPT records are on:

```

EODA@ORA12CR1> select *
  2  from (
  3  select dept_blk, emp_blk,
  4  case when dept_blk <> emp_blk then '*' end flag,
  5  deptno
  6  from (
  7  select dbms_rowid.rowid_block_number(dept.rowid) dept_blk,

```

```

8      dbms_rowid.rowid_block_number(emp.rowid) emp_blk,
9      dept.deptno
10     from emp, dept
11     where emp.deptno = dept.deptno
12         )
13         )
14     where flag = '*'
15     order by deptno
16 /

```

DEPT_BLK	EMP_BLK	F	DEPTNO
24845	22362	*	12
24845	22362	*	12
24845	22362	*	12
...			
24844	22362	*	39
24844	22362	*	39
24844	22362	*	39

46 rows selected.

We can see there are 46 out of 882 EMP rows on a block separate and distinct from the block their corresponding DEPTNO is on in the DEPT table. Given that we undersized the cluster (the SIZE parameter was too small given our real life data), we could re-create it with a cluster SIZE of 1200, and then we would discover the following:

```

EODA@ORA12CR1> select min(count(*)), max(count(*)), avg(count(*))
2     from dept
3     group by dbms_rowid.rowid_block_number(rowid)
4 /

```

MIN(COUNT(*))	MAX(COUNT(*))	AVG(COUNT(*))
6	6	6

```

EODA@ORA12CR1> select *
2     from (
3     select dept_blk, emp_blk,
4           case when dept_blk <> emp_blk then '*' end flag,
5           deptno
6     from (
7     select dbms_rowid.rowid_block_number(dept.rowid) dept_blk,
8           dbms_rowid.rowid_block_number(emp.rowid) emp_blk,
9           dept.deptno
10    from emp, dept
11    where emp.deptno = dept.deptno
12        )
13        )
14    where flag = '*'
15    order by deptno
16 /

```

no rows selected

We only stored six DEPTNO values per block now, leaving sufficient room for all of the EMP data to be stored on the same block with their corresponding DEPT records.

Here is a bit of puzzle to amaze and astound your friends with. Many people mistakenly believe a rowid uniquely identifies a row in a database, and that given a rowid you can tell what table the row came from. In fact, *you cannot*. You can and will get duplicate rowids from a cluster. For example, after executing the preceding code you should find:

```
EODA@ORA12CR1> select rowid from emp
 2 intersect
 3 select rowid from dept;
```

ROWID

```
-----
AAAE+/AAEAAABErAAA
AAAE+/AAEAAABErAAB
...
AAAE+/AAGAAAFdvAAE
AAAE+/AAGAAAFdvAAF
```

36 rows selected.

Every rowid assigned to the rows in DEPT has been assigned to the rows in EMP as well. That is because it takes a table *and* row ID to uniquely identify a row. The rowid pseudo-column is unique only within a table.

I also find that many people believe the cluster object to be an esoteric object that no one really uses—everyone just uses normal tables. In fact, you use clusters every time you use Oracle. Much of the data dictionary is stored in various clusters, for example running the following as SYS:

```
SYS@ORA12CR1> break on cluster_name
SYS@ORA12CR1> select cluster_name, table_name
 2   from user_tables
 3   where cluster_name is not null
 4   order by 1;
```

CLUSTER_NAME	TABLE_NAME
C_COBJ#	CDEF\$
	CCOL\$
C_FILE#_BLOCK#	SEG\$
	UET\$
C_MLOG#	SLOG\$
	MLOG\$
C_OBJ#	LIBRARY\$
	ASSEMBLY\$
	ATTRCOL\$
	TYPE_MISC\$
	VIEWTRCOL\$
	OPQTYPE\$
	ICOL\$
	IND\$
	CLU\$
	TAB\$
	COL\$
	LOB\$



```

COLTYPE$
SUBCOLTYPE$
NTAB$
REFCON$
ICOLDEP$
C_OBJ#_INTCOL# HISTGRM$
C_RG#          RGROUP$
              RGCHILD$
C_TOID_VERSION# RESULT$
              PARAMETER$
              METHOD$
              ATTRIBUTE$
              COLLECTION$
              TYPE$
C_TS#         TS$
              FET$
C_USER#      TSQ$
              USER$
SMON_SCN_TO_TIME_AUX SMON_SCN_TIME

```

37 rows selected.

As you can see, most of the object-related data is stored in a single cluster (the C\_OBJ# cluster): 17 tables sharing the same block. It is mostly column-related information stored there, so all of the information about the set of columns of a table or index is stored physically on the same block. This makes sense, as when Oracle parses a query, it wants to have access to the data for all of the columns in the referenced table. If this data were spread all over the place, it would take a while to get it together. Here, it is on a single block typically and readily available.

When would you use a cluster? It is easier perhaps to describe when *not* to use one:

- *If you anticipate the tables in the cluster will be modified heavily:* You must be aware that an index cluster will have certain negative performance side effects on DML performance, INSERT statements in particular. It takes more work to manage the data in a cluster. The data has to be put away carefully, so it takes longer to put the data away (to insert it).
- *If you need to perform full scans of tables in clusters:* Instead of just having to full scan the data in your table, you have to full scan the data for (possibly) many tables. There is more data to scan through, so full scans will take longer.
- *If you need to partition the tables:* Tables in a cluster cannot be partitioned, nor can the cluster be partitioned.
- *If you believe you will frequently need to TRUNCATE and load the table:* Tables in clusters cannot be truncated. That is obvious—since the cluster stores more than one table on a block, you must delete the rows in a cluster table.

So, if you have data that is mostly read (that does *not* mean “never written”; it is perfectly OK to modify cluster tables) and read via indexes, either the cluster key index or other indexes you put on the tables in the cluster, and join this information together frequently, a cluster would be appropriate. Look for tables that are logically related and always used together, like the people who designed the Oracle data dictionary when they clustered all column-related information together.

## Index Clustered Tables Wrap-up

Clustered tables give you the ability to physically prejoin data together. You use clusters to store related data from many tables on the same database block. Clusters can help read-intensive operations that always join data together or access related sets of data (e.g., everyone in department 10).

Clustered tables reduce the number of blocks that Oracle must cache. Instead of keeping ten blocks for ten employees in the same department, Oracle will put them in one block and therefore increase the efficiency of your buffer cache. On the downside, unless you can calculate your `SIZE` parameter setting correctly, clusters may be inefficient with their space utilization and can tend to slow down DML-heavy operations.

## Hash Clustered Tables

*Hash clustered tables* are very similar in concept to the index clustered tables just described with one main exception: the cluster key index is replaced with a hash function. The data in the table is the index; there is no physical index. Oracle will take the key value for a row, hash it using either an internal function or one you supply, and use that to figure out where the data should be on disk. One side effect of using a hashing algorithm to locate data, however, is that you cannot range scan a table in a hash cluster without adding a conventional index to the table. In an index cluster, the query

```
select * from emp where deptno between 10 and 20
```

would be able to make use of the cluster key index to find these rows. In a hash cluster, this query would result in a full table scan unless you had an index on the `DEPTNO` column. Only exact equality searches (including `IN` lists and subqueries) may be made on the hash key without using an index that supports range scans.

In a perfect world, with nicely distributed hash key values and a hash function that distributes them evenly over all of the blocks allocated to the hash cluster, we can go straight from a query to the data with one I/O. In the real world, we will end up with more hash key values hashing to the same database block address than fit on that block. This will result in Oracle having to chain blocks together in a linked list to hold all of the rows that hash to this block. Now, when we need to retrieve the rows that match our hash key, we might have to visit more than one block.

Like a hash table in a programming language, hash tables in the database have a fixed size. When you create the table, you must determine the number of hash keys your table will have, forever. That does not limit the amount of rows you can put in there.

In Figure 10-9, we can see a graphical representation of a hash cluster with table `EMP` created in it. When the client issues a query that uses the hash cluster key in the predicate, Oracle will apply the hash function to determine which block the data should be in. It will then read that one block to find the data. If there have been many collisions, or the `SIZE` parameter to the `CREATE CLUSTER` was underestimated, Oracle will have allocated overflow blocks that are chained off the original block.

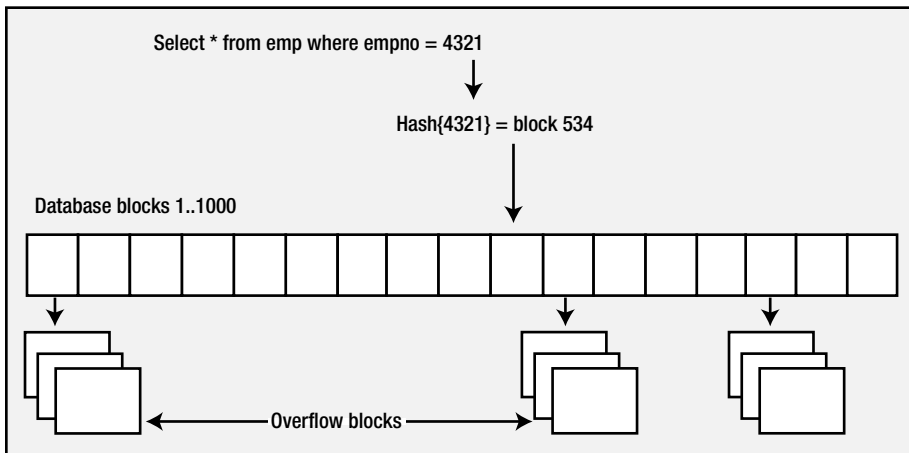

**Figure 10-9.** Depiction of a hash cluster

When you create a hash cluster, you'll use the same `CREATE CLUSTER` statement you used to create the index cluster with different options. You'll just be adding a `HASHKEYS` option to it to specify the size of the hash table. Oracle will take your `HASHKEYS` value and round it up to the nearest prime number; the number of hash keys will always be a prime. Oracle will then compute a value based on the `SIZE` parameter multiplied by the modified `HASHKEYS` value. It will allocate at least that much space in bytes for the cluster. This is a big difference from the preceding index cluster, which dynamically allocates space as it needs it. A hash cluster preallocates enough space to hold  $(\text{HASHKEYS}/\text{trunc}(\text{blocksize}/\text{SIZE}))$  bytes of data. For example, if you set your `SIZE` to 1,500 bytes and you have a 4KB block size, Oracle will expect to store two keys per block. If you plan on having 1,000 `HASHKEYS`, Oracle will allocate 500 blocks.

It is interesting to note that unlike a conventional hash table in a computer language, it is OK to have hash collisions—in fact, it is desirable in many cases. If you take the same `DEPT/EMP` example from earlier, you could set up a hash cluster based on the `DEPTNO` column. Obviously, many rows will hash to the same value, and you expect them to (they have the same `DEPTNO`). This is what the cluster is about in some respects: clustering like data together. This is why Oracle asks you to specify the `HASHKEYS` (how many department numbers you anticipate over time) and `SIZE` (what the size of the data is that will be associated with each department number). It allocates a hash table to hold `HASHKEY` number of departments of `SIZE` bytes each. What you do want to avoid is unintended hash collisions. It is obvious that if you set the size of the hash table to 1,000 (really 1,009, since the hash table size is always a prime number and Oracle rounds up for you), and you put 1,010 departments in the table, there will be at least one collision (two different departments hashing to the same value). Unintended hash collisions are to be avoided, as they add overhead and increase the probability of block chaining occurring.

To see what sort of space hash clusters take, we'll use a small utility stored procedure `SHOW_SPACE` (for details on this procedure, see the “Setting Up Your Environment” section at the beginning of the book) that we'll use in this chapter and in the next chapter. This routine just uses the `DBMS_SPACE`-supplied package to get details about the storage used by segments in the database.

Now, if we issue a `CREATE CLUSTER` statement, such as the following, we can see the storage it allocated:

```
EODA@ORA12CR1> create cluster hash_cluster
 2 ( hash_key number )
 3 hashkeys 1000
 4 size 8192
 5 tablespace mssm
 6 /
Cluster created.
```

```

EODA@ORA12CR1> exec show_space( 'HASH_CLUSTER', user, 'CLUSTER' )
Free Blocks..... 0
Total Blocks..... 1,024
Total Bytes..... 8,388,608
Total MBytes..... 8
Unused Blocks..... 14
Unused Bytes..... 114,688
Last Used Ext FileId..... 7
Last Used Ext BlockId..... 1,024
Last Used Block..... 114

```

PL/SQL procedure successfully completed.

We can see that the total number of blocks allocated to the table is 1,024. Fourteen of these blocks are unused (free). One block goes to table overhead to manage the extents. Therefore, 1,009 blocks are under the HWM of this object, and these are used by the cluster. The prime 1,009 just happens to be the next largest prime over 1,000, and since the block size is 8KB, we can see that Oracle did in fact allocate and format 1009 blocks for us. The figure is a little higher than this due to the way extents are rounded and/or by using locally managed tablespaces with uniformly sized extents.

This example points out one of the issues with hash clusters you need to be aware of. Normally, if we create an empty table, the number of blocks under the HWM for that table is 0. If we full scan it, it reaches the HWM and stops. With a hash cluster, the tables will start out big and will take longer to create, as Oracle must initialize each block, an action that normally takes place as data is added to the table. They have the potential to have data in their first block and their last block, with nothing in between. Full scanning a virtually empty hash cluster will take as long as full scanning a full hash cluster. This is not necessarily a bad thing; we built the hash cluster to have very fast access to the data by a hash key lookup. We did not build it to full scan it frequently.

Now we can start placing tables into the hash cluster in the same fashion we did with index clusters:

```

EODA@ORA12CR1> create table hashed_table
  2 ( x number, data1 varchar2(4000), data2 varchar2(4000) )
  3 cluster hash_cluster(x);
Table created.

```

To see the difference a hash cluster can make, I set up a small test. I created a hash cluster, loaded some data in it, copied this data to a regular table with a conventional index on it, and then did random reads on each table (the same “random” reads on each). Using runstats, SQL\_TRACE, and TKPROF, I was able to determine the characteristics of each. The following is the setup I performed, followed by the analysis:

```

EODA@ORA12CR1> create cluster hash_cluster
  2 ( hash_key number )
  3 hashkeys 75000
  4 size 150
  5 /
Cluster created.

```

```

EODA@ORA12CR1> create table t_hashed
  2 cluster hash_cluster(object_id)
  3 as
  4 select *
  5 from all_objects
  6 /
Table created.

```

```
EODA@ORA12CR1> alter table t_hashed add constraint
  2 t_hashed_pk primary key(object_id)
  3 /
Table altered.
```

```
EODA@ORA12CR1> begin
  2 dbms_stats.gather_table_stats( user, 'T_HASHED' );
  3 end;
  4 /
PL/SQL procedure successfully completed.
```

I created the hash cluster with a SIZE of 150 bytes. This is because I determined the average row size for a row in my table would be about 100 bytes, but would vary up and down based on the data with many rows coming in at around 150 bytes. I then created and populated a table in that cluster as a copy of ALL\_OBJECTS.

Next, I created the conventional clone of the table:

```
EODA@ORA12CR1> create table t_heap
  2 as
  3 select *
  4 from t_hashed
  5 /
Table created.
```

```
EODA@ORA12CR1> alter table t_heap add constraint
  2 t_heap_pk primary key(object_id)
  3 /
Table altered.
```

```
EODA@ORA12CR1> begin
  2 dbms_stats.gather_table_stats( user, 'T_HEAP' );
  3 end;
  4 /
PL/SQL procedure successfully completed.
```

Now, all I needed was some random data to pick rows from each of the tables with. To achieve that, I simply selected all of the OBJECT\_IDs into an array and had them sorted randomly, to hit the table all over in a scattered fashion. I used a PL/SQL package to define and declare the array and a bit of PL/SQL code to prime the array, to fill it up:

```
EODA@ORA12CR1> create or replace package state_pkg
  2 as
  3 type array is table of t_hashed.object_id%type;
  4 g_data array;
  5 end;
  6 /
Package created.
```

```
EODA@ORA12CR1> begin
  2 select object_id bulk collect into state_pkg.g_data
  3 from t_hashed
  4 order by dbms_random.random;
  5 end;
  6 /
PL/SQL procedure successfully completed.
```

To see the work performed by each, I used the following block of code (if you replace occurrences of the word HEAP with HASHED, you have the other block of code you need to test against):

```
EODA@ORA12CR1> declare
  2   l_rec t_heap%rowtype;
  3   begin
  4     for i in 1 .. state_pkg.g_data.count
  5       loop
  6         select * into l_rec from t_heap
  7           where object_id = state_pkg.g_data(i);
  8       end loop;
  9   end;
 10 /
```

PL/SQL procedure successfully completed.

Next, I ran the preceding block of code three times (and the copy of that block of code where HEAP is replaced with HASHED as well). The first run was to warm up the system, to get any hard parses out of the way. The second time I ran the blocks of code, I used runstats to see the material differences between the two: running first the hashed implementation and then the heap. The third time I ran the blocks of code, I did so with SQL\_TRACE enabled so I could see a TKPROF report. The runstats run reported the following:

```
EODA@ORA12CR1> exec runstats_pkg.rs_stop(10000);
```

```
Run1 ran in 198 cpu hsecs
Run2 ran in 206 cpu hsecs
run 1 ran in 96.12% of the time
```

Name	Run1	Run2	Diff
STAT...redo size	21,896	23,716	1,820
STAT...table scan rows gotten	0	4,611	4,611
LATCH.simulator hash latch	4,326	9,114	4,788
LATCH.cache buffers chains	145,070	217,054	71,984
STAT...Cached Commit SCN refer	72,056	0	-72,056
STAT...consistent gets pin	72,119	39	-72,080
STAT...consistent gets pin (fa	72,119	39	-72,080
STAT...no work - consistent re	72,105	24	-72,081
STAT...cluster key scans	72,105	1	-72,104
STAT...cluster key scan block	72,105	1	-72,104
STAT...rows fetched via callba	18	72,123	72,105
STAT...table fetch by rowid	18	72,123	72,105
STAT...index fetch by key	19	72,126	72,107
STAT...buffer is not pinned co	72,141	216,354	144,213
STAT...session logical reads	72,320	216,554	144,234
STAT...consistent gets	72,175	216,419	144,244
STAT...consistent gets from ca	72,175	216,419	144,244
STAT...consistent gets examina	56	216,380	216,324
STAT...consistent gets examina	56	216,380	216,324
STAT...session pga memory	262,144	-65,536	-327,680
STAT...logical read bytes from	592,445,440	1,774,010,368	1,181,564,928

```
Run1 latches total versus runs -- difference and pct
Run1          Run2          Diff          Pct
223,979       299,841          75,862       74.70%
```

PL/SQL procedure successfully completed.

Now, these two simulations ran in about the same amount of time by the CPU clock. The material difference to note, however, is the large reduction in cache buffers chains latches. The first implementation (hashed) used significantly fewer, meaning the hashed implementation should scale better in a read-intensive environment, since it needs fewer resources that require some level of serialization. This was due entirely to the fact that the I/O needed by the hashed implementation was significantly reduced over the HEAP table—you can see the statistic consistent gets in that report bears this out. The TKPROF shows it even more clearly:

```
SELECT * FROM T_HASHED WHERE OBJECT_ID = :B1
```

call	count	cpu	elapsed	disk	query	current	rows
Parse	1	0.00	0.00	0	0	0	0
Execute	72105	0.75	0.75	0	2	0	0
Fetch	72105	0.74	0.71	0	72105	0	72105
total	144211	1.50	1.47	0	72107	0	72105

...

```
Rows (1st) Rows (avg) Rows (max) Row Source Operation
```

```
-----
1          1          1 TABLE ACCESS HASH T_HASHED (cr=1 pr=0 pw=0 time=19 us)
```

```
*****
```

```
SELECT * FROM T_HEAP WHERE OBJECT_ID = :B1
```

call	count	cpu	elapsed	disk	query	current	rows
Parse	1	0.00	0.00	0	0	0	0
Execute	72105	0.81	0.81	0	0	0	0
Fetch	72105	0.75	0.74	0	216315	0	72105
total	144211	1.56	1.55	0	216315	0	72105

...

```
Rows (1st) Rows (avg) Rows (max) Row Source Operation
```

```
-----
1          1          1 TABLE ACCESS BY INDEX ROWID T_HEAP (cr=3 pr=0 pw=0 ...
```

```
1          1          1 INDEX UNIQUE SCAN T_HEAP_PK (cr=2 pr=0 pw=0 time=14...
```

The HASHED implementation simply converted the OBJECT\_ID passed into the query into a FILE/BLOCK to be read and read it—no index. The HEAP table, however, had to do two I/Os on the index for each row. The cr=2 in the TKPROF Row Source Operation line shows us exactly how many consistent reads were done against the index. Each time I looked up OBJECT\_ID = :B1, Oracle had to get the root block of the index and then find the leaf block containing the location of that row. Then, I had to take the leaf block information, which included the ROWID of that row, and access that row in the table for a third I/O. The HEAP table did three times the I/O of the HASHED implementation.

The points of interest here are as follows:

- The hash cluster did significantly less I/O (query column). This is what we anticipated. The query simply took the random `OBJECT_IDs`, performed the hash on them, and went to the block. The hash cluster has to do at least one I/O to get the data. The conventional table with an index had to perform index scans followed by a table access by rowid to get the same answer. The indexed table has to do at least three I/Os in this case to get the data.
- The hash cluster query took the same amount of CPU for all intents and purposes, even though it went to the buffer cache one-third as many times. This, too, could be anticipated. The act of performing a hash is very CPU-intensive. The act of performing an index lookup is I/O-intensive. It was a tradeoff. However, as we scale up users, we would expect the hash cluster query to scale better, as it has to get in line to access the buffer cache less frequently.

This last point is the important one. When working with computers, it is all about resources and their utilization. If we are I/O bound and perform queries that do lots of keyed reads like I just did, a hash cluster may improve performance. If we are already CPU bound, a hash cluster may possibly decrease performance since it needs more CPU horsepower to hash. However, if the extra CPU we are burning is due to spinning on cache buffers chains latches, the hash cluster could significantly reduce the CPU needed. This is one of the major reasons why rules of thumb do not work on real-world systems: what works for you might not work for others in similar but different conditions.

There is a special case of a hash cluster called a *single table hash cluster*. This is an optimized version of the general hash cluster we've already looked at. It supports only one table in the cluster at a time (you have to `DROP` the existing table in a single table hash cluster before you can create another). Additionally, if there is a one-to-one mapping between hash keys and data rows, the access to the rows is somewhat faster as well. These hash clusters are designed for those occasions when you want to access a table by primary key and do not care to cluster other tables with it. If you need fast access to an employee record by `EMPNO`, a single table hash cluster might be called for. I did the preceding test on a single table hash cluster as well and found the performance to be even better than just a hash cluster. You could even go a step further with this example and take advantage of the fact that Oracle will allow you to write your own specialized hash function (instead of using the default one provided by Oracle). You are limited to using only the columns available in the table, and you may use only the Oracle built-in functions (e.g., no PL/SQL code) when writing these hash functions. By taking advantage of the fact that `OBJECT_ID` is a number between 1 and 75,000 in the preceding example, I made my hash function simply be the `OBJECT_ID` column itself. In this fashion, I am guaranteed to never have a hash collision. Putting it all together, I'll create a single table hash cluster with my own hash function via:

```
EODA@ORA12CR1> create cluster hash_cluster
 2 ( hash_key number(10) )
 3 hashkeys 75000
 4 size 150
 5 single table
 6 hash is HASH_KEY
 7 /
Cluster created.
```

I've simply added the key words `SINGLE TABLE` to make it a single table hash cluster. My `HASH IS` clause uses the `HASH_KEY` cluster key in this case. This is a SQL function, so I could have used `trunc(mod(hash_key/324+278,555)/abs(hash_key+1))` if I wanted (not that this is a good hash function—it just demonstrates that we can use a complex function there if we wish). I used a `NUMBER(10)` instead of just a number. Since the hash value must be an integer, it cannot have any fractional components. Then, I create the table in that cluster to build the hashed table:

```
EODA@ORA12CR1> create table t_hashed
 2 cluster hash_cluster(object_id)
 3 as
 4 select OWNER, OBJECT_NAME, SUBOBJECT_NAME,
 5        cast( OBJECT_ID as number(10) ) object_id,
```



```

6      DATA_OBJECT_ID, OBJECT_TYPE, CREATED,
7      LAST_DDL_TIME, TIMESTAMP, STATUS, TEMPORARY,
8      GENERATED, SECONDARY
9  from all_objects
10 /
Table created.

```

Note the use of the CAST built-in function to make the data type of OBJECT\_ID be what it must be. I ran the test as before (three runs of each block), and this time the runstats output was consistently even more positive:

```

Run1 ran in 183 cpu hsecs
Run2 ran in 195 cpu hsecs
run 1 ran in 93.85% of the time

```

Name	Run1	Run2	Diff
STAT...Cached Commit SCN refer	42,970	0	-42,970
LATCH.cache buffers chains	165,638	216,945	51,307
STAT...cluster key scans	72,105	1	-72,104
STAT...table fetch by rowid	13	72,118	72,105
STAT...rows fetched via callba	13	72,118	72,105
STAT...index fetch by key	14	72,121	72,107
STAT...consistent gets pin (fa	82,562	39	-82,523
STAT...consistent gets pin	82,562	39	-82,523
STAT...cluster key scan block	82,548	1	-82,547
STAT...buffer is not pinned co	82,574	216,344	133,770
STAT...session logical reads	82,732	216,516	133,784
STAT...consistent gets	82,603	216,404	133,801
STAT...consistent gets from ca	82,603	216,404	133,801
STAT...session pga memory	0	196,608	196,608
STAT...consistent gets examina	41	216,365	216,324
STAT...consistent gets examina	41	216,365	216,324
STAT...logical read bytes from	677,740,544	1,773,699,072	1,095,958,528

```

Run1 latches total versus runs -- difference and pct
Run1          Run2          Diff          Pct
244,074      299,493          55,419      81.50%

```

PL/SQL procedure successfully completed.

This single table hash cluster required even less latching into the buffer cache to process (it can stop looking for data sooner, and it has more information). As a result, the TKPROF report shows a measurable decrease in CPU utilization this time around:

```
SELECT * FROM T_HASHED WHERE OBJECT_ID = :B1
```

call	count	cpu	elapsed	disk	query	current	rows
Parse	1	0.00	0.00	0	0	0	0
Execute	72105	0.70	0.70	0	2	0	0
Fetch	72105	0.63	0.64	0	82548	0	72105
total	144211	1.33	1.35	0	82550	0	72105
...							

```

Rows (1st) Rows (avg) Rows (max) Row Source Operation
-----
      1          1          1 TABLE ACCESS HASH T_HASHED (cr=1 pr=0 pw=0 time=25 us)
*****
SELECT * FROM T_HEAP WHERE OBJECT_ID = :B1

call      count          cpu    elapsed        disk      query    current     rows
-----
Parse           1         0.00       0.00          0          0          0          0
Execute    72105         0.87       0.84          0          0          0          0
Fetch     72105         0.70       0.71          0     216315          0     72105
-----
total    144211         1.58       1.55          0     216315          0     72105
...
Rows (1st) Rows (avg) Rows (max) Row Source Operation
-----
      1          1          1 TABLE ACCESS BY INDEX ROWID T_HEAP (cr=3 pr=0 pw=0 time=22...
      1          1          1 INDEX UNIQUE SCAN T_HEAP_PK (cr=2 pr=0 pw=0 ...)

```

## Hash Clustered Tables Wrap-up

That is the nuts and bolts of a hash cluster. Hash clusters are similar in concept to index clusters, except a cluster index is not used. *The data is the index* in this case. The cluster key is hashed into a block address and the data is expected to be there. The important things to understand about hash clusters are as follows:

- The hash cluster is allocated right from the beginning. Oracle will take your `HASHKEYS/trunc(blocksize/SIZE)` and allocate and format that space right away. As soon as the first table is put in that cluster, any full scan will hit every allocated block. This is different from every other table in this respect.
- The number of `HASHKEYS` in a hash cluster is a fixed size. You cannot change the size of the hash table without a rebuild of the cluster. This does not in any way limit the amount of data you can store in this cluster; it simply limits the number of unique hash keys that can be generated for this cluster. This may affect performance due to unintended hash collisions if the value was set too low.
- Range scanning on the cluster key is not available. Predicates such as `WHERE cluster_key BETWEEN 50 AND 60` cannot use the hashing algorithm. There are an infinite number of possible values between 50 and 60, and the server would have to generate them all to hash each one and see if there was any data there. This is not possible. The cluster will be full scanned if you use a range on a cluster key and have not indexed it using a conventional index.

Hash clusters are suitable in the following situations:

- You know with a good degree of accuracy how many rows the table will have over its life, or you have some reasonable upper bound. Getting the size of the HASHKEYS and SIZE parameters right is crucial to avoid a rebuild.
- DML, especially inserts, is light with respect to retrieval. This means you have to balance optimizing data retrieval with new data creation. Light inserts might be 100,000 per unit of time for one person and 100 per unit of time for another—all depending on their data retrieval patterns. Updates do not introduce significant overhead, unless you update the HASHKEY, which would not be a good idea as it would cause the row to migrate.
- You access the data by the HASHKEY value constantly. For example, say you have a table of parts, and these parts are accessed by part number. Lookup tables are especially appropriate for hash clusters.

## Sorted Hash Clustered Tables

Sorted hash clusters are available in Oracle 10g and above. They combine the qualities of the hash cluster just described with those of an IOT. They are most appropriate when you constantly retrieve data using a query similar to this:

```
Select *
  From t
 Where KEY=:x
 Order by SORTED_COLUMN
```

That is, you retrieve the data by some key and need that data ordered by some other column. Using a sorted hash cluster, Oracle can return the data without performing a sort at all. It accomplishes this by storing the data upon insert in sorted order physically—by key. Suppose you have a customer order table:

```
EODA@ORA12CR1> select cust_id, order_dt, order_number
2 from cust_orders
3 order by cust_id, order_dt;
```

CUST_ID	ORDER_DT	ORDER_NUMBER
1	31-MAR-05 09.13.57.000000 PM	21453
	11-APR-05 08.30.45.000000 AM	21454
	28-APR-05 06.21.09.000000 AM	21455
2	08-APR-05 03.42.45.000000 AM	21456
	19-APR-05 08.59.33.000000 AM	21457
	27-APR-05 06.35.34.000000 AM	21458
	30-APR-05 01.47.34.000000 AM	21459

7 rows selected.

The table is stored in a sorted hash cluster, whereby the HASH key is CUST\_ID and the field to sort on is ORDER\_DT. Graphically, it might look like Figure 10-10, where 1, 2, 3, 4, ... represent the records stored sorted on each block.

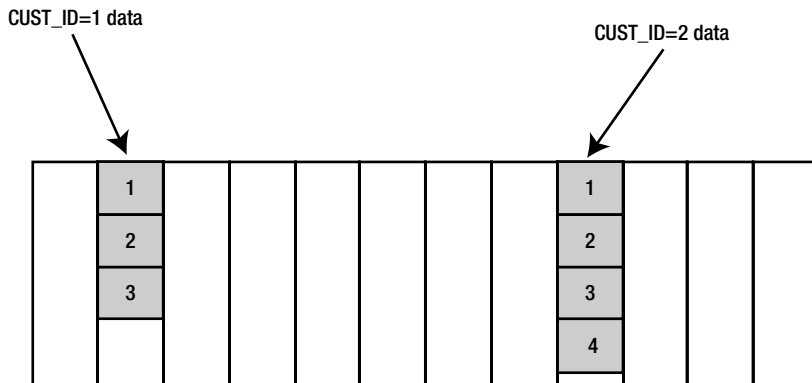

**Figure 10-10.** Depiction of a sorted hash cluster

Creating a sorted hash cluster is much the same as the other clusters. To set up a sorted hash cluster capable of storing the preceding data, we could use the following:

```
EODA@ORA12CR1> CREATE CLUSTER shc
 2 (
 3   cust_id    NUMBER,
 4   order_dt   timestamp SORT
 5 )
 6 HASHKEYS 10000
 7 HASH IS cust_id
 8 SIZE 8192
 9 /
Cluster created.
```

We've introduced a new keyword here: **SORT**. When we created the cluster, we identified the **HASH IS CUST\_ID** and we added an **ORDER\_DT** of type **timestamp** with the keyword **SORT**. This means the data will be located by **CUST\_ID** (where **CUST\_ID=:x**) and physically retrieved sorted by **ORDER\_DT**. Technically, it really means we'll store some data that will be retrieved via a **NUMBER** column and sorted by the **TIMESTAMP**. The column names here are not relevant, as they were not in the **B\*Tree** or **HASH** clusters, but convention would have us name them after what they represent.

The **CREATE TABLE** statement for our **CUST\_ORDERS** table would look like this:

```
EODA@ORA12CR1> CREATE TABLE cust_orders
 2 ( cust_id    number,
 3   order_dt   timestamp SORT,
 4   order_number number,
 5   username   varchar2(30),
 6   ship_addr  number,
 7   bill_addr  number,
 8   invoice_num number
 9 )
10 CLUSTER shc ( cust_id, order_dt )
11 /
Table created.
```

We've mapped the CUST\_ID column of this table to the hash key for the sorted hash cluster and the ORDER\_DT column to the SORT column. We can observe using AUTOTRACE in SQL\*Plus that the normal sort operations we expect are missing when accessing the sorted hash cluster:

```
EODA@ORA12CR1> set autotrace traceonly explain
EODA@ORA12CR1> variable x number
EODA@ORA12CR1> select cust_id, order_dt, order_number
 2   from cust_orders
 3  where cust_id = :x
 4  order by order_dt;
```

Id	Operation	Name	Rows	Bytes	Cost (%CPU)	Time
0	SELECT STATEMENT		1	39	1 (0)	00:00:01
* 1	TABLE ACCESS HASH	CUST_ORDERS	1	39	1 (0)	00:00:01

```
EODA@ORA12CR1> select job, hiredate, empno
 2   from scott.emp
 3  where job = 'CLERK'
 4  order by hiredate;
```

Id	Operation	Name	Rows	Bytes	Cost (%CPU)	Time
0	SELECT STATEMENT		4	112	2 (0)	00:00:01
1	SORT ORDER BY		4	112	2 (0)	00:00:01
2	TABLE ACCESS BY INDEX ROWID BATCHED	EMP	4	112	2 (0)	00:00:01
* 3	INDEX RANGE SCAN	JOB_IDX	4		1 (0)	00:00:01

```
EODA@ORA12CR1> set autotrace off
```

I added the query against the normal SCOTT.EMP table (after indexing the JOB column for this demonstration) to compare what we normally expect to see: the SCOTT.EMP query plan versus what the sorted hash cluster can do for us when we want to access the data in a FIFO mode (like a queue). As you can see, the sorted hash cluster has one step: it takes the CUST\_ID=:X, hashes the input, finds the first row, and just starts reading the rows, as they are in order already. The regular table is much different: it finds all of the JOB='CLERK' rows (which could be anywhere in that heap table), sorts them, and then returns the first one.

So, the sorted hash cluster has all the retrieval aspects of the hash cluster, in that it can get to the data without having to traverse an index, and many of the features of the IOT, in that the data will be sorted within that key by some field of your choice. This data structure works well when the input data arrives in order by the sort field, by key. That is, over time the data arrives in increasing sort order for any given key value. Stock information fits this requirement as an example. Every night you get a new file full of stock symbols, the date (the date would be the sort key and the stock symbol would be the hash key), and related information. You receive and load this data in sort key order. The stock data for stock symbol ORCL for yesterday does not arrive after today—you would load yesterday's value, and then today's value, and later tomorrow's value. If the information arrives randomly (not in sort order), this data structure quickly breaks down during the insert process, as much data has to be moved to put the rows physically in order on disk. A sorted hash cluster is not recommended in that case (an IOT, on the other hand, could well be useful for that data).

When considering using this structure, you should employ the same considerations from the hash cluster section, in addition to the constraint that the data should arrive sorted for each key value over time.

## Nested Tables

Nested tables are part of the object-relational extensions to Oracle. A nested table, one of the two collection types in Oracle, is very similar to a child table in a traditional parent/child table pair in the relational model. It is an unordered set of data elements, all of the same data type, which could be either a built-in data type or an object data type. It goes one step further, however, since it is designed to give the illusion that each row in the parent table has its *own* child table. If there are 100 rows in the parent table, then there are *virtually* 100 nested tables. Physically, there is only the single parent and the single child table. There are large syntactic and semantic differences between nested tables and parent/child tables as well, and we'll look at those in this section.

There are two ways to use nested tables. One is in your PL/SQL code as a way to extend the PL/SQL language. The other is as a physical storage mechanism for persistent storage of collections. I use them in PL/SQL all of the time, but I have never used them as a permanent storage mechanism.

In this section, I'll briefly introduce the syntax to create, query, and modify nested tables. Then we'll look at some of the implementation details and what is important to know about how Oracle really stores nested tables.

## Nested Tables Syntax

The creation of a table with a nested table is fairly straightforward—it is the syntax for manipulating them that gets a little complex. Let's use the simple EMP and DEPT tables to demonstrate. We're familiar with that little data model that is implemented relationally as follows

```
EODA@ORA12CR1> create table dept
  2  (deptno number(2) primary key,
  3   dname   varchar2(14),
  4   loc     varchar2(13)
  5  );
```

Table created.

```
EODA@ORA12CR1> create table emp
  2  (empno   number(4) primary key,
  3   ename   varchar2(10),
  4   job     varchar2(9),
  5   mgr     number(4) references emp,
  6   hiredate date,
  7   sal     number(7, 2),
  8   comm    number(7, 2),
  9   deptno  number(2) references dept
 10 );
```

Table created.

with primary and foreign keys. We'll do the equivalent implementation using a nested table for the EMP table:

```
EODA@ORA12CR1> create or replace type emp_type
  2  as object
  3  (empno   number(4),
  4   ename   varchar2(10),
  5   job     varchar2(9),
```

```

6  mgr          number(4),
7  hiredate    date,
8  sal         number(7, 2),
9  comm        number(7, 2)
10 );
11 /

```

Type created.

```

EODA@ORA12CR1> create or replace type emp_tab_type
2  as table of emp_type
3  /

```

Type created.

To create a table with a nested table, we need a nested table type. The preceding code creates a complex object type, EMP\_TYPE, and a nested table type of that, EMP\_TAB\_TYPE. In PL/SQL, this will be treated much like an array would. In SQL, it will cause a physical nested table to be created. Here is the simple CREATE TABLE statement that uses it:

```

EODA@ORA12CR1> create table dept_and_emp
2  (deptno number(2) primary key,
3   dname   varchar2(14),
4   loc     varchar2(13),
5   emps    emp_tab_type
6  )
7  nested table emps store as emps_nt;

```

Table created.

```

EODA@ORA12CR1> alter table emps_nt add constraint
2  emps_empno_unique unique(empno)
3  /

```

Table altered.

The important part of this CREATE TABLE statement is the inclusion of the column EMPS of EMP\_TAB\_TYPE and the corresponding NESTED TABLE EMPS STORE AS EMPS\_NT. This created a real physical table, EMPS\_NT, separate from and in addition to the table DEPT\_AND\_EMP. We add a constraint on the EMPNO column directly on the nested table to make the EMPNO unique as it was in our original relational model. We cannot implement our full data model; however, there is the self-referencing constraint:

```

EODA@ORA12CR1> alter table emps_nt add constraint mgr_fk
2  foreign key(mgr) references emps_nt(empno);
alter table emps_nt add constraint mgr_fk
*
ERROR at line 1:
ORA-30730: referential constraint not allowed on nested table column

```

This will simply not work. Nested tables do not support referential integrity constraints, as they cannot reference any other table—even themselves. So, we'll just skip that requirement for this demonstration (something you cannot do in real life). Next, we'll populate this table with the existing EMP and DEPT data:

```
EODA@ORA12CR1> insert into dept_and_emp
 2  select dept.*,
 3     CAST( multiset( select empno, ename, job, mgr, hiredate, sal, comm
 4                   from SCOTT.EMP
 5                   where emp.deptno = dept.deptno ) AS emp_tab_type )
 6  from SCOTT.DEPT
 7  /
4 rows created.
```

There are two things to notice here:

- Only four rows were created. There are really only four rows in the DEPT\_AND\_EMP table. The 14 EMP rows don't exist independently.
- The syntax is getting pretty exotic. CAST and MULTISET are syntax most people have never used. You will find lots of exotic syntax when dealing with object-relational components in the database. The MULTISET keyword is used to tell Oracle the subquery is expected to return more than one row (subqueries in a SELECT list have previously been limited to returning one row). The CAST is used to instruct Oracle to treat the returned set as a collection type. In this case, we CAST the MULTISET to be a EMP\_TAB\_TYPE. CAST is a general-purpose routine not limited to use in collections. For example, if we wanted to fetch the EMPNO column from EMP as a VARCHAR2(20) instead of a NUMBER(4) type, we may use the query select cast( empno as VARCHAR2(20) ) e from emp.

We're now ready to query the data. Let's see what one row might look like this:

```
EODA@ORA12CR1> select deptno, dname, loc, d.emps AS employees
 2  from dept_and_emp d
 3  where deptno = 10
 4  /
```

DEPTNO	DNAME	LOC	EMPLOYEES(EMPNO, ENAME, JOB,
10	ACCOUNTING	NEW YORK	EMP_TAB_TYPE(EMP_TYPE(7782, 'CLARK', 'MANAGER', 7839, '09-JUN-81', 2450, NULL), EMP_TYPE(7839, 'KING', 'PRESIDENT', NULL, '17-NOV-81', 5000, NULL), EMP_TYPE(7934, 'MILLER', 'CLERK', 7782, '23-JAN-82', 1300, NULL))

All of the data is there in a single column. Most applications, unless they are specifically written for the object-relational features, will not be able to deal with this particular column. For example, ODBC doesn't have a way to deal with a nested table (JDBC, OCI, Pro\*C, PL/SQL, and most other APIs and languages do). For those cases, Oracle provides a way to un-nest a collection and treat it much like a relational table:

```
EODA@ORA12CR1> select d.deptno, d.dname, emp.*
 2  from dept_and_emp D, table(d.emps) emp
 3  /
```



DEPTNO	DNAME	EMPNO	ENAME	JOB	MGR	HIREDATE	SAL	COMM
10	ACCOUNTING	7782	CLARK	MANAGER	7839	09-JUN-81	2450	
10	ACCOUNTING	7839	KING	PRESIDENT		17-NOV-81	5000	
10	ACCOUNTING	7934	MILLER	CLERK	7782	23-JAN-82	1300	
20	RESEARCH	7369	SMITH	CLERK	7902	17-DEC-80	800	
20	RESEARCH	7566	JONES	MANAGER	7839	02-APR-81	2975	
20	RESEARCH	7788	SCOTT	ANALYST	7566	09-DEC-82	3000	
20	RESEARCH	7876	ADAMS	CLERK	7788	12-JAN-83	1100	
20	RESEARCH	7902	FORD	ANALYST	7566	03-DEC-81	3000	
30	SALES	7499	ALLEN	SALESMAN	7698	20-FEB-81	1600	300
30	SALES	7521	WARD	SALESMAN	7698	22-FEB-81	1250	500
30	SALES	7654	MARTIN	SALESMAN	7698	28-SEP-81	1250	1400
30	SALES	7698	BLAKE	MANAGER	7839	01-MAY-81	2850	
30	SALES	7844	TURNER	SALESMAN	7698	08-SEP-81	1500	0
30	SALES	7900	JAMES	CLERK	7698	03-DEC-81	950	

14 rows selected.

We are able to cast the EMPS column as a table and it naturally did the join for us—no join conditions were needed. In fact, since our EMP type doesn't have the DEPTNO column, there is nothing for us apparently to join on. Oracle takes care of that nuance for us.

So, how can we update the data? Let's say we want to give department 10 a \$100 bonus. We would code the following:

```
EODA@ORA12CR1> update
 2  table( select emps
 3          from dept_and_emp
 4          where deptno = 10
 5          )
 6  set comm = 100
 7  /
3 rows updated.
```

Here is where the “virtually a table for every row” comes into play. In the SELECT predicate shown earlier, it may not have been obvious that there was a table per row, especially since the joins and such aren't there; it looks a little like magic. The UPDATE statement, however, shows that there is a table per row. We selected a discrete table to UPDATE—this table has no name, only a query to identify it. If we use a query that does not SELECT *exactly* one table, we will receive the following:

```
EODA@ORA12CR1> update
 2  table( select emps
 3          from dept_and_emp
 4          where deptno = 1
 5          )
 6  set comm = 100
 7  /
update
*
ERROR at line 1:
ORA-22908: reference to NULL table value
```

```

EODA@ORA12CR1> update
 2  table( select emps
 3          from dept_and_emp
 4          where deptno > 1
 5          )
 6  set comm = 100
 7  /
table( select emps
      *

```

```

ERROR at line 2:
ORA-01427: single-row subquery returns more than one row

```

If we return fewer than one row (one nested table instance), the update fails. Normally an update of zero rows is OK, but not in this case—it returns an error the same as if we left the table name off a regular table update. If we return more than one row (more than one nested table instance), the update fails. Normally an update of many rows is perfectly OK. This shows that Oracle considers each row in the DEPT\_AND\_EMP table to point to another table, not just another set of rows as the relational model does.

This is the semantic difference between a nested table and a parent/child relational table. In the nested table model, there is one table per parent row. In the relational model, there is one set of rows per parent row. This difference can make nested tables somewhat cumbersome to use at times. Consider this model we are using, which provides a very nice view of the data from the perspective of a single department. It is a terrible model if we want to ask questions like “What department does KING work for?,” “How many accountants do we have working for us?,” and so on. These questions are best asked of the EMP relational table, but in this nested table model we can only access the EMP data via the DEPT data. We must always join; we cannot query the EMP data alone. Well, we can’t do it in a supported, documented method, but we can use a trick (more on this trick later). If we needed to update every row in the EMPS\_NT, we would have to do four updates: one each for the rows in DEPT\_AND\_EMP to update the virtual table associated with each row.

Another thing to consider is that when we updated the employee data for department 10, we were semantically updating the EMPS column in the DEPT\_AND\_EMP table. We understand that physically there are two tables involved, but semantically there is only one. Even though we updated no data in the DEPT table, the row that contains the nested table we did modify is locked from update by other sessions. In a traditional parent/child table relationship, this would not be the case.

These are the reasons why I tend to stay away from nested tables as a persistent storage mechanism. It is the *rare* child table that is not queried stand-alone. In the preceding example, the EMP table should be a strong entity. It stands alone, so it needs to be queried alone. I find this to be the case almost all of the time. I tend to use nested tables via views on relational tables.

So, now that we have seen how to update a nested table instance, inserting and deleting are pretty straightforward. Let’s add a row to the nested table instance department 10 and remove a row from department 20:

```

EODA@ORA12CR1> insert into table
 2  ( select emps from dept_and_emp where deptno = 10 )
 3  values
 4  ( 1234, 'NewEmp', 'CLERK', 7782, sysdate, 1200, null );
1 row created.

```

```

EODA@ORA12CR1> delete from table
 2  ( select emps from dept_and_emp where deptno = 20 )
 3  where ename = 'SCOTT';
1 row deleted.

```

```
EODA@ORA12CR1> select d.dname, e.empno, ename, deptno
  2   from dept_and_emp d, table(d.emps) e
  3   where d.deptno in ( 10, 20 );
```

DNAME	EMPNO	ENAME	DEPTNO
ACCOUNTING	7782	CLARK	10
ACCOUNTING	7839	KING	10
ACCOUNTING	7934	MILLER	10
ACCOUNTING	1234	NewEmp	10
RESEARCH	7369	SMITH	20
RESEARCH	7566	JONES	20
RESEARCH	7876	ADAMS	20
RESEARCH	7902	FORD	20

8 rows selected.

That is the basic syntax of how to query and modify nested tables. You will find that you often need to un-nest these tables as we just did, especially in queries, to make use of them. Once you conceptually visualize the “virtual table per row” concept, working with nested tables becomes much easier.

Previously I stated, “We must always join; we cannot query the EMP data alone,” but then I followed that up with a caveat: “You can if you really need to.” It is not documented heavily; use this approach *only* as a last ditch method. Where it will come in most handy is if you ever need to mass update the nested table (remember, you would have to do that through the DEPT table with a join). There is an underdocumented hint (it is mentioned briefly and not fully documented), `NESTED_TABLE_GET_REFS`, which is used by various tools (including the deprecated EXP and IMP utilities) to deal with nested tables. It is also a way to see a little more about the physical structure of the nested tables. If you use this hint, you can query to get some “magical” results. The following query is what EXP (a data unload utility) uses to extract the data from this nested table:

```
EODA@ORA12CR1> SELECT /*+NESTED_TABLE_GET_REFS*/
  2 NESTED_TABLE_ID,SYS_NC_ROWINFO$ FROM "EODA"."EMPS_NT";
```

NESTED_TABLE_ID	SYS_NC_ROWINFO\$(EMPNO, ENAME, JOB, MGR, HIREDATE,
EF6CDA23E32D315AE043B7D04F0AA620	EMP_TYPE(7782, 'CLARK', 'MANAGER', 7839, '09-JUN-81', 2450, 100)
EF6CDA23E32D315AE043B7D04F0AA620	EMP_TYPE(7839, 'KING', 'PRESIDENT', NULL, '17-NOV-81', 5000, 100)
...	

Well, this is somewhat surprising, if you describe this table:

```
EODA@ORA12CR1> desc emps_nt
```

Name	Null?	Type
EMPNO		NUMBER(4)
ENAME		VARCHAR2(10)
JOB		VARCHAR2(9)
MGR		NUMBER(4)
HIREDATE		DATE
SAL		NUMBER(7,2)
COMM		NUMBER(7,2)

These two columns don't even show up. They are part of the hidden implementation of nested tables. The NESTED\_TABLE\_ID is really a foreign key to the parent table DEPT\_AND\_EMP. DEPT\_AND\_EMP actually has a hidden column in it that is used to join to EMPS\_NT. The SYS\_NC\_ROWINFO\$ column is a magic column; it is more of a function than a column. The nested table here is really an object table (it is made of an object type), and SYS\_NC\_ROWINFO\$ is the internal way Oracle references the row as an object, instead of referencing each of the scalar columns. Under the covers, all Oracle has done for us is implement a parent/child table with system-generated primary and foreign keys. If we dig a little deeper, we can query the real data dictionary to see all of the columns in the DEPT\_AND\_EMP table:

```
EODA@ORA12CR1> select name
 2  from sys.col$
 3  where obj# = ( select object_id
 4    from dba_objects
 5    where object_name = 'DEPT_AND_EMP'
 6    and owner = 'EODA' )
 7  /
```

NAME

```
-----
DEPTNO
DNAME
EMPS
LOC
SYS_NC0000400005$
```

Selecting this column out from the nested table, we'll see something like this:

```
EODA@ORA12CR1> select SYS_NC0000400005$ from dept_and_emp;
```

```
SYS_NC0000400005$
-----
EF6CDA23E32D315AE043B7D04F0AA620
EF6CDA23E32E315AE043B7D04F0AA620
EF6CDA23E32F315AE043B7D04F0AA620
EF6CDA23E330315AE043B7D04F0AA620
```

The weird-looking column name, SYS\_NC0000400005\$, is the system-generated key placed into the DEPT\_AND\_EMP table. If we dig even deeper, we will find that Oracle has placed a unique index on this column. Unfortunately, however, it neglected to index the NESTED\_TABLE\_ID in EMPS\_NT. This column really needs to be indexed, as we are always joining *from* DEPT\_AND\_EMP *to* EMPS\_NT. This is an important thing to remember about nested tables if you use them with all of the defaults as just done: *always index* the NESTED\_TABLE\_ID in the nested tables!

I've gotten off track, though, at this point—I was talking about how to treat the nested table as if it were a real table. The NESTED\_TABLE\_GET\_REFS hint does that for us. We can use the hint like this:

```
EODA@ORA12CR1> select /*+ nested_table_get_refs */ empno, ename
 2  from emps_nt where ename like '%A%';
```

```
EMPNO ENAME
-----
7782 CLARK
7876 ADAMS
7499 ALLEN
7521 WARD
```

```

7654 MARTIN
7698 BLAKE
7900 JAMES
7 rows selected.

```

```

EODA@ORA12CR1> update /*+ nested_table_get_refs */ emps_nt set ename = initcap(ename);
14 rows updated.

```

```

EODA@ORA12CR1> select /*+ nested_table_get_refs */ empno, ename
2 from emps_nt where ename like '%a%';

```

```

EMPNO ENAME
-----
7782 Clark
7876 Adams
7521 Ward
7654 Martin
7698 Blake
7900 James
6 rows selected.

```

Again, this is not a thoroughly documented and supported feature. It has a specific functionality for EXP and IMP to work. This is the only environment it is assured to work in. Use it at your own risk, and resist putting it into production code. In fact, if you find you *need to use it*, then by definition you didn't mean to use a nested table at all! It is the wrong construct for you. Use it for one-off fixes of data or to see what is in the nested table out of curiosity. The supported way to report on the data is to un-nest it like this:

```

EODA@ORA12CR1> select d.deptno, d.dname, emp.*
2 from dept_and_emp D, table(d.emps) emp
3 /

```

This is what you should use in queries and production code.

## Nested Table Storage

We have already seen some of the storage of the nested table structure. In this section, we'll take an in-depth look at the structure created by Oracle by default and what control we have over it. Working with the same CREATE statement as before

```

EODA@ORA12CR1> create table dept_and_emp
2 (deptno number(2) primary key,
3  dname   varchar2(14),
4  loc     varchar2(13),
5  emps    emp_tab_type
6 )
7 nested table emps store as emps_nt;
Table created.

```

```

EODA@ORA12CR1> alter table emps_nt add constraint
2 emps_empno_unique unique(empno)
3 /
Table altered.

```

we know that Oracle really creates a structure like the one shown in Figure 10-11.

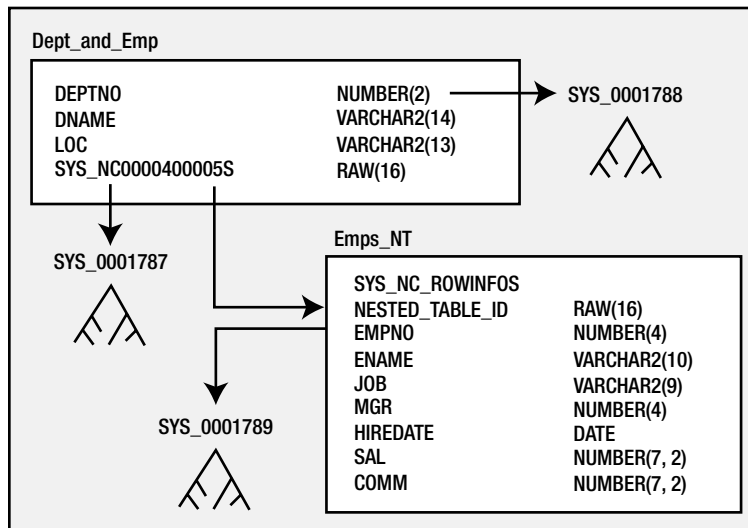

**Figure 10-11.** Nested table physical implementation

The code created two real tables. The table we asked to have is there, but it has an extra hidden column (we'll have one extra hidden column by default for *each* nested table column in a table). It also created a *unique* constraint on this hidden column. Oracle created the nested table, EMPS\_NT, for us. This table has two hidden columns, one of which, SYS\_NC\_ROWINFO\$, is not really a column but a virtual column that returns all of the scalar elements as an object. The other is the foreign key called NESTED\_TABLE\_ID, which can be joined back to the parent table. Notice the *lack* of an index on this column. Finally, Oracle added an index on the DEPTNO column in the DEPT\_AND\_EMP table to enforce the primary key. So, we asked for a table and got a lot more than we bargained for. If you look at it, it is a lot like what you might create for a parent/child relationship, but you would have used the existing primary key on DEPTNO as the foreign key in EMPS\_NT instead of generating a surrogate RAW(16) key.

If we look at the DBMS\_METADATA.GET\_DDL dump of our nested table example, we see the following:

```
EODA@ORA12CR1> begin
 2   dbms_metadata.set_transform_param
 3     ( DBMS_METADATA.SESSION_TRANSFORM, 'STORAGE', false );
 4 end;
 5 /
```

PL/SQL procedure successfully completed.

```
EODA@ORA12CR1> select dbms_metadata.get_ddl( 'TABLE', 'DEPT_AND_EMP' ) from dual;
```

```
DBMS_METADATA.GET_DDL('TABLE','DEPT_AND_EMP')
```

```
-----
CREATE TABLE "EODA"."DEPT_AND_EMP"
(  "DEPTNO" NUMBER(2,0),
   "DNAME" VARCHAR2(14),
   "LOC" VARCHAR2(13),
   "EMPS" "EODA"."EMP_TAB_TYPE",
```

```

        PRIMARY KEY ("DEPTNO")
    USING INDEX PCTFREE 10 INITRANS 2 MAXTRANS 255
    TABLESPACE "USERS" ENABLE
    ) SEGMENT CREATION IMMEDIATE
    PCTFREE 10 PCTUSED 40 INITRANS 1 MAXTRANS 255
    NOCOMPRESS LOGGING
    TABLESPACE "USERS"
    NESTED TABLE "EMPS" STORE AS "EMPS_NT"
    (( CONSTRAINT "EMPS_EMPNO_UNIQUE" UNIQUE ("EMPNO")
    USING INDEX PCTFREE 10 INITRANS 2 MAXTRANS 255 COMPUTE STATISTICS
    TABLESPACE "USERS" ENABLE)
    PCTFREE 10 PCTUSED 40 INITRANS 1 MAXTRANS 255 LOGGING
    TABLESPACE "USERS" ) RETURN AS VALUE

```

The only new thing here so far is the `RETURN AS VALUE` clause. It is used to describe how the nested table is returned to a client application. By default, Oracle will return the nested table by value to the client; the actual data will be transmitted with each row. This can also be set to `RETURN AS LOCATOR`, meaning the client will get a pointer to the data, not the data itself. If—and only if—the client dereferences this pointer will the data be transmitted to it. So, if you believe the client will typically not look at the rows of a nested table for each parent row, you can return a locator instead of the values, saving on the network round-trips. For example, if you have a client application that displays the lists of departments and when the user double-clicks a department it shows the employee information, you may consider using the locator. This is because the details are usually not looked at—that is the exception, not the rule.

So, what else can we do with the nested table? First, the `NESTED_TABLE_ID` column must be indexed. Since we always access the nested table *from* the parent *to* the child, we really need that index. We can index that column using `CREATE INDEX`, but a better solution is to use an IOT to store the nested table. The nested table is another perfect example of what an IOT is excellent for. It will physically store the child rows co-located by `NESTED_TABLE_ID` (so retrieving the table is done with less physical I/O). It will remove the need for the redundant index on the `RAW(16)` column. Going one step further, since the `NESTED_TABLE_ID` will be the leading column in the IOT's primary key, we should also incorporate index key compression to suppress the redundant `NESTED_TABLE_IDs` that would be there otherwise. In addition, we can incorporate our `UNIQUE` and `NOT NULL` constraint on the `EMPNO` column into the `CREATE TABLE` command. Therefore, if we take the preceding `CREATE TABLE` statement and modify it slightly

```

EODA@ORA12CR1> CREATE TABLE "EODA"."DEPT_AND_EMP"
 2  ("DEPTNO" NUMBER(2, 0),
 3  "DNAME"  VARCHAR2(14),
 4  "LOC"    VARCHAR2(13),
 5  "EMPS"  "EMP_TAB_TYPE")
 6  PCTFREE 10 PCTUSED 40 INITRANS 1 MAXTRANS 255 LOGGING
 7  TABLESPACE "USERS"
 8  NESTED TABLE "EMPS"
 9  STORE AS "EMPS_NT"
10  ((empno NOT NULL, unique (empno), primary key(nested_table_id,empno))
11  organization index compress 1 )
12  RETURN AS VALUE;

```

Table created.

we now get the following set of objects. Instead of having a conventional table `EMPS_NT`, we have an IOT `EMPS_NT` as signified by the index structure overlaid on the table in Figure 10-12.

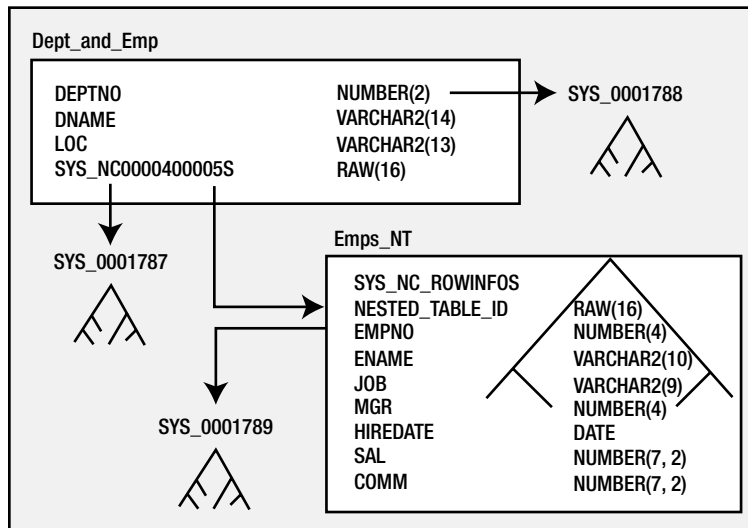

**Figure 10-12.** Nested table implemented as an IOT

Where the `EMPS_NT` is an IOT using compression, it should take less storage than the original default nested table and it has the index we badly need.

## Nested Tables Wrap-up

I do not use nested tables as a permanent storage mechanism myself, for the following reasons:

- The unnecessary storage overhead of the `RAW(16)` columns that are added. Both the parent and child table will have this extra column. The parent table will have an extra 16-byte `RAW` for each nested table column it has. Since the parent table typically already has a primary key (`DEPTNO` in my examples), it makes sense to use this key in the child tables, not a system-generated key.
- The unnecessary overhead of the additional unique constraint on the parent table, when it typically already has a unique constraint.
- The nested table is not easily used by itself, without using unsupported constructs (`NESTED_TABLE_GET_REFS`). It can be un-nested for queries, but not mass updates. I have yet to find a table in real life that isn't queried "by itself."

*I do use nested tables heavily as a programming construct* and in views. This is where I believe they are in their element. As a storage mechanism, I much prefer creating the parent/child tables myself. After creating the parent/child tables, we can, in fact, create a view that makes it appear as if we had a real nested table. That is, we can achieve all of the advantages of the nested table construct without incurring the overhead.

If you do use a nested table as a storage mechanism, be sure to make it an IOT to avoid the overhead of an index on the `NESTED_TABLE_ID` and the nested table itself. See the previous section on IOTs for advice on setting them up with overflow segments and other options. If you do not use an IOT, make sure to create an index on the `NESTED_TABLE_ID` column in the nested table to avoid full scanning it to find the child rows.



## Temporary Tables

Temporary tables are used to hold intermediate resultsets for the duration of either a transaction or a session. The data held in a temporary table is only ever visible to the current session—no other session will see any other session’s data, even if the current session `COMMITs` the data. Multiuser concurrency is not an issue with regard to temporary tables either, as one session can never block another session by using a temporary table. Even if we “lock” the temporary table, it will not prevent other sessions from using their temporary table.

---

■ **Note** As we observed in Chapter 9, temporary tables generate significantly less redo than regular tables. However, since temporary tables generate undo information for the data they contain, they will generate some amount of redo. `UPDATES` and `DELETES` will generate the largest amount; `INSERTs` and `SELECTs` the least amount. We also saw in Chapter 9, starting with Oracle 12c, that temporary tables can be configured to generate next to zero redo; this is done by setting the `TEMP_UNDO_ENABLED` parameter to `TRUE`.

---

Temporary tables will allocate storage from the currently logged-in user’s temporary tablespace, or if they are accessed from a definer rights procedure, the temporary tablespace of the owner of that procedure will be used. A global temporary table is really just a template for the table itself. The act of creating a temporary table involves no storage allocation; no `INITIAL` extent is allocated, as it would be for a regular heap organized table (unless the deferred segment feature is in effect). Rather, at runtime when a session first puts data into the temporary table, a temporary segment for that session will be created. Since each session gets its own temporary segment (not just an extent of an existing segment), every user might be allocating space for her temporary table in different tablespaces. `USER1` might have his temporary tablespace set to `TEMP1`, so his temporary tables will be allocated from this space. `USER2` might have `TEMP2` as her temporary tablespace, and her temporary tables will be allocated there.

Oracle’s temporary tables are similar to temporary tables in other relational databases, with the main exception being that they are *statically* defined. You create them once per database, not once per stored procedure in the database. They always exist—they will be in the data dictionary as objects, but they will always appear empty until your session puts data into them. The fact that they are statically defined allows you to create views that reference temporary tables, to create stored procedures that use static SQL to reference them, and so on.

Temporary tables may be *session* based (data survives in the table across `COMMITs` but not a disconnect/reconnect). They may also be *transaction* based (data disappears after a `COMMIT`). Here is an example showing the behavior of both. I used the `SCOTT.EMP` table as a template:

```
EODA@ORA12CR1> create global temporary table temp_table_session
  2 on commit preserve rows
  3 as
  4 select * from scott.emp where 1=0
  5 /
Table created.
```

The `ON COMMIT PRESERVE ROWS` clause makes this a session-based temporary table. Rows will stay in this table until my session disconnects or I physically remove them via a `DELETE` or `TRUNCATE`. Only my session can see these rows; no other session will ever see my rows, even after I `COMMIT`.

```
EODA@ORA12CR1> create global temporary table temp_table_transaction
  2 on commit delete rows
  3 as
  4 select * from scott.emp where 1=0
  5 /
Table created.
```

The `ON COMMIT DELETE ROWS` makes this a transaction-based temporary table. When my session commits, the rows disappear. The rows will disappear by simply giving back the temporary extents allocated to my table—there is no overhead involved in the automatic clearing of temporary tables.

Now, let's look at the differences between the two types:

```
EODA@ORA12CR1> insert into temp_table_session select * from scott.emp;
14 rows created.
```

```
EODA@ORA12CR1> insert into temp_table_transaction select * from scott.emp;
14 rows created.
```

We've just put 14 rows into each TEMP table, and this shows we can see them:

```
EODA@ORA12CR1> select session_cnt, transaction_cnt
 2   from ( select count(*) session_cnt from temp_table_session ),
 3         ( select count(*) transaction_cnt from temp_table_transaction );
```

```
SESSION_CNT TRANSACTION_CNT
-----
          14             14
```

```
EODA@ORA12CR1> commit;
```

Since we've committed, we'll see the session-based rows but not the transaction-based rows:

```
EODA@ORA12CR1> select session_cnt, transaction_cnt
 2   from ( select count(*) session_cnt from temp_table_session ),
 3         ( select count(*) transaction_cnt from temp_table_transaction );
```

```
SESSION_CNT TRANSACTION_CNT
-----
          14              0
```

```
EODA@ORA12CR1> disconnect
```

Disconnected from Oracle Database 12c Enterprise Edition Release 12.1.0.1.0 - 64bit Production  
With the Partitioning, OLAP, Advanced Analytics and Real Application Testing options

```
EODA@ORA12CR1> connect eoda
```

```
Enter password:
```

```
Connected.
```

Since we've started a new session, we'll see no rows in either table:

```
EODA@ORA12CR1> select session_cnt, transaction_cnt
 2   from ( select count(*) session_cnt from temp_table_session ),
 3         ( select count(*) transaction_cnt from temp_table_transaction );
```

```
SESSION_CNT TRANSACTION_CNT
-----
           0              0
```

You can check whether a table has been created as temporary and the duration of the data (per session or transaction) by querying the `TEMPORARY` and `DURATION` columns of `USER_TABLES` view. The default `DURATION` is `SYS$TRANSACTION` (meaning `ON COMMIT DELETE ROWS`). Here's what these values look like for this example:

```
EODA@ORA12CR1> select table_name, temporary, duration from user_tables;
```

```
TABLE_NAME          T DURATION
-----
TEMP_TABLE_TRANSACTION  Y SYS$TRANSACTION
TEMP_TABLE_SESSION     Y SYS$SESSION
```

If you have experience of temporary tables in SQL Server and/or Sybase, the major consideration for you is that instead of executing `SELECT X, Y, Z INTO #TEMP FROM SOME_TABLE` to dynamically create and populate a temporary table, you will

- Create all your global temporary tables once, as part of the application installation, just as you create permanent tables.
- In your procedures, simply `INSERT INTO TEMP (X,Y,Z) SELECT X,Y,Z FROM SOME_TABLE`.

Just to drive home the point, the goal here is not to create tables in your stored procedures at runtime. That is not the proper way to use temporary tables in Oracle. DDL is an expensive operation; you want to avoid doing that at runtime. The temporary tables for an application should be created during the application installation—*never* at runtime. The pitfalls you will encounter if you attempt to dynamically create the global temporary tables (or just tables in general) at runtime in PL/SQL will be:

- You will be doing DDL at runtime. DDL is extremely expensive, it involves hundreds of recursive SQL statements. DDL involves a lot of serialization (one at a time, get in line).
- You will have to use dynamic SQL in your PL/SQL to use these tables. You lose all of the benefits of static, compile-time SQL. This is a huge loss.
- You will not be able to run two copies of your stored procedure at the same time, ever. Since both stored procedure instances would attempt to drop and create the same temporary table, they would conflict with each other (in this scenario you could dynamically generate a unique name for the temporary table each time the procedure is created, but this would introduce complexity and potential headaches when troubleshooting).
- You will end up having your tables stick around some day—that is, your code will not drop them correctly. Due to an unforeseen error (a power failure is all it would take), your procedure might not complete. Your table will still be there when power is restored. You will have to manually clean up objects from time to time.

In short, there are no good reasons to create tables in PL/SQL at runtime, only reasons to *not* ever create tables in PL/SQL at run time.

Temporary tables can have many of the attributes of a permanent table. They may have triggers, check constraints, indexes, and so on. Features of permanent tables that they do not support include the following:

- They cannot have referential integrity constraints. Neither can they be the *target* of a foreign key, nor can they have a foreign key defined on them.
- They cannot have `NESTED TABLE` type columns. In Oracle9i and earlier, they cannot have `VARRAY` type columns either; this restriction was lifted starting with Oracle 10g.
- They cannot be IOTs.

- They cannot be in a cluster of any type.
- They cannot be partitioned.
- They cannot have statistics generated via the `ANALYZE` table command.

One of the drawbacks of a temporary table in any database is the fact that the optimizer has no real statistics on it normally. When using the *cost-based optimizer (CBO)*, valid statistics are vital to the optimizer's success (or failure). In the absence of statistics, the optimizer will make guesses as to the distribution of data, the amount of data, and the selectivity of an index. When these guesses are wrong, the query plans generated for queries that make heavy use of temporary tables could be less than optimal. In many cases, the correct solution is to not use a temporary table at all, but rather to use an `INLINE VIEW` (for an example of an `INLINE VIEW`, refer to the last `SELECT` just run—it has two of them) in its place. In this fashion, Oracle will have access to all of the relevant statistics for a table and can come up with an optimal plan.

I find many times people use temporary tables because they learned in other databases that joining too many tables in a single query is a bad thing. This is a practice that must be unlearned for Oracle development. Rather than trying to outsmart the optimizer and breaking what should be a single query into three or four queries that store their subresults into temporary tables and then combining the temporary tables, you should just code a single query that answers the original question. Referencing many tables in a single query is OK; the temporary table crutch is not needed in Oracle for this purpose.

In other cases, however, the use of a temporary table in a process is the correct approach. For example, I once wrote a Palm sync application to synchronize the date book on a Palm Pilot with calendar information stored in Oracle. The Palm gives me a list of all records that have been modified since the last hot synchronization. I must take these records and compare them against the live data in the database, update the database records, and then generate a list of changes to be applied to the Palm. This is a perfect example of when a temporary table is very useful. I used a temporary table to store the changes from the Palm in the database. I then ran a stored procedure that bumps the Palm-generated changes against the live (and very large) permanent tables to discover what changes need to be made to the Oracle data, and then to find the changes that need to come from Oracle back down to the Palm. I have to make a couple of passes on this data. First, I find all records that were modified only on the Palm and make the corresponding changes in Oracle. I next find all records that were modified on both the Palm and my database since the last synchronization and rectify them. Then I find all records that were modified only on the database and place their changes into the temporary table. Lastly, the Palm sync application pulls the changes from the temporary table and applies them to the Palm device itself. Upon disconnection, the temporary data goes away.

The issue I encountered, however, is that because the permanent tables were analyzed, the CBO was being used. The temporary table had no statistics on it (you can analyze the temporary table but no statistics are gathered), and the CBO would guess many things about it. I, as the developer, knew the average number of rows I might expect, the distribution of the data, the selectivity of the indexes, and so on. I needed a way to inform the optimizer of these *better* guesses. This is done through generating statistics for a temporary table. That brings us to the next topic regarding how statistics are generated for a temporary table.

---

■ **Note** Since there are significant enhancements to gathering the temporary table statistics introduced in Oracle 12c, I'm going to split the topic of gathering temporary table statistics into two sections: "Statistics Prior to 12c" and "Statistics Starting with 12c."

---

## Statistics Prior to 12c

There are three ways to give the optimizer statistics on the global temporary tables. One is via dynamic sampling (starting with in Oracle9i Release 2 and above) and the other is the `DBMS_STATS` package, which has two ways to accomplish this. First, let's look at dynamic sampling.

*Dynamic sampling* is the optimizer's ability, when hard parsing a query, to scan segments in the database (sample them) to collect statistics useful in optimizing that particular query. It is akin to doing a miniature gather statistics command during a hard parse. In Oracle 10g and above, dynamic sampling will work out of the box, because the default setting has been increased from 1 to 2; at level 2, the optimizer will dynamically sample any unanalyzed object referenced in a query processed by the optimizer prior to evaluating the query plan. In 9i Release 2, the setting of 1 would cause dynamic sampling to be used much less often. We can use an ALTER SESSION|SYSTEM command in Oracle9i Release 2 to make it behave the way Oracle 10g does by default, or we can use the dynamic sampling hint as follows:

```
ops$tkyte@ORA9IR2> create global temporary table gtt
  2 as
  3 select * from scott.emp where 1=0;
Table created.
```

```
ops$tkyte@ORA9IR2> insert into gtt select * from scott.emp;
14 rows created.
```

```
ops$tkyte@ORA9IR2> set autotrace traceonly explain
ops$tkyte@ORA9IR2> select /*+ first_rows */ * from gtt;
```

Execution Plan

```
-----
  0      SELECT STATEMENT Optimizer=HINT: FIRST_ROWS (Cost=17 Card=8168 Bytes...)
  1      0      TABLE ACCESS (FULL) OF 'GTT' (Cost=17 Card=8168 Bytes=710616)
```

```
ops$tkyte@ORA9IR2> select /*+ first_rows dynamic_sampling(gtt 2) */ * from gtt;
```

Execution Plan

```
-----
  0      SELECT STATEMENT Optimizer=HINT: FIRST_ROWS (Cost=17 Card=14 Bytes=1218)
  1      0      TABLE ACCESS (FULL) OF 'GTT' (Cost=17 Card=14 Bytes=1218)
```

```
ops$tkyte@ORA9IR2> set autotrace off
```

Here, we set the dynamic sampling to level 2 for the table GTT in this query. Left to itself, the optimizer guessed 8,168 rows would be returned from the table GTT.

---

■ **Note** The 8,168 default value is actually a function of your default block size. In a database with a 4KB block size, the number of estimated rows would be smaller; with 16KB blocks, it would be larger.

---

Using dynamic sampling, the estimated cardinality will be much closer to reality (which leads to better query plans overall). Using the level 2 setting, the optimizer quickly scans the table to come up with more-realistic estimates of the true size of this table. In Oracle 10g and higher, we should find this to be less of a problem, because the defaults will cause dynamic sampling to take place:

```
EODA@ORA11GR2> create global temporary table gtt
  2 as
  3 select * from scott.emp where 1=0;
Table created.
```

```
EODA@ORA11GR2> insert into gtt select * from scott.emp;
14 rows created.
```

```
EODA@ORA11GR2> set autotrace traceonly explain
EODA@ORA11GR2> select * from gtt;
```

```
-----
```

Id	Operation	Name	Rows	Bytes	Cost (%CPU)	Time
0	SELECT STATEMENT		14	1218	2 (0)	00:00:01
1	TABLE ACCESS FULL	GTT	14	1218	2 (0)	00:00:01

```
-----
```

Note

```
-----
```

- dynamic sampling used for this statement (level=2)

```
EODA@ORA11GR2> set autotrace off
```

We get the right cardinality without having to ask for it. Dynamic sampling does not come free, however—there is a cost associated with having to perform it at query parse time. If we gathered appropriate representative statistics ahead of time, we could avoid this at hard parse time. That leads us into DBMS\_STATS.

There are three methods to use DBMS\_STATS to gather representative statistics. The first way is to use DBMS\_STATS with the GATHER\_SCHEMA\_STATS, or GATHER\_DATABASE\_STATS call. These procedures allow you to pass in a parameter, GATHER\_TEMP, which is a Boolean and defaults to FALSE. When set to TRUE, any ON COMMIT PRESERVE ROWS global temporary table will have statistics gathered and stored (this technique will *not* work on ON COMMIT DELETE ROWS tables). Consider the following (note that this was done in an empty schema; the only objects are those you see created):

```
EODA@ORA11GR2> create table emp as select * from scott.emp;
Table created.
```

```
EODA@ORA11GR2> create global temporary table gtt1 ( x number )
  2 on commit preserve rows;
Table created.
```

```
EODA@ORA11GR2> create global temporary table gtt2 ( x number )
  2 on commit delete rows;
Table created.
```

```
EODA@ORA11GR2> insert into gtt1 select user_id from all_users;
49 rows created.
```

```
EODA@ORA11GR2> insert into gtt2 select user_id from all_users;
49 rows created.
```

```
EODA@ORA11GR2> exec dbms_stats.gather_schema_stats( user );
PL/SQL procedure successfully completed.
```

```
EODA@ORA11GR2> select table_name, last_analyzed, num_rows from user_tables;
```

TABLE_NAME	LAST_ANALYZED	NUM_ROWS
EMP	17-JAN-14	14
GTT2		
GTT1		

As you can see, only the EMP table was analyzed in this case; the two global temporary tables were ignored. We can change that behavior by calling GATHER\_SCHEMA\_STATS with GATHER\_TEMP => TRUE:

```
EODA@ORA11GR2> insert into gtt2 select user_id from all_users;
49 rows created.
```

```
EODA@ORA11GR2> exec dbms_stats.gather_schema_stats( user, gather_temp=>TRUE );
PL/SQL procedure successfully completed.
```

```
EODA@ORA11GR2> select table_name, last_analyzed, num_rows from user_tables;
```

TABLE_NAME	LAST_ANALYZED	NUM_ROWS
EMP	17-JAN-14	14
GTT1	17-JAN-14	49
GTT2	17-JAN-14	0

Notice that the ON COMMIT PRESERVE ROWS table has accurate statistics, but the ON COMMIT DELETE ROWS does not. DBMS\_STATS commits and that wipes out any information in that table. Do note, however, that GTT2 does now have statistics, which in itself is *a bad thing*, because the statistics are very much incorrect! It is doubtful the table will have 0 rows in it at runtime. So, if you use this approach, be aware of two things:

- Make sure to populate your global temporary tables with representative data *in the session that gathers the statistics*. If not, they will appear empty to DBMS\_STATS.
- If you have ON COMMIT DELETE ROWS global temporary tables, this approach should not be used, as you will definitely gather inappropriate values.

The second technique that works with ON COMMIT PRESERVE ROWS global temporary tables is to use GATHER\_TABLE\_STATS directly on the table. You would populate the global temporary table as we just did, and then execute GATHER\_TABLE\_STATS on that global temporary table. Note that just as before, this *does not work* for ON COMMIT DELETE ROWS global temporary tables, as the same issues as just described would come into play.

The last technique using DBMS\_STATS uses a manual process to populate the data dictionary with representative statistics for our temporary tables. For example, if on average the number of rows in the temporary table will be 500, the average row size will be 100 bytes, and the number of blocks will be 7, we could simply use the following:

```
EODA@ORA11GR2> create global temporary table t ( x int, y varchar2(100) )
  2 on commit preserve rows;
Table created.
```

```
EODA@ORA11GR2> begin
 2   dbms_stats.set_table_stats( ownname => USER,
 3                               tabname => 'T',
 4                               numRows => 500,
 5                               numblks => 7,
 6                               avgrlen => 100 );
 7 end;
 8 /
```

PL/SQL procedure successfully completed.

```
EODA@ORA11GR2> select table_name, num_rows, blocks, avg_row_len
 2   from user_tables
 3   where table_name = 'T';
```

TABLE_NAME	NUM_ROWS	BLOCKS	AVG_ROW_LEN
T	500	7	100

Now, the optimizer won't use its best guess—it will use *our* best guess for this information.

## Statistics Starting with 12c

The gathering and use of global temporary table statistics vastly improves starting with Oracle 12c. Listed next is a summary of the changes:

- By default, session-level statistics are generated when gathering statistics for temporary tables.
- Shared statistics can still be gathered (much like they were in 11g), but you must first set the `GLOBAL_TEMP_TABLE_STATS` parameter (of the `DBMS_STATS.SET_TABLE_PREFS` procedure) to `SHARED`.
- For temporary tables defined as `ON COMMIT DELETE ROWS`, several `DBMS_STATS` procedures (such as `GATHER_TABLE_STATS`) no longer issue an implicit `COMMIT`; therefore, it's possible to generate representative statistics for this type of temporary table.
- For temporary tables defined as `ON COMMIT PRESERVE ROWS`, session-level statistics are automatically generated for direct-path operations (like `CTAS` and direct-path `INSERT` statements); this eliminates the need to call `DBMS_STATS` to generate statistics for these specific operations.

We'll look at each of the prior bullets in more detail, starting with session statistics.

## Session Statistics

Prior to 12c, the statistics generated for a temporary table were shared among all sessions using the temporary table. This could lead to less than ideal execution plans, especially if different sessions generated disparate volumes of data or had varying patterns of data.

Starting with 12c, when you generate statistics for a temporary table, the statistics are specific to the session generating the statistics. This provides the Oracle optimizer with better information to create an execution plan tailored for the data generated per session. A small example will demonstrate this; first, a temporary table is created:

```
EODA@ORA12CR1> create global temporary table gt(x number) on commit preserve rows;
Table created.
```



Next, insert some data:

```
EODA@ORA12CR1> insert into gt select user_id from all_users;
51 rows created.
```

Now generate statistics for the table:

```
EODA@ORA12CR1> exec dbms_stats.gather_table_stats( user, 'GT' );
```

PL/SQL procedure successfully completed.

We can verify the existence of session-level statistics by querying USER\_TAB\_STATISTICS:

```
EODA@ORA12CR1> select table_name, num_rows, last_analyzed, scope
  2  from user_tab_statistics
  3  where table_name like 'GT';
```

TABLE_NAME	NUM_ROWS	LAST_ANALYZED	SCOPE
GT			SHARED
GT	51	18-JAN-14	SESSION

We can further verify the optimizer's awareness of session private statistics via autotrace:

```
EODA@ORA12CR1> set autotrace on;
EODA@ORA12CR1> select count(*) from gt;
```

Near the bottom of the output is this optimizer note:

Note

-----

- Global temporary table session private statistics used

Keep in mind that session-level statistics are only valid for the duration of the session. If you disconnect and reconnect, the statistics are gone:

```
EODA@ORA12CR1> disconnect
EODA@ORA12CR1> connect eoda
Enter password:
```

Rerunning the query showing the existence of statistics shows that no session statistics exist now:

```
EODA@ORA12CR1> select table_name, num_rows, last_analyzed, scope
  2  from user_tab_statistics
  3  where table_name like 'GT';
```

TABLE_NAME	NUM_ROWS	LAST_ANALYZED	SCOPE
GT			SHARED

---

■ **Note** If session-level statistics exist when querying a temporary table, the optimizer will use those. If no session-level statistics exist, then the optimizer will check if shared statistics exist, and if so, use those. If no statistics exist, the optimizer will use dynamic statistics (prior to 12c, this was known as *dynamic sampling*).

---

## Shared Statistics

As shown in the previous section, when you generate statistics for a temporary table, the statistics are visible only to the session that generated the statistics; this is by default in Oracle 12c. If you require multiple sessions to share the same statistics for a temporary table, you must first use the `DBMS_STATS.SET_TABLE_STATS` procedure to set the `GLOBAL_TEMP_TABLE_STATS` preference to `SHARED` (the default for this preference is `SESSION`). To demonstrate this, let's create a temporary table and insert some data:

```
EODA@ORA12CR1> create global temporary table gt(x number) on commit preserve rows;
Table created.
```

```
EODA@ORA12CR1> insert into gt select user_id from all_users;
51 rows created.
```

Now set the `GLOBAL_TEMP_TABLE_STATS` preference to `SHARED`:

```
EODA@ORA12CR1> exec dbms_stats.set_table_prefs(user, -
> 'GT', 'GLOBAL_TEMP_TABLE_STATS', 'SHARED');
```

Next, generate statistics for the temporary table:

```
EODA@ORA12CR1> exec dbms_stats.gather_table_stats( user, 'GT' );
```

We can verify that shared statistics have been generated by executing following query:

```
EODA@ORA12CR1> select table_name, num_rows, last_analyzed, scope
 2  from user_tab_statistics
 3  where table_name like 'GT';
```

TABLE_NAME	NUM_ROWS	LAST_ANALYZED	SCOPE
GT	51	18-JAN-14	SHARED

Shared statistics for a global temporary table persist until they are explicitly removed. You can remove shared statistics as follows:

```
EODA@ORA12CR1> exec dbms_stats.delete_table_stats( user, 'GT' );
```

We can verify that the shared statistics have been removed by running the following query:

```
EODA@ORA12CR1> select table_name, num_rows, last_analyzed, scope
 2  from user_tab_statistics
 3  where table_name like 'GT';
```

TABLE_NAME	NUM_ROWS	LAST_ANALYZED	SCOPE
GT			SHARED

## Statistics for ON COMMIT DELETE ROWS

As shown earlier, when running procedures such as `GATHER_TABLE_STATS`, there is an implicit `COMMIT` that takes place. Therefore, when generating statistics for temporary tables defined as `ON COMMIT DELETE ROWS`, the statistics gathered reflect those of a table with zero rows in it (the statistics in this case are useless because you need the statistics to reflect the data within the temporary table before it is removed by a `COMMIT`).

Starting with 12c, several of the procedures in `DBMS_STATS` (such as `GATHER_TABLE_STATS`) no longer issue an implicit `COMMIT` after gathering statistics for temporary tables defined as `ON COMMIT DELETE ROWS`. This means it is now possible to gather representative statistics for this type of temporary table. A simple example will demonstrate this concept; first, create a temporary table with `ON COMMIT DELETE ROWS`:

```
EODA@ORA12CR1> create global temporary table gt(x number) on commit delete rows;
Table created.
```

Next, insert some data:

```
EODA@ORA12CR1> insert into gt select user_id from all_users;
51 rows created.
```

Now generate statistics for the schema:

```
EODA@ORA12CR1> exec dbms_stats.gather_table_stats( user, 'GT' );
PL/SQL procedure successfully completed.
```

A quick count will verify the rows still exist in the `GT` table:

```
EODA@ORA12CR1> select count(*) from gt;

COUNT(*)
-----
         51
```

We can verify the existence of session-level statistics by querying `USER_TAB_STATISTICS`:

```
EODA@ORA12CR1> select table_name, num_rows, last_analyzed, scope
 2  from user_tab_statistics
 3  where table_name like 'GT';
```

TABLE_NAME	NUM_ROWS	LAST_ANALYZED	SCOPE
GT			SHARED
GT	51	18-JAN-14	SESSION

This allows you to generate useful statistics for temporary tables where you desire the rows to be deleted after each transaction.

■ **Note** As of Oracle 12c, the following procedures of `DBMS_STATS` no longer issue a `COMMIT` as part of gathering temporary table statistics for tables created with `ON COMMIT DELETE ROWS`: `GATHER_TABLE_STATS`, `DELETE_TABLE_STATS`, `DELETE_COLUMN_STATS`, `DELETE_INDEX_STATS`, `SET_TABLE_STATS`, `SET_COLUMN_STATS`, `SET_INDEX_STATS`, `GET_TABLE_STATS`, `GET_COLUMN_STATS`, `GET_INDEX_STATS`. The prior procedures do issue an implicit `COMMIT` for temporary tables defined as `ON COMMIT PRESERVE ROWS`.

## Direct-Path Load Automatic Statistics Gathering

Starting with Oracle 12c, when performing direct-path operations on a temporary table (where `ON COMMIT PRESERVE ROWS` is enabled), session-level statistics are gathered by default for the temporary table being loaded. Two typical direct-path load operations are `CREATE TABLE AS SELECT` (CTAS) and direct-path `INSERTs` (`INSERTs` with the `/*+ append */` hint).

A simple example will demonstrate this. Here we create a CTAS table:

```
EODA@ORA12CR1> create global temporary table gt on commit preserve rows
  2 as select * from all_users;
```

Table created.

We can verify that session-level statistics have been generated via the following query:

```
EODA@ORA12CR1> select table_name, num_rows, last_analyzed, scope
  2 from user_tab_statistics
  3 where table_name like 'GT';
```

TABLE_NAME	NUM_ROWS	LAST_ANALYZED	SCOPE
GT			SHARED
GT	51	18-JAN-14	SESSION

This eliminates the need to call `DBMS_STATS` to generate statistics when direct-path loading a temporary table that is defined as `ON COMMIT PRESERVE ROWS`.

## Temporary Tables Wrap-up

Temporary tables can be useful in an application where you need to temporarily store a set of rows to be processed against other tables, for either a session or a transaction. They are not meant to be used as a means to take a single larger query and break it up into smaller result sets that would be combined back together (which seems to be the most popular use of temporary tables in other databases). In fact, you will find in almost all cases that a single query broken up into smaller temporary table queries performs more slowly in Oracle than the single query would have. I've seen this behavior time and time again, when given the opportunity to rewrite the series of `INSERTs` into temporary tables as `SELECTs` in the form of one large query, the resulting single query executes much faster than the original multistep process.

Temporary tables generate a minimum amount of redo, but they still generate some redo. Prior to 12c there is no way to disable that. The redo is generated for the rollback data, and in most typical uses it will be negligible. If you only `INSERT` and `SELECT` from temporary tables, the amount of redo generated will not be noticeable. Only if you `DELETE` or `UPDATE` a temporary table heavily will you see large amounts of redo generated.

---

■ **Note** Starting with 12c, you can instruct Oracle to write undo to the temporary tablespace and thereby eliminate almost all of the redo generation. This is done by setting the `TEMP_UNDO_ENABLED` parameter to `TRUE` (see Chapter 9 for details).

---

Statistics used by the CBO can be generated on a temporary table with care; however, a better guess set of statistics may be set on a temporary table using the `DBMS_STATS` package or dynamically collected by the optimizer at hard parse time using dynamic sampling. Starting with Oracle 12c you can generate statistics specific to a session. This provides the optimizer with better information to generate execution plans that are more optimal for the data loaded in a given session.

## Object Tables

We have already seen a partial example of an object table with nested tables. An *object table* is a table that is created based on a `TYPE`, not as a collection of columns. Normally, a `CREATE TABLE` statement would look like this:

```
create table t ( x int, y date, z varchar2(25) );
```

An object table creation statement looks more like this:

```
create table t of Some_Type;
```

The attributes (columns) of `T` are derived from the definition of `SOME_TYPE`. Let's quickly look at an example involving a couple of types, and then review the resulting data structures:

```
EODA@ORA12CR1> create or replace type address_type
 2 as object
 3 ( city    varchar2(30),
 4   street  varchar2(30),
 5   state   varchar2(2),
 6   zip     number
 7 )
 8 /
Type created.
```

```
EODA@ORA12CR1> create or replace type person_type
 2 as object
 3 ( name      varchar2(30),
 4   dob       date,
 5   home_address address_type,
 6   work_address address_type
 7 )
 8 /
Type created.
```

```
EODA@ORA12CR1> create table people of person_type
 2 /
Table created.
```

```
EODA@ORA12CR1> desc people
```

Name	Null?	Type
NAME		VARCHAR2(30)
DOB		DATE
HOME_ADDRESS		ADDRESS_TYPE
WORK_ADDRESS		ADDRESS_TYPE

In a nutshell, that's all there is to it. We create some type definitions, and then we can create tables of that type. The table appears to have four columns representing the four attributes of the `PERSON_TYPE` we created. We are at the point where we can now perform DML on the object table to create and query data:

```
EODA@ORA12CR1> insert into people values ( 'Tom', '15-mar-1965',
  2  address_type( 'Denver', '123 Main Street', 'Co', '12345' ),
  3  address_type( 'Redwood', '1 Oracle Way', 'Ca', '23456' ) );
1 row created.
```

```
EODA@ORA12CR1> select name, dob, p.home_address Home, p.work_address work
  2  from people p;
```

```
Tom                15-MAR-65
ADDRESS_TYPE('Denver', '123 Main Street', 'Co', 12345)
ADDRESS_TYPE('Redwood', '1 Oracle Way', 'Ca', 23456)
```

```
EODA@ORA12CR1> select name, p.home_address.city from people p;
```

NAME	HOME_ADDRESS.CITY
Tom	Denver

We're starting to see some of the object syntax necessary to deal with object types. For example, in the `INSERT` statement we had to wrap the `HOME_ADDRESS` and `WORK_ADDRESS` with a `CAST`. We cast the scalar values to be of an `ADDRESS_TYPE`. Another way of saying this is that we create an `ADDRESS_TYPE` instance for that row by using the default constructor for the `ADDRESS_TYPE` object.

Now, as far as the external face of the table is concerned, there are four columns in our table. By now, after seeing the hidden magic that took place for the nested tables, we can probably guess that there is something else going on. Oracle stores all object relational data in plain old relational tables—at the end of the day, it is all in rows and columns. If we dig into the real data dictionary, we can see what this table really looks like:

```
EODA@ORA12CR1> select name, segcollength
  2  from sys.col$
  3  where obj# = ( select object_id
  4                  from user_objects
  5                  where object_name = 'PEOPLE' )
  6  /
```

NAME	SEGCOLLENGTH
SYS_NC_OID\$	16
SYS_NC_ROWINFO\$	1
NAME	30
DOB	7
HOME_ADDRESS	1
SYS_NC00006\$	30
SYS_NC00007\$	30
SYS_NC00008\$	2
SYS_NC00009\$	22
WORK_ADDRESS	1
SYS_NC00011\$	30
SYS_NC00012\$	30
SYS_NC00013\$	2
SYS_NC00014\$	22

14 rows selected.

This looks quite different from what DESCRIBE tells us. Apparently, there are 14 columns in this table, not 4. In this case, they are:

- **SYS\_NC\_OID\$:** This is the system-generated object ID of the table. It is a unique RAW(16) column. It has a unique constraint on it, and there is a corresponding unique index created on it as well.
- **SYS\_NC\_ROWINFO\$:** This is the same magic function we observed with the nested table. If we select that from the table, it returns the entire row as a single column:

```
EODA@ORA12CR1> select sys_nc_rowinfo$ from people;
```

```
SYS_NC_ROWINFO$(NAME, DOB, HOME_ADDRESS(CITY, STREET, STATE, ZIP),  
WORK_ADDRESS(CITY, STREET, STATE,
```

```
-----  
PERSON_TYPE('Tom', '15-MAR-65', ADDRESS_TYPE('Denver', '123 Main Street', 'Co', 12345), ADDRESS_TYPE  
( 'Redwood', '1 Oracle Way', 'Ca', 23456))
```

- **NAME, DOB:** These are the scalar attributes of our object table. They are stored much as we would expect, as regular columns.
- **HOME\_ADDRESS, WORK\_ADDRESS:** These are magic functions as well. They return the collection of columns they represent as a single object. These consume no real space except to signify NULL or NOT NULL for the entity.
- **SYS\_NCnnnnn\$:** These are the scalar implementations of our embedded object types. Since the PERSON\_TYPE had the ADDRESS\_TYPE embedded in it, Oracle needed to make room to store them in the appropriate type of columns. The system-generated names are necessary since a column name must be unique, and there is nothing stopping us from using the same object type more than once as we did here. If the names were not generated, we would have ended up with the ZIP column twice.

So, just like with the nested table, there is a lot going on here. A pseudo primary key of 16 bytes was added, there are virtual columns, and an index created for us. We can change the default behavior with regard to the value of the object identifier assigned to an object, as we'll see in a moment. First, let's look at the full verbose SQL that would generate our table for us. This was generated using Data Pump, since I wanted to easily see the dependent objects, including all of the SQL needed to re-create this particular object instance. This was achieved via the following:

```
$ expdp eoda directory=tk tables='PEOPLE' dumpfile=p.dmp logfile=p.log
Export: Release 12.1.0.1.0 - Production on Sat Jan 18 17:10:11 2014
Copyright (c) 1982, 2013, Oracle and/or its affiliates. All rights reserved.
...
$ impdp eoda directory=tk dumpfile=p.dmp logfile=pi.log sqlfile=people.sql
Import: Release 12.1.0.1.0 - Production on Sat Jan 18 17:11:54 2014
...
Connected to: Oracle Database 12c Enterprise Edition Release 12.1.0.1.0 - 64bit Production
With the Partitioning, OLAP, Advanced Analytics and Real Application Testing options
Master table "EODA"."SYS_SQL_FILE_FULL_01" successfully loaded/unloaded
Starting "EODA"."SYS_SQL_FILE_FULL_01":
eoda/***** directory=tk dumpfile=p.dmp logfile=pi.log sqlfile=people.sql
```

Review of the `people.sql` file that results would show this:

```
-- new object type path: TABLE_EXPORT/TABLE/TABLE
CREATE TABLE "EODA"."PEOPLE" OF "EODA"."PERSON_TYPE"
  OID 'F0484A73A93A7093E043B7D04F0A821B'
  OIDINDEX ( PCTFREE 10 INITRANS 2 MAXTRANS 255
    STORAGE(INITIAL 65536 NEXT 1048576 MINEXTENTS 1 MAXEXTENTS 2147483645
      PCTINCREASE 0 FREELISTS 1 FREELIST GROUPS 1
      BUFFER_POOL DEFAULT FLASH_CACHE DEFAULT CELL_FLASH_CACHE DEFAULT)
    TABLESPACE "USERS" )
  PCTFREE 10 PCTUSED 40 INITRANS 1 MAXTRANS 255
  NOCOMPRESS LOGGING
  STORAGE(INITIAL 65536 NEXT 1048576 MINEXTENTS 1 MAXEXTENTS 2147483645
    PCTINCREASE 0 FREELISTS 1 FREELIST GROUPS 1
    BUFFER_POOL DEFAULT FLASH_CACHE DEFAULT CELL_FLASH_CACHE DEFAULT)
  TABLESPACE "USERS" ;
```

This gives us a little more insight into what is actually taking place here. We see the `OIDINDEX` clause clearly now, and we see a reference to the `OID` column followed by a hex number.

The `OID '<big hex number>'` syntax is not documented in the Oracle documentation. All this is doing is ensuring that during an `expdp` and subsequent `impdp`, the underlying type `PERSON_TYPE` is, in fact, the *same* type. This will prevent an error that would occur if we performed the following steps:

1. Create the `PEOPLE` table.
2. Export the table.
3. Drop the table and the underlying `PERSON_TYPE`.
4. Create a new `PERSON_TYPE` with different attributes.
5. Import the old `PEOPLE` data.



Obviously, this export cannot be imported into the new structure—it will not fit. This check prevents that from occurring.

If you remember, I mentioned that we can change the behavior of the object identifier assigned to an object instance. Instead of having the system generate a pseudo primary key for us, we can use the natural key of an object. At first, this might appear self-defeating—the `SYS_NC_OID$` column will still appear in the table definition in `SYS.COL$` and, in fact, it will appear to consume massive amounts of storage as compared to the system-generated column. Once again, however, there is magic at work here. The `SYS_NC_OID$` column for an object table that is based on a *primary key* and not *system* generated is a virtual column and consumes no real storage on disk.

Here is an example that shows what happens in the data dictionary and demonstrates that there is no physical storage consumed for the `SYS_NC_OID$` column. We'll start with an analysis of the system-generated OID table:

```
EODA@ORA12CR1> create table people of person_type
2 /
Table created.
```

```
EODA@ORA12CR1> select name, type#, segcollength
2   from sys.col$
3   where obj# = ( select object_id
4                   from user_objects
5                   where object_name = 'PEOPLE' )
6   and name like 'SYS\NC\_%' escape '\'
7 /
```

NAME	TYPE#	SEGCOLLENGTH
SYS_NC_OID\$	23	16
SYS_NC_ROWINFO\$	121	1

```
EODA@ORA12CR1> insert into people(name)
2   select rownum from all_objects;
72069 rows created.
```

```
EODA@ORA12CR1> exec dbms_stats.gather_table_stats( user, 'PEOPLE' );
PL/SQL procedure successfully completed.
```

```
EODA@ORA12CR1> select table_name, avg_row_len from user_object_tables;
```

TABLE_NAME	AVG_ROW_LEN
PEOPLE	24

We see here that the average row length is 24 bytes: 16 bytes for the `SYS_NC_OID$` column and 8 bytes for the `NAME` column. Now, let's do the same thing, but use a primary key on the `NAME` column as the object identifier:

```
EODA@ORA12CR1> CREATE TABLE "PEOPLE"
2   OF "PERSON_TYPE"
3   ( constraint people_pk primary key(name) )
4   object identifier is PRIMARY KEY
5 /
Table created.
```



object tables/nested tables in that the physical storage is dictated by me, the join conditions are set up by me, and the tables are available as relational tables (which is what many third-party tools and applications will demand) naturally. The people who require an object view of relational data can have it, and the people who need the relational view can have it. Since object tables are really relational tables in disguise, we are doing the same thing Oracle does for us behind the scenes, only we can do it more efficiently, since we don't have to do it generically as they do. For example, using the types defined earlier, I could just as easily use the following:

```
EODA@ORA12CR1> create table people_tab
 2 ( name          varchar2(30) primary key,
 3   dob           date,
 4   home_city     varchar2(30),
 5   home_street   varchar2(30),
 6   home_state    varchar2(2),
 7   home_zip      number,
 8   work_city     varchar2(30),
 9   work_street   varchar2(30),
10  work_state     varchar2(2),
11  work_zip       number
12 )
13 /
```

Table created.

```
EODA@ORA12CR1> create view people of person_type
 2 with object identifier (name)
 3 as
 4 select name, dob,
 5    address_type(home_city,home_street,home_state,home_zip) home_address,
 6    address_type(work_city,work_street,work_state,work_zip) work_address
 7 from people_tab
 8 /
```

View created.

```
EODA@ORA12CR1> insert into people values ( 'Tom', '15-mar-1965',
 2 address_type( 'Denver', '123 Main Street', 'Co', '12345' ),
 3 address_type( 'Redwood', '1 Oracle Way', 'Ca', '23456' ) );
1 row created.
```

However, I achieve very much the same effect, I know exactly what is stored, how it is stored, and where it is stored. For more complex objects, we may have to code `INSTEAD OF` triggers on the object views to allow for modifications through the view.

## Object Tables Wrap-up

Object tables are used to implement an object relational model in Oracle. A single object table will create many physical database objects typically, and add additional columns to your schema to manage everything. There is some amount of magic associated with object tables. Object views allow you to take advantage of the syntax and semantics of objects, while at the same time retaining complete control over the physical storage of the data and allowing for relational access to the underlying data. In that fashion, you can achieve the best of both the relational and object-relational worlds.

## Summary

Hopefully, after reading this chapter you have come to the conclusion that not all tables are created equal. Oracle provides a rich variety of table types that you can exploit. In this chapter, we have covered many of the salient aspects of tables in general and explored the many different table types Oracle provides for us to use.

We began by looking at some terminology and storage parameters associated with tables. We looked at the usefulness of FREELISTS in a multiuser environment where a table is frequently inserted/updated by many people simultaneously, and how the use of ASSM tablespaces could make it so we don't even have to think about that. We investigated the meaning of PCTFREE and PCTUSED, and we developed some guidelines for setting them correctly.

Then we got into the different types of tables, starting with the common heap. The heap organized table is by far the most commonly used table in most Oracle applications, and it is the default table type. We moved on to examine index organized tables, which provide us with the ability to store our table data in an index structure instead of a heap table. We saw how these are applicable for various uses, such as lookup tables and inverted lists, where a heap table would just be a redundant copy of the data. Later, we saw how IOTs can really be useful when mixed with other table types, specifically the nested table type.

We looked at cluster objects, of which Oracle has three kinds: index, hash, and sorted hash. The goals of the cluster are twofold:

- To give us the ability to store data from many tables together on the same database block(s).
- To give us the ability to force like data to be stored physically together based on some cluster key. In this fashion, all of the data for department 10 (from many tables) may be stored together.

These features allow us to access related data very quickly with minimal physical I/O. We observed the main differences between index clusters and hash clusters, and we discussed when each would (and would not) be appropriate.

Next, we covered nested tables. We reviewed the syntax, semantics, and usage of nested tables. We saw how they are, in fact, a system-generated and maintained parent/child pair of tables, and we discovered how Oracle physically does this for us. We looked at using different table types for nested tables, which by default use a heap-based table. We found that there will probably never be a reason not to use an IOT instead of a heap table for nested tables.

Then we looked into the ins and outs of temporary tables, including how to create them, where they get their storage from, and the fact that they introduce no concurrency-related issues at runtime. We explored the differences between session-level and transaction-level temporary tables, and we discussed the appropriate method for using temporary tables in an Oracle database.

This chapter finished with a look into the workings of object tables. As with nested tables, we discovered there is a lot going on under the covers with object tables in Oracle. We discussed how object views on top of relational tables can give us the functionality of an object table, while at the same time giving us easy access to the underlying relational data.



# Indexes

Indexing is a crucial aspect of your application design and development. Too many indexes and the performance of modifications (inserts, updates, merges, and deletes) will suffer. Too few indexes and the performance of DML (including select, inserts, updates, and deletes) will suffer. Finding the right mix is critical to your application's performance.

Frequently, I find that indexes are an afterthought in application development. I believe that this is the wrong approach. If you understand how the data will be used from the very beginning of the process, you should be able to come up with the representative set of indexes you will use in your application. Too often the approach seems to be to throw the application out there and then see where indexes are needed. This implies that you have not taken the time to understand how the data will be used and how many rows you will ultimately require. You'll be adding indexes to this system forever as the volume of data grows over time (i.e., you'll perform *reactive tuning*). You'll have indexes that are redundant and never used; this wastes not only space but also computing resources. A few hours at the start spent properly considering when and how to index your data will save you many hours of tuning further down the road (note that I said doing so *will*, not *might*, save you many hours).

The basic aim of this chapter is to give an overview of the indexes available for use in Oracle and discuss when and where you might use them. This chapter differs from others in this book in terms of its style and format. Indexing is a huge topic—you could write an entire book on the subject—in part because indexing bridges the developer and DBA roles. The developer must be aware of indexes, how indexes apply to their applications, when to use indexes (and when not to use them), and so on. The DBA is concerned with the growth of an index, the use of storage within an index, other physical properties, and the overall performance of the database. We will be tackling indexes mainly from the standpoint of their practical use in applications. The first half of this chapter conveys the basic knowledge I believe you need to make intelligent choices about when to index and what type of index to use. The second half of the chapter answers some of the most frequently asked questions about indexes.

The various examples in this chapter require different feature releases of Oracle. When a specific example requires features found in Oracle Enterprise or Personal Edition but not Standard Edition, I'll specify that.

## An Overview of Oracle Indexes

Oracle provides many different types of indexes for us to use. Briefly, they are as follows:

- *B\*Tree indexes*: These are what I refer to as *conventional* indexes. They are, by far, the most common indexes in use in Oracle and most other databases. Similar in construct to a binary tree, B\*Tree indexes provide fast access, by key, to an individual row or range of rows, normally requiring few reads to find the correct row. It is important to note, however, that the “B” in “B\*Tree” does not stand for *binary* but rather for *balanced*. A B\*Tree index is not a binary tree at all, as we'll see when we look at how one is physically stored on disk. The B\*Tree index has several subtypes:
  - *Index organized tables*: These are tables stored in a B\*Tree structure. Whereas rows of data in a heap table are stored in an unorganized fashion (data goes wherever there is available space), data in an IOT is stored and sorted by primary key. IOTs behave

just like “regular” tables as far as your application is concerned; you use SQL to access them as normal. IOTs are especially useful for information retrieval, spatial, and OLAP applications. We discussed IOTs in some detail in Chapter 10.

- *B\*Tree cluster indexes*: These are a slight variation of conventional B\*Tree indexes. They are used to index the cluster keys (see the section “Index Clustered Tables” in Chapter 10) and will not be discussed again in this chapter. Rather than having a key that points to a row, as for a conventional B\*Tree, a B\*Tree cluster has a cluster key that points to the block that contains the rows related to that cluster key.
- *Descending indexes*: Descending indexes allow for data to be sorted from big-to-small (descending) instead of small-to-big (ascending) in the index structure. We’ll take a look at why that might be important and how they work.
- *Reverse key indexes*: These are B\*Tree indexes whereby the bytes in the key are reversed. Reverse key indexes can be used to obtain a more even distribution of index entries throughout an index that is populated with increasing values. For example, if I am using a sequence to generate a primary key, the sequence will generate values like 987500, 987501, 987502, and so on. These sequence values are monotonic, so if I were using a conventional B\*Tree index, they would all tend to go the same right-hand-side block, thus increasing contention for that block. With a reverse key index, Oracle will logically index 205789, 105789, 005789, and so on instead. Oracle will reverse the bytes of the data to be stored before placing them in the index, so values that would have been next to each other in the index before the byte reversal will instead be far apart. This reversing of the bytes spreads out the inserts into the index over many blocks.
- *Bitmap indexes*: Normally in a B\*Tree, there is a one-to-one relationship between an index entry and a row: an index entry points to a row. With bitmap indexes, a single index entry uses a bitmap to point to many rows simultaneously. They are appropriate for highly repetitive data (data with few distinct values *relative to the total number of rows in the table*) that is mostly read-only. Consider a column that takes on three possible values—Y, N, and NULL—in a table of 1 million rows. This might be a good candidate for a bitmap index, if, for example, you need to frequently count how many rows have a value of Y. That is not to say that a bitmap index on a column with 1,000 distinct values in that same table would not be valid—it certainly can be. Bitmap indexes should never be considered in an OLTP database for concurrency-related issues (which we’ll discuss in due course). Note that bitmap indexes require the Enterprise or Personal Edition of Oracle.
- *Bitmap join indexes*: These provide a means of denormalizing data in an index structure, instead of in a table. For example, consider the simple EMP and DEPT tables. Someone might ask the question, “How many people work in departments located in the city of Boston?” EMP has a foreign key to DEPT, and in order to count the employees in departments with a LOC value of Boston, we would normally have to join the tables to get the LOC column joined to the EMP records to answer this question. Using a bitmap join index, we can instead index the LOC column against the EMP table. The same caveat in regard to OLTP systems applies to a bitmap join index as a regular bitmap index.
- *Function-based indexes*: These are B\*Tree or bitmap indexes that store the computed result of a function on a row’s column(s), not the column data itself. You can consider them an index on a virtual (or derived) column—in other words, a column that is not physically stored in the table. These may be used to speed up queries of the form `SELECT * FROM T WHERE FUNCTION(DATABASE_COLUMN) = SOME_VALUE`, since the value `FUNCTION(DATABASE_COLUMN)` has already been computed and stored in the index.

- *Application domain indexes*: These are indexes you build and store yourself, either in Oracle or perhaps even outside of Oracle. You tell the optimizer how selective your index is and how costly it is to execute, and the optimizer will decide whether or not to use your index based on that information. The Oracle text index is an example of an application domain index; it is built using the same tools you may use to build your own index. It should be noted that the index created here need not use a traditional index structure. The Oracle text index, for example, uses a set of tables to implement its concept of an index.

As you can see, there are many index types to choose from. In the following sections, I'll present some technical details on how each one works and when it should be used. I would like to stress again that we will not cover certain DBA-related topics. For example, we will not discuss the mechanics of an online rebuild; rather, we will concentrate on practical application-related details.

## B\*Tree Indexes

B\*Tree—or what I call conventional—indexes are the most commonly used type of indexing structure in the database. They are similar in implementation to a binary search tree. Their goal is to minimize the amount of time Oracle spends searching for data. Loosely speaking, if you have an index on a number column, then the structure might conceptually look like Figure 11-1.

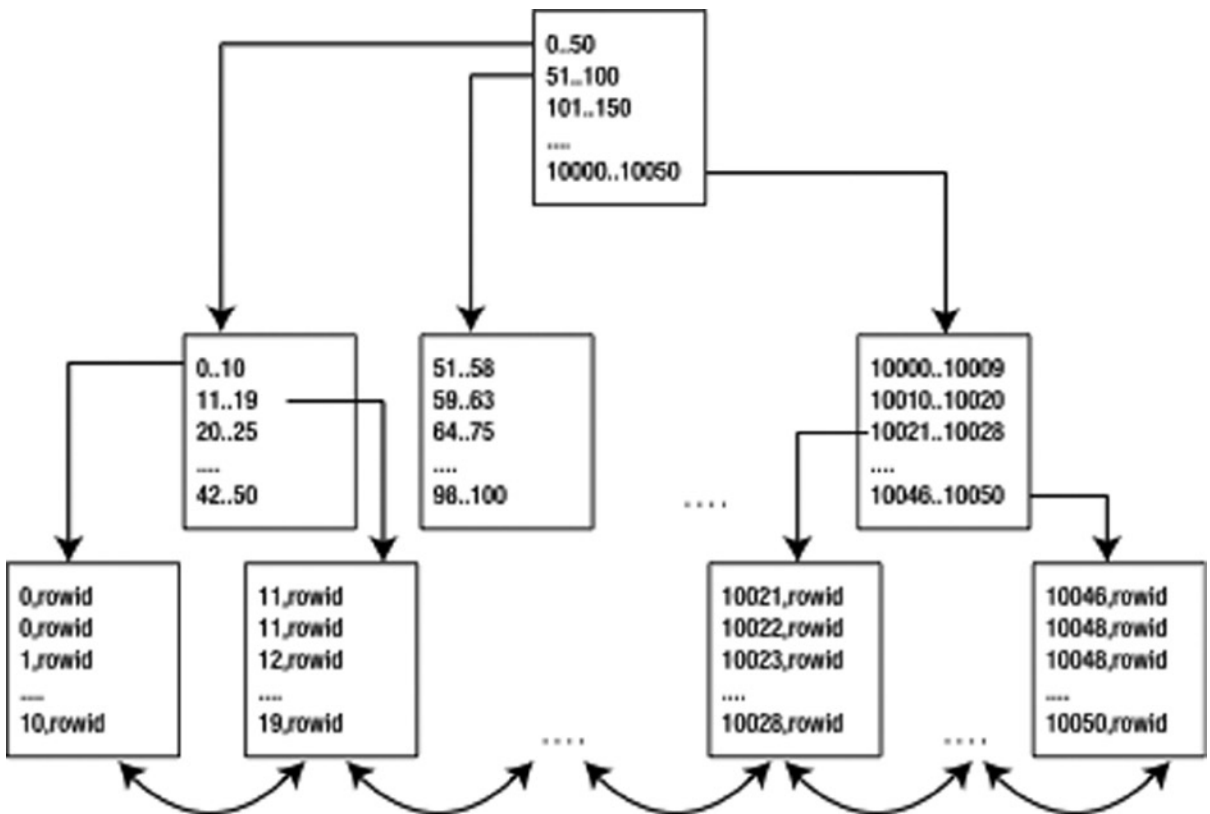

**Figure 11-1.** Typical B\*Tree index layout

---

■ **Note** There are block-level optimizations and compression of data that take place that make the real block structure look different from Figure 11-1. Also, the index depicted in Figure 11-1 is a nonunique index (meaning it allows duplicate key values). For example, if you wanted to find the value of 11, there are two different index entries with the value of 11.

---

The lowest level blocks in the tree, called *leaf nodes* or *leaf blocks*, contain every indexed key and a rowid that points to the row it is indexing. The interior blocks, above the leaf nodes, are known as *branch blocks*. They are used to navigate through the structure. For example, if we wanted to find the value 42 in the index, we would start at the top of the tree and go to the left. We would inspect that block and discover we needed to go to the block in the range “42..50”. This block would be the leaf block and point us to the rows that contained the number 42.

It is interesting to note that the leaf nodes of the index are actually a doubly linked list. Once we find out where to start in the leaf nodes (i.e., once we have found that first value), doing an ordered scan of values (also known as an *index range scan*) is very easy. We don’t have to navigate the structure anymore; we just go forward or backward through the leaf nodes as needed. That makes satisfying a predicate, such as the following, pretty simple:

```
where x between 20 and 30
```

Oracle finds the first index leaf block that contains the lowest key value that is 20 or greater, and then it just walks horizontally through the linked list of leaf nodes until it finally hits a value that is greater than 30.

There really is no such thing as a nonunique entry in a B\*Tree index. In a nonunique index, Oracle simply stores the rowid by appending it to the key as an extra column with a length byte to make the key unique. For example, an index such as `CREATE INDEX I ON T(X,Y)` is conceptually `CREATE UNIQUE INDEX I ON T(X,Y,ROWID)`. In a unique index, as defined by you, Oracle does not add the rowid to the index key. In a nonunique index, you will find that the data is sorted first by index key values (in the order of the index key) and then by rowid ascending. In a unique index, the data is sorted only by the index key values.

One of the properties of a B\*Tree is that all leaf blocks should be at the same level in the tree. This level is also known as the *height* of the index, meaning that any traversal from the root block of the index to a leaf block will visit the same number of blocks. That is, to get to the leaf block to retrieve the first row for a query of the form `"SELECT INDEXED_COL FROM T WHERE INDEXED_COL = :X"` will take the same number of I/Os regardless of the value of `:X` that is used. In other words, the index is *height balanced*. Most B\*Tree indexes will have a height of 2 or 3, even for millions of records. This means that it will take, in general, two or three I/Os to find your key in the index—which is not too bad.

---

■ **Note** Oracle uses two terms with slightly different meanings when referring to the number of blocks involved in traversing from an index root block to a leaf block. The first is `HEIGHT`, which is the number of blocks required to go from the root block to the leaf block. The `HEIGHT` value can be found from the `INDEX_STATS` view after the index has been analyzed using the `ANALYZE INDEX <name> VALIDATE STRUCTURE` command. The other is `BLEVEL`, which is the number of branch levels and differs from `HEIGHT` by one (it does not count the leaf blocks). The value of `BLEVEL` is found in the normal dictionary tables such as `USER_INDEXES` after statistics have been gathered.

---



For example, say we have a 10,000,000-row table (see the “Setting Up Your Environment” section at the beginning of this book for details on creating `BIG_TABLE`) with a primary key index on a number column:

```
EODA@ORA12CR1> select index_name, blevel, num_rows
 2  from user_indexes
 3  where table_name = 'BIG_TABLE';
```

```
INDEX_NAME          BLEVEL  NUM_ROWS
-----
BIG_TABLE_PK        2      9848991
```

The `BLEVEL` is 2, meaning the `HEIGHT` is 3, and it will take two I/Os to find a leaf (resulting in a third I/O). So we would expect three I/Os to retrieve any given key value from this index:

```
EODA@ORA12CR1> set autotrace on
EODA@ORA12CR1> select id from big_table where id = 42;
```

Execution Plan

```
-----
| Id | Operation          | Name          | Rows | Bytes | Cost (%CPU)|  Time |
-----
|  0 | SELECT STATEMENT   |               |     1 |     6 |     2 (0)| 00:00:01|
|*  1 | INDEX UNIQUE SCAN  | BIG_TABLE_PK |     1 |     6 |     2 (0)| 00:00:01|
-----
```

Statistics

```
-----
...      3 consistent gets
...      1 rows processed
```

```
EODA@ORA12CR1> select id from big_table where id = 12345;
```

Statistics

```
-----
...      3 consistent gets
...      1 rows processed
```

```
EODA@ORA12CR1> select id from big_table where id = 1234567;
```

Statistics

```
-----
...      3 consistent gets
...      1 rows processed
```

The B\*Tree is an excellent general-purpose indexing mechanism that works well for large and small tables, and experiences little, if any, degradation in retrieval performance as the size of the underlying table grows.

## Index Key Compression

One of the interesting things you can do with a B\*Tree index is *compress* it. This is not compression in the same manner that ZIP files are compressed; rather, this is compression that removes redundancies from concatenated (multicolumn) indexes.

We covered compressed key indexes in some detail in the section “Index Organized Tables” in Chapter 10, and we will take a brief look at them again here. The basic concept behind a compressed key index is that every entry is broken into two pieces: a *prefix* and *suffix* component. The prefix is built on the leading columns of the concatenated index and will have many repeating values. The suffix is built on the trailing columns in the index key and is the unique component of the index entry within the prefix.

By way of example, we’ll create a table and a concatenated index and measure its space without compression using ANALYZE INDEX.

---

■ **Note** There is a common misperception that ANALYZE should not be used as a command in Oracle—that the DBMS\_STATS package supersedes it. This is not true. What is true is that ANALYZE should not be used to gather statistics, but the other capabilities of ANALYZE still apply. The ANALYZE command should be used to perform operations such as validating the structure of an index (as we will later) or listing chained rows in a table. DBMS\_STATS should be used exclusively to gather statistics on objects.

---

We’ll then re-create the index with index key compression, compressing a different number of key entries, and see the difference. Let’s start with this table and index:

```
EODA@ORA12CR1> create table t
  2  as
  3  select * from all_objects
  4  where rownum <= 50000;
```

Table created.

```
EODA@ORA12CR1> create index t_idx on
  2  t(owner,object_type,object_name);
Index created.
```

```
EODA@ORA12CR1> analyze index t_idx validate structure;
Index analyzed.
```

We then create an IDX\_STATS table in which to save INDEX\_STATS information, and we label the rows in the table as “noncompressed”:

```
EODA@ORA12CR1> create table idx_stats
  2  as
  3  select 'noncompressed' what, a.*
  4  from index_stats a;
```

Table created.

Now, we could realize that the OWNER component is repeated many times, meaning that a single index block in this index will have dozens of entries, as shown in Figure 11-2.

```

Sys.Package.Dbms_Alert
Sys.Package.Dbms_Application_Info
Sys.Package.Dbms_Aq
Sys.Package.Dbms_Aqadm
Sys.Package.Dbms_Aqadm_Sys
Sys.Package.Dbms_Aqadm_Syscalls
Sys.Package.Dbms_Aqin
Sys.Package.Dbms_Aqjms
...

```

**Figure 11-2.** Index block with OWNER column repeated

We could factor the repeated OWNER column out of this, resulting in a block that looks more like Figure 11-3.

```

Sys
Package.Dbms_Alert
Package.Dbms_Application_Info
Package.Dbms_Aq
Package.Dbms_Aqadm
Package.Dbms_Aqadm_Sys
Package.Dbms_Aqadm_Syscalls
Package.Dbms_Aqin
Package.Dbms_Aqjms
...

```

**Figure 11-3.** Index block with OWNER column factored out

In Figure 11-3, the owner name appears once on the leaf block—not once per repeated entry. We run the following script, passing in the number 1, to re-create the scenario whereby the index is using compression on just the leading column:

```

drop index t_idx;
create index t_idx on
t(owner,object_type,object_name)
compress &1;
analyze index t_idx validate structure;
insert into idx_stats
select 'compress &1', a.*
from index_stats a;

```

For comparison reasons, we run this script not only with one column, but also two and three compressed columns, to see what happens. At the end, we query `IDX_STATS` and should observe this:

```
EODA@ORA12CR1> select what, height, lf_blks, br_blks,
 2      btree_space, opt_cmpr_count, opt_cmpr_pctsave
 3      from idx_stats
 4      /
```

WHAT	HEIGHT	LF_BKLS	BR_BKLS	BTREE_SPACE	OPT_CMPR_COUNT	OPT_CMPR_PCTSAVE
noncompressed	2	227	1	1823120	2	28
compress 1	2	206	1	1654380	2	21
compress 2	2	162	1	1302732	2	0
compress 3	2	268	1	2149884	2	39

We see that the `COMPRESS 1` index is about 90 percent the size of the noncompressed index (comparing `BTREE_SPACE`). The number of leaf blocks has decreased measurably. Further, when we use `COMPRESS 2`, the savings are even more impressive. The resulting index is about 71 percent the size of the original. In fact, using the column `OPT_CMPR_PCTSAVE`, which stands for *optimum compression percent saved* or the expected savings from compression, we could have guessed the size of the `COMPRESS 2` index:

```
EODA@ORA12CR1> select 1823120*(1-0.28) from dual;
```

```
1823120*(1-0.28)
-----
1312646.4
```

---

■ **Note** The `ANALYZE` command against the noncompressed index populated the `OPT_CMPR_PCTSAVE/OPT_CMPR_COUNT` columns and estimated a 28 percent savings with `COMPRESS 2`, and we achieved just about exactly that.

---

But notice what happens with `COMPRESS 3`. The resulting index is actually larger: 117 percent the size of the original index. This is due to the fact that each repeated prefix we remove saves the space of `N` copies, but adds 4 bytes of overhead on the leaf block as part of the compression scheme. By adding in the `OBJECT_NAME` column to the compressed key, we made that key almost unique—in this case meaning there were really no duplicate copies to factor out. Therefore, we ended up *adding* 4 bytes to almost every single index key entry and factoring out no repeating data. The `OPT_CMPR_COUNT` column in `IDX_STATS` is dead accurate at providing the best compression count to be used, and `OPT_CMPR_PCTSAVE` will tell you exactly how much savings to expect.

Now, you do not get this compression for free. The compressed index structure is now more complex than it used to be. Oracle will spend more time processing the data in this structure, both while maintaining the index during modifications and when you search the index during a query. What we are doing here is trading off increased CPU time for reduced I/O time. With compression, our block buffer cache will be able to hold more index entries than before, our cache-hit ratio might go up, and our physical I/Os should go down, but it will take a little more CPU horsepower to process the index, and it will also increase the chance of block contention. Just as in our discussion of the hash cluster, where it might take more CPU to retrieve a million random rows but half the I/O, we must be aware of the tradeoff. If you are currently CPU bound, adding compressed key indexes may slow down your processing. On the other hand, if you are I/O bound, using them may speed up things.

## Reverse Key Indexes

Another feature of a B\*Tree index is the ability to reverse its keys. At first you might ask yourself, “Why would I want to do that?” B\*Tree indexes were designed for a specific environment and for a specific issue. They were implemented to reduce contention for index leaf blocks in “right-hand-side” indexes, such as indexes on columns populated by a sequence value or a timestamp, in an Oracle RAC environment.

---

■ **Note** We discussed RAC in Chapter 2.

---

RAC is a configuration of Oracle in which multiple instances can mount and open the same database. If two instances need to modify the same block of data simultaneously, they will share the block by passing it back and forth over a hardware *interconnect*, a private network connection between the two (or more) machines. If you have a primary key index on a column populated from a sequence (a very popular implementation), everyone will be trying to modify the one block that is currently the left block on the right-hand side of the index structure as they insert new values (see Figure 11-1, which shows that higher values in the index go to the right and lower values go to the left). Modifications to indexes on columns populated by sequences are focused on a small set of leaf blocks. Reversing the keys of the index allows insertions to be distributed across all the leaf blocks in the index, though it could tend to make the index much less efficiently packed.

---

■ **Note** You may also find reverse key indexes useful as a method to reduce contention, even in a single instance of Oracle. Again, you will mainly use them to alleviate buffer busy waits on the right-hand side of a busy index, as described in this section.

---

Before we look at how to measure the impact of a reverse key index, let’s discuss what a reverse key index physically does. A reverse key index simply reverses the bytes of each column in an index key. If we consider the numbers 90101, 90102, and 90103, and look at their internal representation using the Oracle DUMP function, we will find they are represented as follows:

```

EODA@ORA12CR1> select 90101, dump(90101,16) from dual
2 union all
3 select 90102, dump(90102,16) from dual
4 union all
5 select 90103, dump(90103,16) from dual
6 /

90101 DUMP(90101,16)
-----
90101 Typ=2 Len=4: c3,a,2,2
90102 Typ=2 Len=4: c3,a,2,3
90103 Typ=2 Len=4: c3,a,2,4

```

Each one is 4 bytes in length and only the last byte is different. These numbers would end up right next to each other in an index structure. If we reverse their bytes, however, Oracle will insert the following:

```

90101 reversed = 2,2,a,c3
90102 reversed = 3,2,a,c3
90103 reversed = 4,2,a,c3

```

The numbers will end up far away from each other. This reduces the number of RAC instances going after the same block (the rightmost block) and reduces the number of block transfers between RAC instances. One of the drawbacks to a reverse key index is that you cannot use it in all cases where a regular index can be applied. For example, in answering the following predicate, a reverse key index on *X* would not be useful:

where  $x > 5$

The data in the index is not sorted by *X* before it is stored, but rather by  $REVERSE(X)$ , hence the range scan for  $X > 5$  will not be able to use the index. On the other hand, some range scans can be done on a reverse key index. If I have a concatenated index on (*X*, *Y*), the following predicate will be able to make use of the reverse key index and will range scan it:

where  $x = 5$

This is because the bytes for *X* are reversed, and then the bytes for *Y* are reversed. Oracle does not reverse the bytes of (*X* || *Y*), but rather stores ( $REVERSE(X)$  ||  $REVERSE(Y)$ ). This means all of the values for  $X = 5$  will be stored together, so Oracle can range scan that index to find them all.

Now, assuming you have a surrogate primary key on a table populated via a sequence, and you do not need to use range scanning on this index—that is, you don't need to query for  $MAX(primary\_key)$ ,  $MIN(primary\_key)$ ,  $WHERE primary\_key < 100$ , and so on—then you could consider a reverse key index in high insert scenarios even in a single instance of Oracle. I set up two different tests, one in a pure PL/SQL environment and one using Pro\*C to demonstrate the differences between inserting into a table with a reverse key index on the primary key and one with a conventional index. In both cases, the table used was created with the following DDL (we will avoid contention on table blocks by using ASSM so we can isolate the contention on the index blocks):

```
create tablespace assm
datafile size 1m autoextend on next 1m
segment space management auto;

create table t tablespace assm
as
select 0 id, owner, object_name, subobject_name,
       object_id, data_object_id, object_type, created,
       last_ddl_time, timestamp, status, temporary,
       generated, secondary
from all_objects a
where 1=0;

alter table t add constraint t_pk primary key (id)
using index (create index t_pk on t(id) &indexType tablespace assm);

create sequence s cache 1000;
```

Whereby `&indexType` was replaced with either the keyword `REVERSE`, creating a reverse key index, or with nothing, thus using a “regular” index. The PL/SQL that would be run by 1, 2, 5, 10, 15, or 20 users concurrently was as follows:

```
create or replace procedure do_sql
as
begin
  for x in ( select rownum r, OWNER, OBJECT_NAME, SUBOBJECT_NAME,
                  OBJECT_ID, DATA_OBJECT_ID, OBJECT_TYPE, CREATED,
                  LAST_DDL_TIME, TIMESTAMP, STATUS, TEMPORARY,
                  GENERATED, SECONDARY from all_objects )
```

```

loop
  insert into t
  ( id, OWNER, OBJECT_NAME, SUBOBJECT_NAME,
    OBJECT_ID, DATA_OBJECT_ID, OBJECT_TYPE, CREATED,
    LAST_DDL_TIME, TIMESTAMP, STATUS, TEMPORARY,
    GENERATED, SECONDARY )
  values
  ( s.nextval, x.OWNER, x.OBJECT_NAME, x.SUBOBJECT_NAME,
    x.OBJECT_ID, x.DATA_OBJECT_ID, x.OBJECT_TYPE, x.CREATED,
    x.LAST_DDL_TIME, x.TIMESTAMP, x.STATUS, x.TEMPORARY,
    x.GENERATED, x.SECONDARY );
  if ( mod(x.r,100) = 0 )
  then
    commit;
  end if;
end loop;
commit;
end;
/

```

Since we discussed the PL/SQL commit time optimization in Chapter 9, I now want to run a test using a different environment, so as to not be misled by this commit time optimization. I use Pro\*C to emulate a data warehouse extract, transform, load (ETL) routine that processes rows in batches of 100 at a time between commits:

```

exec sql declare c cursor for select * from all_objects;
exec sql open c;
exec sql whenever notfound do break;
for(;;)
{
  exec sql
  fetch c into :owner:owner_i,
  :object_name:object_name_i, :subobject_name:subobject_name_i,
  :object_id:object_id_i, :data_object_id:data_object_id_i,
  :object_type:object_type_i, :created:created_i,
  :last_ddl_time:last_ddl_time_i, :timestamp:timestamp_i,
  :status:status_i, :temporary:temporary_i,
  :generated:generated_i, :secondary:secondary_i;

  exec sql
  insert into t
  ( id, OWNER, OBJECT_NAME, SUBOBJECT_NAME,
    OBJECT_ID, DATA_OBJECT_ID, OBJECT_TYPE, CREATED,
    LAST_DDL_TIME, TIMESTAMP, STATUS, TEMPORARY,
    GENERATED, SECONDARY )
  values
  ( s.nextval, :owner:owner_i, :object_name:object_name_i,
    :subobject_name:subobject_name_i, :object_id:object_id_i,
    :data_object_id:data_object_id_i, :object_type:object_type_i,
    :created:created_i, :last_ddl_time:last_ddl_time_i,
    :timestamp:timestamp_i, :status:status_i,
    :temporary:temporary_i, :generated:generated_i,
    :secondary:secondary_i );
}

```

```

    if ( (++cnt%100) == 0 )
    {
        exec sql commit;
    }
}
exec sql whenever notfound continue;
exec sql commit;
exec sql close c;

```

The Pro\*C was precompiled with a PREFETCH of 100, making this C code analogous to the PL/SQL code in Oracle 10g. For example, say you have the prior Pro\*C code stored in a file named `t.pc`, then the Pro\*C compiler command looks like this:

```
$ proc iname=t.pc MODE=ORACLE PREFETCH=100
```

---

■ **Note** In Oracle 10g Release 1 and above, a simple `FOR X IN ( SELECT * FROM T )` in PL/SQL will silently array fetch 100 rows at a time, whereas in Oracle9i and before, it fetches just a single row at a time. Therefore, if you want to reproduce this example on Oracle9i and before, you will need to modify the PL/SQL code to also array fetch with the `BULK COLLECT` syntax.

---

Both would fetch 100 rows at a time and then single row insert the data into another table. The following tables summarize the differences between the various runs, starting with the single user test in Table 11-1.

**Table 11-1.** Performance Test for Use of Reverse Key Indexes with PL/SQL and Pro\*C: Single User Case

	Reverse PL/SQL	No Reverse PL/SQL	Reverse Pro*C	No Reverse Pro*C
Transaction/second	41.5	41.5	42.2	45.5
CPU time (seconds)	0.38	0.37	0.73	0.69
Buffer Busy Waits number/seconds	0/0	0/0	0/0	0/0
Elapsed Time (seconds)	0.38	0.34	3.31	3.09
Log File Sync number/seconds	2/0	2/0	650/4	650/4

From the first single-user test, we can see that PL/SQL was measurably more efficient than Pro\*C in performing this operation, a trend we'll continue to see as we scale up the user load. Part of the reason Pro\*C won't scale as well as PL/SQL will be the log file sync waits that Pro\*C must wait for, but which PL/SQL has an optimization to avoid.

It would appear from this single-user test that reverse key indexes consume slightly more CPU. This makes sense because the database must perform extra work as it carefully reverses the bytes in the key. But, we'll see that this logic won't hold true as we scale up the users. As we introduce contention, the overhead of the reverse key index will completely disappear. In fact, even by the time we get the two-user test, the overhead is mostly offset by the contention on the right hand side of the index, as shown in Table 11-2.



**Table 11-2.** Performance Test for Use of Reverse Key Indexes with PL/SQL and Pro\*C: 2 Users

	Reverse PL/SQL	No Reverse PL/SQL	Reverse Pro*C	No Reverse Pro*C
Transaction/second	55.0	55.0	59.1	53.8
CPU time (seconds)	0.80	0.77	1.57	1.55
Buffer Busy Waits number/seconds	823/0	615/0	649/0	1,580/0
Elapsed Time (seconds)	0.79	0.75	6.99	6.90
Log File Sync number/seconds	3/0	3/0	1,229/19	1,227/26

As you can see from this two-user test, PL/SQL still outperforms Pro\*C, but the use of the reverse key index is showing some positive benefits on the PL/SQL side and not so much on the Pro\*C side. That, too, is a trend that will continue. For the Pro\*C program, the reverse key index is solving the buffer busy wait problem we have due to the contention for the rightmost block in the index structure; however, it does nothing for the log file sync waits that affect the Pro\*C program. This was the main reason for performing both a PL/SQL and a Pro\*C test: to see the differences between these two environments. This begs the question, why would a reverse key index apparently benefit PL/SQL but not Pro\*C in this case? It comes down to the log file sync wait event. PL/SQL was able to continuously insert and rarely had to wait for the log file sync wait event upon commit, whereas Pro\*C was waiting every 100 rows. Therefore, PL/SQL in this case was impacted more heavily by buffer busy waits than Pro\*C was. Alleviating the buffer busy waits in the PL/SQL case allowed it to process more transactions, and so the reverse key index positively benefited PL/SQL. But in the Pro\*C case, the buffer busy waits were not the issue—they were not the major performance bottleneck, so removing the waits had no impact on overall performance.

Let's move on to the five-user test, shown in Table 11-3.

**Table 11-3.** Performance Test for Use of Reverse Key Indexes with PL/SQL and Pro\*C: 5 Users

	Reverse PL/SQL	No Reverse PL/SQL	Reverse Pro*C	No Reverse Pro*C
Transaction/second	82.2	82.2	65.6	70.3
CPU time (seconds)	1.93	1.91	3.97	4.36
Buffer Busy Waits number/seconds	1,963/1	2,644/1	2,707/0	9,839/1
Elapsed Time (seconds)	5.26	5.59	22.14	22.17
Log File Sync number/seconds	6/0	6/0	3,061/138	3,202/128

We see more of the same. PL/SQL, running full steam ahead with few log file sync waits, was very much impacted by the buffer busy waits. With a conventional index and all five users attempting to insert into the right-hand side of the index structure, PL/SQL suffered the most from the buffer busy waits and therefore benefited the most when they were reduced.

Taking a look at the ten-user test in Table 11-4, we can see the trend continues.

**Table 11-4.** Performance Test for Use of Reverse Key Indexes with PL/SQL and Pro\*C: 10 Users

	Reverse PL/SQL	No Reverse PL/SQL	Reverse Pro*C	No Reverse Pro*C
Transaction/second	88.3	91.2	96.8	88.1
CPU time (seconds)	3.83	4.06	8.57	10.01
Buffer Busy Waits number/seconds	2,897/28	6,831/7	5,284/7	34,312/25
Elapsed Time (seconds)	25.6	26.04	116.62	124.70
Log File Sync number/seconds	11/0	119/0	6,051/301	6,441/352

PL/SQL, in the absence of the log file sync wait, is very much helped by removing the buffer busy wait events. Pro\*C is experiencing more buffer busy wait contention now but, due to the fact it is waiting on log file sync events frequently, is not benefiting. One way to improve the performance of the PL/SQL implementation with a regular index would be to introduce a small wait. That would reduce the contention on the right-hand side of the index and increase overall performance. For space reasons, I will not include the 15- and 20-user tests here, but I will confirm that the trend observed in this section continued.

---

■ **Tip** You can download the source code for the reverse key index performance example from [Apress.com](http://Apress.com). In the Chapter 11 scripts folder, there are several `demo3*` files (as well as the `t.pc` file) that automate the running of this entire test suite.

---

We can take away two things from this demonstration. A reverse key index can help alleviate a buffer busy wait situation, but depending on other factors you will get varying returns on investment. In looking at Table 11-4 for the ten-user test, the removal of buffer busy waits (the most waited for wait event in that case) affected transaction throughput marginally, but it did show increased scalability with higher concurrency levels. Doing the same thing for PL/SQL had a markedly different impact on performance: we achieved a measurable increase in throughput by removing that bottleneck.

## Descending Indexes

Descending indexes were introduced in Oracle8i to extend the functionality of a B\*Tree index. They allow for a column to be stored sorted in descending order (from big to small) in the index instead of ascending order (from small to big). Prior releases of Oracle (pre-Oracle8i) always supported the DESC (descending) keyword *syntactically*, but basically ignored it—it had no effect on how the data was stored or used in the index. In Oracle8i and above, however, the DESC keyword changes the way the index is created and used.

Oracle has had the ability to read an index backward for quite a while, so you may be wondering why this feature is relevant. For example, if we use a table T:

```
EODA@ORA12CR1> create table t
 2 as
 3 select *
 4 from all_objects
 5 /
Table created.
```

```
EODA@ORA12CR1> create index t_idx on t(owner,object_type,object_name);
Index created.
```

```
EODA@ORA12CR1> begin
2     dbms_stats.gather_table_stats
3     ( user, 'T', method_opt=>'for all indexed columns' );
4 end;
5 /
```

PL/SQL procedure successfully completed.

and query it as follows

```
EODA@ORA12CR1> set autotrace traceonly explain
EODA@ORA12CR1> select owner, object_type
2     from t
3     where owner between 'T' and 'Z'
4     and object_type is not null
5     order by owner DESC, object_type DESC;
```

Execution Plan

-----  
Plan hash value: 2685572958  
-----

Id	Operation	Name	Rows	Bytes	Cost (%CPU)	Time
0	SELECT STATEMENT		5008	50080	24 (0)	00:00:01
* 1	INDEX RANGE SCAN DESCENDING	T_IDX	5008	50080	24 (0)	00:00:01

Oracle will just read the index backward. There is no final sort step in this plan; the data is sorted. Where this descending index feature comes into play, however, is when you have a mixture of columns, and some are sorted ASC (ascending) and some DESC (descending), for example:

```
EODA@ORA12CR1> select owner, object_type
2     from t
3     where owner between 'T' and 'Z'
4     and object_type is not null
5     order by owner DESC, object_type ASC;
```

Execution Plan

-----  
Plan hash value: 2813023843  
-----

Id	Operation	Name	Rows	Bytes	Cost (%CPU)	Time
0	SELECT STATEMENT		5008	50080	24 (0)	00:00:01
1	SORT ORDER BY		5008	50080	24 (0)	00:00:01
* 2	INDEX RANGE SCAN	T_IDX	5008	50080	24 (0)	00:00:01

Predicate Information (identified by operation id):

```
-----
 2 - access("OWNER">='T' AND "OWNER"<='Z')
     filter("OBJECT_TYPE" IS NOT NULL)
```

Oracle isn't able to use the index we have in place on (OWNER, OBJECT\_TYPE, OBJECT\_NAME) anymore to *sort* the data. It could have read it backward to get the data sorted by OWNER DESC, but it needs to read it “forward” to get OBJECT\_TYPE sorted ASC. Instead, it collected together all of the rows and then sorted. Enter the DESC index:

```
EODA@ORA12CR1> create index desc_t_idx on t(owner desc,object_type asc);
```

Index created.

```
EODA@ORA12CR1> select owner, object_type
 2   from t
 3   where owner between 'T' and 'Z'
 4     and object_type is not null
 5   order by owner DESC, object_type ASC;
```

Execution Plan

Plan hash value: 2494308350

```
-----
| Id | Operation          | Name      | Rows | Bytes | Cost (%CPU)| Time     |
-----|-----|-----|-----|-----|-----|-----|
|  0 | SELECT STATEMENT   |           | 5008 | 50080 |    2   (0)| 00:00:01 |
|*  1 | INDEX RANGE SCAN   | DESC_T_IDX | 5008 | 50080 |    2   (0)| 00:00:01 |
-----
```

Predicate Information (identified by operation id):

```
-----
 1 - access(SYS_OP_DESCEND("OWNER")>=HEXTORAW('A5FF') AND
     SYS_OP_DESCEND("OWNER")<=HEXTORAW('ABFF'))
     filter(SYS_OP_UNDESCEND(SYS_OP_DESCEND("OWNER"))>='T' AND
     SYS_OP_UNDESCEND(SYS_OP_DESCEND("OWNER"))<='Z' AND "OBJECT_TYPE" IS NOT
     NULL)
```

Once more, we are able to read the data sorted, and there is no extra sort step at the end of the plan.

---

■ **Note** Do not be tempted to ever leave an ORDER BY off a query. Just because your query plan includes an index does not mean the data will be returned in “some order.” The *only way* to retrieve data from the database in some sorted order is to include an ORDER BY on your query. There is no substitute for ORDER BY.

---

## When Should You Use a B\*Tree Index?

Not being a big believer in “rules of thumb” (there are exceptions to every rule), I don’t have any rules of thumb for when to use (or not to use) a B\*Tree index. To demonstrate why I don’t have any rules of thumb for this case, I’ll present two equally valid ones:

- Only use B\*Tree to index columns if you are going to access a very small percentage of the rows in the table via the index.
- Use a B\*Tree index if you are going to process many rows of a table and the index can be used *instead of* the table.

These rules seem to offer conflicting advice, but in reality, they do not—they just cover two extremely different cases. There are two ways to use an index given the preceding advice:

- *As the means to access rows in a table:* You will read the index to get to a row in the table. Here you want to access a very small percentage of the rows in the table.
- *As the means to answer a query:* The index contains enough information to answer the entire query—we will not have to go to the table at all. The index will be used as a *thinner* version of the table.

There are other ways as well—for example, we could be using an index to retrieve *all* of the rows in a table, including columns that are not in the index itself. That seemingly goes counter to both rules just presented. The case in which that would be true would be an interactive application where you are getting some of the rows and displaying them, then some more, and so on. You want to have the query optimized for initial response time, not overall throughput.

The first case (i.e., use the index if you are going to access a small percentage of the table) says if you have a table T (using the same table T from earlier) and you have a query plan that looks like this:

```
EODA@ORA12CR1> set autotrace traceonly explain
EODA@ORA12CR1> select owner, status
  2   from t
  3  where owner = USER;
```

### Execution Plan

Plan hash value: 1695850079

Id	Operation	Name	Rows	Bytes	Cost (%CPU)	...
0	SELECT STATEMENT		1716	17160	13 (0)	...
1	TABLE ACCESS BY INDEX ROWID BATCHED	T	1716	17160	13 (0)	...
* 2	INDEX RANGE SCAN	DESC_T_IDX	288		2 (0)	...

### Predicate Information (identified by operation id):

```
2 - access(SYS_OP_DESCEND("OWNER")=SYS_OP_DESCEND(USER@!))
   filter(SYS_OP_UNDESCEND(SYS_OP_DESCEND("OWNER"))=USER@!)
```

You should be accessing a very small percentage of this table. The issue to look at here is the INDEX (RANGE SCAN) followed by the TABLE ACCESS BY INDEX ROWID. This means that Oracle will read the index and then, for the index entries, it will perform a database block read (logical or physical I/O) to get the row data. This is not the most efficient method if you are going to have to access a large percentage of the rows in T via the index (we will soon define what a large percentage might be).

In the second case (i.e., when the index can be used *instead* of the table), you can process 100 percent (or any percentage, in fact) of the rows via the index. You might use an index just to create a thinner version of a table. The following query demonstrates this concept:

```
EODA@ORA12CR1> select count(*)
 2   from t
 3  where owner = user;
```

#### Execution Plan

Plan hash value: 293504097

Id	Operation	Name	Rows	Bytes	Cost (%CPU)	Time
0	SELECT STATEMENT		1	3	10 (0)	00:00:01
1	SORT AGGREGATE		1	3		
* 2	INDEX RANGE SCAN	T_IDX	1716	5148	10 (0)	00:00:01

#### Predicate Information (identified by operation id):

```
2 - access("OWNER"=USER@!)
```

Here, only the index was used to answer the query—it would not matter now what percentage of rows we were accessing, as we would use the index only. We can see from the plan that the underlying table was never accessed; we simply scanned the index structure itself.

It is important to understand the difference between the two concepts. When we have to do a TABLE ACCESS BY INDEX ROWID, we must ensure we are accessing only a small percentage of the total blocks in the table, which typically equates to a small percentage of the rows, or that we *need* the first rows to be retrieved as fast as possible (the end user is waiting for them impatiently). If we access too high a percentage of the rows (larger than somewhere between 1 and 20 percent of the rows), then it will generally take longer to access them via a B\*Tree than by just full scanning the table.

With the second type of query, where the answer is found entirely in the index, we have a different story. We read an index block and pick up many rows to process, then we go on to the next index block, and so on—we never go to the table. There is also a *fast full scan* we can perform on indexes to make this even faster in certain cases. A fast full scan is when the database reads the index blocks in no particular order; it just starts reading them. It is no longer using the index as an index, but even more like a table at that point. Rows do not come out ordered by index entries from a fast full scan.

In general, a B\*Tree index would be placed on columns that we use frequently in the predicate of a query, and we would expect some small fraction of the data from the table to be returned or the end user demands immediate feedback. On a *thin* table (i.e., a table with few or small columns), this fraction may be very small. A query that uses this index should expect to retrieve 2 to 3 percent or less of the rows to be accessed in the table. On a *fat* table (i.e., a table with many columns or very wide columns), this fraction *might* go all the way up to 20 to 25 percent of the table. This advice doesn't always seem to make sense to everyone immediately; it is not intuitive, but it is accurate. An index is stored sorted by index key. The index will be accessed in sorted order by key. The blocks that are pointed to are stored randomly in a heap. Therefore, as we read through an index to access the table, we will perform lots of *scattered*,

random I/O. By “scattered,” I mean that the index will tell us to read block 1, block 1,000, block 205, block 321, block 1, block 1,032, block 1, and so on—it won’t ask us to read block 1, then block 2, and then block 3 in a consecutive manner. We will tend to read and reread blocks in a very haphazard fashion. This single block I/O can be very slow.

As a simplistic example of this, let’s say we are reading that thin table via an index, and we are going to read 20 percent of the rows. Assume we have 100,000 rows in the table. Twenty percent of that is 20,000 rows. If the rows are about 80 bytes apiece in size, on a database with an 8KB block size, we will find about 100 rows per block. That means the table has approximately 1,000 blocks. From here, the math is very easy. We are going to read 20,000 rows via the index; this will mean quite likely 20,000 TABLE ACCESS BY ROWID operations. We will process 20,000 table blocks to execute this query. There are only about 1,000 blocks in the entire table, however! We would end up reading and processing each block in the table on average 20 times. Even if we increased the size of the row by an order of magnitude to 800 bytes per row, and 10 rows per block, we now have 10,000 blocks in the table. Index accesses for 20,000 rows would cause us to still read each block on average two times. In this case, a full table scan will be much more efficient than using an index, as it has to touch each block only once. Any query that used this index to access the data would not be very efficient until it accesses on average less than 5 percent of the data for the 800-byte column (then we access about 5,000 blocks) and even less for the 80-byte column (about 0.5 percent or less).

## Physical Organization

How the data is organized physically on disk deeply impacts these calculations, as it materially affects how expensive (or inexpensive) index access will be. Suppose you have a table where the rows have a primary key populated by a sequence. As data is added to the table, rows with sequential sequence numbers might be, in general, next to each other.

---

■ **Note** The use of features such as ASSM or multiple FREELIST/FREELIST GROUPS will affect how the data is organized on disk. Those features tend to spread the data out, and this natural clustering by primary key may not be observed.

---

The table is naturally clustered in order by the primary key (since the data is added in more or less that order). It will not be strictly clustered in order by the key, of course (we would have to use an IOT to achieve that); in general, rows with primary keys that are close in value will be close together in physical proximity. When you issue the query

```
select * from T where primary_key between :x and :y
```

the rows you want are typically located on the same blocks. In this case, an index range scan may be useful even if it accesses a large percentage of rows, simply because the database blocks that we need to read and reread will most likely be cached since the data is co-located. On the other hand, if the rows are not co-located, using that same index may be disastrous for performance. A small demonstration will drive this fact home. We’ll start with a table that is pretty much ordered by its primary key:

```
EODA@ORA12CR1> create table colocated ( x int, y varchar2(80) );
Table created.
```

```
EODA@ORA12CR1> begin
2     for i in 1 .. 100000
3     loop
4         insert into colocated(x,y)
5             values (i, rpad(dbms_random.random,75,'*') );
6     end loop;
7 end;
8 /
```

PL/SQL procedure successfully completed.

```
EODA@ORA12CR1> alter table colocated
  2 add constraint colocated_pk
  3 primary key(x);
Table altered.
```

```
EODA@ORA12CR1> begin
  2 dbms_stats.gather_table_stats( user, 'COLOCATED');
  3 end;
  4 /
PL/SQL procedure successfully completed.
```

This table fits the description we laid out earlier with about 100 rows/block in an 8KB database. In this table, there is a very good chance that the rows with X=1, 2, 3 are on the same block. Now, we'll take this table and purposely “disorganize” it. In the COLOCATED table, we created the Y column with a leading random number, and we'll use that fact to disorganize the data so that it will definitely not be ordered by primary key anymore:

```
EODA@ORA12CR1> create table disorganized
  2 as
  3 select x,y
  4 from colocated
  5 order by y;
Table created.
```

```
EODA@ORA12CR1> alter table disorganized
  2 add constraint disorganized_pk
  3 primary key (x);
Table altered.
```

```
EODA@ORA12CR1> begin
  2 dbms_stats.gather_table_stats( user, 'DISORGANIZED');
  3 end;
  4 /
PL/SQL procedure successfully completed.
```

Arguably, these are the same tables—it is a relational database, so physical organization has no bearing on the answers returned (at least that's what they teach in theoretical database courses). In fact, the performance characteristics of these two tables are as different as night and day, while the answers returned are identical. Given the same exact question, using the same exact query plans, and reviewing the TKPROF (SQL trace) output, we see the following:

```
select * from colocated where x between 20000 and 40000
```

call	count	cpu	elapsed	disk	query	current	rows
Parse	5	0.00	0.00	0	0	0	0
Execute	5	0.00	0.00	0	0	0	0
Fetch	6675	0.06	0.21	0	14495	0	100005
total	6685	0.06	0.21	0	14495	0	100005

...

Rows (1st)	Rows (avg)	Rows (max)	Row Source Operation
20001	20001	20001	TABLE ACCESS BY INDEX ROWID BATCHED COLOCATED...
20001	20001	20001	INDEX RANGE SCAN COLOCATED_PK (cr=1374 pr=0 pw=0...

\*\*\*\*\*



```
select /*+ index( disorganized disorganized_pk ) */ * from disorganized
      where x between 20000 and 40000
```

call	count	cpu	elapsed	disk	query	current	rows
Parse	5	0.00	0.00	0	0	0	0
Execute	5	0.00	0.00	0	0	0	0
Fetch	6675	0.12	0.41	0	106830	0	100005
total	6685	0.12	0.41	0	106830	0	100005

...

Rows (1st)	Rows (avg)	Rows (max)	Row Source	Operation
20001	20001	20001	TABLE ACCESS BY INDEX ROWID BATCHED	DISORGANIZED...
20001	20001	20001	INDEX RANGE SCAN	DISORGANIZED_PK (cr=1374 pr=0 pw=0...

---

■ **Note** I ran each query five times in order to get a good average runtime for each (hence the TKPROF output shows 100,000+ rows processed).

---

I think this is pretty incredible. What a difference physical data layout can make! Table 11-5 summarizes the results.

**Table 11-5.** Investigating the Effect of Physical Data Layout on the Cost of Index Access

Table	CPU Time	Logical I/O
Co-located	0.21 seconds	14,495
Disorganized	0.41 seconds	106,830
Co-located %	~50%	13%

In my database using an 8KB block size, these tables had the following number of total blocks apiece:

```
EODA@ORA12CR1> select a.index_name,
2      b.num_rows,
3      b.blocks,
4      a.clustering_factor
5 from user_indexes a, user_tables b
6 where index_name in ('COLOCATED_PK', 'DISORGANIZED_PK' )
7      and a.table_name = b.table_name
8 /
```

INDEX_NAME	NUM_ROWS	BLOCKS	CLUSTERING_FACTOR
COLOCATED_PK	100000	1252	1190
DISORGANIZED_PK	100000	1219	99929

The query against the disorganized table bears out the simple math we did earlier: we did 20,000+ logical I/Os (100,000 total blocks queried and five runs of the query). We processed each and every block 20 times! On the other hand, the physically COLOCATED data took the logical I/Os way down. Here is the perfect illustration of why rules of thumb are so hard to provide—in one case, using the index works great, and in the other it doesn't. Consider this the next time you dump data from your production system and load it into development, as it may very well provide at least part of the answer to the question, "Why is it running differently on this machine—aren't they identical?" They are not identical.

---

■ **Note** Recall from Chapter 6 that increased logical I/O is the tip of the iceberg here. Each logical I/O involves one or more latches into the buffer cache. In a multiuser/CPU situation, the CPU used by the second query would have undoubtedly gone up many times faster than the first as we spin and wait for latches. The second example query not only performs more work, but also will not scale as well as the first.

---

## THE EFFECT OF ARRAYSIZE ON LOGICAL I/O

It is interesting to note the effect of the ARRAYSIZE on logical I/O performed. ARRAYSIZE is the number of rows Oracle returns to a client when they ask for the next row. The client will then buffer these rows and use them before asking the database for the next set of rows. The ARRAYSIZE may have a very material effect on the logical I/O performed by a query, resulting from the fact that if you have to access the same block over and over again across calls (across fetch calls specifically, in this case) to the database, Oracle must retrieve that block again from the buffer cache. Therefore, if you ask for 100 rows from the database in a single call, Oracle might be able to fully process a database block and not need to retrieve that block again. If you ask for 15 rows at a time, Oracle might well have to get the same block over and over again to retrieve the same set of rows.

In the example earlier in this section, we were using the SQL\*Plus default array fetch size of 15 rows (if you divide the total rows fetched (100005) by the number of fetch calls (6675), the result is very close to 15). If we were to compare the execution of the previous queries using 15 rows per fetch versus 100 rows per fetch, we would observe the following for the COLOCATED table:

```
select * from colocated a15 where x between 20000 and 40000
```

Rows	Row	Source	Operation
Rows (1st)	Rows (avg)	Rows (max)	Row Source Operation
20001	20001	20001	TABLE ACCESS BY INDEX ROWID BATCHED COLOCATED (cr=2899 pr=0 pw=0 ...
20001	20001	20001	INDEX RANGE SCAN COLOCATED_PK (cr=1374 pr=0 pw=0 ...

```
select * from colocated a100 where x between 20000 and 40000
```

Rows	Row	Source	Operation
Rows (1st)	Rows (avg)	Rows (max)	Row Source Operation
20001	20001	20001	TABLE ACCESS BY INDEX ROWID BATCHED COLOCATED (cr=684 pr=0 pw=0 ...
20001	20001	20001	INDEX RANGE SCAN COLOCATED_PK (cr=245 pr=0 pw=0 ...

The first query was executed with the `ARRAYSIZE` of 15, and the (`cr=nnnn`) values in the `Row Source Operation` shows we performed 1,374 logical I/Os against the index and then 1,625 logical I/Os against the table (2,899–1,374; the numbers are cumulative in the `Row Source Operation` steps). When we increased the `ARRAYSIZE` to 100 from 15 (via the `SET ARRAYSIZE 100` command), the amount of logical I/O against the index dropped to 245, which was the direct result of not having to reread the index leaf blocks from the buffer cache every 15 rows, but only every 100 rows. To understand this, assume that we were able to store 200 rows per leaf block. As we are scanning through the index reading 15 rows at a time, we would have to retrieve the first leaf block 14 times to get all 200 entries off it. On the other hand, when we array fetch 100 rows at a time, we need to retrieve this same leaf block only two times from the buffer cache to exhaust all of its entries.

The same thing happened in this case with the table blocks. Since the table was sorted in the same order as the index keys, we would tend to retrieve each table block less often, as we would get more of the rows from it with each fetch call.

So, if this was good for the `COLOCATED` table, it must have been just as good for the `DISORGANIZED` table, right? Not so. The results from the `DISORGANIZED` table would look like this:

```
select /*+ index( a15 disorganized_pk ) */ *
from disorganized a15 where x between 20000 and 40000
```

Rows (1st)	Rows (avg)	Rows (max)	Row Source Operation
20001	20001	20001	TABLE ACCESS BY INDEX ROWID BATCHED DISORGANIZED (cr=21365 pr=0 ...
20001	20001	20001	INDEX RANGE SCAN DISORGANIZED_PK (cr=1374 pr=0...

```
select /*+ index( a100 disorganized_pk ) */ *
from disorganized a100 where x between 20000 and 40000
```

Rows (1st)	Rows (avg)	Rows (max)	Row Source Operation
20001	20001	20001	TABLE ACCESS BY INDEX ROWID BATCHED DISORGANIZED (cr=20236 pr=0 ...
20001	20001	20001	INDEX RANGE SCAN DISORGANIZED_PK (cr=245 pr=0...

The results against the index here were identical, which makes sense, as the data stored in the index is just the same regardless of how the *table* is organized. The logical I/O went from 1,374 for a single execution of this query to 245, just as before. But overall the amount of logical I/O performed by this query did not differ significantly: 21,365 versus 20,236. The reason? The amount of logical I/O performed against the table did not differ at all—if you subtract the logical I/O against the index from the total logical I/O performed by each query, you’ll find that both queries did 19,991 logical I/Os against the table. This is because every time we wanted *N* rows from the database—the odds that any two of those rows would be on the same block was very small—there was no opportunity to get multiple rows from a table block in a single call.

Every professional programming language I have seen that can interact with Oracle implements this concept of array fetching. In PL/SQL you may use `BULK COLLECT` or rely on the implicit array fetch of 100 that is performed for implicit cursor `FOR` loops. In Java/JDBC, there is a `prefetch` method on a `connect` or `statement` object. Oracle Call Interface (OCI; a C API) allows you to programmatically set the `prefetch` size, as does Pro\*C. As you can see, this can have a material and measurable effect on the amount of logical I/O performed by your query, and it deserves your attention.

Just to wrap up this example, let's look at what happens when we full scan the DISORGANIZED table:

```
select * from disorganized where x between 20000 and 30000
```

call	count	cpu	elapsed	disk	query	current	rows
Parse	1	0.00	0.00	0	0	0	0
Execute	1	0.00	0.00	0	0	0	0
Fetch	668	0.01	0.03	0	1858	0	10001
total	670	0.01	0.03	0	1858	0	10001

...

Rows (1st)	Rows (avg)	Rows (max)	Row Source	Operation
10001	10001	10001	TABLE ACCESS FULL	DISORGANIZED (cr=1858 pr=0 pw=0...

Thus, in this particular case, the full scan is very appropriate due to the way the data is physically stored on disk. So why didn't the optimizer full scan in the first place for this query? Well, it would have if left to its own design, but in the first example query against DISORGANIZED I purposely hinted the query and told the optimizer to construct a plan that used the index. In the second case, I let the optimizer pick the best overall plan.

## The Clustering Factor

Next, let's look at some of the information Oracle will use. We are specifically going to look at the CLUSTERING\_FACTOR column found in the USER\_INDEXES view. The *Oracle Database Reference* manual tells us this column has the following meaning:

*Indicates the amount of order of the rows in the table based on the values of the index:*

- *If the value is near the number of blocks, then the table is very well ordered. In this case, the index entries in a single leaf block tend to point to rows in the same data blocks.*
- *If the value is near the number of rows, then the table is very randomly ordered. In this case, it is unlikely that index entries in the same leaf block point to rows in the same data blocks.*

We could also view the clustering factor as a number that represents the number of logical I/Os against the table that would be performed to read the entire table via the index. That is, the CLUSTERING\_FACTOR is an indication of how ordered the table is with respect to the index itself, and when we look at these indexes we find the following:

```
EODA@ORA12CR1> select a.index_name,
2      b.num_rows,
3      b.blocks,
4      a.clustering_factor
5  from user_indexes a, user_tables b
6  where index_name in ('COLOCATED_PK', 'DISORGANIZED_PK' )
7  and a.table_name = b.table_name
8  /
```

INDEX_NAME	NUM_ROWS	BLOCKS	CLUSTERING_FACTOR
COLOCATED_PK	100000	1252	1190
DISORGANIZED_PK	100000	1219	99929

■ **Note** I used an ASSM managed tablespace for this section’s example, which explains why the clustering factor for the COLOCATED table is less than the number of blocks in the table. There are unformatted blocks in the upcoming COLOCATED table the HWM that do not contain data, as well as blocks used by ASSM itself to manage space, and we will not read these blocks ever in an index range scan. Chapter 10 explains HWMs and ASSM in more detail.

So the database is saying, “If we were to read every row in COLOCATED via the index COLOCATED\_PK from start to finish, we would perform 1,190 I/Os. However, if we did the same to DISORGANIZED, we would perform 99,929 I/Os against the table.” The reason for the large difference is that as Oracle range scans through the index structure, if it discovers the next row in the index is on the same database block as the prior row, it does not perform another I/O to get the table block from the buffer cache. It already has a handle to one and just uses it. However, if the next row is *not* on the same block, then it will release that block and perform another I/O into the buffer cache to retrieve the next block to be processed. Hence the COLOCATED\_PK index, as we range scan through it, will discover that the next row is almost always on the same block as the prior row. The DISORGANIZED\_PK index will discover the opposite is true. In fact, we can actually see this measurement is very accurate. If we hint to the optimizer to use an index full scan to read the entire table and just count the number of non-null Y values, we can see exactly how many I/Os it will take to read the entire table via the index:

```
select count(Y) from
```

```
(select /*+ INDEX(COLOCATED COLOCATED_PK) */ * from colocated)
```

call	count	cpu	elapsed	disk	query	current	rows
Parse	1	0.00	0.00	0	0	0	0
Execute	1	0.00	0.00	0	0	0	0
Fetch	2	0.03	0.03	0	1399	0	1
total	4	0.03	0.03	0	1399	0	1

...

```
Rows (1st) Rows (avg) Rows (max) Row Source Operation
```

```
-----
      1          1          1  SORT AGGREGATE (cr=1399 pr=0 pw=0 time=34740 us)
100000  100000  100000  TABLE ACCESS BY INDEX ROWID BATCHED
COLOCATED (cr=1399 pr=0 pw=0 time=90620 us cost=1400 size=7600000...
100000  100000  100000  INDEX FULL SCAN COLOCATED_PK (cr=209 pr=0 pw=0 ...
*****
```

```
select count(Y) from
```

```
(select /*+ INDEX(DISORGANIZED DISORGANIZED_PK) */ * from disorganized)
```

call	count	cpu	elapsed	disk	query	current	rows
Parse	1	0.00	0.00	0	0	0	0
Execute	1	0.00	0.00	0	0	0	0
Fetch	2	0.11	0.11	0	100138	0	1
total	4	0.11	0.11	0	100138	0	1

...

```

Rows (1st) Rows (avg) Rows (max) Row Source Operation
-----
          1          1          1 SORT AGGREGATE (cr=100138 pr=0 pw=0 time=111897 us)
100000    100000    100000 TABLE ACCESS BY INDEX ROWID BATCHED DISORGANIZED
(cr=100138 pr=0 pw=0 time=203332 us cost=100158 size=7600000 card=100000)
100000    100000    100000 INDEX FULL SCAN DISORGANIZED_PK (cr=209 pr=0 pw=0...
```

In both cases, the index needed to perform 209 logical I/Os (cr=209 in the Row Source Operation lines). If you subtract 209 from the total consistent reads and measure just the number of I/Os against the table, then you'll find that they are identical to the clustering factor for each respective index. The COLOCATED\_PK is a classic “the table is well ordered” example, whereas the DISORGANIZED\_PK is a classic “the table is very randomly ordered” example. It is interesting to see how this affects the optimizer now. If we attempt to retrieve 25,000 rows, Oracle will now choose a full table scan for both queries (retrieving 25 percent of the rows via an index is not the optimal plan, even for the very ordered table). However, if we drop down to 10 percent (bear in mind that 10 percent is *not a threshold value*—it is just a number less than 25 percent that caused an index range scan to happen in this case) of the table data:

```

EODA@ORA12CR1> set autotrace traceonly explain
EODA@ORA12CR1> select * from colocated where x between 20000 and 30000;
```

#### Execution Plan

```
-----
Plan hash value: 2792740192
```

```
-----
| Id | Operation                                | Name           | Rows  | Bytes | Cost ...
-----
|  0 | SELECT STATEMENT                          |                | 10002 | 791K | 142 ...
|  1 | TABLE ACCESS BY INDEX ROWID BATCHED      | COLOCATED      | 10002 | 791K | 142 ...
|*  2 | INDEX RANGE SCAN                          | COLOCATED_PK  | 10002 |      | 22 ...
-----
```

Predicate Information (identified by operation id):

```
-----
2 - access("X">=20000 AND "X"<=30000)
```

```
EODA@ORA12CR1> select * from disorganized where x between 20000 and 30000;
```

#### Execution Plan

```
-----
Plan hash value: 2727546897
```

```
-----
| Id | Operation          | Name           | Rows  | Bytes | Cost (%CPU)| Time     |
-----
|  0 | SELECT STATEMENT  |                | 10002 | 791K | 333 (1)| 00:00:01 |
|*  1 | TABLE ACCESS FULL| DISORGANIZED  | 10002 | 791K | 333 (1)| 00:00:01 |
-----
```

Predicate Information (identified by operation id):

```
-----
1 - filter("X"<=30000 AND "X">=20000)
```

Here we have the same table structures—the same indexes—but different clustering factors. The optimizer in this case chose an index access plan for the COLOCATED table and a full scan access plan for the DISORGANIZED table.

The key point to this discussion is that indexes are not always the appropriate access method. The optimizer may very well be correct in choosing to not use an index, as the preceding example demonstrates. Many factors influence the use of an index by the optimizer, *including* physical data layout. You might be tempted therefore to run out and try to rebuild all of your tables now to make all indexes have a good clustering factor, but that would *be a waste of time* in most cases. It will affect cases where you do index range scans of a large percentage of a table. Additionally, you must keep in mind that, in general, the table will have only *one* index with a good clustering factor! The rows in a table may be sorted in only one way. In the example just shown, if I had another index on the column Y it would be very poorly clustered in the COLOCATED table, but very nicely clustered in the DISORGANIZED table. If having the data physically clustered is important to you, consider the use of an IOT, a B\*Tree cluster, or a hash cluster over continuous table rebuilds.

## B\*Trees Wrap-up

B\*Tree indexes are by far the most common and well-understood indexing structures in the Oracle database. They are an excellent general-purpose indexing mechanism. They provide very scalable access times, returning data from a 1,000-row index in about the same amount of time as a 100,000-row index structure.

When to index and what columns to index are things you need to pay attention to in your design. An index does not always mean faster access; in fact, you will find that indexes will decrease performance in many cases if Oracle uses them. It is purely a function of how large of a percentage of the table you will need to access via the index and how the data happens to be laid out. If you can use the index to answer the question, accessing a large percentage of the rows makes sense, since you are avoiding the extra scattered I/O to read the table. If you use the index to access the table, you will need to ensure you are processing a small percentage of the total table.

You should consider the design and implementation of indexes *during* the design of your application, not as an afterthought (as I so often see). With careful planning and due consideration of how you are going to access the data, the indexes you need will be apparent in most all cases.

## Bitmap Indexes

Bitmap indexes were added to Oracle in version 7.3 of the database. They are currently available with the Oracle Enterprise and Personal Editions, but not the Standard Edition. Bitmap indexes are designed for data warehousing/ ad hoc query environments where the full set of queries that may be asked of the data is not totally known at system implementation time. They are specifically *not* designed for OLTP systems or systems where data is frequently updated by many concurrent sessions.

Bitmap indexes are structures that store pointers to many rows with a single index key entry, as compared to a B\*Tree structure where there is parity between the index keys and the rows in a table. In a bitmap index, there will be a very small number of index entries, each of which points to many rows. In a conventional B\*Tree, one index entry points to a single row.

Let's say we are creating a bitmap index on the JOB column in the EMP table as follows:

```
EOA@ORA12CR1> create BITMAP index job_idx on emp(job);
Index created.
```

Oracle will store something like what is shown in Table 11-6 in the index.

**Table 11-6.** A Representation of How Oracle Would Store the JOB-IDX Bitmap Index

Value/Row	1	2	3	4	5	6	7	8	9	10	11	12	13	14
ANALYST	0	0	0	0	0	0	0	1	0	1	0	0	1	0
CLERK	1	0	0	0	0	0	0	0	0	0	1	1	0	1
MANAGER	0	0	0	1	0	1	1	0	0	0	0	0	0	0
PRESIDENT	0	0	0	0	0	0	0	0	1	0	0	0	0	0
SALESMAN	0	1	1	0	1	0	0	0	0	0	0	0	0	0

Table 11-6 shows that rows 8, 10, and 13 have the value ANALYST, whereas rows 4, 6, and 7 have the value MANAGER. It also shows us that no rows are null (bitmap indexes store null entries; the lack of a null entry in the index implies there are no null rows). If we wanted to count the rows that have the value MANAGER, the bitmap index would do this very rapidly. If we wanted to find all the rows such that the JOB was CLERK or MANAGER, we could simply combine their bitmaps from the index as, shown in Table 11-7.

**Table 11-7.** Representation of a Bitwise OR

Value/Row	1	2	3	4	5	6	7	8	9	10	11	12	13	14
CLERK	1	0	0	0	0	0	0	0	0	0	1	1	0	1
MANAGER	0	0	0	1	0	1	1	0	0	0	0	0	0	0
CLERK or MANAGER	1	0	0	1	0	1	1	0	0	0	1	1	0	1

Table 11-7 rapidly shows us that rows 1, 4, 6, 7, 11, 12, and 14 satisfy our criteria. The bitmap Oracle stores with each key value is set up so that each position represents a rowid in the underlying table, if we need to actually retrieve the row for further processing. Queries such as the following

```
select count(*) from emp where job = 'CLERK' or job = 'MANAGER';
```

will be answered directly from the bitmap index. A query such as this

```
select * from emp where job = 'CLERK' or job = 'MANAGER';
```

on the other hand, will need to get to the table. Here, Oracle will apply a function to turn the fact that the *i*'th bit is on in a bitmap, into a rowid that can be used to access the table.

## When Should You Use a Bitmap Index?

Bitmap indexes are most appropriate on *low distinct cardinality* data (i.e., data with relatively few discrete values when compared to the cardinality of the entire set). It is not really possible to put a value on this—in other words, it is difficult to define what low distinct cardinality is truly. In a set of a couple thousand records, 2 would be low distinct cardinality, but 2 would not be low distinct cardinality in a two-row table. In a table of tens or hundreds of millions records, 100,000 could be low distinct cardinality. So, low distinct cardinality is relative to the size of the



resultset. This is data where the number of distinct items in the set of rows divided by the number of rows is a small number (near zero). For example, a GENDER column might take on the values M, F, and NULL. If you have a table with 20,000 employee records in it, then you would find that  $3/20000 = 0.00015$ . Likewise, 100,000 unique values out of 10,000,000 results in a ratio of 0.01—again, very small. These columns would be candidates for bitmap indexes. They probably would *not* be candidates for a having B\*Tree indexes, as each of the values would tend to retrieve an extremely large percentage of the table. B\*Tree indexes should be selective in general, as outlined earlier. Bitmap indexes should not be selective—on the contrary, they should be very *unselective* in general.

Bitmap indexes are extremely useful in environments where you have lots of ad hoc queries, especially queries that reference many columns in an ad hoc fashion or produce aggregations such as COUNT. For example, suppose you have a large table with three columns: GENDER, LOCATION, and AGE\_GROUP. In this table, GENDER has a value of M or F, LOCATION can take on the values 1 through 50, and AGE\_GROUP is a code representing 18 and under, 19-25, 26-30, 31-40, and 41 and over. You have to support a large number of ad hoc queries that take the following form:

```
select count(*)
  from t
 where gender = 'M'
    and location in ( 1, 10, 30 )
    and age_group = '41 and over';
```

```
select *
  from t
 where ( ( gender = 'M' and location = 20 )
    or ( gender = 'F' and location = 22 ) )
    and age_group = '18 and under';
```

```
select count(*) from t where location in (11,20,30);
```

```
select count(*) from t where age_group = '41 and over' and gender = 'F';
```

You would find that a conventional B\*Tree indexing scheme would fail you. If you wanted to use an index to get the answer, you would need at least three and up to six combinations of possible B\*Tree indexes to access the data via the index. Since any of the three columns or any subset of the three columns may appear, you would need large concatenated B\*Tree indexes on the following:

- GENDER, LOCATION, AGE\_GROUP: For queries that used all three, or GENDER with LOCATION, or GENDER alone
- LOCATION, AGE\_GROUP: For queries that used LOCATION and AGE\_GROUP or LOCATION alone
- AGE\_GROUP, GENDER: For queries that used AGE\_GROUP with GENDER or AGE\_GROUP alone

To reduce the amount of data being searched, other permutations might be reasonable as well in order to decrease the size of the index structure being scanned. This is ignoring the fact that a B\*Tree index on such low cardinality data is not a good idea.

Here is where the bitmap index comes into play. With three small bitmap indexes, one on each of the individual columns, you will be able to satisfy all of the previous predicates efficiently. Oracle will simply use the functions AND, OR, and NOT, with the bitmaps of the three indexes together, to find the solution set for any predicate that references any set of these three columns. It will take the resulting merged bitmap, convert the 1s into rowids if necessary, and access the data (if you are just counting rows that match the criteria, Oracle will just

count the 1 bits). Let's take a look at an example. First, we'll generate test data that matches our specified distinct cardinalities, index it, and gather statistics. We'll make use of the DBMS\_RANDOM package to generate random data fitting our distribution:

```
EODA@ORA12CR1> create table t
  2 ( gender not null,
  3 location not null,
  4 age_group not null,
  5 data
  6 )
  7 as
  8 select decode( round(dbms_random.value(1,2)),
  9 1, 'M',
 10 2, 'F' ) gender,
 11 ceil(dbms_random.value(1,50)) location,
 12 decode( round(dbms_random.value(1,5)),
 13 1, '18 and under',
 14 2, '19-25',
 15 3, '26-30',
 16 4, '31-40',
 17 5, '41 and over'),
 18 rpad( '*', 20, '*')
 19 from dual connect by level <=100000;
Table created.
```

```
EODA@ORA12CR1> create bitmap index gender_idx on t(gender);
Index created.
```

```
EODA@ORA12CR1> create bitmap index location_idx on t(location);
Index created.
```

```
EODA@ORA12CR1> create bitmap index age_group_idx on t(age_group);
Index created.
```

```
EODA@ORA12CR1> exec dbms_stats.gather_table_stats( user, 'T');
PL/SQL procedure successfully completed.
```

Now we'll take a look at the plans for our various ad hoc queries from earlier:

```
EODA@ORA12CR1> set autotrace traceonly explain
EODA@ORA12CR1> select count(*)
  2 from t
  3 where gender = 'M'
  4 and location in ( 1, 10, 30 )
  5 and age_group = '41 and over';
```

## Execution Plan

-----  
 Plan hash value: 320981916

Id	Operation	Name	Rows	Bytes	Cost (%CPU)	...
0	SELECT STATEMENT		1	13	9 (0)	...
1	SORT AGGREGATE		1	13		...
2	BITMAP CONVERSION COUNT		608	7904	9 (0)	...
3	BITMAP AND					...
4	BITMAP OR					...
* 5	BITMAP INDEX SINGLE VALUE	LOCATION_IDX				...
* 6	BITMAP INDEX SINGLE VALUE	LOCATION_IDX				...
* 7	BITMAP INDEX SINGLE VALUE	LOCATION_IDX				...
* 8	BITMAP INDEX SINGLE VALUE	AGE_GROUP_IDX				...
* 9	BITMAP INDEX SINGLE VALUE	GENDER_IDX				...

-----  
 Predicate Information (identified by operation id):

```

5 - access("LOCATION"=1)
6 - access("LOCATION"=10)
7 - access("LOCATION"=30)
8 - access("AGE_GROUP"='41 and over')
9 - access("GENDER"='M')
```

This example shows the power of the bitmap indexes. Oracle is able to see the location in (1,10,30) and knows to read the index on location for these three values and logically OR together the “bits” in the bitmap. It then takes that resulting bitmap and logically ANDs that with the bitmaps for AGE\_GROUP='41 AND OVER' and GENDER='M'. Then a simple count of 1s and the answer is ready.

```

EODA@ORA12CR1> select *
2   from t
3  where ( ( gender = 'M' and location = 20 )
4         or ( gender = 'F' and location = 22 ))
5         and age_group = '18 and under';
```

## Execution Plan

-----  
 Plan hash value: 705811684

Id	Operation	Name	Rows	Bytes	Cost (%CPU)...
0	SELECT STATEMENT		408	13872	68 (0)...
1	TABLE ACCESS BY INDEX ROWID BATCHED	T	408	13872	68 (0)...
2	BITMAP CONVERSION TO ROWIDS				...
3	BITMAP AND				...
* 4	BITMAP INDEX SINGLE VALUE	AGE_GROUP_IDX			...
5	BITMAP OR				...
6	BITMAP AND				...
* 7	BITMAP INDEX SINGLE VALUE	LOCATION_IDX			...
* 8	BITMAP INDEX SINGLE VALUE	GENDER_IDX			...
9	BITMAP AND				...
* 10	BITMAP INDEX SINGLE VALUE	LOCATION_IDX			...
* 11	BITMAP INDEX SINGLE VALUE	GENDER_IDX			...

Predicate Information (identified by operation id):

```

4 - access("AGE_GROUP"='18 and under')
7 - access("LOCATION"=22)
8 - access("GENDER"='F')
10 - access("LOCATION"=20)
11 - access("GENDER"='M')

```

This shows similar logic: the plan shows the OR'd conditions are each evaluated by AND-ing together the appropriate bitmaps and then OR-ing together those results. Throw in another AND to satisfy the AGE\_GROUP='18 AND UNDER' and we have it all. Since we asked for the actual rows this time, Oracle will convert each bitmap 1 and 0 into rowids to retrieve the source data.

In a data warehouse or a large reporting system supporting many ad hoc SQL queries, this ability to use as many indexes as make sense simultaneously comes in very handy indeed. Using conventional B\*Tree indexes here would not be nearly as usual or usable, and as the number of columns that are to be searched by the ad hoc queries increases, the number of combinations of B\*Tree indexes you would need increases as well.

However, there are times when bitmaps are *not* appropriate. They work well in a read-intensive environment, but they are extremely ill suited for a write-intensive environment. The reason is that a single bitmap index key entry points to *many* rows. If a session modifies the indexed data, then all of the rows that index entry points to are effectively locked in most cases. Oracle cannot lock an individual bit in a bitmap index entry; it locks the entire bitmap index entry. Any other modifications that need to update *that same bitmap index entry* will be locked out. This will seriously inhibit concurrency, as each update will appear to lock potentially hundreds of rows preventing their bitmap columns from being concurrently updated. It will not lock *every* row as you might think—just many of them. Bitmaps are stored in chunks, so using the earlier EMP example we might find that the index key ANALYST appears in the index many times, each time pointing to hundreds of rows. An update to a row that modifies the JOB column will need to get exclusive access to two of these index key entries: the index key entry for the *old* value and the index key entry for the *new* value. The hundreds of rows these two entries point to will be unavailable for modification by other sessions until that UPDATE commits.

## Bitmap Join Indexes

In Oracle9i an index type was added: the bitmap join index. Normally, an index is created on a single table, using only columns from that table. A bitmap join index breaks that rule and allows you to index a given table using columns from some other table. In effect, this allows you to denormalize data in an index structure instead of in the tables themselves.

Consider the simple EMP and DEPT tables. EMP has a foreign key to DEPT (the DEPTNO column). The DEPT table has the DNAME attribute (the name of the department). The end users will frequently ask questions such as “How many people work in sales?”, “Who works in sales?”, “Can you show me the top N performing people in sales?” Note that they do not ask, “How many people work in DEPTNO 30?” They don’t use those key values; rather, they use the human-readable department name. Therefore, they end up running queries such as the following:

```
select count(*)
from emp, dept
where emp.deptno = dept.deptno
and dept.dname = 'SALES'
/
select emp.*
from emp, dept
where emp.deptno = dept.deptno
and dept.dname = 'SALES'
/
```

Those queries almost necessarily have to access the DEPT table and the EMP table using conventional indexes. We might use an index on DEPT.DNAME to find the SALES row(s) and retrieve the DEPTNO value for SALES, and then use an INDEX on EMP.DEPTNO to find the matching rows; however, by using a bitmap join index we can avoid all of that. The bitmap join index allows us to index the DEPT.DNAME column, but have that index point not at the DEPT table, but at the EMP table. This is a pretty radical concept—to be able to index attributes from other tables—and it might change the way to implement your data model in a reporting system. You can, in effect, have your cake and eat it, too. You can keep your normalized data structures intact, yet get the benefits of denormalization at the same time.

Here’s the index we would create for this example:

```
EODA@ORA12CR1> create bitmap index emp_bm_idx
 2 on emp( d.dname )
 3 from emp e, dept d
 4 where e.deptno = d.deptno
 5 /
Index created.
```

Note how the beginning of the CREATE INDEX looks “normal” and creates the index INDEX\_NAME on the table. But from there on, it deviates from “normal.” We see a reference to a column in the DEPT table: D.DNAME. We see a FROM clause, making this CREATE INDEX statement resemble a query. We have a join condition between multiple tables. This CREATE INDEX statement indexes the DEPT.DNAME column, but in the context of the EMP table. If we ask those questions mentioned earlier, we would find the database never accesses the DEPT at all, and it need not do so because the DNAME column now exists in the index pointing to rows in the EMP table. For purposes of illustration, we will make the EMP and DEPT tables appear large (to avoid having the CBO think they are small and full scanning them instead of using indexes):

```
EODA@ORA12CR1> begin
 2 dbms_stats.set_table_stats( user, 'EMP',
 3                             numRows => 1000000, numblks => 300000 );
 4 dbms_stats.set_table_stats( user, 'DEPT',
 5                             numRows => 100000, numblks => 30000 );
 6 dbms_stats.delete_index_stats( user, 'EMP_BM_IDX' );
 7 end;
 8 /
PL/SQL procedure successfully completed.
```

■ **Note** You might be wondering why I invoked `DELETE_INDEX_STATS` above, it is because in Oracle 10g and above, a `CREATE INDEX` automatically does a `COMPUTE STATISTICS` as it creates the index. Therefore, in this case, Oracle was “tricked—it thinks it sees a table with 1,000,000 rows and a teeny tiny index on it (the table really only has 14 rows after all). The index statistics were accurate, the table statistics were “fake.” I needed to “fake” the index statistics as well—or I could have loaded the table up with 1,000,000 records before indexing it.

And then we’ll perform our queries:

```
EODA@ORA12CR1> set autotrace traceonly explain
EODA@ORA12CR1> select count(*)
 2  from emp, dept
 3  where emp.deptno = dept.deptno
 4  and dept.dname = 'SALES'
 5  /
```

Execution Plan

Plan hash value: 2538954156

Id	Operation	Name	Rows	Bytes	Cost (%CPU)	Time
0	SELECT STATEMENT		1	3	7 (0)	00:00:01
1	SORT AGGREGATE		1	3		
2	BITMAP CONVERSION COUNT		250K	732K	7 (0)	00:00:01
* 3	BITMAP INDEX SINGLE VALUE	EMP_BM_IDX				

Predicate Information (identified by operation id):

```
3 - access("EMP"."SYS_NC00009$"='SALES')
```

As you can see, to answer this particular question, we did not have to actually access either the `EMP` or `DEPT` table—the entire answer came from the index itself. All the information needed to answer the question was available in the index structure.

Further, we were able to skip accessing the `DEPT` table and, using the index on `EMP` that incorporated the data we needed from `DEPT`, gain direct access to the required rows:

```
EODA@ORA12CR1> select emp.*
 2  from emp, dept
 3  where emp.deptno = dept.deptno
 4  and dept.dname = 'SALES'
 5  /
```

## Execution Plan

-----  
 Plan hash value: 4261295901

Id	Operation	Name	Rows	Bytes	Cost (%CPU)...
0	SELECT STATEMENT		10000	849K	6139 (1)...
1	TABLE ACCESS BY INDEX ROWID BATCHED	EMP	10000	849K	6139 (1)...
2	BITMAP CONVERSION TO ROWIDS				...
* 3	BITMAP INDEX SINGLE VALUE	EMP_BM_IDX			...

Predicate Information (identified by operation id):  
 -----

3 - access("EMP"."SYS\_NC00009\$"='SALES')

Bitmap join indexes do have a prerequisite. The join condition must join to a primary or unique key in the other table. In the preceding example, DEPT.DEPTNO is the primary key of the DEPT table, and the primary key must be in place, otherwise an error will occur:

```

EODA@ORA12CR1> create bitmap index emp_bm_idx
 2 on emp( d.dname )
 3 from emp e, dept d
 4 where e.deptno = d.deptno
 5 /
from emp e, dept d
*
```

ERROR at line 3:

ORA-25954: missing primary key or unique constraint on dimension

## Bitmap Indexes Wrap-up

When in doubt, try it out (in your non-OLTP system, of course). It is trivial to add a bitmap index to a table (or a bunch of them) and see what it does for you. Also, you can usually create bitmap indexes much faster than B\*Tree indexes. Experimentation is the best way to see if they are suited for your environment. I am frequently asked, “What defines low cardinality?” There is no cut-and-dried answer for this. Sometimes it is 3 values out of 100,000. Sometimes it is 10,000 values out of 1,000,000. Low cardinality doesn’t imply single-digit counts of distinct values. Experimentation is the way to discover if a bitmap is a good idea for your application. In general, if you have a large, mostly read-only environment with lots of ad hoc queries, a set of bitmap indexes may be exactly what you need.

## Function-Based Indexes

Function-based indexes were added to Oracle 8.1.5. They are now a feature of Standard Edition, whereas in releases prior to Oracle9i Release 2 they were a feature of Enterprise Edition.

Function-based indexes give us the ability to index computed columns and use these indexes in a query. In a nutshell, this capability allows you to have case-insensitive searches or sorts, search on complex equations, and extend the SQL language efficiently by implementing your own functions and operators and then searching on them.

There are many reasons why you would want to use a function-based index, with the following chief among them:

- They are easy to implement and provide immediate value.
- They can be used to speed up existing applications without changing any of their logic or queries.

The following subsections provide relevant cases of implementing function-based indexes.

## A Simple Function-Based Index Example

Consider the following example. We want to perform a case-insensitive search on the ENAME column of the EMP table. Prior to function-based indexes, we would have approached this in a very different manner. We would have added an extra column to the EMP table called UPPER\_ENAME, for example. This column would have been maintained by a database trigger on INSERT and UPDATE; that trigger would simply have set NEW.UPPER\_NAME := UPPER(:NEW.ENAME). This extra column would have been indexed. Now with function-based indexes, we remove the need for the extra column.

We begin by creating a copy of the demo EMP table in the SCOTT schema and adding some data to it:

```
EODA@ORA12CR1> create table emp
 2 as
 3 select *
 4   from scott.emp
 5  where 1=0;
Table created.
```

```
EODA@ORA12CR1> insert into emp
 2 (empno,ename,job,mgr,hiredate,sal,comm,deptno)
 3 select rownum empno,
 4        initcap(substr(object_name,1,10)) ename,
 5        substr(object_type,1,9) JOB,
 6        rownum MGR,
 7        created hiredate,
 8        rownum SAL,
 9        rownum COMM,
10        (mod(rownum,4)+1)*10 DEPTNO
11  from all_objects
12  where rownum < 10000;
9999 rows created.
```

Next, we will create an index on the UPPER value of the ENAME column, effectively creating a case-insensitive index:

```
EODA@ORA12CR1> create index emp_upper_idx on emp(upper(ename));
Index created.
```

Finally, we'll analyze the table since, as noted previously, we need to make use of the CBO to use function-based indexes. As of Oracle 10g, this step is technically unnecessary, as the CBO is used by default and dynamic sampling would gather the needed information, but gathering statistics is a more correct approach.



```
EODA@ORA12CR1> begin
  2   dbms_stats.gather_table_stats
  3   (user, 'EMP', cascade=>true);
  4 end;
  5 /
PL/SQL procedure successfully completed.
```

We now have an index on the UPPER value of a column. Any application that already issues case-insensitive queries like the following will make use of this index, gaining the performance boost an index can deliver:

```
EODA@ORA12CR1> set autotrace traceonly explain
EODA@ORA12CR1> select *
  2   from emp
  3   where upper(ename) = 'KING';
```

#### Execution Plan

Plan hash value: 3831183638

Id	Operation	Name	Rows	Bytes	Cost (%CPU)...
0	SELECT STATEMENT		2	110	2 (0)...
1	TABLE ACCESS BY INDEX ROWID BATCHED	EMP	2	110	2 (0)...
* 2	INDEX RANGE SCAN	EMP_UPPER_IDX	2		1 (0)...

#### Predicate Information (identified by operation id):

```
2 - access(UPPER("ENAME")='KING')
```

Before this feature was available, every row in the EMP table would have been scanned, uppercased, and compared. In contrast, with the index on UPPER(ENAME), the query takes the constant KING to the index, range scans a little data, and accesses the table by rowid to get the data. This is very fast.

This performance boost is most visible when indexing user-written functions on columns. Oracle 7.1 added the ability to use user-written functions in SQL, so we could do something like this:

```
SQL> select my_function(ename)
  2   from emp
  3   where some_other_function(empno) > 10
  4   /
```

This was great because we could now effectively extend the SQL language to include application-specific functions. Unfortunately, however, the performance of the preceding query was a bit disappointing at times. Say the EMP table had 1,000 rows in it. The function SOME\_OTHER\_FUNCTION would be executed 1,000 times during the query, once per row. In addition, assuming the function took one-hundredth of a second to execute, this relatively simple query now takes at least ten seconds.

Let's look at a real example, where we'll implement a modified SOUNDEX routine in PL/SQL. Additionally, we'll use a package global variable as a counter in our procedure, which will allow us to execute queries that make use of the MY\_SOUNDEX function and see exactly how many times it was called:

```
EODA@ORA12CR1> create or replace package stats
```

```
 2 as
 3     cnt number default 0;
 4 end;
 5 /
```

Package created.

```
EODA@ORA12CR1> create or replace
```

```
 2 function my_soundex( p_string in varchar2 ) return varchar2
 3 deterministic
 4 as
 5     l_return_string varchar2(6) default substr( p_string, 1, 1 );
 6     l_char          varchar2(1);
 7     l_last_digit   number default 0;
 8
 9     type vcArray is table of varchar2(10) index by binary_integer;
10     l_code_table   vcArray;
11
12 begin
13     stats.cnt := stats.cnt+1;
14
15     l_code_table(1) := 'BPFV';
16     l_code_table(2) := 'CSKGJQXZ';
17     l_code_table(3) := 'DT';
18     l_code_table(4) := 'L';
19     l_code_table(5) := 'MN';
20     l_code_table(6) := 'R';
21
22
23     for i in 1 .. length(p_string)
24     loop
25         exit when (length(l_return_string) = 6);
26         l_char := upper(substr( p_string, i, 1 ));
27
28         for j in 1 .. l_code_table.count
29         loop
30             if (instr(l_code_table(j), l_char ) > 0 AND j <> l_last_digit)
31             then
32                 l_return_string := l_return_string || to_char(j,'fm9');
33                 l_last_digit := j;
34             end if;
35         end loop;
36     end loop;
37
38     return rpad( l_return_string, 6, '0' );
39 end;
40 /
```

Function created.

Notice in this function, we are using a keyword, DETERMINISTIC. This declares that the preceding function, when given the same inputs, will always return the exact same output. This is needed to create a function-based index on a user-written function. We must tell Oracle that the function is DETERMINISTIC and will return a consistent result given the same inputs. We are telling Oracle that this function should be trusted to return the same value, call after call, given the same inputs. If this were not the case, we would receive different answers when accessing the data via the index versus a full table scan. This deterministic setting implies, for example, that we cannot create an index on the function DBMS\_RANDOM.RANDOM, the random number generator. Its results are not deterministic; given the same inputs, we'll get random output. The built-in SQL function UPPER used in the first example, on the other hand, is deterministic, so we can create an index on the UPPER value of a column.

Now that we have the function MY\_SOUNDEX, let's see how it performs without an index. This uses the EMP table we created earlier with about 10,000 rows in it:

```
EODA@ORA12CR1> set autotrace on explain
EODA@ORA12CR1> variable cpu number
EODA@ORA12CR1> exec :cpu := dbms_utility.get_cpu_time
PL/SQL procedure successfully completed.
```

```
EODA@ORA12CR1> select ename, hiredate
2   from emp
3   where my_soundex(ename) = my_soundex('Kings')
4   /
```

```
ENAME      HIREDATE
-----
Ku$_Chunk_ 17-DEC-13
Ku$_Chunk_ 17-DEC-13
Ku$_Chunk_ 17-DEC-13
Ku$_Chunk_ 17-DEC-13
```

Execution Plan

-----  
Plan hash value: 3956160932

```
-----
| Id | Operation          | Name | Rows | Bytes | Cost (%CPU)| Time     |
-----
|  0 | SELECT STATEMENT   |      |    1 | 1900 |    24 (9)| 00:00:01 |
|*  1 | TABLE ACCESS FULL| EMP  |    1 | 1900 |    24 (9)| 00:00:01 |
-----
```

Predicate Information (identified by operation id):

-----  
1 - filter("MY\_SOUNDEX"("ENAME")="MY\_SOUNDEX"('Kings'))

```
EODA@ORA12CR1> set autotrace off
EODA@ORA12CR1> begin
2     dbms_output.put_line
3     ( 'cpu time = ' || round((dbms_utility.get_cpu_time-:cpu)/100,2) );
4     dbms_output.put_line( 'function was called: ' || stats.cnt );
5 end;
6 /
```

```
cpu time = .2
function was called: 9916
PL/SQL procedure successfully completed.
```

We can see this query took two-tenths of a CPU second to execute and had to do a full scan on the table. The function `MY_SOUNDEX` was invoked almost 10,000 times (according to our counter). We'd like it to be called much less frequently, however.

---

■ **Note** In older releases (pre-Oracle 10g Release 2), the function would be called many more times than observed above. In fact, it would be invoked approximately 20,000 times—twice for each row! Oracle 10g Release 2 and above use the `DETERMINISTIC` hint to reduce the number of times it feels inclined to invoke the function.

---

Let's see how indexing the function can speed up things. The first thing we'll do is create the index as follows:

```
EODA@ORA12CR1> create index emp_soundex_idx on
  2 emp( substr(my_soundex(ename),1,6) )
  3 /
Index created.
```

The interesting thing to note in this `CREATE INDEX` command is the use of the `SUBSTR` function. This is because we are indexing a function that returns a string. If we were indexing a function that returned a number or date, this `SUBSTR` would not be necessary. The reason we must `SUBSTR` the user-written function that returns a string is that such functions return `VARCHAR2(4000)` types. That may well be too big to be indexed—index entries must fit within about three quarters the size of a block. If we tried, we would receive (in a tablespace with a 4KB block size) the following:

```
EODA@ORA12CR1> create index emp_soundex_idx on
  2 emp( my_soundex(ename) ) tablespace ts4k;
emp( my_soundex(ename) ) tablespace ts4k
  *
ERROR at line 2:
ORA-01450: maximum key length (3118) exceeded
```

It is not that the index actually contains any keys that large, but that *it could* as far as the database is concerned. But the database understands `SUBSTR`. It sees the inputs to `SUBSTR` of 1 and 6, and knows the biggest return value from this is six characters; hence, it permits the index to be created. This size issue can get you, especially with concatenated indexes. Here is an example on an 8KB block size tablespace:

```
EODA@ORA12CR1> create index emp_soundex_idx on
  2 emp( my_soundex(ename), my_soundex(job) );
emp( my_soundex(ename), my_soundex(job) )
  *
ERROR at line 2:
ORA-01450: maximum key length (6398) exceeded
```

The database thinks the maximum key size is 8,000 bytes and fails the `CREATE` statement once again. So, to index a user-written function that returns a string, we should constrain the return type in the `CREATE INDEX` statement. In this example, knowing that `MY_SOUNDEX` returns at most six characters, we are substringing the first six characters.

We are now ready to test the performance of the table with the index on it. We would like to monitor the effect of the index on INSERTs as well as the speedup for SELECTs to see the effect on each. In the unindexed test case, our queries take over one second, and if we were to run SQL\_TRACE and TKPROF during the inserts, we could observe that without the index, the insert of 9,999 records took about 0.30 seconds:

```
insert into emp NO_INDEX
(empno,ename,job,mgr,hiredate,sal,comm,deptno)
select rownum empno,
       initcap(substr(object_name,1,10)) ename,
       substr(object_type,1,9) JOB,
       rownum MGR,
       created hiredate,
       rownum SAL,
       rownum COMM,
       (mod(rownum,4)+1)*10 DEPTNO
from all_objects
where rownum < 10000
```

call	count	cpu	elapsed	disk	query	current	rows
Parse	1	0.08	0.08	0	0	0	0
Execute	1	0.15	0.22	0	2745	13763	9999
Fetch	0	0.00	0.00	0	0	0	0
total	2	0.23	0.30	0	2745	13763	9999

But with the index, it takes about 0.57 seconds:

call	count	cpu	elapsed	disk	query	current	rows
Parse	1	0.07	0.07	0	0	0	0
Execute	1	0.39	0.49	131	2853	23313	9999
Fetch	0	0.00	0.00	0	0	0	0
total	2	0.46	0.57	131	2853	23313	9999

This was the overhead introduced in the management of the new index on the MY\_SOUNDEX function—both in the performance overhead of simply having an index (any type of index will affect insert performance) and the fact that this index had to call a stored procedure 9,999 times.

Now, to test the query, we'll just rerun the query:

```
EODA@ORA12CR1> exec stats.cnt := 0
PL/SQL procedure successfully completed.

EODA@ORA12CR1> exec :cpu := dbms_utility.get_cpu_time
PL/SQL procedure successfully completed.

EODA@ORA12CR1> set autotrace on explain
EODA@ORA12CR1> select ename, hiredate
2   from emp
3   where substr(my_soundex(ename),1,6) = my_soundex('Kings')
4   /
```

```

ENAME      HIREDATE
-----
Ku$_Chunk_ 17-DEC-13
Ku$_Chunk_ 17-DEC-13
Ku$_Chunk_ 17-DEC-13
Ku$_Chunk_ 17-DEC-13

```

Plan hash value: 1897478402

```

-----
| Id | Operation                               | Name           | Rows | Bytes | Cost ...
-----
|  0 | SELECT STATEMENT                       |                |    100 | 3300 | 12 ...
|  1 | TABLE ACCESS BY INDEX ROWID BATCHED   | EMP            |    100 | 3300 | 12 ...
|*  2 | INDEX RANGE SCAN                       | EMP_SOUNDEX_IDX |     40 |      | 1 ...
-----

```

Predicate Information (identified by operation id):

```

-----
2 - access(SUBSTR("EODA"."MY_SOUNDEX"("ENAME"),1,6)="MY_SOUNDEX('Kings'))

```

```

EODA@ORA12CR1> set autotrace off
EODA@ORA12CR1> begin
2      dbms_output.put_line
3      ( 'cpu time = ' || round((dbms_utility.get_cpu_time-:cpu)/100,2) );
4      dbms_output.put_line( 'function was called: ' || stats.cnt );
5  end;
6  /
cpu time = .01
function was called: 1

```

PL/SQL procedure successfully completed.

If we compare the two examples (unindexed versus indexed), we find that the insert into the indexed table was affected by a little more than twice the runtime. However, the select went from two-tenths of a second to effectively instantly. The important things to note here are the following:

- The insertion of 9,999 records took approximately two times longer. Indexing a user-written function will necessarily affect the performance of inserts and some updates. You should realize that any index will impact performance, of course. For example, I did a simple test without the MY\_SOUNDEX function, just indexing the ENAME column itself. That caused the INSERT to take about one second to execute—the PL/SQL function is not responsible for the entire overhead. Since most applications insert and update singleton entries, and each row took less than 1/10,000 of a second to insert, you probably won't even notice this in a typical application. Since we insert a row only once, we pay the price of executing the function on the column once, not the thousands of times we query the data.
- While the insert ran two times slower, the query ran many times faster. It evaluated the MY\_SOUNDEX function a few times instead of almost 10,000 times. The difference in performance of our query here is measurable and quite large. Also, as the size of our table grows, the full scan query will take longer and longer to execute. The index-based query will always execute with nearly the same performance characteristics as the table gets larger.

- We had to use SUBSTR in our query. This is not as nice as just coding WHERE MY\_SOUNDEX(ename)=MY\_SOUNDEX( 'King' ), but we can easily get around that, as we will see shortly.

So, the insert was affected, but the query ran incredibly fast. The payoff for a small reduction in insert/update performance is huge. Additionally, if you never update the columns involved in the MY\_SOUNDEX function call, the updates are not penalized at all (MY\_SOUNDEX is invoked only if the ENAME column is *modified* and its value changed).

Let's see how to make it so the query does not have to use the SUBSTR function call. The use of the SUBSTR call could be error-prone—our end users have to know to SUBSTR from 1 for six characters. If they use a different size, the index will not be used. Also, we want to control in the server the number of bytes to index. This will allow us to reimplement the MY\_SOUNDEX function later with 7 bytes instead of 6 if we want to. We can hide the SUBSTR with a virtual column in Oracle Database 11g Release 1 and above—or a view in any release quite easily as follows:

```
EODA@ORA12CR1> create or replace view emp_v
 2 as
 3 select ename, substr(my_soundex(ename),1,6) ename_soundex, hiredate
 4 from emp
 5 /
View created.
```

```
EODA@ORA12CR1> exec stats.cnt := 0;
PL/SQL procedure successfully completed.
```

```
EODA@ORA12CR1> exec :cpu := dbms_utility.get_cpu_time
PL/SQL procedure successfully completed.
```

```
EODA@ORA12CR1> select ename, hiredate
 2 from emp_v
 3 where ename_soundex = my_soundex('Kings')
 4 /
```

```
ENAME      HIREDATE
-----
Ku$_Chunk_ 17-DEC-13
Ku$_Chunk_ 17-DEC-13
Ku$_Chunk_ 17-DEC-13
Ku$_Chunk_ 17-DEC-13
```

```
EODA@ORA12CR1> begin
 2 dbms_output.put_line
 3 ( 'cpu time = ' || round((dbms_utility.get_cpu_time-:cpu)/100,2) );
 4 dbms_output.put_line( 'function was called: ' || stats.cnt );
 5 end;
 6 /
cpu time = .01
function was called: 1
```

```
PL/SQL procedure successfully completed.
```

We would see the same sort of query plan we did with the base table. All we have done here is hide the `SUBSTR( F(X), 1, 6 )` function call in the view itself. The optimizer still recognizes that this virtual column is, in fact, the indexed column and so does the right thing. We see the same performance improvement and the same query plan. Using this view is as good as using the base table—better even, because it hides the complexity and allows us to change the size of the `SUBSTR` later.

In Oracle 11g Release 1 and above, we have another choice for implementation. Rather than using a view with a “virtual column,” we can use a real virtual column. Using the feature involves dropping our existing function-based index:

```
EODA@ORA12CR1> drop index emp_soundex_idx;
Index dropped.
```

And then adds the virtual column to the table and indexing that column:

```
EODA@ORA12CR1> alter table emp
 2 add
 3   ename_soundex as
 4   (substr(my_soundex(ename),1,6))
 5 /
Table altered.
```

```
EODA@ORA12CR1> create index emp_soundex_idx
 2 on emp(ename_soundex);
Index created.
```

Now we can just query the base table—no extra view layer involved at all:

```
EODA@ORA12CR1> exec stats.cnt := 0;
PL/SQL procedure successfully completed.

EODA@ORA12CR1> exec :cpu := dbms_utility.get_cpu_time;
PL/SQL procedure successfully completed.

EODA@ORA12CR1> select ename, hiredate
 2   from emp
 3   where ename_soundex = my_soundex('Kings')
 4   /
```

```
ENAME          HIREDATE
-----
Ku$_Chunk_    17-DEC-13
Ku$_Chunk_    17-DEC-13
Ku$_Chunk_    17-DEC-13
Ku$_Chunk_    17-DEC-13
```

```
EODA@ORA12CR1> begin
 2     dbms_output.put_line
 3     ( 'cpu time = ' || round((dbms_utility.get_cpu_time-:cpu)/100,2) );
 4     dbms_output.put_line( 'function was called: ' || stats.cnt );
 5 end;
 6 /
cpu time = 0
function was called: 1

PL/SQL procedure successfully completed.
```



## Indexing Only Some of the Rows

In addition to transparently helping out queries that use built-in functions like UPPER, LOWER, and so on, function-based indexes can be used to selectively index only some of the rows in a table. As we'll discuss a little later, B\*Tree indexes do not contain entries for entirely NULL keys. That is, if you have an index I on a table T (as follows) and you have a row where A and B are both NULL, there will be no entry in the index structure.

```
Create index I on t(a,b);
```

This comes in handy when you are indexing just some of the rows in a table.

Consider a large table with a NOT NULL column called PROCESSED\_FLAG that may take one of two values, Y or N, with a default value of N. New rows are added with a value of N to signify not processed, and as they are processed, they are updated to Y to signify processed. We would like to index this column to be able to retrieve the N records rapidly, but there are millions of rows and almost all of them are going to have a value of Y. The resulting B\*Tree index will be large, and the cost of maintaining it as we update from N to Y will be high. This table sounds like a candidate for a bitmap index (this is low cardinality, after all), but this is a transactional system and lots of people will be inserting records at the same time with the processed column set to N and, as we discussed earlier, bitmaps are not good for concurrent modifications. When we factor in the constant updating of N to Y in this table as well, then bitmaps would be out of the question, as this process would serialize entirely.

So, what we would really like is to index only the records of interest (the N records). We'll see how to do this with function-based indexes, but before we do, let's see what happens if we just use a regular B\*Tree index. Using the standard BIG\_TABLE script described in the setup section at the beginning of the book, we'll update the TEMPORARY column, flipping the Ys to Ns and the Ns to Ys:

```
EODA@ORA12CR1> update big_table set temporary = decode(temporary,'N','Y','N');
1000000 rows updated.
```

And we'll check out the ratio of Ys to Ns:

```
EODA@ORA12CR1> select temporary, cnt,
2      round( (ratio_to_report(cnt) over ()) * 100, 2 ) rtr
3  from (
4  select temporary, count(*) cnt
5  from big_table
6  group by temporary
7  )
8  /
```

T	CNT	RTR
Y	998728	99.87
N	1272	.13

As we can see, of the 1,000,000 records in the table, only about one-fifth of 1 percent of the data should be indexed. If we use a conventional index on the TEMPORARY column (which is playing the role of the PROCESSED\_FLAG column in this example), we would discover that the index has 1,000,000 entries, consumes almost 14MB of space, and has a height of 3:

```
EODA@ORA12CR1> create index processed_flag_idx
2  on big_table(temporary);
Index created.
```

```
EODA@ORA12CR1> analyze index processed_flag_idx
  2 validate structure;
Index analyzed.
```

```
EODA@ORA12CR1> select name, btree_space, lf_rows, height from index_stats;
```

NAME	BTREE_SPACE	LF_ROWS	HEIGHT
PROCESSED_FLAG_IDX	14528892	1000000	3

Any retrieval via this index would incur three I/Os to get to the leaf blocks. This index is not only wide, but also tall. To get the first unprocessed record, we will have to perform at least four I/Os (three against the index and one against the table).

How can we change all of this? We need to make it so the index is much smaller and easier to maintain (with less runtime overhead during the updates). Enter the function-based index, which allows us to simply write a function that returns NULL when we don't want to index a given row and returns a non-NULL value when we do. For example, since we are interested just in the N records, let's index just those:

```
EODA@ORA12CR1> drop index processed_flag_idx;
Index dropped.
```

```
EODA@ORA12CR1> create index processed_flag_idx
  2 on big_table( case temporary when 'N' then 'N' end );
Index created.
```

```
EODA@ORA12CR1> analyze index processed_flag_idx validate structure;
Index analyzed.
```

```
EODA@ORA12CR1> select name, btree_space, lf_rows, height from index_stats;
```

NAME	BTREE_SPACE	LF_ROWS	HEIGHT
PROCESSED_FLAG_IDX	32016	1272	2

That is quite a difference—the index is some 32KB, not 14MB. The height has decreased as well. If we use this index, we'll perform one less I/O than we would using the previous taller index.

## Implementing Selective Uniqueness

Another useful technique with function-based indexes is to use them to enforce certain types of complex constraints. For example, suppose you have a table with versioned information, such as a projects table. Projects have one of two statuses: either ACTIVE or INACTIVE. You need to enforce a rule such that “Active projects must have a unique name; inactive projects do not.” That is, there can only be one active “project X,” but you could have as many inactive project Xs as you like.

The first response from a developer when they hear this requirement is typically, “We'll just run a query to see if there are any active project Xs, and if not, we'll create ours.” If you read Chapter 7, you understand that such a simple implementation cannot work in a multiuser environment. If two people attempt to create a new active project X at the same time, they'll both succeed. We need to serialize the creation of project X, but the only way to do that is to lock the entire projects table (not very concurrent) or use a function-based index and let the database do it for us.

Building on the fact that we can create indexes on functions, that entire null entries are not made in B\*Tree indexes, and that we can create a UNIQUE index, we can easily do the following:

```
Create unique index active_projects_must_be_unique
on projects ( case when status = 'ACTIVE' then name end );
```

This will do it. When the status column is ACTIVE, the NAME column will be uniquely indexed. Any attempt to create active projects with the same name will be detected, and concurrent access to this table is not compromised at all.

## Caveat Regarding ORA-01743

One quirk I have noticed with function-based indexes is that if you create one on the built-in function TO\_DATE, it will not succeed in some cases:

```
EODA@ORA12CR1> create table t ( year varchar2(4) );
Table created.

EODA@ORA12CR1> create index t_idx on t( to_date(year,'YYYY') );
create index t_idx on t( to_date(year,'YYYY') )
                        *
ERROR at line 1:
ORA-01743: only pure functions can be indexed
```

This seems strange, since we can *sometimes* create a function using TO\_DATE, like so:

```
EODA@ORA12CR1> create index t_idx on t( to_date('01'||year,'MMYYYY') );
Index created.
```

The error message that accompanies this isn't too illuminating either:

```
EODA@ORA12CR1> !oerr ora 1743
01743, 00000, "only pure functions can be indexed"
// *Cause: The indexed function uses SYSDATE or the user environment.
// *Action: PL/SQL functions must be pure (RNDS, RNPS, WNDS, WNPS). SQL
//          expressions must not use SYSDATE, USER, USERENV(), or anything
//          else dependent on the session state. NLS-dependent functions
//          are OK.
```

We are not using SYSDATE. We are not using the user environment (or are we?). No PL/SQL functions are used, and nothing about the session state is involved. The trick lies in the format we used: YYYY. That format, given the same exact inputs, will return different answers depending on what month you call it in. For example, anytime in the month of May the YYYY format will return May 1, in June it will return June 1, and so on:

```
EODA@ORA12CR1> select to_char( to_date('2015','YYYY'),
2                          'DD-Mon-YYYY HH24:MI:SS' )
3      from dual;
```

```
TO_CHAR(TO_DATE('200
-----
01-May-2015 00:00:00
```

It turns out that `TO_DATE`, when used with `YYYY`, is not deterministic! That is why the index cannot be created: it would only work correctly in the month you created it in (or insert/updated a row in). So, it is due to the user environment, which includes the current date itself.

To use `TO_DATE` in a function-based index, you *must* use a date format that is unambiguous and deterministic—regardless of what day it is currently.

## Function-Based Indexes Wrap-up

Function-based indexes are easy to use and implement, and they provide immediate value. They can be used to speed up existing applications without changing any of their logic or queries. Many orders of magnitude improvement may be observed. You can use them to precompute complex values without using a trigger. Additionally, the optimizer can estimate selectivity more accurately if the expressions are materialized in a function-based index. You can use function-based indexes to selectively index only rows of interest as demonstrated earlier with the `PROCESSED_FLAG` example. You can, in effect, index a `WHERE` clause using that technique. Lastly, you can use function-based indexes to implement a certain kind of integrity constraint: selective uniqueness (e.g., “The fields X, Y, and Z must be unique when some condition is true”).

Function-based indexes will affect the performance of inserts and updates. Whether or not that warning is relevant to you is something you must decide. If you insert and very infrequently query the data, this might not be an appropriate feature for you. On the other hand, keep in mind that you typically insert a row once and you query it thousands of times. The performance hit on the insert (which your individual end user will probably never notice) may be offset many thousands of times by speeding up the queries. In general, the pros heavily outweigh any of the cons in this case.

## Application Domain Indexes

Application domain indexes are what Oracle calls *extensible indexing*. They allow you to create your own index structures that work just like indexes supplied by Oracle. When someone issues a `CREATE INDEX` statement using your index type, Oracle will run your code to generate the index. If someone analyzes the index to compute statistics on it, Oracle will execute your code to generate statistics in whatever format you care to store them in. When Oracle parses a query and develops a query plan that may make use of your index, Oracle will ask you how costly this function is to perform as it is evaluating the different plans. In short, application domain indexes give you the ability to implement a new index type that does not exist in the database as of yet. For example, if you develop software that analyzes images stored in the database, and you produce information about the images, such as the colors found in them, you could create your own *image* index. As images are added to the database, your code is invoked to extract the colors from the images and store them somewhere (wherever you want to store them). At query time, when the user asks for all blue images, Oracle will ask you to provide the answer from your index when appropriate.

The best example of an application domain index is Oracle’s own *text index*. This index is used to provide keyword searching on large text items. You may create a simple text index like this:

```
EODA@ORA12CR1> create index myindex on mytable(docs)
  2  indextype is ctxsys.context
  3  /
Index created.
```

And then use the text operators the creators of that index type introduced into the SQL language.

```
select * from mytable where contains( docs, 'some words' ) > 0;
```

It will even respond to commands such as the following:

```
EODA@ORA12CR1> begin
  2 dbms_stats.gather_index_stats( user, 'MYINDEX' );
  3 end;
  4 /
PL/SQL procedure successfully completed.
```

It will participate with the optimizer at runtime to determine the relative cost of using a text index over some other index or a full scan. The interesting thing about all of this is that you or I could have developed this index. The implementation of the text index was done without *inside kernel knowledge*. It was done using the dedicated, documented, and exposed API. The Oracle database kernel is not aware of how the text index is stored (the APIs store it in many physical database tables per index created). Oracle is not aware of the processing that takes place when a new row is inserted. Oracle text is really an application built on top of the database, but in a wholly integrated fashion. To you and me, it looks just like any other Oracle database kernel function, but it is not.

I personally have not found the need to go and build a new exotic type of index structure. I see this particular feature as being of use mostly to third-party solution providers that have innovative indexing techniques.

I think the most interesting thing about application domain indexes is that they allow others to supply new indexing technology I can use in my applications. Most people will never make use of this particular API to build a new index type, but most of us will use the end results. Virtually every application I work on seems to have some *text* associated with it, *XML* to be dealt with, or *images* to be stored and categorized. The Oracle Multimedia set of functionality, implemented using the Application Domain Indexing feature, provides these capabilities. As time passes, the set of available index types grows. We'll take a more in-depth look at the text index in a subsequent chapter.

## Invisible Indexes

In Oracle Database 11g and higher, you have the option of making an index invisible to the optimizer. The index is only invisible in the sense that the optimizer won't use the index when creating an execution plan. You can either create an index as invisible or alter an existing index to be invisible. Here we create a table, load it with test data, generate statistics, and then create an invisible index:

```
EODA@ORA12CR1> create table t(x int);
Table created.

EODA@ORA12CR1> insert into t select round(dbms_random.value(1,10000)) from dual
  2 connect by level <=10000;

EODA@ORA12CR1> exec dbms_stats.gather_table_stats(user,'T');
PL/SQL procedure successfully completed.

EODA@ORA12CR1> create index ti on t(x) invisible;
Index created.
```

Now we turn on autotrace and run a query where one would expect the optimizer to use the index when generating an execution plan:

```
EODA@ORA12CR1> set autotrace traceonly explain
EODA@ORA12CR1> select * from t where x=5;
-----
| Id | Operation          | Name | Rows | Bytes | Cost (%CPU)| Time |
-----
|  0 | SELECT STATEMENT   |      |    2 |    8 |    7 (0)| 00:00:01 |
|*  1 | TABLE ACCESS FULL| T    |    2 |    8 |    7 (0)| 00:00:01 |
-----
```

The prior output shows that the index wasn't used by the optimizer. You can toggle an index's visibility to the optimizer during a session by setting the `OPTIMIZER_USE_INVISIBLE_INDEXES` initialization parameter to `TRUE` (the default is `FALSE`). For example, for the currently connected session, the following instructs the optimizer to consider invisible indexes when generating an execution plan:

```
EODA@ORA12CR1> alter session set optimizer_use_invisible_indexes=true;
```

Rerunning the prior query shows the optimizer now takes advantage of the index:

```
EODA@ORA12CR1> select * from t where x=5;
```

```
-----
```

Id	Operation	Name	Rows	Bytes	Cost (%CPU)	Time
0	SELECT STATEMENT		2	8	1 (0)	00:00:01
* 1	INDEX RANGE SCAN	TI	2	8	1 (0)	00:00:01

```
-----
```

If you want all sessions to consider using invisible indexes, then alter the `OPTIMIZER_USE_INVISIBLE_INDEXES` parameter via the `ALTER SYSTEM` statement. This makes all invisible indexes visible to the optimizer when generating execution plans.

You can make an index permanently visible to the optimizer by altering it to visible:

```
EODA@ORA12CR1> alter index ti visible;
Index altered.
```

Keep in mind that although an invisible index may be invisible to the optimizer, it can still impact performance in the following ways:

- Invisible indexes consume space and resources as the underlying table has records inserted, updated, or deleted. This could impact performance (slow down DML statements).
- Oracle can still use an invisible index to prevent certain locking situations when a B\*Tree index is placed on a foreign key column.
- If you create a unique invisible index, the uniqueness of the columns will be enforced regardless of the visibility setting.

Therefore, even if you create an index as invisible, it can still influence the behavior of SQL statements. It would be erroneous to assume that an invisible index has no impact on the applications using the tables on which invisible indexes exist. Invisible indexes are only invisible in the sense that the optimizer won't consider them for use when generating execution plans unless instructed to do so.

So what is the usefulness of invisible indexes? These indexes still have to be maintained (hence slowing performance), but cannot be used by queries that can't see them (hence never boosting performance). One example would be if you wanted to drop an index from a production system. The idea being you could make the index invisible and see if performance suffered. In this case, before dropping the index, you'd also have to be careful that the index wasn't placed on a foreign key column or wasn't being used to enforce uniqueness. Another example would be where you wanted to add an index to a production system and test it to determine if performance improved. You could add the index as invisible and selectively make it visible during a session to determine its usefulness. Here again, you'd also have to be mindful that even though the index is invisible, it will consume space and require resources to maintain.

## Multiple Indexes on the Same Column Combinations

Prior to Oracle Database 12c, you could not have multiple indexes defined on one table with the exact same combination of columns. For example:

```
EODA@ORA11GR2> create table t(x int);
Table created.

EODA@ORA11GR2> create index ti on t(x);
Index created.

EODA@ORA11GR2> create bitmap index tb on t(x) invisible;
ERROR at line 1:
ORA-01408: such column list already indexed
```

Starting with 12c, you can define multiple indexes on the same set of columns. However, you can only do this if the indexes are physically different; for example, when one index is created as a B\*Tree index, and the second index as a bitmap index. Also, there can be only one visible index for the same combination of columns on a table. Therefore, running the prior CREATE INDEX statements works in an Oracle 12c database:

```
EODA@ORA12CR1> create table t(x int);
Table created.

EODA@ORA12CR1> create index ti on t(x);
Index created

EODA@ORA12CR1> create bitmap index tb on t(x) invisible;
Index created
```

Why would you want two indexes defined on the same set of columns? Say you had originally built a data warehouse star schema with all B\*Tree indexes on the fact table foreign key columns, and later discover through testing that bitmap indexes will perform better for the types of queries applied to the star schema. Therefore, you want to convert to bitmap indexes as seamlessly as possible. So you first build the bitmap indexes as invisible. Then when you're ready, you can drop the B\*Tree indexes and then alter the bitmap indexes to be visible.

## Indexing Extended Columns

With the advent of Oracle 12c, the VARCHAR2, NVARCHAR2, and RAW datatypes can now be configured to store up to 32,767 bytes of information (previously, the limit was 4,000 bytes for VARCHAR2 and NVARCHAR2, and 2000 bytes for RAW). Since Chapter 12 contains the details for enabling a database with extended datatypes, I won't repeat that information here. The focus of this section is to explore indexing extended columns.

Let's start by creating a table with an extended column and then try to create a regular B\*Tree index on that column:

```
EODA@O12CE> create table t(x varchar2(32767));

Table created.
```

---

■ **Note** If you attempt to create a table with a VARCHAR2 column greater than 4,000 bytes in a database that hasn't been configured for extended datatypes, Oracle will throw an ORA-00910: specified length too long for its datatype message.

---

Next, we attempt to create an index on the extended column:

```
EODA@012CE> create index ti on t(x);
create index ti on t(x)
                *
ERROR at line 1:
ORA-01450: maximum key length (6398) exceeded
```

We've seen this error previously in this chapter. An error is thrown because Oracle imposes a maximum length on the index key, which is about three-fourths of the block size (the block size for the database in this example is 8K). Even though there aren't any entries in this index yet, Oracle knows that it's possible that index key could be larger than 6,398 bytes for a column that can contain up to 32,767 bytes, and therefore won't allow you to create an index in this scenario.

That doesn't mean you can't index extended columns, rather you have to use techniques that limit the length of the index key to less than 6,398 bytes. With that in mind, a few options become apparent:

- Create virtual column based on SUBSTR or STANDARD\_HASH functions, and then create an index on the virtual column.
- Create a function-based index using SUBSTR or STANDARD\_HASH functions.
- Create a tablespace based on a larger block size; for example, a 16K block size would allow for index keys the size of approximately 12,000 bytes. Having said that, if you need 12,000 bytes for an index key, then you're probably doing something wrong and need to rethink what you're doing. This method will not be explored.

Let's start by looking at the virtual column solution.

## Virtual Column Solution

The idea here is to first create a virtual column applying a SQL function on the extended column that returns a value less than 6,398 bytes. Then that virtual column can be indexed and this provides a mechanism for better performance when issuing queries against extended columns. An example will demonstrate this. First, create a table with an extended column:

```
EODA@012CE> create table t(x varchar2(32767));
Table created.
```

Now insert some test data into the table:

```
EODA@012CE> insert into t select to_char(level)|| rpad('abc',10000,'xyz')
 2  from dual connect by level < 1001
 3  union
 4  select to_char(level)
 5  from dual connect by level < 1001;
```

2000 rows created.



Now suppose that you know the first ten characters of the extended column are sufficiently selective enough to return small portions of the rows in the table. Therefore, you create a virtual column based on a substring of the extended column:

```
EODA@O12CE> alter table t add (xv as (substr(x,1,10)));
Table altered.
```

Now create an index on the virtual column and gather statistics:

```
EODA@O12CE> create index te on t(xv);
Index created.
```

```
EODA@O12CE> exec dbms_stats.gather_table_stats(user,'T');
PL/SQL procedure successfully completed.
```

Now when querying the virtual column, the optimizer can take advantage of the index in equality and range predicates in the WHERE clause; for example:

```
EODA@O12CE> set autotrace traceonly explain
EODA@O12CE> select count(*) from t where x = '800';
```

Id	Operation	Name	Rows	Bytes	Cost (%CPU)	Time
0	SELECT STATEMENT		1	5011	2 (0)	00:00:01
1	SORT AGGREGATE		1	5011		
* 2	TABLE ACCESS BY INDEX ROWID BATCHED	T	1	5011	2 (0)	00:00:01
* 3	INDEX RANGE SCAN	TE	1		1 (0)	00:00:01

Notice that even though the index is on the virtual column, the optimizer can still use it when querying directly against the extended column X (and not the virtual column XV). The optimizer can also use this type of index in a range-type search:

```
EODA@O12CE> select count(*) from t where x >'800' and x<'900';
```

Id	Operation	Name	Rows	Bytes	Cost (%CPU)	Time
0	SELECT STATEMENT		1	5011	4 (0)	00:00:01
1	SORT AGGREGATE		1	5011		
* 2	TABLE ACCESS BY INDEX ROWID BATCHED	T	239	1169K	4 (0)	00:00:01
* 3	INDEX RANGE SCAN	TE	241		2 (0)	00:00:01

Like the SUBSTR function, you can also base a virtual column on the STANDARD\_HASH function. The STANDARD\_HASH function can be applied to a long character string and return a fairly unique RAW value much less than 6,398 bytes. Let's look at a couple of examples using a virtual column based on STANDARD\_HASH.

Assuming the same table and seed data as used with the prior SUBSTR examples, here we add a virtual column to the table using STANDARD\_HASH, create an index, and generate statistics:

```
EODA@O12CE> alter table t add (xv as (standard_hash(x)));
Table altered.
```

```
EODA@O12CE> create index te on t(xv);
Index created.
```

```
EODA@O12CE> exec dbms_stats.gather_table_stats(user,'T');
PL/SQL procedure successfully completed.
```

The STANDARD\_HASH works well when using equality predicates in the WHERE clause. For example:

```
EODA@O12CE> set autotrace traceonly explain
EODA@O12CE> select count(*) from t where x='300';
```

Id	Operation	Name	Rows	Bytes	Cost (%CPU)	Time
0	SELECT STATEMENT		1	5025	2 (0)	00:00:01
1	SORT AGGREGATE		1	5025		
* 2	TABLE ACCESS BY INDEX ROWID BATCHED	T	1	5025	2 (0)	00:00:01
* 3	INDEX RANGE SCAN	TE	1		1 (0)	00:00:01

The index on a STANDARD\_HASH-based virtual column allows for efficient equality-based searches, but does not work for range-based searches, as the data is stored in an index based on the randomized hash value; for example:

```
EODA@O12CE> select count(*) from t where x > '800' and x < '900';
```

Id	Operation	Name	Rows	Bytes	Cost (%CPU)	Time
0	SELECT STATEMENT		1	5004	6 (0)	00:00:01
1	SORT AGGREGATE		1	5004		
* 2	TABLE ACCESS FULL	T	239	1167K	6 (0)	00:00:01

## Function-Based Index Solution

The concept here is that you're building an index and applying a function to it in a way that limits the length of the index key and also results in a usable index. Here I use the same code (as in the prior section) to create a table with an extended column and populate it with test data:

```
EODA@O12CE> create table t(x varchar2(32767));
Table created.
```

```
EODA@O12CE> insert into t
 2 select to_char(level)|| rpad('abc',10000,'xyz')
 3 from dual connect by level < 1001
 4 union
 5 select to_char(level)
 6 from dual connect by level < 1001;
```

2000 rows created.

Now suppose you're familiar with the data and know that the first ten characters of the extended columns are usually sufficient for identifying a row; therefore, you create an index on the substring of the first ten characters and generate statistics for the table:

```
EODA@O12CE> create index te on t(substr(x,1,10));
Index created.
```

```
EODA@O12CE> exec dbms_stats.gather_table_stats(user,'T');
PL/SQL procedure successfully completed.
```

The optimizer can use an index like this when there are equality and range predicates in the WHERE clause. Some examples will illustrate this:

```
EODA@O12CE> set autotrace traceonly explain
EODA@O12CE> select count(*) from t where x = '800';
```

Id	Operation	Name	Rows	Bytes	Cost (%CPU)	Time
0	SELECT STATEMENT		1	16407	2 (0)	00:00:01
1	SORT AGGREGATE		1	16407		
* 2	TABLE ACCESS BY INDEX ROWID BATCHED	T	1	16407	2 (0)	00:00:01
* 3	INDEX RANGE SCAN	TE	8		1 (0)	00:00:01

This example uses a range predicate:

```
EODA@O12CE> select count(*) from t where x>'200' and x<'400';
```

Id	Operation	Name	Rows	Bytes	Cost (%CPU)	Time
0	SELECT STATEMENT		1	5011	6 (0)	00:00:01
1	SORT AGGREGATE		1	5011		
* 2	TABLE ACCESS BY INDEX ROWID BATCHED	T	477	2334K	6 (0)	00:00:01
* 3	INDEX RANGE SCAN	TE	479		3 (0)	00:00:01

Assuming the same table and seed data as used with the prior SUBSTR examples, here we add a function-based index using STANDARD\_HASH:

```
EODA@O12CE> create index te on t(standard_hash(x));
```

Now verify that an equality-based search uses the index:

```
EODA@O12CE> set autotrace traceonly explain
EODA@O12CE> select count(*) from t where x = '800';
```

Id	Operation	Name	Rows	Bytes	Cost (%CPU)	Time
0	SELECT STATEMENT		1	5004	4 (0)	00:00:01
1	SORT AGGREGATE		1	5004		
* 2	TABLE ACCESS BY INDEX ROWID BATCHED	T	1	5004	4 (0)	00:00:01
* 3	INDEX RANGE SCAN	TE	8		1 (0)	00:00:01

This allows for efficient equality-based searches, but does not work for range-based searches, as the data is stored in an index based on the randomized hash value.

## Frequently Asked Questions and Myths About Indexes

As I said in the introduction to this book, I field lots of questions about Oracle. I am the Tom behind the “Ask Tom” column in *Oracle Magazine* and at <http://asktom.oracle.com>, where I answer people’s questions about the Oracle database and tools. In my experience, the topic of indexes attracts the most questions. In this section, I answer some of the most frequently asked questions. Some of the answers may seem like common sense, while other answers might surprise you. Suffice it to say, there are lots of myths and misunderstandings surrounding indexes.

### Do Indexes Work on Views?

A related question is, “How can I index a view?” Well, the fact is that a view is nothing more than a stored query. Oracle will replace the text of the query that accesses the view with the view definition itself. Views are for the convenience of the end user or programmer—the optimizer works with the query against the base tables. Any and all indexes that could have been used if the query had been written against the base tables will be considered when you use the view. To index a view, you simply index the base tables.

### Do Nulls and Indexes Work Together?

B\*Tree indexes, except in the special case of cluster B\*Tree indexes, do not store completely Null entries, but bitmap and cluster indexes do. This side effect can be a point of confusion, but it can actually be used to your advantage when you understand what not storing entirely null keys implies.

To see the effect of the fact that Null values are *not* stored, consider this example:

```
EODA@ORA12CR1> create table t ( x int, y int );
Table created.
```

```
EODA@ORA12CR1> create unique index t_idx on t(x,y);
Index created.
```

```
EODA@ORA12CR1> insert into t values ( 1, 1 );
1 row created.
```

```

EODA@ORA12CR1> insert into t values ( 1, NULL );
1 row created.

EODA@ORA12CR1> insert into t values ( NULL, 1 );
1 row created.

EODA@ORA12CR1> insert into t values ( NULL, NULL );
1 row created.

EODA@ORA12CR1> analyze index t_idx validate structure;
Index analyzed.

EODA@ORA12CR1> select name, lf_rows from index_stats;

```

NAME	LF_ROWS
T_IDX	3

The table has four rows, whereas the index only has three. The first three rows, where at least *one* of the index key elements was *not* Null, are in the index. The last row with (NULL, NULL) is not in the index. One of the areas of confusion is when the index is a unique index, as just shown. Consider the effect of the following three INSERT statements:

```

EODA@ORA12CR1> insert into t values ( NULL, NULL );
1 row created.

EODA@ORA12CR1> insert into t values ( NULL, 1 );
insert into t values ( NULL, 1 )
*
ERROR at line 1:
ORA-00001: unique constraint (EODA.T_IDX) violated

EODA@ORA12CR1> insert into t values ( 1, NULL );
insert into t values ( 1, NULL )
*
ERROR at line 1:
ORA-00001: unique constraint (EODA.T_IDX) violated

```

The new (NULL, NULL) row is not considered to be the same as the old row with (NULL, NULL):

```

EODA@ORA12CR1> select x, y, count(*)
2  from t
3  group by x,y
4  having count(*) > 1;

```

X	Y	COUNT(*)
		2

This seems impossible; our unique key isn't unique if we consider all Null entries. The fact is that, in Oracle, (NULL, NULL) is not the same as (NULL, NULL) when considering uniqueness—the SQL standard mandates this. (NULL, NULL) and (NULL, NULL) are considered the same with regard to aggregation, however. The two are unique for comparisons but are the same as far as the GROUP BY clause is concerned. That is something to consider: each *unique* constraint should have at least one NOT NULL column to be truly unique.

The question that comes up with regard to indexes and Null values is, “Why isn't my query using the index?” The query in question is something like the following:

```
select * from T where x is null;
```

This query cannot use the index we just created—the row (NULL, NULL) simply is not in the index, hence the use of the index would return the wrong answer. Only if at least *one* of the columns is defined as NOT NULL can the query use an index. For example, the following shows Oracle will use an index for an X IS NULL predicate if there is an index with X on the leading edge and at least one other column in the index is defined as NOT NULL in the base table:

```
EODA@ORA12CR1> create table t ( x int, y int NOT NULL );
Table created.
```

```
EODA@ORA12CR1> create unique index t_idx on t(x,y);
Index created.
```

```
EODA@ORA12CR1> insert into t values ( 1, 1 );
1 row created.
```

```
EODA@ORA12CR1> insert into t values ( NULL, 1 );
1 row created.
```

```
EODA@ORA12CR1> begin
  2  dbms_stats.gather_table_stats(user,'T');
  3  end;
  4  /
```

PL/SQL procedure successfully completed.

When we go to query that table this time, we'll discover this:

```
EODA@ORA12CR1> set autotrace on
EODA@ORA12CR1> select * from t where x is null;
```

```

      X      Y
-----
          1
```

Execution Plan

...

```
-----
| Id | Operation          | Name | Rows | Bytes | Cost (%CPU)| Time     |
-----
|  0 | SELECT STATEMENT   |      |    1 |    5 |    1   (0)| 00:00:01 |
|*  1 |  INDEX RANGE SCAN | T_IDX |    1 |    5 |    1   (0)| 00:00:01 |
-----
```

Previously, I said that you can use to your advantage the fact that totally Null entries are not stored in a B\*Tree index—here is how. Say you have a table with a column that takes exactly two values. The values are very skewed; say, 90 percent or more of the rows take on one value and 10 percent or less take on the other value. You can index this column efficiently to gain quick access to the minority rows. This comes in handy when you would like to use an index to get to the minority rows, but you want to full scan to get to the majority rows, and you want to conserve space. The solution is to use a Null for majority rows and whatever value you want for minority rows or, as demonstrated earlier, use a function-based index to index only the non-null return values from a function.

Now that you know how a B\*Tree will treat Null values, you can use that to your advantage and take precautions with unique constraints on sets of columns that all allow Nulls (be prepared to have more than one row that is all Null as a possibility in this case).

## Should Foreign Keys Be Indexed?

The question of whether or not foreign keys should be indexed comes up frequently. We touched on this subject in Chapter 6 when discussing deadlocks. There, I pointed out that unindexed foreign keys are the biggest single cause of deadlocks that I encounter, due to the fact that an update to a parent table's primary key or the removal of a parent record will place a table lock on the child table (no modifications to the child table will be allowed until the statement completes). This locks many more rows than it should and decreases concurrency. I see it frequently when people are using a tool that generates the SQL to modify a table. The tool generates an UPDATE statement that updates every column in the table, regardless of whether or not the value was modified. This, in effect, updates the primary key (even though they never changed the value). For example, Oracle Forms will do this by default, unless you tell it to just send modified columns over to the database. In addition to the table lock issue that might hit you, an unindexed foreign key is bad in the following cases as well:

- When you have an ON DELETE CASCADE and have not indexed the child table. For example, EMP is child of DEPT. DELETE FROM DEPT WHERE DEPTNO = 10 should cascade to EMP. If DEPTNO in EMP is not indexed, you will get a full table scan of EMP. This full scan is probably undesirable, and if you delete many rows from the parent table, the child table will be scanned once for each parent row deleted.
- When you query from the parent to the child. Consider the EMP/DEPT example again. It is very common to query the EMP table in the context of a DEPTNO. If you frequently query the following to generate a report or something, you'll find not having the index in place will slow down the queries:

```
select *
  from dept, emp
  where emp.deptno = dept.deptno
  and dept.dname = :X;
```

This is the same argument I gave for indexing the NESTED\_COLUMN\_ID of a nested table in Chapter 10. The hidden NESTED\_COLUMN\_ID of a nested table is nothing more than a foreign key.

So, when do you *not* need to index a foreign key? In general, when the following conditions are met:

- You do *not* delete from the parent table.
- You do *not* update the parent table's unique/primary key value, either purposely or by accident (via a tool).
- You do *not* join from the parent table to the child table, or more generally, the foreign key columns do not support an important access path to the child table and you do not use them in predicates to select data from this table (such as DEPT to EMP).

If you satisfy all three criteria, feel free to skip the index—it is not needed and will slow down DML on the child table. If you do any of the three, be aware of the consequences.

As a side note, if you believe that a child table is getting locked via an unindexed foreign key and you would like to prove it (or just prevent it in general), you can issue the following:

```
ALTER TABLE <child table name> DISABLE TABLE LOCK;
```

Now, any UPDATE or DELETE to the parent table that would cause the table lock will receive the following:

```
ERROR at line 1:
ORA-00069: cannot acquire lock -- table locks disabled for <child table name>
```

This is useful in tracking down the piece of code that is doing what you believe should not be done (no UPDATES or DELETES of the parent primary key), as the end users will immediately report this error back to you.

## Why Isn't My Index Getting Used?

There are many possible causes of this. In this section, we'll take a look at some of the most common.

### Case 1

We're using a B\*Tree index, and our predicate does not use the leading edge of an index. In this case, we might have a table T with an index on T(x,y). We query SELECT \* FROM T WHERE Y = 5. The optimizer will tend not to use the index since our predicate did not involve the column X—it might have to inspect each and every index entry in this case (we'll discuss an index skip scan shortly where this is not true). It will typically opt for a full table scan of T instead. That does not preclude the index from being used. If the query was SELECT X,Y FROM T WHERE Y = 5, the optimizer would notice that it did not have to go to the table to get either X or Y (they are in the index) and may very well opt for a fast full scan of the index itself, as the index is typically much smaller than the underlying table. Note also that this access path is only available with the CBO.

Another case whereby the index on T(x,y) could be used with the CBO is during an index skip scan. The skip scan works well if—and only if—the leading edge of the index (X in the previous example) has very few distinct values and the optimizer understands that. For example, consider an index on (GENDER, EMPNO) where GENDER has the values M and F, and EMPNO is unique. A query such as

```
select * from t where empno = 5;
```

might consider using that index on T to satisfy the query in a *skip scan* method, meaning the query will be processed conceptually like this:

```
select * from t where GENDER='M' and empno = 5
UNION ALL
select * from t where GENDER='F' and empno = 5;
```

It will skip throughout the index, pretending it is two indexes: one for Ms and one for Fs. We can see this in a query plan easily. We'll set up a table with a bivalued column and index it:

```
EODA@ORA12CR1> create table t
  2 as
  3 select decode(mod(rownum,2), 0, 'M', 'F' ) gender, all_objects.*
  4 from all_objects
  5 /
Table created.
```



```
EODA@ORA12CR1> create index t_idx on t(gender,object_id);
Index created.
```

```
EODA@ORA12CR1> exec dbms_stats.gather_table_stats( user, 'T' );
PL/SQL procedure successfully completed.
```

Now, when we query this, we should see the following:

```
EODA@ORA12CR1> set autotrace traceonly explain
EODA@ORA12CR1> select * from t t1 where object_id = 42;
```

Execution Plan

```
...
-----
| Id | Operation                                | Name | Rows | Bytes | Cost (%CPU)| Time |
-----+-----+-----+-----+-----+-----+-----+
|  0 | SELECT STATEMENT                          |      |    1 |    91 |    4  (0)| 00:00:01 |
|  1 | TABLE ACCESS BY INDEX ROWID BATCHED      | T     |    1 |    91 |    4  (0)| 00:00:01 |
|*  2 | INDEX SKIP SCAN                            | T_IDX |    1 |      |    3  (0)| 00:00:01 |
-----
```

The INDEX SKIP SCAN step tells us that Oracle is going to skip throughout the index, looking for points where GENDER changes values and read down the tree from there, looking for OBJECT\_ID=42 in each virtual index being considered. If we increase the number of distinct values for GENDER measurably, as follows, we'll see that Oracle stops seeing the skip scan as being a sensible plan:

```
EODA@ORA12CR1> update t set gender = chr(mod(rownum,256));
17944 rows updated.
```

```
EODA@ORA12CR1> exec dbms_stats.gather_table_stats( user, 'T', cascade=>TRUE );
PL/SQL procedure successfully completed.
```

It would have 256 mini indexes to inspect, and it opts for a full table scan to find our row

```
EODA@ORA12CR1> set autotrace traceonly explain
EODA@ORA12CR1> select * from t t1 where object_id = 42;
```

Execution Plan

```
...
-----
| Id | Operation                | Name | Rows | Bytes | Cost (%CPU)| Time |
-----+-----+-----+-----+-----+-----+
|  0 | SELECT STATEMENT          |      |    1 |    92 |   274  (1)| 00:00:01 |
|*  1 | TABLE ACCESS FULL        | T     |    1 |    92 |   274  (1)| 00:00:01 |
-----
```

## Case 2

We're using a `SELECT COUNT(*) FROM T` query (or something similar) and we have a B\*Tree index on table T. However, the optimizer is full scanning the table, rather than counting the (much smaller) index entries. In this case, the index is probably on a set of columns that can contain Nulls. Since a totally Null index entry would never be made, the count of rows in the index will not be the count of rows in the table. Here the optimizer is doing the right thing—it would get the wrong answer if it used the index to count rows.

## Case 3

For an indexed column, we query using the following and find that the index on `INDEXED_COLUMN` is not used:

```
select * from t where f(indexed_column) = value
```

This is due to the use of the function on the column. We indexed the values of `INDEXED_COLUMN`, not the value of `F(INDEXED_COLUMN)`. The ability to use the index is curtailed here. We can index the function if we choose to do it.

## Case 4

We have indexed a character column. This column contains only numeric data. We query using the following syntax:

```
select * from t where indexed_column = 5
```

Note that the number 5 in the query is the constant *number* 5 (not a character string). The index on `INDEXED_COLUMN` is not used. This is because the preceding query is the same as the following:

```
select * from t where to_number(indexed_column) = 5
```

We have implicitly applied a function to the column and, as noted in case 3, this will preclude the use of the index. This is very easy to see with a small example. In this example, we're going to use the built-in package `DBMS_XPLAN`. This package is available only with Oracle9i Release 2 and above (in Oracle9i Release 1, we will use `AUTOTRACE` instead to see the plan easily, but we will not see the predicate information—that is only available in Oracle9i Release 2 and above):

```
EODA@ORA12CR1> create table t ( x char(1) constraint t_pk primary key,
  2 y date );
Table created.
```

```
EODA@ORA12CR1> insert into t values ( '5', sysdate );
1 row created.
```

```
EODA@ORA12CR1> explain plan for select * from t where x = 5;
Explained.
```

```
EODA@ORA12CR1> select * from table(dbms_xplan.display);
```

## PLAN\_TABLE\_OUTPUT

```
-----
Plan hash value: 1601196873
```

```
-----
| Id | Operation          | Name | Rows | Bytes | Cost (%CPU)| Time     |
-----+-----+-----+-----+-----+-----+-----+
|  0 | SELECT STATEMENT   |      |    1 |    12 |    3   (0)| 00:00:01 |
|*  1 | TABLE ACCESS FULL| T     |    1 |    12 |    3   (0)| 00:00:01 |
-----
```

```
-----
Predicate Information (identified by operation id):
-----
```

```
1 - filter(TO_NUMBER("X")=5)
```

As you can see, it full scanned the table. And even if we were to hint the following query, it uses the index, but not for a UNIQUE SCAN as we might expect—it is FULL SCANNING this index:

```
EODA@ORA12CR1> explain plan for select /*+ INDEX(t t_pk) */ * from t where x = 5;
Explained.
```

```
EODA@ORA12CR1> select * from table(dbms_xplan.display);
```

## PLAN\_TABLE\_OUTPUT

```
-----
Plan hash value: 180604526
```

```
-----
| Id | Operation                                | Name | Rows | Bytes | Cost (%CPU)| Time     |
-----+-----+-----+-----+-----+-----+
|  0 | SELECT STATEMENT                          |      |    1 |    12 |    3   (0)| 00:00:01 |
|  1 | TABLE ACCESS BY INDEX ROWID BATCHED     | T     |    1 |    12 |    3   (0)| 00:00:01 |
|*  2 | INDEX FULL SCAN                           | T_PK  |    1 |      |    2   (0)| 00:00:01 |
-----
```

```
-----
Predicate Information (identified by operation id):
-----
```

```
2 - filter(TO_NUMBER("X")=5)
```

The reason lies in the last line of output there: `filter(TO_NUMBER("X")=5)`. There is an implicit function being applied to the database column. The character string stored in `X` must be converted to a number prior to comparing to the value 5. We cannot convert 5 to a string, since our NLS settings control what 5 might look like in a string (it is not deterministic), so we convert the string into a number, and that precludes the use of the index to rapidly find this row. If we simply compare strings to strings

```
EODA@ORA12CR1> explain plan for select * from t where x = '5';
Explained.
```

```
EODA@ORA12CR1> select * from table(dbms_xplan.display);
```

## PLAN\_TABLE\_OUTPUT

-----  
 Plan hash value: 1303508680

Id	Operation	Name	Rows	Bytes	Cost (%CPU)	Time
0	SELECT STATEMENT		1	12	2 (0)	00:00:01
1	TABLE ACCESS BY INDEX ROWID	T	1	12	2 (0)	00:00:01
* 2	INDEX UNIQUE SCAN	T_PK	1		1 (0)	00:00:01

-----  
 Predicate Information (identified by operation id):  
 -----

2 - access("X"='5')

we get the expected INDEX UNIQUE SCAN, and we can see the function is not being applied. You should *always* avoid implicit conversions anyway. Always compare apples to apples and oranges to oranges. Another case where this comes up frequently is with dates. We try to query

```
-- find all records for today
select * from t where trunc(date_col) = trunc(sysdate);
```

and discover that the index on DATE\_COL will not be used. We can either index the TRUNC(DATE\_COL) or, perhaps more easily, query using range comparison operators. The following demonstrates the use of greater than and less than on a date. Once we realize that the condition

```
TRUNC(DATE_COL) = TRUNC(SYSDATE)
```

is the same as the condition

```
select *
  from t
 where date_col >=trunc(sysdate)
        and date_col < trunc(sysdate+1)
```

this moves all of the functions to the right-hand side of the equation, allowing us to use the index on DATE\_COL (and provides the same result as WHERE TRUNC(DATE\_COL) = TRUNC(SYSDATE)).

*If possible, you should always remove the functions from database columns when they are in the predicate. Not only will doing so allow for more indexes to be considered for use, but it will also reduce the amount of processing the database needs to do. In the preceding case, when we used*

```
where date_col >=trunc(sysdate)
      and date_col < trunc(sysdate+1)
```

the TRUNC values are computed once for the query, and then an index could be used to find just the qualifying values. When we used TRUNC(DATE\_COL) = TRUNC(SYSDATE), the TRUNC(DATE\_COL) had to be evaluated once *per row* for every row in the entire table (no indexes).

## Case 5

The index, if used, would actually be slower. I see this often—people assume that, of course, an index will always make a query go faster. So, they set up a small table, analyze it, and find that the optimizer doesn't use the index. The optimizer is doing exactly the right thing in this case. Oracle (under the CBO) will use an index only when it makes sense to do so. Consider this example:

```
EODA@ORA12CR1> create table t(x int);
Table created.
```

```
EODA@ORA12CR1> insert into t select rownum from dual connect by level < 1000000;
999999 rows created.
```

```
EODA@ORA12CR1> create index ti on t(x);
Index created.
```

```
EODA@ORA12CR1> exec dbms_stats.gather_table_stats(user,'T');
PL/SQL procedure successfully completed.
```

If we run a query that needs a relatively small percentage of the table, as follows

```
EODA@ORA12CR1> set autotrace on explain
EODA@ORA12CR1> select count(*) from t where x < 50;
```

```
COUNT(*)
-----
         49
```

```
Execution Plan
...
```

```
-----
| Id | Operation          | Name | Rows | Bytes | Cost (%CPU)| Time     |
-----
|  0 | SELECT STATEMENT   |      |    1 |    5 |    3   (0)| 00:00:01 |
|  1 |   SORT AGGREGATE   |      |    1 |    5 |           |          |
|*  2 |    INDEX RANGE SCAN| TI   |   49 |   245 |    3   (0)| 00:00:01 |
-----
```

it will happily use the index; however, we'll find that when the estimated number of rows to be retrieved via the index crosses a threshold (which varies depending on various optimizer settings, physical statistics, version, and so on), we'll start to observe a full table scan:

```
EODA@ORA12CR1> select count(*) from t where x < 1000000;
```

```
COUNT(*)
-----
    999999
```

## Execution Plan

```
-----
...
-----
```

Id	Operation	Name	Rows	Bytes	Cost (%CPU)	Time
0	SELECT STATEMENT		1	5	620 (1)	00:00:01
1	SORT AGGREGATE		1	5		
* 2	TABLE ACCESS FULL	T	999K	4882K	620 (1)	00:00:01

```
-----
```

This example shows the optimizer won't *always* use an index and, in fact, it makes the right choice in skipping indexes. While tuning your queries, if you discover that an index isn't used when you think it *ought to be*, don't just force it to be used—test and prove first that the index is indeed faster (via elapsed and I/O counts) before overruling the CBO. Reason it out.

## Case 6

There aren't fresh statistics for tables. The tables used to be small, but now when we look at them, they have grown quite large. An index will now make sense, whereas it didn't originally. If we generate statistics for the table, it will use the index.

Without correct statistics, the CBO *cannot* make the correct decisions.

## Index Case Summary

In my experience, these six cases are the *main* reasons I find that indexes are not being used. It usually boils down to a case of “They cannot be used—using them would return incorrect results,” or “They should not be used—if they were used, performance would be terrible.”

## Myth: Space Is Never Reused in an Index

This is a myth that I would like to dispel once and for all: space *is* reused in an index. The myth goes like this: you have a table, T, in which there is a column, X. At some point, you put the value X=5 in the table. Later you delete it. The myth is that the space used by X=5 will not be reused unless you put X=5 back into the index later. The myth states that once an index slot is used, it will be there forever and can be reused only by the same value. A corollary to this is the myth that free space is never returned to the index structure, and a block will never be reused. Again, this is simply not true.

The first part of the myth is trivial to disprove. All we need to do is to create a table like this:

```
EODA@ORA12CR1> create table t ( x int, constraint t_pk primary key(x) );
Table created.
```

```
EODA@ORA12CR1> insert into t values (1);
1 row created.
```

```
EODA@ORA12CR1> insert into t values (2);
1 row created.
```

```
EODA@ORA12CR1> insert into t values (999999999);
1 row created.
```

```
EODA@ORA12CR1> analyze index t_pk validate structure;
Index analyzed.
```

```
EODA@ORA12CR1> select lf_blks, br_blks, btree_space from index_stats;
```

LF_BLKs	BR_BLKs	BTREE_SPACE
1	0	7996

So, according to the myth, if I delete from T where X=2, that space will never be reused unless I reinsert the number 2. Currently, this index is using one leaf block of space. If the index key entries are never reused upon deletion, and I keep inserting and deleting and never reuse a value, this index should grow like crazy. Let's see:

```
EODA@ORA12CR1> begin
2     for i in 2 .. 999999
3     loop
4         delete from t where x = i;
5         commit;
6         insert into t values (i+1);
7         commit;
8     end loop;
9 end;
10 /
```

PL/SQL procedure successfully completed.

```
EODA@ORA12CR1> analyze index t_pk validate structure;
Index analyzed.
```

```
EODA@ORA12CR1> select lf_blks, br_blks, btree_space from index_stats;
```

LF_BLKs	BR_BLKs	BTREE_SPACE
1	0	7996

This shows the space in the index was reused. As with most myths, however, there is a nugget of truth in there. The truth is that the space used by that initial number 2 would remain on that index block forever. The index will not *coalesce* itself. This means if I load a table with values 1 to 500,000 and then delete every other row (all of the even numbers), there will be 250,000 holes in the index on that column. Only if I reinsert data that will fit onto a block where there is a hole will the space be reused. Oracle will make no attempt to shrink or compact the index. This can be done via an ALTER INDEX REBUILD or COALESCE command. On the other hand, if I load a table with values 1 to 500,000 and then delete from the table every row where the value was 250,000 or less, I would find the blocks that were cleaned out of the index were put back onto the FREELIST for the index. This space can be totally reused.

If you recall, this was the second myth: index space is never *reclaimed*. It states that once an index block is used, it will be stuck in that place in the index structure forever and will only be reused if you insert data that would go into that place in the index anyway. We can show that this is false as well. First, we need to build a table with about 500,000 rows in it. For that, we'll use the `big_table` script found in the Setting Up Your Environment section in the front of this book. After we have that table with its corresponding primary key index, we'll measure how many leaf blocks are in the index and how many blocks are on the FREELIST for the index. Also, with an index, a block will only be on the FREELIST if the block is entirely empty, unlike a table. So any blocks we see on the FREELIST are completely empty and available for reuse:

```
EODA@ORA12CR1> select count(*) from big_table;
```

COUNT(*)
500000

■ **Note** In the following PL/SQL, the index reported on must be built in an MSSM tablespace, and not ASSM. If you attempt to run this against an index in an ASSM tablespace, you'll receive an "ORA-10618: Operation not allowed on this segment" message.

```
EODA@ORA12CR1> declare
  2     l_freelist_blocks number;
  3 begin
  4     dbms_space.free_blocks
  5     ( segment_owner => user,
  6       segment_name => 'BIG_TABLE_PK',
  7       segment_type => 'INDEX',
  8       freelist_group_id => 0,
  9       free_blks => l_freelist_blocks );
 10     dbms_output.put_line( 'blocks on freelist = ' || l_freelist_blocks );
 11 end;
 12 /
```

**blocks on freelist = 0**

PL/SQL procedure successfully completed.

```
EODA@ORA12CR1> select leaf_blocks from user_indexes where index_name = 'BIG_TABLE_PK';
```

```
LEAF_BLOCKS
```

```
-----
      1043
```

Before we perform this mass deletion, we have no blocks on the FREELIST and there are 1,043 blocks in the *leafs* of the index, holding data. Now, we'll perform the delete and measure the space utilization again:

```
EODA@ORA12CR1> delete from big_table where id <= 250000;
250000 rows deleted.
```

```
EODA@ORA12CR1> commit;
Commit complete.
```

```
EODA@ORA12CR1> declare
  2     l_freelist_blocks number;
  3 begin
  4     dbms_space.free_blocks
  5     ( segment_owner => user,
  6       segment_name => 'BIG_TABLE_PK',
  7       segment_type => 'INDEX',
  8       freelist_group_id => 0,
  9       free_blks => l_freelist_blocks );
 10     dbms_output.put_line( 'blocks on freelist = ' || l_freelist_blocks );
 11     dbms_stats.gather_index_stats
 12     ( user, 'BIG_TABLE_PK' );
 13 end;
 14 /
```



```
blocks on freelist = 520
PL/SQL procedure successfully completed.
```

```
EODA@ORA12CR1> select leaf_blocks from user_indexes where index_name = 'BIG_TABLE_PK';
```

```
LEAF_BLOCKS
```

```
-----
          523
```

As we can see, over half of the index is on the FREELIST now (520 blocks) and there are only 523 leaf blocks. If we add 523 and 520, we get the original 1043. This means the blocks are totally empty and ready to be reused (blocks on the FREELIST for an index must be empty, unlike blocks on the FREELIST for a heap organized table).

This demonstration highlights two points:

- Space is reused on index blocks as soon as a row comes along that can reuse it.
- When an index block is emptied, it can be taken out of the index structure and may be reused later. This is probably the genesis of this myth in the first place: blocks are not visible as having free space on them in an index structure as they are in a table. In a table, you can see blocks on the FREELIST, even if they have data on them. In an index, you will only see completely empty blocks on the FREELIST; blocks that have at least one index entry (and remaining free space) will not be as clearly visible.

## Myth: Most Discriminating Elements Should Be First

This seems like common sense. If you are going to create an index on the columns C1 and C2 in a table T with 100,000 rows, and you find C1 has 100,000 distinct values and C2 has 25,000 distinct values, you would want to create the index on T(C1,C2). This means that C1 should be first, which is the commonsense approach. The fact is, when comparing vectors of data (consider C1, C2 to be a vector), it doesn't matter which you put first. Consider the following example. We will create a table based on ALL\_OBJECTS and an index on the OWNER, OBJECT\_TYPE, and OBJECT\_NAME columns (least discriminating to most discriminating) and also on OBJECT\_NAME, OBJECT\_TYPE, and OWNER:

```
EODA@ORA12CR1> create table t as select * from all_objects;
Table created.
```

```
EODA@ORA12CR1> create index t_idx_1 on t(owner,object_type,object_name);
Index created.
```

```
EODA@ORA12CR1> create index t_idx_2 on t(object_name,object_type,owner);
Index created.
```

```
EODA@ORA12CR1> select count(distinct owner), count(distinct object_type),
  2   count(distinct object_name ), count(*)
  3   from t;
```

```
COUNT(DISTINCTOWNER) COUNT(DISTINCTOBJECT_TYPE)
COUNT(DISTINCTOBJECT_NAME)   COUNT(*)
```

```
-----
          34
```

```
          36
```

```
        30813
```

```
        50253
```

Now, to show that neither is more efficient space-wise, we'll measure their space utilization:

```
EODA@ORA12CR1> analyze index t_idx_1 validate structure;
Index analyzed.
```

```
EODA@ORA12CR1> select btree_space, pct_used, opt_cmpr_count, opt_cmpr_pctsave
  2 from index_stats;
```

BTREE_SPACE	PCT_USED	OPT_CMPR_COUNT	OPT_CMPR_PCTSAVE
2526832	89	2	28

```
EODA@ORA12CR1> analyze index t_idx_2 validate structure;
Index analyzed.
```

```
EODA@ORA12CR1> select btree_space, pct_used, opt_cmpr_count, opt_cmpr_pctsave
  2 from index_stats;
```

BTREE_SPACE	PCT_USED	OPT_CMPR_COUNT	OPT_CMPR_PCTSAVE
2510776	90	0	0

They use nearly the exact same amount of space—there are no major differences there. However, the first index is a lot more *compressible* if we use index key compression, as evidenced by the `OPT_CMPR_PCTSAVE` value. There is an argument for arranging the columns in the index in order from the least discriminating to the most discriminating. Now let's see how they perform, to determine if either index is generally more efficient than the other. To test this, we'll use a PL/SQL block with hinted queries (so as to use one index or the other):

```
EODA@ORA12CR1> alter session set sql_trace=true;
Session altered.
```

```
EODA@ORA12CR1> declare
  2     cnt int;
  3 begin
  4   for x in ( select /*+FULL(t)*/ owner, object_type, object_name from t )
  5   loop
  6     select /*+ INDEX( t t_idx_1 ) */ count(*) into cnt
  7     from t
  8     where object_name = x.object_name
  9     and object_type = x.object_type
10     and owner = x.owner;
11
12     select /*+ INDEX( t t_idx_2 ) */ count(*) into cnt
13     from t
14     where object_name = x.object_name
15     and object_type = x.object_type
16     and owner = x.owner;
17   end loop;
18 end;
19 /
```

PL/SQL procedure successfully completed.

These queries read every single row in the table by means of the index. The TKPROF report shows us the following:

```
SELECT /*+ INDEX( t t_idx_1 ) */ COUNT(*) FROM T
WHERE OBJECT_NAME = :B3 AND OBJECT_TYPE = :B2 AND OWNER = :B1
```

call	count	cpu	elapsed	disk	query	current	rows
Parse	1	0.00	0.00	0	0	0	0
Execute	50253	0.69	0.67	0	0	0	0
Fetch	50253	0.46	0.49	0	100850	0	50253
total	100507	1.15	1.16	0	100850	0	50253

...

Rows (1st)	Rows (avg)	Rows (max)	Row Source	Operation
1	1	1	SORT AGGREGATE	(cr=2 pr=0 pw=0 time=16 us)
1	1	1	INDEX RANGE SCAN	T_IDX_1 (cr=2 pr=0 pw=0 time=12...

\*\*\*\*\*

```
SELECT /*+ INDEX( t t_idx_2 ) */ COUNT(*) FROM T
WHERE OBJECT_NAME = :B3 AND OBJECT_TYPE = :B2 AND OWNER = :B1
```

call	count	cpu	elapsed	disk	query	current	rows
Parse	1	0.00	0.00	0	0	0	0
Execute	50253	0.68	0.66	0	0	0	0
Fetch	50253	0.48	0.48	0	100834	0	50253
total	100507	1.16	1.15	0	100834	0	50253

...

Rows (1st)	Rows (avg)	Rows (max)	Row Source	Operation
1	1	1	SORT AGGREGATE	(cr=2 pr=0 pw=0 time=13 us)
1	1	1	INDEX RANGE SCAN	T_IDX_2 (cr=2 pr=0...

They processed the same exact number of rows and very similar numbers of blocks (minor variations coming from accidental ordering of rows in the table and consequential optimizations made by Oracle), used equivalent amounts of CPU time, and ran in about the same elapsed time (run this same test again and the CPU and ELAPSED numbers will be a little different, but on average they will be the same). There are no inherent efficiencies to be gained by placing the indexed columns in order of how discriminating they are, and as stated previously, with index key compression there is an argument for putting the least selective first. If you run the preceding example with COMPRESS 2 on the indexes, you'll find that the first index will perform about two-thirds the I/O of the second, given the nature of the query in this case.

However, the fact is that the decision to put column C1 before C2 *must* be driven by how the index is used. If you have many queries like the following, it makes more sense to place the index on T(C2, C1):

```
select * from t where c1 = :x and c2 = :y;
select * from t where c2 = :y;
```

This single index could be used by either of the queries. Additionally, using index key compression (which we looked at with regard to IOTs and will examine further later), we can build a smaller index if C2 is first. This is because each value of C2 repeats itself, on average, four times in the index. If C1 and C2 are both, on average, 10 bytes in length, the index entries for this index would nominally be 2,000,000 bytes ( $100,000 \times 20$ ). Using index key compression on (C2, C1), we could shrink this index to 1,250,000 ( $100,000 \times 12.5$ ), since three out of four repetitions of C2 could be suppressed.

In Oracle 5 (yes, version 5), there was an argument for placing the most selective columns first in an index. It had to do with the way version 5 implemented index compression (not the same as index key compression). This feature was removed in version 6 with the addition of row-level locking. Since then, it is not true that putting the most discriminating entries first in the index will make the index smaller or more efficient. It seems like it will, but it will not. With index key compression, there is a compelling argument to go the other way since it can make the index smaller. However, it should be driven by *how* you use the index, as previously stated.

## Summary

In this chapter, we covered the different types of indexes Oracle has to offer. We started with the basic B\*Tree index and looked at various subtypes of this index, such as the reverse key index (designed for Oracle RAC) and descending indexes for retrieving data sorted in a mix of descending and ascending order. We spent some time looking at when you should use an index and why an index may not be useful in various circumstances.

We then looked at bitmap indexes, an excellent method for indexing low to medium cardinality data in a data warehouse (read-intensive, non-OLTP) environment. We covered the times it would be appropriate to use a bitmapped index and why you would never consider one for use in an OLTP environment—or any environment where multiple users must concurrently update the same column.

We moved on to cover function-based indexes, which are actually special cases of B\*Tree and bitmapped indexes. A function-based index allows us to create an index on a function of a column (or columns), which means that we can precompute and store the results of complex calculations and user-written functions for blazingly fast index retrieval later. We looked at some important implementation details surrounding function-based indexes, such as the necessary system- and session-level settings that must be in place for them to be used. We followed that with examples of function-based indexes `usnWg` both built-in Oracle functions and user-written ones. Lastly, we looked at a few caveats with regard to function-based indexes.

We then examined a very specialized index type called the *application domain index*. Rather than go into how to build one of those from scratch (which involves a long, complex sequence of events), we looked at an example that had already been implemented: the text index.

We then discussed a couple of 12c topics: indexing extended columns and multiple indexes on the same column combinations. With indexing extended columns this requires either using a virtual column and associated index or a function-based index. When indexing the same column combinations you must use different physical index types and only one index can be designated as visible.

We closed with some of the most frequently asked questions on indexes as well as some myths about indexes. This section covered topics ranging from the simple question “Do indexes work with views?” to the more complex and subtle myth “Space is never reused in an index.” We answered these questions and debunked the myths mostly through example, demonstrating the concepts as we went along.



# Datatypes

Choosing the right datatype seems so easy and straightforward, but many times I see it done incorrectly. The most basic decision—what type you use to store your data in—will have repercussions on your applications and data for years to come. Thus, choosing the appropriate datatype is paramount. It is also hard to change after the fact—in other words, once you implement it, you might be stuck with it for quite a while.

In this chapter, we'll take a look at all of the Oracle basic datatypes available and discuss how they are implemented and when each might be appropriate to use. We won't examine user-defined datatypes as they're simply compound objects derived from the built-in Oracle datatypes. We'll investigate what happens when you use the wrong datatype for the job—or even just the wrong parameters to the datatype (length, precision, scale, and so on). By the end of this chapter, you'll have an understanding of the types available to you, how they're implemented, when to use each type and, as important, why using the right type for the job is key.

## An Overview of Oracle Datatypes

Oracle provides 22 different SQL datatypes. Briefly, they are as follows:

- **CHAR:** A fixed-length character string that will be blank padded with spaces to its maximum length. A non-null `CHAR(10)` will always contain 10 *bytes* of information using the default National Language Support (NLS) settings. We will cover NLS implications in more detail shortly. A CHAR field may store up to 2,000 *bytes* of information.
- **NCHAR:** A fixed-length character string that contains UNICODE formatted data. Unicode is a character-encoding standard developed by the Unicode Consortium with the aim of providing a universal way of encoding characters of any language, regardless of the computer system or platform being used. The NCHAR type allows a database to contain data in two different character sets: the CHAR type and NCHAR type use the database's character set and the national character set, respectively. A non-null `NCHAR(10)` will always contain 10 *characters* of information (note that it differs from the CHAR type in this respect). An NCHAR field may store up to 2,000 *bytes* of information.
- **VARCHAR2:** Also currently synonymous with VARCHAR. This is a variable length character string that differs from the CHAR type in that it is not blank padded to its maximum length. A `VARCHAR2(10)` may contain between 0 and 10 *bytes* of information using the default NLS settings. A VARCHAR2 may store up to 4,000 bytes of information. Starting with Oracle 12c, a VARCHAR2 can be configured to store up to 32,767 bytes of information (see the “Extended Datatypes” section in this chapter for further details).

- **NVARCHAR2:** A variable length character string that contains UNICODE formatted data. An NVARCHAR2(10) may contain between 0 and 10 *characters* of information. An NVARCHAR2 may store up to 4,000 bytes of information. Starting with Oracle 12c, an NVARCHAR2 can be configured to store up to 32,767 bytes of information (see the “Extended Datatypes” section in this chapter for further details).
- **RAW:** A variable length binary datatype, meaning that no character set conversion will take place on data stored in this datatype. It is considered a string of binary bytes of information that will simply be stored by the database. A RAW may store up to 2,000 bytes of information. Starting with Oracle 12c, a RAW can be configured to store up to 32,767 bytes of information (see the “Extended Datatypes” section in this chapter for further details).
- **NUMBER:** This datatype is capable of storing numbers with up to 38 digits of precision. These numbers may vary between  $1.0 \times 10^{(-130)}$  and up to but not including  $1.0 \times 10^{(126)}$ . Each number is stored in a *variable length* field that varies between 0 bytes (for NULL) and 22 bytes. Oracle NUMBER types are very precise—much more so than normal FLOAT and DOUBLE types found in many programming languages.
- **BINARY\_FLOAT:** This is a type available only in Oracle 10g Release 1 and above. This is a 32-bit single-precision floating-point number. It can support at least 6 digits of precision and will consume 5 bytes of storage on disk.
- **BINARY\_DOUBLE:** This is a type available only in Oracle 10g Release 1 and above. This is a 64-bit double-precision floating-point number. It can support at least 15 digits of precision and will consume 9 bytes of storage on disk.
- **LONG:** This type is capable of storing up to 2GB of character data (2 *gigabytes*, not characters, as each character may take multiple bytes in a multibyte character set). LONG types have many restrictions (I’ll discuss later) that are provided for backward compatibility, so it is strongly recommended you do not use this type in new applications. When possible, convert from LONG to CLOB types in existing applications.
- **LONG RAW:** The LONG RAW type is capable of storing up to 2GB of binary information. For the same reasons as noted for LONGs, it is recommended you use the BLOB type in all future development and, when possible, in existing applications as well.
- **DATE:** This is a fixed-width 7-byte date/time datatype. It will always contain the seven attributes of the century, the year within the century, the month, the day of the month, the hour, the minute, and the second.
- **TIMESTAMP:** This is a fixed-width 7- or 11-byte date/time datatype (depending on the precision). It differs from the DATE datatype in that it may contain fractional seconds; up to 9 digits to the right of the decimal point may be preserved for TIMESTAMPS with fractional seconds.
- **TIMESTAMP WITH TIME ZONE:** This is a fixed-width 13-byte date/time datatype, but it also provides for TIME ZONE support. Additional information regarding the time zone is stored with the TIMESTAMP in the data, so the TIME ZONE originally inserted is preserved with the data.
- **TIMESTAMP WITH LOCAL TIME ZONE:** This is a fixed-width 7- or 11-byte date/time datatype (depending on the precision), similar to the TIMESTAMP; however, it is time zone sensitive. Upon modification in the database, the TIME ZONE supplied with the data is consulted, and the date/time component is normalized to the local database time zone. So, if you were to insert a date/time using the time zone U.S./Pacific and the database time zone was U.S./Eastern, the final date/time information would be converted to the Eastern time zone and stored as a TIMESTAMP. Upon retrieval, the TIMESTAMP stored in the database would be converted to the time in the session’s time zone.

- **INTERVAL YEAR TO MONTH:** This is a fixed-width 5-byte datatype that stores a duration of time, in this case as a number of years and months. You may use intervals in date arithmetic to add or subtract a period of time from a `DATE` or the `TIMESTAMP` types.
- **INTERVAL DAY TO SECOND:** This is a fixed-width 11-byte datatype that stores a duration of time, in this case as a number of days and hours, minutes, and seconds, optionally with up to 9 digits of fractional seconds.
- **BLOB:** This datatype permits for the storage of up to 4GB of data in Oracle9i and before or  $(4 \text{ gigabytes} - 1) * (\text{database block size})$  bytes of data in Oracle 10g and above. BLOBs contain “binary” information that is not subject to character set conversion. This would be an appropriate type in which to store a spreadsheet, a word processing document, image files, and the like.
- **CLOB:** This datatype permits for the storage of up to 4GB of data in Oracle9i and before or  $(4 \text{ gigabytes} - 1) * (\text{database block size})$  bytes of data in Oracle 10g and above. CLOBs contain information that is subject to character set conversion. This would be an appropriate type in which to store *large* plain-text information. Note that I said *large* plain-text information; this datatype would not be appropriate if your plain text data is 4,000 bytes or less—for that you would want to use the `VARCHAR2` datatype.
- **NCLOB:** This datatype permits for the storage of up to 4GB of data in Oracle9i and before or  $(4 \text{ gigabytes} - 1) * (\text{database block size})$  bytes of data in Oracle 10g and above. NCLOBs store information encoded in the national character set of the database and are subject to character set conversions just as CLOBs are.
- **BFILE:** This datatype permits you to store an Oracle directory object (a pointer to an operating system directory) and a file name in a database column and to read this file. This effectively allows you to access operating system files available on the database server in a read-only fashion, as if they were stored in the database table itself.
- **ROWID:** A ROWID is effectively a 10-byte address of a row in a database. Sufficient information is encoded in the ROWID to locate the row on disk, as well as identify the object the ROWID points to (the table and so on).
- **UROWID:** A UROWID is a universal ROWID and is used for tables—such as IOTs and tables accessed via gateways to heterogeneous databases—that do not have fixed ROWIDs. The UROWID is a representation of the primary key value of the row and hence will vary in size depending on the object to which it points.

Many types are apparently missing from the preceding list, such as `INT`, `INTEGER`, `SMALLINT`, `FLOAT`, `REAL`, and others. These types are actually implemented on top of one of the base types in the preceding list—that is, they are synonyms for the native Oracle type. Additionally, datatypes such as `XMLType`, `SYS.ANYTYPE`, and `SDO_GEOMETRY` are not listed because we will not cover them in this book. They are complex object types comprising a collection of attributes along with the methods (functions) that operate on those attributes. They are made up of the basic datatypes listed previously and are not truly datatypes in the conventional sense, but rather an implementation, a set of functionality, that you may make use of in your applications.

Now, let’s take a closer look at these basic datatypes.

## Character and Binary String Types

The character datatypes in Oracle are CHAR, VARCHAR2, and their “N” variants. The CHAR and NCHAR can store up to 2,000 bytes of text. The VARCHAR2 and NVARCHAR2 can store up to 4,000 bytes of information.

---

■ **Note** Starting with Oracle 12c, VARCHAR2, NVARCHAR2, and RAW datatypes can be configured to store up to 32,767 bytes of information. Extended datatypes are not enabled by default; therefore unless explicitly configured the maximum size is still 4,000 bytes for VARCHAR2 and NVARCHAR2 datatypes and 2,000 bytes for RAW. See the “Extended Datatypes” section later in this chapter for more details.

---

This text is converted between various character sets as needed by the database. A *character set* is a binary representation of individual characters in bits and bytes. Many different character sets are available, and each is capable of representing different characters, for example:

- The US7ASCII character set is the ASCII standard representation of 128 characters. It uses the low 7 bits of a byte to represent these 128 characters.
- The WE8MSWIN1252 character set is a Western European character set capable of representing the 128 ASCII characters as well as 128 extended characters, using all 8 bits of a byte.

Before we get into the details of CHAR, VARCHAR2, and their “N” variants, it would benefit us to get a cursory understanding of what these different character sets mean to us.

## NLS Overview

As stated earlier, *NLS* stands for *National Language Support*. NLS is a very powerful feature of the database, but one that is often not as well understood as it should be. NLS controls many aspects of our data. For example, it controls how data is sorted, and whether we see commas and a single period in a number (e.g., 1,000,000.01) or many periods and a single comma (e.g., 1.000.000,01). But most important, it controls the following:

- Encoding of the textual data as stored persistently on disk
- Transparent conversion of data from character set to character set

It is this transparent part that confuses people the most—it is so transparent, you cannot even really see it happening. Let’s look at a small example.

Suppose you are storing 8-bit data in a WE8MSWIN1252 character set in your database, but you have some clients that connect using a 7-bit character set such as US7ASCII. These clients are not expecting 8-bit data and need to have the data from the database converted into something they can use. While this sounds wonderful, if you are not aware of it taking place, then you might well find that your data loses characters over time as the characters that are not available in US7ASCII are translated into some character that is. This is due to the character set translation taking place. In short, if you retrieve data from the database in character set 1, convert it to character set 2, and then insert it back (reversing the process), there is a very good chance that you have materially modified the data. Character set conversion is typically a process that will change the data, and you are usually mapping a large set of characters (in this example, the set of 8-bit characters) into a smaller set (that of the 7-bit characters). This is a *lossy conversion*—the characters get modified because it is quite simply not possible to represent every character. But this conversion must take place. If the database is storing data in a single-byte character set but the client (say, a Java application, since the Java language uses Unicode) expects it in a multibyte representation, then it must be converted simply so the client application can work with it.



You can see character set conversion very easily. For example, I have a database whose character set is set to WE8MSWIN1252, a typical Western European character set:

```
EODA@ORA12CR1> select *
  2 from nls_database_parameters
  3 where parameter = 'NLS_CHARACTERSET';
```

PARAMETER	VALUE
NLS_CHARACTERSET	WE8MSWIN1252

Now, if I ensure my NLS\_LANG is set the same as my database character set (Windows users would change/verify this setting in their registry):

```
EODA@ORA12CR1> host echo $NLS_LANG
AMERICAN_AMERICA.WE8MSWIN1252
```

I can create a table and put in some “8-bit” data. This data that will not be usable by a 7-bit client, one that is expecting only 7-bit ASCII data:

```
EODA@ORA12CR1> create table t ( data varchar2(1) );
Table created.
```

```
EODA@ORA12CR1> insert into t values ( chr(224) );
1 row created.
```

```
EODA@ORA12CR1> insert into t values ( chr(225) );
1 row created.
```

```
EODA@ORA12CR1> insert into t values ( chr(226) );
1 row created.
```

```
EODA@ORA12CR1> select data, dump(data) dump from t;
```

```
D DUMP
- -----
à Typ=1 Len=1: 224
á Typ=1 Len=1: 225
â Typ=1 Len=1: 226
```

```
EODA@ORA12CR1> commit;
```

---

■ **Note** If you do this example yourself and do not see the preceding output, make sure your terminal client software is using a UTF-8 character set itself. Otherwise, it might be translating the characters when printing to the screen! A common terminal emulator for UNIX will typically be 7-bit ASCII. This affects both Windows and UNIX/Linux users alike. Make sure your terminal can display the characters.

---

Now, if I go to another window and specify a 7-bit ASCII client, I'll see quite different results:

```
$ export NLS_LANG=AMERICAN_AMERICA.US7ASCII
$ sqlplus eoda
Enter password:

EODA@ORA12CR1> select data, dump(data) dump from t;

D DUMP
- -----
a Typ=1 Len=1: 224
a Typ=1 Len=1: 225
a Typ=1 Len=1: 226
```

Notice how in the 7-bit session I received the letter “a” three times with no diacritical marks. However, the DUMP function is showing me that in the database there are, in fact, three separate distinct characters, not just the letter “a.” The data in the database hasn’t changed—just the values this client received. If this client were to retrieve that data into host variables as follows:

```
EODA@ORA12CR1> variable d varchar2(1)
EODA@ORA12CR1> variable r varchar2(20)
EODA@ORA12CR1> begin
2 select data, rowid into :d, :r from t where rownum = 1;
3 end;
4 /
PL/SQL procedure successfully completed.
```

And then next, do nothing whatsoever with it, just send it back to the database:

```
EODA@ORA12CR1> update t set data = :d where rowid = chartorowid(:r);
1 row updated.
EODA@ORA12CR1> commit;
Commit complete.
```

I would observe in the original 8-bit session that I have lost one of the original characters. It has been replaced with the lowly 7-bit a, not the fancy à I had previously.

```
EODA@ORA12CR1> select data, dump(data) dump from t;

D DUMP
- -----
a Typ=1 Len=1: 97
á Typ=1 Len=1: 225
â Typ=1 Len=1: 226
```

## SQL DUMP FUNCTION

The Oracle SQL DUMP function allows you to display the datatype code, length in bytes, and the internal representation of a data value (also optionally the character set name). Its syntax is as follows:

```
DUMP( expression [,return_format] [,start_position] [,length] )
```

The default `return_format` is 10 (decimal) and can be any of the following: 8, 10, 16, 17, 1008, 1010, 1016, or 1017. Where 8 is octal notation, 10 is decimal, 16 is hexadecimal, 17 is single characters, 1008 is octal with the character set name, 1010 is decimal with character set name, 1016 is hexadecimal with the character set name, and 1017 is single characters with the character set name. The following example dumps information regarding the “a” character:

```
EODA@ORA12CR1> select dump('a'), dump('a',8), dump('a',16) from dual;
DUMP('A')          DUMP('A',8)          DUMP('A',16)
```

```
-----
Typ=96 Len=1: 97 Typ=96 Len=1: 141 Typ=96 Len=1: 61
```

Where 97, 141, and 61 are the corresponding ASCII codes for the “a” character in decimal, octal, and hexadecimal notation. The returned datatype code of `Typ=96` indicates a `CHAR` datatype (see the *Oracle Database SQL Language Reference* manual for a complete list of Oracle datatype codes and meanings).

This demonstrates the immediate impact of an environment with a heterogeneous character set, whereby the clients and database use different NLS settings. It is something to be aware of because it comes into play in many circumstances. For example, if the DBA uses the deprecated legacy EXP tool to extract information, he may observe the following warning:

```
[tkyte@desktop tkyte] exp userid=eoda tables=t
Export: Release 12.1.0.1.0 - Production on Thu Jan 9 16:11:24 2014
Copyright (c) 1982, 2013, Oracle and/or its affiliates. All rights reserved.
Password:
Connected to: Oracle Database 12c Enterprise Edition Release 12.1.0.1.0 - 64bit Production
With the Partitioning, OLAP, Advanced Analytics and Real Application Testing options
Export done in US7ASCII character set and UTF8 NCHAR character set
server uses WE8MSWIN1252 character set (possible charset conversion)
About to export specified tables via Conventional Path
...
```

Such warnings should be treated very seriously. If you were exporting this table with the goal of dropping the table and then using IMP to re-create it, you would find that *all* of your data in that table was now lowly 7-bit data! Beware the unintentional character set conversion.

■ **Note** The problem of unintentional character set conversion does not affect every tool, nor does it affect every tool in the same ways. For example, if you were to use the recommended Data Pump export/import process, you would discover that the export is always done in the character set of the database containing the data, regardless of the client's NLS settings. This is because Data Pump runs in the database server itself; it is not a client side tool at all. Similarly, Data Pump import will always convert the data in the file to be imported from the source database's character set into the destination database's character set— meaning that character set conversion is still possible with Data Pump (if the source and target databases have different character sets) but not in the same fashion as with the legacy EXP/IMP tools!

---

But also be aware that, in general, character set conversions are necessary. If clients are expecting data in a specific character set, it would be disastrous to send them the information in a different character set.

---

■ **Note** I highly encourage everyone to read through the *Oracle Database Globalization Support Guide* document. It covers NLS-related issues to a depth we will not here. Anyone creating applications that will be used around the globe (or even across international boundaries) needs to master the information contained in that document.

---

Now that we have a cursory understanding of character sets and the impact they will have on us, let's take a look at the character string types provided by Oracle.

## Character Strings

There are four basic character string types in Oracle, namely CHAR, VARCHAR2, NCHAR, and NVARCHAR2. All of the strings are stored in the same format in Oracle. On the database block they will have a leading length field of 1 to 3 bytes followed by the data; when they are NULL they will be represented as a single byte value of 0xFF.

---

■ **Note** Trailing NULL columns consume 0 bytes of storage in Oracle. This means that if the last column in a table is NULL, Oracle stores nothing for it. If the last two columns are both NULL, there will be nothing stored for either of them. But if any column after a NULL column in position is *not null*, then Oracle will use the null flag, described in this section, to indicate the missing value.

---

If the length of the string is less than or equal to 250 (0x01 to 0xFA), Oracle will use 1 byte for the length. All strings exceeding 250 bytes in length will have a flag byte of 0xFE followed by 2 bytes that represent the length. So, a VARCHAR2(80) holding the words Hello World might look like Figure 12-1 on a block.

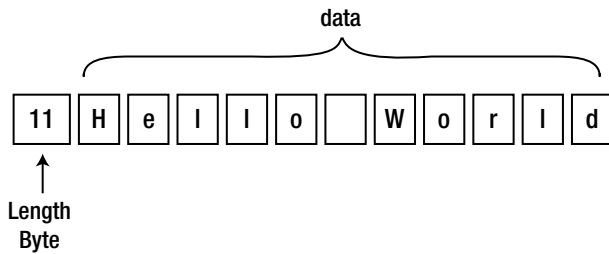

**Figure 12-1.** Hello World stored in a VARCHAR2(80)

A CHAR(80) holding the same data, on the other hand, would look like Figure 12-2.

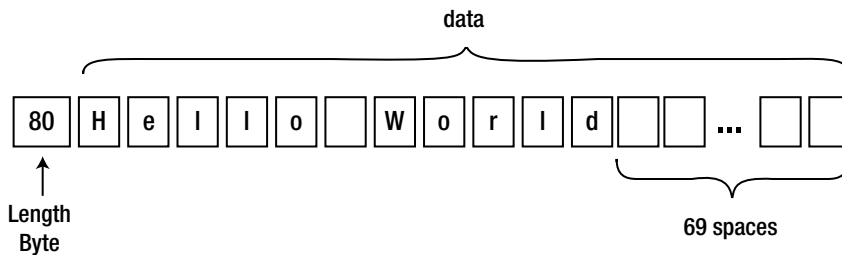

**Figure 12-2.** Hello World stored in a CHAR(80)

The fact that a CHAR/NCHAR is really nothing more than a VARCHAR2/NVARCHAR2 in disguise makes me of the opinion that there are really only two character string types to ever consider, namely VARCHAR2 and NVARCHAR2. I have never found a use for the CHAR type in any application. Since a CHAR type *always* blank pads the resulting string out to a fixed width, we discover rapidly that it consumes maximum storage both in the table segment and any index segments. That would be bad enough, but there is another important reason to avoid CHAR/NCHAR types: they create confusion in applications that need to retrieve this information (many cannot “find” their data after storing it). The reason for this relates to the rules of character string comparison and the strictness with which they are performed. Let’s use the 'Hello World' string in a simple table to demonstrate:

```
EODA@ORA12CR1> create table t
  2 ( char_column      char(20),
  3   varchar2_column varchar2(20)
  4 )
  5 /
```

Table created.

```
EODA@ORA12CR1> insert into t values ( 'Hello World', 'Hello World' );
1 row created.
```

```
EODA@ORA12CR1> select * from t;
CHAR_COLUMN      VARCHAR2_COLUMN
-----
Hello World      Hello World
```

```
EODA@ORA12CR1> select * from t where char_column = 'Hello World';
CHAR_COLUMN          VARCHAR2_COLUMN
-----
Hello World          Hello World
```

```
EODA@ORA12CR1> select * from t where varchar2_column = 'Hello World';
CHAR_COLUMN          VARCHAR2_COLUMN
-----
Hello World          Hello World
```

So far, the columns look identical but, in fact, some implicit conversion has taken place and the CHAR(11) literal 'Hello World' has been promoted to a CHAR(20) and blank padded when compared to the CHAR column. This must have happened since Hello World..... is *not the same* as Hello World without the trailing spaces. We can confirm that these two strings are materially different:

```
EODA@ORA12CR1> select * from t where char_column = varchar2_column;
no rows selected
```

They are not equal to each other. We would have to either blank pad out the VARCHAR2\_COLUMN to be 20 bytes in length or trim the trailing blanks from the CHAR\_COLUMN, as follows:

```
EODA@ORA12CR1> select * from t where trim(char_column) = varchar2_column;
CHAR_COLUMN          VARCHAR2_COLUMN
-----
Hello World          Hello World
```

```
EODA@ORA12CR1> select * from t where char_column = rpad( varchar2_column, 20 );
CHAR_COLUMN          VARCHAR2_COLUMN
-----
Hello World          Hello World
```

---

■ **Note** There are many ways to blank pad the VARCHAR2\_COLUMN, such as using the CAST() function.

---

The problem arises with applications that use variable length strings when they bind inputs, with the resulting “no data found” that is sure to follow:

```
EODA@ORA12CR1> variable varchar2_bv varchar2(20)
EODA@ORA12CR1> exec :varchar2_bv := 'Hello World';
PL/SQL procedure successfully completed.
```

```
EODA@ORA12CR1> select * from t where char_column = :varchar2_bv;
no rows selected
```

```
EODA@ORA12CR1> select * from t where varchar2_column = :varchar2_bv;
CHAR_COLUMN          VARCHAR2_COLUMN
-----
Hello World          Hello World
```

So here, the search for the VARCHAR2 string worked, but the CHAR column did not. The VARCHAR2 bind variable will not be promoted to a CHAR(20) in the same way as a character string literal. At this point, many programmers form the opinion that “bind variables don’t work; we have to use literals.” That would be a very bad decision indeed. The solution is to bind using a CHAR type:

```
EODA@ORA12CR1> variable char_bv char(20)
EODA@ORA12CR1> exec :char_bv := 'Hello World';

PL/SQL procedure successfully completed.
EODA@ORA12CR1>
EODA@ORA12CR1> select * from t where char_column = :char_bv;
CHAR_COLUMN          VARCHAR2_COLUMN
-----
Hello World          Hello World
EODA@ORA12CR1> select * from t where varchar2_column = :char_bv;
no rows selected
```

However, if you mix and match VARCHAR2 and CHAR, you’ll be running into this issue constantly. Not only that, but the developer is now having to consider the field width in her applications. If the developer opts for the RPAD() trick to convert the bind variable into something that will be comparable to the CHAR field (it is preferable, of course, to pad out the bind variable, rather than TRIM the database column, as applying the function TRIM to the column could easily make it impossible to use existing indexes on that column), she would have to be concerned with column length changes over time. If the size of the field changes, then the application is impacted, as it must change its field width.

It is for these reasons—the fixed-width storage, which tends to make the tables and related indexes much larger than normal, coupled with the bind variable issue—that I avoid the CHAR type in all circumstances. I cannot even make an argument for it in the case of the one-character field, because in that case it is really of no material difference. The VARCHAR2(1) and CHAR(1) are identical in all aspects. There is no compelling reason to use the CHAR type in that case, and to avoid any confusion, I “just say no,” even for the CHAR(1) field.

## Character String Syntax

The syntax for the four basic string types is straightforward, as described in Table 12-1.

**Table 12-1.** Four Basic String Types

String Type	<SIZE>
VARCHAR2( <SIZE> <BYTE CHAR> )	A number between 1 and 4,000 for up to 4,000 bytes of storage. In the following section, we’ll examine in detail the differences and nuances of the BYTE versus CHAR modifier in that clause. Starting with 12c, you can configure a VARCHAR2 to store up to 32,767 bytes of information.
CHAR( <SIZE> <BYTE CHAR> )	A number between 1 and 2,000 for up to 2,000 bytes of storage.
NVARCHAR2( <SIZE> )	A number greater than 0 whose upper bound is dictated by your national character set. Starting with 12c, you can configure a NVARCHAR2 to store up to 32,767 bytes of information.
NCHAR( <SIZE> )	A number greater than 0 whose upper bound is dictated by your national character set.

## Bytes or Characters

The VARCHAR2 and CHAR types support two methods of specifying lengths:

- *In bytes*: VARCHAR2(10 byte). This will support up to 10 bytes of data, which could be as few as two characters in a multibyte character set. Remember that bytes are not the same as characters in a multibyte character set!
- *In characters*: VARCHAR2(10 char). This will support up to 10 *characters* of data, which could be as much as 40 bytes of information. Furthermore, VARCHAR2(4000 CHAR) would theoretically support up to 4,000 characters of data, but since a character string datatype in Oracle is limited to 4,000 bytes, you might not be able to store that many characters. See the following for an example.

When using a multibyte character set such as UTF8, you would be well advised to use the CHAR modifier in the VARCHAR2/CHAR definition—that is, use VARCHAR2(80 CHAR), not VARCHAR2(80), since your intention is likely to define a column that can in fact store 80 characters of data. You may also use the session or system parameter NLS\_LENGTH\_SEMANTICS to change the default behavior from BYTE to CHAR. I do not recommend changing this setting at the system level; rather, use it as part of an ALTER SESSION setting in your database schema installation scripts. Any application that requires a database to have a specific set of NLS settings makes for an unfriendly application. Such applications generally cannot be installed into a database with other applications that do not desire these settings, but rely on the defaults to be in place.

One other important thing to remember is that the upper bound of the number of bytes stored in a VARCHAR2 is 4,000. However, even if you specify VARCHAR2(4000 CHAR), you may not be able to fit 4,000 characters into that field. In fact, you may be able to fit as few as 1,000 characters in that field if all of the characters take 4 bytes to be represented in your chosen character set! Regarding the 4,000-byte limit, starting with 12c, a VARCHAR2 can be configured to store up to 32,767 bytes of information.

The following small example demonstrates the differences between BYTE and CHAR and how the upper bounds come into play. We'll create a table with three columns, the first two of which will be 1 byte and one character, respectively, with the last column being 4,000 characters. Notice that we're performing this test on a multibyte character set database using the character set AL32UTF8, which supports the latest version of the Unicode standard and encodes characters in a variable length fashion using from 1 to 4 bytes for each character:

```
EODA@ORA12CR1> select *
  2   from nls_database_parameters
  3   where parameter = 'NLS_CHARACTERSET';
```

PARAMETER	VALUE
NLS_CHARACTERSET	AL32UTF8

```
EODA@ORA12CR1> create table t
  2   ( a varchar2(1),
  3     b varchar2(1 char),
  4     c varchar2(4000 char)
  5   )
  6   /
```

Table created.



Now, if we try to insert into our table a single character that is 2 bytes long in UTF, we observe the following:

```
EODA@ORA12CR1> insert into t (a) values (unistr('\00d6'));
insert into t (a) values (unistr('\00d6'))
*
ERROR at line 1:
ORA-12899: value too large for column "EODA"."T"."A" (actual: 2, maximum: 1)
```

This example demonstrates two things:

- VARCHAR2(1) is in bytes, not characters. We have a single Unicode character, but it won't fit into a single byte.
- As you migrate an application from a single-byte fixed-width character set to a multibyte character set, you might find that the text that once fit into your fields no longer does.

The reason for the second point is that a 20-character string in a single-byte character set is 20 bytes long and will absolutely fit into a VARCHAR2(20). However a 20-character field could be as long as 80 bytes in a multibyte character set, and 20 Unicode characters may well not fit in 20 bytes. You might consider modifying your DDL to be VARCHAR2(20 CHAR) or using the NLS\_LENGTH\_SEMANTICS session parameter mentioned previously when running your DDL to create your tables.

If we insert that single character into a field set up to hold a single character, we will observe the following:

```
EODA@ORA12CR1> insert into t (b) values (unistr('\00d6'));
1 row created.
EODA@ORA12CR1> select length(b), lengthb(b), dump(b) dump from t;
LENGTH(B) LENGTHB(B) DUMP
-----
1          2 Typ=1 Len=2: 195,150
```

That INSERT succeeded, and we can see that the LENGTH of the inserted data is one character—all of the character string functions work *character-wise*. So the length of the field is one character, but the LENGTHB (length in bytes) function shows it takes 2 bytes of storage, and the DUMP function shows us exactly what those bytes are. So, that example demonstrates one very common issue people encounter when using multibyte character sets, namely that a VARCHAR2(N) doesn't necessarily hold N *characters*, but rather N *bytes*.

The next issue people confront frequently is that the maximum length in bytes of a VARCHAR2 is 4,000 and in a CHAR is 2,000:

```
EODA@ORA12CR1> declare
2     l_data varchar2(4000 char);
3     l_ch   varchar2(1 char) := unistr( '\00d6' );
4 begin
5     l_data := rpad( l_ch, 4000, l_ch );
6     insert into t ( c ) values ( l_data );
7 end;
8 /
declare
*
ERROR at line 1:
ORA-01461: can bind a LONG value only for insert into a LONG column
ORA-06512: at line 6
```

This shows that a 4,000-character string that is really 8,000 bytes long cannot be stored permanently in a `VARCHAR2(4000 CHAR)` field. It fits in the PL/SQL variable because there a `VARCHAR2` is allowed to be up to 32KB in size. However, when it is stored in a table, the hard limit is 4,000 bytes. We can store 2,000 of these characters successfully:

```
EODA@ORA12CR1> declare
  2     l_data varchar2(4000 char);
  3     l_ch   varchar2(1 char) := unistr( '\00d6' );
  4 begin
  5     l_data := rpad( l_ch, 2000, l_ch );
  6     insert into t ( c ) values ( l_data );
  7 end;
  8 /
```

PL/SQL procedure successfully completed.

```
EODA@ORA12CR1> select length( c ), lengthb( c )
  2   from t
  3   where c is not null;
```

```
LENGTH(C)  LENGTHB(C)
-----  -----
2000      4000
```

And as you can see, they consume 4,000 bytes of storage.

## The “N” Variant

So, of what use are the `NVARCHAR2` and `NCHAR` (for completeness)? They are used in systems where the need to manage and store multiple character sets arises. This typically happens in a database where the predominant character set is a single-byte fixed-width one (such as `WE8MSWIN1252`), but the need arises to maintain and store some multibyte data. There are many systems that have legacy data but need to support multibyte data for some new applications; likewise, there are systems that want the efficiency of a single-byte character set for most operations (string operations on a string that uses fixed-width characters are more efficient than on a string where each character may use a different number of bytes) but need the flexibility of multibyte data at some points.

The `NVARCHAR2` and `NCHAR` datatypes support this need. They are generally the same as their `VARCHAR2` and `CHAR` counterparts, with the following exceptions:

- Their text is stored and managed in the database’s national character set, not the default character set.
- Their lengths are always provided in characters, whereas a `CHAR/VARCHAR2` may specify either bytes or characters.

In Oracle9i and above, the database’s national character set may take one of two values: `UTF8` or `AL16UTF16` (`UTF-16` in 9i; `AL16UTF16` in 10g). This makes the `NCHAR` and `NVARCHAR` types suitable for storing only multibyte data, which is a change from earlier releases of the database (Oracle8i and earlier allowed you to choose any character set for the national character set).

## Binary Strings: RAW Types

Oracle supports the storage of binary data as well as text. Binary data is not subject to the character set conversions we discussed earlier with regard to the CHAR and VARCHAR2 types. Therefore, binary datatypes are not suitable for storing user-supplied text, but are suitable for storing encrypted information—encrypted data is not “text,” but a binary representation of the original text, word processing documents containing binary markup information, and so on. Any string of bytes that should not be considered by the database to be “text” (or any other base datatype such as a number, date, and so on) and that should not have character set conversion applied to it should be stored in a binary datatype.

Oracle supports three datatypes for storing binary data:

- The RAW type, which we focus on in this section, is suitable for storing RAW data up to 2,000 bytes in size. Starting with 12c, you can configure a RAW to store up to 32,767 bytes of information.
- The BLOB type, which supports binary data of much larger sizes. We’ll defer coverage of this until the “LOB Types” section later in the chapter.
- The LONG RAW type, which is supported for backward compatibility and should not be considered for new applications.

The syntax for the binary RAW type is straightforward:

```
RAW( <size> )
```

For example, the following code creates a table capable of storing 16 bytes of binary information per row:

```
EODA@ORA12CR1> create table t ( raw_data raw(16) );
Table created.
```

The RAW type is much like the VARCHAR2 type in terms of storage on disk. The RAW type is a variable length binary string, meaning that the table T just created, for example, may store anywhere from 0 to 16 bytes of binary data. It is not padded out like the CHAR type.

When dealing with RAW data, you will likely find it being implicitly converted to a VARCHAR2 type—that is, many tools, such as SQL\*Plus, will not display the RAW data directly but will convert it to a hexadecimal format for display. In the following example, we create some binary data in our table using SYS\_GUID(), a built-in function that returns a 16-byte RAW string that is globally unique (*GUID* stands for *globally unique identifier*):

```
EODA@ORA12CR1> insert into t values ( sys_guid() );
1 row created.
EODA@ORA12CR1> select * from t;
```

```
RAW_DATA
```

```
-----
EEF18AA30B563AF0E043B7D04F0A4A30
```

You can immediately note two things here. First, the RAW data looks like a character string. That is just how SQL\*Plus retrieved and printed it; that is not how it is stored on disk. SQL\*Plus cannot print arbitrary binary data on your screen, as that could have serious side effects on the display. Remember that binary data may include control characters such as a carriage return or linefeed—or maybe a Ctrl-G character that would cause your terminal to beep.

Second, the RAW data looks much larger than 16 bytes—in fact, in this example, you can see 32 characters. This is due to the fact that every binary byte takes two hexadecimal characters to display (if the leading character is a zero, the zero is not displayed). The stored RAW data is really 16 bytes in length, and you can see this using the Oracle SQL DUMP function. Here, I am dumping the value of the binary string and using the optional parameter to specify the base that should be used when displaying the value of each byte. I am using base 16, so we can compare the results of dump with the previous string:

```
EODA@ORA12CR1> select dump(raw_data,16) from t;

DUMP(RAW_DATA,16)
-----
Typ=23 Len=16: ee,f1,8a,a3,b,56,3a,f0,e0,43,b7,d0,4f,a,4a,30
```

So, DUMP shows us this binary string is in fact 16 bytes long (Len=16) and displays the binary data byte by byte. As we can see, this dump display matches up with the implicit conversion performed when SQL\*Plus fetched the RAW data into a string. This implicit conversion goes the other direction as well:

```
EODA@ORA12CR1> insert into t values ( 'abcdef' );
1 row created.
```

That did not insert the string abcdef, but rather a 3-byte RAW with the bytes AB, CD, EF, or in decimal with the bytes 171, 205, 239. If you attempt to use a string that does not consist of valid hex characters, you will receive an error message:

```
EODA@ORA12CR1> insert into t values ( 'abcdefgh' );
insert into t values ( 'abcdefgh' )
                        *
ERROR at line 1:
ORA-01465: invalid hex number
```

The RAW type may be indexed and used in predicates—it is as functional as any other datatype. However, you must take care to avoid unwanted implicit conversions, and you must be aware that they will occur.

I prefer and recommend using *explicit* conversions in all cases, which can be performed using the following built-in functions:

- HEXTORAW: To convert strings of hexadecimal characters to the RAW type
- RAWTOHEX: To convert RAW strings to hexadecimal strings

The RAWTOHEX function is invoked implicitly by SQL\*Plus when it fetches a RAW type into a string, and the HEXTORAW function is invoked implicitly when inserting the string. It is a good practice to avoid implicit conversions and to always be explicit when coding. So the previous examples could have been written as follows:

```
EODA@ORA12CR1> select rawtohex(raw_data) from t;

RAWTOHEX(RAW_DATA)
-----
EEF18AA30B563AF0E043B7D04FOA4A30

EODA@ORA12CR1> insert into t values ( hextoraw('abcdef') );
1 row created.
```

## Extended Datatypes

Prior to Oracle 12c, the maximum length allowed for VARCHAR2 and NVARCHAR2 datatypes was 4,000 bytes, and 2,000 bytes for the RAW datatype. Starting with Oracle 12c, these datatypes can be configured to store up to 32,767 bytes. Listed next are the steps for enabling extended datatypes for a noncontainer (see Chapter 2 for a definition of the types of databases), single instance database. These steps must be performed as SYS:

```
SYS@012CE> shutdown immediate;
SYS@012CE> startup upgrade;
SYS@012CE> alter system set max_string_size=extended;
SYS@012CE> @?/rdbms/admin/utl32k.sql
SYS@012CE> shutdown immediate;
SYS@012CE> startup;
```

---

■ **Note** Refer to the *Oracle Database Reference* guide for complete details on implementing extended datatypes for all types of databases (single instance, container, RAC, and Data Guard Logical Standby).

---

Once you've modified the MAX\_STRING\_SIZE to EXTENDED, you cannot modify the value back to the default (of STANDARD). It's a one-way change. If you need to switch back, you will have to perform a recovery to a point in time before the change was made—meaning you'll need RMAN backups (taken prior to the change) or have the flashback database enabled. You can also take a Data Pump export from a database with extended datatypes enabled and import into a database without extended datatypes enabled with the caveat that any tables with extended columns will fail on the import.

After enabling the extended datatype, you can create a table with an extended column, as follows:

```
EODA@012CE> create table t(et varchar2(32727)) tablespace users;
```

Table created.

If you describe the table it will show the large definition:

```
EODA@012CE> desc t
Name                          Null?    Type
-----
ET                              VARCHA2(32727)
```

You can manipulate the extended VARCHAR2 column via SQL just as you would a nonextended column, for example:

```
EODA@012CE> insert into t values(rpad('abc',10000,'abc'));
EODA@012CE> select substr(et,9500,10) from t where UPPER(et) like 'ABC%';
```

The extended datatype is internally implemented as a LOB. Assuming that the T table is created in a schema not containing any other objects, you'll get the following when querying USER\_OBJECTS:

```
EODA@O12CE> select object_name, object_type from user_objects;
```

OBJECT_NAME	OBJECT_TYPE
SYS_LOB0000019479C00001\$\$	LOB
SYS_IL0000019479C00001\$\$	INDEX
T	TABLE

You can further verify the LOB segment details by querying USER\_LOBS:

```
EODA@O12CE> select table_name, column_name, segment_name, tablespace_name, in_row
  2     from user_lobs where table_name='T';
```

TABLE_NAME	COLUMN_NAME	SEGMENT_NAME	TABLESPACE_NAME	IN_
T	ET	SYS_LOB0000019479C00001\$\$	USERS	YES

You have no direct control over the LOB associated with the extended column. This means that you cannot manipulate the underlying LOB column with the DBMS\_LOB package. Also, the internal LOB associated with the extended datatype column is not visible to you via DBA\_TAB\_COLUMNS or COL\$.

The LOB segment and associated LOB index are always stored in the tablespace of the table that the extended datatype was created in. Following normal LOB storage rules, Oracle stores the first 4,000 bytes inline within the table. Anything greater than 4,000 bytes is stored in the LOB segment. If the tablespace that the LOB is created in is using Automatic Segment Space Management (ASSM) then the LOB is created as a SecureFiles LOB, otherwise it is created as a BasicFiles LOB.

---

■ **Note** See the “LOB Types” section later in this chapter for a discussion on in row storage and the technical aspects of SecureFiles and BasicFiles.

---

Your SQL access to any data stored in the extended-column LOB segment is transparently handled by Oracle. This has some interesting implications. For example, you can successfully select data stored in an extended column via a database link. This bit of code selects (via a database link) from a table named T in a remote database named O12CE:

```
EODA@ORA12CR1> select substr(et, 9000,10) from t@O12CE;
```

```
SUBSTR(ET,9000,10)
```

```
-----
cabcabcab
```

Why is that important? Consider what happens when a table is created in the remote O12CE database with a column defined with a LOB datatype:

```
EODA@O12CE> create table c(ct clob);
```

```
Table created.
```

Oracle throws an error if you attempt to select from the LOB column remotely over a database link:

```
EODA@ORA12CR1> select * from c@O12CE;
ERROR:
ORA-22992: cannot use LOB locators selected from remote tables
```

You can also perform set operation comparisons (UNION, UNION ALL, MINUS, INTERSECT) on extended columns, for example:

```
EODA@O12CE> select et from t minus select et from t;
```

Whereas if you tried to compare two LOB columns via a set operator, Oracle returns an error:

```
EODA@O12CE> select ct from c minus select ct from c;
select ct from c minus select ct from c
      *
ERROR at line 1:
ORA-00932: inconsistent datatypes: expected - got CLOB
```

The prior examples demonstrate that you have more flexibility working with an extended datatype than you would if working directly with a LOB column. Therefore, if you have an application that deals with character data greater than 4,000 bytes but less than or equal to 32,727 bytes, then you may want to consider using extended datatypes. Also, if you're migrating from a non-Oracle database (that supports large character columns) to an Oracle database, the extended datatype feature will help make that migration easier, as you can now define large sizes for VARCHAR2, NVARCHAR2, and RAW columns natively in Oracle.

## Number Types

Oracle 10g and above supports three native datatypes suitable for storing numbers. Oracle9i Release 2 and earlier support exactly one native datatype suitable for storing numeric data. In this list, the NUMBER type is supported by all releases, and the subsequent two types are new datatypes supported only in Oracle 10g and above:

- **NUMBER:** The Oracle NUMBER type is capable of storing numbers with an extremely large degree of precision—38 digits of precision, in fact. The underlying data format is similar to a *packed decimal* representation. The Oracle NUMBER type is a variable length format from 0 to 22 bytes in length. It is appropriate for storing any number as small as 10e-130 and numbers up to but not including 10e126. This is by far the most common NUMBER type in use today.
- **BINARY\_FLOAT:** This is an IEEE native single-precision floating-point number. On disk it will consume 5 bytes of storage: 4 fixed bytes for the floating-point number and 1 length byte. It is capable of storing numbers in the range of  $\sim \pm 10^{38.53}$  with 6 digits of precision.
- **BINARY\_DOUBLE:** This is an IEEE native double-precision floating-point number. On disk it will consume 9 bytes of storage: 8 fixed bytes for the floating-point number and 1 length byte. It is capable of storing numbers in the range of  $\sim \pm 10^{308.25}$  with 13 digits of precision.

As you can see from this quick overview, the Oracle NUMBER type has significantly larger precision than the BINARY\_FLOAT and the BINARY\_DOUBLE types, but a much smaller range than the BINARY\_DOUBLE. That is, you can store numbers very precisely with many significant digits in a NUMBER type, but you can store much smaller and larger

numbers in the `BINARY_FLOAT` and `BINARY_DOUBLE` types. As a quick example, we can create a table with the various datatypes in them and see what is stored given the same inputs:

```
EODA@ORA12CR1> create table t
  2 ( num_col number,
  3   float_col binary_float,
  4   dbl_col binary_double
  5 )
  6 /
```

Table created.

```
EODA@ORA12CR1> insert into t ( num_col, float_col, dbl_col )
  2 values ( 1234567890.0987654321,
  3         1234567890.0987654321,
  4         1234567890.0987654321 );
1 row created.
```

```
EODA@ORA12CR1> set numformat 9999999999.9999999999
EODA@ORA12CR1> select * from t;
```

NUM_COL	FLOAT_COL	DBL_COL
1234567890.09876543210	1234567940.00000000000	1234567890.09876540000

Note that the `NUM_COL` returns the exact number we provided as input. There are fewer than 38 significant digits in the input number (I supplied a number with 20 significant digits), so the exact number is preserved. The `FLOAT_COL`, however, using the `BINARY_FLOAT` type, was not able to accurately represent this number. In fact, it preserved only 7 digits accurately. The `DBL_COL` fared much better, accurately representing the number in this case out to 17 digits. Overall, though, this should be a good indication that the `BINARY_FLOAT` and `BINARY_DOUBLE` types will not be appropriate for financial applications! If you play around with different values, you'll see different results:

```
EODA@ORA12CR1> delete from t;
1 row deleted.
```

```
EODA@ORA12CR1> insert into t ( num_col, float_col, dbl_col )
  2 values ( 9999999999.9999999999,
  3         9999999999.9999999999,
  4         9999999999.9999999999 );
1 row created.
```

```
EODA@ORA12CR1> select * from t;
```

NUM_COL	FLOAT_COL	DBL_COL
9999999999.99999999990	10000000000.00000000000	10000000000.00000000000





You should consider the precision and scale to be *edits* for your data—data integrity tools in a way. The precision and scale *do not affect* at all how the data is stored on disk, only what values are permitted and how numbers are to be rounded. For example, if a value exceeds the precision permitted, Oracle returns an error:

```
EODA@ORA12CR1> create table t ( num_col number(5,0) );
Table created.

EODA@ORA12CR1> insert into t (num_col) values ( 12345 );
1 row created.

EODA@ORA12CR1> insert into t (num_col) values ( 123456 );
insert into t (num_col) values ( 123456 )
*
ERROR at line 1:
ORA-01438: value larger than specified precision allowed for this column
```

So, you can use the precision to enforce some data integrity constraints. In this case, NUM\_COL is a column that is not allowed to have more than five digits.

The scale, on the other hand, is used to control rounding of the number. For example:

```
EODA@ORA12CR1> create table t ( msg varchar2(10), num_col number(5,2) );
Table created.

EODA@ORA12CR1> insert into t (msg,num_col) values ( '123.45', 123.45 );
1 row created.

EODA@ORA12CR1> insert into t (msg,num_col) values ( '123.456', 123.456 );
1 row created.

EODA@ORA12CR1> select * from t;
```

MSG	NUM_COL
-----	-----
123.45	123.45
123.456	123.46

Notice how the number 123.456, with more than five digits, succeeded this time. That is because the scale we used in this example was used to round 123.456 to two digits, resulting in 123.46, *and then* 123.46 was validated against the precision, found to fit, and inserted. However, if we attempt the following insert, it fails because the number 1234.00 has more than five digits in total:

```
EODA@ORA12CR1> insert into t (msg,num_col) values ( '1234', 1234 );
insert into t (msg,num_col) values ( '1234', 1234 )
*
ERROR at line 1:
ORA-01438: value larger than specified precision allowed for this column
```

When you specify the scale of 2, at most three digits may be to the left of the decimal place and two to the right. Hence that number does not fit. The `NUMBER(5,2)` column can hold all values between 999.99 and -999.99.

It may seem strange to allow the scale to vary from -84 to 127. What purpose could a negative scale fulfill? It allows you to round values to the left of the decimal place. Just as the `NUMBER(5,2)` rounded values to the nearest .01, so a `NUMBER(5,-2)` would round to the nearest 100, for example:

```
EODA@ORA12CR1> create table t ( msg varchar2(10), num_col number(5,-2) );
Table created.
```

```
EODA@ORA12CR1> insert into t (msg,num_col) values ( '123.45', 123.45 );
1 row created.
```

```
EODA@ORA12CR1> insert into t (msg,num_col) values ( '123.456', 123.456 );
1 row created.
```

```
EODA@ORA12CR1> select * from t;
```

MSG	NUM_COL
123.45	100
123.456	100

The numbers were rounded to the nearest 100. We still have five digits of precision, but there are now seven digits (including the trailing two 0s) permitted to the left of the decimal point:

```
EODA@ORA12CR1> insert into t (msg,num_col) values ( '1234567', 1234567 );
1 row created.
```

```
EODA@ORA12CR1> select * from t;
```

MSG	NUM_COL
123.45	100
123.456	100
1234567	1234600

```
EODA@ORA12CR1> insert into t (msg,num_col) values ( '12345678', 12345678 );
insert into t (msg,num_col) values ( '12345678', 12345678 )
*
```

```
ERROR at line 1:
```

```
ORA-01438: value larger than specified precision allowed for this column
```

So, the precision dictates how many digits are permitted in the number after rounding, using the scale to determine how to round. The precision is an integrity constraint, whereas the scale is an edit.

It is interesting and useful to note that the `NUMBER` type is, in fact, a variable length datatype on disk and will consume between 0 and 22 bytes of storage. Many times, programmers consider a numeric datatype to be a fixed-length type—that is what they typically see when programming with 2- or 4-byte integers and 4- or 8-byte floats.

The Oracle NUMBER type is similar to a variable length character string. We can see what happens with numbers that contain differing amounts of significant digits. We'll create a table with two NUMBER columns and populate the first column with many numbers that have 2, 4, 6, ... 28 significant digits. Then, we'll simply add 1 to each of them:

```
EODA@ORA12CR1> create table t ( x number, y number );
Table created.
```

```
EODA@ORA12CR1> insert into t ( x )
  2  select to_number(rpad('9',rownum*2,'9'))
  3  from all_objects
  4  where rownum <= 14;
14 rows created.
```

```
EODA@ORA12CR1> update t set y = x+1;
14 rows updated.
```

Now, if we use the built-in VSIZE function that shows how much storage the column takes, we can review the size differences between the two numbers in each row:

```
EODA@ORA12CR1> set numformat 99999999999999999999999999999999
EODA@ORA12CR1> column v1 format 99
EODA@ORA12CR1> column v2 format 99
EODA@ORA12CR1> select x, y, vsize(x) v1, vsize(y) v2
  2  from t order by x;
```

X	Y	V1	V2
99	100	2	2
9999	10000	3	2
999999	1000000	4	2
99999999	100000000	5	2
9999999999	10000000000	6	2
999999999999	1000000000000	7	2
99999999999999	100000000000000	8	2
9999999999999999	10000000000000000	9	2
999999999999999999	1000000000000000000	10	2
99999999999999999999	10000000000000000000	11	2
9999999999999999999999	100000000000000000000	12	2
999999999999999999999999	1000000000000000000000	13	2
99999999999999999999999999	10000000000000000000000	14	2
9999999999999999999999999999	100000000000000000000000	15	2

```
14 rows selected.
```

We can see that as we added significant digits to X, the amount of storage required took increasingly more room. Every two significant digits added another byte of storage. But a number just one larger consistently took 2 bytes. When Oracle stores a number, it does so by storing as little as it can to represent that number. It does this by storing the significant digits, an exponent used to place the decimal place, and information regarding the sign of the number (positive or negative). So, the more *significant* digits a number contains, the more storage it consumes.

That last fact explains why it is useful to know that numbers are stored in varying width fields. When attempting to size a table (e.g., to figure out how much storage 1,000,000 rows would need in a table), you have to consider the NUMBER fields carefully. Will your numbers take 2 bytes or 20 bytes? What is the average size? This makes accurately sizing a table without representative test data very hard. You can get the worst-case size and the best-case size, but the real size will likely be some value in between.

## BINARY\_FLOAT/BINARY\_DOUBLE Type Syntax and Usage

Oracle 10g introduced two numeric types for storing data; they are not available in any release of Oracle prior to version 10g. These are the IEEE standard floating-points many programmers are used to working with. For a full description of what these number types look like and how they are implemented, I suggest reading <http://en.wikipedia.org/wiki/Floating-point>. It is interesting to note the following in the basic definition of a floating-point number in that reference (emphasis mine):

*A floating-point number is a digital representation for a number in a certain subset of the rational numbers, and is often used **to approximate** an arbitrary real number on a computer. In particular, it represents an integer or fixed-point number (the significand or, informally, the mantissa) multiplied by a base (usually 2 in computers) to some integer power (the exponent). When the base is 2, it is the binary analogue of scientific notation (in base 10).*

They are used to *approximate* numbers; they are not nearly as precise as the built-in Oracle NUMBER type described previously. Floating-point numbers are commonly used in scientific applications and are useful in many types of applications due to the fact that they allow arithmetic to be done in hardware (on the CPU, the chip) rather than in Oracle subroutines. Therefore, the arithmetic is much faster if you are doing real number-crunching in a scientific application, but you would not want to use floating-points to store financial information. For example, suppose you wanted to add together 0.3 and 0.1 as floats. You might think the answer is of course 0.4. You would be wrong (in floating point arithmetic). The answer is a little bit larger than 0.4:

```
EODA@ORA12CR1> select to_char( 0.3f + 0.1f, '0.999999999999999' ) from dual;
```

```
TO_CHAR(0.3F+0.1F
-----
0.40000000600000
```

This is not a bug, this is the way IEEE floating point numbers work. As a result, they are useful for a certain domain of problems, but definitely not for problems where dollars and cents count!

The syntax for declaring columns of this type in a table is very straightforward:

```
BINARY_FLOAT
BINARY_DOUBLE
```

That is it. There are no options to these types whatsoever.

## Non-Native Number Types

In addition to the NUMBER, BINARY\_FLOAT, and BINARY\_DOUBLE types, Oracle syntactically supports the following numeric datatypes:

- NUMERIC(*p, s*): Maps exactly to a NUMBER(*p, s*). If *p* is not specified, it defaults to 38.
- DECIMAL(*p, s*) or DEC(*p, s*): Maps exactly to a NUMBER(*p, s*). If *p* is not specified, it defaults to 38.
- INTEGER or INT: Maps exactly to the NUMBER(38) type.
- SMALLINT: Maps exactly to the NUMBER(38) type.
- FLOAT(*p*): Maps to the NUMBER type.
- DOUBLE PRECISION: Maps to the NUMBER type.
- REAL: Maps to the NUMBER type.

---

■ **Note** When I say “syntactically supports,” I mean that a CREATE statement may use these datatypes, but under the covers they are all really the NUMBER type. There are precisely three native numeric formats in Oracle 10g Release 1 and above and only one native numeric format in Oracle9i/Release 2 and earlier. The use of any other numeric datatype is always mapped to the native Oracle NUMBER type.

---

## Performance Considerations

In general, the Oracle NUMBER type is the best overall choice for most applications. However, there are performance implications associated with that type. The Oracle NUMBER type is a *software datatype*—it is implemented in the Oracle software itself. We cannot use native hardware operations to add two NUMBER types together, as it is emulated in the software. The floating-point types, however, do not have this implementation. When we add two floating-point numbers together, Oracle will use the hardware to perform the operation.

This is fairly easy to see. If we create a table that contains about 70,000 rows and place the same data in there using the NUMBER and BINARY\_FLOAT/BINARY\_DOUBLE types as follows:

```
EODA@ORA12CR1> create table t
 2 ( num_type    number,
 3   float_type  binary_float,
 4   double_type binary_double
 5 )
 6 /
```

Table created.

```
EODA@ORA12CR1> insert /*+ APPEND */ into t
 2 select rownum, rownum, rownum
 3   from all_objects
 4 /
```

72089 rows created.

```
EODA@ORA12CR1> commit;
Commit complete.
```

We then execute the same query against each type of column, using a complex mathematical function such as LN (natural log). We observe in a TKPROF report radically different CPU utilization:

```
select sum(ln(num_type)) from t
call      count      cpu      elapsed
-----
total      4          4.45      4.66
```

```
select sum(ln(float_type)) from t
call      count      cpu      elapsed
-----
total      4          0.07      0.08
```

```
select sum(ln(double_type)) from t
call      count      cpu      elapsed
-----
total      4          0.06      0.06
```

The Oracle NUMBER type used some 63 times the CPU of the floating-point types in this example. But, you have to remember that we did not receive precisely the same answer from all three queries!

```
EODA@ORA12CR1> set numformat 999999.9999999999999999
```

```
EODA@ORA12CR1> select sum(ln(num_type)) from t;
```

```
          SUM(LN(NUM_TYPE))
-----
734280.3209126472927309
```

```
EODA@ORA12CR1> select sum(ln(double_type)) from t;
```

```
          SUM(LN(DOUBLE_TYPE))
-----
734280.3209126447300000
```

The floating-point numbers were an approximation of the number, with between 6 and 13 digits of precision. The answer from the NUMBER type is much more precise than from the floats. However, when you are performing data mining or complex numerical analysis of scientific data, this loss of precision is typically acceptable, and the performance gain to be had can be dramatic.

---

■ **Note** If you are interested in the gory details of floating-point arithmetic and the subsequent loss of precision, see [http://docs.sun.com/source/806-3568/ncg\\_goldberg.html](http://docs.sun.com/source/806-3568/ncg_goldberg.html).

---

It should be noted that in this case we can sort of have our cake and eat it, too. Using the built-in CAST function, we can perform an on-the-fly conversion of the Oracle NUMBER type to a floating-point type, prior to performing the complex math on it. This results in a CPU usage that is much nearer to that of the native floating-point types:

```
select sum(ln(cast( num_type as binary_double ) )) from t
```

call	count	cpu	elapsed
-----	-----	-----	-----
total	4	0.08	0.08

This implies that we may store our data very precisely, and when the need for raw speed arises, and the floating-point types significantly outperform the Oracle NUMBER type, we can use the CAST function to accomplish that goal.

## Long Types

LONG types come in two flavors in Oracle:

- A LONG text type capable of storing 2GB of text. The text stored in the LONG type is subject to character set conversion, much like a VARCHAR2 or CHAR type.
- A LONG RAW type capable of storing 2GB of raw binary data (data that is not subject to character set conversion).

The LONG types date back to version 6 of Oracle, when they were limited to 64KB of data. In version 7, they were enhanced to support up to 2GB of storage, but by the time version 8 was released, they were superseded by the LOB types, which we will discuss shortly.

Rather than explain how to use the LONG type, I will explain why you do not want to use the LONG (or LONG RAW) type in your applications. First and foremost, the Oracle documentation is very clear in its treatment of the LONG types. The *Oracle Database SQL Language Reference* manual states the following:

*Do not create a table with LONG columns. Use LOB columns (CLOB, NLOB, BLOB) instead. LONG columns are supported only for backward compatibility.*

## Restrictions on LONG and LONG RAW Types

The LONG and LONG RAW types are subject to the restrictions outlined in Table 12-2. Even though it might be considered jumping ahead, I've added a column to say whether the corresponding LOB type, which is the replacement for the LONG/LONG RAW types, is subject to the same restriction.



**Table 12-2.** Long Types Compared to LOBs

LONG/LONG RAW Type	CLOB/BLOB Type
You may have only one LONG or LONG RAW column per table.	You may have up to 1,000 columns of CLOB or BLOB type per table.
User-defined types may not be defined with attributes of type LONG/LONG RAW.	User-defined types may fully use CLOB and BLOB types.
LONG types may not be referenced in the WHERE clause.	LOBs may be referenced in the WHERE clause, and a host of functions is supplied in the DBMS_LOB package to manipulate them.
LONG types do not support distributed transactions.	LOBs do support distributed transactions.
LONG types cannot be replicated using basic or advanced replication.	LOBs fully support replication.
LONG columns cannot be in a GROUP BY, ORDER BY, or CONNECT BY, or in a query that uses DISTINCT, UNIQUE, INTERSECT, MINUS, or UNION.	LOBs may appear in these clauses provided a function is applied to the LOB that converts it into a scalar SQL type (contains an atomic value) such as a VARCHAR2, NUMBER, or DATE.
PL/SQL functions/procedures cannot accept an input of type LONG.	PL/SQL works fully with LOB types.
SQL built-in functions cannot be used against LONG columns (e.g., SUBSTR).	SQL functions may be used against LOB types.
You cannot use a LONG type in a CREATE TABLE AS SELECT statement.	LOBs support CREATE TABLE AS SELECT.
You cannot use ALTER TABLE MOVE on a table containing LONG types.	You may move tables containing LOBs.

As you can see, Table 12-2 presents quite a long list; there are many things you just cannot do when you have a LONG column in the table. For all new applications, do not even consider using the LONG type. Instead, use the appropriate LOB type. For existing applications, you should seriously consider converting the LONG type to the corresponding LOB type if you are hitting any of the restrictions in Table 12-2. Care has been taken to provide backward compatibility so that an application written for LONG types will work against the LOB type transparently.

---

■ **Note** It almost goes without saying that you should perform a full functionality test against your application(s) before modifying your production system from LONG to LOB types.

---

## Coping with Legacy LONG Types

A question that arises frequently is, “What about the data dictionary in Oracle?” It is littered with LONG columns, and this makes using the dictionary columns problematic. For example, it is not possible using SQL to search the ALL\_VIEWS dictionary view to find all views that contain the text HELLO:

```
EODA@ORA12CR1> select *
  2  from all_views
  3  where text like '%HELLO%';
where text like '%HELLO%'
      *
ERROR at line 3:
ORA-00932: inconsistent datatypes: expected CHAR got LONG
```

This issue is not limited to the ALL\_VIEWS view; many views are affected:

```
EODA@ORA12CR1> select table_name, column_name
 2  from dba_tab_columns
 3  where data_type in ( 'LONG', 'LONG RAW' )
 4  and owner = 'SYS'
 5  and table_name like 'DBA%'
 6  order by table_name;
```

TABLE_NAME	COLUMN_NAME
DBA_ADVISOR_SQLPLANS	OTHER
DBA_ARGUMENTS	DEFAULT_VALUE
DBA_CLUSTER_HASH_EXPRESSIONS	HASH_EXPRESSION
DBA_CONSTRAINTS	SEARCH_CONDITION
DBA_IND_EXPRESSIONS	COLUMN_EXPRESSION
DBA_IND_PARTITIONS	HIGH_VALUE
DBA_IND_SUBPARTITIONS	HIGH_VALUE
DBA_MVIEWS	QUERY
DBA_MVIEW_AGGREGATES	MEASURE
DBA_MVIEW_ANALYSIS	QUERY
DBA_NESTED_TABLE_COLS	DATA_DEFAULT
DBA_OUTLINES	SQL_TEXT
DBA_REGISTERED_MVIEWS	QUERY_TXT
DBA_REGISTERED_SNAPSHOTS	QUERY_TXT
DBA_SNAPSHOTS	QUERY
DBA_SQLSET_PLANS	OTHER
DBA_SQLTUNE_PLANS	OTHER
DBA_SUBPARTITION_TEMPLATES	HIGH_BOUND
DBA_SUMMARIES	QUERY
DBA_SUMMARY_AGGREGATES	MEASURE
DBA_TAB_COLS	DATA_DEFAULT
DBA_TAB_COLS_V\$	DATA_DEFAULT
DBA_TAB_COLUMNS	DATA_DEFAULT
DBA_TAB_PARTITIONS	HIGH_VALUE
DBA_TAB_SUBPARTITIONS	HIGH_VALUE
DBA_TRIGGERS	TRIGGER_BODY
DBA_VIEWS	TEXT
DBA_VIEWS_AE	TEXT
DBA_ZONEMAPS	QUERY
DBA_ZONEMAP_MEASURES	MEASURE

30 rows selected.

So, what is the solution? If you want to make use of these columns in SQL, then you'll need to convert them to a SQL-friendly type. You can use a user-defined function for doing so. The following example demonstrates how to accomplish this using a LONG SUBSTR function that will allow you to effectively convert any 4,000 bytes of a LONG type into a VARCHAR2 for use with SQL. When you are done, you'll be able to query:

```
EODA@ORA12CR1> select *
 2   from (
 3   select owner, view_name,
 4         long_help.substr_of( 'select text
 5                               from dba_views
 6                               where owner = :owner
 7                               and view_name = :view_name',
 8                               1, 4000,
 9                               'owner', owner,
10                              'view_name', view_name ) substr_of_view_text
11   from dba_views
12   where owner = user
13   )
14   where upper(substr_of_view_text) like '%INNER%'
15 /
```

You've converted the first 4,000 bytes of the TEXT column from LONG to VARCHAR2 and can now use a predicate on it. Using the same technique, you could implement your own INSTR, LIKE, and so forth for LONG types as well. In this book, I'll only demonstrate how to get the substring of a LONG type.

The package we will implement has the following specification:

```
EODA@ORA12CR1> create or replace package long_help
 2  authid current_user
 3  as
 4    function substr_of
 5    ( p_query in varchar2,
 6      p_from in number,
 7      p_for in number,
 8      p_name1 in varchar2 default NULL,
 9      p_bind1 in varchar2 default NULL,
10     p_name2 in varchar2 default NULL,
11     p_bind2 in varchar2 default NULL,
12     p_name3 in varchar2 default NULL,
13     p_bind3 in varchar2 default NULL,
14     p_name4 in varchar2 default NULL,
15     p_bind4 in varchar2 default NULL )
16     return varchar2;
17 end;
18 /
```

Package created.

Note that on line 2, we specify AUTHID CURRENT\_USER. This makes the package run as the invoker, with all roles and grants in place. This is important for two reasons. First, we'd like the database security to not be subverted—this package will only return substrings of columns we (the invoker) are allowed to see. Specifically, that means this package is not vulnerable to SQL injection attacks—it is not running as the owner of the package but as the invoker. Second, we'd like to install this package once in the database and have its functionality available for all to use; using

invoker rights allows us to do that. If we used the default security model of PL/SQL—definer rights—the package would run with the privileges of the owner of the package, meaning it would only be able to see data the owner of the package could see, which may not include the set of data the invoker is allowed to see.

The concept behind the function `SUBSTR_OF` is to take a query that selects at most one row and one column: the `LONG` value we are interested in. `SUBSTR_OF` will parse that query if needed, bind any inputs to it, and fetch the results programmatically, returning the necessary piece of the `LONG` value.

The package body, the implementation, begins with two global variables. The `G_CURSOR` variable holds a persistent cursor open for the duration of our session. This is to avoid having to repeatedly open and close the cursor and to avoid parsing SQL more than we need to. The second global variable, `G_QUERY`, is used to remember the text of the last SQL query we've parsed in this package. As long as the query remains constant, we'll just parse it once. So, even if we query 5,000 rows in a query, as long as the SQL query we pass to this function doesn't change, we'll have only one parse call:

```
EODA@ORA12CR1> create or replace package body long_help
 2 as
 3
 4     g_cursor number := dbms_sql.open_cursor;
 5     g_query  varchar2(32765);
 6
```

Next in this package is a private procedure, `BIND_VARIABLE`, which we'll use to bind inputs passed to us by the caller. We implemented this as a separate private procedure only to make life easier; we want to bind only when the input name is `NOT NULL`. Rather than perform that check four times in the code for each input parameter, we do it once in this procedure:

```
 7 procedure bind_variable( p_name in varchar2, p_value in varchar2 )
 8 is
 9 begin
10     if ( p_name is not null )
11     then
12         dbms_sql.bind_variable( g_cursor, p_name, p_value );
13     end if;
14 end;
15
```

Next is the actual implementation of `SUBSTR_OF` in the package body. This routine begins with a function declaration from the package specification and the declaration for some local variables. `L_BUFFER` will be used to return the value, and `L_BUFFER_LEN` will be used to hold the length returned by an Oracle-supplied function:

```
16
17 function substr_of
18 ( p_query in varchar2,
19   p_from  in number,
20   p_for   in number,
21   p_name1 in varchar2 default NULL,
22   p_bind1 in varchar2 default NULL,
23   p_name2 in varchar2 default NULL,
24   p_bind2 in varchar2 default NULL,
25   p_name3 in varchar2 default NULL,
26   p_bind3 in varchar2 default NULL,
27   p_name4 in varchar2 default NULL,
28   p_bind4 in varchar2 default NULL )
```

```

29 return varchar2
30 as
31     l_buffer      varchar2(4000);
32     l_buffer_len  number;
33 begin

```

Now, the first thing our code does is a sanity check on the P\_FROM and P\_FOR inputs. P\_FROM must be a number greater than or equal to 1, and P\_FOR must be between 1 and 4,000—just like the built-in function SUBSTR:

```

34     if ( nvl(p_from,0) <= 0 )
35     then
36         raise_application_error
37         (-20002, 'From must be >=1 (positive numbers)' );
38     end if;
39     if ( nvl(p_for,0) not between 1 and 4000 )
40     then
41         raise_application_error
42         (-20003, 'For must be between 1 and 4000' );
43     end if;
44

```

Next, we'll check to see if we are getting a new query that needs to be parsed. If the last query we parsed is the same as the current query, we can skip this step. It is very important to note that on line 47 we are verifying that the P\_QUERY passed to us is just a SELECT—we will use this package *only* to execute SQL SELECT statements. This check validates that for us:

```

45     if ( p_query <> g_query or g_query is NULL )
46     then
47         if ( upper(trim(nvl(p_query,'x'))) not like 'SELECT%' )
48         then
49             raise_application_error
50             (-20001, 'This must be a select only' );
51         end if;
52         dbms_sql.parse( g_cursor, p_query, dbms_sql.native );
53         g_query := p_query;
54     end if;

```

We are ready to bind the inputs to this query. Any non-NULL names that were passed to us will be bound to the query, so when we execute it, it finds the right row:

```

55     bind_variable( p_name1, p_bind1 );
56     bind_variable( p_name2, p_bind2 );
57     bind_variable( p_name3, p_bind3 );
58     bind_variable( p_name4, p_bind4 );
59

```

And now we can execute the query and fetch the row. Using DBMS\_SQL.COLUMN\_VALUE\_LONG, we extract the necessary substring of the LONG and return it:

```

60     dbms_sql.define_column_long(g_cursor, 1);
61     if (dbms_sql.execute_and_fetch(g_cursor)>0)
62     then

```

```

63         dbms_sql.column_value_long
64         (g_cursor, 1, p_for, p_from-1,
65         l_buffer, l_buffer_len );
66     end if;
67     return l_buffer;
68 end substr_of;
69
70 end;
71 /
Package body created.

```

That's it—you should be able to use that package against *any* legacy LONG column in your database, allowing you to perform many WHERE clause operations that were not possible before. For example, you can now find all partitions in your schema such that the HIGH\_VALUE has the year 2014 in it (please remember that if you do not have any tables with 2014 in the partition high value, you would not expect to see anything returned):

```

EODA@ORA12CR1> select *
2   from (
3   select table_owner, table_name, partition_name,
4         long_help.substr_of
5         ( 'select high_value
6           from all_tab_partitions
7           where table_owner = :o
8             and table_name = :n
9             and partition_name = :p',
10        1, 4000,
11        'o', table_owner,
12        'n', table_name,
13        'p', partition_name ) high_value
14   from all_tab_partitions
15   where table_owner = user
16         )
17   where high_value like '%2014%'
18 /

```

TABLE_OWNER	TABLE_NAME	PARTITION_NAME	HIGH_VALUE
EODA	F_CONFIGS	CONFIG_P_7	20140101

Using this same technique—that of processing the result of a query that returns a single row with a single LONG column in a function—you can implement your own INSTR, LIKE, and so on as needed.

This implementation works well on the LONG type, but will not work on LONG RAW types. LONG RAWs are not piecewise accessible (there is no COLUMN\_VALUE\_LONG\_RAW function in DBMS\_SQL). Fortunately, this is not too serious of a restriction since LONG RAWs are not used in the dictionary and the need to “substring” so you can search on it is rare. If you do have a need to do so, however, you will not use PL/SQL unless the LONG RAW is 32KB or less, as there is simply no method for dealing with LONG RAWs over 32KB in PL/SQL itself. Java, C, C++, Visual Basic, or some other language would have to be used.

Another approach is to temporarily convert the LONG or LONG RAW into a CLOB or BLOB using the TO\_LOB built-in function and a global temporary table. Your PL/SQL procedure could be as follows:

```
Insert into global_temp_table ( blob_column )
select to_lob(long_raw_column) from t where...
```

This would work well in an application that occasionally needs to work with a single LONG RAW value. You would not want to continuously do that, however, due to the amount of work involved. If you find yourself needing to resort to this technique frequently, you should definitely convert the LONG RAW to a BLOB once and be done with it.

## Dates, Timestamps, and Interval Types

The native Oracle datatypes of DATE, TIMESTAMP, and INTERVAL are closely related. The DATE and TIMESTAMP types store fixed date/times with varying degrees of precision. The INTERVAL type is used to store an amount of time, such as “8 hours” or “30 days,” easily. The result of subtracting two timestamps might be an interval, the result of adding an interval of 8 hours to a TIMESTAMP results in a new TIMESTAMP that is 8 hours later.

The DATE datatype has been part of Oracle for many releases—as far back as my experience with Oracle goes, which means at least back to version 5 and probably before. The TIMESTAMP and INTERVAL types are relative newcomers to the scene by comparison, as they were introduced with Oracle9i Release 1. For this simple reason, you will find the DATE datatype to be the most prevalent type for storing date/time information. But many new applications are using the TIMESTAMP type for two reasons: it has support for fractions of seconds (the DATE type does not) and it has support for time zones (something the DATE type also does not have).

We'll take a look at each type after discussing DATE/TIMESTAMP formats and their uses.

### Formats

I am not going to attempt to cover all of the DATE, TIMESTAMP, and INTERVAL formats here. This is well covered in the *Oracle Database SQL Language Reference* manual, which is freely available to all. A wealth of formats is available to you, and a good understanding of what they are is vital. I strongly recommended that you investigate them.

I'd like to discuss what the formats do here, as there are a great many misconceptions surrounding this topic. The formats are used for two things:

- To format the data on the way out of the database in a style that pleases you
- To tell the database how to convert an input string into a DATE, TIMESTAMP, or INTERVAL

And that is all. The common misconception I've observed over the years is that the format used somehow affects what is stored on disk and how the data is actually saved. *The format has no effect at all on how the data is stored. The format is only used to convert the single binary format used to store a DATE into a string or to convert a string into the single binary format that is used to store a DATE.* The same is true for TIMESTAMPS and INTERVALS.

My advice on formats is simply this: use them. Use them when you send a string to the database that represents a DATE, TIMESTAMP, or INTERVAL. Do *not* rely on default date formats—defaults can and probably will at some point in the future be changed by someone.

---

■ **Note** Refer back to Chapter 1 for a really good security reason to never use TO\_CHAR/TO\_DATE without an explicit format. In that chapter, I described a SQL injection attack that was available to an end user simply because the developer forgot to use an explicit format. Additionally, performing date operations without using an explicit date format can and will lead to incorrect answers. In order to appreciate this, just tell me what date this string represents: '01-02-03'. Whatever you say it represents, I'll tell you that you are wrong. Never rely on defaults!

---

If you rely on a default date format and it changes, your application may be negatively affected. It might raise an error back to the end user if the date cannot be converted, have a serious security flaw or, as bad, it might silently insert *the wrong data*. Consider the follow INSERT statement, which relies on a default date mask:

```
Insert into t ( date_column ) values ( '01/02/03' );
```

Suppose the application was relying on a default date mask of DD/MM/YY to be in place. That would be February 1, 2003 (assuming that code was executed after the year 2000, but we'll visit the implications of that in a moment). Now, say someone decides the correct date format should be MM/DD/YY. All of a sudden, that previous date changes to January 2, 2003. Or someone decides YY/MM/DD is right, and now you have February 3, 2001. In short, without a date format to accompany that date string, there are many ways to interpret it. That INSERT statement should be:

```
Insert into t ( date_column ) values ( to_date( '01/02/03', 'DD/MM/YY' ) );
```

And if you want my opinion, it has to be:

```
Insert into t ( date_column ) values ( to_date( '01/02/2003', 'DD/MM/YYYY' ) );
```

That is, it must use a four-character year. Several years ago, our industry learned the hard way how much time and effort was spent remedying software that attempted to “save” 2 bytes. We seem to have lost that lesson over time. There is no excuse nowadays *not* to use a four-character year! Just because the year 2000 has come and gone does not mean you can now use a 2 character year. Think about birth dates, for example. If you enter a birth date using

```
Insert into t ( DOB ) values ( to_date( '01/02/10', 'DD/MM/YY' ) );
```

is that Feb 1st, 2010 or Feb 1st, 1910? Either one is a valid value; you cannot just pick one to be correct.

This same discussion applies to data leaving the database. If you execute SELECT DATE\_COLUMN FROM T and fetch that column into a string in your application, then you should apply an explicit date format to it. Whatever format your application is expecting should be explicitly applied there. Otherwise, at some point in the future when someone changes the default date format, your application may break or behave incorrectly.

Next, let's look at the datatypes themselves in more detail.

## DATE Type

The DATE type is a fixed-width 7-byte date/time datatype. It will always contain the seven attributes of the century, the year within the century, the month, the day of the month, the hour, the minute, and the second. Oracle uses an internal format to represent that information, so it is not really storing 20, 05, 06, 25, 12, 01, 00 for June 25, 2005, at 12:01:00. Using the built-in DUMP function, we can see what Oracle really stores:

```
EODA@ORA12CR1> create table t ( x date );
Table created.

EODA@ORA12CR1> insert into t (x) values
  2 ( to_date( '25-jun-2005 12:01:00',
  3          'dd-mon-yyyy hh24:mi:ss' ) );
1 row created.

EODA@ORA12CR1> select x, dump(x,10) d from t;

X          D
-----
25-JUN-05 Typ=12 Len=7: 120,105,6,25,13,2,1
```



The century and year bytes (the 120,105 in the DUMP output) are stored in an excess-100 notation. You would have to subtract 100 from them to determine the correct century and year. The reason for the excess-100 notation is support of BC and AD dates. If you subtract 100 from the century byte and get a negative number, it is a BC date. For example:

```
EODA@ORA12CR1> insert into t (x) values
  2 ( to_date( '01-jan-4712bc',
  3         'dd-mon-yyyybc hh24:mi:ss' ) );
1 row created.
```

```
EODA@ORA12CR1> select x, dump(x,10) d from t;
```

```
X          D
-----
25-JUN-05 Typ=12 Len=7: 120,105,6,25,13,2,1
01-JAN-12 Typ=12 Len=7: 53,88,1,1,1,1,1
```

So, when we insert 01-JAN-4712BC, the century byte is 53 and  $53 - 100 = -47$ , the century we inserted. Because it is negative, we know that it is a BC date. This storage format also allows the dates to be naturally sortable in a binary sense. Since 4712 BC is *less than* 4710 BC, we'd like a binary representation that supports that. By dumping those two dates, we can see that 01-JAN-4710BC is *larger* than the same day in 4712 BC, so they will sort and compare nicely:

```
EODA@ORA12CR1> insert into t (x) values
  2 ( to_date( '01-jan-4710bc',
  3         'dd-mon-yyyybc hh24:mi:ss' ) );
1 row created.
```

```
EODA@ORA12CR1> select x, dump(x,10) d from t;
```

```
X          D
-----
25-JUN-05 Typ=12 Len=7: 120,105,6,25,13,2,1
01-JAN-12 Typ=12 Len=7: 53,88,1,1,1,1,1
01-JAN-10 Typ=12 Len=7: 53,90,1,1,1,1,1
```

The month and day bytes, the next two fields, are stored naturally, without any modification. So, June 25 used a month byte of 6 and a day byte of 25. The hour, minute, and second fields are stored in excess-1 notation, meaning we must subtract 1 from each component to see what time it really was. Hence midnight is represented as 1,1,1 in the date field.

This 7-byte format is naturally sortable, as you have seen—it is a 7 byte field that can be sorted in a binary fashion from small to larger (or vice versa) very efficiently. Additionally, its structure allows for easy truncation, without converting the date into some other format. For example, truncating the date we just stored (25-JUN-2005 12:01:00) to the day (remove the hours, minutes, seconds) is very straightforward. Just set the trailing three bytes to 1,1,1 and the time component is as good as erased. Consider a fresh table, T, with the following inserts:

```
EODA@ORA12CR1> create table t ( what varchar2(10), x date );
Table created.
```

```
EODA@ORA12CR1> insert into t (what, x) values
  2 ( 'orig',
  3   to_date( '25-jun-2005 12:01:00',
  4         'dd-mon-yyyy hh24:mi:ss' ) );
1 row created.
```

```
EODA@ORA12CR1> insert into t (what, x)
 2 select 'minute', trunc(x,'mi') from t
 3 union all
 4 select 'day', trunc(x,'dd') from t
 5 union all
 6 select 'month', trunc(x,'mm') from t
 7 union all
 8 select 'year', trunc(x,'y') from t
 9 /
4 rows created.
```

```
EODA@ORA12CR1> select what, x, dump(x,10) d from t;
```

WHAT	X	D
orig	25-JUN-05	Typ=12 Len=7: 120,105,6,25,13,2,1
minute	25-JUN-05	Typ=12 Len=7: 120,105,6,25,13,2,1
day	25-JUN-05	Typ=12 Len=7: 120,105,6,25,1,1,1
month	01-JUN-05	Typ=12 Len=7: 120,105,6,1,1,1,1
year	01-JAN-05	Typ=12 Len=7: 120,105,1,1,1,1,1

To truncate that date down to the year, all the database had to do was put 1s in the last 5 bytes—a very fast operation. We now have a sortable, comparable DATE field that is truncated to the year level, and we got it as efficiently as possible.

## Adding or Subtracting Time from a DATE

A question I am frequently asked is, “How do I add time to or subtract time from a DATE type?” For example, how do you add one day to a DATE, or eight hours, or one year, or one month, and so on. There are three techniques you’ll commonly use:

- Simply add a NUMBER to the DATE. Adding 1 to a DATE is a method to add 1 day. Adding 1/24 to a DATE therefore adds 1 hour, and so on.
- You may use the INTERVAL type, as described shortly, to add units of time. INTERVAL types support two levels of granularity: years and months, or days/hours/minutes/seconds. That is, you may have an interval of so many years and months *or* an interval of so many days, hours, minutes and seconds.
- Add months using the built-in ADD\_MONTHS function. Since adding a month is generally not as simple as adding 28 to 31 days, a special purpose function was implemented to facilitate this.

Table 12-3 demonstrates the techniques you would use to add (or subtract, of course) N units of time to a date.

**Table 12-3.** Adding Time to a Date

Unit of Time	Operation	Description
N seconds	DATE + n/24/60/60 DATE + n/86400 DATE + NUMTODSINTERVAL(n, 'second')	There are 86,400 seconds in a day. Since adding 1 adds one day, adding 1/86400 adds one second to a date. I prefer the n/24/60/60 technique over the 1/86400 technique. They are equivalent. An even more readable method is to use the NUMTODSINTERVAL (number to day/second interval) to add N seconds.
N minutes	DATE + n/24/60 DATE + n/1440 DATE + NUMTODSINTERVAL(n, 'minute')	There are 1,440 minutes in a day. Adding 1/1440 therefore adds one minute to a DATE. An even more readable method is to use the NUMTODSINTERVAL function.
N hours	DATE + n/24 DATE + NUMTODSINTERVAL(n, 'hour')	There are 24 hours in a day. Adding 1/24 therefore adds one hour to a DATE. An even more readable method is to use the NUMTODSINTERVAL function.
N days	DATE + n	Simply add N to the DATE to add or subtract N days.
N weeks	DATE + 7*n	A week is seven days, so just multiply 7 by the number of weeks to add or subtract.
N months	ADD_MONTHS (DATE, n) DATE + NUMTOYMINTERVAL(n, 'month')	You may use the ADD_MONTHS built-in function or add an interval of N months to the DATE. Please see the important caveat noted shortly regarding using month intervals with DATES.
N years	ADD_MONTHS (DATE, 12*n) DATE + NUMTOYMINTERVAL(n, 'year')	You may use the ADD_MONTHS built-in function with 12*n to add or subtract N years. Similar goals may be achieved with a year interval, but please see the important caveat noted shortly regarding using year intervals with dates.

In general, when using the Oracle DATE type, I recommend the following:

- Use the NUMTODSINTERVAL built-in function to add hours, minutes, and seconds.
- Add a simple number to add days.
- Use the ADD\_MONTHS built-in function to add months and years.

I do not recommend using the NUMTOYMINTERVAL function (to add months and years). The reason has to do with how the functions behave at the months' end.

The ADD\_MONTHS function treats the end of month days specially. It will, in effect, round the dates for us—if we add one month to a month that has 31 days and the next month has fewer than 31 days, ADD\_MONTHS will return the last day of the next month. Additionally, adding one month to the last day of a month results in the last day of the next month. We see this when adding one month to a month with 30 or fewer days:

```
EODA@ORA12CR1> alter session set nls_date_format = 'dd-mon-yyyy hh24:mi:ss';
Session altered.
```

```
EODA@ORA12CR1> select dt, add_months(dt,1)
 2   from (select to_date('29-feb-2000','dd-mon-yyyy') dt from dual )
 3 /
```

```
DT                ADD_MONTHS(DT,1)
-----
29-feb-2000 00:00:00 31-mar-2000 00:00:00
```

```
EODA@ORA12CR1> select dt, add_months(dt,1)
  2   from (select to_date('28-feb-2001','dd-mon-yyyy') dt from dual )
  3 /
```

```
DT                ADD_MONTHS(DT,1)
-----
28-feb-2001 00:00:00 31-mar-2001 00:00:00
```

```
EODA@ORA12CR1> select dt, add_months(dt,1)
  2   from (select to_date('30-jan-2001','dd-mon-yyyy') dt from dual )
  3 /
```

```
DT                ADD_MONTHS(DT,1)
-----
30-jan-2001 00:00:00 28-feb-2001 00:00:00
```

```
EODA@ORA12CR1> select dt, add_months(dt,1)
  2   from (select to_date('30-jan-2000','dd-mon-yyyy') dt from dual )
  3 /
```

```
DT                ADD_MONTHS(DT,1)
-----
30-jan-2000 00:00:00 29-feb-2000 00:00:00
```

See how the result of adding one month to February 29, 2000, results in March 31, 2000? February 29 was the last day of that month so `ADD_MONTHS` returned the last day of the next month. Additionally, notice how adding one month to January 30, 2000 and 2001 results in the last day of February 2000 and 2001, respectively.

If we compare this to how adding an interval would work, we see very different results:

```
EODA@ORA12CR1> select dt, dt+numtoyminterval(1,'month')
  2   from (select to_date('29-feb-2000','dd-mon-yyyy') dt from dual )
  3 /
```

```
DT                DT+NUMTOYMINTERVAL(1
-----
29-feb-2000 00:00:00 29-mar-2000 00:00:00
```

```
EODA@ORA12CR1> select dt, dt+numtoyminterval(1,'month')
  2   from (select to_date('28-feb-2001','dd-mon-yyyy') dt from dual )
  3 /
```

```
DT                DT+NUMTOYMINTERVAL(1
-----
28-feb-2001 00:00:00 28-mar-2001 00:00:00
```

Notice how the resulting date is not the last day of the next month, but rather the *same* day of the next month. It is arguable that this behavior is acceptable, but consider what happens when the resulting month doesn't have that many days:

```
EODA@ORA12CR1> select dt, dt+numtoyminterval(1,'month')
  2   from (select to_date('30-jan-2001','dd-mon-yyyy') dt from dual )
  3 /
select dt, dt+numtoyminterval(1,'month')
      *
```

```
ERROR at line 1:
ORA-01839: date not valid for month specified
```

```
EODA@ORA12CR1> select dt, dt+numtoyminterval(1,'month')
 2   from (select to_date('30-jan-2000','dd-mon-yyyy') dt from dual )
 3 /
select dt, dt+numtoyminterval(1,'month')
      *
```

```
ERROR at line 1:
ORA-01839: date not valid for month specified
```

In my experience, this makes using a month interval in date arithmetic impossible in general. A similar issue arises with a year interval: adding one year to February 29, 2000, results in a runtime error because there is no February 29, 2001.

## Getting the Difference Between Two DATES

Another frequently asked question is, “How do I retrieve the difference between two dates?” The answer is deceptively simple: you just subtract them. This will return a number representing the number of days between the two dates. Additionally, you have the built-in function `MONTHS_BETWEEN` that will return a number representing the number of months—including fractional months—between two dates. Lastly, with the `INTERVAL` datatypes, you have yet another method to see the elapsed time between two dates. The following SQL query demonstrates the outcome of subtracting two dates (showing the number of days between them), using the `MONTHS_BETWEEN` function and then the two functions used with `INTERVAL` types:

```
EODA@ORA12CR1> select dt2-dt1 ,
 2         months_between(dt2,dt1) months_btwn,
 3         numtodsinterval(dt2-dt1,'day') days,
 4         numtoyminterval(trunc(months_between(dt2,dt1)),'month') months
 5   from (select to_date('29-feb-2000 01:02:03','dd-mon-yyyy hh24:mi:ss') dt1,
 6             to_date('15-mar-2001 11:22:33','dd-mon-yyyy hh24:mi:ss') dt2
 7            from dual )
 8 /
```

DT2-DT1	MONTHS_BTWN	DAYS	MONTHS
380.430903	12.5622872	+000000380 10:20:30.000000000	+000000001-00

Those are all correct values, but not of great use to us yet. Most applications would like to display the years, months, days, hours, minutes, and seconds between the dates. Using a combination of the preceding functions, we can achieve that goal. We'll select out two intervals: one for the years and months, and the other for just the day, hours, and so on. We'll use the `MONTHS_BETWEEN` built-in function to determine the decimal number of months between the two dates, and then we'll use the `NUMTOYMINTERVAL` built-in function to convert that number into the years and months. Additionally, we'll use `MONTHS_BETWEEN` to subtract the integer number of months between the two dates from the larger of the two dates to get down to the days and hours between them:

```
EODA@ORA12CR1> select numtoyminterval
 2         (trunc(months_between(dt2,dt1)),'month')
 3         years_months,
 4         numtodsinterval
 5         (dt2-add_months( dt1, trunc(months_between(dt2,dt1)) ),
```

```

6          'day' )
7          days_hours
8  from (select to_date('29-feb-2000 01:02:03', 'dd-mon-yyyy hh24:mi:ss') dt1,
9          to_date('15-mar-2001 11:22:33', 'dd-mon-yyyy hh24:mi:ss') dt2
10         from dual )
11 /

```

```

YEARS_MONTHS    DAYS_HOURS
-----
+0000000001-00  +0000000015 10:20:30.000000000

```

Now it is clear that there is 1 year, 15 days, 10 hours, 20 minutes, and 30 seconds between the two DATES.

## TIMESTAMP Type

The **TIMESTAMP** type is very much like the **DATE**, with the addition of support for fractional seconds and time zones. We'll look at the **TIMESTAMP** type in the following three sections: one with regard to just the fractional second support but no time zone support, and the other two with regard to the two methods of storing the **TIMESTAMP** with time zone support.

## TIMESTAMP

The syntax of the basic **TIMESTAMP** datatype is straightforward

```
TIMESTAMP(n)
```

where *N* is optional; it is used to specify the scale of the seconds component in the timestamp and may take on values between 0 and 9. If you specify 0, then a **TIMESTAMP** is functionally equivalent to a **DATE** and, in fact, stores the same values in the same manner:

```

EODA@ORA12CR1> create table t
2  ( dt  date,
3    ts  timestamp(0)
4  )
5  /
Table created.

```

```

EODA@ORA12CR1> insert into t values ( sysdate, systimestamp );
1 row created.

```

```

EODA@ORA12CR1> select dump(dt,10) dump, dump(ts,10) dump from t;

```

```

DUMP          DUMP
-----
Typ=12 Len=7: 120,110,4,12,20,4,8  Typ=180 Len=7: 120,110,4,12,20,4,8

```

The datatypes are different (the `Typ=field` indicates that), but the manner in which they store data is identical. The `TIMESTAMP` datatype will differ in length from the `DATE` type when you specify some number of fractional seconds to preserve, for example:

```
EODA@ORA12CR1> create table t
  2 ( dt date,
  3   ts timestamp(9)
  4 )
  5 /
Table created.
```

```
EODA@ORA12CR1> insert into t values ( sysdate, systimestamp );
1 row created.
```

```
EODA@ORA12CR1> select dump(dt,10) dump, dump(ts,10) dump
  2   from t;
```

```
DUMP                                DUMP
-----
Typ=12 Len=7: 120,114,1,2,8,20,1   Typ=180 Len=11: 120,114,1,2,8,20,1,
                                         53,55,172,40
```

Now the `TIMESTAMP` consumes 11 bytes of storage, and the extra 4 bytes at the end contain the fractional seconds, which we can see by looking at the time that was stored:

```
EODA@ORA12CR1> alter session set nls_date_format = 'dd-mon-yyyy hh24:mi:ss';
Session altered.
```

```
EODA@ORA12CR1> select * from t;
```

```
DT                TS
-----
02-jan-2014 07:19:00 02-JAN-14 07.19.00.892841000 AM
```

```
EODA@ORA12CR1> select dump(ts,16) dump from t;
```

```
DUMP
-----
Typ=180 Len=11: 78,72,1,2,8,14,1,35,37,ac,28
```

```
EODA@ORA12CR1> select to_number('3537ac28', 'xxxxxxx' ) from dual;
```

```
TO_NUMBER('3537AC28','XXXXXXX')
-----
                        892841000
```

We can see the fractional seconds that were stored are there in the last 4 bytes. We used the `DUMP` function to inspect the data in HEX this time (base 16) so we could easily convert the 4 bytes into the decimal representation.

## Adding or Subtracting Time to/from a TIMESTAMP

The same techniques we applied to DATE for date arithmetic works with a TIMESTAMP, but *the TIMESTAMP will be converted into a DATE in many cases using the preceding techniques*. For example:

```
EODA@ORA12CR1> alter session set nls_date_format = 'dd-mon-yyyy hh24:mi:ss';
Session altered.
```

```
EODA@ORA12CR1> select systimestamp ts, systimestamp+1 dt
2 from dual;
```

TS	DT
-----	
02-JAN-14 07.30.37.627678 AM -07:00	03-jan-2014 07:30:37

Note that adding 1 did, in fact, advance the SYSTIMESTAMP by a day, but the fractional seconds are gone, as would be the time zone information. This is where using INTERVALs will be more important:

```
EODA@ORA12CR1> select systimestamp ts, systimestamp +numtodsinterval(1,'day') dt
2 from dual;
```

TS	DT
-----	
02-JAN-14 07.31.45.451317 AM -07:00	03-JAN-14 07.31.45.451317000 AM -07:00

Using the function that returns an INTERVAL type preserved the fidelity of the TIMESTAMP. You will need to exercise caution when using TIMESTAMPS to avoid the implicit conversions. But bear in mind the caveat about adding intervals of months or years to a TIMESTAMP if the resulting day isn't a valid date—the operation fails (adding one month to the last day in January will always fail if the month is added via an INTERVAL).

## Getting the Difference Between Two TIMESTAMPS

This is where the DATE and TIMESTAMP types diverge significantly. Whereas the results of subtracting a DATE from a DATE was a NUMBER, the result of doing the same to a TIMESTAMP is an INTERVAL:

```
EODA@ORA12CR1> select dt2-dt1
2 from (select to_timestamp('29-feb-2000 01:02:03.122000',
3 'dd-mon-yyyy hh24:mi:ss.ff') dt1,
4 to_timestamp('15-mar-2001 11:22:33.000000',
5 'dd-mon-yyyy hh24:mi:ss.ff') dt2
6 from dual )
7 /
```

DT2-DT1
-----
+000000380 10:20:29.878000000



The difference between two `TIMESTAMP` values is an `INTERVAL`, and this shows us the number of days and hours/minutes/seconds between the two. If we desire to have the years, months, and so forth, we are back to using a query similar to the one we used with dates:

```
EODA@ORA12CR1> select numtoyminterval
 2      (trunc(months_between(dt2,dt1)), 'month')
 3      years_months,
 4      dt2-add_months(dt1,trunc(months_between(dt2,dt1)))
 5      days_hours
 6  from (select to_timestamp('29-feb-2000 01:02:03.122000',
 7              'dd-mon-yyyy hh24:mi:ss.ff') dt1,
 8              to_timestamp('15-mar-2001 11:22:33.000000',
 9              'dd-mon-yyyy hh24:mi:ss.ff') dt2
10      from dual )
11 /
```

```
YEARS_MONTHS  DAYS_HOURS
-----
+0000000001-00 +000000015 10:20:30.000000000
```

Note in this case, since we used `ADD_MONTHS`, `DT1` was converted implicitly into a `DATE` type and we lost the fractional seconds. We would have to add yet more code to preserve them. We could use `NUMTOYMINTERVAL` to add the months and preserve the `TIMESTAMP`; however, we would be subject to runtime errors:

```
EODA@ORA12CR1> select numtoyminterval
 2      (trunc(months_between(dt2,dt1)), 'month')
 3      years_months,
 4      dt2-(dt1 + numtoyminterval( trunc(months_between(dt2,dt1)), 'month' ))
 5      days_hours
 6  from (select to_timestamp('29-feb-2000 01:02:03.122000',
 7              'dd-mon-yyyy hh24:mi:ss.ff') dt1,
 8              to_timestamp('15-mar-2001 11:22:33.000000',
 9              'dd-mon-yyyy hh24:mi:ss.ff') dt2
10      from dual )
11 /
      dt2-(dt1 + numtoyminterval( trunc(months_between(dt2,dt1)), 'month' ))
          *
```

```
ERROR at line 4:
ORA-01839: date not valid for month specified
```

I personally find this unacceptable. The fact is, though, that by the time you are displaying information with years and months, the fidelity of the `TIMESTAMP` is destroyed already. A year is not fixed in duration (it may be 365 or 366 days in length) and neither is a month. If you are displaying information with years and months, the loss of microseconds is not relevant; having the information displayed down to the second is more than sufficient at that point.

## TIMESTAMP WITH TIME ZONE Type

The `TIMESTAMP WITH TIME ZONE` type inherits all of the qualities of the `TIMESTAMP` type and adds time zone support. The `TIMESTAMP WITH TIME ZONE` type consumes 13 bytes of storage, with the extra two bytes being used to preserve the time zone information. It differs from a `TIMESTAMP` structurally only by the addition of these 2 bytes:

```
EODA@ORA12CR1> create table t
  2 (
  3   ts      timestamp,
  4   ts_tz  timestamp with time zone
  5 )
  6 /
```

Table created.

```
EODA@ORA12CR1> insert into t ( ts, ts_tz )
  2 values ( systimestamp, systimestamp );
  1 row created.
```

```
EODA@ORA12CR1> select * from t;
```

TS	TS_TZ
02-JAN-14 03.02.51.890565 PM	02-JAN-14 03.02.51.890565 PM -07:00

```
EODA@ORA12CR1> select dump(ts) dump, dump(ts_tz) dump from t;
```

DUMP

DUMP

```
-----
Typ=180 Len=11: 120,114,1,2,16,3,52,53,20,241,136
```

```
Typ=181 Len=13: 120,114,1,2,23,3,52,53,20,241,136,13,60
```

Upon retrieval, the default `TIMESTAMP WITH TIME ZONE` format included the time zone information (I was on U.S. Mountain Standard Time when this was executed).

`TIMESTAMP WITH TIME ZONE`s store the data in whatever time zone was specified when the data was stored. The time zone becomes part of the data itself. Note how the `TIMESTAMP WITH TIME ZONE` field stored `...23,3,52...` for the hour, minutes, and seconds (in excess-1 notation, so that is 22:02:51), whereas the `TIMESTAMP` field stored simply `...16,3,52...`, which is 15:02:51—the exact time in the string we inserted. The `TIMESTAMP WITH TIME ZONE` had seven hours added to it, in order to store in GMT (also known as UTC) time. The trailing 2 bytes are used upon retrieval to properly adjust the `TIMESTAMP` value.

It is not my intention to cover all of the nuances of time zones here in this book; that is a topic well covered elsewhere. To that end, I'll just point out that there is support for time zones in this datatype. This support is more relevant in applications today than ever before. In the distant past, applications were not nearly as global as they are now. In the days before widespread Internet use, applications were many times distributed and decentralized, and the time zone was implicitly based on where the server was located. Today, with large centralized systems being used by people worldwide, the need to track and use time zones is very relevant.

Before time zone support was built into a datatype, it would have been an application function to store the DATE and in another column the time zone information, and then supply functions to convert DATES from one time zone to another. Now it's the job of the database, and it can store data in multiple time zones:

```
EODA@ORA12CR1> create table t
  2 ( ts1 timestamp with time zone,
  3   ts2 timestamp with time zone
  4 )
  5 /
Table created.
```

```
EODA@ORA12CR1> insert into t (ts1, ts2)
  2 values ( timestamp'2014-02-27 16:02:32.212 US/Eastern',
  3         timestamp'2014-02-27 16:02:32.212 US/Pacific' );
1 row created.
```

And perform correct **TIMESTAMP** arithmetic on them:

```
EODA@ORA12CR1> select ts1-ts2 from t;

TS1-TS2
-----
-000000000 03:00:00.000000
```

Since there is a three-hour time difference between those two time zones, even though they show the same time of 16:02:32.212, the interval reported is a three-hour difference. When performing **TIMESTAMP** arithmetic on **TIMESTAMPS WITH TIME ZONE** types, Oracle automatically converts both types to UTC time first and then performs the operation.

## TIMESTAMP WITH LOCAL TIME ZONE Type

This type works much like the **TIMESTAMP** column. It is a 7- or 11-byte field (depending on the precision of the **TIMESTAMP**), but it is normalized to be stored with the local database's time zone. To see this, we'll use the **DUMP** command once again. First, we create a table with three columns—a **DATE**, a **TIMESTAMP WITH TIME ZONE**, and a **TIMESTAMP WITH LOCAL TIME ZONE**—and then we insert the same value into all three columns:

```
EODA@ORA12CR1> create table t
  2 ( dt date,
  3   ts1 timestamp with time zone,
  4   ts2 timestamp with local time zone
  5 )
  6 /
Table created.

EODA@ORA12CR1> insert into t (dt, ts1, ts2)
  2 values ( timestamp'2014-02-27 16:02:32.212 US/Pacific',
  3         timestamp'2014-02-27 16:02:32.212 US/Pacific',
  4         timestamp'2014-02-27 16:02:32.212 US/Pacific' );
1 row created.
```

```
EODA@ORA12CR1> select dbtimezone from dual;
```

```
DBTIMEZONE
-----
-07:00
```

Now, when we dump those values as follows:

```
EODA@ORA12CR1> select dump(dt), dump(ts1), dump(ts2) from t;
```

```
DUMP(DT)
-----
DUMP(TS1)
-----
DUMP(TS2)
-----
Typ=12 Len=7: 120,114,2,27,17,3,33
Typ=181 Len=13: 120,114,2,28,1,3,33,12,162,221,0,137,156
Typ=231 Len=11: 120,114,2,27,18,3,33,12,162,221,0
```

We can see that, in this case, three totally different date/time representations were stored:

- **DT:** This column stored the date/time 27-FEB-2014 16:02:32. The time zone and fractional seconds are lost because we used the DATE type. No time zone conversions were performed at all. We stored the exact date/time inserted, but lost the time zone.
- **TS1:** This column preserved the TIME\_ZONE information and was normalized to be in UTC with respect to that TIME\_ZONE. The inserted TIMESTAMP value was in the US/Pacific time zone, which at the time of this writing was eight hours off UTC. Therefore, the stored date/time was 28-FEB-2014 00:02:32. It advanced our input time by eight hours to make it UTC time, and it saved the time zone US/Pacific as the last 2 bytes so this data can be properly interpreted later.
- **TS2:** This column *is assumed to be in the database's time zone, which is US/Mountain*. Now, 16:02:32 US/Pacific is 17:02:32 US/Mountain, so that is what was stored in the bytes ...18,3,33... (excess-1 notation; remember to subtract 1).

Since the TS1 column preserved the original time zone in the last 2 bytes, we'll see the following upon retrieval:

```
EODA@ORA12CR1> select ts1, ts2 from t;
```

```
TS1
-----
TS2
-----
27-FEB-14 04.02.32.212000 PM US/PACIFIC
27-FEB-14 05.02.32.212000 PM
```

The database would be able to show that information, but the TS2 column with the LOCAL TIME\_ZONE (the time zone of the database) shows the time in database's time zone, which is the assumed time zone for that column (and in fact all columns in this database with the LOCAL TIME\_ZONE). My database was in the US/Mountain time zone, so 16:02:32 US/Pacific on the way in is now displayed as 5:00 p.m. Mountain time on the way out.

■ **Note** You may get slightly different results if the date was stored when Standard time zone was in effect and then retrieved when Daylight Savings time is in effect. The output in the prior example would show a two-hour difference instead of what you would intuitively think would be a one-hour difference. I only point this out to drive home the fact that time-zone math is much more complex than it appears!

The `TIMESTAMP WITH LOCAL TIME ZONE` provides sufficient support for most applications, if you need not remember the source time zone, but only need a datatype that provides consistent worldwide handling of date/time types. Additionally, the `TIMESTAMP(0) WITH LOCAL TIMEZONE` provides you the equivalent of a `DATE` type with time zone support—it consumes 7 bytes of storage and the ability to have the dates stored normalized in UTC form.

One caveat with regard to the `TIMESTAMP WITH LOCAL TIME ZONE` type is that once you create tables with this column, you will find your database's time zone is frozen—and you will not be able to change it:

```
EODA@ORA12CR1> alter database set time_zone = 'PST';
alter database set time_zone = 'PST'
*
ERROR at line 1:
ORA-30079: cannot alter database timezone when database has
      TIMESTAMP WITH LOCAL TIME ZONE columns

EODA@ORA12CR1> !oerr ora 30079
30079, 00000, "cannot alter database timezone when database has
      TIMESTAMP WITH LOCAL TIME ZONE columns"
// *Cause: An attempt was made to alter database timezone with
//      TIMESTAMP WITH LOCAL TIME ZONE column in the database.
// *Action: Either do not alter database timezone or first drop all the
//      TIMESTAMP WITH LOCAL TIME ZONE columns.
```

It should be obvious why: if you were to change the database's time zone, you would have to rewrite every single table with a `TIMESTAMP WITH LOCAL TIME ZONE` because their current values would be wrong, given the new time zone!

## INTERVAL Type

We briefly saw `INTERVAL` type used in the previous section. It is a way to represent a duration of time or an interval of time. There are two interval types we'll discuss in this section: the `YEAR TO MONTH` type, which is capable of storing a duration of time specified in years and months, and the `DAY TO SECOND` type, which is capable of storing a duration of time in days, hours, minutes, and seconds (including fractional seconds).

Before we get into the specifics of the two `INTERVAL` types, I'd like to look at the `EXTRACT` built-in function, which can be very useful when working with this type. The `EXTRACT` built-in function works on `TIMESTAMPS` and `INTERVALS`, and it returns various bits of information from them, such as the time zone from a `TIMESTAMP` or the hours/days/minutes from an `INTERVAL`. Let's use the previous example, where we got the `INTERVAL` of 380 days, 10 hours, 20 minutes, and 29.878 seconds:

```
EODA@ORA12CR1> select dt2-dt1
 2   from (select to_timestamp('29-feb-2000 01:02:03.122000',
 3               'dd-mon-yyyy hh24:mi:ss.ff') dt1,
 4               to_timestamp('15-mar-2001 11:22:33.000000',
```

```

5          'dd-mon-yyyy hh24:mi:ss.ff') dt2
6      from dual )
7 /

```

DT2-DT1

```
-----
+000000380 10:20:29.878000000
```

We can use EXTRACT to see how easy it is to pull out each bit of information:

```

EODA@ORA12CR1> select extract( day    from dt2-dt1 ) day,
2      extract( hour    from dt2-dt1 ) hour,
3      extract( minute  from dt2-dt1 ) minute,
4      extract( second  from dt2-dt1 ) second
5  from (select to_timestamp('29-feb-2000 01:02:03.122000',
6              'dd-mon-yyyy hh24:mi:ss.ff') dt1,
7              to_timestamp('15-mar-2001 11:22:33.000000',
8              'dd-mon-yyyy hh24:mi:ss.ff') dt2
9      from dual )
10 /

```

DAY	HOUR	MINUTE	SECOND
380	10	20	29.878

Additionally, we've already seen the NUMTOYMINTERVAL and the NUMTODSINTERVAL for creating YEAR TO MONTH and DAY TO SECOND intervals. I find these functions to be the easiest way to create instances of INTERVAL types—over and above the string conversion functions. Rather than concatenate a bunch of numbers representing the days, hours, minutes, and seconds representing some interval together, I'd rather add up four calls to NUMTODSINTERVAL to do the same.

The INTERVAL type can be used to store not just durations, but times as well in a way. For example, if you want to store a specific date and time, you have the DATE or TIMESTAMP types. But what if you want to store just the time 8:00 a.m.? The INTERVAL type would be handy for that (the INTERVAL DAY TO SECOND type in particular).

## INTERVAL YEAR TO MONTH

The syntax for INTERVAL YEAR TO MONTH is straightforward

```
INTERVAL YEAR(n) TO MONTH
```

where N is an optional number of digits to support for the number of years and varies from 0 to 9, with a default of 2 (to store a number of years from 0 to 99). It allows you to store any number of years (up to nine digits' worth, anyway) and months. The function I prefer to use to create INTERVAL instances of this type is NUMTOYMINTERVAL. For example, to create an interval of five years and two months, we can use the following:

```
EODA@ORA12CR1> select numtoyminterval(5,'year')+numtoyminterval(2,'month') from dual;
```

```
NUMTOYMINTERVAL(5,'YEAR')+NUMTOYMINTERVAL(2,'MONTH')
```

```
-----
+000000005-02
```

Or, using a single call and the fact that a year has 12 months, we can use the following approach:

```
EODA@ORA12CR1> select numtoyminterval(5*12+2,'month') from dual;
```

```
NUMTOYMINTERVAL(5*12+2,'MONTH')
```

```
-----  
+000000005-02
```

Either approach works well. Another function, `TO_YMINTERVAL`, can be used to convert a string into a year/month INTERVAL type:

```
EODA@ORA12CR1> select to_yminterval( '5-2' ) from dual;
```

```
TO_YMINTERVAL('5-2')
```

```
-----  
+000000005-02
```

But since the vast majority of the time I have the year and months in two NUMBER fields in my application, I find the `NUMTOYMINTERVAL` function to be more useful, as opposed to building a formatted string from the numbers. Lastly, you can just use the INTERVAL type right in SQL, bypassing the functions altogether:

```
EODA@ORA12CR1> select interval '5-2' year to month from dual;
```

```
INTERVAL '5-2' YEARTOMONTH
```

```
-----  
+05-02
```

## INTERVAL DAY TO SECOND

The syntax for the INTERVAL DAY TO SECOND type is straightforward

```
INTERVAL DAY(n) TO SECOND(m)
```

where N is an optional number of digits to support for the day component and varies from 0 to 9, with a default of 2. M is the number of digits to preserve in the fractional part of the seconds field and varies from 0 to 9, with a default of 6. Once again, the function I prefer to use to create instances of these INTERVAL type is `NUMTODSINTERVAL`:

```
EODA@ORA12CR1> select numtodsinterval( 10, 'day' )+  
 2 numtodsinterval( 2, 'hour' )+  
 3 numtodsinterval( 3, 'minute' )+  
 4 numtodsinterval( 2.3312, 'second' )  
 5 from dual;
```

```
NUMTODSINTERVAL(10,'DAY')+NUMTODSINTERVAL(2,'HOUR')+NUMTODSINTERVAL(3,'MINU
```

```
-----  
+000000010 02:03:02.331200000
```

or simply

```
EODA@ORA12CR1> select numtodsinterval( 10*86400+2*3600+3*60+2.3312, 'second' ) from dual;
NUMTODSINTERVAL(10*86400+2*3600+3*60+2.3312,'SECOND')
-----
+000000010 02:03:02.331200000
```

using the fact that there are 86,400 seconds in a day, 3,600 seconds in an hour, and so on. Alternatively, as before, we can use the `TO_DSINTERVAL` function to convert a string into a `DAY TO SECOND` interval

```
EODA@ORA12CR1> select to_dsinterval( '10 02:03:02.3312' ) from dual;
TO_DSINTERVAL('1002:03:02.3312')
-----
+000000010 02:03:02.331200000
```

or just using an `INTERVAL` literal in SQL itself

```
EODA@ORA12CR1> select interval '10 02:03:02.3312' day to second from dual;
INTERVAL '1002:03:02.3312' DAYTOSECOND
-----
+10 02:03:02.331200
```

## LOB Types

*LOBs*, or *large objects*, are the source of much confusion, in my experience. They are a misunderstood datatype, both in how they are implemented and how best to use them. This section provides an overview of how LOBs are stored physically and the considerations you must take into account when using a LOB type. They have many optional settings, and getting the right mix for your application is crucial.

There are four types of LOBs supported in Oracle:

- **CLOB:** A character LOB. This type is used to store large amounts of textual information, such as XML or just plain text. This datatype is subject to character set translation—that is, the characters in this field will be converted from the database's character set to the client's character set upon retrieval, and from the client's character set to the database's character set upon modification.
- **NCLOB:** Another type of character LOB. The character set of the data stored in this column is the national character set of the database, not the default character set of the database.
- **BLOB:** A binary LOB. This type is used to store large amounts of binary information, such as word processing documents, images, and anything else you can imagine. It is not subject to character set translation. Whatever bits and bytes the application writes into a BLOB are what is returned by the BLOB.
- **BFILE:** A binary file LOB. This is more of a pointer than a database-stored entity. The only thing stored in the database with a BFILE is a pointer to a file in the operating system. The file is maintained outside of the database and is not really part of the database at all. A BFILE provides read-only access to the contents of the file.



When discussing LOBs, I'll break the preceding list into two pieces: LOBs stored in the database, or internal LOBs, which include CLOB, BLOB, and NLOB; and LOBs stored outside of the database, or the BFILE type. I will not discuss CLOB, BLOB, or NLOB independently, since from a storage and option perspective they are the same. It is just that a CLOB and NLOB support textual information and a BLOB does not. But the options we specify for them—the CHUNK size, RETENTION, and so on—and the considerations are the same, regardless of the base type. Since BFILES are significantly different, I'll discuss them separately.

## Internal LOBs

Starting with Oracle Database 11g, Oracle introduced a new underlying architecture for LOBs known as *SecureFiles*. The prior existing LOB architecture is known as *BasicFiles*. By default in 11g, when you create a LOB, it will be created as a BasicFiles LOB. Starting with Oracle 12c, when creating a LOB column in an ASSM-managed tablespace, by default the LOB will be created as a SecureFiles LOB.

Going forward, I recommend using SecureFiles over BasicFiles for the following reasons:

- Oracle's documentation states that BasicFiles will be deprecated in a future release.
- There are fewer parameters to manage with SecureFiles, namely the following attributes don't apply to SecureFiles: CHUNK, PCTVERSION, FREEPOLLS, FREELISTS, or FREELIST GROUPS.
- SecureFiles allow for the use of advanced encryption, compression, and de-duplication. If you're going to use these advanced LOB features, then you need to obtain a license for the Advanced Security Option and/or the Advanced Compression Option. If you're not using advanced LOB features, then you can use SecureFiles LOBs without an extra license.

In the following subsections, I'll detail the nuances of using both SecureFiles and BasicFiles.

## Creating a SecureFiles LOB

The syntax for a SecureFiles LOB is, on the face of it, very simple—deceptively simple. You may create tables with column datatypes of CLOB, BLOB, or NLOB, and that is it.

```
EODA@ORA12CR1> create table t
  2 ( id int primary key,
  3   txt clob
  4 )
  5 segment creation immediate
  6 /
```

Table created.

You can verify that the column was created as a SecureFiles LOB as follows:

```
EODA@ORA12CR1> select column_name, securefile from user_lobs where table_name='T';
```

```
COLUMN_NAME  SECUREFILE
-----
TXT          YES
```

If you're using Oracle Database 11g, the default LOB type is BasicFiles, therefore in Oracle 11g, if you want to create a SecureFiles LOB, you'll need to use the `STORE AS SECUREFILE` clause, as follows:

```
EODA@ORA11GR2> create table t
 2 ( id int primary key,
 3   txt clob
 4 )
 5 segment creation immediate
 6 lob(txt) store as securefile
 7 /
Table created.
```

Seemingly, LOBs are as simple to use as the `NUMBER`, `DATE`, or `VARCHAR2` datatypes. Or are they? The prior small examples show the tip of the iceberg—the bare minimum you can specify about a LOB. Using `DBMS_METADATA`, we can get the entire picture:

```
EODA@ORA12CR1> select dbms_metadata.get_ddl( 'TABLE', 'T' ) from dual;
```

```
DBMS_METADATA.GET_DDL('TABLE','T')
```

```
-----
CREATE TABLE "EODA"."T"
  ( "ID" NUMBER(*,0),
    "TXT" CLOB,
    PRIMARY KEY ("ID")
  USING INDEX PCTFREE 10 INITRANS 2 MAXTRANS 255
  STORAGE(INITIAL 65536 NEXT 1048576 MINEXTENTS 1 MAXEXTENTS 2147483645
  PCTINCREASE 0 FREELISTS 1 FREELIST GROUPS 1
  BUFFER_POOL DEFAULT FLASH_CACHE DEFAULT CELL_FLASH_CACHE DEFAULT)
  TABLESPACE "USERS" ENABLE
  ) SEGMENT CREATION IMMEDIATE
  PCTFREE 10 PCTUSED 40 INITRANS 1 MAXTRANS 255
  NOCOMPRESS LOGGING
  STORAGE(INITIAL 65536 NEXT 1048576 MINEXTENTS 1 MAXEXTENTS 2147483645
  PCTINCREASE 0 FREELISTS 1 FREELIST GROUPS 1
  BUFFER_POOL DEFAULT FLASH_CACHE DEFAULT CELL_FLASH_CACHE DEFAULT)
  TABLESPACE "USERS"
  LOB ("TXT") STORE AS SECUREFILE (
  TABLESPACE "USERS" ENABLE STORAGE IN ROW CHUNK 8192
  NOCACHE LOGGING NOCOMPRESS KEEP_DUPLICATES
  STORAGE(INITIAL 106496 NEXT 1048576 MINEXTENTS 1 MAXEXTENTS 2147483645
  PCTINCREASE 0
  BUFFER_POOL DEFAULT FLASH_CACHE DEFAULT CELL_FLASH_CACHE DEFAULT))
```

As you can see, there are quite a few parameters. Before going into the details of these parameters, in the next section I'll generate the same type of output for a BasicFiles LOB. This will provide a basis for discussing the various LOB attributes.

## Creating a BasicFiles LOB

In versions prior to 12c, the following code will create a BasicFiles LOB:

```
EODA@ORA11GR2> create table t
 2 ( id int primary key,
 3   txt clob
 4 )
 5 segment creation immediate
 6 /
```

Table created.

In 12c, to create a BasicFiles LOB, you'll need to use the `STORE AS BASICFILE` syntax:

```
EODA@ORA12CR1> create table t
 2 ( id int primary key,
 3   txt clob
 4 )
 5 segment creation immediate
 6 lob(txt) store as basicfile
 7 /
```

Table created.

Using the `DBMS_METADATA` package, we can see the details of a BasicFiles LOB:

```
EODA@ORA12CR1> select dbms_metadata.get_ddl( 'TABLE', 'T' ) from dual;
```

```
DBMS_METADATA.GET_DDL('TABLE','T')
```

```
-----
CREATE TABLE "EODA"."T"
  ( "ID" NUMBER(*,0),
    "TXT" CLOB,
    PRIMARY KEY ("ID")
  USING INDEX PCTFREE 10 INITRANS 2 MAXTRANS 255
  STORAGE(INITIAL 65536 NEXT 1048576 MINEXTENTS 1 MAXEXTENTS 2147483645
  PCTINCREASE 0 FREELISTS 1 FREELIST GROUPS 1
  BUFFER_POOL DEFAULT FLASH_CACHE DEFAULT CELL_FLASH_CACHE DEFAULT)
  TABLESPACE "USERS" ENABLE
  ) SEGMENT CREATION IMMEDIATE
  PCTFREE 10 PCTUSED 40 INITRANS 1 MAXTRANS 255
  NOCOMPRESS LOGGING
  STORAGE(INITIAL 65536 NEXT 1048576 MINEXTENTS 1 MAXEXTENTS 2147483645
  PCTINCREASE 0 FREELISTS 1 FREELIST GROUPS 1
  BUFFER_POOL DEFAULT FLASH_CACHE DEFAULT CELL_FLASH_CACHE DEFAULT)
  TABLESPACE "USERS"
  LOB ("TXT") STORE AS BASICFILE (
  TABLESPACE "USERS" ENABLE STORAGE IN ROW CHUNK 8192 RETENTION
  NOCACHE LOGGING
  STORAGE(INITIAL 65536 NEXT 1048576 MINEXTENTS 1 MAXEXTENTS 2147483645
  PCTINCREASE 0 FREELISTS 1 FREELIST GROUPS 1
  BUFFER_POOL DEFAULT FLASH_CACHE DEFAULT CELL_FLASH_CACHE DEFAULT))
```

Most of the parameters for a BasicFiles LOB are identical to those of a SecureFiles LOB. The main differences being that the SecureFiles LOB storage clause contains fewer parameters (like no FREELISTS and FREELIST GROUPS in the LOB storage clause).

## LOB Components

As shown in the DBMS\_METADATA output in the prior sections, the LOB has several interesting attributes:

- A tablespace (USERS in this example)
- ENABLE STORAGE IN ROW as a default attribute
- CHUNK 8192
- RETENTION
- NOCACHE
- A full storage clause

These attributes imply there is a lot going on in the background with LOBs, and there is. A LOB column always results in what I call a *multisegment object*, meaning the table will use multiple physical segments. If we had created that table in an empty schema, we would discover the following:

```
EODA@ORA12CR1> select segment_name, segment_type from user_segments;
```

SEGMENT_NAME	SEGMENT_TY
T	TABLE
SYS_LOB0000020053C00002\$\$	LOBSEGMENT
SYS_IL0000020053C00002\$\$	LOBINDEX
SYS_C005432	INDEX

An index was created in support of the primary key constraint—that is normal—but what about the other two segments, the LOBINDEX and the LOBSEGMENT? Those were created in support of our LOB column. The LOBSEGMENT is where our actual data will be stored (well, it might be stored in the table T also, but we’ll cover that in more detail when we get to the ENABLE STORAGE IN ROW clause). The LOBINDEX is used to navigate our LOB, to find the pieces of it. When we create a LOB column, in general what is stored in the row is a *pointer*, or *LOB locator*. This LOB locator is what our application retrieves. When we ask for “bytes 1,000 through 2,000” of the LOB, the LOB locator is used against the LOBINDEX to find where those bytes are stored, and then the LOBSEGMENT is accessed. The LOBINDEX is used to find the pieces of the LOB easily. You can think of a LOB then as a master/detail sort of relation. A LOB is stored in chunks or pieces, and any piece is accessible to us. If we were to implement a LOB using just tables, for example, we might do so as follows:

```
Create table parent
( id int primary key,
  other-data...
);
```

```
Create table lob
( id references parent on delete cascade,
  chunk_number int,
  data <datatype>(n),
  primary key (id,chunk_number)
);
```

Conceptually, the LOB is stored very much like that—in creating those two tables, we would have primary key on the LOB table on the ID, CHUNK\_NUMBER (analogous to the LOBINDEX created by Oracle), and we would have a table LOB storing the chunks of data (analogous to the LOBSEGMENT). The LOB column implements this master/detail structure for us transparently. Figure 12-3 might make this idea clearer.

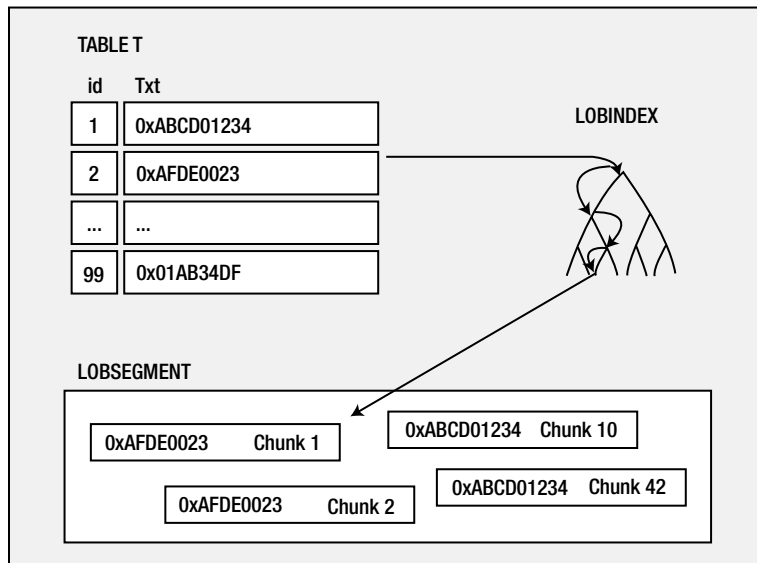

**Figure 12-3.** Table to LOBINDEX to LOBSEGMENT

The LOB locator in the table really just points to the LOBINDEX; the LOBINDEX, in turn, points to all of the pieces of the LOB itself. To get bytes N through M of the LOB, you would dereference the pointer in the table (the LOB locator), walk the LOBINDEX structure to find the needed chunks, and then access them in order. This makes random access to any piece of the LOB equally fast—you can get the front, the middle, or the end of a LOB equally fast, as you don't always just start at the beginning and walk the LOB.

Now that you understand conceptually how a LOB is stored, I'd like to walk through each of the optional settings listed previously and explain what they are used for and what exactly they imply.

## LOB Tablespace

The CREATE TABLE statement returned from DBMS\_METADATA both the SecureFiles and BasicFiles included the following:

```
LOB ("TXT") STORE AS ... ( TABLESPACE "USERS" ...
```

The TABLESPACE specified here is the tablespace where the LOBSEGMENT and LOBINDEX will be stored, and this may be different from the tablespace where the table itself resides. That is, the tablespace that holds the LOB data may be separate and distinct from the tablespace that holds the actual table data.

The main reasons you might consider using a different tablespace for the LOB data versus the table data are mostly administrative and performance related. From the administrative angle, a LOB datatype represents a sizable amount of information. If the table had millions of rows, and each row has a sizeable LOB associated with it, the LOB data would be huge. It would make sense to segregate the table from the LOB data just to facilitate backup and recovery and space management. You may well want a different uniform extent size for your LOB data than you have for your regular table data, for example.

The other reason could be for I/O performance. By default, LOBs are not cached in the buffer cache (more on that later). Therefore, by default every LOB access, be it read or write, is a physical I/O—a direct read from disk or a direct write to disk.

---

■ **Note** LOBs may be in line or stored in the table. In that case, the LOB data would be cached, but this applies only to LOBs that are 4,000 bytes or less in size. We'll discuss this further in the section "IN ROW Clause."

---

Because each access is a physical I/O, it makes sense to segregate the objects you know for a fact will be experiencing more physical I/O than most objects in real time (as the user accesses them) to their own disks.

It should be noted that the LOBINDEX and the LOBSEGMENT will *always be in the same tablespace*. You cannot have the LOBINDEX and LOBSEGMENT in separate tablespaces. Much earlier releases of Oracle allowed you to separate them, but versions 8i Release 3 and up at least do not allow you to specify separate tablespaces for the LOBINDEX and LOBSEGMENT. In fact, all storage characteristics of the LOBINDEX are inherited from the LOBSEGMENT, as we'll see shortly.

## IN ROW Clause

The CREATE TABLE statement returned from DBMS\_METADATA earlier, both the SecureFiles and BasicFiles included the following:

```
LOB ("TXT") STORE AS ... (... ENABLE STORAGE IN ROW ...
```

This controls whether the LOB data is always stored separate from the table in the LOBSEGMENT or if it can sometimes be stored right in the table itself without being placed into the LOBSEGMENT. If ENABLE STORAGE IN ROW is set, as opposed to DISABLE STORAGE IN ROW, small LOBs of up to 4,000 bytes will be stored in the table itself, much like a VARCHAR2 would be. Only when LOBs exceed 4,000 bytes will they be moved out of line into the LOBSEGMENT.

Enabling storage in the row is the default and, in general, should be the way to go if you know the LOBs will many times fit in the table itself. For example, you might have an application with a description field of some sort in it. The description might be anywhere from 0 to 32KB of data (or maybe even more, but mostly 32KB or less). Many of the descriptions are known to be very short, consisting of a couple of hundred characters. Rather than going through the overhead of storing these out of line and accessing them via the index every time you retrieve them, you can store them in line, in the table itself. Further, if the LOB is using the default of NOCACHE (the LOBSEGMENT data is not cached in the buffer cache), then a LOB stored in the table segment (which is cached) will avoid the physical I/O required to retrieve the LOB.

---

■ **Note** Starting with Oracle 12c, you can create a VARCHAR2, NVARCHAR2, or RAW column that will store up to 32,767 bytes of information. See the "Extended Datatypes" section in this chapter for details.

---

We can see the effect of this with a rather simple example. We'll create a table with a LOB that can store data in row and one that cannot:

```
EODA@ORA12CR1> create table t
 2 ( id int primary key,
 3   in_row clob,
 4   out_row clob
 5 )
```

```

6 lob (in_row) store as ( enable storage in row )
7 lob (out_row) store as ( disable storage in row )
8 /

```

Table created.

Into this table we'll insert some string data, all of which is less than 4,000 bytes in length:

```

EODA@ORA12CR1> insert into t
2 select rownum,
3      owner || ' ' || object_name || ' ' || object_type || ' ' || status,
4      owner || ' ' || object_name || ' ' || object_type || ' ' || status
5 from all_objects
6 /

```

72085 rows created.

```

EODA@ORA12CR1> commit;
Commit complete.

```

Now, if we try to read out each row and, using the DBMS\_MONITOR package, do this with SQL\_TRACE enabled, we'll be able to see the performance upon data retrieval of each:

```

EODA@ORA12CR1> declare
2      l_cnt    number;
3      l_data   varchar2(32765);
4 begin
5      select count(*)
6      into l_cnt
7      from t;
8
9      dbms_monitor.session_trace_enable;
10     for i in 1 .. l_cnt
11     loop
12         select in_row into l_data from t where id = i;
13         select out_row into l_data from t where id = i;
14     end loop;
15 end;
16 /

```

PL/SQL procedure successfully completed.

When we review the TKPROF report for this small simulation, the results are rather obvious:

```
SELECT IN_ROW FROM T WHERE ID = :B1
```

call	count	cpu	elapsed	disk	query	current	rows
Parse	1	0.00	0.00	0	0	0	0
Execute	18240	0.23	0.25	0	0	0	0
Fetch	18240	0.22	0.27	0	54720	0	18240
total	36481	0.46	0.53	0	54720	0	18240

\*\*\*\*\*

```
SELECT OUT_ROW FROM T WHERE ID = :B1
```

call	count	cpu	elapsed	disk	query	current	rows
Parse	1	0.00	0.00	0	0	0	0
Execute	18240	0.23	0.24	0	0	0	0
Fetch	18240	1.95	1.67	18240	72960	0	18240
total	36481	2.18	1.91	18240	72960	0	18240

Elapsed times include waiting on following events:

Event waited on	Times Waited	Max. Wait	Total Waited
direct path read	18240	0.00	0.14

The retrieval of the IN\_ROW column was significantly faster and consumed far fewer resources. We can see that it used 54,720 logical I/Os (query mode gets), whereas the OUT\_ROW column used significantly more logical I/Os. At first it is not clear where these extra logical I/Os are coming from, but if you remember how LOBs are stored, it will become obvious. These are the I/Os against the LOBINDEX segment in order to find the pieces of the LOB. Those extra logical I/Os are all against this LOBINDEX.

Additionally, you can see that the retrieval of 18,240 rows with out of row storage incurred 18,240 physical I/Os and resulted in 18,240 I/O waits for *direct path read*. These were the reads of the noncached LOB data. We might be able to reduce them in this case by enabling caching on the LOB data, but then we'd have to ensure we had sufficient additional buffer cache to be used for this. Also, if there were some really large LOBs in there, we might not really want this data to be cached.

This in row/out of row storage will affect modifications as well as reads. If we were to update the first 100 rows with short strings, and insert 100 new rows with short strings and use the same techniques to monitor performance as follows:

```
EODA@ORA12CR1> create sequence s start with 100000;
Sequence created.
```

```
EODA@ORA12CR1> declare
2     l_cnt    number;
3     l_data   varchar2(32765);
4 begin
5     dbms_monitor.session_trace_enable;
6     for i in 1 .. 100
7     loop
8         update t set in_row =
9             to_char(sysdate,'dd-mon-yyyy hh24:mi:ss') where id = i;
10        update t set out_row =
11            to_char(sysdate,'dd-mon-yyyy hh24:mi:ss') where id = i;
12        insert into t (id, in_row) values ( s.nextval, 'Hello World' );
13        insert into t (id,out_row) values ( s.nextval, 'Hello World' );
14    end loop;
15 end;
```

PL/SQL procedure successfully completed.



we would discover findings similar to the following output in the resulting TKPROF report

```
UPDATE T SET IN_ROW = TO_CHAR(SYSDATE, 'dd-mon-yyyy hh24:mi:ss') WHERE ID = :B1
```

call	count	cpu	elapsed	disk	query	current	rows
Parse	1	0.00	0.00	0	0	0	0
Execute	100	0.00	0.01	0	200	214	100
Fetch	0	0.00	0.00	0	0	0	0
total	101	0.00	0.01	0	200	214	100

Misses in library cache during parse: 1  
 Misses in library cache during execute: 1  
 Optimizer mode: ALL\_ROWS  
 Parsing user id: 66 (recursive depth: 1)  
 Number of plan statistics captured: 1

Rows (1st)	Rows (avg)	Rows (max)	Row Source	Operation
0	0	0	UPDATE T	(cr=2 pr=0 pw=0 time=463 us)
1	1	1	INDEX UNIQUE SCAN	SYS_C005434 (cr=2 pr=0 pw=0 time=16...

```
*****
UPDATE T SET OUT_ROW = TO_CHAR(SYSDATE, 'dd-mon-yyyy hh24:mi:ss') WHERE ID = :B1
```

call	count	cpu	elapsed	disk	query	current	rows
Parse	1	0.00	0.00	0	0	0	0
Execute	100	0.03	0.99	0	200	302	100
Fetch	0	0.00	0.00	0	0	0	0
total	101	0.03	0.99	0	200	302	100

Misses in library cache during parse: 1  
 Misses in library cache during execute: 1  
 Optimizer mode: ALL\_ROWS  
 Parsing user id: 66 (recursive depth: 1)  
 Number of plan statistics captured: 1

Rows (1st)	Rows (avg)	Rows (max)	Row Source	Operation
0	0	0	UPDATE T	(cr=2 pr=0 pw=1 time=8759 us)
1	1	1	INDEX UNIQUE SCAN	SYS_C005434 (cr=2 pr=0 pw=0 time=6...

Elapsed times include waiting on following events:

Event waited on	Times Waited	Max. Wait	Total Waited
Disk file operations I/O	1	0.00	0.00
direct path write	163	0.01	0.96

As we can see, the update of the out-of-line LOB consumed measurably more resources. It spent some amount of time doing direct path writes (physical I/O) and performed many more current mode gets. These were in response to the fact that the LOBINDEX and LOBSEGMENT had to be maintained in addition to the table itself. The INSERT activity shows the same disparity:

```
INSERT INTO T (ID, IN_ROW) VALUES ( S.NEXTVAL, 'Hello World' )
```

call	count	cpu	elapsed	disk	query	current	rows
Parse	1	0.00	0.00	0	0	0	0
Execute	100	0.00	0.00	0	4	317	100
Fetch	0	0.00	0.00	0	0	0	0
total	101	0.00	0.00	0	4	317	100

```
INSERT INTO T (ID,OUT_ROW) VALUES ( S.NEXTVAL, 'Hello World' )
```

call	count	cpu	elapsed	disk	query	current	rows
Parse	1	0.00	0.00	0	0	0	0
Execute	100	0.02	0.61	0	4	440	100
Fetch	0	0.00	0.00	0	0	0	0
total	101	0.02	0.61	0	4	440	100

...

Elapsed times include waiting on following events:

Event waited on	Times Waited	Max. Wait	Total Waited
direct path write	100	0.01	0.60

Note the increased I/O usage, both on the read and writes. All in all, this shows that if you use a CLOB, and many of the strings are expected to fit in the row (i.e., will be less than 4,000 bytes), then using the default of `ENABLE STORAGE IN ROW` is a good idea.

## CHUNK Clause

LOBs are stored in chunks; the index that points to the LOB data points to individual chunks of data. *Chunks* are logically contiguous sets of blocks and are the smallest unit of allocation for LOBs, whereas normally a block is the smallest unit of allocation. The `CHUNK` size must be an integer multiple of your Oracle blocksize—this is the only valid value.

---

■ **Note** The `CHUNK` clause only applies to `BasicFiles`. The `CHUNK` clause appears in the syntax clause for `SecureFiles` for backward compatibility purposes only.

---

You must take care to choose a `CHUNK` size from two perspectives. First, each LOB instance (each LOB value stored out of line) will consume at least one `CHUNK`. A single `CHUNK` is used by a single LOB value. If a table has 100 rows and each row has a LOB with 7KB of data in it, you can be sure that there will be 100 chunks allocated. If you set the `CHUNK` size to 32KB, you will have 100 32KB chunks allocated. If you set the `CHUNK` size to 8KB, you will have (probably) 100 8KB chunks allocated. The point is, a chunk is used by only one LOB entry (two LOBs will not use the same

CHUNK). If you pick a chunk size that does not meet your expected LOB sizes, you could end up wasting an excessive amount of space. For example, if you have that table with 7KB LOBs on average, and you use a CHUNK size of 32KB, you will be wasting approximately 25KB of space per LOB instance. On the other hand, if you use an 8KB CHUNK, you will minimize any sort of waste.

You also need to be careful when you want to minimize the number of CHUNKs you have per LOB instance. As you have seen, there is a LOBINDEX used to point to the individual chunks, and the more chunks you have, the larger this index is. If you have a 4MB LOB and use an 8KB CHUNK, you will need at least 512 CHUNKs to store that information. This means you need at least enough LOBINDEX entries to point to these chunks. It might not sound like a lot until you remember this is per LOB instance; if you have thousands of 4MB LOBs, you now have many thousands of entries. This will also affect your retrieval performance, as it takes longer to read and manage many small chunks than it takes to read fewer, but larger, chunks. The ultimate goal is to use a CHUNK size that minimizes your waste, but also efficiently stores your data.

## RETENTION Clause

The RETENTION clause differs depending on whether you're using SecureFiles or BasicFiles. If you look back at the output of DBMS\_METADATA at the beginning of the "Internal Lobs" section, notice that there is no RETENTION clause in the CREATE TABLE statement for a SecureFiles LOB whereas there is one for a BasicFiles LOB. This is because RETENTION is automatically enabled for SecureFiles.

RETENTION is used to control the read consistency of the LOB. I'll provide details in subsequent subsections on how RETENTION is handled differently between SecureFiles and BasicFiles.

## Read Consistency for LOBs

In previous chapters, we've discussed read consistency, multiversioning, and the role that undo plays in that. Well, when it comes to LOBs, the way read consistency is implemented changes. The LOBSEGMENT does not use undo to record its changes; rather, it versions the information directly in the LOBSEGMENT itself. The LOBINDEX generates undo just as any other segment would, but the LOBSEGMENT does not. Instead, when you modify a LOB, Oracle allocates a new CHUNK and leaves the old CHUNK in place. If you roll back your transaction, the changes to the LOB index are rolled back and the index will point to the old CHUNK again. So the undo maintenance is performed right in the LOBSEGMENT itself. As you modify the data, the old data is left in place and new data is created.

This comes into play for reading the LOB data as well. LOBs are read consistent, just as all other segments are. If you retrieve a LOB locator at 9:00 a.m., the LOB data you retrieve from it will be "as of 9:00 a.m." Just like if you open a cursor (a resultset) at 9:00 a.m., the rows it produces will be as of that point in time. Even if someone else comes along and modifies the LOB data and commits (or not), your LOB locator will be "as of 9:00 a.m.," just like your resultset would be. Here, Oracle uses the LOBSEGMENT along with the read-consistent view of the LOBINDEX to undo the changes to the LOB, to present you with the LOB data as it existed when you retrieved the LOB locator. It does not use the undo information for the LOBSEGMENT, since none was generated for the LOBSEGMENT itself.

We can see that LOBs are read-consistent easily. Consider this small table with an out-of-line LOB (it is stored in the LOBSEGMENT):

```
EODA@ORA12CR1> create table t
 2 ( id int    primary key,
 3   txt      clob
 4 )
 5 lob( txt) store as ( disable storage in row )
 6 /
```

Table created.

```
EODA@ORA12CR1> insert into t values ( 1, 'hello world' );
1 row created.
```

```
EODA@ORA12CR1> commit;
Commit complete.
```

If we fetch out the LOB locator and open a cursor on this table as follows

```
EODA@ORA12CR1> declare
2         l_clob clob;
3
4         cursor c is select id from t;
5         l_id   number;
6 begin
7         select txt into l_clob from t;
8         open c;
```

and then we modify that row and commit

```
9
10        update t set id = 2, txt = 'Goodbye';
11        commit;
12
```

we'll see upon working with the LOB locator and opened cursor that the data is presented “as of the point in time we retrieved or opened them”

```
13        dbms_output.put_line( dbms_lob.substr( l_clob, 100, 1 ) );
14        fetch c into l_id;
15        dbms_output.put_line( 'id = ' || l_id );
16        close c;
17 end;
18 /
hello world
id = 1
```

PL/SQL procedure successfully completed.

but the data is most certainly updated/modified in the database

```
EODA@ORA12CR1> select * from t;
```

```

ID TXT
-----
2 Goodbye
```

The read-consistent images for the cursor C came from the undo segments, whereas the read-consistent images for the LOB came from the LOBSEGMENT itself. So, that gives us a reason to be concerned: if the undo segments are not used to store rollback for LOBs *and* LOBs support read consistency, how can we prevent the dreaded ORA-01555: snapshot too old error from occurring? And, as important, how do we control the amount of space used by these old versions? That is where RETENTION, and alternatively, PCTVERSION come into play.

## BasicFiles RETENTION

RETENTION tells the database to retain modified LOB segment data in the LOB segment in accordance with your database's UNDO\_RETENTION setting. If you set your UNDO\_RETENTION to 2 days, Oracle will attempt to not reuse LOB segment space freed by a modification. That is, if you deleted all of your rows pointing to LOBS, Oracle would attempt to retain the data in the LOB segment (the deleted data) for two days in order to satisfy your UNDO\_RETENTION policy, just as it would attempt to retain the undo information for the structured data (your relational rows and columns) in the UNDO tablespace for two days. It is important you understand this: the freed space in the LOB segment will not be immediately reused by subsequent INSERTs or UPDATEs. This is a frequent cause of questions in the form of, "Why is my LOB segment growing and growing?" A mass purge followed by a reload of information will tend to cause the LOB segment to just grow, since the retention period has not yet expired.

---

■ **Note** To use RETENTION, the BasicFiles LOB must reside in an automatic segment space management (ASSM) tablespace. The RETENTION parameter is ignored if the BasicFiles LOB resides in a manual segment space management (MSSM) tablespace. See Chapter 10 for a discussion on ASSM and MSSM.

---

Alternatively, the BasicFiles LOB storage clause could use PCTVERSION, which controls the percentage of allocated (used by LOBs at some point and blocks under the LOBSEGMENT's HWM) LOB space that should be used for versioning of LOB data. The default of 10 percent is adequate for many uses since many times you only ever INSERT and retrieve LOBs (updating of LOBs is typically not done; LOBs tend to be inserted once and retrieved many times). Therefore, not much space, if any, needs to be set aside for LOB versioning.

However, if you have an application that does modify the LOBs frequently, the default of 10 percent may be too small if you frequently read LOBs at the same time some other session is modifying them. If you hit an ORA-22924 error while processing a LOB, the solution is not to increase the size of your undo tablespace, or increase the undo retention, or add more rollback segments if you are using manual undo management. Rather you should use the following:

```
ALTER TABLE tablename MODIFY LOB (lobname) ( PCTVERSION n );
```

and increase the amount of space to be used in that LOBSEGMENT for versioning of data.

## SecureFiles RETENTION

SecureFiles use RETENTION to control read consistency (just like BasicFiles). In the CREATE TABLE output of DBMS\_METADATA for the SecureFiles LOB, there is no RETENTION clause. This is because the default RETENTION is set to AUTO, which instructs Oracle to retain undo long enough for read-consistent purposes.

If you want to alter the default RETENTION behavior, you can adjust it via the following parameters:

- Use MAX to indicate that the undo should be retained until the LOB segment has reached the MAXSIZE specified in the storage clause (therefore, MAX must be used in conjunction with the MAXSIZE clause in the storage clause).
- Set MIN N if the flashback database is enabled to limit the undo duration for the LOB to N seconds.
- Set NONE if undo is not required for consistent reads or flashback operations.

If you don't set the RETENTION parameter for SecureFiles, or specify RETENTION with no parameters, then it is set to DEFAULT (which is equivalent of AUTO).

## CACHE Clause

The CREATE TABLE statement returned from DBMS\_METADATA previously included the following for both SecureFiles and BasicFiles:

```
LOB ("TXT") STORE AS ... (... NOCACHE ... )
```

The alternative to NOCACHE is CACHE or CACHE READS. This clause controls whether or not the LOBSEGMENT data is stored in the buffer cache. The default NOCACHE implies that every access will be a direct read from disk and every write/modification will likewise be a direct read from disk. CACHE READS allows LOB data that is read from disk to be buffered, but writes of LOB data will be done directly to disk. CACHE permits the caching of LOB data during both reads and writes.

In many cases, the default might not be what you want. If you have small- to medium-sized LOBS (e.g., you are using them to store descriptive fields of just a couple of kilobytes), caching them makes perfect sense. If they are not cached, when the user updates the description field the user must also wait for the I/O to write the data to disk (an I/O the size of a CHUNK will be performed and the user will wait for this I/O to complete). If you are performing a large load of many LOBs, you will have to wait for the I/O to complete on each row as they are loaded. It makes sense to enable caching on these LOBs. You may turn caching on and off easily:

```
ALTER TABLE tablename MODIFY LOB (lobname) ( CACHE );
ALTER TABLE tablename MODIFY LOB (lobname) ( NOCACHE );
```

to see the effect this may have on you. For a large initial load, it would make sense to enable caching of the LOBs and allow DBWR to write the LOB data out to disk in the background while your client application keeps loading more. For small- to medium-sized LOBs that are frequently accessed or modified, caching makes sense so the end user doesn't have to wait for physical I/O to complete in real time. For a LOB that is 50MB in size, however, it probably does not make sense to have that in the cache.

---

■ **Tip** Bear in mind that you can make excellent use of the Keep or Recycle pools (discussed in Chapter 4) here. Instead of caching the LOBSEGMENT data in the default cache with all of the regular data, you can use the Keep or Recycle pools to separate it out. In that fashion, you can achieve the goal of caching LOB data without affecting the caching of existing data in your system.

---

## LOB STORAGE Clause

And lastly, the CREATE TABLE statement returned from DBMS\_METADATA previously included the following for SecureFiles:

```
LOB ("TXT") STORE AS SECUREFILE (...
STORAGE(INITIAL 106496 NEXT 1048576 MINEXTENTS 1 MAXEXTENTS 2147483645
PCTINCREASE 0
BUFFER_POOL DEFAULT FLASH_CACHE DEFAULT CELL_FLASH_CACHE DEFAULT))
```

And here is the corresponding output for BasicFiles:

```
LOB ("TXT") STORE AS BASICFILE ( ...
STORAGE(INITIAL 65536 NEXT 1048576 MINEXTENTS 1 MAXEXTENTS 2147483645
PCTINCREASE 0 FREELISTS 1 FREELIST GROUPS 1
BUFFER_POOL DEFAULT FLASH_CACHE DEFAULT CELL_FLASH_CACHE DEFAULT))
```

Both SecureFiles and BasicFiles have a full storage clause you can employ to control the physical storage characteristics. It should be noted that this storage clause applies to the LOBSEGMENT *and* the LOBINDEX equally—a setting for one is used for the other.

The management of the storage with SecureFiles is less complicated than that of a BasicFiles. Recall that a SecureFiles LOB must be created within an ASSM-managed tablespace, and therefore the following attributes no longer apply: FREELISTS, FREELIST GROUPS, and FREEPools.

For a BasicFiles LOB, the relevant settings for a LOB would be the FREELISTS, FREELIST GROUPS (when not using ASSM, as discussed in Chapter 10). The same rules apply to the LOBINDEX segment, as the LOBINDEX is managed the same as any other index segment. If you have highly concurrent modifications of LOBs, multiple FREELISTS on the index segment might be recommended.

As mentioned in the previous section, using the Keep or Recycle pools for LOB segments can be a useful technique to allow you to cache LOB data, without damaging your existing default buffer cache. Rather than having the LOBs age out block buffers from normal tables, you can set aside a dedicated piece of memory in the SGA just for these objects. The BUFFER\_POOL clause could be used to achieve that.

## BFILES

The last of the LOB types to talk about is the BFILE type. A BFILE type is simply a pointer to a file in the operating system. It is used to provide *read-only* access to these operating system files.

---

■ **Note** The built-in package UTL\_FILE provides read and write access to operating system files, too. It does not use the BFILE type, however.

---

When you use BFILES, you will also be using an Oracle DIRECTORY object. The DIRECTORY object simply maps an operating system directory to a string or a name in the database (providing for portability; you refer to a string in your BFILES, not an operating system-specific file-naming convention). So, as a quick example, let's create a table with a BFILE column, create a DIRECTORY object, and insert a row referencing a file in the file system:

```
EODA@ORA12CR1> create table t
 2 ( id      int primary key,
 3   os_file bfile
 4 )
 5 /
Table created.
```

```
EODA@ORA12CR1> create or replace directory my_dir as '/tmp/';
Directory created.
```

```
EODA@ORA12CR1> insert into t values ( 1, bfilename( 'MY_DIR', 'test.dmp' ) );
1 row created.
```

For this example, I'll create a test.dmp file in the /tmp directory using the UNIX/Linux dd command:

```
dd if=/dev/zero of=/tmp/test.dmp bs=1056768 count=1
```

Now the BFILE can be treated as if it were a LOB—because it is. For example:

```
EODA@ORA12CR1> select dbms_lob.getlength(os_file) from t;

DBMS_LOB.GETLENGTH(OS_FILE)
-----
                        1056768
```

We can see the file pointed to is 1MB in size. Note that the use of MY\_DIR in the INSERT statement was intentional. If we use mixed case or lowercase, we would get the following:

```
EODA@ORA12CR1> update t set os_file = bfilename( 'my_dir', 'test.dmp' );
1 row updated.

EODA@ORA12CR1> select dbms_lob.getlength(os_file) from t;
select dbms_lob.getlength(os_file) from t
*
ERROR at line 1:
ORA-22285: non-existent directory or file for GETLENGTH operation
ORA-06512: at "SYS.DBMS_LOB", line 850
```

This example points out that DIRECTORY objects in Oracle are identifiers, and identifiers are stored in uppercase by default. The BFILENAME built-in function accepts a string, and this string's case must match the case of the DIRECTORY object exactly as stored in the data dictionary. So, we must either use uppercase in the BFILENAME function or use quoted identifiers when creating the DIRECTORY object:

```
EODA@ORA12CR1> create or replace directory "my_dir" as '/tmp/';

Directory created.

EODA@ORA12CR1> select dbms_lob.getlength(os_file) from t;

DBMS_LOB.GETLENGTH(OS_FILE)
-----
                        1056768
```

I recommend against using quoted identifiers; rather, use the uppercase name in the BFILENAME call. Quoted identifiers are not usual and tend to create confusion downstream.

A BFILE (the pointer object in the database, not the actual binary file on disk) consumes a varying amount of space on disk, depending on the length of the DIRECTORY object name and the file name. In the preceding example, the resulting BFILE was about 35 bytes in length. In general, you'll find the BFILE consumes approximately 20 bytes of overhead *plus* the length of the DIRECTORY object name *plus* the length of the file name itself.

---

■ **Note** BFILE data is *not read consistent* as other LOB data is. Since the BFILE is managed outside of the database, whatever happens to be in the file when you dereference the BFILE is what you will get. So, repeated reads from the same BFILE may produce different results—unlike a LOB locator used against a CLOB, BLOB, or NCLOB.

---



## ROWID/UROWID Types

The last datatypes to discuss are the ROWID and UROWID types. A ROWID is the address of a row in a table (remember from Chapter 10 that it takes a ROWID plus a tablename to uniquely identify a row in a database). Sufficient information is encoded in the ROWID to locate the row on disk, as well as identify the object the ROWID points to (the table and so on). ROWID's close relative, UROWID, is a universal ROWID and is used for tables, such as IOTs and tables accessed via gateways to heterogeneous databases that do not have fixed ROWIDs. The UROWID is a representation of the primary key value of the row and hence will vary in size depending on the object it points to.

Every row in every table has either a ROWID or a UROWID associated with it. They are considered *pseudo columns* when retrieved from a table, meaning they are not actually stored with the row, but rather are a derived attribute of the row. A ROWID is generated based on the physical location of the row, it is not stored with it. A UROWID is generated based on the row's primary key, so in a sense it is stored with the row, but not really, as the UROWID does not exist as a discrete column, but rather as a function of the existing columns.

It used to be that for rows with ROWIDs (the most common type of rows in Oracle; with the exception of rows in IOTs, all rows have ROWIDs), the ROWIDs were immutable. When a row was inserted, it would be associated with a ROWID, an address, and that ROWID would be associated with that row until it was deleted, until it was physically removed from the database. Over time, this is becoming less true, as there are now operations that may cause a row's ROWID to change, for example:

- Updating the partition key of a row in a partitioned table such that the row must move from one partition to another
- Using the FLASHBACK table command to restore a database table to a prior point in time
- MOVE operations and many partition operations such as splitting or merge partitions
- Using the ALTER TABLE SHRINK SPACE command to perform a segment shrink

Now, since ROWIDs can change over time (since they are no longer immutable), it is not recommended to physically store them as columns in database tables. That is, using a ROWID as a datatype of a database column is considered a bad practice and should be avoided. The primary key of the row (which should be immutable) should be used instead, and referential integrity can be in place to ensure data integrity is preserved. You cannot do this with the ROWID types—you cannot create a foreign key from a child table to a parent table by ROWID, and you cannot enforce integrity across tables like that. You must use the primary key constraint.

Of what use is the ROWID type, then? It is still useful in applications that allow the end user to interact with the data—the ROWID, being a physical address of a row, is the fastest way to access a single row in any table. An application that reads data out of the database and presents it to the end user can use the ROWID upon attempting to update that row. The application must use the ROWID in combination with other fields or checksums (refer to Chapter 7 for further information on application locking). In this fashion, you can update the row in question with the least amount of work (e.g., no index lookup to find the row again) and ensure the row is the same row you read out in the first place by verifying the column values have not changed. So, a ROWID is useful in applications that employ optimistic locking.

## Summary

In this chapter, we've examined many basic datatypes provided by Oracle; we've seen how they are physically stored and what options are available with each. We started with character strings, the most basic of types, and looked into considerations surrounding multibyte characters and raw binary data. We then discussed extended datatypes (available in Oracle 12c and above) and how this feature allows you to define VARCHAR2, NVARCHAR2, and RAW datatypes to be as large as 32, 727 bytes. Next, we studied the numeric types, including the very precise Oracle NUMBER type and the new floating-point types provided with Oracle 10g and later.

We also gave consideration to the legacy `LONG` and `LONG RAW` types, concentrating on how you might work around their existence, as the functionality provided by these types falls far short of that provided by the `LOB` types. Next, we looked at the datatypes capable of storing dates and times. We covered the basics of date arithmetic, a perplexing issue until you've seen it demonstrated. Lastly, in the section on dates and timestamps, we looked at the `INTERVAL` type and how best to use it.

The most detailed part of the chapter from a physical storage perspective was the `LOB` section. The `LOB` type is frequently misunderstood by developers and DBAs alike, so the bulk of the section was spent looking at how they are physically implemented as well as certain performance considerations and the differences between `SecureFiles` and `BasicFiles`.

The last datatype we looked at was the `ROWID/URROWID` type. For what now should be obvious reasons, you should not use this datatype as a database column, since `ROWIDs` are not immutable and no integrity constraints could enforce the parent/child relationship. Rather, you want to store primary keys if you need to point to another row.



# Partitioning

*Partitioning*, first introduced in Oracle 8.0, is the process of physically breaking a table or index into many smaller, more manageable pieces. As far as the application accessing the database is concerned, there is logically only one table or one index, but physically that table or index may comprise many dozens of physical partitions. Each partition is an independent object that may be manipulated either by itself or as part of the larger object.

---

■ **Note** Partitioning is an extra cost option to the Enterprise Edition of the Oracle database. It is not available in the Standard Edition.

---

In this chapter, we will investigate why you might consider using partitioning. The reasons range from increased availability of data to reduced administrative (DBA) burdens and, in certain situations, increased performance. Once you have a good understanding of the reasons for using partitioning, we'll look at how you may partition tables and their corresponding indexes. The goal of this discussion is not to teach you the details of administering partitions, but rather to present a practical guide to implementing your applications with partitions.

We will also discuss the important fact that partitioning of tables and indexes is not a guaranteed “fast = true” setting for the database. It has been my experience that many developers and DBAs believe that increased performance is an automatic side effect of partitioning an object. Partitioning is just a tool, and one of three things will happen when you partition an index or table: the application using these partitioned tables might run slower, might run faster, or might not be affected one way or the other. I put forth that if you just apply partitioning without understanding how it works and how your application can make use of it, then the odds are you will negatively impact performance by just turning it on.

Lastly, we'll investigate a very common use of partitions in today's world: supporting a large online audit trail in OLTP and other operational systems. We'll discuss how to incorporate partitioning and segment space compression to efficiently store online a large audit trail and provide the ability to archive old records out of this audit trail with minimal work.

## Partitioning Overview

Partitioning facilitates the management of very large tables and indexes using *divide and conquer* logic. Partitioning introduces the concept of a *partition key* that is used to segregate data based on a certain range value, a list of specific values, or the value of a hash function. If I were to put the benefits of partitioning in some sort of order, it would be as follows:

1. *Increases availability of data.* This attribute is applicable to all system types, be they OLTP or warehouse systems by nature.
2. *Eases administration of large segments by removing them from the database.* Performing administrative operations on a 100GB table, such as a reorganization to remove migrated rows or to reclaim “whitespace” left in the table after a purge of old information, would be much more onerous than performing the same operation ten times on individual 10GB table partitions. Additionally, using partitions, we might be able to conduct a purge routine without leaving whitespace behind at all, removing the need for a reorganization entirely!
3. *Improves the performance of certain queries.* This is mainly beneficial in a large warehouse environment where we can use partitioning to eliminate large ranges of data from consideration, avoiding accessing this data at all. This will not be as applicable in a transactional system, since we are accessing small volumes of data in that system already.
4. *May reduce contention on high-volume OLTP systems by spreading out modifications across many separate partitions.* If you have a segment experiencing high contention, turning it into many segments could have the side effect of reducing that contention proportionally.

Let’s take a look at each of these potential benefits of using partitioning.

### Increased Availability

Increased availability derives from the independence of each partition. The availability (or lack thereof) of a single partition in an object does not mean the object itself is unavailable. The optimizer is aware of the partitioning scheme that is in place and will remove unreferenced partitions from the query plan accordingly. If a single partition is unavailable in a large object, and your query can eliminate this partition from consideration, then Oracle will successfully process the query.

To demonstrate this increased availability, we’ll set up a hash partitioned table with two partitions, each in a separate tablespace. We’ll create an EMP table that specifies a partition key on the EMPNO column; EMPNO will be our partition key. In this case, this structure means that for each row inserted into this table, the value of the EMPNO column is hashed to determine the partition (and hence the tablespace) into which the row will be placed. First, we create two tablespaces (P1 and P2) and then a partitioned table with two partitions (PART\_1 and PART\_2), with one partition in each tablespace:

```
EODA@ORA12CR1> create tablespace p1 datafile size 1m autoextend on next 1m;
Tablespace created.
```

```
EODA@ORA12CR1> create tablespace p2 datafile size 1m autoextend on next 1m;
Tablespace created.
```

```
EODA@ORA12CR1> CREATE TABLE emp
2 ( empno int,
3  ename varchar2(20)
4 )
5 PARTITION BY HASH (empno)
```

```

6 ( partition part_1 tablespace p1,
7   partition part_2 tablespace p2
8 )
9 /

```

Table created.

---

■ **Note** The tablespaces in this example use Oracle Managed Files with the initialization parameter `DB_CREATE_FILE_DEST` set to `/u01/dbfile/ORA12CR1`.

---

Next, we insert some data into the EMP table and then, using the partition-extended table name, inspect the contents of each partition:

```
EODA@ORA12CR1> insert into emp select empno, ename from scott.emp;
14 rows created.
```

```
EODA@ORA12CR1> select * from emp partition(part_1);
```

```

EMPNO ENAME
-----
7369 SMITH
7499 ALLEN
7654 MARTIN
7698 BLAKE
7782 CLARK
7839 KING
7876 ADAMS
7934 MILLER

```

8 rows selected.

```
EODA@ORA12CR1> select * from emp partition(part_2);
```

```

EMPNO ENAME
-----
7521 WARD
7566 JONES
7788 SCOTT
7844 TURNER
7900 JAMES
7902 FORD

```

6 rows selected.

You should note that the data is somewhat randomly assigned. That is by design here. Using hash partitioning, we are asking Oracle to randomly—but hopefully evenly—distribute our data across many partitions. We cannot control the partition into which data goes; Oracle decides that based on hashing the hash key value itself. Later, when we look at range and list partitioning, we'll see how we can control what partitions receive which data.

Now, we take one of the tablespaces offline (simulating, for example, a disk failure), thus making unavailable the data in that partition:

```
EODA@ORA12CR1> alter tablespace p1 offline;
Tablespace altered.
```

Next, we run a query that hits every partition, and we see that this query fails:

```
EODA@ORA12CR1> select * from emp;
select * from emp
      *
ERROR at line 1:
ORA-00376: file 9 cannot be read at this time
ORA-01110: data file 9: '/u01/dbfile/ORA12CR1/datafile/o1_mf_p1_9gck8ndv_.dbf'
```

However, a query that does not access the offline tablespace will function as normal; Oracle will eliminate the offline partition from consideration. I use a bind variable in this particular example just to demonstrate that even though Oracle does not know at query optimization time which partition will be accessed, it is nonetheless able to perform this elimination at runtime:

```
EODA@ORA12CR1> variable n number
EODA@ORA12CR1> exec :n := 7844;
PL/SQL procedure successfully completed.

EODA@ORA12CR1> select * from emp where empno = :n;
```

```
      EMPNO ENAME
-----
      7844 TURNER
```

In summary, when the optimizer can eliminate partitions from the plan, it will. This fact increases availability for those applications that use the partition key in their queries.

Partitions also increase availability by reducing downtime. If you have a 100GB table, for example, and it is partitioned into 50 2GB partitions, then you can recover from errors that much faster. If one of the 2GB partitions is damaged, the time to recover is now the time it takes to restore and recover a 2GB partition, not a 100GB table. So availability is increased in two ways:

- Partition elimination by the optimizer means that many users may never even notice that some of the data was unavailable.
- Downtime is reduced in the event of an error because of the significantly reduced amount of work that is required to recover.

## Reduced Administrative Burden

The administrative burden relief is derived from the fact that performing operations on small objects is inherently easier, faster, and less resource intensive than performing the same operation on a large object.

For example, say you have a 10GB index in your database. If you need to rebuild this index and it is not partitioned, then you will have to rebuild the entire 10GB index as a single unit of work. While it is true that you could rebuild the index online, it requires a huge number of resources to completely rebuild an entire 10GB index. You'll need at least 10GB of free storage elsewhere to hold a copy of both indexes, you'll need a temporary transaction log table to record the changes made against the base table during the time you spend rebuilding the index, and so on.

On the other hand, if the index itself had been partitioned into ten 1GB partitions, then you could rebuild each index partition individually, one by one. Now you need 10 percent of the free space you needed previously. Likewise, the individual index rebuilds will each be much faster (ten times faster, perhaps), so far fewer transactional changes occurring during an online index rebuild need to be merged into the new index, and so on.

Also, consider what happens in the event of a system or software failure just before completing the rebuilding of a 10GB index. The entire effort is lost. By breaking the problem down and partitioning the index into 1GB partitions, at most you would lose 10 percent of the total work required to rebuild the index.

Last, but not least, it may be that you need to rebuild only 10 percent of the total aggregate index—for example, only the “newest” data (the active data) is subject to this reorganization, and all of the “older” data (which is relatively static) remains unaffected.

Another example could be that you discover 50 percent of the rows in your table are “migrated” rows (see Chapter 10 for details on migrated rows), and you would like to fix this. Having a partitioned table will facilitate the operation. To “fix” migrated rows, you must typically rebuild the object—in this case, a table. If you have one 100GB table, you will need to perform this operation in one very large chunk serially, using `ALTER TABLE MOVE`. On the other hand, if you have 25 partitions, each 4GB in size, then you can rebuild each partition one by one. Alternatively, if you are doing this during off-hours and have ample resources, you can even do the `ALTER TABLE MOVE` statements in parallel, in separate sessions, potentially reducing the amount of time the whole operation will take. Virtually everything you can do to a nonpartitioned object, you can do to an individual partition of a partitioned object. You might even discover that your migrated rows are concentrated in a very small subset of your partitions, hence you could rebuild one or two partitions instead of the entire table.

Here is a quick example demonstrating the rebuild of a table with many migrated rows. Both `BIG_TABLE1` and `BIG_TABLE2` were created from a 10,000,000-row instance of `BIG_TABLE` (see the “Setting up Your Environment” at the beginning of the book for the `BIG_TABLE` creation script). `BIG_TABLE1` is a regular, nonpartitioned table whereas `BIG_TABLE2` is a hash partitioned table in eight partitions (we’ll cover hash partitioning in detail in a subsequent section; suffice it to say, it distributed the data rather evenly into eight partitions). This example creates two tablespaces and then creates the two tables:

```
EODA@ORA12CR1> create tablespace big1 datafile size 1200m;
Tablespace created.
```

```
EODA@ORA12CR1> create tablespace big2 datafile size 1200m;
Tablespace created.
```

```
EODA@ORA12CR1> create table big_table1
 2 ( ID, OWNER, OBJECT_NAME, SUBOBJECT_NAME,
 3   OBJECT_ID, DATA_OBJECT_ID,
 4   OBJECT_TYPE, CREATED, LAST_DDL_TIME,
 5   TIMESTAMP, STATUS, TEMPORARY,
 6   GENERATED, SECONDARY )
 7 tablespace big1
 8 as
 9 select ID, OWNER, OBJECT_NAME, SUBOBJECT_NAME,
10        OBJECT_ID, DATA_OBJECT_ID,
11        OBJECT_TYPE, CREATED, LAST_DDL_TIME,
12        TIMESTAMP, STATUS, TEMPORARY,
13        GENERATED, SECONDARY
14 from big_table;
Table created.
```

```

EODA@ORA12CR1> create table big_table2
 2 ( ID, OWNER, OBJECT_NAME, SUBOBJECT_NAME,
 3   OBJECT_ID, DATA_OBJECT_ID,
 4   OBJECT_TYPE, CREATED, LAST_DDL_TIME,
 5   TIMESTAMP, STATUS, TEMPORARY,
 6   GENERATED, SECONDARY )
 7 partition by hash(id)
 8 (partition part_1 tablespace big2,
 9   partition part_2 tablespace big2,
10   partition part_3 tablespace big2,
11   partition part_4 tablespace big2,
12   partition part_5 tablespace big2,
13   partition part_6 tablespace big2,
14   partition part_7 tablespace big2,
15   partition part_8 tablespace big2
16 )
17 as
18 select ID, OWNER, OBJECT_NAME, SUBOBJECT_NAME,
19        OBJECT_ID, DATA_OBJECT_ID,
20        OBJECT_TYPE, CREATED, LAST_DDL_TIME,
21        TIMESTAMP, STATUS, TEMPORARY,
22        GENERATED, SECONDARY
23 from big_table;
Table created.

```

Now, each of those tables is in its own tablespace, so we can easily query the data dictionary to see the allocated and free space in each tablespace:

```

EODA@ORA12CR1> select b.tablespace_name,
 2         mbytes_alloc,
 3         mbytes_free
 4 from ( select round(sum(bytes)/1024/1024) mbytes_free,
 5         tablespace_name
 6         from dba_free_space
 7         group by tablespace_name ) a,
 8       ( select round(sum(bytes)/1024/1024) mbytes_alloc,
 9         tablespace_name
10        from dba_data_files
11        group by tablespace_name ) b
12 where a.tablespace_name (+) = b.tablespace_name
13       and b.tablespace_name in ('BIG1','BIG2')
14 /

```

TABLESPACE_NAME	MBYTES_ALLOC	MBYTES_FREE
BIG2	1200	175
BIG1	1200	223



BIG1 and BIG2 are both 1200 MB in size and each have about 200M of free space. We'll try to rebuild the first table, BIG\_TABLE1:

```
EODA@ORA12CR1> alter table big_table1 move;
alter table big_table1 move
*
ERROR at line 1:
ORA-01652: unable to extend temp segment by 1024 in tablespace BIG1
```

This fails—we need sufficient free space in tablespace BIG1 to hold an entire copy of BIG\_TABLE1 at the same time as the old copy is there—in short, we need about two times the storage for a short period (maybe more, maybe less—it depends on the resulting size of the rebuilt table). We now attempt the same operation on BIG\_TABLE2:

```
EODA@ORA12CR1> alter table big_table2 move;
alter table big_table2 move
*
ERROR at line 1:
ORA-14511: cannot perform operation on a partitioned object
```

This is Oracle telling us we can't do the MOVE operation on the *table*; we must perform the operation on each *partition* of the table instead. We can move (hence rebuild and reorganize) each partition one by one:

```
EODA@ORA12CR1> alter table big_table2 move partition part_1;
Table altered.
EODA@ORA12CR1> alter table big_table2 move partition part_2;
Table altered.
EODA@ORA12CR1> alter table big_table2 move partition part_3;
Table altered.
EODA@ORA12CR1> alter table big_table2 move partition part_4;
Table altered.
EODA@ORA12CR1> alter table big_table2 move partition part_5;
Table altered.
EODA@ORA12CR1> alter table big_table2 move partition part_6;
Table altered.
EODA@ORA12CR1> alter table big_table2 move partition part_7;
Table altered.
EODA@ORA12CR1> alter table big_table2 move partition part_8;
Table altered.
```

Each individual move only needs sufficient free space to hold a copy of one-eighth of the data! Therefore, these commands succeed given the same amount of free space as we had before. We need significantly less temporary resources and, further, if the system fails (e.g., due to a power outage) after we move PART\_4 but before PART\_5 finished moving, we won't lose all of the work performed: The first four partitions would still be moved when the system recovers, and we may resume processing at partition PART\_5.

Some may look at that and say, "Wow, eight statements—that is a lot of typing," and it's true that this sort of thing would be unreasonable if you had hundreds of partitions (or more). Fortunately, it is very easy to script a solution, and the previous would become simply:

```
EODA@ORA12CR1> begin
2     for x in ( select partition_name
3               from user_tab_partitions
4               where table_name = 'BIG_TABLE2' )
```

```

5      loop
6          execute immediate
7          'alter table big_table2 move partition ' ||
8          x.partition_name;
9      end loop;
10 end;
11 /

```

PL/SQL procedure successfully completed.

All of the information you need is there in the Oracle data dictionary, and most sites that have implemented partitioning also have a series of stored procedures they use to make managing large numbers of partitions easy. Additionally, many GUI tools such as Enterprise Manager have the built-in capability to perform these operations as well, without your needing to type in the individual commands.

Another factor to consider with regard to partitions and administration is the use of *sliding windows* of data in data warehousing and archiving. In many cases, you need to keep data online that spans the last N units of time. For example, say you need to keep the last 12 months or the last 5 years online. Without partitions, this is generally a massive INSERT followed by a massive DELETE two massive transactions. Lots of DML, and lots of redo and undo generated. Now with partitions, you can simply do the following:

1. Load a separate table with the new months' (or years', or whatever) data.
2. Index the table fully. (These steps could even be done in another instance and transported to this database).
3. Attach this newly loaded and indexed table onto the *end* of the partitioned table using a fast DDL command: ALTER TABLE EXCHANGE PARTITION.
4. Detach the oldest partition off the other end of the partitioned table.

So, you can now very easily support extremely large objects containing time-sensitive information. The old data can easily be removed from the partitioned table and simply *dropped* if you do not need it, or it can be archived off elsewhere. New data can be loaded into a separate table, so as to not affect the partitioned table until the loading, indexing, and so on is complete. We will take a look at a complete example of a sliding window later.

In short, partitioning can make what would otherwise be daunting, or in some cases unfeasible, operations as easy as they are in a small database.

## Enhanced Statement Performance

The third general (potential) benefit of partitioning is in the area of enhanced statement (SELECT, INSERT, UPDATE, DELETE, MERGE) performance. We'll take a look at two classes of statements—those that modify information and those that just read information—and discuss what benefits we might expect from partitioning in each case.

## Parallel DML

Statements that modify data in the database may have the potential to perform *parallel DML (PDML)*. During PDML, Oracle uses many threads or processes to perform your INSERT, UPDATE, DELETE or MERGE instead of a single serial process. On a multi-CPU machine with plenty of I/O bandwidth, the potential increase in speed may be large for mass DML operations. In releases of Oracle prior to 9i, PDML required partitioning. If your tables were not partitioned, you could not perform these operations in parallel in the earlier releases. If the tables were partitioned, Oracle would assign a *maximum* degree of parallelism to the object, based on the number of physical partitions it had. This restriction was, for the most part, relaxed in Oracle9i and later with two notable exceptions. If the table you wish to perform PDML on has a bitmap index or a LOB column, then the table must be partitioned in order to have the operation take place in parallel, and the degree of parallelism will be restricted to the number of partitions.

Having said that, we should also note starting with Oracle 12c, you can now perform PDML on SecureFiles LOBs without having to partition. In general, you no longer need to partition to use PDML.

---

■ **Note** We will cover parallel operations in more detail in Chapter 14.

---

## Query Performance

In the area of strictly read query performance (SELECT statements), partitioning comes into play with two types of specialized operations:

- *Partition elimination*: Some partitions of data are not considered in the processing of the query. We have already seen an example of partition elimination.
- *Parallel operations*: Examples of this are parallel full table scans and parallel index range scans.

However, the benefit you can derive from these depends very much on the type of system you are using.

## OLTP Systems

You should not look toward partitions as a way to massively improve query performance in an OLTP system. In fact, in a traditional OLTP system, you must apply partitioning with care so as to not *negatively* affect runtime performance. In a traditional OLTP system, most queries are expected to return virtually instantaneously, and most of the retrievals from the database are expected to be via very small index range scans. Therefore, the main performance benefits of partitioning listed previously would not come into play. Partition elimination is useful where you have full scans of large objects, because it allows you to avoid full scanning large pieces of an object. However, in an OLTP environment, *you are not full scanning* large objects (if you are, you have a serious design flaw). Even if you partition your indexes, any increase in performance achieved by scanning a smaller index will be miniscule—if you actually achieve an increase in speed at all. If some of your queries use an index *and* they cannot eliminate all but one partition from consideration, you may find your queries actually run slower after partitioning since you now have 5, 10, or 20 small indexes to probe, instead of one larger index. We will investigate this in much more detail later when we look at the types of partitioned indexes available to us.

As for parallel operations, as we'll investigate in more detail in the next chapter, you do not want to do a parallel query in an OLTP system. You would reserve your use of parallel operations for the DBA to perform rebuilds, create indexes, gather statistics, and so on. The fact is that in an OLTP system, your queries should already be characterized by very fast index accesses, and partitioning will not speed that up very much, if at all. This does not mean that you should avoid partitioning for OLTP; it means that you shouldn't expect partitioning to offer massive improvements in performance. Most OLTP applications are not able to take advantage of the times where partitioning is able to enhance query performance, but you can still benefit from the other possible partitioning benefits: administrative ease, higher availability, and reduced contention.

## Data Warehouse Systems

In a data warehouse/decision-support system, partitioning is not only a great administrative tool, but something that will speed up processing. For example, you may have a large table on which you need to perform an ad hoc query. You always do the ad hoc query by sales quarter, as each sales quarter contains hundreds of thousands of records and you have millions of online records. So, you want to query a relatively small slice of the entire data set, but it is not really feasible to index it based on the sales quarter. This index would point to hundreds of thousands of records,

and doing the index range scan in this way would be terrible (refer to Chapter 11 for more details on this). A full table scan is called for to process many of your queries, but you end up having to scan millions of records, most of which won't apply to your query. Using an intelligent partitioning scheme, you can segregate the data by quarter such that when you query the data for any given quarter, you will full scan only that quarter's data. This is the best of all possible solutions.

In addition, in a data warehouse/decision-support system environment, parallel query is used frequently. Here, operations such as parallel index range scans or parallel fast full index scans are not only meaningful, but also beneficial to us. We want to maximize our use of all available resources, and parallel query is a way to do it. So, in this environment, partitioning stands a very good chance of speeding up processing.

## Reduced Contention in an OLTP System

The last general benefit area for partitioning is potentially increasing concurrency by decreasing contention in an OLTP system. Partitions can be used to spread the modifications of a single table out over many physical partitions. The idea being if you have a segment experiencing high contention, turning it into many segments could have the side effect of reducing that contention proportionally.

For example, instead of having a single table segment with a single index segment, you might have 20 table partitions and 20 index partitions. It could be like having 20 tables instead of 1 (and 20 indexes instead of 1), hence contention would be decreased for this shared resource during modifications.

## Table Partitioning Schemes

There are currently nine methods by which you can partition tables in Oracle:

- *Range partitioning*: You may specify ranges of data that should be stored together. For example, everything that has a timestamp within the month of Jan-2014 will be stored in partition 1, everything with a timestamp within Feb-2014 in partition 2, and so on. This is probably the most commonly used partitioning mechanism in Oracle.
- *Hash partitioning*: You saw this in the first example in this chapter. A column (or columns) has a hash function applied to it, and the row will be placed into a partition according to the value of this hash.
- *List partitioning*: You specify a discrete set of values, which determines the data that should be stored together. For example, you could specify that rows with a STATUS column value in ( 'A', 'M', 'Z' ) go into partition 1, those with a STATUS value in ( 'D', 'P', 'Q' ) go into partition 2, and so on.
- *Interval partitioning*: This is very similar to range partitioning with the exception that the database itself can create new partitions as data arrives. With traditional range partitioning, the DBA was tasked with pre-creating partitions to hold every possible data value, for now and into the future. This typically meant that a DBA was tasked with creating partitions on a schedule—to hold next months' or next weeks' data. With interval partitioning, the database itself will create partitions as new data arrives that doesn't fit into any existing partition based on a rule specified by the DBA.
- *Reference partitioning*: This allows a child table in a parent/child relationship enforced by a foreign key to inherit the partitioning scheme of the parent table. This makes it possible to equi-partition a child table with its parent table without having to denormalize the data model. In the past, a table could only be partitioned based on attributes it physically stored; reference partitioning in effect allows you to partition a table based on attributes from its parent table.

- *Interval reference partitioning*: As the name implies, this is a combination of interval and reference partitioning. This partitioning type is available starting with Oracle 12c. It allows for the automatic adding of partitions to parent/child reference partitioned tables.
- *Virtual column partitioning*: This allows partitioning on an expression based on one or more existing columns of the table. The expression is stored as metadata only.
- *Composite partitioning*: This is a combination of range, hash, and list partitioning. It allows you to first apply one partitioning scheme to some data, and then within each resulting partition, have that partition subdivided into subpartitions using some other partitioning scheme.
- *System partitioning*: The application determines which partition a row is explicitly inserted into. This partitioning type has limited uses and won't be covered in this chapter; we only mention it here to complete the list of partition types that Oracle supports. For more details on system partitioning, see the Oracle *Database Cartridge Developer's Guide*.

In the following sections, we'll look at the benefits of each type of partitioning and at the differences between them. We'll also look at when to apply which schemes to different application types. This section is not intended to present a comprehensive demonstration of the syntax of partitioning and all of the available options. Rather, the examples are simple and illustrative, and designed to give you an overview of how partitioning works and how the different types of partitioning are designed to function.

---

■ **Note** For full details on partitioning syntax, I refer you to either the *Oracle Database SQL Language Reference* manual or to *Oracle Database Administrator's Guide*. Additionally, the *Oracle Database VLDB and Partitioning Guide* and *Oracle Database Data Warehousing Guide* are both excellent sources of information on the partitioning options and are must-reads for anyone planning to implement partitioning.

---

## Range Partitioning

The first type we will look at is a range partitioned table. The following CREATE TABLE statement creates a range partitioned table using the column RANGE\_KEY\_COLUMN. All data with a RANGE\_KEY\_COLUMN *strictly less than* 01-JAN-2014 will be placed into the partition PART\_1, and all data with a value *strictly less than* 01-JAN-2015 (and greater than or equal to 01-JAN-2014) will go into partition PART\_2. Any data not satisfying either of those conditions (e.g., a row with a RANGE\_KEY\_COLUMN value of 01-JAN-2015 or greater) will fail upon insertion, as it cannot be mapped to a partition:

```
EODA@ORA12CR1> CREATE TABLE range_example
 2 ( range_key_column date NOT NULL,
 3   data          varchar2(20)
 4 )
 5 PARTITION BY RANGE (range_key_column)
 6 ( PARTITION part_1 VALUES LESS THAN
 7   (to_date('01/01/2014', 'dd/mm/yyyy')),
 8   PARTITION part_2 VALUES LESS THAN
 9   (to_date('01/01/2015', 'dd/mm/yyyy'))
10 )
11 /
```

Table created.

■ **Note** We are using the date format DD/MM/YYYY in the CREATE TABLE statement to make this international. If we used a format of DD-MON-YYYY, then the CREATE TABLE would fail with ORA-01843: not a valid month if the abbreviation of January was not Jan on your system. The NLS\_LANGUAGE setting would affect this. I have used the three-character month abbreviation in the text and inserts, however, to avoid any ambiguity as to which component is the day and which is the month.

Figure 13-1 shows that Oracle will inspect the value of the RANGE\_KEY\_COLUMN and, based on that value, insert it into one of the two partitions.

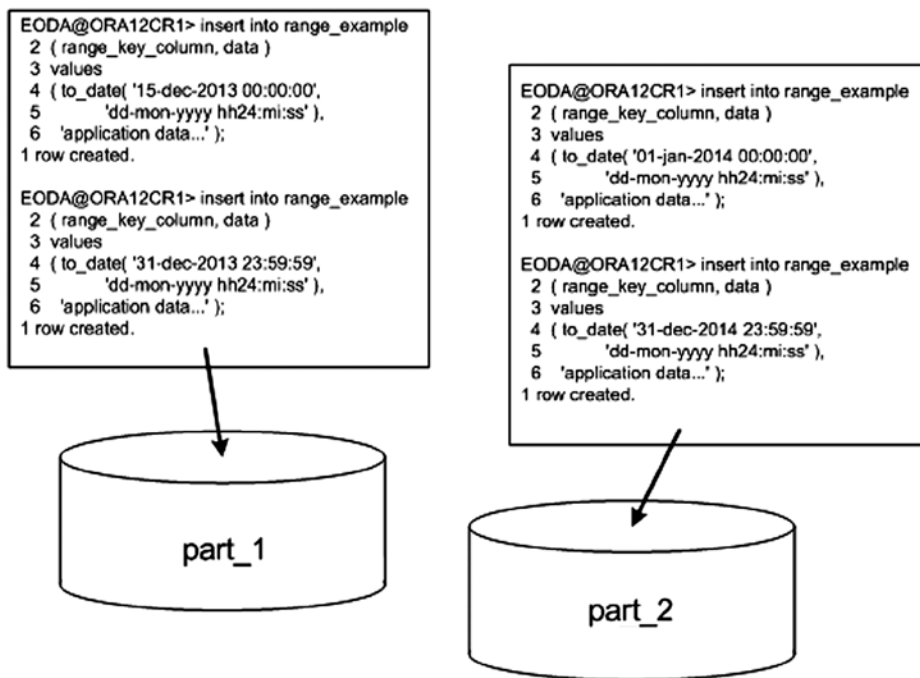

**Figure 13-1.** Range partition insert example

The rows inserted were specifically chosen with the goal of demonstrating that the partition range is strictly *less than* and not *less than or equal to*. We first insert the value 15-DEC-2013, which will definitely go into partition PART\_1. We also insert a row with a date/time that is one second before 01-JAN-2014—that row will also go into partition PART\_1 since that is *less than* 01-JAN-2014. However, the next insert of midnight on 01-JAN-2014 goes into partition PART\_2 because that date/time is not strictly less than the partition range boundary for PART\_1. The last row obviously belongs in partition PART\_2 since it is greater than or equal to the partition range boundary for PART\_1 and less than the partition range boundary for PART\_2.

We can confirm that this is the case by performing SELECT statements from the individual partitions:

```

EODA@ORA12CR1> select to_char(range_key_column,'dd-mon-yyyy hh24:mi:ss')
 2   from range_example partition (part_1);

```

```
TO_CHAR(RANGE_KEY_COLUMN, 'DD-
-----
15-dec-2013 00:00:00
31-dec-2013 23:59:59
```

```
EODA@ORA12CR1> select to_char(range_key_column, 'dd-mon-yyyy hh24:mi:ss')
2   from range_example partition (part_2);
```

```
TO_CHAR(RANGE_KEY_COLUMN, 'DD-
-----
01-jan-2014 00:00:00
31-dec-2014 23:59:59
```

You might be wondering what would happen if you inserted a date that fell outside of the upper bound. The answer is that Oracle would raise an error:

```
EODA@ORA12CR1> insert into range_example
2 ( range_key_column, data )
3 values
4 ( to_date( '01-jan-2015 00:00:00',
5           'dd-mon-yyyy hh24:mi:ss' ),
6   'application data...' );
insert into range_example
*
ERROR at line 1:
ORA-14400: inserted partition key does not map to any partition
```

There are two approaches to the preceding situation—one would be to use Interval partitioning described later or to use a catch-all partition, which we'll demonstrate now. Suppose you want to segregate 2013 and 2014 dates into their separate partitions as we have, but you want all other dates to go into a third partition. With range partitioning, you can do this using the MAXVALUE clause, which looks like this:

```
EODA@ORA12CR1> CREATE TABLE range_example
2 ( range_key_column date,
3   data          varchar2(20)
4 )
5 PARTITION BY RANGE (range_key_column)
6 ( PARTITION part_1 VALUES LESS THAN
7   (to_date('01/01/2014', 'dd/mm/yyyy')),
8   PARTITION part_2 VALUES LESS THAN
9   (to_date('01/01/2015', 'dd/mm/yyyy')),
10  PARTITION part_3 VALUES LESS THAN
11  (MAXVALUE)
12 )
13 /
Table created.
```

Now when you insert a row into that table, it will go into one of the three partitions—no row will be rejected, since partition PART\_3 can take any value of RANGE\_KEY\_COLUMN that doesn't go into PART\_1 or PART\_2 (even null values of the RANGE\_KEY\_COLUMN will be inserted into this new partition).

## Hash Partitioning

When *hash* partitioning a table, Oracle will apply a hash function to the partition key to determine in which of the N partitions the data should be placed. Oracle recommends that N be a number that is a power of 2 (2, 4, 8, 16, and so on) to achieve the best overall distribution, and we'll see shortly that this is absolutely good advice.

### How Hash Partitioning Works

Hash partitioning is designed to achieve a good spread of data across many different devices (disks), or just to segregate data out into more manageable chunks. The hash key chosen for a table should be a column or set of columns that are unique, or at least have as many distinct values as possible to provide for a good spread of the rows across partitions. If you choose a column that has only four values, and you use two partitions, then all the rows could quite easily end up hashing *to the same partition*, obviating the goal of partitioning in the first place!

We will create a hash table with two partitions in this case. We will use a column named `HASH_KEY_COLUMN` as our partition key. Oracle will take the value in this column and determine the partition this row will be stored in by hashing that value:

```
EODA@ORA12CR1> CREATE TABLE hash_example
 2 ( hash_key_column  date,
 3   data              varchar2(20)
 4 )
 5 PARTITION BY HASH (hash_key_column)
 6 ( partition part_1 tablespace p1,
 7   partition part_2 tablespace p2
 8 )
 9 /
Table created.
```

Figure 13-2 shows that Oracle will inspect the value in the `HASH_KEY_COLUMN`, hash it, and determine which of the two partitions a given row will appear in.



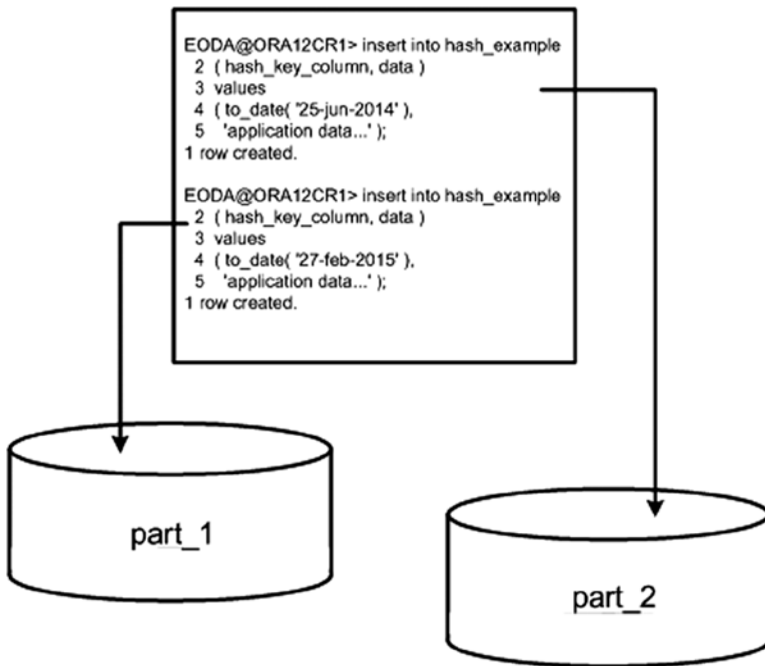

**Figure 13-2.** Hash partition insert example

As noted earlier, hash partitioning gives you no control over which partition a row ends up in. Oracle applies the hash function and the outcome of that hash determines where the row goes. If you want a specific row to go into partition PART\_1 for whatever reason, you should *not*—in fact, you *cannot*—use hash partitioning. The row will go into whatever partition the hash function says to put it in. If you change the number of hash partitions, the data will be redistributed over all of the partitions (adding or removing a partition to a hash partitioned table will cause all of the data to be rewritten, as every row may now belong in a different partition).

Hash partitioning is most useful when you have a large table, such as the one shown in the “Reduced Administrative Burden” section, and you would like to *divide and conquer* it. Rather than manage one large table, you would like to have 8 or 16 smaller tables to manage. Hash partitioning is also useful to increase availability to some degree, as demonstrated in the “Increased Availability” section; the temporary loss of a single hash partition permits access to all of the remaining partitions. Some users may be affected, but there is a good chance that many will not be. Additionally, the unit of recovery is much smaller now. You do not have a single large table to restore and recover; you have a fraction of that table to recover. Lastly, hash partitioning is useful in high update contention environments, as mentioned in the “Reduced Contention in an OLTP System” section. Instead of having a single hot segment, we can hash partition a segment into 16 pieces, each of which is now receiving modifications.

## Hash Partition Using Powers of Two

I mentioned earlier that the number of partitions should be a power of two. This is easily observed to be true. To demonstrate, we'll set up a stored procedure to automate the creation of a hash partitioned table with N partitions (N will be a parameter). This procedure will construct a dynamic query to retrieve the counts of rows by partition and then display the counts and a simple histogram of the counts by partition. Lastly, it will open this query and let us see the results. This procedure starts with the hash table creation. We will use a table named T:

```
EODA@ORA12CR1> create or replace
 2 procedure hash_proc
 3     ( p_nhash in number,
 4       p_cursor out sys_refcursor )
 5 authid current_user
 6 as
 7     l_text      long;
 8     l_template long :=
 9         'select $POS$ oc, ''p$POS$'' pname, count(*) cnt ' ||
10         'from t partition ( $PNAME$ ) union all ';
11     table_or_view_does_not_exist exception;
12     pragma exception_init( table_or_view_does_not_exist, -942 );
13 begin
14     begin
15         execute immediate 'drop table t';
16     exception when table_or_view_does_not_exist
17         then null;
18     end;
19
20     execute immediate '
21 CREATE TABLE t ( id )
22 partition by hash(id)
23 partitions ' || p_nhash || '
24 as
25 select rownum
26     from all_objects';
```

Next, we will dynamically construct a query to retrieve the count of rows by partition. It does this using the template query defined earlier. For each partition, we'll gather the count using the partition-extended table name and union all of the counts together:

```
28     for x in ( select partition_name pname,
29                 PARTITION_POSITION pos
30                 from user_tab_partitions
31                 where table_name = 'T'
32                 order by partition_position )
33 loop
34     l_text := l_text ||
35         replace(
36             replace(l_template,
37                 '$POS$', x.pos),
38             '$PNAME$', x.pname );
39 end loop;
```

Now, we'll take that query and select out the partition position (PNAME) and the count of rows in that partition (CNT). Using RPAD, we'll construct a rather rudimentary but effective histogram:

```

41     open p_cursor for
42         'select pname, cnt,
43             substr( rpad('* ',30*round( cnt/max(cnt)over(),2), '* '),1,30) hg
44             from ( || substr( l_text, 1, length(l_text)-11 ) || ' )
45             order by oc';
46
47 end;
48 /

```

Procedure created.

If we run this with an input of 4, for four hash partitions, we would expect to see output similar to the following:

```

EODA@ORA12CR1> variable x refcursor
EODA@ORA12CR1> set autoprint on
EODA@ORA12CR1> exec hash_proc( 4, :x );
PL/SQL procedure successfully completed.

```

PN	CNT	HG
p1	12141	*****
p2	12178	*****
p3	12417	*****
p4	12105	*****

The simple histogram depicted shows a nice, even distribution of data over each of the four partitions. Each has close to the same number of rows in it. However, if we simply go from four to five hash partitions, we'll see the following:

```

EODA@ORA12CR1> exec hash_proc( 5, :x );
PL/SQL procedure successfully completed.

```

PN	CNT	HG
p1	6102	*****
p2	12180	*****
p3	12419	*****
p4	12106	*****
p5	6040	*****

This histogram points out that the first and last partitions have just half as many rows as the interior partitions. The data is not very evenly distributed at all. We'll see the trend continue for six and seven hash partitions:

```
EODA@ORA12CR1> exec hash_proc( 6, :x );
PL/SQL procedure successfully completed.
```

PN	CNT	HG
p1	6104	*****
p2	6175	*****
p3	12420	*****
p4	12106	*****
p5	6040	*****
p6	6009	*****

6 rows selected.

```
EODA@ORA12CR1> exec hash_proc( 7, :x );
PL/SQL procedure successfully completed.
```

PN	CNT	HG
p1	6105	*****
p2	6176	*****
p3	6161	*****
p4	12106	*****
p5	6041	*****
p6	6010	*****
p7	6263	*****

7 rows selected.

As soon as we get back to a number of hash partitions that is a power of two, we achieve the goal of even distribution once again:

```
EODA@ORA12CR1> exec hash_proc( 8, :x );
PL/SQL procedure successfully completed.
```

PN	CNT	HG
p1	6106	*****
p2	6178	*****
p3	6163	*****
p4	6019	*****
p5	6042	*****
p6	6010	*****
p7	6264	*****
p8	6089	*****

8 rows selected.

If we continue this experiment up to 16 partitions, we would see the same effects for the ninth through the fifteenth partitions—a skewing of the data to the interior partitions, away from the edges—and then upon hitting the sixteenth partition, you would see a flattening-out again. The same would be true again up to 32 partitions, and then 64, and so on. This example just points out the importance of using a power of two as the number of hash partitions.

## List Partitioning

List partitioning was a new feature of Oracle9i Release 1. It provides the ability to specify in which partition a row will reside, based on discrete lists of values. It is often useful to be able to partition by some code, such as a state or region code. For example, we might want to pull together in a single partition all records for people in the states of Maine (ME), New Hampshire (NH), Vermont (VT), and Massachusetts (MA), since those states are located next to or near each other and our application queries data by geographic region. Similarly, we might want to group together Connecticut (CT), Rhode Island (RI), and New York (NY).

We can't use a range partition, since the range for the first partition would be ME through VT, and the second range would be CT through RI. Those ranges overlap. We can't use hash partitioning since we can't control which partition any given row goes into; the built-in hash function provided by Oracle does that.

With list partitioning, we can accomplish this custom partitioning scheme easily:

```
EODA@ORA12CR1> create table list_example
 2 ( state_cd  varchar2(2),
 3   data      varchar2(20)
 4 )
 5 partition by list(state_cd)
 6 ( partition part_1 values ( 'ME', 'NH', 'VT', 'MA' ),
 7   partition part_2 values ( 'CT', 'RI', 'NY' )
 8 )
 9 /
Table created.
```

Figure 13-3 shows that Oracle will inspect the STATE\_CD column and, based on its value, place the row into the correct partition.

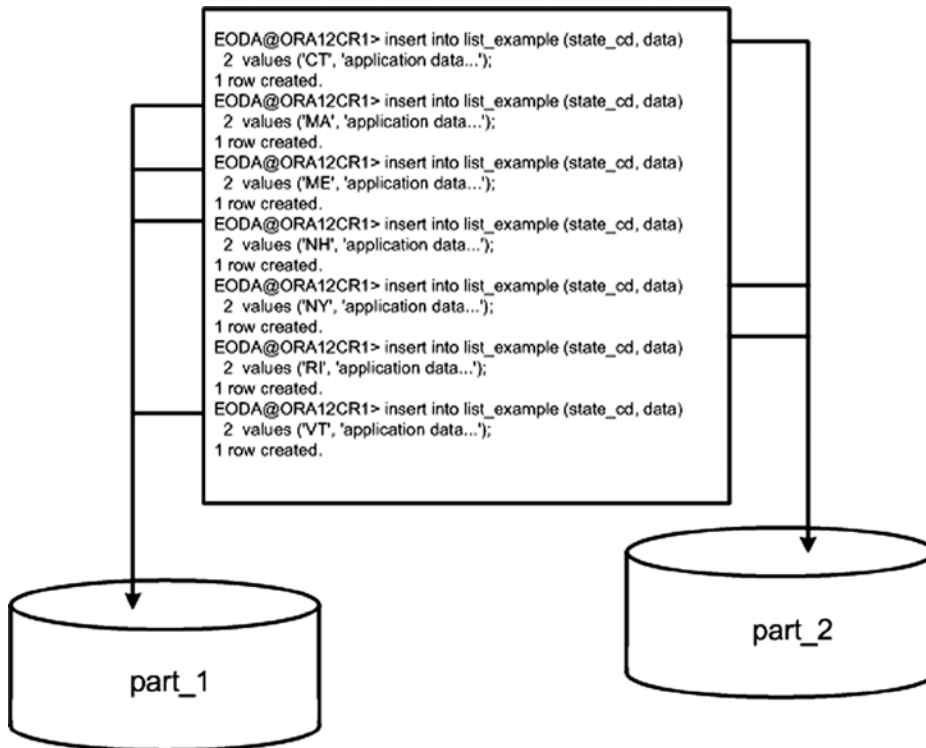

**Figure 13-3.** List partition insert example

As we saw for range partitioning, if we try to insert a value that isn't specified in the list partition, Oracle will raise an appropriate error back to the client application. In other words, a list partitioned table without a DEFAULT partition will implicitly impose a constraint much like a check constraint on the table:

```

EODA@ORA12CR1> insert into list_example values ( 'VA', 'data' );
insert into list_example values ( 'VA', 'data' )
*
ERROR at line 1:
ORA-14400: inserted partition key does not map to any partition

```

If we want to segregate these seven states into their separate partitions, as we have, but have all remaining state codes (or, in fact, any other row that happens to be inserted that doesn't have one of these seven codes) go into a third partition, then we can use the VALUES ( DEFAULT ) clause. Here, we'll alter the table to add this partition (we could use this in the CREATE TABLE statement as well):

```

EODA@ORA12CR1> alter table list_example
  2 add partition
  3 part_3 values ( DEFAULT );
Table altered.

EODA@ORA12CR1> insert into list_example values ( 'VA', 'data' );
1 row created.

```

All values that are not explicitly in our list of values will go here. A word of caution on the use of DEFAULT: once a list partitioned table has a DEFAULT partition, you cannot add any more partitions to it. So:

```
EODA@ORA12CR1> alter table list_example
 2 add partition
 3 part_4 values( 'CA', 'NM' );
alter table list_example
      *
ERROR at line 1:
ORA-14323: cannot add partition when DEFAULT partition exists
```

We would have to remove the DEFAULT partition, then add PART\_4, and then put the DEFAULT partition back. The reason behind this is that the DEFAULT partition could have had rows with the list partition key value of CA or NM—they would not belong in the DEFAULT partition after adding PART\_4.

## Interval Partitioning

Interval partitioning is a feature available in Oracle Database 11g Release 1 and above. It is very similar to range partitioning described previously—in fact, it starts with a range partitioned table but adds a rule (the interval) to the definition so the database knows how to add partitions in the future.

The goal of interval partitioning is to create new partitions for data—if, and only if, data exists for a given partition and only when that data arrives in the database. In other words, to remove the need to pre-create partitions for data, to allow the data itself to create the partition as it is inserted. To use interval partitioning, you start with a range partitioned table without a MAXVALUE partition and specify an interval to add to the *upper bound*, the highest value of that partitioned table to create a new range. You need to have a table that is range partitioned on a single column that permits adding a NUMBER or INTERVAL type to it (e.g. a table partitioned by a VARCHAR2 field cannot be interval partitioned; there is nothing you can add to a VARCHAR2). You can use interval partitioning with any suitable existing range partitioned table; that is, you can ALTER an existing range partitioned table to be interval partitioned, or you can create one with the CREATE TABLE command.

For example, suppose you had a range partitioned table that said “anything strictly less than 01-JAN-2015 (data in the year 2014 and before) goes into partition P1—and that was it. So it had one partition for all data in the year 2014 and before. If you attempted to insert data for the year 2015 into the table, the insert would fail as demonstrated previously in the section on range partitioning. With interval partitioning you can create a table and specify both a range (strictly less than 01-JAN-2015) and an interval—say 1 month in duration—and the database would create monthly partitions (a partition capable of holding exactly one month’s worth of data) as the data arrived. The database would not pre-create all possible partitions because that would not be practical. But, as each row arrived the database would see whether the partition for the month in question existed. The database would create the partition if needed.

Here is an example of the syntax:

```
EODA@ORA12CR1> create table audit_trail
 2 ( ts timestamp,
 3 data varchar2(30)
 4 )
 5 partition by range(ts)
 6 interval (numtoyminterval(1,'month'))
 7 store in (users, example )
 8 (partition p0 values less than
 9 (to_date('01-01-1900', 'dd-mm-yyyy'))
10 )
11 /
```

Table created.

■ **Note** You might have a question in your mind, especially if you just finished reading the previous chapter on datatypes. You can see we are partitioning by a `TIMESTAMP` and we are adding an `INTERVAL` of one month to it. In the “Datatypes” chapter, we saw how adding an `INTERVAL` of one month to a `TIMESTAMP` that fell on January 31<sup>st</sup> would raise an error, since there is no February 31<sup>st</sup>. Will the same issue happen with interval partitioning? The answer is yes, if you attempt to use a date such as '29-01-1990' (any day of the month after 28 would suffice), you will receive an error "ORA-14767: Cannot specify this interval with existing high bounds". The database will not permit you to use a boundary value that is not safe to add the interval to.

On lines 8 and 9, you see the range partitioning scheme for this table; it starts with a single empty partition that would contain any data prior to 01-JAN-1900. Presumably, since the table holds an audit trail, this partition will remain small and empty forever. It is a mandatory partition and is referred to as the *transitional* partition. All data that is strictly less than this current high value partition will be range partitioned, using traditional range partitioning. Only data that is created *above* the transitional partition high value will use interval partitioning. If we query the data dictionary we can see what has been created so far:

```
EODA@ORA12CR1> select a.partition_name, a.tablespace_name, a.high_value,
 2      decode( a.interval, 'YES', b.interval ) interval
 3 from user_tab_partitions a, user_part_tables b
 4 where a.table_name = 'AUDIT_TRAIL'
 5 and a.table_name = b.table_name
 6 order by a.partition_position;
```

PARTITION_	TABLESPACE	HIGH_VALUE	INTERVAL
P0	USERS	TIMESTAMP' 1900-01-01 00:00:00'	

So far, we have just the single partition and it is not an `INTERVAL` partition, as shown by the empty `INTERVAL` column. Rather it is just a regular `RANGE` partition right now; it will hold anything strictly less than 01-JAN-1900.

Looking at the `CREATE TABLE` statement again, we can see the new interval partitioning specific information on lines 6 through 7:

```
6 interval (numtoyminterval(1,'month'))
7 store in (users, example )
```

On line 6 we have the actual interval specification of `NUMTOYMINTERVAL(1, 'MONTH')`. Our goal was to store monthly partitions—a new partition for each month’s worth of data—a very common goal. By using a date that is safe to add a month to (refer to Chapter 12 for why adding a month to a timestamp can be error prone in some cases)—the first of the month—we can have the database create monthly partitions on the fly, as data arrives, for us.

On line 7 we have specifics: `store in (users, example)`. This allows us to tell the database where to create these new partitions—what tablespaces to use. As the database figures out what partitions it wants to create, it uses this list to decide what tablespace to create each partition in. This allows the DBA to control the maximum desired tablespace size: they might not want a single 500GB tablespace but they would be comfortable with 10 50GB tablespaces. In that case, they would set up 10 tablespaces and allow the database to use all 10 to create partitions.

Let’s insert a row of data now and see what happens:

```
EODA@ORA12CR1> insert into audit_trail (ts,data) values
 2 ( to_timestamp('27-feb-2014','dd-mon-yyyy'), 'xx' );
1 row created.
```



```

EODA@ORA12CR1> select a.partition_name, a.tablespace_name, a.high_value,
2      decode( a.interval, 'YES', b.interval ) interval
3  from user_tab_partitions a, user_part_tables b
4  where a.table_name = 'AUDIT_TRAIL'
5     and a.table_name = b.table_name
6     order by a.partition_position;

```

PARTITION_	TABLESPACE	HIGH_VALUE	INTERVAL
P0	USERS	TIMESTAMP' 1900-01-01 00:00:00'	
SYS_P1623	USERS	TIMESTAMP' 2014-03-01 00:00:00'	NUMTOYMINTERVAL(1, 'MONTH')

If you recall from the range partition section, you would expect that INSERT to fail. However, since we are using interval partitioning, it succeeds and, in fact, creates a new partition SYS\_P1623. The HIGH\_VALUE for this partition is 01-MAR-2014 which, if we were using range partitioning, would imply anything strictly less than 01-MAR-2014 and greater than or equal to 01-JAN-1900 would go into this partition, but since we have an interval the rules are different. When the interval is set, the range for this partition is anything greater than or equal to the HIGH\_VALUE - INTERVAL and strictly less than the HIGH\_VALUE. So, this partition would have the range of:

```

EODA@ORA12CR1> select TIMESTAMP' 2014-03-01 00:00:00'-NUMTOYMINTERVAL(1, 'MONTH') ←
greater_than_eq_to,
2      TIMESTAMP' 2014-03-01 00:00:00' strictly_less_than
3  from dual
4  /

```

GREATER\_THAN\_EQ\_TO

STRICTLY\_LESS\_THAN

```

01-FEB-14 12.00.00.000000000 AM
01-MAR-14 12.00.00.000000000 AM

```

That is—all of the data for the month of February, 2014. If we insert another row in some other month, as follows, we can see that another partition, SYS\_P1624, is added that contains all of the data for the month of June, 2014:

```

EODA@ORA12CR1> insert into audit_trail (ts,data) values
2  ( to_date('25-jun-2014','dd-mon-yyyy'), 'xx' );

```

1 row created.

```

EODA@ORA12CR1> select a.partition_name, a.tablespace_name, a.high_value,
2      decode( a.interval, 'YES', b.interval ) interval
3  from user_tab_partitions a, user_part_tables b
4  where a.table_name = 'AUDIT_TRAIL'
5     and a.table_name = b.table_name
6     order by a.partition_position;

```

PARTITION_	TABLESPACE	HIGH_VALUE	INTERVAL
P0	USERS	TIMESTAMP' 1900-01-01 00:00:00'	
SYS_P1623	USERS	TIMESTAMP' 2014-03-01 00:00:00'	NUMTOYMINTERVAL(1, 'MONTH')
SYS_P1624	USERS	TIMESTAMP' 2014-07-01 00:00:00'	NUMTOYMINTERVAL(1, 'MONTH')

You might be looking at this output and asking why everything is in the USERS tablespace. We clearly asked for the data to be spread out over the USERS tablespace and the EXAMPLE tablespace, so why is everything in a single tablespace? It has to do with the fact that when the database is figuring out what partition the data goes into, it is also computing which tablespace it would go into. Since each of our partitions is an even number of months away from each other and we are using just two tablespaces, we end up using the same tablespace over and over. If we only loaded “every other month” into this table, we would end up using only a single tablespace. We can see that the EXAMPLE tablespace can be used by adding some row that is an ‘odd’ number of months away from our existing data:

```
EODA@ORA12CR1> insert into audit_trail (ts,data) values
  2 ( to_date('15-mar-2014','dd-mon-yyyy'), 'xx' );
1 row created.
```

```
EODA@ORA12CR1> select a.partition_name, a.tablespace_name, a.high_value,
  2 decode( a.interval, 'YES', b.interval ) interval
  3 from user_tab_partitions a, user_part_tables b
  4 where a.table_name = 'AUDIT_TRAIL'
  5 and a.table_name = b.table_name
  6 order by a.partition_position;
```

PARTITION_	TABLESPACE	HIGH_VALUE	INTERVAL
PO	USERS	TIMESTAMP' 1900-01-01 00:00:00'	
SYS_P1623	USERS	TIMESTAMP' 2014-03-01 00:00:00'	NUMTOYMINTERVAL(1,'MONTH')
SYS_P1625	EXAMPLE	TIMESTAMP' 2014-04-01 00:00:00'	NUMTOYMINTERVAL(1,'MONTH')
SYS_P1624	USERS	TIMESTAMP' 2014-07-01 00:00:00'	NUMTOYMINTERVAL(1,'MONTH')

Now we have used the EXAMPLE tablespace. This new partition was slid in between the two existing partitions and will contain all of our March 2014 data.

You might be asking, “What happens if I rollback at this point?” If we were to rollback, it should be obvious that the AUDIT\_TRAIL rows we just inserted would go away:

```
EODA@ORA12CR1> select * from audit_trail;
```

TS	DATA
27-FEB-14 12.00.00.000000 AM	xx
15-MAR-14 12.00.00.000000 AM	xx
25-JUN-14 12.00.00.000000 AM	xx

```
EODA@ORA12CR1> rollback;
Rollback complete.
```

```
EODA@ORA12CR1> select * from audit_trail;
no rows selected
```

But what isn’t clear immediately is what would happen to the partitions we added: do they stay or will they go away as well? A quick query will verify that they will stay:

```
EODA@ORA12CR1> select a.partition_name, a.tablespace_name, a.high_value,
  2 decode( a.interval, 'YES', b.interval ) interval
  3 from user_tab_partitions a, user_part_tables b
  4 where a.table_name = 'AUDIT_TRAIL'
```

```

5  and a.table_name = b.table_name
6  order by a.partition_position;

```

PARTITION_	TABLESPACE	HIGH_VALUE	INTERVAL
P0	USERS	TIMESTAMP' 1900-01-01 00:00:00'	
SYS_P1623	USERS	TIMESTAMP' 2014-03-01 00:00:00'	NUMTOYMINTERVAL(1, 'MONTH')
SYS_P1625	EXAMPLE	TIMESTAMP' 2014-04-01 00:00:00'	NUMTOYMINTERVAL(1, 'MONTH')
SYS_P1624	USERS	TIMESTAMP' 2014-07-01 00:00:00'	NUMTOYMINTERVAL(1, 'MONTH')

As soon as they are created, they are committed and visible. These partitions are created using a *recursive* transaction, a transaction executed separate and distinct from any transaction you might already be performing. When we went to insert the row and the database discovered that the partition we needed did not exist, the database immediately started a new transaction, updated the data dictionary to reflect the new partition's existence, and committed its work. It must do this, or there would be severe contention (serialization) on many inserts as other transactions would have to wait for us to commit to be able to see this new partition. Therefore, this DDL is done outside of your existing transaction and the partitions will persist.

You might have noticed that the database names the partition for us; SYS\_P1625 is the name of the newest partition. The names are not sortable nor very meaningful in the sense most people would be used to. They show the order in which the partitions were added to the table (although you cannot rely on that always being true; it is subject to change) but not much else. Normally, in a range partitioned table, the DBA would have named the partition using some naming scheme and in most cases would have made the partition names sortable. For example, the February data would be in a partition named PART\_2014\_02 (using a format of PART\_yyyy\_mm), March would be in PART\_2014\_03, and so on. With interval partitioning, you have no control over the partition names as they are created, but you can easily rename them afterward if you like. For example, we could query out the HIGH\_VALUE string and using dynamic SQL convert that into nicely formatted, meaningful names. We can do this because we understand how we'd like the names formatted; the database does not. For example:

```

EODA@ORA12CR1> declare
2     l_str varchar2(4000);
3  begin
4     for x in ( select a.partition_name, a.tablespace_name, a.high_value
5                from user_tab_partitions a
6                where a.table_name = 'AUDIT_TRAIL'
7                      and a.interval = 'YES'
8                      and a.partition_name like 'SYS\P%' escape '\' )
9     loop
10        execute immediate
11        'select to_char( ' || x.high_value ||
12            '-numtodsinterval(1, ''second''), ''PART_''yyyy_mm'' ) from dual'
13        into l_str;
14        execute immediate
15        'alter table audit_trail rename partition "' ||
16            x.partition_name || "' to "' || l_str || "'";
17    end loop;
18 end;
19 /

```

PL/SQL procedure successfully completed.

So, what we've done is take the `HIGH_VALUE` and subtract one second from it. We know that the `HIGH_VALUE` represents the *strictly less than* value, so one second before its value would be a value in the range. Once we have that, we applied the format "PART\_"yyyy\_mm to the resulting `TIMESTAMP` and get a string such as `PART_2014_03` for March 2014. We use that string in a rename command and now our data dictionary looks like this:

```
EODA@ORA12CR1> select a.partition_name, a.tablespace_name, a.high_value,
2      decode( a.interval, 'YES', b.interval ) interval
3      from user_tab_partitions a, user_part_tables b
4      where a.table_name = 'AUDIT_TRAIL'
5            and a.table_name = b.table_name
6      order by a.partition_position;
```

PARTITION_NAME	TABLESPACE	HIGH_VALUE	INTERVAL
PO	USERS	TIMESTAMP' 1900-01-01 00:00:00'	
PART_2014_02	USERS	TIMESTAMP' 2014-03-01 00:00:00'	NUMTOYMINTERVAL(1, 'MONTH')
PART_2014_03	EXAMPLE	TIMESTAMP' 2014-04-01 00:00:00'	NUMTOYMINTERVAL(1, 'MONTH')
PART_2014_06	USERS	TIMESTAMP' 2014-07-01 00:00:00'	NUMTOYMINTERVAL(1, 'MONTH')

We would just run that script every now and then to rename any newly added partitions to keep the nice naming convention in place. Bear in mind, to avoid any SQL Injection issues (we are using string concatenation, not bind variables; we cannot use bind variables in DDL) we would want to keep this script as an anonymous block or as an invoker's rights routine if we decide to make it a stored procedure. That will prevent others from running SQL in our schema as if they were us, which could be a disaster.

## Reference Partitioning

Reference partitioning is a feature of Oracle Database 11g Release 1 and above. It addresses the issue of parent/child equi-partitioning; that is, when you need the child table to be partitioned in such a manner that each child table partition has a one-to-one relationship with a parent table partition. This is important in situations such as a data warehouse where you want to keep a specific amount of data online (say the last five years' worth of `ORDER` information) and need to ensure the related child data (the `ORDER_LINE_ITEMS` data) is online as well. In this classic example, the `ORDERS` table would typically have a column `ORDER_DATE`, making it easy to partition by month and thus facilitate keeping the last five years of data online easily. As time advances, you would just have next month's partition available for loading and you would drop the oldest partition. However, when you consider the `ORDER_LINE_ITEMS` table, you can see you would have a problem. It does not have the `ORDER_DATE` column, there is nothing in the `ORDER_LINE_ITEMS` table to partition it by; therefore, it's not facilitating the purging of old information or loading of new information.

In the past, prior to reference partitioning, developers would have to denormalize the data, in effect copying the `ORDER_DATE` attribute from the parent table `ORDERS` into the child `ORDER_LINE_ITEMS` table. This presented the typical problems of data redundancy, that of increased storage overhead, increased data loading resources, cascading update issues (if you modify the parent, you have to ensure you update all copies of the parent data) and so on. Additionally, if you enabled foreign key constraints in the database (as you should), you would discover that you lost the ability to truncate or drop old partitions in the parent table. For example, let's set up the conventional `ORDERS` and `ORDER_LINE_ITEMS` tables starting with the `ORDERS` table:

```
EODA@ORA12CR1> create table orders
2 (
3   order#      number primary key,
4   order_date  date,
5   data        varchar2(30)
6 )
```

```

7 enable row movement
8 PARTITION BY RANGE (order_date)
9 (
10 PARTITION part_2014 VALUES LESS THAN (to_date('01-01-2015','dd-mm-yyyy')) ,
11 PARTITION part_2015 VALUES LESS THAN (to_date('01-01-2016','dd-mm-yyyy'))
12 )
13 /
Table created.

```

```

EODA@ORA12CR1> insert into orders values
2 ( 1, to_date( '01-jun-2014', 'dd-mon-yyyy' ), 'xxx' );
1 row created.

```

```

EODA@ORA12CR1> insert into orders values
2 ( 2, to_date( '01-jun-2015', 'dd-mon-yyyy' ), 'xxx' );
1 row created.

```

And now we'll create the ORDER\_LINE\_ITEMS table – with a bit of data pointing to the ORDERS table:

```

EODA@ORA12CR1> create table order_line_items
2 (
3 order#      number,
4 line#      number,
5 order_date  date, -- manually copied from ORDERS!
6 data       varchar2(30),
7 constraint c1_pk primary key(order#,line#),
8 constraint c1_fk_p foreign key(order#) references orders
9 )
10 enable row movement
11 PARTITION BY RANGE (order_date)
12 (
13 PARTITION part_2014 VALUES LESS THAN (to_date('01-01-2015','dd-mm-yyyy')) ,
14 PARTITION part_2015 VALUES LESS THAN (to_date('01-01-2016','dd-mm-yyyy'))
15 )
16 /
Table created.

```

```

EODA@ORA12CR1> insert into order_line_items values
2 ( 1, 1, to_date( '01-jun-2014', 'dd-mon-yyyy' ), 'yyy' );
1 row created.

```

```

EODA@ORA12CR1> insert into order_line_items values
2 ( 2, 1, to_date( '01-jun-2015', 'dd-mon-yyyy' ), 'yyy' );
1 row created.

```

Now, if we were to drop the `ORDER_LINE_ITEMS` partition containing 2014 data, you know and I know that the corresponding `ORDERS` partition for 2014 could be dropped as well, without violating the referential integrity constraint. You and I know it, but the database is not aware of that fact:

```
EODA@ORA12CR1> alter table order_line_items drop partition part_2014;
Table altered.
```

```
EODA@ORA12CR1> alter table orders drop partition part_2014;
alter table orders drop partition part_2014
*
```

```
ERROR at line 1:
ORA-02266: unique/primary keys in table referenced by enabled foreign keys
```

So, not only is the approach of denormalizing the data cumbersome, resource intensive, and potentially damaging to our data integrity, it prevents us from doing something we frequently need to do when administering partitioned tables: purging old information.

Enter reference partitioning. With reference partitioning, a child table will inherit the partitioning scheme of its parent table without having to denormalize the partitioning key *and* it allows the database to understand that the child table is equi-partitioned with the parent table. That is, we'll be able to drop or truncate the parent table partition when we truncate or drop the corresponding child table partition.

The simple syntax to re-implement our previous example could be as follows. We'll reuse the existing parent table `ORDERS` and just truncate that table:

```
EODA@ORA12CR1> drop table order_line_items cascade constraints;
Table dropped.
```

```
EODA@ORA12CR1> truncate table orders;
Table truncated.
```

```
EODA@ORA12CR1> insert into orders values
  2 ( 1, to_date( '01-jun-2014', 'dd-mon-yyyy' ), 'xxx' );
1 row created.
```

```
EODA@ORA12CR1> insert into orders values
  2 ( 2, to_date( '01-jun-2015', 'dd-mon-yyyy' ), 'xxx' );
1 row created.
```

And create a new child table:

```
EODA@ORA12CR1> create table order_line_items
  2 (
  3   order#      number,
  4   line#      number,
  5   data        varchar2(30),
  6   constraint c1_pk primary key(order#,line#),
  7   constraint c1_fk_p foreign key(order#) references orders
  8 )
  9 enable row movement
 10 partition by reference(c1_fk_p)
 11 /
Table created.
```

```
EODA@ORA12CR1> insert into order_line_items values ( 1, 1, 'zzz' );
1 row created.
```

```
EODA@ORA12CR1> insert into order_line_items values ( 2, 1, 'zzz' );
1 row created.
```

The magic is on line 10 of the CREATE TABLE statement. Here, we replaced the range partitioning statement with PARTITION BY REFERENCE.

---

■ **Note** If you are using Oracle Database 11g Release 1 and you receive an error "ORA-14652: reference partitioning foreign key is not supported", it is due to the fact that Release 1 necessitated a "NOT NULL" constraint on every foreign key column. Since ORDER# is part of our primary key, we know it is not null, but Release 1 did not recognize that. You need to define the foreign key columns as NOT NULL.

---

This allows us to name the foreign key constraint to use to discover what our partitioning scheme will be. Here we see the foreign key is to the ORDERS table—the database read the structure of the ORDERS table and determined that it had two partitions—therefore, our child table will have two partitions. In fact, if we query the data dictionary right now, we can see that the two tables have the same exact partitioning structure:

```
EODA@ORA12CR1> select table_name, partition_name
 2   from user_tab_partitions
 3   where table_name in ( 'ORDERS', 'ORDER_LINE_ITEMS' )
 4   order by table_name, partition_name
 5   /
```

TABLE_NAME	PARTITION_NAME
ORDERS	PART_2014
ORDERS	PART_2015
ORDER_LINE_ITEMS	PART_2014
ORDER_LINE_ITEMS	PART_2015

Further, since the database understands these two tables are related, we can drop the parent table partition and have it automatically clean up the related child table partitions (since the child inherits from the parent, any alteration of the parent's partition structure cascades down):

```
EODA@ORA12CR1> alter table orders drop partition part_2014 update global indexes;
Table altered.
```

```
EODA@ORA12CR1> select table_name, partition_name
 2   from user_tab_partitions
 3   where table_name in ( 'ORDERS', 'ORDER_LINE_ITEMS' )
 4   order by table_name, partition_name
 5   /
```

TABLE_NAME	PARTITION_NAME
ORDERS	PART_2015
ORDER_LINE_ITEMS	PART_2015

So, the DROP we were prevented from performing before is now permitted, and it cascades to the child table automatically. Further, if we ADD a partition, as follows, we can see that that operation is cascaded as well; there will be a one-to-one parity between parent and child:

```
EODA@ORA12CR1> alter table orders add partition
 2 part_2016 values less than
 3 (to_date( '01-01-2017', 'dd-mm-yyyy' ));
Table altered.
```

```
EODA@ORA12CR1> select table_name, partition_name
 2 from user_tab_partitions
 3 where table_name in ( 'ORDERS', 'ORDER_LINE_ITEMS' )
 4 order by table_name, partition_name
 5 /
```

TABLE_NAME	PARTITION_NAME
ORDERS	PART_2015
ORDERS	PART_2016
ORDER_LINE_ITEMS	PART_2015
ORDER_LINE_ITEMS	PART_2016

A part of the preceding CREATE TABLE statement that we did not discuss is the ENABLE ROW MOVEMENT. This option was added in Oracle8i and we'll be discussing it fully in a section all its own. In short, the syntax allows an UPDATE to take place such that the UPDATE modifies the partition key value and modifies it in such a way as to cause the row to move from its current partition into some other partition. Prior to Oracle Database 8i, that operation was not permitted; you could update partition keys but not if they caused the row to belong to another partition.

Now, since we defined our parent table originally as permitting row movement, we were forced to define all of our child tables (and their children and so on) as having that capability as well, for if the parent row moves and we are using reference partitioning, we know the child row(s) must move as well. For example:

```
EODA@ORA12CR1> select '2015', count(*) from order_line_items partition(part_2015)
 2 union all
 3 select '2016', count(*) from order_line_items partition(part_2016);

'201  COUNT(*)
---- -
2015      1
2016      0
```

We can see that right now our data in the child table ORDER\_LINE\_ITEMS is in the 2015 partition. By performing a simple update against the parent ORDERS table, as follows, we can see our data moved—in the child table:

```
EODA@ORA12CR1> update orders set order_date = add_months(order_date,12);
1 row updated.
```

```
EODA@ORA12CR1> select '2015', count(*) from order_line_items partition(part_2015)
 2 union all
 3 select '2016', count(*) from order_line_items partition(part_2016);
```



```
'201  COUNT(*)
-----
2015      0
2016      1
```

An update against the parent was cascaded down to the child table and caused the child table to move a row (or rows as needed).

To summarize, reference partitioning removes the need to denormalize data when partitioning parent and child tables. Furthermore, when dropping a parent partition, it will automatically drop the referenced child partition. These features are very useful in data warehousing environments.

## Interval Reference Partitioning

Prior to Oracle 12c, the combination of interval and reference partitioning was not supported. For example, in Oracle 11g if you create an interval range partitioned parent table, as follows:

```
EODA@ORA11GR2> create table orders
 2  (order#      number primary key,
 3  order_date  timestamp,
 4  data        varchar2(30))
 5  PARTITION BY RANGE (order_date)
 6  INTERVAL (numtoyminterval(1,'year'))
 7  (PARTITION part_2014 VALUES LESS THAN (to_date('01-01-2015','dd-mm-yyyy')) ,
 8  PARTITION part_2015 VALUES LESS THAN (to_date('01-01-2016','dd-mm-yyyy')));
Table created.
```

And then attempt to create a reference partitioned child table, an error is thrown, as follows:

```
EODA@ORA11GR2> create table order_line_items
 2  ( order#      number,
 3  line#        number,
 4  data         varchar2(30),
 5  constraint c1_pk primary key(order#,line#),
 6  constraint c1_fk_p foreign key(order#) references orders)
 7  partition by reference(c1_fk_p);
create table order_line_items
*
ERROR at line 1:
ORA-14659: Partitioning method of the parent table is not supported
```

That is no longer the case starting with Oracle 12c, where you can combine interval and reference partitioning. Running the prior code in an Oracle 12c database, the creation of the child table succeeds:

```
EODA@ORA12CR1> create table order_line_items
 2  ( order#      number,
 3  line#        number,
 4  data         varchar2(30),
 5  constraint c1_pk primary key(order#,line#),
 6  constraint c1_fk_p foreign key(order#) references orders)
 7  partition by reference(c1_fk_p);
Table created.
```

To see interval reference partitioning in action, let's insert some data. First, we insert rows that will fit within existing range partitions:

```
EODA@ORA12CR1> insert into orders values (1, to_date( '01-jun-2014', 'dd-mon-yyyy' ), 'xxx');
1 row created.
```

```
EODA@ORA12CR1> insert into orders values (2, to_date( '01-jun-2015', 'dd-mon-yyyy' ), 'xxx');
1 row created.
```

```
EODA@ORA12CR1> insert into order_line_items values( 1, 1, 'yyy' );
1 row created.
```

```
EODA@ORA12CR1> insert into order_line_items values( 2, 1, 'yyy' );
1 row created.
```

All of the prior rows fit into the partitions specified when creating the tables. The following query displays the current partitions:

```
EODA@ORA12CR1> select table_name, partition_name from user_tab_partitions
 2  where table_name in ( 'ORDERS', 'ORDER_LINE_ITEMS' )
 3  order by table_name, partition_name;
```

TABLE_NAME	PARTITION_NAME
ORDERS	PART_2014
ORDERS	PART_2015
ORDER_LINE_ITEMS	PART_2014
ORDER_LINE_ITEMS	PART_2015

Next, rows are inserted that don't fit into an existing range partition; therefore, Oracle automatically creates partitions to hold the newly inserted rows:

```
EODA@ORA12CR1> insert into orders values (3, to_date( '01-jun-2016', 'dd-mon-yyyy' ), 'xxx');
1 row created.
```

```
EODA@ORA12CR1> insert into order_line_items values (3, 1, 'zzz' );
1 row created.
```

The following query shows that two interval partitions were automatically created, one for the parent table and one for the child table:

```
EODA@ORA12CR1> select a.table_name, a.partition_name, a.high_value,
 2  decode( a.interval, 'YES', b.interval ) interval
 3  from user_tab_partitions a, user_part_tables b
 4  where a.table_name IN ( 'ORDERS', 'ORDER_LINE_ITEMS' )
 5  and a.table_name = b.table_name
 6  order by a.table_name;
```

TABLE_NAME	PARTITION_	HIGH_VALUE	INTERVAL
ORDERS	PART_2014	TIMESTAMP' 2015-01-01 00:00:00'	
ORDERS	PART_2015	TIMESTAMP' 2016-01-01 00:00:00'	
ORDERS	SYS_P1626	TIMESTAMP' 2017-01-01 00:00:00'	NUMTOYMINTERVAL(1, 'YEAR')
ORDER_LINE_ITEMS	PART_2014		
ORDER_LINE_ITEMS	PART_2015		
ORDER_LINE_ITEMS	SYS_P1626		YES

Two partitions named SYS\_P1626 were created, with the parent table partition having a high value of 2017-01-01. If desired, you can rename the partitions via the ALTER TABLE command:

```
EODA@ORA12CR1> alter table orders rename partition sys_p1626 to part_2016;
Table altered.
```

```
EODA@ORA12CR1> alter table order_line_items rename partition sys_p1626 to part_2016;
Table altered.
```

---

■ **Tip** See the “Interval Partitioning” section of this chapter for an example of automating the renaming of partitions via PL/SQL.

---

## Virtual Column Partitioning

Virtual column partitioning allows you to partition based on a SQL expression. This type of partitioning is useful when a table column is overloaded with multiple business values and you want to partition on a portion of that column. For example, let's say you have a RESERVATION\_CODE column in a table:

```
EODA@ORA12CR1> create table res(reservation_code varchar2(30));
Table created.
```

And the first character in the RESERVATION\_CODE column defines a region from which the reservation originated. For the purposes of this example, let's say a first character of an A or C map to the NE region, and values of B map to the SW region, and values of D map to the NW region.

Next some test data is inserted into the table:

```
EODA@ORA12CR1> insert into res (reservation_code)
  2  select chr(64+(round(dbms_random.value(1,4)))) || level
  3  from dual connect by level < 100000;
```

```
EODA@ORA12CR1> select * from res;
```

Here's a partial snippet of the output:

```
RESERVATION_CODE
-----
C1
D2
...
A72827
B72828
```

In this scenario, we know that the first character represents the region and we want to be able to list partition by region. With the data as it is, it's not practical to list partition by the `RESERVATION_CODE` column. Whereas virtual partitioning allows us to apply a SQL function to the column and list partition by the first character. Here's what the table definition looks like with virtual column partitioning:

```
EODA@ORA12CR1> create table res(
  reservation_code varchar2(30),
  region as
    (decode(substr(reservation_code,1,1),'A','NE'
              , 'C','NE'
              , 'B','SW'
              , 'D','NW')
    )
)
partition by list (region)
(partition p1 values('NE'),
 partition p2 values('SW'),
 partition p3 values('NW'));
Table created.
```

In this way, virtual column partitioning is often appropriate when there is a business requirement to partition on portions of data in a column, or combinations of data from different columns (especially when there might not be an obvious way to list or range partition). The expression behind a virtual column can be a complex calculation, return a subset of a column string, combinations of column values, and so on.

## Composite Partitioning

Lastly, we'll look at some examples of composite partitioning, which is a mixture of range, hash, and/or list. The methods by which you can composite partition, that is the types of partitioning schemes you can mix and match, varies by release. Table 13-1 lists what is available in each of the major releases. The partitioning scheme listed down the table is the top level partitioning scheme permitted, whereas the partitioning scheme listed across the table is the subpartition—the partition within the partition—scheme.

**Table 13-1.** Oracle Database Supported Composite Partitioning Schemes by Version

	Range	List	Hash
Range	11g Release 1	9i Release 2	9i Release 1
List	11g Release 1	11g Release 1	11g Release 1
Hash	11g Release 2	11g Release 2	11g Release 2

So, for example, in Oracle9i Release 2 and later you can partition a table by RANGE and then within each range partition, by LIST or HASH. Starting in Oracle 11g Release 1 and above, you go from two composite schemes to six. And in Oracle 11g Release 2 and later, you have nine to choose from.

It is interesting to note that when you use composite partitioning, there will be no partition segments; there will be only subpartition segments. When using composite partitioning, the partitions themselves do not have segments (much like a partitioned table doesn't have a segment). The data is physically stored in subpartition segments and the partition becomes a *logical container*, or a container that points to the actual subpartitions.

In our example, we'll look at a range-hash composite partitioning. Here, we are using a different set of columns for the range partition from those used for the hash partition. This is not mandatory; we could use the same set of columns for both:

```
EODA@ORA12CR1> CREATE TABLE composite_example
 2 ( range_key_column  date,
 3   hash_key_column   int,
 4   data              varchar2(20)
 5 )
 6 PARTITION BY RANGE (range_key_column)
 7 subpartition by hash(hash_key_column) subpartitions 2
 8 (
 9 PARTITION part_1
10     VALUES LESS THAN(to_date('01/01/2014','dd/mm/yyyy'))
11     (subpartition part_1_sub_1,
12      subpartition part_1_sub_2
13     ),
14 PARTITION part_2
15     VALUES LESS THAN(to_date('01/01/2015','dd/mm/yyyy'))
16     (subpartition part_2_sub_1,
17      subpartition part_2_sub_2
18     )
19 )
20 /
```

Table created.

In range-hash composite partitioning, Oracle will first apply the range partitioning rules to figure out which range the data falls into. Then it will apply the hash function to decide into which physical partition the data should finally be placed. This process is described in Figure 13-4.

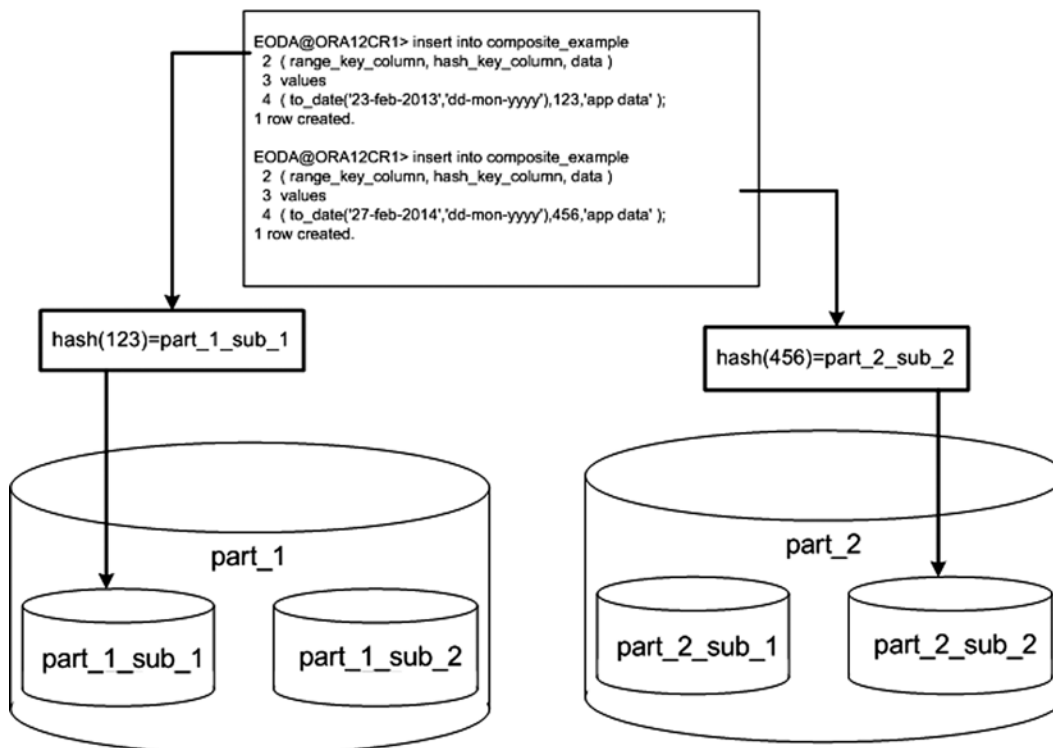

**Figure 13-4.** Range-hash composite partition example

So, composite partitioning gives you the ability to break your data up by range and, when a given range is considered too large or further partition elimination could be useful, to break it up further by hash or list. It is interesting to note that each range partition need not have the same number of subpartitions; for example, suppose you were range partitioning on a date column in support of data purging (to remove all old data rapidly and easily). In the year 2013 and before, you had equal amounts of data in odd code numbers in the CODE\_KEY\_COLUMN and in even code numbers. But after that, you knew the number of records associated with the odd code number was more than double, and you wanted to have more subpartitions for the odd code values. You can achieve that rather easily just by defining more subpartitions:

```

EODA@ORA12CR1> CREATE TABLE composite_range_list_example
 2 ( range_key_column    date,
 3   code_key_column    int,
 4   data                varchar2(20)
 5 )
 6 PARTITION BY RANGE (range_key_column)
 7 subpartition by list(code_key_column)
 8 (
 9 PARTITION part_1
10   VALUES LESS THAN(to_date('01/01/2014','dd/mm/yyyy'))
11   (subpartition part_1_sub_1 values( 1, 3, 5, 7 ),
12    subpartition part_1_sub_2 values( 2, 4, 6, 8 )
13   ),

```

```

14 PARTITION part_2
15     VALUES LESS THAN(to_date('01/01/2015','dd/mm/yyyy'))
16     (subpartition part_2_sub_1 values ( 1, 3 ),
17      subpartition part_2_sub_2 values ( 5, 7 ),
18      subpartition part_2_sub_3 values ( 2, 4, 6, 8 )
19     )
20 )
21 /

```

Table created.

Here you end up with five partitions altogether: two subpartitions for partition PART\_1 and three for partition PART\_2.

## Row Movement

You might wonder what would happen if the value of the column used to determine the partition is modified in any of the preceding partitioning schemes. There are two cases to consider:

- The modification would not cause a different partition to be used; the row would still belong in this partition. This is supported in all cases.
- The modification would cause the row to *move* across partitions. This is supported *if* row movement is enabled for the table; otherwise, an error will be raised.

We can observe these behaviors easily. In the previous example in the Range Partitioning section, we inserted a pair of rows into PART\_1 of the RANGE\_EXAMPLE table:

```

EODA@ORA12CR1> CREATE TABLE range_example
 2 ( range_key_column date,
 3   data              varchar2(20)
 4 )
 5 PARTITION BY RANGE (range_key_column)
 6 ( PARTITION part_1 VALUES LESS THAN
 7   (to_date('01/01/2014','dd/mm/yyyy')),
 8   PARTITION part_2 VALUES LESS THAN
 9   (to_date('01/01/2015','dd/mm/yyyy'))
10 )
11 /

```

Table created.

```

EODA@ORA12CR1> insert into range_example
 2 ( range_key_column, data )
 3 values
 4 ( to_date( '15-dec-2013 00:00:00',
 5           'dd-mon-yyyy hh24:mi:ss' ),
 6   'application data...' );
1 row created.

```

```
EODA@ORA12CR1> insert into range_example
 2 ( range_key_column, data )
 3 values
 4 ( to_date( '01-jan-2014 00:00:00',
 5         'dd-mon-yyyy hh24:mi:ss' )-1/24/60/60,
 6   'application data...' );
1 row created.
```

```
EODA@ORA12CR1> select * from range_example partition(part_1);
RANGE_KEY DATA
-----
15-DEC-13 application data...
31-DEC-13 application data...
```

We take one of the rows and update the value in its RANGE\_KEY\_COLUMN such that it can remain in PART\_1:

```
EODA@ORA12CR1> update range_example
 2 set range_key_column = trunc(range_key_column)
 3 where range_key_column =
 4 to_date( '31-dec-2013 23:59:59',
 5         'dd-mon-yyyy hh24:mi:ss' );
1 row updated.
```

As expected, this succeeds: the row remains in partition PART\_1. Next, we update the RANGE\_KEY\_COLUMN to a value that would cause it to belong in PART\_2:

```
EODA@ORA12CR1> update range_example
 2 set range_key_column = to_date('01-jan-2014','dd-mon-yyyy')
 3 where range_key_column = to_date('31-dec-2013','dd-mon-yyyy');
update range_example
*
ERROR at line 1:
ORA-14402: updating partition key column would cause a partition change
```

This immediately raises an error since we did not explicitly enable row movement. In Oracle8i and later releases, we can enable row movement on this table to allow the row to move from partition to partition.

You should be aware of a subtle side effect of doing this, however; namely that the ROWID of a row will change as the result of the update:

```
EODA@ORA12CR1> select rowid
 2 from range_example
 3 where range_key_column = to_date('31-dec-2013','dd-mon-yyyy');
```

```
ROWID
-----
AAAtzXAAGAAAa06AAB
```

```
EODA@ORA12CR1> alter table range_example enable row movement;
Table altered.
```



```
EODA@ORA12CR1> update range_example
 2   set range_key_column = to_date('01-jan-2014','dd-mon-yyyy')
 3   where range_key_column = to_date('31-dec-2013','dd-mon-yyyy');
1 row updated.
```

```
EODA@ORA12CR1> select rowid
 2   from range_example
 3   where range_key_column = to_date('01-jan-2014','dd-mon-yyyy');
```

```
ROWID
```

```
-----
AAAtzYAAGAAAae6AAA
```

As long as you understand that the ROWID of the row will change on this update, enabling row movement will allow you to update partition keys.

---

■ **Note** There are other cases where a ROWID can change as a result of an update. It can happen as a result of an update to the primary key of an IOT. The universal ROWID will change for that row, too. The Oracle 10g and above FLASHBACK TABLE command may also change the ROWID of rows, as might the Oracle 10g and above ALTER TABLE SHRINK command.

---

You need to understand that, internally, row movement is done as if you had, in fact, deleted the row and reinserted it. It will update every single index on this table, and delete the old entry and insert a new one. It will do the physical work of a DELETE plus an INSERT. However, it is considered an update by Oracle even though it physically deletes and inserts the row—therefore, it won't cause INSERT and DELETE triggers to fire, just the UPDATE triggers. Additionally, child tables that might prevent a DELETE due to a foreign key constraint won't. You do have to be prepared, however, for the extra work that will be performed; it is much more expensive than a normal UPDATE. Therefore, it would be a bad design decision to construct a system whereby the partition key was modified frequently and that modification would cause a partition movement.

## Table Partitioning Schemes Wrap-up

In general, range partitioning is useful when you have data that is logically segregated by some value(s). Time-based data immediately comes to the forefront as a classic example—partition by “Sales Quarter,” “Fiscal Year,” or “Month.” Range partitioning is able to take advantage of partition elimination in many cases, including the use of exact equality and ranges (less than, greater than, between, and so on).

Hash partitioning is suitable for data that has no natural ranges by which you can partition. For example, if you had to load a table full of census-related data, there might not be an attribute by which it would make sense to range partition by. However, you would still like to take advantage of the administrative, performance, and availability enhancements offered by partitioning. Here, you would simply pick a unique or almost unique set of columns to hash on. This would achieve an even distribution of data across as many partitions as you like. Hash partitioned objects can take advantage of partition elimination when exact equality or IN ( value, value, . . . ) is used, but not when ranges of data are used.

List partitioning is suitable for data that has a column with a discrete set of values, and partitioning by the column makes sense based on the way your application uses it (e.g., it easily permits partition elimination in queries). Classic examples would be a state or region code—or, in fact, many code type attributes in general.

Interval partitioning extends the range partitioning feature and allows partitions to automatically be added when data inserted into the table doesn't fit into an existing partition. This feature greatly enhances range partitioning in that there is less maintenance involved (because the DBA doesn't have to necessarily monitor the ranges and manually add partitions).

Reference partitioning eases the implementation of partitioned tables that are related through referential integrity constraints. This allows the child table to be logically partitioned in the same manner as the parent table without having to duplicate parent table columns to the child table.

Interval reference partitioning allows you to combine the interval and reference partitioning features. This ability is new starting with Oracle 12c and is useful when you need to use the interval and reference partitioning features in tandem.

Virtual column partitioning allows you to partition using a virtual column as the key. This feature provides you the flexibility to partition on a substring of a regular column value (or any other SQL expression). This is useful when it's not feasible to use an existing column as the partition key, but you can partition on a subset of the value contained in an existing column.

Composite partitioning is useful when you have something logical by which you can range partition, but the resulting range partitions are still too large to manage effectively. You can apply the range, list, or hash partitioning and then further divide each range by a hash function or use lists to partition or even ranges. This will allow you to spread I/O requests out across many devices in any given large partition. Additionally, you may achieve partition elimination at three levels now. If you query on the partition key, Oracle is able to eliminate any partitions that do not meet your criteria. If you add the subpartition key to your query, Oracle can eliminate the other subpartitions within that partition. If you just query on the subpartition key (not using the partition key), Oracle will query only those hash or list subpartitions that apply from each partition.

It is recommended that if there is something by which it makes sense to range partition your data, you should use that over hash or list partitioning. Hash and list partitioning add many of the salient benefits of partitioning, but they are not as useful as range partitioning when it comes to partition elimination. Using hash or list partitions within range partitions is advisable when the resulting range partitions are too large to manage or when you want to use all PDML capabilities or parallel index scanning against a single range partition.

## Partitioning Indexes

Indexes, like tables, may be partitioned. There are two possible methods to partition indexes:

- *Equipartition the index with the table:* This is also known as a *local index*. For every table partition, there will be an index partition that indexes just that table partition. All of the entries in a given index partition point to a single table partition, and all of the rows in a single table partition are represented in a single index partition.
- *Partition the index by range or hash:* This is also known as a *globally partitioned index*. Here the index is partitioned by range, or optionally in Oracle 10g and above by hash, and a single index partition may point to *any* (and all) table partitions.

Figure 13-5 demonstrates the difference between a local and a global index.

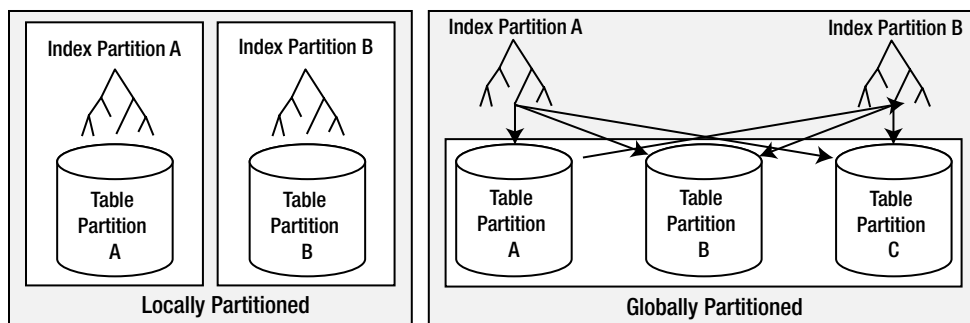

Figure 13-5. Local and global index partitions

In the case of a globally partitioned index, note that the number of index partitions may be different from the number of table partitions.

Since global indexes may be partitioned by range or hash only, you must use local indexes if you wish to have a list or composite partitioned index. The local index will be partitioned using the same scheme as the underlying table.

## Local Indexes vs. Global Indexes

In my experience, most partition implementations in data warehouse systems use local indexes. In an OLTP system, global indexes are much more common, and we'll see why shortly. It has to do with the need to perform partition elimination on the index structures to maintain the same query response times after partitioning as before partitioning them.

---

■ **Note** Over the last couple of years, it has become more common to see local indexes used in OLTP systems, as such systems have rapidly grown in size.

---

Local indexes have certain properties that make them the best choice for most data warehouse implementations. They support a more available environment (less downtime), since problems will be isolated to one range or hash of data. On the other hand, since it can point to many table partitions, a global index may become a point of failure, rendering all partitions inaccessible to certain queries.

Local indexes are more flexible when it comes to partition maintenance operations. If the DBA decides to move a table partition, only the associated local index partition needs to be rebuilt or maintained. With a global index, all index partitions must be rebuilt or maintained in real time. The same is true with sliding window implementations, where old data is aged out of the partition and new data is aged in. No local indexes will be in need of a rebuild, but all global indexes will be either rebuilt or maintained during the partition operation. In some cases, Oracle can take advantage of the fact that the index is locally partitioned with the table and will develop optimized query plans based on that. With global indexes, there is no such relationship between the index and table partitions.

Local indexes also facilitate a partition point-in-time recovery operation. If a single partition needs to be recovered to an earlier point in time than the rest of the table for some reason, all locally partitioned indexes can be recovered to that same point in time. All global indexes would need to be rebuilt on this object. This does not mean “avoid global indexes”—in fact, they are vitally important for performance reasons, as you'll learn shortly—you just need to be aware of the implications of using them.

## Local Indexes

Oracle makes a distinction between the following two types of local indexes:

- *Local prefixed indexes*: These are indexes whereby the partition keys are on the leading edge of the index definition. For example, if a table is range partitioned on a column named `LOAD_DATE`, a local prefixed index on that table would have `LOAD_DATE` as the first column in its column list.
- *Local nonprefixed indexes*: These indexes do *not* have the partition key on the leading edge of their column list. The index may or may not contain the partition key columns.

Both types of indexes are able to take advantage of partition elimination, both can support uniqueness (as long as the nonprefixed index includes the partition key), and so on. The fact is that a query that uses a local prefixed index will always *allow* for index partition elimination, whereas a query that uses a local nonprefixed index might not. This is why local nonprefixed indexes are said to be slower by some people—they do not *enforce* partition elimination (but they do support it).

There is nothing inherently better about a local prefixed index as opposed to a local nonprefixed index when that index is used as the initial path to the table in a query. What I mean is that if the query can start with “scan an index” as the first step, there isn’t much difference between a prefixed and a nonprefixed index.

## Partition Elimination Behavior

For the query that starts with an index access, whether or not it can eliminate partitions from consideration all really depends on the predicate in your query. A small example will help demonstrate this. The following code creates a table, `PARTITIONED_TABLE`, that is range partitioned on a numeric column `A` such that values less than two will be in partition `PART_1` and values less than three will be in partition `PART_2`:

```
EODA@ORA12CR1> CREATE TABLE partitioned_table
 2 ( a int,
 3   b int,
 4   data char(20)
 5 )
 6 PARTITION BY RANGE (a)
 7 (
 8 PARTITION part_1 VALUES LESS THAN(2) tablespace p1,
 9 PARTITION part_2 VALUES LESS THAN(3) tablespace p2
10 )
11 /
Table created.
```

We then create both a local prefixed index, `LOCAL_PREFIXED`, and a local nonprefixed index, `LOCAL_NONPREFIXED`. Note that the nonprefixed index does not have `A` on the leading edge of its definition, which is what makes it a nonprefixed index:

```
EODA@ORA12CR1> create index local_prefixed on partitioned_table (a,b) local;
Index created.

EODA@ORA12CR1> create index local_nonprefixed on partitioned_table (b) local;
Index created.
```

Next, we’ll insert some data into one partition and gather statistics:

```
EODA@ORA12CR1> insert into partitioned_table
 2 select mod(rownum-1,2)+1, rownum, 'x'
 3 from dual connect by level <= 70000;
70000 rows created.

EODA@ORA12CR1> begin
 2   dbms_stats.gather_table_stats
 3   ( user,
 4     'PARTITIONED_TABLE',
 5     cascade=>TRUE );
 6 end;
 7 /
PL/SQL procedure successfully completed.
```

We take tablespace P2 offline, which contains the PART\_2 partition for both the tables and indexes:

```
EODA@ORA12CR1> alter tablespace p2 offline;
Tablespace altered.
```

Taking tablespace P2 offline will prevent Oracle from accessing those specific index partitions. It will be as if we had suffered media failure, causing them to become unavailable. Now we'll query the table to see what index partitions are needed by different queries. This first query is written to permit the use of the local prefixed index:

```
EODA@ORA12CR1> select * from partitioned_table where a = 1 and b = 1;
      A          B DATA
-----
      1          1 x
```

This query succeeded, and we can see why by reviewing the explain plan. We'll use the built-in package DBMS\_XPLAN to see what partitions this query accesses. The PSTART (partition start) and PSTOP (partition stop) columns in the output show us exactly what partitions this query needs to have online and available in order to succeed:

```
EODA@ORA12CR1> explain plan for select * from partitioned_table where a = 1 and b = 1;
Explained.
```

Now access DBMS\_XPLAN.DISPLAY and instruct it to show the basic explain plan details plus partitioning information:

```
EODA@ORA12CR1> select * from table(dbms_xplan.display(null,null,'BASIC +PARTITION'));
-----
| Id | Operation                                | Name                | Pstart | Pstop |
-----
|  0 | SELECT STATEMENT                          |                      |        |        |
|  1 | PARTITION RANGE SINGLE                     |                      |      1 |      1 |
|  2 | TABLE ACCESS BY LOCAL INDEX ROWID BATCHED | PARTITIONED_TABLE   |      1 |      1 |
|  3 | INDEX RANGE SCAN                           | LOCAL_PREFIXED      |      1 |      1 |
-----
```

So, the query that uses LOCAL\_PREFIXED succeeds. The optimizer was able to exclude PART\_2 of LOCAL\_PREFIXED from consideration because we specified A=1 in the query, and we can see that clearly in the plan PSTART and PSTOP are both equal to 1. Partition elimination kicked in for us. The second query fails, however:

```
EODA@ORA12CR1> select * from partitioned_table where b = 1;
ERROR:
ORA-00376: file 10 cannot be read at this time
ORA-01110: data file 10: '/u01/dbfile/ORA12CR1/datafile/o1_mf_p2_9hstdql2_.dbf'
no rows selected
```

And using the same technique, we can see why:

```
EODA@ORA12CR1> explain plan for select * from partitioned_table where b = 1;
Explained.
```

```
EODA@ORA12CR1> select * from table(dbms_xplan.display(null,null,'BASIC +PARTITION'));
```

Id	Operation	Name	Pstart	Pstop
0	SELECT STATEMENT			
1	PARTITION RANGE ALL		1	2
2	TABLE ACCESS BY LOCAL INDEX ROWID BATCHED	PARTITIONED_TABLE	1	2
3	INDEX RANGE SCAN	LOCAL_NONPREFIXED	1	2

Here the optimizer was *not* able to remove PART\_2 of LOCAL\_NONPREFIXED from consideration—it needed to look in both the PART\_1 and PART\_2 partitions of the index to see if B=1 was in there. Herein lies a performance issue with local nonprefixed indexes: they do not *make* you use the partition key in the predicate as a prefixed index does. It is not that prefixed indexes are better; it's just that in order to use them, you must use a query that allows for partition elimination.

If we drop the LOCAL\_PREFIXED index and rerun the original successful query, as follows:

```
EODA@ORA12CR1> drop index local_prefixed;
Index dropped.
```

```
EODA@ORA12CR1> select * from partitioned_table where a = 1 and b = 1;
   A      B DATA
-----
   1      1 x
```

It succeeds, but as we'll see, it used the same index that just a moment ago failed us. The plan shows that Oracle was able to employ partition elimination here—the predicate A=1 was enough information for the database to eliminate index partition PART\_2 from consideration:

```
EODA@ORA12CR1> explain plan for select * from partitioned_table where a = 1 and b = 1;
Explained.
```

```
EODA@ORA12CR1> select * from table(dbms_xplan.display(null,null,'BASIC +PARTITION'));
```

Id	Operation	Name	Pstart	Pstop
0	SELECT STATEMENT			
1	PARTITION RANGE SINGLE		1	1
2	TABLE ACCESS BY LOCAL INDEX ROWID BATCHED	PARTITIONED_TABLE	1	1
3	INDEX RANGE SCAN	LOCAL_NONPREFIXED	1	1

Note the PSTART and PSTOP column values of 1 and 1. This proves that the optimizer is able to perform partition elimination even for nonprefixed local indexes.

If you frequently query the preceding table with the following queries, then you might consider using a local nonprefixed index on (b,a):

```
select ... from partitioned_table where a = :a and b = :b;
select ... from partitioned_table where b = :b;
```

That index would be useful for both of the preceding queries. The local prefixed index on (a,b) would be useful only for the first query.

The bottom line here is that you should not be afraid of nonprefixed indexes or consider them as major performance inhibitors. If you have many queries that could benefit from a nonprefixed index as outlined previously, then you should consider using one. The main concern is to ensure that your queries contain predicates that allow for index partition elimination whenever possible. The use of prefixed local indexes enforces that consideration. The use of nonprefixed indexes does not. Consider also how the index will be used. If it will be used as the first step in a query plan, there are not many differences between the two types of indexes.

## Local Indexes and Unique Constraints

To enforce uniqueness—and that includes a UNIQUE constraint or PRIMARY KEY constraints—your partitioning key *must be included in the constraint itself* if you want to use a local index to enforce the constraint. This is the largest limitation of a local index, in my opinion. Oracle enforces uniqueness only within an index partition—never across partitions. What this implies, for example, is that you cannot range partition on a TIMESTAMP field and have a primary key on the ID that is enforced using a locally partitioned index. Oracle will instead utilize a *global* index to enforce uniqueness.

In the next example, we will create a range partitioned table that is partitioned by a column named TIMESTAMP but has a primary key on the ID column. We can do that by executing the following CREATE TABLE statement in a schema that owns no other objects, so we can easily see exactly what objects are created by looking at every segment this user owns:

```
EODA@ORA12CR1> CREATE TABLE partitioned
 2 ( timestamp date,
 3   id      int,
 4   constraint partitioned_pk primary key(id)
 5 )
 6 PARTITION BY RANGE (timestamp)
 7 (
 8 PARTITION part_1 VALUES LESS THAN
 9 ( to_date('01/01/2014','dd/mm/yyyy') ) ,
10 PARTITION part_2 VALUES LESS THAN
11 ( to_date('01/01/2015','dd/mm/yyyy') )
12 )
13 /
Table created.
```

And inserting some data so that we get segments created:

```
EODA@ORA12CR1> insert into partitioned values(to_date('01/01/2013','dd/mm/yyyy'),1);
1 row created.
EODA@ORA12CR1> insert into partitioned values(to_date('01/01/2014','dd/mm/yyyy'),2);
1 row created.
```

Assuming we run this in a schema with no other objects created, we'll see the following:

```
EODA@ORA12CR1> select segment_name, partition_name, segment_type from user_segments;
```

SEGMENT_NAME	PARTITION_NAME	SEGMENT_TYPE
PARTITIONED	PART_1	TABLE PARTITION
PARTITIONED	PART_2	TABLE PARTITION
PARTITIONED_PK		INDEX

The PARTITIONED\_PK index is not even partitioned, let alone locally partitioned, and as we'll see, it cannot be locally partitioned. Even if we try to trick Oracle by realizing that a primary key can be enforced by a nonunique index as well as a unique index, we'll find that this approach will not work either:

```
EODA@ORA12CR1> CREATE TABLE partitioned
 2 ( timestamp date,
 3   id          int
 4 )
 5 PARTITION BY RANGE (timestamp)
 6 (
 7   PARTITION part_1 VALUES LESS THAN
 8   ( to_date('01-jan-2014','dd-mon-yyyy') ) ,
 9   PARTITION part_2 VALUES LESS THAN
10   ( to_date('01-jan-2015','dd-mon-yyyy') )
11 )
12 /
Table created.
```

```
EODA@ORA12CR1> create index partitioned_idx on partitioned(id) local;
Index created.
```

And inserting some data so that we get segments created:

```
EODA@ORA12CR1> insert into partitioned values(to_date('01/01/2013','dd/mm/yyyy'),1);
1 row created.
EODA@ORA12CR1> insert into partitioned values(to_date('01/01/2014','dd/mm/yyyy'),2);
1 row created
```

```
EODA@ORA12CR1> select segment_name, partition_name, segment_type
 2   from user_segments;
```

SEGMENT_NAME	PARTITION_NAME	SEGMENT_TYPE
PARTITIONED	PART_1	TABLE PARTITION
PARTITIONED	PART_2	TABLE PARTITION
PARTITIONED_IDX	PART_1	INDEX PARTITION
PARTITIONED_IDX	PART_2	INDEX PARTITION



```

EODA@ORA12CR1> alter table partitioned
  2  add constraint
  3  partitioned_pk
  4  primary key(id)
  5  /
alter table partitioned
*
ERROR at line 1:
ORA-01408: such column list already indexed

```

Here, Oracle attempts to create a global index on ID, but finds that it cannot since an index already exists. The preceding statements would work if the index we created was not partitioned, as Oracle would have used that index to enforce the constraint.

The reasons why uniqueness cannot be enforced, unless the partition key is part of the constraint, are twofold. First, if Oracle allowed this, it would void most of the advantages of partitions. Availability and scalability would be lost, as each and every partition would always have to be *available* and *scanned* to do any inserts and updates. The more partitions you had, the less available the data would be. The more partitions you had, the more index partitions you would have to scan, and the less scalable partitions would become. Instead of providing availability and scalability, doing this would actually decrease both.

Additionally, Oracle would have to effectively *serialize* inserts and updates to this table at the transaction level. This is because if we add ID=1 to PART\_1, Oracle would have to somehow *prevent* anyone else from adding ID=1 to PART\_2. The only way to do this would be to prevent others from modifying index partition PART\_2, since there isn't anything to really lock in that partition.

In an OLTP system, unique constraints must be system enforced (i.e., enforced by Oracle) to ensure the integrity of data. This implies that the logical model of your application will have an impact on the physical design. Uniqueness constraints will either drive the underlying table partitioning scheme, driving the choice of the partition keys, or point you toward the use of *global* indexes instead. We'll take a look at global indexes in more depth next.

## Global Indexes

Global indexes are partitioned using a scheme that is different from that used in the underlying table. The table might be partitioned by a *TIMESTAMP* column into ten partitions, and a global index on that table could be partitioned into five partitions by the *REGION* column. Unlike local indexes, there is only one class of global index, and that is a *prefixed global index*. There is no support for a global index whose index key does not begin with the partitioning key *for that index*. That implies that whatever attribute(s) you use to partition the index will be on the leading edge of the index key itself.

Building on our previous example, here is a quick example of the use of a global index. It shows that a global partitioned index can be used to enforce uniqueness for a primary key, so you can have partitioned indexes that enforce uniqueness, but do not include the partition key of the table. The following example creates a table partitioned by *TIMESTAMP* that has an index partitioned by *ID*:

```

EODA@ORA12CR1> CREATE TABLE partitioned
  2  ( timestamp date,
  3  id          int
  4  )
  5  PARTITION BY RANGE (timestamp)
  6  (
  7  PARTITION part_1 VALUES LESS THAN
  8  ( to_date('01-jan-2014','dd-mon-yyyy') ) ,
  9  PARTITION part_2 VALUES LESS THAN
 10  ( to_date('01-jan-2015','dd-mon-yyyy') )

```

```

11 )
12 /
Table created.

```

```

EODA@ORA12CR1> create index partitioned_index
2 on partitioned(id)
3 GLOBAL
4 partition by range(id)
5 (
6 partition part_1 values less than(1000),
7 partition part_2 values less than (MAXVALUE)
8 )
9 /
Index created.

```

Note the use of MAXVALUE in this index. MAXVALUE can be used in any range partitioned table as well as in the index. It represents an *infinite upper bound* on the range. In our examples so far, we've used hard upper bounds on the ranges (values less than <some value>). However, a global index has a requirement that the highest partition (the last partition) must have a partition bound whose value is MAXVALUE. This ensures that all rows in the underlying table can be placed in the index.

Now, completing this example, we'll add our primary key to the table:

```

EODA@ORA12CR1> alter table partitioned add constraint
2 partitioned_pk
3 primary key(id)
4 /
Table altered.

```

It is not evident from this code that Oracle is using the index we created to enforce the primary key (it is to me because I know that Oracle is using it), so we can prove it by simply trying to drop that index:

```

EODA@ORA12CR1> drop index partitioned_index;
drop index partitioned_index
*
ERROR at line 1:
ORA-02429: cannot drop index used for enforcement of unique/primary key

```

To show that Oracle will not allow us to create a *nonprefixed* global index, we only need try the following:

```

EODA@ORA12CR1> create index partitioned_index2
2 on partitioned(timestamp,id)
3 GLOBAL
4 partition by range(id)
5 (
6 partition part_1 values less than(1000),
7 partition part_2 values less than (MAXVALUE)
8 )
9 /
partition by range(id)
*
ERROR at line 4:
ORA-14038: GLOBAL partitioned index must be prefixed

```

The error message is pretty clear. The global index *must* be prefixed. So, when would you use a global index? We'll take a look at two system types, data warehouse and OLTP, and see when they might apply.

## Data Warehousing and Global Indexes

In the past, data warehousing and global indexes were pretty much mutually exclusive. A data warehouse implies certain things, such as large amounts of data coming in and going out. Many data warehouses implement a sliding window approach to managing data—that is, drop the oldest partition of a table and add a new partition for the newly loaded data. In the past (Oracle8i and earlier), these systems would have avoided the use of global indexes for a very good reason: lack of availability. It used to be the case that most partition operations, such as dropping an old partition, would *invalidate* the global indexes, rendering them unusable until they were rebuilt. This could seriously compromise availability.

In the following sections, we'll take a look at what is meant by a *sliding window of data* and the *potential* impact of a global index on it. I stress the word “potential” because we'll also look at how we may get around this issue and how to understand what getting around the issue might imply.

## Sliding Windows and Indexes

The following example implements a classic sliding window of data. In many implementations, data is added to a warehouse over time and the oldest data is aged out. Many times, this data is range partitioned by a date attribute, so that the oldest data is stored together in a single partition, and the newly loaded data is likewise stored together in a new partition. The monthly load process involves the following:

- *Detaching the old data:* The oldest partition is either dropped or exchanged with an empty table (turning the oldest partition into a table) to permit archiving of the old data.
- *Loading and indexing of the new data:* The new data is loaded into a work table and indexed and validated.
- *Attaching the new data:* Once the new data is loaded and processed, the table it is in is exchanged with an empty partition in the partitioned table, turning this newly loaded data in a table into a partition of the larger partitioned table.

This process is repeated every month, or however often the load process is performed; it could be every day or every week. We will implement this very typical process in this section to show the impact of global partitioned indexes and demonstrate the options we have during partition operations to increase availability, allowing us to implement a sliding window of data and maintain continuous availability of data.

We'll process yearly data in this example and have fiscal years 2014 and 2015 loaded up. The table will be partitioned by the `TIMESTAMP` column, and it will have two indexes created on it—one is a locally partitioned index on the `ID` column, and the other is a global index (nonpartitioned, in this case) on the `TIMESTAMP` column:

```

EODA@ORA12CR1> CREATE TABLE partitioned
 2 ( timestamp date,
 3   id          int
 4 )
 5 PARTITION BY RANGE (timestamp)
 6 (
 7 PARTITION fy_2014 VALUES LESS THAN
 8 ( to_date('01-jan-2015','dd-mon-yyyy') ) ,
 9 PARTITION fy_2015 VALUES LESS THAN
10 ( to_date('01-jan-2016','dd-mon-yyyy') )
11 )
12 /
Table created.

```

```
EODA@ORA12CR1> insert into partitioned partition(fy_2014)
  2  select to_date('31-dec-2014','dd-mon-yyyy')-mod(rownum,360), rownum
  3  from dual connect by level <= 70000
  4  /
70000 rows created.
```

```
EODA@ORA12CR1> insert into partitioned partition(fy_2015)
  2  select to_date('31-dec-2015','dd-mon-yyyy')-mod(rownum,360), rownum
  3  from dual connect by level <= 70000
  4  /
70000 rows created.
```

```
EODA@ORA12CR1> create index partitioned_idx_local
  2  on partitioned(id)
  3  LOCAL
  4  /
Index created.
```

```
EODA@ORA12CR1> create index partitioned_idx_global
  2  on partitioned(timestamp)
  3  GLOBAL
  4  /
Index created.
```

This sets up our warehouse table. The data is partitioned by fiscal year and we have the last two years' worth of data online. This table has two indexes: one is LOCAL and the other is GLOBAL. Now it's the end of the year and we would like to do the following:

1. Remove the oldest fiscal year data. We do not want to lose this data forever; we just want to age it out and archive it.
2. Add the newest fiscal year data. It will take a while to load it, transform it, index it, and so on. We would like to do this work without impacting the availability of the current data, if at all possible.

The first step is to set up an empty table for fiscal year 2014 that looks just like the partitioned table. We'll use this table to exchange with the FY\_2014 partition in the partitioned table, turning that partition into a table and in turn emptying out the partition in the partitioned table. The net effect is that the oldest data in the partitioned table will have been in effect removed after the exchange:

```
EODA@ORA12CR1> create table fy_2014 ( timestamp date, id int );
Table created.
```

```
EODA@ORA12CR1> create index fy_2014_idx on fy_2014(id);
Index created.
```

We'll do the same to the new data to be loaded. We'll create and load a table that structurally looks like the existing partitioned table (but that is not itself partitioned):

```
EODA@ORA12CR1> create table fy_2016 ( timestamp date, id int );
Table created.
```

```
EODA@ORA12CR1> insert into fy_2016
 2  select to_date('31-dec-2016','dd-mon-yyyy')-mod(rownum,360), rownum
 3  from dual connect by level <= 70000
 4  /
70000 rows created.
```

```
EODA@ORA12CR1> create index fy_2016_idx on fy_2016(id) nologging;
Index created.
```

We'll turn the current full partition into an empty partition and create a full table with the FY\_2014 data in it. Also, we've completed all of the work necessary to have the FY\_2016 data ready to go. This would have involved verifying the data, transforming it—whatever complex tasks we need to undertake to get it ready.

Now we're ready to update the live data using an exchange partition:

```
EODA@ORA12CR1> alter table partitioned
 2  exchange partition fy_2014
 3  with table fy_2014
 4  including indexes
 5  without validation
 6  /
Table altered.
```

```
EODA@ORA12CR1> alter table partitioned drop partition fy_2014;
Table altered.
```

This is all we need to do to age the old data out. We turned the partition into a full table and the empty table into a partition. This was a simple data dictionary update. No large amount of I/O took place—it just happened. We can now export that FY\_2014 table (perhaps using a transportable tablespace) out of our database for archival purposes. We could reattach it quickly if we ever needed to.

Next, we want to slide in the new data:

```
EODA@ORA12CR1> alter table partitioned
 2  add partition fy_2016
 3  values less than ( to_date('01-jan-2017','dd-mon-yyyy') )
 4  /
Table altered.
```

```
EODA@ORA12CR1> alter table partitioned
 2  exchange partition fy_2016
 3  with table fy_2016
 4  including indexes
 5  without validation
 6  /
Table altered.
```

Again, this was instantaneous; it was accomplished via simple data dictionary updates – the `WITHOUT VALIDATION` clause allowed us to accomplish that. When you use that clause, the database will trust that the data you are placing into that partition is, in fact, valid for that partition. Adding the empty partition took very little time to process. Then, we exchange the newly created empty partition with the full table, and the full table with the empty partition, and that operation is performed quickly as well. The new data is online.

Looking at our indexes, however, we'll find the following:

```
EODA@ORA12CR1> select index_name, status from user_indexes;
```

```
INDEX_NAME          STATUS
-----
PARTITIONED_IDX_LOCAL  N/A
PARTITIONED_IDX_GLOBAL UNUSABLE
FY_2014_IDX           VALID
FY_2016_IDX           VALID
```

The global index is, of course, unusable after this operation. Since each index partition can point to any table partition, *and* we just took away a partition and added a partition, that index is invalid. It has entries that point into the partition we dropped. It has *no* entries that point into the partition we just added. Any query that would make use of this index would fail and not execute, or, if we skip unusable indexes the query's performance would be negatively impacted by not being able to use the index:

```
EODA@ORA12CR1> select /*+ index( partitioned PARTITIONED_IDX_GLOBAL ) */ count(*)
 2  from partitioned
 3  where timestamp between to_date( '01-mar-2016', 'dd-mon-yyyy' )
 4    and to_date( '31-mar-2016', 'dd-mon-yyyy' );
select /*+ index( partitioned PARTITIONED_IDX_GLOBAL ) */ count(*)
*
```

ERROR at line 1:

```
ORA-01502: index 'EODA.PARTITIONED_IDX_GLOBAL' or partition of such index is in unusable state
```

```
EODA@ORA12CR1> explain plan for select count(*)
```

```
 2  from partitioned
 3  where timestamp between to_date( '01-mar-2016', 'dd-mon-yyyy' )
 4    and to_date( '31-mar-2016', 'dd-mon-yyyy' );
```

```
EODA@ORA12CR1> select * from table(dbms_xplan.display(null,null,'BASIC +PARTITION'));
```

```
-----
| Id | Operation                | Name          | Pstart | Pstop |
-----
| 0  | SELECT STATEMENT         |               |        |       |
| 1  | SORT AGGREGATE           |               |        |       |
| 2  | PARTITION RANGE SINGLE   |               | 2      | 2     |
| 3  | TABLE ACCESS FULL       | PARTITIONED   | 2      | 2     |
-----
```

So, our choices after performing this partition operation with global indexes are

- Skip the index, either transparently as Oracle is doing in this example or by setting the session parameter `SKIP_UNUSABLE_INDEXES=TRUE` in 9i (Oracle 10g defaults this setting to `TRUE`). But then we lose the performance the index was giving us.
- Have queries receive an error, as they would without `SKIP_UNUSABLE_INDEXES` set to `FALSE` in 9i and before or queries that explicitly request to use a hint will in 10g. We need to rebuild this index to make the data truly usable again.

The sliding window process, which so far has resulted in virtually no downtime, will now take a very long time to complete while we rebuild the global index. Runtime query performance of queries that relied on these indexes will be negatively affected during this time—either they will not run at all or they will run without the benefit of the index. All of the data must be scanned and the entire index reconstructed from the table data. If the table is many hundreds of gigabytes in size, this will take considerable resources.

## “Live” Global Index Maintenance

Starting in Oracle9i, another option was added to partition maintenance: the ability to *maintain the global indexes* during the partition operation using the `UPDATE GLOBAL INDEXES` clause. This means that as you drop a partition, split a partition, perform whatever operation necessary on a partition, Oracle will perform the necessary modifications to the global index to keep it up to date. Since most partition operations will cause this global index invalidation to occur, this feature can be a boon to systems that need to provide continual access to the data. You’ll find that you sacrifice the raw speed of the partition operation, but with the associated window of unavailability immediately afterward as you rebuild indexes, for a slower overall response time from the partition operation but coupled with 100 percent data availability. In short, if you have a data warehouse that cannot have downtime, but must support these common data warehouse techniques of sliding data in and out, then this feature is for you—but you must understand the implications.

Revisiting our previous example, if our partition operations had used the `UPDATE GLOBAL INDEXES` clause when relevant (in this example, it would not be needed on the `ADD PARTITION` statement since the newly added partition would not have any rows in it), we would have discovered the indexes to be perfectly valid and usable both *during* and *after* the operation:

```
EODA@ORA12CR1> alter table partitioned
  2 exchange partition fy_2014
  3 with table fy_2014
  4 including indexes
  5 without validation
  6 UPDATE GLOBAL INDEXES
  7 /
```

Table altered.

```
EODA@ORA12CR1> alter table partitioned drop partition fy_2014
  2 update global indexes;
```

Table altered.

```
EODA@ORA12CR1> alter table partitioned
  2 add partition fy_2016
  3 values less than ( to_date('01-jan-2017','dd-mon-yyyy') )
  4 /
```

Table altered.

```
EODA@ORA12CR1> alter table partitioned
 2 exchange partition fy_2016
 3 with table fy_2016
 4 including indexes
 5 without validation
 6 UPDATE GLOBAL INDEXES
 7 /
```

Table altered.

Note in the following output, the N/A status observed for the PARTITIONED\_IDX\_LOCAL index simply means the statuses are associated with the index *partitions* associated with that index not the index itself. It doesn't make sense to say the locally partitioned index is valid or not; it is just a container that logically holds the index partitions themselves:

```
EODA@ORA12CR1> select index_name, status from user_indexes;
```

INDEX_NAME	STATUS
PARTITIONED_IDX_LOCAL	N/A
PARTITIONED_IDX_GLOBAL	VALID
FY_2014_IDX	VALID
FY_2016_IDX	VALID

```
EODA@ORA12CR1> explain plan for select count(*)
 2 from partitioned
 3 where timestamp between to_date( '01-mar-2016', 'dd-mon-yyyy' )
 4 and to_date( '31-mar-2016', 'dd-mon-yyyy' );
```

```
EODA@ORA12CR1> select * from table(dbms_xplan.display(null,null,'BASIC +PARTITION'));
```

Id	Operation	Name
0	SELECT STATEMENT	
1	SORT AGGREGATE	
2	INDEX RANGE SCAN	PARTITIONED_IDX_GLOBAL

But there is a tradeoff: we are performing the logical equivalent of DELETE and INSERT operations on the global index structures. When we drop a partition, we have to delete all of the global index entries that might be pointing to that partition. When we did the exchange of a table with a partition, we had to delete all of the global index entries pointing to the original data and then insert all of the new ones that we just slid in there. So the amount of work performed by the ALTER commands was significantly increased.

You should expect with global index maintenance considerations that the approach without index maintenance will consume fewer database resources and therefore perform faster but incur a measurable period of downtime. The second approach, involving maintaining the indexes, will consume more resources and perhaps take longer overall, but will not incur downtime. As far as the end users are concerned, their ability to work never ceased. They might have been processing a bit slower (since we were competing with them for resources), but *they were still processing, and they never stopped*.

The index rebuild approach will almost certainly run faster, considering both the elapsed time and the CPU time. This fact has caused many a DBA to pause and say, “Hey, I don't want to use UPDATE GLOBAL INDEXES—it's slower.” That is too simplistic of a view, however. What you need to remember is that while the operations overall took longer,



processing on your system was not necessarily interrupted. Sure, you as the DBA might be looking at your screen for a longer period of time, but the really important work that takes place on your system was still taking place. You need to see if this tradeoff makes sense for you. If you have an eight-hour maintenance window overnight in which to load new data, then by all means, use the rebuild approach if that makes sense. However, if you have a mandate to be available continuously, then the ability to maintain the global indexes will be crucial.

One more thing to consider is the redo generated by each approach. You will find that the `UPDATE GLOBAL INDEXES` generates considerably more redo (due to the index maintenance) and you should expect that to only go up as you add more and more global indexes to the table. The redo generated by the `UPDATE GLOBAL INDEXES` processing is unavoidable and cannot be turned off via `NOLOGGING`, since the maintenance of the global indexes is not a complete rebuild of their structure but more of an incremental maintenance. Additionally, since you are maintaining the live index structure, you must generate undo for that—in the event the partition operation fails, you must be prepared to put the index back the way it was. And remember, undo is protected by redo itself, so some of the redo you see generated is from the index updates and some is from the rollback. Add another global index or two and you would reasonably expect these numbers to increase.

So, `UPDATE GLOBAL INDEXES` is an option that allows you to trade off availability for resource consumption. If you need to provide continuous availability, it's the option for you. But you have to understand the ramifications and size other components of your system appropriately. Specifically, many data warehouses have been crafted over time to use bulk direct path operations, bypassing undo generation and, when permitted, redo generation as well. Using `UPDATE GLOBAL INDEXES` cannot bypass either of those two elements. You need to examine the rules you use to size your redo and undo needs before using this feature, so you can assure yourself it can work on your system.

## Asynchronous Global Index Maintenance

As shown in the prior section, starting with Oracle9i and higher you can maintain global indexes while dropping or truncating partitions via the `UPDATE GLOBAL INDEXES` clause. However, as shown previously, such operations come at a cost in terms of time and resource consumption.

Starting with Oracle 12c, when dropping or truncating table partitions, Oracle postpones the removal of the global index entries associated with the dropped or truncated partitions. This is known as *asynchronous global index maintenance*. Oracle postpones the maintenance of the global index to a future time while keeping the global index usable. The idea being that this improves the performance of dropping/truncating partitions while keeping any global indexes in a usable state. The actual cleanup of the index entries is done later (asynchronously) either by the DBA or by an automatically scheduled Oracle job. It's not that less work is being done, rather it's the cleanup of index entries is decoupled from the `DROP/TRUNCATE` statement.

A small example will demonstrate asynchronous global index maintenance. To set this up, we create a table in an 11g database, populate it with test data, and create a global index:

```
EODA@ORA11GR2> CREATE TABLE partitioned
 2  ( timestamp date,
 3    id      int
 4  )
 5  PARTITION BY RANGE (timestamp)
 6  (PARTITION fy_2014 VALUES LESS THAN
 7  (to_date('01-jan-2015', 'dd-mon-yyyy')),
 8  PARTITION fy_2015 VALUES LESS THAN
 9  ( to_date('01-jan-2016', 'dd-mon-yyyy')));

EODA@ORA11GR2> insert into partitioned partition(fy_2014)
 2  select to_date('31-dec-2014', 'dd-mon-yyyy')-mod(rownum,364), rownum
 3  from dual connect by level < 100000;
99999 rows created.
```

```
EODA@ORA11GR2> insert into partitioned partition(fy_2015)
  2  select to_date('31-dec-2015','dd-mon-yyyy')-mod(rownum,364), rownum
  3  from dual connect by level < 100000;
99999 rows created.
```

```
EODA@ORA11GR2> create index partitioned_idx_global
  2  on partitioned(timestamp)
  3  GLOBAL;
Index created.
```

Next we'll run a query to retrieve the current values of redo size and db block gets statistics for the current session:

```
EODA@ORA11GR2> col r1 new_value r2
EODA@ORA11GR2> col b1 new_value b2
EODA@ORA11GR2> select * from
  2  (select b.value r1
  3  from v$statname a, v$mystat b
  4  where a.statistic# = b.statistic#
  5  and a.name = 'redo size'),
  6  (select b.value b1
  7  from v$statname a, v$mystat b
  8  where a.statistic# = b.statistic#
  9  and a.name = 'db block gets');
```

R1	B1
-----	-----
4816712	4512

Next a partition is dropped with the UPDATE GLOBAL INDEXES clause specified:

```
EODA@ORA11GR2> alter table partitioned drop partition fy_2014 update global indexes;
Table altered.
```

Now we'll calculate the amount of redo generated and the number of current blocks accessed:

```
EODA@ORA11GR2> select * from
  2  (select b.value - &r2 redo_gen
  3  from v$statname a, v$mystat b
  4  where a.statistic# = b.statistic#
  5  and a.name = 'redo size'),
  6  (select b.value - &b2 db_block_gets
  7  from v$statname a, v$mystat b
  8  where a.statistic# = b.statistic#
  9  and a.name = 'db block gets');
```

```
old 2: (select b.value - &r2 redo_gen
new 2: (select b.value - 4816712 redo_gen
old 6: (select b.value - &b2 db_block_gets
new 6: (select b.value - 4512 db_block_gets
```

```

REDO_GEN DB_BLOCK_GETS
-----
2459820      1495

```

If we re-run the same code in a 12c database, we get the following when dropping the partition with UPDATE GLOBAL INDEXES specified:

```

REDO_GEN DB_BLOCK_GETS
-----
 9872      43

```

Compared to the 11g example, a fraction of the redo is generated and blocks accessed when running this in an Oracle 12c database. The reason behind this is that Oracle doesn't immediately perform the index maintenance of removing the index entries from the dropped partition. Rather these entries are marked as *orphaned* and will later be cleaned up by Oracle. The existence of orphaned entries can be verified via the following:

```

EODA@ORA12CR1> select index_name, orphaned_entries, status from user_indexes
 2 where table_name='PARTITIONED';

```

```

INDEX_NAME          ORP STATUS
-----
PARTITIONED_IDX_GLOBAL  YES VALID

```

How do the orphaned entries get cleaned up? Oracle 12c has an automatically scheduled PMO\_DEFERRED\_GIDX\_MAINT\_JOB, which runs in a nightly maintenance window. If you don't want to wait for that job, you can manually clean up the entries yourself:

```

EODA@ORA12CR1> exec dbms_part.cleanup_gidx;
PL/SQL procedure successfully completed.

```

In this way you can perform operations such as dropping and truncating partitions and still leave your global indexes in a usable state without the immediate overhead of cleaning up the index entries as part of the drop/truncate operation.

---

■ **Tip** See MOS note 1482264.1 for further details on asynchronous global index maintenance.

---

## OLTP and Global Indexes

An OLTP system is characterized by the frequent occurrence of many small read and write transactions. In general, fast access to the row (or rows) you need is paramount. Data integrity is vital. Availability is also very important.

Global indexes make sense in many cases in OLTP systems. Table data can be partitioned by only one key—one set of columns. However, you may need to access the data in many different ways. You might partition EMPLOYEE data by LOCATION in the table, but you still need fast access to EMPLOYEE data by

- DEPARTMENT: Departments are geographically dispersed. There is no relationship between a department and a location.
- EMPLOYEE\_ID: While an employee ID will determine a location, you don't want to have to search by EMPLOYEE\_ID and LOCATION, hence partition elimination cannot take place on the index partitions. Also, EMPLOYEE\_ID by itself must be *unique*.
- JOB\_TITLE: There is no relationship between JOB\_TITLE and LOCATION. All JOB\_TITLE values may appear in any LOCATION.

There is a need to access the EMPLOYEE data by many different keys in different places in the application, and speed is paramount. In a data warehouse, we might just use locally partitioned indexes on these keys and use parallel index range scans to collect a large amount of data fast. In these cases, we don't necessarily need to use index partition elimination. In an OLTP system, however, we do need to use it. Parallel query is not appropriate for these systems; we need to provide the indexes appropriately. Therefore, we will need to make use of global indexes on certain fields.

The following are the goals we need to meet:

- Fast access
- Data integrity
- Availability

Global indexes can help us accomplish these goals in an OLTP system. We will probably not be doing sliding windows, auditing aside for a moment. We will not be splitting partitions (unless we have a scheduled downtime), we will not be moving data, and so on. The operations we perform in a data warehouse are not done on a live OLTP system in general.

Here is a small example that shows how we can achieve the three goals just listed with global indexes. I am going to use simple, *single partition* global indexes, but the results would not be different with global indexes in multiple partitions (except for the fact that availability and manageability would *increase* as we added index partitions). We start by creating tablespaces P1, P2, P3, and P4, then create a table that is range partitioned by location, LOC, according to our rules, which place all LOC values less than 'C' into partition P1, those less than 'D' into partition P2, and so on:

```
EODA@ORA12CR1> create tablespace p1 datafile size 1m autoextend on next 1m;
Tablespace created.
```

```
EODA@ORA12CR1> create tablespace p2 datafile size 1m autoextend on next 1m;
Tablespace created.
```

```
EODA@ORA12CR1> create tablespace p3 datafile size 1m autoextend on next 1m;
Tablespace created.
```

```
EODA@ORA12CR1> create tablespace p4 datafile size 1m autoextend on next 1m;
Tablespace created.
```

```
EODA@ORA12CR1> create table emp
 2 (EMPNO          NUMBER(4) NOT NULL,
 3  ENAME          VARCHAR2(10),
 4  JOB            VARCHAR2(9),
 5  MGR            NUMBER(4),
 6  HIREDATE       DATE,
 7  SAL            NUMBER(7,2),
 8  COMM           NUMBER(7,2),
 9  DEPTNO         NUMBER(2) NOT NULL,
```

```

10 LOC                VARCHAR2(13) NOT NULL
11 )
12 partition by range(loc)
13 (
14 partition p1 values less than('C') tablespace p1,
15 partition p2 values less than('D') tablespace p2,
16 partition p3 values less than('N') tablespace p3,
17 partition p4 values less than('Z') tablespace p4
18 )
19 /
Table created.

```

We alter the table to add a constraint on the primary key column:

```

EODA@ORA12CR1> alter table emp add constraint emp_pk
 2 primary key(empno)
 3 /
Table altered.

```

A side effect of this is that there exists a unique index on the EMPNO column. This shows we can support and enforce data integrity, one of our goals. Finally, we create two more global indexes on DEPTNO and JOB to facilitate accessing records quickly by those attributes:

```

EODA@ORA12CR1> create index emp_job_idx on emp(job)
 2 GLOBAL
 3 /
Index created.

```

```

EODA@ORA12CR1> create index emp_dept_idx on emp(deptno)
 2 GLOBAL
 3 /
Index created.

```

```

EODA@ORA12CR1> insert into emp
 2 select e.*, d.loc
 3   from scott.emp e, scott.dept d
 4  where e.deptno = d.deptno
 5 /
14 rows created.

```

Let's see what is in each partition:

```

EODA@ORA12CR1> break on pname skip 1
EODA@ORA12CR1> select 'p1' pname, empno, job, loc from emp partition(p1)
 2 union all
 3 select 'p2' pname, empno, job, loc from emp partition(p2)
 4 union all
 5 select 'p3' pname, empno, job, loc from emp partition(p3)
 6 union all
 7 select 'p4' pname, empno, job, loc from emp partition(p4)
 8 /

```

```

PN      EMPNO JOB      LOC
-----
p2      7499 SALESMAN CHICAGO
        7521 SALESMAN CHICAGO
        7654 SALESMAN CHICAGO
        7698 MANAGER  CHICAGO
        7844 SALESMAN CHICAGO
        7900 CLERK   CHICAGO

p3      7369 CLERK    DALLAS
        7566 MANAGER  DALLAS
        7788 ANALYST  DALLAS
        7876 CLERK   DALLAS
        7902 ANALYST  DALLAS

p4      7782 MANAGER  NEW YORK
        7839 PRESIDENT NEW YORK
        7934 CLERK   NEW YORK
14 rows selected.

```

This shows the distribution of data, by location, into the individual partitions. We can now review some query plans to see what we could expect performance-wise:

```

EODA@ORA12CR1> variable x varchar2(30);
EODA@ORA12CR1> begin
  2   dbms_stats.set_table_stats
  3   ( user, 'EMP', numRows=>100000, numblks => 10000 );
  4 end;
  5 /

```

PL/SQL procedure successfully completed.

```

EODA@ORA12CR1> explain plan for select empno, job, loc from emp where empno = :x;
Explained.

```

```

EODA@ORA12CR1> select * from table(dbms_xplan.display(null,null,'BASIC +PARTITION'));

```

```

-----
| Id | Operation                                | Name   | Pstart | Pstop |
-----
| 0  | SELECT STATEMENT                        |        |        |        |
| 1  | TABLE ACCESS BY GLOBAL INDEX ROWID    | EMP    | ROWID  | ROWID  |
| 2  | INDEX UNIQUE SCAN                       | EMP_PK |        |        |
-----

```

The plan here shows an `INDEX UNIQUE SCAN` of the nonpartitioned index `EMP_PK` that was created in support of our primary key. Then there is a `TABLE ACCESS BY GLOBAL INDEX ROWID`, with a `PSTART` and `PSTOP` of `ROWID/ROWID`, meaning that when we get the `ROWID` from the index, it will tell us precisely which index partition to read to

get this row. This index access will be as effective as on a nonpartitioned table and perform the same amount of I/O to do so. It is just a simple, single index unique scan followed by “get this row by rowid.” Now, let’s look at one of the other global indexes, the one on JOB:

```
EODA@ORA12CR1> explain plan for select empno, job, loc from emp where job = :x;
Explained.
```

```
EODA@ORA12CR1> select * from table(dbms_xplan.display);
```

Id	Operation	Name	Pstart	Pstop
0	SELECT STATEMENT			
1	TABLE ACCESS BY GLOBAL INDEX ROWID BATCHED	EMP	ROWID	ROWID
2	INDEX RANGE SCAN	EMP_JOB_IDX		

Sure enough, we see a similar effect for the INDEX RANGE SCAN. Our indexes are used and can provide high-speed OLTP access to the underlying data. If they were partitioned, they would have to be prefixed and enforce index partition elimination; hence, they are scalable as well, meaning we can partition them and observe the same behavior. In a moment, we’ll look at what would happen if we used LOCAL indexes only.

Lastly, let’s look at the area of availability. The Oracle documentation claims that globally partitioned indexes make for less available data than locally partitioned indexes. I don’t fully agree with this blanket characterization. I believe that in an OLTP system they are as highly available as a locally partitioned index. Consider the following:

```
EODA@ORA12CR1> alter tablespace p1 offline;
Tablespace altered.
```

```
EODA@ORA12CR1> alter tablespace p2 offline;
Tablespace altered.
```

```
EODA@ORA12CR1> alter tablespace p3 offline;
Tablespace altered.
```

```
EODA@ORA12CR1> select empno, job, loc from emp where empno = 7782;
```

EMPNO	JOB	LOC
7782	MANAGER	NEW YORK

Here, even though most of the underlying data is unavailable in the table, we can still gain access to any bit of data available via that index. As long as the EMPNO we want is in a tablespace that is available, and our GLOBAL index is available, our GLOBAL index works for us. On the other hand, if we *had* been using the highly available local index in the preceding case, we might have been prevented from accessing the data! This is a side effect of the fact that we partitioned on LOC but needed to query by EMPNO. We would have had to probe each local index partition and would have failed on the index partitions that were not available.

Other types of queries, however, will not (and cannot) function at this point in time:

```
EODA@ORA12CR1> select empno, job, loc from emp where job = 'CLERK';
select empno, job, loc from emp where job = 'CLERK'
                *
ERROR at line 1:
ORA-00376: file 10 cannot be read at this time
ORA-01110: data file 10: '/u01/dbfile/ORA12CR1/datafile/o1_mf_p2_9hx10fqv_.dbf'
```

The CLERK data is in all of the partitions, and the fact that three of the tablespaces are offline does affect us. This is unavoidable unless we had partitioned on JOB, but then we would have had the same issues with queries that needed data by LOC. Anytime you need to access the data from many different *keys*, you will have this issue. Oracle will give you the data whenever it can.

Note, however, that if the query can be answered from the index, avoiding the TABLE ACCESS BY ROWID, the fact that the data is unavailable is not as meaningful:

```
EODA@ORA12CR1> select count(*) from emp where job = 'CLERK';

COUNT(*)
-----
         4
```

Since Oracle didn't need the table in this case, the fact that most of the partitions were offline doesn't affect this query (assuming the index isn't in one of the offline tablespaces of course). As this type of optimization (i.e., answer the query using just the index) is common in an OLTP system, there will be many applications that are not affected by the data that is offline. All we need to do now is make the offline data available as fast as possible (restore it and recover it).

## Partial Indexes

Starting with Oracle 12c, you can create either local or global indexes on a subset of partitions in a table. You may want to do this if you've pre-created partitions and don't yet have data for range partitions that map to future dates—the idea being that you'll build the index after the partitions have been loaded (at some future date).

You set up the use of a partial index by first specifying INDEXING ON|OFF for each partition in the table. In this next example, PART\_1 has indexing turned on and PART\_2 has indexing turned off:

```
EODA@ORA12CR1> CREATE TABLE p_table (a int)
 2 PARTITION BY RANGE (a)
 3 (PARTITION part_1 VALUES LESS THAN(1000) INDEXING ON,
 4 PARTITION part_2 VALUES LESS THAN(2000) INDEXING OFF);
Table created.
```

Next, a partial local index is created:

```
EODA@ORA12CR1> create index pi1 on p_table(a) local indexing partial;
Index created.
```



In this scenario, the INDEXING PARTIAL clause instructs Oracle to only build and make usable local index partitions that point to partitions in the table that were defined with INDEXING ON. In this case, one usable index partition will be created with index entries pointing to data in the PART\_1 table partition:

```
EODA@ORA12CR1> select a.index_name, a.partition_name, a.status
 2 from user_ind_partitions a, user_indexes b
 3 where b.table_name = 'P_TABLE'
 4 and a.index_name = b.index_name;
```

INDEX_NAME	PARTITION_NAME	STATUS
PI1	PART_2	UNUSABLE
PI1	PART_1	USABLE

Next we'll insert some test data, generate statistics, set autotrace on, and run a query that should locate data in the PART\_1 partition:

```
EODA@ORA12CR1> insert into p_table select rownum from dual connect by level < 2000;
1999 rows created.
```

```
EODA@ORA12CR1> exec dbms_stats.gather_table_stats(user,'P_TABLE');
PL/SQL procedure successfully completed.
```

```
EODA@ORA12CR1> explain plan for select * from p_table where a = 20;
Explained.
```

```
EODA@ORA12CR1> select * from table(dbms_xplan.display(null,null,'BASIC +PARTITION'));
```

Id	Operation	Name	Pstart	Pstop
0	SELECT STATEMENT			
1	PARTITION RANGE SINGLE		1	1
2	INDEX RANGE SCAN	PI1	1	1

As expected, the optimizer was able to generate an execution plan utilizing the index. Next, a query is issued that selects data from the partition defined with INDEXING OFF:

```
EODA@ORA12CR1> explain plan for select * from p_table where a = 1500;
Explained.
```

```
EODA@ORA12CR1> select * from table(dbms_xplan.display(null,null,'BASIC +PARTITION'));
```

Id	Operation	Name	Pstart	Pstop
0	SELECT STATEMENT			
1	PARTITION RANGE SINGLE		2	2
2	TABLE ACCESS FULL	P_TABLE	2	2

The output shows a full table scan of PART\_2 was required, as there is no usable index with entries pointing at data in PART\_2. We can instruct Oracle to create index entries pointing to data in PART\_2 by rebuilding the index partition associated with the PART\_2 partition:

```
EODA@ORA12CR1> alter index pi1 rebuild partition part_2;
Index altered.
```

Re-running the previous select query shows that the optimizer is now utilizing the local partitioned index pointing to the PART\_2 table partition:

Id	Operation	Name	Pstart	Pstop
0	SELECT STATEMENT			
1	PARTITION RANGE SINGLE		2	2
2	INDEX RANGE SCAN	PI1	2	2

In this way, partial indexes allow you to disable the index while the table partition is being loaded (increasing the loading speed), and then later you can rebuild the partial index to make it available.

## Partitioning and Performance, Revisited

Many times I hear people say, “I’m very disappointed in partitioning. We partitioned our largest table and *it went much slower*. So much for partitioning being a performance increasing feature!”

Partitioning can do one of the following three things to overall query performance:

- Make your queries go faster
- Not impact the performance of your queries at all
- Make your queries go much slower and use many times the resources as the nonpartitioned implementation

In a data warehouse, with an understanding of the questions being asked of the data, the first bullet point is very much achievable. Partitioning can positively impact queries that frequently full scan large database tables by eliminating large sections of data from consideration. Suppose you have a table with 1 billion rows in it. There is a timestamp attribute. Your query is going to retrieve one years’ worth of data from this table (and it has 10 years of data). Your query uses a full table scan to retrieve this data. Had it been partitioned by this timestamp entry—say, a partition per month—then you could have full scanned one-tenth the data (assuming a uniform distribution of data over the years). Partition elimination would have removed the other 90 percent of the data from consideration. Your query would likely run faster.

Now, take a similar table in an OLTP system. You would never retrieve 10 percent of a 1 billion row table in that type of application. Therefore, the massive increase in speed seen by the data warehouse just would not be achievable in a transactional system. You are not doing the same sort of work, and the same possible improvements are just not realistic. Therefore, in general, in your OLTP system the first bullet point is not achievable, and you won’t be applying partitioning predominantly for increased performance. Increased availability—absolutely. Administrative ease of use—very much so. But in an OLTP system, I say you have to work hard to make sure you achieve the second point: that you do not impact the performance of your queries at all, negatively or positively. Many times, your goal is to apply partitioning without affecting query response time.

On many occasions, I've seen that the implementation team will see they have a medium-sized table, say of 100 million rows. Now, 100 million *sounds* like an incredibly large number (and five or ten years ago, it would have been, but time changes all things). So the team decides to partition the data. But in looking at the data, there are no logical attributes that make sense for RANGE partitioning. There are no sensible attributes for that. Likewise, LIST partitioning doesn't make sense. Nothing pops out of this table as being the right thing to partition by. So, the team opts for hash partitioning on the primary key, which just happens to be populated by an Oracle sequence number. It looks perfect, it is unique and easy to hash, and many queries are of the form `SELECT * FROM T WHERE PRIMARY_KEY = :X`.

But the problem is there are many other queries against this object that are not of that form. For illustrative purposes, assume the table in question is really the `ALL_OBJECTS` dictionary view, and while internally many queries would be of the form `WHERE OBJECT_ID = :X`, the end users frequently have these requests of the application as well:

- Show me the details of SCOTT's EMP table (where `owner = :o` and `object_type = :t` and `object_name = :n`).
- Show me all of the tables SCOTT owns (where `owner = :o` and `object_type = :t`).
- Show me all of the objects SCOTT owns (where `owner = :o`).

In support of those queries, you have an index on (`OWNER,OBJECT_TYPE,OBJECT_NAME`). But you also read that local indexes are more available, and you would like to be more available regarding your system, so you implement them. You end up re-creating your table like this, with 16 hash partitions:

```
EODA@ORA12CR1> create table t
 2 ( OWNER, OBJECT_NAME, SUBOBJECT_NAME, OBJECT_ID, DATA_OBJECT_ID,
 3   OBJECT_TYPE, CREATED, LAST_DDL_TIME, TIMESTAMP, STATUS,
 4   TEMPORARY, GENERATED, SECONDARY )
 5 partition by hash(object_id)
 6 partitions 16
 7 as
 8 select OWNER, OBJECT_NAME, SUBOBJECT_NAME, OBJECT_ID, DATA_OBJECT_ID,
 9   OBJECT_TYPE, CREATED, LAST_DDL_TIME, TIMESTAMP, STATUS,
10   TEMPORARY, GENERATED, SECONDARY
11 from all_objects;
Table created.
```

```
EODA@ORA12CR1> create index t_idx
 2 on t(owner,object_type,object_name)
 3 LOCAL
 4 /
Index created.
```

```
EODA@ORA12CR1> exec dbms_stats.gather_table_stats( user, 'T' );
PL/SQL procedure successfully completed.
```

And you execute your typical OLTP queries that you know you will run frequently:

```
variable o varchar2(30)
variable t varchar2(30)
variable n varchar2(30)

exec :o := 'SCOTT'; :t := 'TABLE'; :n := 'EMP';
```

```

select *
  from t
 where owner = :o
       and object_type = :t
       and object_name = :n
/
select *
  from t
 where owner = :o
       and object_type = :t
/
select *
  from t
 where owner = :o
/

```

However, when you run this with `SQL_TRACE=TRUE` and review the resulting TKPROF report, you notice the following performance characteristics:

```

select * from t where owner = :o and object_type = :t and object_name = :n

```

call	count	cpu	elapsed	disk	query	current	rows
total	4	0.00	0.01	0	34	0	1

...

Rows (1st)	Rows (avg)	Rows (max)	Row Source	Operation
1	1	1	PARTITION HASH ALL PARTITION: 1 16	(cr=34 pr=0 pw=0 time=95...
1	1	1	TABLE ACCESS BY LOCAL INDEX ROWID BATCHED T PARTITION: ...	
1	1	1	INDEX RANGE SCAN T_IDX PARTITION: 1 16	(cr=33 pr=0 pw=0...

You compare that to the same table, only with *no partitioning implemented*, and discover the following:

```

select * from t where owner = :o and object_type = :t and object_name = :n

```

call	count	cpu	elapsed	disk	query	current	rows
total	4	0.00	0.00	0	4	0	1

...

Rows (1st)	Rows (avg)	Rows (max)	Row Source	Operation
1	1	1	TABLE ACCESS BY INDEX ROWID BATCHED T (cr=4 pr=0 pw=0...	
1	1	1	INDEX RANGE SCAN T_IDX (cr=3 pr=0 pw=0 time=14 us cost=1...	

You might immediately jump to the (erroneous) conclusion that partitioning causes an eightfold increase in I/O: 4 query mode gets without partitioning and 34 with partitioning. If your system had an issue with high consistent gets (logical I/Os before), it is worse now. If it didn't have one before, it might well get one. The same thing can be observed for the other two queries. In the following, the first total line is for the partitioned table and the second is for the nonpartitioned table:

```

select * from t where owner = :o and object_type = :t

```

call	count	cpu	elapsed	disk	query	current	rows
total	5	0.00	0.00	0	49	0	20
total	5	0.00	0.00	0	11	0	20

```
select * from t where owner = :o
```

call	count	cpu	elapsed	disk	query	current	rows
total	5	0.00	0.00	0	665	0	26
total	5	0.00	0.00	0	628	0	26

Each of the queries had the same outcome answer-wise, but consumed significantly more I/Os to accomplish it—this is not good. The root cause? The index-partitioning scheme. Notice in the preceding plan the partitions listed in the last line: 1 through 16.

```
1          1          1 PARTITION HASH ALL PARTITION: 1 16 (cr=34 pr=0 pw=0 time=95...
1          1          1 TABLE ACCESS BY LOCAL INDEX ROWID BATCHED T PARTITION: ...
1          1          1 INDEX RANGE SCAN T_IDX PARTITION: 1 16 (cr=33 pr=0 pw=0...
```

This query has to look at *each and every* index partition here. The reason for that is because entries for SCOTT may well be in *each and every* index partition and probably is. The index is logically hash partitioned by OBJECT\_ID; any query that uses this index and that does not also refer to the OBJECT\_ID in the predicate must consider *every* index partition! So, what is the solution here? You should globally partition your index. Using the previous case as the example, we could choose to hash partition the index:

---

■ **Note** Hash partitioning of indexes was a feature added in Oracle 10g that is not available in Oracle9i. There are considerations to be taken into account with hash partitioned indexes regarding range scans, which we'll discuss later in this section.

---

```
EODA@ORA12CR1> create index t_idx
 2 on t(owner,object_type,object_name)
 3 global
 4 partition by hash(owner)
 5 partitions 16
 6 /
```

Index created.

Much like the hash partitioned tables we investigated earlier, Oracle will take the OWNER value, hash it to a partition between 1 and 16, and place the index entry in there. Now when we review the TKPROF information for these three queries again, as follows, we can see we are much closer to the work performed by the nonpartitioned table earlier—that is, we have not negatively impacted the work performed by our queries:

call	count	cpu	elapsed	disk	query	current	rows
total	4	0.00	0.00	0	4	0	1
total	5	0.00	0.00	0	11	0	20
total	5	0.00	0.00	0	628	0	26

It should be noted, however, that a hash partitioned index cannot be range scanned; in general, it is most suitable for exact equality (equals or in-lists). If you were to query “WHERE OWNER > :X” using the preceding index, it would not be able to perform a simple range scan using partition elimination. You would be back to inspecting all 16 hash partitions.

## USING ORDER BY

This example brought to mind an unrelated but very important fact. When looking at hash partitioned indexes, we are faced with another case where the use of an index to retrieve data would *not* automatically retrieve the data sorted. Many people assume that if the query plan shows an index is used to retrieve the data, the data will be retrieved sorted. *This has never been true.* The only way we can retrieve data in any sort of sorted order is to use an ORDER BY clause on the query. If your query does not contain an ORDER BY statement, you cannot make any assumptions about the sorted order of the data.

A quick example demonstrates this. We create a small table as a copy of ALL\_USERS and create a hash partitioned index with four partitions on the USER\_ID column:

```
EODA@ORA12CR1> create table t
  2 as
  3 select *
  4   from all_users
  5 /
Table created.
```

```
EODA@ORA12CR1> create index t_idx
  2 on t(user_id)
  3 global
  4 partition by hash(user_id)
  5 partitions 4
  6 /
Index created.
```

Now, we will query that table and use a hint to have Oracle use the index. Notice the ordering (actually, the lack of ordering) of the data:

```
EODA@ORA12CR1> set autotrace on explain
EODA@ORA12CR1> select /*+ index( t t_idx ) */ user_id
  2   from t
  3  where user_id > 0
  4 /

  USER_ID
-----
        13
...
        97
        22
...
       104
         8
```

```

...
    93
    7
...
    96
43 rows selected.

```

Id	Operation	Name	Rows	Bytes	Cost (%CPU)	Time	Pstart	Pstop
0	SELECT STATEMENT		43	172	4 (0)	00:00:01		
1	PARTITION HASH ALL		43	172	4 (0)	00:00:01	1	4
* 2	INDEX RANGE SCAN	T_IDX	43	172	4 (0)	00:00:01	1	4

```
EODA@ORA12CR1> set autotrace off
```

So, even though Oracle used the index in a range scan, the data is obviously not sorted. In fact, you might observe a pattern in this data. There are four sorted results here: the ... replaces values that were increasing in value; and between the rows with `USER_ID = 13` and `97`, the values were increasing in the output. Then the row with `USER_ID = 22` appeared. What we are observing is Oracle returning “sorted data” from each of the four hash partitions, one after the other.

This is just a warning that unless your query has an `ORDER BY`, you have no reason to anticipate the data being returned to you in any kind of sorted order whatsoever. (And no, `GROUP BY` doesn’t have to sort either! There is no substitute for `ORDER BY`.)

Does that mean partitioning won’t affect OLTP performance at all in a positive sense? No, not entirely—you just have to look in a different place. In general, it will not positively impact the performance of your data retrieval in OLTP; rather, care has to be taken to ensure data retrieval isn’t affected negatively. But on data modification, partitioning may provide salient benefits in highly concurrent environments.

Consider the preceding a rather simple example of a single table with a single index, and add into the mix a primary key. Without partitioning, there is a single table: all insertions go into this single table. There is contention perhaps for the freelists on this table. Additionally, the primary key index that would be on the `OBJECT_ID` column would be a heavy right-hand-side index, as we discussed in Chapter 11. Presumably it would be populated by a sequence; hence, all inserts would go after the rightmost block leading to buffer busy waits. Also, there would be a single index structure `T_IDX` that people would be contending for. So far, a lot of single items.

Enter partitioning. You hash partition the table by `OBJECT_ID` into 16 partitions. There are now 16 tables to contend for, and each table has one-sixteenth the number of users hitting it simultaneously. You locally partition the primary key index on `OBJECT_ID` into 16 partitions. You now have 16 right-hand sides, and each index structure will receive one-sixteenth the workload it had before. And so on. That is, you can use partitioning in a highly concurrent environment to reduce contention, much like we used a reverse key index in Chapter 11 to reduce the buffer busy waits. However, you must be aware that the very process of partitioning out the data consumes more CPU itself than not having partitioning. That is, it takes more CPU to figure out where to put the data than it would if the data had but one place to go.

So, as with everything, before applying partitioning to a system to increase performance, make sure you understand what that system *needs*. If your system is currently CPU bound, but that CPU usage is not due to contention and latch waits, introducing partitioning could make the problem worse, not better!

## Ease of Maintenance Features

At the beginning of this chapter I stated the goal was to provide a practical guide to implement applications with partitioning, and that I wouldn't be focusing so much on administration. However, there are a few new administrative features available starting with Oracle 12c that deserve some discussion, namely:

- Multiple partition maintenance operations
- Cascade exchange
- Cascade delete

These features have a positive impact in terms of ease of maintenance, data integrity, and performance. Therefore it's important to be aware of these features when implementing partitioning.

## Multiple Partition Maintenance Operations

This feature eases the administration of partitioning and in some scenarios reduces the database resources required to perform maintenance operations. Prior to Oracle 12c, when performing partition operations such as adding a partition, you were only allowed to work with one partition at a time. For example, take the following range partitioned table:

```
EODA@ORA12CR1> create table p_table
  2 (a int)
  3 partition by range (a)
  4 (partition p1 values less than (1000),
  5 partition p2 values less than (2000));
Table created.
```

Prior to 12c, if you wanted to add two partitions to a table, it was done with two separate SQL statements:

```
EODA@ORA12CR1> alter table p_table add partition p3 values less than (3000);
Table altered.

EODA@ORA12CR1> alter table p_table add partition p4 values less than (4000);
Table altered.
```

Starting with Oracle 12c, you can perform multiple partition operations in one statement. The prior code can be run as follows:

```
EODA@ORA12CR1> alter table p_table add
  2 partition p3 values less than (3000),
  3 partition p4 values less than (4000);
Table altered.
```

---

■ **Note** In addition to adding partitions, multiple partition maintenance operations can be applied to dropping, merging, splitting, and truncating.

---



Performing multiple maintenance partition operations in one DDL statement is particularly advantageous for splitting partitions and thus deserves more discussion. Think about what happens in Oracle 11g in the scenario of where you need to split a P2014 yearly partition into four quarterly partitions: Q1, Q2, Q3, and Q4. You would have to split the P2014 with three separate DDL statements; each operation requiring a scan of all of the rows in the partition being split, Oracle determining which partition the row should be inserted into, and then inserting. Having to split and re-split multiple times consumes many more resources than it would if you could simply split multiple partitions as one operation. A small example will illustrate this. Let's set this up by creating a table and loading it with data:

```
EODA@ORA12CR1> CREATE TABLE sales(
  2  sales_id int
  3  ,s_date  date)
  4  PARTITION BY RANGE (s_date)
  5  (PARTITION P2014 VALUES LESS THAN (to_date('01-jan-2015','dd-mon-yyyy')));
Table created.
```

```
EODA@ORA12CR1> insert into sales
  2  select level, to_date('01-jan-2014','dd-mon-yyyy') + ceil(dbms_random.value(1,364))
  3  from dual connect by level < 100000;
99999 rows created.
```

Next we create a small utility function to help us measure the resources consumed while performing an operation:

```
EODA@ORA12CR1> create or replace function get_stat_val( p_name in varchar2 ) return number
  2  as
  3  l_val number;
  4  begin
  5  select b.value
  6  into l_val
  7  from v$statname a, v$mystat b
  8  where a.statistic# = b.statistic#
  9  and a.name = p_name;
 10  return l_val;
 11 end;
 12 /
Function created.
```

Now we'll use the pre-12c method of splitting a partition into multiple partitions and measure the amount of redo our session generates. Using GET\_STAT\_VAL, we get the current value for the redo statistic:

```
EODA@ORA12CR1> var r1 number
EODA@ORA12CR1> exec :r1 := get_stat_val('redo size');
PL/SQL procedure successfully completed.
```

And using DBMS\_UTILITY, we'll record the current CPU time:

```
EODA@ORA12CR1> var c1 number
EODA@ORA12CR1> exec :c1 := dbms_utility.get_cpu_time;
PL/SQL procedure successfully completed.
```

Next, using the pre-12c syntax, the P2014 partition is split into four partitions with three separate DDL statements:

```
EODA@ORA12CR1> alter table sales split partition
 2 P2014 at (to_date('01-apr-2014','dd-mon-yyyy'))
 3 into (partition Q1, partition Q2);
Table altered.
```

```
EODA@ORA12CR1> alter table sales split partition
 2 Q2 at (to_date('01-jul-2014','dd-mon-yyyy'))
 3 into (partition Q2, partition Q3);
Table altered.
```

```
EODA@ORA12CR1> alter table sales split partition
 2 Q3 at (to_date('01-oct-2014','dd-mon-yyyy'))
 3 into (partition Q3, partition Q4);
Table altered.
```

Now we'll display the difference in the redo size statistic and CPU time:

```
EODA@ORA12CR1> exec dbms_output.put_line(get_stat_val('redo size') - :r1);
4747712
```

```
EODA@ORA12CR1> exec dbms_output.put_line(dbms_utility.get_cpu_time - :c1);
16
```

A sizable amount of redo has been generated due to the multiple split operations, resulting in many insert statements as Oracle splits the partition multiple times and re-inserts rows.

Next we'll run the exact same test except using the new 12c syntax, we'll split the P2014 partition into four partitions in one DDL statement (re-creating and populating the table not shown here for brevity):

```
EODA@ORA12CR1> var r1 number
EODA@ORA12CR1> exec :r1 := get_stat_val('redo size');
PL/SQL procedure successfully completed.
```

```
EODA@ORA12CR1> var c1 number
EODA@ORA12CR1> exec :c1 := dbms_utility.get_cpu_time;
PL/SQL procedure successfully completed.
```

```
EODA@ORA12CR1> alter table sales split partition P2014
 2 into (partition Q1 values less than (to_date('01-apr-2014','dd-mon-yyyy')),
 3      partition Q2 values less than (to_date('01-jul-2014','dd-mon-yyyy')),
 4      partition Q3 values less than (to_date('01-oct-2014','dd-mon-yyyy')),
 5      partition Q4);
Table altered.
```

```
EODA@ORA12CR1> exec dbms_output.put_line(get_stat_val('redo size') - :r1);
2099288
```

```
EODA@ORA12CR1> exec dbms_output.put_line(dbms_utility.get_cpu_time - :c1);
6
```

The amount of redo generated via the single DDL statement is less than half the amount generated by the multiple partition operation statements and consumes less than half the CPU time. Depending on the number of partitions being split and if you're updating indexes at the same time, the amount of redo generated and CPU consumed can be considerably less than when splitting the maintenance operations into multiple statements.

## Cascade Truncate

Starting with Oracle 12c you can truncate parent/child tables in tandem as a single atomic DDL statement. While the truncate cascade is taking place, any queries issued against the parent/child table combination are always presented with a read consistent view of the data. Meaning that the data in the parent/child tables will either be seen as both tables populated or both tables truncated.

The truncate cascade functionality is initiated with a TRUNCATE ... CASCADE statement on the parent table. For the cascading truncate to take place, any child tables must be defined with the foreign key relational constraint of ON DELETE CASCADE. What does cascade truncate have to do with partitioning? In a reference partitioned table, you can truncate a parent table partition and have it cascade to the child table partition in one transaction.

Let's look at an example of this. Applying the TRUNCATE ... CASCADE functionality to reference partitioned tables, the parent ORDERS table is created here and the ORDER\_LINE\_ITEMS table is created with ON DELETE CASCADE applied to the foreign key constraint:

```
EODA@ORA12CR1> create table orders
 2 (
 3   order#      number primary key,
 4   order_date  date,
 5   data        varchar2(30)
 6 )
 7 PARTITION BY RANGE (order_date)
 8 (
 9   PARTITION part_2014 VALUES LESS THAN (to_date('01-01-2015','dd-mm-yyyy')) ,
10   PARTITION part_2015 VALUES LESS THAN (to_date('01-01-2016','dd-mm-yyyy'))
11 )
12 /
```

Table created.

```
EODA@ORA12CR1> insert into orders values
 2 ( 1, to_date( '01-jun-2014', 'dd-mon-yyyy' ), 'xyz' );
1 row created.
```

```
EODA@ORA12CR1> insert into orders values
 2 ( 2, to_date( '01-jun-2015', 'dd-mon-yyyy' ), 'xyz' );
1 row created.
```

And now we'll create the ORDER\_LINE\_ITEMS table, ensuring we include the ON DELETE CASCADE clause:

```
EODA@ORA12CR1> create table order_line_items
 2 (
 3   order#      number,
 4   line#       number,
 5   data        varchar2(30),
 6   constraint c1_pk primary key(order#,line#),
 7   constraint c1_fk_p foreign key(order#) references orders on delete cascade
 8 ) partition by reference(c1_fk_p)
 9 /
```

```
EODA@ORA12CR1> insert into order_line_items values ( 1, 1, 'yyy' );
1 row created.
```

```
EODA@ORA12CR1> insert into order_line_items values ( 2, 1, 'yyy' );
1 row created.
```

Now we can issue a TRUNCATE ... CASCADE that truncates both the parent table partition and the child table partition as a single transaction:

```
EODA@ORA12CR1> alter table orders truncate partition PART_2014 cascade;
Table truncated.
```

In other words, the TRUNCATE ... CASCADE functionality prevents applications from seeing the child table truncated before the parent table is truncated.

You can also truncate all partitions in the parent and child tables via:

```
EODA@ORA12CR1> truncate table orders cascade;
Table truncated.
```

Again, just to be clear, the ability to cascade truncate parent/child tables is not exclusively a partitioning feature. This feature also applies to nonpartitioned parent/child tables. This allows you to use one DDL statement to initiate truncate operations and also ensures the database application is always presented with a consistent view of parent/child partitions.

## Cascade Exchange

Prior to Oracle 12c, when exchanging partitions for a reference partitioned table, the sequence was roughly this:

1. Create and load parent table.
2. Create parent partition in reference partitioned table.
3. Exchange parent table specifying UPDATE GLOBAL INDEXES.
4. Create child table with a foreign key constraint that points at the reference partitioned parent.
5. Load child table.
6. Exchange child table with child reference partition.

As you can see from the prior steps, there exists the potential for users accessing the database to see data in the parent table without the corresponding rows in the child table. Prior to Oracle 12c there was no way around this behavior.

Starting with Oracle 12c you can exchange the combination of parent/child reference partitioned tables in one atomic DDL statement. A small example will demonstrate this. First, a reference partitioned parent and child table is created to set this up:

```
EODA@ORA12CR1> create table orders
 2  ( order#      number primary key,
 3    order_date date,
 4    data       varchar2(30))
 5  PARTITION BY RANGE (order_date)
 6  (PARTITION part_2014 VALUES LESS THAN (to_date('01-01-2015', 'dd-mm-yyyy')) ,
 7    PARTITION part_2015 VALUES LESS THAN (to_date('01-01-2016', 'dd-mm-yyyy')));
Table created.
```

```
EODA@ORA12CR1> insert into orders values (1, to_date( '01-jun-2014', 'dd-mon-yyyy' ), 'xyz');
1 row created.
```

```
EODA@ORA12CR1> insert into orders values (2, to_date( '01-jun-2015', 'dd-mon-yyyy' ), 'xyz');
1 row created.
```

```
EODA@ORA12CR1> create table order_line_items
 2      (order#      number,
 3        line#      number,
 4        data       varchar2(30),
 5        constraint c1_pk primary key(order#,line#),
 6        constraint c1_fk_p foreign key(order#) references orders
 7        ) partition by reference(c1_fk_p);
Table created.
```

```
EODA@ORA12CR1> insert into order_line_items values ( 1, 1, 'yyy' );
1 row created.
```

```
EODA@ORA12CR1> insert into order_line_items values ( 2, 1, 'yyy' );
1 row created.
```

Next, an empty partition is added to the reference partitioned table:

```
EODA@ORA12CR1> alter table orders add partition part_2016
 2      values less than (to_date('01-01-2017','dd-mm-yyyy'));
Table altered.
```

Next, a parent and child table are created and loaded with data. These are the tables that will be exchanged with the empty partitions in the reference partitioned table:

```
EODA@ORA12CR1> create table part_2016
 2      ( order#      number primary key,
 3        order_date  date,
 4        data       varchar2(30));
Table created.
```

```
EODA@ORA12CR1> insert into part_2016 values (3, to_date('01-jun-2016', 'dd-mon-yyyy' ), 'xyz');
1 row created.
```

```
EODA@ORA12CR1> create table c_2016
 2      (order#      number,
 3        line#      number,
 4        data       varchar2(30),
 5        constraint ce1_pk primary key(order#,line#),
 6        constraint ce1_fk_p foreign key(order#) references part_2016);
Table created.
```

```
EODA@ORA12CR1> insert into c_2016 values(3, 1, 'xyz');
1 row created.
```

Now we can exchange the prior two tables in one transaction into the reference partitioned tables. Notice the CASCADE option is specified:

```
EODA@ORA12CR1> alter table orders
 2  exchange partition part_2016
 3  with table part_2016
 4  without validation
 5  CASCADE
 6  update global indexes;
Table altered.
```

That's it. With one DDL statement, we simultaneously exchanged two tables related by a foreign key constraint into a reference partitioned table. Anybody accessing the database will see the parent and child table partitions added seamlessly as one unit of work.

## Auditing and Segment Space Compression

Not too many years ago, U.S. government constraints such as those imposed by the HIPAA act (<http://www.hhs.gov/ocr/hipaa>) were not in place. Companies such as Enron were still in business, and another U.S. government requirement for Sarbanes-Oxley compliance did not exist. Back then, auditing was considered something that “we might do someday, maybe.” Today, however, auditing is at the forefront, and many DBAs are challenged to retain online up to seven years of audit trail information for their financial, business, and health care databases.

Audit trail information is the one piece of data in your database that you might well insert but never retrieve during the normal course of operation. It is there predominantly as a forensic, after-the-fact trail of evidence. We need to have it, but from many perspectives, it is just something that sits on our disks and consumes space—lots and lots of space. And then every month or year or some other time interval, we have to purge or archive it. Auditing is something that if not properly designed from the beginning can kill you at the end. Seven years from now when you are faced with your first purge or archive of the old data is not when you want to be thinking about how to accomplish it. Unless you designed for it, getting that old information out is going to be painful.

Enter two technologies that make auditing not only bearable, but also pretty easy to manage and consume less space. These technologies are partitioning and segment space compression, as we discussed in Chapter 10. That second one might not be as obvious since *basic* segment space compression only works with large bulk operations like a direct path load (OLTP compression is a feature of the Advanced Compression Option—not available with all database editions), and audit trails are typically inserted into a row at a time, as events happen. The trick is to combine sliding window partitions with segment space compression.

Suppose we decide to partition the audit trail by month. During the first month of business, we just insert into the partitioned table; these inserts go in using the conventional path, not a direct path, and hence are not compressed. Now, before the month ends, we'll add a new partition to the table to accommodate next month's auditing activity. Shortly after the beginning of next month, we will perform a large bulk operation on last month's audit trail—specifically, we'll use the ALTER TABLE command to move last month's partition, which will have the effect of compressing the data as well. If we, in fact, take this a step further, we could move this partition from a read-write tablespace, which it must have been in, into a tablespace that is normally read-only (and contains other partitions for

this audit trail). In that fashion, we can back up that tablespace once a month, after we move the partition in there; ensure we have a good, clean, current readable copy of the tablespace; and then not back it up anymore that month. We might have the following tablespaces for our audit trail:

- A current online, read-write tablespace that gets backed up like every other normal tablespace in our system. The audit trail information in this tablespace is not compressed, and it is constantly inserted into.
- A read-only tablespace containing “this year to date” audit trail partitions in a compressed format. At the beginning of each month, we make this tablespace read-write, move and compress last month’s audit information into this tablespace, make it read-only again, and back it up.
- A series of tablespaces for last year, the year before, and so on. These are all read-only and might even be on slow, cheap media. In the event of a media failure, we just need to restore from backup. We would occasionally pick a year at random from our backup sets to ensure they are still restorable (tapes go bad sometimes).

In this fashion, we have made purging easy (i.e., drop a partition). We have made archiving easy, too—we could just transport a tablespace off and restore it later. We have reduced our space utilization by implementing compression. We have reduced our backup volumes, as in many systems, the single largest set of data is *audit trail data*. If you can remove some or all of that from your day-to-day backups, the difference will be measurable.

In short, audit trail requirements and partitioning are two things that go hand in hand, regardless of the underlying system type, be it data warehouse or OLTP.

---

■ **Tip** Consider using Oracle’s Flashback Data Archive feature for auditing requirements. When enabled for a table, the Flashback Data Archive will automatically create an underlying partitioned table to record transactional information.

---

## Summary

Partitioning is extremely useful in scaling up large database objects in the database. This scaling is visible from the perspective of performance scaling, availability scaling, and administrative scaling. All three are extremely important to different people. The DBA is concerned with administrative scaling. The owners of the system are concerned with availability, because downtime is lost money, and anything that reduces downtime—or reduces the impact of downtime—boosts the payback for a system. The end users of the system are concerned with performance scaling. No one likes to use a slow system, after all.

We also looked at the fact that in an OLTP system, partitions may not increase performance, especially if applied improperly. Partitions can increase the performance of certain classes of queries, but those queries are generally not applied in an OLTP system. This point is important to understand, as many people associate partitioning with “free performance increase.” This does not mean that partitions should *not* be used in OLTP systems—they do provide many other salient benefits in this environment—just don’t expect a massive increase in throughput. Expect reduced downtime. Expect the same good performance (partitioning *will not* slow you down when applied appropriately). Expect easier manageability, which may lead to increased performance due to the fact that some maintenance operations are performed by the DBAs more frequently because they can be.

We investigated the various table-partitioning schemes offered by Oracle—range, hash, list, interval, reference, interval reference, virtual column, and composite—and talked about when they are most appropriately used. We spent the bulk of our time looking at partitioned indexes and examining the differences between prefixed and nonprefixed and local and global indexes. We investigated partition operations in data warehouses combined with global indexes, and the tradeoff between resource consumption and availability. We also looked at new Oracle 12c new ease of maintenance features such as the ability to perform maintenance operations on multiple partitions at a time, cascading truncate, and cascade exchange. Oracle continues to update and improve partitioning with each new release.

Over time, I see this feature becoming more relevant to a broader audience as the size and scale of database applications grow. The Internet and its database-hungry nature along with legislation requiring longer retention of audit data are leading to more and more extremely large collections of data, and partitioning is a natural tool to help manage that problem.





# Parallel Execution

*Parallel execution*, a feature of Oracle Enterprise Edition (it is not available in the Standard Edition), was first introduced in Oracle version 7.1.6 in 1994. It is the ability to physically break a large serial task (any DML, or DDL in general) into many smaller bits that may all be processed simultaneously. Parallel executions in Oracle mimic the real-life processes we see all of the time. For example, you would not expect to see a single individual build a house; rather, many people team up to work concurrently to rapidly assemble the house. In that way, certain operations can be divided into smaller tasks and performed concurrently; for instance, the plumbing and electrical wiring can take place concurrently to reduce the total amount of time required for the job as a whole.

Parallel execution in Oracle follows much the same logic. It is often possible for Oracle to divide a certain large job into smaller parts and to perform each part concurrently. In other words, if a full table scan of a large table is required, there is no reason why Oracle cannot have four parallel sessions, P001–P004, perform the full scan together, with each session reading a different portion of the table. If the data scanned by P001–P004 needs to be sorted, this could be carried out by four more parallel sessions, P005–P008, which could ultimately send the results to an overall coordinating session for the query.

Parallel execution is a tool that, when wielded properly, may result in increased orders of magnitude with regard to response time for some operations. When it's wielded as a "fast = true" switch, the results are typically quite the opposite. In this chapter, the goal is not to explain precisely how parallel query is implemented in Oracle, the myriad combinations of plans that can result from parallel operations, and the like; this material is covered quite well in *Oracle Database Administrator's Guide*, *Oracle Database Concepts* manual, *Oracle VLDB and Partitioning Guide*, and, in particular, *Oracle Database Data Warehousing Guide*. This chapter's goal is to give you an understanding of what class of problems parallel execution is and isn't appropriate for. Specifically, after looking at when to use parallel execution, we will cover

- *Parallel query*: This is the capability of Oracle to perform a single query using many operating system processes or threads. Oracle will find operations it can perform in parallel, such as full table scans or large sorts, and create a query plan that does them in parallel.
- *Parallel DML (PDML)*: This is very similar in nature to parallel query, but it is used in reference to performing modifications (INSERT, UPDATE, DELETE, and MERGE) using parallel processing. In this chapter, we'll look at PDML and discuss some of the inherent limitations associated with it.
- *Parallel DDL*: Parallel DDL is the ability of Oracle to perform large DDL operations in parallel. For example, an index rebuild, creation of a new index, loading of data via a CREATE TABLE AS SELECT, and reorganization of large tables may all use parallel processing. This, I believe, is the sweet spot for parallelism in the database, so we will focus most of the discussion on this topic.

- *Parallel load*: External tables and SQL\*Loader have the ability to load data in parallel. This topic is touched on briefly in this chapter and in Chapter 15.
- *Procedural parallelism*: This is the ability to run our developed code in parallel. In this chapter, I'll discuss two approaches to this. The first approach involves Oracle running our developed PL/SQL code in parallel in a fashion transparent to developers (developers are not developing parallel code; rather, Oracle is parallelizing their code for them transparently). The other is something I term “do-it-yourself parallelism,” whereby the developed code is designed to be executed in parallel. We'll take a look at two methods to employ this “do-it-yourself parallelism,” a rather manual implementation valid for Oracle Database 11g Release 1 and before—and a new automated method available in Oracle Database 11g Release 2 and above.

There are two other types of parallel execution that deserve mentioning, but are beyond the scope of this book. I mention them here for completeness and also so that you're aware of them when dealing with either recovery or replication operations:

- *Parallel recovery*: Another form of parallel execution in Oracle is the ability to perform parallel recovery. Parallel recovery may be performed at the instance level, perhaps by increasing the speed of a recovery that needs to be performed after a software, operating system, or general system failure (e.g., an unexpected power outage). Parallel recovery may also be applied during media recovery (e.g., restoration from backups). It is not my goal to cover recovery-related topics in this book, so I'll just mention the existence of parallel recovery in passing. For further reading on the topic, see the *Oracle Backup and Recovery User's Guide*.
- *Parallel propagation*: A type of parallel execution used by the Oracle Advanced Replication option that provides for asynchronous parallel propagation of transactions. In this mode, Oracle uses parallel processes to increase the bandwidth of replication operations. For more details on parallel propagation, see the *Oracle Database Advanced Replication* manual.

Now that you have a brief introduction to parallel execution, let's get started with when it would be appropriate to use this feature.

## When to Use Parallel Execution

Parallel execution can be fantastic. It can allow you to take a process that executes over many hours or days and complete it in minutes. Breaking down a huge problem into small components may, in some cases, dramatically reduce the processing time. However, one underlying concept that is useful to keep in mind while considering parallel execution is summarized by this very short quote from *Practical Oracle8i: Building Efficient Databases* (Addison-Wesley, 2001) by Jonathan Lewis:

*PARALLEL QUERY option is essentially nonscalable.*

Although this quote is over a dozen years old as of this writing, it is as valid today, if not more so, as it was back then. Parallel execution is essentially a nonscalable solution. It was designed to allow an individual user or a particular SQL statement to consume all resources of a database. If you have a feature that allows an individual to make use of everything that is available, and then allow two individuals to use that feature, you'll have obvious contention issues. As the number of concurrent users on your system begins to overwhelm the number of resources you have (memory, CPU, and I/O), the ability to deploy parallel operations becomes questionable. If you have a four-CPU machine, for example, and you have 32 users on average executing queries simultaneously, the odds are that you do *not* want to parallelize their operations. If you allowed each user to perform just a “parallel 2” query, you would now have 64 concurrent operations taking place on a machine with just four CPUs. If the machine was not overwhelmed before parallel execution, it almost certainly would be now.

In short, parallel execution can also be a terrible idea. In many cases, the application of parallel processing will only lead to increased resource consumption, as parallel execution attempts to use *all available resources*. In a system where resources must be shared by many concurrent transactions, such as in an OLTP system, you would likely observe *increased* response times due to this. It avoids certain execution techniques that it can use efficiently in a serial execution plan and adopts execution paths such as full scans in the hope that by performing many pieces of the larger, bulk operation in parallel, it would be better than the serial plan. Parallel execution, when applied inappropriately, may be the cause of your performance problem, not the solution for it.

So, before applying parallel execution, you need the following two things to be true:

- You must have a very large task, such as the full scan of 50GB of data.
- You must have sufficient *available* resources. Before parallel full scanning 50GB of data, you want to make sure that there is sufficient free CPU to accommodate the parallel processes as well as sufficient I/O. The 50GB should be spread over more than one physical disk to allow for many concurrent read requests to happen simultaneously, there should be sufficient I/O channels from the disk to the computer to retrieve the data from disk in parallel, and so on.

If you have a small task, as generally typified by the queries carried out in an OLTP system, or you have insufficient *available* resources, again as is typical in an OLTP system where CPU and I/O resources are often already used to their maximum, then parallel execution is not something you'll want to consider. So you can better understand this concept, I present the following analogy.

## A Parallel Processing Analogy

I often use an analogy to describe parallel processing and why you need both a large task *and* sufficient free resources in the database. It goes like this: suppose you have two tasks to complete. The first is to write a one-page summary of a new product. The other is to write a ten-chapter comprehensive report, with each chapter being very much independent of the others. For example, consider this book: this chapter, “Parallel Execution,” is very much separate and distinct from the chapter titled “Redo and Undo”—they did not have to be written sequentially.

How do you approach each task? Which one do you think would benefit from parallel processing?

### One-Page Summary

In this analogy, the one-page summary you have been assigned is not a large task. You would either do it yourself or assign it to a single individual. Why? Because the amount of work required to parallelize this process would exceed the work needed just to write the paper yourself. You would have to sit down, figure out that there should be 12 paragraphs, determine that each paragraph is not dependent on the other paragraphs, hold a team meeting, pick 12 individuals, explain to them the problem and assign them each a paragraph, act as the coordinator and collect all of their paragraphs, sequence them into the right order, verify they are correct, and then print the report. This is all likely to take longer than it would to *just write the paper yourself, serially*. The overhead of managing a large group of people on a project of this scale will far outweigh any gains to be had from having the 12 paragraphs written in parallel.

The exact same principle applies to parallel execution in the database. If you have a job that takes seconds or less to complete serially, then the introduction of parallel execution and its associated managerial overhead will likely make the entire thing take longer.

### Ten-Chapter Report

But consider the second task. If you want that ten-chapter report fast—as fast as possible—the slowest way to accomplish it would be to assign all of the work to a single individual (trust me, I know—look at this book! Some days I wished there were 15 of me working on it). So you would hold the meeting, review the process, assign the work,

act as the coordinator, collect the results, bind up the finished report, and deliver it. It would not have been done in one-tenth the time, but perhaps one-eighth or so. Again, I say this with the proviso that *you have sufficient free resources*. If you have a large staff that is currently not doing anything, then splitting the work up makes complete sense.

However, consider that as the manager, your staff is multitasking and they have a lot on their plates. In that case, you have to be careful with that big project. You need to be sure not to overwhelm them; you don't want to work them beyond the point of exhaustion. You can't delegate out more work than your resources (your people) can cope with, otherwise they'll quit. If your staff is already fully utilized, adding more work will cause all schedules to slip and all projects to be delayed.

Parallel execution in Oracle is very much the same. If you have a task that takes many minutes, hours, or days, then the introduction of parallel execution may be the thing that makes it run eight times faster. But if you are already seriously low on resources (the overworked team of people), then the introduction of parallel execution would be something to avoid, as the system will become even more bogged down. While the Oracle server processes won't quit in protest, they could start running out of RAM and failing, or just suffer from such long waits for I/O or CPU as to make it appear as if they were doing no work whatsoever.

If you keep this in mind, remembering never to take an analogy to illogical extremes, you'll have the commonsense guiding rule to see if parallelism can be of some use. If you have a job that takes seconds, it is doubtful that parallel execution can be used to make it go faster—the converse would be more likely. If you are low on resources already (i.e., your resources are fully utilized), adding parallel execution would likely make things worse, not better. Parallel execution is excellent for when you have a really big job and plenty of excess capacity. In this chapter, we'll take a look at some of the ways we can exploit those resources.

## Oracle Exadata

Oracle Exadata Database Machine is a combined hardware/software offering by Oracle Corporation that takes parallel operations to the next level. Oracle Exadata is a massively parallel solution to large database problems (on the order of hundreds to thousands of terabytes, or more). It combines hardware—a specialized storage area network (SAN) for the database, with software—Oracle Enterprise Linux or Oracle Solaris and parts of the Oracle Database software at the physical disk level to offload what typically has been database server processing functions such as the following, and performing them at the storage level itself.

- Scanning blocks
- Processing blocks
- Decrypting/encrypting blocks
- Filtering blocks (applying a WHERE clause)
- Selecting columns from blocks
- Processing regular expressions

This results in a tremendous resource usage decrease on the database server—as it receives and processes only the rows and columns that are needed (the storage devices perform the WHERE clause processing and the SELECT column list already, among other things) instead of the full set of data. Not only is the scanning of the disk significantly faster (many times in magnitude faster), but the processing of the data itself is sped up by being performed in a massively parallel fashion.

So, at the core, Oracle Exadata is about parallel processing, but it will not be covered in detail in this book. In the future I do envision that changing, at which point, a chapter (or two) on the topic will be called for. For now, I'm going to focus on the native parallel processing capabilities of the Oracle Database without Exadata itself.

## Parallel Query

Parallel query allows a single SQL `SELECT` statement to be divided into many smaller queries, with each component query being run concurrently, and then the results from each combined to provide the final answer. For example, consider the following query:

```
EODA@ORA12CR1> select count(status) from big_table;
```

Using parallel query, this query could use some number of parallel sessions, break the `BIG_TABLE` into small, nonoverlapping slices, and then ask each parallel session to read the table and count its section of rows. The parallel query coordinator for this session would then receive each of the aggregated counts from the individual parallel sessions and further aggregate them, returning the final answer to the client application. Graphically it might look like Figure 14-1.

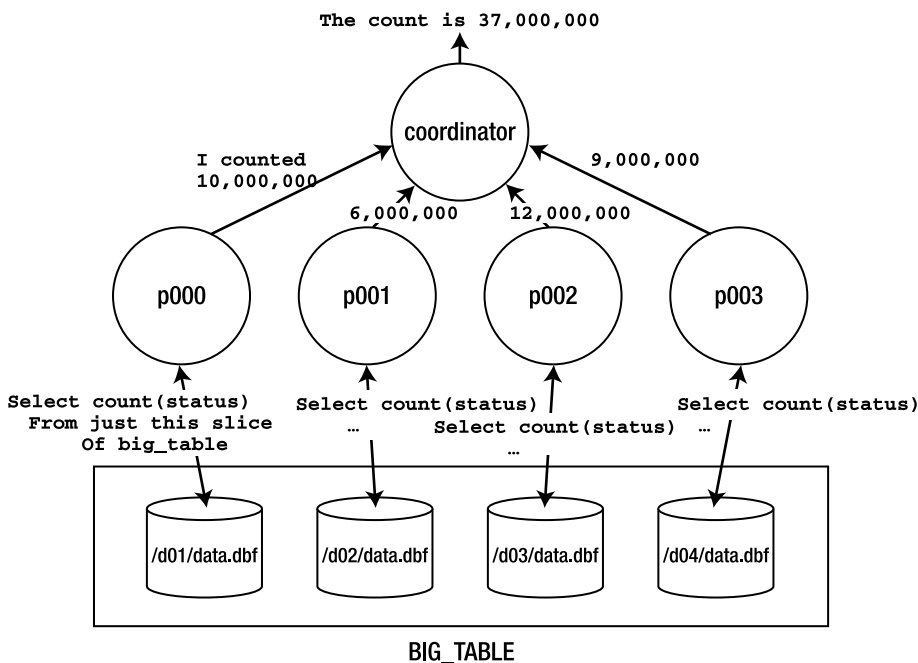

**Figure 14-1.** Parallel select count (status) depiction

---

■ **Note** There is not a 1-1 mapping between processes and files as Figure 14-1 depicts. In fact, all of the data for `BIG_TABLE` could have been in a single file, processed by four parallel processes. Or, there could have been two files processed by the four, or any number of files in general.

---

The p000, p001, p002, and p003 processes are known as *parallel execution servers*, sometimes also referred to as *parallel query (PQ) slaves*. Each of these parallel execution servers is a separate session connected as if it were a dedicated server process. Each one is responsible for scanning a nonoverlapping region of `BIG_TABLE`, aggregating their results subsets, and sending back their output to the coordinating server—the original session’s server process—which will aggregate the subresults into the final answer.

We can see this in an explain plan. Using a `BIG_TABLE` with 10 million rows in it (see the “Setting Up Your Environment” section at the beginning of the book for details on creating a `BIG_TABLE`), we’ll walk through enabling a parallel query for that table and discover how we can see parallel query in action. This example was performed on a four-CPU machine with default values for all parallel parameters on Oracle 12c Release 1; that is, this is an out-of-the-box installation where only necessary parameters were set, including `MEMORY_TARGET` (set to 4GB), `CONTROL_FILES`, `DB_BLOCK_SIZE` (set to 8KB), and `PGA_AGGREGATE_TARGET` (set to 512MB). Initially, we would expect to see the following plan:

```
EODA@ORA12CR1> explain plan for select count(status) from big_table;
Explained.
```

```
EODA@ORA12CR1> select * from table(dbms_xplan.display(null, null,
2 'TYPICAL -ROWS -BYTES -COST'));
```

```
-----
```

Id	Operation	Name	Time
0	SELECT STATEMENT		00:00:03
1	SORT AGGREGATE		
2	TABLE ACCESS FULL	BIG_TABLE	00:00:03

```
-----
```

---

■ **Note** Different releases of Oracle have different default settings for various parallel features—sometimes radically different settings. Do not be surprised if you test some of these examples on older releases and see different output as a result of that.

---

That is a typical *serial* plan. No parallelism is involved because we did not request parallel query to be enabled, and by default it will not be.

We may enable parallel query in a variety of ways, including use of a hint directly in the query or by altering the table to enable the consideration of parallel execution paths (which is the option we use here).

We can specifically dictate the degree of parallelism to be considered in execution paths against this table. For example, we can tell Oracle, “We would like you to use parallel degree 4 when creating execution plans against this table.” This translates into the following code:

```
EODA@ORA12CR1> alter table big_table parallel 4;
Table altered.
```

I prefer to just tell Oracle, “Please consider parallel execution, but you figure out the appropriate degree of parallelism based on the current system workload and the query itself.” That is, let the degree of parallelism vary over time as the workload on the system increases and decreases. If we have plenty of free resources, the degree of parallelism will go up; in times of limited available resources, the degree of parallelism will go down. Rather than overload the machine with a fixed degree of parallelism, this approach allows Oracle to dynamically increase or decrease the amount of concurrent resources required by the query.

We simply enable parallel query against this table via the ALTER TABLE command:

```
EODA@ORA12CR1> alter table big_table parallel;
Table altered.
```

That is all there is to it—parallel query will now be considered for operations against this table. When we rerun the explain plan, this time we see the following:

```
EODA@ORA12CR1> explain plan for select count(status) from big_table;
Explained.
```

```
EODA@ORA12CR1> select * from table(dbms_xplan.display(null, null,
2 'TYPICAL -ROWS -BYTES -COST'));
-----
```

Id	Operation	Name	Time	TQ	IN-OUT	PQ Distrib
0	SELECT STATEMENT		00:00:01			
1	SORT AGGREGATE					
2	PX COORDINATOR					
3	PX SEND QC (RANDOM)	:TQ10000		Q1,00	P->S	QC (RAND)
4	SORT AGGREGATE			Q1,00	PCWP	
5	PX BLOCK ITERATOR		00:00:01	Q1,00	PCWC	
6	TABLE ACCESS FULL	BIG_TABLE	00:00:01	Q1,00	PCWP	

Notice the aggregate time for the query running in parallel was 00:00:01 as opposed to the previous estimate of 00:00:03 for the serial plan. Remember, these are *estimates*, not promises!

If you read this plan from the bottom up, starting at ID=6, it shows the steps described in Figure 14-1. The full table scan would be split up into many smaller scans (step 5). Each of those would aggregate their COUNT(STATUS) values (step 4). These subresults would be transmitted to the parallel query coordinator (steps 2 and 3), which would aggregate these results further (step 1) and output the answer.

## DEFAULT PARALLEL EXECUTION SERVERS

When an instance starts, Oracle uses the value of the PARALLEL\_MIN\_SERVERS initialization parameter to determine how many parallel execution servers to automatically start. These processes are used to service parallel execution statements. In Oracle 11g, the default value of PARALLEL\_MIN\_SERVERS was 0; meaning, by default, no parallel processes start at instance startup.

Starting with Oracle 12c, the minimum value of PARALLEL\_MIN\_SERVERS is calculated from CPU\_COUNT \* PARALLEL\_THREADS\_PER\_CPU \* 2. In a Linux/UNIX environment, you can view these processes using the ps command:

```
$ ps -aef | grep '^oracle.*ora_p00._ORA12CR1'
```

```
oracle 18518 1 0 10:13 ? 00:00:00 ora_p000_ORA12CR1
oracle 18520 1 0 10:13 ? 00:00:00 ora_p001_ORA12CR1
```

```

oracle  18522      1  0 10:13 ?          00:00:00 ora_p002_ORA12CR1
oracle  18524      1  0 10:13 ?          00:00:00 ora_p003_ORA12CR1
oracle  18526      1  0 10:13 ?          00:00:00 ora_p004_ORA12CR1
...

```

Prior to Oracle 12c, if you hadn't modified the value of `PARALLEL_MIN_SERVERS` from the default of 0, you wouldn't initially see any parallel execution server processes when you first started your instance. These processes appeared after you ran a statement that processed in parallel.

---

If we are curious enough to want to watch parallel query, we can easily do so using two sessions. In the session that we will run the parallel query in, we'll start by determining our SID:

```
EODA@ORA12CR1> select sid from v$mystat where rownum = 1;
```

```

      SID
-----
      258

```

In another session, we get this query ready to run (but don't run it yet, just type it in!):

```
EODA@ORA12CR1> select sid, qcsid, server#, degree
 2  from v$px_session
 3  where qcsid = 258
```

Now, going back to the original session that we queried the SID from, we'll start the parallel query. In the session with the query setup, we can run it now and see output similar to this:

```

4  /

```

SID	QCSID	SERVER#	DEGREE
26	258	1	8
102	258	2	8
177	258	3	8
267	258	4	8
23	258	5	8
94	258	6	8
169	258	7	8
12	258	8	8
258	258		

9 rows selected.

We see here that our parallel query session (SID=258) is the query coordinator SID (QCSID) for nine rows in this dynamic performance view. Our session is *coordinating* or controlling these parallel query resources now. We can



see each has its own SID; in fact, each is a separate Oracle session and shows up as such in V\$SESSION during the execution of our parallel query:

```
EODA@ORA12CR1> select sid, username, program
 2  from v$session
 3  where sid in ( select sid
 4                  from v$px_session
 5                  where qcsid = 258 )
 6  /
```

SID	USERNAME	PROGRAM
12	EODA	oracle@heera07 (P007)
23	EODA	oracle@heera07 (P004)
26	EODA	oracle@heera07 (P000)
94	EODA	oracle@heera07 (P001)
102	EODA	oracle@heera07 (P005)
169	EODA	oracle@heera07 (P006)
177	EODA	oracle@heera07 (P002)
258	EODA	sqlplus@heera07 (TNS V1-V3)
267	EODA	oracle@heera07 (P003)

9 rows selected.

---

■ **Note** If a parallel execution is not occurring in your system, do not expect to see the parallel execution servers in V\$SESSION. They will be in V\$PROCESS, but will not have a session established unless they are being used. The parallel execution servers will be connected to the database, but will not have a session established. See Chapter 5 for details on the difference between a session and a connection.

---

In a nutshell, that is how parallel query—and, in fact, parallel execution in general—works. It entails a series of parallel execution servers working in tandem to produce subresults that are fed either to other parallel execution servers for further processing or to the coordinator for the parallel query.

In this particular example, as depicted, we had BIG\_TABLE spread across four separate devices in a single tablespace (a tablespace with four data files). When implementing parallel execution, it is generally optimal to have your data spread over as many physical devices as possible. You can achieve this in a number of ways:

- Using RAID striping across disks
- Using ASM, with its built-in striping
- Using partitioning to physically segregate BIG\_TABLE over many disks
- Using multiple data files in a single tablespace, thus allowing Oracle to allocate extents for the BIG\_TABLE segment in many files

In general, parallel execution works best when given access to as many resources (CPU, memory, and I/O) as possible. However, that is not to say that nothing can be gained from parallel query if the entire set of data were on a single disk, but you would perhaps not gain as much as would be gained using multiple disks. The reason you would likely gain some speed in response time, even when using a single disk, is that when a given parallel execution server is counting rows, it is not reading them, and vice versa. So, two parallel execution servers may well be able to complete the counting of all rows in less time than a serial plan would.

Likewise, you can benefit from parallel query even on a single CPU machine. It is doubtful that a serial `SELECT COUNT(*)` would use 100 percent of the CPU on a single CPU machine—it would be spending part of its time performing (and waiting for) physical I/O to disk. Parallel query would allow you to fully utilize the resources (the CPU and I/O, in this case) on the machine, whatever those resources may be.

That final point brings us back to the earlier quote from *Practical Oracle8i: Building Efficient Databases*: parallel query is essentially nonscalable. If you allowed four sessions to simultaneously perform queries with two parallel execution servers on that single CPU machine, you would probably find their response times to be longer than if they just processed serially. The more processes clamoring for a scarce resource, the longer it will take to satisfy all requests.

And remember, parallel query requires two things to be true. First, you need to have a large task to perform—for example, a long-running query, the runtime of which is measured in minutes, hours, or days, not in seconds or subseconds. This implies that parallel query is not a solution to be applied in a typical OLTP system, where you are not performing long-running tasks. Enabling parallel execution on these systems is often disastrous.

Second, you need ample free resources such as CPU, I/O, and memory. If you are lacking in any of these, then parallel query may well push your utilization of that resource over the edge, negatively impacting overall performance and runtime.

In Oracle 11g Release 2 and above, a new bit of functionality has been introduced to try and limit this over commitment of resources: Parallel Statement Queuing (PSQ). When using PSQ, the database will limit the number of concurrently executing parallel queries—and place any further parallel requests in an execution queue. When the CPU resources are exhausted (as measured by the number of parallel execution servers in concurrent use), the database will prevent new requests from becoming active. These requests will not fail—rather they will have their start delayed, they will be queued. As resources become available (as parallel execution servers that were in use finish their tasks and become idle), the database will begin to execute the queries in the queue. In this fashion, as many parallel queries as make sense can run concurrently, without overwhelming the system, while subsequent requests politely wait their turn. In all, everyone gets their answer faster, but a waiting line is involved.

Parallel query was once considered mandatory for many data warehouses simply because in the past (say, in 1995), data warehouses were rare and typically had a very small, focused user base. Today, data warehouses are literally everywhere and support user communities that are as large as those found for many transactional systems. This means that you might not have sufficient free resources at any given point in time to enable parallel query on these systems. This doesn't mean parallel execute is not useful in this case—it just might be more of a DBA tool, as we'll see in the section “Parallel DDL,” rather than a parallel query tool.

## Parallel DML

The Oracle documentation limits the scope of parallel DML (PDML) to include only `INSERT`, `UPDATE`, `DELETE`, and `MERGE` (it does not include `SELECT` as normal DML does). During PDML, Oracle may use many parallel execution servers to perform your `INSERT`, `UPDATE`, `DELETE`, or `MERGE` instead of a single serial process. On a multi-CPU machine with plenty of I/O bandwidth, the potential increase in speed may be large for mass DML operations.

However, you should *not* look to PDML as a feature to speed up your OLTP-based applications. As stated previously, parallel operations are designed to fully and totally maximize the utilization of a machine. They are designed so that a single user can completely use all of the disks, CPU, and memory on the machine. In a certain data warehouse (with lots of data and few users), this is something you may want to achieve. In an OLTP system (with a lot of users all doing short, fast transactions), you do not want to give a user the ability to fully take over the machine resources.

This sounds contradictory: we use parallel query to scale up, so how could it not be scalable? When applied to an OLTP system, the statement is quite accurate. Parallel query is not something that scales up as the number of concurrent users increases. Parallel query was designed to allow a single session to generate as much work as 100 concurrent sessions would. In our OLTP system, we really do not want a single user to generate the work of 100 users.

PDML is useful in a large data warehousing environment to facilitate bulk updates to massive amounts of data. The PDML operation is executed in much the same way as a distributed query would be executed by Oracle, with each parallel execution server acting like a process in a separate database instance. Each slice of the table is modified by a separate thread with its own independent transaction (and hence its own undo segment, hopefully). After they are all done, the equivalent of a fast two-phase commit is performed to commit the separate, independent transactions. Figure 14-2 depicts a parallel update using four parallel execution servers. Each of the parallel execution servers has its own independent transaction, in which either all are committed with the PDML coordinating session or none commits.

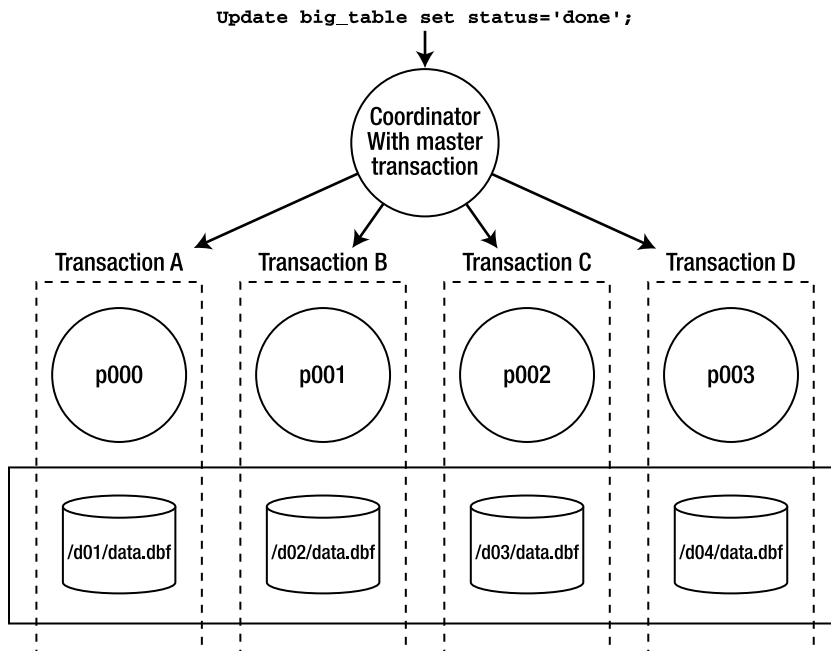

**Figure 14-2.** Parallel update (PDML) depiction

We can actually observe the fact that there are separate independent transactions created for the parallel execution servers. We'll use two sessions again. In the session with SID=258, we explicitly enable parallel DML. PDML differs from parallel query in that regard; unless you explicitly ask for it, you will *not* get it:

```
EODA@ORA12CR1> alter session enable parallel dml;
Session altered.
```

You can verify that parallel DML has been enabled for your session via:

```
EODA@ORA12CR1> select pdml_enabled from v$session where sid = sys_context('userenv','sid');
PDM
---
```

The fact that the table is “parallel” is not sufficient, as it was for parallel query. The reasoning behind the need to explicitly enable PDML in your session is the fact that PDML has certain limitations associated with it, which I list after this example.

In the same session, we do a bulk UPDATE that, because the table is “parallel enabled,” will in fact be done in parallel:

```
EODA@ORA12CR1> update big_table set status = 'done';
```

In the other session, we'll join V\$SESSION to V\$TRANSACTION to show the active sessions for our PDML operation, as well as their independent transaction information:

```
EODA@ORA12CR1> select a.sid, a.program, b.start_time, b.used_ublk,
2      b.xidusn || '.' || b.xidslot || '.' || b.xidsqn trans_id
3   from v$session a, v$transaction b
4  where a.taddr = b.addr
5     and a.sid in ( select sid
6                   from v$px_session
7                   where qcsid = 258)
8  order by sid
9  /
```

SID	PROGRAM	START_TIME	USED_UBLK	TRANS_ID
11	oracle@heera07 (P00B)	02/25/14 14:10:17	13985	26.32.15
12	oracle@heera07 (P000)	02/25/14 14:10:17	1	70.16.6
21	oracle@heera07 (P00F)	02/25/14 14:10:17	13559	20.18.37
23	oracle@heera07 (P007)	02/25/14 14:10:17	1	12.3.62
26	oracle@heera07 (P004)	02/25/14 14:10:17	1	33.4.11
95	oracle@heera07 (P005)	02/25/14 14:10:17	1	48.15.10
97	oracle@heera07 (P00C)	02/25/14 14:10:17	12676	9.5.1730
103	oracle@heera07 (P008)	02/25/14 14:10:17	14434	44.32.10
105	oracle@heera07 (P001)	02/25/14 14:10:17	1	64.0.9
169	oracle@heera07 (P002)	02/25/14 14:10:17	1	34.19.11
176	oracle@heera07 (P00D)	02/25/14 14:10:17	14621	4.22.1739
177	oracle@heera07 (P006)	02/25/14 14:10:17	1	74.14.6
191	oracle@heera07 (P009)	02/25/14 14:10:17	13070	54.11.10
258	sqlplus@heera07 (TNS V1-V3)	02/25/14 14:10:17	1	59.8.12
261	oracle@heera07 (P00A)	02/25/14 14:10:17	13521	7.13.1748
263	oracle@heera07 (P00E)	02/25/14 14:10:17	12186	14.23.76
267	oracle@heera07 (P003)	02/25/14 14:10:17	1	28.23.19

17 rows selected.

As you can see, there is more happening here than when we simply queried the table in parallel. We have 17 processes working on this operation, not just 9 as before. This is because the plan that was developed includes a step to update the table and independent steps to update the index entries. Look at a BASIC plus PARALLEL-enabled explain plan output from DBMS\_XPLAN:

```
EODA@ORA12CR1> explain plan for update big_table set status = 'done';
Explained.
EODA@ORA12CR1> select * from table(dbms_xplan.display(null,null,'BASIC +PARALLEL'));
```

We see the following:

Id	Operation	Name	TQ	IN-OUT	PQ Distrib
0	UPDATE STATEMENT				
1	PX COORDINATOR				
2	PX SEND QC (RANDOM)	:TQ10001	Q1,01	P->S	QC (RAND)
3	INDEX MAINTENANCE	BIG_TABLE	Q1,01	PCWP	
4	PX RECEIVE		Q1,01	PCWP	
5	PX SEND RANGE	:TQ10000	Q1,00	P->P	RANGE
6	UPDATE	BIG_TABLE	Q1,00	PCWP	
7	PX BLOCK ITERATOR		Q1,00	PCWC	
8	TABLE ACCESS FULL	BIG_TABLE	Q1,00	PCWP	

As a result of the pseudo-distributed implementation of PDML, certain limitations are associated with it:

- Triggers are not supported during a PDML operation. This is a reasonable limitation in my opinion, since triggers tend to add a large amount of overhead to the update, and you are using PDML to go fast—the two features don't go together.
- There are certain declarative RI constraints that are not supported during the PDML, since each slice of the table is modified as a separate transaction in the separate session. Self-referential integrity is not supported, for example. Consider the deadlocks and other locking issues that would occur if it were supported.
- You cannot access the table you've modified with PDML until you commit or roll back.
- Advanced replication is not supported with PDML (because the implementation of advanced replication is trigger-based).
- Deferred constraints (i.e., constraints that are in the deferred mode) are not supported.
- PDML may only be performed on tables that have bitmap indexes or LOB columns if the table is partitioned, and then the degree of parallelism would be capped at the number of partitions. You cannot parallelize an operation within partitions in this case, as each partition would get a single parallel execution server to operate on it. We should note that starting with Oracle 12c, you can run PDML on SecureFiles LOBs without partitioning.
- Distributed transactions are not supported when performing PDML.
- Clustered tables are not supported with PDML.

If you violate any of those restrictions, one of two things will happen: either the statement will be performed serially (no parallelism will be involved) or an error will be raised. For example, if you already performed the PDML against table T and then attempted to query table T before ending your transaction, then you will receive the error ORA-12838: cannot read/modify an object after modifying it in parallel.

It's also worth noting in the prior example in this section, that had you *not* enabled parallel DML for the UPDATE statement, then the explain plan output would look quite different, for example:

```
-----
```

Id	Operation	Name	TQ	IN-OUT	PQ Distrib
0	UPDATE STATEMENT				
1	UPDATE	BIG_TABLE			
2	PX COORDINATOR				
3	PX SEND QC (RANDOM)	:TQ10000	Q1,00	P->S	QC (RAND)
4	PX BLOCK ITERATOR		Q1,00	PCWC	
5	TABLE ACCESS FULL	BIG_TABLE	Q1,00	PCWP	

```
-----
```

To the untrained eye it may look like the UPDATE happened in parallel, but in fact it did not. What the prior output shows is that the UPDATE is serial and that the full scan (read) of the table was parallel. So there was parallel query involved, but not PDML.

## VERIFYING PARALLEL OPERATIONS

You can quickly verify the parallel operations that have occurred in a session by querying the data dictionary. For example, here's a parallel DML operation:

```
EODA@ORA12CR1> alter session enable parallel dml;
EODA@ORA12CR1> update big_table set status='AGAIN';
```

Next verify the type and number of parallel activities via:

```
EODA@ORA12CR1> select name, value from v$statname a, v$mystat b
  2  where a.statistic# = b.statistic# and name like '%parallel%';
```

Here is some sample output for this session:

```
NAME                                VALUE
-----
```

DBWR parallel query checkpoint buffers written	0
queries parallelized	0
DML statements parallelized	1
DDL statements parallelized	0
DFO trees parallelized	1

The prior output verifies that one parallel DML statement has executed in this session.

## Parallel DDL

I believe that parallel DDL is the real sweet spot of Oracle's parallel technology. As we've discussed, parallel execution is generally not appropriate for OLTP systems. In fact, for many data warehouses, parallel query is becoming less and less of an option. It used to be that a data warehouse was built for a very small, focused user community—sometimes comprised of just one or two analysts. However, over the last decade or so, I've watched them grow from small user

communities to user communities of hundreds or thousands. Consider a data warehouse front-ended by a web-based application: it could be accessible to literally thousands or more users simultaneously.

But a DBA performing the large batch operations, perhaps during a maintenance window, is a different story. The DBA is still a single individual and he or she might have a huge machine with tons of computing resources available. The DBA has only one thing to do, such as load this data, or reorganize that table, or rebuild that index. Without parallel execution, the DBA would be hard-pressed to really use the full capabilities of the hardware. With parallel execution, they can. The following SQL DDL commands permit parallelization:

- **CREATE INDEX:** Multiple parallel execution servers can scan the table, sort the data, and write the sorted segments out to the index structure.
- **CREATE TABLE AS SELECT:** The query that executes the SELECT may be executed using parallel query, and the table load itself may be done in parallel.
- **ALTER INDEX REBUILD:** The index structure may be rebuilt in parallel.
- **ALTER TABLE MOVE:** A table may be moved in parallel.
- **ALTER TABLE SPLIT|COALESCE PARTITION:** The individual table partitions may be split or coalesced in parallel.
- **ALTER INDEX SPLIT PARTITION:** An index partition may be split in parallel.
- **CREATE/ALTER MATERIALIZED VIEW:** Create a materialized view with parallel processes or change the default degree of parallelism.

---

■ **Note** See the *Oracle Database SQL Language Reference* manual for a complete list of statements that support parallel operations.

---

The first four of these commands work for individual table/index partitions as well—that is, you may MOVE an individual partition of a table in parallel.

To me, parallel DDL is where the parallel execution in Oracle is of greatest measurable benefit. Sure, it can be used with parallel query to speed up certain long-running operations, but from a maintenance standpoint, and from an administration standpoint, parallel DDL is where the parallel operations affect us, DBAs and developers, the most. If you think of parallel query as being designed for the end user for the most part, then parallel DDL is designed for the DBA/developer.

## Parallel DDL and Data Loading Using External Tables

One of my favorite features introduced in Oracle 9i was external tables; they are especially useful in the area of data loading. We'll cover data loading and external tables in some detail in the next chapter, but as a quick introduction, we'll take a brief look at these topics here to study the effects of parallel DDL on extent sizing and extent trimming.

External tables allow us to easily perform parallel direct path loads without “thinking” too hard about it. Oracle 7.1 gave us the ability to perform parallel direct path loads, whereby multiple sessions could write directly to the Oracle data files, bypassing the buffer cache entirely, bypassing undo for the table data, and perhaps even bypassing redo generation. This was accomplished via SQL\*Loader. The DBA would have to script multiple SQL\*Loader sessions, split the input data files to be loaded manually, determine the degree of parallelism, and coordinate all of the SQL\*Loader processes. In short, it could be done, but it was hard.

With parallel DDL or parallel DML plus external tables, we have a parallel direct path load that is implemented via a simple `CREATE TABLE AS SELECT` or `INSERT /*+ APPEND */`. No more scripting, no more splitting of files, and no more coordinating the N number of scripts that would be running. In short, this combination provides pure ease of use, without a loss of performance.

Let's take a look at a simple example of this in action. We'll see shortly how to create an external table. (We'll look at data loading with external tables in much more detail in the next chapter.) For now, we'll use a real table to load another table from, much like many people do with staging tables in their data warehouse. The technique, in short, is as follows:

1. Use some extract, transform, load (ETL) tool to create input files.
2. Load these input files into staging tables.
3. Load a new table using queries against these staging tables.

We'll use the same `BIG_TABLE` from earlier, which is parallel-enabled and contains 10 million records. We're going to join this to a second table, `USER_INFO`, which contains `OWNER`-related information from the `ALL_USERS` dictionary view. The goal is to denormalize this information into a flat structure.

To start, we'll create the `USER_INFO` table, enable it for parallel operations, and then gather statistics on it:

```
EODA@ORA12CR1> create table user_info as select * from all_users;
Table created.
```

```
EODA@ORA12CR1> alter table user_info parallel;
Table altered.
```

```
EODA@ORA12CR1> exec dbms_stats.gather_table_stats( user, 'USER_INFO' );
PL/SQL procedure successfully completed.
```

Now, we would like to parallel direct path load a new table with this information. The query we'll use is simply:

```
create table new_table parallel
as
select a.*, b.user_id, b.created user_created
   from big_table a, user_info b
  where a.owner = b.username;
```

The plan for that particular `CREATE TABLE AS SELECT` statement looked like this in Oracle 12c:

Id	Operation	Name	Time	TQ	IN-OUT	PQ Distrib
0	CREATE TABLE STATEMENT		00:00:01			
1	PX COORDINATOR					
2	PX SEND QC (RANDOM)	:TQ10000	00:00:01	Q1,00	P->S	QC (RAND)
3	LOAD AS SELECT	NEW_TABLE		Q1,00	PCWP	
4	OPTIMIZER STATISTICS GATHERING		00:00:01	Q1,00	PCWP	
* 5	HASH JOIN		00:00:01	Q1,00	PCWP	
6	TABLE ACCESS FULL	USER_INFO	00:00:01	Q1,00	PCWP	
7	PX BLOCK ITERATOR		00:00:01	Q1,00	PCWC	
8	TABLE ACCESS FULL	BIG_TABLE	00:00:01	Q1,00	PCWP	



If you look at the steps from 5 on down, this is the query (SELECT) component. The scan of `BIG_TABLE` and hash join to `USER_INFO` was performed in parallel, and each of the subresults was loaded into a portion of the table (step 3, the `LOAD AS SELECT`). After each of the parallel execution servers finished its part of the join and load, it sent its results up to the query coordinator. In this case, the results simply indicated “success” or “failure,” as the work had already been performed.

And that is all there is to it—parallel direct path loads made easy. The most important thing to consider with these operations is how space is used (or not used). Of particular importance is a side effect called *extent trimming*. Let’s spend some time investigating that now.

## Parallel DDL and Extent Trimming

Parallel DDL relies on direct path operations. That is, the data is not passed to the buffer cache to be written later; rather, an operation such as a `CREATE TABLE AS SELECT` will create new extents and write directly to them, and the data goes straight from the query to disk in those newly allocated extents. Each parallel execution server performing its part of the `CREATE TABLE AS SELECT` will write to its own extent. The `INSERT /*+ APPEND */` (a direct path insert) writes “above” a segment’s HWM, and each parallel execution server will again write to its own set of extents, never sharing them with other parallel execution servers. Therefore, if you do a parallel `CREATE TABLE AS SELECT` and use four parallel execution servers to create the table, then you will have *at least* four extents—maybe more. But each of the parallel execution servers will allocate its own extent, write to it and, when it fills up, allocate another new extent. The parallel execution servers will never use an extent allocated by some other parallel execution server.

Figure 14-3 depicts this process. We have a `CREATE TABLE NEW_TABLE AS SELECT` being executed by four parallel execution servers. In the figure, each parallel execution server is represented by a different color (white, light-gray, dark-gray, or black). The boxes in the disk drum represent the extents that were created in some data file by this `CREATE TABLE` statement. Each extent is presented in one of the aforementioned four colors, for the simple reason that all of the data in any given extent was loaded by only one of the four parallel execution servers—`p003` is depicted as having created and then loaded four of these extents. `p000`, on the other hand, is depicted as having five extents, and so on.

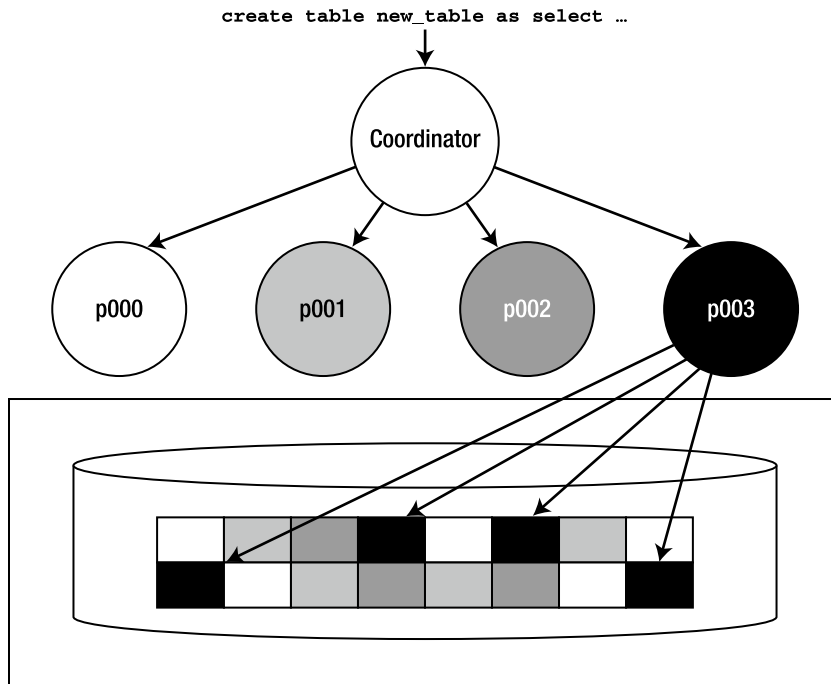

**Figure 14-3.** Parallel DDL extent allocation depiction

This sounds all right at first, but in a data warehouse environment, this can lead to wastage after a large load. Let's say you want to load 1,010MB of data (about 1GB), and you are using a tablespace with 100MB extents. You decide to use ten parallel execution servers to load this data. Each would start by allocating its own 100MB extent (there will be ten of them in all) and filling it up. Since each has 101MB of data to load, they would fill up their first extent and then proceed to allocate another 100MB extent, of which they would use 1MB. You now have 20 extents (10 of which are full, and 10 of which have 1MB each) and the remaining 990MB is "allocated but not used." This space could be used the next time you load more data, but right now you have 990MB of dead space. This is where extent trimming comes in. Oracle will attempt to take the last extent of each parallel execution server and trim it back to the smallest size possible.

## Extent Trimming and Dictionary-Managed Tablespaces

If you are using legacy dictionary-managed tablespaces, then Oracle will be able to convert each of the 100MB extents that contain just 1MB of data into 1MB extents. Unfortunately, that would (in dictionary-managed tablespaces) tend to leave ten noncontiguous 99MB extents free, and since your allocation scheme was for 100MB extents, this 990MB of space would not be very useful! The next allocation of 100MB would likely *not* be able to use the existing space, since it would be 99MB of free space, followed by 1MB of allocated space, followed by 99MB of free space, and so on. We will not review the dictionary-managed approach further in this book.

## Extent Trimming and Locally-Managed Tablespaces

Enter locally-managed tablespaces. There are two types: UNIFORM SIZE, whereby every extent in the tablespace is always precisely the same size, and AUTOALLOCATE, whereby Oracle decides how big each extent should be using an internal algorithm. Both of these approaches nicely solve the *99MB of free space/followed by 1MB of used space/followed by 99MB of free space* problem. However, they each solve it very differently. The UNIFORM SIZE approach obviates extent trimming from consideration all together. When you use UNIFORM SIZES, Oracle cannot perform extent trimming. All extents are of that single size—none can be smaller (or larger) than that single size. AUTOALLOCATE extents, on the other hand, do support extent trimming, but in an intelligent fashion. They use a few specific sizes of extents and have the ability to use space of different sizes—that is, the algorithm permits the use of all free space over time in the tablespace. Unlike the dictionary-managed tablespace, where if you request a 100MB extent, Oracle will fail the request if it can find only 99MB free extents (so close, yet so far), a locally-managed tablespace with AUTOALLOCATE extents can be more flexible. It may reduce the size of the request it was making in order to attempt to use all of the free space.

Let's now look at the differences between the two locally-managed tablespace approaches. To do that, we need a real-life example to work with. We'll set up an external table capable of being used in a parallel direct path load situation, which is something that we do frequently. Even if you are still using SQL\*Loader to parallel direct path load data, this section applies entirely—you just have manual scripting to do to actually load the data. So, in order to investigate extent trimming, we need to set up our example load and then perform the loads under varying conditions and examine the results.

## Setting Up for Locally-Managed Tablespaces

To get started, we need an external table. I've found time and time again that I have a legacy control file from SQL\*Loader that I used to use to load data, one that looks like this, for example:

```
LOAD DATA
INFILE '/tmp/big_table.dat'
INTO TABLE big_table
REPLACE
FIELDS TERMINATED BY '|'
```

```
( id ,owner ,object_name ,subobject_name ,object_id
,data_object_id ,object_type ,created ,last_ddl_time
,timestamp ,status ,temporary ,generated ,secondary
,namespace ,edition_name
)
```

We can convert this *easily* into an external table definition using SQL\*Loader itself:

```
$ sqlldr eoda/foo big_table.ctl external_table=generate_only
SQL*Loader: Release 12.1.0.1.0 - Production on Mon Feb 17 14:39:21 2014
Copyright (c) 1982, 2013, Oracle and/or its affiliates. All rights reserved.
```

---

■ **Note** If you are curious about the SQLLDR command and the options used with it, we'll be covering that in detail in the next chapter.

---

Notice the parameter EXTERNAL\_TABLE passed to SQL\*Loader. It causes SQL\*Loader, in this case, to not load data, but rather to generate a CREATE TABLE statement for us in the log file. This CREATE TABLE statement looked as follows (this is an abridged form; I've edited out repetitive elements to make the example smaller):

```
CREATE TABLE "SYS_SQLLDR_X_EXT_BIG_TABLE"
(
  "ID" NUMBER,
  ...
  "EDITION_NAME" VARCHAR2(128)
)
ORGANIZATION external
(
  TYPE oracle_loader
  DEFAULT DIRECTORY my_dir
  ACCESS PARAMETERS
  (
    RECORDS DELIMITED BY NEWLINE CHARACTERSET US7ASCII
    BADFILE 'SYS_SQLLDR_XT_TMPDIR_00001': 'big_table.bad'
    LOGFILE 'SYS_SQLLDR_XT_TMPDIR_00001': 'big_table.log_xt'
    READSIZE 1048576
    FIELDS TERMINATED BY "|" LDRTRIM
    REJECT ROWS WITH ALL NULL FIELDS
  (
    "ID" CHAR(255)
      TERMINATED BY "|",
    ...
    "EDITION_NAME" CHAR(255)
      TERMINATED BY "|"
  )
  )
)
```

```

location
(
  'big_table.dat'
)
)REJECT LIMIT UNLIMITED

```

All we need to do is edit it to name the external table the way we want, perhaps change the directories, and so on:

```
EODA@ORA12CR1> create or replace directory my_dir as '/tmp/';
Directory created.
```

And after that, all we need to do is actually create the external table:

```

1 CREATE TABLE "BIG_TABLE_ET"
2 (
3   "ID" NUMBER,
...
18  "EDITION_NAME" VARCHAR2(128)
19 )
20 ORGANIZATION external
21 (
22  TYPE oracle_loader
23  DEFAULT DIRECTORY my_dir
24  ACCESS PARAMETERS
25  (
26   records delimited by newline
27   fields terminated by ','
28   missing field values are null
29 )
30 location
31 (
32  'big_table.dat'
33 )
34 )REJECT LIMIT UNLIMITED
35 /
Table created.

```

Then we make this table parallel enabled. This is the magic step—this is what will facilitate an easy parallel direct path load:

```
EODA@ORA12CR1> alter table big_table_et PARALLEL;
Table altered.
```

---

■ **Note** The `PARALLEL` clause may also be used on the `CREATE TABLE` statement itself. Right after the `REJECT LIMIT UNLIMITED`, the keyword `PARALLEL` could have been added. I used the `ALTER` statement just to draw attention to the fact that the external table is, in fact, parallel enabled.

---

## Extent Trimming with UNIFORM vs. AUTOALLOCATE Locally-Managed Tablespaces

That's all we need to do with regard to setting up the load component. Now, we would like to investigate how space is managed in a locally-managed tablespace (LMT) that uses UNIFORM extent sizes, compared to how space is managed in an LMT that AUTOALLOCATEs extents. In this case, we'll use 100MB extents. First, we create a tablespace called LMT\_UNIFORM, which uses uniform extent sizes:

```
EODA@ORA12CR1> create tablespace lmt_uniform
 2  datafile '/u01/dbfile/ORA12CR1/lmt_uniform.dbf' size 1048640K reuse
 3  autoextend on next 100m
 4  extent management local
 5  UNIFORM SIZE 100m;
Tablespace created.
```

Next, we create a tablespace named LMT\_AUTO, which uses AUTOALLOCATE to determine extent sizes:

```
EODA@ORA12CR1> create tablespace lmt_auto
 2  datafile '/u01/dbfile/ORA12CR1/lmt_auto.dbf' size 1048640K reuse
 3  autoextend on next 100m
 4  extent management local
 5  AUTOALLOCATE;
Tablespace created.
```

Each tablespace started with a 1GB data file (plus 64KB used by locally-managed tablespaces to manage the storage; it would be 128KB extra instead of 64KB if we were to use a 32KB blocksize). We permit these data files to autoextend 100MB at a time. We are going to load the following file, which is a 10,000,000-record file:

```
$ ls -lag big_table.dat
-rw-r----- 1 dba 1018586660 Feb 27 21:27 big_table.dat
```

It was created using the big\_table.sql script found in the “Setting Up Your Environment” section at the beginning of this book and then unloaded using the flat.sql script available on <http://tkyte.blogspot.com/2009/10/httpasktomoraclecomtkyteflat.html>. Next, we do a parallel direct path load of this file into each tablespace:

```
EODA@ORA12CR1> create table uniform_test
 2  parallel
 3  tablespace lmt_uniform
 4  as
 5  select * from big_table_et;
Table created.
```

```
EODA@ORA12CR1> create table autoallocate_test
 2  parallel
 3  tablespace lmt_auto
 4  as
 5  select * from big_table_et;
Table created.
```

On my four-CPU system, these CREATE TABLE statements executed with eight parallel execution servers and one coordinator. I verified this by querying one of the dynamic performance views related to parallel execution, V\$PX\_SESSION, while these statements were running:

```
EODA@ORA12CR1> select sid, serial#, qcsid, qcserial#, degree from v$px_session;
```

SID	SERIAL#	QCSID	QCSerial#	DEGREE
375	1275	243	1697	8
18	3145	243	1697	8
135	3405	243	1697	8
244	3065	243	1697	8
376	177	243	1697	8
5	875	243	1697	8
134	2829	243	1697	8
249	467	243	1697	8
243	1697	243	243	8

9 rows selected.

---

**Note** In creating the UNIFORM\_TEST and AUTOALLOCATE\_TEST tables, we simply specified “parallel” on each table, with Oracle choosing the degree of parallelism. In this case, I was the sole user of the machine (all resources available) and Oracle defaulted it to 8 based on the number of CPUs (four) and the PARALLEL\_THREADS\_PER\_CPU parameter setting, which defaults to 2.

---

The SID, SERIAL# are the identifiers of the parallel execution sessions, and the QCSID, QCSerial# is the identifier of the query coordinator of the parallel execution. So, with eight parallel execution sessions running, we would like to see how the space was used. A quick query against USER\_SEGMENTS gives us a good idea:

```
EODA@ORA12CR1> select segment_name, blocks, extents
 2 from user_segments
 3 where segment_name in ( 'UNIFORM_TEST', 'AUTOALLOCATE_TEST' );
```

SEGMENT_NAME	BLOCKS	EXTENTS
AUTOALLOCATE_TEST	153696	131
UNIFORM_TEST	166400	13

Since we were using an 8KB blocksize, this shows a difference of about 100MB; looking at it from a ratio perspective, AUTOALLOCATE\_TEST is about 92 percent the size of UNIFORM\_TEST as far as allocated space goes. The actual used space results are as follows:

```
EODA@ORA12CR1> exec show_space('UNIFORM_TEST' );
Unformatted Blocks ..... 0
FS1 Blocks (0-25) ..... 0
FS2 Blocks (25-50) ..... 0
FS3 Blocks (50-75) ..... 0
FS4 Blocks (75-100)..... 12,782
```

```

Full Blocks ..... 153,076
Total Blocks..... 166,400
Total Bytes..... 1,363,148,800
Total MBytes..... 1,300
Unused Blocks..... 0
Unused Bytes..... 0
Last Used Ext FileId..... 5
Last Used Ext BlockId..... 153,728
Last Used Block..... 12,800
PL/SQL procedure successfully completed.

```

```

EODA@ORA12CR1> exec show_space('AUTOALLOCATE_TEST' );
Unformatted Blocks ..... 0
FS1 Blocks (0-25) ..... 0
FS2 Blocks (25-50) ..... 0
FS3 Blocks (50-75) ..... 0
FS4 Blocks (75-100)..... 0
Full Blocks ..... 153,076
Total Blocks..... 153,696
Total Bytes..... 1,259,077,632
Total MBytes..... 1,200
Unused Blocks..... 0
Unused Bytes..... 0
Last Used Ext FileId..... 6
Last Used Ext BlockId..... 147,584
Last Used Block..... 6,240
PL/SQL procedure successfully completed.

```

---

■ **Note** The SHOW\_SPACE procedure is described in the “Setting Up Your Environment” section at the beginning of this book.

---

Notice that the autoallocated table shows 1,200MB used space vs. 1,300MB used for the uniform extent table. This is all due to the extent trimming that *did not* take place. If we look at UNIFORM\_TEST, we see this clearly:

```

EODA@ORA12CR1> select segment_name, extent_id, blocks
  2 from user_extents where segment_name = 'UNIFORM_TEST';

```

SEGMENT_NAME	EXTENT_ID	BLOCKS
UNIFORM_TEST	0	12800
UNIFORM_TEST	1	12800
UNIFORM_TEST	2	12800
UNIFORM_TEST	3	12800
UNIFORM_TEST	4	12800
UNIFORM_TEST	5	12800
UNIFORM_TEST	6	12800
UNIFORM_TEST	7	12800
UNIFORM_TEST	8	12800
UNIFORM_TEST	9	12800

```

UNIFORM_TEST          10      12800
UNIFORM_TEST          11      12800
UNIFORM_TEST          12      12800
13 rows selected.

```

Each extent is 100MB in size. Now, it would be a waste of paper to list all 131 extents allocated to the AUTOALLOCATE\_TEST tablespace, so let's look at them in aggregate:

```

EODA@ORA12CR1> select segment_name, blocks, count(*)
 2  from user_extents
 3  where segment_name = 'AUTOALLOCATE_TEST'
 4  group by segment_name, blocks
 5  order by blocks;

```

SEGMENT_NAME	BLOCKS	COUNT(*)
AUTOALLOCATE_TEST	1024	128
AUTOALLOCATE_TEST	6240	1
AUTOALLOCATE_TEST	8192	2

This generally fits in with how locally-managed tablespaces with AUTOALLOCATE are observed to allocate space (the results of the prior query will vary depending on the amount of data and the version of Oracle). Values such as the 1,024 and 8,192 block extents are normal; we will observe them all of the time with AUTOALLOCATE. The rest, however, are not normal; we do not usually observe them. They are due to the extent trimming that takes place. Some of the parallel execution servers finished their part of the load—they took their last 64MB (8,192 blocks) extent and trimmed it, resulting in a spare bit left over. One of the other parallel execution sessions, as it needed space, could use this spare bit. In turn, as these other parallel execution sessions finished processing their own loads, they would trim their last extent and leave spare bits of space.

So, which approach should you use? If your goal is to direct path load in parallel as often as possible, I suggest AUTOALLOCATE as your extent management policy. Parallel direct path operations like this will not use space under the object's HWM—the space on the freelist. So, unless you do some conventional path inserts into these tables also, UNIFORM allocation will permanently have additional free space in it that it will never use. Unless you can size the extents for the UNIFORM locally-managed tablespace to be much smaller, you will see what I would term excessive wastage over time, and remember that this space is associated with the segment and will be included in a full scan of the table.

To demonstrate this, let's do another parallel direct path load into these existing tables, using the same inputs:

```

EODA@ORA12CR1> alter session enable parallel dml;
Session altered.

```

```

EODA@ORA12CR1> insert /*+ append */ into UNIFORM_TEST
 2  select * from big_table_et;
10000000 rows created.

```

```

EODA@ORA12CR1> insert /*+ append */ into AUTOALLOCATE_TEST
 2  select * from big_table_et;
10000000 rows created.

```

```

EODA@ORA12CR1> commit;
Commit complete.

```



If we compare the space utilization of the two tables after that operation, as follows, we can see that as we load more and more data into the table UNIFORM\_TEST using parallel direct path operations, the space utilization gets worse over time:

```
EODA@ORA12CR1> exec show_space( 'UNIFORM_TEST' );
Unformatted Blocks ..... 0
FS1 Blocks (0-25) ..... 0
FS2 Blocks (25-50) ..... 0
FS3 Blocks (50-75) ..... 0
FS4 Blocks (75-100)..... 25,564
Full Blocks ..... 306,152
Total Blocks..... 332,800
Total Bytes..... 2,726,297,600
Total MBytes..... 2,600
Unused Blocks..... 0
Unused Bytes..... 0
Last Used Ext FileId..... 5
Last Used Ext BlockId..... 320,128
Last Used Block..... 12,800
PL/SQL procedure successfully completed.
```

```
EODA@ORA12CR1> exec show_space( 'AUTOALLOCATE_TEST' );
Unformatted Blocks ..... 0
FS1 Blocks (0-25) ..... 0
FS2 Blocks (25-50) ..... 0
FS3 Blocks (50-75) ..... 0
FS4 Blocks (75-100)..... 0
Full Blocks ..... 306,152
Total Blocks..... 307,392
Total Bytes..... 2,518,155,264
Total MBytes..... 2,401
Unused Blocks..... 0
Unused Bytes..... 0
Last Used Ext FileId..... 6
Last Used Ext BlockId..... 301,312
Last Used Block..... 6,240
PL/SQL procedure successfully completed.
```

We would want to use a significantly smaller uniform extent size or use the AUTOALLOCATE clause. The AUTOALLOCATE clause may well generate more extents over time, but the space utilization is superior due to the extent trimming that takes place.

---

■ **Note** I noted earlier in this chapter that your mileage may vary when executing the prior parallelism examples. It's worth highlighting this point again; your results will vary depending on the version of Oracle, the degree of parallelism used, and the amount of data loaded. The prior output in this section was generated using Oracle 12c Release 1 with the default degree of parallelism on a 4 CPU box.

---

## Procedural Parallelism

I would like to discuss two types of procedural parallelism:

- Parallel pipelined functions, which is a feature of Oracle.
- Do-it-yourself (DIY) parallelism, which is the application to your own applications of the same techniques that Oracle applies to parallel full table scans. DIY parallelism is more of a development technique than anything built into Oracle directly in Oracle Database 11g Release 1 and before – and a native database feature in Oracle Database 11g Release 2 and later.

Often you'll find that applications—typically batch processes—designed to execute serially will look something like the following procedure:

```
Create procedure process_data
As
Begin
For x in ( select * from some_table )
    Perform complex process on X
    Update some other table, or insert the record somewhere else
End loop
end
```

In this case, Oracle's parallel query or PDML won't help a bit (in fact, parallel execution of the SQL by Oracle here would likely only cause the database to consume more resources and take longer). If Oracle were to execute the simple `SELECT * FROM SOME_TABLE` in parallel, it would provide this algorithm no apparent increase in speed whatsoever. If Oracle were to perform in parallel the `UPDATE` or `INSERT` after the complex process, it would have no positive affect (it is a single-row `UPDATE/INSERT`, after all).

There is one obvious thing you could do here: use array processing for the `UPDATE/INSERT` after the complex process. However, that isn't going to give you a 50 percent reduction or more in runtime, which is often what you're looking for. Don't get me wrong, you definitely want to implement array processing for the modifications here, but it won't make this process run two, three, four, or more times faster.

Now, suppose this process runs at night on a machine with four CPUs, and it is the only activity taking place. You have observed that only one CPU is partially used on this system, and the disk system is not being used very much at all. Further, this process is taking hours, and every day it takes a little longer as more data is added. You need to reduce the runtime dramatically—it needs to run four or eight times faster—so incremental percentage increases will not be sufficient. What can you do?

There are two approaches you can take. One approach is to implement a parallel pipelined function, whereby Oracle will decide on appropriate degrees of parallelism (assuming you have opted for that, which would be recommended). Oracle will create the sessions, coordinate them, and run them, very much like the previous example with parallel DDL or parallel DML where, by using `CREATE TABLE AS SELECT` or `INSERT /*+ APPEND */`, Oracle fully automated parallel direct path loads for us. The other approach is DIY parallelism. We'll take a look at both approaches in the sections that follow.

## Parallel Pipelined Functions

We'd like to take that very serial process `PROCESS_DATA` from earlier and have Oracle execute it in parallel for us. To accomplish this, we need to turn the routine inside out. Instead of selecting rows from some table, processing them, and inserting them into another table, we will insert into another table the results of fetching some rows and processing them. We will remove the `INSERT` at the bottom of that loop and replace it in the code with a `PIPE ROW` clause. The `PIPE ROW` clause allows our PL/SQL routine to generate table data as its output, so we'll be able to `SELECT`

from our PL/SQL process. The PL/SQL routine that used to procedurally process the data becomes a *table*, in effect, and the rows we fetch and process are the outputs. We've seen this many times throughout this book every time we've issued the following:

```
Select * from table(dbms_xplan.display);
```

That is a PL/SQL routine that reads the PLAN\_TABLE; restructures the output, even to the extent of adding rows; and then outputs this data using PIPE ROW to send it back to the client. We're going to do the same thing here, in effect, but we'll allow for it to be processed in parallel.

We're going to use two tables in this example: T1 and T2. T1 is the table we were reading previously in the `select * from some_table` line of the PROCESS\_DATA procedure; T2 is the table we need to move this information into. Assume this is some sort of ETL process we run to take the transactional data from the day and convert it into reporting information for tomorrow. The two tables we'll use are as follows:

```
EODA@ORA12CR1> create table t1
 2 as
 3 select object_id id, object_name text
 4 from all_objects;
Table created.
```

```
EODA@ORA12CR1> begin
 2 dbms_stats.set_table_stats
 3 ( user, 'T1', numRows=>10000000,numblks=>100000 );
 4 end;
 5 /
PL/SQL procedure successfully completed.
```

```
EODA@ORA12CR1> create table t2
 2 as
 3 select t1.*, 0 session_id
 4 from t1
 5 where 1=0;
Table created.
```

We used DBMS\_STATS to trick the optimizer into thinking that there are 10,000,000 rows in that input table and that it consumes 100,000 database blocks. We want to simulate a big table here. The second table, T2, is a copy of the first table's structure with the addition of a SESSION\_ID column. That column will be useful to actually see the parallelism that takes place.

Next, we need to set up object types for our pipelined function to return. The object type is a structural definition of the output of the procedure we are converting. In this case, it looks just like T2:

```
EODA@ORA12CR1> CREATE OR REPLACE TYPE t2_type
 2 AS OBJECT (
 3 id number,
 4 text varchar2(30),
 5 session_id number
 6 )
 7 /
Type created.
```

```
EODA@ORA12CR1> create or replace type t2_tab_type
  2 as table of t2_type
  3 /
Type created.
```

And now for the pipelined function, which is simply the original `PROCESS_DATA` procedure rewritten. The procedure is now a function that produces rows. It accepts as an input the data to process in a ref cursor. The function returns a `T2_TAB_TYPE`, the type we just created. It is a pipelined function that is `PARALLEL_ENABLED`. The partition clause we are using says to Oracle, “Partition, or slice up, the data by any means that works best. We don’t need to make any assumptions about the order of the data.”

You may also use hash or range partitioning on a specific column in the ref cursor. This would involve using a strongly typed ref cursor, so the compiler knows what columns are available. Hash partitioning would just send equal rows to each parallel execution server to process based on a hash of the column supplied. Range partitioning would send nonoverlapping ranges of data to each parallel execution server, based on the partitioning key. For example, if you range partitioned on `ID`, each parallel execution server might get ranges `1...1000`, `1001...20000`, `20001...30000`, and so on (`ID` values in that range).

Here, we just want the data split up. How the data is split up is not relevant to our processing, so our definition looks like this:

```
EODA@ORA12CR1> create or replace
  2 function parallel_pipelined( l_cursor in sys_refcursor )
  3 return t2_tab_type
  4 pipelined
  5 parallel_enable ( partition l_cursor by any )
```

We’d like to be able to see what rows were processed by which parallel execution servers, so we’ll declare a local variable `L_SESSION_ID` and initialize it from `V$MYSTAT`:

```
6
7 is
8   l_session_id number;
9   l_rec        t1%rowtype;
10 begin
11   select sid into l_session_id
12   from v$mystat
13   where rownum =1;
```

Now we are ready to process the data. We simply fetch out a row (or rows, as we could certainly use `BULK COLLECT` here to array process the ref cursor), perform our complex process on it, and pipe it out. When the ref cursor is exhausted of data, we close the cursor and return:

```
14   loop
15     fetch l_cursor into l_rec;
16     exit when l_cursor%notfound;
17     -- complex process here
18     pipe row(t2_type(l_rec.id,l_rec.text,l_session_id));
19   end loop;
20   close l_cursor;
21   return;
22 end;
23 /
Function created.
```

And that's it. We're ready to process the data in parallel, letting Oracle figure out based on the resources available what the most appropriate degree of parallelism is:

```
EODA@ORA12CR1> alter session enable parallel dml;
Session altered.
```

```
EODA@ORA12CR1> insert /*+ append */
 2  into t2(id,text,session_id)
 3  select *
 4  from table(parallel_pipelined
 5             (CURSOR(select /*+ parallel(t1) */ *
 6                    from t1 )
 7                ))
 8  /
17914 rows created.
```

```
EODA@ORA12CR1> commit;
Commit complete.
```

Just to see what happened here, we can query the newly inserted data out and group by `SESSION_ID` to see how many parallel execution servers were used and how many rows each one processed:

```
EODA@ORA12CR1> select session_id, count(*)
 2  from t2
 3  group by session_id;
```

SESSION_ID	COUNT(*)
198	2166
11	2569
13	2493
185	1865
95	2613
17	2377
256	2331
103	1500

```
8 rows selected.
```

Apparently, we used eight parallel execution servers for the `SELECT` component of this parallel operation, and each one processed about 2,000 records each.

As you can see, Oracle parallelized our process, but we underwent a fairly radical rewrite of our process. This is a long way from the original implementation. So, while Oracle can process our routine in parallel, we may well not have any routines that are coded to be parallelized. If a rather large rewrite of your procedure is not feasible, you may well be interested in the next implementation: DIY parallelism.

## Do-It-Yourself Parallelism

Say we have that same process as in the preceding section: the serial, simple procedure. We cannot afford a rather extensive rewrite of the implementation, but we would like to execute it in parallel. What can we do?

Starting with Oracle Database 11g Release 2 and above, we have a new way to implement parallelism via the `DBMS_PARALLEL_EXECUTE` built-in package. Using it, you can execute a SQL or PL/SQL statement in parallel by taking the data to be processed and breaking it up into multiple, smaller streams. You can implement the same approach yourself, manually, and I show how in the section on “Old School Do-It-Yourself Parallelism” that follows. The beauty of the new package, though, is that it eliminates much of the tedious work that you otherwise need to perform.

Let’s start with the premise that we have a SERIAL routine that we’d like to execute in parallel against some large table. We’d like to do it with as little work as possible; in other words, modify as little code as possible and be responsible for generating very little new code. Enter `DBMS_PARALLEL_EXECUTE`. We will not cover every possible use of this package (it is fully documented in the *Oracle Database PL/SQL Packages and Types Reference* manual but we will use just enough of it to implement the process I’ve just described.

Assuming we start with the empty table T2, we’ll modify our serial process now to look like this (additions to the original, simple serial process are in **bold**):

```
EODA@ORA12CR1> create or replace
 2 procedure serial( p_lo_rowid in rowid, p_hi_rowid in rowid )
 3 is
 4 begin
 5     for x in ( select object_id id, object_name text
 6               from big_table
 7               where rowid between p_lo_rowid
 8                 and p_hi_rowid )
 9     loop
10         -- complex process here
11         insert into t2 (id, text, session_id )
12         values ( x.id, x.text, sys_context( 'userenv', 'sessionid' ) );
13     end loop;
14 end;
15 /
```

Procedure created.

That’s it: just add the ROWID inputs and the predicate. The modified code has not changed much at all. I am using `SYS_CONTEXT` to get the `SESSIONID` so we can monitor how much work was done by each thread, each parallel session.

Now, to start the process, we first need to break up the table into small pieces. We can do this by some numeric range—useful for tables that use a `SEQUENCE` to populate their primary key, by any arbitrary SQL you want to code or by ROWID ranges. We’ll use the ROWID range. I find it to be the most efficient because it creates non-overlapping ranges of the table (contention free) and doesn’t require querying the table to decide the ranges; it just uses the data dictionary. So, we’ll make the following API calls:

```
EODA@ORA12CR1> begin
 2     dbms_parallel_execute.create_task('PROCESS BIG TABLE');
 3     dbms_parallel_execute.create_chunks_by_rowid
 4     ( task_name => 'PROCESS BIG TABLE',
 5       table_owner => user,
 6       table_name => 'BIG_TABLE',
 7       by_row => false,
 8       chunk_size => 10000 );
 9 end;
10 /
```

PL/SQL procedure successfully completed.

We started by creating a named task: 'PROCESS BIG TABLE' in this case. This is just a unique name we'll use to refer to our big process. Second, we invoked the CREATE\_CHUNKS\_BY\_ROWID procedure. This procedure does exactly what its name implies: it "chunks up" a table by ROWID ranges in a manner similar to what we just did. We told the procedure to read the information about the currently logged in user's table named BIG\_TABLE and to break it up into chunks of no more than about 10,000 blocks (CHUNK\_SIZE). The parameter BY\_ROW was set to false which implies, in this case, that the CHUNK\_SIZE is not a count of rows to create ROWID ranges by but rather a count of blocks to create them.

We can see the number of chunks and information about each chunk immediately after this block of code executes by querying DBA\_PARALLEL\_EXECUTE\_CHUNKS:

```
EODA@ORA12CR1> select *
 2   from (
 3   select chunk_id, status, start_rowid, end_rowid
 4   from dba_parallel_execute_chunks
 5   where task_name = 'PROCESS BIG TABLE'
 6   order by chunk_id
 7   )
 8   where rownum <= 5
 9   /
```

CHUNK_ID	STATUS	START_ROWID	END_ROWID
1	UNASSIGNED	AAAEyWAAEAAAAQoAAA	AAAEyWAAEAAAAQvCcP
2	UNASSIGNED	AAAEyWAAEAAAAQwAAA	AAAEyWAAEAAAAQ3CcP
3	UNASSIGNED	AAAEyWAAEAAAAQ4AAA	AAAEyWAAEAAAAQ/CcP
4	UNASSIGNED	AAAEyWAAEAAAAARAAA	AAAEyWAAEAAAAARHcCP
5	UNASSIGNED	AAAEyWAAEAAAAARIAAA	AAAEyWAAEAAAAARPCcP

The query in this example shows the first five rows in the view; in my case, there were 218 total rows in there for the table in question, each representing a non-overlapping chunk of the table to process. This does not mean we'll be processing the table in "parallel 218," just that we have 218 chunks in total to process. We are now ready to run our task via this API call:

```
EODA@ORA12CR1> begin
 2   dbms_parallel_execute.run_task
 3   ( task_name      => 'PROCESS BIG TABLE',
 4     sql_stmt       => 'begin serial( :start_id, :end_id ); end;',
 5     language_flag  => DBMS_SQL.NATIVE,
 6     parallel_level => 4 );
 7 end;
 8 /
```

PL/SQL procedure successfully completed.

Here we asked to run our task 'PROCESS BIG TABLE'—which points to our chunks. The SQL statement we want to execute is 'begin serial( :start\_id, :end\_id ); end;'—a simple call to our stored procedure with the ROWID range to process. The PARALLEL\_LEVEL I decided to use was four, meaning we'll have four parallel threads/processes executing this. Even though there were 218 chunks, we'll only do four at a time. Internally, this package uses the DBMS\_SCHEDULER package to run these threads in parallel.

Once our task starts running, it will create four jobs; each job is told to process the chunks identified by the key value 'PROCESS BIG TABLE' and run the stored procedure SERIAL against each chunk. So, these four sessions start and each reads a chunk from the DBA\_PARALLEL\_EXECUTE\_CHUNKS view, processes it, and updates the STATUS column. If the chunk is successful, the row will be marked as PROCESSED; if it fails for any reason or if a given chunk cannot be

processed, it will be marked as PROCESSED\_WITH\_ERROR and other columns will contain the detailed error message indicating the cause of the error. In either case, the session will then retrieve another chunk and process it and so on. So, eventually these four jobs will have processed all of the chunks and the task will complete.

If any of the chunks failed, you can correct the underlying cause of the error and resume the task. This will cause it to reprocess the failed chunks. When all complete successfully, you are done.

```
EODA@ORA12CR1> select *
 2   from (
 3   select chunk_id, status, start_rowid, end_rowid
 4   from dba_parallel_execute_chunks
 5   where task_name = 'PROCESS BIG TABLE'
 6   order by chunk_id
 7   )
 8   where rownum <= 5
 9   /
```

CHUNK_ID	STATUS	START_ROWID	END_ROWID
1	PROCESSED	AAAEyWAAEAAAAQoAAA	AAAEyWAAEAAAAQvCcP
2	PROCESSED	AAAEyWAAEAAAAQwAAA	AAAEyWAAEAAAAQ3CcP
3	PROCESSED	AAAEyWAAEAAAAQ4AAA	AAAEyWAAEAAAAQ/CcP
4	PROCESSED	AAAEyWAAEAAAAARAAA	AAAEyWAAEAAAAARHCcP
5	PROCESSED	AAAEyWAAEAAAAARIAAA	AAAEyWAAEAAAAARPCcP

You can either retain the task for history or remove it. The following example shows how to remove the task:

```
EODA@ORA12CR1> begin
 2   dbms_parallel_execute.drop_task('PROCESS BIG TABLE' );
 3 end;
 4 /
```

PL/SQL procedure successfully completed.

If we review our own application table, we can see that the job was done using parallel 4, and each of the four processed about the same number of rows:

```
EODA@ORA12CR1> select session_id, count(*)
 2   from t2
 3   group by session_id
 4   order by session_id;
```

SESSION_ID	COUNT(*)
22603	2521812
22604	2485273
22605	2529386
22606	2463529

4 rows selected.

If you aren't yet up to Oracle Database 11g Release 2 or higher, then you can implement the same sort of parallelism using the more labor-intensive approach detailed in the next section. However, the new package provides a rich API (which we've just touched on here) that has much more functionality than the manual implementation does.



## Old School Do-It-Yourself Parallelism

Prior to Oracle Database 11g Release 2, you can implement a parallelization approach similar to that in the previous section. You won't have a rich API to support you, and you'll need to do more of the tedious work yourself, but it can be done. My approach many times has been to use rowid ranges to break the table up into some number of ranges that don't overlap (yet completely cover the table).

---

■ **Note** If you are running Oracle Database 11g Release 2 or higher, refer to the previous section for an example using the `DBMS_PARALLEL_EXECUTE` package. If it's available to you, you really should be using that package rather than the manual approach described here.

---

This manually intensive approach is very similar to how Oracle performs a parallel query conceptually. If you think of a full table scan, Oracle processes it by coming up with some method to break the table into many small tables, each of which is processed by a parallel execution server. We are going to do the same thing using rowid ranges. In early releases, Oracle's parallel implementation actually used rowid ranges itself.

Again, we'll use a `BIG_TABLE` of 1,000,000 rows, as the technique I'm describing works best on big tables with lots of extents, and the method I use for creating rowid ranges depends on extent boundaries. The more extents used, the better the data distribution. So, after creating the `BIG_TABLE` with 1,000,000 rows, we'll create `T2` like this:

```
EODA@ORA12CR1> create table t2
 2 as
 3 select object_id id, object_name text, 0 session_id
 4 from big_table
 5 where 1=0;
Table created.
```

We are going to use the job queues built into the database to parallel process our procedure. We will schedule some number of jobs. Each job is our procedure slightly modified to just process the rows in a given rowid range.

---

■ **Note** In Oracle 10g and above, you could also use the scheduler for something so simple. In order to make the example 9i compatible, we'll use the job queues here.

---

To efficiently support the job queues, we'll use a parameter table to pass inputs to our jobs:

```
EODA@ORA12CR1> create table job_parms
 2 ( job          number primary key,
 3   lo_rid      rowid,
 4   hi_rid      rowid
 5 )
 6 /
Table created.
```

This will allow us to just pass the job ID into our SERIAL procedure, so it can query this table to get the rowid range it is to process. Now, for our procedure (the code in **bold** is the new code we'll be adding):

```
EODA@ORA12CR1> create or replace
 2 procedure serial( p_job in number )
 3 is
 4   l_rec          job_parms%rowtype;
 5 begin
 6   select * into l_rec
 7     from job_parms
 8     where job = p_job;
 9
10   for x in ( select object_id id, object_name text
11             from big_table
12             where rowid between l_rec.lo_rid
13             and l_rec.hi_rid )
14   loop
15     -- complex process here
16     insert into t2 (id, text, session_id )
17     values ( x.id, x.text, p_job );
18   end loop;
19
20   delete from job_parms where job = p_job;
21   commit;
22 end;
23 /
```

Procedure created.

As you can see, it is not a significant change. Most of the added code was simply to get our inputs and the rowid range to process. The only change to our *logic* was the change in the predicate on lines 12 and 13.

Now let's schedule our job. We'll use a rather complex query using analytics to divide the table. The innermost query on lines 19 through 26 breaks the data into eight groups in this case. The first sum on line 22 is computing a running total of the sum of blocks; the second sum on line 23 is the total number of blocks. If we integer divide the running total by the desired chunk size (the total size divided by 8 in this case), we can create groups of files/blocks that cover about the same amount of data. The query on lines 8 through 28 finds the high and low file numbers and block numbers by GRP and returns the distinct entries. It builds the inputs we can then send to DBMS\_ROWID to create the rowids Oracle wants. We take that output and, using DBMS\_JOB, submit a job to process the rowid range:

```
EODA@ORA12CR1> declare
 2   l_job number;
 3 begin
 4   for x in (
 5     select dbms_rowid.rowid_create
 6           ( 1, data_object_id, lo_fno, lo_block, 0 ) min_rid,
 7           dbms_rowid.rowid_create
 8           ( 1, data_object_id, hi_fno, hi_block, 10000 ) max_rid
 9     from (
10     select distinct grp,
11            first_value(relative_fno)
12              over (partition by grp order by relative_fno, block_id
13                  rows between unbounded preceding and unbounded following) lo_fno,
```

```

11     first_value(block_id      )
12         over (partition by grp order by relative_fno, block_id
13             rows between unbounded preceding and unbounded following) lo_block,
14     last_value(relative_fno)
15         over (partition by grp order by relative_fno, block_id
16             rows between unbounded preceding and unbounded following) hi_block,
17     last_value(block_id+blocks-1)
18         over (partition by grp order by relative_fno, block_id
19             rows between unbounded preceding and unbounded following) hi_block,
20     sum(blocks) over (partition by grp) sum_blocks
21 from (
22 select relative_fno,
23        block_id,
24        blocks,
25        trunc( (sum(blocks) over (order by relative_fno, block_id)-0.01) /
26              (sum(blocks) over ( )/8) ) grp
27 from dba_extents
28 where segment_name = upper('BIG_TABLE')
29        and owner = user order by block_id
30 )
31 loop
32     dbms_job.submit( l_job, 'serial(JOB);' );
33     insert into job_parms(job, lo_rid, hi_rid)
34     values ( l_job, x.min_rid, x.max_rid );
35 end loop;
36 end;
37 /

```

PL/SQL procedure successfully completed.

This PL/SQL block would have scheduled up to eight jobs for us (fewer, if the table could not be broken into eight pieces due to insufficient extents or size). We can see how many jobs were scheduled and what their inputs were as follows:

```
EODA@ORA12CR1> select * from job_parms;
```

	JOB	LO_RID	HI_RID
1	AAAEzwAAEAAABKAAAA	AAAEzwAAEAAAAB1/CcQ	
2	AAAEzwAAEAAACyAAAA	AAAEzwAAEAAAADR/CcQ	
3	AAAEzwAAEAAAuAAAA	AAAEzwAAEAAAABJ/CcQ	
4	AAAEzwAAEAAACCAAAA	AAAEzwAAEAAAACR/CcQ	
5	AAAEzwAAEAAADSAAAA	AAAEzwAAEAAABGUnCcQ	
6	AAAEzwAAEAAAQoAAA	AAAEzwAAEAAAAt/CcQ	
7	AAAEzwAAEAAABmAAAA	AAAEzwAAEAAACB/CcQ	
8	AAAEzwAAEAAACSAAAA	AAAEzwAAEAAACx/CcQ	

8 rows selected.

```
EODA@ORA12CR1> commit;
Commit complete.
```

This commit released our jobs for processing. We have `JOB_QUEUE_PROCESSES` set to 1000 in the parameter file, so all eight started running and shortly finished. After they all completed, the results are as follows:

```
EODA@ORA12CR1> select session_id, count(*)
 2   from t2
 3   group by session_id;
```

SESSION_ID	COUNT(*)
1	127651
6	124431
2	147606
5	124590
4	72961
8	147544
3	127621
7	127596

8 rows selected.

Suppose, however, that you do not want to use the rowid processing—perhaps the query is not as simple as `SELECT * FROM T` and involves joins and other constructs that make using the rowid impractical. You can use the primary key of some table instead. For example, say you want to break that same `BIG_TABLE` into ten pieces to be processed concurrently by primary key. You can do that easily using the `NTILE` built-in analytic function. The process is rather straightforward:

```
EODA@ORA12CR1> select nt, min(id), max(id), count(*)
 2   from (
 3   select id, ntile(10) over (order by id) nt
 4   from big_table
 5   )
 6   group by nt;
```

NT	MIN(ID)	MAX(ID)	COUNT(*)
1	1	100000	100000
6	500001	600000	100000
2	100001	200000	100000
5	400001	500000	100000
4	300001	400000	100000
8	700001	800000	100000
3	200001	300000	100000
7	600001	700000	100000
9	800001	900000	100000
10	900001	1000000	100000

10 rows selected.

Now you have ten nonoverlapping primary key ranges (all of nice equal size) that you can use to implement the same `DBMS_JOB` technique as shown earlier to parallelize your process.

## Summary

In this chapter, we explored the concept of parallel execution in Oracle. I started by presenting an analogy to help frame where and when parallel execution is applicable—namely, when you have long-running statements or procedures and plenty of available resources.

Then we looked at how Oracle can employ parallelism. We started with parallel query and how Oracle can break large serial operations, such as a full scan, into smaller pieces that can run concurrently. We moved on to parallel DML (PDML) and covered the rather extensive list of restrictions that accompany it.

Then we looked at the sweet spot for parallel operations: parallel DDL. Parallel DDL is a tool for the DBA and developer alike to quickly perform those large maintenance operations typically done during off-peak times when resources are available. We next looked at procedural parallelism and saw two techniques for parallelizing our procedures: one where Oracle does it and the other where we do it ourselves.

If we're designing a process from scratch, we might well consider designing it to allow Oracle to parallelize it for us, as the future addition or reduction of resources would easily permit the degree of parallelism to vary. However, if we have existing code that needs to quickly be fixed to be parallel, we may opt for DIY parallelism, which we covered by examining two techniques, manual and automatic. Each uses either rowid ranges or primary key ranges, which both use `DBMS_JOB` or `DBMS_SCHEDULER` to carry out the job in parallel in the background for us.



# Data Loading and Unloading

In this chapter, we will discuss data loading and unloading—in other words, how to get data *into* and *out of* an Oracle database. The main focus of the chapter is on the following bulk data loading tools:

- *External tables*: This is a feature with Oracle9i and above that permits access to operating system files as if they were database tables and, in Oracle 10g and above, even allows for the creation of operating system files as extracts of tables.
- *SQL\*Loader* (pronounced “sequel loader” and hereafter referred to as *SQLLDR*): This is Oracle’s historical data loader that is still a common method for loading data.

In the area of data unloading, we’ll look at the following techniques:

- *Data Pump unload*: Data Pump is a binary format proprietary to Oracle and accessible via the Data Pump tool and external tables.
- *Flat file unload*: The flat file unloads will be custom developed implementations, but provide you with a result that is portable to other types of systems (even a spreadsheet).

## External Tables

External tables were first introduced in Oracle9i Release 1. Put simply, they allow us to treat an operating system file as if it is a read-only database table. They are not intended to be a replacement for a “real” table, or to be used in place of a real table; rather, they are intended to be used as a tool to ease the loading and, in Oracle 10g and above, unloading of data.

When the external tables feature was first unveiled, I often referred to it as “the replacement for SQLLDR.” This idea still holds true—*most* of the time. Having said this, you might wonder why there is material in this chapter that covers SQLLDR. The reason is that SQLLDR has been around for a long time, and there are many, many legacy control files lying around. SQLLDR is still a commonly used tool; it is what many people know and have used. We are still in a period of transition from the use of SQLLDR to external tables, thus SQLLDR is still very relevant.

What many DBAs don’t realize is that their knowledge of SQLLDR control files is readily transferable to the use of external tables. You’ll discover, as we work through the examples in this part of the chapter, that external tables incorporate much of the SQLLDR syntax and many of the techniques.

Having said that, SQLLDR should be chosen *over* external tables in the following situations:

- You have to load data over a network—in other words, when the input file is not on the database server itself. One of the restrictions of external tables is that the input file must be accessible on the database server.
- Multiple users must *concurrently* work with the *same* external table processing different input files.

With those exceptions in mind, in general I strongly recommend using external tables for their extended capabilities. SQLLDR is a fairly simple tool that generates an `INSERT` statement and loads data. Its ability to use SQL is limited to calling SQL functions on a row-by-row basis. External tables open the entire SQL set of functionality to data loading. Some of the key functionality features that external tables have over SQLLDR, in my experience, are as follows:

- The ability to use complex `WHERE` conditions to selectively load data. SQLLDR has a `WHEN` clause to select rows to load, but you are limited to using only `AND` expressions and expressions using equality—no ranges (greater than, less than), no `OR` expressions, no `IS NULL`, and so on.
- The ability to `MERGE` data. You can take an operating system file full of data and update existing database records from it.
- The ability to perform efficient code lookups. You can join an external table to other database tables as part of your load process.
- The ability to load data *sorted* by including an `ORDER BY` statement in the `CREATE TABLE` or `INSERT` statement.
- Easier multitable inserts using `INSERT`. Starting in Oracle9i, an `INSERT` statement can insert into one or *more* tables using complex `WHEN` conditions. While SQLLDR can load into multiple tables, it can be quite complex to formulate the syntax.
- The ability to specify one or more operating system commands to be executed as the first step (preprocess) when selecting data from an external table.
- A shallower learning curve for new developers. SQLLDR is *yet another tool to learn*, in addition to the programming language, the development tools, the SQL language, and so on. As long as a developer knows SQL, he or she can immediately apply that knowledge to bulk data loading, without having to learn a new tool (SQLLDR).

So, with that in mind, let's look at how to use external tables.

## Setting Up External Tables

There are two simple methods for getting started with external tables:

- Executing SQLLDR with the `EXTERNAL_TABLE` parameter
- Starting with Oracle 12c, running SQLLDR in express mode

Interestingly, both techniques utilize the SQLLDR command-line tool. They are discussed in the following sections.

## Executing SQLLDR with the EXTERNAL\_TABLE Parameter

One of the easiest ways to get started with external tables is to use an existing legacy control file to provide the definition of the external table. As a first simple demonstration, a SQLLDR control file (complete details on SQLLDR control files comes later in this chapter in the SQLLDR section) is used as follows:

```
LOAD DATA
INFILE *
INTO TABLE DEPT
FIELDS TERMINATED BY ','
(DEPTNO, DNAME, LOC)
BEGINDATA
10,Sales,Virginia
20,Accounting,Virginia
30,Consulting,Virginia
40,Finance,Virginia
```

First make sure a DEPT table exists:

```
EODA@ORA12CR1> create table dept as select * from scott.dept;
Table created.
```

Now the following SQLLDR command will generate the CREATE TABLE statement for our external table:

```
$ sqlldr eoda demo1ctl external_table=generate_only
Password:
SQL*Loader: Release 12.1.0.1.0 - Production on Fri Mar 7 16:28:38 2014
Copyright (c) 1982, 2013, Oracle and/or its affiliates. All rights reserved.
Path used: External Table
```

The EXTERNAL\_TABLE parameter has one of three values:

1. NOT\_USED: This is self-evident in meaning and is the default value.
2. EXECUTE: This value means that SQLLDR will not generate a SQL INSERT statement and execute it. Rather, it will create an external table and use a single bulk SQL statement to load it.
3. GENERATE\_ONLY: This value causes SQLLDR to not actually load any data, but only to generate the SQL DDL and DML statements it would have executed into the log file it creates.

---

■ **Note** DIRECT=TRUE overrides EXTERNAL\_TABLE=GENERATE\_ONLY. If you specify DIRECT=TRUE, the data will be loaded and no external table will be generated in Oracle 10g and before. In Oracle 11g Release 1 and above you will receive "SQL\*Loader-144: Conflicting load methods: direct=true/external\_table=generate\_only specified" instead. Not that you would think to do that, but just be aware these two options are incompatible.

---



When using `GENERATE_ONLY`, we can see the following in the `demo1.log` file:

```
CREATE DIRECTORY statements needed for files
```

```
-----  
CREATE DIRECTORY SYS_SQLLDR_XT_TMPDIR_00000 AS '/home/tkyte'
```

We may or may not see a `CREATE DIRECTORY` statement in the log file. `SQLLDR` connects to the database during the external table script generation and queries the data dictionary to see if a suitable directory already exists. In this case, there was no suitable directory in place, so `SQLLDR` generated a `CREATE DIRECTORY` statement for us. Next, it generated the `CREATE TABLE` statement for our external table:

```
CREATE TABLE statement for external table:
```

```
-----  
CREATE TABLE "SYS_SQLLDR_X_EXT_DEPT"  
(  
  "DEPTNO" NUMBER(2),  
  "DNAME" VARCHAR2(14),  
  "LOC" VARCHAR2(13)  
)
```

`SQLLDR` had logged into the database; that is how it knows the exact datatypes to be used in this external table definition (e.g., that `DEPTNO` is a `NUMBER(2)`). It picked them up right from the data dictionary. Next, we see the beginning of the external table definition:

```
ORGANIZATION external  
(  
  TYPE oracle_loader  
  DEFAULT DIRECTORY SYS_SQLLDR_XT_TMPDIR_00000
```

The `ORGANIZATION EXTERNAL` clause tells Oracle this is not a “normal” table. We saw this clause before in Chapter 10 when we looked at IOTs. Currently there are three organization types: `HEAP` for a normal table, `INDEX` for an IOT, and `EXTERNAL` for an external table. The rest of the text starts to tell Oracle more about the external table. The `ORACLE_LOADER` type is one of two supported types (in Oracle9i it is the *only* supported type). The other type is `ORACLE_DATAPUMP`, the proprietary Data Pump format used by Oracle in Oracle 10g and later. We will take a look at that type in a subsequent section on data unloading—it is a format that can be used to both load and unload data. An external table may be used both to create a Data Pump format file and to subsequently read it.

The very next section we encounter is the `ACCESS PARAMETERS` section of the external table. Here we describe to the database how to process the input file. As you look at this, you should notice the similarity to a `SQLLDR` control file; this is no accident. For the most part, `SQLLDR` and external tables use very similar syntax:

```
ACCESS PARAMETERS  
(  
  RECORDS DELIMITED BY NEWLINE CHARACTERSET US7ASCII  
  BADFILE 'SYS_SQLLDR_XT_TMPDIR_00000':'demo1.bad'  
  LOGFILE 'demo1.log_xt'  
  READSIZE 1048576  
  SKIP 6  
  FIELDS TERMINATED BY "," LDRTRIM  
  REJECT ROWS WITH ALL NULL FIELDS
```

```
(
  "DEPTNO" CHAR(255)
    TERMINATED BY ", ",
  "DNAME" CHAR(255)
    TERMINATED BY ", ",
  "LOC" CHAR(255)
    TERMINATED BY ", "
)
)
```

These access parameters show how to set up an external table so that it processes files pretty much identically to the way SQLLDR would:

- **RECORDS:** Records are terminated by newlines by default, as they are for SQLLDR.
- **BADFILE:** There is a bad file (a file where records that fail processing are recorded to) set up in the directory we just created.
- **LOGFILE:** There is a log file that is equivalent to SQLLDR's log file set up in the current working directory.
- **READSIZE:** This is the default buffer used by Oracle to read the input data file. It is 1MB in this case. This memory comes from the PGA in dedicated server mode and the SGA in shared server mode, and it is used to buffer the information in the input data file for a session (refer to Chapter 4, where we discussed PGA and SGA memory). Keep that shared server fact in mind if you're using shared servers: the memory is allocated from the SGA.
- **SKIP 6:** This determines how many records in the input file should be skipped. You might be asking, "Why 'skip 6'?" Well, we used `INFILE *` in this example; `SKIP 6` is used to skip over the control file itself to get to the embedded data. If we did not use `INFILE *`, there would be no `SKIP` clause at all.
- **FIELDS TERMINATED BY:** This is just as we used in the control file itself. However, the external table did add `LDRTRIM`, which stands for *LoaDeR TRIM*. This is a trim mode that emulates the way in which SQLLDR trims data by default. Other options include `LRTRIM`, `LTRIM`, and `RTRIM` (for left/right trimming of whitespace); and `NOTRIM` to preserve all leading/trailing whitespace.
- **REJECT ROWS WITH ALL NULL FIELDS:** This causes the external table to log to the bad file any entirely blank lines and to not load that row.
- *The column definitions themselves:* This is the metadata about the expected input data values. They are all character strings in the data file to be loaded, and they can be up to 255 characters in length (SQLLDR's default size), and terminated by `,` and optionally enclosed by quotes.

---

■ **Note** For a comprehensive list of all options available to you when using external tables, review the *Oracle Utilities Guide*. This reference contains a section dedicated to external tables. The *Oracle SQL Language Reference Guide* provides the basic syntax, but not the details of the `ACCESS PARAMETERS` section.

---

Lastly, we get to the LOCATION section of the external table definition:

```
location
(
  'demo1.ct1'
)
) REJECT LIMIT UNLIMITED
```

This tells Oracle the name of the file to load, which is demo1.ct1 in this case since we used INFILE \* in the original control file. The next statement in the control file is the default INSERT that can be used to load the table from the external table itself:

INSERT statements used to load internal tables:

```
-----
INSERT /*+ append */ INTO DEPT
(
  DEPTNO,
  DNAME,
  LOC
)
SELECT
  "DEPTNO",
  "DNAME",
  "LOC"
FROM "SYS_SQLLDR_X_EXT_DEPT"
```

This would perform the logical equivalent of a direct path load if possible (assuming the APPEND hint may be obeyed; the existence of triggers or foreign key constraints may prevent the direct path operation from taking place).

Lastly, in the log file, we'll see statements that may be used to remove the objects SQLLDR would have us create after the load was complete:

statements to cleanup objects created by previous statements:

```
-----
DROP TABLE "SYS_SQLLDR_X_EXT_DEPT"
DROP DIRECTORY SYS_SQLLDR_XT_TMPDIR_00000
```

And that is it. If we take that log file and insert / where appropriate to make it a valid SQL\*Plus script, then we should be ready to go—or not, depending on the permissions in place. For example, assuming the schema I log into has the CREATE ANY DIRECTORY privilege or READ and WRITE access to an existing directory, I might observe the following:

```
EODA@ORA12CR1> INSERT /*+ append */ INTO DEPT
2 (
3   DEPTNO,
4   DNAME,
5   LOC
6 )
7 SELECT
8   "DEPTNO",
9   "DNAME",
10  "LOC"
```

```

11 FROM "SYS_SQLLDR_X_EXT_DEPT"
12 /
INSERT /*+ append */ INTO DEPT
*
ERROR at line 1:
ORA-29913: error in executing ODCIEXTTABLEOPEN callout
ORA-29400: data cartridge error
KUP-04063: unable to open log file demo1.log_xt
OS error Permission denied
ORA-06512: at "SYS.ORACLE_LOADER", line 19
ORA-06512: at line 1

```

Well, that doesn't seem right at first. I'm logged into the operating system as TKYTE, the directory I'm logging in to is /home/tkyte, and I own that directory, so I can certainly write to it (I created the SQLLDR log file there, after all). What happened? The fact is that the external table code is running in the Oracle server software in my dedicated or shared server. The process trying to read the input data file is the Oracle software owner, not my account. The process trying to create the log file is the Oracle software owner, not my account. Apparently, Oracle did not have the privilege required to write into my directory, and hence the attempted access of the external table failed. This is an important point. To read a table, the account under which the database is running (the Oracle software owner) must be able to

- *Read* the file we are pointing to. In UNIX/Linux, that means the Oracle software owner must have read and execute permissions on all directory paths leading to the file. In Windows, the Oracle software owner must be able to read that file.
- *Write* to the directories where the log file will be written to (or bypass the generation of the log file altogether, but this is not generally recommended). In fact, if the log file already exists, the Oracle software owner must be able to write to the existing file.
- *Write* to any of the bad files we have specified, just like the log file.

Returning to the example, the following command gives Oracle the ability to write into my directory:

```
EODA@ORA12CR1> host chmod a+rw.
```

---

■ **Caution** This command actually gives everyone the ability to write into our directory! This is just a demonstration; normally, we would use a special directory—perhaps owned by the Oracle software owner itself—to do this.

---

Next, I rerun my INSERT statement:

```
EODA@ORA12CR1> list
1 INSERT /*+ append */ INTO DEPT
2 (
3   DEPTNO,
4   DNAME,
5   LOC
6 )
7 SELECT
8   "DEPTNO",
9   "DNAME",
10  "LOC"
11* FROM "SYS_SQLLDR_X_EXT_DEPT"
EODA@ORA12CR1> /
4 rows created.
```

```
EODA@ORA12CR1> host ls -l demo1.log_xt
-rw-r----- 1 oracle dba 687 Mar 8 14:35 demo1.log_xt
```

You can see that this time I accessed the file, I successfully loaded four rows, and the log file was created and in fact is owned by “oracle,” not by my operating system account.

## Running SQLLDR in Express Mode

Starting with Oracle 12c, SQLLDR express mode allows you to quickly load data from a CSV file into a table. If the schema you’re using has CREATE ANY DIRECTORY privilege, then express mode will attempt to use an external table to load the data. Otherwise it will use SQLLDR in direct path mode.

A simple example will illustrate this. Suppose you have a table created as follows:

```
EODA@ORA12CR1> create table dept
2 ( deptno number(2) constraint dept_pk primary key,
3   dname varchar2(14),
4   loc varchar2(13)
5 )
6 /
```

And you have the following data stored in a CSV file named dept.dat:

```
10,Sales,Virginia
20,Accounting,Virginia
30,Consulting,Virginia
40,Finance,Virginia
```

First, we'll run this example when the user *does not* have the CREATE ANY DIRECTORY privilege. SQLLDR express mode is invoked via the TABLE keyword:

```
$ sqlldr eoda table=dept
Password:
SQL*Loader: Release 12.1.0.1.0 - Production on Sat Mar 8 14:42:02 2014
Copyright (c) 1982, 2013, Oracle and/or its affiliates. All rights reserved.
Express Mode Load, Table: DEPT
Path used: External Table, DEGREE_OF_PARALLELISM=AUTO
SQL*Loader-816: error creating temporary directory object SYS_SQLLDR_XT_TMPDIR_00000 for file
dept.dat
ORA-01031: insufficient privileges
SQL*Loader-579: switching to direct path for the load
SQL*Loader-583: ignoring trim setting with direct path, using value of LDRTRIM
SQL*Loader-584: ignoring DEGREE_OF_PARALLELISM setting with direct path, using value of NONE
Express Mode Load, Table: DEPT
Path used: Direct
Load completed - logical record count 4.
Table DEPT:
  4 Rows successfully loaded.
Check the log file:
  dept.log
for more information about the load.
```

The prior output tells us that the schema did not have the privilege to create a directory object; therefore, SQLLDR used its direct path method of loading the data. Querying the table confirms the data was successfully loaded:

```
EODA@ORA12CR1> select * from dept;
```

DEPTNO	DNAME	LOC
10	Sales	Virginia
20	Accounting	Virginia
30	Consulting	Virginia
40	Finance	Virginia

Now we grant the CREATE ANY DIRECTORY privilege to the user:

```
SYS@ORA12CR1> grant create any directory to eoda;
Grant succeeded.
```

To set this up again, first remove the records from the DEPT table:

```
EODA@ORA12CR1> truncate table dept;
```

Now we invoke SQLLDR from the OS command line in express mode:

```
$ sqlldr eoda table=dept
Password:
SQL*Loader: Release 12.1.0.1.0 - Production on Sat Mar 8 14:45:53 2014
Copyright (c) 1982, 2013, Oracle and/or its affiliates. All rights reserved.
Express Mode Load, Table: DEPT
Path used: External Table, DEGREE_OF_PARALLELISM=AUTO
Table DEPT:
  4 Rows successfully loaded.
Check the log files:
  dept.log
  dept_%p.log_xt
for more information about the load.
```

Since express mode was able to create a directory object, an external table using `dept.dat` as its data source is accessed by an `INSERT` statement to load the data into the `DEPT` table. After the load is finished, the external table is dropped.

All of the code required to perform the prior steps is generated and recorded in the `dept.log` file. This file is automatically populated for you when running SQLLDR in express mode. If you only want SQL\*Loader to generate the log file and not execute its contents, then specify the `EXTERNAL_TABLE=GENERATE_ONLY` option. For example:

```
$ sqlldr eoda table=dept external_table=generate_only
```

If you inspect the `dept.log` file, you'll see the code that was generated. First, there's a SQLLDR control file (SQLLDR control files are described in detail in the SQLLDR section of this chapter):

```
OPTIONS(EXTERNAL_TABLE=EXECUTE, TRIM=LRTRIM)
LOAD DATA
INFILE 'dept'
APPEND
INTO TABLE DEPT
FIELDS TERMINATED BY ","
(
  DEPTNO,
  DNAME,
  LOC
)
```

Next is the SQL that will create an external table:

```
CREATE TABLE "SYS_SQLLDR_X_EXT_DEPT"
(
  "DEPTNO" NUMBER(2),
  "DNAME" VARCHAR2(14),
  "LOC" VARCHAR2(13)
)
ORGANIZATION external
(
  TYPE oracle_loader
  DEFAULT DIRECTORY SYS_SQLLDR_XT_TMPDIR_00000
  ACCESS PARAMETERS
```

```

(
  RECORDS DELIMITED BY NEWLINE CHARACTERSET US7ASCII
  BADFILE 'SYS_SQLLDR_XT_TMPDIR_00000': 'dept_%p.bad'
  LOGFILE 'dept_%p.log_xt'
  READSIZE 1048576
  FIELDS TERMINATED BY "," LRTRIM
  REJECT ROWS WITH ALL NULL FIELDS
  (
    "DEPTNO" CHAR(255),
    "DNAME" CHAR(255),
    "LOC" CHAR(255)
  )
)
location
(
  'dept.dat'
)
)REJECT LIMIT UNLIMITED

```

That is followed by a direct path INSERT statement that can be used to load data from the external table into the regular database table (DEPT in this example):

```

INSERT /*+ append parallel(auto) */ INTO DEPT
(
  DEPTNO,
  DNAME,
  LOC
)
SELECT
  "DEPTNO",
  "DNAME",
  "LOC"
FROM "SYS_SQLLDR_X_EXT_DEPT"

```

Lastly, the temporary table and directory object are dropped:

```

DROP TABLE "SYS_SQLLDR_X_EXT_DEPT"
DROP DIRECTORY SYS_SQLLDR_XT_TMPDIR_00000

```

The idea being that when you run SQLLDR in express mode with EXTERNAL\_TABLE=GENERATE\_ONLY, you can use the contents of the log file to run the SQL statements manually from SQL (if so desired).

---

■ **Tip** For full details of all options available with SQLLDR express mode, refer to the *Oracle Database Utilities* manual.

---

## Dealing with Errors

In a perfect world, there would be no errors. The data in the input file would be perfect, and it would all load correctly. That almost never happens. So, how can we track errors with this process?



The most common method is to use the `BADFILE` option. Here, Oracle will record all records that failed processing. For example, if our control file contained a record with `DEPTNO 'ABC'`, that record would fail and end up in the bad file because 'ABC' cannot be converted into a number. We'll demonstrate that in the following example.

First, we add the following as the last line of `demo1.ct1` (this will add a line of data that cannot be loaded to our input):

```
ABC,XYZ,Hello
```

Next, we run the following command, to prove that the `demo1.bad` file does not yet exist:

```
EODA@ORA12CR1> host ls -l demo1.bad
ls: demo1.bad: No such file or directory
```

Then we query the external table to display the contents:

```
EODA@ORA12CR1> select * from SYS_SQLLDR_X_EXT_DEPT;
```

DEPTNO	DNAME	LOC
10	Sales	Virginia
20	Accounting	Virginia
30	Consulting	Virginia
40	Finance	Virginia

Now we will find that the file exists and we can review its contents:

```
EODA@ORA12CR1> host ls -l demo1.bad
-rw-r----- 1 oracle dba 14 Mar 9 10:38 demo1.bad
```

```
EODA@ORA12CR1> host cat demo1.bad
ABC,XYZ,Hello
```

But how can we programmatically inspect these bad records and the log that is generated? Fortunately, that is easy to do by using yet another external table. Suppose we set up this external table:

```
EODA@ORA12CR1> create table et_bad
 2 ( text1 varchar2(4000) ,
 3   text2 varchar2(4000) ,
 4   text3 varchar2(4000)
 5 )
 6 organization external
 7 (type oracle_loader
 8  default directory SYS_SQLLDR_XT_TMPDIR_00000
 9  access parameters
10  (
11   records delimited by newline
12   fields
13   missing field values are null
14   ( text1 position(1:4000),
15     text2 position(4001:8000),
```

```

16      text3 position(8001:12000)
17    )
18  )
19  location ('demo1.bad')
20  )
21  /

```

Table created.

This is just a table that can read any file without failing on a datatype error, as long as the lines in the file consist of fewer than 12,000 characters. If they are longer than 12,000 characters, then we can simply add more text columns to accommodate them.

We can clearly see the rejected records via a simple query:

```
EODA@ORA12CR1> select * from et_bad;
```

```

TEXT1          TEXT2          TEXT3
-----
ABC,XYZ,Hello

```

A `COUNT(*)` could tell us how many records were rejected. Another external table created on the log file associated with this external table could tell us why the record was rejected. We would need to go one step further to make this a repeatable process, however. The reason is that the bad file is not blanked out if there were no errors in our use of the external table. So, if there were some preexisting bad file with data in it and our external table generated no errors, we would be misled into thinking there were errors.

I've taken four approaches in the past to resolve this issue:

- Use `UTL_FILE` and reset the bad file—truncate it, in effect, by simply opening it for write and closing it.
- Use `UTL_FILE` to rename any preexisting bad files, preserving their contents, but allowing us to create a new one.
- Incorporate the PID into the bad (and log) file names. We'll demonstrate this later in the "Multiuser Issues" section.
- Manually use operating system commands to resolve issues (like renaming the file, removing it, and so on).

In that fashion, we'll be able to tell if the bad records in the bad file were generated by us just recently or if they were left over from some older version of the file itself and are not meaningful.

## PROJECT REFERENCED COLUMNS

The `COUNT(*)` earlier in this section made me think about a feature available in Oracle 10g and above: the ability to optimize external table access by only accessing the fields in the external file that are referenced in the query. That is, if the external table is defined to have 100 number fields, but you select out only one of them, you can direct Oracle to bypass converting the other 99 strings into numbers. It sounds great, but it can cause a different number of rows to be returned from each query. Suppose the external table has 100 lines of data in it. All of the data for column C1 is "valid" and converts to a number. None of the data for column C2 is "valid," and it does not convert into a number. If you select C1 from that external table, you'll get 100 rows back. If you select C2 from that external table, you'll get 0 rows back.

You have to explicitly enable this optimization, and you should think about whether it is safe for you to use or not (only you know enough about your application and its processing to answer the question “Is it safe?”). Using the earlier example with the bad line of data added, we would expect to see the following output upon querying our external table:

```
EODA@ORA12CR1> select dname from SYS_SQLLDR_X_EXT_DEPT;
```

```
DNAME
-----
Sales
Accounting
Consulting
Finance
```

```
EODA@ORA12CR1> select deptno from SYS_SQLLDR_X_EXT_DEPT;
```

```
DEPTNO
-----
      10
      20
      30
      40
```

We know the bad record has been logged into the BADFILE. But if we simply ALTER the external table and tell Oracle to only project (process) the referenced columns as follows, we get different numbers of rows from each query:

```
EODA@ORA12CR1> alter table SYS_SQLLDR_X_EXT_DEPT
  2 project column referenced
  3 /
```

Table altered.

```
EODA@ORA12CR1> select dname from SYS_SQLLDR_X_EXT_DEPT;
```

```
DNAME
-----
Sales
Accounting
Consulting
Finance
XYZ
```

```
EODA@ORA12CR1> select deptno from SYS_SQLLDR_X_EXT_DEPT;
```

```
DEPTNO
-----
      10
      20
      30
      40
```

The DNAME field was valid for every single record in the input file, but the DEPTNO column was not. If we do not retrieve the DEPTNO column, it does not fail the record—the resultset is materially changed.

## Using an External Table to Load Different Files

A common need is to use an external table to load data from differently named files over a period of time. That is, this week we must load `file1.dat`, and next week it will be `file2.dat`, and so on. So far, we've been loading from a fixed file name, `demo1.ctl`. What if we subsequently need to load from a second file, `demo2.ctl`?

Fortunately, that is pretty easy to accommodate. The `ALTER TABLE` command may be used to repoint the location setting of the external table:

```
EODA@ORA12CR1> alter table SYS_SQLLDR_X_EXT_DEPT location( 'demo2.ctl' );
Table altered.
```

And that would pretty much be it—the very next query of that external table would have it accessing the file `demo2.ctl`.

## Multiuser Issues

In the introduction to this section, I described three situations where external tables might not be as useful as `SQLLDR`. One of them was a specific multiuser issue. We just saw how to change the location of an external table—how to make it read from file 2 instead of file 1 and so on. The problem arises when multiple users each try to concurrently use that external table and have it point to different files for each session.

This cannot be done. The external table will point to a single file (or set of files) at any given time. If I log in and alter the table to point to file 1 and you do the same at about the same time, and then we both query that table, we'll both be processing the same file.

This issue is generally not one that you should encounter—external tables are not a replacement for database tables; they are a means to load data, and as such you would not use them on a daily basis as part of your application. They are generally a DBA or developer tool used to load information, either as a one-time event or on a recurring basis, as in a data warehouse load. If the DBA has ten files to load into the database using the same external table, she would *not* do them sequentially—that is, pointing the external table to file 1 and processing it, then file 2 and processing it, and so on. Rather, she would simply point the external table to *both files* and let the database process both of them:

```
EODA@ORA12CR1> alter table SYS_SQLLDR_X_EXT_DEPT
 2 location( 'file1.dat', 'file2.dat' )
 3 /
Table altered.
```

If *parallel processing* is required, then the database already has the built-in ability to do this, as demonstrated in the last chapter.

So the only multiuser issue would be if two sessions both tried to alter the location at about the same time (assuming they had the privilege to `ALTER` the table)—and this is just a possibility to be aware of, not something I believe you'll actually run into very often.

Another multiuser consideration is that of the bad and log file names. What if you have many sessions concurrently looking at the same external table or using parallel processing (which, in some respects, is a multiuser situation)? It would be nice to be able to segregate these files by session, and fortunately you can do that. You may incorporate the following special strings:

- %p: PID.
- %a: Parallel execution servers agent ID. The parallel execution servers have numbers 001, 002, 003, and so on assigned to them.

In this fashion, each session will tend to generate its own bad and log files. For example, let's say that you used the following `BADFILE` syntax in the `CREATE TABLE` statement from earlier:

```
RECORDS DELIMITED BY NEWLINE CHARACTERSET US7ASCII
BADFILE 'SYS_SQLLDR_XT_TMPDIR_00000': 'demo1_%p.bad'
LOGFILE 'demo1.log_xt'
```

You would expect to find a file named similarly to the following if any records failed loading:

```
$ ls *.bad
demo1_7108.bad
```

However, you still might have issues over lengthy periods of time. The PIDs will be reused on most operating systems. So the techniques outlined in dealing with errors may well still be relevant—you'll need to reset your bad file or rename it if it exists if you determine this to be an issue.

## Preprocessing

*Preprocessing* is an external table feature that allows you to execute one or more operating system commands as the first step when selecting from an external table. This feature was added in Oracle 11g Release 2, but was subsequently back-ported to version 10.2.0.5 as well (so this works in Oracle 10g Release 2 and above). You invoke preprocessing by specifying the `PREPROCESSOR` clause. The input of this clause can be an OS command or a shell script.

Sometimes the utility of preprocessing isn't intuitive. Consider the following use cases:

- Dynamically display the output of an OS command (or a combination of commands) by selecting from an external table
- Search for files and filter columns and/or rows before displaying the data
- Process and modify the contents of a file before returning the data

Examples of these scenarios follow.

## Monitoring the File System Through SQL

In some of my customer's databases, the DBAs are using data files with automatic extension, but with many data files sharing the same file system, such as the following and so on:

```
tablespace A, datafiles /u01/oradata/ts_A_file01.dbf autoextend unlimited
tablespace B, datafiles /u01/oradata/ts_B_file01.dbf autoextend unlimited
```

The requested extension is that all data files must be capable of growing by at least 20 percent of their current size; so if, for example, `ts_A_file01.dbf` currently is 100GB and `ts_B_file01.dbf` is 200GB, we must ensure that at least  $20\text{GB} + 40\text{GB} = 60\text{GB}$  is free in the `/u01/oradata` file system.

The question is: How can we monitor this in a single query inside the database? Right now, we have a complex script gathering free space from the `df` command in a text file, opening a cursor, calculating the current allocated space from `DBA_DATA_FILES`, and reading the `df` data via an external table.

This can be done in a single SQL query. To accomplish this, I'll need to be able to query disk free (`df`) interactively—without a complex set of maneuvers such as running a script or redirecting output. I'll start by making it so that the `df` output can be queried as if it were in a table. I'll use the preprocessor directive to achieve this.

To start I'll create a directory where I can place a small shell script that will produce the `df` output:

```
EODA@ORA12CR1> create or replace directory exec_dir as '/orahome/oracle/bin';
Directory created.
```

To perform this operation safely, we need to grant `EXECUTE` on the directory object containing the program we want to invoke. This allows us to control precisely which program will be executed by Oracle database and avoid executing a “Trojan horse” program by accident. As a privileged account, I grant the following to the `EODA` user:

```
SYS@ORA12CR1> grant execute on directory exec_dir to eoda;
```

Next, I'll create a shell script named `run_df.bsh` in that directory. This script will contain only the following:

```
#!/bin/bash
/bin/df -Pl
```

Also, I'll make the shell script executable:

```
$ chmod +x run_df.bsh
```

And the output of that script will look something like this:

```
EODA@ORA12CR1> !./run_df.bsh
Filesystem          512-blocks      Used    Available Capacity  Mounted on
rpool/ROOT/solaris-1 205406208      4576073   92886960      5% /
...
orapool1/ora01       629145600      382371882 246773718     61% /ora01
orapool2/ora02       629145600      429901328 199244272     69% /ora02
orapool1/ora03       629145600      415189806 213955794     66% /ora03
orapool2/ora04       629145600      343152972 285992628     55% /ora04
```

Note that in the `run_df.bsh` script, I used explicit pathnames to run `df`; I did not rely on the environment and on the `path` environment variable in particular. This is very important: when coding scripts for external tables—when coding scripts, in general—you always want to use explicit paths to run the program you actually intend to run. You don't have any real control over the environment this script will run in, so relying on the environment being set a certain way is a recipe for disaster.

So, now that I have the script and the directory, I am ready to create the external table. As you can see from the following code, all I need to do is have the external table skip the first record and then parse each subsequent line, using white space as a delimiter. This is something an external table can do easily, as shown next:

```
EODA@ORA12CR1>create table df
 2 (
 3  fsname  varchar2(100),
 4  blocks  number,
 5  used    number,
 6  avail   number,
 7  capacity varchar2(10),
 8  mount   varchar2(100)
 9 )
10 organization external
11 (
12  type oracle_loader
13  default directory exec_dir
14  access parameters
15  (
16  records delimited
17  by newline
18  preprocessor
19  exec_dir:'run_df.bsh'
20  skip 1
21  fields terminated by
22  whitespace ldrtrim
23  )
24  location
25  (
26  exec_dir:'run_df.bsh'
27  )
28 )
29 /
```

Table created.

With the df external table created, I can now review the df output easily in a query, as shown next:

```
EODA@ORA12CR1> select * from df;
```

FSNAME	BLOCKS	USED	AVAIL	CAPACITY	MOUNT
orapool1/ora01	629145600	382371882	246773718	61%	/ora01
orapool2/ora02	629145600	429901326	199244274	69%	/ora02
orapool1/ora03	629145600	415189808	213955792	66%	/ora03
orapool2/ora04	629145600	343152974	285992626	55%	/ora04

---

■ **Tip** Hopefully, you see how this approach could work easily for ps, ls, du, and so on—all the UNIX/Linux utilities could easily be considered “tables” now!

---

With this data available to me in the `df` external table, it is easy to start working on the query. All I need to do is join `df` to `DBA_DATA_FILES` with a join condition that matches the longest mount point possible to each file name. My single-query solution to the issue in this example is shown in the next bit of code. Here's what's happening on some of the lines:

```
EODA@ORA12CR1> with fs_data
2   as
3   (select /*+ materialize */ *
4     from df
5   )
6   select mount,
7     file_name,
8     bytes/1024/1024 mbytes,
9     tot_bytes/1024/1024 tot_mbytes,
10    avail_bytes/1024/1024 avail_mbytes,
11    case
12      when 0.2 * tot_bytes < avail_bytes
13       then 'OK'
14       else 'Short on disk space'
15     end status
16  from (
17  select file_name, mount, avail_bytes, bytes,
18         sum(bytes) over
19           (partition by mount) tot_bytes
20  from (
21  select a.file_name,
22         b.mount,
23         b.avail*1024 avail_bytes, a.bytes,
24         row_number() over
25           (partition by a.file_name
26            order by length(b.mount) DESC) rn
27  from dba_data_files a,
28       fs_data b
29  where a.file_name
30         like b.mount || '%'
31       )
32  where rn = 1
33       )
34  order by mount, file_name
35  /
```

MOUNT	FILE_NAME	MBYTES	TOT_MBYTES	AVAIL_MBYTES	STATUS
/ora01	/ora01/dbfile/ORA12CR1/cia_data_01.dbf	1024	93486	240989.959	OK
/ora01	/ora01/dbfile/ORA12CR1/config_tbsp_1_01.dbf	1500	93486	240989.959	OK
...					
/ora04	/ora04/dbfile/ORA12CR1/dim_data08.dbf	30720	136202	279289.674	OK
/ora04	/ora04/dbfile/ORA12CR1/dim_data_02.dbf	30720	136202	279289.674	OK

48 rows selected.



On lines 3 and 4, I query the `df` external table. I purposely use a materialize hint to force the optimizer to load the `df` data into the equivalent of a global temporary table, because the query would tend to read and reread the external table over and over, and the results of the `df` table could change as the query runs. This provides the logical equivalent of a consistent read on the `df` data. Also, if the query plan did involve rereading the external table, I would receive an error message at runtime:

```
KUP-04108 unable to reread file string
```

The documentation explains the error:

- *Cause:* The query that is executing requires that a datasource for an external table be read multiple times. However, the datasource is a sequential device that cannot be reread. Examples of this type of datasource are a tape or a pipe.
- *Action:* There are a few ways around this problem. One is to rewrite the query so that the external table is referenced only once. Another option is to move the datasource to a rereadable device such as a disk file. A third option is to load the data for the external table into a temporary table and change the query so that it references the temporary table.

On lines 27–30, I join `DBA_DATA_FILES` to `df` data with a `WHERE` clause, using `LIKE`. This will join every file in `DBA_DATA_FILES` to every possible mount point in the `df` output. I know that the goal, however, is to find the “longest” matching mount point, so to accomplish that I assign—on lines 24–26—a `ROW_NUMBER` to each row. This `ROW_NUMBER` will be sequentially assigned to each duplicated row in `DBA_DATA_FILES`, so if the `FILE_NAME` matches more than one `MOUNT`, each `FILE_NAME` occurrence will be assigned a unique, increasing `ROW_NUMBER` value. This `ROW_NUMBER` will be assigned after the data is sorted by the length of the `MOUNT`, from big to small.

Once I have that data, I apply a `WHERE` clause to save only the first entry for each `FILE_NAME` value—that predicate is `WHERE rn = 1`, on line 32. At the same time, I’ve added another column—`TOT_MBYTES`—on lines 18–19. This will enable me to verify the 20 percent threshold.

The last step is to format and output the data. I print the columns I’m interested in and add a `CASE` statement on lines 11–15 to verify that 20 percent of the total bytes of storage allocated on a given mount point does not exceed the remaining available bytes of free storage.

So, now you see how to use external tables to query operating system output such as `df`, `ps`, `find`, and `ls`. Additionally, you can use them to query anything that writes to standard out, including `gunzip`, `sed`, and so on.

## Reading and Filtering Compressed Files in a Directory Tree

When working with large data loads, it’s common to use compressed files. Normally when working with compressed files as part of the data load processing, you would have an initial step that uncompresses the file and then another step to load it into staging tables. With external tables, you can streamline this by instructing the external table to uncompress the data as it is read from the compressed file.

An example will illustrate this. To set this up, suppose you have multiple zipped files that you want to read and process. And furthermore, assume that the files are in different directories and that you need the process to search through the various levels of directories, find the zipped files, and make the data available by selecting from an external table.

To set this up, we’ll first create three directories:

```
$ mkdir /tmp/base
$ mkdir /tmp/base/base2a
$ mkdir /tmp/base/base2b
```

Next, we'll create three test files, compress them, and place each in a separate directory:

```
$ echo 'base col1,base col2' | gzip > /tmp/base/filebase.csv.gz
$ echo 'base2a col1,base2a col2' | gzip > /tmp/base/base2a/filebase2a.csv.gz
$ echo 'base2b col1,base2b col2' | gzip > /tmp/base/base2b/filebase2b.csv.gz
```

Next, two directory objects are created—one that points to the directory that will contain a shell script and another one that points to a base directory that serves a starting point for searching for files to be processed:

```
EODA@ORA12CR1> create or replace directory exec_dir as '/orahome/oracle/bin';
Directory created.
```

```
EODA@ORA12CR1> create or replace directory data_dir as '/tmp';
Directory created.
```

Next, a shell script is created named `search_dir.bsh`. The file is located in the `/oracle/home/bin` directory in this example. The following code is placed within the script:

```
#!/bin/bash
/usr/bin/find $* -name "*.gz" -exec /bin/zcat {} \; | /usr/bin/cut -f1 -d,
```

The prior script will search starting in a directory that gets passed into the script; it will search the base directory and all subdirectories underneath it for files with the extension `.gz`. And then for each file that is found, `zcat` is used to view uncompressed data. Finally, `cut` displays just the first column of data.

And this makes the shell script executable:

```
$ chmod +x search_dir.bsh
```

Now all we need is an external table the uses `search_dir.bsh` to display data in the compressed files:

```
EODA@ORA12CR1> create table csv
 2 ( col1 varchar2(20)
 3 )
 4 organization external
 5 (
 6 type oracle_loader
 7 default directory data_dir
 8 access parameters
 9 (
10 records delimited by newline
11 preprocessor exec_dir:'search_dir.bsh'
12 fields terminated by ',' ldrtrim
13 )
14 location
15 (
16 data_dir:'base'
17 )
18 )
19 /
```

Table created.

Now notice in the output that only the first column from the compressed files is displayed; this is because the code in `search_dir.bsh` uses `cut` to only display the first column:

```
EODA@ORA12CR1> select * from csv;
```

```
COL1
-----
base2a col1
base col1
base2b col1
```

Notice how we can dynamically alter the directory location where we want the search for files to begin:

```
EODA@ORA12CR1> create or replace directory data_dir as '/tmp/base';
EODA@ORA12CR1> alter table csv location( 'base2a' );
```

Now when we select from the table, it returns just one record:

```
COL1
-----
base2a col1
```

Also, we can easily modify the shell script code and have it filter the data based on other criteria, such as filtering rows by searching for a string within the CSV file (such as `base2`). Create a `search_dir2.bsh` script to do just that:

```
#!/bin/bash
/usr/bin/find $* -name "*.gz" -print0 | /usr/bin/xargs -0 -I {} /usr/bin/zgrep "base2" {}
```

And make it executable:

```
$ chmod +x search_dir2.bsh
```

Here a new external table definition allows for two columns in the output:

```
EODA@ORA12CR1> create table csv2
 2 ( col1 varchar2(20)
 3 ,col2 varchar2(20)
 4 )
 5 organization external
 6 (
 7 type oracle_loader
 8 default directory data_dir
 9 access parameters
10 (
11 records delimited by newline
12 preprocessor exec_dir:'search_dir2.bsh'
13 fields terminated by ',' ldrtrim
14 )
15 location
```

```

16      (
17      data_dir:'base'
18      )
19  )
20  /

```

Table created.

Select from the external table:

```
EODA@ORA12CR1> select * from csv2;
```

You can see from the output that only two rows are returned, the ones that contain the string of base2:

COL1	COL2
base2a col1	base2a col2
base2b col1	base2b col2

## FINDING THE LARGEST FILES

When dealing with disk space issues, sometimes it's handy to display the top *N* largest files in a directory tree. You can use a preprocessing external table to accomplish this task. First, create two directory objects:

```

EODA@ORA12CR1> create or replace directory exec_dir as '/orahome/oracle/bin';
EODA@ORA12CR1> create or replace directory data_dir as '/';

```

Then create a shell (place it in `/orahome/oracle/bin`) script named `flf.bsh` with the following code:

```

#!/bin/bash
/usr/bin/find $1 -ls|/bin/sort -nrk7|/usr/bin/head -10|/bin/awk '{print $11,$7}'

```

Make `flf.bsh` executable:

```
$ chmod +x flf.bsh
```

Now create an external table with the `PREPROCESSOR` directive:

```

create table flf (fname varchar2(200), bytes number)
organization external (
  type oracle_loader
  default directory exec_dir
  access parameters
  ( records delimited by newline
    preprocessor exec_dir:'flf.bsh'
    fields terminated by whitespace ldrtrim)
  location (data_dir:'u01'));

```

Now select from the external table to return the ten largest files under the directory (and subdirectories) of /u01:

```
EODA@ORA12CR1> select * from flf;
FNAME                                BYTES
-----
/u01/dbfile/ORA12CR1/temp01.dbf      1.0737E+10
...
/u01/app/oracle/unloadir/big_table.dat 2786618287
```

Now suppose you want to change the directory location to search a starting point from /u01 to /orahome/oracle. Do the following:

```
EODA@ORA12CR1> create or replace directory data_dir as '/orahome';
EODA@ORA12CR1> alter table flf location(data_dir:'oracle');
```

Now selecting from the external table, the directory path that starts searching for the largest files in a directory tree is changed:

```
EODA@ORA12CR1> select * from flf;
FNAME                                BYTES
-----
/orahome/oracle/orainst/12.1.0.2/database1.zip 1652417511
...
/orahome/oracle/orainst/12.1.0.2/database2.zip 1212882524
```

So not a typical use of an external table; rather it's an illustration of what's possible with preprocessing.

---

## Trimming Characters Out of a File

I worked with a DBA who would receive an occasional fire-drill manager e-mail with an attached spreadsheet asking, “Can you load this spreadsheet into the production database?” In this environment, there wasn't direct network access to the production database; so the DBA didn't have the option of loading over the network via a tool like SQL\*Loader. In this situation, the steps for loading data are as follows:

1. Save the spreadsheet on a Windows laptop as a CSV file.
2. Copy the CSV file to a secure server configured specifically for file transfers to the production server, and then copy the CSV file to the production server.
3. Use an OS utility to remove hidden DOS characters that are embedded in the CSV file.
4. As the Oracle user, create an external table based on the CSV file.
5. Use SQL to insert into a production table by selecting from the external table.

Step 3 of the preceding list is what I'll focus on here because this is where the preprocessor eliminates the need for that step (as for the other steps, the DBA will have to figure something else out long term).

Assume the file to be loaded is called `load.csv` located in the `/tmp` directory and contains the following data:

```
emergency data|load now^M
more data|must load data^M
```

The ^M characters are carriage-return characters from the Windows environment that should be removed before the data is loaded. To achieve this, we'll set up a couple of directories and then use an external table with the PREPROCESSOR directive, which invokes a shell script to remove the special ^M characters before the data is retrieved:

```
EODA@ORA12CR1> create or replace directory data_dir as '/tmp';
Directory created.
```

```
EODA@ORA12CR1> create or replace directory exec_dir as '/orahome/oracle/bin';
Directory created.
```

Now create a shell script named run\_sed.bsh that uses sed to remove ^M characters from a file. This example places the run\_sed.bsh script in the /orahome/oracle/bin directory:

```
#!/bin/bash
/bin/sed -e 's/^M//g' $*
```

---

■ **Tip** Also consider using the dos2unix utility to remove unwanted characters when transferring from Windows/DOS to UNIX/Linux.

---

The ^M character in the run\_sed.bsh script is placed in there by pressing CTRL+V and then CTRL+M (or instead of CTRL+M, you can press the Return key here); you can't simply type in ^ and then an M. It needs to be the special character ^M.

And this makes the script executable:

```
$ chmod +x run_sed.bsh
```

Next is the external table definition:

```
EODA@ORA12CR1> create table csv3
 2   ( col1 varchar2(20)
 3     ,col2 varchar2(20)
 4   )
 5 organization external
 6   (
 7     type oracle_loader
 8     default directory data_dir
 9     access parameters
10   (
11     records delimited by newline
12     preprocessor exec_dir:'run_sed.bsh'
13     fields terminated by '|' ldrtrim
14   )
15 location
16   (
17     data_dir:'load.csv'
18   )
19 )
20 /
```

Table created.

Now selecting from the external table:

```
EODA@ORA12CR1> select * from csv3;
```

COL1	COL2
emergency data	load now
more data	must load data

How do we know the extraneous ^M was removed from each line? Check the length of COL2:

```
EODA@ORA12CR1> select length(col2) from csv3;
```

```
LENGTH(COL2)
-----
            8
           14
```

If the hidden ^M characters had not been removed, the length of COL2 would have been at least one byte longer than the character data within the column (not to mention we could have had some surprises with searches and joins).

## Preprocessing Wrap-Up

The prior examples show the power of external table PREPROCESSOR directive. Sure, you could achieve the same results without preprocessing, but you would have more steps, more code to maintain, and more places where things can break.

Specific examples were chosen to illustrate the power and flexibility of preprocessing. In the first example, the file operated on was a shell script; there was no data file. The output of the OS command was the data returned when selecting from the external table.

In the second example, a base directory was operated on by the preprocessor script. This provided a starting point for a directory tree search of compressed files, on-the-fly uncompressing of the contents, and then additional filtering of columns and/or rows with commands like `find`, `cut`, and `zgrep`.

The third example showed a script operating on a CSV file to remove unwanted characters by using `sed` before displaying the data. This is a common need when transferring files to and from DOS and UNIX/Linux platforms.

These three examples demonstrate distinctive ways to use the PREPROCESSOR directive. This provides a base knowledge of the possible uses and allows you to build on this to simplify your loading requirements.

## External Tables Summary

In this section, we explored external tables. They are a feature available with Oracle9i and later that may for the most part replace SQLLDR. We investigated the quickest way to get going with external tables: the technique of using SQLLDR to convert the control files we have from past experiences. We demonstrated some techniques for detecting and handling errors via the bad files and, we also explored some multiuser issues regarding external tables. Lastly, we demonstrated preprocessing techniques to execute operating system commands as a first step when selecting from an external table.

We are now ready to get into the next section in this chapter, which deals with unloading data from the database.

## Data Pump Unload

Oracle9i introduced external tables as a method to read external data into the database. Oracle 10g introduced the ability to go the other direction and use a `CREATE TABLE` statement to create external data, to unload data from the database. Starting with Oracle 10g, this data is extracted in a proprietary binary format known as *Data Pump format*, which is the same format the EXPDP and IMPDP tools provided by Oracle to move data from database to database use.

Using the external table unload is actually quite easy—as easy as a `CREATE TABLE AS SELECT` statement. To start, we need a `DIRECTORY` object:

```
EODA@ORA12CR1> create or replace directory tmp as '/tmp';
Directory created.
```

Now we are ready to unload data to this directory using a simple `SELECT` statement, for example:

```
EODA@ORA12CR1> create table all_objects_unload
 2 organization external
 3 ( type oracle_datapump
 4   default directory TMP
 5   location( 'allobjects.dat' )
 6 )
 7 as
 8 select
 9 *
10 from all_objects
11 /
Table created.
```

I purposely chose the `ALL_OBJECTS` view because it is a quite complex view with lots of joins and predicates. This shows you can use this datapump unload technique to extract arbitrary data from your database. We could add predicates or whatever else we wanted to extract a slice of data.

---

■ **Note** This example shows you can use this to extract arbitrary data from your database. Yes, that is repeated text. From a security perspective, this does make it rather easy for someone with access to the information to take the information elsewhere. You need to control access to the set of people who have the ability to create `DIRECTORY` objects and write to them, and who have the necessary access to the physical server to get the unloaded data.

---



The final step would be to copy `allobjects.dat` onto another server, perhaps a development machine for testing with, and extract the DDL to re-create this table over there:

```
EODA@ORA12CR1> select dbms_metadata.get_ddl( 'TABLE', 'ALL_OBJECTS_UNLOAD' ) from dual;
```

```
DBMS_METADATA.GET_DDL('TABLE','ALL_OBJECTS_UNLOAD')
```

```
-----
CREATE TABLE "EODA"."ALL_OBJECTS_UNLOAD"
(
  "OWNER" VARCHAR2(128),
  "OBJECT_NAME" VARCHAR2(128),
  "SUBOBJECT_NAME" VARCHAR2(128),
  "OBJECT_ID" NUMBER,
  "DATA_OBJECT_ID" NUMBER,
  "OBJECT_TYPE" VARCHAR2(23),
  "CREATED" DATE,
  "LAST_DDL_TIME" DATE,
  "TIMESTAMP" VARCHAR2(19),
  "STATUS" VARCHAR2(7),
  "TEMPORARY" VARCHAR2(1),
  "GENERATED" VARCHAR2(1),
  "SECONDARY" VARCHAR2(1),
  "NAMESPACE" NUMBER,
  "EDITION_NAME" VARCHAR2(128),
  "SHARING" VARCHAR2(13),
  "EDITIONABLE" VARCHAR2(1),
  "ORACLE_MAINTAINED" VARCHAR2(1)
)
ORGANIZATION EXTERNAL
( TYPE ORACLE_DATAPUMP
  DEFAULT DIRECTORY "TMP"
  LOCATION
  ( 'allobjects.dat'
  )
)
```

This makes it rather easy to load this extract on another database, as it would simply be the following, and you are done—the data is loaded:

```
EODA@ORA12CR1> insert /*+ append */ into some_table select * from all_objects_unload;
```

---

■ **Note** Starting with Oracle 11g, you can create compressed and encrypted dump files. These features require the Enterprise Edition of Oracle, as well as the Advanced Compression option (for compression) and the Advanced Security option (for encryption).

---

# SQLLDR

SQLLDR is Oracle's high-speed, bulk data loader. It is an extremely useful tool for getting data into an Oracle database from a variety of flat file formats. SQLLDR can be used to load enormous amounts of data in an amazingly short period of time. It has two modes of operation:

- *Conventional path:* SQLLDR will employ SQL inserts on our behalf to load data.
- *Direct path:* SQLLDR does not use SQL in this mode; it formats database blocks directly.

The direct path load allows you to read data from a flat file and write it directly to formatted database blocks, bypassing the entire SQL engine, undo generation and, optionally, redo generation at the same time. Parallel direct path load is among the fastest ways to go from having no data to a fully loaded database.

We will not cover every single aspect of SQLLDR. For all of the details, refer to the *Oracle Database Utilities* manual, which dedicates seven chapters to SQLLDR in Oracle 12c Release 1. The fact that it is covered in seven chapters is notable, since every other utility, such as DBVERIFY, DBNEWID, and LogMiner get one chapter or less. For complete syntax and all of the options, I will again refer you to the *Oracle Database Utilities* manual, as this chapter is intended to answer the “How do I...?” questions that a reference manual does not address.

It should be noted that the Oracle Call Interface (OCI) allows you to write your own direct path loader using C. This is useful when the operation you want to perform is not feasible in SQLLDR or when seamless integration with your application is desired. SQLLDR is a command-line tool (i.e., it's a separate program). It is not an API or anything that can be “called from PL/SQL,” for example.

If you execute SQLLDR from the command line with no inputs, it gives you the following help:

```
$ sqlldr
SQL*Loader: Release 12.1.0.1.0 - Production on Sun Mar 9 11:57:29 2014
Copyright (c) 1982, 2013, Oracle and/or its affiliates. All rights reserved.
Usage: SQLLDR keyword=value [,keyword=value,...]
Valid Keywords:
  userid -- ORACLE username/password
  control -- control file name
  log -- log file name
  bad -- bad file name
  data -- data file name
  discard -- discard file name
discardmax -- number of discards to allow (Default all)
  skip -- number of logical records to skip (Default 0)
  load -- number of logical records to load (Default all)
  errors -- number of errors to allow (Default 50)
  rows -- number of rows in conventional path bind array or between direct path data saves
         (Default: Conventional path 64, Direct path all)
bindsize -- size of conventional path bind array in bytes (Default 256000)
  silent -- suppress messages during run (header,feedback,errors,discards,partitions)
  direct -- use direct path (Default FALSE)
  parfile -- parameter file: name of file that contains parameter specifications
  parallel -- do parallel load (Default FALSE)
  file -- file to allocate extents from
skip_unusable_indexes -- disallow/allow unusable indexes or index partitions (Default FALSE)
skip_index_maintenance -- do not maintain indexes, mark affected indexes as unusable (Default
FALSE)
commit_discontinued -- commit loaded rows when load is discontinued (Default FALSE)
  readsize -- size of read buffer (Default 1048576)
external_table -- use external table for load; NOT_USED, GENERATE_ONLY, EXECUTE
```

```

columnarrayrows -- number of rows for direct path column array (Default 5000)
streamsize -- size of direct path stream buffer in bytes (Default 256000)
multithreading -- use multithreading in direct path
  resumable -- enable or disable resumable for current session (Default FALSE)
resumable_name -- text string to help identify resumable statement
resumable_timeout -- wait time (in seconds) for RESUMABLE (Default 7200)
date_cache -- size (in entries) of date conversion cache (Default 1000)
no_index_errors -- abort load on any index errors (Default FALSE)
...

```

For technical definitions of each individual parameter, please refer to Chapter 8 of the *Oracle Database Utilities* manual. I will demonstrate the usage of a few of these parameters in this chapter.

To use SQLLDR, you will need a *control file*. A SQLLDR control file simply contains information describing the input data—its layout, datatypes, and so on—as well as information about the target table(s).

---

■ **Note** Don't confuse a SQLLDR control file with a database control file. Recall from Chapter 3 that a database control file is small binary file that stores a directory of the files Oracle requires along with other information such as checkpoint data, the name of the database, and so on.

---

The control file can even contain the data to load. In the following example, we'll build a simple control file in a step-by-step fashion, and I'll provide an explanation of the commands. (Note that the parenthetical numbers to the left in the code are *not* part of this control file; they are just there for reference.) I'll refer to the file later as `demo1.ct1`.

```

(1) LOAD DATA
(2) INFILE *
(3) INTO TABLE DEPT
(4) FIELDS TERMINATED BY ','
(5) (DEPTNO, DNAME, LOC)
(6) BEGINDATA
(7) 10,Sales,Virginia
(8) 20,Accounting,Virginia
(9) 30,Consulting,Virginia
(10) 40,Finance,Virginia

```

- `LOAD DATA (1)`: This tells SQLLDR what to do (in this case, load data). The other thing SQLLDR can do is `CONTINUE_LOAD` to resume a load. You would use this latter option only when continuing a multitable direct path load.
- `INFILE * (2)`: This tells SQLLDR the data to be loaded is actually contained within the control file itself as shown on lines 6 through 10. Alternatively, you could specify the name of another file that contains the data. You can override this `INFILE` statement using a command-line parameter if you wish. Be aware that *command-line options override control file settings*.
- `INTO TABLE DEPT (3)`: This tells SQLLDR to which table you are loading data (in this case, the `DEPT` table).
- `FIELDS TERMINATED BY ',' (4)`: This tells SQLLDR that the data will be in the form of comma-separated values. There are dozens of ways to describe the input data to SQLLDR; this is just one of the more common methods.

- (DEPTNO, DNAME, LOC) (5): This tells SQLLDR what columns you are loading, their order in the input data, and their datatypes. The datatypes are for the data in the *input* stream, not the datatypes in the database. In this case, they are defaulting to CHAR(255), which is sufficient.
- BEGINDATA (6): This tells SQLLDR you have finished describing the input data and that the very next lines, lines 7 to 10, are the actual data to be loaded into the DEPT table.

This is a control file in one of its most simple and common formats: to load delimited data into a table. We will take a look at some much more complex examples in this chapter, but this is a good one to get our feet wet with. To use this control file, which we will name `demo1.ctl`, all we need to do is create an empty DEPT table:

```
EODA@ORA12CR1> create table dept
 2 ( deptno number(2) constraint dept_pk primary key,
 3   dname  varchar2(14),
 4   loc    varchar2(13)
 5 )
 6 /
Table created.
```

And run the following command:

```
$ sqlldr userid=eoda control=demo1.ctl
Password:
SQL*Loader: Release 12.1.0.1.0 - Production on Sun Mar 9 12:03:26 2014
Copyright (c) 1982, 2013, Oracle and/or its affiliates. All rights reserved.
Path used: Conventional
Commit point reached - logical record count 4
Table DEPT:
 4 Rows successfully loaded.
Check the log file:
  demo1.log
```

If the table is not empty, we will receive an error message to the following effect:

```
SQL*Loader-601: For INSERT option, table must be empty. Error on table DEPT
```

This is because we allowed almost everything in the control file to default, and the default load option is INSERT (as opposed to APPEND, TRUNCATE, or REPLACE). To INSERT, SQLLDR assumes the table is empty. If we wanted to *add* records to the DEPT table, we could have specified APPEND; to replace the data in the DEPT table, we could have used REPLACE or TRUNCATE. REPLACE uses a conventional DELETE FROM TABLE statement to remove records; hence, if the table to be loaded into already contains many records, it could be quite slow to perform. TRUNCATE uses the TRUNCATE SQL command and is typically faster, as it does not have to physically remove each row.

Every load will generate a log file. The log file from our simple load looks like this:

SQL\*Loader: Release 12.1.0.1.0 - Production on Sun Mar 9 12:03:26 2014  
Copyright (c) 1982, 2013, Oracle and/or its affiliates. All rights reserved.

Control File: demo1.ctl  
Data File: demo1.ctl  
Bad File: demo1.bad  
Discard File: none specified

(Allow all discards)

Number to load: ALL  
Number to skip: 0  
Errors allowed: 50  
Bind array: 64 rows, maximum of 256000 bytes  
Continuation: none specified  
Path used: Conventional

Table DEPT, loaded from every logical record.  
Insert option in effect for this table: INSERT

Column Name	Position	Len	Term	Encl	Datatype
DEPTNO	FIRST	*	,		CHARACTER
DNAME	NEXT	*	,		CHARACTER
LOC	NEXT	*	,		CHARACTER

Table DEPT:  
4 Rows successfully loaded.  
0 Rows not loaded due to data errors.  
0 Rows not loaded because all WHEN clauses were failed.  
0 Rows not loaded because all fields were null.

Space allocated for bind array: 49536 bytes(64 rows)  
Read buffer bytes: 1048576

Total logical records skipped: 0  
Total logical records read: 4  
Total logical records rejected: 0  
Total logical records discarded: 0

Run began on Sat Mar 01 10:10:35 2014  
Run ended on Sat Mar 01 10:10:36 2014

Elapsed time was: 00:00:01.01  
CPU time was: 00:00:00.01

The log file tells us about many of the aspects of our load. We can see the options we used (defaulted or otherwise). We can see how many records were read, how many loaded, and so on. The log files specify the locations of all BAD and DISCARD files. They even tell us how long it took. These log files are crucial for verifying that the load was successful, as well as for diagnosing errors. If the loaded data resulted in SQL errors (i.e., the input data was “bad” and created records in the BAD file), these errors would be recorded here. The information in the log files is largely self-explanatory, so we will not spend any more time on it.

## Loading Data with SQLLDR FAQs

We will now cover what I have found to be the most frequently asked questions with regard to loading data in an Oracle database using SQLLDR.

### Why Do I Receive “exceeds maximum length” in My Log File?

This is perhaps the most frequently recurring question I’ve heard with SQLLDR: Why does my log file contain something similar to (the following)?:

```
Record 4: Rejected - Error on table DEPT, column DNAME.
Field in data file exceeds maximum length
```

This is due to the fact that the default datatype in SQLLDR for processing an input record is a char(255). If you have any string datatypes in your table that exceed that, you’ll have to explicitly tell SQLLDR that the input record can contain more than 255 characters.

For example, suppose you add a column that can hold more than 255 characters:

```
EODA@ORA12CR1> alter table dept modify dname varchar2(1000);
Table altered.
```

And you had a control file such as the following (the line with more text repeated is a single line in that input file):

```
LOAD DATA
INFILE *
INTO TABLE DEPT
FIELDS TERMINATED BY ','
(DEPTNO, DNAME, LOC)
BEGINDATA
10,Sales,Virginia
20,Accounting,Virginia
30,Consulting,Virginia
40,Finance more text more text more text more ... <repeated many times> ...more text,Virginia
```

When you ran SQLLDR, you would receive the previous error message. The solution is rather simple:

```
LOAD DATA
INFILE *
INTO TABLE DEPT
FIELDS TERMINATED BY ','
(DEPTNO, DNAME char(1000), LOC)
BEGINDATA ...
```

That’s it! Just tell SQLLDR the maximum width of the field in the input record—in this case 1,000.

## How Do I Load Delimited Data?

*Delimited data*, or data that is separated by some special character and perhaps enclosed in quotes, is the most popular data format for flat files today. On a mainframe, a fixed-length, fixed-format file would probably be the most recognized file format, but on UNIX/Linux and Windows, delimited files are the norm. In this section, we will investigate the popular options used to load delimited data.

The most popular format for delimited data is the *comma-separated values (CSV)* format. In this file format, each field of data is separated from the next by a comma. Text strings can be enclosed within quotes, thus allowing for the string itself to contain commas. If the string must contain a quotation mark as well, the convention is to double up the quotation mark (in the following code we use "" in place of just "). A typical control file to load delimited data will look much like our first example earlier, but the `FIELDS TERMINATED BY` clause would generally be specified like this:

```
FIELDS TERMINATED BY ',' OPTIONALLY ENCLOSED BY ''''
```

It specifies that a comma separates the data fields, and that each field *might* be enclosed in double quotes. Let's say that we were to modify the bottom of this control file to be as follows:

```
FIELDS TERMINATED BY ',' OPTIONALLY ENCLOSED BY ''''
(DEPTNO, DNAME, LOC)
BEGINDATA
10,Sales,"Virginia,USA"
20,Accounting,"Va, ""USA""
30,Consulting, Virginia
40,Finance, Virginia
```

When we run `SQLLDR` using this control file, the results will be as follows:

```
EODA@ORA12CR1> select * from dept;
```

DEPTNO	DNAME	LOC
10	Sales	Virginia,USA
20	Accounting	Va, "USA"
30	Consulting	Virginia
40	Finance	Virginia

Notice the following in particular:

- `Virginia,USA` in department 10: This results from input data that was `"Virginia,USA"`. This input data field had to be enclosed in quotes to retain the comma as part of the data. Otherwise, the comma would have been treated as the end-of-field marker, and `Virginia` would have been loaded without the `USA` text.
- `Va, "USA"`: This resulted from input data that was `"Va, ""USA""`. `SQLLDR` counted the double occurrence of `"` as a single occurrence within the enclosed string. To load a string that contains the optional enclosure character, you must ensure the enclosure character is doubled up.

Another popular format is *tab-delimited data*, which is data separated by tabs rather than commas. There are two ways to load this data using the `TERMINATED BY` clause:

- `TERMINATED BY X'09'` (the tab character using hexadecimal format; in ASCII, 9 is a tab character)
- `TERMINATED BY WHITESPACE`

The two are very different in implementation, as the following shows. Using the `DEPT` table from earlier, we'll load using this control file:

```
LOAD DATA
INFILE *
INTO TABLE DEPT
REPLACE
FIELDS TERMINATED BY WHITESPACE
(DEPTNO, DNAME, LOC)
BEGINDATA
10 Sales Virginia
```

It is not readily visible on the page, but there are *two* tabs between each piece of data here. The data line is actually as follows, where the `\t` is the universally recognized tab escape sequence.

```
10\t\tSales\t\tVirginia
```

When you use this control file with the `TERMINATED BY WHITESPACE` clause as previously, the resulting data in the table `DEPT` is this:

```
EODA@ORA12CR1> select * from dept;
```

DEPTNO	DNAME	LOC
10	Sales	Virginia

`TERMINATED BY WHITESPACE` parses the string by looking for the first occurrence of whitespace (tab, blank, or newline), and then it continues until it finds the next *non*-whitespace character. Hence, when it parsed the data, `DEPTNO` had 10 assigned to it, the two subsequent tabs were considered as whitespace, `Sales` was assigned to `DNAME`, and so on.

On the other hand, suppose you were to use `FIELDS TERMINATED BY X'09'`, as the following modified control file does:

```
...
FIELDS TERMINATED BY X'09'
(DEPTNO, DNAME, LOC)
...
```

You would find `DEPT` loaded with the following data:

```
EODA@ORA12CR1> select * from dept;
```

DEPTNO	DNAME	LOC
10	Sales	



Here, once SQLLDR encountered a tab, it output a value. Hence, 10 is assigned to DEPTNO, and DNAME gets NULL since there is no data between the first tab and the next occurrence of a tab. Sales gets assigned to LOC.

This is the intended behavior of TERMINATED BY WHITESPACE and TERMINATED BY <character>. The one that is more appropriate to use will be dictated by the input data and how you need it to be interpreted.

Lastly, when loading delimited data such as this, it is very common to want to skip over various columns in the input record. For example, you might want to load fields 1, 3, and 5, skipping columns 2 and 4. To do this, SQLLDR provides the FILLER keyword. This allows you to map a column in an input record, but not put it into the database. For example, given the DEPT table and the last control file from earlier, we can modify the control file to load the data correctly (skipping over the tabs) using the FILLER keyword:

```
LOAD DATA
INFILE *
INTO TABLE DEPT
REPLACE
FIELDS TERMINATED BY x'09'
(DEPTNO, dummy1 filler, DNAME, dummy2 filler, LOC)
BEGINDATA
10      Sales      Virginia
```

The resulting DEPT table is now as follows:

```
EODA@ORA12CR1> select * from dept;
```

```
DEPTNO DNAME      LOC
-----
10 Sales      Virginia
```

## How Do I Load Fixed Format Data?

Often, you have a flat file generated from some external system, and this file is a fixed-length file with positional data. For example, the NAME field is in bytes 1 to 10, the ADDRESS field is in bytes 11 to 35, and so on. We will look at how SQLLDR can import this kind of data for us.

This fixed-width, positional data is the optimal data format for SQLLDR to load. It will be the fastest way to process, as the input data stream is somewhat trivial to parse. SQLLDR will have stored fixed-byte offsets and lengths into data records, and extracting a given field is very simple. If you have an extremely large volume of data to load, converting it to a fixed position format is generally the best approach. The downside to a fixed-width file is, of course, that it can be much larger than a simple, delimited file format.

To load fixed-width positional data, you will use the POSITION keyword in the control file, for example:

```
LOAD DATA
INFILE *
INTO TABLE DEPT
REPLACE
( DEPTNO position(1:2),
  DNAME  position(3:16),
  LOC    position(17:29)
)
BEGINDATA
10Accounting  Virginia,USA
```

This control file does not employ the `FIELDS TERMINATED BY` clause; rather, it uses `POSITION` to tell `SQL*Loader` where fields begin and end. Note that with the `POSITION` clause, we could use overlapping positions and go back and forth in the record. For example, suppose we were to alter the `DEPT` table as follows:

```
EODA@ORA12CR1> alter table dept add entire_line varchar2(29);
Table altered.
```

And then we used the following control file:

```
LOAD DATA
INFILE *
INTO TABLE DEPT
REPLACE
( DEPTNO      position(1:2),
  DNAME       position(3:16),
  LOC         position(17:29),
  ENTIRE_LINE position(1:29)
)
BEGINDATA
10Accounting  Virginia,USA
```

The field `ENTIRE_LINE` is defined as `POSITION(1:29)`. It extracts its data from all 29 bytes of input data, whereas the other fields are substrings of the input data. The outcome of this control file will be as follows:

```
EODA@ORA12CR1> select * from dept;
```

DEPTNO	DNAME	LOC	ENTIRE_LINE
10	Accounting	Virginia,USA	10Accounting Virginia,USA

When using `POSITION`, we can use relative or absolute offsets. In the preceding example, we used absolute offsets. We specifically denoted where fields begin and where they end. We could have written the preceding control file as follows:

```
LOAD DATA
INFILE *
INTO TABLE DEPT
REPLACE
( DEPTNO      position(1:2),
  DNAME       position(*:16),
  LOC         position(*:29),
  ENTIRE_LINE position(1:29)
)
BEGINDATA
10Accounting  Virginia,USA
```

The `*` instructs the control file to pick up where the last field left off. Therefore `(*:16)` is just the same as `(3:16)` in this case. Notice that you can mix relative and absolute positions in the control file. Additionally, when using the `*` notation, you can add to the offset. For example, if `DNAME` started 2 bytes *after* the end of `DEPTNO`, we could have used `(*+2:16)`. In this example, the effect would be identical to using `(5:16)`.

The ending position in the POSITION clause must be the absolute column position where the data ends. At times, it can be easier to specify just the length of each field, especially if they are contiguous, as in the preceding example. In this fashion, we would just have to tell SQLLDR the record starts at byte 1, and then specify the length of each field. This will save us from having to compute start and stop byte offsets into the record, which can be hard at times. In order to do this, we'll leave off the ending position and instead specify the *length* of each field in the fixed-length record as follows:

```
LOAD DATA
INFILE *
INTO TABLE DEPT
REPLACE
( DEPTNO      position(1) char(2),
  DNAME       position(*) char(14),
  LOC         position(*) char(13),
  ENTIRE_LINE position(1) char(29)
)
BEGINDATA
10Accounting   Virginia,USA
```

Here we had to tell SQLLDR only where the first field begins and its length. Each subsequent field starts where the last one left off and continues for a specified length. It is not until the last field that we have to specify a position again, since this field goes back to the beginning of the record.

## How Do I Load Dates?

Loading dates using SQLLDR is fairly straightforward, but it seems to be a common point of confusion. You simply need to use the DATE data type in the control file and specify the date mask to be used. This date mask is the same mask you use with TO\_CHAR and TO\_DATE in the database. SQLLDR will apply this date mask to your data and load it for you.

For example, let's say we alter our DEPT table again, as follows:

```
EODA@ORA12CR1> alter table dept add last_updated date;
Table altered.
```

We can load it with the following control file:

```
LOAD DATA
INFILE *
INTO TABLE DEPT
REPLACE
FIELDS TERMINATED BY ','
(DEPTNO,
  DNAME,
  LOC,
  LAST_UPDATED date 'dd/mm/yyyy'
)
BEGINDATA
10,Sales,Virginia,1/5/2014
20,Accounting,Virginia,21/6/2014
30,Consulting,Virginia,5/1/2013
40,Finance,Virginia,15/3/2014
```

The resulting DEPT table will look like this:

```
EODA@ORA12CR1> select * from dept;
```

DEPTNO	DNAME	LOC	LAST_UPDA
10	Sales	Virginia	01-MAY-14
20	Accounting	Virginia	21-JUN-14
30	Consulting	Virginia	05-JAN-13
40	Finance	Virginia	15-MAR-14

It is that easy. Just supply the format in the control file and SQLLDR will convert the date for us. In some cases, it might be appropriate to use a more powerful SQL function. For example, your input file might contain dates in many different formats: sometimes with the time component, sometimes without; sometimes in DD-MON-YYYY format; sometimes in DD/MM/YYYY format; and so on. You'll learn in the next section how to use functions in SQLLDR to overcome these challenges.

## How Do I Load Data Using Functions?

In this section, you'll see how to refer to functions while loading data. Bear in mind, however, that the use of such functions (including database sequences) requires the SQL engine, and hence won't work in a direct path load.

Using functions in SQLLDR is very easy once you understand how SQLLDR builds its INSERT statement. To have a function applied to a field in a SQLLDR script, simply add it to the control file in double quotes. For example, say you have the DEPT table from earlier, and you would like to make sure the data being loaded is in uppercase. You could use the following control file to load it:

```
LOAD DATA
INFILE *
INTO TABLE DEPT
REPLACE
FIELDS TERMINATED BY ','
(DEPTNO,
  DNAME      "upper(:dname)",
  LOC        "upper(:loc)",
  LAST_UPDATED date 'dd/mm/yyyy'
)
BEGINDATA
10,Sales,Virginia,1/5/2014
20,Accounting,Virginia,21/6/2014
30,Consulting,Virginia,5/1/2013
40,Finance,Virginia,15/3/2014
```

The resulting data in the database will be as follows:

```
EODA@ORA12CR1> select * from dept;
```

DEPTNO	DNAME	LOC	LAST_UPDA	ENTIRE_LINE
10	SALES	VIRGINIA	01-MAY-14	
20	ACCOUNTING	VIRGINIA	21-JUN-14	
30	CONSULTING	VIRGINIA	05-JAN-13	
40	FINANCE	VIRGINIA	15-MAR-14	

Notice how you are able to easily uppercase the data just by applying the UPPER function to a bind variable. It should be noted that the SQL functions could refer to any of the columns, regardless of the column the function is actually applied to. This means that a column can be the result of a function on two or more of the other columns. For example, if you wanted to load the column ENTIRE\_LINE, you could use the SQL concatenation operator. It is a little more involved than that, though, in this case. Right now, the input data set has four data elements in it. Let's say that you were to simply add ENTIRE\_LINE to the control file like this:

```
LOAD DATA
INFILE *
INTO TABLE DEPT
REPLACE
FIELDS TERMINATED BY ','
(DEPTNO,
 DNAME      "upper(:dname)",
 LOC        "upper(:loc)",
 LAST_UPDATED date 'dd/mm/yyyy',
 ENTIRE_LINE " :deptno||:dname||:loc||:last_updated"
)
BEGINDATA
10,Sales,Virginia,1/5/2014
20,Accounting,Virginia,21/6/2014
30,Consulting,Virginia,5/1/2013
40,Finance,Virginia,15/3/2014
```

You would find this error in your log file for each input record:

```
Record 1: Rejected - Error on table DEPT, column ENTIRE_LINE.
Column not found before end of logical record (use TRAILING NULLCOLS)
```

Here, SQLLDR is telling you that it ran out of data in the record before it ran out of columns. The solution is easy in this case, and in fact SQLLDR even tells us what to do: use TRAILING NULLCOLS. This will have SQLLDR bind a NULL value in for that column if no data exists in the input record. In this case, adding TRAILING NULLCOLS will cause the bind variable :ENTIRE\_LINE to be NULL. So, you retry with this control file:

```
LOAD DATA
INFILE *
INTO TABLE DEPT
REPLACE
FIELDS TERMINATED BY ','
TRAILING NULLCOLS
(DEPTNO,
  DNAME      "upper(:dname)",
  LOC        "upper(:loc)",
  LAST_UPDATED date 'dd/mm/yyyy',
  ENTIRE_LINE ":deptno||:dname||:loc||:last_updated"
)
BEGINDATA
10,Sales,Virginia,1/5/2014
20,Accounting,Virginia,21/6/2014
30,Consulting,Virginia,5/1/2013
40,Finance,Virginia,15/3/2014
```

Now the data in the table is as follows:

```
EODA@ORA12CR1> select * from dept;
```

DEPTNO	DNAME	LOC	LAST_UPDA	ENTIRE_LINE
10	SALES	VIRGINIA	01-MAY-14	10SalesVirginia1/5/2014
20	ACCOUNTING	VIRGINIA	21-JUN-14	20AccountingVirginia21/6/2014
30	CONSULTING	VIRGINIA	05-JAN-13	30ConsultingVirginia5/1/2013
40	FINANCE	VIRGINIA	15-MAR-14	40FinanceVirginia15/3/2014

What makes this feat possible is the way SQLLDR builds its INSERT statement. SQLLDR will look at the preceding and see the DEPTNO, DNAME, LOC, LAST\_UPDATED, and ENTIRE\_LINE columns in the control file. It will set up five bind variables named after these columns. Normally, in the absence of any functions, the INSERT statement it builds is simply:

```
INSERT INTO DEPT ( DEPTNO, DNAME, LOC, LAST_UPDATED, ENTIRE_LINE )
VALUES ( :DEPTNO, :DNAME, :LOC, :LAST_UPDATED, :ENTIRE_LINE );
```

It would then parse the input stream, assigning the values to its bind variables, and then execute the statement. When you begin to use functions, SQLLDR incorporates them into its INSERT statement. In the preceding example, the INSERT statement SQLLDR builds will look like this:

```
INSERT INTO T (DEPTNO, DNAME, LOC, LAST_UPDATED, ENTIRE_LINE)
VALUES ( :DEPTNO, upper(:dname), upper(:loc), :last_updated,
        :deptno||:dname||:loc||:last_updated );
```

It then prepares and binds the inputs to this statement, and executes it. So, pretty much anything you can think of doing in SQL, you can incorporate into your SQL\*DR scripts. With the addition of the CASE statement in SQL, doing this can be extremely powerful and easy. For example, say your input file could have dates in the following formats:

- HH24:MI:SS: Just a time; the date should default to the first day of the current month.
- DD/MM/YYYY: Just a date; the time should default to midnight.
- HH24:MI:SS DD/MM/YYYY: The date and time are both explicitly supplied.

You could use a control file like this:

```
LOAD DATA
INFILE *
INTO TABLE DEPT
REPLACE
FIELDS TERMINATED BY ','
TRAILING NULLCOLS
(DEPTNO,
 DNAME          "upper(:dname)",
 LOC            "upper(:loc)",
 LAST_UPDATED
"case
when length(:last_updated) > 9
then to_date(:last_updated,'hh24:mi:ss dd/mm/yyyy')
when instr(:last_updated,':') > 0
then to_date(:last_updated,'hh24:mi:ss')
else to_date(:last_updated,'dd/mm/yyyy')
end"
)
BEGINDATA
10,Sales,Virginia,12:03:03 17/10/2014
20,Accounting,Virginia,02:23:54
30,Consulting,Virginia,01:24:00 21/10/2014
40,Finance,Virginia,17/8/2014
```

This results in the following:

```
EODA@ORA12CR1> alter session set nls_date_format = 'dd-mon-yyyy hh24:mi:ss';
Session altered.
```

```
EODA@ORA12CR1> select deptno, dname, loc, last_updated from dept;
```

DEPTNO	DNAME	LOC	LAST_UPDATED
10	SALES	VIRGINIA	17-oct-2014 12:03:03
20	ACCOUNTING	VIRGINIA	01-mar-2014 02:23:54
30	CONSULTING	VIRGINIA	21-oct-2014 01:24:00
40	FINANCE	VIRGINIA	17-aug-2014 00:00:00

Now, one of three date formats will be applied to the input character string (notice that you are *not* loading a DATE anymore; you are just loading a string). The CASE function will look at the length and the contents of the string to determine which of the masks it should use.

It is interesting to note that you can write your *own* functions to be called from SQL\*Loader. This is a straightforward application of the fact that PL/SQL can be called from SQL.

## How Do I Load Data with Embedded Newlines?

This is something that has been problematic for SQL\*Loader historically: how to load free-form data that may include a newline in it. The newline character is the default end-of-line character to SQL\*Loader, and the ways around this did not offer much flexibility in the past. Fortunately, in Oracle 8.1.6 and later versions we have some new options. The options for loading data with embedded newlines are now as follows:

- Load the data with some other character in the data that represents a newline (e.g., put the string `\n` in the text where a newline should appear) and use a SQL function to replace that text with a `CHR(10)` during load time.
- Use the `FIX` attribute on the `INFILE` directive, and load a fixed-length flat file. In this case there is no record terminator; rather, the fact that each record is exactly as long as every other record is used to determine where records begin and end.
- Use the `VAR` attribute on the `INFILE` directive, and load a variable-width file that uses a format such that the first few bytes of each line specify the length in bytes of the line to follow.
- Use the `STR` attribute on the `INFILE` directive to load a variable-width file with some sequence of characters that represents the end of line, as opposed to just the newline character representing this.

The following sections demonstrate each in turn.

### Use a Character Other Than a Newline

This is an easy method if you have control over how the input data is produced. If it is easy enough to convert the data when creating the data file, this will work fine. The idea is to apply a SQL function to the data on the way into the database, replacing some string of characters with a newline. Let's add another column to our `DEPT` table:

```
EODA@ORA12CR1> alter table dept add comments varchar2(4000);
Table altered.
```

We'll use this column to load text into. An example control file with inline data could be as follows:

```
LOAD DATA
INFILE *
INTO TABLE DEPT
REPLACE
FIELDS TERMINATED BY ','
TRAILING NULLCOLS
(DEPTNO,
 DNAME          "upper(:dname)",
 LOC            "upper(:loc)",
 COMMENTS      "replace(:comments, '\\n', chr(10))"
)
BEGINDATA
10,Sales,Virginia,This is the Sales\nOffice in Virginia
20,Accounting,Virginia,This is the Accounting\nOffice in Virginia
30,Consulting,Virginia,This is the Consulting\nOffice in Virginia
40,Finance,Virginia,This is the Finance\nOffice in Virginia
```



Notice how in the call to replace we had to use `\\n`, not just `\n`. This is because `\n` is recognized by SQL\*Loader as a newline, and SQL\*Loader would have converted it into a newline, not a two-character string. When we execute SQL\*Loader with the preceding control file, the table DEPT is loaded with the following:

```
EODA@ORA12CR1> select deptno, dname, comments from dept;
```

DEPTNO	DNAME	COMMENTS
10	SALES	This is the Sales Office in Virginia
20	ACCOUNTING	This is the Accounting Office in Virginia
30	CONSULTING	This is the Consulting Office in Virginia
40	FINANCE	This is the Finance Office in Virginia

## Use the FIX Attribute

The FIX attribute is another method available to us. If we use this, the input data must appear in fixed-length records. Each record will be exactly the same number of bytes as any other record in the input data set. When using *positional* data, the use of the FIX attribute is especially valid. These files are typically fixed-length input files to begin with. When using free-form delimited data, it is less likely that we will have a fixed-length file, as these files are generally of varying length (this is the entire point of delimited files: to make each line only as big as it needs to be).

When using the FIX attribute, we must use an INFILE clause, as this is an option to the INFILE clause. Additionally, the data must be stored externally, not in the control file itself, using this option. So, assuming we have fixed-length input records, we can use a control file such as this:

```
LOAD DATA
INFILE demo.dat "fix 80"
INTO TABLE DEPT
REPLACE
FIELDS TERMINATED BY ','
TRAILING NULLCOLS
(DEPTNO,
 DNAME      "upper(:dname)",
 LOC        "upper(:loc)",
 COMMENTS
)
```

This file specifies an input data file that will have records that are 80 bytes each. *This includes the trailing newline* that may or may not be there. In this case, the newline is nothing special in the input data file. It is just another character to be loaded or not. This is the thing to understand: the newline at the end of the record (if present) will become part of the record. To fully understand this, we need a utility to dump the contents of a file on the screen so we can see what is really in there. Using any UNIX/Linux variant, this is pretty easy to do with `od`, a program to dump files to the screen in octal and other formats. We'll use the following `demo.dat` file. Note that the first column in the

following output is actually in octal (base 8), so the number 0000012 on the second line is in octal and represents the decimal number 10. This tells us what byte in the file we are looking at. I've formatted the output to show ten characters per line (using `-w10`), so 0, 12, 24, and 36 are really 0, 10, 20, and 30:

```
[tkyte@desktop tkyte]$ od -c -w10 -v demo.dat
0000000 1 0 , S a l e s , V
0000012 i r g i n i a , T h
0000024 i s i s t h e
0000036 S a l e s \n O f f i
0000050 c e i n V i r g
0000062 i n i a
0000074
0000106
0000120 2 0 , A c c o u n t
0000132 i n g , V i r g i n
0000144 i a , T h i s i s
0000156 t h e A c c o u
0000170 n t i n g \n O f f i
0000202 c e i n V i r g
0000214 i n i a
0000226
0000240 3 0 , C o n s u l t
0000252 i n g , V i r g i n
0000264 i a , T h i s i s
0000276 t h e C o n s u
0000310 l t i n g \n O f f i
0000322 c e i n V i r g
0000334 i n i a
0000346
0000360 4 0 , F i n a n c e
0000372 , V i r g i n i a ,
0000404 T h i s i s t h
0000416 e F i n a n c e \n
0000430 O f f i c e i n
0000442 V i r g i n i a
0000454
0000466
0000500
[tkyte@desktop tkyte]$
```

Notice that in this input file, the newlines (`\n`) are not there to indicate where the end of the record for `SQLLDR` is; rather, they are just data to be loaded in this case. `SQLLDR` is using the `FIX` width of 80 bytes to figure out how much data to read. In fact, if we look at the input data, the records for `SQLLDR` are not even terminated by `\n` in this input file. The character right before department 20's record is a space, not a newline.

Now that we know each and every record is 80 bytes long, we are ready to load it using the control file listed earlier with the `FIX 80` clause. When we do so, we can see the following:

```
EODA@ORA12CR1> select ''' || comments || ''' comments from dept;

COMMENTS
-----
"This is the Sales
Office in Virginia          "

"This is the Accounting
Office in Virginia        "

"This is the Consulting
Office in Virginia        "

"This is the Finance
Office in Virginia        "
```

You might need to *trim* this data, since the trailing whitespace is preserved. You can do that in the control file, using the `TRIM` built-in SQL function.

A word of caution to those of you lucky enough to work on both Windows and UNIX/Linux: the end-of-line marker is different on these platforms. On UNIX/Linux, it is simply `\n` (`CHR(10)` in SQL). On Windows/DOS, it is `\r\n` (`CHR(13) || CHR(10)` in SQL). In general, if you use the `FIX` approach, make sure to *create and load* the file on a homogenous platform (UNIX/Linux and UNIX/Linux, or Windows and Windows).

## Use the VAR Attribute

Another method of loading data with embedded newline characters is to use the `VAR` attribute. When using this format, each record will begin with some fixed number of bytes that represent the total length of the incoming record. Using this format, we can load variable-length records that contain embedded newlines, but only if we have a *record length field* at the beginning of *each and every* record. So, suppose we use a control file such as the following:

```
LOAD DATA
INFILE demo.dat "var 3"
INTO TABLE DEPT
REPLACE
FIELDS TERMINATED BY ','
TRAILING NULLCOLS
(DEPTNO,
 DNAME      "upper(:dname)",
 LOC        "upper(:loc)",
 COMMENTS
)
```

Then the VAR 3 says that the first 3 bytes of each input record contain the length of that input record. If we take a data file such as the following, we can load it using that control file:

```
[tkyte@desktop tkyte]$ cat demo.dat
05510,Sales,Virginia,This is the Sales
Office in Virginia
06520,Accounting,Virginia,This is the Accounting
Office in Virginia
06530,Consulting,Virginia,This is the Consulting
Office in Virginia
05940,Finance,Virginia,This is the Finance
Office in Virginia
[tkyte@desktop tkyte]$
```

In our input data file, we have four rows of data. The first row starts with 055, meaning that the next 55 bytes represent the first input record. This 55 bytes includes the terminating newline after the word *Virginia*. The next row starts with 065. It has 65 bytes of text, and so on. Using this format data file, we can easily load our data with embedded newlines.

Again, if you are using UNIX/Linux and Windows (the preceding example was with UNIX/Linux, where a newline is one character long), you would have to adjust the length field for each record. On Windows, the preceding example's .dat file would have to contain 56, 66, 66, and 60 for the values in the length fields.

## Use the STR Attribute

This is perhaps the most flexible method of loading data with embedded newlines. Using the STR attribute, we can specify a new end-of-line character (or sequence of characters). This allows us to create an input data file that has some special character at the end of each line—the newline is no longer “special.”

I prefer to use a sequence of characters, typically some special marker, and then a newline. This makes it easy to see the end-of-line character when viewing the input data in a text editor or some utility, as each record still has a newline at the end of it. The STR attribute is specified in hexadecimal, and perhaps the easiest way to get the exact hexadecimal string we need is to use SQL and UTL\_RAW to produce the hexadecimal string for us. For example, assuming we are on UNIX/Linux where the end-of-line marker is CHR(10) (linefeed) and our special marker character is a pipe symbol (|), we can write this:

```
EODA@ORA12CR1> select utl_raw.cast_to_raw( '|' || chr(10) ) from dual;
```

```
UTL_RAW.CAST_TO_RAW(' '|' || CHR(10))
```

```
-----
7COA
```

It shows us that the STR we need to use on UNIX/Linux is X'7COA'.

---

■ **Note** On Windows, you would use UTL\_RAW.CAST\_TO\_RAW( '|' || chr(13) || chr(10) ).

---

To use this, we might have a control file like this:

```
LOAD DATA
INFILE demo.dat "str X'7C0A'"
INTO TABLE DEPT
REPLACE
FIELDS TERMINATED BY ','
TRAILING NULLCOLS
(DEPTNO,
 DNAME      "upper(:dname)",
 LOC        "upper(:loc)",
 COMMENTS
)
```

So, if our input data looks like the following, where each record in the data file ends with a `|`, the previous control file will load it correctly:

```
[tkyte@desktop tkyte]$ cat demo.dat
10,Sales,Virginia,This is the Sales
Office in Virginia|
20,Accounting,Virginia,This is the Accounting
Office in Virginia|
30,Consulting,Virginia,This is the Consulting
Office in Virginia|
40,Finance,Virginia,This is the Finance
Office in Virginia|
[tkyte@desktop tkyte]$
```

## Embedded Newlines Wrap-up

We explored at least four ways to load data with embedded newlines in this section. In the upcoming section titled “Flat File Unload,” we will use one of these techniques, the STR attribute, in a generic unload utility to avoid issues with regard to newlines in text.

Additionally, one thing to be very aware of—and I’ve mentioned it previously a couple of times—is that in Windows (all flavors), text files may end in `\r\n` (ASCII 13 + ASCII 10, carriage return/linefeed). Your control file will have to accommodate this: that `\r` is part of the record. The byte counts in the FIX and VAR, and the string used with STR must accommodate this. For example, if you took any of the previous .dat files that currently contain just `\n` in them and FTP-ed them to Windows using an ASCII transfer (the default), every `\n` would turn into `\r\n`. The same control file that just worked in UNIX/Linux would not be able to load the data anymore. This is something you must be aware of and take into consideration when setting up the control file.

## How Do I Load LOBs?

We will now consider some methods for loading into LOBs. This is not a LONG or LONG RAW field, but rather the preferred datatypes of BLOB and CLOB. These datatypes were introduced in Oracle 8.0 and later, and they support a much richer interface/set of functionality than the legacy LONG and LONG RAW types, as discussed in Chapter 12.

We will investigate two methods for loading these fields: SQLLDR and PL/SQL. Others exist, such as Java streams, Pro\*C, and OCI. We will begin working with the PL/SQL method of loading LOBs, and then we’ll look at using SQLLDR to load them as well.

## Loading a LOB via PL/SQL

The DBMS\_LOB package has entry points called LoadFromFile, LoadBLOBFromFile, and LoadCLOBFromFile. These procedures allow us to use a BFILE (which can be used to read operating system files) to populate a BLOB or CLOB in the database. There is not a significant difference between the LoadFromFile and LoadBLOBFromFile routines, other than the latter returns OUT parameters that indicate how far into the BLOB column we have loaded data. The LoadCLOBFromFile routine, however, provides a significant feature: character set conversion. If you recall, in Chapter 12 we discussed some of the National Language Support (NLS) features of the Oracle database and the importance of character sets. LoadCLOBFromFile allows us to tell the database that the file it is about to load is in a character set different from the one the database is using, and that it should perform the required character set conversion. For example, you may have a UTF8-compatible database, but the files received to be loaded are encoded in the WE8ISO8859P1 character set, or vice versa. This function allows you to successfully load these files.

---

■ **Note** For complete details on the procedures available in the DBMS\_LOB package and their full set of inputs and outputs, please refer to the *Oracle PL/SQL Packages and Types Reference*.

---

To use these procedures, we will need to create a DIRECTORY object in the database. This object will allow us to create BFILES (and open them) that point to a file existing on the file system that the database server has access to. This last phrase, “that the database server has access to,” is a key point when using PL/SQL to load LOBs. The DBMS\_LOB package executes entirely in the server. It can see only the file systems the server can see. It cannot, in particular, see your local file system if you are accessing Oracle over the network.

So we need to begin by creating a DIRECTORY object in the database. This is a straightforward process. We will create two directories for this example (note that these examples are executed in a UNIX/Linux environment; you will use the syntax for referring to directories that is appropriate for your operating system):

```
EODA@ORA12CR1> create or replace directory dir1 as '/tmp/';
Directory created.
```

```
EODA@ORA12CR1> create or replace directory "dir2" as '/tmp/';
Directory created.
```

---

■ **Note** Oracle DIRECTORY objects are logical directories, meaning they are pointers to existing, physical directories in your operating system. The CREATE DIRECTORY command *does not* actually create a directory in the file system—you must perform that operation separately.

---

The user who performs this operation needs to have the CREATE ANY DIRECTORY privilege. The reason we create two directories is to demonstrate a common case-related (“case” as in uppercase versus lowercase characters) issue with regard to DIRECTORY objects. When Oracle created the first directory DIR1, it stored the object name DIR1 in *uppercase* as it is the default. In the second example with dir2, it will have created the DIRECTORY object preserving the case we used in the name. The importance of this will be demonstrated shortly when we use the BFILE object.

Now, we want to load some data into either a BLOB or a CLOB. The method for doing so is rather easy, for example:

```
EODA@ORA12CR1> create table demo
 2 ( id          int primary key,
 3   theClob     clob
 4 )
 5 /
```

Table created.

```
EODA@ORA12CR1> host echo 'Hello World!' > /tmp/test.txt
```

```
EODA@ORA12CR1> declare
 2   l_clob     clob;
 3   l_bfile    bfile;
 4   begin
 5     insert into demo values ( 1, empty_clob() )
 6     returning theclob into l_clob;
 7
 8     l_bfile := bfilename( 'DIR1', 'test.txt' );
 9     dbms_lob.fileopen( l_bfile );
10
11     dbms_lob.loadfromfile( l_clob, l_bfile,
12                           dbms_lob.getlength( l_bfile ) );
13
14     dbms_lob.fileclose( l_bfile );
15 end;
16 /
```

PL/SQL procedure successfully completed.

```
EODA@ORA12CR1> select dbms_lob.getlength(theClob), theClob from demo
 2 /
DBMS_LOB.GETLENGTH(THECLOB) THECLOB
-----
13 Hello World!
```

Walking through the preceding code we see:

- On lines 5 and 6, we create a row in our table, set the CLOB to an `EMPTY_CLOB()`, and retrieve its value in one call. With the exception of temporary LOBs, LOBs live in the database—we cannot write to a LOB variable without having a pointer to either a temporary LOB or a LOB that is already in the database. An `EMPTY_CLOB()` is not a `NULL CLOB`; it is a valid non-`NULL` pointer to an empty structure. The other thing this did for us was to get a LOB locator, which points to data in a row that is locked. If we were to have selected this value out without locking the underlying row, our attempts to write to it would fail because LOBs must be locked prior to writing (unlike other structured data). By inserting the row, we have, of course, locked the row. If we were modifying an existing row instead of inserting, we would have used `SELECT FOR UPDATE` to retrieve and lock the row.
- On line 8, we create a `BFILE` object. Note how we use `DIR1` in uppercase—this is key, as we will see in a moment. This is because we are passing to `BFILENAME()` the *name* of an object, not the object itself. Therefore, we must ensure the name matches the case Oracle has stored for this object.

- On line 9, we open the LOB. This will allow us to read it.
- On lines 11 and 12, we load the entire contents of the operating system file /tmp/test.txt into the LOB locator we just inserted. We use DBMS\_LOB.GETLENGTH() to tell the LOADFROMFILE() routine how many bytes of the BFILE to load (all of them).
- Lastly, on line 14, we close the BFILE we opened, and the CLOB is loaded.

If we had attempted to use dir1 instead of DIR1 in the preceding example, we would have encountered the following error:

```
EODA@ORA12CR1> declare
...
6     returning theclob into l_clob;
7
8     l_bfile := bfilename( 'dir1', 'test.txt' );
9     dbms_lob.fileopen( l_bfile );
...
15 end;
16 /
declare
*
ERROR at line 1:
ORA-22285: non-existent directory or file for FILEOPEN operation
ORA-06512: at "SYS.DBMS_LOB", line 523
ORA-06512: at line 9
```

This is because the directory dir1 does not exist—DIR1 does. If you prefer to use directory names in mixed case, you should use quoted identifiers when creating them as we did for dir2. This will allow you to write code as shown here:

```
EODA@ORA12CR1> declare
2     l_clob   clob;
3     l_bfile  bfile;
4 begin
5     insert into demo values ( 1, empty_clob() )
6     returning theclob into l_clob;
7
8     l_bfile := bfilename( 'dir2', 'test.txt' );
9     dbms_lob.fileopen( l_bfile );
10
11    dbms_lob.loadfromfile( l_clob, l_bfile,
12                          dbms_lob.getlength( l_bfile ) );
13
14    dbms_lob.fileclose( l_bfile );
15 end;
16 /
PL/SQL procedure successfully completed.
```



I mentioned earlier in this section that `LoadCLOBFromFile` allows us to tell the database that the file it is about to load is in a character set different from the one the database is using, and that it should perform the required character set conversion. If you run the prior examples and get this for your output:

```
DBMS_LOB.GETLENGTH(THECLOB) THECLOB
-----
                6 ??????
```

then you most likely are running into a character set mismatch between your database and the encoding used for the file. This next example uses the `LoadCLOBFromFile` to account for a file encoded in `WE8ISO8859P1`:

```
EODA@ORA12CR1> declare
  2  l_clob    clob;
  3  l_bfile   bfile;
  4  dest_offset integer := 1;
  5  src_offset integer := 1;
  6  src_csid  number    := NLS_CHARSET_ID('WE8ISO8859P1');
  7  lang_context integer := dbms_lob.default_lang_ctx;
  8  warning  integer;
  9  begin
 10  insert into demo values ( 1, empty_clob() )
 11  returning theclob into l_clob;
 12  l_bfile := bfilename( 'dir2', 'test.txt' );
 13  dbms_lob.fileopen( l_bfile );
 14  dbms_lob.loadclobfromfile( l_clob, l_bfile, dbms_lob.getlength( l_bfile ), dest_offset,
src_offset,
                src_csid, lang_context,warning );
 15  dbms_lob.fileclose( l_bfile );
 16  end;
 17 /
```

PL/SQL procedure successfully completed.

Now selecting from the table we see this in the output:

```
EODA@ORA12CR1> select dbms_lob.getlength(theClob), theClob from demo;
DBMS_LOB.GETLENGTH(THECLOB) THECLOB
-----
                13 Hello World!
```

There are methods other than the load from file routines by which you can populate a LOB using PL/SQL. Using `DBMS_LOB` and its supplied routines is by far the easiest if you are going to load the entire file. If you need to process the contents of the file while loading it, you may also use `DBMS_LOB.READ` on the `BFILE` to read the data. The use of `UTL_RAW.CAST_TO_VARCHAR2` is handy here if the data you are reading is text, not `RAW`. You may then use `DBMS_LOB.WRITE` or `WRITEAPPEND` to place the data into a CLOB or BLOB.

## Loading LOB Data via SQLLDR

We will now investigate how to load data into a LOB via SQLLDR. There is more than one method for doing this, but we will investigate the two most common:

- When the data is inline with the rest of the data.
- When the data is stored out of line, and the input data contains a file name to be loaded with the row. These are also known as *secondary data files* (SDFs) in SQLLDR terminology.

We will start with data that is inline.

### Loading LOB Data That Is Inline

These LOBs will typically have newlines and other special characters embedded in them. Therefore, you will almost always use one of the four methods detailed in the “How Do I Load Data with Embedded Newlines?” section to load this data. Let’s begin by modifying the DEPT table to have a CLOB instead of a big VARCHAR2 field for the COMMENTS column:

```
EODA@ORA12CR1> truncate table dept;
Table truncated.
```

```
EODA@ORA12CR1> alter table dept drop column comments;
Table altered.
```

```
EODA@ORA12CR1> alter table dept add comments clob;
Table altered.
```

For example, say we have a data file (demo.dat) that has the following contents:

```
10, Sales, Virginia, This is the Sales
Office in Virginia|
20, Accounting, Virginia, This is the Accounting
Office in Virginia|
30, Consulting, Virginia, This is the Consulting
Office in Virginia|
40, Finance, Virginia, "This is the Finance
Office in Virginia, it has embedded commas and is
much longer than the other comments field. If you
feel the need to add double quoted text in here like
this: ""You will need to double up those quotes!"" to
preserve them in the string. This field keeps going for up to
1000000 bytes (because of the control file definition I used)
or until we hit the magic end of record marker,
the | followed by an end of line - it is right here ->|
```

Each record ends with a pipe symbol (|), followed by the end-of-line marker. The text for department 40 is much longer than the rest, with many newlines, embedded quotes, and commas. Given this data file, we can create a control file such as this:

```
LOAD DATA
INFILE demo.dat "str X'7COA'"
INTO TABLE DEPT
REPLACE
FIELDS TERMINATED BY ',' OPTIONALLY ENCLOSED BY '''
```

## TRAILING NULLCOLS

```
(DEPTNO,
  DNAME      "upper(:dname)",
  LOC        "upper(:loc)",
  COMMENTS   char(1000000)
)
```

---

■ **Note** This example is from UNIX/Linux, where the end-of-line marker is 1 byte, hence the STR setting in the preceding control file. On Windows, it would have to be '7C0D0A'.

---

To load the data file, we specify CHAR(1000000) on column COMMENTS since SQLLDR defaults to CHAR(255) for any input field as discussed previously. The CHAR(1000000) will allow SQLLDR to handle up to 1,000,000 bytes of input text. You must set this to a value that is larger than any expected chunk of text in the input file. Reviewing the loaded data, we see the following:

```
EODA@ORA12CR1> select comments from dept;
```

```
COMMENTS
```

```
-----
This is the Consulting
Office in Virginia
This is the Finance
Office in Virginia, it has embedded commas and is
much longer than the other comments field. If you
feel the need to add double quoted text in here like
this: "You will need to double up those quotes!" to
preserve them in the string. This field keeps going for up to
1000000 bytes or until we hit the magic end of record marker,
the | followed by an end of line - it is right here ->
```

```
This is the Sales
Office in Virginia
```

```
This is the Accounting
Office in Virginia
```

The one thing to observe here is that the doubled-up quotes are no longer doubled up. SQLLDR removed the extra quotes we placed there.

## Loading LOB Data That Is Out of Line

A common scenario is to have a data file that contains the names of files to load into the LOBs, instead of having the LOB data mixed in with the structured data. This offers a greater degree of flexibility, as the data file given to SQLLDR does not have to use one of the four methods to get around having embedded newlines in the input data, as would frequently happen with large amounts of text or binary data. SQLLDR calls this type of additional data file a LOBFILE.

SQLLDR can also support the loading of a structured data file that points to another, single data file. We can tell SQLLDR how to parse LOB data from this other file, so that each row in the structured data gets loaded with a piece of it. I find this mode to be of limited use (in fact, I've never found a use for it to date), and I will not discuss it here. SQLLDR refers to these externally referenced files as *complex secondary data files*.

LOBFILES are relatively simple data files aimed at facilitating LOB loading. The attribute that distinguishes LOBFILES from the main data files is that in LOBFILES, there is no concept of a record, hence *newlines never get in the way*. In LOBFILES, the data is in any of the following formats:

- Fixed-length fields (e.g., load bytes 100 through 1000 from the LOBFILE)
- Delimited fields (terminated by something or enclosed by something)
- Length/value pairs, a variable-length field

The most common of these types is the delimited fields—ones that are terminated by an end-of-file (EOF), in fact. Typically, you have a directory full of files you would like to load into LOB columns, and each file in its entirety will go into a BLOB. The LOBFILE statement with TERMINATED BY EOF is what you will use.

So, let's say we have a directory full of files we would like to load into the database. We would like to load the OWNER of the file, the TIME\_STAMP of the file, the NAME of the file, and the file itself. The table we would load into would be created as follows:

```
EODA@ORA12CR1> create table lob_demo
 2 ( owner      varchar2(255),
 3   time_stamp date,
 4   filename   varchar2(255),
 5   data       blob
 6 )
 7 /
```

Table created.

Using a simple `ls -l` on UNIX/Linux, and `dir /q /n` on Windows, and capturing that output, we can generate our input file and load it using a control file such as this on UNIX/Linux:

```
LOAD DATA
INFILE *
REPLACE
INTO TABLE LOB_DEMO
( owner      position(14:19),
  time_stamp position(31:42) date "Mon DD HH24:MI",
  filename   position(44:100),
  data       LOBFILE(filename) TERMINATED BY EOF
)
BEGINDATA
-rwxr-xr-x 1 oracle dba 14889 Jul 22 22:01 demo1.log_xt
-rwxr-xr-x 1 oracle dba  123 Jul 22 20:07 demo2.ctl
-rwxr-xr-x 1 oracle dba  712 Jul 23 12:11 demo.bad
-rwxr-xr-x 1 oracle dba 8136 Mar  9 12:36 demo.control_files
-rwxr-xr-x 1 oracle dba  825 Jul 23 12:26 demo.ctl
-rwxr-xr-x 1 oracle dba 1681 Jul 23 12:26 demo.log
-rw-r----- 1 oracle dba  118 Jul 23 12:52 dl.sql
-rwxr-xr-x 1 oracle dba  127 Jul 23 12:05 lob_demo.sql
-rwxr-xr-x 1 oracle dba  171 Mar 10 13:53 p.bsh
-rwxr-xr-x 1 oracle dba  327 Mar 10 11:10 prime.bsh
-rwxr-xr-x 1 oracle dba   24 Mar  6 12:09 run_df.sh
```

Now, if we inspect the contents of the LOB\_DEMO table after running SQLLDR, we will discover the following:

```
EODA@ORA12CR1> select owner, time_stamp, filename, dbms_lob.getlength(data)
 2  from lob_demo
 3  /
```

OWNER	TIME_STAM	FILENAME	DBMS_LOB.GETLENGTH(DATA)
oracle	22-JUL-14	demo1.log_xt	14889
oracle	22-JUL-14	demo2ctl	123
oracle	23-JUL-14	demo.bad	712
oracle	09-MAR-14	demo.control_files	8136
oracle	23-JUL-14	demo.ctl	825
oracle	23-JUL-14	demo.log	0
oracle	23-JUL-14	dl.sql	118
oracle	23-JUL-14	lob_demo.sql	127
oracle	10-MAR-14	p.bsh	171
oracle	10-MAR-14	prime.bsh	327
oracle	06-MAR-14	run_df.sh	24

11 rows selected.

---

■ **Note** You might ask, “Why is the size of demo.log apparently 0?” During the running of SQLLDR it would open the demo.log file for writing, which would zero out the length of that file and reset that file. So while loading the demo.log file, it was empty.

---

This works with CLOBs as well as BLOBs. Loading a directory of text files using SQLLDR in this fashion is easy.

## Loading LOB Data into Object Columns

Now that we know how to load into a simple table we have created ourselves, we might also find the need to load into a table that has a complex object type with a LOB in it. This happens most frequently when using the image capabilities. The image capabilities are implemented using a complex object type, ORDSYS.ORDIMAGE. We need to be able to tell SQLLDR how to load into this.

To load a LOB into an ORDIMAGE type column, we must understand a little more about the structure of the ORDIMAGE type. Using a table we want to load into, and a DESCRIBE on that table in SQL\*Plus, we discover that we have a column called IMAGE of type ORDSYS.ORDIMAGE, which we want to ultimately load into IMAGE.SOURCE.LOCALDATA. The following examples will work only if you have Oracle Text installed and configured; otherwise, the datatype ORDSYS.ORDIMAGE will be an unknown type:

```
EODA@ORA12CR1> create table image_load(
 2  id number,
 3  name varchar2(255),
 4  image ordsys.ordimage
 5  )
 6  /
```

Table created.

```
EODA@ORA12CR1> desc image_load
```

Name	Null?	Type
-----	-----	-----
ID		NUMBER
NAME		VARCHAR2(255)
IMAGE		ORDSYS.ORDIMAGE

```
EODA@ORA12CR1> desc ordsys.ordimage
```

Name	Null?	Type
-----	-----	-----
SOURCE		ORDSYS.ORDSOURCE
HEIGHT		NUMBER(38)
WIDTH		NUMBER(38)
CONTENTLENGTH		NUMBER(38)
FILEFORMAT		VARCHAR2(4000)
...		

```
EODA@ORA12CR1> desc ordsys.ordsource
```

Name	Null?	Type
-----	-----	-----
LOCALDATA		BLOB
SRCTYPE		VARCHAR2(4000)
SRCLOCATION		VARCHAR2(4000)
SRCNAME		VARCHAR2(4000)
UPDATETIME		DATE
...		

---

■ **Note** You could issue `SET DESC DEPTH ALL` or `SET DESC DEPTH <n>` in SQL\*Plus to have the entire hierarchy displayed at once. Given that the output from describing the `ORDSYS.ORDIMAGE` type would have been many pages long, I chose to do it piece by piece.

---

So a control file to load this might look like this:

```
LOAD DATA
INFILE *
INTO TABLE image_load
REPLACE
FIELDS TERMINATED BY ','
(
  ID,
  NAME,
  file_name FILLER,
  IMAGE column object
  (
    SOURCE column object
    (
      LOCALDATA LOBFILE (file_name) TERMINATED BY EOF
      NULLIF file_name = 'NONE'
    )
  )
)
)
BEGINDATA
1,icons,icons.gif
```

I have introduced two new constructs here:

- **COLUMN OBJECT**: This tells SQLLDR that this is not a column name; rather, it is part of a column name. It is not mapped to a field in the input file, but is used to build the correct object column reference to be used during the load. In the preceding file, we have two column object tags, one nested inside the other. Therefore, the column name that will be used is `IMAGE.SOURCE.LOCALDATA`, as we need it to be. Note that we are not loading any of the other attributes of these two object types (e.g., `IMAGE.HEIGHT`, `IMAGE.CONTENTLENGTH`, and `IMAGE.SOURCE.SRCTYPE`). We'll shortly see how to get those populated.
- `NULLIF FILE_NAME = 'NONE'`: This tells SQLLDR to load a NULL into the object column in the event that the field `FILE_NAME` contains the word `NONE` in it.

Once you have loaded an Oracle Text type, you will typically need to postprocess the loaded data using PL/SQL to have Oracle Text operate on it. For example, with the preceding data, you would probably want to run the following to have the properties for the image set up correctly:

```
begin
  for c in ( select * from image_load ) loop
    c.image.setproperties;
  end loop;
end;
/
```

`SETPROPERTIES` is an object method provided by the `ORDSYS.ORDIMAGE` type, which processes the image itself and updates the remaining attributes of the object with appropriate values.

## How Do I Call SQLLDR from a Stored Procedure?

The short answer is that you cannot do this. SQLLDR is not an API; it is not something that is callable. SQLLDR is a command-line program. You can definitely write an external procedure in Java or C that runs SQLLDR, but that won't be the same as "calling" SQLLDR. The load will happen in another session, and it will not be subject to your transaction control. Additionally, you will have to parse the resulting log file to determine if the load was successful or not, and how successful (i.e., how many rows got loaded before an error terminated the load) it may have been. Invoking SQLLDR from a stored procedure is not something I recommend doing.

In the past, before Oracle9i, you might have implemented your own SQLLDR-like process. For example, the options could have been as follows:

- Write a mini-SQLLDR in PL/SQL. It can use either BFILES to read binary data or UTL\_FILE to read text data to parse and load.
- Write a mini-SQLLDR in Java. This can be a little more sophisticated than a PL/SQL-based loader and can make use of the many available Java routines.
- Write a SQLLDR in C, and call it as an external procedure.

I'd like to finish up the topic of SQLLDR by discussing a few topics that are not immediately intuitive.

## SQLLDR Caveats

In this section, we will discuss some things to have to watch out for when using SQLLDR.

### TRUNCATE Appears to Work Differently

The TRUNCATE option of SQLLDR might appear to work differently than TRUNCATE does in SQL\*Plus, or any other tool. SQLLDR, working on the assumption you will be reloading the table with a similar amount of data, uses the extended form of TRUNCATE. Specifically, it issues the following:

```
truncate table t reuse storage
```

The REUSE STORAGE option does not release allocated extents—it just marks them as free space. If this were not the desired outcome, you would truncate the table prior to executing SQLLDR.

### SQLLDR Defaults to CHAR(255)

This issue comes up so often, I've decided to talk about it twice in this chapter. The default length of input fields is 255 characters. If your field is longer than this, you will receive an error message:

```
Record N: Rejected - Error on table T, column C.
Field in data file exceeds maximum length
```

This does not mean the data will not fit into the database column; rather, it indicates that SQLLDR was expecting 255 bytes or less of input data, and it received somewhat more than that. The solution is to simply use CHAR(N) in the control file, where N is big enough to accommodate the largest field length in the input file. Refer to the very first item in the earlier section "Loading Data with SQLLDR FAQs" for an example.



## Command Line Overrides Control File

Many of the SQLLDR options may be either placed in the control file or used on the command line. For example, I can use `INFILE FILENAME` as well as `SQLLDR ... DATA=FILENAME`. The command line overrides any options in the control file. You cannot count on the options in a control file actually being used, as the person executing SQLLDR can override them.

## SQLLDR Summary

In this section, we explored many areas of loading data. We covered the typical, everyday issues we will encounter: loading delimited files, loading fixed-length files, loading a directory full of image files, using functions on input data to transform the input, and so on. We did not cover massive data loads using the direct path loader in any detail; rather, we touched lightly on that subject. Our goal was to answer the questions that arise frequently with the use of SQLLDR and that affect the broadest audience.

## Flat File Unload

One thing SQLLDR does not do, and that Oracle supplies no command-line tools for, is unloading data in a format understandable by SQLLDR or other programs. This would be useful for moving data from system to system without using Data Pump EXPDP/IMPDP. Using EXPDP/IMPDP to move data from system to system works fine for moderate amounts of data—as long as both systems are Oracle.

---

■ **Note** APEX provides a data export feature as part of its SQL Workshop as does SQL Developer. You may export the information in a CSV format easily. This works well for a few megabytes of information, but it is not appropriate for many tens of megabytes or more.

---

We will develop a small PL/SQL utility that may be used to unload data on a server in a SQLLDR-friendly format. Also, equivalent tools for doing so in Pro\*C and SQL\*Plus are provided on the Ask Tom web site at <http://tkyte.blogspot.com/2009/10/httpasktomoraclecomtkyteflat.html>. The PL/SQL utility will work fine in most small cases, but better performance will be had using Pro\*C. Note that Pro\*C and SQL\*Plus are also useful if you need the files to be generated on the client and not on the server, which is where PL/SQL will create them.

The specification of the package we will create is as follows:

```

EODA@ORA12CR1> create or replace package unloader
 2 AUTHID CURRENT_USER
 3 as
 4 /* Function run -- unloads data from any query into a file
 5    and creates a control file to reload that
 6    data into another table
 7
 8    p_query      = SQL query to "unload". May be virtually any query.
 9    p_tname      = Table to load into. Will be put into control file.
10    p_mode       = REPLACE|APPEND|TRUNCATE -- how to reload the data
11    p_dir        = directory we will write the ctl and dat file to.
12    p_filename   = name of file to write to. I will add .ctl and .dat
13                  to this name
14    p_separator  = field delimiter. I default this to a comma.
15    p_enclosure  = what each field will be wrapped in
16    p_terminator = end of line character. We use this so we can unload
17                  and reload data with newlines in it. I default to
18                  "|\\n" (a pipe and a newline together) and "\\r\\n" on NT.
19                  You need only to override this if you believe your
20                  data will have that default sequence of characters in it.
21                  I ALWAYS add the OS "end of line" marker to this sequence, you should not
22 */
23 function run( p_query      in varchar2,
24              p_tname      in varchar2,
25              p_mode       in varchar2 default 'REPLACE',
26              p_dir        in varchar2,
27              p_filename   in varchar2,
28              p_separator  in varchar2 default ',',
29              p_enclosure  in varchar2 default '"',
30              p_terminator in varchar2 default '|' )
31 return number;
32 end;
33 /
Package created.

```

Note the use of AUTHID CURRENT\_USER. This permits this package to be installed *once* in a database and used by anyone to unload data. All the person needs is SELECT privileges on the table(s) he wants to unload and EXECUTE privileges on this package. If we did not use AUTHID CURRENT\_USER in this case, then the owner of this package would need direct SELECT privileges on all tables to be unloaded. Additionally, since this routine would be completely subject to “SQL Injection” attacks (it takes an arbitrary SQL statement as input), the CREATE statement must specify AUTHID CURRENT\_USER. If it was a default definer’s rights routine, anyone with EXECUTE on it would be able to execute *any* SQL statement using the owner’s permissions. If you know a routine is SQL injectable, it had better be an invoker’s rights routine!

---

■ **Note** The SQL will execute with the privileges of the invoker of this routine. However, all PL/SQL calls will run with the privileges of the *definer* of the called routine; therefore, the ability to use UTL\_FILE to write to a directory is implicitly given to anyone with execute permission on this package.

---

The package body follows. We use UTL\_FILE to write a control file and a data file. DBMS\_SQL is used to dynamically process any query. We use one datatype in our queries: a VARCHAR2(4000). This implies we cannot use this method to unload LOBs, and that is true if the LOB is greater than 4,000 bytes. We can, however, use this to unload up to 4,000 bytes of any LOB using SUBSTR. Additionally, since we are using a VARCHAR2 as the only output data type, we can handle RAWs up to 2,000 bytes in length (4,000 hexadecimal characters), which is sufficient for everything except LONG RAWs and LOBs. Additionally, any query that references a nonscalar attribute (a complex object type, nested table, and so on) will not work with this simple implementation. The following is a 90 percent solution, meaning it solves the problem 90 percent of the time:

```
EODA@ORA12CR1> create or replace package body unloader
 2  as
 3
 4
 5  g_theCursor      integer default dbms_sql.open_cursor;
 6  g_descTbl        dbms_sql.desc_tab;
 7  g_nl             varchar2(2) default chr(10);
 8
```

These are some global variables used in this package body. The global cursor is opened once, the first time we reference this package, and it will stay open until we log out. This avoids the overhead of getting a new cursor every time we call this package. The G\_DESCRIBL is a PL/SQL table that will hold the output of a DBMS\_SQL.DESCRIBE call. G\_NL is a newline character. We use this in strings that need to have newlines embedded in them. We do not need to adjust this for Windows—UTL\_FILE will see the CHR(10) in the string of characters and automatically turn that into a carriage return/linefeed for us.

Next, we have a small convenience function used to convert a character to hexadecimal. It uses the built-in functions to do this:

```
 9
10 function to_hex( p_str in varchar2 ) return varchar2
11 is
12 begin
13     return to_char( ascii(p_str), 'fm0x' );
14 end;
15
```

Finally, we create one more convenience function, IS\_WINDOWS, that returns TRUE or FALSE depending on if we are on the Windows platform, and therefore the end of line is a two-character string instead of the single character it is on most other platforms. We are using the built-in DBMS\_UTILITY function, GET\_PARAMETER\_VALUE, which can be used to read most any parameter. We retrieve the CONTROL\_FILES parameter and look for the existence of a \ in it—if we find one, we are on Windows:

```
16 function is_windows return boolean
17 is
18     l_cfiles varchar2(4000);
19     l_dummy  number;
20 begin
21     if (dbms_utility.get_parameter_value( 'control_files', l_dummy, l_cfiles )>0)
22     then
23         return instr( l_cfiles, '\' ) > 0;
24     else
25         return FALSE;
26     end if;
27 end;
```

■ **Note** The `IS_WINDOWS` function does rely on you using the `\` in your `CONTROL_FILES` parameter. Be aware that you may use `/`, but it would be highly unusual.

The following is a procedure to create a control file to reload the unloaded data, using the `DESCRIBE` table generated by `DBMS_SQL.DESCRIBE_COLUMNS`. It takes care of the operating system specifics for us, such as whether the operating system uses a carriage return/linefeed (this is used for the `STR` attribute):

```

28
29 procedure dump_ctl( p_dir          in varchar2,
30                   p_filename     in varchar2,
31                   p_tname        in varchar2,
32                   p_mode         in varchar2,
33                   p_separator    in varchar2,
34                   p_enclosure    in varchar2,
35                   p_terminator   in varchar2 )
36 is
37     l_output      utl_file.file_type;
38     l_sep         varchar2(5);
39     l_str         varchar2(5) := chr(10);
40
41 begin
42     if ( is_windows )
43     then
44         l_str := chr(13) || chr(10);
45     end if;
46
47     l_output := utl_file.fopen( p_dir, p_filename || '.ctl', 'w' );
48
49     utl_file.put_line( l_output, 'load data' );
50     utl_file.put_line( l_output, 'infile ''' ||
51                       p_filename || '.dat''' "str x''' ||
52                       utl_raw.cast_to_raw( p_terminator ||
53                       l_str ) || '''' );
54     utl_file.put_line( l_output, 'into table ' || p_tname );
55     utl_file.put_line( l_output, p_mode );
56     utl_file.put_line( l_output, 'fields terminated by X''' ||
57                       to_hex(p_separator) ||
58                       ''' enclosed by X''' ||
59                       to_hex(p_enclosure) || ''' ' );
60     utl_file.put_line( l_output, '(' );
61
62     for i in 1 .. g_descTbl.count
63     loop
64         if ( g_descTbl(i).col_type = 12 )
65         then
66             utl_file.put( l_output, l_sep || g_descTbl(i).col_name ||
67                           ' date ''ddmmyyyyhh24miss'' ');
68         else

```

```

69         utl_file.put( l_output, l_sep || g_descTbl(i).col_name ||
70                     ' char(' ||
71                     to_char(g_descTbl(i).col_max_len*2) || ' )' );
72     end if;
73     l_sep := ','||g_nl ;
74 end loop;
75 utl_file.put_line( l_output, g_nl || ' )' );
76 utl_file.fclose( l_output );
77 end;
78

```

Here is a simple function to return a quoted string using the chosen enclosure character. Notice how it not only encloses the character, but also doubles up the enclosure character if it exists in the string as well, so that they are preserved:

```

79 function quote(p_str in varchar2, p_enclosure in varchar2)
80     return varchar2
81 is
82 begin
83     return p_enclosure ||
84         replace( p_str, p_enclosure, p_enclosure||p_enclosure ) ||
85         p_enclosure;
86 end;
87

```

Next we have the main function, RUN. As it is fairly large, I'll comment on it as we go along:

```

88 function run( p_query      in varchar2,
89             p_tname       in varchar2,
90             p_mode        in varchar2 default 'REPLACE',
91             p_dir         in varchar2,
92             p_filename    in varchar2,
93             p_separator   in varchar2 default ',',
94             p_enclosure   in varchar2 default '"',
95             p_terminator  in varchar2 default '|' ) return number
96 is
97     l_output      utl_file.file_type;
98     l_columnValue varchar2(4000);
99     l_colCnt      number default 0;
100    l_separator    varchar2(10) default '';
101    l_cnt          number default 0;
102    l_line         long;
103    l_datefmt      varchar2(255);
104    l_descTbl      dbms_sql.desc_tab;
105 begin

```

We will save the NLS\_DATE\_FORMAT into a variable so we can change it to a format that preserves the date and time when dumping the data to disk. In this fashion, we will preserve the time component of a date. We then set up an exception block so that we can reset the NLS\_DATE\_FORMAT upon any error:

```

106     select value
107         into l_datefmt
108         from nls_session_parameters
109         where parameter = 'NLS_DATE_FORMAT';
110
111     /*
112         Set the date format to a big numeric string. Avoids
113         all NLS issues and saves both the time and date.
114     */
115     execute immediate
116         'alter session set nls_date_format='''ddmmyyyyhh24miss''' ';
117
118     /*
119         Set up an exception block so that in the event of any
120         error, we can at least reset the date format.
121     */
122     begin

```

Next we will parse and describe the query. The setting of G\_DESC\_TBL to L\_DESC\_TBL is done to reset the global table; otherwise, it might contain data from a previous DESCRIBE in addition to data for the current query. Once we have done that, we call DUMP\_CTL to actually create the control file:

```

123     /*
124         Parse and describe the query. We reset the
125         descTbl to an empty table so .count on it
126         will be reliable.
127     */
128     dbms_sql.parse( g_theCursor, p_query, dbms_sql.native );
129     g_descTbl := l_descTbl;
130     dbms_sql.describe_columns( g_theCursor, l_colCnt, g_descTbl );
131
132     /*
133         Create a control file to reload this data
134         into the desired table.
135     */
136     dump_ctl( p_dir, p_filename, p_tname, p_mode, p_separator,
137              p_enclosure, p_terminator );
138
139     /*
140         Bind every single column to a varchar2(4000). We don't care
141         if we are fetching a number or a date or whatever.
142         Everything can be a string.
143     */

```

We are ready to dump the actual data out to disk. We begin by defining every column to be a VARCHAR2(4000) for fetching into. All NUMBERS, DATES, RAWs—every type will be converted into VARCHAR2. Immediately after this, we execute the query to prepare for the fetching phase:

```

144     for i in 1 .. l_colCnt loop
145         dbms_sql.define_column( g_theCursor, i, l_columnValue, 4000);
146     end loop;
147
148     /*
149     Run the query - ignore the output of execute. It is only
150     valid when the DML is an insert/update or delete.
151     */

```

Now we open the data file for writing, fetch all of the rows from the query, and print it out to the data file:

```

152     l_cnt := dbms_sql.execute(g_theCursor);
153
154     /*
155     Open the file to write output to and then write the
156     delimited data to it.
157     */
158     l_output := utl_file.fopen( p_dir, p_filename || '.dat', 'w',
159                               32760 );
160     loop
161         exit when ( dbms_sql.fetch_rows(g_theCursor) <= 0 );
162         l_separator := ',';
163         l_line := null;
164         for i in 1 .. l_colCnt loop
165             dbms_sql.column_value( g_theCursor, i,
166                                   l_columnValue );
167             l_line := l_line || l_separator ||
168                     quote( l_columnValue, p_enclosure );
169             l_separator := p_separator;
170         end loop;
171         l_line := l_line || p_terminator;
172         utl_file.put_line( l_output, l_line );
173         l_cnt := l_cnt+1;
174     end loop;
175     utl_file.fclose( l_output );
176

```

Lastly, we set the date format back (and the exception block will do the same if any of the preceding code fails for any reason) to what it was and return:

```

177      /*
178      Now reset the date format and return the number of rows
179      written to the output file.
180      */
181      execute immediate
182      'alter session set nls_date_format='' || l_datefmt || ''';
183      return l_cnt;
184  exception
185      /*
186      In the event of ANY error, reset the date format and
187      re-raise the error.
188      */
189      when others then
190      execute immediate
191      'alter session set nls_date_format='' || l_datefmt || ''';
192      RAISE;
193  end;
194  end run;
195
196
197  end unloader;
198  /
Package body created.

```

To run this, we can simply use the following (note that the following does, of course, require that you have SELECT on SCOTT.EMP granted to one of your roles or to yourself directly):

```

EODA@ORA12CR1> set serveroutput on

EODA@ORA12CR1> create or replace directory my_dir as '/tmp';
Directory created.

EODA@ORA12CR1> declare
2     l_rows    number;
3  begin
4     l_rows := unloader.run
5         ( p_query    => 'select * from scott.emp order by empno',
6           p_tname    => 'emp',
7           p_mode     => 'replace',
8           p_dir      => 'MY_DIR',
9           p_filename => 'emp',
10          p_separator => ',',
11          p_enclosure => '',
12          p_terminator => '~' );
13
14     dbms_output.put_line( to_char(l_rows) ||
15                           ' rows extracted to ascii file' );
16  end;
17  /
14 rows extracted to ascii file
PL/SQL procedure successfully completed.

```



The control file that was generated by this shows the following (note that the numbers in parentheses in **bold** on the right are not actually in the file; they are solely for reference purposes):

```
load data                                (1)
infile 'emp.dat' "str x'7EOA'"          (2)
into table emp                           (3)
replace                                  (4)
fields terminated by X'2c' enclosed by X'22' (5)
((6)
EMPNO char(44),                          (7)
ENAME char(20),                           (8)
JOB char(18),                              (9)
MGR char(44),                             (10)
HIREDATE date 'ddmmyyyyhh24miss' ,        (11)
SAL char(44),                             (12)
COMM char(44),                            (13)
DEPTNO char(44),                          (14)
)(15)
```

The things to note about this control file are as follows:

- Line (2): We use the STR feature of SQL\*Loader. We can specify what character or string is used to terminate a record. This allows us to load data with embedded newlines easily. The string `x'7EOA'` is simply a tilde followed by a newline.
- Line (5): We use our separator character and enclosure character. We do not use `OPTIONALLY ENCLOSED BY`, since we will be enclosing every single field after doubling any occurrence of the enclosure character in the raw data.
- Line (11): We use a large numeric date format. This does two things: it avoids any NLS issues with regard to the data, and it preserves the time component of the date field.

The raw data (.dat) file generated from the preceding code looks like this:

```
"7369","SMITH","CLERK","7902","17121980000000","800","","20"~
"7499","ALLEN","SALESMAN","7698","20021981000000","1600","300","30"~
"7521","WARD","SALESMAN","7698","22021981000000","1250","500","30"~
"7566","JONES","MANAGER","7839","02041981000000","2975","","20"~
"7654","MARTIN","SALESMAN","7698","28091981000000","1250","1400","30"~
"7698","BLAKE","MANAGER","7839","01051981000000","2850","","30"~
"7782","CLARK","MANAGER","7839","09061981000000","2450","","10"~
"7788","SCOTT","ANALYST","7566","19041987000000","3000","","20"~
"7839","KING","PRESIDENT","","17111981000000","5000","","10"~
"7844","TURNER","SALESMAN","7698","08091981000000","1500","0","30"~
"7876","ADAMS","CLERK","7788","23051987000000","1100","","20"~
"7900","JAMES","CLERK","7698","03121981000000","950","","30"~
"7902","FORD","ANALYST","7566","03121981000000","3000","","20"~
"7934","MILLER","CLERK","7782","23011982000000","1300","","10"~
```

Things to note in the .dat file are as follows:

- Each field is enclosed in our enclosure character.
- The DATES are unloaded as large numbers.
- Each line of data in this file ends with a ~ as requested.

We can now reload this data easily using SQLLDR. You may add options to the SQLLDR command line as you see fit.

As stated previously, the logic of the unload package may be implemented in a variety of languages and tools. On the Ask Tom web site, you will find this example implemented not only in PL/SQL as it is here but also in Pro\*C and SQL\*Plus scripts. Pro\*C is the fastest implementation, and it always writes to the client workstation file system. PL/SQL is a good all-around implementation (no need to compile and install on client workstations), but it always writes to the server file system. SQL\*Plus is a good middle ground, offering fair performance and the ability to write to the client file system.

## Summary

In this chapter, we covered many of the ins and outs of data loading and unloading. First we discussed the advantages that external tables have over SQLLDR. Then we looked at easy techniques to get started with external tables. We also showed examples of using the PREPROCESSOR directive to execute OS commands prior to loading the data.

Then we looked at an Oracle 10g and above feature, the external table unload, and the ability to easily create and move extracts of data from database to database. We wrapped this up by investigating how to unload data from a table into a dump file that can be used to move data from one database to another.

We discussed that in most scenarios you should be using external tables and not SQLLDR. However, there are some situations that may require the use of SQLLDR, like loading data over the network. We then examined many of the basic techniques for loading delimited data, fixed-width data, LOBs, and the like.

Finally, we looked at the reverse process, data unloading, and how to get data out of the database in a format that other tools—such as spreadsheets or the like—may use. In the course of that discussion, we developed a PL/SQL utility to demonstrate the process—one that unloads data in a SQLLDR (or external table) friendly format, but could easily be modified to meet your needs.

# Index

## ■ A

- ACCOUNTS table, 31
- ACTIVE status project, 484
- ADD command, 610
- ADD\_MONTHS function, 549–551, 555
- Advanced Compression Option, 656
- Advance Queuing (AQ), 10
- Alert files, 73
  - ADRCI tool, 101
  - CREATE TABLE statement, 99–101
  - definition, 99
  - EXTERNAL TABLE, 99
  - LAG() analytic function, 101
  - LIKE clause, 101
  - ORACLE instance, 99
  - XML version, 101
- ALL\_OBJECTS table, 129
- ALL\_VIEWS dictionary view, 539
- ALTER commands, 634
- ALTER INDEX REBUILD command, 505, 673
- ALTER INDEX SPLIT PARTITION command, 673
- ALTER SESSION command, 147
- ALTER SYSTEM command, 79, 136
- ALTER TABLE command, 656
- ALTER TABLE EXCHANGE PARTITION command, 588
- ALTER TABLE MOVE command, 585, 673
- ALTER TABLE SHRINK SPACE command, 579
- ALTER TABLE SPLIT|COALESCE PARTITION command, 673
- ALTER TABLE T operation, 236
- ANALYZE INDEX command, 444, 446
- ANALYZE INDEX <name> VALIDATE STRUCTURE command, 442
- AND function, 467, 469–470
- Application domain indexes, 441, 486
- Application Express (APEX), 47
- Architecture overview
  - components, 53
  - database and instance
    - \$ORACLE\_HOME/dbs
      - directory, 57–58
    - container/root, 54–55
    - definition, 54
    - ipcs command, 55
    - log writer (lgwr), 58
    - naming convention, 57
    - operating system processes, 55
    - pluggable, 54
    - process monitor (pmon), 58
    - pwd command, 55
    - RAC, 55
    - SGA and background processes, 61
    - single-tenant, 54
    - startup command, 58
    - TNS connect string, 56
    - UNIX/Linux, 59
    - V\$CONTROLFILE, 60
    - V\$DATAFILE, 59
    - V\$LOGFILE, 60
  - dedicated server
    - configuration, 65
    - ora12cr1, 63–64
  - pluggable databases
    - definition, 69
    - goals of, 70
    - maintenance, 70–71
    - resource utilization, 70
    - SCOTT schema, 70
  - shared server
    - dispatcher process, 66
    - UNIX/Linux process, 65
    - vs. dedicated server, 66
  - TCP/IP network
    - client issues, 67
    - easy connect method, 68
    - LDAP, 68

Architecture overview (*cont.*)

- listener process, 68–69
- TNS connection string, 67

ARCHIVELOG mode, 114

ARRAYSIZE property, 460–461

ASC keyword, 453

AS OF SCN/AS OF TIMESTAMP clause, 30

ASSM feature, 457

AUTHID CURRENT\_USER statement, 541

AUTOALLOCATE clause, 683

Automatic Diagnostic Repository Command Interpreter (ADRCI), 95, 97

Automatic memory

- management (AMM), 127, 146–147, 170

ACTIVE column, 138

coding implementation, 137

issues, 135

LAG() function, 142

NAME column, 138

PGA\_AGGREGATE\_TARGET parameter, 136–137, 139–140, 142–143

pivot feature, 141

SESS\_STATS table, 140

SORT\_AREA\_SIZE parameter, 137, 142–143

SQL\*Plus script, 138

VALUE column, 138

WORKAREA\_SIZE\_POLICY, 136

Automatic Segment Space

- Management (ASSM), 359–360

Automatic shared memory management

- (ASMM), 127, 169

Automatic Storage Management (ASM), 53–54, 103

AUTOTRACE utility, 500

## ■ B

Background processes, 173

ARCn process, 196

ASMB process, 197

Automatic Workload Repository (AWR), 200

binary executable program, 192

block buffer cache, 187

checkpoint process, 194

CTWR process, 201

DBRM process, 197

DBWn process, 194

DIAG process, 196

DMnn process, 201

EMNC process, 200

FBDA process, 196

GEN0 process, 197

init.ora parameters, 188

job queue process, 199

LCK0 process, 198

LGWR process, 195

LMD0 process, 198

LMON process, 198

LMSn process, 198

LREG process, 192

MMAN process, 200

MMNL process, 200

MMON process, 200

Mnnn process, 200

PMON process, 192

PSP0 process, 198

QMNC and Qnnn processes, 200

RAC environment

- high availability, 197

- scalability, 198

ReBALance (RBAL) process, 197

RECO process

- block readers, 194

- in-doubt distributed transaction, 194

- two-phase commit (2PC), 194

RVWR process, 201

SMCO process, 198

SMON process, 193

TMON/TTOO process, 201

VKRM process, 198

VKTM process, 198

BFILENAME function, 578

BFILE type, 513, 562

BIG\_TABLE script, 483

BIG\_TABLE segment, 667

BINARY\_DOUBLE type, 512, 535

BINARY\_FLOAT type, 512, 535

Binary string

- NLS (*see* National Language Support (NLS))

RAW type

- DUMP function, 526

- explicit conversions, 526

- LONG RAW, 525

- syntax, 525

- SYS\_GUID() function, 525

BIND\_VARIABLE procedure, 542

Bind variables

- CPU time, 15–16

- definition, 13

- hard parse, 13

- Java compiler, 16

- latches, 13

- latching mechanism, 16

- literals (constants), 13

- NLS\_DATE\_FORMAT, 20

- runstats tool, 15

- runstats utility, 16

- SGA, 16

- soft parse, 13

- SQL injection, 17–18

- stored procedures, 14

- TAB dictionary view, 19
- USER\_PW table, 19
- Bitmap indexes, 440, 465
  - bitmap join, 470
  - experimentation in large read-only environment, 473
  - low distinct cardinality data, 466
- Bitmap join indexes, 440
- Bitwise OR operator, 466
- BLEVEL property, 442–443
- BLOB type, 525, 539, 562
- Branch blocks, 442
- Breakable parse locks, 236, 239
- B\*Tree cluster indexes, 440
- B\*Tree indexes, 439
  - BLEVEL property, 442–443
  - branch blocks, 442
  - descending, 452
  - height balanced, 442
  - HEIGHT property, 442–443
  - index range scan, 442
  - key compression, 444
  - leaf nodes/blocks, 442
  - nonunique index, 442
  - reverse key, 447
  - rules of thumb, 455
    - clustering factor, 462
    - physical organization, 457
  - scalable access time, 465
  - typical layout, 441
  - unique index, 442
- BULK COLLECT statement, 461, 686
- BYTE modifier, 521

## C

- CACHE clause, 576
- CAST() function, 520, 538
- Change-tracking file, 73, 118–119
- Character (CHAR) string
  - ALTER SESSION setting, 522
  - definition, 511
  - Hello World string, 519
  - implicit conversion, 520
  - INSERT statement, 523
  - NLS (*see* National Language Support (NLS))
  - NLS\_LENGTH\_SEMANTICS session parameter, 523
  - N Variant, 524
  - RPAD() method, 521
  - syntax, 521
  - TRIM function, 521
  - US7ASCII, 514
  - VARCHAR2, 518, 521, 523
  - VARCHAR2(10 byte), 522
  - VARCHAR2(10 char), 522

- VARCHAR2\_COLUMN, 520
- WE8MSWIN1252, 514
- CHAR datatype, 145
- CHAR modifier, 521
- CHUNK clause, 572–573
- CHUNKSIZE option, 563
- CLOB type, 513, 539, 562
- Clustered file system, 103
- Clustered index tables, 355, 395
  - creation, 389–391
  - data storage, 389
  - DBMS\_ROWID package, 391
  - definition, 388
  - EMP table creation, 391
  - keys, 389
  - primary key, 390
  - SIZE parameter, 389
- CNT query, 597
- COALESCE command, 505
- COLOCATED\_PK index, 463–464
- COLOCATED table, 458, 460–461, 463, 465
- Comma-separated values (CSV) format, 730
- COMMIT statement, 226
- Composite partitioning, 591, 614
- COMPUTE STATISTICS operation, 472
- Concurrency controls
  - ANSI isolation, 255
  - definition, 253
  - latches and mutexes, 253
  - multiversioning architecture, 254
  - READ COMMITTED isolation, 257
  - read consistency
    - data warehousing technique, 264
    - I/O on hot tables, 265
    - MERGE operation, 264
    - SERIALIZABLE isolation level, 266
    - V\$TRANSACTION table, 265
  - READ ONLY transactions, 263
  - READ UNCOMMITTED isolation, 256
  - REPEATABLE READ isolation, 259
  - SERIALIZABLE transaction, 261
  - TM (DML Enqueue) and DDL locks, 253
  - transaction isolation
    - dirty read, 254
    - nonrepeatable read, 254
    - phantom read, 254
  - TX (Transaction) locks, 253
  - write consistency
    - BEFORE FOR EACH ROW trigger, 273
    - consistent reads, 268
    - CPU columns, 268
    - current reads, 268
    - DELETE statement, 272
    - DISK columns, 268
    - ELAPSED columns, 268

Concurrency controls (*cont.*)  
 nontransactional trigger, 273  
 READ COMMITTED statement, 269  
 restart, 270  
 UPDATE statement, 267, 272  
 UTL\_MAIL function, 273

Concurrent users *vs.* transactions per second, 185

CONS view, 223

Container/root database, 54–55

Control files, 73, 111

Cost-based optimizer (CBO), 422

CREATE INDEX command, 478, 673

CREATE INDEX ONLINE command, 238

CREATE INDEX statement, 471–472, 478, 486

CREATE statement, 230, 478, 536

CREATE TABLE AS SELECT statement, 673–674

CREATE VIEW command, 238

CURSOR\_SHARING parameter, 162

## ■ D

Database block writer (DBWn), 173

database configuration assistant (DBCA), 108

Database resident connection pooling (DRCP), 177, 186

Database tables  
 clustered index (*see* Clustered index tables)  
 hash clustered  
     creation, 397–399, 402  
     depiction of, 397  
     HASHKEYS option, 397  
     HEAP table, 402  
     HWM, 398  
     I/O bound and perform queries, 402  
     PL/SQL package, 399–401  
     single table, 402–403  
     TKPROF shows, HEAP table, 401  
     usage, 396  
 heap organized  
     COMPRESS/NOCOMPRESS, 373  
     creation, 370–371  
     DBMS\_METADATA, 372  
     definition, 370  
     FREELIST, 372  
     INTRANS, 372  
     INSERTs, 371  
     ORDER BY statement, 371  
     PCTFREE, 372  
     PCTUSED, 372  
     usage, 371  
 IOTs (*see* Index organized tables (IOTs))  
 nested tables (*see* Nested tables)  
 object table (*see* Object table)  
 sorted hash clusters, 405  
 temporary tables (*see* Temporary tables)  
 terminology (*see* Terminology, database tables)

types of, 357  
     clustered index, 355  
     External, 356  
     Hash clusters, 355  
     Heap organized, 355  
     IOTs, 355  
     Nested, 356  
     Object, 356  
     Sorted hash clusters, 356  
     Temporary, 356

Data Definition Language (DDL)  
 locks, 212, 225  
     breakable parse locks, 239–240  
     CREATE INDEX ONLINE command, 238  
     CREATE VIEW command, 238  
     DBMS\_\* packages, 239  
     ONLINE keyword, 237  
     pseudo-code, 236  
     SELECT statement, 237  
     types of, 236  
     statements, 283

Data files, 73

Automatic Storage Management (ASM), 103

Clustered file system, 103

definition, 102

dictionary-managed and locally-managed  
 tablespaces, 107

operating system (OS) file systems, 102

Raw partitions, 103

storage hierarchy  
     blocks, 104–106  
     extents, 104–105  
     segments, 104–105  
     tablespaces, 104, 106–107

Data loading, 697  
     external tables (*see* External tables)  
     SQLLDR (*see* SQLLDR)

Data Manipulation Language (DML) locks, 225

TM, 234

TX (Transaction) lock, 226  
     CREATE statement, 230–231  
     DEPT table creation, 227–228  
     INTRANS parameter, 233  
     NOWAIT option, 226  
     PCTFREE parameter, 233  
     process, 226  
     REQUEST column, 229  
     stored procedure, 231–232  
     V\$ tables, 227–229

Data Pump files, 74  
     CREATE TABLE statement, 123–124  
     DIRECTORY object, 123  
     EXPDP and IMPDP tools, 123  
     usage, 122  
     XML, 122

Data Pump master (DMnn), 201  
 Data unloading, 697  
   data pump format, 723  
   flat file, 756  
     AUTHID CURRENT\_USER, 757  
     CONTROL\_FILES parameter, 758  
     data file, 762  
     date format, 763  
     DESCRIBE table, 759  
     DUMP\_CTL, 761  
     enclosure character, 760  
     NLS\_DATE\_FORMAT, 761  
     specification package, 757  
 Data warehouse systems, 589  
 DATE\_COL column, 502  
 DATE type  
   ADD\_MONTHS function, 549–551  
   attributes of, 546  
   definition, 512  
   DUMP function, 546–547  
   formats, 545  
   MONTHS\_BETWEEN function, 551  
   NUMTODSINTERVAL function, 549  
   NUMTOYMINTERVAL function, 549  
   table creation, 547–548  
   techniques, 548  
   truncation, 547  
 DBA\_DDL\_LOCKS view, 239  
 DB\_\*\_CACHE\_SIZE parameter, 150  
 DBMS\_CRYPTO.HASH method, 214  
 DBMS\_LOCK package, 218–219, 250  
 DBMS\_OBFUSCATION\_TOOLKIT.MD5 method, 214  
 DBMS\_RANDOM package, 468  
 DBMS\_RANDOM.RANDOM function, 477  
 DBMS\_SHARED\_POOL package, 162  
 DBMS\_SQLHASH.GETHASH method, 215  
 DBMS\_STATS package, 444  
 DBMS\_UTILITY.GET\_HASH\_VALUE statement, 219  
 DBMS\_XPLAN package, 500, 623  
 Deadlocks  
   B\*Tree index, 224  
   CONS view, 223  
   foreign key, 222–223  
   primary key, 222  
   scenarios, 221  
   trace file, 220  
 Decision Support System (DSS), 113  
 decode() function, 210  
 DEFAULT partitioning, 600  
 Default pool, 155  
 Default Trace File, 91  
 DELETE command, 206  
 DELETE\_INDEX\_STATS statement, 472  
 Descending indexes, 440, 452  
 DESC keyword, 452

DETERMINISTIC keyword, 477–478  
 Diag Trace, 91  
 Discriminating elements, 507  
 DISORGANIZED\_PK index, 463–464  
 DISORGANIZED table, 461–463, 465  
 Do-it-yourself (DIY) parallelism, 684  
   BIG\_TABLE creation, 691  
   CREATE\_CHUNKS\_BY\_ROWID procedure, 689  
   DBA\_PARALLEL\_EXECUTE\_CHUNKS  
     view, 689–690  
   DBMS\_PARALLEL\_EXECUTE package, 688  
   DBMS\_SCHEDULER package, 689  
   JOB\_QUEUE\_PROCESSES, 692, 694  
   NTILE function, 694  
   SERIAL procedure, 692  
   SERIAL routine, 688  
   SYS\_CONTEXT, 688  
 DROP command, 610  
 DT column, 558  
 DUAL table, 158  
 Dump (DMP) files, 74, 121  
 DUMP function, 447, 516, 526, 546  
 Dump (trace) destinations, 90

## E

Edition-based redefinition (EBR), 240  
 Embedded newlines  
   FIX attribute, 740  
   STR attribute, 743  
   string characters, 739  
   VAR attribute, 742  
   wrap-up, 744  
 EMPNO primary key, 210  
 EMP table, 465  
 ENABLE STORAGE IN ROW clause, 566  
 Enterprise Java Beans (EJBs), 5  
 Entity Relation Diagram (ERD), 44  
 EXP/IMP Files, 121  
 EXP tool, 517  
 Extended column indexes, 489  
   function-based index, 492  
   virtual column, 490  
 Extensible indexing, 486  
 External tables, 356  
   ALTER TABLE command, 711  
   BADFILE option, 708  
   COUNT(\*), 709  
   datatype error, 709  
   INSERT statement, 698  
   multiuser issues, 711  
   parallel processing, 711  
   preprocessing, 712  
   compressed file, directories, 716  
   df command, 713

External tables (*cont.*)

- error documentation, 716
- PREPROCESSOR directive, 722
- trimming characters, 720
- WHERE clause, 716

set up, 698

SQLLDR

- access parameters, 700
- control files, 697, 699
- CREATE DIRECTORY statement, 700
- CREATE TABLE statement, 699
- in express mode, 704
- EXTERNAL\_TABLE parameter, 699
- INSERT statements, 702
- READ and WRITE access, 702
- TKYTE directory, 703

EXTRACT function, 559

Extract, transform, load (ETL) tool, 674

■ F

Fast full scan, 456

Fear, Uncertainty, and Doubt (FUD), 3

Fine-grained access control (FGAC), 48

FIX attribute, 740

Flashback log files, 73

- Fast Recovery Area, 120–121

- FLASHBACK DATABASE command, 119–120

FLASHBACK table command, 579, 619

Flat files, 74, 124

Floating-point number, 535

Focused background processes. *See*

- Background processes

Foreign keys, 497

FOR UPDATE clause, 225

FOR UPDATE NOWAIT command, 209

FOR X IN ( SELECT \* FROM T ) query, 450

free() function, 164

FREELIST, 505–507

FREELIST GROUPS feature, 457

FROM clause, 471

FULL SCAN function, 501

function-based indexes, 492

Function-based indexes, 440, 473

- advantages of, 486

- caveat regarding ORA-01743, 485

- example of, 474

- indexing only some rows, 483

- selective uniqueness, 484

■ G

G\_CURSOR variable, 542

Global index partition

- asynchronous maintenance

- creation, 635

- dropping/truncating table, 635

- UPDATE GLOBAL INDEXES clause, 636–637

data warehouse, 629

definition, 620

maintenance, 633

MAXVALUE attribute, 628

nonprefixed, 628

OLTP system, 637

- CLERK data, 642

- DEPTNO and JOB, 639

- EMPLOYEE data, 638

- goals, 638

- INDEX RANGE SCAN, 641

- INDEX UNIQUE SCAN, 640

- primary key, 639

- query plans, 640

- TABLE ACCESS BY ROWID, 642

sliding windows and

- FY\_2014 partition, 631

- load process, 629

- performance, 632

- sets up, warehouse table, 630

- TIMESTAMP column, 629–630

- WITHOUT VALIDATION clause, 632

TIMESTAMP type, 627

G\_QUERY variable, 542

GROUP BY clause, 496, 649

■ H

HASH\_AREA\_SIZE parameter, 129

Hash clustered tables, 355

Hash partitioning, 598

- definition, 590

- histogram points, 597

- RPAD, 597

- stored procedure, 596

- table name and union, 596

- working principles, 594

Heap organized tables, 355

- COMPRESS/NOCOMPRESS, 373

- creation, 370–371

- DBMS\_METADATA, 372

- definition, 370

- FREELIST, 372

- INITTRANS, 372

- INSERTs, 371

- ORDER BY statement, 371

- PCTFREE, 372

- PCTUSED, 372

- usage, 371

Height balanced, 442

HEIGHT property, 442–443

HEXTORAW function, 526





IDX\_STATS table, 444, 446  
 Image index, 486  
 INACTIVE status project, 484  
 INDEX command, 471  
 INDEXED\_COLUMN, 500  
 Indexes  
   application domain indexes, 441, 486  
   bitmap indexes, 440, 465  
     bitmap join, 470  
     experimentation in large read-only environment, 473  
     low distinct cardinality data, 466  
   bitmap join indexes, 440  
   B\*Tree cluster indexes, 440  
   B\*Tree indexes, 439  
     BLEVEL property, 442–443  
     branch blocks, 442  
     descending, 452  
     height balanced, 442  
     HEIGHT property, 442–443  
     index range scan, 442  
     key compression, 444  
     leaf nodes/blocks, 442  
     nonunique index, 442  
     reverse key, 447  
     rules of thumb (*see* B\*Tree indexes, rules of thumb)  
     scalable access time, 465  
     typical layout, 441  
     unique index, 442  
   descending indexes, 440  
   discriminating elements, 507  
   extended columns, 489  
     function-based index, 492  
     virtual column, 490  
   foreign keys, 497  
   function-based indexes, 440, 473  
     advantages of, 486  
     caveat regarding ORA-01743, 485  
     example of, 474  
     indexing only some rows, 483  
     selective uniqueness, 484  
   index organized tables, 439  
   invisible indexes, 487  
   multiple indexes, 489  
   Null keys, 483, 494  
   reuse of space, 504  
   reverse key indexes, 440  
   unused/flawed indexes, 498  
     character column, 500  
     INDEXED\_COLUMN, 500  
     lack of table statistics, 504  
     SELECT COUNT(\*) FROM T query, 500  
     slower index, 503

    working on views, 494  
 INDEXING PARTIAL clause, 643  
 Index key compression, 444  
 Index organized tables (IOTs), 355, 439  
   benefits, 379  
   clustered index, 374  
   code lookup table, 374  
   creation, 373  
   definition, 373  
   EMP table creation, 374–375, 377  
   heap table, 375–376  
   KEYWORDS table, 374  
   PL/SQL block, 377–379  
   primary key, 373–374  
   WHERE clause, 374  
 Index range scan, 442  
 INDEX (RANGE SCAN) statement, 456  
 INDEX SKIP SCAN statement, 499  
 INDEX\_STATS view, 442  
 INDEX UNIQUE SCAN function, 502  
 INITRANS parameter, 230, 233  
 INSERT statement, 34, 206, 218, 242, 246, 474, 479, 495, 523, 546, 572, 578  
 Instance, 54  
 Internal locks, 225  
 INTERVAL DAY TO SECOND type, 513, 561–562  
 Interval partitioning  
   AUDIT\_TRAIL rows, 604  
   database creation, 601  
   definition, 590  
   EXAMPLE tablespace, 604  
   HIGH\_VALUE-INTERVAL, 603  
   HIGH\_VALUE string, 605  
   INTERVAL partition, 602  
   MAXVALUE, 601  
   recursive transaction, 605  
   SYS\_P1624, 603  
   TIMESTAMP, 606  
   transitional, 602  
   USERS tablespace, 604  
 Interval reference partitioning, 591, 611  
 INTERVAL type  
   EXTRACT function, 559–560  
   formats, 545  
   INTERVAL DAY TO SECOND, 513, 561–562  
   INTERVAL YEAR TO MONTH, 513, 560–561  
   INTERVAL YEAR TO MONTH type, 513, 560–561  
 Invisible indexes, 487



Java pool, 149, 165  
 JAVA\_POOL\_SIZE parameter, 150, 165  
 Java Server Pages (JSPs), 5  
 Java Virtual Machine (JVM), 2  
 JOB-IDX Bitmap Index, 466

**K**

Keep pool, 155

**L**

LAG() analytic function, 101, 142

Large objects (LOB)

BasicFiles creation, 565

BFILES, 513

BFILENAME function, 578

DIRECTORY object creation, 577

INSERT statement, 578

usage, 577

CACHE clause, 576

CHUNK clause, 572–573

CLOB, 513

components, 566

data

DBMS\_LOB package, 745

DIRECTORY object, 745

inline, 749

LoadCLOBFromFile, 748

object columns, 752

out of line, 750

definition, 513

IN ROW clause

DBMS\_MONITOR package, 569

INSERT statement, 572

LOBINDEX segment, 570

LOBSEGMENT, 568

monitor performance, 570

NOCACHE option, 568

TKPROF report, 569–571

NCLOB, 513

RETENTION clause

BasicFiles, 575

read consistency, 573

SecureFiles, 575

SecureFiles, 563

DBMS\_METADATA, 564

STORE AS SECUREFILE clause, 564

STORAGE clause, 576

tablespace, 567

types of, 562

Large pool, 149, 164

LARGE\_POOL\_SIZE parameter, 150

Latches, 225

with bind variables, 246

without bind variables, 244

definition, 240

performance/scalability, 249

SELECT FOR UPDATE NOWAIT, 240

spinning, 241

testing setting up, 243

Latch Sleep Breakdown, 246

Leaf nodes/blocks, 442

Least Recently Used (LRU), 156

Lightweight Directory Access Protocol (LDAP), 68

List partitioning, 590, 599

LOBINDEX segment, 566, 570, 573, 577

LOBSEGMENT, 573–574, 577

Local index partition

definition, 620

vs. global index, 621

nonprefixed, 621–622

prefixed, 622

PRIMARY KEY constraint, 625

UNIQUE constraint, 625

Locally-managed tablespace (LMT)

setting up, 676

types, 676

UNIFORM vs. AUTOALLOCATE, 681

big\_table.sql script, 679

direct path load, existing tables, 682–683

LMT\_UNIFORM, 679

QCSID and QCSERIAL# identifiers, 680

SID and SERIAL# identifiers, 680

USER\_SEGMENTS, 680

v\$px\_session, 680

Local nonprefixed indexes, 622

Local prefixed indexes, 622

Locking

benchmark, 206

blocking

DBMS\_LOCK package, 218–219

definition, 217

DML statements, 217

INSERT statement, 218–219

SELECT FOR UPDATE NOWAIT query, 220

SYS\_GUID() function, 218

commit rule, 207

concurrency and consistency, 207

DDL locks (*see* Data Definition

Language (DDL), locks

deadlocks

B\*Tree index, 224

CONS view, 223

foreign key, 222–223

primary key, 222

scenarios, 221

trace file, 220

DML locks (*see* Data Manipulation

Language (DML) locks)

escalation, 224–225

internal (*see* Internal locks)

latches (*see* Latches)

lost update, 208

manual, 250

mutexes, 249

- optimistic (*see* Optimistic locking)
- ORA\_HASH method, 217
- overview of, 205
- pessimistic, 209
- types, 225
  - user-defined locks, 250
- LOG\_BUFFER parameter, 150, 154
- Log writer (LGWR), 173
- LONG RAW type, 512, 525, 538
- LONG SUBSTR function, 541
- LONG types, 538
  - ALL\_VIEWS dictionary view, 539–540
  - AUTHID CURRENT\_USER statement, 541
  - BIND\_VARIABLE procedure, 542
  - DBMS\_SQL.COLUMN\_VALUE\_LONG, 543
  - definition, 512
  - G\_CURSOR variable, 542
  - G\_QUERY variable, 542
  - L\_BUFFER\_LEN, 542
  - LONG RAW type, 538–539
  - package, 541
  - PL/SQL procedure, 545
  - SQL SELECT statements, 543
  - SUBSTR function, 541, 543
  - SUBSTR\_OF function, 542
  - VARCHAR2, 541
  - WHERE clause, 544
- Low distinct cardinality data, 466
- LOWER function, 483

## M

- malloc() function, 61, 128, 135, 164
- Manual locking, 250
- Manual PGA memory management, 127
- Manual Segment Space Management, 359
- Manual shared memory management, 127
  - DBMS\_SHARED\_POOL package, 167
  - file initialization, 167
  - shared pool, 168
- MAXTRANS parameter, 230
- MAXVALUE clause, 593
- MAXVALUE partition, 601
- mmap() function, 128
- Memory control, 136
- MEMORY\_MAX\_SIZE parameter, 150
- Memory structures, 127
  - PGA (*see* Process global area (PGA))
  - SGA (*see* System global area (SGA))
  - UGA (*see* User global area (UGA))
- MEMORY\_TARGET parameter, 127–128, 150–151
- MILLER row, 209–210
- MONTHS\_BETWEEN function, 551
- MOVE command, 579
- Multiple indexes, 489

- Multisegment object, 566
- Multitenant architecture, 71
- Mutexes, 249
- MY\_SOUNDEX function, 476–479

## N

- National Language Support (NLS), 511
  - ASCII client, 516
  - DUMP function, 516
  - EXP tool, 517–518
  - US7ASCII, 514
  - WE8MSWIN1252, 515
- NCHAR data type, 511
- NCLOB type, 513, 562
- Nested tables, 356
  - CAST and MULTISSET syntax, 410
  - constraint, 409
  - creation, 408–409
  - EMP table creation, 413–414
  - Oracle, 410
  - primary and foreign keys, 408
  - relational model, 412–413
  - storage, 415
    - DBMS\_METADATA.GET\_DDL, 416–417
    - IOT, 418
    - NOT NULL constraint, 417
    - physical implementation, 416
    - primary key, 418
    - RETURN AS VALUE clause, 417
    - UNIQUE constraint, 416–417
  - UPDATE statement, 411
  - usage, 408
- NLS\_LANGUAGE setting, 592
- NOARCHIVELOG mode, 114
- NOCACHE option, 568
- NOLOGGING option, 635
- NOT function, 467
- NOWAIT option, 226
- NTILE function, 694
- NULL keys, 483, 494
- Null pool, 150
- Number type
  - BINARY\_DOUBLE, 512, 529–530, 535
  - BINARY\_FLOAT, 512, 529, 535
  - CAST() function, 538
  - definition, 512, 529
  - FLOAT\_COL column, 530
  - Non-Native, 536
  - NUM\_COL column, 530
  - precision, 531, 533
  - scale, 531–532
  - table creation, 536
  - TKPROF report, 537
  - VSIZE function, 534

NUMTODSINTERVAL function, 549, 561  
 NUMTOYMINTERVAL function, 549, 555, 560  
 NVARCHAR2 data type, 512  
 NVL2 function, 223

**O**

Object table, 356  
   creation, 431  
   definition, 431  
   HOME\_ADDRESS, WORK\_ADDRESS, 433  
   INSERT statement, 432  
   NAME, DOB scalar attributes, 433  
   OIDINDEX clause, 434  
   PERSON\_TYPE, 432  
   pseudo primary key, 434  
   SQL, 434  
   SYS\_NCnnnnn\$, 433  
   SYS\_NC\_OID\$ column, 435–437  
   SYS\_NC\_ROWINFO\$ function, 433  
   YS\_NC\_OID\$ function, 433  
 ON DELETE CASCADE function, 497  
 ON DELETE CASCADE statement, 224  
 ONLINE keyword, 237  
 Online Transaction Processing  
   (OLTP), 105, 170, 589, 668  
 Operating System Dependent (OSD), 42  
 Operating system (OS) file, 102  
 OPT\_CMP\_PCTSAVE value, 508  
 Optimistic locking  
   data updation, 211  
   hash/checksum, 214  
   LAST\_MOD column, 212–213  
   NUMBER column, 211  
   stored procedure, 214  
   table creation, 212  
   TIMESTAMP data type, 212  
   UPDATE command, 211  
 OPTIMIZER\_USE\_INVISIBLE\_INDEXES parameter, 488  
 ORA-00054 resource busy error, 210  
 ORA-22924 error, 575  
 Oracle applications  
   architecture  
     bind variables (*see* Bind variables)  
     ramifications, 12  
     single connection, 12  
   auto binder, 48  
   black box approach  
     autonomous transaction, 6  
     bitmap index, 5  
     B\*Tree index creation, 7  
     database feature, 6  
     deadlock, 6  
     EJBs, 5, 11  
     FUD, 3

    important piece of software, 4  
     Instrumenting/traceable code, 5  
     issues, 10  
     Java Server Pages, 5  
     processed flag, 7  
     single-user system, 4  
 concurrency control  
   definition, 23  
   FOR UPDATE clause, 26  
   locks implementation, 24  
   mechanisms, 23  
   RESOURCES tables, 26  
   SCHEDULES table, 25–26  
 CURSOR\_SHARING parameter, 49–50  
 database independence  
   analytic functions, 45  
   APEX, 47  
   autonomous transactions, 45  
   B\*Tree index creation, 35–36  
   database. perhaps, 48  
   deadlock, 34  
   Entry-level, 37  
   ERD, 44  
   features, 43  
   fine-grained access control, 48  
   FOR UPDATE clause, 34  
   Full level, 37  
   functions, 43  
   IDENTITY attribute, 40  
   Intermediate level, 37  
   layered programming, 41–42  
   Null comparison, 35  
   ONE\_SESSION profile, 46  
   Oracle 12c, 40  
   PL/SQL, 34, 47  
   primary key, 41  
   SELECT COUNT(\*), 47  
   SELECT statements, 40  
   serializable transaction, 39  
   stored procedure, 36  
   SYS\_GUID() function, 38  
   table creation, 38  
   Transitional level, 37  
   UPDATE statements, 40  
   V\$SESSION table, 46  
   Visual Basic code and ActiveX controls, 48  
   WITH clause, 44–45  
 database-level switches, 50  
 DBA/SA, 51  
 JVM, 2  
 multiversioning  
   ALL\_USERS table, 28  
   flashback query, 29  
   read consistency and nonblocking reads, 31  
   Read-consistent queries, 27

- Oracle Exadata, 50
- PL/SQL, 3
- statements, 1
- substr constants, 49
- Windows vs. UNIX/Linux, 2
- Oracle datatypes, 562
  - binary string (*see* Binary string)
  - character string (*see* Character (CHAR) string)
  - DATE type (*see* DATE type)
  - extended datatypes, 527, 529
  - INTERVAL type (*see* INTERVAL type)
  - LOB (*see* Large objects (LOB))
  - LONG types (*see* LONG types)
  - NCHAR, 511
  - number type (*see* Number type)
  - NVARCHAR2, 512
  - ROWID type, 579
  - TIMESTAMP type (*see* TIMESTAMP type)
  - UROWID type, 579
  - VARCHAR2, 511
- Oracle Enterprise Manager (OEM), 79
- ORA\_HASH method, 215, 217
- ORDER BY clause, 454, 648–649
- ORDER\_LINE\_ITEMS table, 653
- OR function, 467, 469
- OWA\_OPT\_LOCK.CHECKSUM method, 214
- OWNER column, 444–445

## P

- Parallel DDL, 659
  - commands permit parallelization, 673
  - data loading and external tables, 673
  - extent trimming
    - CREATE TABLE AS SELECT operation, 675
    - definition, 675
    - dictionary-managed tablespaces, 676
    - extent allocation depiction, 675
    - LMT (*see* Locally-managed tablespace (LMT))
- Parallel DML (PDML), 588, 659
  - data warehousing environment, 669
  - DBMS\_XPLAN, 671
  - limitations, 671
  - OLTP system, 668
  - update depiction, 669
  - UPDATE statement, 672
  - V\$SESSION to V\$TRANSACTION, 670
- Parallel execution, 659
  - DDL (*see* Parallel DDL)
  - one-page summary, 661
  - Oracle Exadata Database Machine, 662
  - PARALLEL QUERY option, 660
  - PDML (*see* Parallel DML (PDML))
  - PQ (*see* Parallel query (PQ))
  - procedural parallelism (*see* Procedural parallelism)
  - propagation, 660
  - recovery, 660
  - ten-chapter report, 661–662
- Parallel query (PQ), 659
  - ALTER TABLE command, 665
  - BIG\_TABLE, 664
  - COUNT(STATUS) values, 665
  - physical devices, 667
  - ps command, 665
  - PSQ, 668
  - QCSID, 666
  - SELECT COUNT(\*), 668
  - select count (status) depiction, 663
  - serial plan, 664
  - servers, 664
  - SID, 666
  - slaves, 664
  - SQL SELECT statement, 663
  - V\$SESSION, 667
- Parallel Statement Queuing (PSQ), 668
- PARALLEL\_THREADS\_PER\_CPU parameter, 680
- Parameter files, 73
  - control\_files parameter, 77
  - EODA, 75
  - init.ora file, 74
  - Legacy init.ora file, 78
  - RMAN, 74
  - SHOW PARAMETER command, 75
  - SPFILEs (*see* Server Parameter Files (SPFILEs))
  - V\$distributed\_transactions, 77
  - V\$PARAMETER view, 76
- PART\_1 partition, 595
- Partial index, 642
- PARTITIONED\_IDX\_LOCAL index, 634
- PARTITIONED\_PK index, 626
- Partitioning, 581, 619
  - administrative burden
    - ALTER TABLE MOVE command, 585
    - definition, 584
    - MOVE operation, 587
    - sliding windows, 588
    - system/software failure, 585
    - tablespaces creation, 585–586
  - auditing, 656
  - benefits of, 582
  - cascade exchange, 654
  - cascade truncate, 653
  - composite, 591, 614
  - downtime reduction, 584
  - EMP table, 583
  - global index partition (*see* Global index partition)
  - hash (*see* Hash partitioning)
  - hash key, 583
  - interval, 591
  - interval (*see* Interval partitioning)

Partitioning (*cont.*)

- interval reference, 611
  - list, 590, 599
  - local index partition
    - definition, 620
    - vs.* global index, 621
    - nonprefixed, 621–622
    - prefixed, 622
    - PRIMARY KEY constraint, 625
    - UNIQUE constraint, 625
  - multiple partition maintenance
    - operations, 650, 653
  - OLTP system, 590
  - partial index, 642
  - PDML, 588
  - performance
    - ALL\_OBJECTS dictionary view, 645
    - LIST partitioning, 645
    - OBJECT\_ID, 647
    - ORDER BY clause, 648
    - primary key, 649
    - RANGE partitioning, 645
    - timestamp attribute, 644
    - TKPROF report, 646–647
    - USER\_ID column, 648–649
  - query performance
    - data warehouse systems, 589
    - OLTP system, 589
    - operations, 589
  - range (*see* Range partitioning)
  - reference (*see* Reference partitioning)
  - row movement
    - cases, 617
    - RANGE\_EXAMPLE table, 617–618
    - RANGE\_KEY\_COLUMN, 618
    - ROWID type, 618–619
  - runtime elimination, 584
  - segment space compression, 656
  - tablespace, 582
  - virtual column, 591, 613
- Partition key, 582
- Password files, 73
- command-line tool, 116
  - OP\$TKYTE, 117–118
  - ora12cr1 group, 115
  - REMOTE\_LOGIN\_PASSWORDFILE parameter, 116
  - SYSDBA, 116–117
  - @tns-connect-string, 115
- PCTFREE parameter, 233
- PCTVERSION option, 563
- Pessimistic locking, 209
- PGA\_AGGREGATE\_TARGET parameter, 128, 147
- Pluggable database, 54
- PNAME query, 597
- Prefix component, 444

- PRIMARY KEY constraint, 625
- Pro\*C, 449–450
- Procedural parallelism, 660
- approaches, 684
  - creation, 684
- DIY
- BIG\_TABLE creation, 691
  - CREATE\_CHUNKS\_BY\_ROWID
    - procedure, 689
  - DBA\_PARALLEL\_EXECUTE\_CHUNKS
    - view, 689–690
  - DBMS\_PARALLEL\_EXECUTE package, 688
  - DBMS\_SCHEDULER package, 689
  - JOB\_QUEUE\_PROCESSES, 692, 694
  - NTILE function, 694
  - SERIAL procedure, 692
  - SERIAL routine, 688
  - SYS\_CONTEXT, 688
- pipelined functions
- object type, 685
  - partition clause, 686
  - PIPE ROW clause, 684
  - PL/SQL routine, 685
  - PROCESS\_DATA, 684
  - ref cursor, 686
  - SESSION\_ID, 687
  - V\$MYSTAT, 686
- types, 684
- UPDATE/INSERT commands, 684
- Process global area (PGA)
- automatic memory management, 127, 146
    - ACTIVE column, 138
    - coding implementation, 137
    - issues, 135
    - LAG() function, 142
    - NAME column, 138
    - PGA\_AGGREGATE\_TARGET parameter, 136–137, 139–140, 142–143
    - pivot feature, 141
    - SESS\_STATS table, 140
    - SORT\_AREA\_SIZE parameter, 137, 142–143
    - SQL\*Plus script, 138
    - VALUE column, 138
    - WORKAREA\_SIZE\_POLICY, 136
  - manual memory management, 127, 146–147
    - \*\_AREA\_SIZE parameters, 135
    - dynamic performance views, 129
    - HASH\_AREA\_SIZE parameter, 129
    - INSERT/UPDATE script, 131
    - malloc() function, 135
    - ORDER BY queries, 129–130
    - run\_query.sql, 133
    - SORT\_AREA\_RETAINED\_SIZE parameter, 129
    - SORT\_AREA\_SIZE parameter, 129, 132, 134
    - watch\_stat.sql script, 133

techniques, 128  
 with Oracle9i Release 1, 128  
 ps command, 62  
 pstat tool, Window, 62–63

## Q

Query coordinator SID (QCSID), 666

## R

Range partitioning  
 CREATE TABLE statement, 591  
 definition, 590  
 MAXVALUE clause, 593  
 RANGE\_KEY\_COLUMN, 592  
 SELECT statements, 592–593  
 Raw partitions, 103  
 RAWTOHEX function, 526  
 RAW type, 512  
 Real Application Clusters (RAC), 55  
 Recovery Manager (RMAN), 74  
 Recursive transaction, 605  
 Recycle pool, 155  
 Redo log files, 73  
 ARCHIVELOG and NOARCHIVELOG  
 mode, 114–115  
 instance/media failure, 111  
 online  
 ALERT log, 113  
 blocks modification, 114  
 buffer cache, 113  
 checkpointing, 112  
 DSS/DW system, 113  
 groups, 112  
 log switch, 112  
 Mean time to recover, 114  
 Peak workloads, 113  
 SGA, 113  
 recovery purposes, 111  
 SYS.OBJ\$ table, 112  
 Redundant Array of Independent Disks (RAID), 114  
 Reference partitioning  
 data warehouse, 606  
 definition, 590  
 foreign key constraint, 609  
 integrity constraint, 608  
 ORDER\_LINE\_ITEMS table, 606–607, 610  
 truncate/drop command, 608, 610  
 UPDATE statement, 610  
 Relational database management system (RDBMS), 205  
 Reverse key indexes, 440, 447  
 REVERSE keyword, 448  
 RI constraints, 671  
 ROLLBACK statement, 226

ROWID type, 513, 579, 618–619  
 ROW SHARE TABLE lock, 225  
 Row Source Operation, 461  
 RPAD() method, 521

## S

SELECT COUNT(\*) FROM T query, 500  
 SELECT DUMMY FROM DUAL query, 158  
 SELECT FOR UPDATE NOWAIT query, 220  
 SELECT \* FROM T WHERE Y = 5 query, 498  
 SELECT statement, 33, 210, 237, 479  
 SELECT SYSDATE FROM DUAL query, 158  
 SELECT SYSDATE query, 158  
 SELECT X,Y FROM T WHERE Y = 5 query, 498  
 SERIAL procedure, 692  
 Server Parameter Files (SPFILES)  
 ALTER SYSTEM command, 82  
 command, element of, 82  
 COMMENT= assignment, 84  
 corrupted fixing, 86  
 CREATE SPFILE command, 80  
 INSTANCE\_NUMBER, 82  
 issues, 80  
 naming convention, 80  
 PFILES creation, 85–86  
 pluggable databases, 87  
 RESET clause, unsetting values, 85  
 SHOW PARAMETER command, 81  
 SORT\_AREA\_SIZE code, 83–84  
 SYSOPER administrator privilege, 81  
 Server processes, 173  
 Advanced Queuing (AQ), 187  
 connection, 174, 177  
 database resident connection pooling  
 (DRCP), 177, 186  
 dedicated server, 174  
 address space isolation, 175  
 AUTOTRACE session, 178  
 CONNECT command, 180  
 DML operations, 179  
 exec(), 175  
 features, 186  
 fork(), 175  
 interprocess communication (IPC), 175  
 n-tier proxy authentication, 182  
 one-to-one mapping, 183  
 PADDR column, 178  
 process ID (PID), 176  
 remote execution, 175  
 parent/child process creation, 175  
 session, 174, 177  
 shared server, 174,  
 artificial deadlock, 183  
 attribute, 181

Server processes (*cont.*)

- degree of concurrency, 184
- develop and test, 186
- dispatcher method, 181
- dispatcher process, 176
- features, 186
- memory reduction, 186
- OLTP system, 184
- operating system, reduction, 184
- SCOTT, 182
- session query, 181
- SESS\_STATS table, 131
- SGA configuration, 245
- SGA\_MAX\_SIZE parameter, 150, 160
- SGA\_TARGET parameter, 150–151
- Shared Global Area (SGA), 74
- Shared pool, 149, 162
- SHARED\_POOL\_SIZE parameter, 150, 163–164
- shmat() function, 61
- shmget() function, 61
- SHOW\_SPACE procedure, 681
- Single-tenant database, 54
- SKIP\_UNUSABLE\_INDEXES parameter, 633
- Slave processes, 173, 201
  - I/O slaves, 202
  - parallel query execution servers, 202
- SORT\_AREA\_RETAINED\_SIZE parameter, 129
- SORT\_AREA\_SIZE parameter, 129, 132, 137, 147
- Sorted hash clustered tables, 356, 405
- SORT|HASH\_AREA\_SIZE parameter, 147
- SQL isolation levels, 255
  - READ COMMITTED isolation, 257
  - READ ONLY transactions, 263
  - READ UNCOMMITTED isolation, 256
  - REPEATABLE READ isolation, 259
  - SERIALIZABLE transaction, 261
- SQLLDR
  - command line option, 756
  - command line tool, 725
  - control file, 726
  - default length, 755
  - error message, 727
  - load data
    - CASE statement, 738
    - comma-separated values (CSV) format, 730
    - data storage, 755
    - DATE data type, 734
    - delimited data, 730
    - embedded newlines (*see* Embedded newlines)
    - FILLER keyword, 732
    - INSERT statement, 735, 737
    - LOBs (*see* Large objects (LOB))
    - my log file, 729
    - POSITION keyword, 732
    - tab-delimited data, 731
    - TERMINATED BY WHITESPACE, 731
    - TRAILING NULLCOLS, 737
    - UPPER function, 736
  - log file, 728
  - Oracle Call Interface (OCI), 725
  - TRUNCATE option, 755
- SQL\*Loader tool, 677
- SQL\_TRACE query, 479
- STANDARD\_HASH method, 215
- Storage area network (SAN), 662
- STR attribute, 743
- Streams pool, 150, 165
- SUBSTR function, 478, 543
- SUBSTR\_OF function, 542
- Suffix component, 444
- SYSDATE column, DUAL table, 158
- SYS\_GUID() function, 218, 525
- System global area (SGA), 127
  - automatic memory management (AMM), 170
  - automatic shared memory management, 169
  - block buffer cache
    - DBA\_OBJECTS view, 157
    - DB\_nK\_CACHE\_SIZE, 156
    - dirty blocks, 156
    - DUAL table, 158–159
    - hybrid system, 161
    - nondirty blocks, 156
    - segments, 155
    - SGA\_MAX\_SIZE parameter, 161
    - tablespace creation, 160
    - TCH column, 159
    - V\$SGASTAT, 161
    - X\$BH table, 157
    - X\$ tables, 156
  - fixed component, 153
  - Java pool, 149, 165
  - large pool, 149, 164
  - LOG\_BUFFER parameter, 154
  - manual shared memory management, 166
    - DBMS\_SHARED\_POOL package, 167
    - file initialization, 167
    - shared pool, 168
  - MEMORY\_TARGET parameter, 151
  - null pool, 150
  - redo buffer, 153–154
  - SGA\_TARGET parameter, 151–153
  - shared pool, 149, 162
  - streams pool, 150, 165
  - UNIX/Linux, 148
  - V\$SGA\_DYNAMIC\_COMPONENTS, 151
  - V\$SGASTAT view, 149
- System Global Area (SGA), 16, 53
- System partitioning, 591
- SYSTEM tablespace, 105
- SYSTIMESTAMP data type, 554



**T**

TABLE ACCESS BY INDEX ROWID statement, 456

TABLE ACCESS BY ROWID operation, 457

TCP/IP network

client issues, 67

easy connect method, 68

LDAP, 68

listener process, 68–69

TNS connection string, 67

Temp files, 73

CREATE TEMPORARY TABLESPACE

command, 109

ls output, 110

nonsparse file, 110

REDO tablespace, 109

REUSE option, 111

UNDO tablespace, 109

Temporary tables, 356

CBO, 422

DDL, 421

DELETE/TRUNCATE statement, 419

features of, 421–422

global, 419

INLINE VIEW, 422

ON COMMIT DELETE ROWS, 420

optimizer statistics, Oracle 12c

CTAS table, 430

DBMS\_STATS, 424–425

Dynamic sampling, 423

ON COMMIT DELETE ROWS, 429

sessions statistics, 426

shared statistics, 428

Palm sync application, 422

PL/SQL, 421

SCOTT.EMP table, 419

stored procedure, 419, 422

tablespace, 419

usage, 419

Terminology, database tables

FREELISTS

ASSM managed tablespace, 365–366

huge positive performance

influence/inhibitor, 363

hyperthreaded Xeon CPUs, 364

INSERT/UPDATE activity, 363

master and process, 365

MSSM tablespace creation, 363

script, 363

tradeoff, 365

truly concurrent, 365

high-water mark (HWM), 360

INITRANS, 370

LOGGING clause, 369

MAXTRANS, 370

NOLOGGING clause, 369

PCTFREE and PCTUSED

definition, 366

row migration, 367

setting values, 369

segment

cluster, 357

definition, 357

IMMEDIATE clause, 359

index partition, 357–358

nested table, 358

Rollback and Type2 undo, 358

space management, 359

table creation, 357–358

table partition/subpartition, 357

Text index, 486

Thin table, 456

T\_IDX structure, 649

TIMESTAMP type, 545

adding/subtracting time, 554

DATE, 553

definition, 512

DUMP function, 553

formats, 545

vs. INTERVAL, 554–555

syntax of, 552

TIMESTAMP WITH LOCAL TIME

ZONE type, 512, 557

TIMESTAMP WITH TIME ZONE, 512, 556

TIMESTAMP WITH LOCAL TIME ZONE

type, 512, 557

TIMESTAMP WITH TIME ZONE type, 512, 556

TKPROF function, 479

TKPROF report, 509, 537

TKPROF (SQL trace) operation, 458

TM (DML Enqueue) locks, 234

to\_char function, 545

to\_date function, 545

TO\_DATE function, 485–486

TO\_DSINTERVAL function, 562

TO\_YMINTERVAL function, 561

Trace files, 73

AUDIT command, 88

database event triggers, 88

DBMS\_TRACE, 88

debugging code, 88

internal errors, 94

ADRCI, 95, 97

ORA-00600 error, 94

show incident command, 95

SQL, 98

stack trace, 98

TNS connect string, 97

tracefile command, 95–96

user/pass@ora10g.localdomain, 97

locations, 89

naming convention, 92–93

Trace files (*cont.*)

- Oracle events, 88
- Resource Manager, 88
- SQL\_TRACE/DBMS\_MONITOR, 88
- tagging, 93
- types, 89
- V\$ views, 88
- Transactions
  - atomicity, 275
    - DDL statements, 283
    - procedure-level, 279
    - statement-level, 277
    - transaction-level, 283
  - autonomous transactions, 300
    - actions and consequences, 301
    - AUDIT command, 303
    - error logging table, 303
    - mutating table constraint, 303
    - nonautonomous transaction, behavior, 302
    - pragma, 301
    - recursive transaction, 303
    - ROLLBACK command, 302
  - bad habits, 291
    - error message, 294
    - performance implications, 292
    - restartable process, 297
    - using autocommit, 298
  - consistency, 275
  - control statements, 275
    - COMMIT, 276
    - ROLLBACK, 276
    - SAVEPOINT, 276
    - SET TRANSACTION, 277
  - distributed transactions, 299–300
  - durability, 275, 283
    - PL/SQL blocks, 285
    - WRITE extensions, 284
  - integrity constraints
    - CASCADE UPDATE, 288
    - DEFERRABLE constraints, 287
    - IMMEDIATE constraints, 287
  - isolation, 275
    - WHEN OTHERS clause, 281
- TRIM function, 521
- Trimming characters, 720
- TRUNCATE statement, 361
- TRUNC value, 502
- Two-phase commit protocol (2PC), 254, 299

■ U

- UNDO\_RETENTION policy, 575
- UNIQUE constraint, 625
- UNIQUE index, 485

- UNIQUE SCAN function, 501
- UPDATE command, 206, 211
- UPDATE GLOBAL INDEXES
  - clause, 633–634
- UPDATE statement, 470, 474, 497, 610
- UPPER function, 483
- UROWID type, 513, 579
- User-defined locks, 250
- User global area (UGA), 127
  - dynamic performance
    - views, 129
  - LAG() function, 142
  - run\_query.sql, 133
  - SORT\_AREA\_SIZE parameter, 134
  - SQL\*Plus command line, 132
  - UNION ALL, 139
    - with Oracle9i Release 1, 128
- USER\_INDEXES view, 462
- USER\_INFO table, 674–675
- Utility background processes.
  - See Background processes
- UTL\_FILE routine, 250

■ V

- V\$LATCH view, 242
- V\$LOCK table, 227–229, 235
- V\$SESSION table, 227
- V\$SGA\_DYNAMIC\_COMPONENTS
  - parameter, 151
- V\$SGAINFO view, 166
- V\$SGASTAT view, 149
- V\$TRANSACTION table, 227–228
- VAR attribute, 742
- VARCHAR2(4000) data type, 478
- VARCHAR2 data type, 511
- Virtual column indexes, 490
- Virtual column
  - partitioning, 591, 613
- VSIZE function, 534

■ W

- WAIT [n] statement, 241
- WHERE clause, 131, 486, 539, 662
- WITHOUT VALIDATION
  - clause, 632
- WORKAREA\_SIZE\_POLICY
  - parameter, 129
- Workload Manager (WLM), 53

■ X, Y, Z

- XML manifest file, 71

# Expert Oracle Database Architecture

Third Edition



Thomas Kyte

Darl Kuhn

Apress®

## Expert Oracle Database Architecture

Copyright © 2014 by Thomas Kyte and Darl Kuhn

This work is subject to copyright. All rights are reserved by the Publisher, whether the whole or part of the material is concerned, specifically the rights of translation, reprinting, reuse of illustrations, recitation, broadcasting, reproduction on microfilms or in any other physical way, and transmission or information storage and retrieval, electronic adaptation, computer software, or by similar or dissimilar methodology now known or hereafter developed. Exempted from this legal reservation are brief excerpts in connection with reviews or scholarly analysis or material supplied specifically for the purpose of being entered and executed on a computer system, for exclusive use by the purchaser of the work. Duplication of this publication or parts thereof is permitted only under the provisions of the Copyright Law of the Publisher's location, in its current version, and permission for use must always be obtained from Springer. Permissions for use may be obtained through RightsLink at the Copyright Clearance Center. Violations are liable to prosecution under the respective Copyright Law.

ISBN-13 (pbk): 978-1-4302-6298-5

ISBN-13 (electronic): 978-1-4302-6299-2

Trademarked names, logos, and images may appear in this book. Rather than use a trademark symbol with every occurrence of a trademarked name, logo, or image we use the names, logos, and images only in an editorial fashion and to the benefit of the trademark owner, with no intention of infringement of the trademark.

The use in this publication of trade names, trademarks, service marks, and similar terms, even if they are not identified as such, is not to be taken as an expression of opinion as to whether or not they are subject to proprietary rights.

While the advice and information in this book are believed to be true and accurate at the date of publication, neither the authors nor the editors nor the publisher can accept any legal responsibility for any errors or omissions that may be made. The publisher makes no warranty, express or implied, with respect to the material contained herein.

Managing Director: Welmoed Spahr

Lead Editor: Jonathan Gennick

Developmental Editor: Douglas Pundick

Technical Reviewer: Melanie Caffrey, Christopher Beck, Frits Hoogland, Alex Fatkulin, and Stéphane Faroult

Editorial Board: Steve Anglin, Mark Beckner, Ewan Buckingham, Gary Cornell, Louise Corrigan, Jim DeWolf, Jonathan Gennick, Robert Hutchinson, Michelle Lowman, James Markham, Matthew Moodie, Jeff Olson, Jeffrey Pepper, Douglas Pundick, Ben Renow-Clarke, Dominic Shakeshaft, Gwenan Spearing, Matt Wade, Steve Weiss

Coordinating Editor: Jill Balzano

Copy Editor: Kim Burton-Weisman

Compositor: SPi Global

Indexer: SPi Global

Artist: SPi Global

Cover Designer: Anna Ishchenko

Distributed to the book trade worldwide by Springer Science+Business Media New York, 233 Spring Street, 6th Floor, New York, NY 10013. Phone 1-800-SPRINGER, fax (201) 348-4505, e-mail [orders-ny@springer-sbm.com](mailto:orders-ny@springer-sbm.com), or visit [www.springeronline.com](http://www.springeronline.com). Apress Media, LLC is a California LLC and the sole member (owner) is Springer Science + Business Media Finance Inc (SSBM Finance Inc). SSBM Finance Inc is a Delaware corporation.

For information on translations, please e-mail [rights@apress.com](mailto:rights@apress.com), or visit [www.apress.com](http://www.apress.com).

Apress and friends of ED books may be purchased in bulk for academic, corporate, or promotional use. eBook versions and licenses are also available for most titles. For more information, reference our Special Bulk Sales–eBook Licensing web page at [www.apress.com/bulk-sales](http://www.apress.com/bulk-sales).

Any source code or other supplementary material referenced by the author in this text is available to readers at [www.apress.com](http://www.apress.com). For detailed information about how to locate your book's source code, go to [www.apress.com/source-code/](http://www.apress.com/source-code/).

# Contents

<b>About the Authors</b> .....	<b>xvii</b>
<b>About the Technical Reviewers</b> .....	<b>xix</b>
<b>Acknowledgments</b> .....	<b>xxi</b>
<b>Introduction</b> .....	<b>xxiii</b>
<b>Setting Up Your Environment</b> .....	<b>xxxi</b>
<b>■ Chapter 1: Developing Successful Oracle Applications</b> .....	<b>1</b>
My Approach .....	2
The Black Box Approach.....	3
How (and How Not) to Develop Database Applications .....	11
Understanding Oracle Architecture.....	12
Understanding Concurrency Control.....	23
Multiversioning .....	27
Database Independence? .....	34
How Do I Make It Run Faster? .....	48
The DBA-Developer Relationship.....	51
Summary.....	51
<b>■ Chapter 2: Architecture Overview</b> .....	<b>53</b>
Defining Database and Instance .....	54
The SGA and Background Processes.....	61
Connecting to Oracle .....	63
Dedicated Server .....	63
Shared Server.....	65
Mechanics of Connecting over TCP/IP .....	67

Pluggable Databases.....	69
Reduced Resource Utilization.....	70
Reduced Maintenance .....	70
How Is a Pluggable Database Different?.....	71
Summary.....	71
<b>■ Chapter 3: Files .....</b>	<b>73</b>
Parameter Files .....	74
What Are Parameters?.....	75
Legacy init.ora Parameter Files.....	78
Server Parameter Files (SPFILEs).....	80
Converting to SPFILEs.....	80
Trace Files .....	88
Requested Trace Files.....	89
Trace Files Generated in Response to Internal Errors.....	94
Trace File Wrap-up.....	98
Alert File .....	99
Data Files .....	102
A Brief Review of File System Mechanisms .....	102
The Storage Hierarchy in an Oracle Database.....	104
Dictionary-Managed and Locally-Managed Tablespaces .....	107
Temp Files .....	109
Control Files .....	111
Redo Log Files.....	111
Online Redo Log.....	112
Archived Redo Log.....	114
Password Files .....	115
Change Tracking File .....	118
Flashback Logs .....	119
Flashback Database .....	119
Fast Recovery Area.....	120

DMP Files (EXP/IMP Files) .....	121
Data Pump Files .....	122
Flat Files.....	124
Summary.....	125
<b>■ Chapter 4: Memory Structures .....</b>	<b>127</b>
The Process Global Area and User Global Area .....	128
Manual PGA Memory Management .....	129
Automatic PGA Memory Management.....	135
Choosing Between Manual and Auto Memory Management.....	146
PGA and UGA Wrap-up.....	147
The System Global Area .....	148
Fixed SGA .....	153
Redo Buffer.....	153
Block Buffer Cache .....	155
Shared Pool .....	162
Large Pool.....	164
Java Pool .....	165
Streams Pool .....	165
SGA Memory Management.....	166
Summary.....	171
<b>■ Chapter 5: Oracle Processes .....</b>	<b>173</b>
Server Processes .....	173
Dedicated Server Connections .....	174
Shared Server Connections .....	176
Database Resident Connection Pooling (DRCP).....	177
Connections vs. Sessions .....	177
Dedicated Server vs. Shared Server vs. DRCP .....	183
Dedicated/Shared Server Wrap-up.....	186
Background Processes.....	187
Focused Background Processes .....	188
Utility Background Processes.....	199

Slave Processes .....	201
I/O Slaves.....	202
Pnnn: Parallel Query Execution Servers .....	202
Summary.....	203
<b>■ Chapter 6: Locking and Latching.....</b>	<b>205</b>
What Are Locks?.....	205
Locking Issues.....	208
Lost Updates.....	208
Pessimistic Locking.....	209
Optimistic Locking.....	210
Optimistic or Pessimistic Locking?.....	217
Blocking.....	217
Deadlocks .....	220
Lock Escalation.....	224
Lock Types.....	225
DML Locks .....	225
DDL Locks.....	236
Latches .....	240
Mutexes .....	249
Manual Locking and User-Defined Locks .....	250
Summary.....	251
<b>■ Chapter 7: Concurrency and Multiversioning.....</b>	<b>253</b>
What Are Concurrency Controls?.....	253
Transaction Isolation Levels .....	254
READ UNCOMMITTED.....	256
READ COMMITTED .....	257
REPEATABLE READ.....	259
SERIALIZABLE .....	261
READ ONLY.....	263



Implications of Multiversion Read Consistency.....	264
A Common Data Warehousing Technique That Fails.....	264
An Explanation for Higher Than Expected I/O on Hot Tables.....	265
Write Consistency.....	267
Consistent Reads and Current Reads .....	268
Seeing a Restart.....	270
Why Is a Restart Important to Us? .....	273
Summary.....	274
<b>■ Chapter 8: Transactions.....</b>	<b>275</b>
Transaction Control Statements .....	275
Atomicity .....	277
Statement-Level Atomicity .....	277
Procedure-Level Atomicity.....	279
Transaction-Level Atomicity .....	283
DDL and Atomicity .....	283
Durability.....	283
WRITE Extensions to COMMIT.....	284
COMMITs in a Nondistributed PL/SQL Block .....	285
Integrity Constraints and Transactions.....	287
IMMEDIATE Constraints .....	287
DEFERRABLE Constraints and Cascading Updates.....	287
Bad Transaction Habits.....	291
Committing in a Loop.....	292
Using Autocommit .....	298
Distributed Transactions.....	299
Autonomous Transactions .....	300
How Autonomous Transactions Work.....	301
When to Use Autonomous Transactions.....	303
Summary.....	305

<b>Chapter 9: Redo and Undo .....</b>	<b>307</b>
What Is Redo? .....	307
What Is Undo? .....	308
How Redo and Undo Work Together .....	312
Example INSERT-UPDATE-DELETE-COMMIT Scenario .....	312
Commit and Rollback Processing.....	316
What Does a COMMIT Do? .....	316
What Does a ROLLBACK Do? .....	323
Investigating Redo.....	324
Measuring Redo.....	324
Can I Turn Off Redo Log Generation? .....	326
Why Can't I Allocate a New Log? .....	330
Block Cleanout.....	331
Log Contention.....	334
Temporary Tables and Redo/Undo .....	336
Investigating Undo.....	341
What Generates the Most and Least Undo?.....	341
ORA-01555: Snapshot Too Old Error .....	343
Summary .....	354
<b>Chapter 10: Database Tables .....</b>	<b>355</b>
Types of Tables .....	355
Terminology.....	357
Segment .....	357
Segment Space Management .....	359
High-water Mark.....	360
FREELISTS .....	362
PCTFREE and PCTUSED .....	366
LOGGING and NOLOGGING.....	369
INITRANS and MAXTRANS .....	370

Heap Organized Tables .....	370
Index Organized Tables .....	373
Index Organized Tables Wrap-up .....	388
Index Clustered Tables .....	388
Index Clustered Tables Wrap-up .....	396
Hash Clustered Tables .....	396
Hash Clustered Tables Wrap-up .....	404
Sorted Hash Clustered Tables .....	405
Nested Tables .....	408
Nested Tables Syntax .....	408
Nested Table Storage .....	415
Nested Tables Wrap-up .....	418
Temporary Tables .....	419
Statistics Prior to 12c .....	422
Statistics Starting with 12c .....	426
Temporary Tables Wrap-up .....	430
Object Tables .....	431
Object Tables Wrap-up .....	437
Summary .....	438
■ <b>Chapter 11: Indexes</b> .....	<b>439</b>
An Overview of Oracle Indexes .....	439
B*Tree Indexes .....	441
Index Key Compression .....	444
Reverse Key Indexes .....	447
Descending Indexes .....	452
When Should You Use a B*Tree Index? .....	455
B*Trees Wrap-up .....	465

<b>Bitmap Indexes.....</b>	<b>465</b>
When Should You Use a Bitmap Index? .....	466
Bitmap Join Indexes .....	470
Bitmap Indexes Wrap-up .....	473
<b>Function-Based Indexes.....</b>	<b>473</b>
A Simple Function-Based Index Example.....	474
Indexing Only Some of the Rows.....	483
Implementing Selective Uniqueness .....	484
Caveat Regarding ORA-01743 .....	485
Function-Based Indexes Wrap-up .....	486
<b>Application Domain Indexes.....</b>	<b>486</b>
<b>Invisible Indexes.....</b>	<b>487</b>
<b>Multiple Indexes on the Same Column Combinations.....</b>	<b>489</b>
<b>Indexing Extended Columns.....</b>	<b>489</b>
Virtual Column Solution .....	490
Function-Based Index Solution.....	492
<b>Frequently Asked Questions and Myths About Indexes.....</b>	<b>494</b>
Do Indexes Work on Views?.....	494
Do Nulls and Indexes Work Together? .....	494
Should Foreign Keys Be Indexed? .....	497
Why Isn't My Index Getting Used? .....	498
Myth: Space Is Never Reused in an Index .....	504
Myth: Most Discriminating Elements Should Be First .....	507
<b>Summary.....</b>	<b>510</b>
<b>■ Chapter 12: Datatypes.....</b>	<b>511</b>
An Overview of Oracle Datatypes.....	511
Character and Binary String Types.....	514
NLS Overview .....	514
Character Strings.....	518

Binary Strings: RAW Types .....	525
Extended Datatypes .....	527
Number Types.....	529
NUMBER Type Syntax and Usage.....	531
BINARY_FLOAT/BINARY_DOUBLE Type Syntax and Usage.....	535
Non-Native Number Types.....	536
Performance Considerations .....	536
Long Types .....	538
Restrictions on LONG and LONG RAW Types.....	538
Coping with Legacy LONG Types.....	539
Dates, Timestamps, and Interval Types .....	545
Formats .....	545
DATE Type .....	546
TIMESTAMP Type .....	552
INTERVAL Type .....	559
LOB Types.....	562
Internal LOBs .....	563
BFILEs.....	577
ROWID/UROWID Types .....	579
Summary.....	579
<b>■ Chapter 13: Partitioning .....</b>	<b>581</b>
Partitioning Overview .....	582
Increased Availability.....	582
Reduced Administrative Burden .....	584
Enhanced Statement Performance.....	588
Reduced Contention in an OLTP System.....	590
Table Partitioning Schemes.....	590
Range Partitioning .....	591
Hash Partitioning .....	594
List Partitioning .....	599

Interval Partitioning .....	601
Reference Partitioning .....	606
Interval Reference Partitioning .....	611
Virtual Column Partitioning .....	613
Composite Partitioning .....	614
Row Movement .....	617
Table Partitioning Schemes Wrap-up .....	619
<b>Partitioning Indexes.....</b>	<b>620</b>
Local Indexes vs. Global Indexes .....	621
Local Indexes.....	621
Global Indexes .....	627
Partial Indexes .....	642
<b>Partitioning and Performance, Revisited .....</b>	<b>644</b>
<b>Ease of Maintenance Features .....</b>	<b>650</b>
Multiple Partition Maintenance Operations .....	650
Cascade Truncate .....	653
Cascade Exchange .....	654
<b>Auditing and Segment Space Compression .....</b>	<b>656</b>
<b>Summary.....</b>	<b>657</b>
<b>■ Chapter 14: Parallel Execution .....</b>	<b>659</b>
<b>When to Use Parallel Execution.....</b>	<b>660</b>
A Parallel Processing Analogy .....	661
<b>Oracle Exadata .....</b>	<b>662</b>
<b>Parallel Query .....</b>	<b>663</b>
<b>Parallel DML .....</b>	<b>668</b>
<b>Parallel DDL.....</b>	<b>672</b>
Parallel DDL and Data Loading Using External Tables .....	673
Parallel DDL and Extent Trimming .....	675

Procedural Parallelism .....	684
Parallel Pipelined Functions .....	684
Do-It-Yourself Parallelism .....	687
Old School Do-It-Yourself Parallelism.....	691
Summary.....	695
<b>■ Chapter 15: Data Loading and Unloading .....</b>	<b>697</b>
External Tables .....	697
Setting Up External Tables.....	698
Dealing with Errors .....	707
Using an External Table to Load Different Files .....	711
Multiuser Issues .....	711
Preprocessing.....	712
External Tables Summary .....	722
Data Pump Unload.....	723
SQLLDR.....	725
Loading Data with SQLLDR FAQs.....	729
SQLLDR Caveats .....	755
SQLLDR Summary .....	756
Flat File Unload.....	756
Summary.....	765
<b>Index.....</b>	<b>767</b>

# About the Authors



I am **Tom Kyte**. I have been working for Oracle since version 7.0.9 (that's 1993 for people who don't mark time by Oracle versions). However, I've been working with Oracle since about version 5.1.5c (the \$99 single-user version for DOS on 360KB floppy disks). Before coming to work at Oracle, I worked for more than six years as a systems integrator, building large-scale, heterogeneous databases and applications, mostly for military and government customers. These days, I spend a great deal of my time working with the Oracle database and, more specifically, helping people who are using the Oracle database. I work directly with customers, either in specifying and building their systems or, more frequently, in helping them rebuild or tune them ("tuning" frequently being a synonym for rebuilding). In addition, I am the Tom behind the "Ask Tom" column in *Oracle Magazine*,

where I answer people's questions about the Oracle database and tools. On a typical day, I receive and answer dozens of questions at <http://asktom.oracle.com>. Every two months, I publish a "best of" in the magazine (all of the questions asked are available on the Web, stored in an Oracle database, of course). Additionally, I give technical seminars covering much of the material you'll find in this book. Basically, I spend a lot of my time helping people be successful with the Oracle database. Oh yes, in my spare time, I build applications and develop software within Oracle Corporation itself.

This book is a reflection of what I do every day. The material within covers topics and questions that I see people struggling with every day. These issues are covered from a perspective of "When I use this, I do it this way." It is the culmination of many years of experience using the product in myriad situations.



**Darl Kuhn** is a DBA/developer working for Oracle. He also teaches Oracle classes at Regis University in Denver, Colorado, and is an active member of the Rocky Mountain Oracle Users Group. Darl enjoys sharing knowledge, which has led to several book projects over the years.



# About the Technical Reviewers



**Melanie Caffrey** is a senior development manager for Oracle Corporation, providing front-end and back-end Oracle solutions for the business needs of various clients. She is co-author of several technical publications including *Expert Oracle Practices: Oracle Database Administration from the Oak Table* published by Apress, as well as *Oracle Web Application Programming for PL/SQL Developers*, *The Oracle DBA Interactive Workbook*, and *Oracle Database Administration: The Complete Video Course*, all published by Prentice Hall. She instructed students in Columbia University's Computer Technology and Applications program in New York City, teaching advanced Oracle database administration and PL/SQL development. She is also a frequent Oracle conference speaker.



**Christopher Beck** has a degree in computer science from Rutgers University and has been working with multiple DBMSs for more than 19 years. He has spent the last 15 years as an Oracle employee, where he is currently a principal technologist focusing on core database technologies. He is a co-inventor of two US patents on software methodologies, which were the basis for what is now known as Oracle Application Express. Chris has reviewed other Oracle books, including Tom's first book, *Expert One-On-One* (Apress, 2003), and is himself the co-author of two books, *Beginning Oracle Programming* (Apress, 2003) and *Mastering Oracle PL/SQL* (Apress, 2004). He resides in Northern Virginia with his wife, Marta, and four children, and when not spending time with them, can usually be found wasting time playing video games or watching Series A football.

**Frits Hoogland** is an IT professional specializing in Oracle database performance and internals. Frits frequently presents on Oracle technical topics at conferences around the world. In 2009 he received an Oracle ACE award from the Oracle Technology Network and a year later became an Oracle ACE Director. In 2010 he joined the OakTable Network. In addition to developing his Oracle expertise, Frits works with PostgreSQL and modern operating systems. Frits currently works at Accenture in the Accenture Enkitech group.



**Alex Fatkulin** is a master of the full range of Oracle technologies. This mastery has been essential in addressing some of the greatest challenges that his customers meet.

Alex draws on years of experience, working with some of the world's largest companies, where he has been involved with almost everything related to Oracle databases—from data modeling to architecting high-availability solutions and resolving the performance issues of extremely large production sites.

Alex holds a bachelor of computer science from Far Eastern National University in Vladivostok, Russia. He is also an Oracle ACE and a proud OakTable member.

**Stéphane Faroult** first learned SQL in 1983 on IBM's SQL/DS, and in 1986 he joined a very small team at the newly created Oracle France after teaching for a year and a half at the University of Ottawa in Canada, and then spending a year with IBM France. He left Oracle in 1988 for software development, and returned to databases through consulting in August 1989. From then on, he has worked with databases, mostly Oracle, consulting work for major French companies for 25 years. He has published books on SQL, given a series of seminars for Oracle in Asia, posted database tutorials on YouTube, and taught database classes to French IT students while consulting with a major bank. Enjoying teaching quite a lot, Stéphane is currently teaching full-time computer science at Kansas State University.

# Acknowledgments

I would like to thank many people for helping me complete this book.

First, I would like to thank you, the reader of this book. There is a high probability that if you are reading this book, you have participated in my site <http://asktom.oracle.com> in some fashion, perhaps by asking a question or two. It is that act—the act of asking questions, and of questioning the answers—that provides me with the material for the book and the knowledge behind the material. Without the questions, I would not be as knowledgeable about the Oracle database as I am. So, it is you who ultimately makes this book possible.

I would like to thank Tony Davis for his previous work making my work read well. If you enjoy the flow of the sections, the number of section breaks, and the clarity, then that is in some part due to him. I have worked with Tony writing technical material since the year 2000 and have watched his knowledge of Oracle grow over that time. He now has the ability to not only edit the material, but in many cases tech edit it as well. Many of the examples in this book are there because of him (pointing out that the casual reader was not going to “get it” without them). Tony did not edit the second edition of this book, but the contents rely heavily on the first edition. This book would not be what it is without him.

Without a technical review team of the caliber I had during the writing of this book and the previous edition, I would be nervous about the content. The first edition had Jonathan Lewis, Roderick Manalac, Michael Möller, and Gabe Romanescu as technical reviewers. They spent many hours poring over the material and verifying it was technically accurate as well as useful in the real world. This second edition had a team of similar caliber: Melanie Caffrey, Christopher Beck, and Jason Straub. I firmly believe a technical book should be judged not only by who wrote it, but also by who reviewed it. Given these seven people, I feel confident in the material.

At Oracle, I work with the best and brightest people I have ever known, and they all have contributed in one way or another. I would like to thank Ken Jacobs in particular for his support and enthusiasm over the years. Ken is unfortunately (for us) no longer with Oracle Corporation, but his impact will long be felt.

Lastly, but most important, I would like to acknowledge the unceasing support I’ve received from my family. You know you must be important to someone when you try to do something that takes a lot of “outside of work hours” and that someone lets you know about it. Without the continual support of my wife, Melanie (who also was a technical reviewer on the book), son Alan, and daughter Megan, I don’t see how I could have finished this book.

—Tom Kyte

I’d like to thank Tom for inviting me to work with him on this book; this is a great technical honor. I’d also like to acknowledge Jonathan Gennick; his guidance (over many years and books) laid the foundation for me being able to work on a book of this caliber. And I’d like to thank Heidi, Lisa, and Brandi; without their support, I could not have successfully participated.

—Darl Kuhn

# Setting Up Your Environment

In this section, I will cover how to set up an environment capable of executing the examples in this book. Specifically:

- How to setup the EODA account used for many of the examples in this book
- How to set up the SCOTT/TIGER demonstration schema properly
- The environment you need to have up and running
- Configuring AUTOTRACE, a SQL\*Plus facility
- Installing StatsPack
- Installing and running runstats, and other custom utilities used throughout the book
- The coding conventions I use in this book

All of the non-Oracle supplied scripts are available for download from the [www.apress.com](http://www.apress.com) web site. If you download the scripts, there will be a chNN folder that contains the scripts for each chapter (where NN is the number of the chapter). The ch00 folder contains the scripts listed here in the Setting Up Your Environment section.

## Setting Up the EODA Schema

The EODA user is used for most of the examples in this book. This is simply a schema that has been granted the DBA role and granted execute and select on certain objects owned by SYS:

```
connect / as sysdba
define username=eoda
define usernamepwd=foo
create user &&username identified by &&usernamepwd;
grant dba to &&username;
grant execute on dbms_stats to &&username;
grant select on V_$STATNAME to &&username;
grant select on V_$MYSTAT to &&username;
grant select on V_$LATCH to &&username;
grant select on V_$TIMER to &&username;
conn &&username/&&usernamepwd
```

You can setup whatever user you want to run the examples in this book. I picked the username of EODA simply because it's an acronym for the title of the book.

## Setting Up the SCOTT/TIGER Schema

The SCOTT/TIGER schema will often already exist in your database. It is generally included during a typical installation, but it is not a mandatory component of the database. You may install the SCOTT example schema into any database account; there is nothing magic about using the SCOTT account. You could install the EMP/DEPT tables directly into your own database account if you wish.

Many of my examples in this book draw on the tables in the SCOTT schema. If you would like to be able to work along with them, you will need these tables. If you are working on a shared database, it would be advisable to install your own copy of these tables in some account other than SCOTT to avoid side effects caused by other users mucking about with the same data.

## Executing the Script

In order to create the SCOTT demonstration tables, you will simply:

- `cd $ORACLE_HOME/sqlplus/demo`
- run `demobl.d.sql` when connected as any user

---

■ **Note** In Oracle 10g and above, you must install the demonstration subdirectories from the installation media. I have reproduced the necessary components of `demobl.d.sql` as well.

---

The `demobl.d.sql` script will create and populate five tables. When it is complete, it exits SQL\*Plus automatically, so don't be surprised when SQL\*Plus disappears after running the script—it's supposed to do that.

The standard demo tables do not have any referential integrity defined on them. Some of my examples rely on them having referential integrity. After you run `demobl.d.sql`, it is recommended you also execute the following:

```
alter table emp add constraint emp_pk primary key(empno);
alter table dept add constraint dept_pk primary key(deptno);
alter table emp add constraint emp_fk_dept foreign key(deptno) references dept;
alter table emp add constraint emp_fk_emp foreign key(mgr) references emp;
```

This finishes off the installation of the demonstration schema. If you would like to drop this schema at any time to clean up, you can simply execute `$ORACLE_HOME/sqlplus/demo/demodrop.sql`. This will drop the five tables and exit SQL\*Plus.

---

■ **Tip** You can also find the SQL to create and drop the SCOTT user in the `$ORACLE_HOME/rdbms/admin/utlsamp1.sql` script.

---

## Creating the Schema Without the Script

In the event you do not have access to `demobl.d.sql`, the following is sufficient to run the examples in this book:

```
CREATE TABLE EMP
(EMPNO NUMBER(4) NOT NULL,
 ENAME VARCHAR2(10),
  JOB VARCHAR2(9),
  MGR NUMBER(4),
  HIREDATE DATE,
  SAL NUMBER(7, 2),
  COMM NUMBER(7, 2),
  DEPTNO NUMBER(2)
);

INSERT INTO EMP VALUES (7369, 'SMITH', 'CLERK', 7902,
 TO_DATE('17-DEC-1980', 'DD-MON-YYYY'), 800, NULL, 20);
INSERT INTO EMP VALUES (7499, 'ALLEN', 'SALESMAN', 7698,
 TO_DATE('20-FEB-1981', 'DD-MON-YYYY'), 1600, 300, 30);
INSERT INTO EMP VALUES (7521, 'WARD', 'SALESMAN', 7698,
 TO_DATE('22-FEB-1981', 'DD-MON-YYYY'), 1250, 500, 30);
INSERT INTO EMP VALUES (7566, 'JONES', 'MANAGER', 7839,
 TO_DATE('2-APR-1981', 'DD-MON-YYYY'), 2975, NULL, 20);
INSERT INTO EMP VALUES (7654, 'MARTIN', 'SALESMAN', 7698,
 TO_DATE('28-SEP-1981', 'DD-MON-YYYY'), 1250, 1400, 30);
INSERT INTO EMP VALUES (7698, 'BLAKE', 'MANAGER', 7839,
 TO_DATE('1-MAY-1981', 'DD-MON-YYYY'), 2850, NULL, 30);
INSERT INTO EMP VALUES (7782, 'CLARK', 'MANAGER', 7839,
 TO_DATE('9-JUN-1981', 'DD-MON-YYYY'), 2450, NULL, 10);
INSERT INTO EMP VALUES (7788, 'SCOTT', 'ANALYST', 7566,
 TO_DATE('09-DEC-1982', 'DD-MON-YYYY'), 3000, NULL, 20);
INSERT INTO EMP VALUES (7839, 'KING', 'PRESIDENT', NULL,
 TO_DATE('17-NOV-1981', 'DD-MON-YYYY'), 5000, NULL, 10);
INSERT INTO EMP VALUES (7844, 'TURNER', 'SALESMAN', 7698,
 TO_DATE('8-SEP-1981', 'DD-MON-YYYY'), 1500, 0, 30);
INSERT INTO EMP VALUES (7876, 'ADAMS', 'CLERK', 7788,
 TO_DATE('12-JAN-1983', 'DD-MON-YYYY'), 1100, NULL, 20);
INSERT INTO EMP VALUES (7900, 'JAMES', 'CLERK', 7698,
 TO_DATE('3-DEC-1981', 'DD-MON-YYYY'), 950, NULL, 30);
INSERT INTO EMP VALUES (7902, 'FORD', 'ANALYST', 7566,
 TO_DATE('3-DEC-1981', 'DD-MON-YYYY'), 3000, NULL, 20);
INSERT INTO EMP VALUES (7934, 'MILLER', 'CLERK', 7782,
 TO_DATE('23-JAN-1982', 'DD-MON-YYYY'), 1300, NULL, 10);

CREATE TABLE DEPT
(DEPTNO NUMBER(2),
 DNAME VARCHAR2(14),
 LOC VARCHAR2(13)
);
```

```
INSERT INTO DEPT VALUES (10, 'ACCOUNTING', 'NEW YORK');
INSERT INTO DEPT VALUES (20, 'RESEARCH', 'DALLAS');
INSERT INTO DEPT VALUES (30, 'SALES', 'CHICAGO');
INSERT INTO DEPT VALUES (40, 'OPERATIONS', 'BOSTON');
```

If you create the schema by executing the preceding commands, do remember to go back to the previous subsection and execute the commands to create the constraints.

## Setting Your Environment

Most of the examples in this book are designed to run 100 percent in the SQL\*Plus environment. Other than SQL\*Plus though, there is nothing else to set up and configure. I can make a suggestion, however, on using SQL\*Plus. Almost all of the examples in this book use DBMS\_OUTPUT in some fashion. In order for DBMS\_OUTPUT to work, the following SQL\*Plus command must be issued:

```
SQL> set serveroutput on
```

If you are like me, typing this in each and every time would quickly get tiresome. Fortunately, SQL\*Plus allows us to setup a `login.sql` file, a script that is executed each and every time we start SQL\*Plus. Further, it allows us to set an environment variable, `SQLPATH`, so that it can find this `login.sql` script, no matter what directory it is in.

The following is the `login.sql` script I use for all examples in this book:

```
define _editor=vi
set serveroutput on size 1000000
set trimspool on
set long 5000
set linesize 100
set pagesize 9999
column plan_plus_exp format a80
set sqlprompt '&_user. @&_connect_identifier.> '
```

An annotated version of this file is as follows:

- `define _editor=vi`: Set up the default editor SQL\*Plus would use. You may set that to be your favorite text editor (not a word processor) such as Notepad or emacs.
- `set serveroutput on size unlimited`: Enable DBMS\_OUTPUT to be on by default (hence we don't have to type `set serveroutput on` every time). Also set the default buffer size to be as large as possible.
- `set trimspool on`: When spooling text, lines will be blank-trimmed and not fixed width. If this is set off (the default), spooled lines will be as wide as your `linesize` setting.
- `set long 5000`: Sets the default number of bytes displayed when selecting LONG and CLOB columns.
- `set linesize 100`: Set the width of the lines displayed by SQL\*Plus to be 100 characters.
- `set pagesize 9999`: Set the `pagesize`, which controls how frequently SQL\*Plus prints out headings, to a big number (we get one set of headings per page).
- `column plan_plus_exp format a80`: This sets the default width of the explain plan output we receive with AUTOTRACE. `a80` is generally wide enough to hold the full plan.

The last bit in the `login.sql` sets up my SQL\*Plus prompt for me:

```
set sqlprompt '&_user. @&_connect_identifier.> '
```

That makes my prompt look like the following, so that I know who I am as well as where I am:

```
EODA@ORA12CR1>
```

## Setting Up AUTOTRACE in SQL\*Plus

AUTOTRACE is a facility within SQL\*Plus to show us the explain plan of the queries we've executed, and the resources they used. This book makes extensive use of this facility. There is more than one way to get AUTOTRACE configured.

### Initial Setup

AUTOTRACE relies on a table named `PLAN_TABLE` being available. Starting with Oracle 10g, the `SYS` schema contains a global temporary table named `PLAN_TABLE$`. All required privileges to this table have been granted to `PUBLIC` and there is a public synonym (named `PLAN_TABLE` that points to `SYS.PLAN_TABLE$`). This means any user can access this table.

---

■ **Note** If you're using a very old version of Oracle, you can manually create the `PLAN_TABLE` by executing the `$ORACLE_HOME/rdbms/admin/utlxplan.sql` script.

---

You must also create and grant the `PLUSTRACE` role:

- `cd $ORACLE_HOME/sqlplus/admin`
- log into SQL\*Plus as `SYS` or as a user granted the `SYSDBA` privilege
- `run @plustrce`
- `run GRANT PLUSTRACE TO PUBLIC;`

You can replace `PUBLIC` in the `GRANT` command with some user if you want.

### Controlling the Report

You can automatically get a report on the execution path used by the SQL optimizer and the statement execution statistics. The report is generated after successful SQL DML (that is, `SELECT`, `DELETE`, `UPDATE`, `MERGE`, and `INSERT`) statements. It is useful for monitoring and tuning the performance of these statements.

You can control the report by setting the `AUTOTRACE` system variable.

- `SET AUTOTRACE OFF:` No AUTOTRACE report is generated. This is the default.
- `SET AUTOTRACE ON EXPLAIN:` The AUTOTRACE report shows only the optimizer execution path.
- `SET AUTOTRACE ON STATISTICS:` The AUTOTRACE report shows only the SQL statement execution statistics.
- `SET AUTOTRACE ON:` The AUTOTRACE report includes both the optimizer execution path and the SQL statement execution statistics.



- `SET AUTOTRACE TRACEONLY`: Like `SET AUTOTRACE ON`, but suppresses the printing of the user's query output, if any.
- `SET AUTOTRACE TRACEONLY EXPLAIN`: Like `SET AUTOTRACE ON`, but suppresses the printing of the user's query output (if any), and also suppresses the execution statistics.

## Setting Up StatsPack

StatsPack is designed to be installed when connected as `SYS` (`CONNECT/AS SYSDBA`) or as a user granted the `SYSDBA` privilege. In many installations, installing StatsPack will be a task that you must ask the DBA or administrators to perform.

Installing StatsPack is trivial. You simply run `@spcreate.sql`. This script will be found in `$ORACLE_HOME/rdbms/admin` and should be executed when connected as `SYS` via `SQL*Plus`.

You'll need to know the following three pieces of information before running the `spcreate.sql` script:

- The password you would like to use for the `PERFSTAT` schema that will be created
- The default tablespace you would like to use for `PERFSTAT`
- The temporary tablespace you would like to use for `PERFSTAT`

Running the script will look something like this:

```
$ sqlplus / as sysdba
```

```
SQL*Plus: Release 12.1.0.1.0 Production on Fri May 23 15:45:05 2014
```

```
Copyright (c) 1982, 2013, Oracle. All rights reserved.
```

```
Connected to:
```

```
Oracle Database 12c Enterprise Edition Release 12.1.0.1.0 - 64bit Production
```

```
With the Partitioning, OLAP, Advanced Analytics and Real Application Testing options
```

```
SYS@ORA12CR1> @spcreate
```

```
Choose the PERFSTAT user's password
```

```
-----
```

```
Not specifying a password will result in the installation FAILING
```

```
Enter value for perfstat_password:
```

```
... <output omitted for brevity> ...
```

The script will prompt you for the needed information as it executes. In the event you make a typo or inadvertently cancel the installation, you should use `spdrop.sql` found in `$ORACLE_HOME/rdbms/admin` to remove the user and installed views prior to attempting another install of StatsPack. The StatsPack installation will create a file called `spcpkg.lis`. You should review this file for any possible errors that might have occurred. The user, views, and PL/SQL code should install cleanly, however, as long as you supplied valid tablespace names (and didn't already have a user `PERFSTAT`).

---

■ **Tip** StatsPack is documented in the following text file: `$ORACLE_HOME/rdbms/admin/spdoc.txt`.

---

# Custom Scripts

In this section, I will describe the requirements (if any) needed by various scripts used throughout this book. As well, we will investigate the code behind the scripts.

## Runstats

Runstats is a tool I developed to compare two different methods of doing the same thing and show which one is superior. You supply the two different methods and Runstats does the rest. Runstats simply measures three key things:

- *Wall clock or elapsed time:* This is useful to know, but not the most important piece of information.
- *System statistics:* This shows, side by side, how many times each approach did something (such as a parse call, for example) and the difference between the two.
- *Latching:* This is the key output of this report.

As we'll see in this book, latches are a type of lightweight lock. Locks are serialization devices. Serialization devices inhibit concurrency. Applications that inhibit concurrency are less scalable, can support fewer users, and require more resources. Our goal is always to build applications that have the potential to scale—ones that can service one user as well as 1,000 or 10,000. The less latching we incur in our approaches, the better off we will be. I might choose an approach that takes longer to run on the wall clock but that uses 10 percent of the latches. I know that the approach that uses fewer latches will scale substantially better than the approach that uses more latches.

Runstats is best used in isolation; that is, on a single-user database. We will be measuring statistics and latching (locking) activity that result from our approaches. We do not want other sessions to contribute to the system's load or latching while this is going on. A small test database is perfect for these sorts of tests. I frequently use my desktop PC or laptop, for example.

---

■ **Note** I believe all developers should have a test bed database they control to try ideas on, without needing to ask a DBA to do something all of the time. Developers definitely should have a database on their desktop, given that the licensing for the personal developer version is simply “use it to develop and test with, do not deploy, and you can just have it.” This way, there is nothing to lose! Also, I've taken some informal polls at conferences and seminars. Virtually every DBA out there started as a developer! The experience and training developers could get by having their own database—being able to see how it really works—pays dividends in the long run.

---

In order to use Runstats, you need to set up access to several V\$ views, create a table to hold the statistics, and create the Runstats package. You will need access to four V\$ tables (those magic, dynamic performance tables): V\$STATNAME, V\$MYSTAT, V\$TIMER and V\$LATCH. Here is a view I use:

```
create or replace view stats
as select 'STAT...' || a.name name, b.value
   from v$statname a, v$mystat b
   where a.statistic# = b.statistic#
union all
select 'LATCH.' || name, gets
   from v$latch
union all
select 'STAT...Elapsed Time', hsecs from v$timer;
```

■ **Note** The actual object names you need to be granted access to will be `V_$STATNAME`, `V_$MYSTAT`, and so on—that is, the object name to use in the grant will start with `V_` not `V$`. The `V$` name is a synonym that points to the underlying view with a name that starts with `V_`. So, `V$STATNAME` is a synonym that points to `V_``$STATNAME` – a view. You need to be granted access to the view.

You can either have `SELECT` on `V$STATNAME`, `V$MYSTAT`, `V$TIMER`, and `V$LATCH` granted directly to you (so you can create the view yourself) or you can have someone that does have `SELECT` on those objects create the view for you and grant `SELECT` privileges on the view to you.

Once you have that set up, all you need is a small table to collect the statistics:

```
create global temporary table run_stats
( runid varchar2(15),
  name varchar2(80),
  value int )
on commit preserve rows;
```

Last, you need to create the package that is `Runstats`. It contains three simple API calls:

- `RS_START` (`Runstats Start`) to be called at the beginning of a `Runstats` test
- `RS_MIDDLE` to be called in the middle, as you might have guessed
- `RS_STOP` to finish off and print the report

The specification is as follows:

```
EODA@ORA12CR1> create or replace package runstats_pkg
2 as
3   procedure rs_start;
4   procedure rs_middle;
5   procedure rs_stop( p_difference_threshold in number default 0 );
6 end;
7 /
Package created.
```

The parameter, `p_difference_threshold`, is used to control the amount of data printed at the end. `Runstats` collects statistics and latching information for each run, and then prints a report of how much of a resource each test (each approach) used and the difference between them. You can use this input parameter to see only the statistics and latches that had a difference greater than this number. By default, this is zero, and you see all of the outputs.

Next, we'll look at the package body procedure by procedure. The package begins with some global variables. These will be used to record the elapsed times for our runs:

```
EODA@ORA12CR1> create or replace package body runstats_pkg
2 as
3
4   g_start number;
5   g_run1 number;
6   g_run2 number;
7
```

Next is the RS\_START routine. This will simply clear out our statistics holding table and then populate it with the “before” statistics and latches. It will then capture the current timer value, a clock of sorts that we can use to compute elapsed times in hundredths of seconds:

```

8 procedure rs_start
9 is
10 begin
11   delete from run_stats;
12
13   insert into run_stats
14     select 'before', stats.* from stats;
15
16   g_start := dbms_utility.get_cpu_time;
17 end;
18

```

Next is the RS\_MIDDLE routine. This procedure simply records the elapsed time for the first run of our test in G\_RUN1. Then it inserts the current set of statistics and latches. If we were to subtract these values from the ones we saved previously in RS\_START, we could discover how many latches the first method used, how many cursors (a statistic) it used, and so on.

Last, it records the start time for our next run:

```

19 procedure rs_middle
20 is
21 begin
22   g_run1 := (dbms_utility.get_cpu_time-g_start);
23
24   insert into run_stats
25     select 'after 1', stats.* from stats;
26
27   g_start := dbms_utility.get_cpu_time;
28 end;
29

```

The next and final routine in this package is the RS\_STOP routine. Its job is to print out the aggregate CPU times for each run and then print out the difference between the statistic/latching values for each of the two runs (only printing out those that exceed the threshold):

```

30 procedure rs_stop(p_difference_threshold in number default 0)
31 is
32 begin
33   g_run2 := (dbms_utility.get_cpu_time-g_start);
34
35   dbms_output.put_line( 'Run1 ran in ' || g_run1 || ' cpu hsecs' );
36   dbms_output.put_line( 'Run2 ran in ' || g_run2 || ' cpu hsecs' );
37
38   if ( g_run2 <> 0 )
39   then
40     dbms_output.put_line
41       ( 'run 1 ran in ' || round(g_run1/g_run2*100,2) ||
42         '% of the time' );
43   end if;

```

```

44  dbms_output.put_line( chr(9) );
45
46  insert into run_stats
47  select 'after 2', stats.* from stats;
48
49  dbms_output.put_line
50  ( rpad( 'Name', 30 ) || lpad( 'Run1', 16 ) ||
51  lpad( 'Run2', 16 ) || lpad( 'Diff', 16 ) );
52
53  for x in
54  ( select rpad( a.name, 30 ) ||
55    to_char( b.value-a.value, '999,999,999,999' ) ||
56    to_char( c.value-b.value, '999,999,999,999' ) ||
57    to_char( ( (c.value-b.value)-(b.value-a.value)),
58    '999,999,999,999' ) data
59    from run_stats a, run_stats b, run_stats c
60    where a.name = b.name
61    and b.name = c.name
62    and a.runid = 'before'
63    and b.runid = 'after 1'
64    and c.runid = 'after 2'
65
66    and abs( (c.value-b.value) - (b.value-a.value) )
67    > p_difference_threshold
68    order by abs( (c.value-b.value)-(b.value-a.value))
69  ) loop
70  dbms_output.put_line( x.data );
71  end loop;
72
73  dbms_output.put_line( chr(9) );
74  dbms_output.put_line
75  ( 'Run1 latches total versus runs -- difference and pct' );
76  dbms_output.put_line
77  ( lpad( 'Run1', 14 ) || lpad( 'Run2', 19 ) ||
78    lpad( 'Diff', 18 ) || lpad( 'Pct', 11 ) );
79
80  for x in
81  ( select to_char( run1, '9,999,999,999,999' ) ||
82    to_char( run2, '9,999,999,999,999' ) ||
83    to_char( diff, '9,999,999,999,999' ) ||
84    to_char( round( run1/decode( run2, 0, to_number(0), run2) *100,2 ), '99,999.99' ) || '%' data
85    from ( select sum(b.value-a.value) run1, sum(c.value-b.value) run2,
86    sum( (c.value-b.value)-(b.value-a.value)) diff
87    from run_stats a, run_stats b, run_stats c
88    where a.name = b.name
89    and b.name = c.name
90    and a.runid = 'before'
91    and b.runid = 'after 1'
92    and c.runid = 'after 2'
93    and a.name like 'LATCH%'
94    )
95  ) loop

```

```

96     dbms_output.put_line( x.data );
97     end loop;
98 end;
99
100 end;
101 /
Package body created.

```

Now you are ready to use Runstats. By way of example, we'll demonstrate how to use Runstats to see which is more efficient, a single bulk INSERT versus row-by-row processing. We'll start by setting up two tables into which we'll insert 1,000,000 rows (the BIG\_TABLE table creation script is provided later in this section):

```

EODA@ORA12CR1> create table t1
  2 as
  3 select * from big_table
  4 where 1=0;
Table created.

```

```

EODA@ORA12CR1> create table t2
  2 as
  3 select * from big_table
  4 where 1=0;
Table created.

```

And now we are ready to perform the first method of inserting the records, using a single SQL statement. We start by calling RUNSTATS\_PKG.RS\_START:

```

EODA@ORA12CR1> exec runstats_pkg.rs_start;
PL/SQL procedure successfully completed.

```

```

EODA@ORA12CR1> insert into t1
  2 select *
  3   from big_table
  4   where rownum <= 1000000;
1000000 rows created.

```

```

EODA@ORA12CR1> commit;
Commit complete.

```

Now we are ready to perform the second method, row-by-row insertion of data:

```

EODA@ORA12CR1> exec runstats_pkg.rs_middle;
PL/SQL procedure successfully completed.

```

```
EODA@ORA12CR1> begin
  2     for x in ( select *
  3                 from big_table
  4                 where rownum <= 1000000 )
  5     loop
  6         insert into t2 values X;
  7     end loop;
  8     commit;
  9 end;
10 /
PL/SQL procedure successfully completed.
```

And finally, we'll generate the report:

```
EODA@ORA12CR1> exec runstats_pkg.rs_stop(1000000)
Run1 ran in 119 cpu hsecs
Run2 ran in 3376 cpu hsecs
run 1 ran in 3.52% of the time
```

Name	Run1	Run2	Diff
STAT...execute count	29	1,000,032	1,000,003
STAT...opened cursors cumulati	29	1,000,035	1,000,006
LATCH.shared pool	582	1,001,466	1,000,884
STAT...session logical reads	148,818	1,158,009	1,009,191
STAT...recursive calls	183	1,010,218	1,010,035
STAT...db block changes	95,964	2,074,283	1,978,319
LATCH.cache buffers chains	443,882	5,462,356	5,018,474
STAT...undo change vector size	3,620,400	67,938,496	64,318,096
STAT...KTFB alloc space (block	109,051,904	176,160,768	67,108,864
STAT...redo size	105,698,540	384,717,388	279,018,848
STAT...logical read bytes from	1,114,251,264	9,300,803,584	8,186,552,320

```
Run1 latches total versus runs -- difference and pct
Run1          Run2          Diff          Pct
555,593      6,795,317      6,239,724      8.18%
```

PL/SQL procedure successfully completed.

This confirms you have the RUNSTATS\_PKG package installed and shows you why you should use a single SQL statement instead of a bunch of procedural code when developing applications whenever possible!

## Mystat

The `mystat.sql` and its companion, `mystat2.sql`, are used to show the increase in some Oracle "statistic" before and after some operation. The `mystat.sql` script captures the begin value of some statistic:

```
set echo off
set verify off
column value new_val V
define S="&1"
```

```

set autotrace off
select a.name, b.value
from v$statname a, v$mystat b
where a.statistic# = b.statistic#
and lower(a.name) = lower('&S')
/
set echo on

```

And `mystat2.sql` reports the difference (&V is populated by running the first script, `mystat.sql`—it uses the SQL\*Plus `NEW_VAL` feature for that. It contains the last VALUE selected from the preceding query):

```

set echo off
set verify off
select a.name, b.value V, to_char(b.value-&V,'999,999,999,999') diff
from v$statname a, v$mystat b
where a.statistic# = b.statistic#
and lower(a.name) = lower('&S')
/
set echo on

```

For example, to see how much redo is generated by an UPDATE statement, we can do the following:

```

EODA@ORA12CR1> @mystat "redo size"
EODA@ORA12CR1> set echo off

```

NAME	VALUE
redo size	491167892

```

EODA@ORA12CR1> update big_table set owner = lower(owner)
  2 where rownum <= 1000;

```

1000 rows updated.

```

EODA@ORA12CR1> @mystat2
EODA@ORA12CR1> set echo off

```

NAME	V DIFF	
redo size	491265640	97,748

This shows our UPDATE of 1,000 rows generated 97,748 bytes of redo.



## Show\_Space

The SHOW\_SPACE routine prints detailed space utilization information for database segments. Here is the interface to it:

```
EODA@ORA12CR1> desc show_space
PROCEDURE show_space
Argument Name          Type                In/Out Default?
-----
P_SEGNAME              VARCHAR2           IN
P_OWNER                VARCHAR2           IN    DEFAULT
P_TYPE                 VARCHAR2           IN    DEFAULT
P_PARTITION            VARCHAR2           IN    DEFAULT
```

The arguments are as follows:

- P\_SEGNAME: Name of the segment—the table or index name, for example.
- P\_OWNER: Defaults to the current user, but you can use this routine to look at some other schema.
- P\_TYPE: Defaults to TABLE and represents the type of object you are looking at. For example, `select distinct segment_type from dba_segments` lists valid segment types.
- P\_PARTITION: Name of the partition when you show the space for a partitioned object. SHOW\_SPACE shows space for only a partition at a time.

The output of this routine looks as follows, when the segment resides in an Automatic Segment Space Management (ASSM) tablespace:

```
EODA@ORA12CR1> exec show_space('BIG_TABLE');
Unformatted Blocks ..... 0
FS1 Blocks (0-25) ..... 0
FS2 Blocks (25-50) ..... 0
FS3 Blocks (50-75) ..... 0
FS4 Blocks (75-100)..... 0
Full Blocks ..... 14,469
Total Blocks..... 15,360
Total Bytes..... 125,829,120
Total MBytes..... 120
Unused Blocks..... 728
Unused Bytes..... 5,963,776
Last Used Ext FileId..... 4
Last Used Ext BlockId..... 43,145
Last Used Block..... 296
```

PL/SQL procedure successfully completed.

The items reported are as follows:

- *Unformatted Blocks*: The number of blocks that are allocated to the table below the high-water mark, but have not been used. Add unformatted and unused blocks together to get a total count of blocks allocated to the table but never used to hold data in an ASSM object.
- *FS1 Blocks-FS4 Blocks*: Formatted blocks with data. The ranges of numbers after their name represent the emptiness of each block. For example, (0-25) is the count of blocks that are between 0 and 25 percent empty.
- *Full Blocks*: The number of blocks that are so full that they are no longer candidates for future inserts.
- *Total Blocks, Total Bytes, Total Mbytes*: The total amount of space allocated to the segment measured in database blocks, bytes, and megabytes.
- *Unused Blocks, Unused Bytes*: Represents a portion of the amount of space never used. These are blocks allocated to the segment, but are currently above the high-water mark of the segment.
- *Last Used Ext FileId*: The file ID of the file that contains the last extent that contains data.
- *Last Used Ext BlockId*: The block ID of the beginning of the last extent; the block ID within the last-used file.
- *Last Used Block*: The block ID offset of the last block used in the last extent.

When you use SHOW\_SPACE to look at objects in Manual Segment Space Managed tablespaces, the output resembles this:

```
EODA@ORA12CR1> exec show_space( 'BIG_TABLE' )
Free Blocks..... 1
Total Blocks..... 147,456
Total Bytes..... 1,207,959,552
Total MBytes..... 1,152
Unused Blocks..... 1,616
Unused Bytes..... 13,238,272
Last Used Ext FileId..... 7
Last Used Ext BlockId..... 139,273
Last Used Block..... 6,576
```

PL/SQL procedure successfully completed.

The only difference is the Free Blocks item at the beginning of the report. This is a count of the blocks in the first freelist group of the segment. My script reports only on this freelist group. You would need to modify the script to accommodate multiple freelist groups.

The commented code follows. This utility is a simple layer on top of the DBMS\_SPACE API in the database.

```
create or replace procedure show_space
( p_segname in varchar2,
  p_owner   in varchar2 default user,
  p_type    in varchar2 default 'TABLE',
  p_partition in varchar2 default NULL )
-- this procedure uses authid current user so it can query DBA_*
```

## ■ SETTING UP YOUR ENVIRONMENT

```
-- views using privileges from a ROLE and so it can be installed
-- once per database, instead of once per user that wants to use it
authid current_user
as
    l_free_blks            number;
    l_total_blocks        number;
    l_total_bytes         number;
    l_unused_blocks       number;
    l_unused_bytes        number;
    l_LastUsedExtFileId   number;
    l_LastUsedExtBlockId  number;
    l_LAST_USED_BLOCK     number;
    l_segment_space_mgmt  varchar2(255);
    l_unformatted_blocks  number;
    l_unformatted_bytes   number;
    l_fs1_blocks number; l_fs1_bytes number;
    l_fs2_blocks number; l_fs2_bytes number;
    l_fs3_blocks number; l_fs3_bytes number;
    l_fs4_blocks number; l_fs4_bytes number;
    l_full_blocks number; l_full_bytes number;

    -- inline procedure to print out numbers nicely formatted
    -- with a simple label
    procedure p( p_label in varchar2, p_num in number )
    is
    begin
        dbms_output.put_line( rpad(p_label,40,'.') ||
                               to_char(p_num,'999,999,999,999') );
    end;

begin
    -- this query is executed dynamically in order to allow this procedure
    -- to be created by a user who has access to DBA_SEGMENTS/TABLESPACES
    -- via a role as is customary.
    -- NOTE: at runtime, the invoker MUST have access to these two
    -- views!
    -- this query determines if the object is an ASSM object or not
    begin
        execute immediate
            'select ts.segment_space_management
              from dba_segments seg, dba_tablespaces ts
             where seg.segment_name      = :p_segname
                   and (:p_partition is null or
                        seg.partition_name = :p_partition)
                   and seg.owner = :p_owner
                   and seg.tablespace_name = ts.tablespace_name'
            into l_segment_space_mgmt
            using p_segname, p_partition, p_partition, p_owner;
```

```

exception
  when too_many_rows then
    dbms_output.put_line
      ( 'This must be a partitioned table, use p_partition => ');
    return;
end;

-- if the object is in an ASSM tablespace, we must use this API
-- call to get space information, else we use the FREE_BLOCKS
-- API for the user managed segments
if l_segment_space_mgmt = 'AUTO'
then
  dbms_space.space_usage
  ( p_owner, p_segname, p_type, l_unformatted_blocks,
    l_unformatted_bytes, l_fs1_blocks, l_fs1_bytes,
    l_fs2_blocks, l_fs2_bytes, l_fs3_blocks, l_fs3_bytes,
    l_fs4_blocks, l_fs4_bytes, l_full_blocks, l_full_bytes, p_partition);

  p( 'Unformatted Blocks ', l_unformatted_blocks );
  p( 'FS1 Blocks (0-25) ', l_fs1_blocks );
  p( 'FS2 Blocks (25-50) ', l_fs2_blocks );
  p( 'FS3 Blocks (50-75) ', l_fs3_blocks );
  p( 'FS4 Blocks (75-100)', l_fs4_blocks );
  p( 'Full Blocks      ', l_full_blocks );
else
  dbms_space.free_blocks(
    segment_owner   => p_owner,
    segment_name    => p_segname,
    segment_type    => p_type,
    freelist_group_id => 0,
    free_blks       => l_free_blks);

  p( 'Free Blocks', l_free_blks );
end if;

-- and then the unused space API call to get the rest of the
-- information
dbms_space.unused_space
( segment_owner   => p_owner,
  segment_name    => p_segname,
  segment_type    => p_type,
  partition_name  => p_partition,
  total_blocks    => l_total_blocks,
  total_bytes     => l_total_bytes,
  unused_blocks   => l_unused_blocks,
  unused_bytes    => l_unused_bytes,
  LAST_USED_EXTENT_FILE_ID => l_LastUsedExtFileId,
  LAST_USED_EXTENT_BLOCK_ID => l_LastUsedExtBlockId,
  LAST_USED_BLOCK => l_LAST_USED_BLOCK );

```

```

p( 'Total Blocks', l_total_blocks );
p( 'Total Bytes', l_total_bytes );
p( 'Total MBytes', trunc(l_total_bytes/1024/1024) );
p( 'Unused Blocks', l_unused_blocks );
p( 'Unused Bytes', l_unused_bytes );
p( 'Last Used Ext FileId', l_LastUsedExtFileId );
p( 'Last Used Ext BlockId', l_LastUsedExtBlockId );
p( 'Last Used Block', l_LAST_USED_BLOCK );
end;
/

```

## Big\_Table

For examples throughout this book, I use a table called BIG\_TABLE. Depending on which system I use, this table has between one record and four million records and varies in size from 200MB to 800MB. In all cases, the table structure is the same.

To create BIG\_TABLE, I wrote a script that does the following:

- Creates an empty table based on ALL\_OBJECTS. This dictionary view is used to populate the BIG\_TABLE.
- Makes this table NOLOGGING. This is optional. I did it for performance. Using NOLOGGING mode for a test table is safe; you won't use it in a production system, so features like Oracle Data Guard will not be enabled.
- Populates the table by seeding it with the contents of ALL\_OBJECTS and then iteratively inserting into itself, approximately doubling its size on each iteration.
- Creates a primary key constraint on the table.
- Gathers statistics.

To build the BIG\_TABLE table, you can run the following script at the SQL\*Plus prompt and pass in the number of rows you want in the table. The script will stop when it hits that number of rows.

```

create table big_table
as
select rownum id, OWNER, OBJECT_NAME, SUBOBJECT_NAME, OBJECT_ID,
DATA_OBJECT_ID, OBJECT_TYPE, CREATED, LAST_DDL_TIME, TIMESTAMP,
STATUS, TEMPORARY, GENERATED, SECONDARY, NAMESPACE, EDITION_NAME
  from all_objects
 where 1=0
/

alter table big_table nologging;

declare
  l_cnt number;
  l_rows number := &numrows;

```

```

begin
  insert /*+ append */
  into big_table
  select rownum id, OWNER, OBJECT_NAME, SUBOBJECT_NAME, OBJECT_ID,
  DATA_OBJECT_ID, OBJECT_TYPE, CREATED, LAST_DDL_TIME, TIMESTAMP,
  STATUS, TEMPORARY, GENERATED, SECONDARY, NAMESPACE, EDITION_NAME
  from all_objects
  where rownum <= &numrows;
  --
  l_cnt := sql%rowcount;
  commit;
  while (l_cnt < l_rows)
  loop
    insert /*+ APPEND */ into big_table
    select rownum+l_cnt,OWNER, OBJECT_NAME, SUBOBJECT_NAME, OBJECT_ID,
    DATA_OBJECT_ID, OBJECT_TYPE, CREATED, LAST_DDL_TIME, TIMESTAMP,
    STATUS, TEMPORARY, GENERATED, SECONDARY, NAMESPACE, EDITION_NAME
    from big_table a
    where rownum <= l_rows-l_cnt;
    l_cnt := l_cnt + sql%rowcount;
    commit;
  end loop;
end;
/

alter table big_table add constraint
big_table_pk primary key(id);

exec dbms_stats.gather_table_stats( user, 'BIG_TABLE', estimate_percent=> 1);

```

I estimated baseline statistics on the table. The index associated with the primary key will have statistics computed automatically when it is created.

## Coding Conventions

The one coding convention I use in this book that I would like to point out is how I name variables in PL/SQL code. For example, consider a package body like this:

```

create or replace package body my_pkg
as
  g_variable varchar2(25);

  procedure p( p_variable in varchar2 )
  is
    l_variable varchar2(25);
  begin
    null;
  end;
end;
/

```

Here I have three variables: a global package variable, `G_VARIABLE`; a formal parameter to the procedure, `P_VARIABLE`; and a local variable, `L_VARIABLE`. I name my variables after the scope they are contained in. All globals begin with `G_`, parameters with `P_`, and local variables with `L_`. The main reason for this is to distinguish PL/SQL variables from columns in a database table. For example, a procedure such as the following would always print out every row in the `EMP` table where `ENAME` is not null:

```
create procedure p( ENAME in varchar2 )
as
begin
  for x in ( select * from emp where ename = ENAME ) loop
    Dbms_output.put_line( x.empno );
  end loop;
end;
```

SQL sees `ename = ENAME`, and compares the `ENAME` column to itself (of course). We could use `ename = P.ENAME`; that is, qualify the reference to the PL/SQL variable with the procedure name, but this is too easy to forget, leading to errors.

I just always name my variables after the scope. That way, I can easily distinguish parameters from local variables and global variables, in addition to removing any ambiguity with respect to column names and variable names.