

Winpower

User Manual

Table of Contents

Chapter 1 Winpower Introduction.....	4
1. Winpower profile.....	4
2. Winpower Structure.....	4
3. Winpower Application Range	5
4. Winpower Functions & Advantages.....	6
Chapter 2 Winpower Installation, Start & Uninstall	7
1. System Requirements.....	7
2. Platforms supported by Winpower include the following	7
3. Winpower Installation Steps	7
4. Start/Stop Winpower	13
5. Uninstall Winpower.....	15
Chapter 3 Winpower User Interface	19
1. "Winpower Manager" window.....	19
2. Menu and Dialog	24
1) Auto Search Device	24
2) "Administrator" Dialog	26
3) "Administrator Password Settings" Dialog.....	26
4) "Event log Viewer" Dialog.....	27
5) "Data log Viewer" Dialog	27
6) "Record Setting" Dialog	28
7) " Device Control Parameters" Dialog	32
8) "Event Action" Dialog.....	42
9) "Shutdown Settings" Dialog	42
10) "UPS Self-Test Immediately" Dialog	45
11) "UPS Test Manager" Dialog.....	45
12) "UPS On/Off Manager" Dialog.....	46
13) "Schedule Viewer" Dialog	47
14) "Broadcast Message Settings" Dialog	48
15) "Email Settings" Dialog.....	49
16) "SMS Setting" Dialog.....	51
17) "Pager Setting" Dialog	52
18) "Monitor Remote Device" Dialog	53
19) Bottom image	54
20) Temp	55
21) Date Format.....	55
22) Advance Settings	56
23) Language menu	57
24) "Communication Port Settings" Dialog	58
Chapter 4 How to do.....	59
1. How to realize the conversion of the appointed COM port?.....	59
2. How to realize broadcasting message in LAN.....	60

3. How to realize the schedule of adding/Removing UPS self-test.....	63
4. How to realize the schedule of adding/Removing UPS on/off.....	66
5. How to realize the network shutdown function.....	70
6. How to realize Setting up shutdown parameter.....	71
7. How to realize the modification of Device control parameter	73
8. How to realize system administrator operation and password modifying realize.....	77
9. How to realize sending event message by email.....	78
10. How to realize sending event messages by mobile phone	79
11. How to realize sending event messages by pager	80
12. How to realize monitoring device remotely in LAN within the same network	82
13. How to realize remote control of any device in different network in LAN.....	85
14. How to realize the Remote Control of any one of the device in Internet	88
15. How to install software on VMware ESX 3.5/4.0	91
16. How to install software on Windows 2008 server core.....	95
17. How to install software on VMware ESXi 4.0/4.1	97
18. How to configure the computer powered by Multi-UPS shut down safely.....	105
Appendix A—Glossary Explanation	109
Appendix B---Winpower Event Table.....	110
Frequently Asked Questions.....	112

Chapter 1 Winpower Introduction

1. Winpower profile

Winpower is a device monitoring software, which supports individual computer and computers connected with network (including LAN & WAN).

It is used to monitor the intelligent device to protect computer systems from being shut down abnormally when power fails. User can monitor and configure the device on any computer in the same LAN. With the software, a device can provide security protection for more than one computer at the same time, including shutting down system in security, saving application data and shutting down the UPS when power fails.

Note: the diagrams about communication between software and UPS shown in the following chapters are just for reference. For different model UPS, the display could be different.

2. Winpower Structure

Winpower contains three components: **Agent**, **Monitor** and **TrayIcon**.

Note : The concrete meaning of Agent refer to Appendix A — glossary explanation.

Agent is the key component of Winpower and runs as a system service on background. Agent communicates with the device, logs events, notifies users when UPS's event happens, arranges actions according to user's requirement and impending shutdown when necessary. Furthermore, Agent can be managed by Monitor.

Monitor is the user interface application of Winpower. Relying on Agent, it gathers real-time information and status of the device, server information and allows user to set the control parameters of the device. It can run on any computer (individual or connected with network).

TrayIcon is the management tool of Winpower. It exists on Windows platform only. It appears in the Status Area of System task bar. TrayIcon has two different icons to display the current Agent status. The icons and the related status, please refer to the following table 1-2-1.

	Indicate the Agent is Stopped.
	Indicate the Agent is Running.

Table 1-2-1

When user right clicks the Manager icon, a shortcut menu will be shown. The menu items are listed as below.

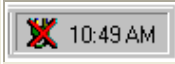
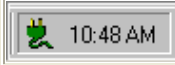
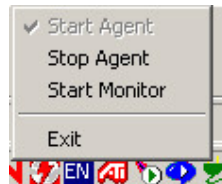

Diagram 1-2-1

The relationship between Agent and Monitor, please refer to the following Diagram 1-2-2.

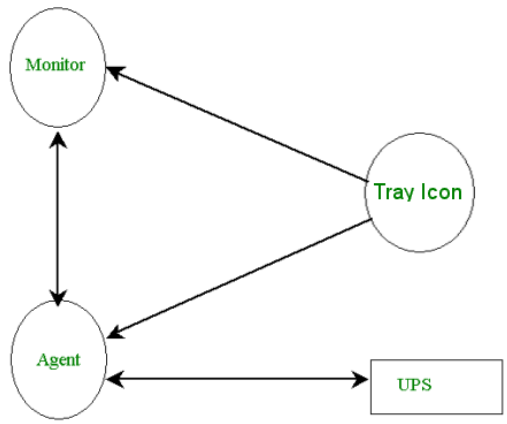

Diagram 1-2-2

3. Winpower Application Range

- ✓ Application of individual computers refers to the following Diagram 1-3-1.

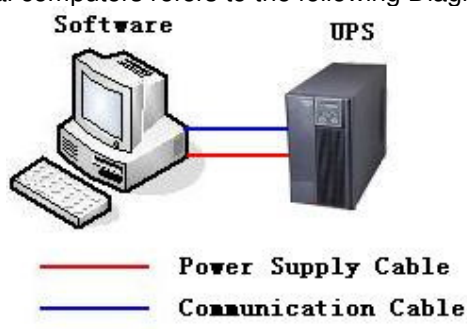

Diagram 1-3-1

- ✓ Application in the LAN refers to the following Diagram 1-3-2.

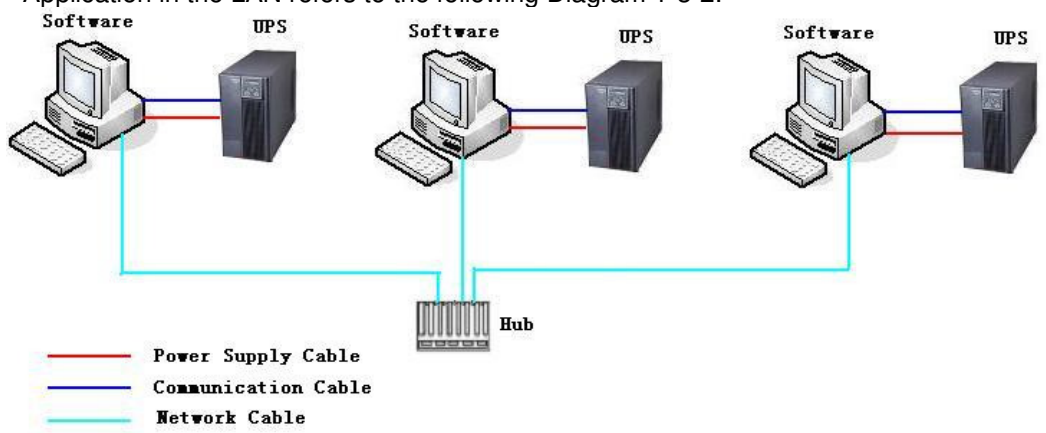

Diagram 1-3-2

- ✓ Application in the Internet refers to the following Diagram 1-3-3.

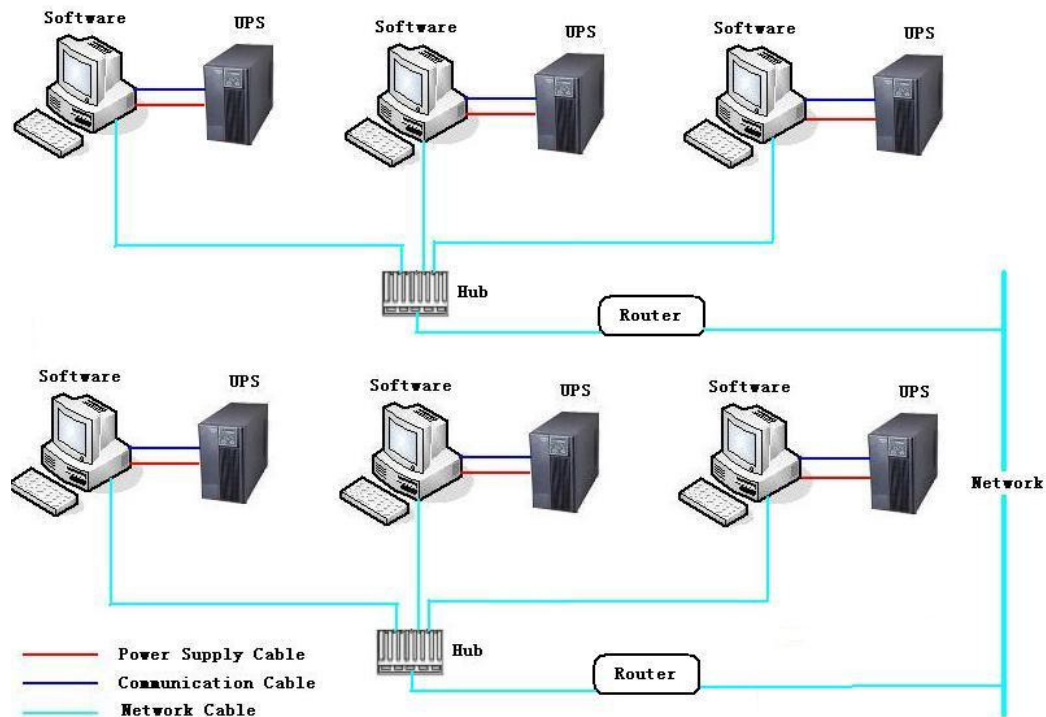

Diagram 1-3-3

4. Winpower Functions & Advantages

- ✓ When Agent is started, it will protect your equipment continuously in every moment.
- ✓ Uninstalled easily and clearly with no trace. Never increase the spending of system.
- ✓ You can have a detailed view about all information of the device, such as utility power, device type, load and battery. The information is shown in the same window, so you can take all the information in a glance.
- ✓ With the function of searching automatically and monitoring any device in the LAN.
- ✓ With the function of searching manually and monitoring any device in the Internet.
- ✓ With security protect function. The software administrator password can be set to prevent others from sabotaging. Only the software administrator has the right of full access, other users only have the right of view.
- ✓ With the function of data auto protection, it can close most of the running applications and save the related files.
- ✓ With the function of time turning on and off the device, it can give maximum protection to your computer system.
- ✓ With the function of time self test of the UPS, it can provide maximum protection to your UPS system.
- ✓ With the function of shutting down system by network, it supplies your system maximum protection.
- ✓ With the function of data logging (including utility power, device type, load and battery) and event logging, so that the software administrator can carry out the device system daily maintenance.
- ✓ Flexible means of information transfer let you know the device status at any moment and anywhere, never miss any one even though the change of time and place.
 - With the function of broadcasting messages to every users in the network.
 - With the function of sending messages via pager.
 - With the function of sending messages by Email.
 - With the function of sending SMS messages via mobile phone.

Chapter 2 Winpower Installation, Start & Uninstall

1. System Requirements

- 128 MB physical memory at least (256MB is recommended)
- 160 MB hard disk space at least
- More than 256 colors and 800 * 600 resolutions or above display is recommended
- The user is required to have the right as system administrator
- On Linux or UNIX operating system, user must log in system with "**root**" account to carry out the installation. After installation finished, system need to be reboot
- TCP/IP protocol must be installed to support network management
- An available communication port (RS-232 Serial Port or USB port) is needed while connecting to device with a special communication cable.

2. Platforms supported by Winpower include the following

Windows 98
Windows me
Windows NT 4.0 (sp6)
Windows 2000
Windows 2003
Windows 2008
Windows 2008 server core
Windows XP
Windows vista
Windows 7
Linux
Solaris/Sparc 2.6, 7, 8, 9,10
Solaris/Intel 2.6, 7, 8, 9 ,10
HP-UX 11.x, 11i.x (PARISC CPU)
AIX 4.3.3, 5.1, 5.2
Mac OS X
Compaq Tru64 Alpha
SCO UnixWare 7.1.1, 7.1.3
SCO Unix 8.0
FreeBSD x86
SGI Irix 6.5.x
VMware ESX 3.5, 4.0, 4.1
VMware ESXi 4.0, 4.1

Note: Telecom power only supports the windows platforms.

3. Winpower Installation Steps

Note: The installation must be started with "root" account in Linux and UNIX systems! And after installation you must restart the system!

Enter the right directory of the CD according the system platform type.

For GUI mode environment:

✓ Insert the Winpower CD, find out the operate system of your computer in the CD directory, Refer to Diagram 2-3-1 as below.

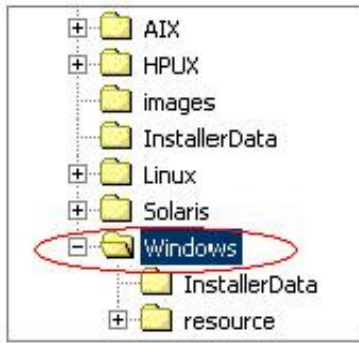

Diagram 2-3-1

For Windows platform, enter \Windows directory, run setup.exe to start the installation. Refer to the following diagram 2-3-2-1.



setup.exe

Diagram 2-3-2-1

Note: For windows vista, windows 7 and windows 2008, enter \Windows directory, you should run setup.exe as an administrator. Right click on the setup icon, then select "Run as administrator", a "user account control" dialog will pop up, please select "Allow". Refer to the following diagram 2-3-2-2.

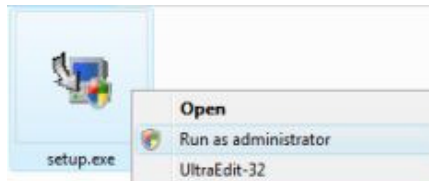

Diagram 2-3-2-2

For Mac OS X platform, enter \MacOSX directory, double click the setup.app to start the installation. Refer to the following diagram 2-3-3-1.



setup.zip



setup

Diagram 2-3-3-1

Click Lock Icon here. Refer to the following diagram 2-3-3-2.

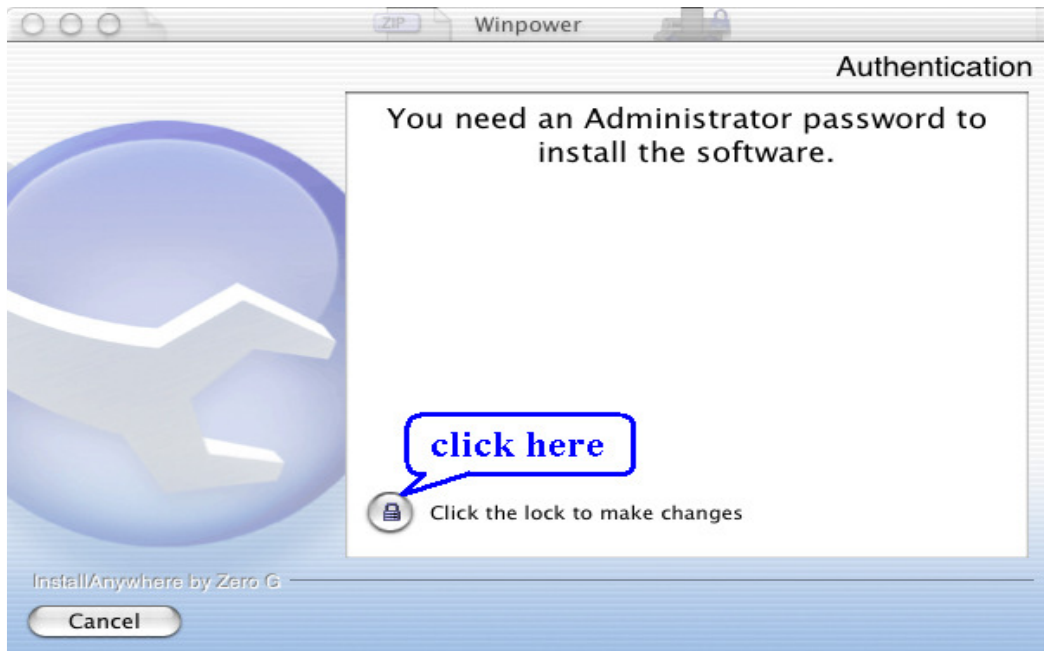

Diagram 2-3-3-2

Input the Administrator account name and password. Refer to the following diagram 2-3-3-3



Diagram 2-3-3-3

For other operating system, execute `./setup.bin` or `setup_console.bin`, Refer to the following diagram 2-3-4.

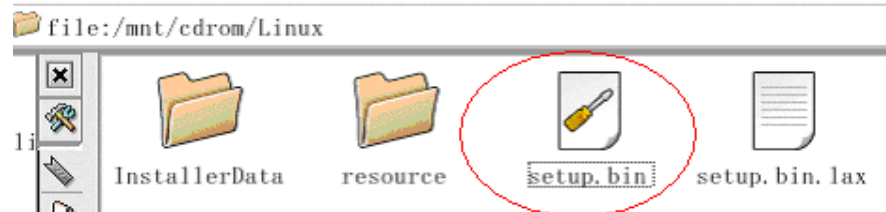

Diagram 2-3-4

Read the introduction. Refer to the following diagram 2-3-5.

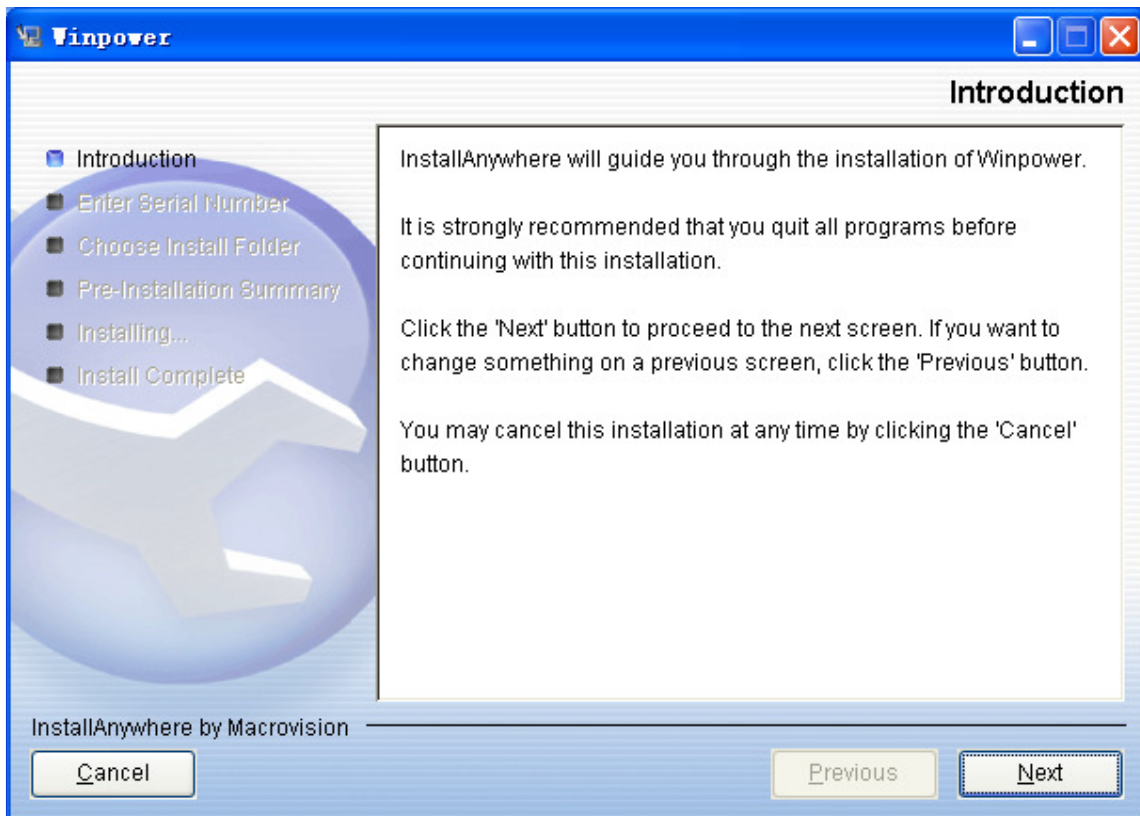

Diagram2-3-5

Click "Next" and input the Serial Number, Refer to the following diagram 2-3-6.

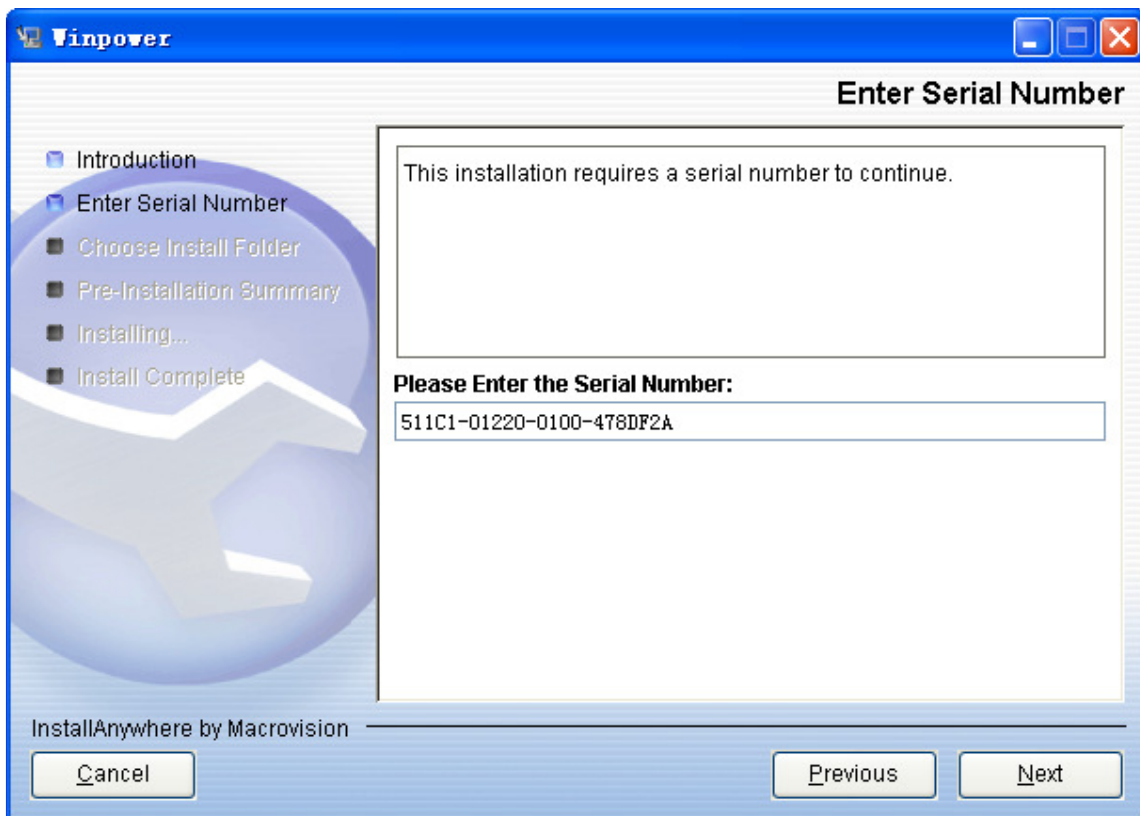

Diagram 2-3-6

Click “Next” and choose install folder. Refer to the following diagram 2-3-7.

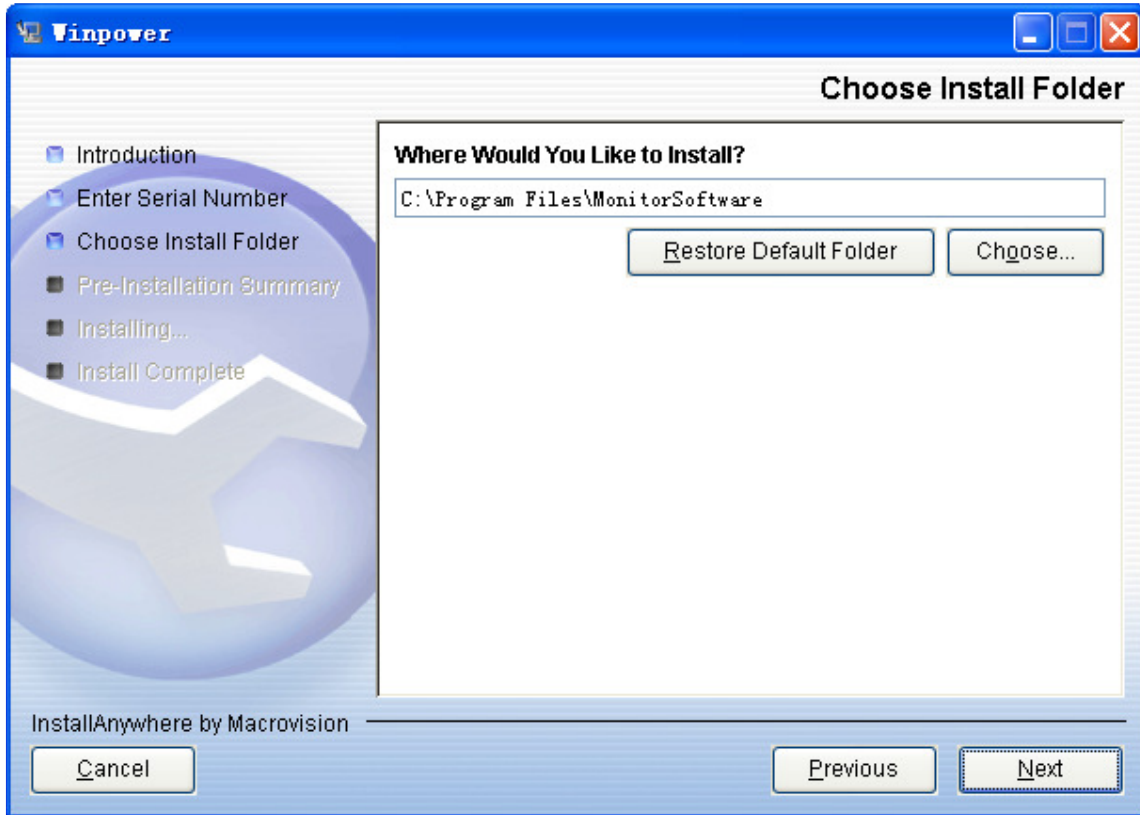

Diagram 2-3-7

Review the Pre-installation Summary. Refer to the following diagram 2-3-8.

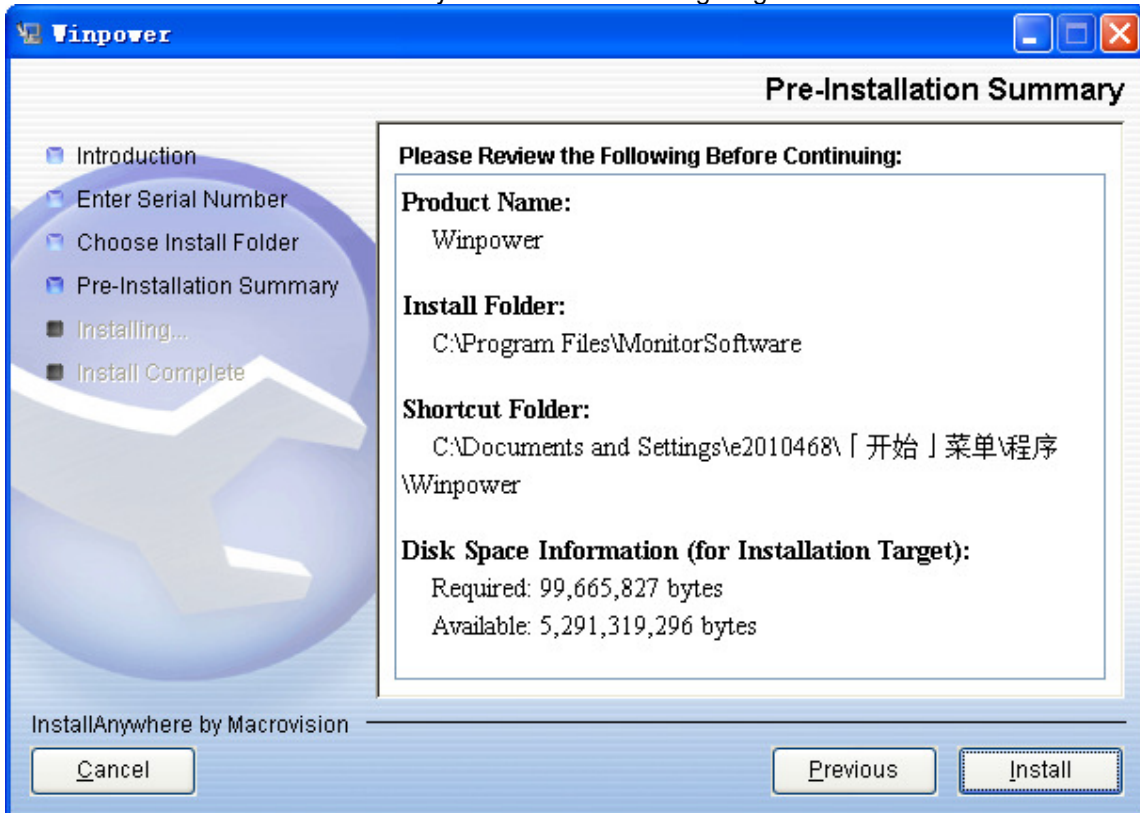

Diagram 2-3-8

The installing process, refer to the following diagram 2-3-9.

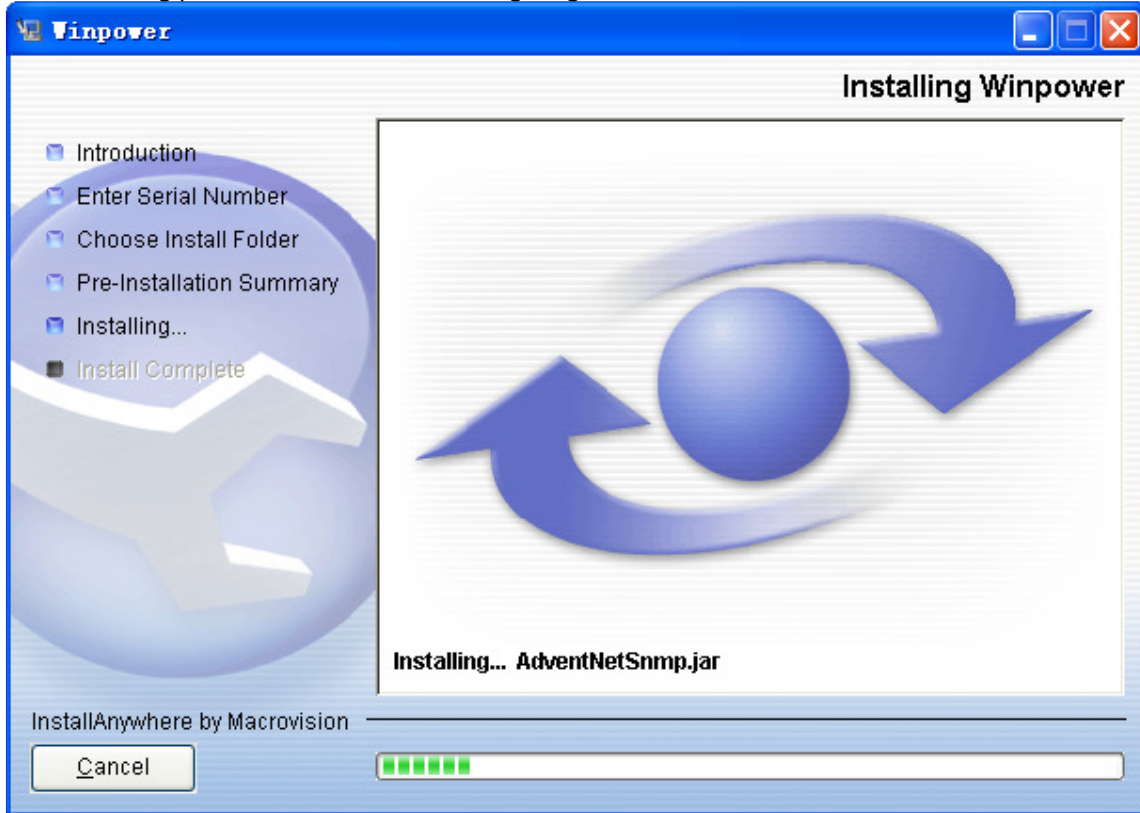

Diagram 2-3-9

When the installation program is completed, click "Done". Refer to the following diagram 2-3-10.

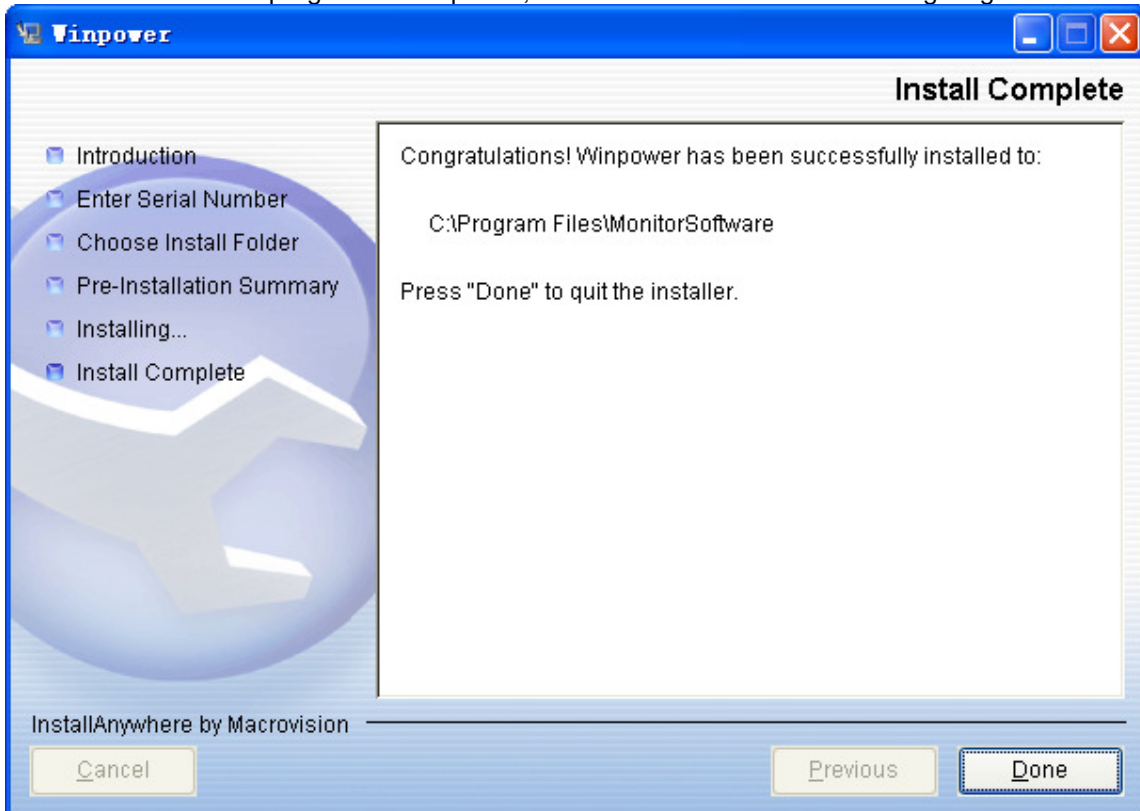

Diagram 2-3-10

If the software is installed successfully, winpower application can be found in the Start menu\Programs\. Refer to the following diagram 2-3-11.

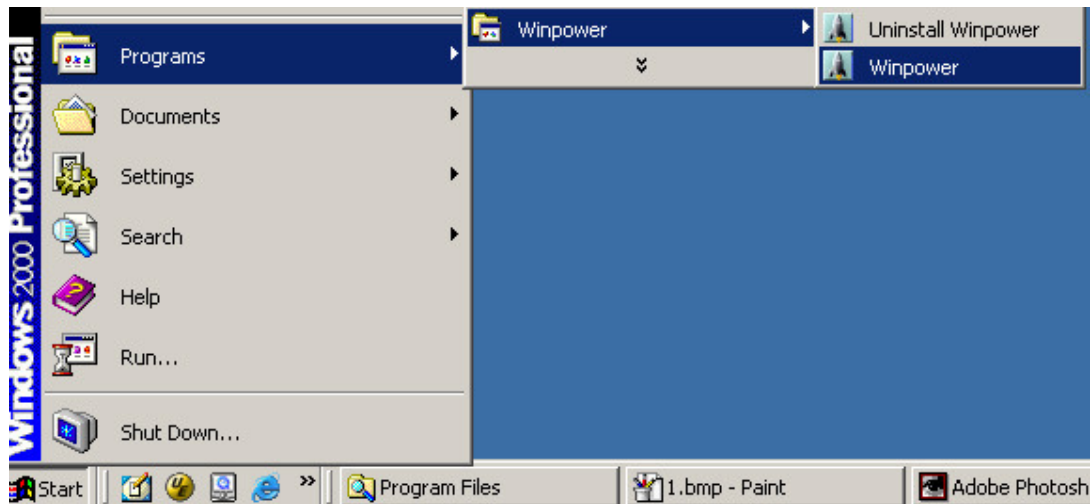

Diagram 2-3-11

For console mode environment:

1. Enter the directory according to the system, run setup.bin or setup_console.bin to start the installation program.

Note: For UnixWare platform, make sure JRE1.3.1 has been installed in your system, then enter the /GenericUnix directory to start the setup.

2. Read the information provided, press ENTER to continue the installation.
3. When the installation program is completed, click "Done".
4. Reboot the Linux and UNIX system after installation.

The installation will set environment variables for Winpower in /etc/profile file. (For details to see 'Set environment variable' below). Reboot the system in order to make the setting valid.

**4. Start/Stop Winpower
In Windows operating system**

✓ Start Agent:

Run the Winpower from Start\Program\Winpower will start the Traylcon and Agent. For windows7 operating system, you should restart computer after the first installation.

Refer to the Diagram 2-4-1 as below.

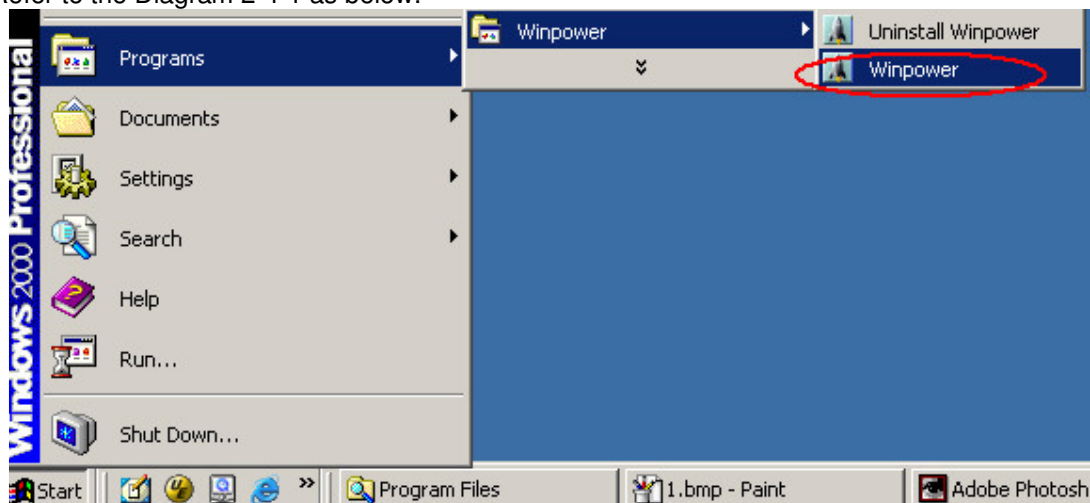

Diagram 2-4-1

The Agent can be start by the following methods:

- 1) Run the Winpower from Start\Program\Winpower will start the Traylcon and Agent. Refer to diagram 2-4-1.
- 2) Right click the agent icon shown on the bottom right corner of the display and select the "Start Agent" item. Refer to Diagram 2-4-2.

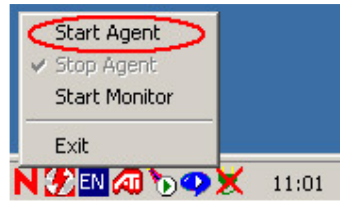

Diagram 2-4-2

- 3) On all Windows operating system, agent can be started automatically when the computer reboots.

To start the Monitor, right click the Traylcon, and select "Start Monitor", or double click the icon.

✓ **Start Monitor:**

Right click the Traylcon and select the "Start Monitor" item. Refer to Diagram 2-4-3.

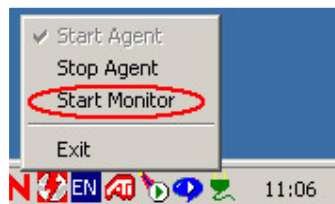

Diagram 2-4-3

✓ **Stop Agent:**

Right click the Traylcon and select the "Stop Agent" menu item. Refer to the following diagram 2-4-4

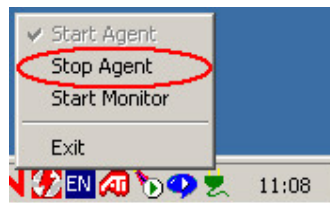

Diagram 2-4-4

✓ **Exit:**

On Windows vista, Windows 2008 and Windows7, if you want to exit, right click the winpower Software tray icon, and select "Exit". Once you exit it, you should restart the computer to start it automatically. But if you have administrator privilege, you can start it again without restart computer. There are two steps: the first to start the agent, open the "Services" from the "Start menu" > "Control Panel" > "Administrative tools", and find the service "UPSmonitor", right click on it, select "Start". The second to start Traylcon, click the winpower software from Start menu > Program \ Winpower.

For other windows OS, to exit, right click the winpower Software tray icon, and select "Exit". If you want to start Traylcon, just click the winpower soft from Start menu > Program \ Winpower.

On Mac OS X

Set Agent to be auto started when System boots:

Open "System Preferences -> Accounts -> Login items", click "+" icon to add the "Applications/Winpower/Agent" as Login auto start item. Refer to the following diagram 2-4-5.

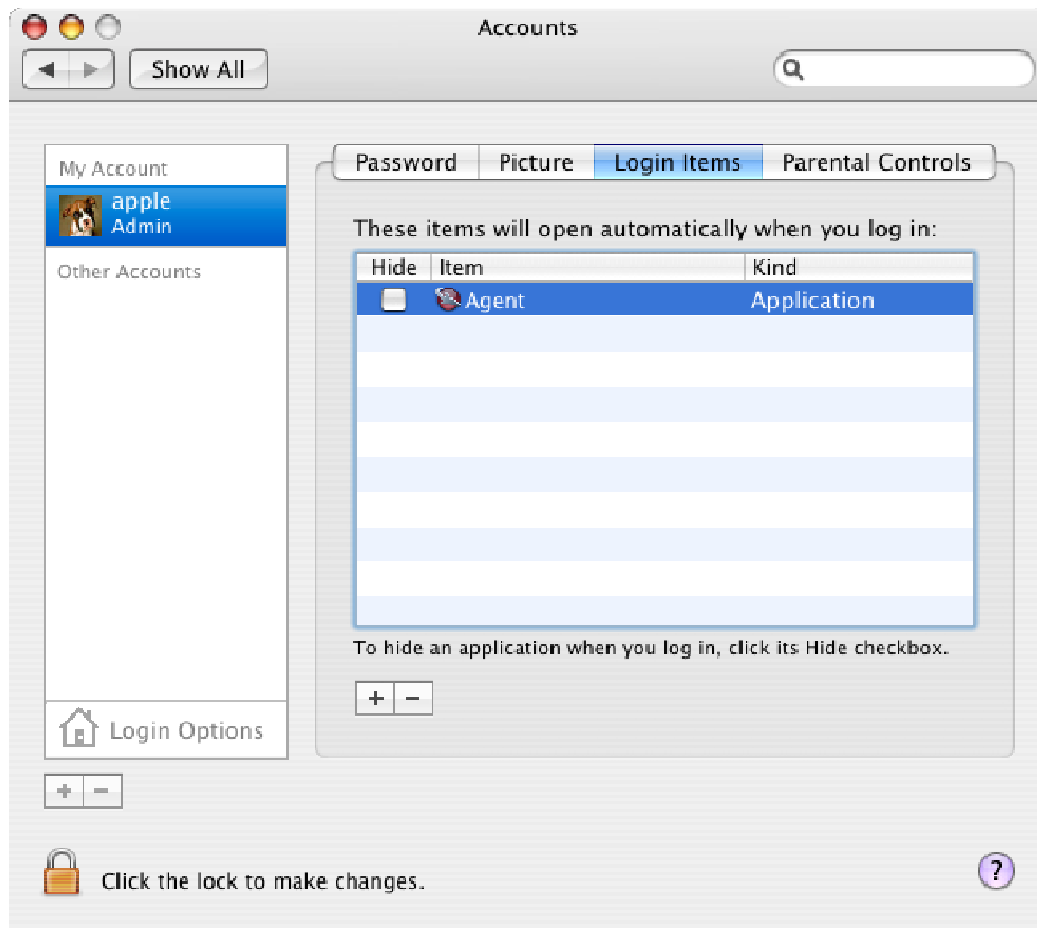

Diagram 2-4-5

Start Agent:

You can double click the agent link in "Applications/Winpower" directory to start the Agent.

You can also start it in terminal by enter install directory and execute command:

Enter "/opt/MonitorSoftware" directory and execute command:./agent start

Start Monitor:

Double click the executable monitor link in "Applications/Winpower" directory to start Monitor.

You can also start it in terminal by enter install directory and execute command:./monitor

Stop Agent:

Enter install directory and execute command:

./agent stop

On Linux and UNIX:

Start Agent:

Enter "/opt/MonitorSoftware" directory and execute command:

./agent start

Start Monitor:

Enter "/opt/MonitorSoftware" directory and execute command:

./monitor

Stop Agent:

Enter "/opt/MonitorSoftware" directory and execute command:

./agent stop

5. Uninstall Winpower

On Windows operating system

There are two methods of uninstalling Winpower

- ✓ One is to click “Uninstall Winpower” icon in “Start/Program/Winpower” with left mouse button, refer to Diagram 2-5-1 as below.

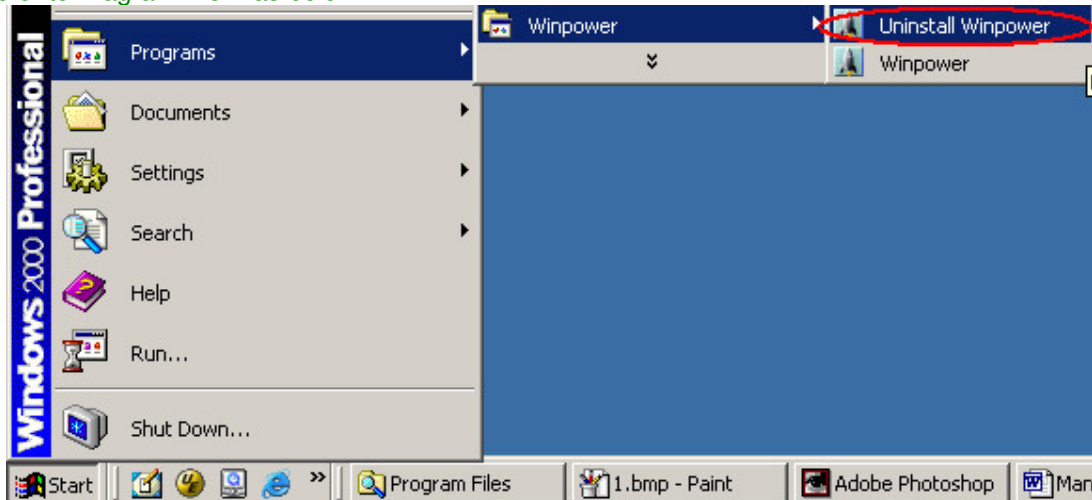

Diagram 2-5-1

Note: On Windows Vista, Windows 2008 and Windows 7, make sure you have administrator privilege, right click and select “Run as administrator”.

- ✓ The other is to left click “Control Panel”/Add/Remove Program”/Change/Remove(C)” button, refer to Diagram 2-5-2 as below.

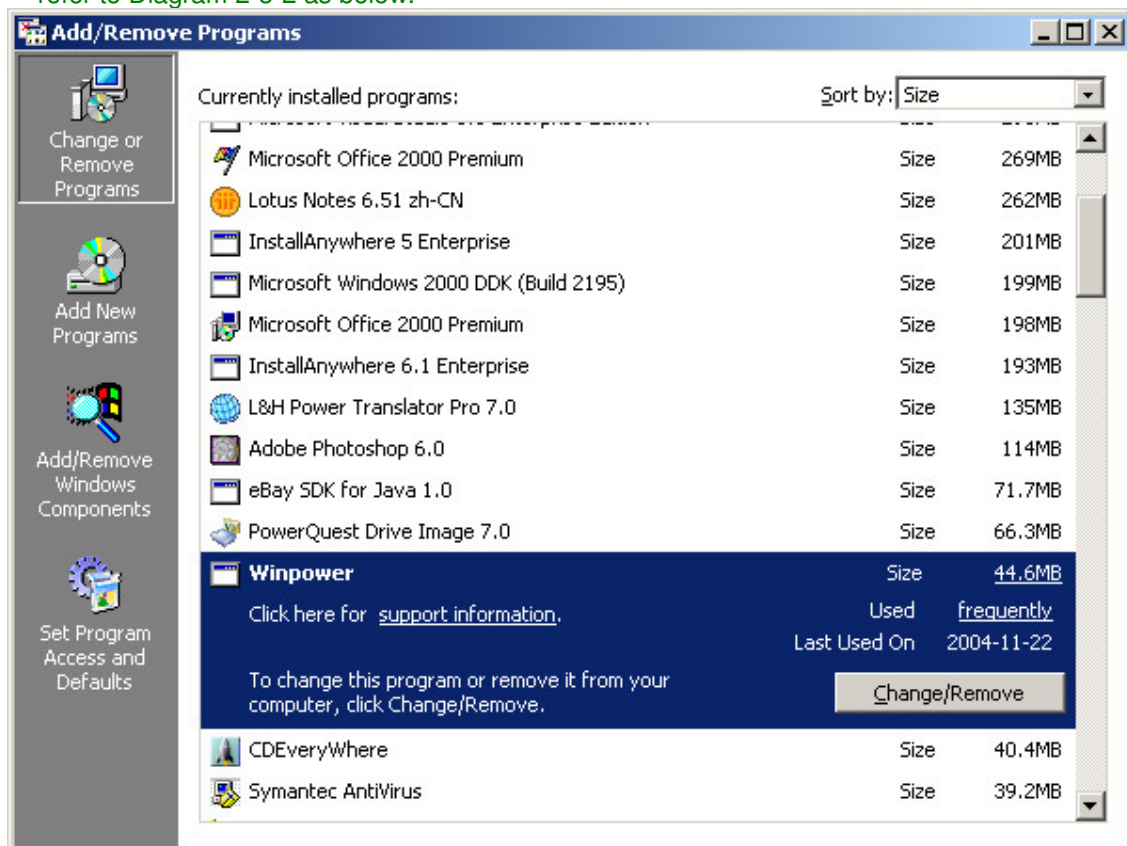

Diagram 2-5-2

Note: Before uninstalling Winpower, you must stop all Winpower program first! Otherwise it can't be uninstalled completely.

- After left click, the Uninstall Program will pop up a dialog shown on Diagram 2-5-3 as below.

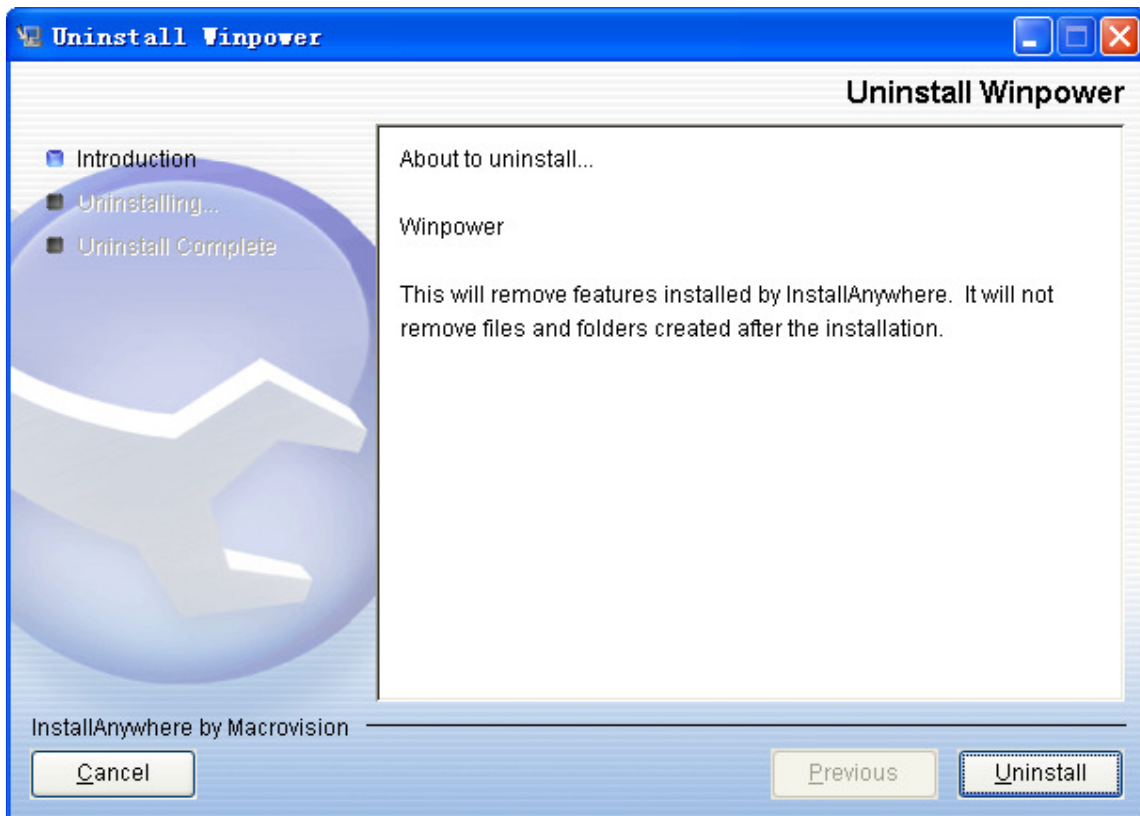

Diagram 2-5-3

Click the "Uninstall" to begin to uninstall Winpower software, refer to the following diagram 2-5-4.

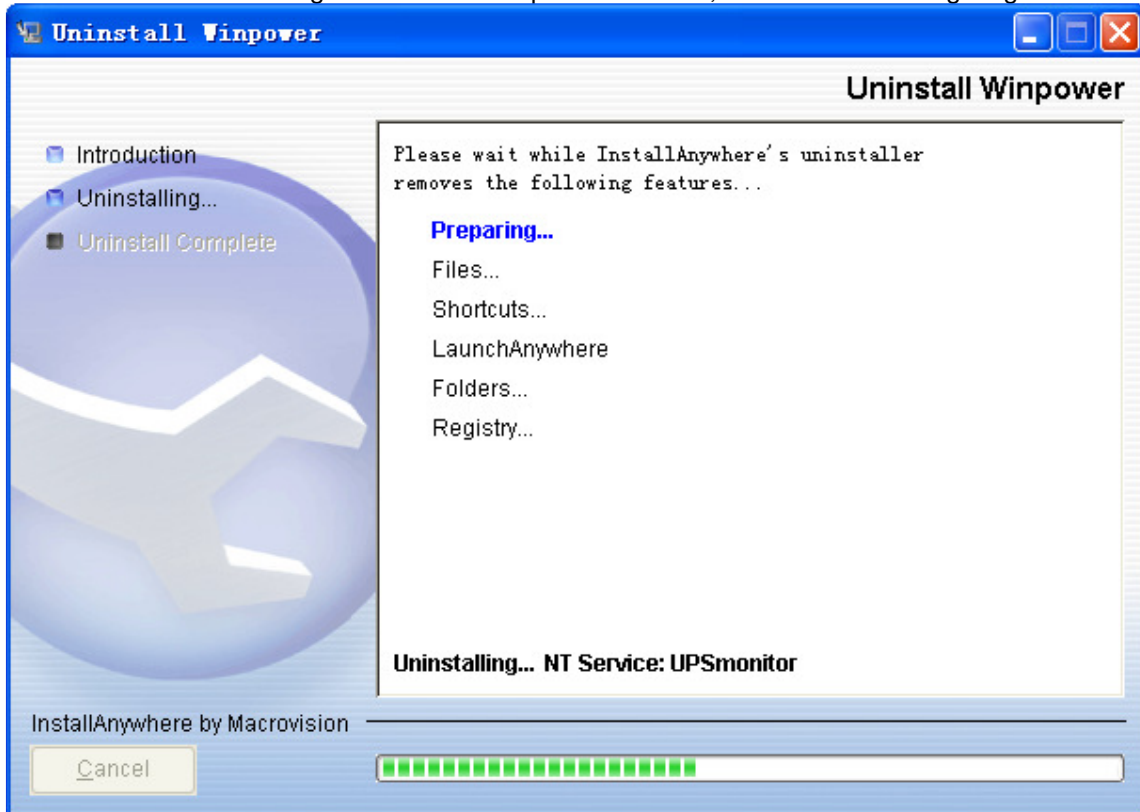

Diagram 2-5-4

Click "Done" and Winpower has been uninstalled completely. Refer to the following diagram 2-5-5.

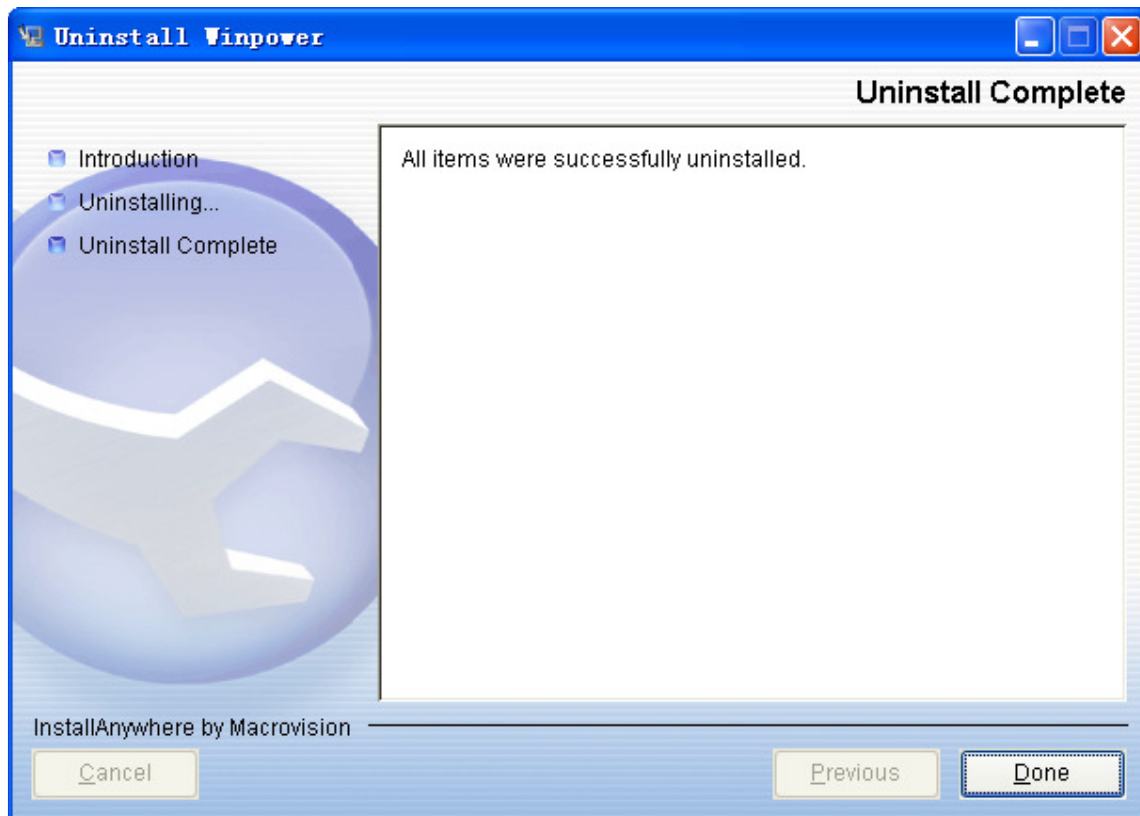

Diagram 2-5-5

On Mac OS X:

Open the Terminal from "Applications/Utilities/Terminal", execute commands:

cd /opt/MonitorSoftware

sudo ./Uninstall

Input the system account password when it prompts, and uninstall will be carried out with administrator privilege. The software can be uninstalled completely.

If you only execute the command "*./Uninstall*", maybe some files of the software can't be uninstalled.

On Linux and UNIX:

Open the Terminal, enter "/opt/MonitorSoftware" directory and execute command: *./Uninstall*

Chapter 3 Winpower User Interface

1. "Winpower Manager" window

Winpower Monitor shows "Winpower Manager" window, which displays a list of agents within the LAN.

There is a tree view on the left side of the window, which displays a hierarchical list of items. Such as "Root", "networks", the Agent, the COM port, USB port and the UPS or ATS models or telecom power. By clicking an item for UPS, the user can expand or collapse the associated list of submenu. Refer to the following diagram 3-1-1.

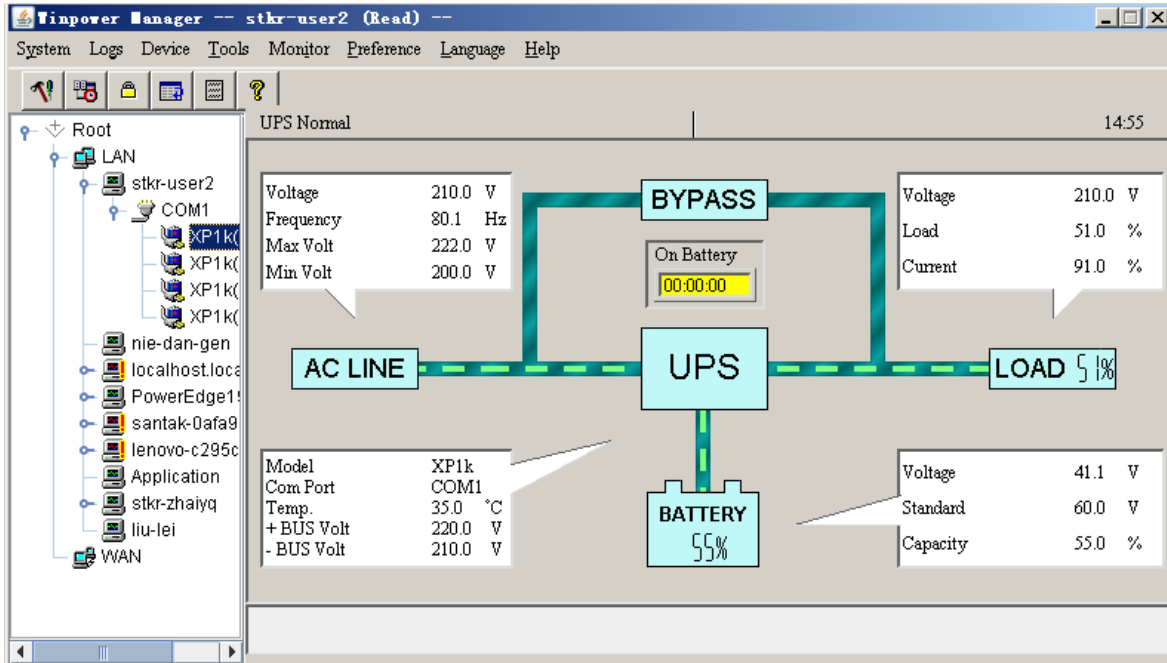

Diagram 3-1-1

For telecom power, the interface is different, Refer to the following diagram 3-1-1-1.

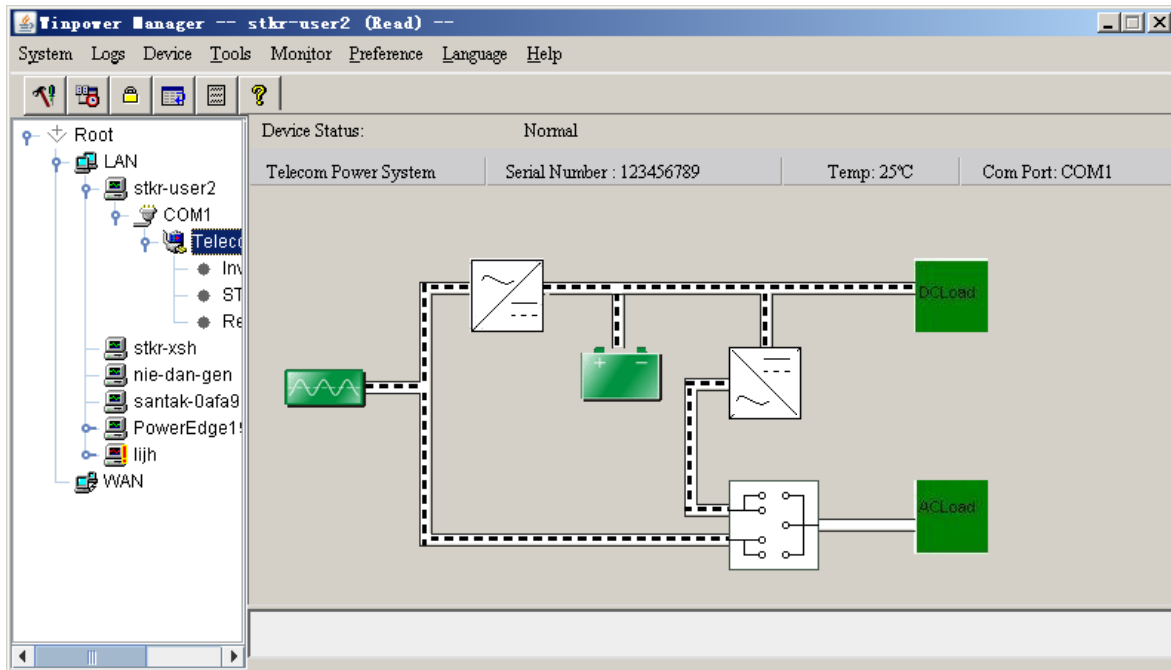

Diagram 3-1-1-1

For ATS, refer to the following diagram 3-1-1-2.

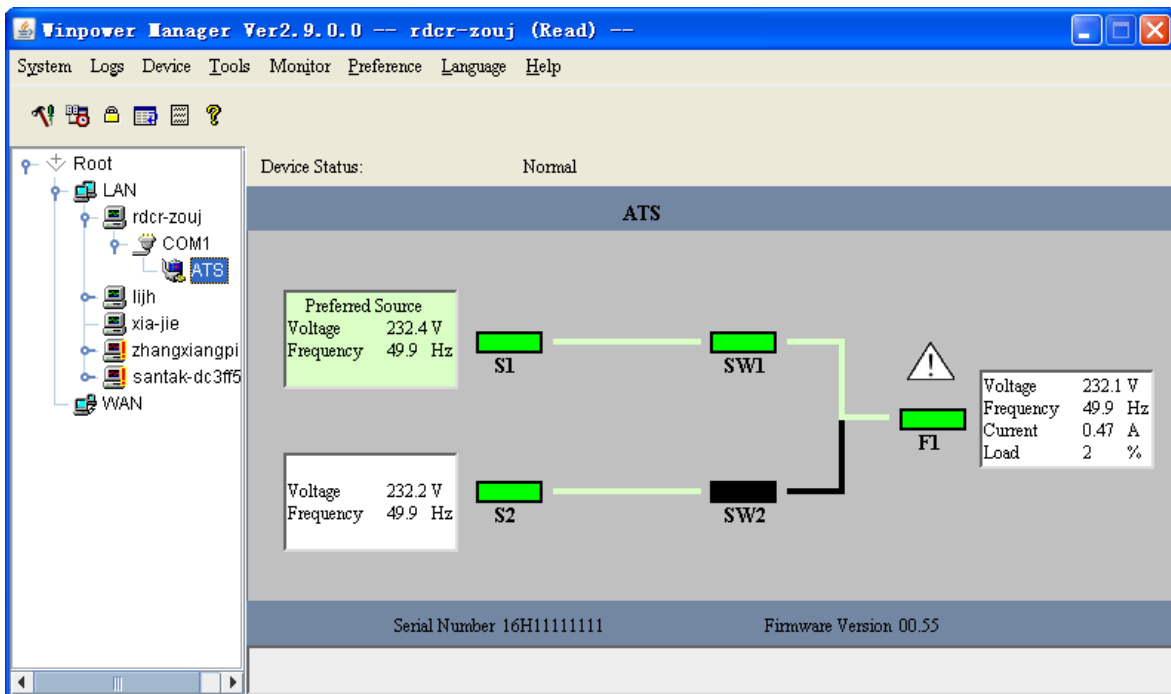

Diagram 3-1-1-2

For Inverter system, refer to the following diagram 3-1-1-3.

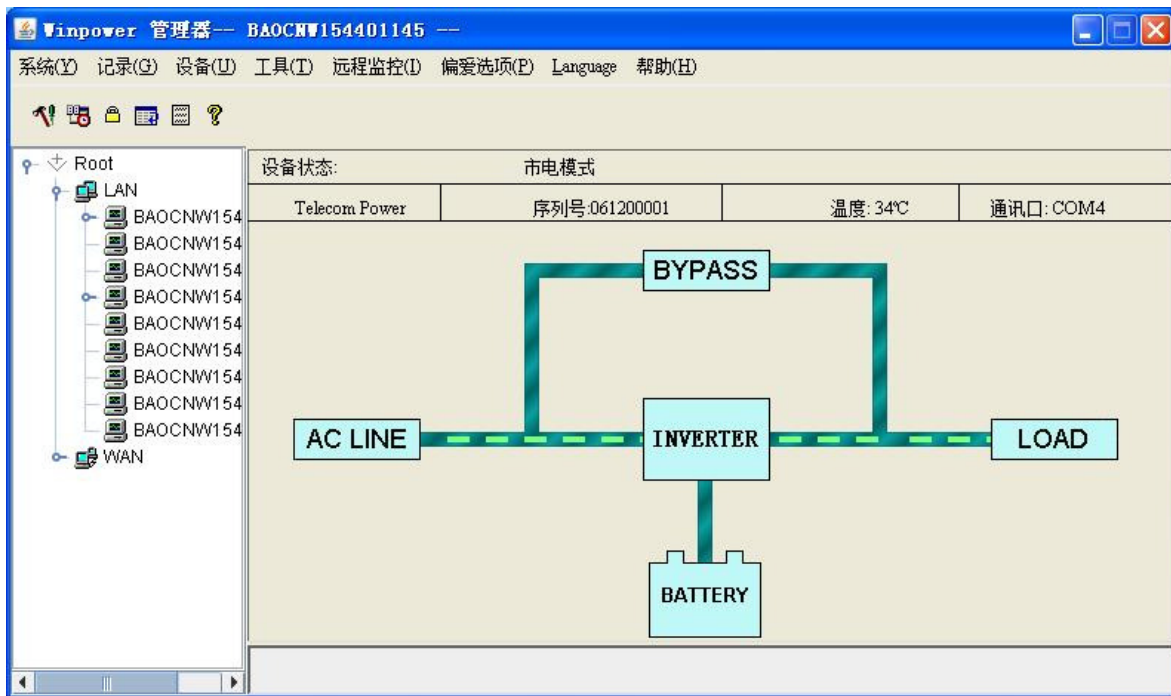

Diagram 3-1-1-3

If you select one of the UPS model from the List, details about it will be displayed on the right side, Refer to the following diagram 3-1-2-1.

1. The middle area displays the UPS Status Figure. The Status Figure is different according to various UPS status and UPS type.
2. The upper area displays the UPS Status Description and recommendation, and the Agent system times with right align.
3. The lower area displays last two events information.
4. It is able to minimize the window by clicking the minimum button on the top right corner of the window.
5. It is able to exit from the system by clicking "X".

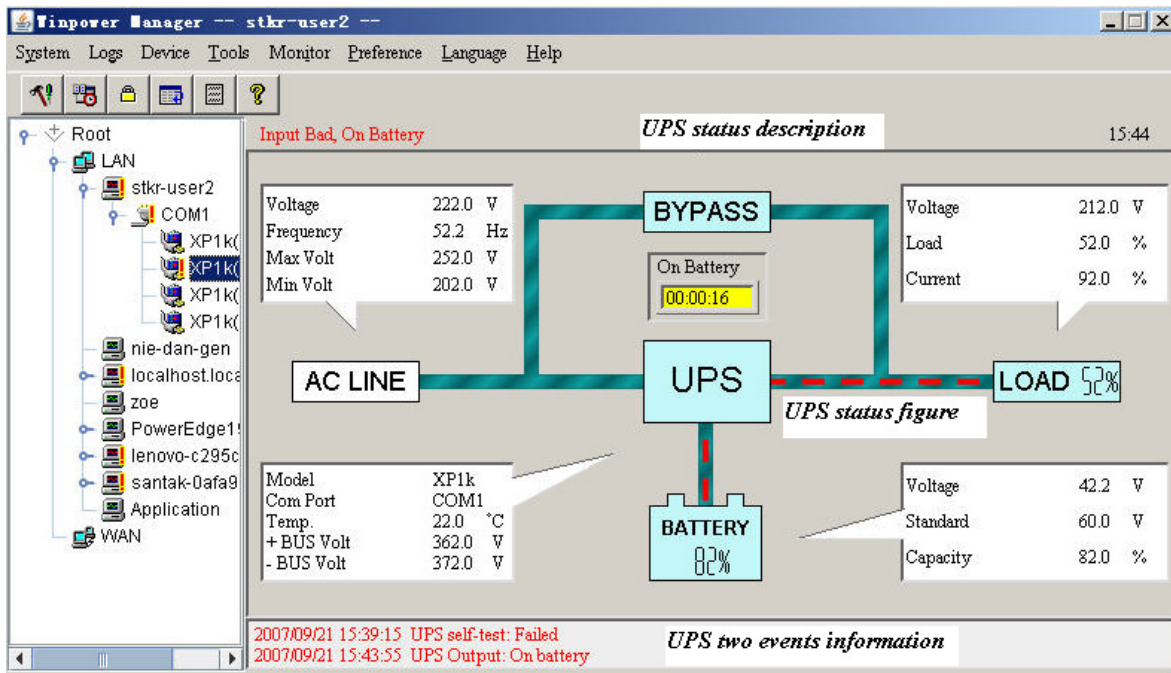

Diagram 3-1-2-1

Illustration of UPS Status information bar:

The UPS status figure contains five parts: AC LINE, UPS, BATTERY, LOAD and BYPASS.

If you select one of the telecom power models from the List, details about it will be displayed on the right side, Refer to the following diagram 3-1-2-2:

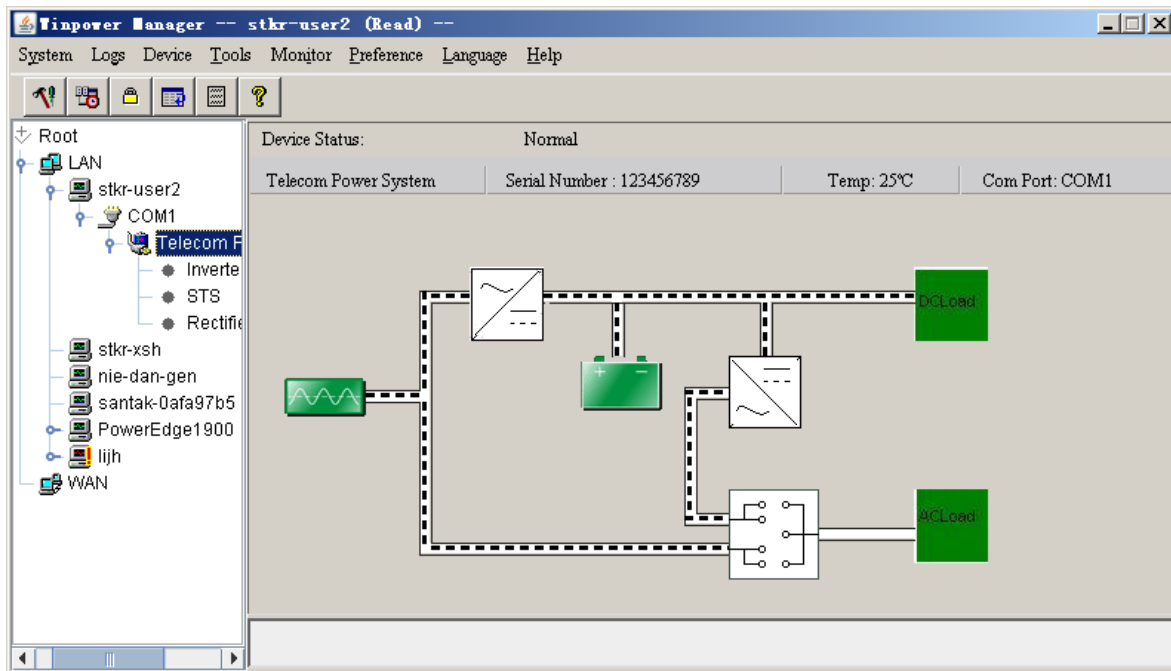

Diagram 3-1-2-2

1. The middle area displays the telecom power Status Figure. The Status Figure is different according to telecom power status. If there is something wrong with some module, the related figure will turn red. For example, STS in above figure. Otherwise, it is green or white.

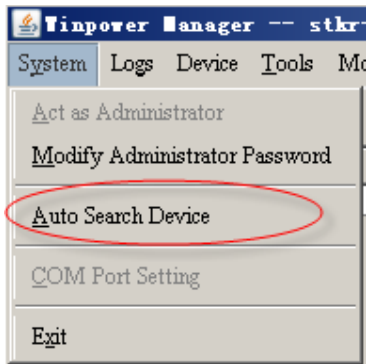

Diagram 3-2-1-1

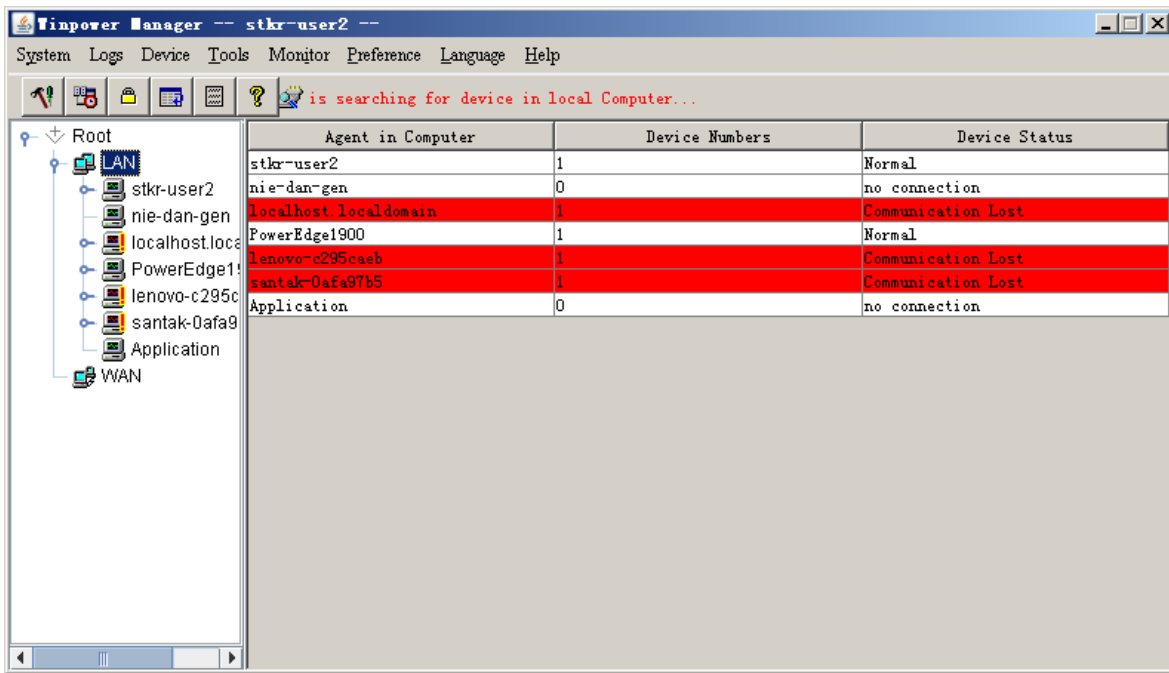

Diagram 3-2-1-2

By clicking the item in the tree view, user can get the information following, refer to the diagram 3-2-1-3.

- 1) All the computer running Winpower Agent on the LAN.
- 2) Device COM Port or USB Port.
- 3) The model type of Device to which the Agent is connecting.
- 4) The Current Status of the Agent which user selected in the tree view.

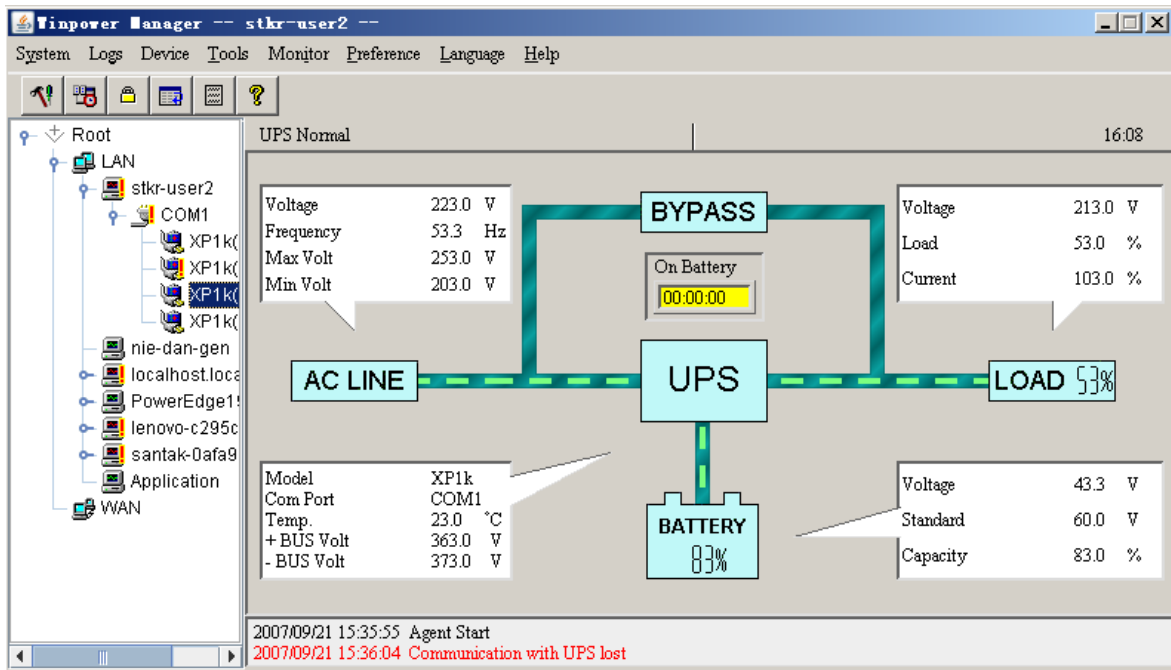

Diagram 3-2-1-3

2) "Administrator" Dialog

"Administrator" dialog can be opened by clicking "Act as Administrator" in the "System" menu. See the following diagram 3-2-2. Enter the administrator password in the edit box and then click "OK" button. If the password is not correct, the system will pop up a message dialog to prompt users that the user password is not correct. If the password is correct, users can get the administrator access right and set up the Agent.

Note: The initial password is "Administrator".

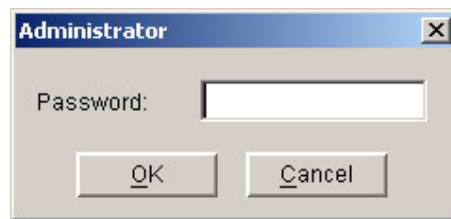

Diagram 3-2-2

3) "Administrator Password Settings" Dialog

"Administrator Password Settings" dialog can be opened from the "Modify Administrator Password" menu item of "System" menu. Refer to the following diagram 3-2-3.



Diagram 3-2-3

Administrator password only can be set by super user in local machine. If you are not a super user yet, the "Administrator" Dialog will pop up first for you to log on as an administrator.

User needs to enter a new password in the "New Password" text box and reenter the new password in the "Confirm Password" text box. If the passwords are not consistent with each other, a message dialog will pop up to notify the user that the password is not correct and request the user to enter it once again. If the passwords are consistent with each other and the button "OK" is selected, the new password will be accepted by the system.

4) "Event log Viewer" Dialog

"Event Log Viewer" Dialog will be shown when user selects the "Event Log" menu item from "Logs" Menu or click buttons from toolbar, or click the "View log" button of event log in the "Record Setting" dialog, then the "Event Log" dialog will pop up. Refer to the following Diagram 3-2-4. The dialog displays a list of history events.

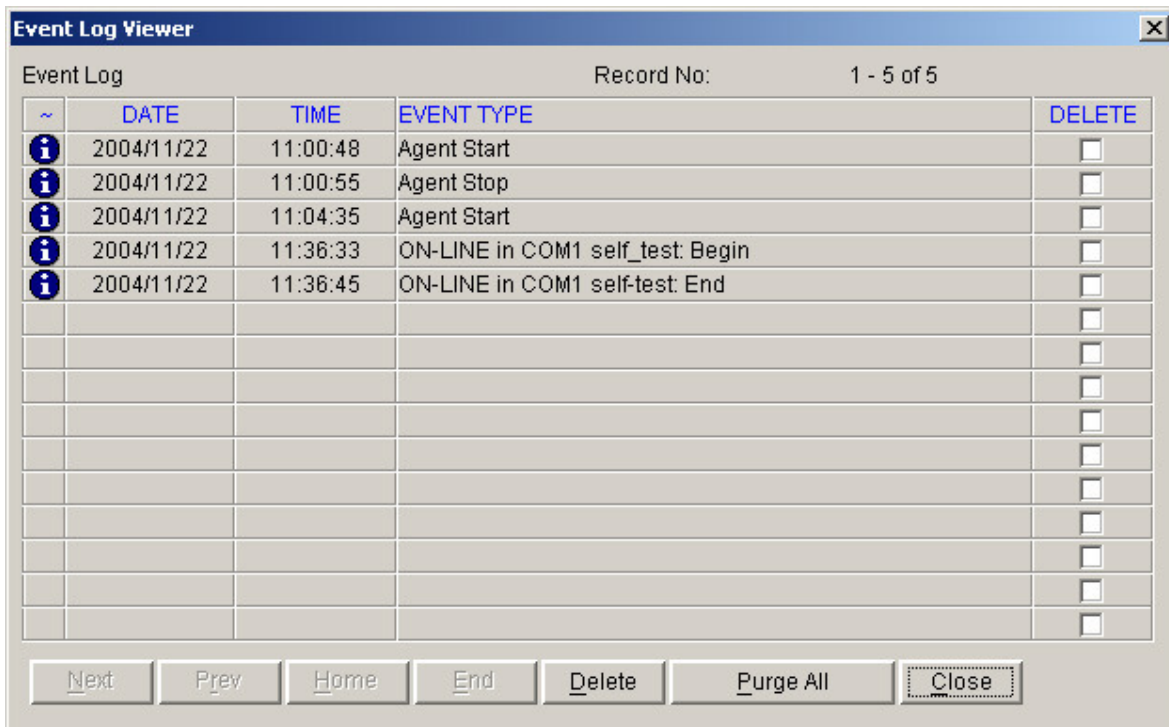

Diagram 3-2-4

User can select the check box "Delete" and click "Delete" button to remove the selected events.

User can click "Close" button to close the dialog.

User can click "Purge All" button to delete all of the events.

Note: If "Delete" and "Purge All" button are invalid, it means your access right to the current Agent is "Read Only", you can't carry out the operation. You should log in as a super user.

5) "Data log Viewer" Dialog

"Data Log Viewer" Dialog will pop up when user selects "Data Log" item of "Logs" Menu , or click buttons from toolbar or click "View log" button of data log in the "Record Setting" dialog. Refer to the following Diagram 3-2-5, the history data will be displayed in this dialog.

Users can select the port and UPS to show the data of that device.

Users can click “Next”, “Prev”, “Home” and “End” button to display the data log.

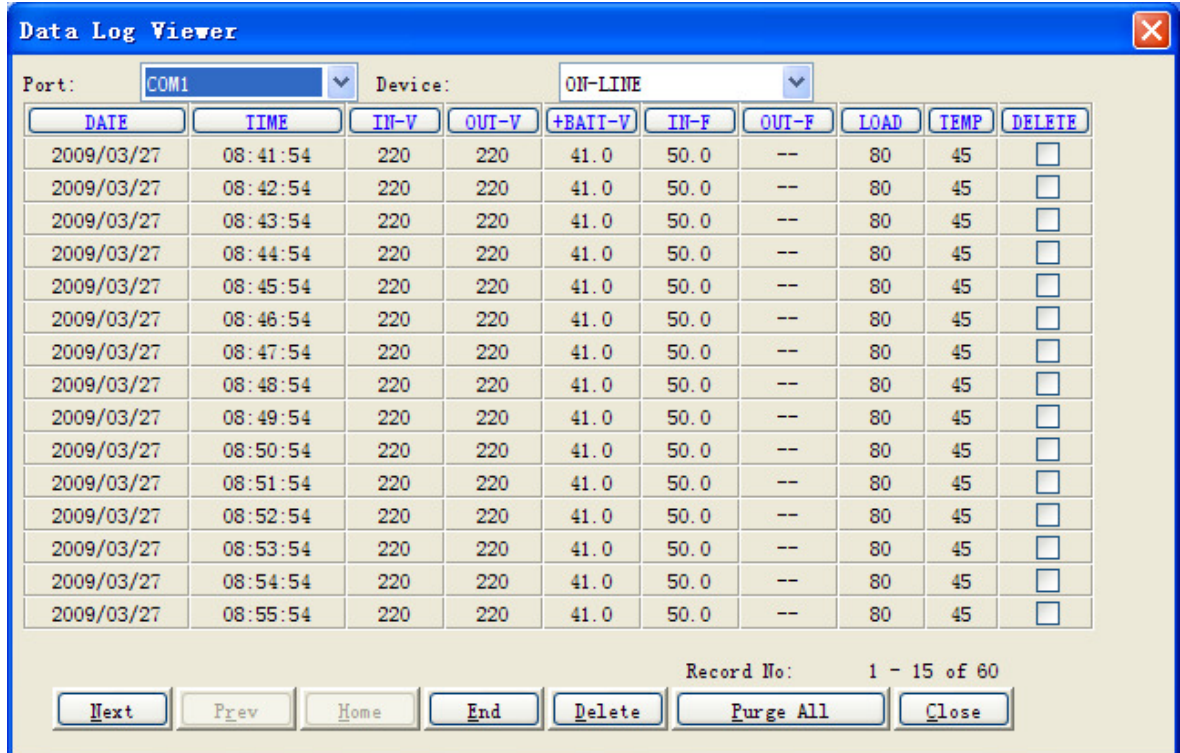

Diagram 3-2-5

User can select the check box “Delete” and click "Delete" button to remove the selected data log.

User can click “Close” button to close the dialog.

User can click "Purge All" button to delete all of the data.

Note: If “Delete” and “Purge All” button are invalid, it means your access right to the current Agent is “Read Only” and you can’t carry out these operations. You should log in as a super user.

6) “Record Setting” Dialog

The “Record Setting” dialog can be opened from the “Record Setting” item of “Logs” menu. Refer to the following Diagram 3-2-6-1.

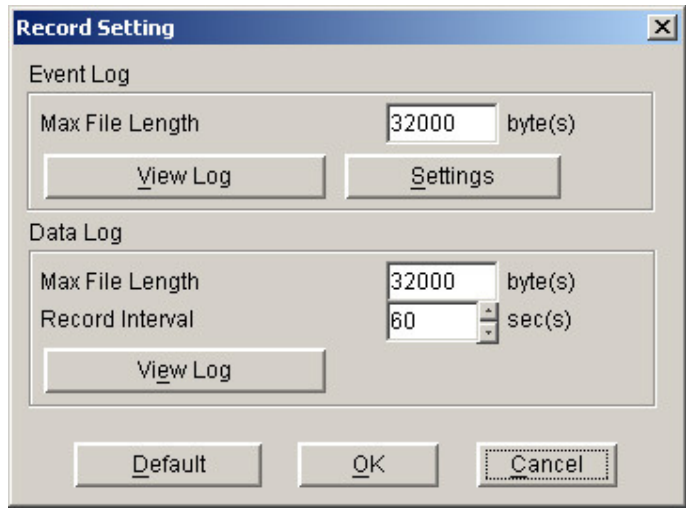

Diagram 3-2-6-1

The default value of the maximum file length of Event Log Viewer is 32KB (the maximum value is 1MB).

Click the “View Log” button of the event log in the “Record Setting” dialog (Refer to the following diagram 3-2-6-2) to pop up the “Event Log Viewer” dialog (Refer to the following diagram 3-2-6-3)

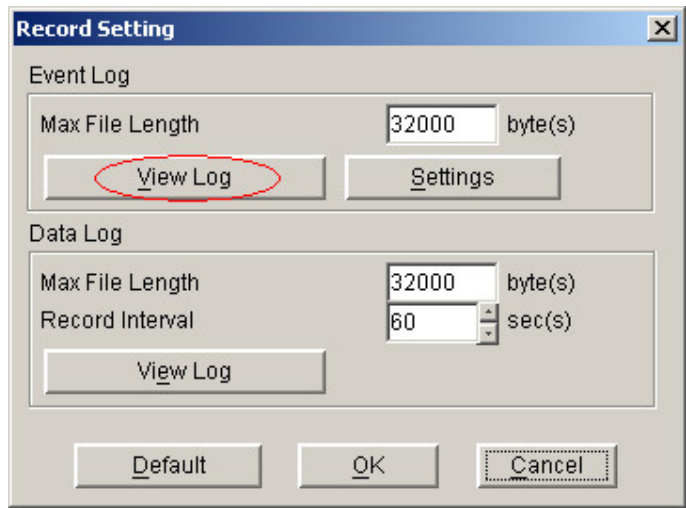

Diagram 3-2-6-2

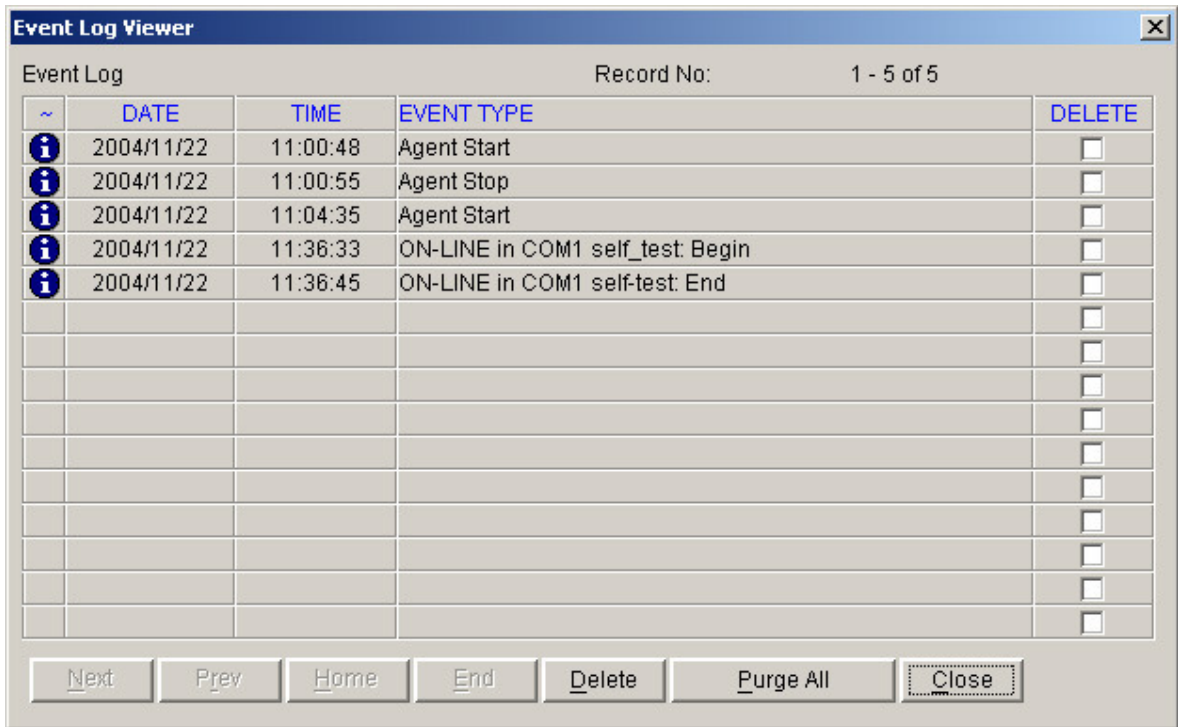

Diagram 3-2-6-3

Click the “Settings” button of the event log in the “Record Setting” dialog (Refer to the following diagram 3-2-6-4) to pop up the “Event Action” dialog. Refer to the following diagram 3-2-6-5.

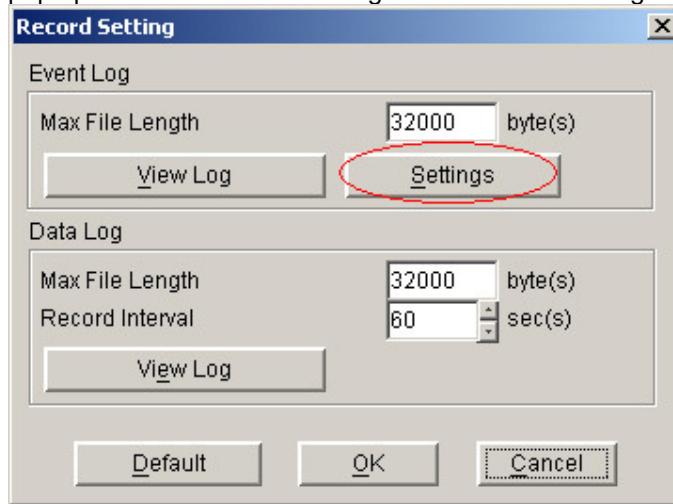

Diagram 3-2-6-4

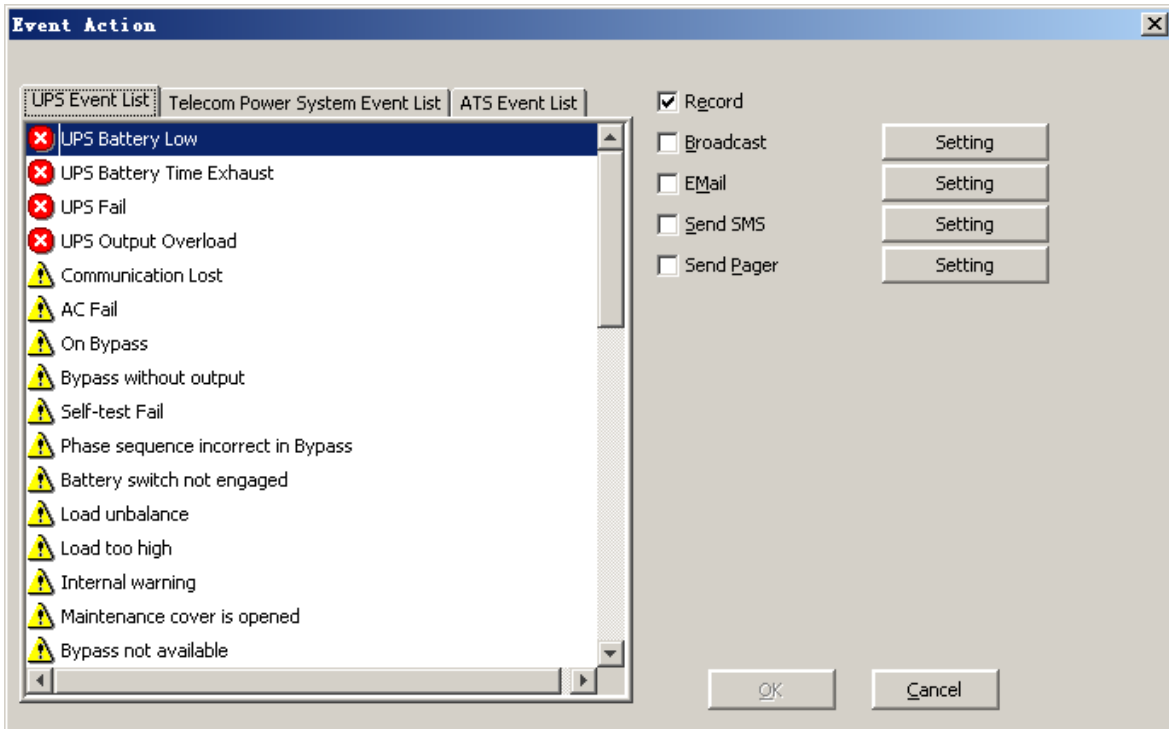

Diagram 3-2-6-5

The default value of the “Maximum file length” in the “Data Log Viewer” is 32KB (the maximum is 1MB).

The default value of record interval in the “Data Log Viewer” is 60 second (the maximum is 3600 second).

Click the “View Log” button of data log in the “Record Setting” dialog (refer to the following diagram 3-3-5-6) to pop up the “Data Log Viewer” dialog (refer to the following diagram 3-2-6-7).

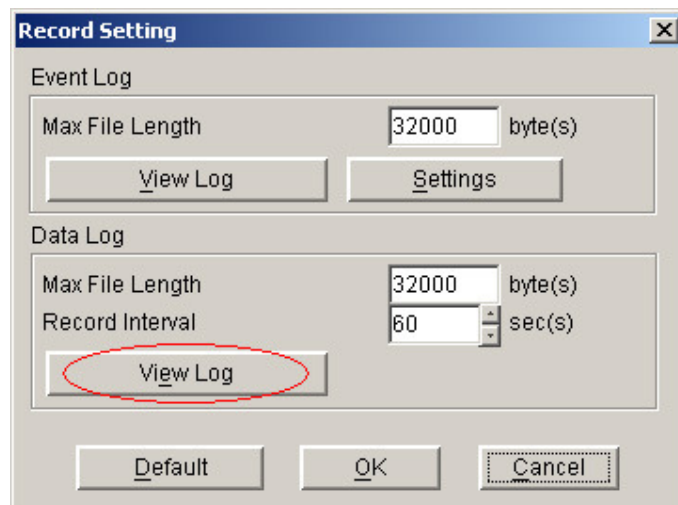

Diagram 3-2-6-6

Data Log Viewer

Port: **COM1** Device: **ON-LINE**

DATE	TIME	IN-V	OUT-V	+BATT-V	IN-F	OUT-F	LOAD	TEMP	DELETE
2009/03/27	08:41:54	220	220	41.0	50.0	--	80	45	<input type="checkbox"/>
2009/03/27	08:42:54	220	220	41.0	50.0	--	80	45	<input type="checkbox"/>
2009/03/27	08:43:54	220	220	41.0	50.0	--	80	45	<input type="checkbox"/>
2009/03/27	08:44:54	220	220	41.0	50.0	--	80	45	<input type="checkbox"/>
2009/03/27	08:45:54	220	220	41.0	50.0	--	80	45	<input type="checkbox"/>
2009/03/27	08:46:54	220	220	41.0	50.0	--	80	45	<input type="checkbox"/>
2009/03/27	08:47:54	220	220	41.0	50.0	--	80	45	<input type="checkbox"/>
2009/03/27	08:48:54	220	220	41.0	50.0	--	80	45	<input type="checkbox"/>
2009/03/27	08:49:54	220	220	41.0	50.0	--	80	45	<input type="checkbox"/>
2009/03/27	08:50:54	220	220	41.0	50.0	--	80	45	<input type="checkbox"/>
2009/03/27	08:51:54	220	220	41.0	50.0	--	80	45	<input type="checkbox"/>
2009/03/27	08:52:54	220	220	41.0	50.0	--	80	45	<input type="checkbox"/>
2009/03/27	08:53:54	220	220	41.0	50.0	--	80	45	<input type="checkbox"/>
2009/03/27	08:54:54	220	220	41.0	50.0	--	80	45	<input type="checkbox"/>
2009/03/27	08:55:54	220	220	41.0	50.0	--	80	45	<input type="checkbox"/>

Record No: 1 - 15 of 60

Diagram 3-2-6-7

Note: Click "Default" button and the parameters in this page will become default. If the "OK" button is invalid, it means your access right to the current Agent is "Read Only", and you cannot setup the parameters. You should log in as a super user.

7) " Device Control Parameters" Dialog

The "Device Control Parameters" Dialog will pop up when user selects "Device Control Parameters" item of "Device" menu.

For **ON-LINE** Device, refer to the following diagram 3-2-7-1.

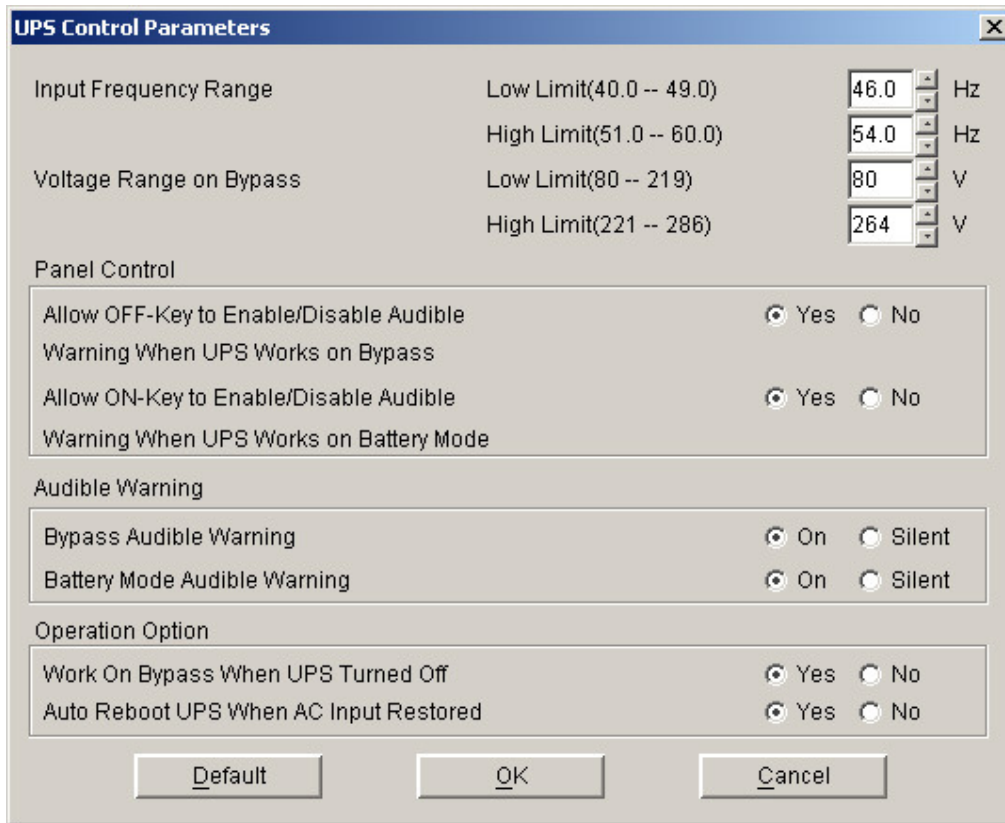

Diagram 3-2-7-1

Refer to the following table 3-2-7-1:

Parameter	Unit	Maximum	Minimum	Default
High limit of input frequency on bypass	Hz	60.0 (for 50Hz system) 70.0 (for 60Hz system)	51.0 (for 50Hz system) 61.0 (for 60Hz system)	54.0 (for 50Hz system) 64.0 (for 60Hz system)
Low limit of input frequency on bypass	Hz	49.0 (for 50Hz system) 59.0 (for 60Hz system)	40.0 (for 50Hz system) 50.0 (for 60Hz system)	46.0 (for 50Hz system) 56.0 (for 60Hz system)
High limit of input voltage on bypass	V	286 (for 1~3K 220V UPS) 132 (for 1~3K 110V UPS) 261 (for 6~20K UPS)	221 (for 1~3K 220V UPS) 110 (for 1~3K 110V UPS) 231 (for 6~20K UPS)	264 (for 1~3K 220V UPS) 132 (for 1~3K 110V UPS) 261 (for 6~20K UPS)
Low limit of input voltage on bypass	V	219 (for 1~3K 220V UPS) 110 (for 1~3K 110V UPS) 209 (for 6~20K UPS)	80 (for 1~3K 220V UPS) 40 (for 1~3K 110V UPS) 140 (for 6~20K UPS)	80 (for 1~3K 220V UPS) 50 (for 1~3K 110V UPS) 176 (for 6~20K UPS)
ON button can control battery mode audible warning	-	-	-	Yes
OFF button can control bypass mode audible warning	-	-	-	Yes (for 1~3K UPS) No (for 6~20K UPS)
Do audible warning when on bypass mode	-	-	-	Yes
Do audible warning when on battery mode	-	-	-	Yes
Restore line mode when AC restored	-	-	-	Yes
Work on bypass when UPS turned off	-	-	-	No (for 1~3K UPS) Yes (for 6~20K UPS)

Table 3-2-7-1

For special ON-LINE Device, refer to the following diagram 3-2-7-2.



Diagram 3-2-7-2

Refer to the following table 3-2-7-2.

Parameter	Unit	Maximum	Minimum	Default
High limit of input frequency on bypass	HZ	60.0 (for 50Hz system) 70.0 (for 60Hz system)	51.0(for 50Hz system) 61.0 (for 60Hz system)	55.0(for 50Hz system) 66.0 (for 60Hz system)
Low limit of input frequency on bypass	HZ	49.0 (for 50Hz system) 59.0 (for	40.0 (for 50Hz system) 50.0 (for	45.0 (for 50Hz system) 54.0 (for 60Hz system)

		60Hz system)	60Hz system)	
High limit of input voltage on bypass	V	276	Low limit of input voltage on bypass +10	264
Low limit of input voltage on bypass	V	High limit of input voltage on bypass - 10	110	110
High limit of input frequency on ECO	-	+10%	+5%	+5%
Low limit of input frequency on ECO	-	-10%	-5%	-5%
High limit of input voltage on ECO	-	+10%	+5%	+5%
Low limit of input voltage on ECO	-	-10%	-5%	-5%
High limit of input frequency on Line	-	+10%	+2%	+10%
Low limit of input frequency on Line	-	-10%	-2%	-10%
Output voltage rating	V	240	200	220V(Can be 200V,208V,220V,230V,240V,can be set in no output or bypass mode)
Voltage adjustability	-	+10	-10	0
Output frequency rating	HZ	60	50	50(Can be 50 or 60, can be set in no output mode or bypass mode)
Battery Quantity Per String	-	24 or 20(depend on the UPS model)	12	20(only for 6-10k)
Maximum charging current	A	4 or 1(depend on the UPS model)	0.5	4 or 1(depend on the UPS model, only for 6-10k ups)
Allow button to enable/disable audible warning	-	-	-	No
Bypass Forbidden	-	-	-	No
UPS Auto Restart				
Buzzer Alarm	-	-	-	Yes
Converter Mode	-	-	-	No
ECO Mode	-	-	-	No
Parallel Mode	-	-	-	No
Frequency Auto Detection	-	-	-	Yes
Auto Re-transfer After Overload Clearance	-	-	-	Yes
Auto Short-Circuit Clearance				Yes
EPO Function				Yes
Load Segment				Yes (for 1-3K UPS)
Bypass when UPS is off				Yes
Deep Discharge Function				No

Table 3-2-7-2

Note: click the “default” button, the parameters in this page will become the default value.

For regular LINE-INT UPS, user can enable/disable battery mode alarm audible though this dialog. Refer to the following diagram 3-2-7-3:

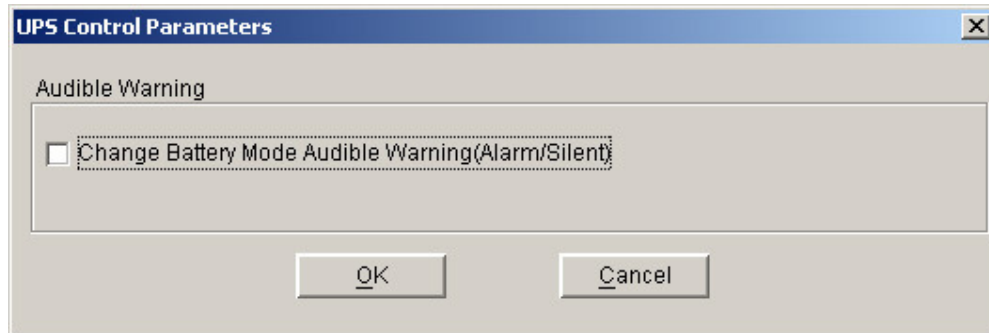

Diagram 3-2-7-3

For special LINE-INT UPS, Refer to the following diagram 3-2-7-4.

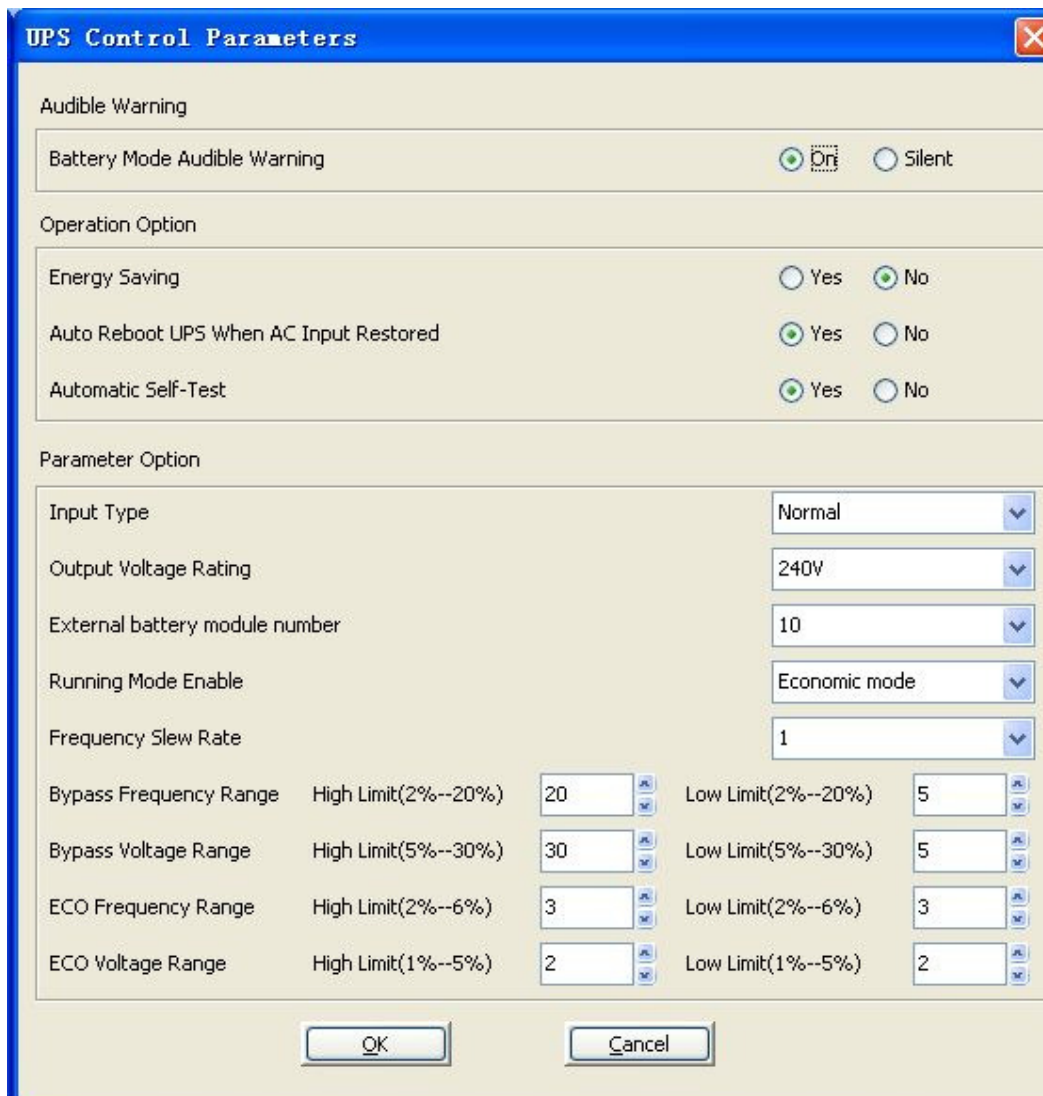

Diagram 3-2-7-4

Refer to the following table 3-2-7-3

Parameter	Value
Battery Mode Audible Warning	Yes – Allow audible warning in battery mode No – Keep silence in battery mode
Energy Saving	Yes – If the load is light, Shut down UPS in 5 minutes when AC Fail No – UPS won't be shut down until battery backup time exhaust
Auto Reboot UPS When AC Input Restored	Yes – Auto-restart enable No – Auto-restart disable
Automatic Self-Test	Yes – Automatic self-test enable No – Automatic self-test disable
Input Type	Normal – Accept normal AC line range Wide range – Accept wide AC line range Generator – Accept generator's output
Output Voltage Rating	Can be 110V,120V,127V,220V,230V,240V
External battery module number	Only long time discharged model has this option, the number is from 00 to 10.
Running mode enable(only for vigor)	Economic mode – enable economic mode Normal – disable economic mode
Frequency slew rate(only for vigor)	Can be 1,2,3
Bypass frequency range, Bypass voltage range, ECO frequency range, ECO voltage range(only for vigor)	High loss limit and low loss limit

Table 3-2-7-3

For special LINE-INT UPS, Refer to the following diagram 3-2-7-5.

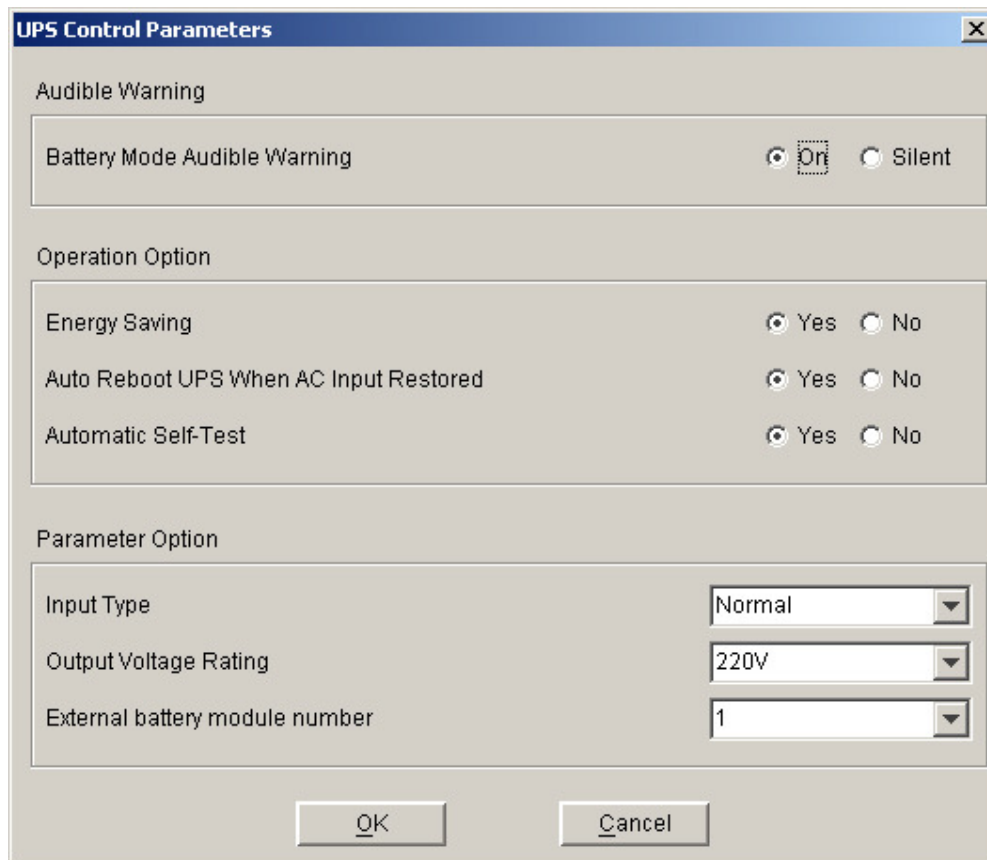

Diagram 3-2-7-5

Refer to the following table 3-2-7-4.

Parameter	Value
Battery Mode Audible Warning	Yes – Allow audible warning in battery mode No – Keep silence in battery mode
Energy Saving	Yes – If the load is light, Shut down UPS in 5 minutes when AC Fail No – UPS won't be shut down until battery backup time exhaust
Auto Reboot UPS When AC Input Restored	Yes – Auto-restart enable No – Auto-restart disable
Automatic Self-Test	Yes – Automatic self-test enable No – Automatic self-test disable
Input Type	Normal – Accept normal AC line range Wide range – Accept wide AC line range Generator – Accept generator's output
Output Voltage Rating	Can be 110V,120V,127V,220V,230V,240V
External battery module number	Only long time discharged model has this option, the number is from 00 to 10.

Table 3-2-7-4

For telecom power, Refer to the following diagram 3-2-7-6

Telecom Power System Control Parameter Setting

System Settings

Baud Rate: 2400 R422 Address (0--9999): 0

Inverter Settings

O/P Volt: 230V O/P Freq: 60Hz

Output Volt Low Loss (176--...): 220 V Output Volt High Loss (233--...): 220 V

Input Volt LVSD (38.0V--46.0V): 42.0 V Power Limited (50%--100%): 100 %

Fan Speed: Normal Inverter On/Off: All On Off

STS Settings

AC Volt Low Loss (176--209): 220 V AC Volt High Loss (233--252): 220 V

Inv. IPV Low Loss (176--209): 110 V Inv. IPV High Loss (233--252): 110 V

Fan Speed: Normal Output Priority: On Line Off Line

Rectifier Settings

Output voltage: 54.0 V Output voltage limit: 59 V

Current limit: 100 % Restart time: 10 S

Fan Speed: Normal Rectifier On/Off: All On Off

Notice: Please don't execute settings when readdressing; Restart TPS after setting output voltage of Inverter

OK Cancel

Diagram 3-2-7-6

For ATS, Refer to the following diagram 3-2-7-7

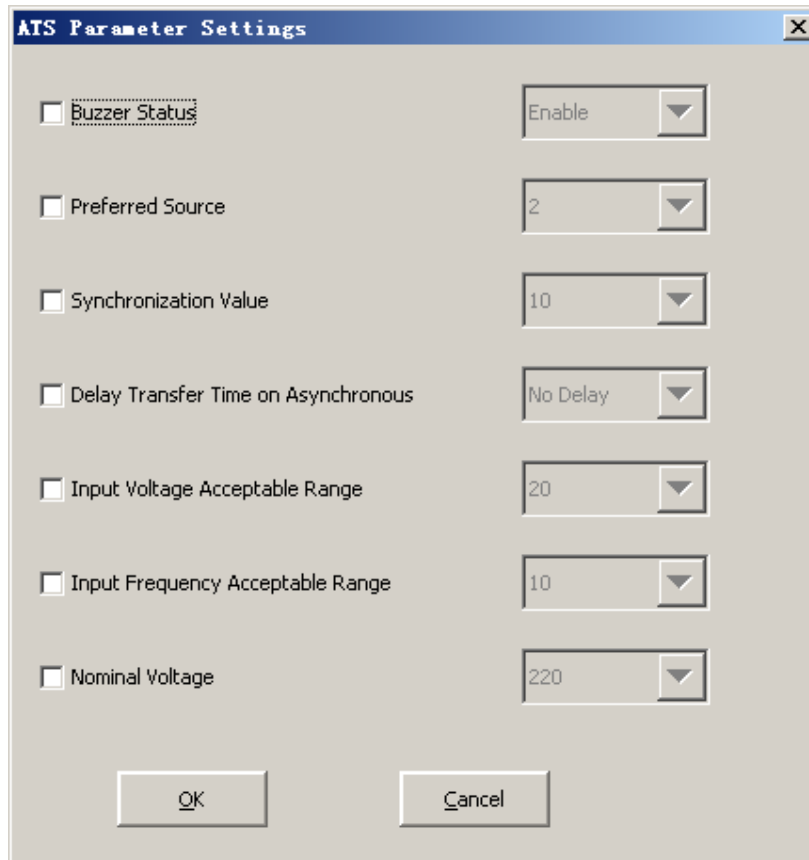

Diagram 3-2-7-7

Refer to the following table 3-2-7-5.

Parameter	Value
Buzzer Status	can be Enable, Mute, Disable
Preferred Source	1 - The Preferred source is S1 2 - The Preferred source is S2
Synchronization Value	The value can be 10,15,20. If the phase difference between S1 and S2 is less than this value degree, ATS will regard two input sources as synchronous source
Delay Transfer Time on Asynchronous	The value can be No delay, half cycle and one cycle. When switching input source due to preferred source fail if two input sources are not synchronous, the ATS will add a period of delay time.
Input Voltage Acceptable Range	The value can be between 12 and 20. for example ,the range of input voltage window is +/-12% if this value is 12
Input Frequency Acceptable Range	The value can be between 5 and 15. for example ,the range of input frequency window is +/-15% if this value is 15
Nominal Voltage	The value can be 220,230 and 240. This is only available for HV system

Table 3-2-7-5

Note: If the "OK" buttons is invalid, it means that your access right to the current Agent is "read only" and you can't carry out setup. You should log in as a super user.

8) "Event Action" Dialog

The "Event Action" dialog can be opened, by clicking "Event Action" item of "Device" menu or button in the toolbar. Refer to the following diagram 3-2-8. In the "Event Action" dialog, users can select that which action will be carried out when some events occur. For each event, the actions that users can select are Record, Broadcast, Email, Send SMS and Send Pager. There are three kinds events, The UPS event list is for UPS, Telecom Power System event list for Telecom Power System and ATS Event List for ATS.

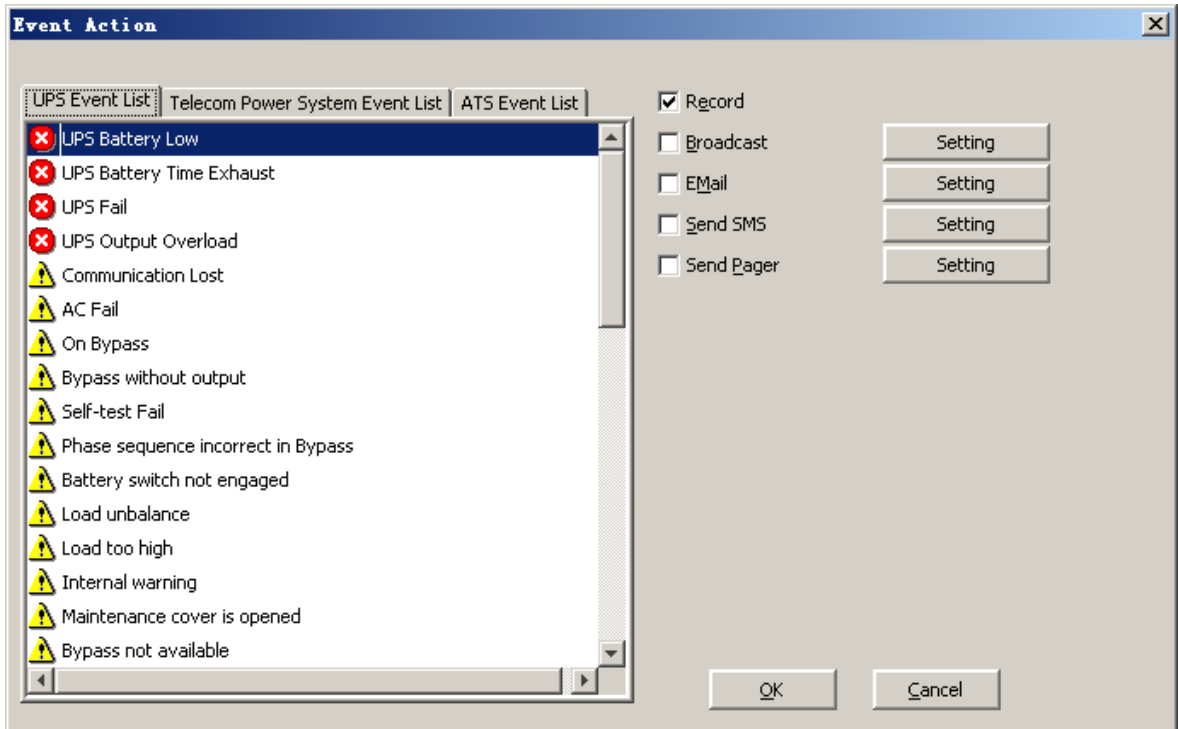

Diagram 3-2-8

Three grades icon of event: Severity (red), Warning (yellow) and Message (blue).

Note: if you want to use the e-mail notification function, you must setup SMTP server first. For the detailed information, please refer to "How to realize sending event message by e-mail".

9) "Shutdown Settings" Dialog

The "Shutdown settings" dialog can be opened from the "Shutdown Parameter" item of the "Device" menu. Refer to the following diagram 3-2-9.

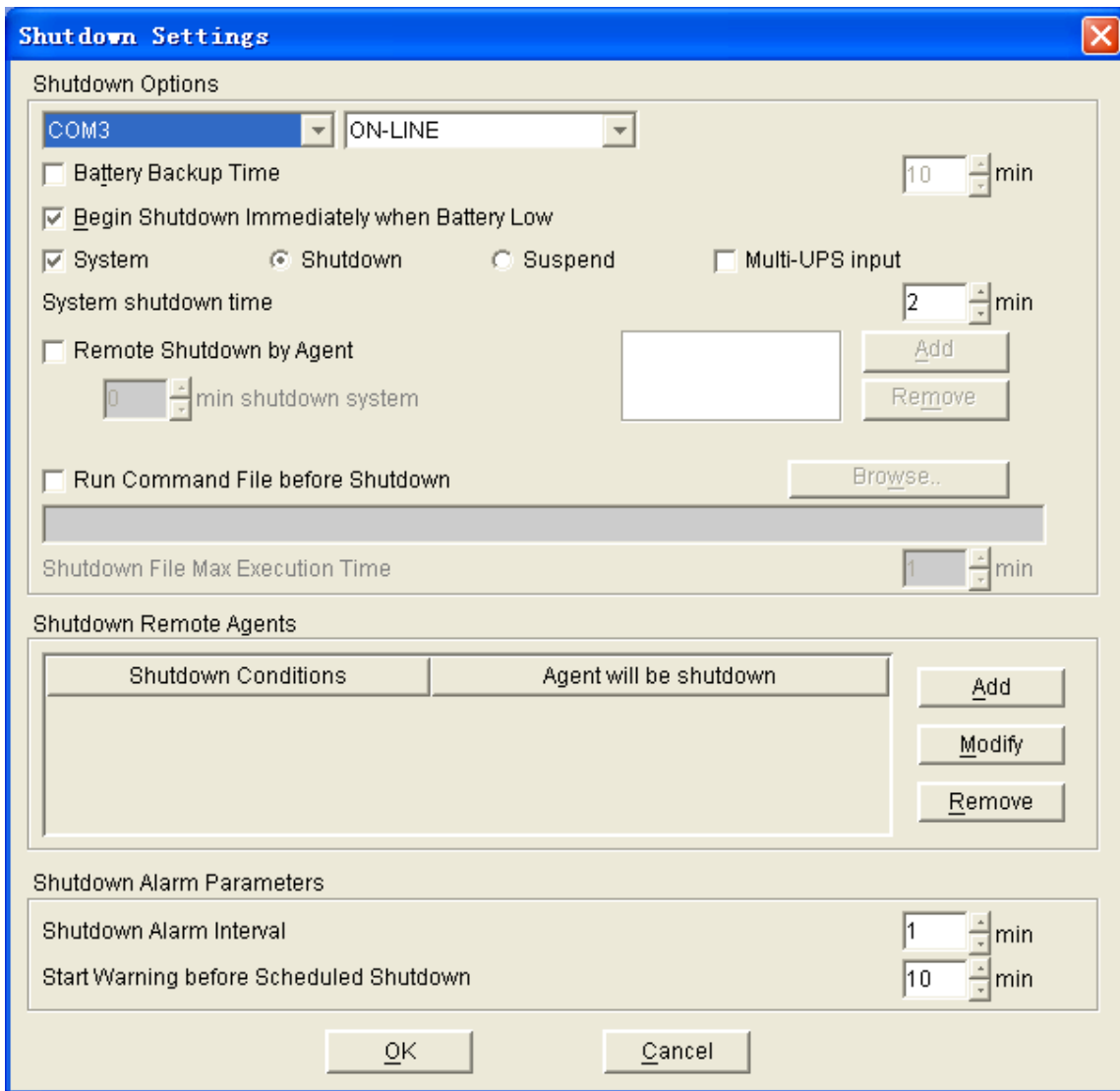

Diagram 3-2-9

The function is only for UPS.

In the “Shutdown Settings” dialog, the setting parameters are shown in the following Table 3-2-9.

Parameter	Unit	Maximum Value	Minimum Value	Default	Remark
Battery backup time	Minute	4320	1	10	When the check box with the function is selected and the utility power fails, the software will send the shutdown command to UPS once the setting time is expired, and the output of UPS will be turned off
Shutdown System	—	—	—	No	When this check box is selected, System will be shutdown while the appointed UPS is being turn off.
Suspend System	—	—	—	No	When this radio box is selected, System will be

					suspended to disk in shutdown sequence. This function only can be carry out in some Windows platforms and hibernate support must be enabled from /Control Panel/Power Options/Hibernate .
Multi-UPS input	—	—	—	NO	When the check box is selected, system won't be shut down until all the conditions of all selected UPS are met.
System shutdown need time	Minute	99	1	2	The time to be needed to shutdown the system, which is from the beginning of shutting down to the end of that.
Remote Shutdown by Agent	—	—	—	No	If Yes, System will be shut down by specified Agent.
XX min shutdown system	Minute	4320	0	0	Receiving the specified agent's shutdown signal, delay XX minutes. System will be shut down.
Run Command File before Shutdown	—	—	—	Nothing	Before system shutting down, Agent can execute a file, if this parameter isn't null, Agent will not begin to shut down the system until the "Execution file before system shutting down" ends.
Shutdown File Max Execution Time	Minute	60	1	1	Before system shutting down, the time to be needed to execute the shutdown file.
Begin Shutting down immediately while battery low	—	—	—	Yes	When this check box is selected and battery low event occurs, Agent will shut down the UPS immediately, otherwise the shutting down time will be controlled by battery back up time.
Shutdown remote Agents' Conditions	—	—	—	—	The condition can be "UPS be shutdown" or "The time on battery exceed setting time".
Agents be Shutdown	—	—	—	—	When shutdown condition is satisfied, Agent will send shutdown signal to the appointed remote Agents.
Shutdown Alarm Interval	Minute	60	1	1	The interval that Agent pop up an alarm message before shutting down.
Start Warning before Scheduled	Minute	60	1	10	If user has setup schedule shutting down, AGENT will sound alarm prior to the set time.

Shutdown					
----------	--	--	--	--	--

Table 3-2-9

Note: If the “OK” button is invalid, it means that your access right to the current Agent is “Read Only”, you can’t setup the parameters. You should log in as a super user.

10) “UPS Self-Test Immediately” Dialog

The “UPS Self-Test Immediately” dialog can be opened from the “Battery Self-Test Now” item of “Device” menu. Refer to the following diagram 3-2-10.



Diagram 3-2-10

The function is only for UPS.

In the “UPS Self-Test Immediately” dialog, users can select the type of self test: Self-Test for 10 seconds, Self-Test until battery low, Self-Test for XX minutes. The time range of self test for XX minutes is from 1 to 99 minutes.

Note: If the “OK” button is invalid, it means that your access right to the current Agent is “Read Only”, you can’t carry out the operation. You should log in as a super user.

11) “UPS Test Manager” Dialog

The “UPS Test Manager” dialog can be opened from the “Battery Self-Test Schedule” item of “Device” menu. Refer to the following diagram 3-2-11.

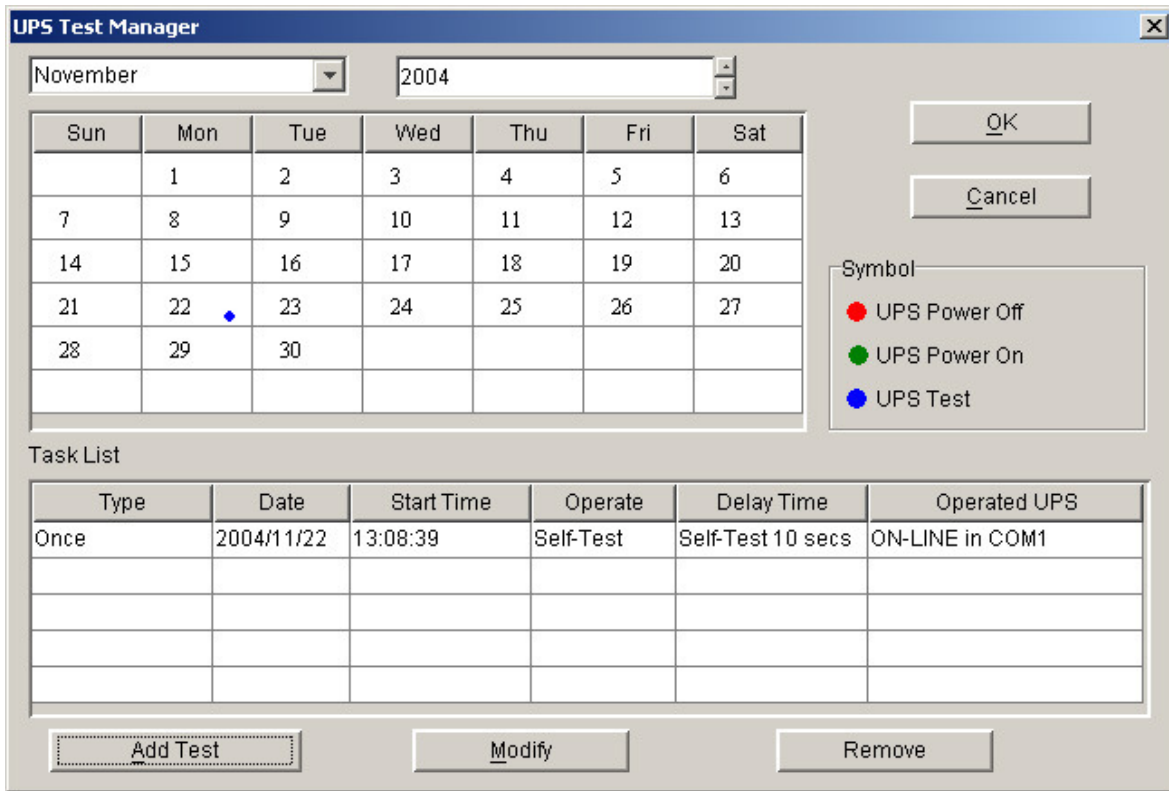

Diagram 3-2-11

The function is only for UPS.

The function can be used to display and setup UPS self test task. UPS self test task has two types: "once" and "monthly".

UPS self test type: UPS self test for 10 seconds, UPS self test to battery low, and UPS self test for the appointed time. The appointed time range is 1 to 99 minutes, and the default value is 10 minutes.

The "UPS Test Manager" dialog contains two parts: task list and calendar. All the UPS self test and UPS on/off tasks are shown in the calendar. The red dot denotes the Power Off action, the green dot denotes the Power On action and the blue dot denotes the self test action. Click the "Add Test" button and users can setup the special time and monthly UPS self test task in the popped up dialog. The self test task added will be shown in the schedule.

If you select one of the UPS self test tasks in the list, you can modify the task that has been set by clicking the "Modify" button. If you select one of the UPS self test tasks, you also can remove the task by clicking "Remove" button.

Note: If the "OK", "Add Test", "Modify" and "Remove" buttons are invalid, it means that your access right to the current Agent is "read only" and you can't carry out the setting. You should log in as a super user.

12) "UPS On/Off Manager" Dialog

The "UPS On/Off Manager" dialog can be opened from the "UPS On/Off Schedule" item of "Device" menu. Refer to the following diagram 3-2-12.

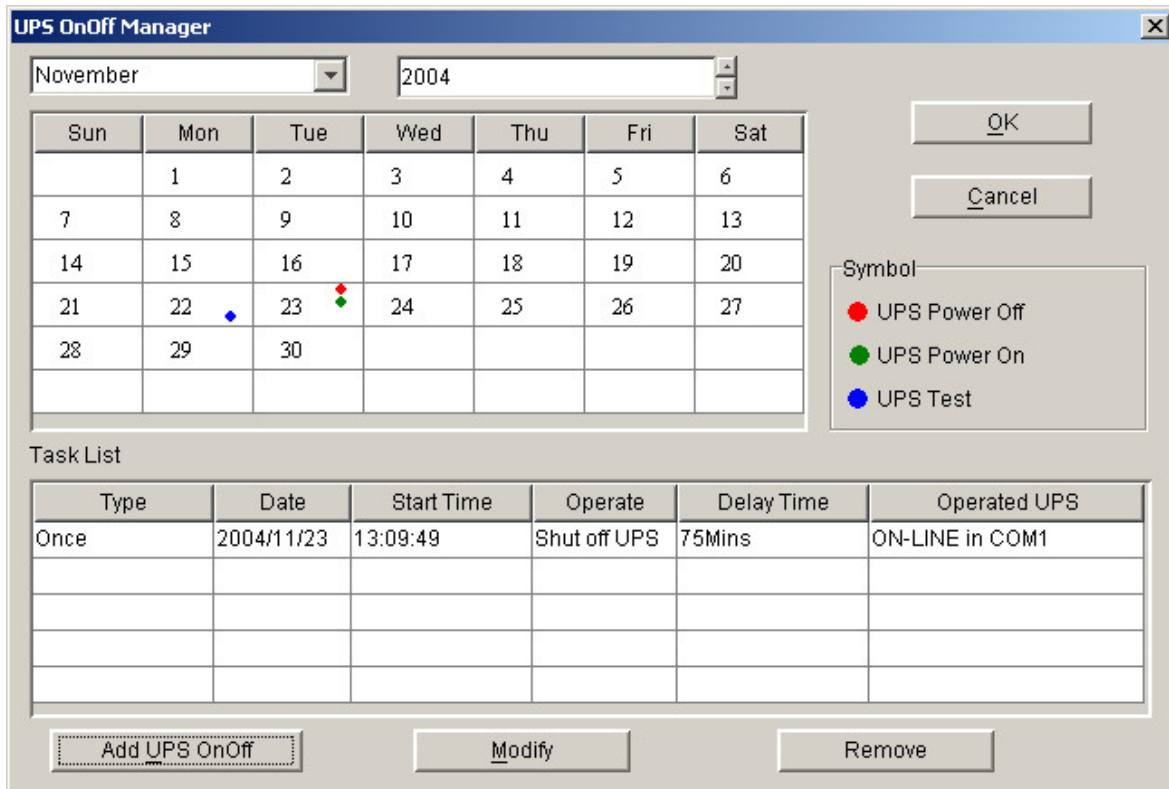

Diagram 3-2-12

The function is only for UPS.

The "UPS On/Off Manager" dialog is used to display and set up UPS On/Off tasks. The UPS On/Off tasks include two types: "Once" and "Weekly". The UPS Power Off time range (from shutdown to turning on next time) that can be set is 1-9999 minutes, i.e. the longest power off time is 6 days 22 hours and 39 minutes. The input range for the year is 2002-2035. The "UPS On/Off Manager" dialog contains task list and calendar. All the UPS self test and UPS On/Off tasks are shown in the calendar. We use red dot to denote the Power Off action, green dot to denote the Power On action and blue dot to denote self test action in the calendar. Users can setup weekly and special time's UPS Power On/Off tasks in the popped up dialog by clicking "Add UPS shutdown" button. Note: In terms of time, the new added task can't conflict with the UPS self test task and UPS Power On/Off tasks that have been set. If you select one of the UPS self test tasks in the list, you can modify the setup task by clicking the "Modify" button. You also can remove the task by clicking "Remove" button.

Note: If the "OK", "Add Test", "Modify" and "Remove" buttons are invalid, it means that your access right to the current Agent is "read only" and you can't carry out the setting. You should log in as a super user.

13) "Schedule Viewer" Dialog

The "Schedule Viewer" dialog can be opened from the "View Schedule" item of the "UPS" menu. Refer to the following diagram 3-2-13.

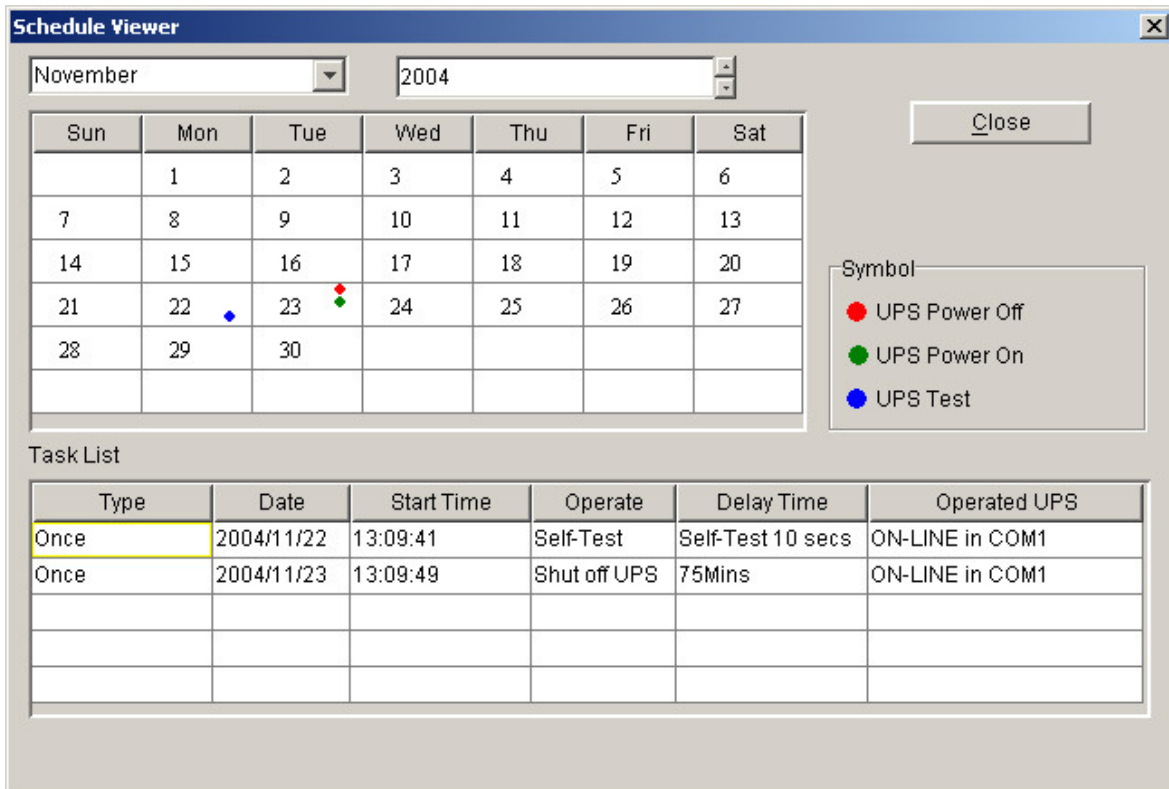

Diagram 3-2-13

The function is only for UPS.

The "Schedule Viewer" dialog is used to show the set up UPS Power On/Off and self test tasks. "Schedule" dialog contains task list and calendar graphic. Only the tasks of the current month are displayed in the task list. We use red dot to denote the Power Off action, green dot to denote the Power On action and blue dot to denote the self test action in the calendar.

14) "Broadcast Message Settings" Dialog

The "Broadcast Message Settings" dialog can be opened from the "Broadcast Setting" item of "Tools" menu or click broadcast "Setting" button in "Event Action" Dialog. Refer to the following diagram 3-2-14.

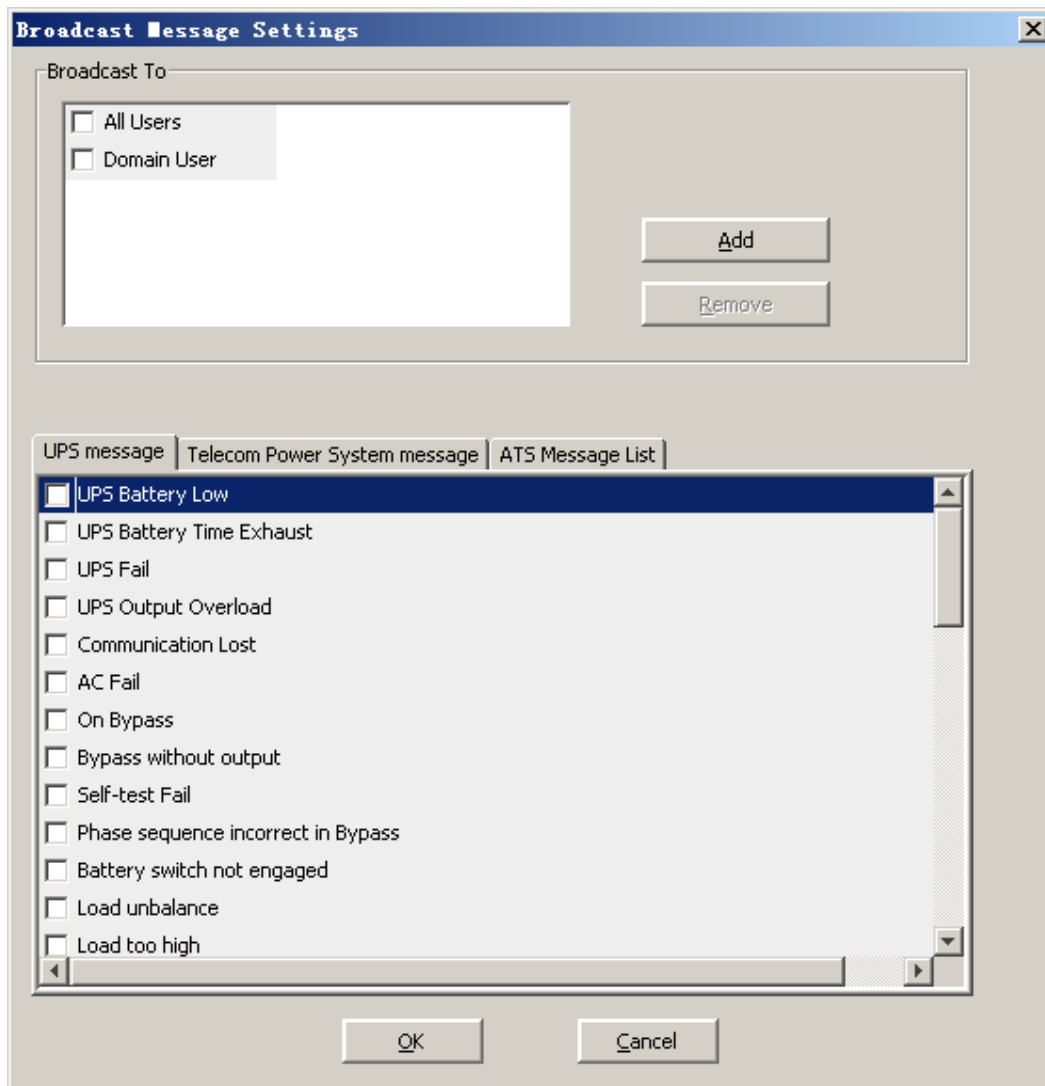

Diagram 3-2-14

The "Broadcast To" list box lists the users. The user item must be selected if the user wants to receive broadcast message. You can add and delete user item by click "Add" and "Remove" button (Note: the "All Users" and "Domain User" item can not be deleted). "All Users" means all computers in LAN. "Domain User" means computers in the same domain with local Agent.

The "UPS message", "Telecom Power System message" and "ATS message list" list boxes list all the message, you can select the message by click the check box with the message item.

Note: The function is valid only for windows. To receive broadcast message, "Winpopup" in Windows95/98 and "Messenger Service" in Windows NT/2000/XP must be started. If the "OK" button is invalid, it means that your access right to the current Agent is "Read only", and you can't carry out the operation. You should log in as a super user.

15) "Email Settings" Dialog

The "E-Mail Settings" dialog can be opened from the "E-Mail Setting" item of "Tools" menu or click E-Mail "Setting" button in "Event Action" Dialog. Refer to the following diagram 3-2-15.

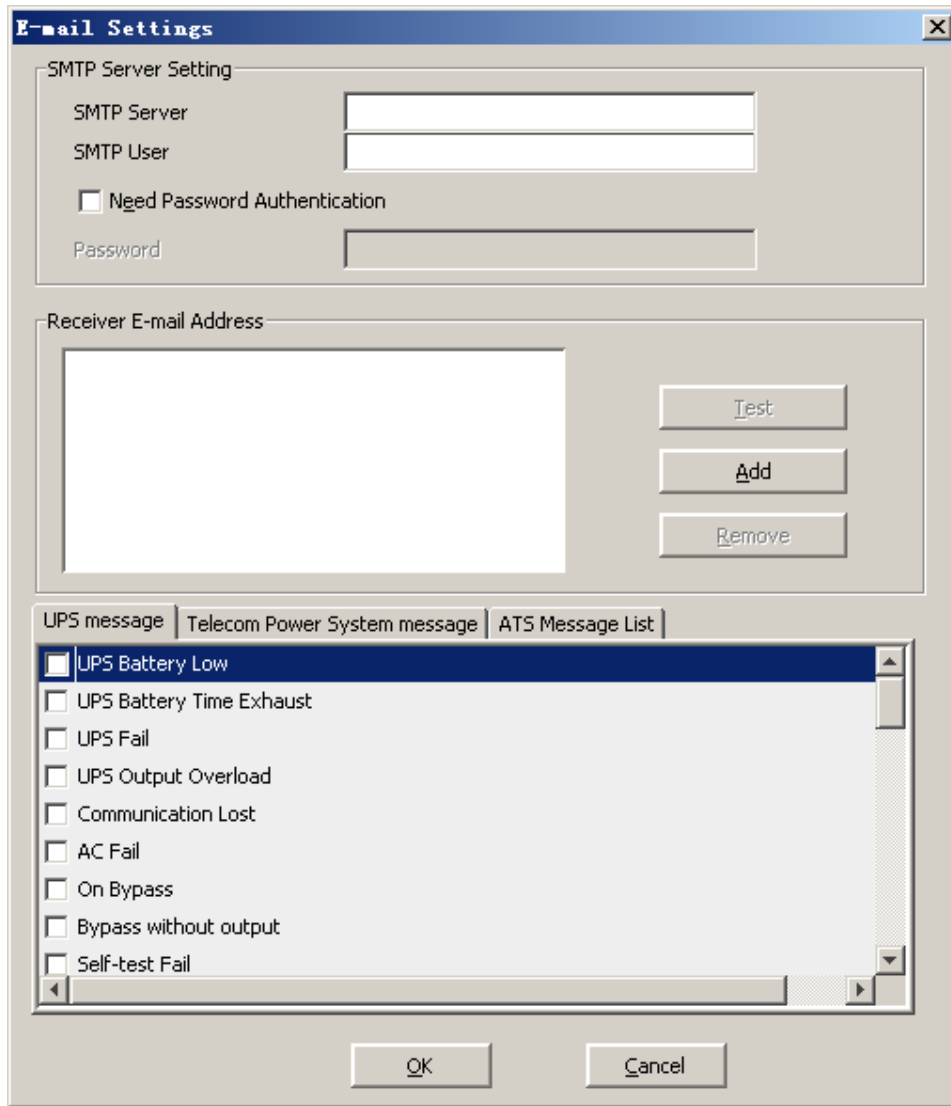

Diagram 3-2-15

The included items of the email parameter setting are shown in the following Table 3-2-15.

SMTP Server Name	This is the mail server, which is used to send emails to the appointed users. It could accept two formats: IP address and host name. For example: smtp.163.com
SMTP Account Name	This is the account for logging in the server. Enter the complete address format here. For example: yyy@163.com
Password	Input the SMTP account password in needed

Table 3-2-15

The "Receiver E-Mail Address" list box lists the email addresses. Click "Add" button to add an email address item. Select an address item and click "Remove" button will delete the item. Selected an email address item, and click the "Test" button will send a test email to the email address.

The "UPS message", "Telecom Power System message" and "ATS message list" list boxes list all the message, you can select the message by click the check box with the message item.

All of the SMTP parameter's default value is vacancy, and it can be setup in the local Agent only. To send email to the appointed user, the SMTP server name or IP address must be set, or the email will not be sent successfully.

Note: If you want to send email via Internet, you must have a SMTP account in the Internet. If the "OK" button is invalid, it means that your access right to the current Agent is "read only", and you can't carry out the parameter setting. You should log in as a super user.

16) "SMS Setting" Dialog

The "SMS Setting" dialog can be opened from the "SMS Setting" item of "Tools" menu or click Send SMS "Setting" button in "Event Action" Dialog. Refer to the following diagram 3-2-16.

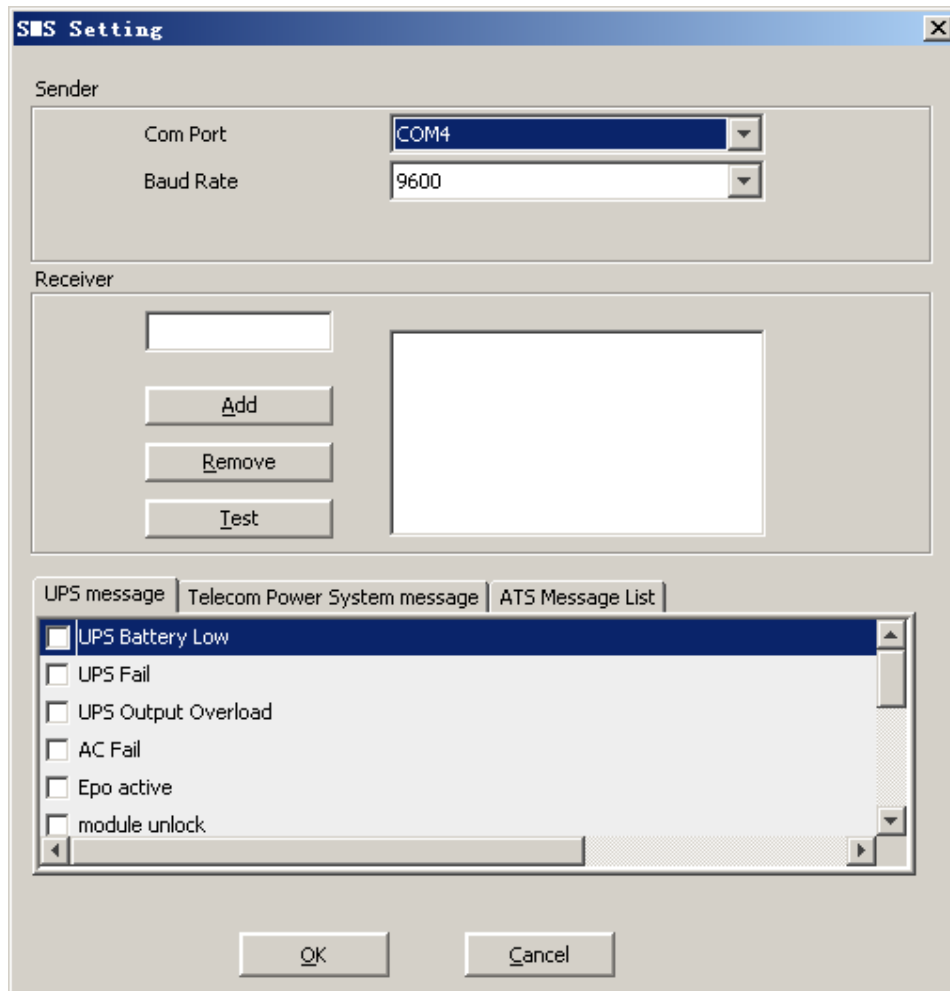

Diagram 3-2-16

Below is the use remark of SMS setting:

1. Sender

SMS is sent through GSM modem or mobile phone connected with your computer. User should select COM port that is being used by GSM Modem or mobile phone, and set baud Rate of the COM port.

2. Receiver:

Receiver is the mobile phones numbers who can receive the SMS. It can be one or more. If the Event that you have selected occurs, winpower will send the event message to the phone numbers in the "Receiver" list.

3. UPS message, Telecom Power System message and ATS message list

User can select the events that need to be informed by SMS.

Note: If the OK button is invalid, it means that your access right to the current Agent is "Read Only", and you can't carry out the operation. You should log in as a super user.

17) "Pager Setting" Dialog

The "Pager Setting" dialog can be opened from the "Pager Setting" item of "Tools" menu or click "Send Pager Setting" button in the "Event Setting" dialog. Refer to the following diagram 3-2-17.

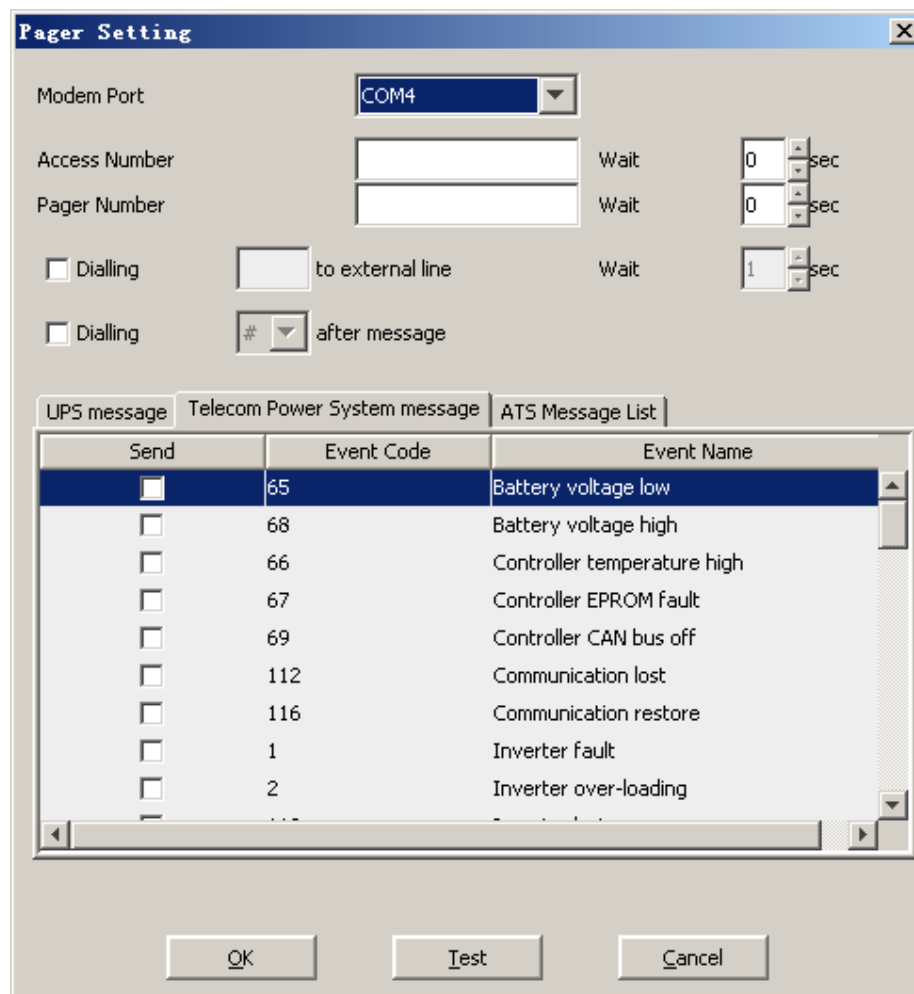

Diagram 3-2-17

To configure the pager parameters, user must have full access. User can get full access by selecting "Act as Administrator" item of "System" menu and enter right Agent Password in the popup dialog.

Refer to the following table 3-2-17.

Parameter	Description
Modem Port	Select COM port which is being used by Modem.
Access Number	For some pager service, a delay is needed between dialing access number and Pager Number.
Pager Number	For some pager service, a delay is needed between dialing pager number and message code.
Dialing number to exterior line	For extension line, it is always necessary to dial a specified number and delay a specified time to access Exterior Line.
Dialing number after message	For some pager service, need to dial a specified number to end message code.
Event Code	The event code is dialed as the message code and will be displayed on pager.

Table 3-2-17

Note: If the "OK" button is invalid, it means that your access right to the current Agent is "Read Only", and you can't carry out the operation. You should log in as a super user.

18) "Monitor Remote Device" Dialog

The "Monitor Remote Device" Dialog will show when user selects "Monitor Remote Device" item of "Monitor" menu. Refer to the following diagram 3-2-18-1.

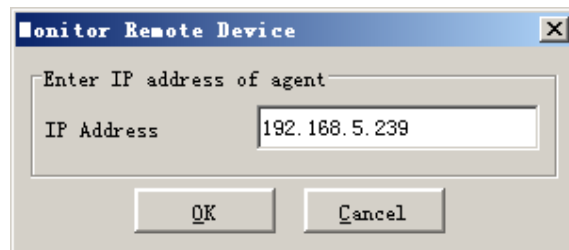

Diagram 3-2-18-1

Enter the IP address of an Agent to be monitored, and press "OK" button. If the agent exists, its information will be shown below the "WAN" node in the tree view of the Manager window.

Note:

- 1) The number of remote agent monitored is up to 256.
- 2) If the software can't communicate with the remote agent in 1 minute, the agent will be kept on the left tree, and the status of this agent will be "Network Communication Lost".
- 3) You can delete a remote agent by select the agent node manually, then click the mouse right button to show a pop up menu, select "Delete" menu item to remove it. Refer to the following diagram 3-2-18-2.

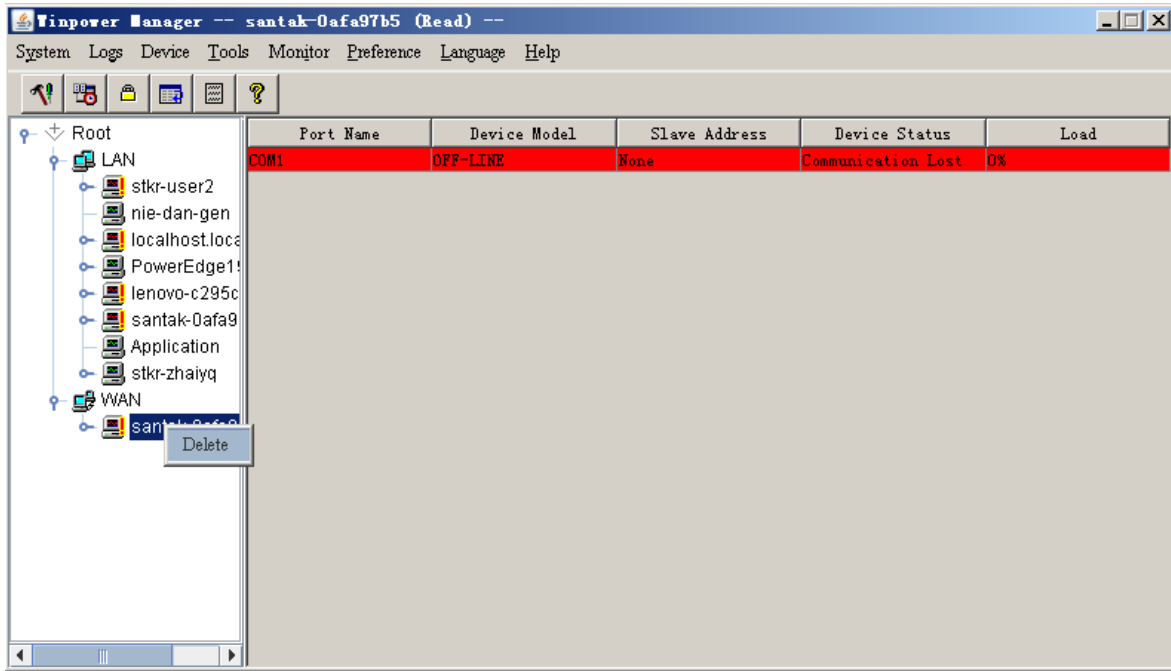

Diagram 3-2-18-2

19) Bottom image

If you select the submenu “BottomImage” of the menu “Preference”, you can change the bottom image of the interface. Refer to the following diagram 3-2-19.

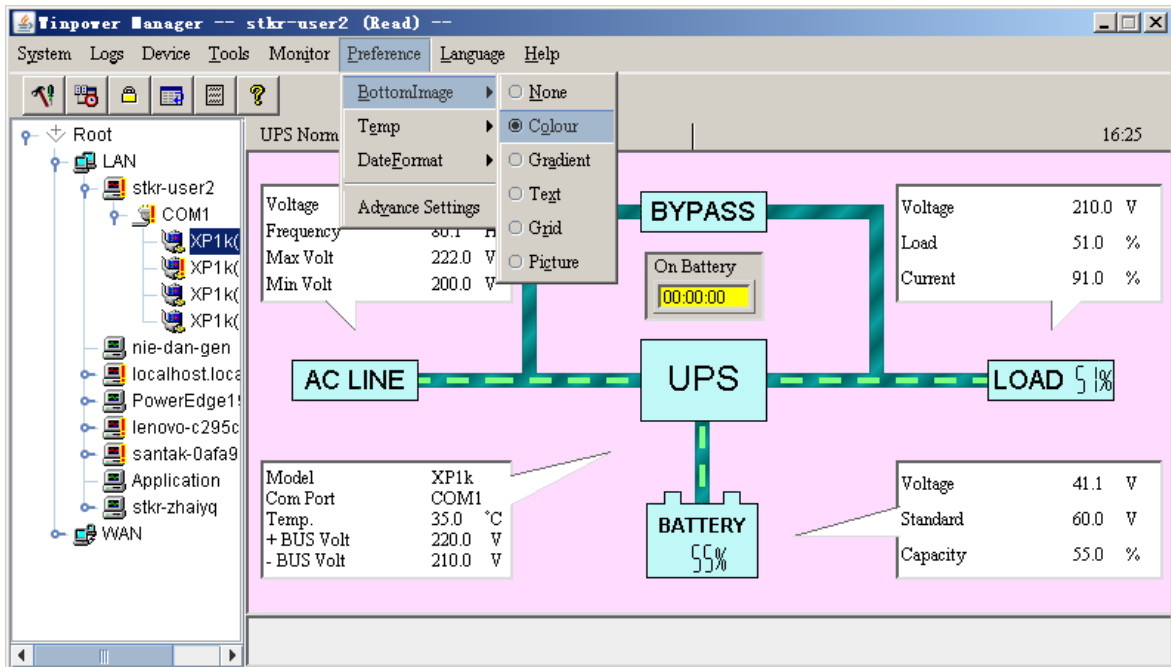

Diagram 3-2-19

20) Temp

The centigrade or Fahrenheit temperature shown in the interface can be changed by selecting the submenu “Temp” of the menu “Preference”. Refer to the following diagram 3-2-20.

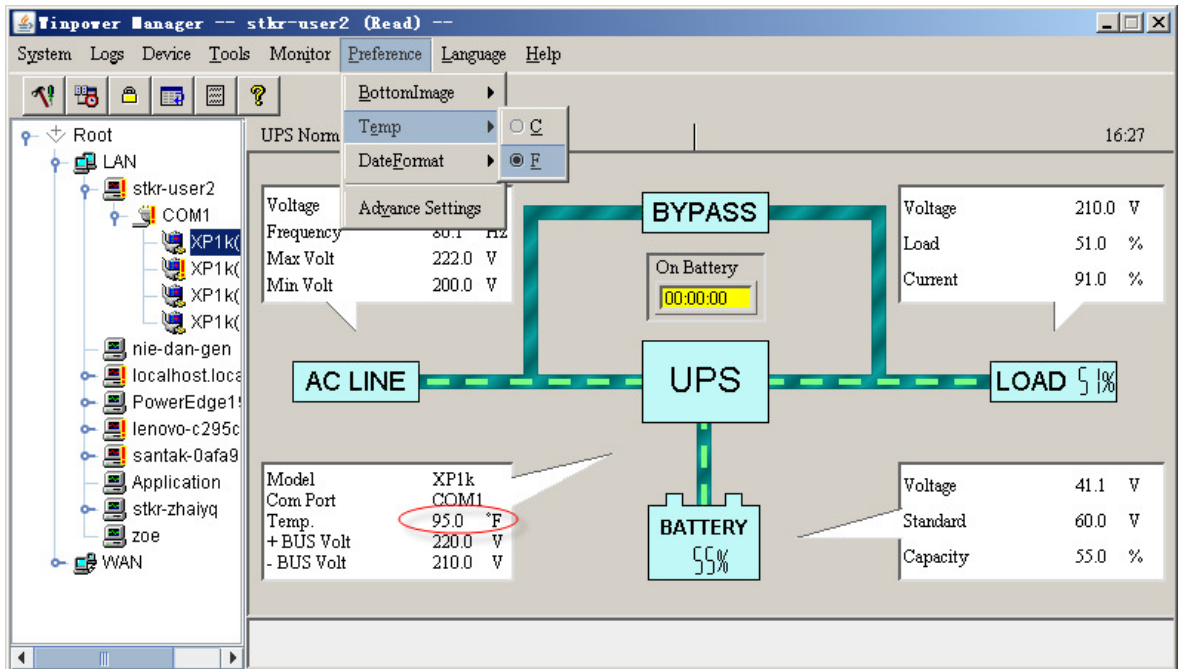

Diagram 3-2-20

21) Date Format

The date format can be changed by selecting the submenu “DateFormat” of the menu “Preference”. The format is “Year/Month/Day”, “Month/Day/Year” or “Day/Month/Year”. Refer to the following diagram 3-2-21.

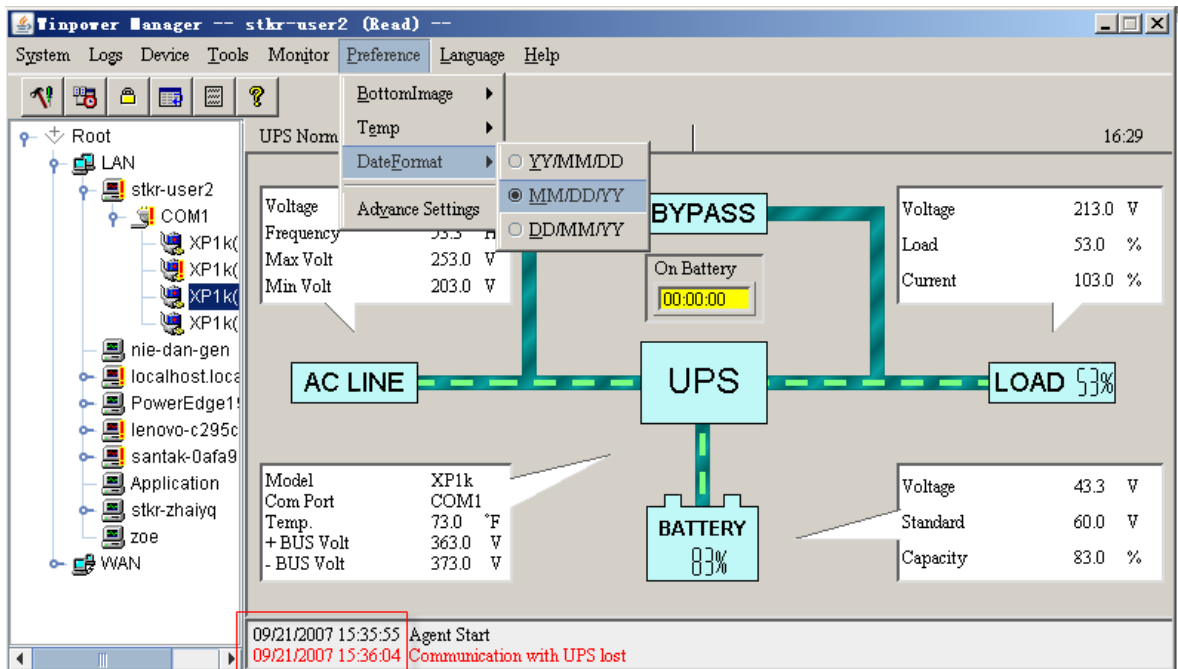

Diagram 3-2-21

22) Advance Settings

The font, size, color and bottom image of the interface can be changed by selecting the submenu “Advance Settings” of the menu “Preference”.

The “Advance Settings” dialog contains two parts: “General” and “BottomImage”.

Refer to the following diagram 3-2-22-1.

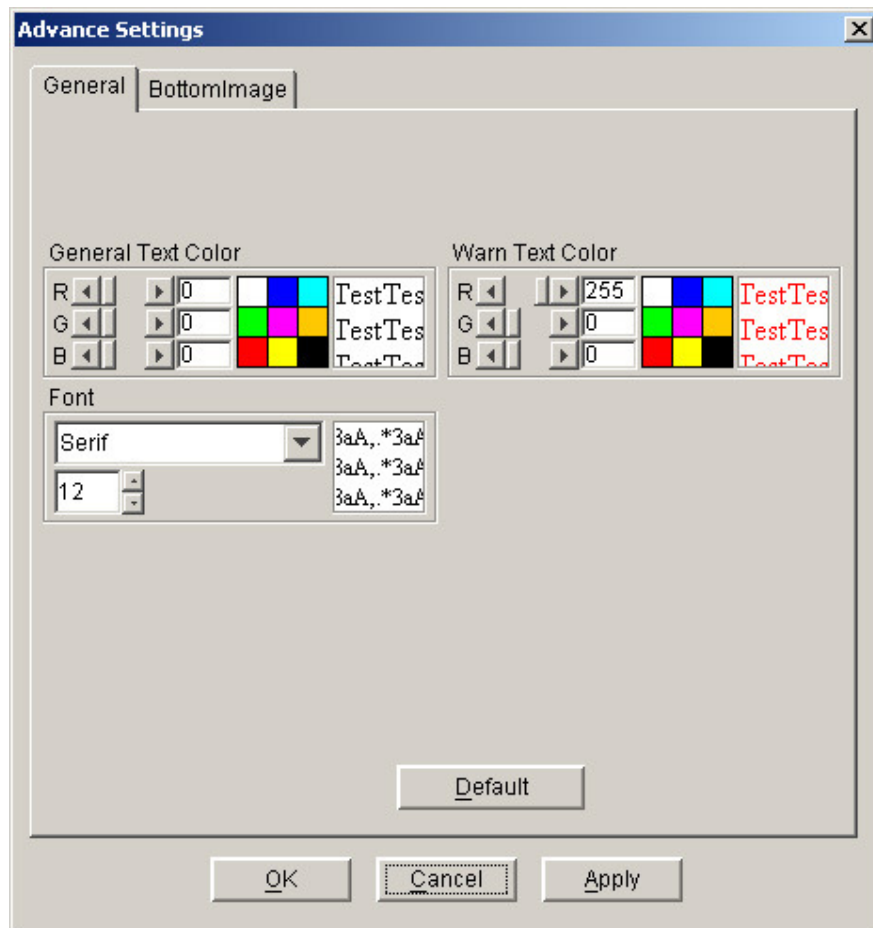

Diagram 3-2-22-1

Note: If you click “Default” button, the parameters in this view will be turned into default value.

If the “OK” button is invalid, it means that your access right to the current Agent is “read only”, so you can’t carry out the parameter setup. You should log in as a super user.

In the “BottomImage” view:

If you click “None” box, the bottom image of the interface is “background color”.

Users can select the color that they want by clicking “Color” box.

Users can select the color and gradient direction that they want by clicking “Gradient” box.

Users can select background color, character size and light and shade degree of background text by clicking “Text” box. The bottom image is the background that has the appointed text.

Users can select the background color, the grid offset, the grid size and the grid light and shade degree in the background by clicking “Grid” box, the bottom image of the interface is “Grid”.

Users can select the background picture from the popped up list box by clicking the “Picture” box, the bottom image of the interface is “Picture”.

Refer to the following diagram 3-2-22-2.

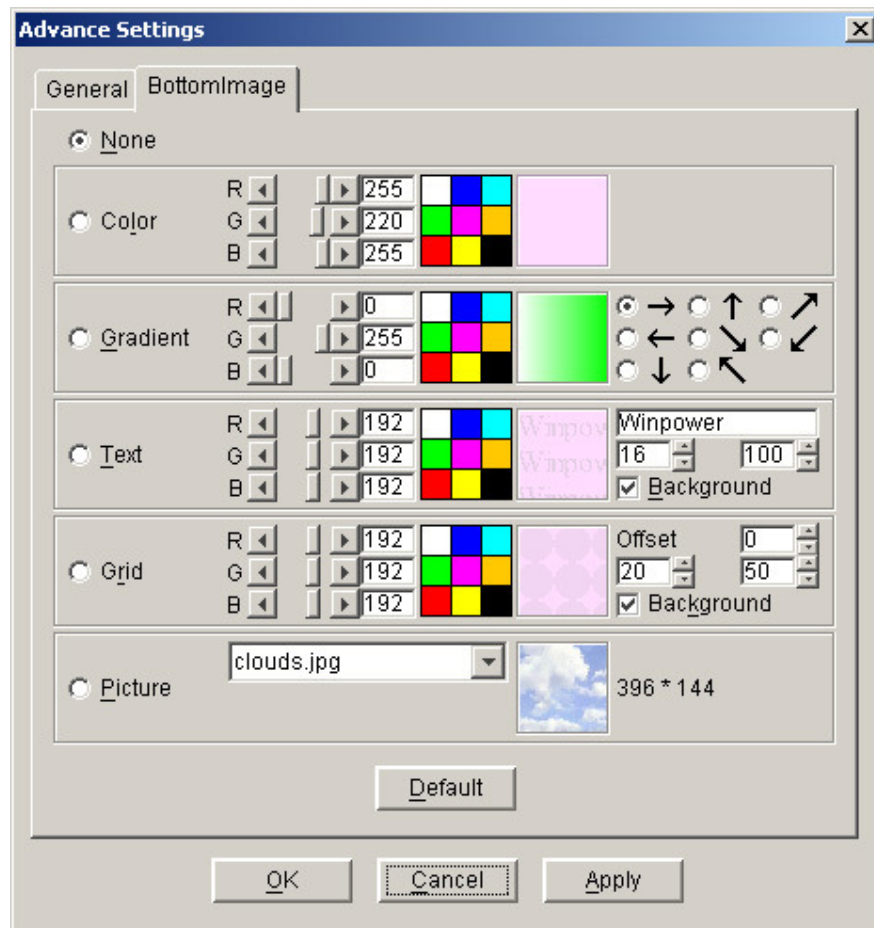

Diagram 3-2-22-2

Note: Click “Default” button, the parameters in this view will turn to default value. If the “OK” button is invalid, it means that your access right to the current Agent is “read only”, and you can’t carry out the parameter setup. You should log in as a super user.

23) Language menu

Users can select languages in the “Language” menu to display different languages, there are ten kinds of languages to be selected: “English”, “German”, “French”, “Italian”, “Spanish”, “Polish”, “Turkish” or “Portuguese”. Refer to the following diagram 3-2-23

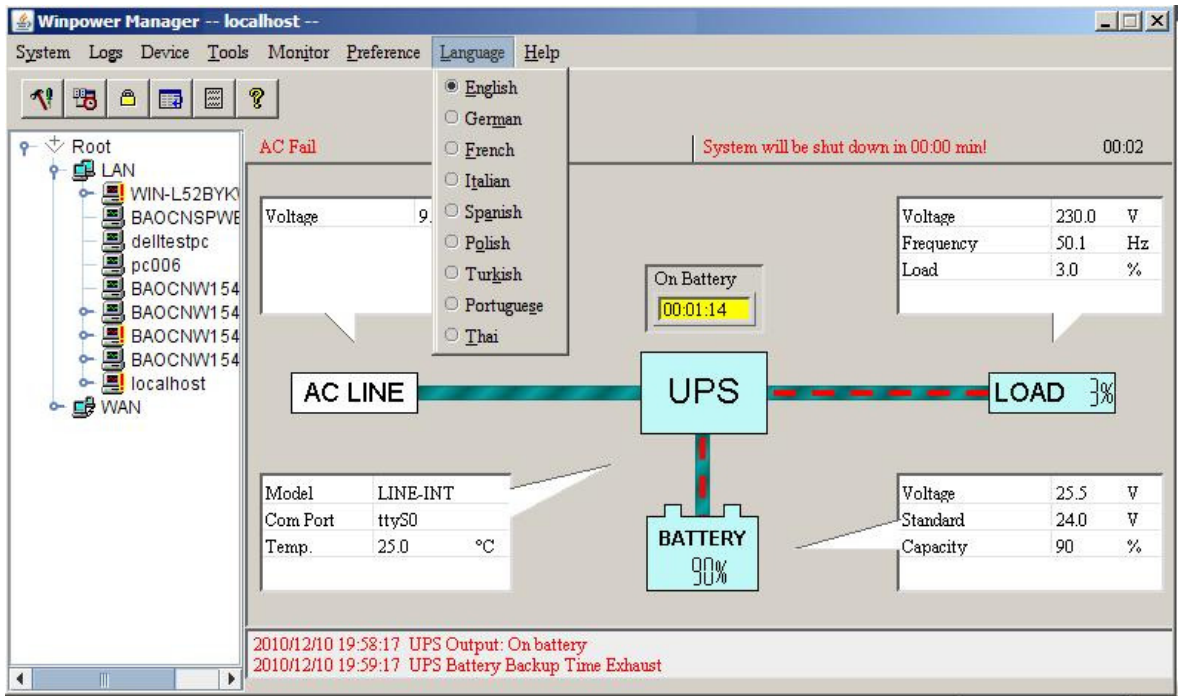

Diagram 3-2-23

24) "Communication Port Settings" Dialog

The "Communication Port Settings" dialog can be opened from the "COM Port Setting" item of "System" menu.

On Linux and UNIX, Winpower can't detect the serial port devices automatically. If the system has a Serial Port that can't be found in the default setting table, you must add it manually in the "Communication Port Settings" dialog. Refer to the following diagram 3-2-24.

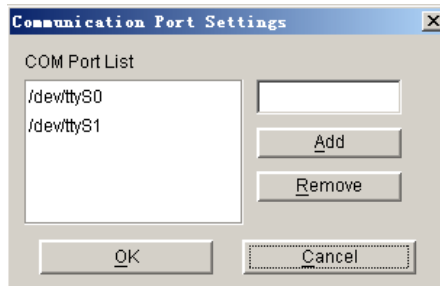

Diagram 3-2-24

The default serial port device, please refer to the following Table 3-2-24.

Platform	Serial Port Devices
Linux	/dev/ttyS0 /dev/ttyS1.
Solaris	/dev/ttya /dev/ttyb
HP-UX	/dev/tty0p0 /dev/tty1p0 /dev/tty0p1 /dev/tty0p2
AIX	/dev/tty0 /dev/tty1
UnixWare	/dev/tty1A /dev/tty2A
Tru64	/dev/tty00 /dev/tty01
FreeBSD	/dev/ttyd0 /dev/ttyd1

Table 3-2-24

Note: If the "OK" button is invalid, it means that your access right to the current Agent is "read only", so you can't carry out the parameter setting. You should log in as a super user.

Chapter 4 How to do

1. How to realize the conversion of the appointed COM port?

If the computer with Winpower has multiple serial ports, Winpower can allow the users to change the current serial ports connected to the device via "Auto search Device" menu. Refer to the following Diagram 4-1-1.

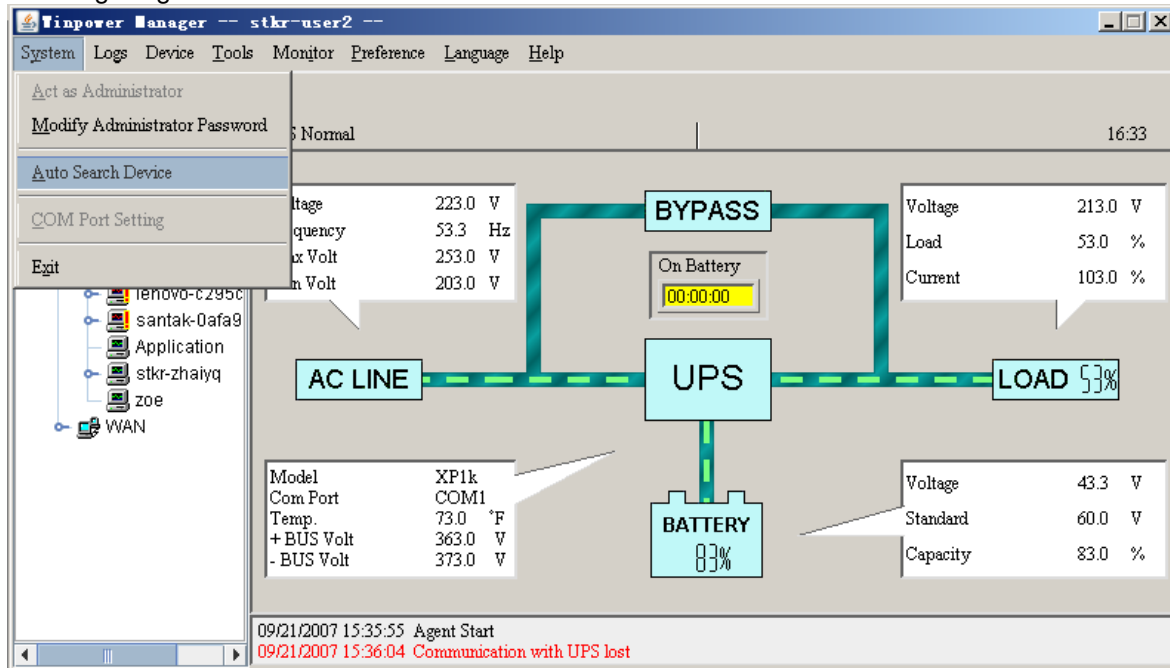

There is a tree view on the left displaying a hierarchical list, such as Root, LAN, the Agent name, the COM port and the Device model. Refer to the following diagram 4-1-2.

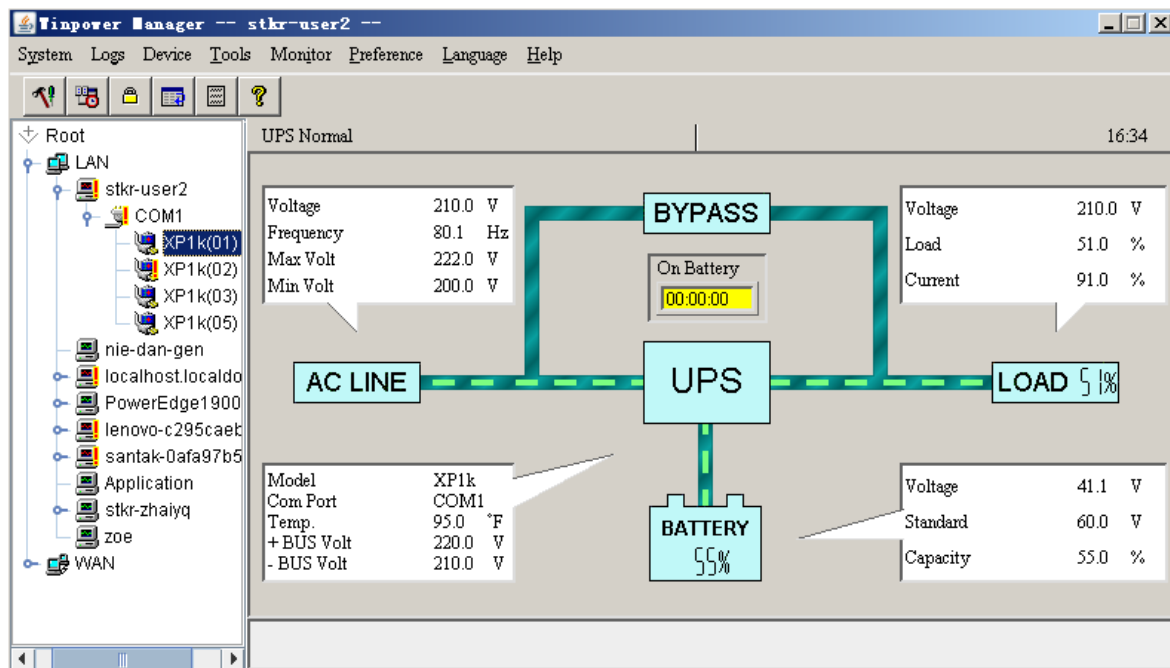

When user selects a device model, "Manager" Window will show detail about the device on the right.

For Linux and UNIX, Winpower can't detect the serial port device automatically. If the serial port can't be found in the default setting table, you must add it manually in the "Communication Port Settings" dialog. Refer to the following Diagram 4-1-3.

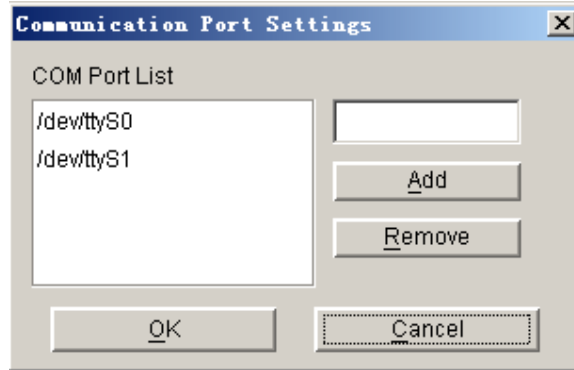

Diagram 4-1-3

The default serial port devices setting: refer to the following Table4-1-1.

Platform	Serial Port Devices
Linux	/dev/ttyS0 /dev/ttyS1.
Solaris	/dev/ttya /dev/ttyb
HP-UX	/dev/tty0p0 /dev/tty1p0 /dev/tty0p1 /dev/tty0p2
AIX	/dev/tty0 /dev/tty1
UnixWare	/dev/tty1A /dev/tty2A
Tru64	/dev/tty00 /dev/tty01
FreeBSD	/dev/ttyd0 /dev/ttyd1

Table4-1-1

Note: For the first time, starting Agent takes more time than later to communicate with the device. And the software will keep a record of the device. Next time, Winpower will start according to the last record. If device COM port, device model or slave address have been changed, user should click "Auto Search Device" item of "System" menu to get correct device information.

2. How to realize broadcasting message in LAN

Winpower has the function of sending the event message to the customer timely via Windows message service. Refer to the notice in section 13 of Chapter 3 ("Broadcast Message Settings" Dialog) and Appendix B (Winpower Event Table) to learn general operation. Refer to the following diagram 4-2-1.

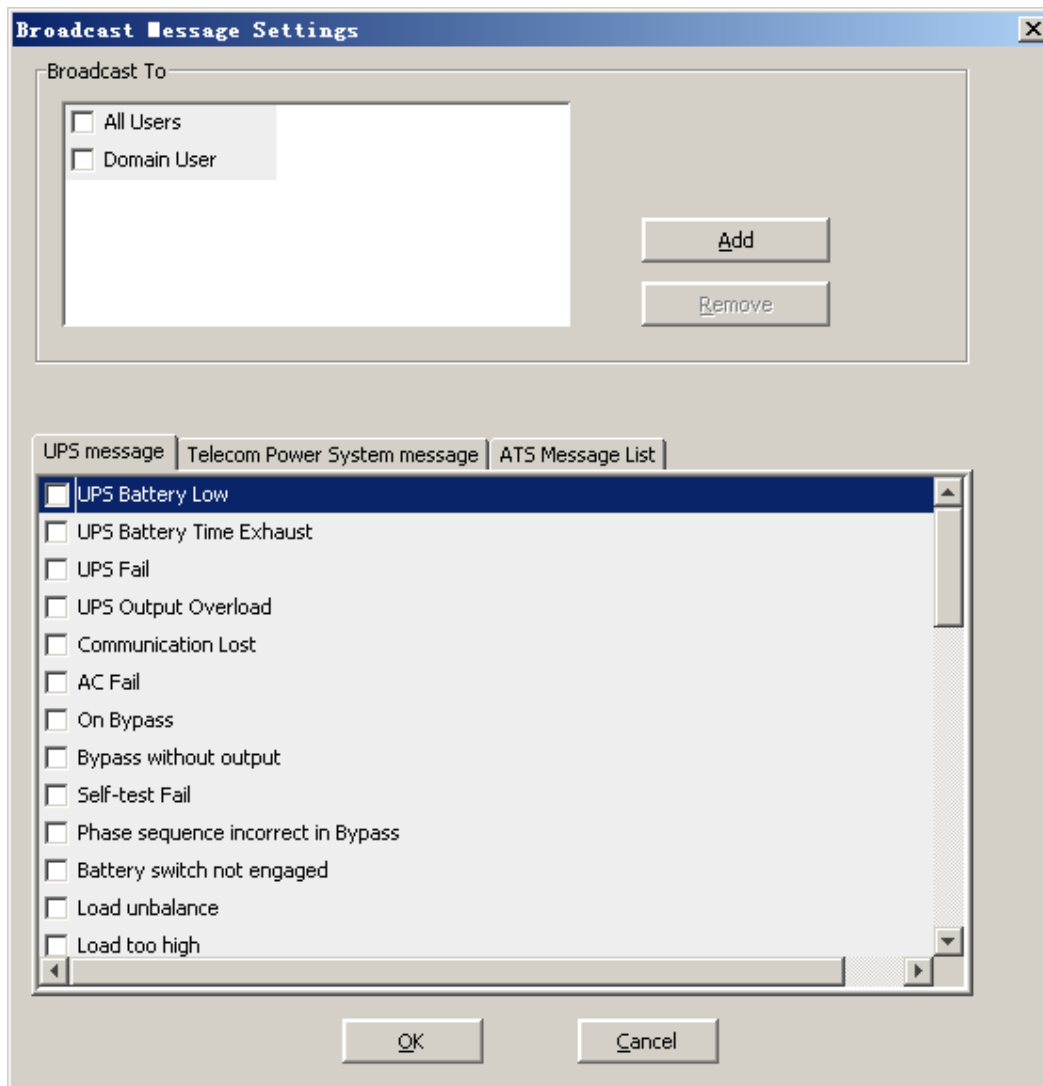

Diagram 4-2-1

Refer to the range of broadcasting, there are three options: All Users, Domain Users and special users.

All users indicate that the message will be sent to all computers in the same network with this computer, no matter whether it is in the same domain.

Domain users indicate that the message will be sent to all computers only in the same NT domain with this computer.

Special users indicate that the message will be sent only to one or a group of defined users, but not others any more.

To realize the function, you should set up the “Add Broadcast User” dialog first. Refer to the following diagram 4-2-2.

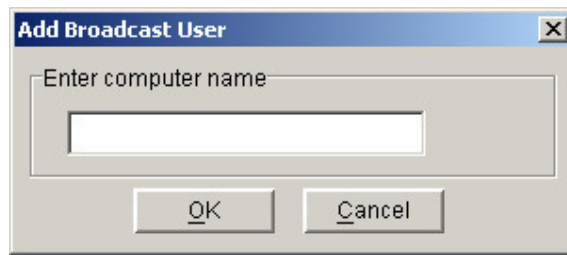

Diagram 4-2-2

In the dialog above, after inputting the computer name which will receive messages, select "OK" button to finish the setting. The name of the computer which you have keyed in will be displayed in the "Broadcast Message Settings" dialog. Select the events that will be sent to the users, and press the "OK" button, the setting will become effective. Refer to the following diagram 4-2-3.

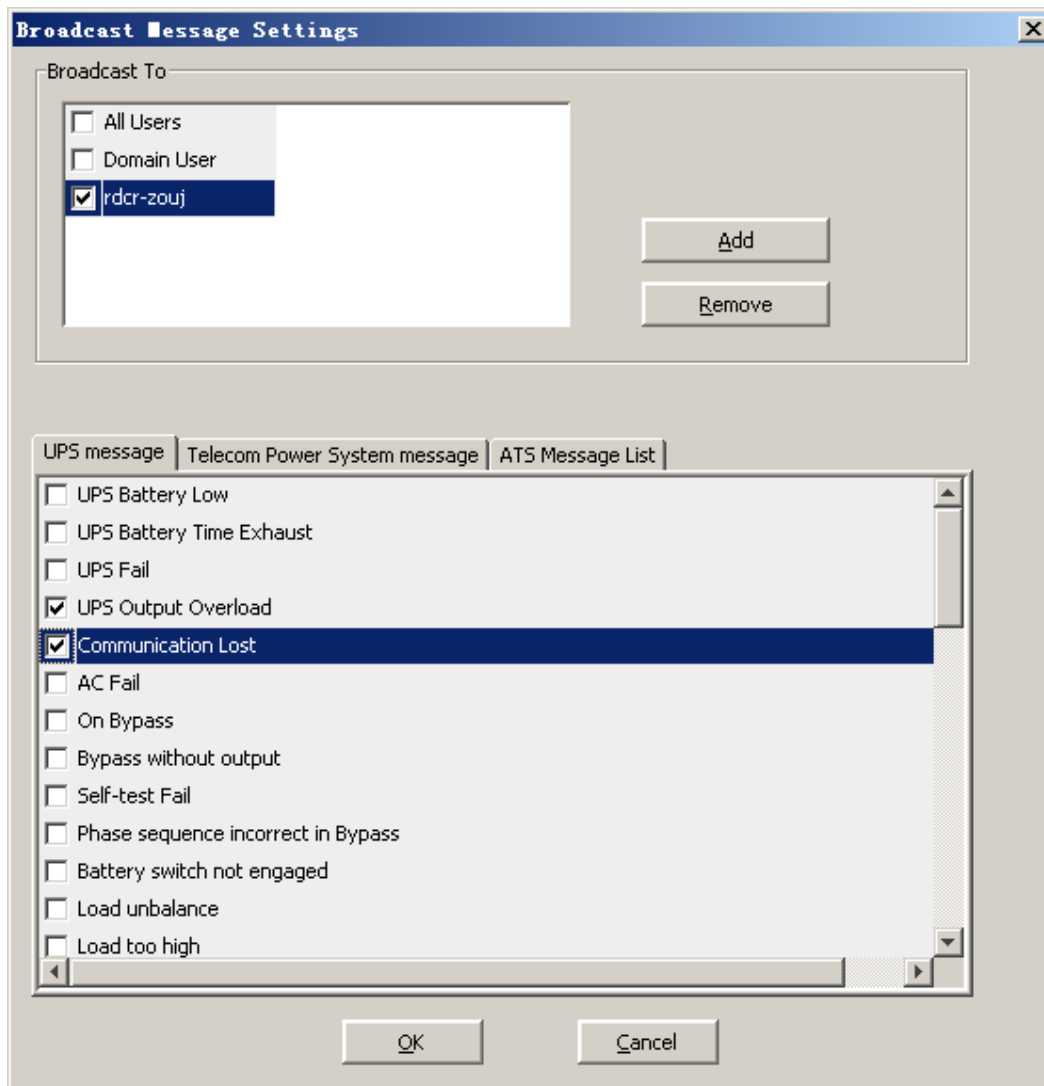

Diagram 4-2-3

Note: Only on Windows, the function can be carried out. To receive broadcast message, "Winpopup" in Windows95/98 and "Messenger Service" in Windows NT/2000 must be started.

3. How to realize the schedule of adding/Removing UPS self-test

Click the “Battery Self-Test Schedule” menu of “Device” menu to popup the “UPS Test Manager” dialog. Refer to the following diagram 4-3-1.

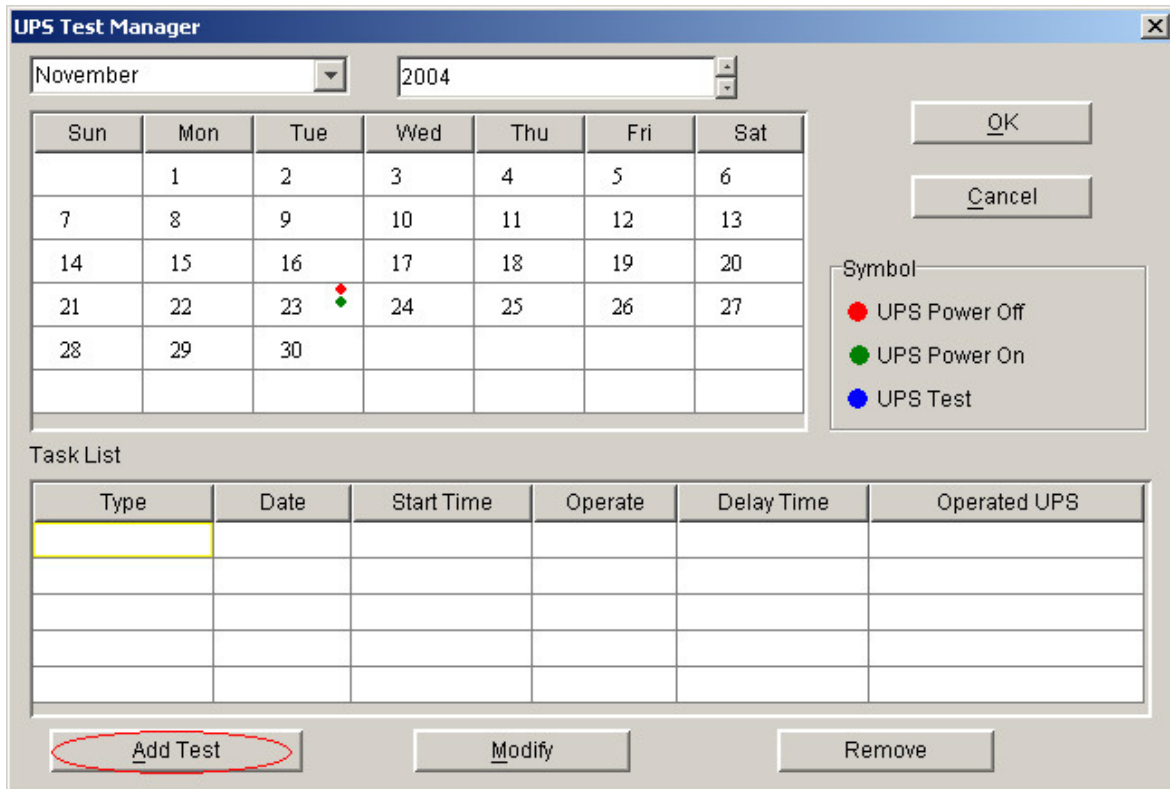

Diagram 4-3-1

Note: If the “OK” button of the dialog is invalid, it means that your access to the current Agent is “read only”, and you can’t setup it. You should log in as a super user.

➤ Add the task of UPS self-test

Click the “Add test” button, and will popup the “UPS Self-test” dialog. Refer to the following diagram 4-3-2.

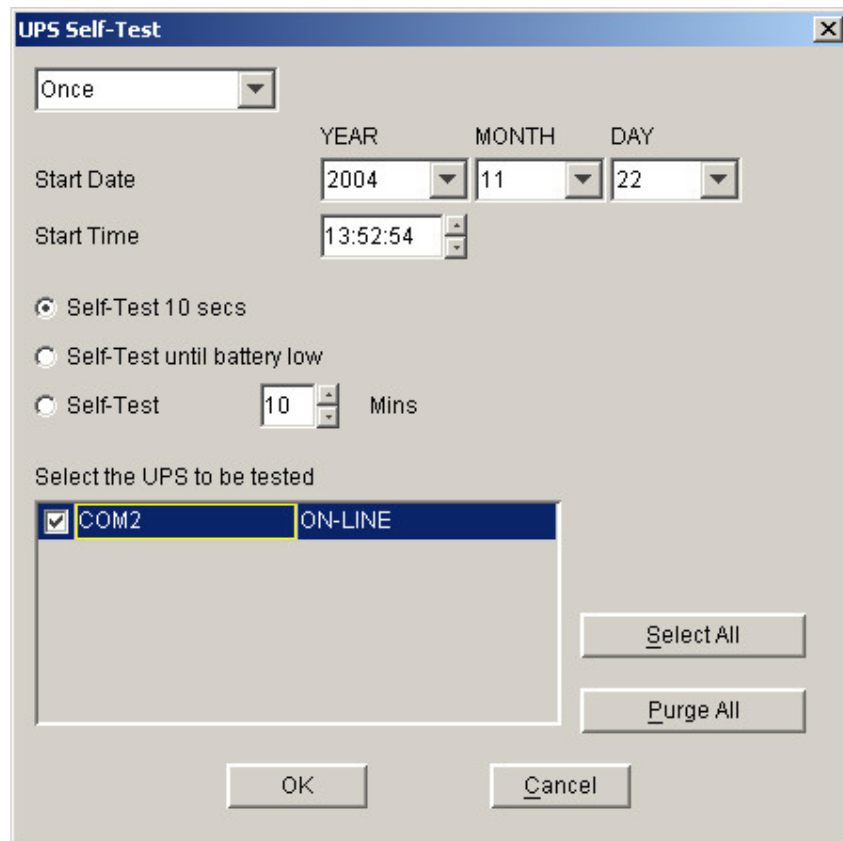

Diagram 4-3-2

In the dialog, users can make a choice of setting UPS self-test task as in a special time or monthly from the options of “once” or “monthly”. You may set the start time of UPS self-test in date and time combo box.

Note: the new self-test task can't conflict with the UPS self-test or UPS Power on/off task that has already been set.

You can select one of the self-test modes from the following.

- Self-test for 10 seconds
- Self-test until the battery low
- Self-test for 1 to 99 minutes

Press the “Cancel” button, the dialog will be closed and the setting above is invalid. Press the “Ok” button, the dialog will be closed and the task setting will present to the task list. Refer to the following diagram 4-3-3.

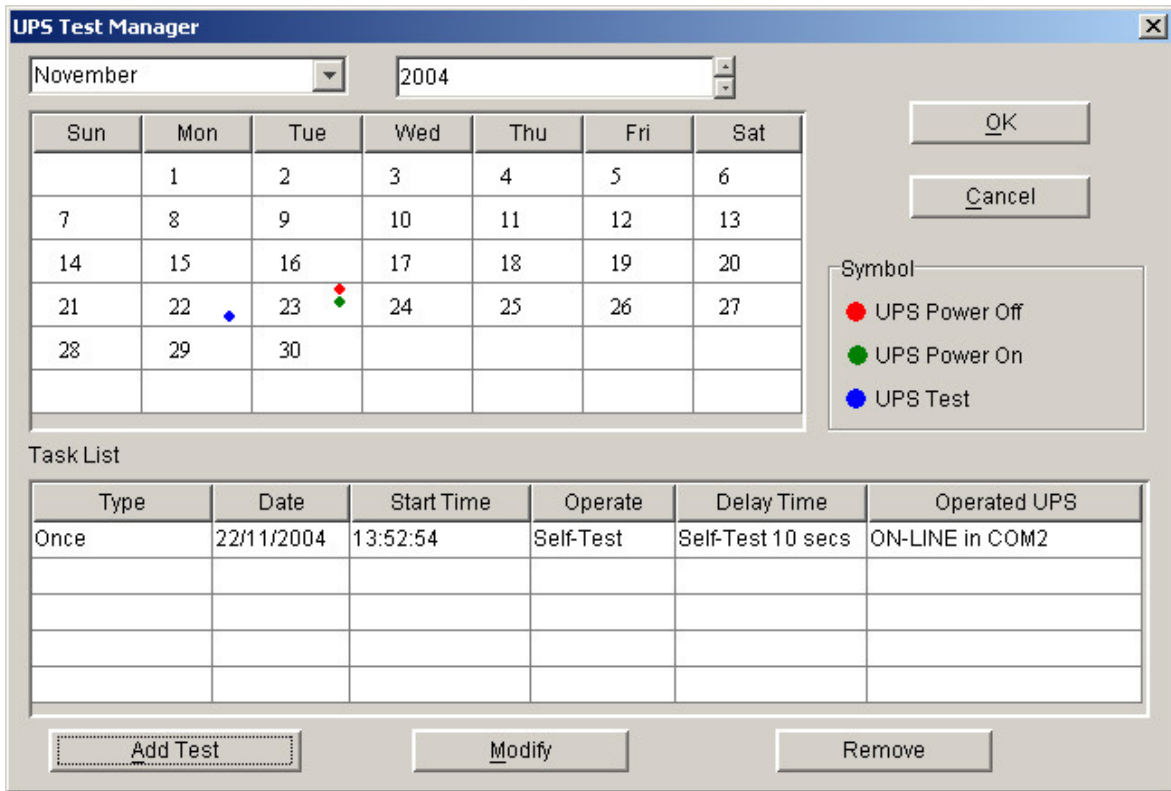

Diagram 4-3-3

Press the “OK” button to finish the setting. Refer to the diagram 4-3-3.

➤ **Modifying UPS self-test task**

Select one of the UPS self-test tasks in the task list, click “Modify” button to modify the task that has been set in the popup dialog. Refer to the following diagram 4-3-4.

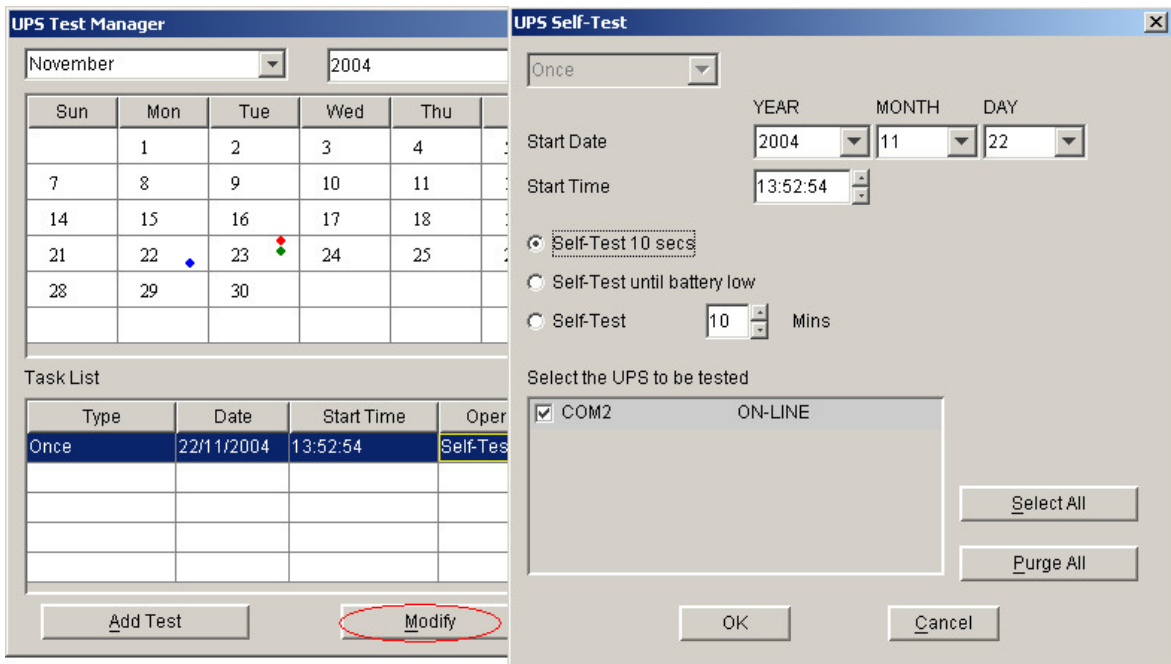

Diagram 4-3-4

After finishing the modification, click “OK” button to save.

➤ **Remove UPS self-test task**

Select one of the UPS self-test tasks in the task list. Click “Remove” button to cancel the task. Refer to the following diagram 4-3-5.

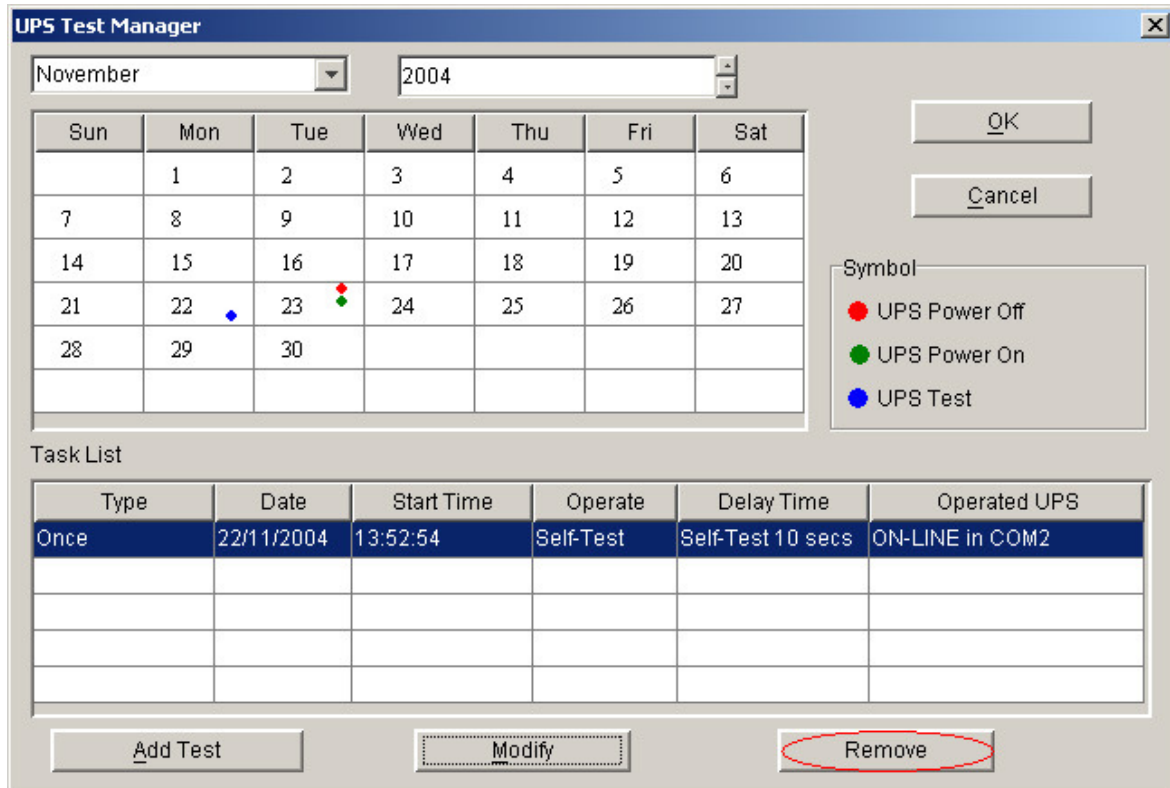

Diagram 4-3-5

4. How to realize the schedule of adding/Removing UPS on/off

Click the “UPS On/Off Manager” menu of the “Control” menu, and will pop up the “UPS On/Off Manager” dialog. Refer to the following diagram 4-4-1.

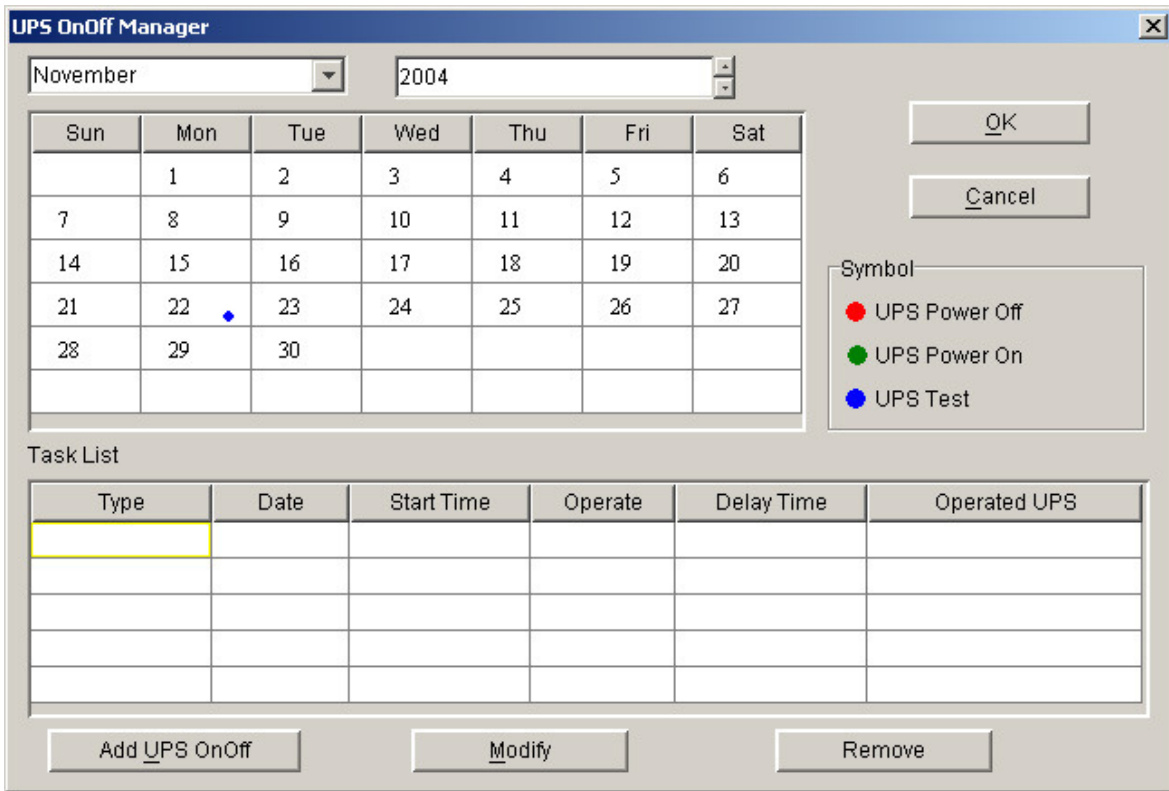

Diagram 4-4-1

Note: the function only for UPS. If the “OK” button of the dialog is invalid, it means that your access to the current Agent is “read only”, and you can’t modify it. You should log in as a super user.

➤ Add the task of UPS On/Off

Click “Add UPS On/Off” button, and will pop up “Off UPS” dialog. Refer to the following diagram 4-4-2.

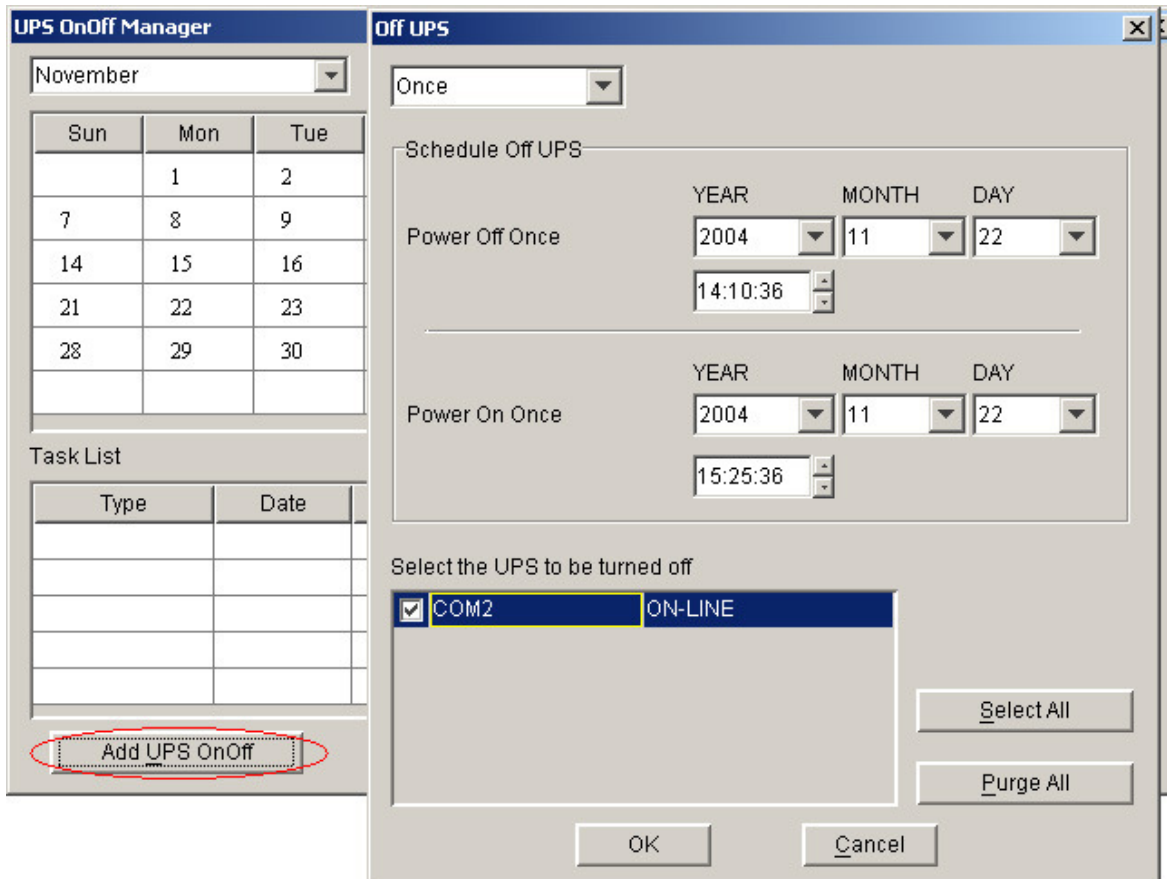

Diagram 4-4-2

In the dialog, users can make a choice in the setting of UPS Power On/Off weekly or in a special time via the option of “Once” or “Weekly” in the combo box. Set the UPS off and restart time in the date and time combo box.

Note: the new task of UPS On/Off can’t conflict with the UPS self-test and UPS On/Off tasks that have been set.

Click the “Cancel” button, the dialog will be closed and the above settings are invalid. Click “Ok” button, the dialog is closed and the task settings will be shown in the task list. Refer to the following diagram 4-4-3.

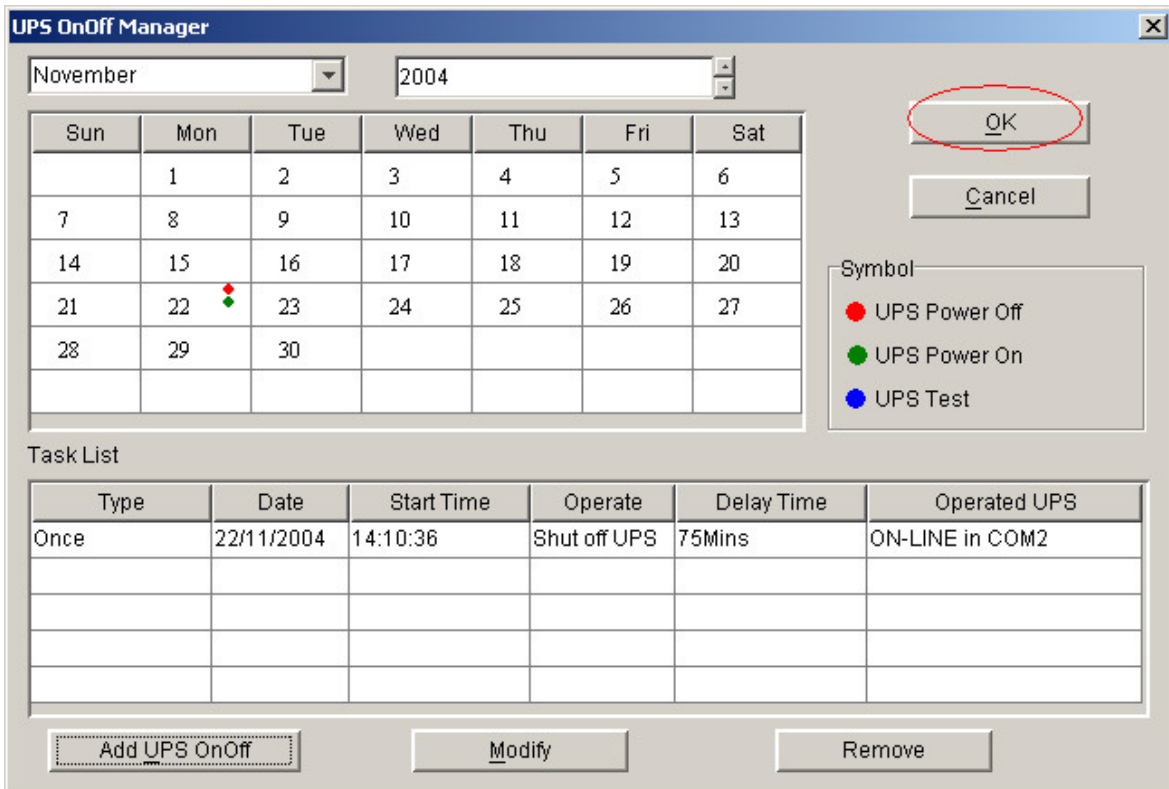

Diagram 4-4-3

Click the “OK” button to finish the settings. Refer to the following diagram 4-4-3.

➤ **Modify the task of UPS On/Off**

Select one of the UPS On/Off tasks in the task list, click “Modify” button to modify the tasks that have been set in the popped up dialog. Refer to the following diagram 4-4-4.

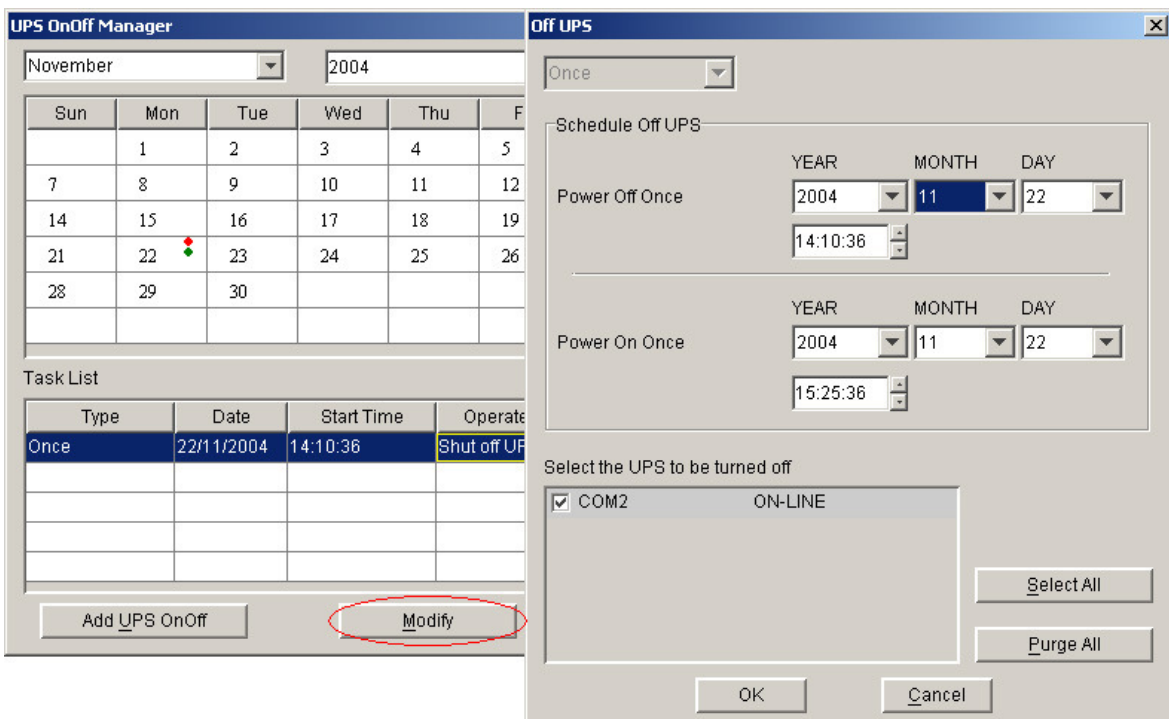

Diagram 4-4-4

After finish the modification, press the “OK” button to save.

➤ **Remove the UPS On/Off task**

Select one of the UPS On/Off tasks in the task list, click “Remove” button to remove the task. Refer to the following diagram 4-4-5.

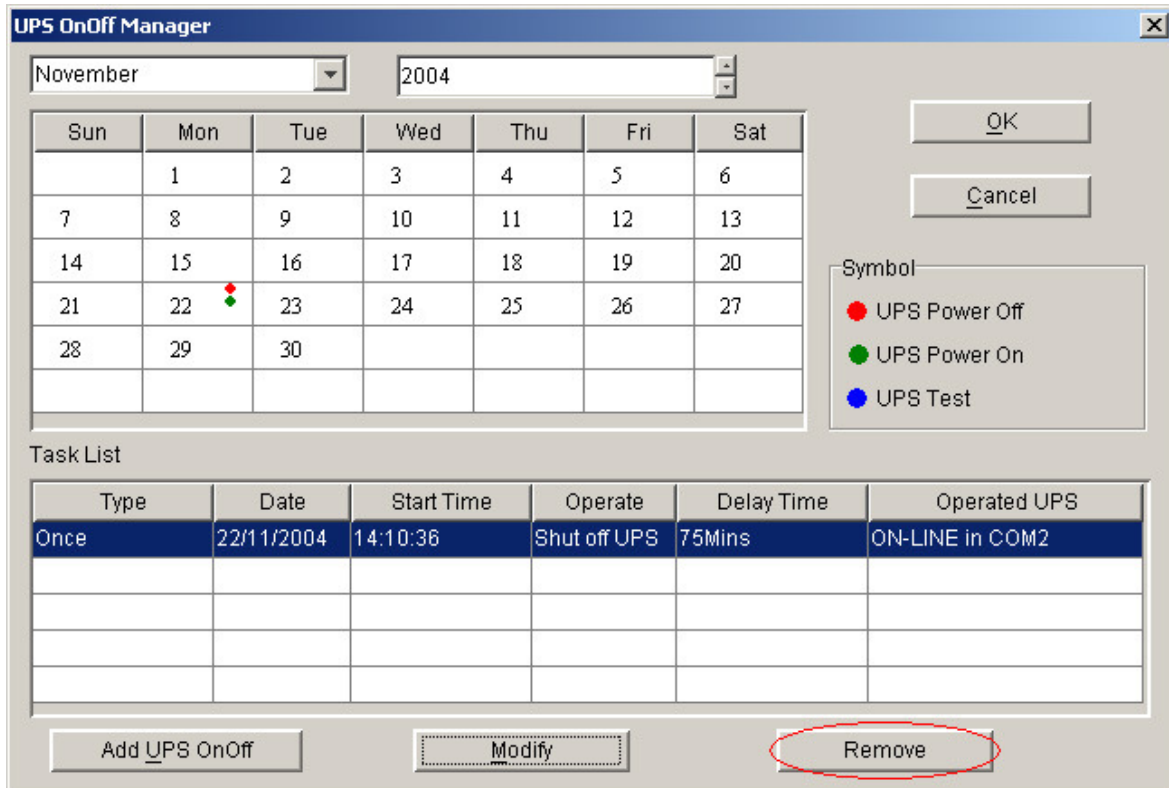

Diagram 4-4-5

5. How to realize the network shutdown function

The function is only for UPS.

Click the “Shutdown Parameter” item of the “Device” menu, and will pop up “Shutdown Settings” dialog. Refer to the following diagram 4-5-1.

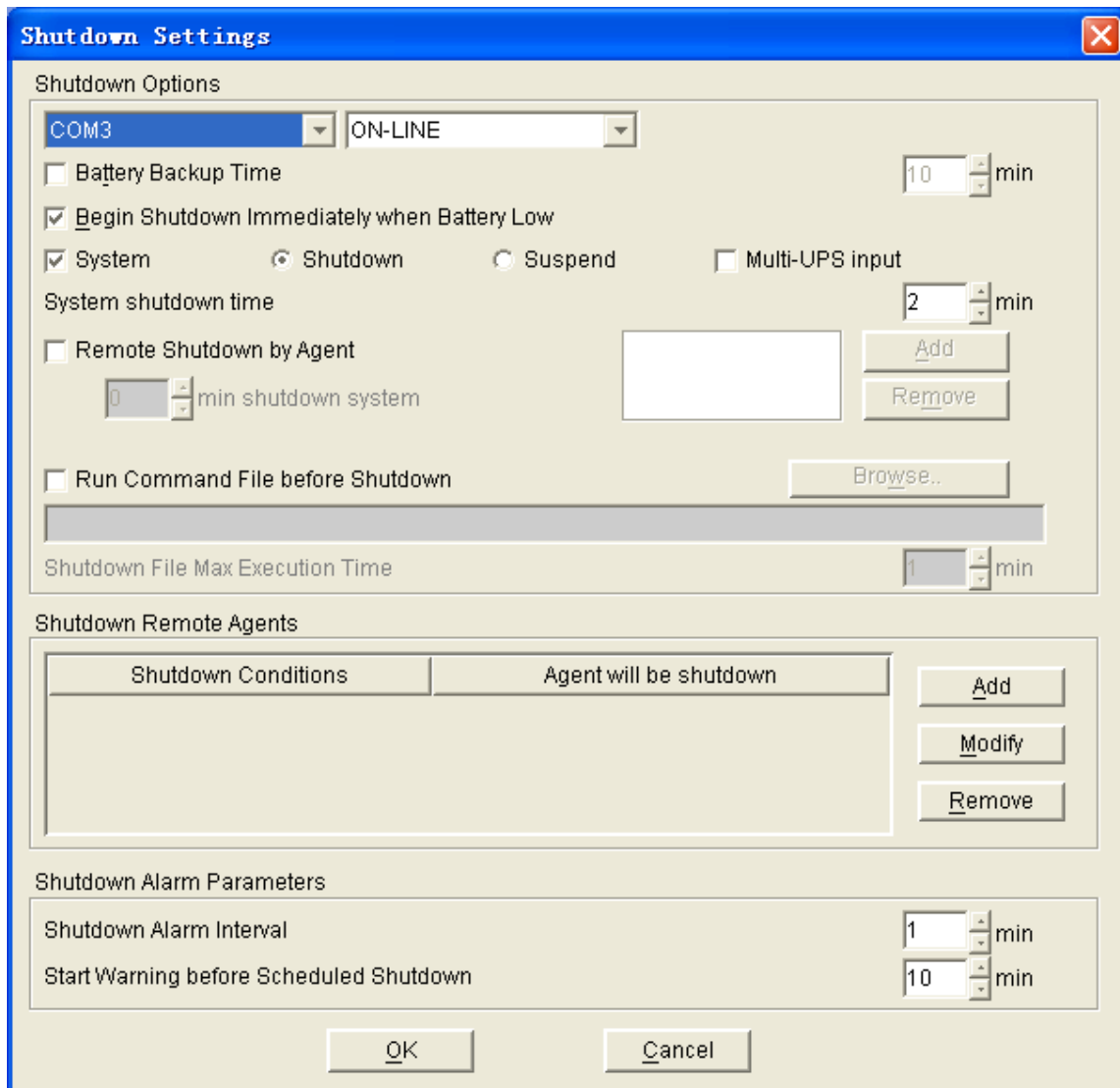

Diagram 4-5-1

Remote Shutdown by Agent:

Click the “Add” button in the “Shutdown Options”, enter IP address of agent in the popped up dialog, and click the “OK” button to finish the setting. When the Agent received the specified agent's shutdown signal, system will be shut down in delay time.

Shutdown Remote Agents:

Click the “Add” button in the “Shutdown Remote Agents”, configure the shutdown conditions, enter IP address of agent in the popped up dialog, and click the “OK” button to finish the setting. When shutdown condition is touched off, agent will send shutdown signal to the appointed remote Agents.

6. How to realize Setting up shutdown parameter

The function is only for UPS.

Click the “Shutdown Parameter” item of the “Device” menu, and will pop up “Shutdown Settings” dialog. Refer to the following diagram 4-6-1.

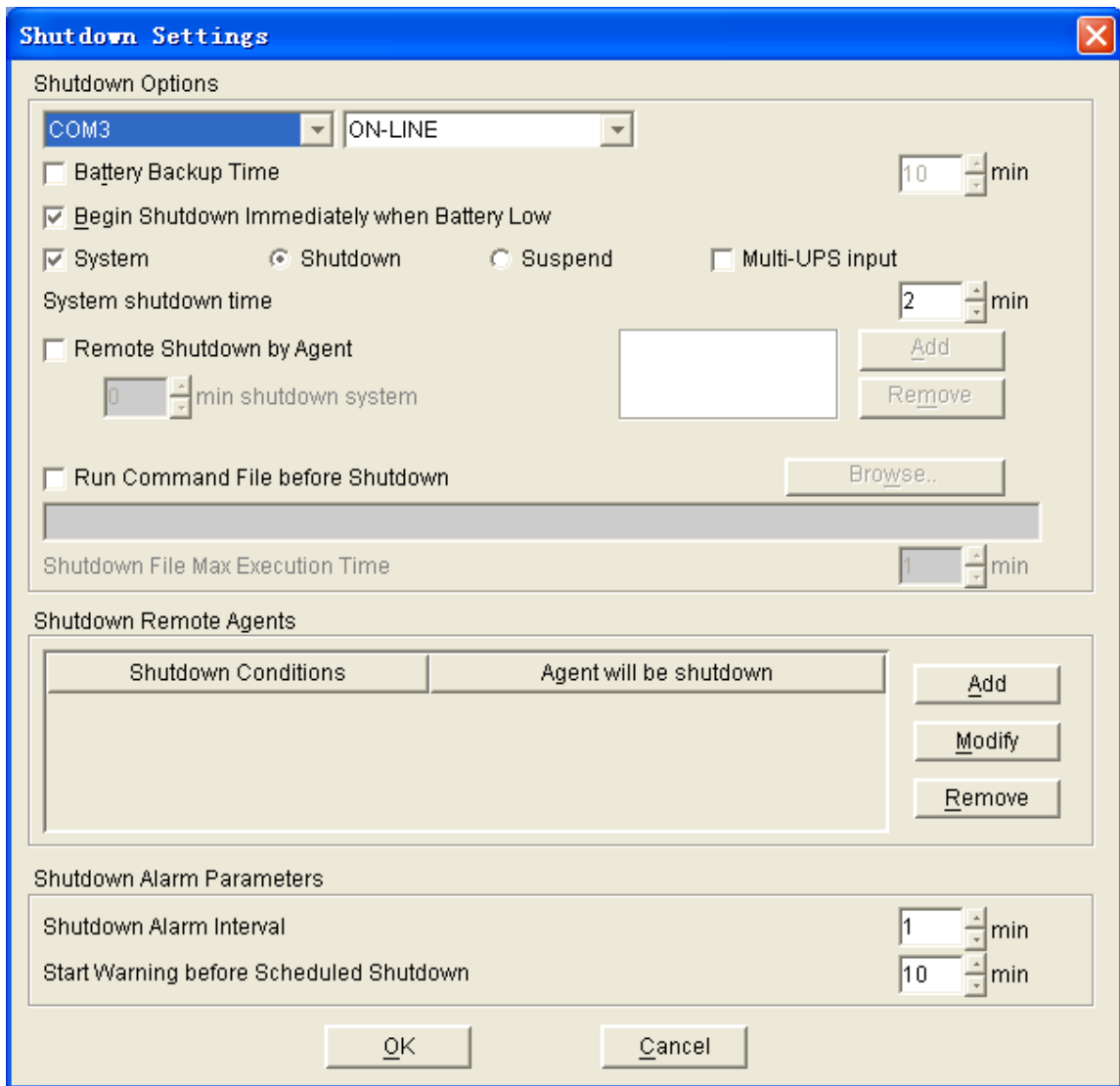

Diagram 4-6-1

Click the “Add” button in the “Shutdown Options”, and enter the IP address of agent in the popped up “Agent’s IP address” dialog. Refer to the following diagram 4-6-2.

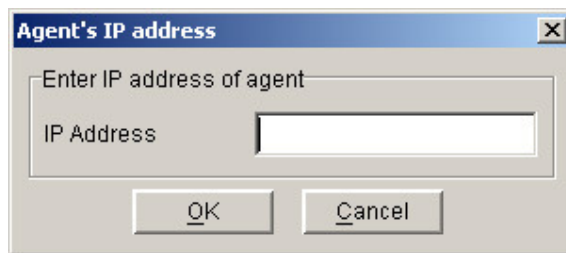

Diagram 4-6-2

Click the “Add” button in the “Shutdown Remote Agents”, and configure the Shutdown conditions in the popped up “Shutdown Remote Agents” dialog. Click the “Add” button in the “Shutdown Remote Agents” dialog, and enter the Agent’s IP address in the popped up “Shutdown Remote Agents” dialog. Refer to the following diagram 4-6-3.

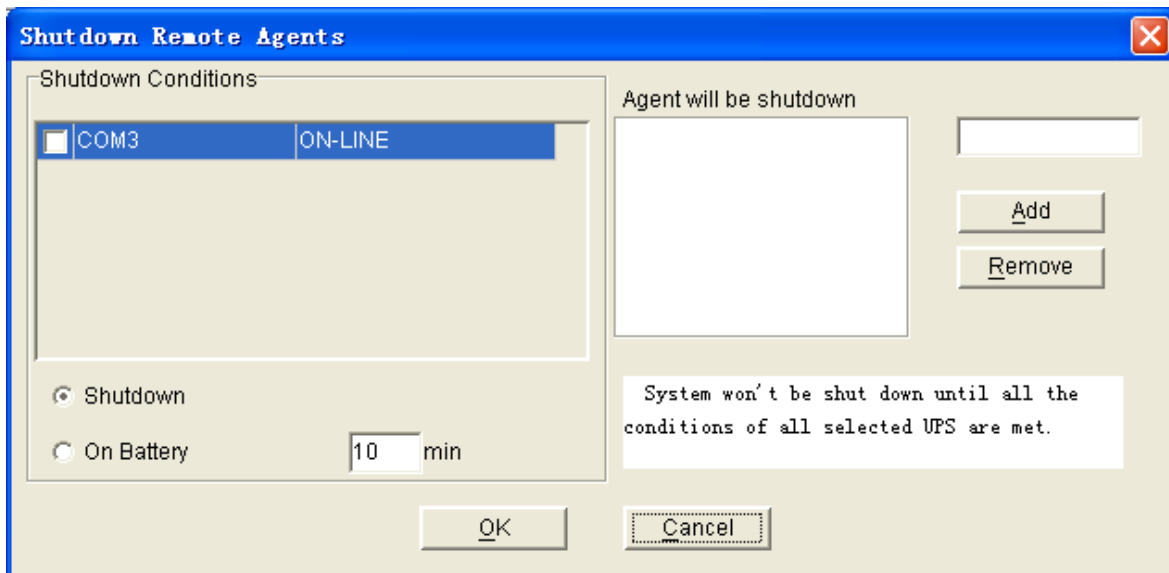

Diagram 4-6-3

Configure the shutdown parameter in the dialog:

✓ Shutdown options:

- **Battery backup time:** The time that the UPS's battery is able to supply power when utility power fails.
- **Begin Shutdown Immediately when Battery Low:** When the check box is selected and battery low event occurs, Agent will shut down the UPS immediately, otherwise the shutting down time will be controlled according to battery back up time.
- **Shutdown System:** When this check box is selected, system will be shut down while the appointed UPS is being turned off.
- **Suspend System:** When the radio box is selected, system will suspend in the disk in shutdown sequence. The function only can be carry out on some Windows, and hibernate support must be enabled from /Control Panel/Power Options/Hibernate.
- **Multi-UPS input:** When the check box is selected, system won't be shut down until all the conditions of all selected UPS are met.
- **System shut down need time:** The time to be needed to shut down the system, from the beginning of shutdown to the end.
- **Remote Shutdown by Agent:** When the check box is selected, system can be shutdown by other Agent.
- **XX min shutdown system:** Receive the specified agent's shutdown signal, delay XX minutes and shut down system.
- **Run Command File before Shutdown:** Before system shutting down, Agent can execute a file, if the parameter isn't null, agent won't begin to shut down the system until the execution file has been executed.
- **Shutdown File Max Execution Time:** Before system shutting down, the time to be needed to execute the shutdown file.

✓ Shutdown Remote Agents:

- **Shutdown remote Agent's Conditions:** The condition can be "UPS be shutdown" or "The time UPS on battery exceed setting time".
- **Agents be Shutdown:** When shutdown condition is touched off, Agent will send shutdown signal to the appointed remote agents.

✓ Shutdown Alarm Parameters:

- **Shutdown Alarm Interval:** The interval that agent pops up an alarm message before shutting down.
- **Start Warning before Scheduled Shutdown:** If user has setup shutting down on schedule, agent will begin to alarm user before the set time.

7. How to realize the modification of Device control parameter

For ON-LINE UPS:

- Click “UPS control parameters” item of the “Device” menu, and will pop up “UPS control parameters” dialog. Refer to the following diagram 4-7-1.

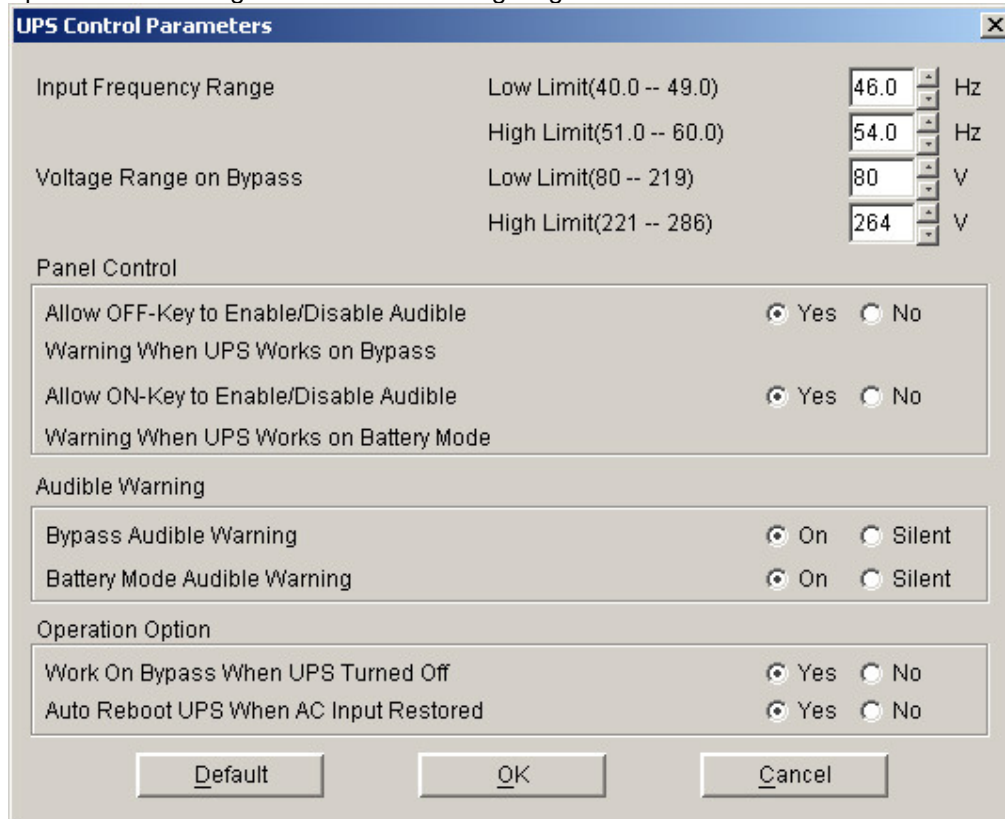

Diagram 4-7-1

- The following UPS control parameter can be modified in the dialog:
 - **The limit value of the input frequency:** when the frequency of the utility power is out of this range, UPS will count it abnormal and switch to battery supply.
 - **The limit value of the bypass voltage:** when UPS supplies in bypass mode, if the utility voltage is out of this range, UPS will cut off bypass output.
 - **Allow OFF-Key to Enable/Disable Audible Warning When UPS Works on Bypass:** to choose “Yes”, when UPS is supplied by bypass, users can turn off the bypass audible alarm (beep once every 2 minutes) by pressing “OFF” button on the UPS panel for one time, and pressing one more time to recover it. To choose “No”, the “OFF” button on the UPS panel cannot be used to control bypass audible alarm on or off.
 - **Allow ON-Key to Enable/Disable Audible Warning When UPS Works on Battery Mode:** to choose “Yes”, when UPS is supplied by batteries, users can turn off the audible alarm (beep once every 4 seconds) supplied by batteries by pressing “ON” button on the UPS panel for one time, and pressing one more time the audible alarm can be turned on again. To choose “No”, the “ON” button on the UPS panel can’t be used to control the audible alarm supplied by batteries on or off.
 - **Bypass Audible Warning:** to choose “On”, when UPS is supplied by bypass, it is allowed to enable bypass audible alarm. To choose “Silent”, when UPS is supplied by bypass, it is not allowed to enable audible alarm, at this time the “OFF” button on the UPS panel can’t turn on the bypass audible alarm.
 - **Battery Mode Audible Warning:** to choose “On”, when UPS is supplied by batteries, it is allowed to enable audible alarm of battery supply. To choose “Silent”, when UPS is supplied by battery, it is not allowed to enable audible alarm of battery supply. At this time the “ON” button on the UPS panel can’t turn on the audible alarm of battery supply.
 - **Work On Bypass When UPS Turned Off:** to choose “Yes”, when UPS is not turned on, it is in the mode of bypass supply. To choose “No”, when UPS is not turned on, no bypass output is offered.
 - **Auto Reboot UPS When AC Input Restored:** to choose “Yes”, when UPS is

shutdown for the backup time is exhausted or the battery is in low capacitance, once the utility power is recovered, UPS can restart automatically to the normal operating mode. To choose “No”, when the utility power is recovered, UPS can't restart automatically but in the mode of being not turned on.

Click “OK” button to save what have modified. Click “Cancel” button to make the modification invalid. Click “Default” button to make all the settings to default value.

For special ON-LINE Device:

Parameter	Value	Unit
Bypass Frequency Range - Low Limit (40.0-49.0)	46.5	Hz
Bypass Frequency Range - High Limit (51.0-60.0)	55.5	Hz
Bypass Voltage Range - Low Limit (110--124)	120	V
Bypass Voltage Range - High Limit (130--276)	134	V
Input Frequency Range - Low Limit (2%--10%)	4	
Input Frequency Range - High Limit (2%--10%)	2	
ECO Frequency Range - Low Limit (5%--10%)	5	
ECO Frequency Range - High Limit (5%--10%)	6	
ECO Voltage Range - Low Limit (5%--10%)	8	
ECO Voltage Range - High Limit (5%--10%)	7	
Rated Output Voltage	200	V
Voltage Adjustment	+0.5	V
Rated Output Frequency	50	Hz
Maximum Charging Current	3.0	A
Battery Quantity Per String	15	
Panel Control - Allow Button to Enable/Disable Audible Warning	<input type="radio"/> Yes <input checked="" type="radio"/> No	
Operation Option - Bypass Forbidden	<input checked="" type="radio"/> Yes <input type="radio"/> No	
Operation Option - Auto Reboot UPS When AC Input Restored	<input checked="" type="radio"/> Yes <input type="radio"/> No	
Operation Option - Buzzer Alarm	<input checked="" type="radio"/> Yes <input type="radio"/> No	
Operation Option - Converter Mode	<input checked="" type="radio"/> Yes <input type="radio"/> No	
Operation Option - ECO Mode	<input checked="" type="radio"/> Yes <input type="radio"/> No	
Operation Option - Parallel Function	<input type="radio"/> Yes <input checked="" type="radio"/> No	
Operation Option - Auto Frequency Detection	<input type="radio"/> Yes <input checked="" type="radio"/> No	
Operation Option - Auto Recover from Overload	<input type="radio"/> Yes <input checked="" type="radio"/> No	
Operation Option - Auto Short-Circuit Clearance	<input type="radio"/> Yes <input checked="" type="radio"/> No	
Operation Option - Deep Discharge function	<input checked="" type="radio"/> Yes <input type="radio"/> No	
Operation Option - EPO Function	<input checked="" type="radio"/> Yes <input type="radio"/> No	
Operation Option - Load Segment	<input type="radio"/> Yes <input checked="" type="radio"/> No	
Operation Option - Bypass when UPS is Off	<input type="radio"/> Yes <input checked="" type="radio"/> No	

Diagram 4-7-2

The following UPS control parameter can be modified in the dialog. Some parameter is same as the on-line ups. Other parameter is as following.

- the limit value of the ECO frequency: If ECO mode is enable, and bypass output frequency is in the range, the load power will be supplied by bypass output
- the limit value of the ECO voltage: If ECO mode is enable, and bypass output voltage is in the range, the load power will be supplied by bypass output
- The limit value of the Line frequency: If the line frequency is out of range, UPS will turn to battery mode.
- Output voltage rating: Only be set in no output mode or bypass mode, it can be 200,208,220,230,240
- Voltage adjustability: Only be set in no output mode or bypass mode
- Output frequency rating: Only in no output mode or bypass mode can be set, it can be 50HZ or 60 HZ
- Battery Quantity Per String: Only in no output mode can be set, for 6-10K UPS
- Maximum charging current: Only in no output mode can be set, for 6-10K UPS
- Converter Mode: choose “Enable”, then UPS can work in converter mode
- ECO Mode: choose “Enable”, then UPS can work in ECO mode
- Parallel Mode: choose “Enable”, then UPS can work in parallel mode
- Frequency Auto Detection: choose “Enable”, then UPS can be set output rating frequency via input frequency
- Auto Re-transfer After Overload Clearance: choose “Enable”, if output load overload, UPS will shut down output off, when the load is decreased to 70%, UPS will reboot automatically
- Auto Short-Circuit Clearance: choose “Enable”, then ups will delay 4 seconds and shut down output
- Deep Discharge Function: choose “Enable”, then UPS can discharge deeply
- EPO Function: choose “Enable”, UPS will cut off output immediately until you press the ON_SW more than 2 minutes.
- Power Segment: choose “Enable”, then UPS can manage output itself, only for 1-3K UPS
- Auto Bypass: choose “Enable”, it will switch to the bypass output, when AC power restores

For OFF-LINE UPS:

user can enable or disable battery mode alarm audible by this dialog, Refer to the following diagram 4-7-2.

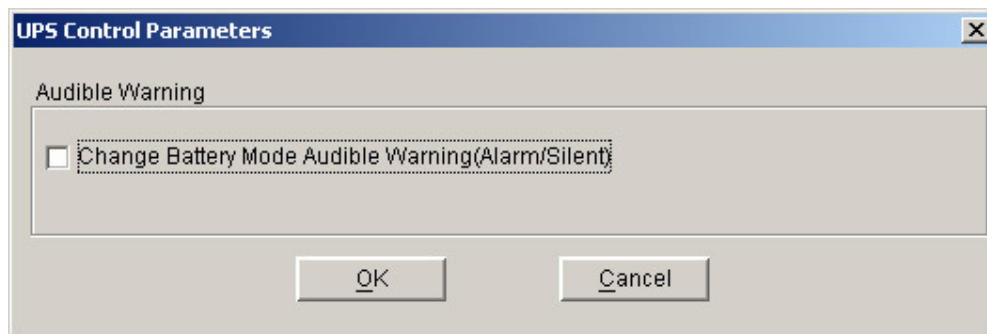

Diagram 4-7-2

Click “OK” button to save what have been modified. Click “Cancel” button to make the modification invalid.

Note: If the “OK” button is invalid, it means that your access right to the current Agent is “read only”, and you can’t carry out setup. You should log in as a super user.

8. How to realize system administrator operation and password modifying realize

System administrator operation

Click “Act as Administrator” item of “System” menu, and will pop up “Administrator” dialog. Refer to the following diagram 4-8-1.

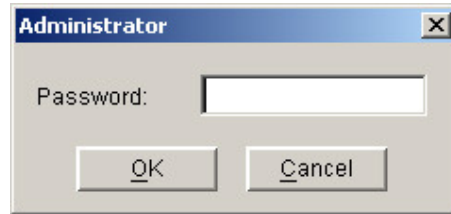

Diagram 4-8-1

Enter the system administrator password in the dialog, and click the “OK” button to finish the setting. If the password is correct, you can get the administrator access right to configure the agent. If the password is incorrect, warning message will popup. Refer to the following diagram 4-8-2.



Diagram 4-8-2

Modifying the system administrator password

Click the “Modify Administrator Password” menu of the “System” menu to popup the “Administrator Password Settings” dialog. The menu is valid within the local Agent only. Refer to the following diagram 4-8-3.



Diagram 4-8-3

Enter the new password in the “New Password” edit box, reenter it in the “confirm password” edit box. Click the “OK” button to finish the setting.

Note: If the “OK” button is invalid, it means that the access right to the current Agent is “read only”, and you can’t operate. You should log in as a super user.

9. How to realize sending event message by email

✓ Precondition

When event occurs, the precondition of realizing sending message by email is connecting the computer with Winpower to the Internet.

✓ Steps

Set "Email Service": click the "Email setting" item of the "Tools" menu, and will pop up the "Email Settings" dialog. Refer to the following diagram 4-9-1.

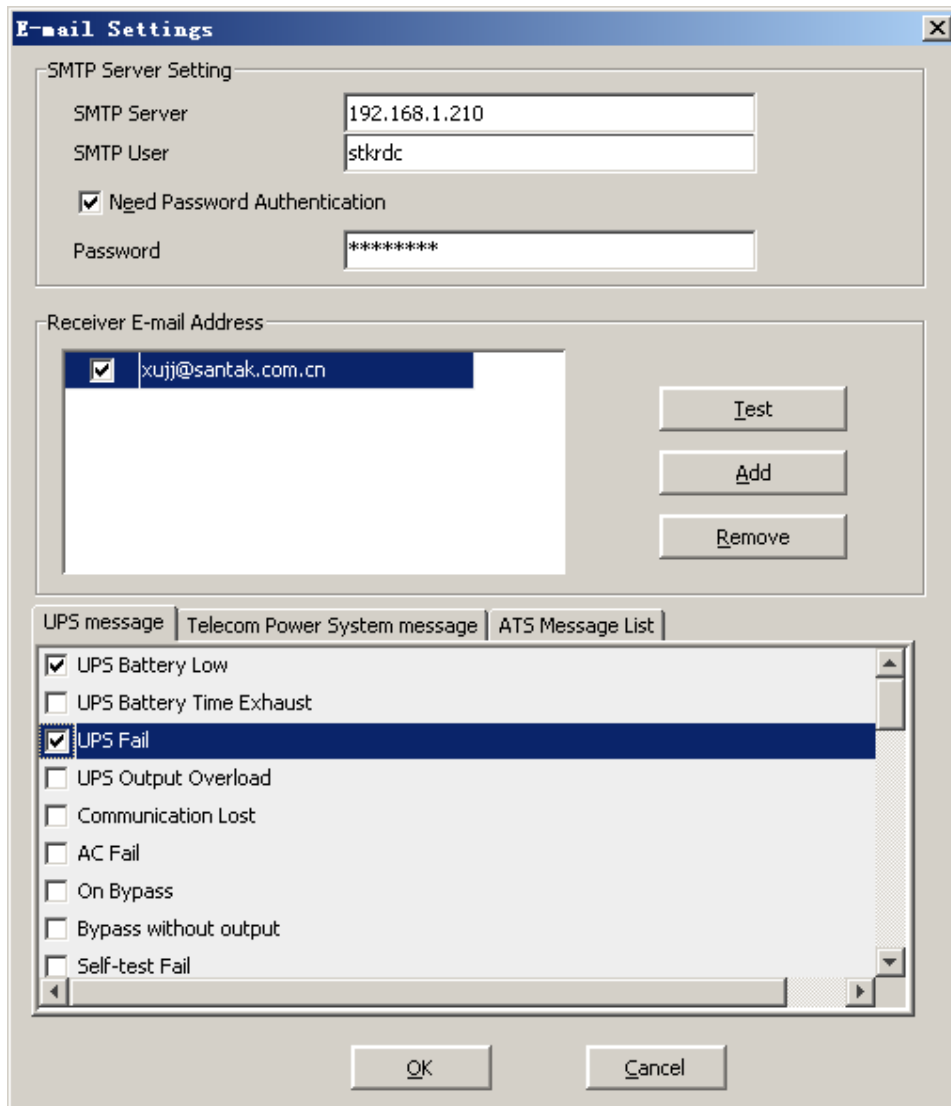

Diagram 4-9-1

SMTP Server is the SMTP Server's address; SMTP User is the account for logging in the server. If SMTP mail server needs password, authentication user should input the password.

Set the receiver Email Address: click the "Add" button of the "Email Settings" dialog, and then pop up "Add Receiver Email Address" dialog. Refer to the following diagram 4-9-2.

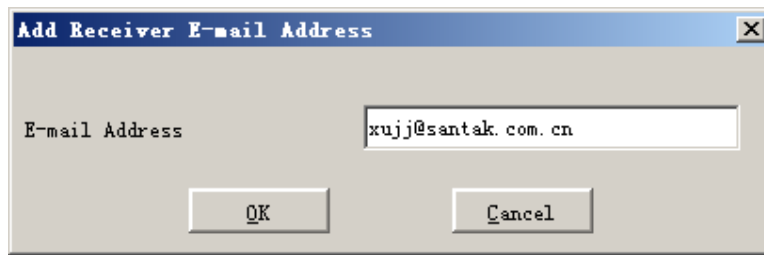

Diagram 4-9-2

Enter the Email Address in the “Add Receiver Email Address” dialog, and select “OK” button to save and exit.

Completing event setting: select one of the events (For example, UPS battery low) from the “Send message”; and then select the user that has been set in the “Receiver Email Address” list, finally select the “OK” button to save and exit.

10. How to realize sending event messages by mobile phone

✓ Precondition

The precondition of sending messages by mobile phone is that the computers with Winpower must have at least one communication port used to be connected to GSM Modem or mobile phone.

✓ Steps

Configure “SMS”: click the “SMS setting” item of the “Tools” menu, and will pop up the “SMS Setting” dialog. Refer to the following diagram 4-10-1.

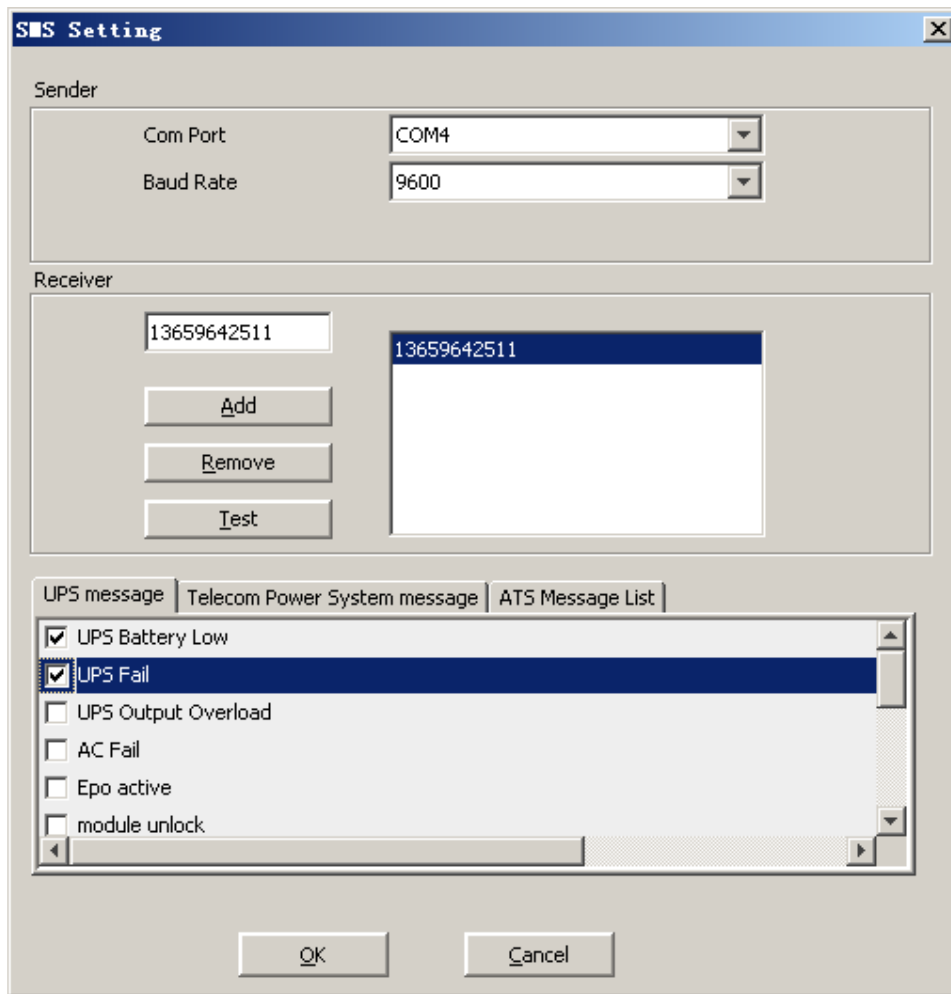

Diagram 4-10-1

Below is the use remark of SMS Setting, refer to the diagram 4-10-1.

1. Sender: SMS is sent through GSM modem or mobile phone connected with your computer. User should select COM port used by GSM Modem or mobile phone, and set baud Rate of this COM port.

2. Receiver: the mobile phones numbers that can receive the SMS. It can be one or more. If the event occurs, the software will send the short message to all the phone numbers in the "Receiver" list.

3. Send message: Use can select the event that need to be informed by SMS.

Another method to select event code:

Select one of the events (for example: AC Fail) from the "Event List", that is on the left side of the "Event Action"; and then select "Send SMS" on the right side, finally select the "OK" button to save and exit.

11. How to realize sending event messages by pager

- ✓ Precondition

When event happens, the precondition of sending messages by pager is that the computers with Winpower must have at least one communication port used to connect to modem.

✓ Events supported

For UPS, the function only supports the following events:

- UPS AC fails
- UPS low battery
- UPS hardware failure
- UPS output overload

For Telecom power and ATS, all events are supported.

✓ Steps

Configure “Pager”: click the “Pager setting” item of the “Tools” menu, and will pop up the “Pager Setting” dialog. Refer to the following diagram 4-11-1.

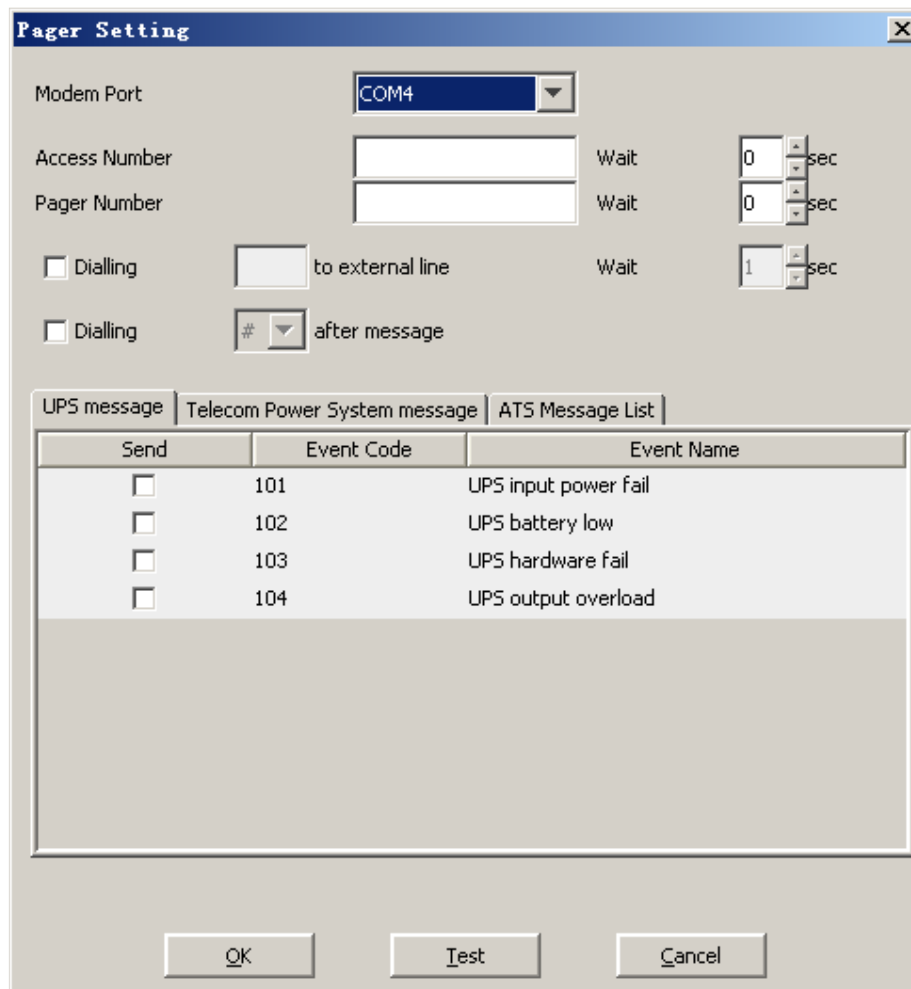

Diagram 4-11-1

In the “Pager Setting” dialog, the parameters that can be set are shown in the following Table 4-11-1.

Parameter	Description
Modem Port	Select COM port which is being used by Modem.
Access Number	For some pager service, a delay is needed between dialing access number and message code.
Pager Number	For some pager service, a delay is needed between dialing pager number and message code.
dialing number to exterior line	For extension line, it is always necessary to dial a specified number and delay a specified time to access Exterior Line.
dialing number after message	For some pager service, need to dial a specified number to end message code.
Event Code	The event code is dialed as the message code and will be displayed on pager.

Table 4-11-1

If the exterior line phone number can't be dialed directly, please fill in the switch number in the "Dialing to exterior line bar". The waiting time after dialing can be set according to what you need, the default value is one second.

"Access number" is the station number that the pager joined (which can only be auto station). The waiting time is the delay time between dialing paging station number and pager number, the delay time is decided by the paging station, for LianTong 192 auto station, the waiting time is 1 second.

"Pager Number" is the number of the pager that accepts the communication. The waiting time is the delay time between dialing pager number and message code (paging message content), the delay time is decided by the paging station, for LianTong 192 auto station, the waiting time is 1second.

Select event code from the "Pager Setting" and select "OK" button to save and exit.

Another method to select event code:

Select one of the events (for example: AC Fail) from the "Event List", that is on the left side of the "Event Action", and then select "Send Pager" on the right side, finally select the "OK" button to save and exit.

12. How to realize monitoring device remotely in LAN within the same network

✓ Precondition

To realize monitoring device remotely in LAN within the same network, the communication protocol of the computers with Winpower must include TCP/IP protocol.

✓ Steps for realization

- **Keep network communication smooth:** test with network command "PING" under command prompt window. For example, a computer named xc in LAN, whose corresponding IP address is 192.168.1.221, and then you can finish the test with command "ping 192.168.1.221". Refer to the following Diagram 4-12-1, which indicates that the physical link of LAN is smooth.

```

Command Prompt
Microsoft Windows 2000 [Version 5.00.21951
(C) Copyright 1985-2000 Microsoft Corp.

C:\>ping 192.168.1.221

Pinging 192.168.1.221 with 32 bytes of data:

Reply from 192.168.1.221: bytes=32 time<10ms TTL=128
Reply from 192.168.1.221: bytes=32 time<10ms TTL=128
Reply from 192.168.1.221: bytes=32 time<10ms TTL=128
Reply from 192.168.1.221: bytes=32 time<10ms TTL=128

Ping statistics for 192.168.1.221:
    Packets: Sent = 4, Received = 4, Lost = 0 (0% loss),
    Approximate round trip times in milli-seconds:
        Minimum = 0ms, Maximum = 0ms, Average = 0ms

C:\>

```

Diagram 4-12-1

- **Remote Control Permission Switch:** This is a selectable menu item. User can click the submenu “Accept Remote Device” of the “Monitor” menu. Refer to the following diagram 4-12-2.

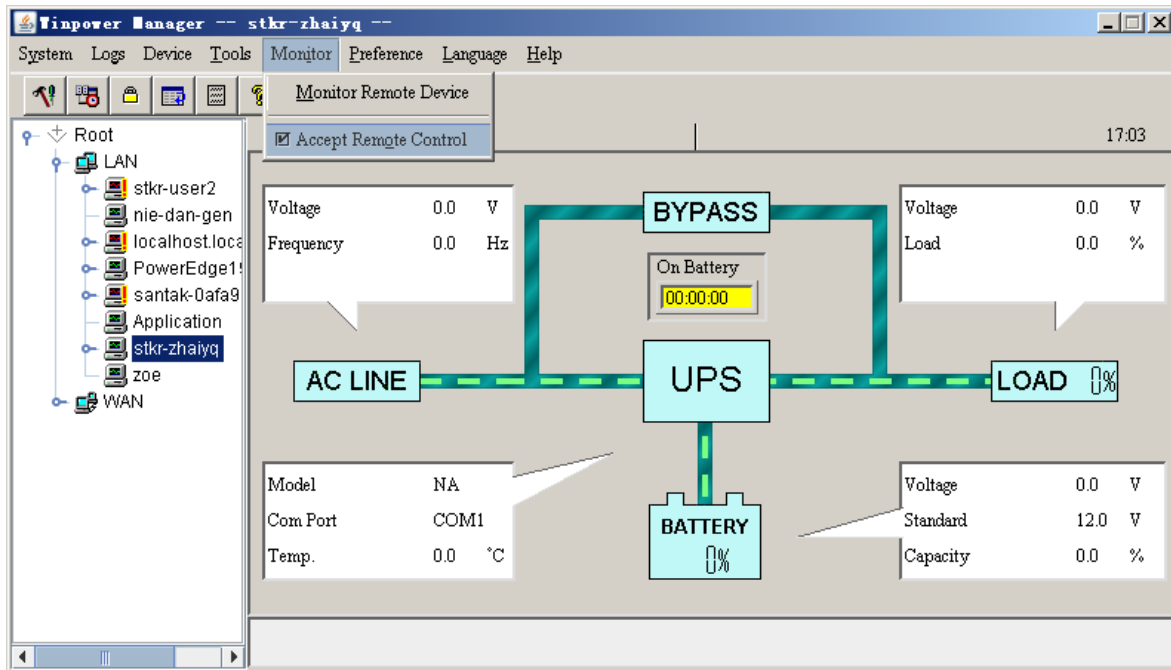

Diagram 4-12-2

- **Startup Monitor:** Refer to the following diagram 4-12-3.

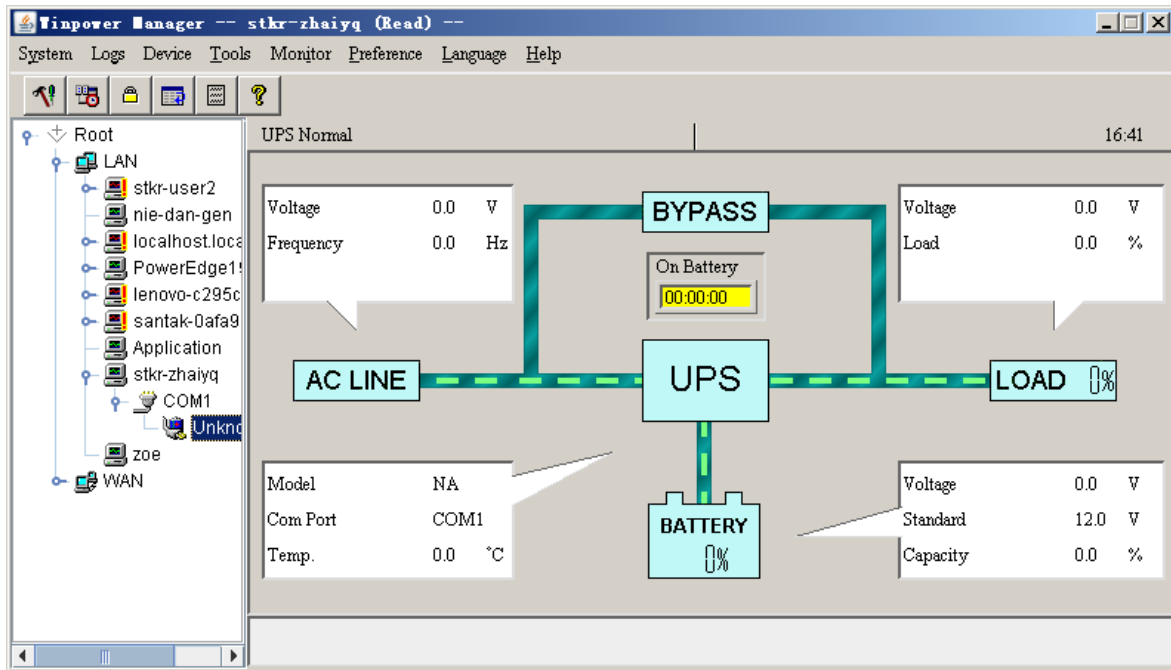

Diagram 4-12-3

- Select the Device you want to monitor

You can select the Device from the tree view on the left side of the window.

If the Remote Accept Control Permission Switch of the Agent is not on, you can only monitor but not control. The submenu “Act as Administrator” of the menu “System” is gray and can’t be selected. So if you don’t log in as an administrator, you can’t control all of the operation, Refer to the following diagram 4-12-4.

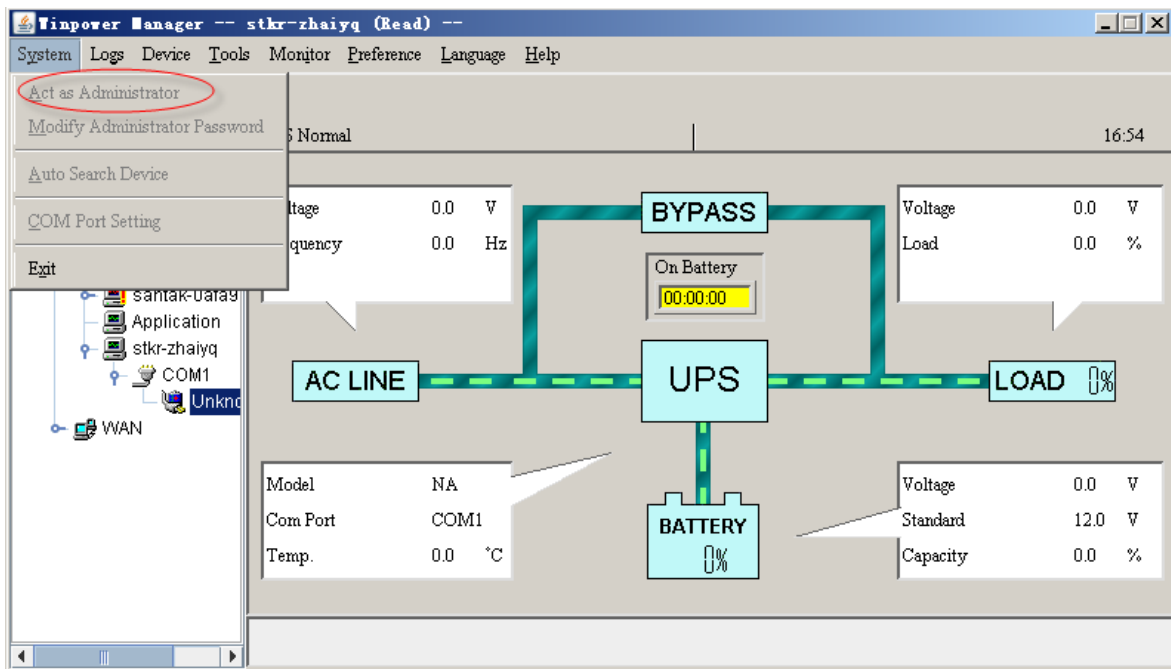

Diagram 4-12-4

If the Remote Control Permission Switch of the Agent is on, you can monitor and control this device. The submenu “Act as Administrator” of the menu “System” is black and can be selected. So

after you log in as an Administrator, you can control all of the operation, Refer to the following diagram 4-12-5.

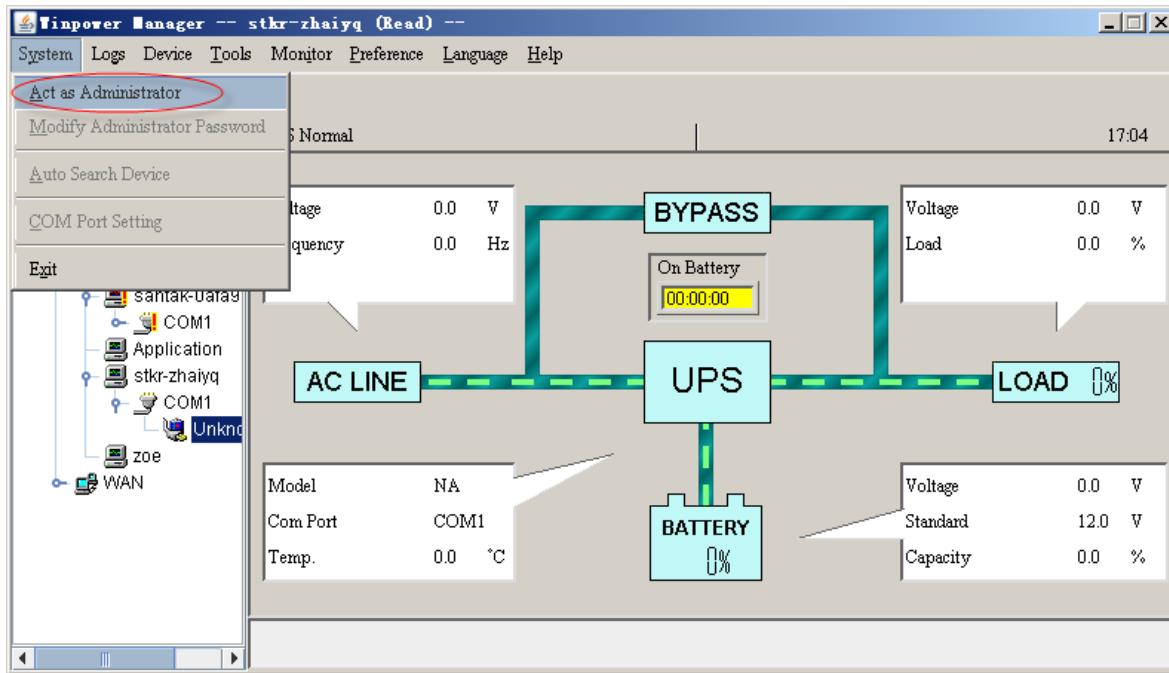

Diagram 4-12-5

13. How to realize remote control of any device in different network in LAN

- ✓ Precondition
 - The computers with Winpower must setup TCP/IP protocol in the communication protocol.
- ✓ Steps for realization
 - **Keep the communication smooth:** test with network command "PING" under command prompt window. For example, a computer named tj2k with IP address 192.168.2.228, you can test with command "ping 192.168.2.228". Refer to the following Diagram 4-13-1, which indicates that the physical link of LAN is smooth.

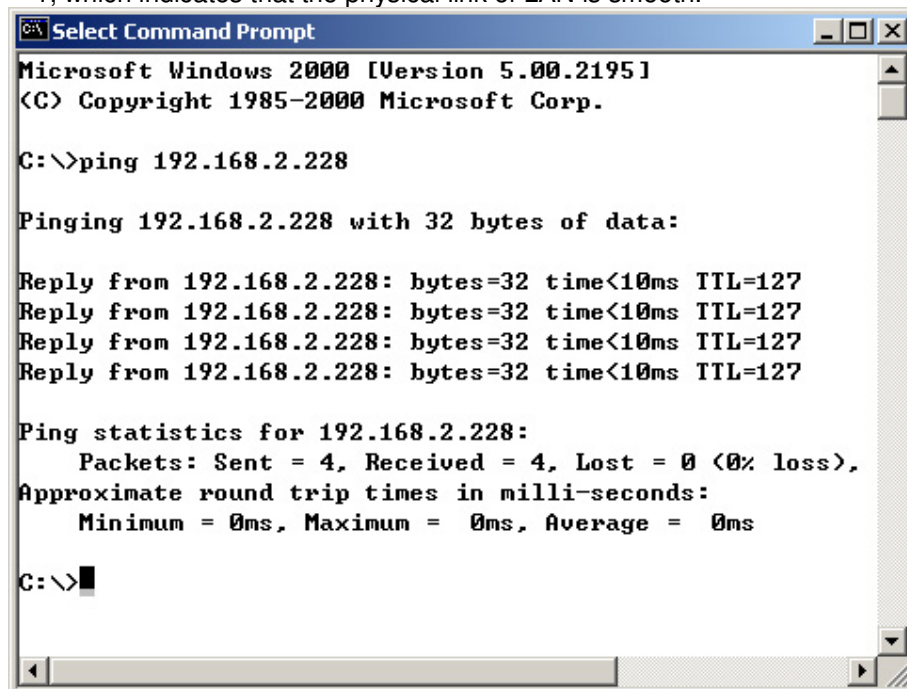

Diagram 4-13-1

- **Remote Control Permission Switch:** This is a selectable menu item. User can click the submenu “Accept Remote Device” of the “Monitor” menu. Refer to the following diagram 4-13-2.

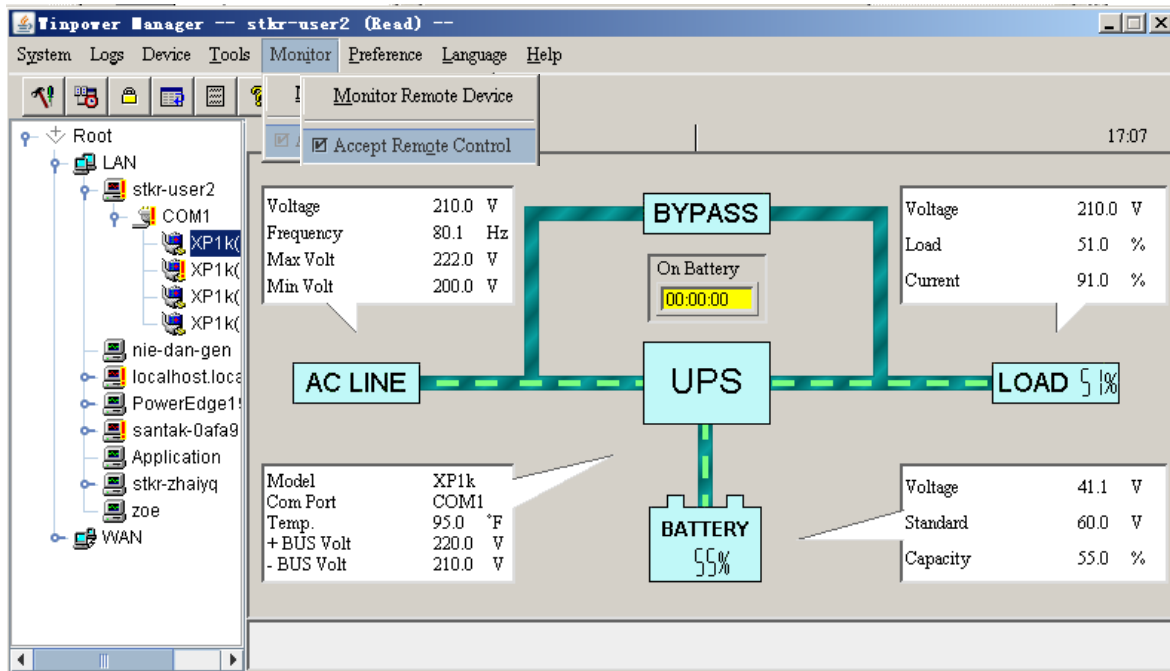

Diagram 4-13-2

- **Select the device you want to monitor**
Click the “Monitor Remote Device” item of the “Monitor” menu, and will pop up the “Monitor Remote Device” dialog. Refer to the following diagram 4-13-3.

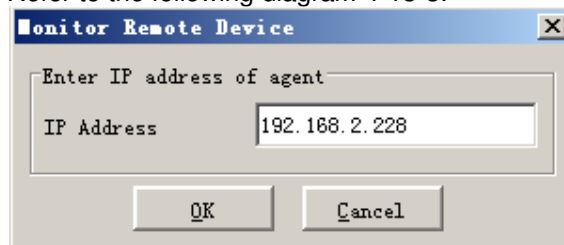

Diagram 4-13-3

User can enter a computer name or IP address in the "Monitor Remote Device" Dialog. Click the “OK” button to finish the setting.

Now you can find the device in the WAN, Refer to the following diagram 4-13-4.

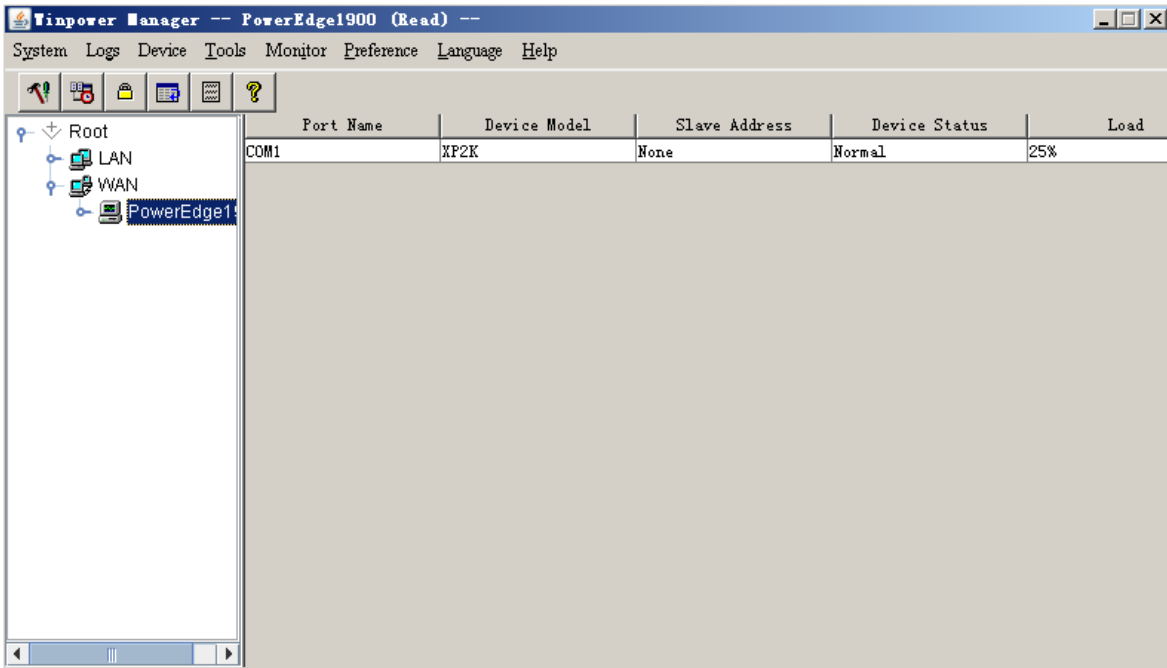

Diagram 4-13-4

If the Remote Control Permission switch of this Agent is not on, then you can only monitor but not control. Refer to the following diagram 4-13-5.

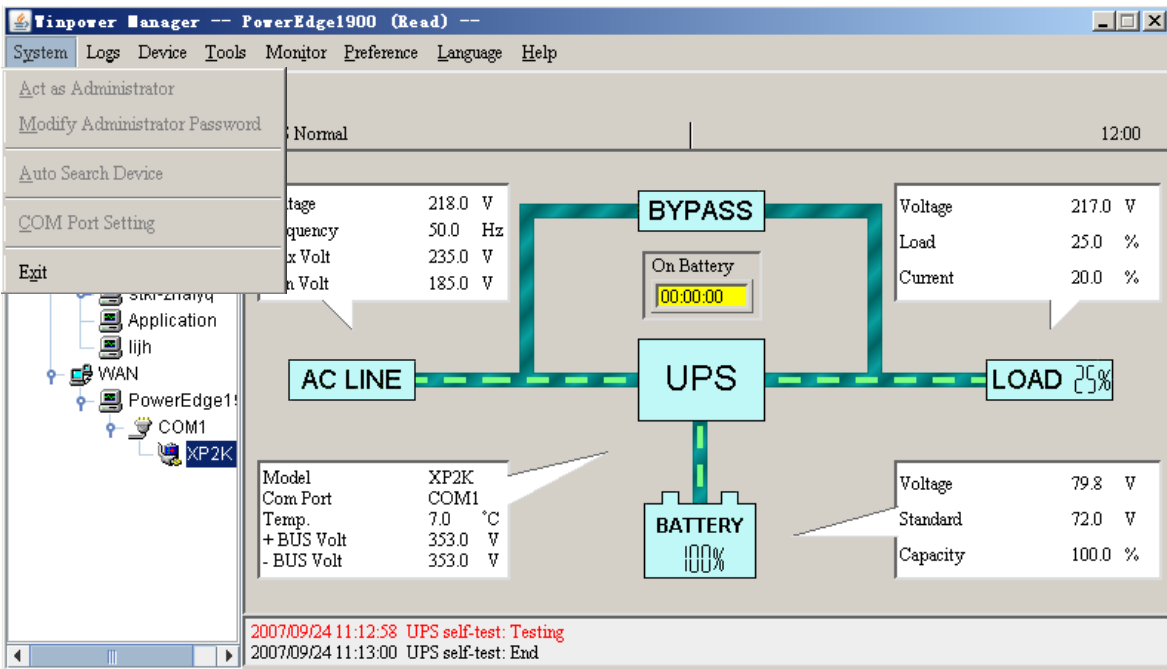

Diagram 4-13-5

If the Remote Control Permission Switch is on, then you can monitor and control this device. So after you login as a super user, you can control all of the operation, Refer to the following diagram 4-13-6.

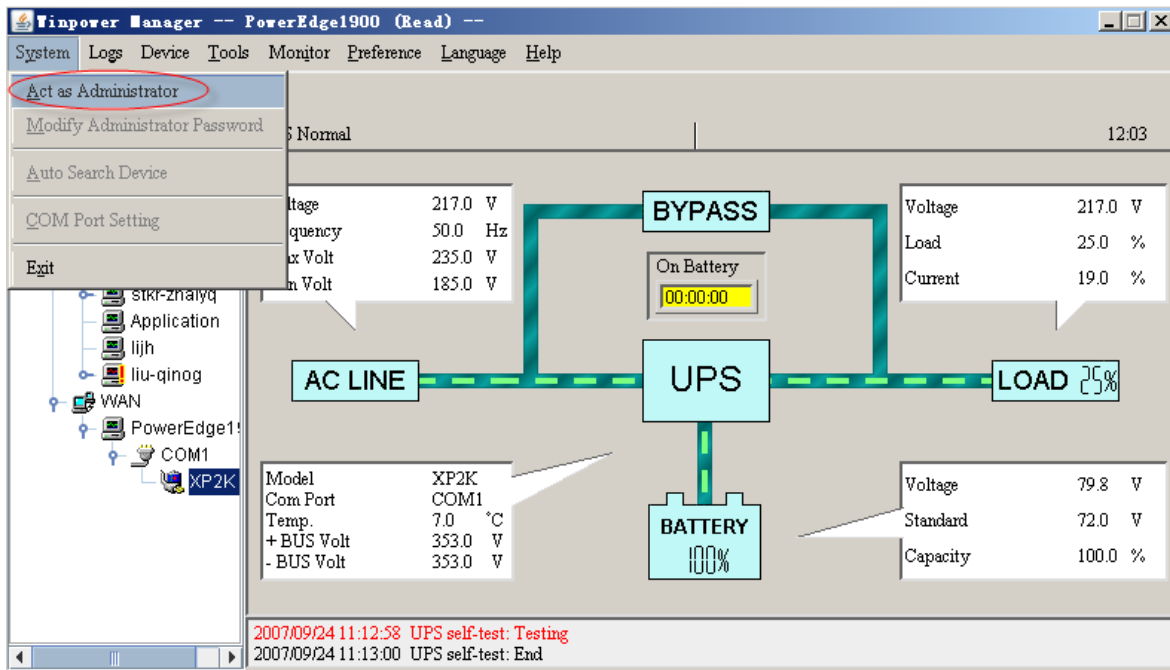

Diagram 4-13-6

14. How to realize the Remote Control of any one of the device in Internet

- ✓ Precondition
 - The computers with Winpower must setup TCP/IP protocol in the communication protocol.
 - The computer with Winpower has been connected to the Internet.
- ✓ Steps for realization
 - **Keep the communication smooth:** test with network command "PING" under command prompt window. For example, a computer named ssc-test in internet, whose corresponding IP address is 202.103.190.87, and then you can finish the test with command "ping 202.103.190.87". Refer to the following Diagram 4-14-1, which indicates that the physical link of Internet is smooth.

```

Microsoft Windows [Version 5.00.2195]
(C) Copyright 1985-2000 Microsoft Corp.

C:\>ping 202.103.190.87

Pinging 202.103.190.87 with 32 bytes of data:

Reply from 202.103.190.87: bytes=32 time<10ms TTL=125
Reply from 202.103.190.87: bytes=32 time<10ms TTL=125
Reply from 202.103.190.87: bytes=32 time<10ms TTL=125
Reply from 202.103.190.87: bytes=32 time<10ms TTL=125

Ping statistics for 202.103.190.87:
    Packets: Sent = 4, Received = 4, Lost = 0 (0% loss),
    Approximate round trip times in milli-seconds:
        Minimum = 0ms, Maximum = 0ms, Average = 0ms

C:\>_

```

Diagram 4-14-1

- **Remote Control Permission Switch:** This is a selectable menu item. User can open the submenu "Accept Remote Device" of the "Monitor" menu. Refer to the following diagram 4-14-2.

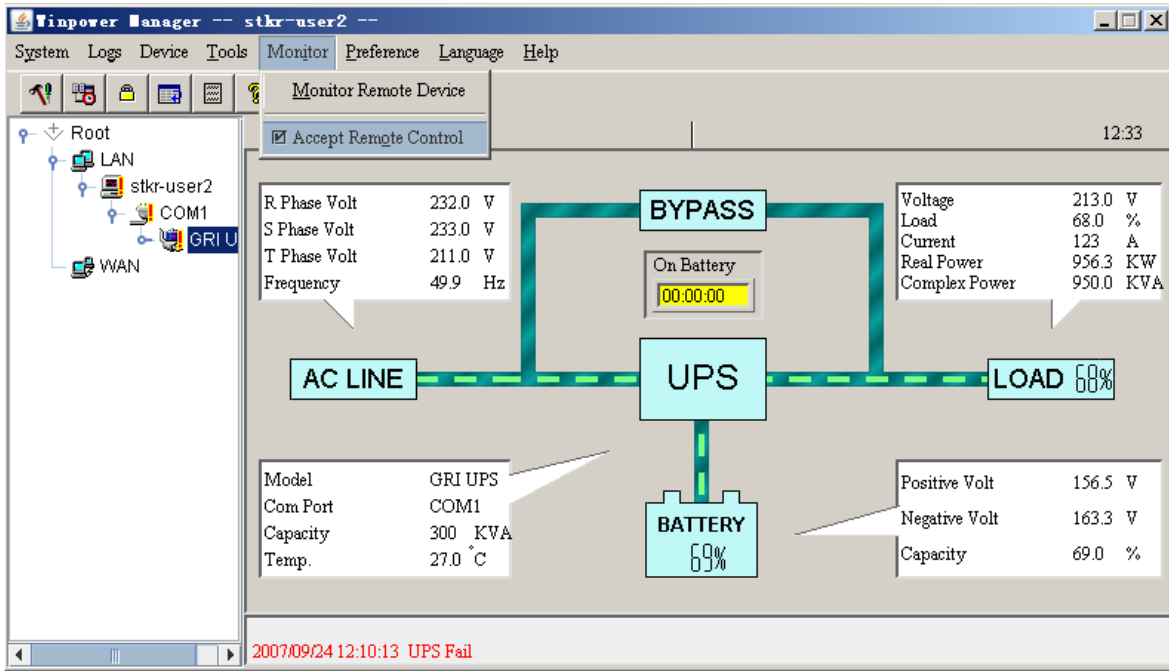

Diagram 4-14-2

➤ **Startup Monitor:** Refer to the following diagram 4-14-3.

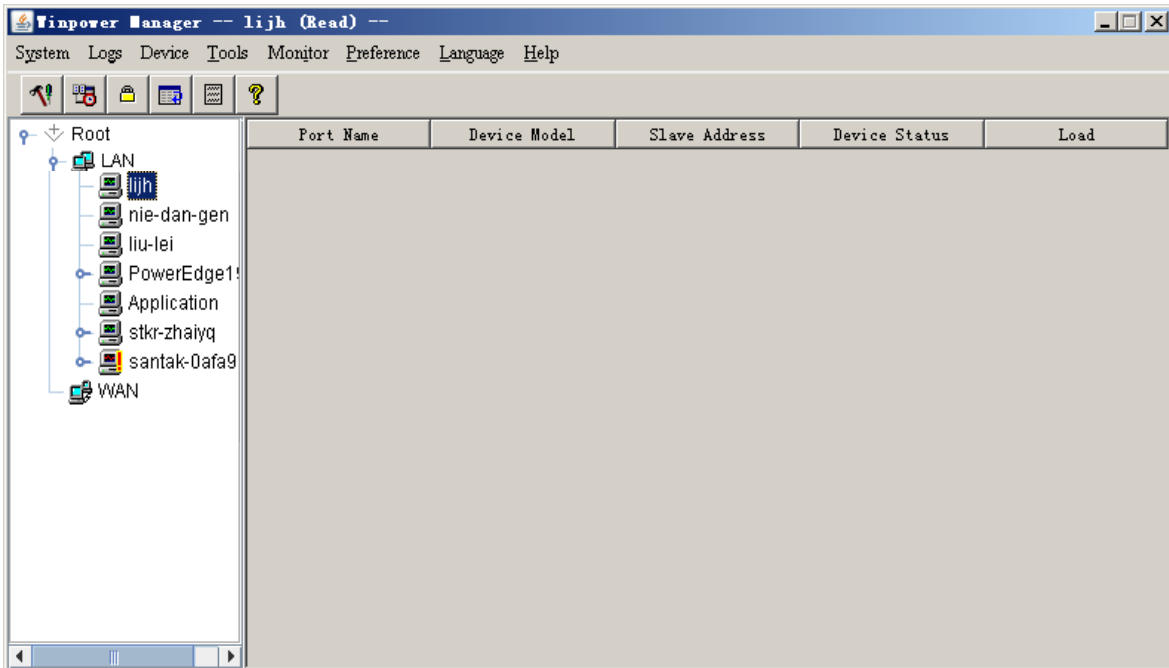

Diagram 4-14-3

➤ **Select the device you want to monitor**
Click the “Monitor Remote device” item of the “Monitor” menu, and will pop up the “Monitor Remote Device” dialog. Refer to the following diagram 4-14-4.

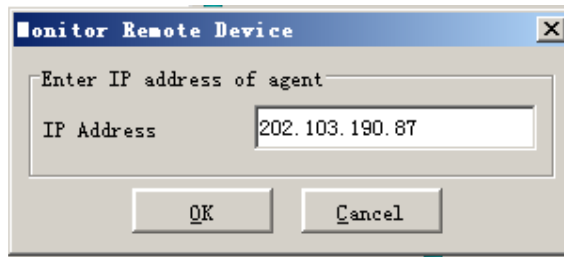

Diagram 4-14-4

User can enter a computer name or IP address in the popped up "Monitor Remote Device" dialog. Click the "OK" button to finish the setting.

Now you can find the device in the WAN, select the device from the tree view on the left side of the window. Refer to the following diagram 4-14-5.

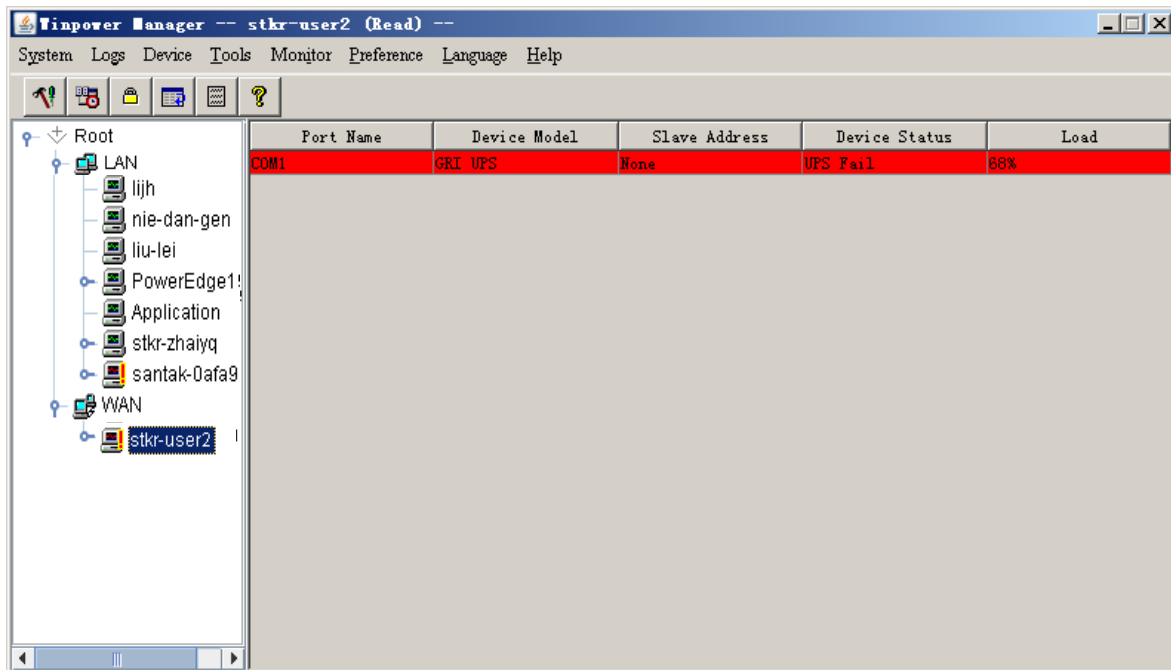

Diagram 4-14-5

If the Remote Control Permission switch of this Agent is not on, then you can only monitor but not control. Refer to the following diagram 4-14-6.

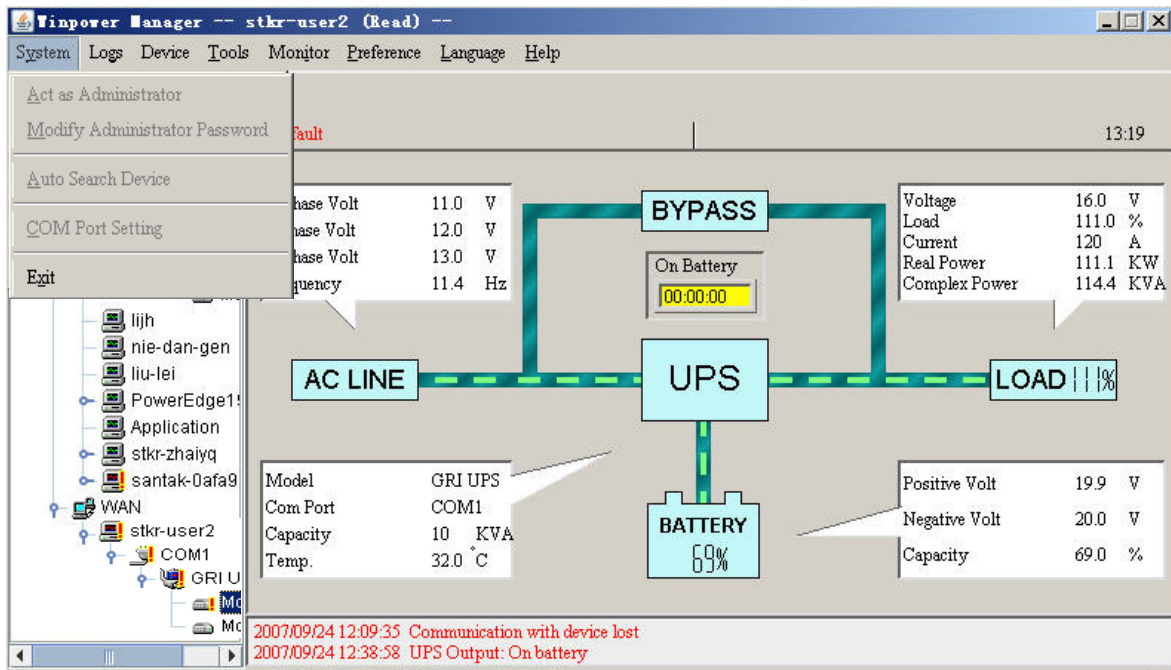

Diagram 4-14-6

If the Remote Control Permission Switch is on, you can monitor and control this device. So after you login in as a super user, you can control all of the operation, Refer to the following diagram 4-14-7.

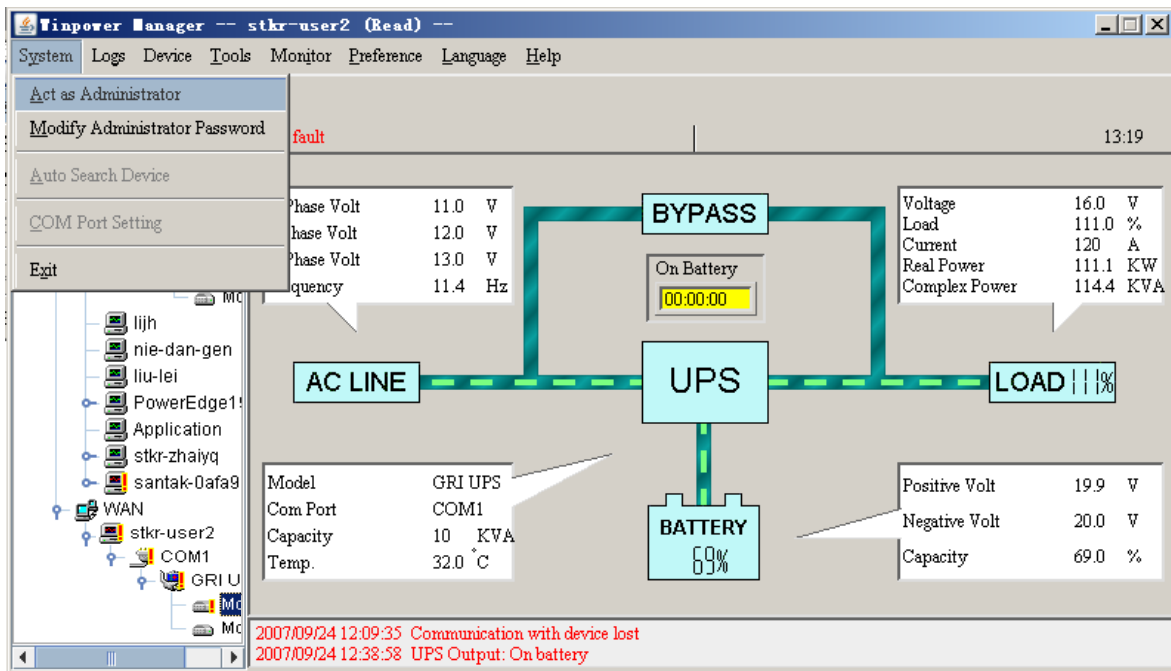

Diagram 4-14-7

15. How to install software on VMware ESX 3.5/4.0

This section describes the installation and configuration of the Software on a VMware ESX Server.

Software allows you to connect VMware ESX 3.5 with a UPS through the RS - 232 or USB port. Software allows you to connect VMware ESX 4.0 with a UPS through the RS-232 port or USB port.

Please notice: When you want to connect VMware ESX 4.0 with a UPS through USB port, you should execute the command to activate the usb.o on your System to make the USB

communication normal, and then restart the VMware ESX 4.0 server. The command: **esxcfg-module -s "libusb_support=1" usb.o**

If you don't want to input the command above, you can start the agent of software after first installation. And then restart the VMware ESX 4.0 server, the USB communication will be normal.

The software will be monitored and configured by a remote Agent on either a Microsoft Windows or Linux platform.

The software notifies the VMware server of power events or UPS alerts with pop - up broadcast information on the console. It also safely shuts down the VMware ESX server and the guest operating system.

Before the VMware ESX system shuts down, use the **shutdown.sh** script to shut down the guest operating system.

All operations are tested on VMware server with two guest operating systems (Windows 2003 and Windows XP) , when the certain conditions exist, such as:

- ◆ UPS Battery is low
- ◆ Battery backup time is reached

Tested operations include:

- ◆ Safely shuts down the VMware server
- ◆ Safely shuts down the guest operating system
- ◆ Software notifies the VMware server of power events or the UPS alerts

Installation

This section provides information about installing and configuring Software on a VMware server and installing VMware Tools on a guest operating system.

Prerequisites

- ◆ VMware ESX Server with 125 MB free space for the software.
- ◆ VMware Infrastructure client must be installed on different machine.

Software Installation

To install the software:

1. Download the software from the Web site or from the CD provided with the UPS.
2. Enter the command to install software:

▲ For the CD installation, enter the command:

```
mount /dev/cdrom /mnt
cd /mnt/Linux
./setup_console.bin
```

▲ For the download installation, enter the command:

```
tar -zxvf Winpower_setup_Linux.tar.gz
cd /mnt/Linux
./setup_console.bin
```

- 3 Start the Agent. From the installation path, enter the command:

```
./agent start
```

Installing VMware Tools on a Microsoft Windows Guest

To install the VMware Tools for a Microsoft Windows guest:

1. On the VM Templates page, move the pointer over the virtual machine template name and select View Console from the menu.
2. Insert and start the Microsoft Windows operating system installation CD.
3. Log in to the guest operating system inside the virtual machine console, and then click Install VMware Tools.
4. From within the guest operating system, click OK to confirm that you want to install VMware Tools and launch the Install Shield wizard.

▲ If auto - run is enabled in the guest operating system (the default setting for Microsoft Windows operating systems), a window opens.

▲ If auto - run is not enabled, run the VMware Tools installer. Click Start > Run and enter D:\setup.exe, where D: is the first virtual CD - ROM drive.

5. Follow the on-screen instructions.

▲ On Microsoft Windows Server 2003, the SVGA driver is installed automatically, and the guest operating system uses it after it reboots.

▲ After you install VMware Tools, Microsoft Windows 2000 and Microsoft Windows XP guest operating systems must be rebooted to use the new driver.

Installing VMware Tools on a Linux Guest

The VMware Tools installation package is on the VMware server installation CD on the path `\VMware\RPMS`.

To install the VMware Tools for a Linux guest:

1. On the VM Templates page, move the pointer over the virtual machine template name and select View Console from the menu.
2. Insert and start the VMware server installation CD.
3. Log in to the guest operating system inside the virtual machine console, then click Install VMware Tools.

4. Mount the CD with the command:
`mount /dev/cdrom /mnt`

5. Install the package with the command:
`cd /mnt/VMware/RPMS`

`rpm -Uvh VMware - esx - tools - 3.5.0 - 123630.i386.rpm`

NOTE: The package name is likely to be different.

6. Configure the VMware Tools with the command:
`vmware - config - tools.pl`

7. Enter number: 1

8. Start the VMware Tools with the command:
`vmware - toolbox &`

VMware Tools on the summary row displays OK if the tools are available (refer to Diagram 4-15-1):

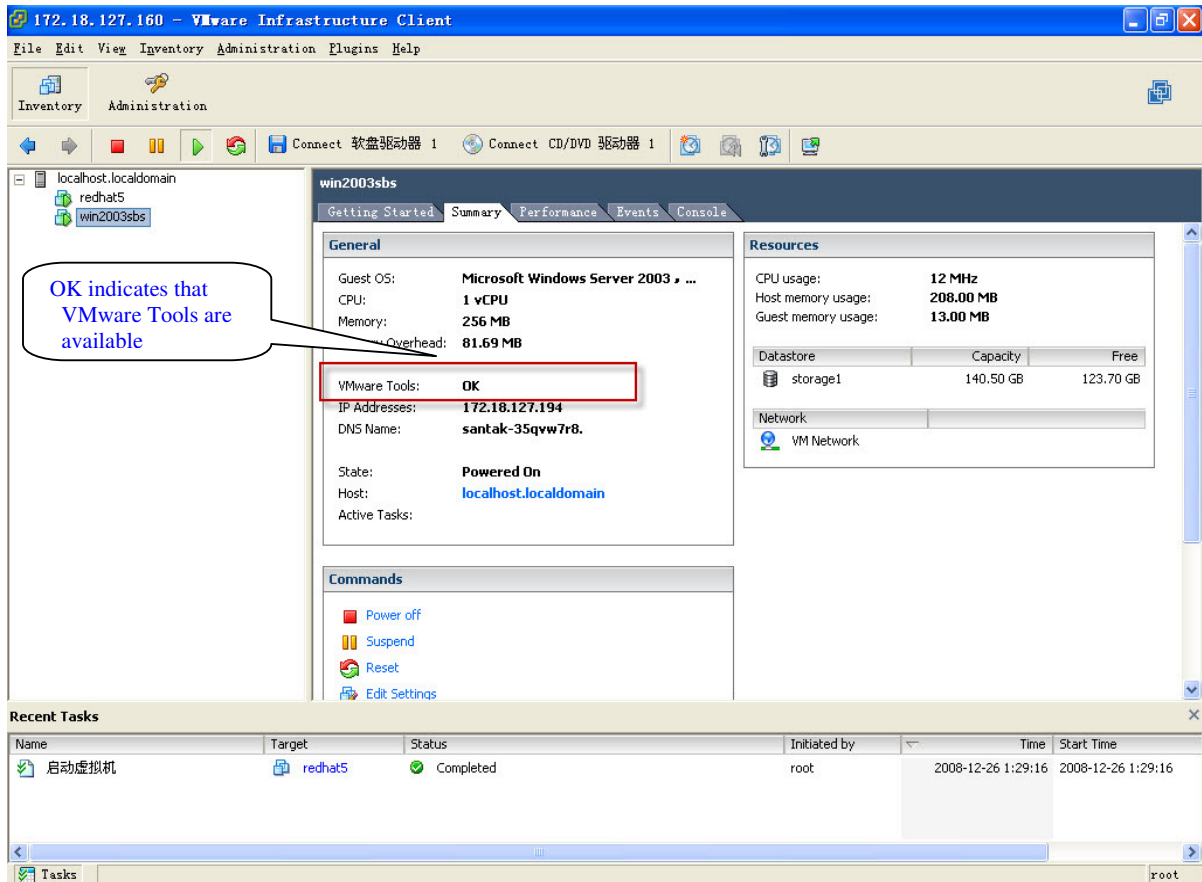

Diagram 4-15-1

Configuration

This section explains configuration for the Software and for the VMware server.

Software Configuration

The VMware server works in console mode and can't be used for configuration. Use a remote Agent with the same Software version to configure the VMware server.

1. Start the manager interface on the remote software Agent in the Microsoft Windows operating system.

2. If the two Agents are in the same LAN, the VMware server client will be added to the topology automatically. Otherwise, add the Agent manually (select Monitor Remote Device from the Monitor menu). The software will auto search the UPS when the Agent starts for the first time after installation.

If the search fails:

▲ Select the VMware Server Agent from the tree view.

▲ Acting as the Administrator, select Auto Search UPS from the System menu. The UPS connected with VMware server appears in the LAN tree view.

3. Select Shutdown Settings from the UPS menu. Set the battery backup time, and select the Begin Shutdown Immediately if Battery Low check box and the Run Command File before Shutdown check box (refer to Diagram 4-15-2).

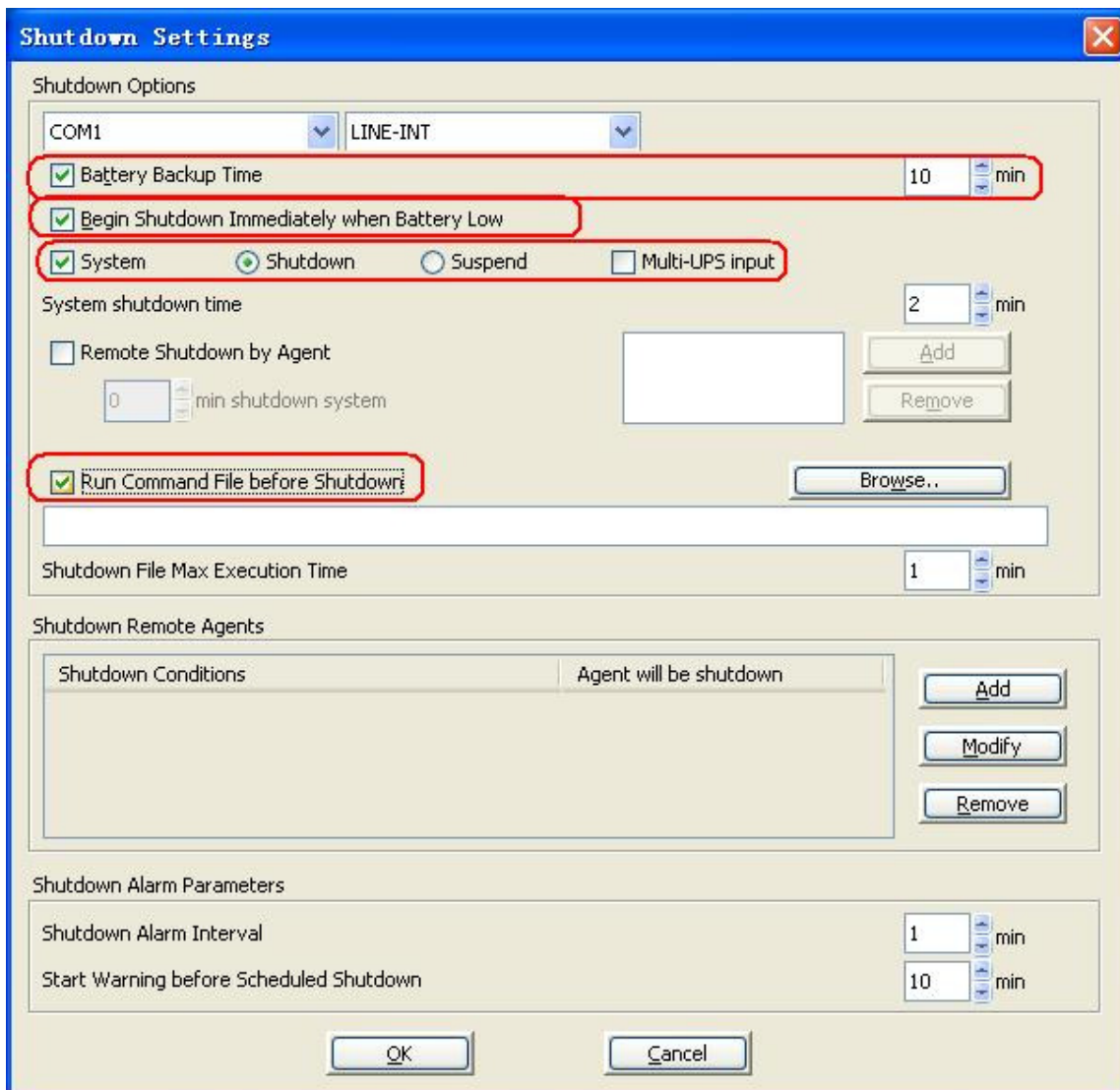

Diagram 4-15-2

VMware Server Configuration

All hardware elements must have an operational network configuration that allows them to communicate freely with each other. Software uses TCP and UDP for communication with UPS.

1. Confirm that the following UDP ports are opened on the ESX server Firewall:
2198,2199,2200
2. Confirm that the following TCP ports are opened on the ESX server Firewall: 2099

For Example:

```
esxcfg-firewall -o 2198,udp,in,UPSMS
```

```
esxcfg-firewall -o 2099,tcp,in,UPSMS
```

3. If you want to disable the firewall permanently, enter the command: `chkconfig iptables off`
4. To disable the firewall temporarily, enter the command: `service iptables stop`

16. How to install software on Windows 2008 server core

Windows Server 2008 Core OS prepared

Before installing software, please ensure the configuration of Windows Server 2008 Core is correct, including network settings, port settings.

Note: if you want to set the software by another agent, please shut down the firewall first. If you want to use the remote desktop function of Windows Server 2008 Core, you should enable the remote desktop function.

The following command may be useful for you to reference.

➤ **Command for shutting down the firewall**

Command: `netsh firewall set opmode disable`

➤ **Enable the remote desktop function**

1. Enter command "regedit", open the REGEDIT UI.
2. Edit HKEY_LOCAL_MACHINE\SYSTEM\CurrentControlSet\Control\Terminal Server\DenyTSConnections = 0
3. Open the Port for remote desktop function
Enter command: `Netsh firewall set portopening tcp 3389`

Software installation

- Copy the installation file "setup.exe" to Windows Server 2008 Core.
➤ Enter the path where the installation file exists.
➤ Start to install.

You can install UPS monitoring software in Silent installation method or Interface installation method.

Silent installation method: Enter command: "setup -i silent" or "setup.exe -i silent", then the installation can be started, waiting for a moment to finish the installation.

Interface installation method: Enter command: "setup" or "setup.exe", then the installation can be started, please follow "next" button of interface to finish the installation.

- Check if the installation is successful:

1. Enter the installation path, the default path is `c:\Program file (X86)\MonitorSoftware`, Find file "UPSEVENT.CSV", Enter command: "type UPSEVENT.CSV", the log of agent action will be shown. See the below screenshot, that means the agent is running.

```
C:\Program Files (x86)\MonitorSoftware>type UPSEVENT.CSV
15 01/20/2010 04:28:01 [ in Agent Start] [,-1,]
C:\Program Files (x86)\MonitorSoftware>
```

2. Enter the installation path, start the interface of UPS monitoring software with the command "manager". Software interface will be shown as following picture.

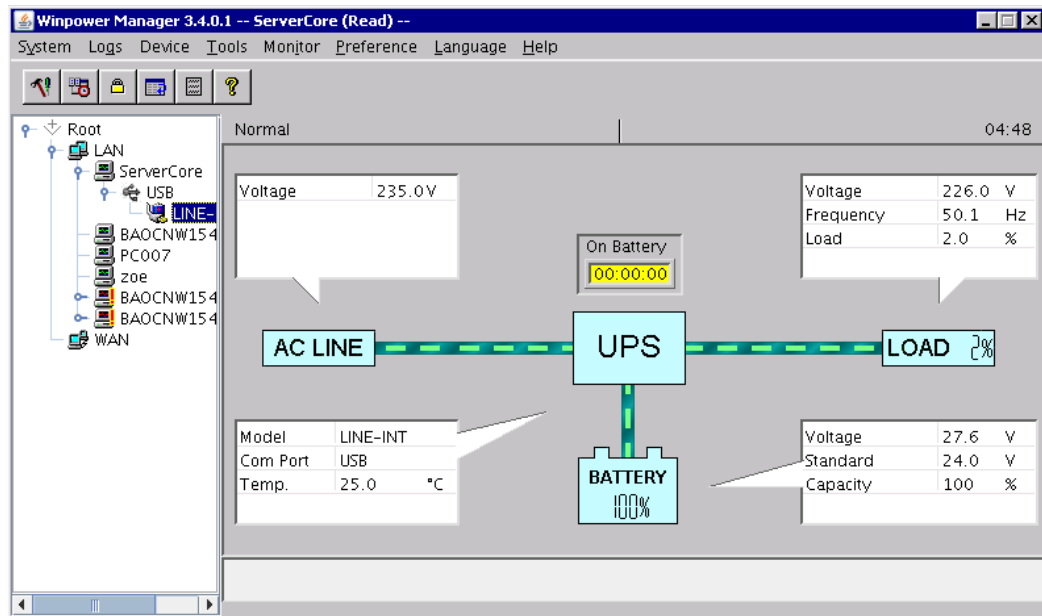

3. Check the status of the processes of UPS monitoring software.
Enter command "tasklist" to open the task manager. See below screenshot, if these processes are all running, that means the UPS monitoring software is running normally.

```

C:\Program Files (x86)\MonitorSoftware>tasklist
Image Name                PID Session Name        Session#    Mem Usage
-----
System Idle Process        0 Services              0           24 K
System                     4 Services              0           300 K
smss.exe                   220 Services              0          1,012 K
csrss.exe                  300 Services              0          3,608 K
csrss.exe                  352 RDP-Tcp#0             1          4,612 K
wininit.exe               360 Services              0          4,176 K
winlogon.exe              388 RDP-Tcp#0             1          5,004 K
services.exe              448 Services              0          7,172 K
lsass.exe                  456 Services              0          9,760 K
lsn.exe                    464 Services              0          5,712 K
svchost.exe               556 Services              0          8,288 K
svchost.exe               628 Services              0          6,424 K
svchost.exe               720 Services              0         10,956 K
svchost.exe               760 Services              0         27,284 K
svchost.exe               808 Services              0          8,872 K
svchost.exe               872 Services              0         15,452 K
svchost.exe               988 Services              0         10,836 K
svchost.exe               540 Services              0          2,576 K
svchost.exe              1148 Services              0          9,332 K
svchost.exe              1212 Services              0          5,420 K
svchost.exe              1336 Services              0          4,612 K
taskhost.exe              1820 RDP-Tcp#0             1          3,816 K
cmd.exe                   1864 RDP-Tcp#0             1          3,028 K
conhost.exe               1872 RDP-Tcp#0             1          3,160 K
msdtc.exe                 1460 Services              0          7,124 K
csrss.exe                  436 Console                 3          3,504 K
winlogon.exe              1628 Console                 3          3,844 K
LogonUI.exe               584 Console                 3         13,076 K
rdpclip.exe               1716 RDP-Tcp#0             1          5,720 K
monitor.exe               1540 Services              0          3,480 K
javaw.exe                 2028 Services              0         20,992 K
wpRMI.exe                 1044 Services              0          3,420 K
javaw.exe                 1988 Services              0         21,696 K
manager.exe               1548 RDP-Tcp#0             1          3,096 K
javaw.exe                 1384 RDP-Tcp#0             1         33,668 K
tasklist.exe              1980 RDP-Tcp#0             1          5,004 K
WmiPrvSE.exe              1188 Services              0          5,732 K

```

Uninstall software

1. Close the interface of the UPS monitoring software and enter the installation path, the default path is c:\Program file (X86)\ MonitorSoftware, enter command: "wpExit" to stop software, waiting for a moment.
2. Enter the installation path, the default path is c:\Program file (X86)\ MonitorSoftware, find the file "UninstallerData".

You can uninstall software in Silent installation method or with Interface uninstall method.

Silent uninstall method: Enter the file “UninstallerData” and then enter command: “Uninstall –i silent” or “Uninstall.exe –i silent” to uninstall the software, then uninstall can be starting, waiting for a moment to finish uninstall.

With interface uninstall method: Enter the file “UninstallerData” and then enter command: “Uninstall” or “Uninstall.exe” to uninstall the software with interface, please follow “next” button of interface to finish uninstall.

17. How to install software on VMware ESXi 4.0/4.1

This section describes the installation and configuration of the Software on VMware ESXi 4.0/4.1 Server.

Notice: the version of VMware ESXi 4.0/4.1 should be purchased, because of free of charge version without some function, software can't be used normally on free of charge version OS.

The software agent can't be installed on the hypervisor system, because VMware ESXi doesn't have an administrative console for hypervisor. However, the software can be installed on VMware Infrastructure Management Assistant (VIMA) 1.0 or on vSphere Management Assistant (vMA) 4.0/4.1 to manage the shutdown of VMware ESXi hosts. You can suspend or shutdown guest operating systems safely and orderly by configuring the ESXi hypervisor. This allows one software agent on one guest operating system (VIMA/vMA). The software installed on VIMA or vMA should be configured to be shut down by another software agent communicating with UPS by RS232 or USB. Another software agent should be installed on operating system with GUI.

The software notifies the VMware server of important message with pop-up broadcast information on the console. It also safely shuts down the VMware ESXi server and the guest operating system. Before the VMware ESXi system shuts down, use the **shutdownESXi.sh** script to shut down the guest operating system.

All operations are tested on VMware ESXi server with two guest operating systems (SBS 2003 and Red Hat).

Tested operations include:

- Safe shut down of the VMware server
- Safe shut down of the guest operating system

Installation and Configuration

This section provides information about installing and configuring the Software on a VMware ESXi server and installing VMware Tools and vMA 4.0/4.1 on a guest operating system.

Prerequisites

- VMware ESXi server machine
- VIMA 1.0 or vMA 4.0/4.1 installed as guest
- VMware Infrastructure client installed on a different machine for VMware ESXi Server

configuration

• Secure Copy Protocol (SCP) client like WinSCP to upload packages to the VMware ESXi server

- The Software installed on the vMA

vMA Installation

To install the vMA application:

1. Go to <http://www.vmware.com/support/developer/vima/> to download the software from the VMware Web site.

2. Unzip the vMA virtual application package.

3. Start the VMware Infrastructure client:

- Select **File > Deploy OVF Template**.
- Click **Browse**.
- Select the Open Virtualization Format (OVF) and click **Next**

vMA Configuration

To configure the vMA software:

1. Enter the following command to add Target Servers to vMA:

sudo vifp addserver <servername>

Example command: **sudo vifp addserver 172.18.127.11**

2. Enter the following command to enable seamless authentication for remote CLI and VI Perl Toolkit:

Example command: **sudo vifpinit 172.18.127.11**

3. Verify that the target server has been added. Enter the following command to display target servers:

sudo vifp listservers

Example response: 172.18.127.11 ESXi

VMware ESXi Server Configuration

To allow interactions between physical and virtual machines, VMware tools must be installed on each virtual machine. Go to http://www.vmware.com/pdf/osp_install_guide.pdf to download the VMware Tools Installation Guide Operating System Specific Packages on the VMware Web site for further information.

Installing VMware Tools on a Microsoft Windows Guest Operating System

To install the VMware Tools for a Microsoft Windows guest operating system:

1. On the VM Templates page, select the virtual machine template name and then select the **Console** tab. The Console window opens (see diagram 4-17-1).

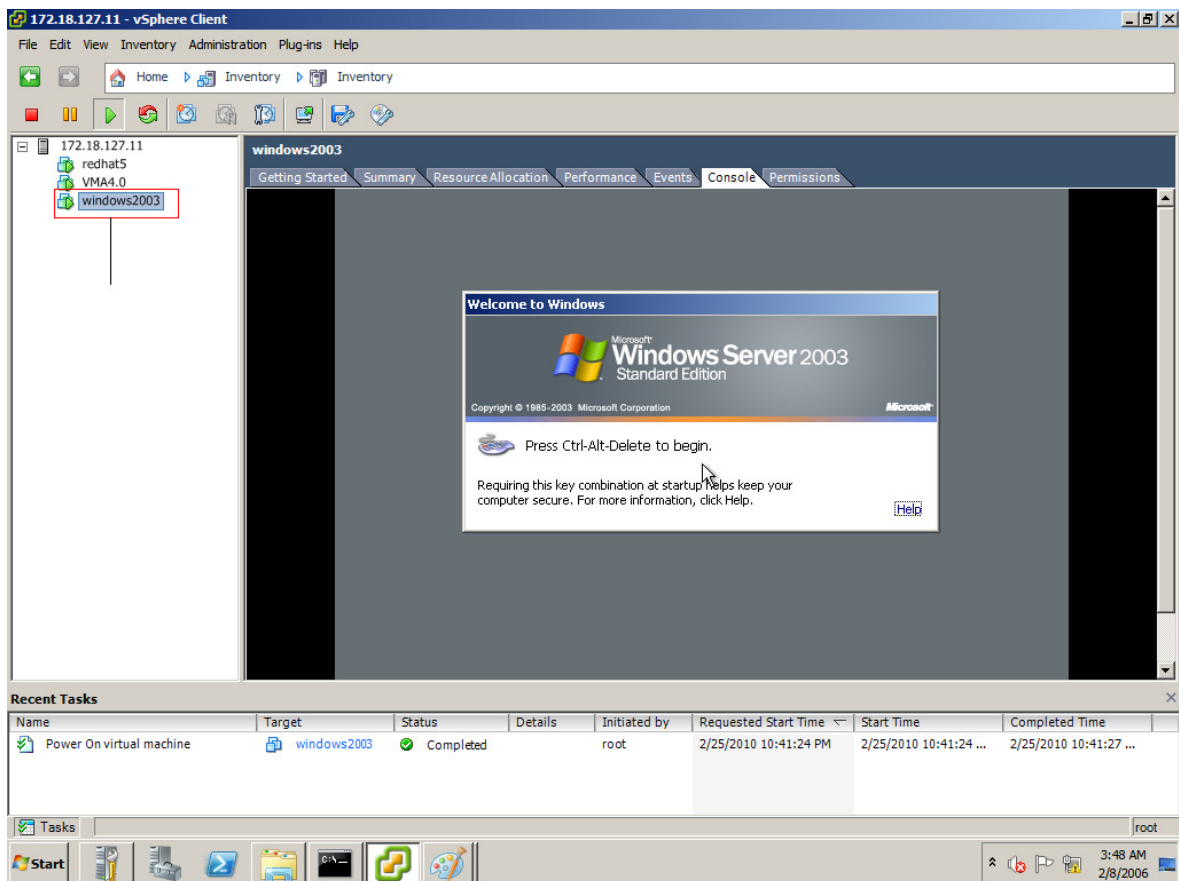

Diagram 4-17-1

2. Insert and start the Microsoft Windows operating system installation CD.

3. Log in to the guest operating system from the virtual machine console.

4. Select the template name and then right-click and select **Guest>Install/Upgrade VMware Tools** from the menu. (see Diagram 4-17-2.)

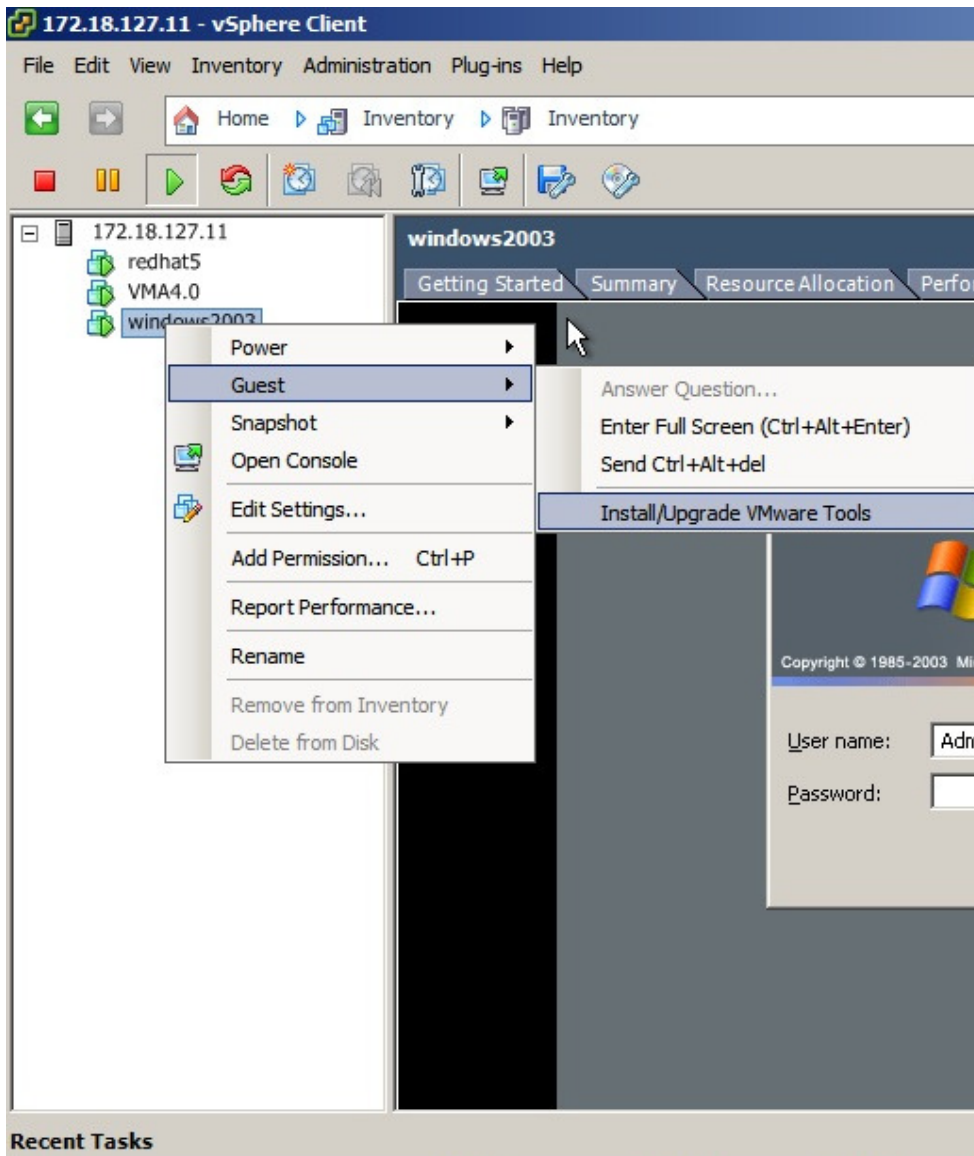

Diagram 4-17-2

5. From within the guest operating system, click **OK** to confirm that you want to install VMware Tools and launch the Install Shield wizard.

- If auto - run is enabled in the guest operating system (the default setting for Microsoft Windows operating systems), a window opens
- If auto - run is not enabled, run the VMware Tools installer. Click **Start > Run** and enter **D:\setup.exe**, where D: is the first virtual CD - ROM drive.

6. Follow the on-screen instructions.

- On Microsoft Windows Server 2003, the SVGA driver is installed automatically, and the guest operating system uses it after it reboots.
- After you install VMware Tools, Microsoft Windows 2000 and Microsoft Windows XP guest operating systems must be rebooted to use the new driver.

Installing VMware Tools on a Linux Guest Operating System

To install the VMware Tools for a Linux guest operating system:

1. On the VM Templates page, select the virtual machine template name and then select the **Console** tab. The Console window opens (see diagram 4-17-3).

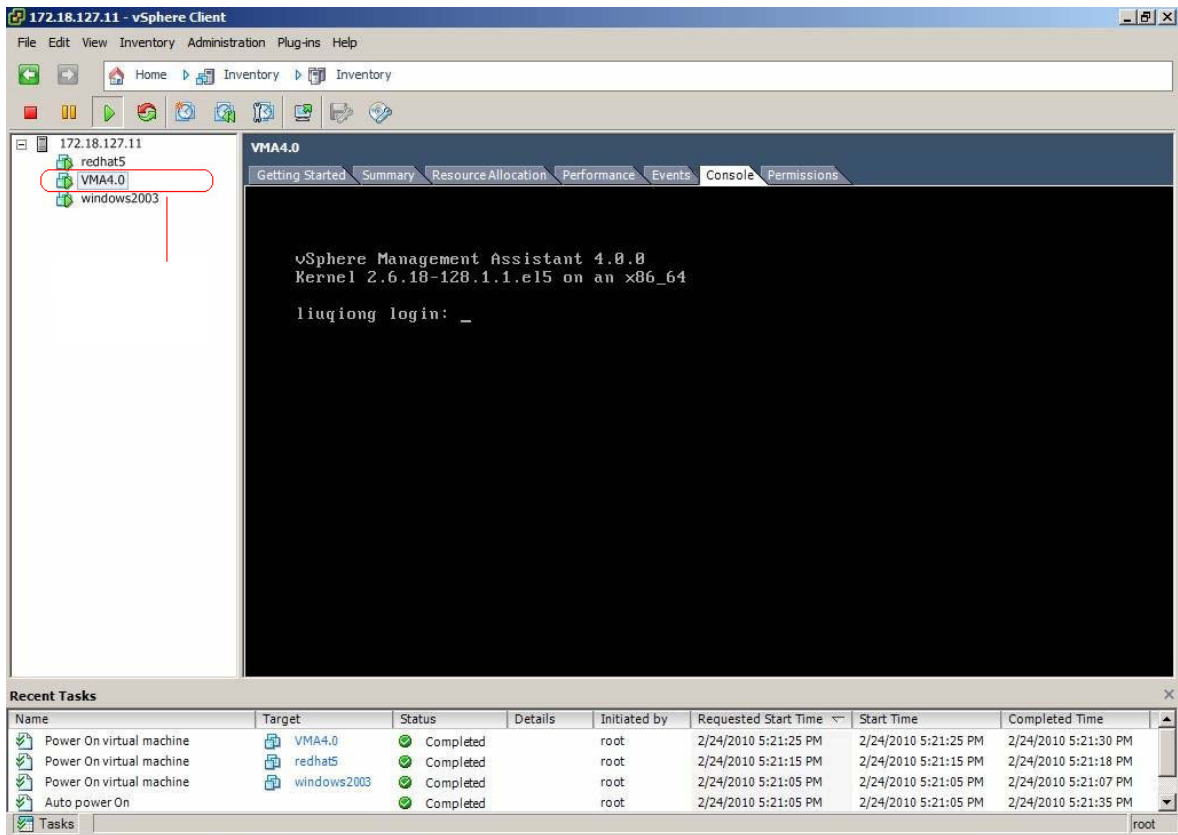

Diagram 4-17-3

2. Insert the VMware server installation CD.

Go to **VMware RPMS** to locate the VMware Tools installation package.

3. Log in to the guest operating system from the virtual machine console (see diagram 4-17-4).

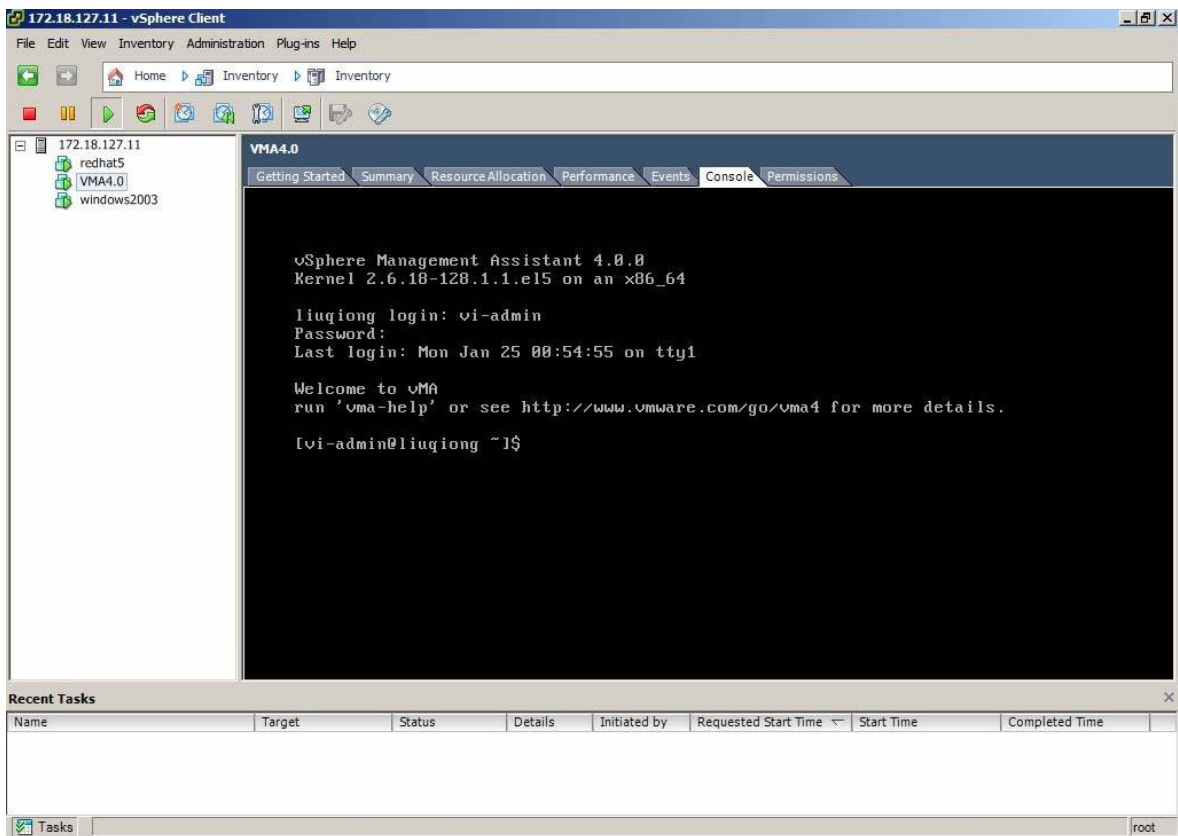

Diagram 4-17-4

4. Select the template name and then right-click and select **Install/Upgrade VMware Tools** from the menu. (see diagram 4-17-2.)
 5. Mount the CD with the command: **mount /dev/cdrom /mnt**
 6. Install the package with the command:
cd /mnt/VMware/RPMS
rpm -Uvh VMware - esx*.rpm
 - NOTE: The package name is likely to be different.**
 7. Configure the VMware Tools with the command:
vmware - config - tools.pl
 8. Enter number: **1**
 9. Start the VMware Tools with the command:
vmware - toolbox &
- VMware Tools on the summary page displays **OK** if the tools are available (see diagram 4-17-5).

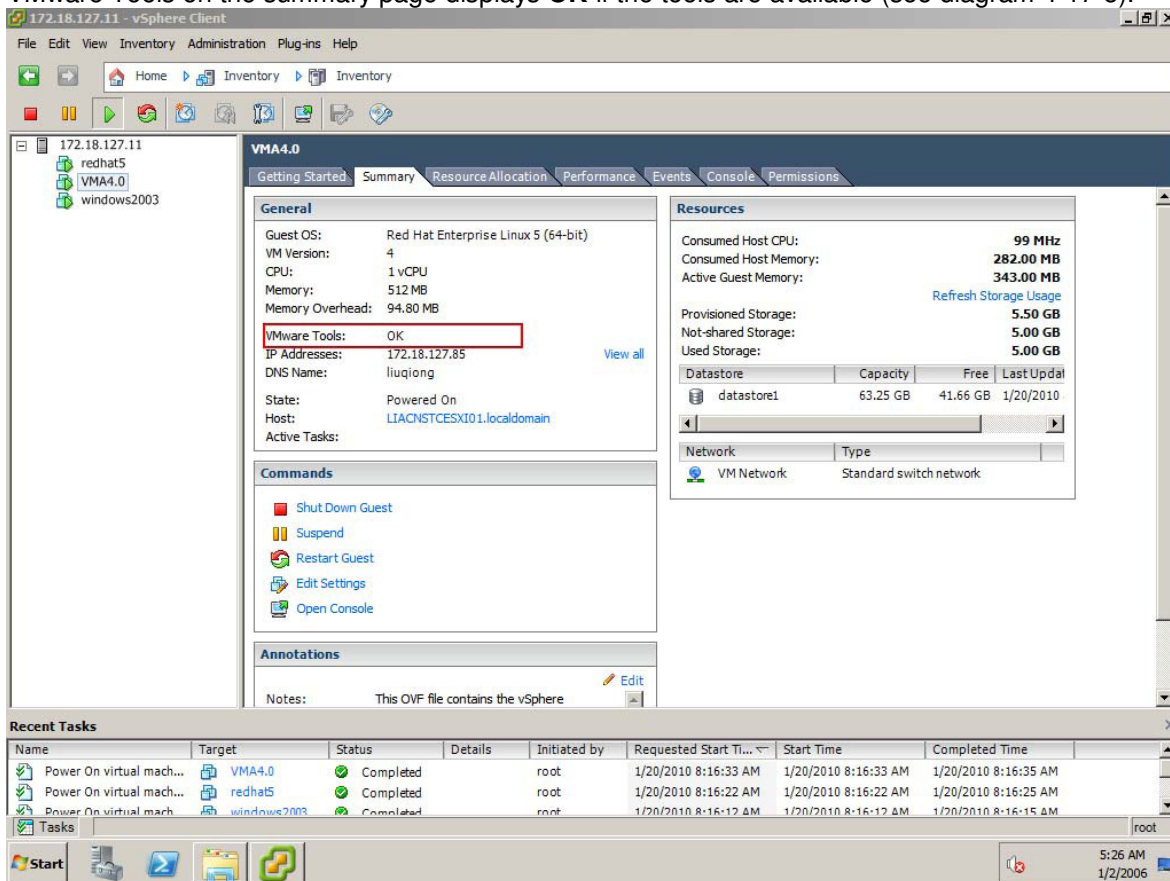

Diagram 4-17-5

VIMA/vMA Shutdown and Startup Configuration

NOTE: You can configure the physical machine to boot the automatic operating system on startup. This setting is located in your machine's basic input/output system (BIOS). For further information, refer to your specific technical hardware documentation.

NOTE: You can configure the automatic startup and shutdown properties of guest operating systems as suspended.

- Automatic Shutdown of guest (VIMA/vMA) when ESXi host is shutting down
- Automatic Startup of guest (VIMA/vMA) when ESXi host is starting

To configure VIMA/vMA shutdown and startup:

1. Choose the host server from the left pane tree hierarchy by the Virtual Infrastructure Client interface and then select the Configuration tab.
2. Select **Virtual Machine Startup/Shutdown** from the Software list and click **Properties**. The Virtual Machine Startup and Shutdown window opens (see diagram 4-17-6).
3. Enter the settings as shown on the Virtual Machine Startup and Shutdown window:

- For each virtual machine, set delay startup for 10 seconds
- For each virtual machine, set delay shutdown for 30 seconds

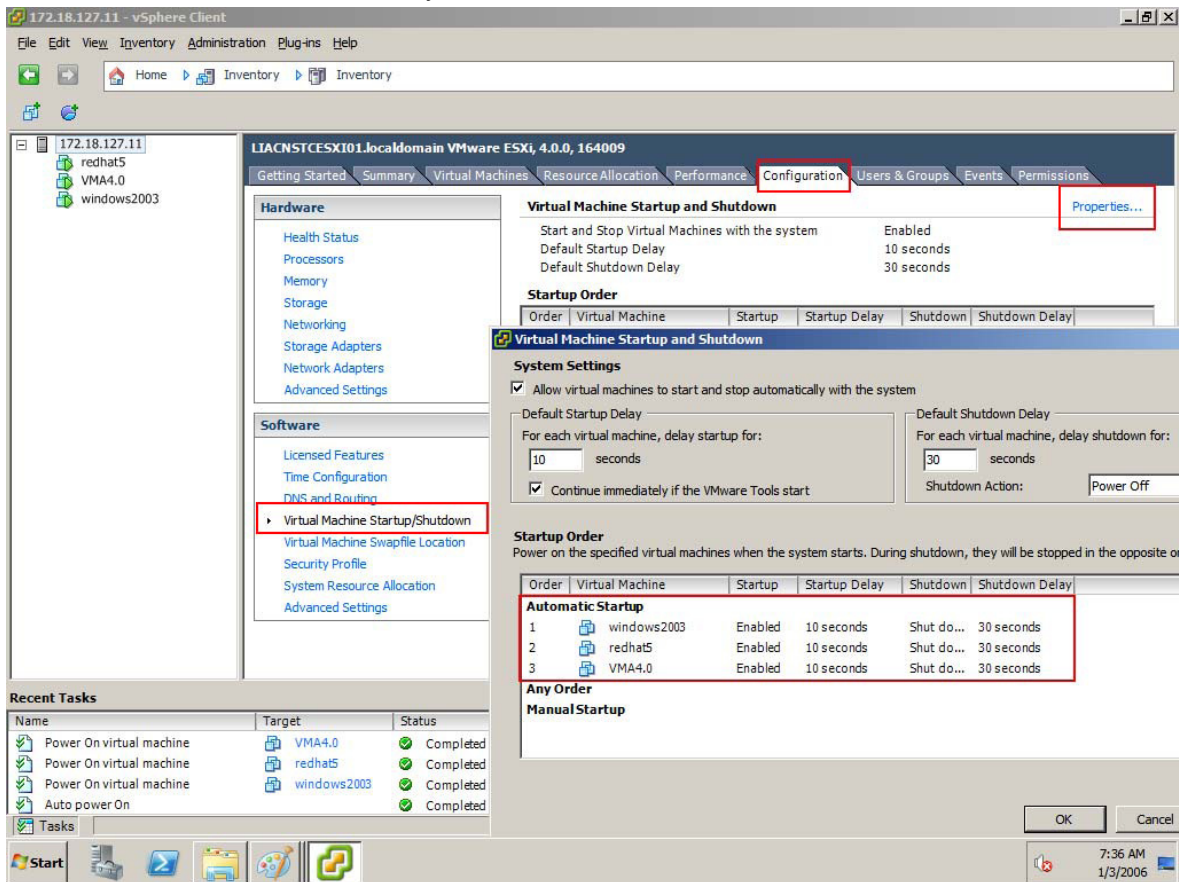

Diagram 4-17-6

NOTE: All hardware elements must have an operational network configuration that allows them to communicate freely with each other. The Software uses TCP and UDP for communication with UPS.

4. Confirm that the following UDP ports are enabled on the VIMA/vMA firewall: **2198, 2199, 2200.**

Example commands:

```
sudo iptables -I INPUT -p udp dport 2198 -j ACCEPT
sudo iptables -I INPUT -p udp dport 2199 -j ACCEPT
```

5. Confirm that the following TCP port is enabled on the VIMA/vMA firewall: **2099**

The Software Installation and configuration

NOTE: The "vi-admin" is default user name of vMA 4.0/4.1 without the administrator privilege. If you can't install or start software normally, please add "sudo" before every command to act as the administrator privilege.

To install the software:

1. Start the vMA 4.0/4.1 guest operating system.
2. Download the software from the Web site or from the CD provided with the UPS.
3. Upload the software from Windows to vMA 4.0/4.1 using WinSCP tools.
4. Copy the **Linux** and **InstallerData** files from the CD to vMA. Enter the following commands to access the **Linux** and **InstallerData** files:

```
sudo chmod -R 777 Linux
sudo chmod -R 777 InstallerData
```

5. Enter the **Linux** path and then enter the following command to install the software:

```
cd Linux
sudo ./setup_console.bin
```

6. Edit the shutdown script "shutdownESXi.sh". Modify the **.pl** file name and the parameters

value of **timeout** and **vma_name**.

If the VMware server is VMware ESXi 4.0, the **.pl** file name should be **ghettoHostShutdown.pl**, **vma_name** should be **VMA4.0**. For example: perl ghettoHostShutdown.pl --host_operation shutdown --vm_operation shutdown --timeout 2 --ups_vm VMA4.0

If the VMware server is VMware ESXi 4.1, the **.pl** file name should be **ghettoHostShutdown41.pl**, **vma_name** should be **VMA4.1**. For example: perl ghettoHostShutdown41.pl --host_operation shutdown --vm_operation shutdown --timeout 2 --vma_name VMA4.1

One required variable is **timeout** that specifies how long the system will wait for all VMs to shutdown before initiating the host shutdown operation. Each guest operating system requires a minimum of 30 seconds to shutdown.

Notice: if you are not sure the accurate time, you can use --host_operation **autoquery** in conjunction with --vm_operation **auto** to view what is the current amount of time that's been configured and help you select a **timeout** value.

For Example:

```
perl ghettoHostShutdown41.pl --host_operation autoquery --vm_operation auto --timeout 2 --vma_name vMA4.1. After running the script of "shutdownESXi.sh", The required timeout will be list as blow:
```

```
07-29-2010 19:00:02 -- info: RECOMMENDED_TIMEOUT_VALUE = > 2 minutes.
```

7. Start the Agent. From the installation path, enter the command:

```
./agent start
```

Notice: if the VMware ESXi server version is VMware ESXi 4.1, after the server restarts, you should stop the agent first with the command “./agent stop” and start the agent again with the command “./agent start”.

8. Configure the shutdown parameter of the software agent installed on vMA 4.0/4.1 to shut down the guest OS and VMware ESXi server safely.

- the software agent installed on vMA 4.0/4.1 should select the check box of Remote Shutdown by Agent and add the IP of another software agent, and select the check box of Run Command File before Shutdown in shutdown settings dialog. Please refer to diagram 4-17-7. For example: another software agent IP is 172.18.127.10.

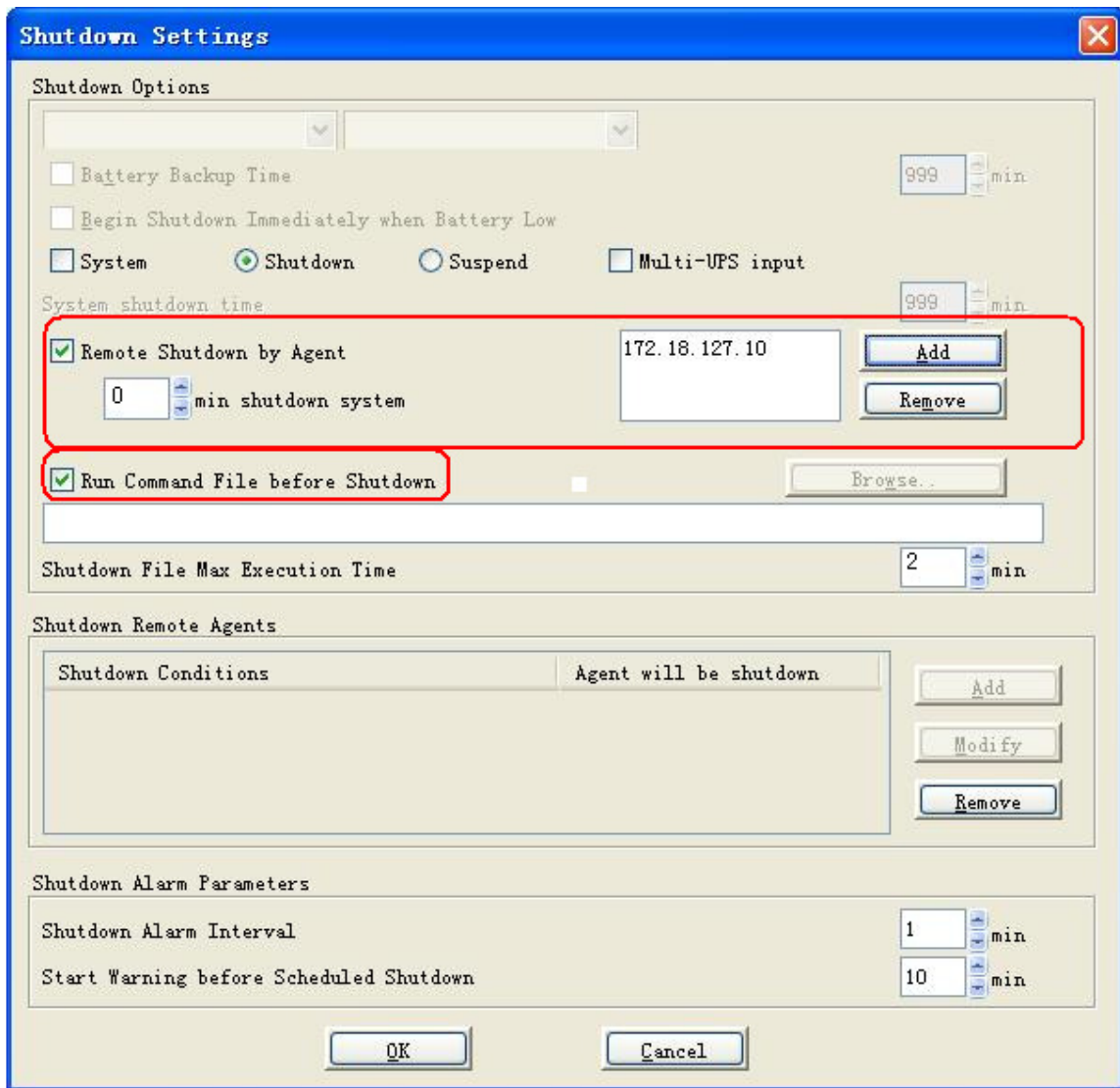

Diagram 4-17-7

Notice: The shutdown settings dialog of the software agent installed on vMA 4.0/4.1 should be open from the shutdown parameter of device menu, by selecting the agent name on the manager window of another agent installed on operating system with GUI.

The time of “shutdown File Max Execution time” in shutdown setting dialog should be in conjunction with the timeout value in the shutdownESXi.sh.

- Another software agent should be installed on operating system with GUI, the agent should communicate with UPS by RS232 or USB and should configure shutdown remote agents in shutdown settings dialog. Here the remote agent means the software agent installed on vMA 4.0/4.1. Please refer to diagram 4-17-8. For example, the IP of the software agent installed on vMA 4.0/4.1 is 172.18.127.20. When the shutdown conditions is met, software agent installed on vMA 4.0/4.1 will receive shutdown signal, and run command file before shutdown to shut down all the guest OS and VMware ESXi server safely.

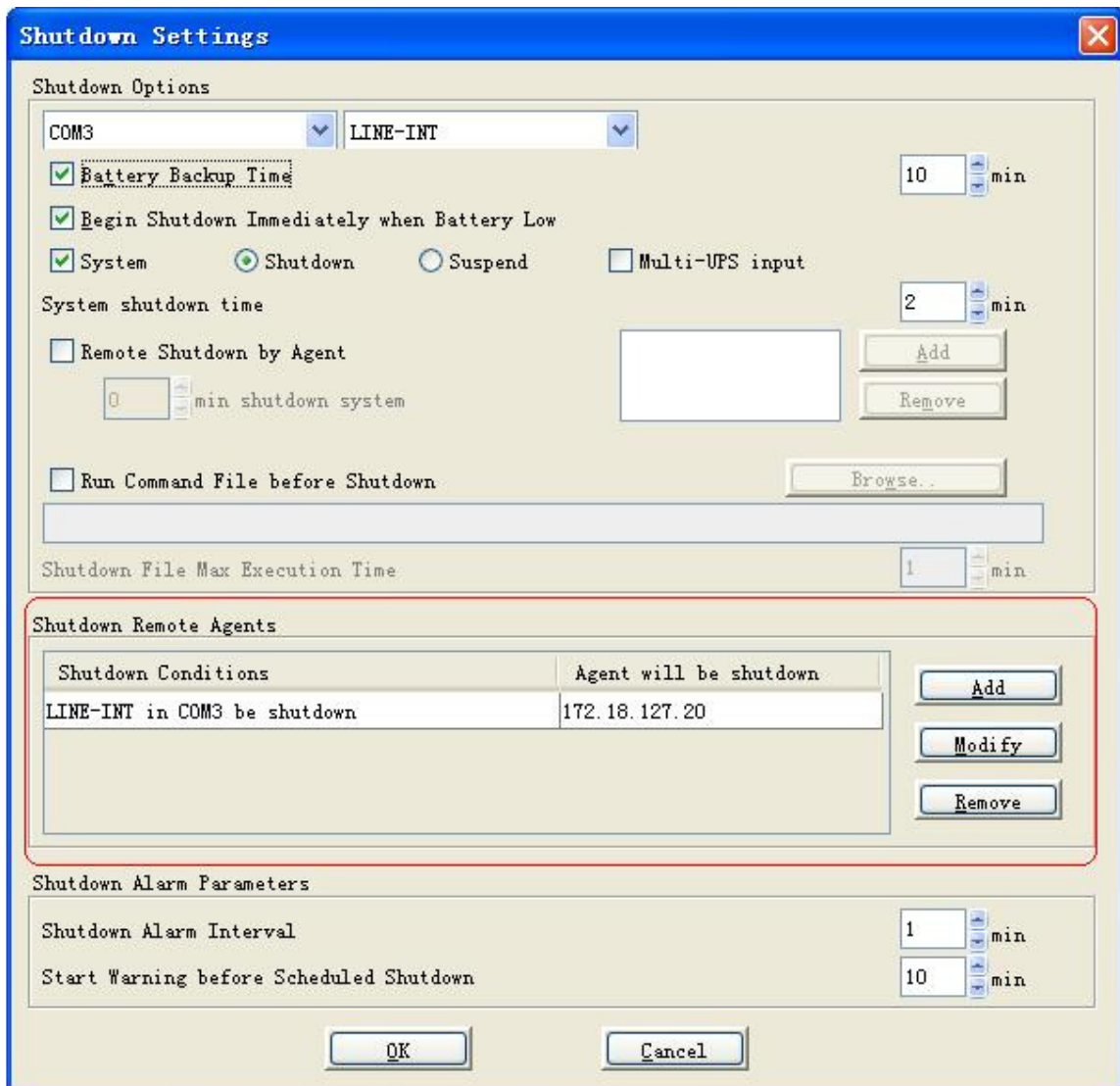
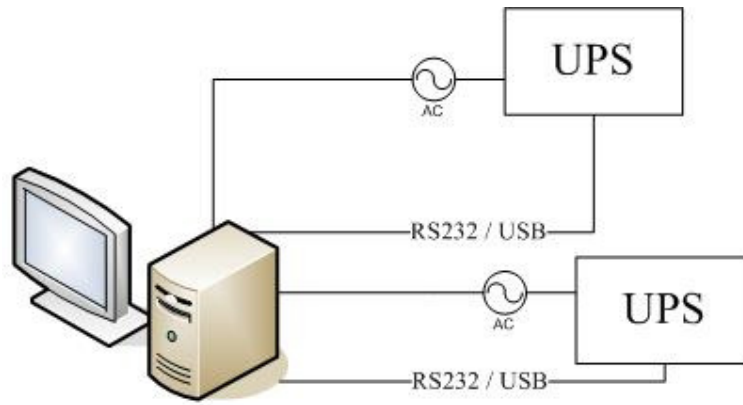

Diagram 4-17-8

Notice: Another software agent installed on operating system with GUI should be the same version as the software installed on vMA 4.0/4.1.

18. How to configure the computer powered by Multi-UPS shut down safely

For local computer: If there are more than one UPS supplying power to the local computer with software as below 4-18-1, you want to safely shut down or suspend the local computer before all UPS can't supply power to the local computer. You should select the "Multi-UPS input" option in the "shutdown settings" dialog of each UPS and set condition, refer to the following picture 4-18-2. The local computer won't be shut down or in suspend mode until all the condition of all UPS is met.



Server powered from two redundant power supply

Diagram 4-18-1

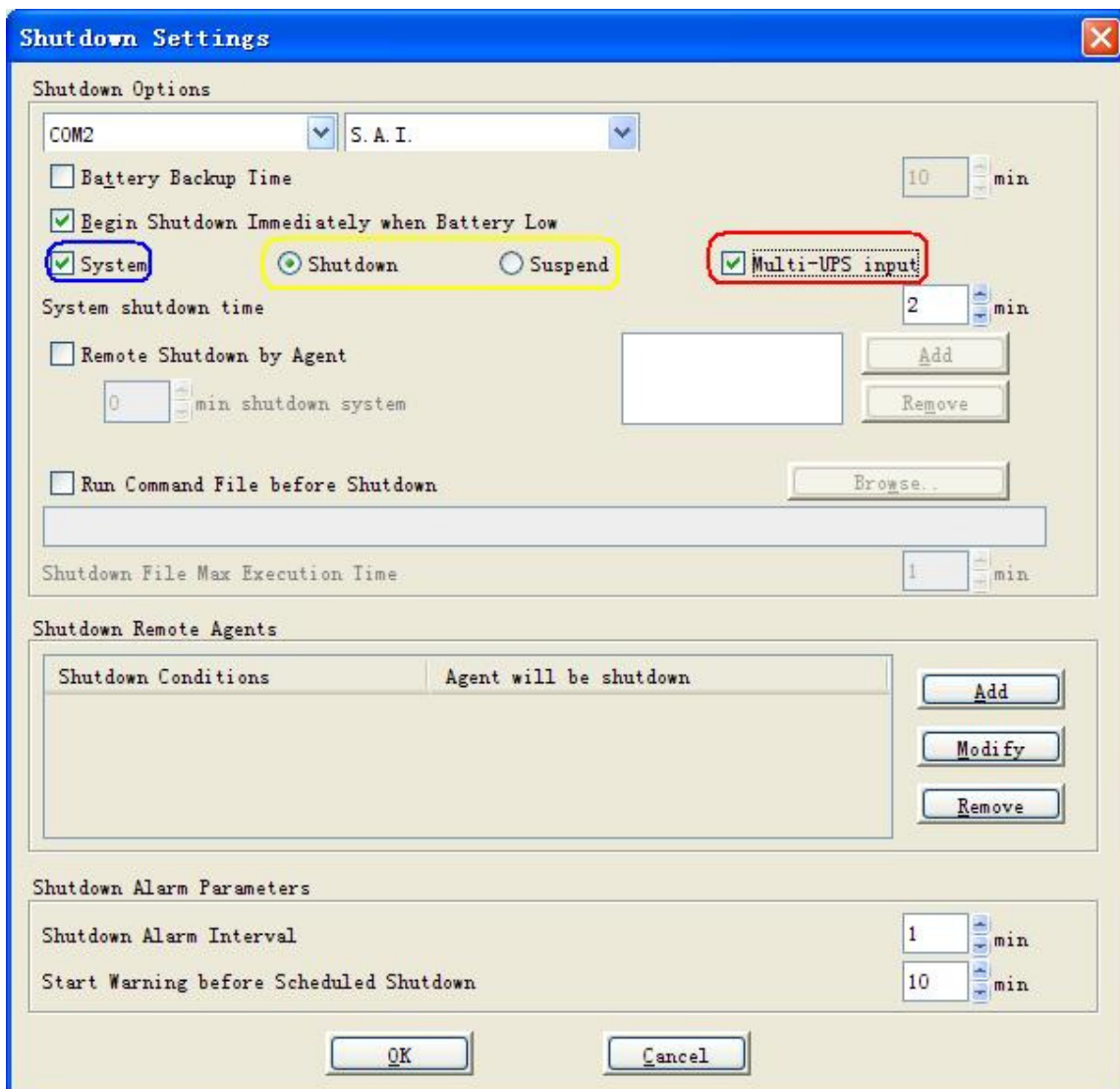

Diagram 4-18-2

For remote computer without communication with UPS: If there are more than one UPS supplying power to the remote computer with software, you want to safely shut down or suspend the remote computer before all UPS can't supply power to the remote computer. You should configure the software installed on the remote computer to be shut down by another computer, refer to the

following picture 4-18-3, and in the “shutdown settings” dialog of another computer with software communicating with the two UPS to shut down the remote computer, the shutdown condition of each UPS should be set separately, refer to the following picture 4-18-4 and 4-18-5. The remote computer won't be shut down or in suspend mode until all the condition of all UPS is met.

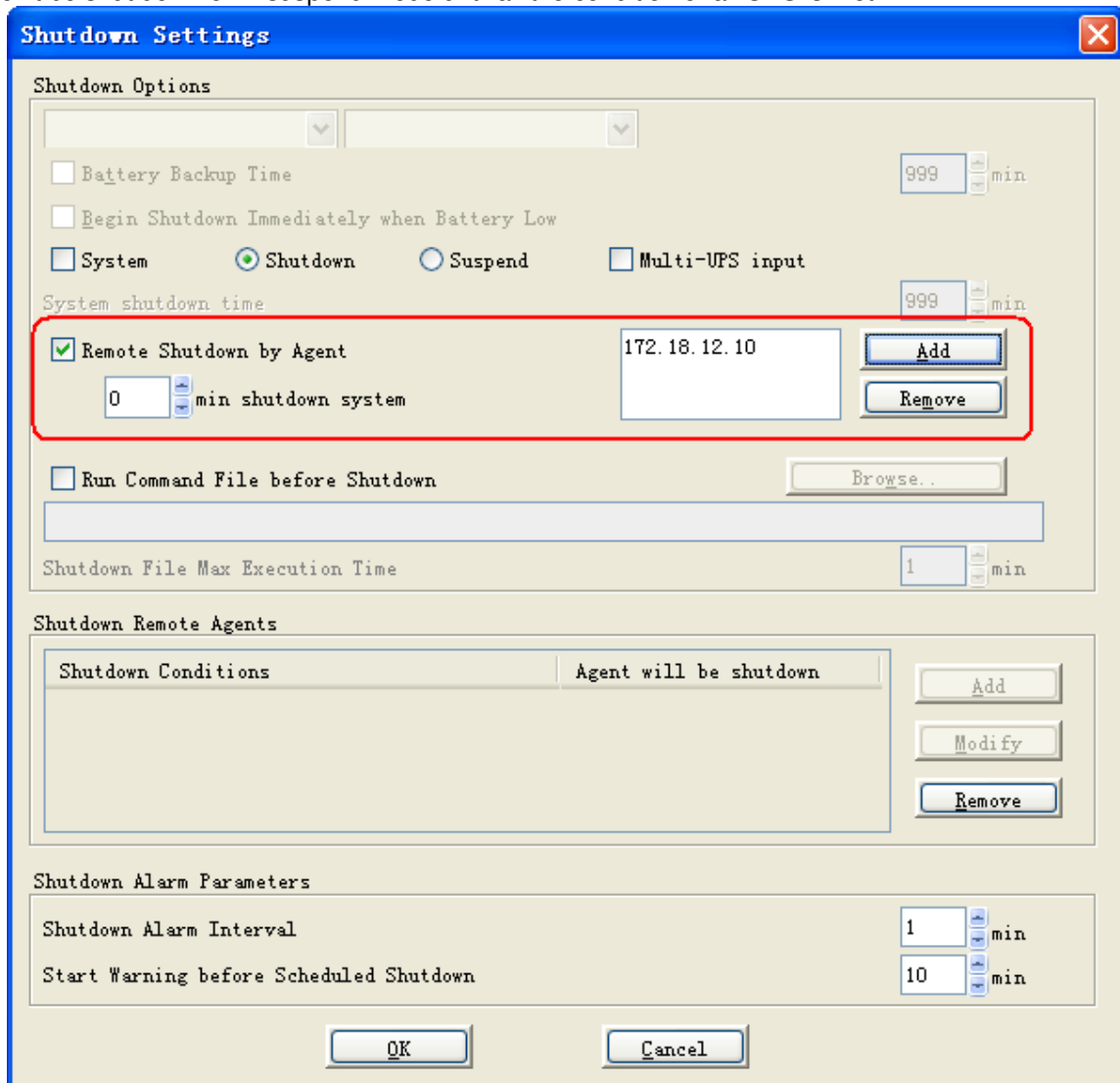

Diagram 4-18-3

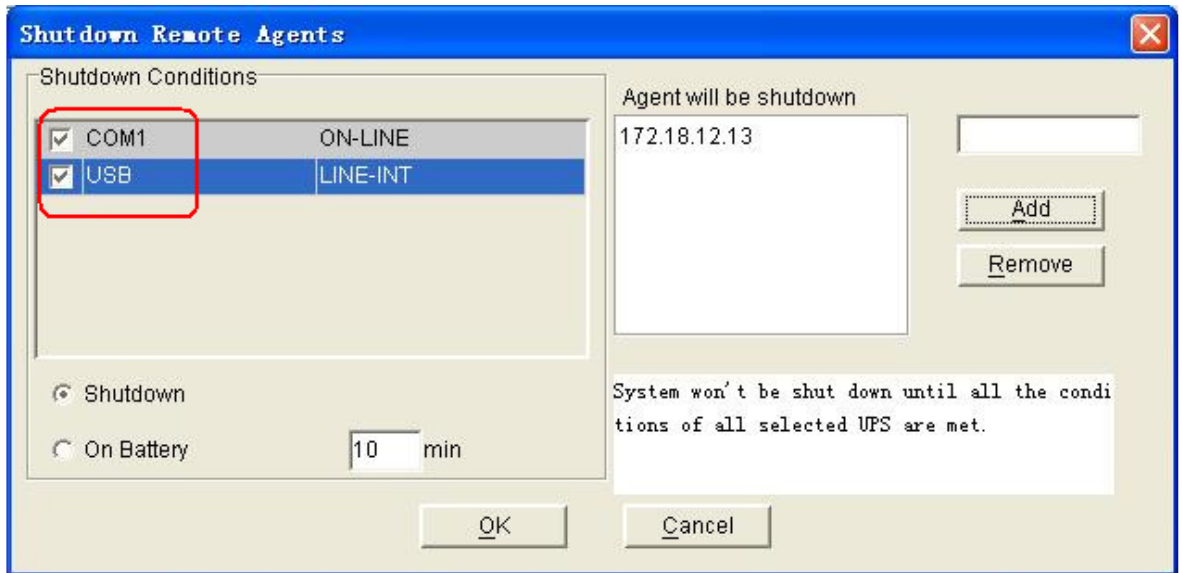

Diagram 4-18-4

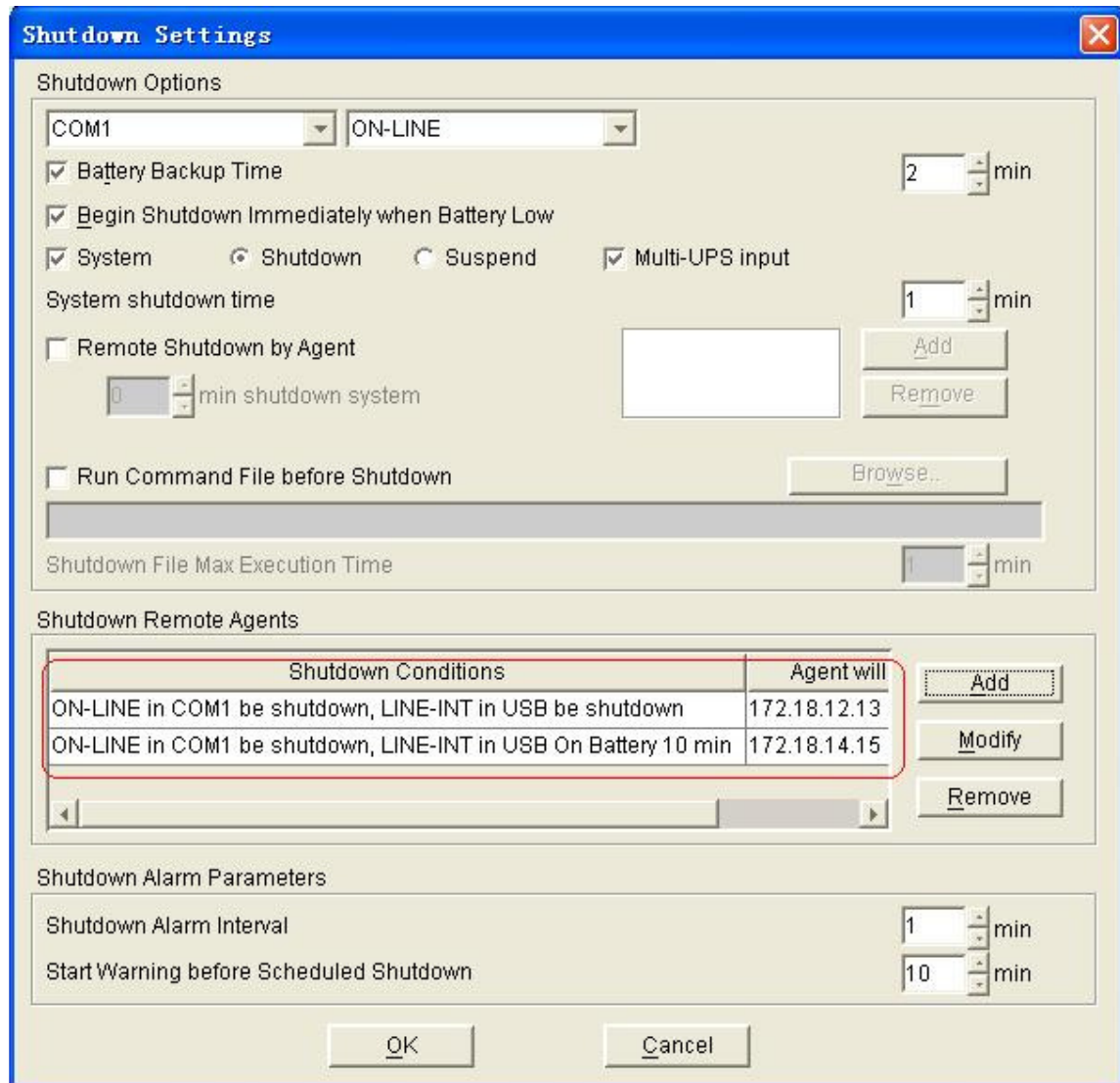

Diagram 4-18-5

Appendix A—Glossary Explanation

Agent—Agent is a background application of the Windows/Unix/Linux operating system.

UPS Battery Low—When Utility Power fails and battery supplies power, if the battery voltage is lower than a certain value (refer to UPS Specification), UPS will send a warning tone at intervals of 1 second for battery low.

UPS battery backup time exhausted—Indicates when UPS AC fails, battery supply time has exceeded the “battery backup time” which has been set (“Battery backup time” can be set in the “Shutdown parameter” dialog of Winpower).

UPS output overload—UPS load is more than 110% Rated load.

Load too high—UPS load is more than 100%~110% rated load.

Supply power in Bypass mode—For the reason of UPS not on or the hardware fault, the input will not go through the inverter of UPS, but output directly. At this moment, if AC fails, UPS will not startup backup battery to supply, so the output will also out of electricity.

UPS self test—After UPS' supply mode is switched from utility power mode to battery mode and work on for a period of time, return to utility power mode again. The purpose of self test: First is to check if it can supply normally in battery mode; second is to make the battery discharge termly (as every month), that is helpful for the battery maintenance and can prolong the battery's service life.

Self test failure—Indicates that the battery can't supply power normally in battery mode via self test .

Battery Backup Time—Indicate the time that battery supplies power when utility power fails. After this time is used up, the Agent begins to shutdown the opened application.

Shutdown File Max Execution Time—The max time which the shutdown file execute.

System Shutdown Need Time—The time for system shutdown, is also the time from system begin shutdown to turn off UPS outlet.

Remote Shutdown by Agent—Local Agent will shutdown in shutdown delay time after the specified Agent Shutdown.

Start Warning before Scheduled Shutdown—If user has set time shutdown, Winpower will begin warning at this time earlier than shutdown.

Shutdown Alarm Interval—Indicate after the shutdown warning begins (include time shutdown warning and AC fail shutdown warning), interval of each warning.

Appendix B---Winpower Event Table

Serial Number	Event Description	Type of Message	Remarks
1	UPS Battery Low	Serious	Can be set as no shutdown system through "Shutdown parameter"
2	UPS Battery Time Exhaust	Serious	Can set battery backup time through "Shutdown parameter"
3	UPS Fail	Serious	
4	UPS Output Overload	Serious	Output load is more than 110%
6	Communication Lost	Warning	The connection of communication cable is not good, or communication port fault.
7	AC Fail	Warning	
8	On Bypass	Warning	UPS will be switched to bypass mode for the reason of overload, hardware fault and so on. Online UPS is also in bypass mode when it is off, at this time UPS has no protection function.
9	Bypass without output		
10	Self-test Fail	Warning	
11	Phase sequence incorrect in Bypass	Warning	Three-phase UPS support
12	Battery switch not engaged	Warning	Three-phase UPS support
13	Load unbalance	Warning	Three-phase UPS support
14	Load too high	Warning	
15	Internal warning	Warning	Three-phase UPS support
16	Maintain cover is open	Warning	
17	AC Restore	Information	.
18	Communication Create	Information	.
19	Agent Start	Information	.
20	Agent Stop	Information	.
21	System be shutdown	Information	.
22	System be Shutdown by Other Agent	Information	Set the Agent need to be in response to through "Shutdown parameter".
23	Special date Close UPS	Information	.
24	Weekly Close UPS	Information	.
25	Self-test Start	Information	Self-test begins immediately.
26	Self-test cancel	Information	.
27	Self-test End	Information	.

28	Special date Self-test Start	Information	.
29	Special date Self-test Cancel	Information	.
30	Special date Self-test End	Information	.
31	Monthly Self-test Start	Information	.
32	Monthly Self-test Cancel	Information	.
33	Monthly Self-test End	Information	.

Frequently Asked Questions

Question:

UPS can not communication with Winpower under Debian Etch Stable Core 2.6 18-5-486

Method to fix it:

Here are the procedures to solve this question:

1. Login in Debian as root, the permission of general user is limited to install winpower. Debian refuse to login as root, some special settings is needed.

Remark

- a. In the login interface, there are three icons: "Language", "Session" and "Action", choose "Action"
 - b. Choose the last icon of "configure the login manager" in the dialog pop-up
 - c. Choose the icon of "security" in the dialog pop-up
 - d. Choose "allow local system administrator login"
2. Input the user name of root and the password, and then install the winpower manually.
Use the command `./agent start` to start Winpower service, and then use the command of `./monitor` to start the monitor interface
 3. Copy the document of s99UPS from Linux (attached CD) to `/etc/rcS.d`,
The file s99UPS is used to start Winpower service automatically.
When the computer reboots, Winpower service will be started automatically. Just need to start the monitor interface by the command `./monitor`

Remark:

- a. If the third step is executed, no matter what the user login in as root or a general user, the communication with UPS will be successful.
- b. If the third step have not been executed, you should login as root, and use the command `./agent start` to start Winpower service. If login in as a general user, the communication with UPS will be failed

Question:

UPS can't communication with Winpower under RedHat Core 2.6 9

Method to fix it:

Add the word of "none /proc/bus/usb usbdevfs defaults 0 0" to the document `/etc/fstab`
Winpower can find the UPS when choose the icon of "auto search".

Question:

Mac 10.5 OS with the terminal interface opened can't be shut down normally by winpower. The information is shown as the following figure.

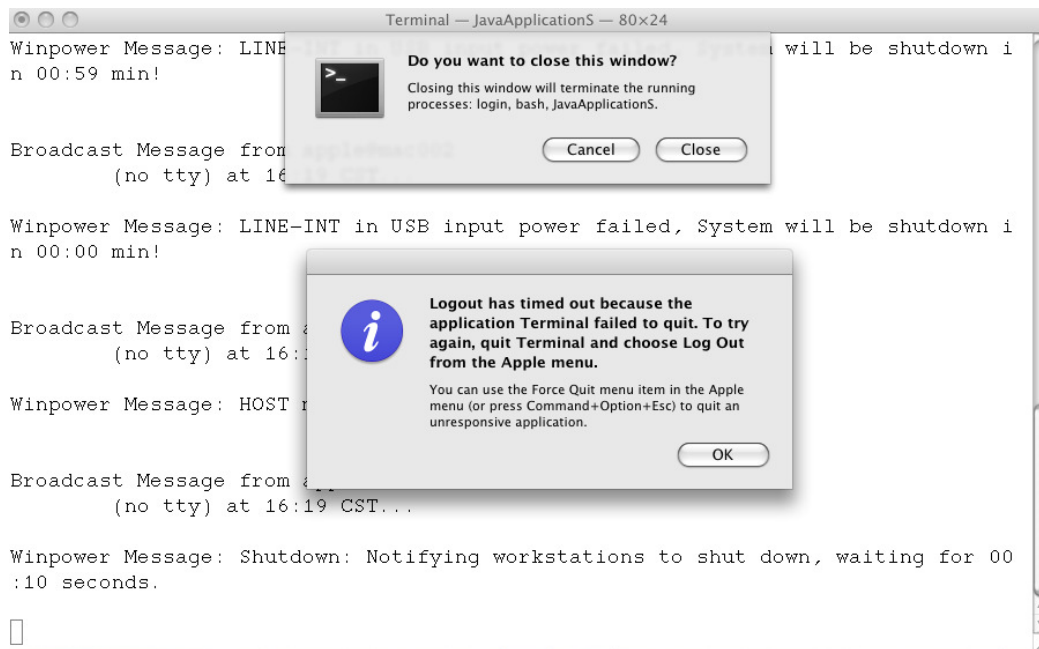

Method to fix it:

Change the setting of the terminal as the following steps:

1. Open the terminal interface
2. Click "Terminal" shown on the left corner of Mac 10.5 OS, and select "Preferences...", There will be a dialog shown as below. Please select "Never" of "Prompt before closing" in the "Shell" interface.

