

USER MANUAL

DSL-2640B

VERSION 1.0



Table of Contents

PRODUCT OVERVIEW	3	INBOUND IP FILTER	46
PACKAGE CONTENTS	3	DNS SETUP	47
SYSTEM REQUIREMENTS	3	FIREWALL & DMZ.....	49
INTRODUCTION	4	ADVANCED ADSL.....	52
FEATURES	5	ADVANCED WIRELESS	53
HARDWARE OVERVIEW	6	ADVANCED LAN	54
CONNECTIONS.....	6	SNMP SETUP	54
LEDs.....	7	TR-069	54
INSTALLATION.....	8	REMOTE MANAGEMENT	54
BEFORE YOU BEGIN	8	MAINTENANCE	64
INSTALLATION NOTES.....	9	PASSWORD	64
INFORMATION YOU WILL NEED FROM YOUR ADSL SERVICE PROVIDER	11	SAVE/RESTORE SETTINGS.....	65
INFORMATION YOU WILL NEED ABOUT DSL-2640B	13	FIRMWARE UPDATE.....	66
WIRELESS INSTALLATION CONSIDERATIONS	15	DIAGNOSTICS	67
DEVICE INSTALLATION	16	SYSTEM LOG	68
POWER ON ROUTER.....	16	STATUS	70
NETWORK CONNECTIONS	17	DEVICE INFO	70
CONFIGURATION.....	19	CONNECTED CLIENTS.....	72
WEB-BASED CONFIGURATION UTILITY	19	STATISTICS	73
SETUP	20	ROUTING INFO.....	75
WIZARD	20	TROUBLESHOOTING	75
ADSL SETUP.....	25	WIRELESS BASICS	78
WIRELESS	27	NETWORKING BASICS	81
LAN SETUP.....	32	CHECK YOUR IP ADDRESS.....	81
TIME	34	STATICALLY ASSIGN AN IP ADDRESS.....	82
PARENTAL CONTROL	35	TECHNICAL SPECIFICATIONS	83
LOGOUT	36	CONTACTING TECHNICAL SUPPORT	84
ADVANCED	37		
PORT FORWARDING	37		
APPLICATION RULES	39		
QoS SETUP.....	41		
OUTBOUND IP FILTER	45		

Package Contents

- DSL-2640B Wireless ADSL Router
- 1 Detachable Antenna
- Power Adapter
- CD-ROM with Installation Wizard, User Manual, and Special Offers
- One twisted-pair telephone cable used for ADSL connection
- One straight-through Ethernet cable
- One Quick Installation Guide

Note: Using a power supply with a different voltage rating than the one included with the DSL-2640B will cause damage and void the warranty for this product.



System Requirements

- ADSL Internet service
- Computer with:
 - 200MHz Processor
 - 64MB Memory
 - CD-ROM Drive
 - Ethernet Adapter with TCP/IP Protocol Installed
 - Windows XP/2000/98 SE/ME
 - Internet Explorer v6 or later, FireFox v1.5
- D-Link Click'n Connect Utility
 - Computer with Windows 2000/XP

Introduction

HIGH-SPEED ADSL2/2+ INTERNET CONNECTION

Latest ADSL2/2+ standards provide Internet transmission of up to 24Mbps downstream, 1Mbps upstream.

HIGH-PERFORMANCE WIRELESS

Embedded latest 802.11 technology for high-speed wireless connection, complete compatibility with 802.11b wireless devices

TOTAL SECURITY & QoS

Firewall protection from Internet attacks, user access control, WPA/WPA2 wireless security and priority queues for smooth VoIP traffic/streaming multimedia

ULTIMATE INTERNET CONNECTION

The DSL-2640B ADSL2+ router is a versatile, high-performance remote router for home and the small office. With integrated ADSL2/2+ supporting up to 24Mbps download speed, firewall protection, Quality of Service (QoS), 802.11g wireless LAN and 4 Ethernet switch ports, this router provides all the functions that a home or small office needs to establish a secure and high-speed remote link to the outside world.

FIREWALL PROTECTION & QoS

Security features prevents unauthorized access to the home and office network, be it from the wireless devices or from the Internet. The router provides firewall security using Stateful Packet Inspection (SPI) and hacker attack logging for Denial of Service (DoS) attack protection. SPI inspects the contents of all incoming packet headers before deciding what packets are allowed to pass through. Router access control is provided with packet filtering based on port and source/destination MAC/IP addresses. For Quality of Service (QoS), the router supports multiple priority queues to enable a group of home or office users to experience the benefit of smooth network connection of inbound and outbound data without concern of traffic congestion. This QoS support allows users to enjoy high ADSL transmission for applications such as VoIP and streaming multimedia over the Internet.

*Maximum wireless signal rate derived from IEEE standard 802.11g. Actual data throughput will vary. Network conditions and environmental factors, including volume of network traffic, building materials and construction, and network overhead, lower actual data throughput rate. Environmental factors will adversely affect wireless signal range.

Features

- **Faster Wireless Networking** - The DSL-2640B provides up to 270Mbps* wireless connection with other 802.11g wireless clients. This capability allows users to participate in real-time activities online, such as video streaming, online gaming, and real-time audio.
- **Compatible with 802.11b Devices** - The DSL-2640B is still fully compatible with the IEEE 802.11b and g standards, so it can connect with existing 802.11b and g PCI, USB and Cardbus adapters.
- **DHCP Support** - Dynamic Host Configuration Protocol automatically and dynamically assigns all LAN IP settings to each host on your network. This eliminates the need to reconfigure every host whenever changes in network topology occur.
- **Network Address Translation (NAT)** - For small office environments, the DSL-2640B allows multiple users on the LAN to access the Internet concurrently through a single Internet account. This provides Internet access to everyone in the office for the price of a single user. NAT improves network security in effect by hiding the private network behind one global and visible IP address. NAT address mapping can also be used to link two IP domains via a LAN-to-LAN connection.
- **High Performance** - Very high rates of data transfer are possible with the Router. Up to 24Mbps downstream bit rate using the G.dmt standard. (For ADSL2+)
- **Easy Installation** - The DSL-2640B uses a web-based graphical user interface program for convenient management access and easy set up. Any common web browser software can be used to manage the Router.

*Maximum wireless signal rate derived from IEEE standard 802.11g. Actual data throughput will vary. Network conditions and environmental factors, including volume of network traffic, building materials and construction, and network overhead, lower actual data throughput rate. Environmental factors will adversely affect wireless signal range.

Hardware Overview

Connections

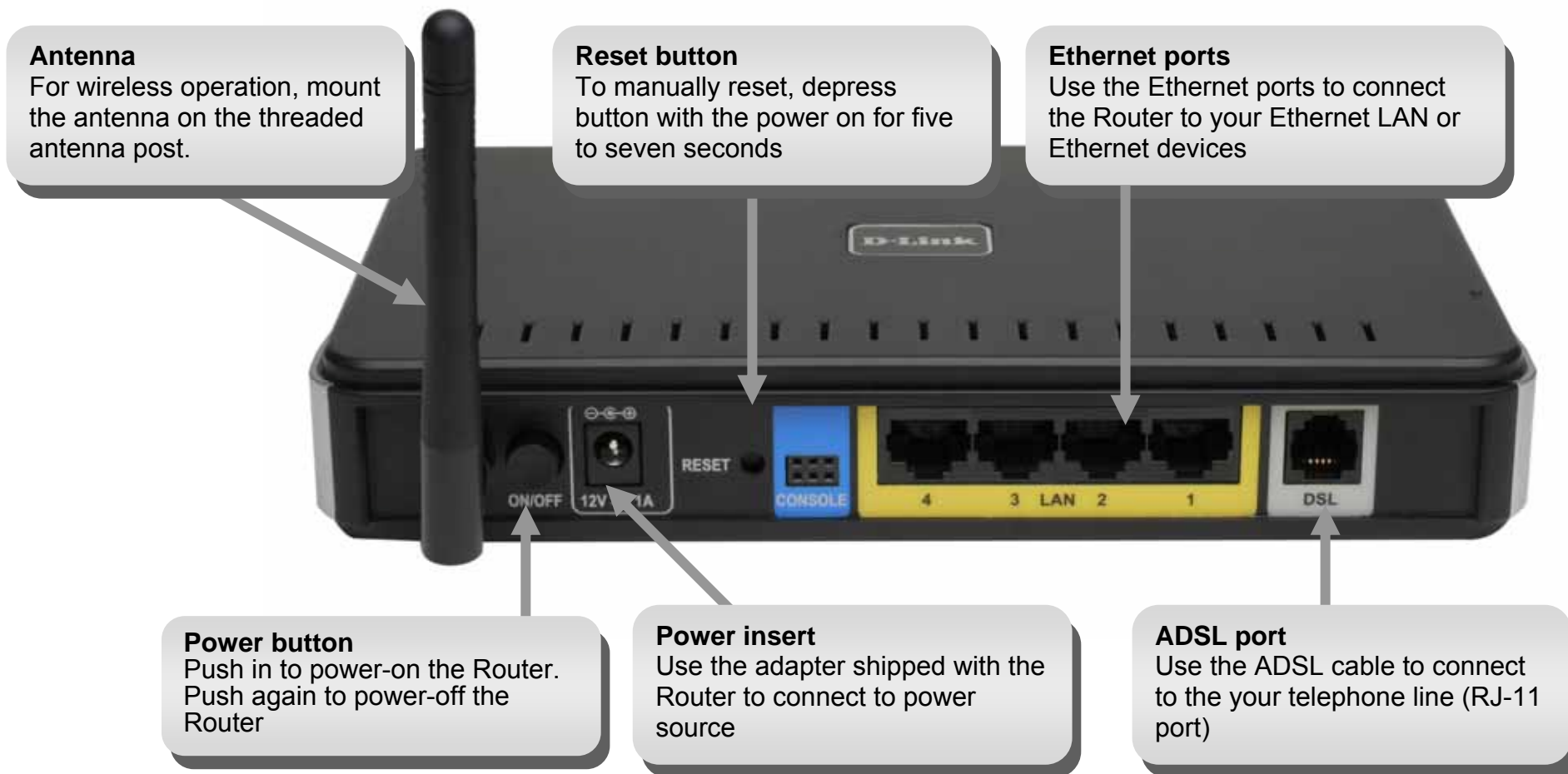

Hardware Overview

LEDs

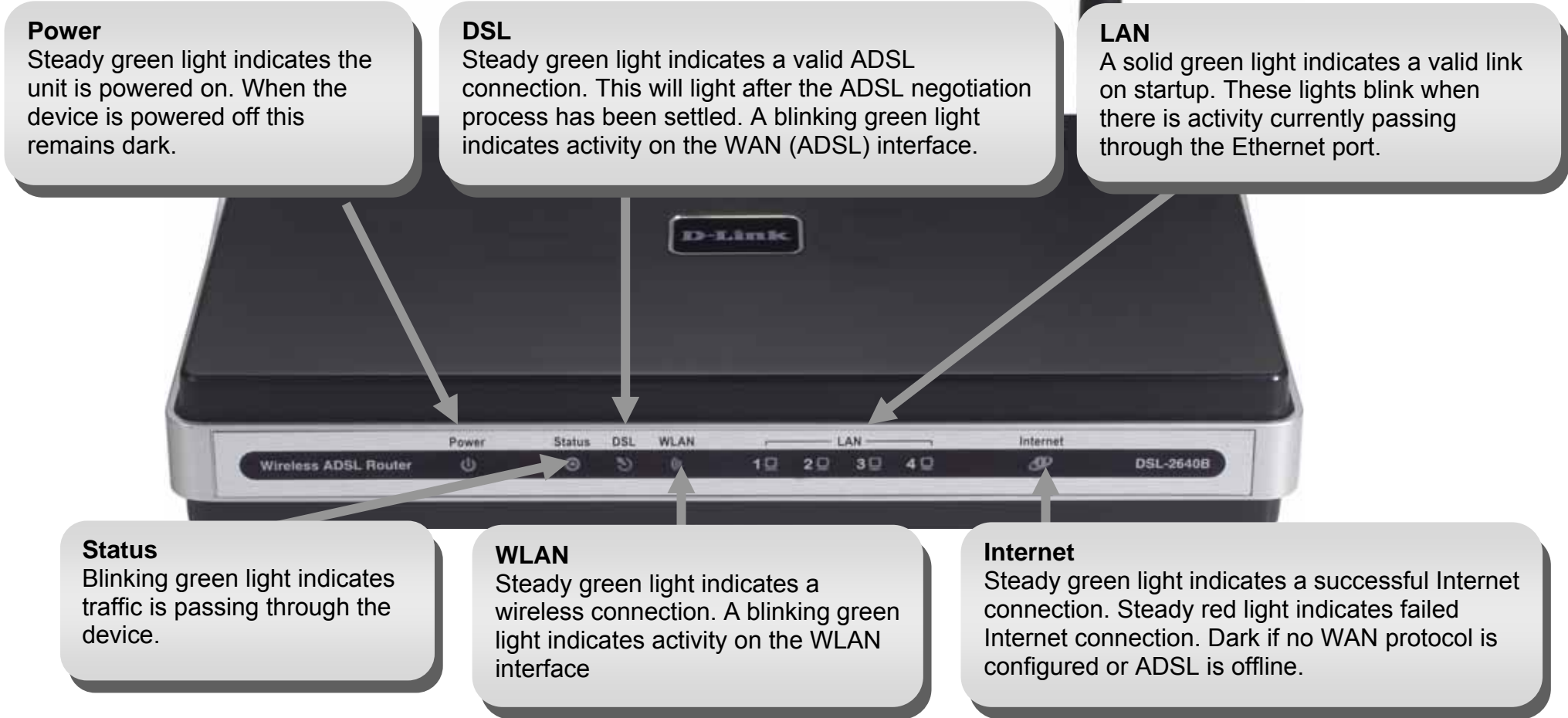

Installation

This section will walk you through the installation process. Placement of the router is very important. Do not place the router in an enclosed area such as a closet, cabinet, or in the attic or garage.

Before you Begin

Please read and make sure you understand all the prerequisites for proper installation of your new Router. Have all the necessary information and equipment on hand before beginning the installation.

Installation Notes

In order to establish a connection to the Internet it will be necessary to provide information to the Router that will be stored in its memory. For some users, only their account information (Username and Password) is required. For others, various parameters that control and define the Internet connection will be required. You can print out the two pages below and use the tables to list this information. This way you have a hard copy of all the information needed to setup the Router. If it is necessary to reconfigure the device, all the necessary information can be easily accessed. Be sure to keep this information safe and private.

Low Pass Filters

Since ADSL and telephone services share the same copper wiring to carry their respective signals, a filtering mechanism may be necessary to avoid mutual interference. A low pass filter device can be installed for each telephone that shares the line with the ADSL line. These filters are easy to install passive devices that connect to the ADSL device and/or telephone using standard telephone cable. Ask your service provider for more information about the use of low pass filters with your installation.

Operating Systems

The DSL-2640B uses an HTML-based web interface for setup and management. The web configuration manager may be accessed using any operating system capable of running web browser software, including Windows 98 SE, Windows ME, Windows 2000, and Windows XP.

Web Browser

Any common web browser can be used to configure the Router using the web configuration management software. The program is designed to work best with more recently released browsers such as Opera, Microsoft Internet Explorer® version 6.0, Netscape Navigator® version 6.2.3, or later versions. The web browser must have JavaScript enabled. JavaScript is enabled by default on many browsers. Make sure JavaScript has not been disabled by other software (such as virus protection or web user security packages) that may be running on your computer.

Ethernet Port (NIC Adapter)

Any computer that uses the Router must be able to connect to it through the Ethernet port on the Router. This connection is an Ethernet connection and therefore requires that your computer be equipped with an Ethernet port as well. Most notebook computers are now sold with an Ethernet port already installed. Likewise, most fully assembled desktop computers come with an Ethernet NIC adapter as standard equipment. If your computer does not have an Ethernet port, you must install an Ethernet NIC adapter before you can use the Router. If you must install an adapter, follow the installation instructions that come with the Ethernet NIC adapter.

802.11 Wireless LAN Configuration

All the 802.11 wireless LAN settings may be configured on a single page using the web-based manager. For basic wireless communication you need to decide what channel to use and what SSID to assign. These two settings must be the same for any wireless workstations or other wireless access point that communicate with the DSL-2640B through the wireless interface.

Security for wireless communication can be accomplished in a number of ways. The DSL-2640B supports WPA (Wi-Fi Protected Access), WPA2, and mixed WPA/WPA2. Wireless access can also be controlled by selecting MAC addresses that are allowed to associate with the device. Please read the section on Wireless Configuration.

Information you will need from your ADSL service provider

Username

This is the Username used to log on to your ADSL service provider's network. It is commonly in the form `user@isp.co.uk`. Your ADSL service provider uses this to identify your account.

Password

This is the Password used, in conjunction with the Username above, to log on to your ADSL service provider's network. This is used to verify the identity of your account.

WAN Setting / Connection Type

These settings describe the method your ADSL service provider uses to transport data between the Internet and your computer. Most users will use the default settings. You may need to specify one of the following WAN Setting and Connection Type configurations (Connection Type settings listed in parenthesis):

- PPPoE/PPoA (PPPoE LLC, PPoA LLC or PPoA VC-Mux)
- IPoA/MER (Static IP Address) (Bridged IP LLC, 1483 Bridged IP VC Mux, 1483 Routed IP LLC, 1483 Routed IP VC-Mux or IPoA)
- MER (Dynamic IP Address) (1483 Bridged IP LLC or 1483 Bridged IP VC-Mux)

Modulation Type

ADSL uses various standardized modulation techniques to transmit data over the allotted signal frequencies. Some users may need to change the type of modulation used for their service. The default DSL modulation (ADSL2+ Multi-Mode) used for the Router automatically detects all types of ADSL, ADSL2, and ADSL2+ modulation. However, if you are instructed to specify the modulation type used for the Router, you may choose among the numerous options available on the Modulation Type drop-down menu on the ADSL Configuration window (Advanced > ADSL)

VPI

Most users will not be required to change this setting. The Virtual Path Identifier (VPI) is used in conjunction with the Virtual Channel Identifier (VCI) to identify the data path between your ADSL service provider's network and your computer. If you are setting up the Router for multiple virtual connections, you will need to configure the VPI and VCI as instructed by your ADSL service provider for the additional connections. This setting can be changed in the WAN Settings window of the web management interface.

VCI

Most users will not be required to change this setting. The Virtual Channel Identifier (VCI) used in conjunction with the VPI to identify the data path between your ADSL service provider's network and your computer. If you are setting up the Router for multiple virtual connections, you will need to configure the VPI and VCI as instructed by your ADSL service provider for the additional connections. This setting can be changed in the WAN Settings window of the web management interface.

Information you will need about DSL-2640B

Username

This is the Username needed access the Router's management interface. When you attempt to connect to the device through a web browser you will be prompted to enter this Username. The default Username for the Router is "admin." The user cannot change this.

Password

This is the Password you will be prompted to enter when you access the Router's management interface. The default Password is "admin." The user may change this.

LAN IP addresses for the DSL-2640B

This is the IP address you will enter into the Address field of your web browser to access the Router's configuration graphical user interface (GUI) using a web browser. The default IP address is 192.168.1.1. This may be changed to suit any IP address scheme the user desires. This address will be the base IP address used for DHCP service on the LAN when DHCP is enabled.

LAN Subnet Mask for the DSL-2640B

This is the subnet mask used by the DSL-2640B, and will be used throughout your LAN. The default subnet mask is 255.255.255.0. This can be changed later.

Information you will need about your LAN or computer:

Ethernet NIC

If your computer has an Ethernet NIC, you can connect the DSL-2640B to this Ethernet port using an Ethernet cable. You can also use the Ethernet ports on the DSL-2640B to connect to other computer or Ethernet devices.

DHCP Client status

Your DSL-2640B ADSL Router is configured, by default, to be a DHCP server. This means that it can assign an IP address, subnet mask, and a default gateway address to computers on your LAN. The default range of IP addresses the DSL-2640B will assign are from 192.168.1.2 to 192.168.1.254. Your computer (or computers) needs to be configured to obtain an IP address automatically (that is, they need to be configured as DHCP clients.)

It is recommended that you collect and record this information here, or in some other secure place, in case you have to re-configure your ADSL connection in the future.

Once you have the above information, you are ready to setup and configure your DSL-2640B Wireless ADSL Router.

Wireless Installation Considerations

DSL-2640B lets you access your network using a wireless connection from virtually anywhere within the operating range of your wireless network. Keep in mind, however, that the number, thickness and location of walls, ceilings, or other objects that the wireless signals must pass through, may limit the range. Typical ranges vary depending on the types of materials and background RF (radio frequency) noise in your home or business. The key to maximizing wireless range is to follow these basic guidelines:

1. Keep the number of walls and ceilings between the D-Link router and other network devices to a minimum - each wall or ceiling can reduce your adapter's range from 3-90 feet (1-30 meters.) Position your devices so that the number of walls or ceilings is minimized.
2. Be aware of the direct line between network devices. A wall that is 1.5 feet thick (.5 meters), at a 45-degree angle appears to be almost 3 feet (1 meter) thick. At a 2-degree angle it looks over 42 feet (14 meters) thick! Position devices so that the signal will travel straight through a wall or ceiling (instead of at an angle) for better reception.
3. Building Materials make a difference. A solid metal door or aluminum studs may have a negative effect on range. Try to position access points, wireless routers, and computers so that the signal passes through drywall or open doorways. Materials and objects such as glass, steel, metal, walls with insulation, water (fish tanks), mirrors, file cabinets, brick, and concrete will degrade your wireless signal.
4. Keep your product away (at least 3-6 feet or 1-2 meters) from electrical devices or appliances that generate RF noise.
5. If you are using 2.4GHz cordless phones or X-10 (wireless products such as ceiling fans, lights, and home security systems), your wireless connection may degrade dramatically or drop completely. Make sure your 2.4GHz phone base is as far away from your wireless devices as possible. The base transmits a signal even if the phone is not in use.

Device Installation

The DSL-2640B Wireless ADSL Router maintains three separate interfaces, an Ethernet LAN, a wireless LAN and an ADSL Internet (WAN) connection. Carefully consider the Router's location suitable for connectivity for your Ethernet and wireless devices. You must have a functioning broadband connection in order to use the Router's WAN function.

Place the Router in a location where it can be connected to the various devices as well as to a power source. The Router should not be located where it will be exposed to moisture, direct sunlight or excessive heat. Make sure the cables and power cord are placed safely out of the way so they do not create a tripping hazard. As with any electrical appliance, observe common sense safety procedures.

The Router can be placed on a shelf, desktop, or other stable platform. If possible, you should be able to see the LED indicators on the front if you need to view them for troubleshooting.

Power on Router

The Router must be used with the power adapter included with the device.

1. Insert the AC Power Adapter cord into the power receptacle located on the rear panel of the Router and plug the adapter into a suitable nearby power source.
2. Push down the Power button, and you should see the Power LED indicator light up and remain lit.
3. If the Ethernet port is connected to a working device, check the Ethernet Link/Act LED indicators to make sure the connection is valid. The Router will attempt to establish the ADSL connection, if the ADSL line is connected and the Router is properly configured this should light up after several seconds. If this is the first time installing the device, some settings may need to be changed before the Router can establish a connection.

Factory Reset Button

The Router may be reset to the original factory default settings by using a ballpoint or paperclip to gently push down the reset button in the following sequence:

1. Press and hold the reset button while the device is powered off.
2. Turn on the power.
3. Wait for 5~7 seconds and then release the reset button.

Remember that this will wipe out any settings stored in flash memory including user account information and LAN IP settings. The device settings will be restored to the factory default IP address **192.168.1.1** and the subnet mask is **255.255.255.0**, the default management Username is “admin” and the default Password is “admin.”

Network Connections

Connect ADSL Line

Use the ADSL cable included with the Router to connect it to a telephone wall socket or receptacle. Plug one end of the cable into the ADSL port (RJ-11 receptacle) on the rear panel of the Router and insert the other end into the RJ-11 wall socket. If you are using a low pass filter device, follow the instructions included with the device or given to you by your service provider. The ADSL connection represents the WAN interface, the connection to the Internet. It is the physical link to the service provider’s network backbone and ultimately to the Internet.

Connect Router to Ethernet

The Router may be connected to a single computer or Ethernet device through the 10BASE-TX Ethernet port on the rear panel. Any connection to an Ethernet concentrating device such as a switch or hub must operate at a speed of 10/100 Mbps only. When connecting the Router to any Ethernet device that is capable of operating at speeds higher than 10Mbps, be sure that the device has auto-negotiation (NWay) enabled for the connecting port. Use standard twisted-pair cable with RJ-45 connectors. The RJ-45 port on the Router is a crossed port (MDI-X). Follow standard Ethernet guidelines when deciding what type of cable to use to make this connection. When connecting the Router directly to a PC or server use a normal straight-through cable. You should use a crossed cable when connecting the Router to a normal (MDI-X) port on a switch or hub. Use a normal straight-through cable when connecting it to an uplink (MDI-II) port on a hub or switch. The rules governing Ethernet cable lengths apply to the LAN to Router connection. Be sure that the cable connecting the LAN to the Router does not exceed 100 meters.

Section 2 - Installation

Hub or Switch to Router Connection

Connect the Router to an uplink port (MDI-II) on an Ethernet hub or switch with a straight-through cable as shown in this diagram. If you wish to reserve the uplink port on the switch or hub for another device, connect to any on the other MDI-X ports (1x, 2x, etc.) with a crossed cable.

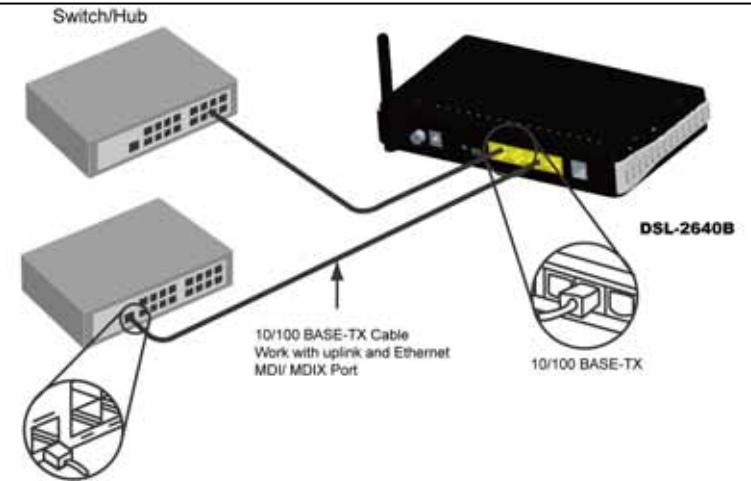

Computer to Router Connection

You can connect the Router directly to a 10/100BASE-TX Ethernet adapter card (NIC) installed on a PC using the Ethernet cable provided as shown in this diagram.

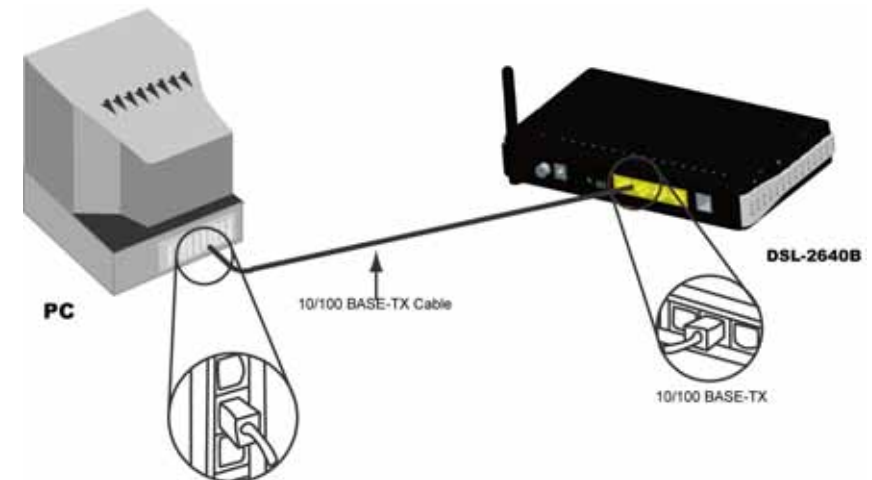

Configuration

This section will show you how to configure your new D-Link wireless router using the web-based configuration utility.

Web-based Configuration Utility

Connect to the Router

To configure the WAN connection used by the Router it is first necessary to communicate with the Router through its management interface, which is HTML-based and can be accessed using a web browser. The easiest way to make sure your computer has the correct IP settings is to configure it to use the DHCP server in the Router. The next section describes how to change the IP configuration for a computer running a Windows operating system to be a DHCP client.

To access the configuration utility, open a web-browser such as Internet Explorer and enter the IP address of the router (192.168.1.1).

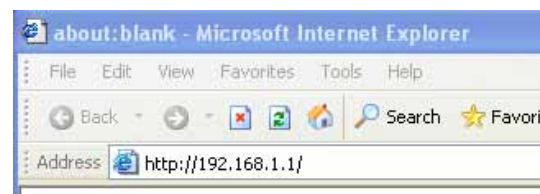

Type "admin" for the User Name and "admin" in the Password field. If you get a **Page Cannot be Displayed** error, please refer to the **Troubleshooting** section for assistance.

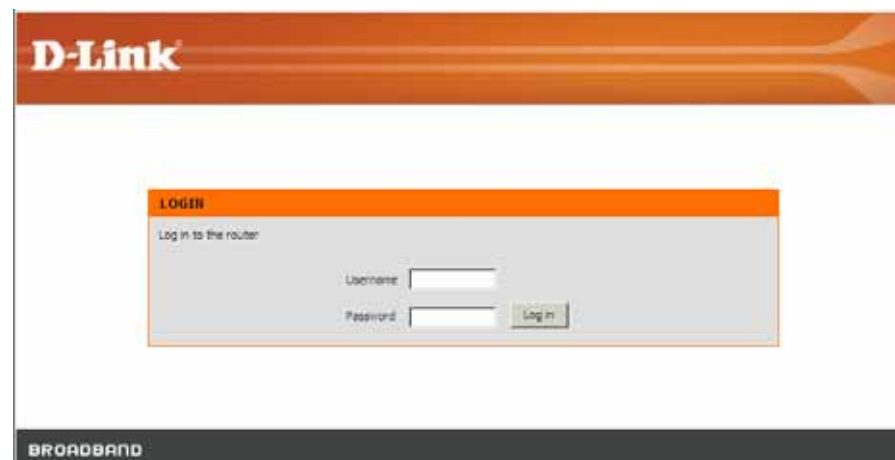

SETUP

This chapter is concerned with using your computer to configure the WAN connection. The following chapter describes the various windows used to configure and monitor the Router including how to change IP settings and DHCP server setup.

WIZARD

ADSL SETUP

Click on the **Setup Wizard** button to launch the **Setup Wizard**.

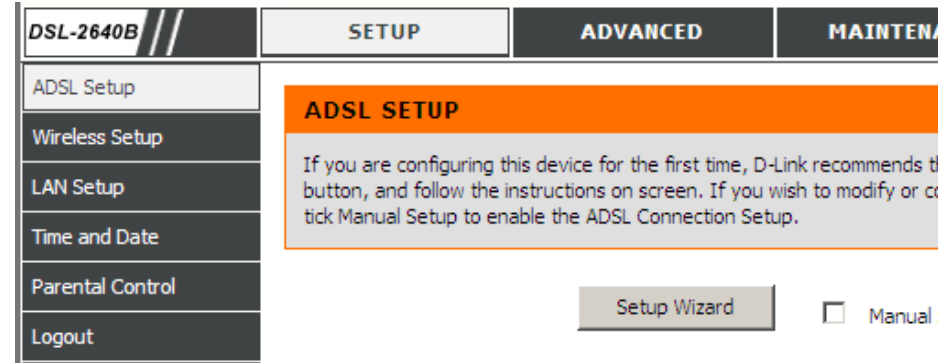

WELCOME TO D-LINK SETUP WIZARD

There are three steps to configuring your router. Click on the **Next** to continue.



STEP 1: CHANGE YOUR DSL-2640B PASSWORD

The default password is "admin", in order to secure your network, please modify the password. Note: Confirm Password must be same as "New Password". Of course, you can click on the **Skip** to ignore the step.

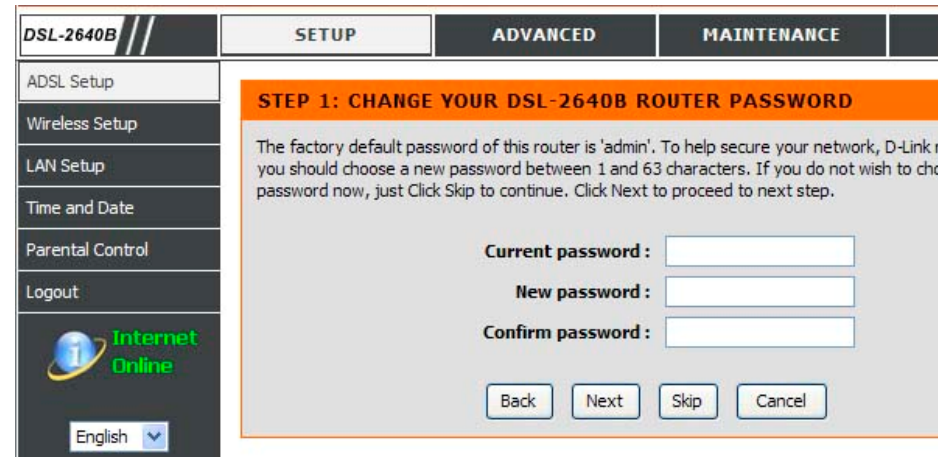

STEP 2: SELECT INTERNET CONNECTION TYPE

Please select your **Country** and **ISP**, the VPI and VCI information Will display Automatically. Of course, you can modify the information.

If, you can not find the country and ISP in the list below; you can select "Others".

Click on the **Next** button to go to the next **Setup Wizard** window.

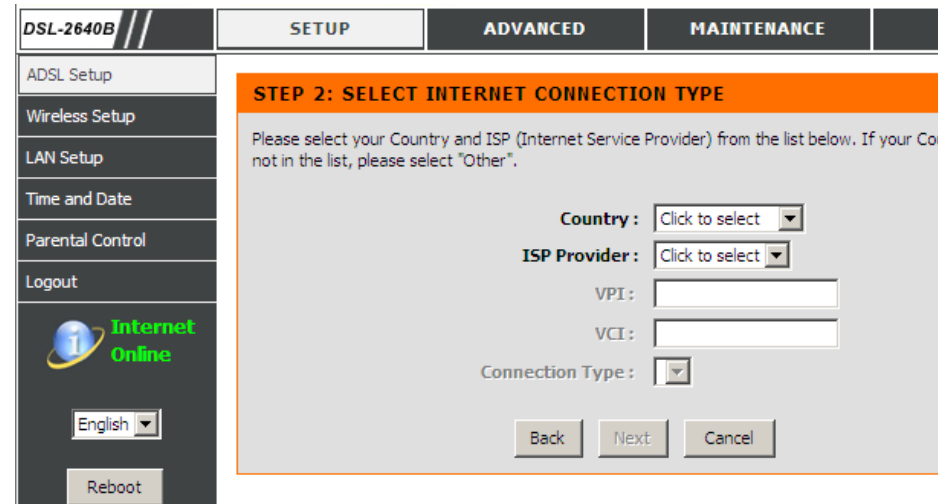

Section 4 - Troubleshooting

STEP 2: SELECT INTERNET CONNECTION TYPE

Select the appropriate Internet connection type based on the information provided to you by your ISP.

Click on the **Next** button to go to the next **Setup Wizard** window.

DSL-2640B // SETUP ADVANCED MAINTENANCE STATUS

ADSL Setup
Wireless Setup
LAN Setup
Time and Date
Parental Control
Logout
Internet Online
English
Reboot

STEP 2: SELECT INTERNET CONNECTION TYPE

Select the appropriate Internet connection type based on the information as provided by your ISP. Click Next to continue.

PPPoE/PPPoA Choose this option if your ISP uses PPPoE/PPPoA. (For most DSL users)

Dynamic IP Address Choose this option if your ISP uses Dynamic IP Address over DSL.

Static IP Address Choose this option if your ISP uses Static IP assignments.

Bridging Choose this option if your ISP uses Bridging.

Back Next Cancel

Using the Setup Wizard - For PPPoE/PPPoA connection

Type in the **Username** and **Password** (and PPPoE Service Name, if required by your ISP).

The **Auto PVC Scan** feature will not work in all cases so please enter the VPI/VCI numbers if provided by the ISP.

Select the **Connection Type** that your ISP has informed you to use.

Click on the **Next** button to go to the next **Setup Wizard** window.

DSL-2640B // SETUP ADVANCED MAINTENANCE STATUS

ADSL Setup
Wireless Setup
LAN Setup
Time and Date
Parental Control
Logout
Internet Online
English
Reboot

STEP 2: SELECT INTERNET CONNECTION TYPE

You have selected PPPoE/PPPoA Internet connection. Please enter the appropriate information below as provided by your ISP.

Please enter the information exactly as shown taking note of upper and lower cases. The Auto PVC Scan feature will not work in all cases so please enter the VPI/VCI numbers if provided by the ISP.

Click Next to continue.

Username :

Password :

Auto PVC Scan :

VPI :

VCI :

Connection Type :

Back Next Cancel

Section 4 - Troubleshooting

Using the Setup Wizard - For Dynamic IP Address connection

Please enter the appropriate information below as provided by your ISP. The **Auto PVC Scan** feature will not work in all cases so please enter the **VPI/VCI** numbers if provided by the ISP.

Click on the **Next button** to go to the next **Setup Wizard** window.

The screenshot shows the 'STEP 2: SELECT INTERNET CONNECTION TYPE' window. The left sidebar contains navigation options: ADSL Setup (selected), Wireless Setup, LAN Setup, Time and Date, Parental Control, and Logout. Below these is an 'Internet Online' status indicator, a language dropdown set to 'English', and a 'Reboot' button. The main content area has an orange header and contains the following text: 'You have selected Dynamic IP Internet connection. Please enter the appropriate information below as provided by your ISP.' and 'The Auto PVC Scan feature will not work in all cases so please enter the VPI/VCI numbers if provided by the ISP. Some ISPs require that you clone your PC MAC address to the DSL router, simply Click on the button provided.' Below this is a 'Click Next to continue.' instruction. The form fields are: 'Auto PVC Scan' (checkbox, unchecked), 'VPI' (text box with '1'), 'VCI' (text box with '32'), 'Connection Type' (dropdown menu with '1483 Bridged IP LLC' selected), and 'Cloned MAC Address' (text box with '00:00:00:00:00'). A 'Copy Your PC's MAC Address' button is located below the Cloned MAC Address field. At the bottom are 'Back', 'Next', and 'Cancel' buttons.

Using the Setup Wizard - For Static IP Address connection

Please enter the appropriate information below as provided by your ISP. The **Auto PVC Scan** feature will not work in all cases so please enter the **VPI/VCI** numbers if provided by the ISP.

Please input the correct **IP address**, **Subnet Mask**, **Default Gateway** and **DNS information**. Note: Should you select to leave default Gateway and DNS information blank, they should be automatically generated.

Click on the **Next button** to go to the next **Setup Wizard** window.

The screenshot shows the 'STEP 2: SELECT INTERNET CONNECTION TYPE' window for a static IP connection. The left sidebar is identical to the previous screenshot. The main content area has an orange header and contains the following text: 'You have selected Static IP Internet connection. Please enter the appropriate information below as provided by your ISP. The Auto PVC Scan feature will not work in all cases so please enter the VPI/VCI numbers if provided by the ISP. Click Next to continue.' Below this is a 'Click Next to continue.' instruction. The form fields are: 'Auto PVC Scan' (checkbox, unchecked), 'VPI' (text box with '0'), 'VCI' (text box with '38'), 'IP Address' (text box with '0.0.0.0'), 'Subnet Mask' (text box with '0.0.0.0'), 'Connection Type' (dropdown menu with '1483 Bridged IP LLC' selected), 'Default Gateway' (text box with '135.154.13.254'), 'Primary DNS Server' (text box with '192.168.73.2'), and 'Secondary DNS Server' (text box with '168.95.1.1'). At the bottom are 'Back', 'Next', and 'Cancel' buttons.

Section 4 - Troubleshooting

Using the Setup Wizard - For Bridging connection

Please enter the appropriate information below as provided by your ISP. The **Auto PVC Scan** feature will not work in all cases so please enter the **VPI/VCI** numbers if provided by the ISP.

The screenshot shows the DSL-2640B router's setup wizard. The left sidebar contains navigation options: ADSL Setup, Wireless Setup, LAN Setup, Time and Date, Parental Control, Logout, and an Internet Online status indicator. The main content area is titled "STEP 2: SELECT INTERNET CONNECTION TYPE". It contains the following text: "You have selected Bridge Internet connection. Please enter the appropriate information below as provided by your ISP. The Auto PVC Scan feature will not work in all cases so please enter the VPI/VCI numbers if provided by the ISP." Below this text is the instruction "Click Next to continue." and a form with the following fields: "Auto PVC Scan" (checkbox, unchecked), "VPI" (text input field with "8"), "VCI" (text input field with "35"), and "Connection Type" (dropdown menu with "1483 Bridged IP LLC" selected). At the bottom of the form are three buttons: "Back", "Next", and "Cancel".

STEP 3: RESTART

Click **Back** to review or modify settings. Click on **Restart** to apply current settings and reboot the DSL-2640B router. If your Internet connection does not work after the router restarts, you can try the **Setup Wizard** again with alternative settings or use Manual Setup instead provided you have your Internet connection details as provided to you by your ISP.

The screenshot shows the DSL-2640B router's setup wizard. The left sidebar is the same as in the previous screenshot. The main content area is titled "STEP 3: RESTART". It contains the following text: "Setup complete. Click Back to review or modify settings. Click Restart to apply current settings at the DSL-2640B router. If your Internet connection does not work after restart, you can try the Setup Wizard again with alternative settings or use Manual Setup instead if you have your Internet connection details as provided by your ISP." Below this text are three buttons: "Back", "Restart", and "Cancel".

DSL ROUTER REBOOT

Please ensure you do not turn the Router off while it is rebooting. After the Router has successfully rebooted, you can again configure the Router as desired. You can also test the WAN connection by accessing the Internet with your browser.

Close the DSL Router Configuration window and wait for 1 minute before reopening your web browser. If necessary, please reconfigure your computer's IP address to match your new configuration.

The screenshot shows a message box titled "DSL ROUTER REBOOT". The text inside reads: "The DSL Router has been configured and is rebooting. Please wait... If necessary, reconfigure your PC's IP address to match your new configuration." Below the text is a progress bar with several vertical bars of varying heights, indicating the progress of the reboot process.

ADSL SETUP

To access the **ADSL SETUP** (WAN) settings window, click on the **ADSL Setup** button in the **SETUP** directory and select the **Manual Setup** to configure the MANUAL ADSL interface in this page:

ADSL SETUP

Check the **Manual Setup** item and configure the below messages as in **WIZARD**.

Click on the **Save Settings** button to save your settings. You will be asked to reboot by a pop-up window. Click on the **OK** to reboot the router.

Click on the **Connect** button to connect the router to the Internet with the WAN interface.

Section 4 - Troubleshooting

When the router is connected to the Internet, the **Internet Online** graphical icon will be lit in colour. If it is in dark and you are having problems browsing web pages, then there may be a problem with your internet settings and you will need to revert to step 2.

Click on the **Disconnect** button to disconnect the router to the Internet and the icon will be dark.

DSL-2640B // SETUP ADVANCED MAINTENANCE STATUS

ADSL Setup
Wireless Setup
LAN Setup
Time and Date
Parental Control
Logout

Internet Online

English
Reboot

ADSL SETUP

If you are configuring this device for the first time, D-Link recommends that you click the Setup Wizard button, and follow the instructions on screen. If you wish to modify or configure the ADSL settings manually, tick Manual Setup to enable the ADSL Connection Setup.

Setup Wizard Manual Setup

MANUAL ADSL CONNECTION SETUP

Please select the appropriate option to connect to your ISP.

- PPPoE/PPPoA** Choose this option if your ISP uses PPPoE/PPPoA. (For most DSL users)
- Dynamic IP Address** Choose this option if your ISP uses Dynamic IP Address over DSL.
- Static IP Address** Choose this option if your ISP uses Static IP assignments.
- Bridging** Choose this option if your ISP uses Bridging.

PPPOE/PPPOA INTERNET CONNECTION TYPE :

Enter the information provided by your Internet Service Provider (ISP).

Username :

Password :

Service Name :

Connection Type : PPPoA LLC

MTU : 1492

Idle Time Out : 0 Minutes (0 = Always On)

VPI :

VCI :

Save Settings Connect Cancel

WIRELESS

Use this section to configure the wireless settings for your D-Link router. Please note that changes made in this section will also need to be duplicated onto your wireless clients and PC.

To access the **WIRELESS** (WLAN) settings window, click on the **Wireless Setup** button in the **SETUP** directory.

WIRELESS NETWORK SETTINGS

Click on the **Enable Wireless** box to allow the router to operate in the wireless environment.

The **SSID** identifies members of the Service Set. Accept the default name or change it to something else. If the default SSID is changed, all other devices on the wireless network must also use the same SSID.

Enable Auto Channel Scan so that the router can select the best possible channel for your wireless network to operate on.

The **Wireless Channel** can let you select the channel of your access point. Channel availability is different for different countries due to their regulation.

Select **802.11 Mode** to operate in b/g mode. Or select specified mode to use.

Transmission Rate, suggest keeping the Best (automatic) selection.

Click on the **Hide Wireless Network** box to allow the router to stop broadcasting its SSID.

DSL-2640B // SETUP ADVANCED MAINTENANCE STATUS

ADSL Setup
Wireless Setup
LAN Setup
Time and Date
Parental Control
Logout

Internet Online

English

Reboot

WIRELESS

Use this section to configure the wireless settings for your D-Link router. Please note that changes made on this section will also need to be duplicated to your wireless clients and PC.

WIRELESS SECURITY WIZARD

If you are setting up your wireless network for the first time, D-Link recommends that you click the Secure My Wireless Network button and follow the step by step instructions.

Secure My Wireless Network

WIRELESS NETWORK SETTINGS

Enable Wireless :

Wireless Network Name (SSID) : dlink

Enable Auto Channel Scan :

Wireless Channel : 2.412 GHz - CH 1

802.11 Mode : Mixed 802.11g and 802.11b

Transmission Rate : Best (automatic) (Mbit/s)

Hide Wireless Network :

WIRELESS SECURITY MODE

To protect your privacy you can configure wireless security features. This device supports three wireless security modes including: WEP, WPA-Personal, and WPA-Enterprise. WEP is the original wireless encryption standard. WPA provides a higher level of security. WPA-Personal does not require an authentication server. The WPA-Enterprise option requires an external RADIUS server.

Security Mode : None

Please take note of your SSID and security Key as you will need to duplicate the same settings to your wireless devices and PC.

Apply Settings Cancel

Section 4 - Troubleshooting

WIRELESS SECURITY WIZARD

Click on the **Secure My Wireless Network** button to enter the **SECURE MY WIRELESS NETWORK** window.

SECURE MY WIRELESS NETWORK

Input the **SSID**.

Select the **Wireless Channel**.

Select the **Encryption** type. **WPA-PSK** is more secure than **WEP 64 bit**.

Click on the **Apply Settings** button to apply the settings

The screenshot shows the D-Link DSL-2640B web interface. The top navigation bar includes tabs for **DSL-2640B**, **SETUP**, **ADVANCED**, **MAINTENANCE**, and **STATUS**. The left sidebar contains a menu with options: **ADSL Setup**, **Wireless Setup**, **LAN Setup**, **Time and Date**, **Parental Control**, **Logout**, **Internet Online**, **English**, and **Reboot**. The main content area is titled **SECURE MY WIRELESS NETWORK** and contains the following text and form elements:

D-Link recommends that you secure your wireless network.

Wireless Network Name (SSID):

Please chose a name for your wireless network. This name can be between 1-32 characters long. Example: 'dlink'.

Wireless Channel:

D-Link will automatically select the best wireless channel for your environment. It is recommended not to change this setting.

Encryption:

This setting will add security to your wireless network, preventing unauthorised wireless users from accessing your network. You can choose WEP 64 bit, or the stronger WPA-PSK.

At the bottom of the page, there are two buttons: **Apply Settings** and **Cancel**.

WIRELESS SECURITY MODE – WEP

WEP (Wireless Encryption Protocol) encryption can be enabled for security and privacy. WEP encrypts the data portion of each frame transmitted from the wireless adapter using one of the predefined keys. The router offers 64 or 128 bit encryption with four keys available.

Select **WEP Key Length** from the drop-down menu. (**128 bit** is stronger than **64 bit**)

Enter the key into the **WEP Key** field 1~4. (Key length is outlined at the bottom of the window.)

Specify the encryption key from the **Default WEP Key** drop-down menu.

Select **Authentication** type from the drop-down menu. (**Shared** is better than **Open**)

Click on the **Apply Settings** button to apply settings.

WIRELESS SECURITY MODE

To protect your privacy you can configure wireless security features. This device supports three wireless security modes including: WEP, WPA-Personal, and WPA-Enterprise. WEP is the original wireless encryption standard. WPA provides a higher level of security. WPA-Personal does not require an authentication server. The WPA-Enterprise option requires an external RADIUS server.

Security Mode :

WEP

WEP is the wireless encryption standard. To use it you must enter the same key(s) into the router and the wireless stations. For 64 bit keys you must enter 10 hex digits into each key box. For 128 bit keys you must enter 26 hex digits into each key box. A hex digit is either a number from 0 to 9 or a letter from A to F. For the most secure use of WEP set the authentication type to "Shared Key" when WEP is enabled.

You may also enter any text string into a WEP key box, in which case it will be converted into a hexadecimal key using the ASCII values of the characters. A maximum of 5 text characters can be entered for 64 bit keys, and a maximum of 13 characters for 128 bit keys.

WEP Key Length : (length applies to all keys)

WEP Key 1 :

WEP Key 2 :

WEP Key 3 :

WEP Key 4 :

Default WEP Key :

Authentication :

Please take note of your SSID and security Key as you will need to duplicate the same settings to your wireless devices and PC.

WIRELESS SECURITY MODE – WPA-Personal

WPA-PSK

WPA-PSK configuration is similar to WEP. The key length is between 8 to 63 ASCII codes.

WIRELESS SECURITY MODE

To protect your privacy you can configure wireless security features. This device supports three wireless security modes including: WEP, WPA-Personal, and WPA-Enterprise. WEP is the original wireless encryption standard. WPA provides a higher level of security. WPA-Personal does not require an authentication server. The WPA-Enterprise option requires an external RADIUS server.

Security Mode :

WPA

Use **WPA** or **WPA2** mode to achieve a balance of strong security and best compatibility. This mode uses WPA for legacy clients while maintaining higher security with stations that are WPA2 capable. Also the strongest cipher that the client supports will be used. For best security, use **WPA2 Only** mode. This mode uses AES(CCMP) cipher and legacy stations are not allowed access with WPA security. For maximum compatibility, use **WPA Only**. This mode uses TKIP cipher. Some gaming and legacy devices work only in this mode.

To achieve better wireless performance use **WPA2 Only** security mode (or in other words AES cipher).

WPA Mode :

Group Key Update Interval : (seconds)

PRE-SHARED KEY

Pre-Shared Key :

Please take note of your SSID and security Key as you will need to duplicate the same settings to your wireless devices and PC.

WIRELESS SECURITY MODE – WPA-Enterprise

802.1x

Some network-security experts now recommend that wireless networks use 802.1X security measures to overcome some weaknesses in standard WEP applications. A RADIUS server is used to authenticate all potential users.

Enter your RADIUS server data: **IP Address, Port, and Key.**

Click on the **Apply Settings** button to apply settings.

EAP (802.1X)

When WPA enterprise is enabled, the router uses EAP (802.1x) to authenticate clients via a remote RADIUS server.

Authentication Timeout : (minutes)

RADIUS server IP Address :

RADIUS server Port :

RADIUS server Shared Secret :

Please take note of your SSID and security Key as you will need to duplicate the same settings to your wireless devices and PC.

Apply Settings

Cancel

LAN SETUP

You can configure the LAN IP address to suit your preference. Many users will find it convenient to use the default settings together with DHCP service to manage the IP settings for their private network. The IP address of the Router is the base address used for DHCP. In order to use the Router for DHCP on your LAN, the IP address pool used for DHCP must be compatible with the IP address of the Router. The IP addresses available in the DHCP IP address pool will change automatically if you change the IP address of the Router.

To access the **LAN SETUP** setting window, click on the **LAN Setup** button in the **SETUP** directory.

ROUTER SETTINGS

To change the **Router IP Address** or **Subnet Mask**, type in the desired values.

DSL-2640B	SETUP	ADVANCED	MAINTENANCE	STATUS
ADSL Setup	<div style="background-color: #f4a460; padding: 5px;">LAN SETUP</div> <p>This section allows you to configure the local network settings of your router. Please note that this section is optional and you should not need to change any of the settings here to get your network up and running.</p> <div style="background-color: #333; color: white; padding: 5px;">ROUTER SETTINGS</div> <p>Use this section to configure the local network settings of your router. The IP Address that is configured here is the IP Address that you use to access the Web-based management interface. If you change the IP Address here, you may need to adjust your PC's network settings to access the network again.</p> <p style="text-align: center;">Router IP Address : <input type="text" value="192.168.1.1"/></p> <p style="text-align: center;">Subnet Mask : <input type="text" value="255.255.255.0"/></p>			
Wireless Setup				
LAN Setup				
Time and Date				
Parental Control				
Logout				
 <input type="text" value="English"/>				

DHCP SERVER SETTINGS (OPTIONAL)

The **Enable DHCP Server** is selected by default for the Router's Ethernet LAN interface. DHCP service will supply IP settings to workstations configured to automatically obtain IP settings that are connected to the Router through the Ethernet port. When the Router is used for DHCP it becomes the default gateway for DHCP client connected to it. Keep in mind that if you change the IP address of the Router the range of IP addresses in the pool used for DHCP on the LAN will also be changed. The IP address pool can be up to 253 IP addresses.

DHCP SERVER SETTINGS (OPTIONAL)	
Use this section to configure the built-in DHCP Server to assign IP addresses to the computers on your network.	
Enable DHCP Server :	<input checked="" type="checkbox"/>
DHCP IP Address Range :	<input type="text" value="192.168.1.2"/> to <input type="text" value="192.168.1.254"/>
DHCP Lease Time :	<input type="text" value="24"/> (hours)

Section 4 - Troubleshooting

ADD STATIC DHCP (OPTIONAL)

Select **Enable** to let you reserve the **IP Address** for the designate PC with the configured **MAC Address**.

The **Computer Name** can help you recognize the PC with the **MAC Address**, such as “Father’s Laptop”.

Clicking on the **Copy Your PC’s MAC Address** button will help you get the Mac address from the PC you are using now browsing this web page.

Click on the **Save button** to save the settings

STATIC DHCP LIST

After saved the DHCP reservation, the **STATIC DHCP LIST** will list the configuration.

The **NUMBER OF DYNAMIC DHCP CLIENTS** shows how many DHCP clients (PC or Laptop) connected to the router currently and detailed information of the computer(s) connected.

Click on the **Save Settings** button. You will be asked to reboot by a pop-up window. Click on the **OK** to reboot the router.

LAN SETUP

Do not turn the Router off while it is rebooting.

You might need to re-configure your PC NIC settings to enter the Router’s web manager after reboot.

ADD STATIC DHCP (OPTIONAL)

Enable :

Computer Name : << Computer Name ▾

IP Address :

MAC Address :

Copy Your PC's MAC Address

Save Clear

STATIC DHCP LIST

Enable	Computer Name	MAC Address	IP Address
--------	---------------	-------------	------------

NUMBER OF DYNAMIC DHCP CLIENTS : 0

Computer Name	MAC Address	IP Address	Expire Time
---------------	-------------	------------	-------------

Save Settings

DSL ROUTER REBOOT

The DSL Router has been configured and is rebooting. Please wait...
If necessary, reconfigure your PC's IP address to match your new configuration after reboot finishes.

Progress bar: 10%

TIME

The **TIME** configuration option allows you to configure, update, and maintain the correct time on the internal system clock. From this section you can set the time zone that you are in and set the NTP (Network Time Protocol) Server. Daylight Saving can also be configured to automatically adjust the time when needed.

To access the **TIME** setting window, click on the **Time and Date** button in the **SETUP** directory

TIME

Check the **Enable NTP Server**.

Select specific time server to use from the **NTP Server Used** drop-down menu.

Select your operating time zone from the **Time Zone** drop-down menu.

Check the **Enable Daylight Saving** if needed and then select the proper **Daylight Saving Offset** drop-down menu. **Configure the Daylight Saving Dates** from start date to end.

Click on the **Save Settings** button to apply your settings.

The screenshot shows the web interface for a D-Link DSL-2640B router. The main navigation bar includes 'DSL-2640B', 'SETUP', 'ADVANCED', 'MAINTENANCE', and 'STATUS'. The left sidebar contains links for 'ADSL Setup', 'Wireless Setup', 'LAN Setup', 'Time and Date', 'Parental Control', and 'Logout'. The 'Time and Date' section is active, showing 'Internet Online' status, 'English' language, and a 'Reboot' button.

The main content area is titled 'TIME' and contains the following sections:

- TIME CONFIGURATION:**
 - Current Router Time: 1.01.2007,00:03:40 Mon
 - Time Zone: (GMT-00:00) Greenwich Mean Time: Dublin, Edinburgh, Lisbon, London
 - Enable Daylight Saving:
 - Daylight Saving Offset: +1:00
 - Daylight Saving Dates: DST Start (Jan, 1st, Sun, 12 am) and DST End (Jan, 1st, Sun, 12 am)
- AUTOMATIC TIME CONFIGURATION:**
 - Enable NTP Server:
 - NTP Server Used: ntp.dlink.com.tw
- SET THE DATE AND TIME MANUALLY:**
 - Date And Time: Year: 2007, Month: 1, Day: 1
 - Hour: 12 am, Minute: 0, Second: 0
 - Copy Your Computer's Time Settings button

A 'Save Settings' button is located at the bottom right of the page.

PARENTAL CONTROL

The **PARENT CONTROL** provides two useful tools for restricting Internet access. **Block Websites** allows you to quickly create a list of all web sites that you wish to stop users from accessing. **Time Restrictions** allows you to control when clients or PCs connected to Router are allowed to access the Internet.

To access the **PARENT CONTROL** setting window, click on the **Parent Control** button in the **SETUP** directory

BLOCKED WEBSITES SCHEDULING

Type the **Website** and select the corresponding time and days. Click on the **Block Website** button to add to your blocked websites scheduling configuration.

Check the **Unblock** field in the tail of the row, and then click on the **Unblock Website** button. The checked items will be deleted from the table.

INTERNET ACCESS TIME RESTRICTIONS

Select days and time frame to allow/deny this rule.

Click on the **Save Settings** button to apply settings.

The screenshot shows the D-Link DSL-2640B web interface. The left sidebar contains navigation options: ADSL Setup, Wireless Setup, LAN Setup, Time and Date, Parental Control, and Logout. The main content area has a top navigation bar with 'SETUP', 'ADVANCED', 'MAINTENANCE', and 'STATUS'. Below this, the 'PARENTAL CONTROL' section is highlighted in orange. The 'BLOCKED WEBSITES SCHEDULING' section includes a form for adding a website, with fields for 'Website', 'Day(s)' (All Week or Select Day(s)), and checkboxes for each day of the week. It also has 'Start Time' and 'End Time' fields and a 'Block Website' button. The 'INTERNET ACCESS TIME RESTRICTIONS' section features a table with columns for 'Time', days of the week, and 'All', 'Allow', and 'Deny' options. A 'Save Settings' button is located at the bottom of the table.

LOGOUT

The **LOGOUT** page enables you to logout of your router configuration and close the browser.

To access the **LOGOUT** setting window, click on the **Logout** button in the **SETUP** directory

LOGOUT

Click on the **Logout** button to logout of the router configuration settings and close the browser.

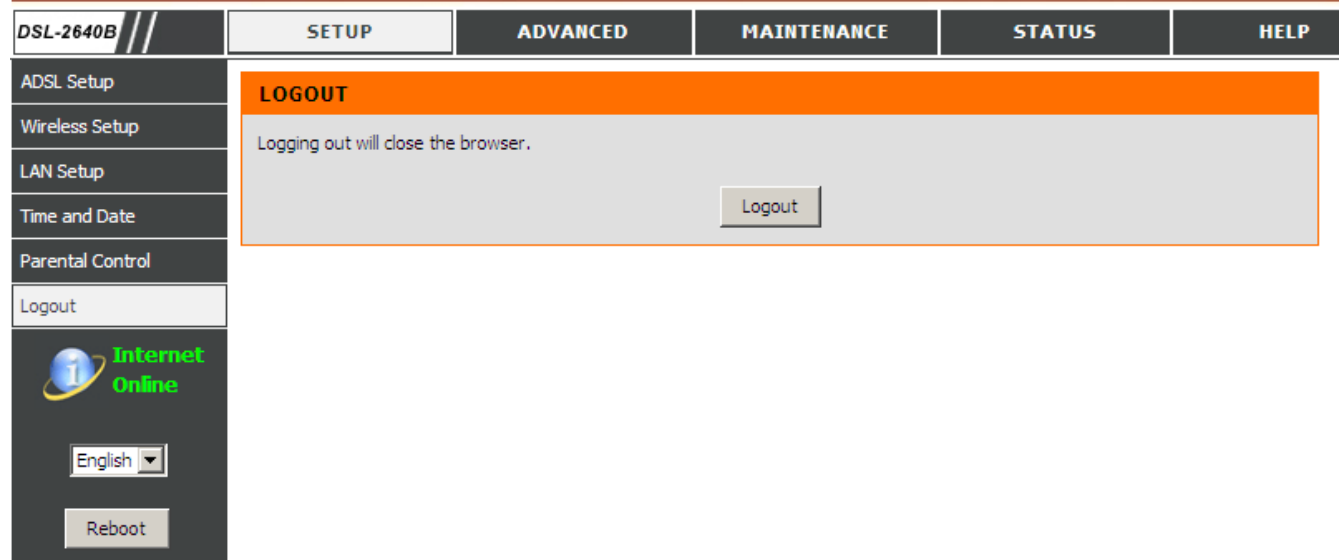

ADVANCED

This chapter includes the more advanced features used for network management and security as well as administrative tools to manage the router, view status and other information used to examine performance and for troubleshooting.

PORT FORWARDING

Use the **PORT FORWARDING** window to open ports in your router and re-direct data through those ports to a single PC on your network (WAN-to-LAN traffic). The Port Forwarding function allows remote users to access services on your LAN such as FTP for file transfers or SMTP and POP3 for e-mail. The DSL-2640B will accept remote requests for these services at your Global IP Address, using the specified TCP or UDP protocol and port number, and then redirect these requests to the server on your LAN with the LAN IP address you specify. Remember that the specified Private IP Address must be within the useable range of the subnet occupied by the Router.

To access the **PORT FORWARDING** settings window, click on the **Port Forwarding** button in the **ADVANCED** directory

PORT FORWARDING RULES CONFIGURATION

Select a service from the **Select a Service** drop-down menu for a pre-configured application or type a name in the **Custom Server** input box to define your own application.

Type an IP address in the **Server IP address** input box to appoint the PC to receive the forwarded packets.

The **External Port Start** and **External Port End** box shows the range of the ports you want to open on the router. The **TCP/UDP** means the protocol type of the opened ports. The **Internal Port Start** and **Internal Port End** box shows the range of the ports in your PC to receive the forwarded packets

Click on the **Add/Apply** button to apply settings.

DSL-2640B
SETUP
ADVANCED
MAINTENANCE
STATUS

- Port Forwarding
- Application Rules
- QoS Setup
- Outbound Filter
- Inbound Filter
- DNS Setup
- Firewall & DMZ
- Advanced ADSL
- Advanced Wireless
- Advanced LAN
- SNMP Setup
- TR-069
- Remote Management
- Logout



English v

Reboot v

PORT FORWARDING
 This is the ability to open ports in your router and re-direct data through those ports to a single PC on your network.

PORT FORWARDING SETUP

Remaining number of entries that can be configured: 32

Select a Service : (Click to Select) v

Custom Server :

Server IP Address : 192.168.1.

External Port Start	External Port End	Protocol	Internal Port Start	Internal Port End	Remote Ip
<input type="text"/>	<input type="text"/>	TCP v	<input type="text"/>	<input type="text"/>	<input type="text"/>
<input type="text"/>	<input type="text"/>	TCP v	<input type="text"/>	<input type="text"/>	<input type="text"/>
<input type="text"/>	<input type="text"/>	TCP v	<input type="text"/>	<input type="text"/>	<input type="text"/>
<input type="text"/>	<input type="text"/>	TCP v	<input type="text"/>	<input type="text"/>	<input type="text"/>
<input type="text"/>	<input type="text"/>	TCP v	<input type="text"/>	<input type="text"/>	<input type="text"/>
<input type="text"/>	<input type="text"/>	TCP v	<input type="text"/>	<input type="text"/>	<input type="text"/>
<input type="text"/>	<input type="text"/>	TCP v	<input type="text"/>	<input type="text"/>	<input type="text"/>
<input type="text"/>	<input type="text"/>	TCP v	<input type="text"/>	<input type="text"/>	<input type="text"/>
<input type="text"/>	<input type="text"/>	TCP v	<input type="text"/>	<input type="text"/>	<input type="text"/>
<input type="text"/>	<input type="text"/>	TCP v	<input type="text"/>	<input type="text"/>	<input type="text"/>
<input type="text"/>	<input type="text"/>	TCP v	<input type="text"/>	<input type="text"/>	<input type="text"/>
<input type="text"/>	<input type="text"/>	TCP v	<input type="text"/>	<input type="text"/>	<input type="text"/>
<input type="text"/>	<input type="text"/>	TCP v	<input type="text"/>	<input type="text"/>	<input type="text"/>
<input type="text"/>	<input type="text"/>	TCP v	<input type="text"/>	<input type="text"/>	<input type="text"/>
<input type="text"/>	<input type="text"/>	TCP v	<input type="text"/>	<input type="text"/>	<input type="text"/>
<input type="text"/>	<input type="text"/>	TCP v	<input type="text"/>	<input type="text"/>	<input type="text"/>
<input type="text"/>	<input type="text"/>	TCP v	<input type="text"/>	<input type="text"/>	<input type="text"/>
<input type="text"/>	<input type="text"/>	TCP v	<input type="text"/>	<input type="text"/>	<input type="text"/>

Add/Apply

PORT FORWARDING SETUP

Server Name	External Port Start	External Port End	Protocol	Internal Port Start	Internal Port End	Server IP Address	Remote Ip	Remove

APPLICATION RULES

Some applications require that specific ports in the Router's firewall be opened for access by the remote parties. Application rules dynamically open up the **Open Start/End** ports when an application on the LAN initiates a TCP/UDP connection to a remote party using the **Trigger Start/End** ports. The router allows the remote party from the WAN side to establish new connections back to the application on the LAN side using the **Open Start/End** ports. A maximum of 32 entries can be configured.

To access the **APPLICATION RULES** setting window, click on the **Application Rules** button in the **ADVANCED** directory.

APPLICATION RULES CONFIGURATION

Select a name from the **Select an Application** drop-down menu for pre-configured application or type a name in the **Custom Application** input box to define your own rules.

Enter your **Trigger Port Start**, **Trigger Port End** and the **Trigger Protocol**. Enter values for **Open Port Start** and **Open Port End**, and select the **Open Protocol** to be used.

Click on the **Add/Apply** button to apply settings.

DSL-2640B
SETUP
ADVANCED
MAINTENANCE
STATUS

- Port Forwarding
- Application Rules
- QoS Setup
- Outbound Filter
- Inbound Filter
- DNS Setup
- Firewall & DMZ
- Advanced ADSL
- Advanced Wireless
- Advanced LAN
- SNMP Setup
- TR-069
- Remote Management
- Logout



English v

Reboot

APPLICATION RULES

This option is used to pre-configure single or multiple trigger ports on your router that will automatically activate when the router senses data sent to the Internet from one of these applications.

The maximum entries can be configured are 32

ADD APPLICATION RULES CONFIGURATION

Remaining number of entries that can be configured: 32

Select an application : (Click to Select) v

Custom application :

Trigger Port Start	Trigger Port End	Trigger Protocol	Open Port Start	Open Port End	Open Protocol
<input type="text"/>	<input type="text"/>	TCP v	<input type="text"/>	<input type="text"/>	TCP v
<input type="text"/>	<input type="text"/>	TCP v	<input type="text"/>	<input type="text"/>	TCP v
<input type="text"/>	<input type="text"/>	TCP v	<input type="text"/>	<input type="text"/>	TCP v
<input type="text"/>	<input type="text"/>	TCP v	<input type="text"/>	<input type="text"/>	TCP v
<input type="text"/>	<input type="text"/>	TCP v	<input type="text"/>	<input type="text"/>	TCP v
<input type="text"/>	<input type="text"/>	TCP v	<input type="text"/>	<input type="text"/>	TCP v
<input type="text"/>	<input type="text"/>	TCP v	<input type="text"/>	<input type="text"/>	TCP v
<input type="text"/>	<input type="text"/>	TCP v	<input type="text"/>	<input type="text"/>	TCP v
<input type="text"/>	<input type="text"/>	TCP v	<input type="text"/>	<input type="text"/>	TCP v
<input type="text"/>	<input type="text"/>	TCP v	<input type="text"/>	<input type="text"/>	TCP v

Add/Apply

ACTIVE APPLICATION RULES

Application Name	Trigger		Open			Remove	
	Protocol	Port Range		Protocol	Port Range		
		Start	End		Start		End

QoS SETUP

QoS or Quality of service allows your Router to help prioritize the data packet flow in your router and network. This is very important for time sensitive applications such as VoIP where it may help prevent dropped calls. Large amounts of non-critical data can be scaled so as not to affect these prioritised sensitive real-time programs. D-Link has pre-setup some often used rules for the QoS. VoIP and H.323 are often used for Internet calls.

To access the **QoS SETUP** setting window, click on the **QoS Setup** button in the **ADVANCED** directory.

Section 4 - Troubleshooting

QoS SETUP

Check the service type and configure the port range if need.

Click on the **Save Settings** button to apply settings

WMM(WI-FI MULTIMEDIA) SETTINGS

Enable or Disable WMM for Wi-fi Multimedia QoS settings. (Enabling this will enable Wireless QoS button)

ADVANCED QoS SETUP

Click on the **Advanced QoS** button to enter the **QUALITY OF SERVICE SETUP** window.

The screenshot displays the web interface for a D-Link DSL-2640B router. The top navigation bar includes tabs for SETUP, ADVANCED, MAINTENANCE, and STATUS. The left sidebar lists various configuration options, with 'QoS Setup' highlighted. The main content area is divided into three sections:

- QoS SETUP**: A header section with an orange background. Below it, a grey box contains the text: "Quality of Service Setup can be used to improve data flow for different applications by prioritising the network traffic based on selected criteria." The main configuration area for QoS SETUP includes several service types, each with a checkbox and port range input fields:
 - VOIP(SIP)**: Start Port: 5060 End Port: 5060
 - H.323**: Start Port: 1720 End Port: 1720
 - FTP**: Start Port: 20 End Port: 21
 - MSN Messenger**: Start Port: 1863 End Port: 1864
 - IPSEC(VPN Passthrough)**:A "Save Settings" button is located at the bottom of this section.
- WMM(WI-FI MULTIMEDIA) SETTINGS**: A section with a dark header. It contains two dropdown menus:
 - WMM(Wi-Fi Multimedia)**: Disabled
 - WMM No Acknowledgement**: DisabledAn "Apply WMM Settings" button is positioned below the dropdowns.
- ADVANCED QoS SETUP**: A section with a dark header containing a single "Advanced QoS" button.

The bottom of the sidebar features an "Internet Online" status indicator, a language dropdown menu set to "English", and a "Reboot" button.

Section 4 - Troubleshooting

QoS

The **QUALITY OF SERVICE SETUP** table shows the list of Quality of Service Setup rules that have been added.

To add a new QoS rule, click on the **Add** button

QoS SETUP

Enter the **QoS Class Name** and specify the **Rule Status**.

Assign a **Classification Queue** to where the QoS will be used and its **Differentiated Services Code Point (DSCP) Mark**.

QoS

Choose "Add" or "Remove" to configure network traffic classes.

QUALITY OF SERVICE SETUP

MARK						
Class Name	DSCP Mark	Queue ID	802.1P Mark	Enable/Disable	Details	Edit/Remove

Add

QoS SETUP

The screen creates a traffic class rule to classify the upstream traffic, assign queue which defines the precedence and the interface and optionally overwrite the IP header DSCP byte. A rule consists of a class name and at least one condition below. All of the specified conditions in this classification rule must be satisfied for the rule to take effect. Click "Apply" to save and activate the rule.

Assign ATM Priority and/or DSCP Mark for the class

If non-blank value is selected for 'Assign Differentiated Services Code Point (DSCP) Mark', the corresponding DSCP byte in the IP header of the upstream packet is overwritten by the selected value.

NETWORK TRAFFIC CLASS RULE

QoS Class Name :

Rule Status :

Assign Classification Queue :

Assign Differentiated Services Code Point (DSCP) Mark :

SPECIFY TRAFFIC CLASSIFICATION RULES

Define the set of conditions for **SET-1** by specifying the **Physical LAN Port**, **Protocol**, **Differentiated Services Code Point Check**, **Source and Destination IP Types and MAC Address**.

Choose the **802.1p Priority** for **SET-2** and click on the **Apply** button to add this new rule.

SPECIFY TRAFFIC CLASSIFICATION RULES

Enter the following conditions either for IP level, SET-1, or for IEEE 802.1p, SET-2.

SET-1	
Physical LAN Port :	Any <input type="button" value="v"/>
Protocol :	Any <input type="button" value="v"/>
Differentiated Services Code Point (DSCP) Check :	Any <input type="button" value="v"/>
Source IP Type :	Any <input type="button" value="v"/>
Source IP Address :	<input type="text"/>
Source Subnet Mask :	<input type="text"/>
Source Port Type :	Any <input type="button" value="v"/>
UDP/TCP Source Port (port or port:port) :	<input type="text"/>
Destination IP Type :	Any <input type="button" value="v"/>
Destination IP Address :	<input type="text"/>
Destination Subnet Mask :	<input type="text"/>
Destination Port Type :	Any <input type="button" value="v"/>
UDP/TCP Destination Port (port or port:port) :	<input type="text"/>
Source MAC Address :	<input type="text"/>
Source MAC Mask :	<input type="text"/>
Destination MAC Address :	<input type="text"/>
Destination MAC Mask :	<input type="text"/>

SET-2	
802.1p Priority :	Any <input type="button" value="v"/>

OUTBOUND IP FILTER

By default, all outgoing IP traffic from the LAN is allowed. The Outbound Filter allows you to create a filter rule to block outgoing IP traffic by specifying a filter name and at least one condition below. All of the specified conditions in this filter rule must be satisfied for the rule to take effect.

To access the **OUTBOUND IP FILTER** setting window, click on the **Outbound Filter** button in the **ADVANCED** directory.

ADD OUTBOUND IP FILTER

Enter the **Filter name** and at least one of the following criteria: **Protocol**, **Source/Destination IP Address** and **Subnet Mask**, and **Source/Destination Port**.

Click on the **Add/Apply** button to add and apply settings.

The **Active Outbound IP Filter** shows detailed information about each created outbound IP filter. To remove an IP filter, click on the **Remove** button (only appears when there is an existing IP filter).

DSL-2640B // SETUP ADVANCED MAINTENANCE STATUS

Port Forwarding
Application Rules
QoS Setup
Outbound Filter
Inbound Filter
DNS Setup
Firewall & DMZ
Advanced ADSL
Advanced Wireless
Advanced LAN
SNMP Setup
TR-069
Remote Management
Logout

Internet Online

English ▾
Reboot

OUTBOUND FILTER

By default, all outgoing IP traffic from the LAN is allowed.

The Outbound Filter allows you to create a filter rule to block outgoing IP traffic by specifying a filter name and at least one condition below. All of the specified conditions in this filter rule must be satisfied for the rule to take effect.

ADD OUTBOUND IP FILTER

Remaining number of entries that can be configured: 32

Filter Name :

Protocol :

Source IP address :

Source Subnet Mask :

Source Port (port or port:port) :

Destination IP address :

Destination Subnet Mask :

Destination Port (port or port:port) :

Add/Apply

ACTIVE OUTBOUND IP FILTER

Name	Protocol	Src. Addr./Mask	Src. Port	Dest. Addr./Mask	Dest. Port	Remove

INBOUND IP FILTER

By default, all incoming IP traffic that does not originate from the internal network is blocked when the firewall is enabled. Normal outgoing Internet requests created by web browsing, email and other software you run will work as usual as the requests originate from inside your internal network. The Inbound Filter allows you to create a filter rule to allow incoming IP traffic by specifying a filter name and at least one condition below. All of the specified conditions in this filter rule must be satisfied for the rule to take effect.

To access the **INBOUND IP FILTER** setting window, click on the **Inbound Filter** button in the **ADVANCED** directory.

ADD INBOUND IP FILTER

Enter the **Filter name** and at least one of the following criteria: **Protocol**, **Source/Destination IP Address** and **Subnet Mask**, and **Source/Destination Port**.

Click on the **Add/Apply** button to add and apply settings.

Note: This section only applies when the Firewall is enabled.

The **Active Inbound IP Filter** shows detailed information about each created inbound IP filter. To remove an IP filter, click on the **Remove** button (only appears when there is an existing IP filter).

The screenshot shows the web interface for a D-Link DSL-2640B router. The top navigation bar includes 'DSL-2640B', 'SETUP', 'ADVANCED', 'MAINTENANCE', and 'STATUS'. The left sidebar lists various configuration options, with 'Inbound Filter' selected. The main content area is titled 'INBOUND FILTER' and contains a note: 'Note: This section only applies when the Firewall is enabled. By default, all incoming IP traffic from the Internet is blocked when the firewall is enabled. The Inbound Filter allows you to create a filter rule to allow incoming IP traffic by specifying a filter name and at least one condition below. All of the specified conditions in this filter rule must be satisfied for the rule to take effect.'

Below the note is the 'ADD INBOUND IP FILTER' section, which states 'Remaining number of entries that can be configured: 32'. It contains several input fields: 'Filter Name', 'Protocol' (a dropdown menu), 'Source IP address', 'Source Subnet Mask', 'Source Port (port or port:port)', 'Destination IP address', 'Destination Subnet Mask', and 'Destination Port (port or port:port)'. An 'Add/Apply' button is located at the bottom of this section.

At the bottom of the page is the 'ACTIVE INBOUND FILTER' section, which displays a table with columns: 'Name', 'Protocol', 'Src. Addr./Mask', 'Src. Port', 'Dest. Addr./Mask', 'Dest. Port', and 'Remove'.

DNS SETUP

The Router can be configured to relay DNS settings from your ISP or another available service to workstations on your LAN. When using DNS relay, the Router will accept DNS requests from hosts on the LAN and forward them to the ISP's, or alternative DNS servers. DNS relay can use auto discovery or the DNS IP address can be manually entered by the user. Alternatively, you may also disable the DNS relay and configure hosts on your LAN to use DNS servers directly. Most users, who are using the Router for DHCP service on the LAN and are using DNS servers on the ISP's network, should check **Obtain DNS server address automatically** box.

The Router supports DDNS (Dynamic Domain Name Service). The Dynamic DNS service allows a dynamic public IP address to be associated with a static host name in any of the many domains, allowing access to a specified host from various locations on the Internet. This is enabled to allow remote access to a host by clicking on a hyperlinked URL in the form hostname.dyndns.org, Many ISPs assign public IP addresses using DHCP, and this can make it difficult to locate a specific host on the LAN using standard DNS. If for example you are running a public web server or VPN server on your LAN, this ensures that the host can be located from the Internet if the public IP address changes. DDNS requires that an account be setup with one of the supported DDNS service providers (DyndDNS.org or dlinkddns.com).

To access the **DNS SETUP** setting window, click on the **DNS Setup** button in the **ADVANCED** directory.

Section 4 - Troubleshooting

DNS SERVER CONFIGURATION

If you are using the Router for DHCP service on the LAN and are using DNS servers on the ISP's network, check **Obtain DNS server address automatically** box.

If you have DNS IP addresses provided by your ISP, enter these IP addresses in the available entry fields for the **Preferred DNS Server** and the **Alternate DNS Server**.

DDNS CONFIGURATION

Check the **Enable Dynamic DNS** box.

Select DDNS Service provider from the **Server Address** drop-down menu and enter your account data.

After configure the DNS settings as desired, click on the **Apply Settings** button to apply settings.

Server Address: Select one of the DDNS registration organizations from those listed in the pull-down menu. Available servers include DynDns.org and dlinkddns.com.

Host Name: Enter the Host Name that you registered with your DDNS service provider.

Username or Key: Enter the Username for your DDNS account.

Password or Key: Enter the Password for your DDNS account.

DSL-2640B // SETUP ADVANCED MAINTENANCE STATUS

Port Forwarding
Application Rules
QoS Setup
Outbound Filter
Inbound Filter
DNS Setup
Firewall & DMZ
Advanced ADSL
Advanced Wireless
Advanced LAN
SNMP Setup
TR-069
Remote Management
Logout

Internet Online
English
Reboot

DNS SETUP

Domain Name Server (DNS) is a server that translates URL/domain names to the corresponding IP address. Most users will not need to change the DNS servers from default unless instructed by your ISP.

The DDNS feature allows you to host a server (Web, FTP, Game Server, etc...) using a domain name that you have purchased (www.whateveryournameis.com) with your dynamically assigned IP address. Most broadband Internet Service Providers assign dynamic (changing) IP addresses. Using a DDNS service provider, your friends can enter your host name to connect to your game server no matter what your IP address is.

DNS SERVER CONFIGURATION

Obtain DNS server address automatically
 Use the following DNS server addresses

Preferred DNS Server:
Alternate DNS Server:

DDNS CONFIGURATION

Enable Dynamic DNS:

Server Address: <<

Host Name: (e.g.: myhost.mydomain.net)

Username:

Password:

Verify Password:

Apply Settings Cancel

FIREWALL & DMZ

The **Firewall & DMZ** window allows the Router to enforce specific predefined policies intended to protect against certain common types of attacks. There are two general types of protection (DoS, Port Scan) that can be enabled on the Router, as well as filtering for specific packet types sometimes used by hackers.

Since some applications are not compatible with NAT, the Router supports use of a DMZ IP address for a single host on the LAN. This IP address is not protected by NAT and will therefore be visible to agents on the Internet with the right type of software. Keep in mind that any client PC in the DMZ will be exposed to various types of security risks. If you use the DMZ, take measures (such as client-based virus protection) to protect the remaining client PCs on your LAN from possible contamination through the DMZ.

To access the **FIREWALL & DMZ** setting window, click on the **Firewall & DMZ** button under the **ADVANCED** tab.

FIREWALL SETTINGS

DoS and Port Scan Protection:

A DoS (denial-of-service) attack is characterized by an explicit attempt by attackers to prevent legitimate users of a service from using that service. Examples include: attempts to "flood" a network, thereby preventing legitimate network traffic, attempts to disrupt connections between two machines, thereby preventing access to a service, attempts to prevent a particular individual from accessing a service, or, attempts to disrupt service to a specific system or person.

Port scan protection is designed to block attempts to discover vulnerable ports or services that might be exploited in an attack from the WAN.

DSL-2640B	SETUP	ADVANCED	MAINTENANCE	STATUS
Port Forwarding	<div style="border: 1px solid orange; padding: 5px;"> <p>FIREWALL & DMZ</p> <p>The router already provides a simple firewall by virtue of the way NAT works. By default NAT does not respond to unsolicited incoming requests on any port, thereby making your LAN invisible to Internet cyberattackers.</p> <p>DMZ means 'Demilitarised Zone'. DMZ allows computers behind the router firewall to be accessible to Internet traffic. Typically, your DMZ would contain Web servers, FTP servers, and others.</p> </div>			
Application Rules				
QoS Setup				
Outbound Filter				
Inbound Filter				
DNS Setup				
Firewall & DMZ				
Advanced ADSL				
Advanced Wireless				
Advanced LAN				
SNMP Setup	<p>FIREWALL SETTINGS</p> <p>Enable D0S and Portscan Protection : <input type="checkbox"/></p> <p style="padding-left: 100px;">SYN attack : <input type="checkbox"/></p> <p style="padding-left: 100px;">FIN/URG/PSH attack : <input type="checkbox"/></p> <p style="padding-left: 100px;">Ping Attack : <input type="checkbox"/></p> <p style="padding-left: 100px;">Xmas Tree attack : <input type="checkbox"/></p> <p style="padding-left: 100px;">TCP reset attack : <input type="checkbox"/></p> <p style="padding-left: 100px;">Null scanning attack : <input type="checkbox"/></p> <p style="padding-left: 100px;">Ping of Death attack : <input type="checkbox"/></p> <p style="padding-left: 100px;">SYN/RST SYN/FIN attack : <input type="checkbox"/></p>			
TR-069				
Remote Management				
Logout				
				

DMZ SETTING

Check the **Enable DMZ** box and type the IP Address of the server or device on your LAN in the **DMZ IP Address** box.

DMZ SETTINGS

The DMZ (Demilitarized Zone) option lets you set a single computer on your network outside of the router. If you have a computer that cannot run Internet applications successfully from behind the router, then you can place the computer into the DMZ for unrestricted Internet access.

Note: Putting a computer in the DMZ may expose that computer to a variety of security risks. Use of this option is only recommended as a last resort.

Enable DMZ :

DMZ IP Address : <<

APPLICATION LEVEL GATEWAY (ALG) CONFIGURATION

Check the relevant ALG options as required.

Click on the **Apply Settings** button to apply settings.

APPLICATION LEVEL GATEWAY (ALG) CONFIGURATION

PPTP :	<input checked="" type="checkbox"/>	
IPSec (VPN Passthrough) :	<input type="checkbox"/>	
RTSP (Online Video Streaming) :	<input type="checkbox"/>	
Windows/MSN Messenger :	<input checked="" type="checkbox"/>	(automatically disabled if UPnP is enabled)
FTP :	<input checked="" type="checkbox"/>	
H.323 (Video Conferencing) :	<input checked="" type="checkbox"/>	
SIP :	<input checked="" type="checkbox"/>	
MMS :	<input type="checkbox"/>	

ADVANCED ADSL

The **ADVANCED ADSL** settings allow you to choose which ADSL modulation settings your modem router will support. D-Link does not recommend changing these settings unless directed to do so by your ISP.

To access the **ADVANCED ADSL** setting window, click on the **Advanced ADSL** button in the **ADVANCED** directory.

ADVANCED ADSL SETTINGS

The **Modulation Type** drop-down menu allows the user to select the configuration for ADSL protocols. For most ADSL accounts the default settings (**Auto sense**) will work. This configuration works with all ADSL implementations. Do not change any settings unless you have been instructed.

To make ADSL settings, select the desired items and click on the **Apply Settings** button to apply the settings.

The screenshot displays the configuration interface for the DSL-2640B. The left sidebar lists various settings, with 'Advanced ADSL' highlighted. The top navigation bar includes 'SETUP', 'ADVANCED', 'MAINTENANCE', and 'STATUS'. The 'ADVANCED' tab is active, showing a warning message: 'The Advanced ADSL settings allow you to choose which ADSL modulation settings your router will support. D-Link do not recommend that you change these settings unless directed to do so by your ISP.' Below this, the 'ADVANCED ADSL SETTINGS' section is visible, featuring a 'Modulation Type' dropdown menu set to 'Autosense'. Under the 'Capability' section, there are two checkboxes: 'Bitswap Enable' (checked) and 'SRA Enable' (unchecked). At the bottom of the settings area, there are 'Apply Settings' and 'Cancel' buttons.

ADVANCED WIRELESS

These options are for users that wish to change the behavior of their 802.11g wireless radio from the standard setting. D-Link does not recommend changing these settings from the factory default. Incorrect settings may impair the performance of your wireless radio. The default settings should provide the best wireless radio performance in most environments.

To access the **ADVANCED WIRELESS** setting window, click on the **Advanced Wireless** button in the **ADVANCED** directory.

ADVANCED WIRELESS SETTINGS

This page allows you 3 options.

Advanced Settings to change advanced wireless settings

MAC Filtering to configure wireless firewall by denying or allowing designated MAC addresses

Security Settings to configure Wireless LAN security.

DSL-2640B	SETUP	ADVANCED	MAINTENANCE	STATUS
Port Forwarding	<div style="border: 1px solid black; padding: 5px;"> <p>ADVANCED WIRELESS -- ADVANCED SETTINGS</p> <p>Allows you to configure advanced features of the wireless LAN interface.</p> <p style="text-align: center;">Advanced Settings</p> </div> <div style="border: 1px solid black; padding: 5px; margin-top: 10px;"> <p>ADVANCED WIRELESS -- MAC FILTERING</p> <p>Allows you to configure wireless firewall by denying or allowing designated MAC addresses.</p> <p style="text-align: center;">MAC Filtering</p> </div> <div style="border: 1px solid black; padding: 5px; margin-top: 10px;"> <p>ADVANCED WIRELESS -- SECURITY SETTINGS</p> <p>Allows you to configure security features of the wireless LAN interface.</p> <p style="text-align: center;">Security Settings</p> </div>			
Application Rules				
QoS Setup				
Outbound Filter				
Inbound Filter				
DNS Setup				
Firewall & DMZ				
Advanced ADSL				
Advanced Wireless				
Advanced LAN				
SNMP Setup				
TR-069				
Remote Management				

ADVANCED SETTINGS – ADVANCED WIRELESS SETTINGS

- Transmission Rate:** The wireless link rate for the transmit/receive of your wireless network
- Multicast Rate:** Rate in which a message is sent to a group of recipients
- Transmit Power:** The percentage of power transmitted from your wireless network.
- Beacon Period:** This value indicates the frequency interval of the beacon. Where the value is between **20** to **65535** milliseconds.
- RTS Threshold:** (Request to Send Threshold) is used to determine the packet size of a wireless packet to help control traffic flow.
- Fragmentation Threshold:** Maximum frame size. Frame larger than the threshold are fragmented into multiple packets and transmitted. The range is **256~2346** bytes.
- DTIM Interval:** Sets the Wake-up interval in power-saving mode. The range is **1~255** milliseconds,
- Preamble Type:** This is the length of the CRC (Cyclic Redundancy Check) block for communication between the router and wireless clients. High network traffic areas should select Short preamble type

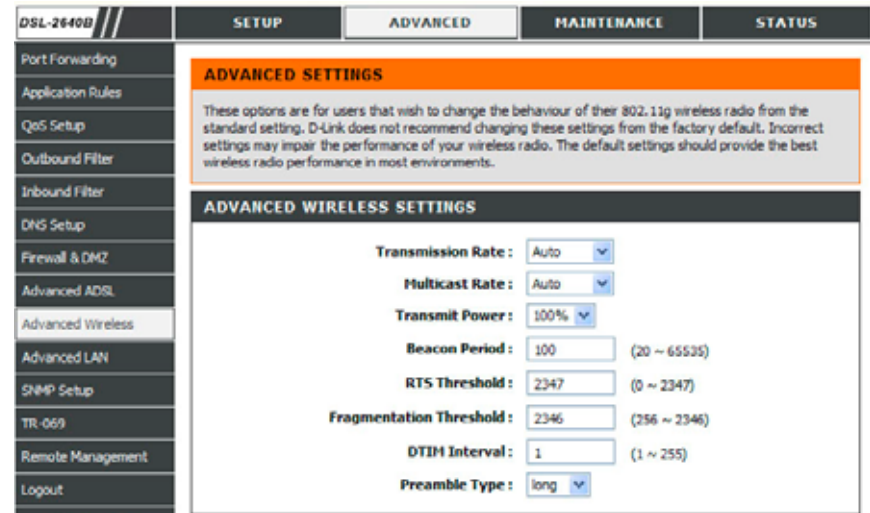

ADVANCED SETTINGS – ADVANCED WIRELESS SETTINGS

SSID, GUEST/VIRTUAL ACCESS POINT- 1,2 & 3

The router allows 1 SSID and 3 Virtual Access Points to be configured.

To enable the setting for a SSID or Virtual Access Points, check the **Enable Wireless** or **Enable Wireless Guest Network** checkbox.

Specify the **Wireless Network Name** or **Guest SSID** and determine its **Visibility Status** to be Visible or Invisible.

Choose if you want to turn on **User Isolation** and **Disable WMM Advertise**.

Specify the **Max Client** value between a range of **1** to **128** for that SSID or Guest Network.

The screenshot displays the 'ADVANCED WIRELESS SETTINGS' page, divided into two sections: 'SSID' and 'GUEST/VIRTUAL ACCESS POINT-1'.

SSID Section:

- Enable Wireless:**
- Wireless Network Name (SSID):** dlink
- Visibility Status:** Visible Invisible
- User Isolation:** Off
- Disable WMM Advertise:** Off
- Max Clients:** 128 (1 ~ 128)

GUEST/VIRTUAL ACCESS POINT-1 Section:

- Enable Wireless Guest Network:**
- Guest SSID:** Guest
- Visibility Status:** Visible Invisible
- User Isolation:** Off
- Disable WMM Advertise:** Off
- Max Clients:** 128 (1 ~ 128)

ADVANCED SETTINGS – MAC FILTERING

Tick the **Enable Wireless MAC Filtering** checkbox to enable Wireless MAC filtering. Then choose if you want to **Allow** or **Deny** the wireless clients with the MAC address in the **WIRELESS MAC FILTERING LIST**.

To add a new MAC address. Enter the MAC Address. Specify the SSID and click on the **Apply Settings** button.

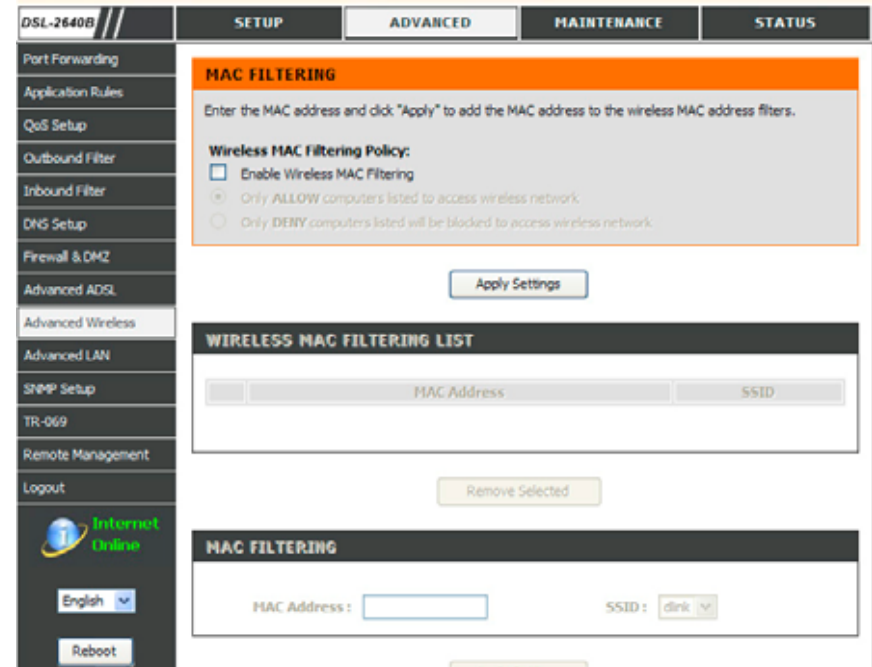

Section 4 - Troubleshooting

ADVANCED SETTINGS – SECURITY SETTINGS

The security settings in Advanced Settings allows you to set security settings by SSID.

Please consult how to configure security settings in the **SETUP** tab for configuring security for your wireless security.

The screenshot shows the 'ADVANCED' tab of the DSL-2640B web interface. The left sidebar contains a navigation menu with items like 'Port Forwarding', 'Application Rules', 'QoS Setup', 'Outbound Filter', 'Inbound Filter', 'DNS Setup', 'Firewall & DMZ', 'Advanced ADSL', 'Advanced Wireless', 'Advanced LAN', 'SNMP Setup', 'TR-069', 'Remote Management', and 'Logout'. The 'Advanced Wireless' item is highlighted. The main content area is titled 'SECURITY SETTINGS' and contains the following sections:

- SECURITY SETTINGS**: A text box explaining that this page allows configuration of wireless LAN security features, including authentication method, encryption, and network key.
- WIRELESS SSID**: A dropdown menu labeled 'Select SSID:' with 'dlink' selected.
- WIRELESS SECURITY MODE**: A text box explaining that the device supports three security modes: WEP, WPA, and WPA2. It provides instructions on how to choose between WPA/WPA2 for compatibility and WPA2 Only for security.
- Security Mode**: A dropdown menu currently set to 'None'.

At the bottom of the page, there is a red warning message: 'Please take note of your SSID and security Key as you will need to duplicate the same settings to your wireless devices and PC.' Below this message are two buttons: 'Apply Settings' and 'Cancel'.

ADVANCED LAN

The **ADVANCED LAN** options are for users that wish to change the LAN settings. D-Link does not recommend changing these settings from factory default. Changing these settings may affect the behavior of your network.

UPnP is used for much popular Audio Visual software. It allows the auto discovery of your device on the network. If you feel that UPnP is a security concern we provide you with the option to disable it here. Block ICMP Ping should be enabled so that the router does not respond to malicious Internet requests. Multicast streams are used by advance network functions like IPTV and distributed by your ISP.

To access the **ADVANCED LAN** setting window, click on the **Advanced LAN** button in the **ADVANCED** directory.

Section 4 - Troubleshooting

UPnP

Check the **Enable UPnP** box to enable the UPnP function.

MULTICAST STREAMS

Check the **Enable Multicast Streams** box to allow the multicast packets received from WAN to LAN.

Click on the **Apply Settings** button to apply settings.

ROUTING – RIP CONFIGURATION

Check the Enable Global RIP Mode to enable RIP configuration to be applied globally

Select which Interface RIP packets are to be used and select the RIP **Version 1,2 or both**. Choose if the **Operation** is **Active** or **Passive** and check the **Enabled** checkbox to enable the selected Interface for RIP protocol

The screenshot shows the web interface for a D-Link DSL-2640B router. The top navigation bar includes tabs for SETUP, ADVANCED, MAINTENANCE, and STATUS. The left sidebar lists various configuration options, with 'Advanced LAN' selected. The main content area is divided into three sections:

- ADVANCED LAN:** A warning message states: "These options are for users that wish to change the LAN settings. D-Link does not recommend changing these settings from factory default. Changing these settings may affect the behaviour of your network."
- UPnP:** The 'Enable UPnP' checkbox is checked. Below it are 'Apply' and 'Cancel' buttons.
- MULTICAST STREAMS:** The 'Enable Multicast Streams (IGMP)' checkbox is unchecked. Below it are 'Apply' and 'Cancel' buttons.
- ROUTING -- RIP CONFIGURATION:** The 'Enable Global RIP Mode' checkbox is unchecked. Below it is a table with columns for Interface, VPI/VCI, Version, Operation, and Enabled.

Interface	VPI/VCI	Version	Operation	Enabled
br0	(LAN)	2	Active	<input type="checkbox"/>
nas_0_0_35	0/0/35	2	Passive	<input type="checkbox"/>

Below the table are 'Apply' and 'Cancel' buttons.

STATIC ROUTE AND ROUTING ADD

Click on the **Add** button to Add a Static Route and **Delete** button to remove a Static route

To add a Static Route, enter a value in **Destination Network Address** and the **Subnet Mask** to be used and select **Use Gateway IP Address** or **Use Interface** where the static route would be used.

ROUTING - STATIC ROUTE AND ROUTING

A maximum 32 entries can be configured

Destination	Subnet Mask	Gateway	Interface
-------------	-------------	---------	-----------

STATIC ROUTE AND ROUTING ADD

Destination Network Address :

Subnet Mask :

Use Gateway IP Address :

Use Interface : wizard_pvc/ppp_1_40_1 ▾

SNMP SETUP

Simple Network Management Protocol (SNMP) allows a management application to retrieve statistics and status from the SNMP agent in this device.

To access the **SNMP SETUP** setting window, click on the **SNMP SETUP** button in the **ADVANCED** directory.

SNMP CONFIGURATION

Check the **Enable SNMP Agent** checkbox to allow the device's SNMP agent to work.

Specify the **Read Community**, **Set Community**, **System Name**, **System Location**, **System Contact** and the **Trap Manager IP** to allow SNMP agent to work properly.

DSL-2640B	SETUP	ADVANCED	MAINTENANCE	STATUS
-----------	-------	----------	-------------	--------

- Port Forwarding
- Application Rules
- QoS Setup
- Outbound Filter
- Inbound Filter
- DNS Setup
- Firewall & DMZ
- Advanced ADSL
- Advanced Wireless
- Advanced LAN
- SNMP Setup
- TR-069
- Remote Management
- Logout



SNMP SETUP

Simple Network Management Protocol (SNMP) allows a management application to retrieve statistics and status from the SNMP agent in this device.

Select the desired values and click "Apply" to configure the SNMP options.

SNMP -- CONFIGURATION

Enable SNMP Agent

Read Community :

Set Community :

System Name :

System Location :

System Contact :

Trap Manager IP :

TR-069

TR-069 allows an Auto Configuration Server (ACS) to manage this device remotely.

To access the **TR-069** setting window, click on the **TR-069** button in the **ADVANCED** directory.

TR-069

Choose to enable or disable the **Inform** feature of TR-069 client

Specify the **Inform Interval**, **ACS URL**, **ACS User Name**, and the **ACS Password** to allow TR-069 agent to work properly.

Tick on the **Connection Request Authentication** if you want to enable authentication before the router could be managed. Specify the **Connection Request User Name** and **Connection Request Password**.

Click on the **Apply** button for changes to take effect.

Click on the **GetRPCMethods** button to get RPC methods of the ACS server.

Note: Choose to change this option if only specified by your ISP.

The screenshot displays the TR-069 configuration window in the DSL-2640B web interface. The navigation menu on the left includes options such as Port Forwarding, Application Rules, QoS Setup, Outbound Filter, Inbound Filter, DNS Setup, Firewall & DMZ, Advanced ADSL, Advanced Wireless, Advanced LAN, SNMP Setup, TR-069, Remote Management, and Logout. The main configuration area is titled "TR-069" and contains the following settings:

- Inform:** Radio buttons for "Disable" (selected) and "Enable".
- Inform Interval:** Text input field containing "300".
- ACS URL:** Text input field.
- ACS User Name:** Text input field containing "admin".
- ACS Password:** Password input field with masked characters.
- Connection Request Authentication:** Checked checkbox.
- Connection Request User Name:** Text input field containing "admin".
- Connection Request Password:** Password input field with masked characters.

At the bottom of the configuration area, there are three buttons: "GetRPCMethods", "Apply", and "Cancel".

REMOTE MANAGEMENT

This section allows you to enable/disable remote access to the router from the Internet. Remote access control allows you to configure access via specific services. Most users will not need to change any of these settings.

To access the **REMOTE MANAGEMENT** setting window, click on the **Remote Management** button under the **ADVANCED** tab.

REMOTE MANAGEMENT SETTINGS

Check the **Enable Remote Management** box to enable the remote management.

Input the **Remote Admin Port** listened by the web UI for the remote PC to browse.

Select the **Remote Admin Inbound Filter** to filter the remote PCs who want to use remote management.

REMOTE ACCESS CONTROL

Select the management services which you want to enable/disable on your LAN/WAN interface.

Click on the **Apply Settings** button to apply settings.

Notice If you disable HTTP service, you'll not be able to access the router's configuration window permanently.

DSL-2640B // SETUP ADVANCED MAINTENANCE STATUS

REMOTE MANAGEMENT

This section allows you to enable/disable remote access to the router from the Internet. Remote Access Control allows you to configure access via specific services. Most users will not need to change any of these settings.

REMOTE MANAGEMENT SETTINGS

Enable Remote Management :

Remote Admin Port :

Remote Admin Inbound Filter :

Details :

REMOTE ACCESS CONTROL

Service	LAN	WAN
FTP	<input type="checkbox"/> Enabled	<input type="checkbox"/> Enabled
HTTP	<input checked="" type="checkbox"/> Enabled	<input type="checkbox"/> Enabled
ICMP (Ping)	<input checked="" type="checkbox"/> Enabled	<input type="checkbox"/> Enabled
SNMP	<input checked="" type="checkbox"/> Enabled	<input type="checkbox"/> Enabled
SSH	<input checked="" type="checkbox"/> Enabled	<input type="checkbox"/> Enabled
TELNET	<input checked="" type="checkbox"/> Enabled	<input type="checkbox"/> Enabled
TFTP	<input checked="" type="checkbox"/> Enabled	<input type="checkbox"/> Enabled

Apply Settings Cancel

MAINTENANCE

Click on the **MAINTENANCE** tab to reveal the window buttons for various functions located in this directory. The **PASSWORD** window is the first item in the **MAINTENANCE** directory.

PASSWORD

The factory default password of this router is 'admin'. To help secure your network, D-Link recommends that you should choose a new password. Please make sure to choose a password you can remember or write it down and keep in a safe and separate location for future reference. If you forget your device password, the only solution is to reset your router to factory default settings and you will lose all your device configuration settings.

To access the **PASSWORD** setting window, click on the **Password** button under the **MAINTENANCE** tab.

SET PASSWORD (OPTIONAL)

To change password, enter the old/new password.

Click on the **Apply Settings** button to apply settings.

The screenshot shows the web interface for a D-Link DSL-2640B router. At the top, there are navigation tabs: **DSL-2640B**, **SETUP**, **ADVANCED**, **MAINTENANCE** (which is selected), and **STATUS**. On the left side, there is a sidebar menu with the following items: **Password**, **Save/Restore Settings**, **Firmware Update**, **Diagnostics**, **System Log**, **Logout**, **Internet Online** (with a globe icon), and a language dropdown menu set to **English**. The main content area is titled **PASSWORD** and contains the following text: "The factory default password of this router is 'admin'. To help secure your network, D-Link recommends that you should choose a new password between 1 and 63 characters." Below this is a section titled **SET PASSWORD (OPTIONAL)** with the instruction: "To change the router password, please type in the current password, then the new password twice." There are three input fields labeled **Current Password:**, **New Password:**, and **Confirm Password:**.

SAVE/RESTORE SETTINGS

Once the router is configured you can save the configuration settings to a configuration file on your hard drive. You also have the option to load configuration settings, or restore the factory default settings.

To access the **SAVE/RESTORE SETTINGS** setting window, click on the **Save/Restore Settings** button under the **MAINTENANCE** tab.

SAVE/RESTORE CONFIGURATION

Click on the **Save** button to Save Settings to Local Hard Drive. You will be prompted to select a location on your computer to put the file. You may name the configuration file anything you like.

Click on the **Browse** button to browse to the configuration file in the PC and click on the **Update Settings** button to load settings from local hard drive. Confirm that you want to load the file when prompted and the process will complete automatically. The Router will reboot and begin operating with the configuration settings that have just been loaded.

To reset the Router to its factory default settings, click on the **Restore Device** button. You will be prompted to confirm your decision to reset the Router. The Router will reboot with the factory default settings including IP settings (192.168.1.1) and Administrator password (admin).

The screenshot shows the web interface for a D-Link DSL-2640B router. At the top, there are navigation tabs: SETUP, ADVANCED, MAINTENANCE (selected), and STATUS. Below the tabs is a sidebar menu with options: Password, Save/Restore Settings (highlighted), Firmware Update, Diagnostics, System Log, Logout, Internet Online (with a globe icon), English (language dropdown), and Reboot. The main content area is titled 'SAVE/RESTORE SETTINGS' and contains the following text: 'Once the router is configured you can save the configuration settings to a configuration file on your hard drive. You also have the option to load configuration settings, or restore the factory default settings.' Below this is a section titled 'SAVE/RESTORE CONFIGURATION' with three main options: 'Save Settings to Local Hard Drive' with a 'Save' button; 'Load Settings From Local Hard Drive' with a text input field, a 'Browse...' button, and an 'Update Settings' button; and 'Restore To Factory Default Settings' with a 'Restore Device' button.

FIRMWARE UPDATE

Use the **FIRMWARE UPDATE** window to load the latest firmware for the device. Note that the device configuration settings may return to the factory default settings, so make sure you first save the configuration settings with the **SAVE/RESTORE SETTINGS** window described above.

To access the **FIRMWARE UPDATE** setting window, click on the **Firmware Update** button under the **MAINTENANCE** tab.

FIRMWARE UPDATE

To update firmware, click on the **Browse...** button to search for the file and then click on the **Update Firmware** button to begin copying the file. The Router will load the file and restart automatically.

Notice Performing a Firmware Upgrade can sometimes change the configuration settings. Be sure to back-up the Router's configuration settings before upgrading the firmware.

The current firmware version in the screenshot may not be the same as the one in the current product.

The screenshot displays the web management interface for a D-Link DSL-2640B router. The top navigation bar includes tabs for SETUP, ADVANCED, MAINTENANCE (which is selected), and STATUS. The left sidebar contains a menu with items: Password, Save/Restore Settings, Firmware Update (highlighted), Diagnostics, System Log, and Logout. Below the menu is an 'Internet Online' status indicator, a language dropdown set to 'English', and a 'Reboot' button. The main content area is titled 'UPDATE' and features a red warning box: 'Note: Please do not update the firmware on this router unless instructed to do so by D-Link technical support or your ISP.' Below this is the 'FIRMWARE INFORMATION' section, which reports 'Current Firmware Version : EU_4.00' and 'Current Firmware Date : Jun 10 2008'. The 'FIRMWARE UPDATE' section contains another red warning: 'Note: Some firmware updates reset the configuration options to factory defaults. Before performing an update, be sure to save the current configuration from the Maintenance -> Save/Restore Settings screen.' This section includes a 'Backup Now' button, a text instruction: 'To update the firmware, your PC must have a wired connection to the router. Enter the name of the firmware update file, and click on the Upload button.', and an 'Upload:' field with a 'Browse...' button and an 'Update Firmware' button.

Diagnostics

This page shows the result of your router's self diagnostic and connection test results. The Internet connectivity status will only show **PASS** if you have correctly configured your Internet connection and your router is currently online.

To access the **DIAGNOSTICS** setting window, click on the **Diagnostics** button under the **MAINTENANCE** tab.

INTERNET CONNECTIVITY CHECK

Click on the **Re-run Diagnostics Tests** button to run the diagnostics again.

Notice: The **Diagnostic Test** window is used to test connectivity of the Router. A Ping test may be done through the local or external interface to test connectivity to known IP addresses. The diagnostics feature executes a series of test on your system software and hardware connections. Use this window when working with your ISP to troubleshoot problems.

The screenshot displays the router's web interface. At the top, there are tabs for 'DSL-2640B', 'SETUP', 'ADVANCED', 'MAINTENANCE', and 'STATUS'. The 'MAINTENANCE' tab is active. On the left sidebar, there are links for 'Password', 'Save/Restore Settings', 'Firmware Update', 'Diagnostics' (highlighted), 'System Log', and 'Logout'. Below these is an 'Internet Online' status indicator and a language dropdown set to 'English'. A 'Reboot' button is also present. The main content area features an orange 'DIAGNOSTICS' header with a message: 'Your router is capable of testing your DSL connection. The individual tests are listed below. If a test displays a fail status, click "Re-run Diagnostics Tests" at the bottom of this page to make sure fail status is consistent.' Below this is a 'SYSTEM CHECK' section with a table of test results:

Test your Ethernet(1-4) Connection:	PASS
Test your Wireless Connection:	PASS
Test ADSL Synchronization:	PASS

Below the system check is an 'INTERNET CONNECTIVITY CHECK' section with another table of test results:

Test PPP server session:	PASS
Test authentication:	PASS
Test the assigned IP address:	PASS
Ping ISP Default Gateway:	PASS
Ping Primary DNS server:	PASS

At the bottom of the diagnostics area is a 'Re-run Diagnostics Tests' button.

SYSTEM LOG

The system log displays chronological event log data. The event log can be read from local host or sent to a System Log server. The available event severity levels are: **Emergency, Alert, Critical, Error, Warning, Notice, Informational and Debugging.**

To access the **SYSTEM LOG** setting window, click on the **System Log** button under the **MAINTENANCE** tab.

SYSTEM LOG

Click on the **Log** checkbox and select **Log/Display Level** from the drop-down menu.

Select display mode from the **Mode** drop-down menu, enter the **Server IP Address** and **Server UDP Port** number if **Both/Remote** Mode is selected.

Log Level: All events above or equal to the selected level will be logged.

Display Level: All logged events above or equal to the selected level will be displayed.

Mode: Display mode of system log.
Local: Display on local host only
Remote: Send log file to remote system log server only

Server IP Address: IP address of the remote system log server

Server UDP Port: UDP port number of the remote system log server

The screenshot shows the web interface for a DSL-2640B device. At the top, there are tabs for SETUP, ADVANCED, MAINTENANCE, and STATUS. The MAINTENANCE tab is selected. On the left side, there is a navigation menu with the following items: Password, Save/Restore Settings, Firmware Update, Diagnostics, System Log (highlighted), and Logout. Below the menu is an 'Internet Online' status indicator and a language dropdown set to 'English', along with a 'Reboot' button. The main content area is titled 'SYSTEM LOG' and contains the following configuration options:

- Log:**
- Log Level:** Debugging (dropdown menu)
- Display Level:** Error (dropdown menu)
- Mode:** Local (dropdown menu)
- Server IP Address:** [text input field]
- Server UDP Port:** [text input field]

Section 4 - Troubleshooting

ENABLE EMAIL NOTIFICATION

Click on the **Enable EMAIL Notification** check-box to enable the E-mail alarm system log.

EMAIL SETTINGS

Set the E-mail address messages to receive the E-mail alarm system log.

EMAIL LOG WHEN FULL

Click on the **On Log Full** check-box to let the system send the E-mail alarm message when the local log is full.

VIEW SYSTEM LOG

The table lists the system log.

Click on the **Apply Settings** button to apply your settings.

ENABLE EMAIL NOTIFICATION

Enable Email Notification:

EMAIL SETTINGS

To Email Address:

SMTP Server Address:

Enable Authentication:

Account Name:

Password:

Verify Password:

EMAIL LOG WHEN FULL

On Log Full:

SYSTEM LOG

Date/Time	Facility	Severity	Message
Jan 1 01:01:26	syslog	emerg	BCM96345 started: BusyBox v1.00 (2005.04.12-18:11+0000)
Jan 1 01:01:27	user	crit	kernel: eth0 Link UP.
Jan 1 01:01:27	user	crit	kernel: ADSL G.994 training
Jan 1 01:01:27	user	crit	kernel: ADSL G.992 started
Jan 1 01:01:27	user	crit	kernel: ADSL G.992 channel analysis
Jan 1 01:01:27	user	crit	kernel: L link up, interleaved, us=800, ds=7616

Apply Settings

Cancel

STATUS

Click on the **STATUS** tab to reveal the window buttons for various functions located in this directory. The **DEVICE INFO** window is the first item in the **STATUS** directory. Use these windows to view system information and monitor performance.

DEVICE INFO

The **Device Info** page displays a summary overview of your router status, including: Device software version and summary of your Internet configuration (both wireless and Ethernet status).

To access the **DEVICE INFO** setting window, click on the **Device Info** button in the **STATUS** directory.

GENERAL

This window displays current system time and the firmware version.

The screenshot shows the router's web interface. At the top left, it says 'DSL-2640B'. There are four main tabs: 'SETUP', 'ADVANCED', 'MAINTENANCE', and 'STATUS'. The 'STATUS' tab is selected. On the left side, there is a vertical menu with options: 'Device Info', 'Connected Clients', 'Statistics', 'Routing Info', and 'Logout'. The 'Device Info' option is highlighted. Below the menu, there is a green 'Internet Online' indicator. The main content area has an orange header 'DEVICE INFO' and a grey box with the text: 'The Device Status page allows you to check the status of your Internet connection, Wireless LAN and LAN.' Below this is a 'GENERAL' section with a white background, displaying 'Time : 1.01.2007,00:05:32 Mon' and 'Firmware Version : EU_4.00'. At the bottom, there is a partially visible 'INTERNET STATUS' section.

Section 4 - Troubleshooting

INTERNET STATUS

This window displays WAN information including IP address, Mask, Default Gateway, Primary/Secondary DNS Server.

INTERNET STATUS	
Connection Type :	G.DMT
Cable Status :	No Defect
Network Status :	Connected
Connection Up Time :	1 hour, 39 min, 6 sec
	<input type="button" value="DHCP Renew"/> <input type="button" value="DHCP Release"/>
MAC Address :	
Authentication & Security :	AUTO
IP Address :	135.154.13.3
Subnet Mask :	255.255.255.255
Default Gateway :	135.154.13.254
Primary DNS Server :	192.168.73.2
Secondary DNS Server :	168.95.1.1

WIRELESS LAN

This window displays authenticated wireless stations and their status.

WIRELESS LAN	
Wireless Radio :	ON
MAC Address :	02:E0:18:00:00:01
Network Name (SSID) :	dlink
Channel :	0
Security Type :	None

LAN

This window displays LAN information including IP address, Subnet Mask, and DHCP Server.

LAN	
MAC Address :	00:E0:18:00:00:01
IP Address :	192.168.1.1
Subnet Mask :	255.255.255.0
DHCP Server :	ON

CONNECTED CLIENTS

This page shows all the currently connected wireless and LAN computers or PCs.

To access the **CONNECTED CLIENTS** setting window, click on the **Connected Clients** button in the **STATUS** directory.

CONNECTED WIRELESS CLIENTS

This window displays authenticated wireless stations and their status.

CONNECTED DHCP LAN CLIENTS

This window displays all the client devices which have obtained IP addresses from the router.

BLOCKED CLIENTS

This window displays the list of clients that are blocked from having access to the router and the Internet.

DSL-2640B				SETUP	ADVANCED	MAINTENANCE	STATUS								
CONNECTED CLIENTS This page shows all the currently connected wireless and LAN computers or PCs.															
CONNECTED WIRELESS CLIENTS <table border="1"> <thead> <tr> <th>BSSID</th> <th>Associated</th> <th>Authorized</th> </tr> </thead> <tbody> <tr> <td> </td> <td> </td> <td> </td> </tr> </tbody> </table>								BSSID	Associated	Authorized					
BSSID	Associated	Authorized													
CONNECTED DHCP LAN CLIENTS <table border="1"> <thead> <tr> <th>Hostname</th> <th>MAC Address</th> <th>IP Address</th> <th>Expires In</th> </tr> </thead> <tbody> <tr> <td> </td> <td> </td> <td> </td> <td> </td> </tr> </tbody> </table>								Hostname	MAC Address	IP Address	Expires In				
Hostname	MAC Address	IP Address	Expires In												
BLOCKED CLIENTS <table border="1"> <thead> <tr> <th>Hostname</th> <th>MAC Address</th> </tr> </thead> <tbody> <tr> <td> </td> <td> </td> </tr> </tbody> </table>								Hostname	MAC Address						
Hostname	MAC Address														

STATISTICS

This page displays your router network and data transfer statistics and is helpful for D-Link technicians to assist you in identifying if your router is functioning properly. The information provided is primarily informative and does not affect the function of your router.

To access the **STATISTICS** setting window, click on the **Statistics** button in the **STATUS** directory.

WAN STATISTICS

This window displays WAN information

The screenshot shows the router's web interface. At the top, there are navigation tabs: **DSL-2640B**, **SETUP**, **ADVANCED**, **MAINTENANCE**, and **STATUS**. The **STATUS** tab is selected. On the left side, there is a sidebar menu with options: **Device Info**, **Connected Clients**, **Statistics** (highlighted), **Routing Info**, and **Logout**. Below the menu is an **Internet Online** indicator and a language dropdown set to **English**. The main content area is titled **STATISTICS** and contains a message: "This information reflects the current status of your router." Below this is the **WAN STATISTICS** section, which features a table with the following data:

Service	VPI/VCI	Protocol	Received				Transmitted			
			Bytes	Pkts	Errs	Drops	Bytes	Pkts	Errs	Drops
wizard_pvc	1/40	PPPoE	0	0	0	0	0	0	0	0

LAN STATISTICS

This window displays LAN information.

The screenshot shows the **LAN STATISTICS** section of the router's web interface. It contains a table with the following data:

Interface	Received				Transmitted			
	Bytes	Pkts	Errs	Drops	Bytes	Pkts	Errs	Drops
Ethernet	552229	5285	0	0	4529910	6282	0	0
Wireless	108377	918	0	0	342146	1491	10	0

Section 4 - Troubleshooting

ADSL STATISTICS

This window displays ADSL information including Link Rate, SNR, and some Error Counters.

ADSL STATISTICS		
Mode:	G.DMT	
Type:	Interleave	
Line Coding:	Trellis On	
Status:	No Defect	
	Downstream	Upstream
Rate (Kbps):	7616	800
SNR Margin (dB):	22.5	13.0
Attenuation (dB):	1.0	2.0
Output Power (dBm):	11.9	7.8
Super Frames:	390165	390163
Super Frame Errors:	0	0
RS Words:	26531286	3316385
RS Correctable Errors:	0	0
RS Uncorrectable Errors:	0	N/A
HEC Errors:	0	0
OCD Errors:	0	0
LCD Errors:	0	0
Total Cells:	119141113	0
Data Cells:	9117	0
Bit Errors:	0	0
Total ES:	0	0
Total SES:	0	0
Total UAS:	15	0

ROUTING INFO

This page displays the routing table of your router

To access the **ROUTING INFO** setting window, click on the **ROUTING INFO** button in the **STATUS** directory.

DEVICE INFO -- ROUTE

This window displays a table containing the routing information of the router

DSL-2640B
SETUP
ADVANCED
MAINTENANCE
STATUS

Device Info

Connected Clients

Statistics

Routing Info

Logout



English ▾

Reboot

ROUTING

The Routing Info page allows you to check the routing table of your router.
 Flags: U - up, ! - reject, G - gateway, H - host, R - reinstate
 D - dynamic (redirect), M - modified (redirect).

DEVICE INFO -- ROUTE

Destination	Gateway	Subnet Mask	Flags	Metric	Service
61.229.168.254	0.0.0.0	255.255.255.255	UH	0	wizard_pvc
192.168.1.0	0.0.0.0	255.255.255.0	U	0	
0.0.0.0	61.229.168.254	0.0.0.0	UG	0	wizard_pvc

Troubleshooting

This chapter provides solutions to problems that can occur during the installation and operation of the DSL-2640B. Read the following descriptions if you are having problems. (The examples below are illustrated in Windows® XP. If you have a different operating system, the screenshots on your computer will look similar to the following examples.)

1. Why can't I access the web-based configuration utility?

When entering the IP address of the D-Link router (192.168.1.1 for example), you are not connecting to a website on the Internet or have to be connected to the Internet. The device has the utility built-in to a ROM chip in the device itself. Your computer must be on the same IP subnet to connect to the web-based utility.

- Make sure you have an updated Java-enabled web browser. We recommend the following:
 - Internet Explorer 6.0 or higher
 - Firefox 1.5 or higher
- Verify physical connectivity by checking for solid link lights on the device. If you do not get a solid link light, try using a different cable or connect to a different port on the device if possible. If the computer is turned off, the link light may not be on.
- Disable any internet security software running on the computer. Software firewalls such as Zone Alarm, Black Ice, Sygate, Norton Personal Firewall, and Windows® XP firewall may block access to the configuration pages. Check the help files included with your firewall software for more information on disabling or configuring it.

Section 4 - Troubleshooting

- Configure your Internet settings:
 - Go to **Start > Settings > Control Panel**. Double-click on the **Internet Options** icon. From the **Security** tab, click on the button to restore the settings to their defaults.
 - Click on the **Connection** tab and set the dial-up option to Never Dial a Connection. Click on the LAN Settings button. Make sure nothing is checked. Click on the **OK**.
 - Go to the **Advanced** tab and click on the button to restore these settings to their defaults. Click on the **OK** button three times.
 - Close your web browser (if open) and open it.
- Access the web management. Open your web browser and enter the IP address of your D-Link router in the address bar. This should open the login page for the web management.
- If you still cannot access the configuration, unplug the power to the router for 10 seconds and plug back in. Wait about 30 seconds and try accessing the configuration. If you have multiple computers, try connecting using a different computer.

2. What can I do if I forgot my password?

If you forgot your password, you must reset your router. Unfortunately this process will change all your settings back to the factory defaults.

To reset the router, locate the reset button (hole) on the rear panel of the unit. With the router powered on, use a paperclip to hold the button down for 5-7 seconds. Release the button and the router will go through its reboot process.

Wait about 30 seconds to access the router. The default IP address is 192.168.1.1. When logging in, type in the default User Name “admin,” and the default Password “admin” then click on the OK button to access the web-based manager.

Wireless Basics

D-Link wireless products are based on industry standards to provide easy-to-use and compatible high-speed wireless connectivity within your home, business or public access wireless networks. Strictly adhering to the IEEE standard, the D-Link wireless family of products will allow you to securely access the data you want, when and where you want it. You will be able to enjoy the freedom that wireless networking delivers.

A wireless local area network (WLAN) is a cellular computer network that transmits and receives data with radio signals instead of wires. Wireless LANs are used increasingly in both home and office environments, and public areas such as airports, coffee shops and universities. Innovative ways to utilize WLAN technology are helping people to work and communicate more efficiently. Increased mobility and the absence of cabling and other fixed infrastructure have proven to be beneficial for many users.

Wireless users can use the same applications they use on a wired network. Wireless adapter cards used on laptop and desktop systems support the same protocols as Ethernet adapter cards.

Under many circumstances, it may be desirable for mobile network devices to link to a conventional Ethernet LAN in order to use servers, printers or an Internet connection supplied through the wired LAN. A Wireless Router is a device used to provide this link.

What is Wireless?

Wireless or Wi-Fi technology is another way of connecting your computer to the network without using wires. Wi-Fi uses radio frequency to connect wirelessly, so you have the freedom to connect computers anywhere in your home or office network.

Why D-Link Wireless?

D-Link is the worldwide leader and award winning designer, developer, and manufacturer of networking products. D-Link delivers the performance you need at a price you can afford. D-Link has all the products you need to build your network.

How does wireless work?

Wireless works similar to how cordless phone work, through radio signals to transmit data from one point A to point B. But wireless technology has restrictions as to how you can access the network. You must be within the wireless network range area to be able to connect your computer. There are two different types of wireless networks Wireless Local Area Network (WLAN), and Wireless Personal Area Network (WPAN).

Wireless Local Area Network (WLAN)

In a wireless local area network, a device called an Access Point (AP) connects computers to the network. The access point has a small antenna attached to it, which allows it to transmit data back and forth over radio signals. With an indoor access point as seen in the picture, the signal can travel up to 300 feet. With an outdoor access point the signal can reach out up to 30 miles to serve places like manufacturing plants, industrial locations, college and high school campuses, airports, golf courses, and many other outdoor venues.

Wireless Personal Area Network (WPAN)

Bluetooth is the industry standard wireless technology used for WPAN. Bluetooth devices in WPAN operate in a range up to 30 feet away. Compared to WLAN the speed and wireless operation range are both less than WLAN, but in return it doesn't use nearly as much power which makes it ideal for personal devices, such as mobile phones, PDAs, headphones, laptops, speakers, and other devices that operate on batteries.

Who uses wireless?

Wireless technology has become so popular in recent years that almost everyone is using it, whether it's for home, office, business, D-Link has a wireless solution for it.

Home

- Gives everyone at home broadband access
- Surf the web, check email, instant message, download multimedia files.
- Gets rid of the cables around the house
- Simple and easy to use

Small Office and Home Office

- Stay on top of everything at home as you would at the office
- Remotely access your office network from home
- Share the Internet connection and printer with multiple computers
- No need to dedicate office space

Where is wireless used?

Wireless technology is expanding everywhere not just at home or office. People like the freedom of mobility and it's becoming so popular that more and more public facilities now provide wireless access to attract people. The wireless connection in public places is usually called "hotspots".

Appendix A - Wireless Basics

Using a D-Link Cardbus Adapter with your laptop, you can access the hotspot to connect to Internet from remote locations like: Airports, Hotels, Coffee Shops, Libraries, Restaurants, and Convention Centers.

Wireless network is easy to setup, but if you're installing it for the first time it could be quite a task not knowing where to start. That's why we've put together a few setup steps and tips to help you through the process of setting up a wireless network.

Tips

Here are a few things to keep in mind, when you install a wireless network.

Centralize your router or Access Point

Make sure you place the router/access point in a centralized location within your network for the best performance. Try to place the router/access point as high as possible in the room, so the signal gets dispersed throughout your home. If you have a two-story home, you may need a repeater to boost the signal to extend the range.

Eliminate Interference

Place home appliances such as cordless telephones, microwaves, and televisions as far away as possible from the router/access point. This would significantly reduce any interference that the appliances might cause since they operate on same frequency.

Security

Don't let you next-door neighbors or intruders connect to your wireless network. Secure your wireless network by turning on the WPA security feature on the router. Refer to product manual for detail information on how to set it up.

Wireless Modes

There are basically two modes of networking:

- **Infrastructure** – All wireless clients will connect to an access point or wireless router.
- **Ad-Hoc** – Directly connecting to another computer, for peer-to-peer communication, using wireless network adapters on each computer, such as two or more D-Link wireless network adapters.

An Infrastructure network contains an Access Point or wireless router. All the wireless devices, or clients, will connect to the wireless router or access point.

An Ad-Hoc network contains only clients, such as laptops with wireless cardbus adapters. All the adapters must be in Ad-Hoc mode to communicate.

Networking Basics

Check your IP address

After you install your new D-Link adapter, by default, the TCP/IP settings should be set to obtain an IP address from a DHCP server (i.e. wireless router) automatically. To verify your IP address, please follow the steps below.

Click on **Start > Run**. In the run box type **cmd** and click on the **OK**.

At the prompt, type **ipconfig** and press **Enter**.

This will display the IP address, subnet mask, and the default gateway of your adapter.

If the address is 0.0.0.0, check your adapter installation, security settings, and the settings on your router. Some firewall software programs may block a DHCP request on newly installed adapters.

If you are connecting to a wireless network at a hotspot (e.g. hotel, coffee shop, airport), please contact an employee or administrator to verify their wireless network settings.

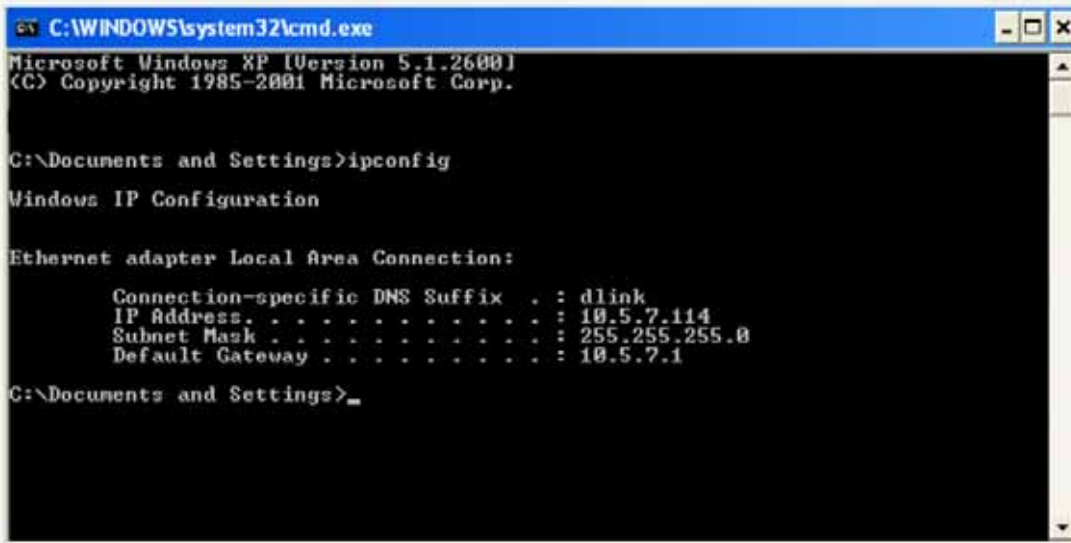

```
C:\WINDOWS\system32\cmd.exe
Microsoft Windows XP [Version 5.1.2600]
(C) Copyright 1985-2001 Microsoft Corp.

C:\Documents and Settings>ipconfig

Windows IP Configuration

Ethernet adapter Local Area Connection:

    Connection-specific DNS Suffix  . : dlink
    IP Address. . . . .               : 10.5.7.114
    Subnet Mask . . . . .            : 255.255.255.0
    Default Gateway . . . . .        : 10.5.7.1

C:\Documents and Settings>
```

Statically Assign an IP address

If you are not using a DHCP capable gateway/router, or you need to assign a static IP address, please follow the steps below:

Step 1

Windows® XP - Click on **Start > Control Panel > Network Connections**.

Windows® 2000 - From the desktop, right-click on the **My Network Places > Properties**.

Step 2

Right-click on the **Local Area Connection** which represents your D-Link network adapter and select **Properties**.

Step 3

Highlight **Internet Protocol (TCP/IP)** and click on the **Properties**.

Step 4

Click on the **Use the following IP address** and enter an IP address that is on the same subnet as your network or the LAN IP address on your router.

Example: If the router's LAN IP address is 192.168.1.1, make your IP address 192.168.1.X where X is a number between 2 and 99. Make sure that the number you choose is not in use on the network. Set Default Gateway the same as the LAN IP address of your router (192.168.1.1).

Set Primary DNS the same as the LAN IP address of your router (192.168.1.1). The Secondary DNS is not needed or you may enter a DNS server from your ISP.

Step 5

Click on the **OK** twice to save your settings.

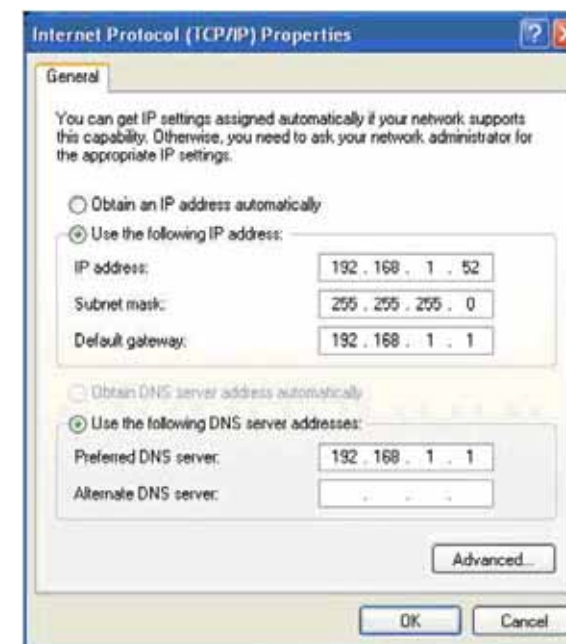

Technical Specifications

ADSL Standards

- ANSI T1.413 Issue 2
- ITU G.992.1 (G.dmt) Annex A
- ITU G.992.2 (G.lite) Annex A
- ITU G.994.1 (G.hs)
- ITU G.992.5 Annex A

ADSL2 Standards

- ITU G.992.3 (G.dmt.bis) Annex A
- ITU G.992.4 (G.lite.bis) Annex A

Protocols

- IEEE 802.1d Spanning Tree
- TCP/UDP
- ARP
- RARP
- ICMP
- RFC1058 RIP v1
- RFC1213 SNMP v1 & v2c
- RFC1334 PAP
- RFC1389 RIP v2
- RFC1483/2684 Multiprotocol Encapsulation over ATM Adaptation Layer 5 (AAL5)
- RFC1994 CHAP
- RFC2131 DHCP Client / DHCP Server
- RFC2364 PPP over ATM
- RFC2516 PPP over Ethernet

Data Transfer Rate

- G.dmt full rate downstream: up to 8 Mbps / upstream: up to 1 Mbps
- G.lite: ADSL downstream up to 1.5 Mbps / upstream up to 512 Kbps
- G.dmt.bis full rate downstream: up to 12 Mbps / upstream: up to 12 Mbps
- ADSL full rate downstream: up to 24 Mbps / upstream: up to 1 Mbps

Media Interface

- ADSL interface: RJ-11 connector for connection to 24/26 AWG twisted pair telephone line
- LAN interface: RJ-45 port for 10/100BASE-T Ethernet connection

WIRELESS LAN

- 802.11b/g standards
- Wireless speed: up to 54Mbps (802.11G)
- Frequency range: 2.4 GHz to 2.484G Hz
- Antenna: 1 detachable dipole antenna.
- WEP data encryption
- WPA/WPA2 (Wi-Fi Protected Access) security
- Multiple SSID
- 802.11e Wireless QoS (WMM/WME)
- MAC address-based access control

* Maximum wireless signal rate derived from IEEE Standard 802.11g specifications. Actual data throughput will vary. Network conditions and environmental factors, including volume of network traffic, building materials and construction, and network overhead, lower actual data throughput rate. Environmental factors will adversely affect wireless signal range.

Contacting Technical Support

You can find software updates and user documentation on the D-Link websites.

If you require product support, we encourage you to browse our FAQ section on the Web Site before contacting the Support line.

We have many FAQ's which we hope will provide you a speedy resolution for your problem.

For Customers within the United Kingdom & Ireland:

D-Link UK & Ireland Technical Support over the Internet:

<http://www.dlink.co.uk>

<ftp://ftp.dlink.co.uk>

D-Link UK & Ireland Technical Support over the Telephone:

08456 12 0003 (United Kingdom)

+1890 886 899 (Ireland)

Lines Open

8.00am-10.00pm Mon-Fri

10.00am-7.00pm Sat & Sun

For Customers within Canada:

D-Link Canada Technical Support over the Telephone:

1-800-361-5265 (Canada)

Mon. to Fri. 7:30AM to 9:00PM EST

D-Link Canada Technical Support over the Internet:

<http://support.dlink.ca>

email: support@dlink.ca