

# Access Point/Wireless Router with Power over Ethernet (PoE) Open Source

By *Emanuele*

Created *May 5 2009 - 08:41*

The [MPC8377EWLAN](#) [1] access point/router is a complete production-ready, BOM (Bill of Materials)-optimized reference design solution capable of supporting wireless data rates up to 600 Mbps is suited to maximize performance while still meeting the required power and cost budgets required by this application.



## Application Challenges

- ? WLAN market is highly competitive and customers are requiring turn-key solutions from vendors
- ? Ability to power devices over ethernet with maximum operating efficiencies
- ? Ability to stream data wirelessly with little interruption
- ? Ability to secure data streams using high levels of encryption



## Device Advantages

- ? Time to market, class B certified production ready system
- ? Support for Power over Ethernet and 802.11N
- ? Based on market-proven open source software
- ? Atheros and Ralink Support for wireless
- ? Variable applications depending on configuration

## MPC8377EWLAN - Hardware Features

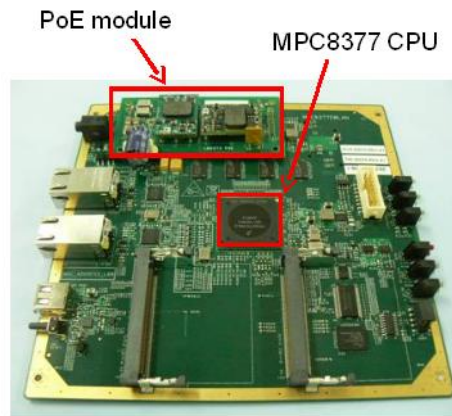

- ? Memory subsystem
  - ? 256MB to 512MB DDR2 SDRAM
  - ? 32MB to 64MB NOR FLASH
- ? Interfaces (Internal)
  - ? 2 x MiniPCI
  - ? 2 x MiniPCI-Express
  - ? RS232
- ? Interfaces (External)
  - ? 2 x 10/100/1000 Base-T
  - ? USB 2.0 Type A connector
- ? Power over Ethernet
  - ? IEEE 802.3af compliant 3 x 3 MIMO solution
- ? MPC8377E PQII Pro CPU
- ? 667MHz Core Frequency
- ? 400MHz DDR2 interface;
- ? CE/FCC Class B certified
- ? Lead Free (ROHS)
- ? 6-Layer mini-ITX form factor PCB
- ? BOM Cost <\$119 for 25Ku+/yr

## Wireless Security

- ? Pre-Shared Key (PSK)
- ? Wi-Fi® Protected Access 2 (WPA2)
- ? 802.11i AES-CCMP
- ? Wired Equivalent Privacy (WEP) 128/256-bit
- ? 802.11i EAP authentication with RADIUS

# MPC8377EWLAN: Power over Ethernet (PoE)

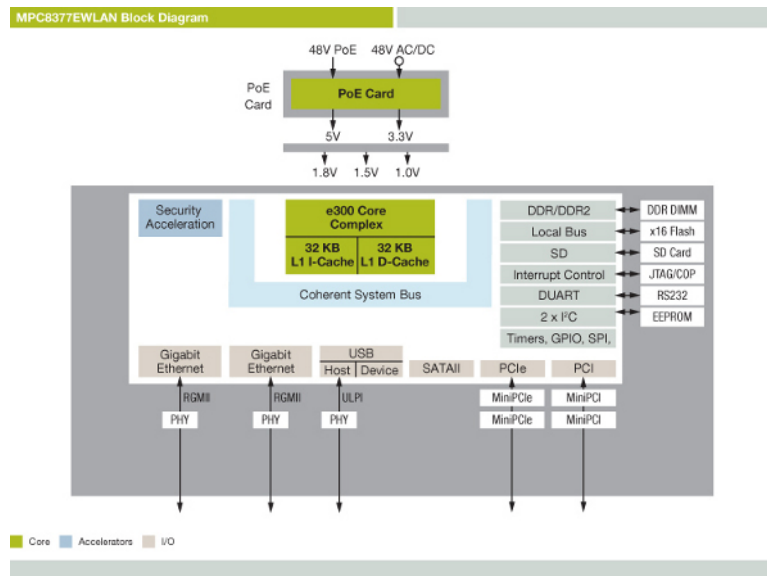

- Eliminates the need to run 110/220 VAC power to Wireless Access Points.
- Single CAT5 Ethernet cable carries both power and data
- Allows greater flexibility in the locating of Access Points
- Significantly decreasing installation costs
- IEEE 802.3af specifies 12.95W maximum power

## MPC8377E-WLAN Main Board Schematics

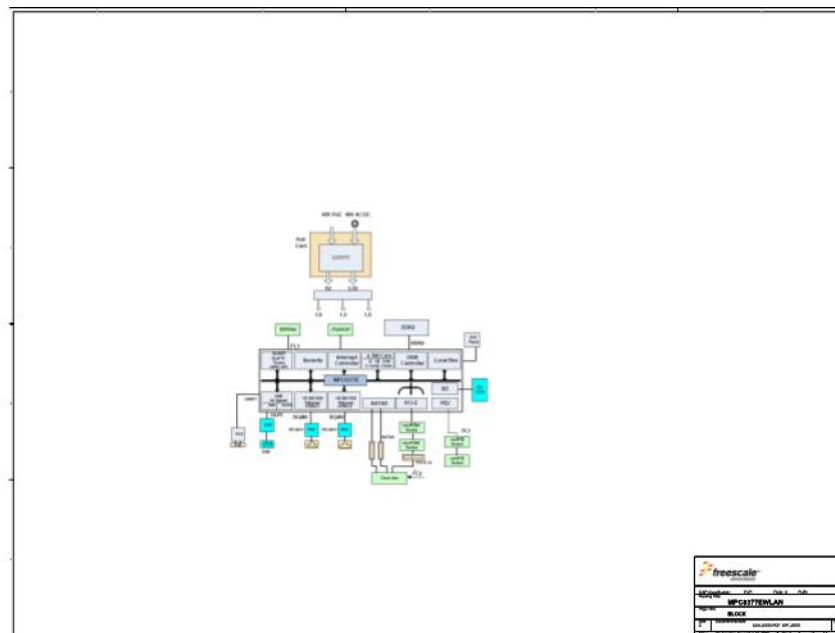

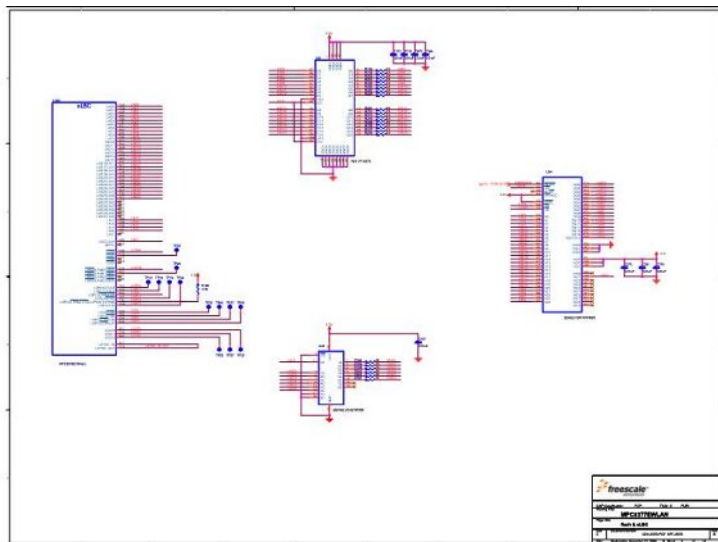
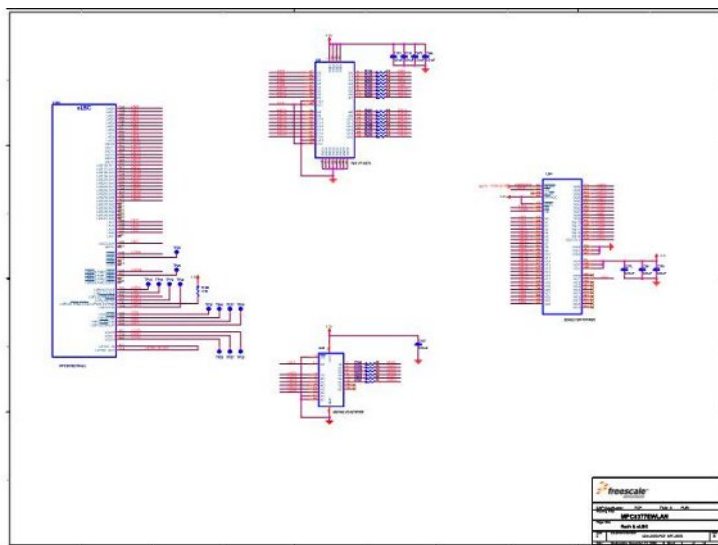
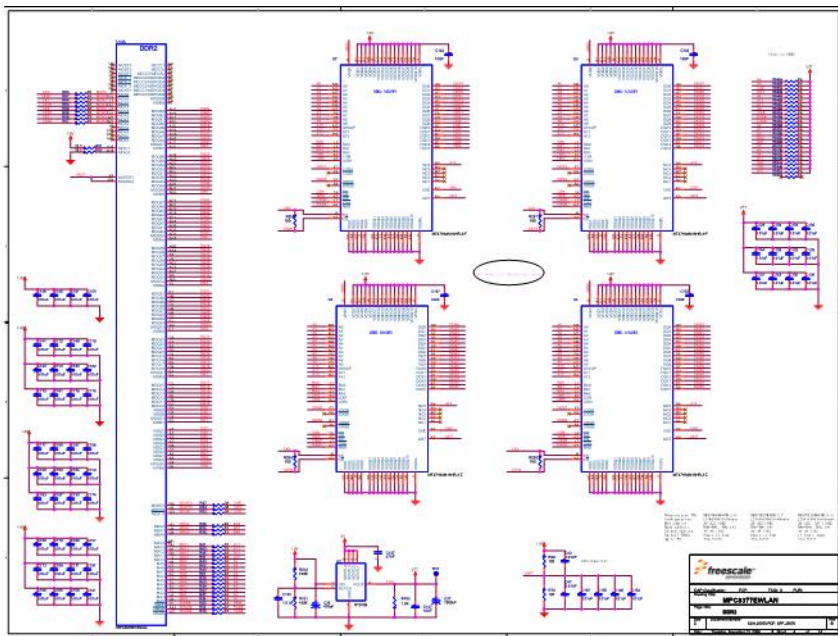







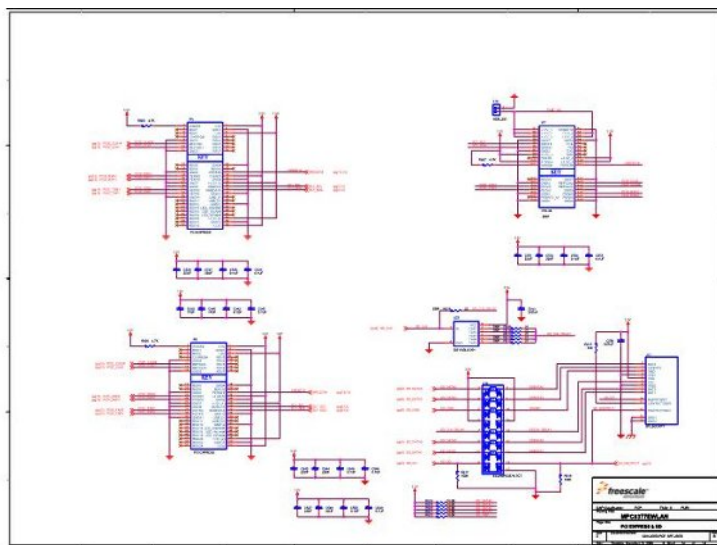
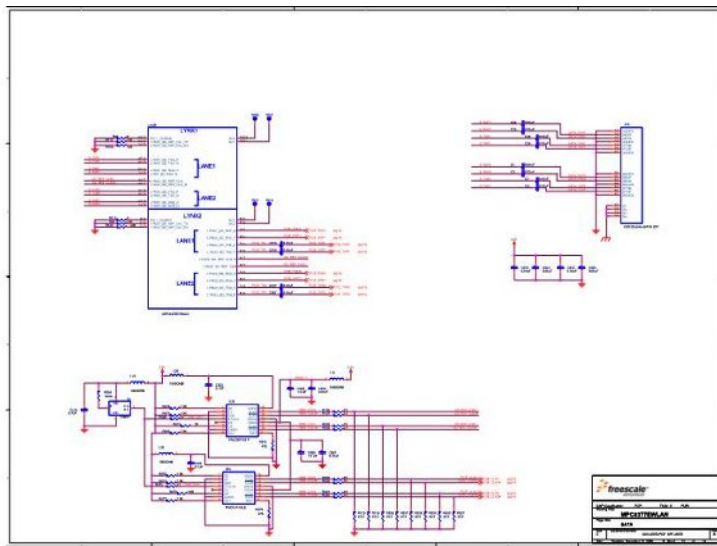

Click [here](#) [2] to see these schematics at high resolution

## MPC8377E-WLAN Power Card Schematics

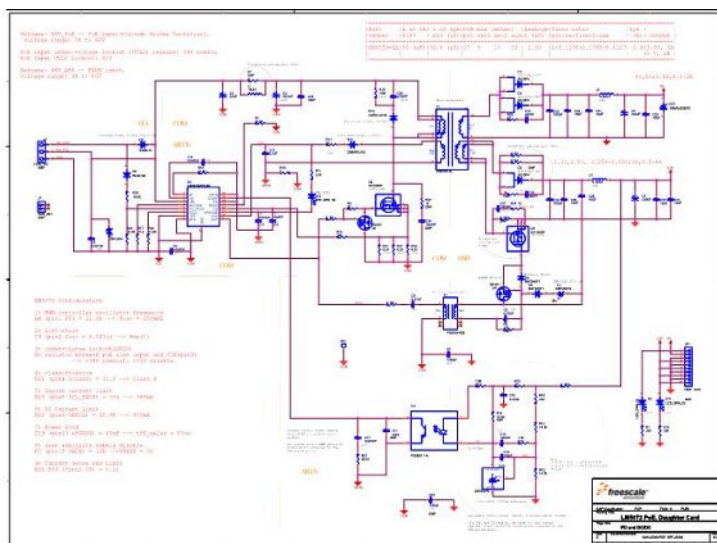

[High resolution](#) [3]

The **MPC8377EWLAN** can be used for intrusion detection or remote access point, wireless access, VPN router for secure remote access.

Read the Italian version: [Router wireless/Access point con PoE \(Power on Ethernet\) open source](#) [4]

## CONTACT REQUEST

If you want to know more about this **Freescale** product, please submit your request to **Arrow Italy** using [this form](#) [5].

**NOTE:** this form is valid ONLY for Companies or Customers based in Italy and working in the Italian area.

[Technology access point MPC8377EWLAN poe power over ethernet router](#)

Trademarks

---

**Source URL:** <http://dev.emcelettronica.com/access-pointwireless-router-power-over-ethernet-poe-open-source>

### Links:

[1]

[http://www.freescale.com/webapp/sps/site/prod\\_summary.jsp?code=MPC8377EWLAN&nodeId=0162468rH3bTdGJk19143](http://www.freescale.com/webapp/sps/site/prod_summary.jsp?code=MPC8377EWLAN&nodeId=0162468rH3bTdGJk19143)

[2]

[http://www.freescale.com/files/32bit/doc/support\\_info/MPC8377EWLANMAINBRDSCH.pdf?fpsp=1&WT\\_TYPE=Supporting Information&WT\\_VENDOR=FREESCALE&WT\\_FILE\\_FORMAT=pdf&WT\\_ASSET=Documentation](http://www.freescale.com/files/32bit/doc/support_info/MPC8377EWLANMAINBRDSCH.pdf?fpsp=1&WT_TYPE=Supporting Information&WT_VENDOR=FREESCALE&WT_FILE_FORMAT=pdf&WT_ASSET=Documentation)

[3]

[http://www.freescale.com/files/32bit/doc/support\\_info/MPC8377EWLANPWRCRDSCH.pdf?fpsp=1&WT\\_TYPE=Supporting Information&WT\\_VENDOR=FREESCALE&WT\\_FILE\\_FORMAT=pdf&WT\\_ASSET=Documentation](http://www.freescale.com/files/32bit/doc/support_info/MPC8377EWLANPWRCRDSCH.pdf?fpsp=1&WT_TYPE=Supporting Information&WT_VENDOR=FREESCALE&WT_FILE_FORMAT=pdf&WT_ASSET=Documentation)

[4] <http://it.emcelettronica.com/router-wirelessaccess-point-con-poe-power-ethernet-open-source>

[5] <http://it.emcelettronica.com/contact/freescale>