

A-26 INVADER

in action

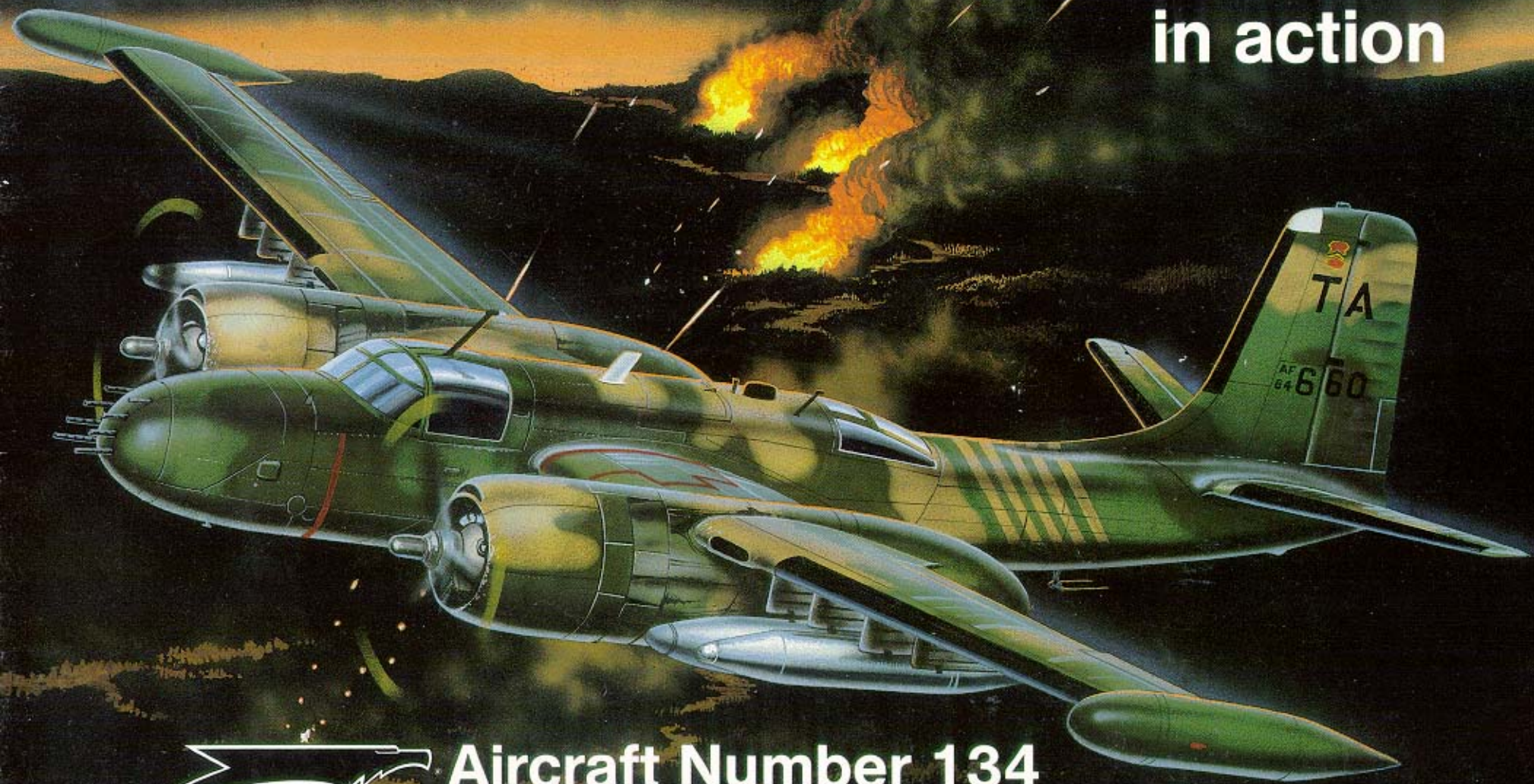

 Aircraft Number 134
squadron/signal publications



An A-26A (B-26K) of the 609th Special Operations Squadron, 56th Special Operations Wing, attacks targets along the Ho Chi Minh trail during 1969. The unit flew missions over Laos and North Vietnam from Nakhan Phanom Royal Thai Air Force Base using the call sign *Nimrod*.



Introduction

As war clouds began to gather over Europe during the late 1930s, certain American political and military leaders began to push for a modernization of the U.S. Armed Forces. These leaders realized that if fighting broke out, America would eventually become involved. The aviation industry, still caught up in the aftermath of the depression, was eager to submit new proposals to the government for consideration. One of the leading aviation companies, Douglas Aircraft, decided to design a new type of aircraft for the Army Air Corps: a light twin engine attack aircraft. Douglas felt that the single engine attack aircraft then in service would be obsolete in modern aerial warfare and a new approach was needed. The company decided to gamble on this decision and work began on the design before the Army even formulated a request for such an aircraft.

Eventually, under the direction of Jack Northrop and Ed Heinemann, the design emerged as the Model 7A. The Army, in the meantime, had formulated their requirements and these were issued in the Fall of 1937. Work began on a new version to meet this requirement without the help of Northrop who had decided to leave Douglas to form his own company. The new design, the Model 7B, went through a number of changes and finally evolved as the A-20 Havoc, one of the finest light bombers of Second World War.

As Douglas began production of the A-20, which first saw action in French service during the Spring of 1940, company officials began to formulate a new proposal for an aircraft to supplement the various twin engine light and medium bomber/attack aircraft then in service. During early 1941, Heinemann and project engineer Robert Donovan began work on this new aircraft. They decided to make the aircraft as advanced as possible and used various concepts and components which were considered state-of-the-art

The prototype XA-26 flies over California during the initial flight testing of the new Douglas aircraft. The aircraft made its first flight on 10 July 1942 with Ben Howard at the controls. Howard enthusiastically told Army officials that the A-26 was ready for service but, unfortunately, it would not see widespread use until the last ten months of the war. (AFM)



for the time. The twin engine design that evolved featured a mid-mounted, laminar flow airfoil wing fitted with double slotted, electrically operated flaps. In order to streamline the aircraft and conserve weight, defensive armament was concentrated in remote controlled dorsal and ventral turrets which were under the control of a gunner in the rear fuselage. Certain features from the A-20 design were also incorporated, including a tri-cycle landing gear, a large bomb bay in the fuselage and additional bomb racks under the wings. The aircraft was to be powered by two 2,000 hp eighteen cylinder Pratt and Whitney R-2800 air-cooled radial engines.

With the basic layout in hand, work began on the construction of a full scale mockup. Officials from the Air Corps looked over the wood mockup during mid-April of 1941 and, liking what they saw, recommended that Douglas be given a contract to develop the design. Approval for two prototypes was received from Washington on 2 June and Douglas began work immediately on the prototypes. At the end of June, Douglas was informed that the Army wanted a third prototype and the initial contract was changed to incorporate this increase. The new aircraft was designated the XA-26 and the three prototypes were to be built at Douglas, El Segundo Division. As a result each prototype had the letters -DE added to their designation which stood for Douglas, El Segundo.

Heinemann and his design team had engineered the XA-26 so that the basic aircraft could be easily modified to fill a variety of roles with relatively minor changes. The initial prototype, the XA-26-DE, was a three-man attack bomber with a transparent nose for the bombardier/navigator. The second aircraft, the XA-26A-DE, was a two-man night-fighter which carried an AI radar in the nose and four 20MM cannons in a ventral tray under the bomb bay. The last prototype, the XA-26B-DE, carried a three man crew like

The second prototype, the XA-26A, was designed as a night fighter with an AI radar in the nose. Armament consisted of a ventral gondola housing four 20MM cannons under the bomb bay, along with the dorsal machine gun turret. It never went into production since it offered no significant improvement over the Northrop P-61 Black Widow. (AFM)



the XA-26-DE, but replaced the clear nose with a solid nose which could be equipped with various armament options.

As U. S. involvement in the ever widening conflict in Europe and Asia became a certainty, Air Corps officials issued Douglas a contract for 500 A-26s. The contract, issued in October of 1941, was let before the first prototype was completed. Despite the need for new equipment, however, Douglas was also given additional orders for A-20s so that the Army would at least have some aircraft ready for action when the war broke out. This later turned out to be a wise precaution.

Work progressed on the three prototypes rather slowly, particularly in light of the fact that the U. S. was now in the war (the Japanese attack on Pearl Harbor came a little over a month after Douglas received the Army contract). Eventually, the first prototype was ready and it was rolled out of the El Segundo plant during June of 1942. The first flight took place on 10 July when Douglas test pilot Ben Howard put the XA-26 through its paces for a crowd of Douglas and Army officials. This first flight went off without major problems, prompting Howard to tell the Air Corps observers that the ship was ready for duty. Unfortunately, his enthusiastic appraisal was unrealistic and it would be nearly two years until the A-26 would see service.

Most of the initial flight testing was done with the first XA-26. Some difficulties did arise, the most serious being an engine cooling problem which was solved by the removal of the large propeller spinners and making minor changes to the cowling. Gradually the first prototype underwent changes to approximate more closely the production aircraft. It was eventually joined in the test program by the night fighter and solid nose variants, although the lions share of flight test work was done with the XA-26. Aside from the cooling difficulty, no additional major problems were discovered although, as in the case with most new aircraft, numerous minor problems arose. While the three prototypes all met the specification, the Army opted to only place the XA-26-DE and XA-26B into production. The XA-26A night-fighter was cancelled since it offered no significant improvement over the Northrop XP-61 Black Widow which had begun flight testing some two months earlier than the XA-26.

The final prototype was the XA-26B which had a solid nose that could be fitted with a variety of armament depending on the mission. This prototype was fitted with a 75mm cannon in addition to the four .50 caliber machine guns carried in the dorsal and ventral gun turrets. (AFM)



With the elimination of the night-fighter variant, the only significant detail left to be decided was what type of armament the XA-26B was to carry. The prototype was initially fitted with a 75mm cannon in the lower starboard side of the nose; however, the A-26B was so designed that a variety of cannon/machine gun arrangements could be carried, which proved to be a rather difficult decision to reach. Eventually, production models were fitted with either a six or eight .50 caliber machine gun nose, since the cannon was found to have too slow a rate of fire.

As the prototypes were being tested, Douglas began to gear up for production of the A-26 in both the A-26C glass and A-26B solid nose models, which were given the name Invader by the Army. At first it was thought that both versions would be built concurrently at the Douglas plants in Long Beach, California and Tulsa, Oklahoma. Eventually, this plan was revised, with Long Beach producing the A-26B and Tulsa the A-26C. Aircraft produced at Long Beach were labeled, DL, while those manufactured at Tulsa were labeled, DT.

Unfortunately, the high hopes for quick production never developed. Douglas, involved in massive wartime production of a variety of aircraft for the military, could not assign as many engineers as the program needed. In addition, a lack of manufacturing equipment hampered construction at both plants. Finally, the type of nose the A-26B was to be equipped with could not be decided on by the Army, resulting in further delays. As a result of these factors, the prototype which Ben Howard described as ready to go in July of 1942 did not go into full scale production until September of 1943. The aircraft did not see widespread service until over a year later. Nevertheless, the XA-26 had showed tremendous potential and would eventually justify the high praise Howard paid them on that hot July day in 1942.

To help streamline the 75mm cannon barrel and keep out debris, retractable petal type flaps were fitted over it when it was not in use. The cannon barrel protruded through the flaps when the weapon was made ready for firing. (AFM)

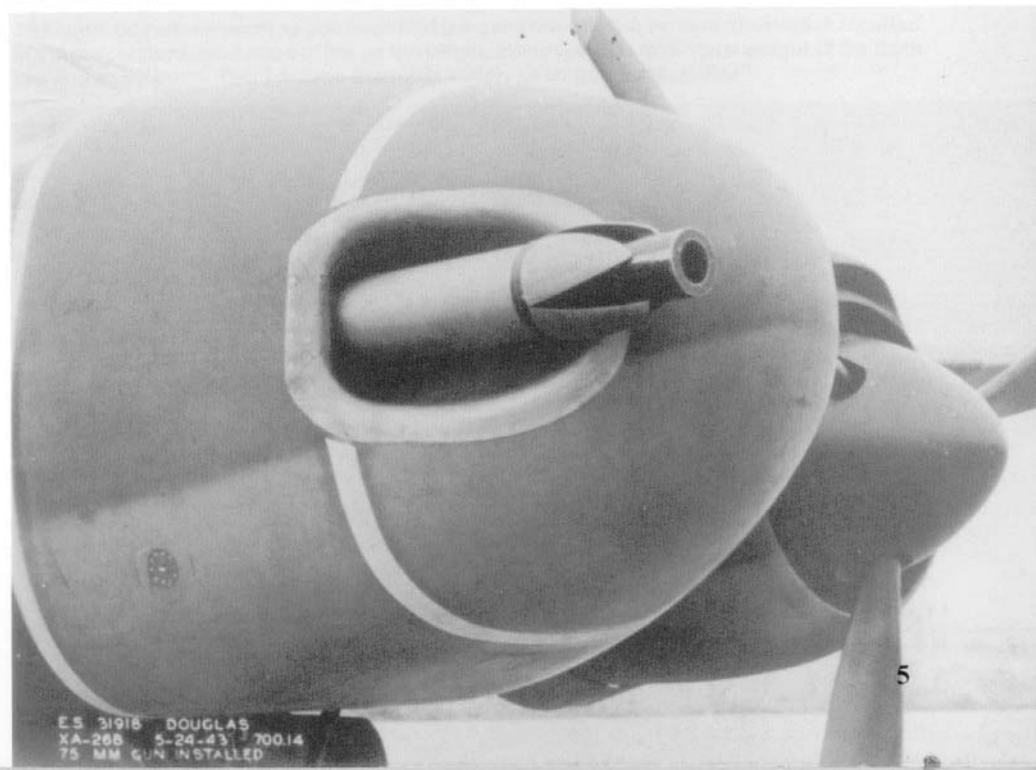

Development

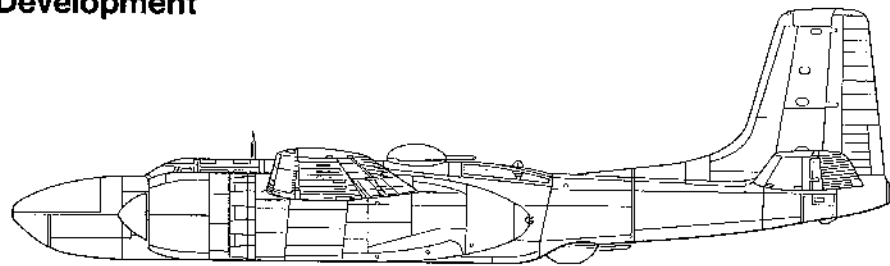

XA-26

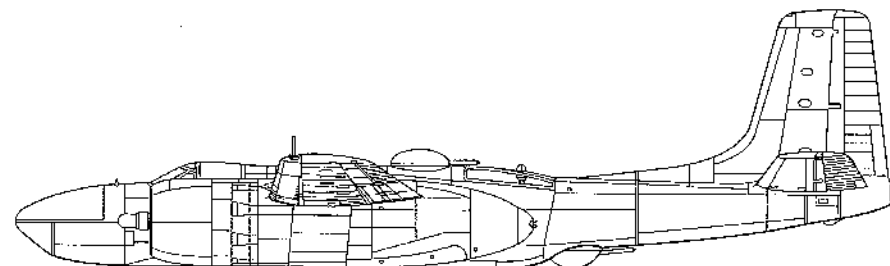

A-26C

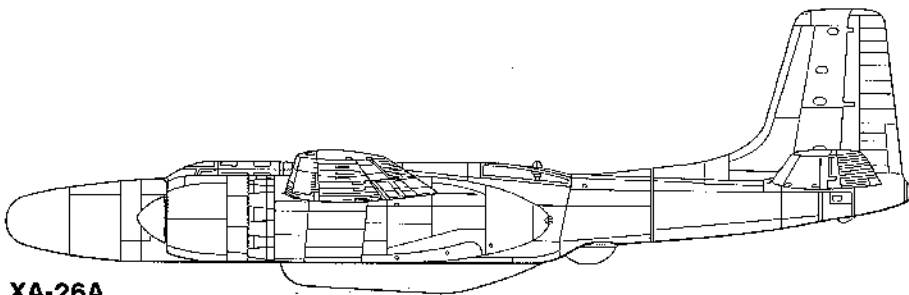

XA-26A

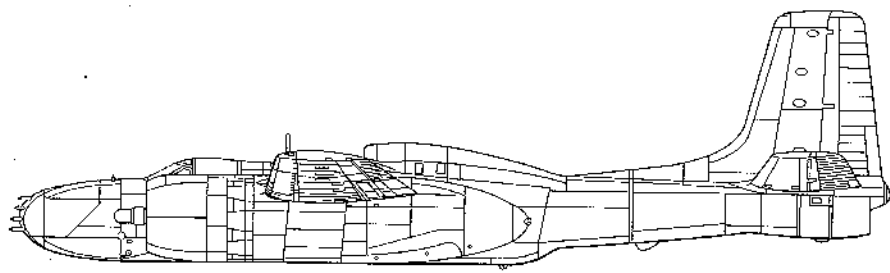

XA-26F

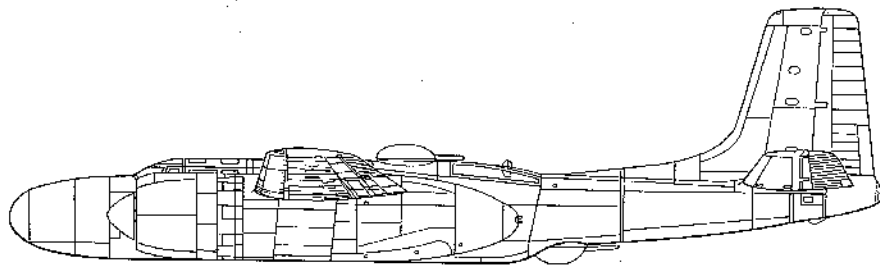

XA-26B

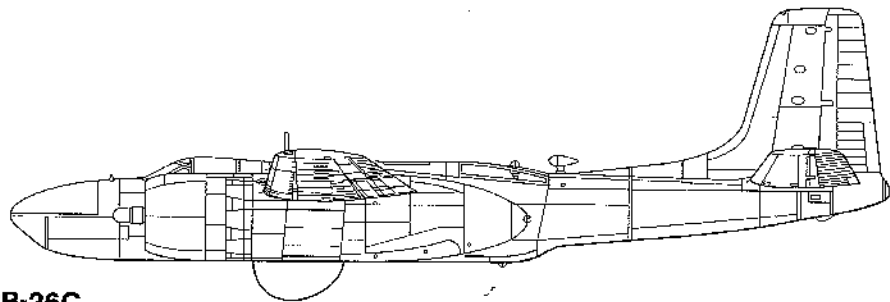

RB-26C

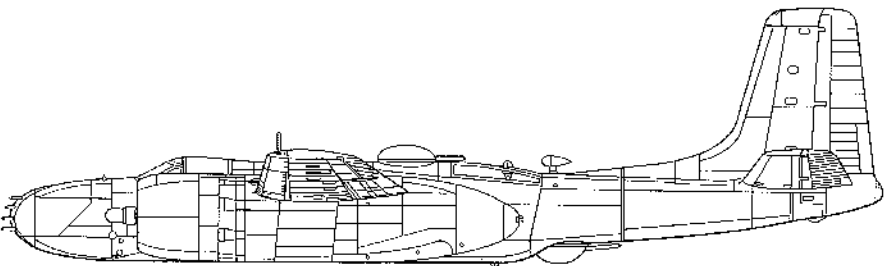

A-26B (Late)

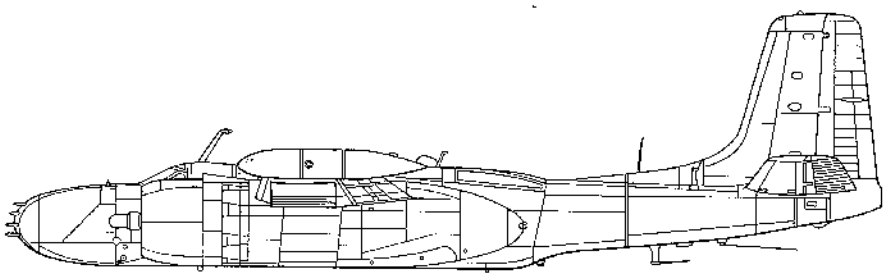

B-26K (A-26A)

A-26B Invader

With the cancellation of the XA-26A night-fighter variant there was no production A-26A. The A-26B, which was based on the third prototype, was very similar to the XA-26B with only a few external changes. The production aircraft differed from the prototype in that the large propeller spinners were deleted and the cowling was slightly revised. After much consideration, Army officials decided to opt for a six .50 caliber machine gun nose which mounted four guns on the starboard side and two on the port side in a staggered arrangement. Later, this would be changed to eight .50 caliber machine guns mounted in two rows of four arranged vertically on either side of the nose centerline. The eight gun nose came about after a mockup was built by Douglas which had this arrangement coupled with the standard six gun arrangement for a total of fourteen .50 caliber machine guns. This would have given the Invader one of the most awesome concentrations of firepower of any Second World War II aircraft, but this option was never accepted.

While the six and eight gun noses became standard for the A-26B, a number of different nose armament options were available and had been tested. These included: a 75MM cannon and two .50 caliber machine guns, a 75MM and 37MM cannon, two 37MM cannons and one 37MM cannon with either two or four .50 caliber machine guns. While tests on these various nose packages were fairly successful, it was felt that the all-machine gun armament provided the needed firepower with far simpler logistics.

In addition to its forward firing armament, the A-26B was also equipped with two remotely controlled turrets, mounted one above and one below and to the rear of the bomb-bay. These were controlled by a gunner who sat in a compartment just to the rear of the bomb bay. Sighting was done through a periscope sight arrangement similar to that used in the B-29. Although isolated in the back, the gunner could come forward by

carefully moving along the bomb bay to a small hatch located to the right and slightly behind the pilot's seat. Entrance to the gunner's compartment from the ground was through a small hatch on the starboard side of the fuselage. In an emergency, a jettisonable hatch was located on the upper canopy, in front of the periscope. To augment forward firepower, the upper turret could be traversed forward and fired by the pilot in conjunction with the nose guns.

Originally, provisions were made for the carrying of either one or two twin .50 caliber machine gun pods under each wing outboard of the engine nacelles. Ammunition for these guns was carried internally within the wing. While these were used quite frequently during early deployment of the aircraft, it was found that the gun pods (or tubs) caused substantial drag and a reduction in speed. As a result, Douglas mounted three .50 caliber machine guns in each wing which reduced drag significantly.

Like the prototypes, early A-26Bs were fitted with a heavy framed flat canopy over the cockpit which opened upward on the starboard side over the navigator's seat. This arrangement made it nearly impossible for the pilot to make an emergency exit from the aircraft. Additionally, the heavy canopy framing severely restricted visibility from the cockpit. Following complaints from the field, Douglas redesigned the canopy, eventually coming up with a clear clamshell style canopy which greatly increased visibility, gave the crew more headroom and allowed easier egress in case of an emergency. The new canopy became an immediate success and quickly came to be preferred by the crews to the older "flat top" type.

Production A-26Bs were powered by two 2,000 hp R-2800 radial engines, built by either Pratt and Whitney (R-2800-27) or Ford (R-2800-71). After the 700th production model, the Ford R-2800-79 replaced the earlier variants, since it produced the same horsepower but had water injection which boosted engine performance to 2,370 hp at sea level in case of an emergency. The A-26B also featured enlarged oil cooler air intakes on the wing

An early production A-26B flies over the California countryside during a flight test. The aircraft is fitted with the original "flat top" canopy and a six gun nose. The Invader was designed to use various nose gun arrangements; however, only two saw widespread use: the horizontal six gun nose or the later eight gun vertical layout. (Douglas)



The eight .50 caliber machine gun nose had the guns mounted in vertical rows which resulted in a more concentrated cone of fire on the target, along with the additional weight of fire from the two extra guns. This became the most widely used gun nose. (USAF)



outboard of the engine replacing the prototype's smaller, flush intakes. The new intake provided a significant improvement in general engine performance and load carrying capability.

The Invader's load carrying capability was impressive. The Invader had a total bomb load of 6,000 pounds, 4,000 pounds in the internal bomb bay and another 2,000 pounds on underwing racks outboard of the engine nacelles. This was an increase of some 1,000 pounds over the XA-26. Later in the production cycle, provisions were made for fitting zero length rocket launchers under the wings for 5 inch HVAR rockets.

The prototypes had a fuel capacity of approximately 1,000 gallons while production A-26Bs had additional internal fuel tanks that allowed the Invader to carry an additional 600 gallons of fuel. With the introduction of the eight gun nose variant, internal fuel capacity was again increased by another 300 gallons. Late production Invaders had the capability to be fitted with an additional 125 gallon tank at the rear of the bomb bay, raising total internal fuel capacity to over 2,000 gallons.

Production of the A-26B was concentrated primarily at the Douglas Long Beach plant where a total of 1,150 A-26B aircraft were built (along with five A-26Cs). An additional 205 A-26Bs were built at the Tulsa, Oklahoma plant for a grand total of 1,355 A-26Bs.

Armament

Standard

A-26B
(Early)

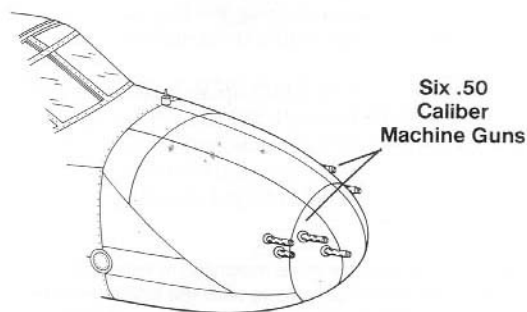

A-26B
(Late)

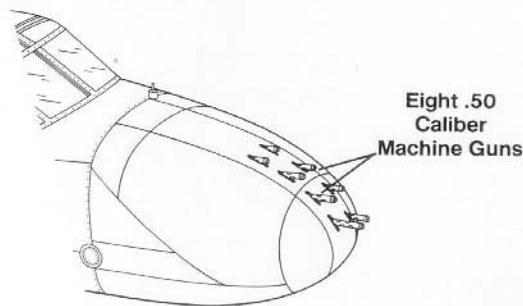

Optional

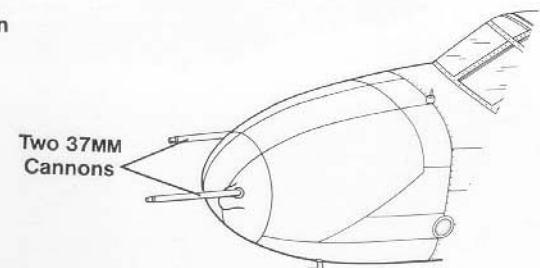
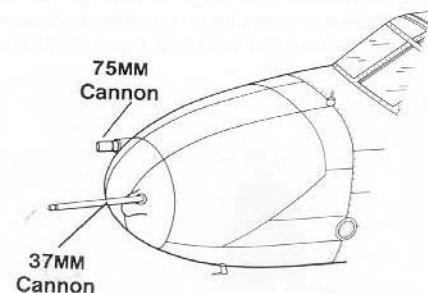
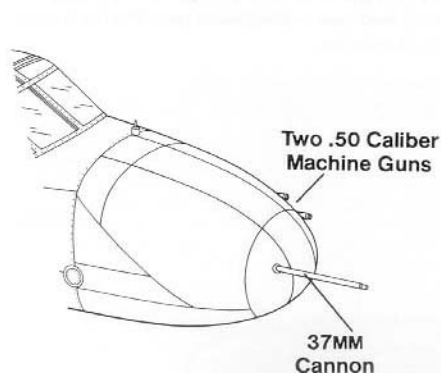
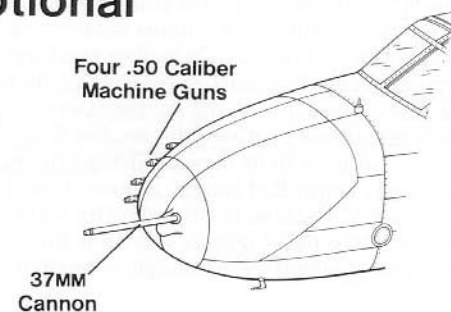
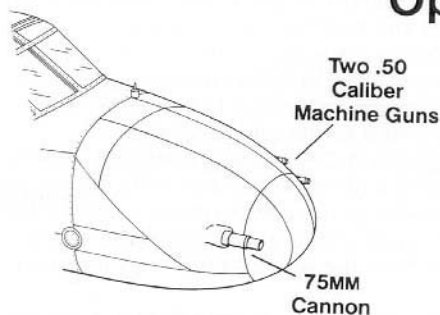

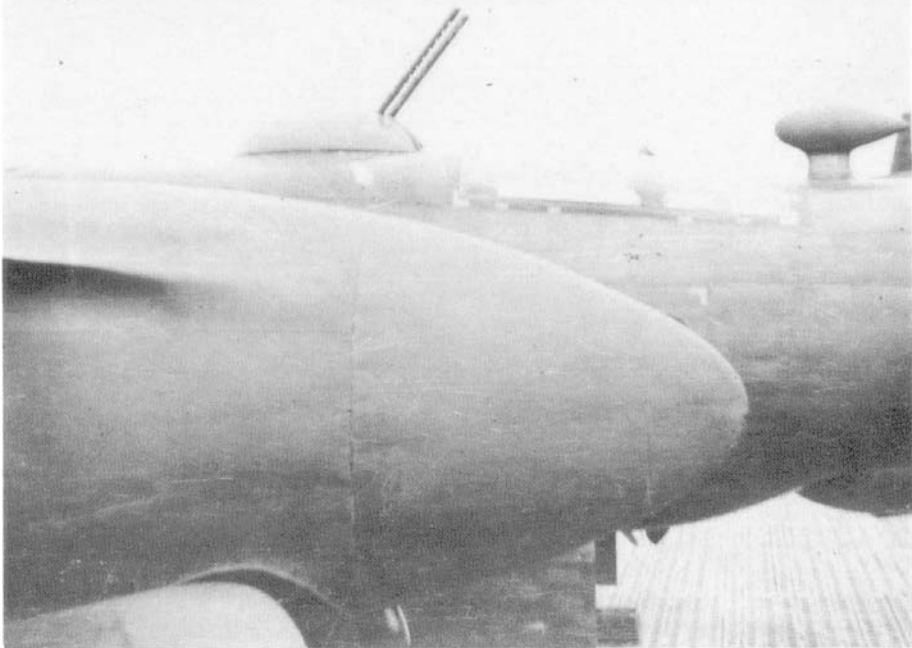

For defense, the A-26 was equipped with two remote controlled .50 caliber machine turrets which were operated by a gunner in a compartment in the rear fuselage behind the bomb bay. The top turret could also be rotated forward for use in strafing. (Schild via Squadron Archives)



To augment the Invader's forward firepower, one or two gun pods housing two .50 caliber machine guns each could be carried under the outboard wing panels. Each pod was fed ammunition from magazines in the wings. While the gun pods increased firepower, they cut the Invader's speed. (Mikesh)

Depending on the position of the target, both turrets could be aimed and fired in unison by the gunner. Both turrets on this A-26 are tracking a target at the 4 o'clock position during a training mission. (Mikesh)

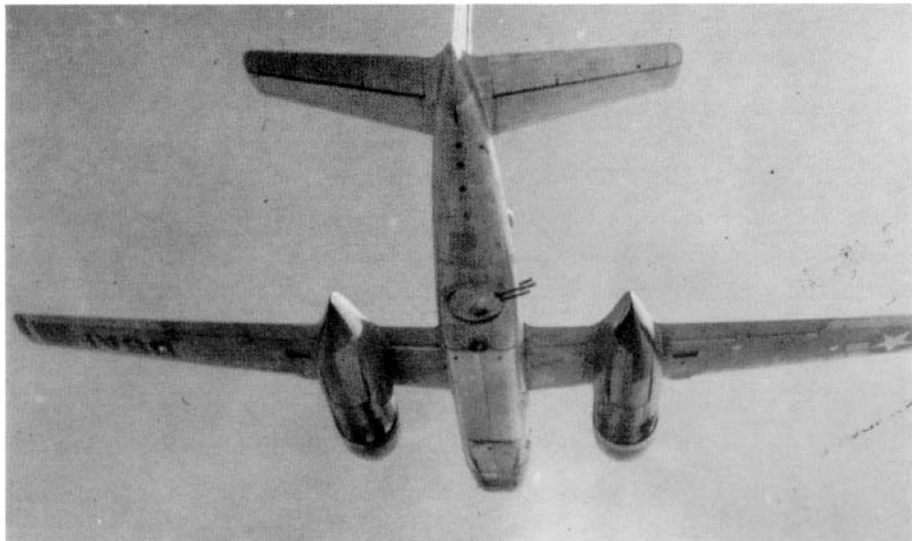

Gun Pod

A-26B
(Early)

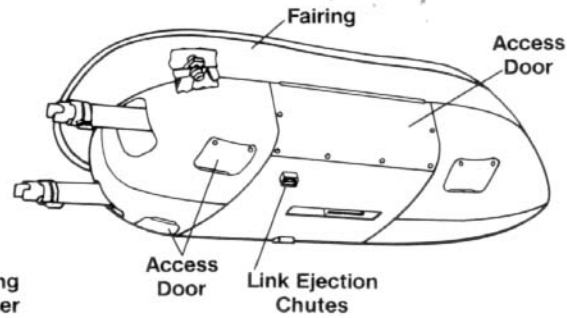

Two Browning
M2 .50 Caliber
Machine Guns

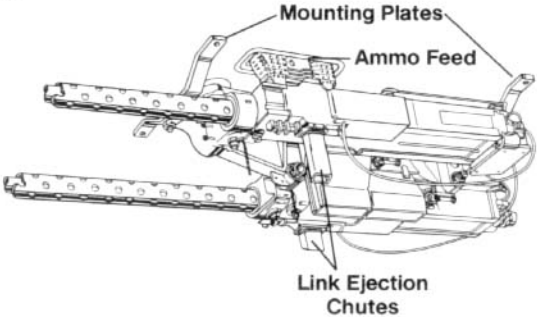

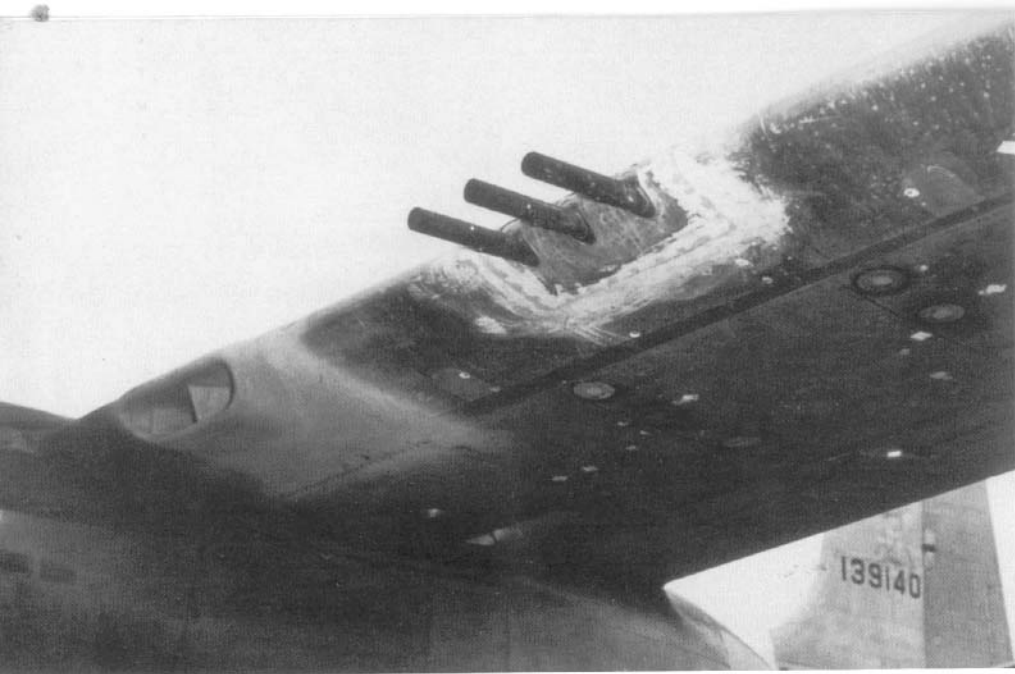

Later production aircraft had three .50 caliber machine guns mounted internally in the wings, eliminating the need for the underwing gun pods and the drag these pods caused. This gave the A-26B a total of fourteen forward firing .50 caliber machine guns. (Mikesh)



Early production Invaders were fitted with a heavy framed "flat top" style cockpit canopy which only opened on the right side. The heavy framing severely restricted the pilot's visibility. (Mikesh)

The three wing mounted .50 caliber machine guns were loaded from ammunition bins in the wing, in a similar fashion to the wing guns of fighter aircraft such as the P-51 Mustang or P-47 Thunderbolt. (USAF)



The heavy framed canopy opened upward on the starboard side, making escape during an emergency almost impossible for the pilot who was seated on the port side. (Mikesh)





On early A-26 Invaders a large piece of bulletproof glass could be positioned in front of the pilot for additional protection from flak or bullets. It is visible directly in front of the pilot of this early Invader of the 416th Bomb Group. (E. & K. Bishop)



Unlike the earlier canopy, the clear canopy opened outward to both sides, allowing easy escape for both crewmen. This "clamshell" style canopy quickly gained favor with the crews and was retrofitted to earlier aircraft soon after it was introduced on the production line. (Mikesh)

To solve the cockpit emergency exit problem, Douglas tried a number of different canopy styles. Finally they settled on this clear blown canopy that increased head room and pilot visibility since it eliminated the heavy framing. (Mikesh)



Canopy Development

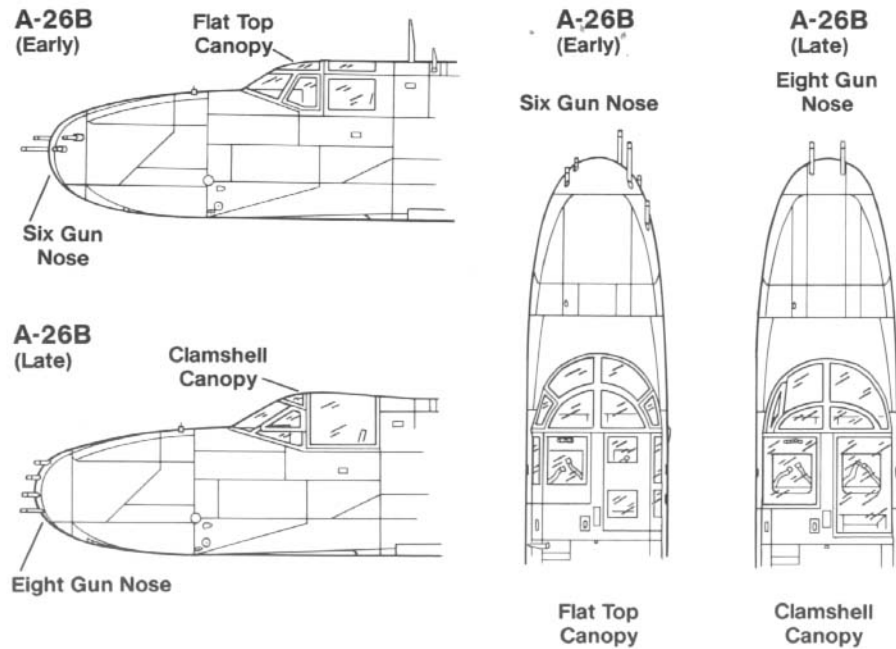



Ground crewmen perform maintenance on an early A-26B Invader in France during late 1944 or early 1945. The A-26 was powered by either the 2,000 hp Pratt and Whitney R-2800-27 or 2,000 hp Ford R-2800-71 radial. The engines drove twelve and a half foot propellers which differed from the prototype in that they did not have large spinners. (Tweedy via AFM)

All switches and circuits were within easy reach of the pilot, either on the control panel or on the side of the cockpit. The cockpit was painted in Zinc Chromate Green while the instruments and panels were in Flat Black. (AFM)

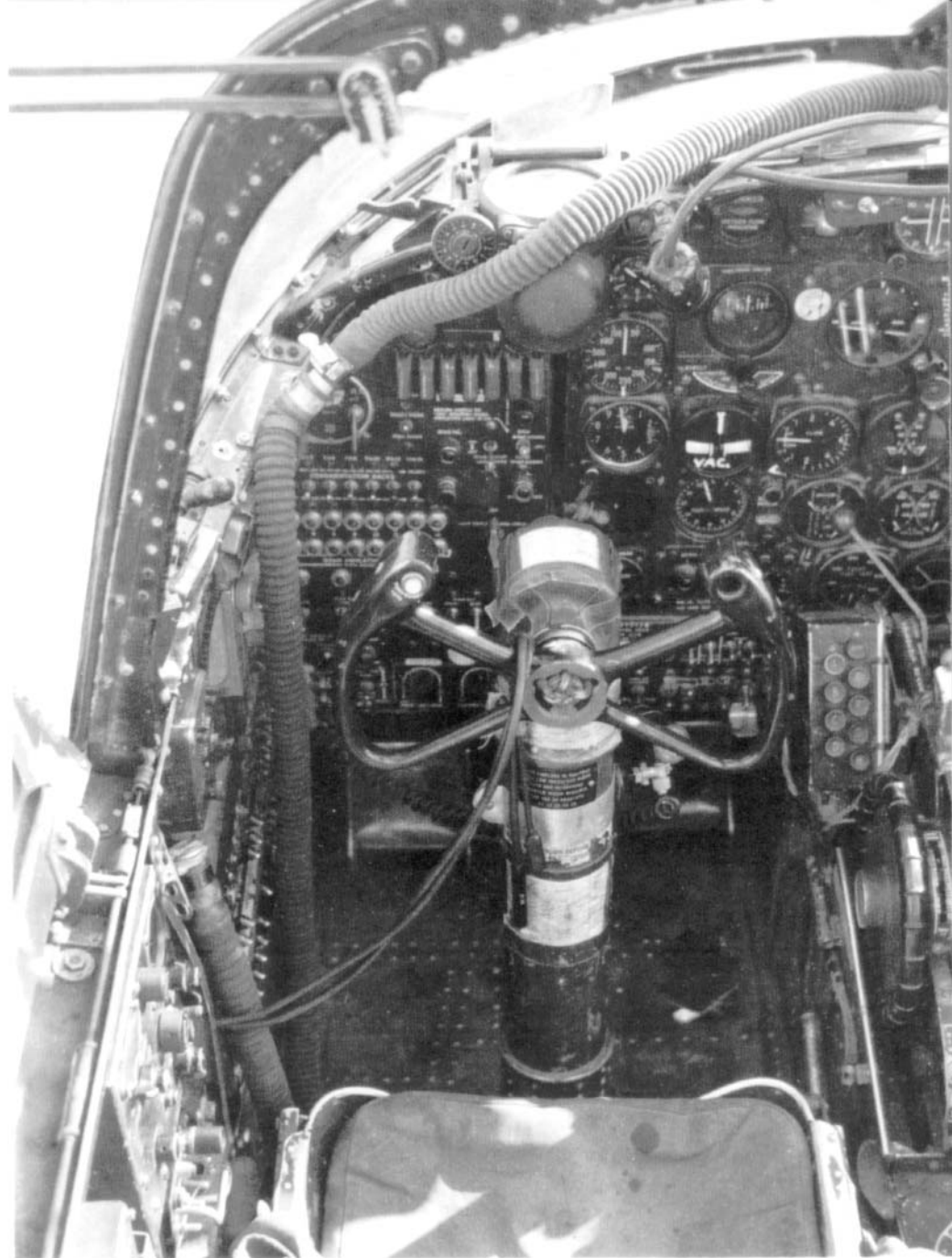

Like the A-20 Havoc, the A-26 had only a single set of controls on the left side of the cockpit while the right side had a jump seat for the navigator. The reflector gunsight was located directly above the control column at the top of the instrument panel. (Mikesh)

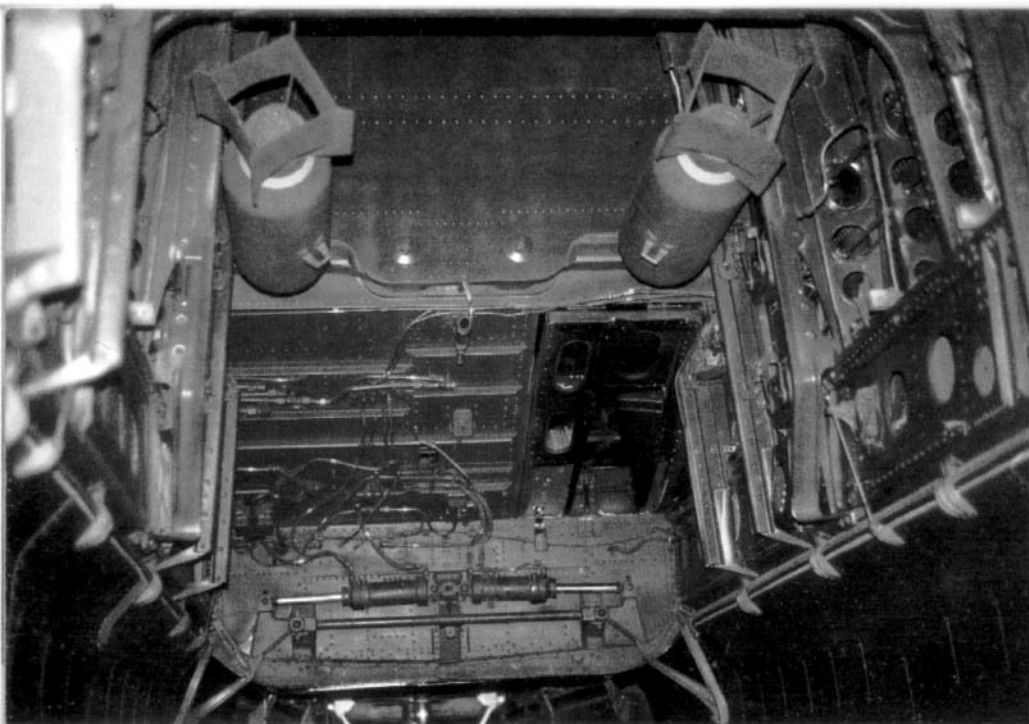

The large bomb bay could hold two tons of bombs in racks positioned along the fuselage sides. The dark object to the right of the forward bulkhead is a small hatch that led into the cockpit. (Lundh)

There was an access hatch to the gunner's compartment on the rear bulkhead of the bomb bay. If necessary, the crew could move between the pilot's compartment and gunner's compartment through the bomb bay but extreme care had to be taken because the bomb bay doors could give way under the weight of the crewman. (Lundh)

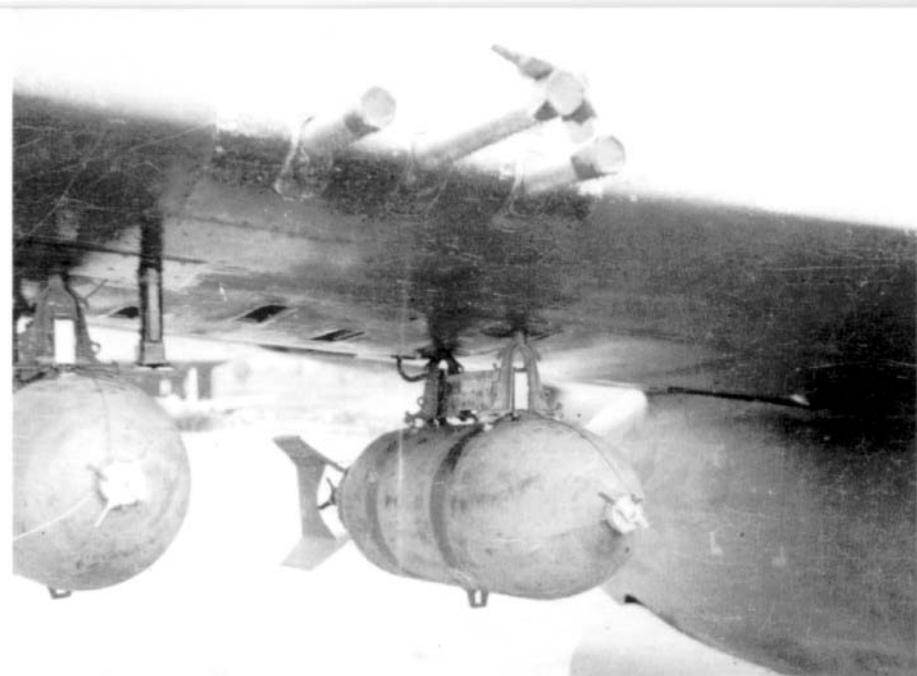

In addition to the bomb load carried in the internal bomb bay, ordnance could also be carried on external racks carried under the outer wing panels. The weapons load included a wide variety of bombs and tanks. These are 500 pound General Purpose (GP) weapons. (Schild)

Seven zero length rocket launchers stubs could also be fitted under each wing to carry the five inch High Velocity Aircraft Rocket (HVAR). These rockets gave the Invader a tremendous amount of firepower. (USAF)

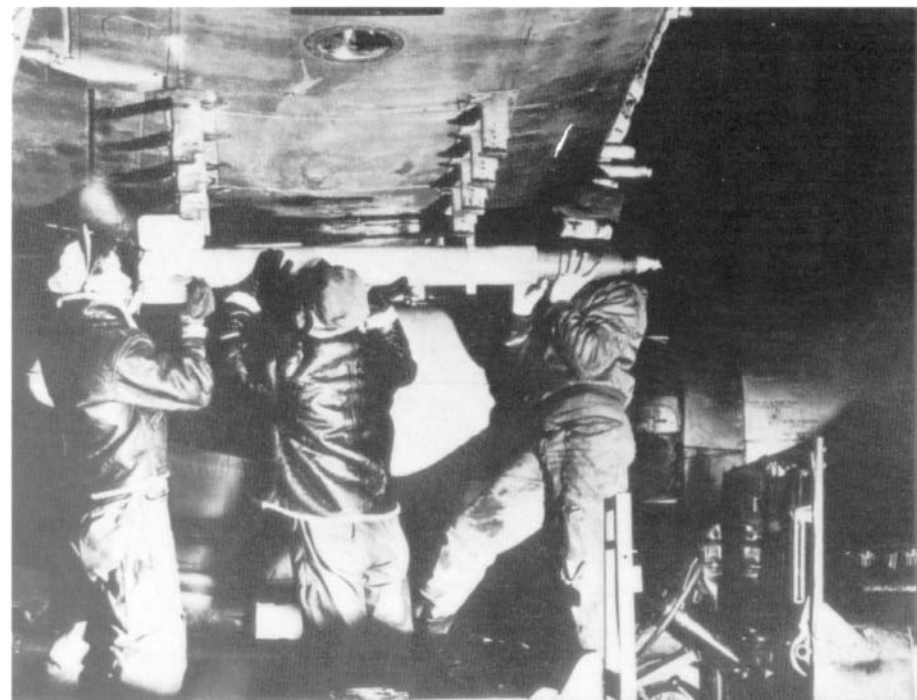

A-26C Invader

Initially, the designation A-26C was to have gone to a proposed version which mounted four 20MM cannons in the nose. When this variant was cancelled the designation was assigned to the glass nosed aircraft. The A-26C paralleled the development of the A-26B and aside from the clear nose with its bombardier's station, the two aircraft were identical. As basic improvements in the A-26B was made (such as the new canopy, more powerful engines, fuel capacity increase and other modifications) they were also made on the A-26C assembly line at the Tulsa plant where the majority were manufactured.

The glass nosed A-26C was designed to supplement the A-26B in the medium to high altitude bombing role. It was anticipated that A-26Cs could be used as lead ships for formations of A-26Bs which would drop their bomb loads on a signal from the lead A-26C. The A-26C nose was outfitted with a bombsight and related equipment for the bombardier who also doubled as a navigator. The upper and lower halves of the nose section canopy were held in place by screws and the lower portion also contained an optically flat panel for the bomb sight. Entrance into the nose was either through a small hatch under the nose or through a crawl space which ran along the starboard side of the fuselage from the cockpit. While the bombardier could ride in the nose during takeoffs and landings, this was not encouraged since, in a crash, the nose tended to break off with deadly consequences. As a result, he usually rode in a "jump seat" next to the pilot during takeoffs and landings.

Armament for the A-26C was similar to the A-26B model, except for the nose. Two .50 caliber machine guns were carried on the lower starboard side of the nose for some forward firepower, although these were sometimes removed. In all other respects, the A-26C followed the progressive upgradings instituted with the A-26B with regards to armament and bomb load.

Originally it was intended for both versions of the Invader to be produced on the assembly lines at Long Beach and Tulsa simultaneously, but this was changed, only five A-26Cs being produced at Long Beach before that plant concentrated solely on the gun nosed B-26B. In the event, Tulsa produced 1,086 A-26Cs along with 205 A-26Bs.

FA-26C

Due to the Invader's high performance and load carrying capabilities, a number of A-26Cs were modified for use as a night reconnaissance platform under the designation FA-26C. These converted aircraft were outfitted with a variety of cameras and radars depending on the mission profile and most aircraft had all their armament removed. A special radome for electronics equipment was fitted on the fuselage undersurface in place of the ventral gun turret. Some aircraft had special equipment positioned in the bomb bay or in pods under the wings. Eventually, a radar was fitted in the nose in place of the bombsight and related gear on a number of aircraft. A wide variety of camera equipment could be carried, depending on the specific mission, normally housed in the bomb bay or nose. Flares could be carried as needed and the range could be extended through the use of drop tanks or additional tanks in the bomb bay. Later, under the new designation system, this version became the RB-26C.



A pair of early production A-26C Invaders on the Douglas Tulsa, Oklahoma facility ramp awaiting delivery to the Army Air Force. A total of 1,086 A-26Cs were built at the Tulsa plant (along with 205 A-26Bs). (Bruce A. Geil)

Nose Development

A-26B
(Late)

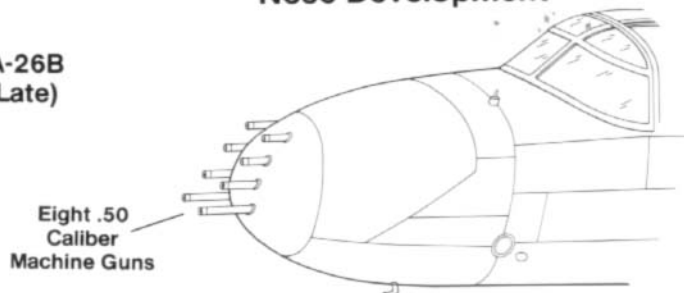

A-26C

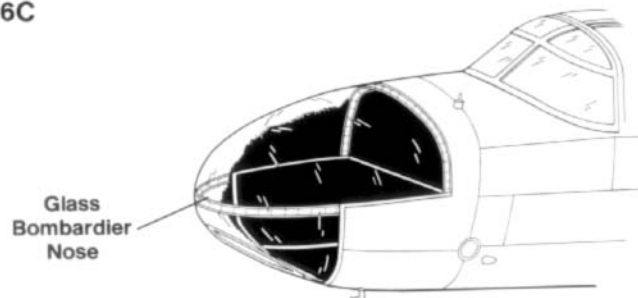



The A-26C Invader replaced the solid gun nose with a bombardier's compartment which housed a Norden bombsight and related equipment. The clear plexiglass nose was composed of two sections which were riveted together. The lower forward section had an optically flat panel for the bombsight. This A-26C carries the insignia of GB 1/25 *Tunisie*, a French unit that flew Invaders in Indochina. (ECPA)

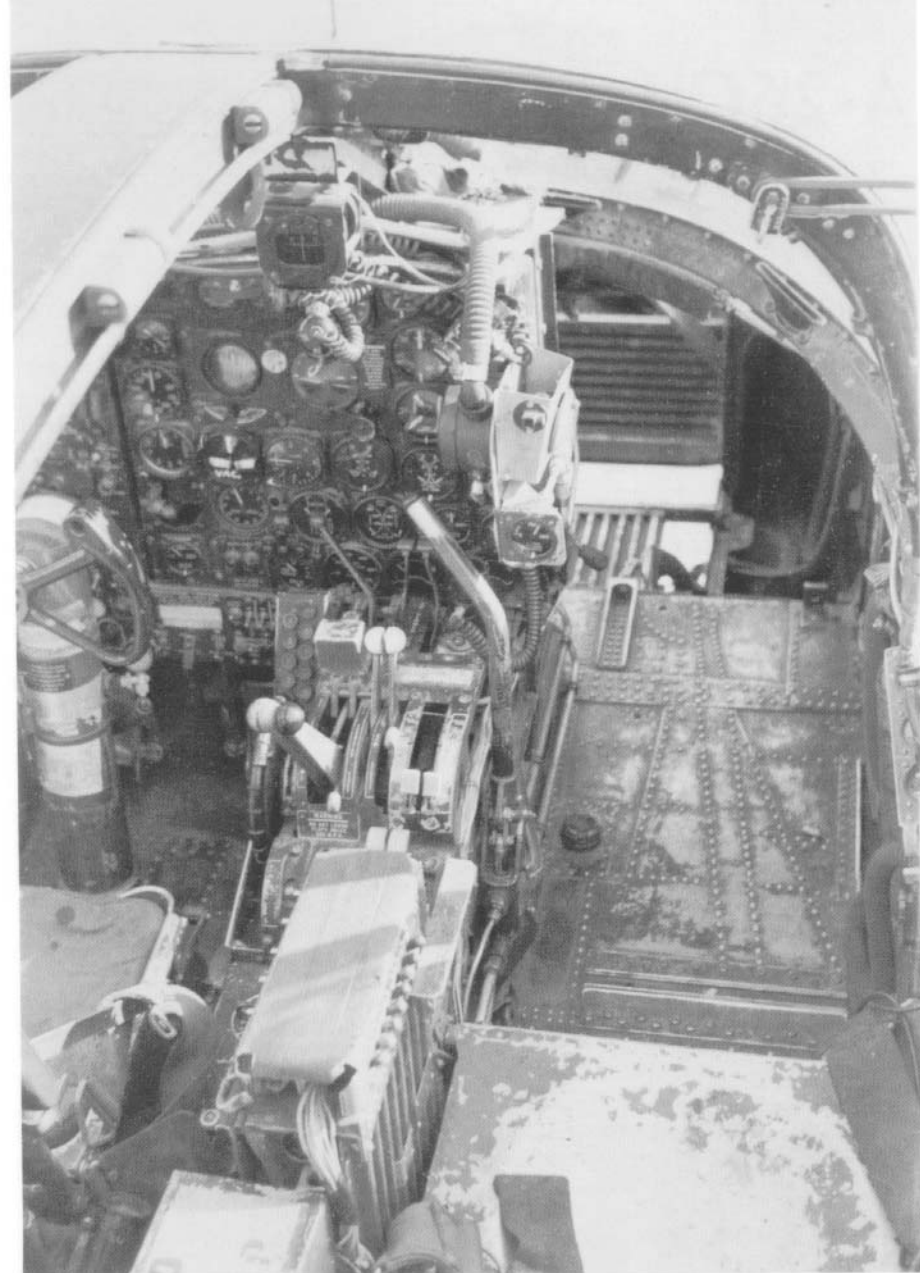

The bombardier gained access to the nose compartment through a passageway on the starboard side of the nose. A small jump seat was provided on the starboard side of the cockpit for the bombardier/navigator during takeoff, landings and when he was not using the nose section. (Mikesh)



The FA-26C carried various electronic reconnaissance equipment and radars installed in pods or blisters. Some were carried under the wings, in the bomb bay and in the nose. (USAF)

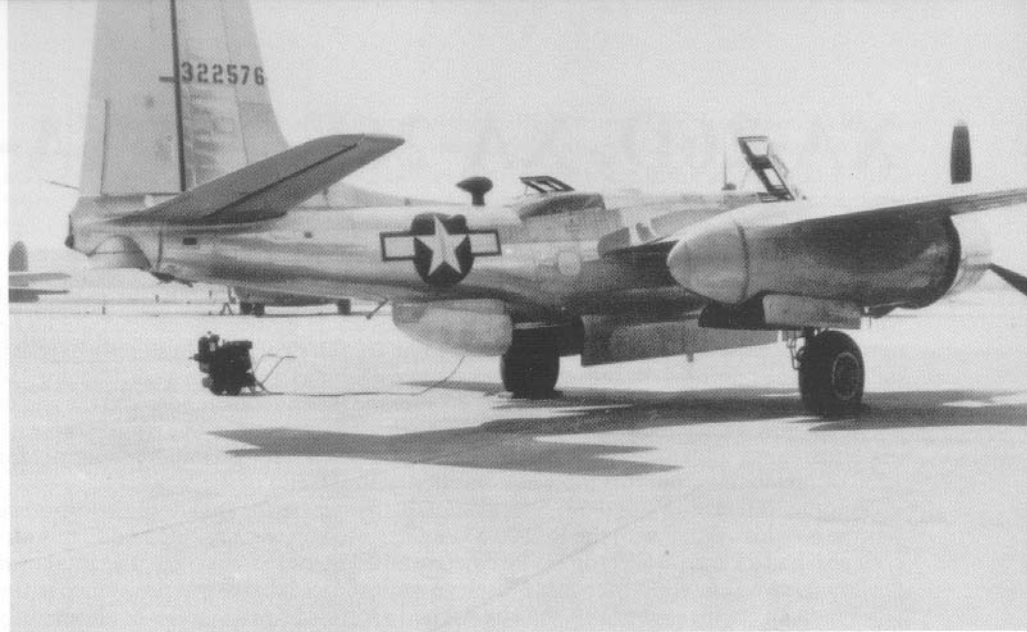

The FA-26C was a standard A-26C with the armament removed for the night reconnaissance mission. The top turret was faired over and the lower turret was replaced with a fiberglass radome. An additional electronics fairing was installed under the tail. (USAF)

The large radome has been removed from the lower fuselage of this FA-26C to reveal the mapping radar antenna installed in place of the lower gun turret. The radome was made of light weight fiberglass. (USAF)

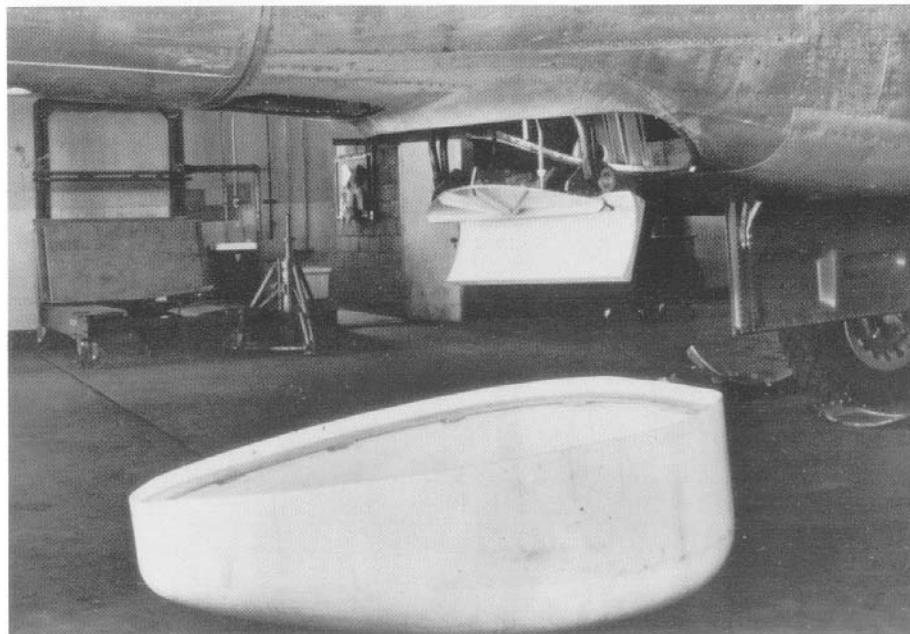

The electronics fairing under the tail was unique to the FA-26C. Besides the radomes and electronics bulges, the FA-26C carried a variety of cameras in the bomb bay along with photo flash bombs and flares. (USAF)

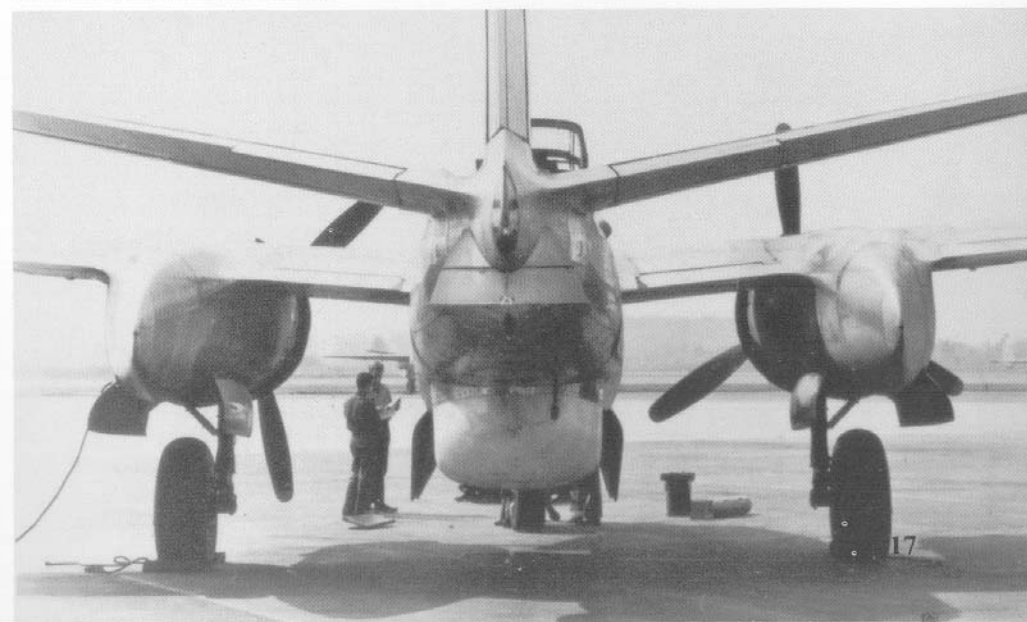

XA-26D, XA-26E and XA-26F

In an effort to increase the performance of the Invader, one A-26B was re-engined with two 2,100 hp Chevrolet built R-2800-83 engines under the designation XA-26D. The new engines raised the A-26's top speed by some 80 miles per hour to slightly over 400 miles per hour. Impressed with this performance, Douglas was given a contract for 750 A-26Ds; however, the contract was cancelled after the Japanese surrender and the end of the war. A glass nosed A-26C was also fitted with the same engines with a similar increase in performance under the designation XA-26E. Douglas received another contract for 1,250 of this variant, but this too was cancelled with the end of the war.

Another interesting and more radical attempt to increase the Invader's performance was the XA-26F. Fitted with the R-2800-83 engines used on the XA-26D and E, this aircraft also had a General Electric J31 turbojet installed in the rear fuselage. The intake for the jet engine was mounted above the fuselage while the jet exhaust was positioned in the tail. When all engines were used, the aircraft had a top speed of 435 miles per hour, only slightly higher than the XA-26D/E. This marginal increase in speed, along with a reduction in the useful bomb load (the rear bay was needed for a fuel tank for the J31) resulted in no contract being placed for this model. The XA-26F was used throughout the late 1940s as a test bed and was finally disposed of in the early 1950s.



In an attempt to increase the speed and performance of the Invader, one aircraft was fitted with a turbojet engine mounted in the rear fuselage. While the speed did increase, it was only marginally faster than the earlier XA-26D/E. (AFM)

Douglas also made tentative proposals to the government for additional improvements in the basic Invader under the designations A-26G and A-26H. These featured new canopies, wing tip drop tanks, rearranged cockpits and other improvements based on combat reports from the field. With the end of the war, however, interest in such variants died and Douglas was told to forgo any further work on new Invader variants. As a result, neither the G nor the H ever got beyond the design study phase and no aircraft were modified to these configurations.

The Westinghouse J31 turbojet was installed in the rear fuselage, taking up the space normally occupied by the gunner and turret. The exhaust ran through the fuselage and exited under the tail. The rear fuselage required some rebuilding to house the jet exhaust cone. (AFM)

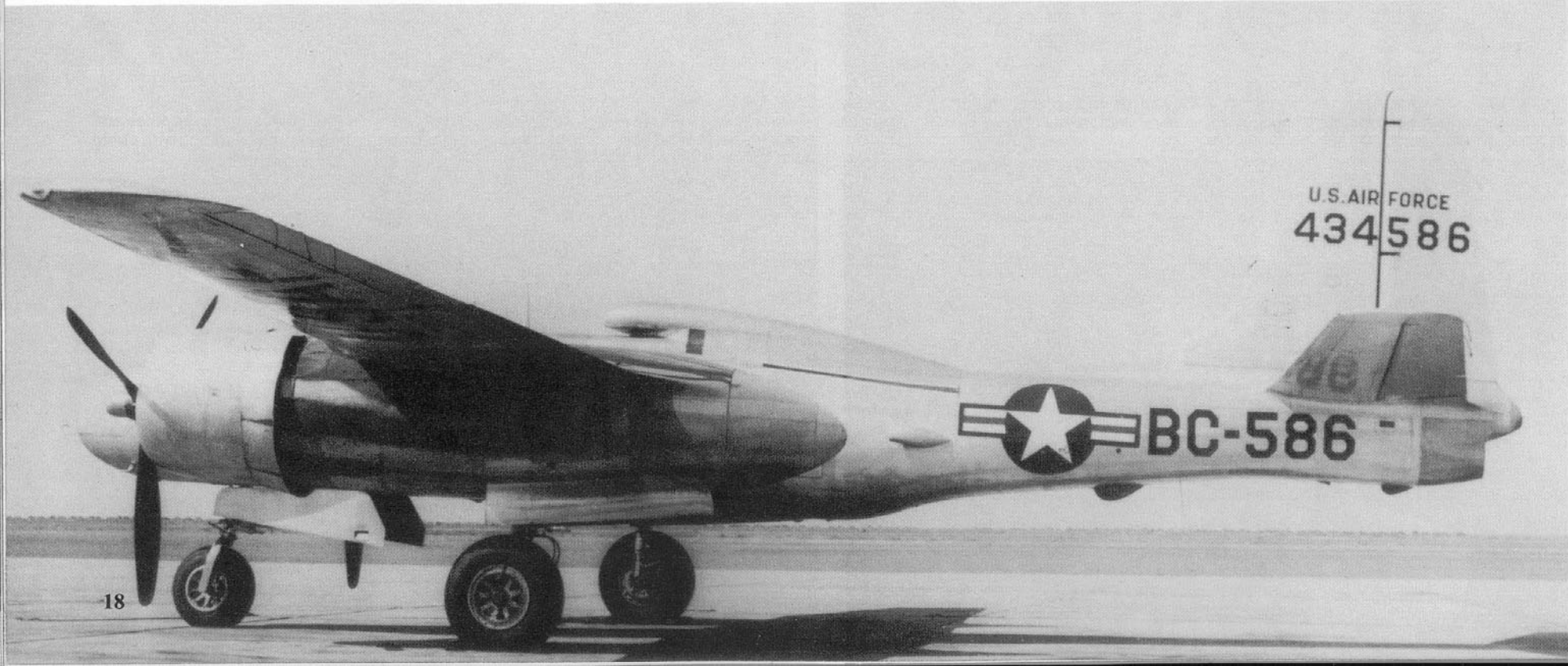

B-26K (A-26A)

During the early 1960s, the United States found itself increasingly involved in a guerrilla war in South Vietnam. This conflict led to the development of a new class of aircraft called counter-insurgency or COIN. To meet the need for aircraft to fight these limited conflicts, the Air Force began developing both specialized aircraft or modifying existing aircraft for the role. Since there were still relatively large numbers of B-26s held in storage, serious consideration was given to using the Invader in the COIN role, especially since unmodified B-26s were being used by the 4400th Combat Crew Training Squadron (CCTS) *Jungle Jims* in Vietnam with some success.

To modify the Invaders for their new mission, the Air Force picked the On Mark Engineering Company of Van Nuys, California with the contract being let during 1962. On Mark was chosen due to its extensive experience in the reconditioning and modification of surplus B-26s for the civil market, mainly as high speed executive transports.

Following a review of the Air Force requirements, On Mark proposed the following major modifications to the B-26 airframe: a complete remanufacture of the fuselage and tail assembly, an enlarged rudder for improved single-engined handling performance, a rebuilt/redesigned wing structure with the original aluminum spar caps being reinforced on the top and bottom with steel straps from the wing root to the wing tip, re-engining with 2,500 hp Pratt & Whitney water injected R-2800-103W engines, larger, fully reversible propellers with automatic feathering and clipped tips, full dual flight controls with the right side removable for access to the bombardier's station, de-icer boots, propeller/windshield/carburetor anti-icing systems, heavy duty brakes with an anti-skid system, a 100,000 BTU heater system, complete fire extinguisher system, eight underwing hard point (specifically designed for the YB-26K), fixed 165 gallon wing tip fuel tanks with a quick fuel dump system, a quick change eight gun or glass nose, provisions for a full complement of airborne electronics (HF, VHF, UHF and intercom communications, VOR navigation, LF/ADF, ILS, TACAN, IFF coder and marker beacon), two 300 amp d.c. generators and two 2,500-VA inverters and provisions for installation of a sophisticated photographic reconnaissance package.

In October, On Mark began working on the prototype under the designation YB-26K. The conversion work was completed during early January of 1963, with the first flight taking place on 28 January. The aircraft was then ferried to Eglin Air Force Base, Florida where it underwent an extensive series of flight tests under a variety of conditions. Various types of ordnance was delivered under different simulated battle conditions and after extensive evaluation, the Air Force decided to accept the aircraft for combat. In November of 1963, On Mark was given a 13 million dollar contract to modify forty B-26s to YB-26K standards. The only major change was the substitution of the R-2800-52W engine for the R-2800-103W and deletion of the six wing mounted machine guns. Production began during late 1963 and the first aircraft was delivered to the Air Force in June 1964 (with new serial numbers) under the designation B-26K. Late aircraft had revised cowlings with the air scoop being relocated further back on the cowl. The last of the forty aircraft was delivered in April of 1965. Additionally, a number of other countries including Brazil, Columbia, and the Dominican Republic had their older B-26s reworked to B-26K standards.

Following the acceptance of the forty aircraft, a number were involved with test programs prior to the formation of a unit to take them into combat in Southeast Asia. Eventually two units, the 603rd Special Operations Squadron (SOS) and the 609th SOS, flew the aircraft. The former unit was a stateside training unit, while the latter deployed for combat operations to Thailand. While the revised Invader could be fitted with a glass nose and reconnaissance equipment, these were never used operationally in Southeast Asia, although a number of the early production models were fitted with the clear nose for test work with the camera arrangement.

While operating out of Thailand, a dispute arose between the U.S. and Thai governments over the basing of "bomber" aircraft on Royal Thai Air Force bases. As a result, the B-26K designation was changed to A-26A so that the Invader would not violate Thai sensitivity on this matter and conform to the U.S.-Thai basing agreement.

During the early 1960s the USAF realized it needed an aircraft to fight guerrilla conflicts such as the kind going on in Southeast Asia. Air Commando personnel look over the YB-26K Counter Invader on the ramp at Eglin Air Force Base, Florida, where it was put through a series of tests to determine its usefulness as a counter-insurgency (COIN) aircraft. (USAF)





In addition to the eight gun nose, the B-26K could also be equipped as a reconnaissance platform with a glass nose under the designation RB-26K. The first RB-26K retained its ability to carry under wing ordnance and, if necessary, the clear nose could be replaced by a solid gun nose in a short period of time. (AFM)

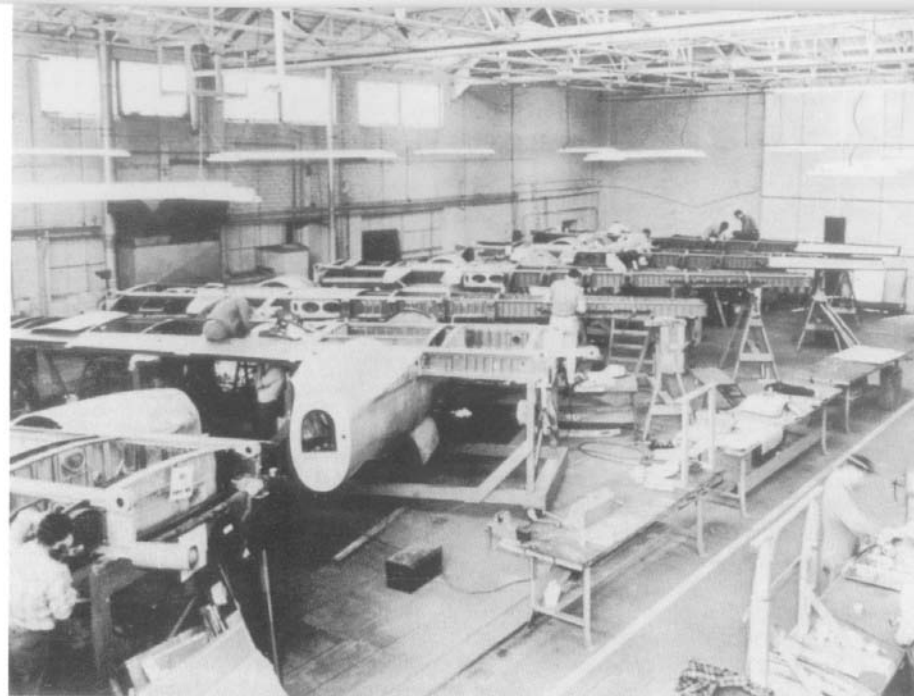

Following acceptance of the YB-26K by the Air Force, the On Mark company began work on converting forty aircraft for the USAF. The original wings were completely rebuilt and reinforced to take the additional stress of low level operations and to carry heavier bomb loads. (AFM)

The California firm of On Mark was chosen to modify existing B-26s due to the company's experience with converting Invaders for the civilian market. On Mark modified one aircraft as the YB-26K prototype for testing at Eglin AFB. In the event, it passed its evaluation and the Air Force authorized a conversion program. (USAF)



B-26K Modifications

B-26B

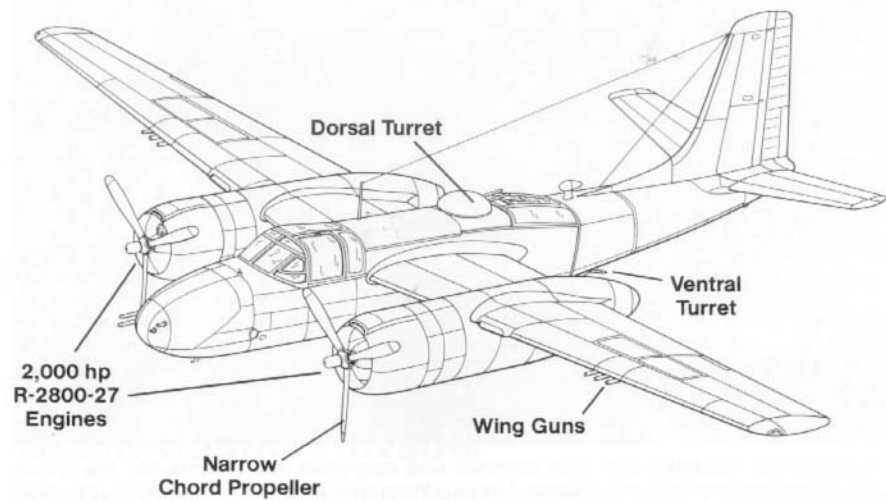

B-26K (A-26A)

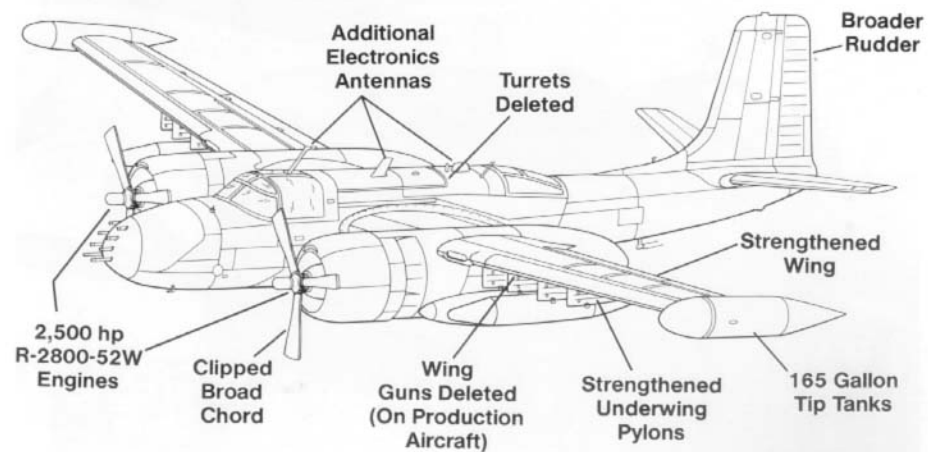

Other changes on the B-26K included new engines, wing tip fuel tanks and stronger underwing ordnance hardpoints. The first B-26K aircraft to complete the conversion program demonstrates its maneuverability as it pulls a tight right bank during a flight test. (USAF)

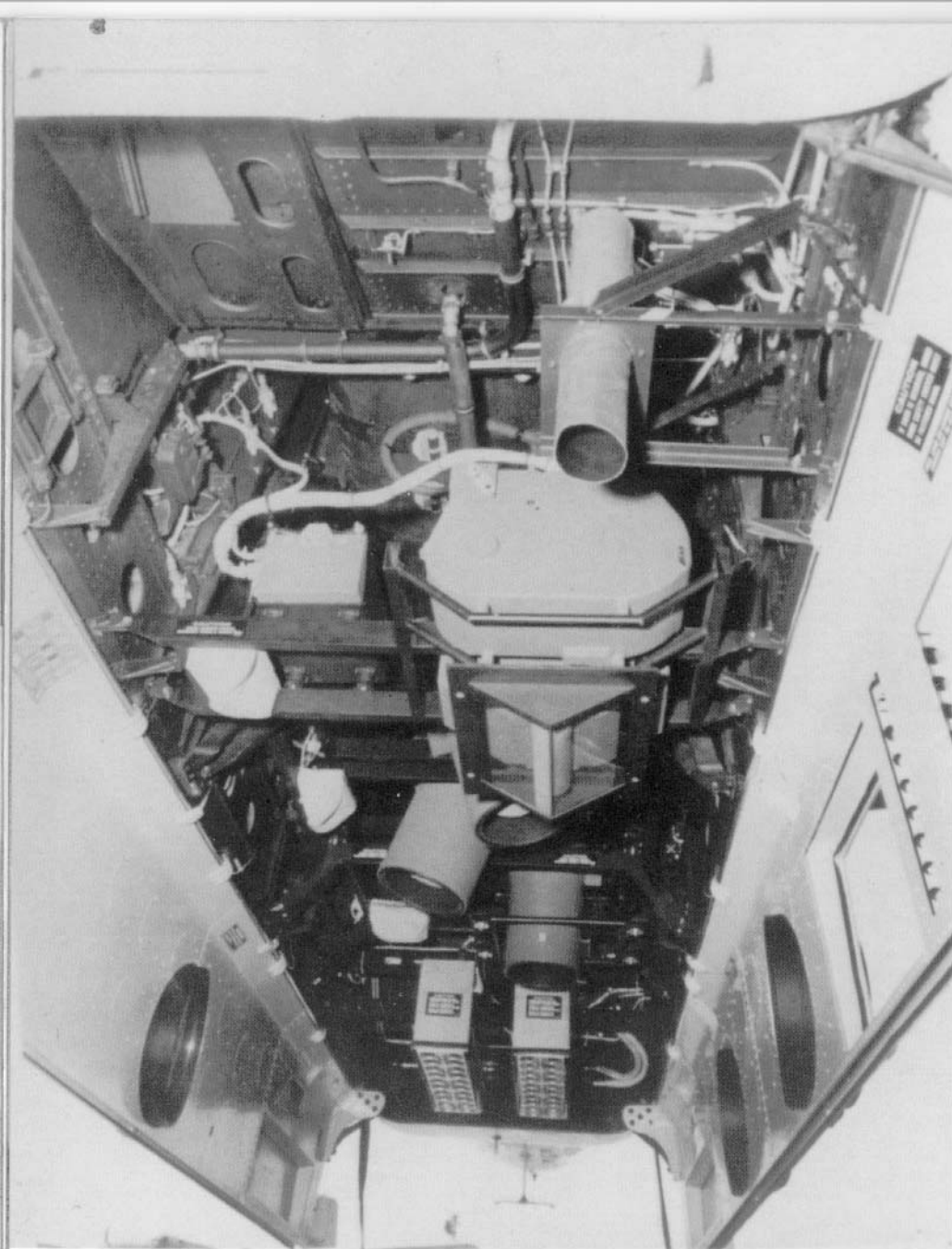

The RB-26K carried the F-492 camera system in the bomb bay with windows cut into the bomb bay doors. The closest camera is a KA-56A panoramic mirror camera system which was equipped with an automatic in-flight processing system. (AFM)



The cockpit was modified with dual controls and upgraded instruments but the layout remained basically similar to the original. The new instrumentation was installed in a panel on the right side of the cockpit. (AFM)

A K38 forward oblique reconnaissance camera could also be located in the nose, looking out the bombardier's optically flat panel and a P2 vertical camera was located in the tail. (AFM)



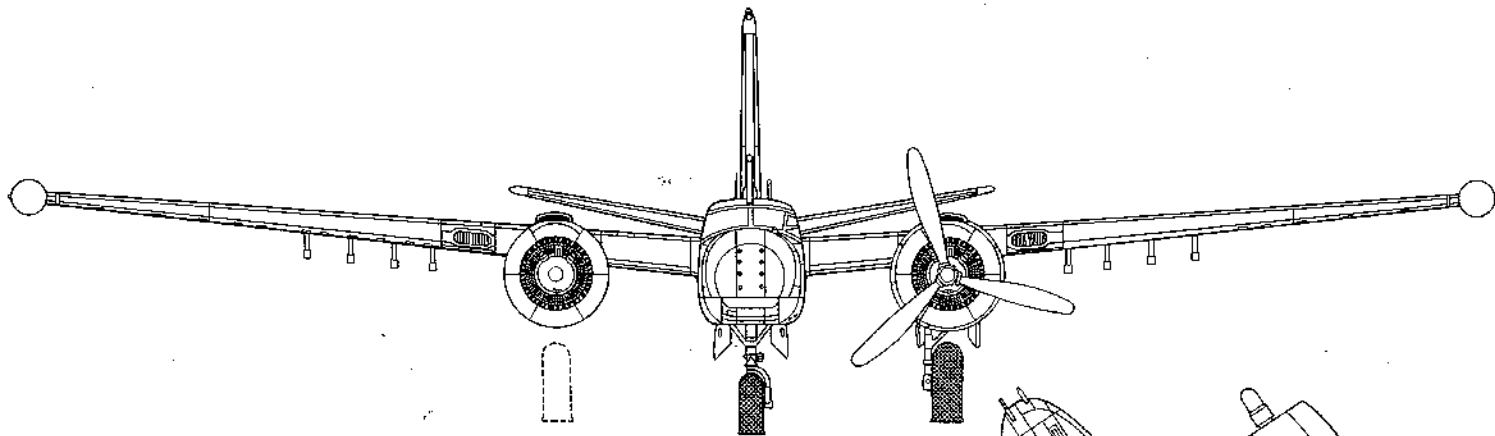

Specifications

B-26K Counter-Invader

| | |
|----------------------|---|
| Wingspan | 71 feet 6 inches (21.79m) |
| Length | 51 feet 7 3/16 inches (15.73m) |
| Height | 19 feet (5.79m) |
| Empty Weight | 25,130 pounds (11,399kg) |
| Maximum Weight | 39,250 pounds (17,804kg) |
| Powerplant | Two 2,500 hp Pratt & Whitney R-2800-52W radial engines |

Armament..... Eight underwing hardpoints and
eight .50 caliber machine guns

Performance

| | |
|-----------------------|-----------------------|
| Maximum Speed | 327 mph (526km/h) |
| Service ceiling | 30,500 feet (9,295m) |
| Range | 2,700 miles (4,345km) |
| Crew | Three |

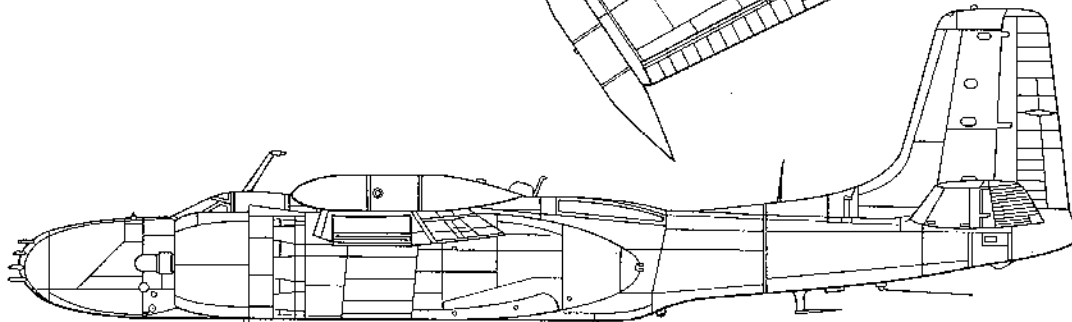
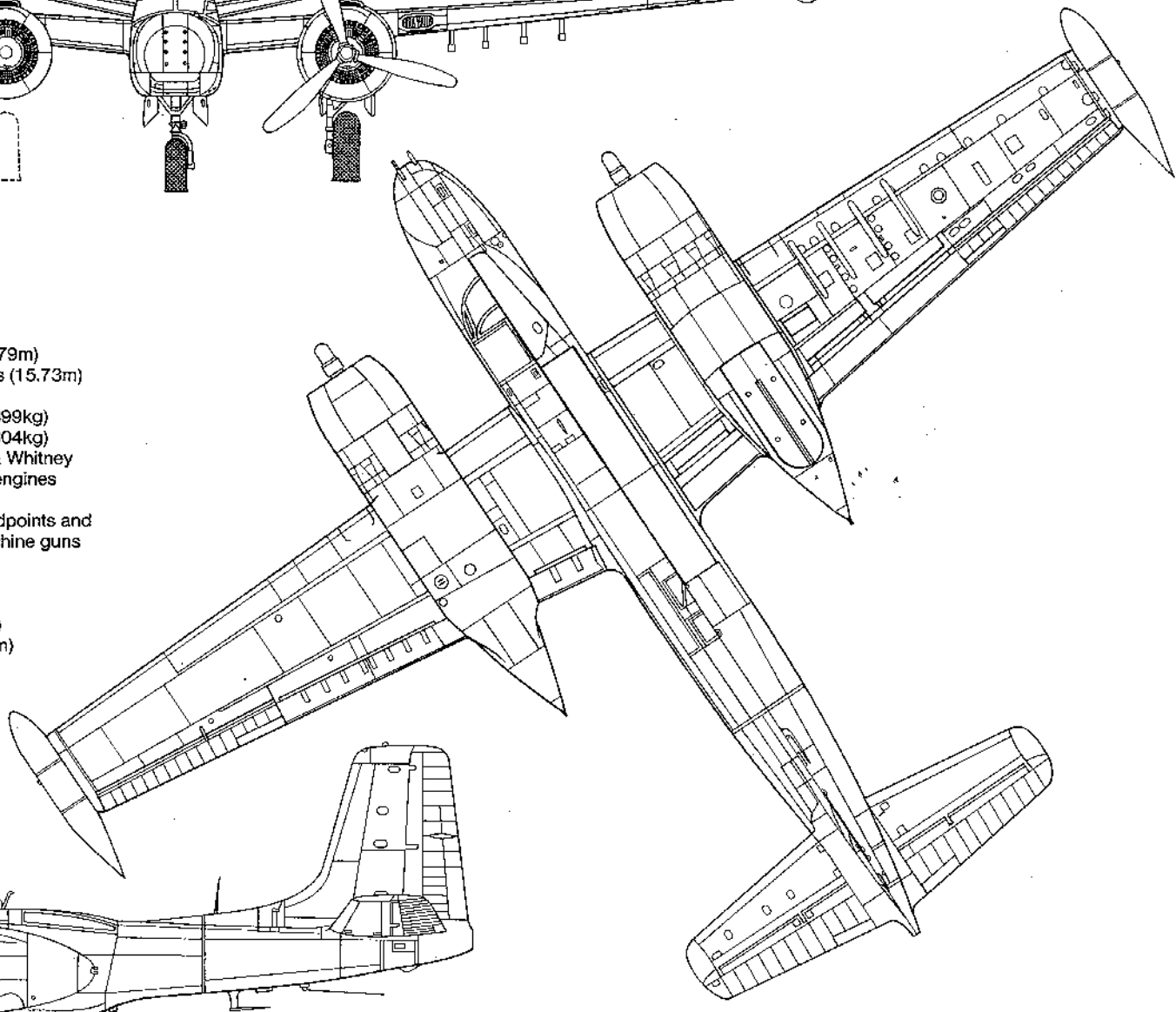



Originally, ten RB-26Ks reconnaissance aircraft were ordered, but the aircraft was never used operationally in Southeast Asia. The aircraft was, however, tested under a variety of conditions. This RB-26K operated out of Albrook AFB, Panama Canal Zone, during 1967 and carried a camouflage scheme of Gloss Green over Light Gray. (USAF)



This overall Light Gray RB-26K, on the apron at Eglin AFB, was loaded with a full ordnance load of Mk 82 bombs under its wings for a practice bombing mission. The overall Gray scheme was tested along with the Gloss Green and Gray scheme but eventually all B-26Ks received the three-tone Southeast Asia camouflage scheme. (USAF via Bell)

MIGHTY MOUSE (64-17651), a late A-26A with modified cowlings, starts its number two engine under the watchful guidance of its crew chief. Unlike many of the other aircraft used in Southeast Asia, the A-26s carried relatively little nose art. It was more common to see names on the engines cowlings, although even this was rather unusual. (USAF)



Cowling Development

B-26K
(Early)

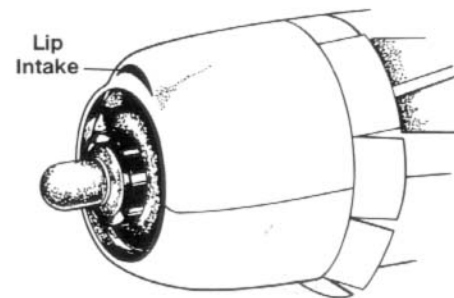

B-26K
(Late)

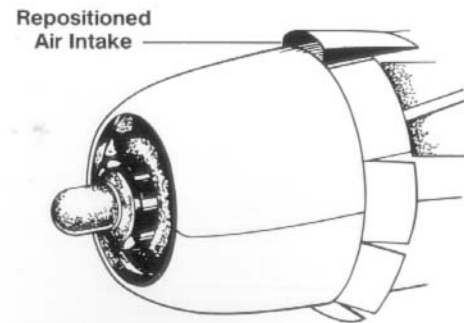



Kiwi Boid was an A-26B Invader assigned to the 554th Bomb Squadron, 386th Bomb Group during 1945.

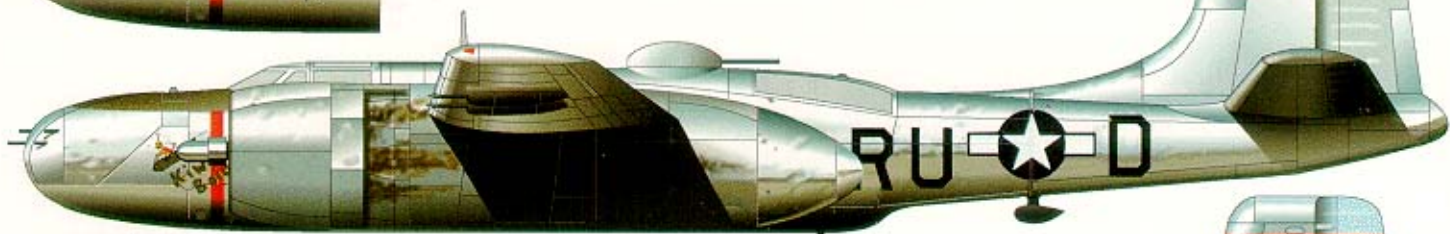

This A-26B served with the 10th Tactical Reconnaissance Squadron, 69th Reconnaissance Group at Nancy, France during early 1945.

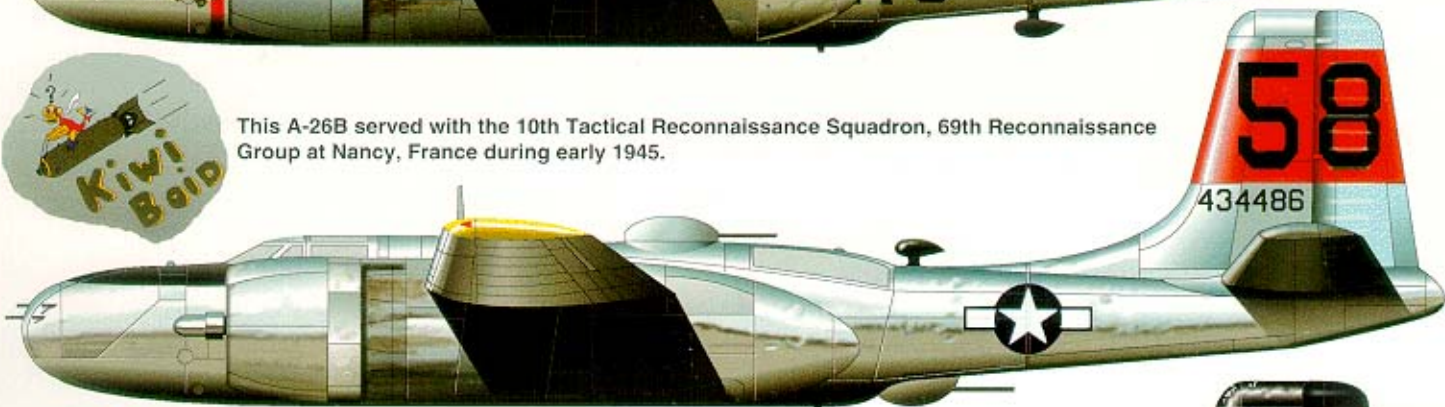

This A-26C flew with the 86th Bomb Squadron, 47th Bomb Group, 12th Air Force in Italy during 1945.

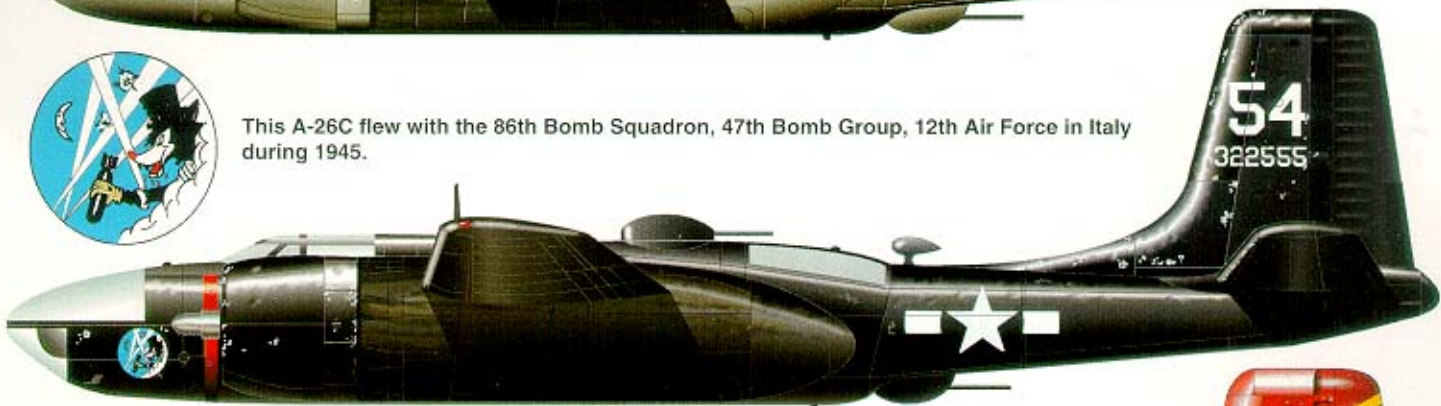

An A-26B Invader of the USAF All Weather Flying Center, Clinton County Airport, Wilmington, Ohio during 1947.



Jersey Bounce was a B-26B modified with a B-26C glass nose. The aircraft was assigned to the 90th Bomb Squadron, 3rd Bomb Group in Korea during 1952.

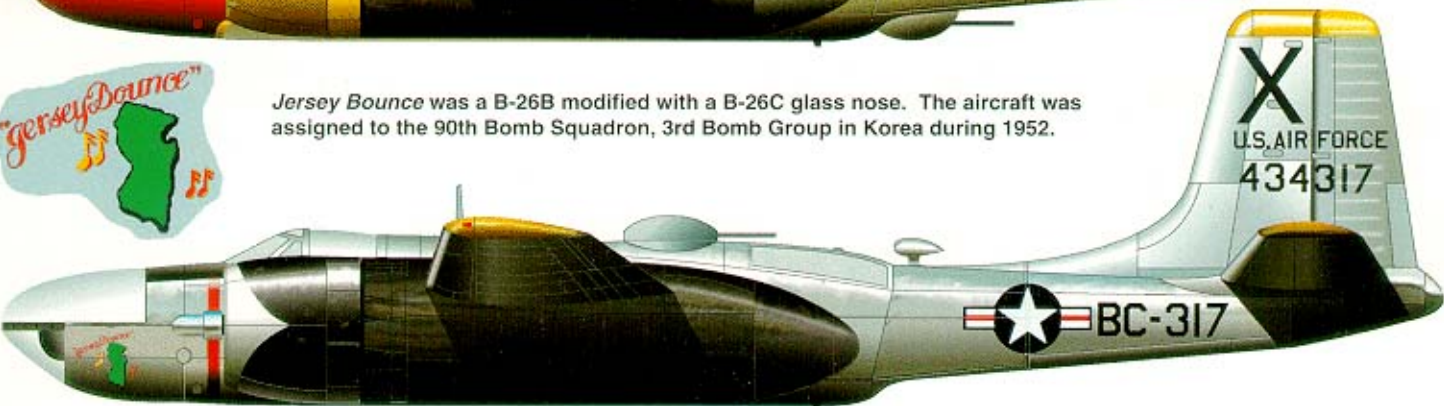

This highly modified B-26B served as a pathfinder with the 13th Bomb Squadron, 3rd Bomb Group in Korea during 1953.



This overall Gloss Black RB-26C of the 63rd TRW at Shaw Air Force Base, SC during January of 1955 carried a Red and White checkerboard fin.



A B-26B Invader of GB 11/23 Guyenne, French Air Force stationed in Algeria during 1959.

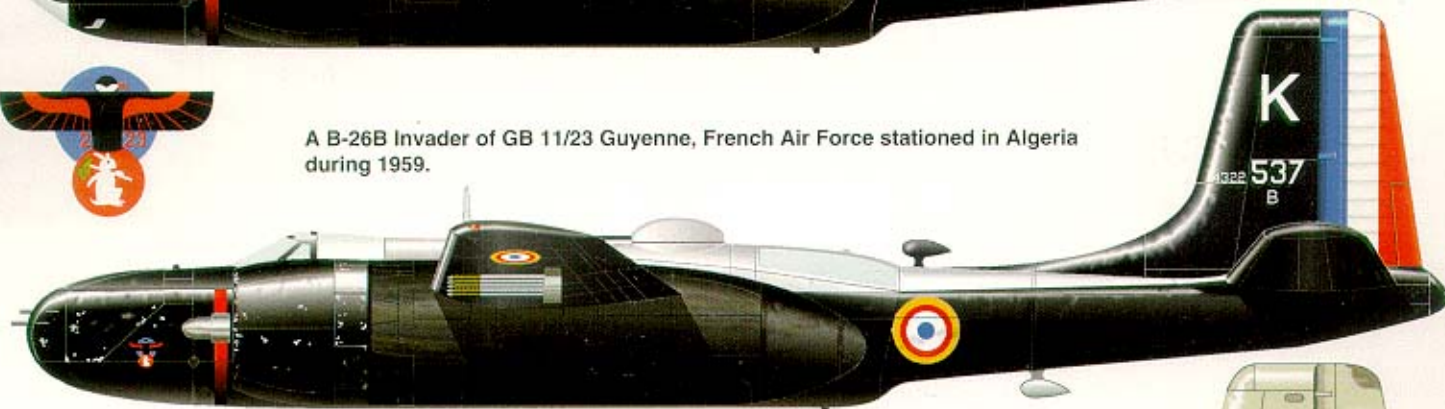

This camouflaged B-26B served with the El Salvadorean Air Force in the counter-insurgency role well into the 1970s.



Conair Aviation used this modified B-26B for fire-fighting duties in British Columbia during the Spring of 1984.



Target Tugs and Drone Controllers

Both the Air Force and Navy used the B-26 for the target towing role and later in the drone controller role. In the target towing role, all armament was removed and one or two winches were fitted in the bomb bay which were operated from the gunner's compartment. The Air Force designated these aircraft as TB-26s and both B and C variants were used.

In Navy service, the Invader was designated the JD-1 and was modified with a different clear nose cone than the standard B-26C model. Eventually, the Navy received 150 B-26s from Air Force surplus stocks and these were assigned to VU (Utility) squadrons. During 1962 when the military reorganized its designation system, the JD-1s were redesignated as UB-26Js.

Once in use as target tow, it was only natural that when drones entered service, B-26s would be modified to carry them due to their size, load carrying capability and crew size. Drones were carried under the outer wings on specially designed racks. While the Air Force normally carried two drones, the Navy usually mounted a control pod under the port wing and the drone under the starboard wing. Various models of the Ryan Firebee were the most common types carried and these were used for live fire exercises at gunnery competitions such as "William Tell," and to help develop air-to-air missiles which were then coming into service at the time. The Air Force designation for drone controller Invaders was DB-26B/C while the Navy designated them JD-1Ds. Later under the new designation system, Navy drone controllers became DB-26Js. These aircraft were used extensively throughout the 1960s but by the early 1970s they had been withdrawn from service.



This overall Natural Metal B-26C (44-36459) Invader was used as a target tow to train aircraft gunners at Biggs Army Air Field near El Paso, Texas during August of 1947. (R.V. Powell via R.V. Powell III)

In Navy service the B-26 was known as the JD-1 (later redesignated the UB-26J). These aircraft carried a bright Yellow, Red and Engine Gray color scheme and were flown by utility squadrons in support of combat units. This JD-1 of VU-7 is parked on the ramp of an unidentified base in California during 1956. (Sullivan via Bowers)



A number of Invaders were converted to target tugs by removing the armament and installing target towing gear, which consisted of one or two winches in the bomb bay, operated from the gunner's compartment. The bracket under this B-26 housed the tow wire guide. The aircraft was from the 6th Tow Target Squadron based at Johnson AB, Japan during 1957. (Mikesh)



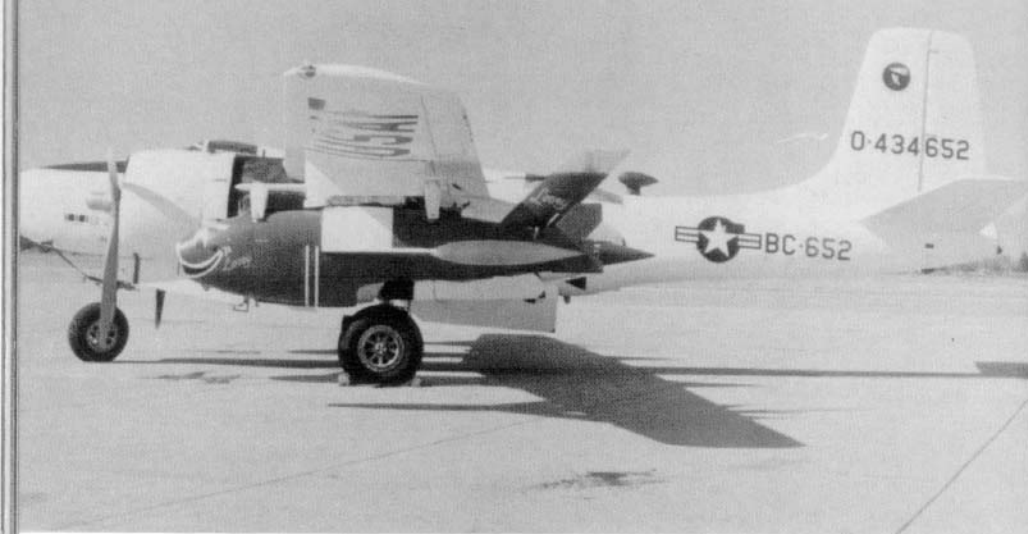

With the introduction of target drones a number of Invaders were modified to carry them and to act as a control aircraft under the designation DB-26D. This DB-26D carried an overall White color scheme with Yellow engine cowlings. The underwing Firebee drones were Red with White and Yellow trim. (AFM)



In Navy service the drone controller aircraft were designated JD-1Bs until 1962 when the services realigned the aircraft designation system. At that time they were redesignated as DB-26Js. Normal practice in the Navy was to carry a drone under the starboard wing and a control pod under the port wing. (JEM Aviation)

A DB-26C Invader takes off with two Firebee drones under the outer wing panels. Often these drones were used as targets during fighter competitions or in the development of new air-to-air missile systems. (USAF)

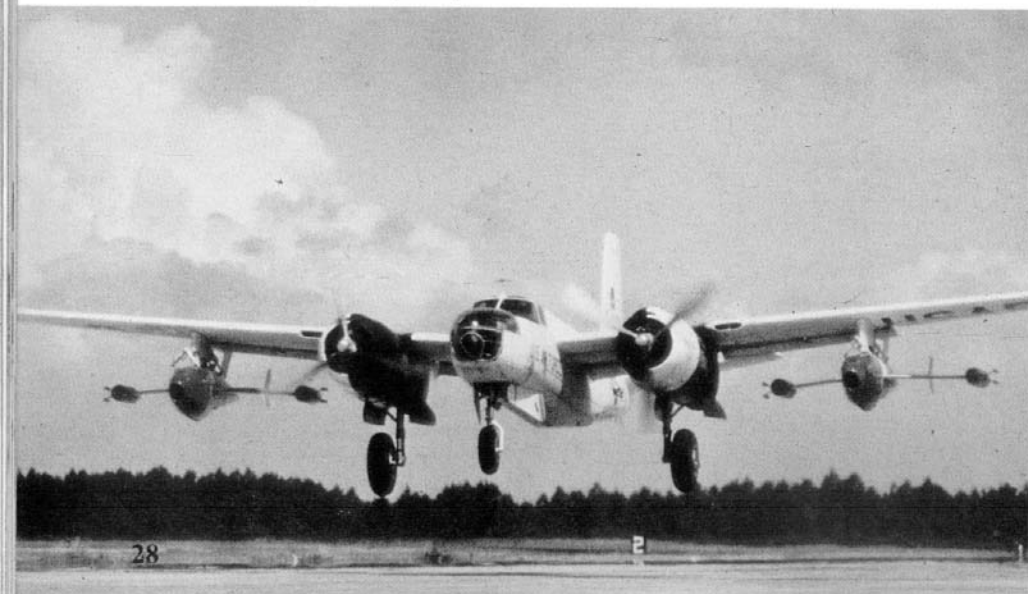

Nose Development

B-26C

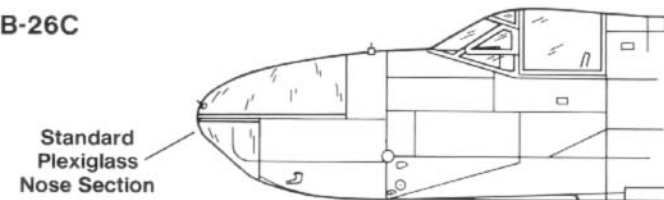

JD-1

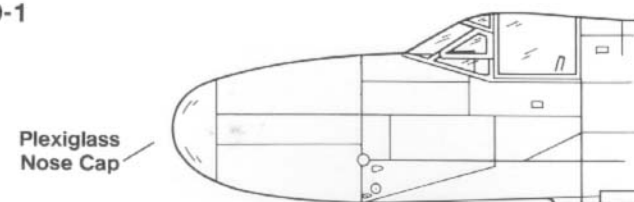

World War II Service

The combat debate of the A-26 Invader was anything but auspicious. In the Summer of 1944, four early production A-26Bs (six gun nose and flat canopy) were ferried to the Pacific from California for testing by the 13th Bomb Squadron, 3rd Bomb Group then based in New Guinea. The 13th BS was flying A-20s and was not impressed with the new aircraft. Complaints included poor cockpit visibility to the sides and a lack of forward firepower for strafing (none of the four A-26s were fitted with under wing gun pods because of a concern over a drop in speed). The comment concerning the lack of firepower was interesting since the Invader carried the same number of machine guns as the Havoc.

Cockpit visibility was probably the more serious of the two criticisms due to the low level formation attacks carried out by the unit against Japanese ground and naval targets. At the end of the evaluation, GEN George Kennedy, Commander of the 5th Air Force to which the aircraft were assigned, specifically stated that he had no desire for A-26s to replace any of his current aircraft. In perhaps the most telling rebuke, the four A-26s were left in New Guinea when the 3rd BG moved out toward the Philippines.

Fortunately for the A-26, the next combat test was to achieve far better results. By mid-1944, Douglas had come under heavy criticism for delays in getting the Invader into full scale production and another bad report from the field might have put the entire program in jeopardy. In the late Summer of 1944, eighteen A-26Bs were sent to the 553rd BS, 386th BG located at Great Dunnow, England. Between 6 and 19 September eight medium level missions were flown with no losses. After action reports indicated that the crews were pleased with the Invader's performance and as a result of this, 9th Air Force Headquarters indicated it would be more than willing to re-equip its light and medium bomber units with the A-26. It was found that the Invader had a greater range than the Martin B-26 Marauder or A-20 Havoc, better load carrying capabilities than the A-20 and better overall characteristics than either aircraft.

With this recommendation, the Invaders career was assured. On 17 November the first unit to be re-equipped with the aircraft, the 416th BG, which had previously flown A-

Following a trial with the Pacific based 3rd BG, the A-26 was sent to the 386th BG in Europe for operational testing. Impressed with the Invader, the 9th Air Force approved the aircraft to equip its ground attack units. This A-26B of the 386th BG banks over the English country side during a training flight. The cowlings were Blue and the tail stripe was Yellow. (Denison)



20s, flew its first Invader mission. Due to a lack of A-26Cs, clear nosed A-20Js and A-20Ks were retained as lead ships until sufficient numbers of A-26Cs were available to lead formations in bombing runs. In late November another A-20 unit, the 409th BG, converted to the A-26 just in time to see action during the Battle of the Bulge. During February and April of 1945, the 386th BG and 391st BG, both Marauder units, re-equipped with Invaders. When Germany surrendered, two other units, the 397th BG and 410th BG, were in the process of changing over to the A-26. Besides these bomb groups, the 69th Tactical Reconnaissance Group also received a small number of A-26Bs for recon work.

The Invaders were used for a variety of roles by the various units of the 9th Air Force. These ranged from medium bombing to low level strafing attacks against German supply columns. While fighter opposition was rare, flak was deadly and inflicted most of the losses suffered. Losses were relatively light, thanks to the robust construction of the A-26 and on numerous occasions severely damaged aircraft made it home safely — to the amazement of everyone. When the Luftwaffe did rise to challenge them, A-26 crews held their own, thanks to their heavy forward armament and rear turrets.

Further south in Italy, the 47th BG began to re-equip with the A-26 during the Fall of 1944, although it would take the unit's four squadrons nearly six months to totally convert from the A-20. Tasked with the job of disrupting German logistical routes, the 47th operated around the clock and did pioneer work in night interdiction against enemy supply routes in the Po River Valley.

Despite its earlier poor showing in the Pacific, the Invader finally began to re-equip the 3rd BG during the Summer of 1945 while the unit was stationed in the Philippines. Unlike the earlier models they had received for evaluation, these A-26Bs were fitted with eight gun noses, wing guns and the new clamshell canopy for improved visibility. As a result, these A-26s were received with far more enthusiasm and quickly proved their worth to the combat veterans of the 3rd. Before the group could really get into the swing of things, however, the war ended. Another group, the 319th BG which had flown Marauders in Italy, had converted in the U.S. prior to redeployment to the Pacific in the late Spring of 1945. Arriving on Okinawa in July of 1945, the 319th began flying missions against targets in both China and Japan but, like the 3rd, their activities were cut short when the two atomic bombs were dropped on Japan in August. A number of other units were in the process of converting to the A-26, but the end of the war ended this activity.

A gun pod equipped A-26C of the 386th BG on the ramp of its English base prior to a mission. Delays in getting the A-26C into production resulted in some units having to retain glass-nosed A-20J/K Havocs as lead ships for level bombing. (Denison)





A formation of A-26Bs and A-26Cs conduct a level bombing mission over Germany during the Spring of 1945. The aircraft are from the 554th BS of the 386th BG. Gun pods are evident on the two center aircraft and were probably fitted to the others as well. (AFM)

In Italy, the 47th Bomb Group slowly re-equipped with the Invader, taking over six months to complete the process. The unit took part in experiments with night bombing and painted some of their aircraft Flat Black. This A-26C of the 86th BS carries the squadron insignia on the nose. (Sullivan via Bowers)

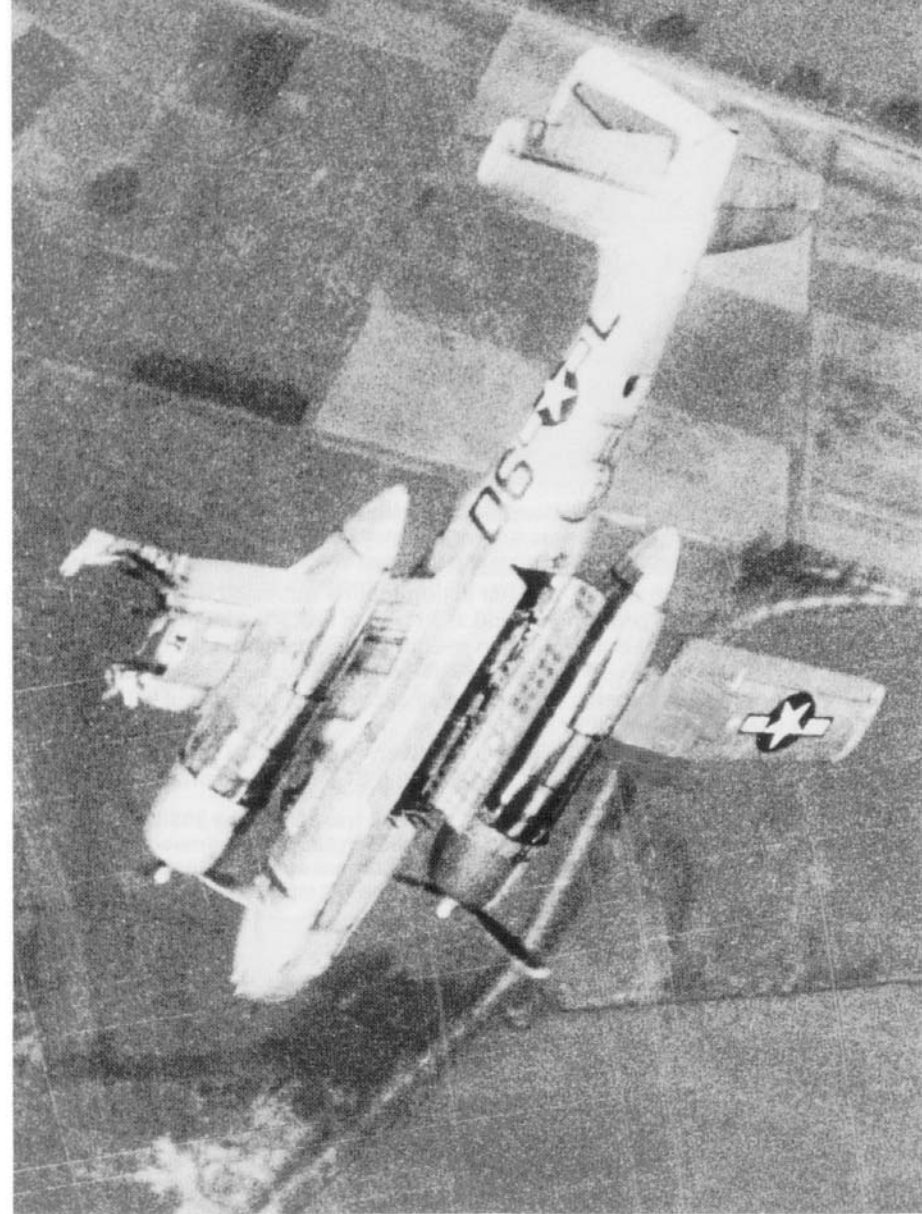

Flak was the main threat faced by Invader crews. This A-26B from the 642nd BS, 409th BG took a direct hit in the port outer wing panel during a bomb run which blew off the wing. The aircraft flipped over and dove into the ground (none of the crew were able to bail out). (USAF via Mikesh)



In the Pacific, the 3rd Bomb Group began to re-equip with the A-26 during the Spring of 1945. The pilot of this eight gun A-26B poses in front of his aircraft on the island of Okinawa near the end of the war. (AFM)



A group of A-26Bs and A-26Cs parked on the runway at the East India Air Depot, Paragash, Calcutta, India near the end of the war. It is believed that these aircraft belong to the 12th Bomb Group, 10th Air Force because of the face markings carried on the nearest six gun A-26B. (Spencer)

An overall Natural Metal six gun A-26B, possibly of the 319th BG, parked off the side of the runway on Okinawa. The aircraft was fitted with the zero length rocket launchers for five inch HVAR rockets under the outer wing panels.



Post War Activities

When the Second World War ended, the A-26 had just started to re-equip units flying the A-20, B-25 and B-26. With the cessation of hostilities, the Air Force decided to standardize on the A-26 as its main twin engine medium bomber and reconnaissance aircraft. Drastic cuts in the military quickly reduced the total strength of the Army Air Force (which became a separate service in 1947) until only a few active A-26 units were left. Fortunately, however, many A-26s were assigned to Air National Guard and Reserve units whose personnel were, in many cases, veterans of Second World War combat. This somewhat compensated for the drastic cutbacks in the regular Air Force. The A-26 was also redesignated as the B-26 by the Air Force during 1947 when the attack category was abolished and the aircraft was reclassified from a medium to a light bomber.

One Second World War unit which had flown the A-26 in combat, the 47th BG, did extensive work in night interdiction and bombing. This unit, which had done pioneer work in this area during the war, had developed special equipment and tactics for night attacks but during 1948 the group switched over to the new North American B-45 Tornado jet bomber and the unit's expertise was lost.

A variety of other roles were also given to the Invader. Some became high speed staff transports, target tugs or were used for experimental work. A small number were used by non-bomber units as squadron hacks or for liaison work. A large number were put into storage against the day they might be needed again.

Following the end of the war, America cut its forces drastically. Since the A-26 was the most modern medium bomber in service, it was selected as the standard bomber. These Invaders were visiting Prague, Czechoslovakia during 1947 (prior to the communist takeover) and carry the Red-Yellow-Red tail stripes which identified American occupation aircraft in Germany. (Zetik)



In the U.S. the 47th BG did extensive work in night interdiction tactics but this information and specialized equipment was discarded when the unit converted to North American B-45 Tornados in 1948. This formation was taking part in a practice mission near Barksdale AFB in Louisiana during early 1947. (USAF)

The "Wingless Wonder" was used to test various parachute braking systems used to slow down a landing aircraft. The outer wing panels and landing gear doors were removed to lighten the aircraft so that its speed could simulate an aircraft that had just landed. (AFM)

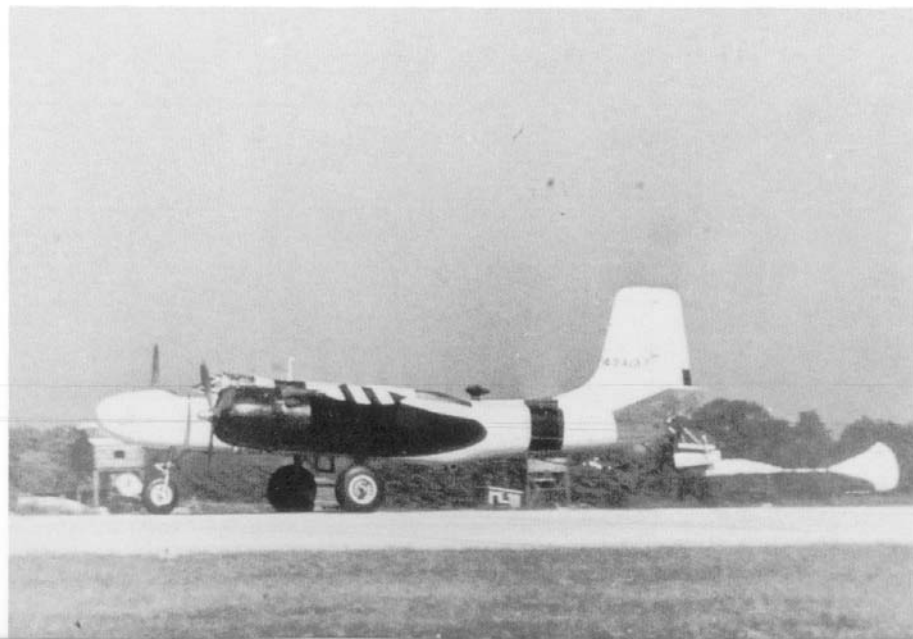



A number of Invaders were assigned various test duties in the postwar years. This A-26B was used to test the effects of storms at the All Weather Flying Center located at Clinton County Airport in Wilmington, Ohio during 1947. The aircraft was overall Natural Metal with Red and Yellow trim. (AFM)



A number of Invaders were used to test the feasibility of underwing cargo pallets which could be carried by combat aircraft into forward bases. The small wooden container used a combination of skids and wheels to land. (AFM)

Numerous Air Force Reserve and Air Guard units used both the A-26B and A-26C following the war. This A-26C was flown by the 112th Bomb Squadron of the Ohio National Guard during the late 1940s and early 1950s. (AFM)



Korean Service

When North Korean tanks and troops poured across the DMZ into South Korea on 25 June 1950, the United States was ill-prepared to fight a conventional war. In Japan, the 3rd BG was immediately ordered to provide cover for the evacuation of U.S. personnel and their dependents from Korea. Within a few days they were ordered on the offensive and began to hit North Korean forces south of the DMZ. On 29 June, in response to North Korean air attacks, the group received orders to take out the main enemy base at Pyong Yang, the first attack north of the border. Bombing results were good, with twenty-five aircraft destroyed on the ground along with an intercepting Yak-3 in the air. Attacks such as these quickly wiped out the small North Korean Air Force and the B-26s quickly shifted to interdiction and ground support operations. This support was desperately needed as the North Koreans forced U.S. and South Korean forces into a small area known as the Pusian Perimeter. Had it not been for air support, the North Koreans would have easily overrun the entire country.

With only two squadrons, the 3rd BG was stretched thin and to alleviate the problem, the Air Force activated the 452nd BG (a reserve unit) in August. After a quick, intense workup period, the unit arrived in Japan during October and immediately commenced operations. One of its four squadrons was reassigned to the 3rd BG to bring it up to full strength. Both units operated out of Japan for the first year of the war, the 3rd BG at Iwakuni Air Base and the 452nd at Milo Air Base.

After a few months, the air war changed as the North Koreans, and later the Chinese, realized that trying to move men and material in daylight with the U.S. in command of the air was far too costly. As a result, nearly all enemy movement took place at night and gradually the B-26s were shifted to the night bombing role. With only limited training

When the Korean War broke out on 25 June 1950, the only B-26s in the Far East belonged to the 3rd Bomb Group at Johnson AB, Japan and on 28 June they flew their first official offensive mission of the war. Initially the B-26s were camouflaged Olive Drab over Neutral Gray with Yellow fin tips for the 8th BS and Red for the 13th BS.



and equipment, this change in mission taxed both units but they responded and slowly developed effective tactics to hinder enemy logistics and troop movements. Unfortunately, much of the information, tactics and equipment developed by the 45th BG before it changed roles in 1948 had been discarded or lost, forcing the two groups to relearn the information which the 47th had worked so hard to perfect.

In the Spring and Summer of 1951, when new airfields became available in Korea, the two groups were moved from Japan, with the 3rd BG going to Kunsan (K-8) and the 452nd BG going to Pusan (K-9). From these bases, the Invader units basically split the country in half, the 3rd BG becoming responsible for targets in western Korea while the 452nd BG took targets in eastern Korea. Night interdiction was a very difficult mission and a variety of approaches were tried. At first the crews looked for truck lights and the steam from railroad engines but the enemy quickly learned to turn off their lights or head for a tunnel at the first sound of an approaching aircraft.

To counter this, the Invaders teamed up with C-47 "Firefly" transports which dropped flares to help the bombers locate targets. Some aircraft even tried special searchlight pods mounted under the wings which, while illuminating the target, also made it easier for enemy gunners to spot the B-26. For fixed targets, short range navigation radar (SHORAN) could be used but the target had to be stationary, such as a bridge or road junction.

In an attempt to increase their effectiveness, a number of solid nosed B-26Bs were converted to glass nosed versions to allow the bombardier/navigator a better chance at locating targets. One new tactic which was developed to increase the unit's effectiveness at night was the hunter-killer team. This involved a pair of B-26s, one of which flew a few miles ahead of its partner. When the enemy heard or sighted the first B-26, they immediately cut their lights until after it passed, switching them on just as the second arrived. After the attack, the aircraft would then switch roles.

While the 3rd BG and 452nd BG were hitting the enemy hard, another group of Invaders were used to try to locate the enemy. These were the RB-26Cs which specialized in night reconnaissance work. Originally, in August of 1950, the 162nd Tactical Reconnaissance Squadron (TRS), 363rd Tactical Reconnaissance Group (TRG) in Langley,

A group of 452nd BG B-26Bs return from a mission over North Korea during January of 1951. Since the 3rd BG was spread thin in the early days of the war, the Air Force called up the 452nd BG (a reserve unit) for duty in Korea. One squadron, the 731st BS, was reassigned to the 3rd BG to bring that group up to strength. (USAF)





The 162nd Tactical Reconnaissance Squadron, 363rd Tactical Reconnaissance Group was sent to Korea to help with the reconnaissance mission. This well worn RB-26C of the 162nd TRS was parked on the ramp at Taegu during the Fall of 1950. The squadron insignia, an owl with a camera, was carried on the nose. (Ballweg)

Virginia, had been rushed to Japan to locate enemy targets. Moving to Talger (K-2) in Korea in October, the unit performed sterling service until they disbanded in February of 1951. Its men and aircraft were then assigned to the 12th TRS, 67th TRG which moved back to Korea, first at Talger, then finally at Kempo (K-14).

As the war stabilized along the original boundary lines, the B-26s roamed over the breadth and width of Korea. Although occasionally taking part in daylight bombing missions, the bulk of their work was done at night. In May of 1952, the 452nd BG was deactivated, with its men and aircraft becoming the 17th BG. Operations continued unabated until a truce was signed and hostilities ended on 27 July 1953.

The last bombing mission of the war was carried out, shortly before the truce went into effect, by aircraft of the 3rd BG, a fitting climax for the unit and aircraft which also carried out the first attack of the war.

In the Spring of 1951, the 452nd BG moved to Pusan East (K-9) for operations closer to the battlefield. This 452nd BG B-26B was being armed prior to a mission. The aircraft was flown by CAPT Edward Bishop, whose Second World War B-26B, *Miss Mildred*, was the subject of a model kit by the Airfix company. (E. & K. Bishop)



The 3rd BG followed the 452nd to Korea in August, being based at Kunsan (K-8) airfield. This B-26B of the 13th BS, 3rd BG parked on the PSP ramp off the side of the runway was being refueled for another mission. (USAF via Bell)

A six gun B-26B and an eight gun B-26B of the 8th Bomb Squadron, 3rd Bomb Group share the ramp at Iwakuni Air Base, Japan just before their move to Korea. The aircraft in the foreground carried the squadron emblem on the starboard side and the name *My Asses Draggin* along with a dragon painting on the port side. (R.V. Powell, via R. V. Powell III)

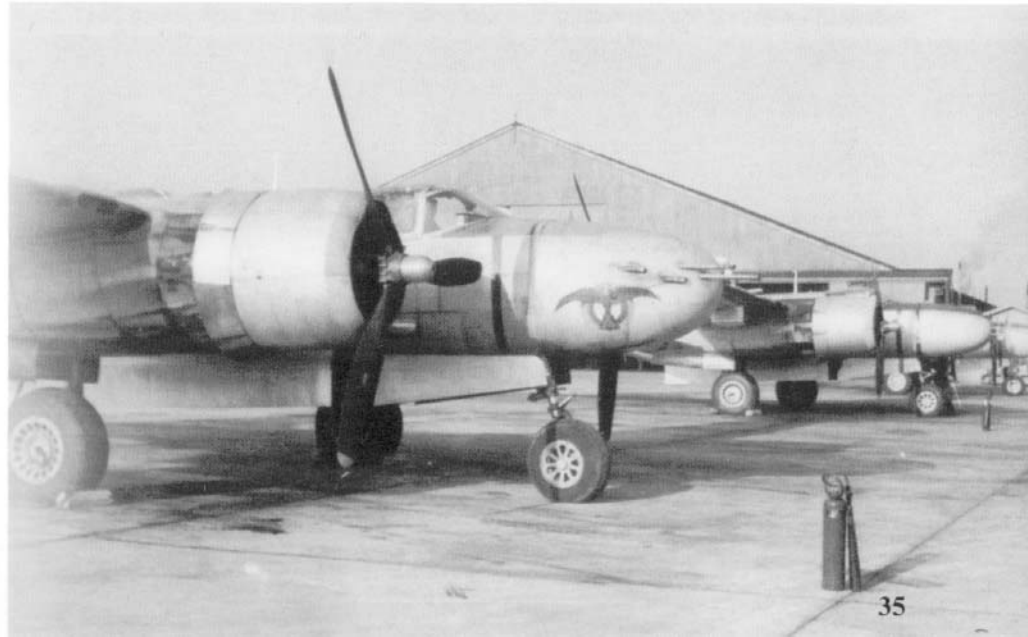



An Olive Drab over Neutral Gray eight gun B-26B of the 13th Bomb Squadron, 3rd Bomb Group taxis in after a mission over Korea. The 13th Bomb Squadron had the fin tip painted Red as a unit identification marking. The 3rd Group flew both camouflaged and overall Natural Metal aircraft. (R.V. Powell via R.V. Powell III)



A number of B-26Cs from the 3rd BG were fitted with special electronics and radar gear in a modified nose section for night detection work. The original nose was modified with additional framing and the upper section was been extended to house the radome. (Kerr)

The 3rd Bomb Group used a letter on the fin as an aircraft within squadron identification. The T on this Natural Metal six gun B-26B of the 8th Bomb Squadron was in Black, while on Olive Drab camouflaged aircraft the letter was in White. Later on Black aircraft the letter was in Red. (R.V. Powell via R.V. Powell III)



Pathfinder Nose

B-26C

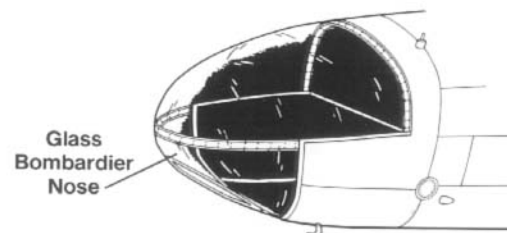

B-26C Pathfinder

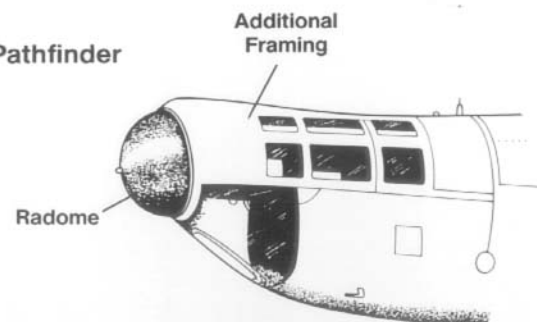



Ground personnel work on the radar in the nose of one of the specially modified radar equipped B-26s. The radar tracking gear was mounted in a gimble arrangement and could rotate through a large arc to detect ground targets. (Kerr)



In early January of 1951, the 162nd TRS was deactivated with its men and material going to the 12th TRS, 67th TRG. This RB-26C, named *Juanita*, operated out of Taegu before being transferred to Kimpo. Aside from nose art, the aircraft carried little in the way of markings. (USAF via Bell)

Gradually the two Invader groups shifted over to night work as the Communists began to move men and material only at night. As a result, the aircraft were repainted Gloss Black. This six gun nose B-26B from the 13th BS, 3rd BG awaits the arrival of its crew for a night interdiction mission. (USAF via Bell)

This B-26B (modified with a glass nose) taxis out for a daylight bombing mission during late 1952 from K-9 airfield. The aircraft carries the kicking mule insignia of the 95th BS on the nose. The cowling was Black while the wing tips and fin tip were Medium Blue. (Geiddel)



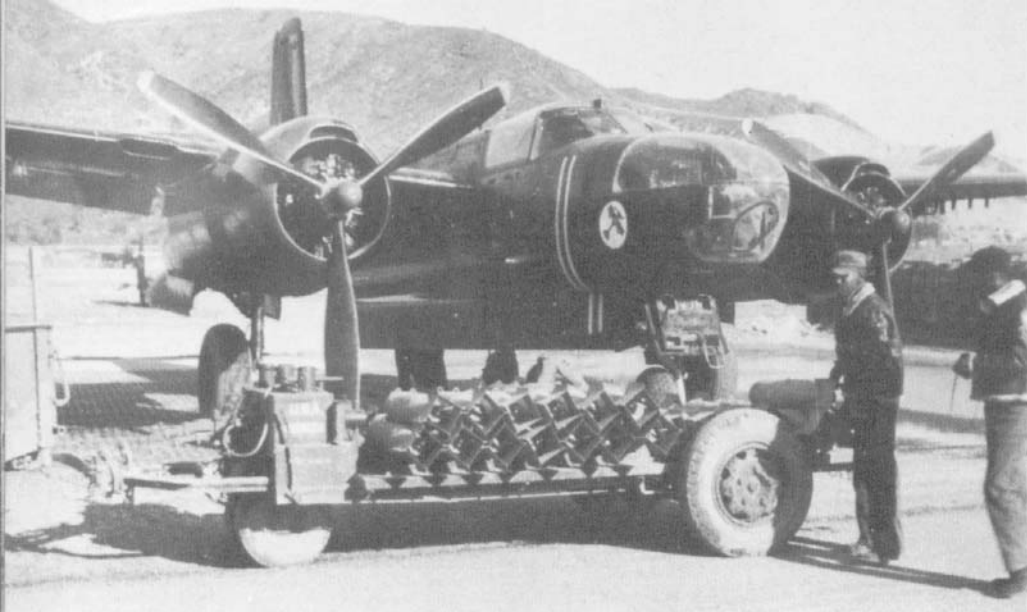

In the Spring of 1952, the 452nd BG was returned to inactive status but its men and aircraft were used to form the 17th Bomb Group. The 17th was composed of the 34th, 37th and 95th Bomb Squadrons. This B-26 carries the stylized Thunderbird insignia of the 34th BS on the nose.



Besides enemy fire, the B-26s faced horrible weather conditions. Following a heavy snow, these two B-26s struck high snow drifts which sheered off the nose gear. In the ensuing crash the entire nose section broke away and at least one navigator/bombardier lost his life. After these two incidents, no one was allowed to ride in the nose during takeoff or landing. (Geidel)

Martha Ann, a B-26B from the 3rd BG, undergoes preflight before a mission over North Korea. The parachutes of the pilot and bombardier are stacked on top the fuselage. The crew will put them on after they climb up on the wing to make things a little easier on themselves.



A freshly repainted overall Gloss Black B-26B (with a glass nose) parked in a revetment made of fifty-five gallon fuel drums filled with dirt. It is believed that this aircraft was from the 95th Bomb Squadron. The Red and White stripes around the nose are propeller warning stripes. (Geidel)





Following the Korean War, a number of units continued to fly the Invader, including the 363rd TRW based at Shaw AFB, South Carolina. This unit carried very distinctive unit markings consisting of a Red and White checker board fin. (AFM)



The B-26 Invader still equipped the National Guard and some of the aircraft which had served in Korea were returned to their former Air Guard units, such as this B-26C of the Virginia Air National Guard. (AFM)

During 1954, the 345th Bomb Group (Air Apaches of World War II fame) was reactivated at Langley AFB, Virginia and equipped with B-26s. These aircraft, lining up to begin a training mission, were from the 500th Bomb Squadron. (Mikesh)





The 345th BG staged Saturday formation reviews to hone their formation flying skills and to give the group's ground personnel a sense of pride in the unit. This formation was a little more than half of the full thirty-six ship formation. (Mikesh)



Two glass nosed B-26s peel off from the formation for landing at Langley, revealing the gun pods carried on the B-26 in the background. For an aircraft of its size the Invader was extremely maneuverable. The 345th later re-equipped with the Martin B-57 jet bomber. (Mikesh)

Gradually the B-26 was replaced by aircraft like the B-57 or B-66 in the bombing and reconnaissance role. Some aircraft were kept as liaison or squadron hacks, while some were used for a variety of miscellaneous duties. This B-26C, stripped of all armament, was assigned to the Air Material Command for use as a high speed transport. (USAF)



Vietnam Operations

With the end of the Korean War, the United States had a short period of relative peace. Four bomber and two reconnaissance wings of B-26s remained in service following the Korean Armistice, along with additional RB-26Cs assigned to a number of reconnaissance units. Stationed in the Far East was the 3rd Bomb Wing (BW) and the 67th TRW (RB-26s). Europe had the 38th BW and the 10th TRW, while in the U.S. the 345th BW, 461st BW and the 363rd TRW were all equipped with B-26s. Additionally, the 432nd TRW had a small number of RB-26s.

With the introduction of the Douglas B-66 and Martin B-57 jet bombers, however, the remaining days of front line service of the Invader were numbered. By the late 1950, the jet aircraft had taken over the bombing and reconnaissance work of the B-26 and the old girl was slowly put out to pasture. While still functioning as a high speed transport, drone controller, target tug, and in a variety of other miscellaneous roles, it appeared the glory days of the Invader in U.S. service was over.

Unfortunately, during the late 1950s and early 1960s the U.S. was becoming increasingly involved in unconventional or guerrilla type conflicts, especially in Southeast Asia. To counter this threat, the Air Force developed a counter-insurgency unit which could be deployed to assist friendly governments against communist insurgents. Designated the 4400th Combat Crew Training Squadron (CCTS), it was nicknamed the *Jungle Jims* (later the unit became better known as the *Air Commandos*). Rather than use sophisticated jets, it operated a variety of older propeller-driven transports, fighters and bombers. Since the only propeller bomber still around in any numbers was the B-26, it was the natural choice for use by the unit.

In late 1961, four RB-26s were sent to Vietnam under the *Farm Gate* program to provide valuable reconnaissance work for South Vietnamese forces and their American advisors. The following Spring two more RB-26s along with four B-26Bs were sent to augment the initial detachment. While officially tasked with training South Vietnamese Air Force personnel, Air Commando crews flew numerous combat missions with their aircraft (which were painted in South Vietnamese markings). As the war heated up, additional Invaders were sent until a unit strength of twelve aircraft was reached. Increased Viet Cong anti-aircraft fire took its toll and two Invaders were lost in early 1963. Two more were lost when they shed wings during bomb runs. An investigation revealed that the wing spars had been over stressed by taxiing over uneven PSP ramps and runways with wing mounted ordnance. This had caused the wings to flex, resulting in the spars cracking and eventual wing failure. This problem led to a decision to withdraw the Invaders from service during the Spring of 1964.

This, however, was not to be the end of the B-26's service with the Air Force in Vietnam. In late 1962, On Mark Engineering began work on rebuilding and modifying the B-26 specifically for use as a counter-insurgency aircraft. After successful testing of the prototype during 1963, the Air Force placed a contract for forty modified aircraft under the designation B-26K. These were used to equip two squadrons, one for training, the 603rd Special Operations Squadron (SOS), and one which deployed to Thailand, the 609th SOS (originally the 606th Air Commando Squadron). Operating from Nakhom Phanom (NKP) Air Base in Thailand, the modified Invaders were used primarily for night interdiction of the Ho Chi Minh trail, although on occasion they flew daylight missions in support of Laotian forces under the command of GEN Vang Pao over the Plain of Jars.

Other missions were flown right up to the Chinese border, although details on these are quite sketchy. Using the call sign *Nimrod*, the B-26Ks began flying missions during early 1966. Later, when the Thai government objected to "bombers" being stationed in their country, the B-26Ks were redesignated as A-26As. The Invaders became very adept at truck busting along the Ho Chi Minh Trail, just as had their counterparts done in Korea, becoming one of the most effective aircraft for the job. Unfortunately, attrition and a lack of spare parts took its toll and in November of 1969, the 609th SOS stood down. While most of the remaining aircraft were ferried back to Davis Monthan AFB for storage and eventual disposal, a small number (perhaps five) were sent to Nha Trang, South Vietnam. Rumors arose that they were being used for CIA operations, or more mundanely as instruction airframes for the South Vietnamese. Whatever the case, these were the last A-26s to see service in a war zone under U. S. control.

Stateside, only a few Invaders remained in service in miscellaneous roles. These few were slowly retired and, in late 1972, the last B-26 in service was turned over to the National Air and Space Museum for eventual display. Thus past into history the only American combat aircraft to see service in the Second World War, Korea and Vietnam — a tribute to the rugged design formulated by Douglas during 1941, some thirty-one years earlier.

In response to the ever increasing communist threat in South Vietnam, a detachment of the 4400th CCTS was sent to the country during late 1961, including four RB-26s for reconnaissance work (later augmented by B-26Bs). These Invaders are parked on the runway at Bien Hoa during September of 1962. The aircraft on the left has a sharks mouth painted on its napalm tank. (USAF)





A six gun B-26B provides escort for a C-123 defoliation mission, code named *Ranch Hand*. The gun powder from the nose guns has stained the fuselage sides almost back to the cockpit. At this time all *Farm Gate* detachment aircraft carried the markings of the Vietnamese Air Force. (USAF)



Carrying napalm tanks and rocket pods, in addition to its internal bomb load, a B-26B makes a run at a suspected Viet Cong position north of Saigon. Initially, the Viet Cong had few anti-aircraft weapons but as the war intensified they increased their capabilities tremendously and, by the early 1963, they had knocked down a number of B-26s. (USAF)

Ground crewmen go over a B-26B prior to a mission out of Bien Hoa Air Base, South Vietnam. The Air Commandos flew a mixture of six and eight gun nosed B-26Bs. The aircraft were modified with special wing racks so they could carry heavier ordnance loads. (USAF)



AB-26 taxis past a T-28 of the *Farm Gate* detachment which had a small sharks mouth on the outboard rocket pod. Normal colors for *Farm Gate* B-26s was overall Gloss Light Gray. The aircraft in the background are Vietnamese Air Force T-6s being readied for return to the U.S. (USAF)



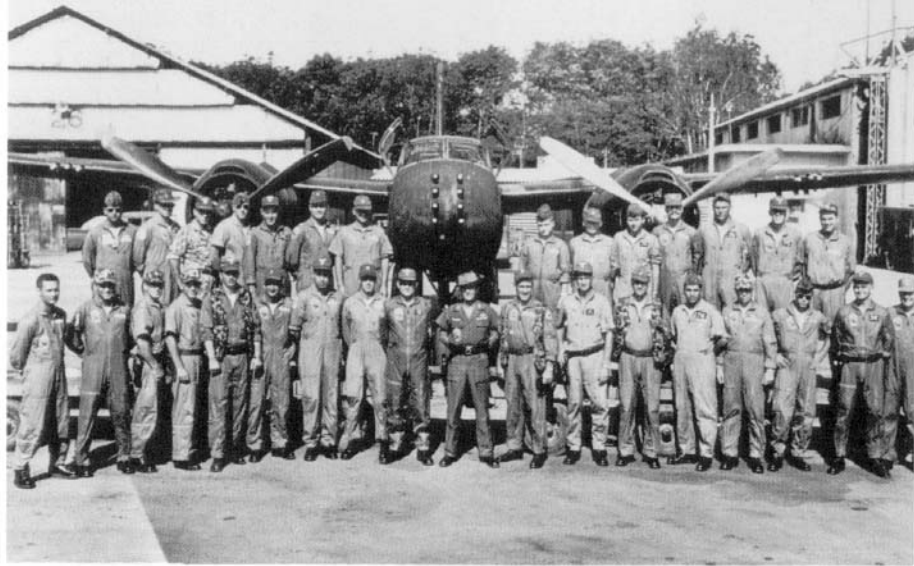

Pilots of the 1st Air Commando Squadron pose in front of a B-26B just prior to its being withdrawn from service. The aircraft is unusual in that it appears to have an overall dark color (possibly Black) which may have been applied for night missions or for a secret assignment which was not uncommon at this stage of the war. (USAF)



Training for B-26K crews was undertaken by the 603rd SOS, which carried the tail code IF along with the national insignia on the fuselage (a practice not followed in Thailand). This aircraft was camouflaged in the three tone Southeast Asia scheme with Black undersides, although some aircraft had Light Gray undersides.

The first contingent of B-26Ks arrived at NKP, Thailand during early 1966 and carried no tail codes to identify the unit. Initially designated the 606th Air Commando Squadron, the unit would later be redesignated as the 609th Special Operations Squadron. (AFM).



Southeast Asia Camouflage

B-26K/A-26A

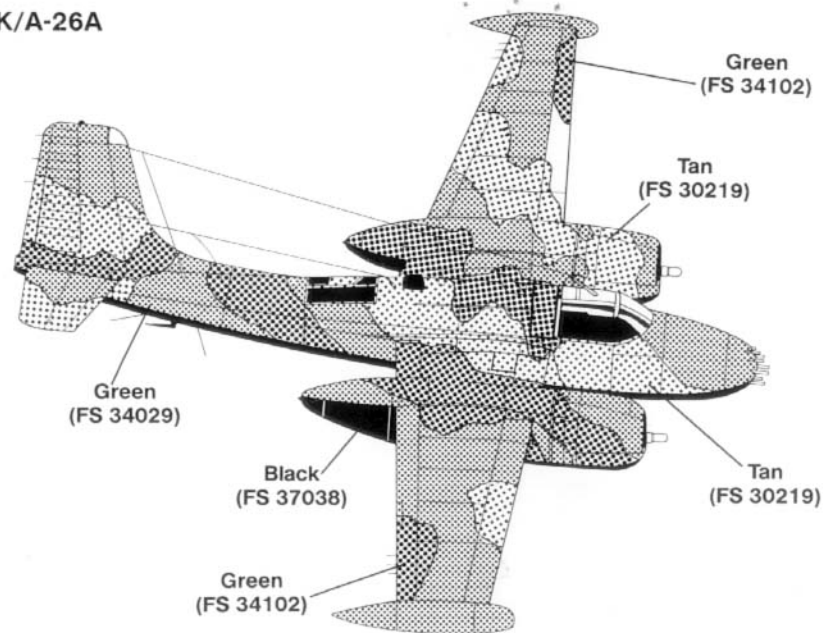

(Note: Some stateside aircraft had Light Gray (FS 36622) undersides).

Foreign Service

As in the case of many American aircraft, the A-26 served with many other countries through various military aid agreements. At least twenty air forces used the Invader along with several quasi-military or covert organizations, although in some cases information on these covert operations is extremely scarce or non-existent. The following list and short summary covers known users of the aircraft.

France: The *Armie de l'Air* was the largest single foreign user of the A-26. Following a change in American attitude toward the French war in Indochina, the U.S. began supplying the French both A-26Bs and A-26Cs during January of 1951. Over a three year period 111 aircraft were delivered to the French under the Mutual Defense Assistance Program. These aircraft were used to equip three bombardment groups (GBs) and one reconnaissance unit (ERP): GB 1/19 *Gascogne*, GB 1/25 *Tunisie*, GB 1/91 *Bourgogne* and ERP 2/19 *Armagnac*. The A-26s provided a much needed boost to the hard pressed French air units as they fought the elusive Viet Minh.

Twenty-five were lost and the rest, save for one used as a test aircraft, were returned to U.S. control after the French lost the war. This return was premature for shortly after the end of the Indochina war an insurrection broke out in Algeria and again the French needed bombers. Eventually eighty-five A-26s were purchased. These were used to equip two bomber training units, CIB 328 and 329, a night fighter unit ECN 1/71 (which flew specially modified B-26s), two bomber groups GB 12/91 *Gascogne* and GB 2/91 *Guyenne* and two reconnaissance groups ERP 1/31 *Armagnac* and ERP 2/32. The Invaders performed sterling service for the French, but with the conclusion of hostilities all the aircraft were returned to France and the units were disbanded. A few aircraft were used for tests, liaison duties, or fast transports and it was not until 1968 that the last Invader was retired from French service.

Brazil: The Brazilian Air force (FAB) was the largest operator of the B-26 after the French, acquiring thirty-six B-26B/Cs during the mid-1950s. In 1968 a number of the remaining aircraft were modified by Hamilton Aircraft of Tucson to near B-26K standards and these modified Invaders were assigned to the 1st Squadron of the 10th Group. The Invader served the FAB until 1976 when they were phased out in favor of the AT-26 Xavante (MB-326).

Chile: Chile received thirty-four B-26Cs and four B-26Bs with deliveries starting during December of 1954 and ending in March of 1958. The Invader replaced the B-25s operated by Grupo 8 based at Autofagasta. Over the years most were lost in accidents and the last two aircraft were converted to the fast transport role with Grupo 10 at Los Cerrillos remaining in service until 1976.

Biafra: This rebel province of Nigeria acquired one (possibly two) B-26s during the fight for independence. Little is known of their operations.

China: An unknown number of B-26/RB-26s were received by Nationalist China. It is known that some of these aircraft were used for missions over the Chinese mainland during 1958. Other than a serial number on the tail, most of the aircraft were flown unmarked and were painted overall Black.

Colombia: Nineteen B-26B/Cs were received by the Colombian Air Force with deliveries beginning in 1954 and ending in 1956. During the late 1960s the remaining eight Invaders were modified to B-26K standards and these remained in service with the Reconnaissance and Attack Group at Luis Gomez Nino air base until the mid-1980s.

Congolese Republic: During the fighting in the Belgian Congo during the early 1960s a number of B-26Ks, with CIA supplied Cuban aircrews, were used to support the U.S. backed government. These eventually formed the equipment of 211 Squadron, a nine aircraft squadron that was used primarily for counter-insurgency work.

Cuba: Eighteen B-26B/Cs and TB-26C were acquired by the Cuban Air Force prior to the imposition of an arms embargo against the ruling Batista regime. When Castro took over, the remaining Invaders in service were incorporated into the *Fuerza Aerea Revolucionaria* (FAC). In April of 1961, these were used to help repel the rebel invasion at the Bay of Pigs and a number were destroyed in the air or on the ground by the rebel air force which flew B-26B/Cs out of Nicaragua.

Cuban Rebel Air Force: This unit, with the backing of the CIA, tried to overthrow the communist regime of Fidel Castro during April of 1961. Equipped with seventeen B-26B/Cs, the rebels flew numerous missions during the Bay of Pigs invasion, losing at least five Invaders (including two piloted by four U.S. advisors who were killed on the last mission). Another rebel aircraft was used to stage a fake "defection" to Miami as part of the cover story during the initial stages of the invasion.

Dominican Republic: This country acquired nine Invaders through various ways, starting in the late 1950s. The survivors were reportedly upgraded to B-26K standards in the late 1960s.

The largest foreign user of the B-26 was the French *Armee de l' Air*. B-26s served under French colors in Indochina and later in Algeria. The first unit to receive the B-26 was GB 1/19 *Gascogne* which began operating the Invader during early 1951 from bases in northern Tonkin (North Vietnam). (ECPA)



Guatemala: Seven B-26Bs and one B-26C were acquired with deliveries starting in 1960. Another B-26B was acquired when one of the aircraft used by the Cuban rebels during the Bay of Pigs landed in Guatemala and was taken on charge as FAG 420. In September of 1968, the surviving B-26s were assigned to the Special Air Warfare Strike/Reconnaissance unit. These remained in service until replaced by Cessna A-37Bs during the early 1970s.

Indonesia: Indonesia's No 1 Squadron was a mixed unit of B-25Js and B-26Bs that was active during the early 1960s. These were later relegated to second line duties during the late 1960s when Soviet Il-28 Beagle jet bombers entered service. A change in the political climate in Indonesia later led to the Il-28s being grounded and the surviving B-26s once again became first line equipment. The AURI Invaders saw one last brief combat use during 1976 when an insurgency broke out in East Timor.

Laos: Little is known about the use of the B-26 in Laos although from all reports it appears this was a CIA sponsored operation using U.S. Air Force personnel.

Honduras: In 1969 a single B-26B was purchased from a Costa Rica civilian source. The aircraft was armed, painted an overall Dark Green camouflage with a sharkmouth and the serial FAH 510. It was the only Invader in the inventory and remained in service for only a short time.

Mexico: Ten B-26s were acquired and most were converted to staff transports during the early 1960s. Two were later given to the French Air Force and it is believed the last were stricken from the inventory during the mid-1970s.

Nicaragua: The Nicaraguan Air Force (FAN) had one B-26 in 1958 but acquired four B-26Bs from the Cuban rebels after the failed Bay of Pigs invasion of 1961. An additional nine were acquired from various sources during the mid-1960s and these were used to

A six-gun B-26B, possibly from GB 1/25 *Tunisie*, flies a mission to Dien Bien Phu during the later stages of the siege at the French base. Many of the Invaders which were received by the French were reconditioned USAF aircraft from the Korean War which had been overhauled in Japan. (ECPA)



equipped one bomber squadron which remained active until the fall of the Somoza government in 1979.

Peru: Eight B-26Cs were acquired in the mid-1950s, followed by an additional eight B-26B/Cs toward the end of the decade. These were used to replace B-25s in *Escuadrión de Bombardeo 21* until replaced by British Canberra jet bombers in the late 1960s.

Portugal: Twenty B-26s were purchased by Portugal in 1966 for use in Angola but only seven were received, the remainder being confiscated by U.S. Customs. None saw combat, although one was used for test work in Portugal (serial 7104) and reportedly two were abandoned in Angola. The rest were disposed of on the international market.

Royal Air Force: The British acquired three Invaders for evaluation in 1944 and 1945 and placed a contract for 140 aircraft under the designation Invader I. Due to difficulties in filling USAAF needs, only two were delivered to the RAF and these, along with the evaluation aircraft, were returned to the U.S.

Saudi Arabia: In 1955 nine B-26Bs were acquired by the Royal Saudi Air Force to equip their first operational unit, No 3 Squadron, at Jeddah. Unfortunately, a lack of trained personnel and spare parts severely limited their operations.

Turkey: A total of twenty-eight B-26B/Cs were taken on charge by the Turkish Air Force during 1948. Some were used to replace the Baltimore bombers of the 1st Battalion, 2nd Regiment while others were assigned to the 10th Regiment and to the Eskisehir Bombing School. Later, at least ten were retained for target towing duties after they were replaced in first line service by jets during the late 1950s. These were retired from service in 1959.

Vietnam: While the Invader flew in South Vietnamese markings in the early 1960s, they were manned by U.S. Air Force crews (although Vietnamese personnel did fly missions,

The Turkish Air Force received a number of Invaders, including this B-26B, to replace the Martin Baltimore bombers of the 1st Battalion, 2nd Regiment. After the B-26 was withdrawn from first line service, at least ten Invaders were retained for the target towing role. The last Turkish Invader was retired in 1959.(PM Plastik Model)





The Brazilian Air Force was another large user of the Invader, flying both the B-26B and B-26C. This group of Brazilian B-26B and Cs were part of a number of FAB Invaders that underwent conversion to B-26K standards at Tucson, Arizona by the Hamilton Aircraft Factory.

more for political purposes than for anything else). Following wing structural failures during 1963, the B-26s were withdrawn from service. During 1970, a number of A-26As were delivered to the Vietnamese at Nha Trang but whether or not they were used for special missions by the Vietnamese is unknown.

A number of other clandestine missions by CIA backed groups were flown in the Caribbean (Haiti) and Asia (at least one B-26 was flown in Cambodian markings) using the Invader. One such operation, flown by a CIA contract pilot in support of Indonesian

rebels on the island of Sumatra (1958-1961), nearly led to an international incident when the aircraft was shot down and the pilot captured. The CIA pilot held a Chinese Nationalist civil license and American authorities claimed that he was a mercenary and they had no knowledge of his actions. The pilot was tried and spent many years in an Indonesian jail.

By 1980, all foreign operators of the B-26 had finally withdrawn them from active service. The only aircraft that are still flying are civil aircraft being operated on the Warbird air show circuit.



El Salvador received a small number of B-26s in the early 1970s and these saw limited use in the counter-insurgency role before being replaced by more modern types. Some, if not all, of the aircraft were eventually given two or three tone camouflage schemes. (H. Rowe via N.J. Waters III)

rebels on the island of Sumatra (1958-1961), nearly led to an international incident when the aircraft was shot down and the pilot captured. The CIA pilot held a Chinese Nationalist civil license and American authorities claimed that he was a mercenary and they had no knowledge of his actions. The pilot was tried and spent many years in an Indonesian jail.

By 1980, all foreign operators of the B-26 had finally withdrawn them from active service. The only aircraft that are still flying are civil aircraft being operated on the Warbird air show circuit.

In the early 1960s Guatemala acquired a number of Invaders including a few that had been left in Guatemala by anti-Castro forces after the Bay of Pigs Invasion. These remained in service until replaced during the early 1970s by A-37 Dragonflies. (Via N.J. Waters III)



Civilian Invaders

Following the Second World War, relatively few A-26s were disposed of on the civilian market since the aircraft was still considered to be first line equipment. One, however, was acquired by millionaire Milton Reynolds and used to break Howard Hughes' around-the-world speed record on two different occasions. Named the *Reynolds Bombshell*, the A-26B was flown by Bill Odum who beat Hughes time of 91 hours 41 minutes with times of 78 hours 56 minutes and 73 hours 5 minutes. After the record flights the aircraft was sold. Bill Odum was later killed flying a modified P-51 Mustang in the 1949 National Air Races in Cleveland, Ohio.

Other Invaders were used in the 1946 and 1947 National Air Races in attempts to win the Bendix "R" Trophy. In 1946 the *Caribbean Queen*, a slightly modified A-26C flown by Don Husted, finished sixth in a field of twenty-two entries. The following year, Dianna Cyrus, in an A-26B fitted with bomb bay tanks, flew in the race but became lost and landed in Michigan. Had she stayed on course she probably would have been one of the money winners.

After the Korean War, more Invaders were declared surplus and were acquired by civil operators for a wide variety of roles. The most common roles were fire fighting and executive transport. A number of companies modified B-26s with a large tank in the bomb bay which could hold either water or chemical fire retardants. The Invaders speed and agility proved useful in getting into the narrow valleys of the western U.S. and Canadian forests and Invaders saw many years of service in this role. In the movie "Always," Richard Dreyfuss and John Goodman use B-26 Borite Bombers for some spectacular flying sequences. Gradually, newer aircraft have taken over this role and the B-26 has all but disappeared from fire fighting service.

A number of firms were involved with the modification of surplus Invaders during the late 1950s and early 1960s. Some aircraft were only slightly modified in small numbers by relatively small companies which specialized in production of one-of-a-kind executive transports. Others ran assembly line type operations modifying a number of aircraft. One of these firms was the On Mark Engineering Company which had four Invader transport variants, the Marksman A, B and C and the On Mark Marketeer. Basic differences were in engines, fuel capacity, wing tanks and whether they were pressurized.



A large number of Invaders were converted for use as fire bombers to help fight forest fires in the U.S. and Canada. One of the larger users of the type was Conair Aviation of British Columbia who flew Red and White Invaders. (Conair)

Another firm, L.B. Smith, also marketed four basic models, the Super 26, the Tempo I and II and the Biscayne 26. Unlike the On Mark aircraft, the Smith models all had stretched fuselages, but otherwise were different only in engines, pressurization and fuel capacity. Relatively large numbers of B-26 aircraft were converted into civil transports and they were a common sight at airports for many years. Some were acquired because of their high speed and large cargo area for use in drug smuggling and several were confiscated by the U. S. Drug Enforcement Agency (DEA). While some are still in use, the high operating costs and hard to find spare parts has resulted in an ever lessening number being used.

Other roles for civilian B-26s have included aerial mapping and photography, surveying, test beds for various aircraft systems and a host of other such duties. By the 1980s most of these roles had been taken over by newer aircraft, but in 1983 McDonnell Douglas was named in a law suit when three people died following the crash of a civilian B-26 being used for tests involving airframe stress and equipment. Considering all the diverse and different roles civil Invaders were put through, and the few crashes which occurred, the B-26's civilian record was a remarkably safe one for such a high performance aircraft.

Some A-26s were used by civil firms for contract test work. This Invader of Claspam from Buffalo, New York did various test projects for the military during the 1970s and 1980s. The aircraft was Red with White trim. (Via Sullivan)

In 1947, the Howard Hughes record for the fastest trip around the world was broken twice by Bill Odum flying the *Reynolds Bombshell* which had been acquired by millionaire Milton Reynolds from Air Force surplus stocks. (Mikesh)



B-26 Nose Art Gallery

BUGS II was a B-26C of the 452nd BG.
(E. & K. Bishop)



"The Waiting Lady" of the 452nd BG was flown by
CAPT Williams. (E. & K. Bishop)



Dream Girl flew with the 452nd BG. (E. & K. Bishop)



HELL'S BELLE was a B-26B converted to
B-26C standards. (E. & K. Bishop)



My Mary Lou was a six gun B-26B of the 17th BG.
(Geidel)

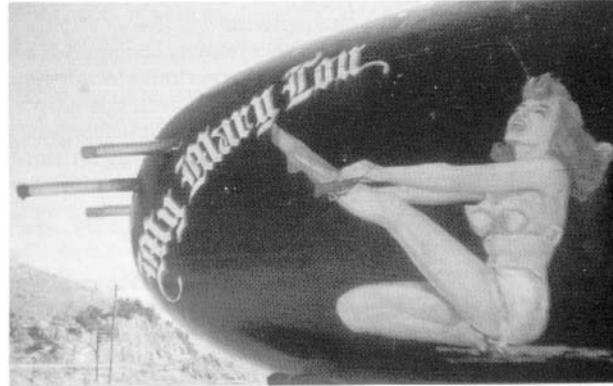

SWEET SUE was a B-26C of an unidentified unit.
(Kerr)



GARDEN STATE EXPRESS was inspired by
Marilyn Monroe. (Kerr)



Pretty Barbara Lee adorned the nose of a Black B-26B.
(Shibusawa via Warren)



An unnamed Marilyn Monroe takeoff was carried on
this B-26C. (Clutts)



This overall Black B-26B Invader of the 95th Bomb Squadron, 17th Bomb Wing (Light), flew missions over Korea during the Summer of 1952.



A DB-26B, based at Van Nuys Air National Guard Base, California during 1957, launches one of its Ryan Firebee target drones during a fighter interceptor weapons meet.



ISBN 0-89747-296-9