

4

ENTITY RELATIONSHIP (ER) MODELING

FOUR

In this chapter, you will learn:

- The main characteristics of entity relationship components
- How relationships between entities are defined, refined, and incorporated into the database design process
- How ERD components affect database design and implementation
- That real-world database design often requires the reconciliation of conflicting goals

This chapter expands coverage of the data modeling aspect of database design. Data modeling is the first step in the database design journey, serving as a bridge between real-world objects and the database model that is implemented in the computer. Therefore, the importance of data modeling details, expressed graphically through entity relationship diagrams (ERDs), cannot be overstated.

Most of the basic concepts and definitions used in the entity relationship model (ERM) were introduced in Chapter 2, Data Models. For example, the basic components of entities and relationships and their representation should now be familiar to you. This chapter goes much deeper and broader, analyzing the graphic depiction of relationships among the entities and showing how those depictions help you summarize the wealth of data required to implement a successful design.

Finally, the chapter illustrates how conflicting goals can be a challenge in database design, possibly requiring you to make design compromises.



Preview

NOTE

Because this book generally focuses on the relational model, you might be tempted to conclude that the ERM is exclusively a relational tool. Actually, conceptual models such as the ERM can be used to understand and design the data requirements of an organization. Therefore, the ERM is independent of the database type. Conceptual models are used in the conceptual design of databases, while relational models are used in the logical design of databases. However, because you are now familiar with the relational model from the previous chapter, the relational model is used extensively in this chapter to explain ER constructs and the way they are used to develop database designs.

4.1 THE ENTITY RELATIONSHIP MODEL (ERM)

You should remember from Chapter 2 and Chapter 3, The Relational Database Model, that the ERM forms the basis of an ERD. The ERD represents the conceptual database as viewed by the end user. ERDs depict the database's main components: entities, attributes, and relationships. Because an entity represents a real-world object, the words *entity* and *object* are often used interchangeably. Thus, the entities (objects) of the Tiny College database design developed in this chapter include students, classes, teachers, and classrooms. The order in which the ERD components are covered in the chapter is dictated by the way the modeling tools are used to develop ERDs that can form the basis for successful database design and implementation.

In Chapter 2, you also learned about the various notations used with ERDs—the original Chen notation and the newer Crow's Foot and UML notations. The first two notations are used at the beginning of this chapter to introduce some basic ER modeling concepts. Some conceptual database modeling concepts can be expressed only using the Chen notation. However, because the emphasis is on *design and implementation* of databases, the Crow's Foot and UML class diagram notations were used for the final Tiny College ER diagram example. Because of its implementation emphasis, the Crow's Foot notation can represent only what could be implemented. In other words:

- The Chen notation favors conceptual modeling.
- The Crow's Foot notation favors a more implementation-oriented approach.
- The UML notation can be used for both conceptual and implementation modeling.

4.1.1 ENTITIES

Recall that an entity is an object of interest to the end user. In Chapter 2, you learned that at the ER modeling level, an entity actually refers to the *entity set* and not to a single entity occurrence. In other words, the word *entity* in the ERM corresponds to a table—not to a row—in the relational environment. The ERM refers to a table row as an *entity instance* or *entity occurrence*. In both the Chen and Crow's Foot notations, an entity is represented by a rectangle containing the entity's name. The entity name, a noun, is usually written in all capital letters.

4.1.2 ATTRIBUTES

Attributes are characteristics of entities. For example, the STUDENT entity includes, among many others, the attributes STU_LNAME, STU_FNAME, and STU_INITIAL. In the original Chen notation, attributes are represented by ovals and are connected to the entity rectangle with a line. Each oval contains the name of the attribute it represents. In the Crow's Foot notation, the attributes are written in the attribute box below the entity rectangle. See Figure 4.1. Because the Chen representation is rather space-consuming, software vendors have adopted the Crow's Foot style attribute display.

Required and Optional Attributes

A **required attribute** is an attribute that must have a value; in other words, it cannot be left empty. As shown in Figure 4.1, there are two boldfaced attributes in the Crow's Foot notation. This indicates that a data entry will be

FIGURE 4.1 The attributes of the STUDENT entity

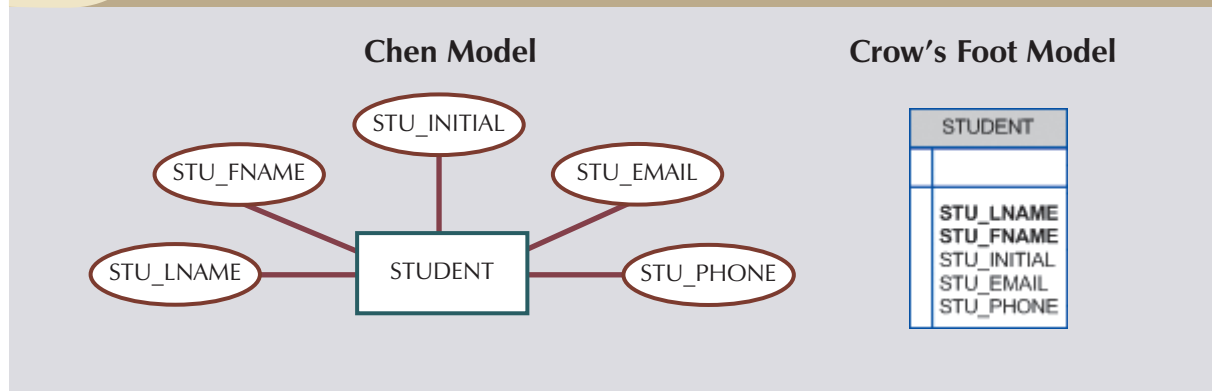

required. In this example, STU_LNAME and STU_FNAME require data entries because of the assumption that all students have a last name and a first name. But students might not have a middle name, and perhaps they do not (yet) have a phone number and an e-mail address. Therefore, those attributes are not presented in boldface in the entity box. An **optional attribute** is an attribute that does not require a value; therefore, it can be left empty.



ONLINE CONTENT

To learn how to create ER diagrams with the help of Microsoft Visio, see the Student Online Companion:

- **Appendix A, Designing Database with Visio Professional: A Tutorial** shows you how to create Crow's Foot ERDs.
- **Appendix H, Unified Modeling Language (UML)**, shows you how to create UML class diagrams.

Domains

Attributes have a domain. As you learned in Chapter 3, a *domain* is the set of possible values for a given attribute. For example, the domain for the grade point average (GPA) attribute is written (0,4) because the lowest possible GPA value is 0 and the highest possible value is 4. The domain for the gender attribute consists of only two possibilities: M or F (or some other equivalent code). The domain for a company's date of hire attribute consists of all dates that fit in a range (for example, company startup date to current date).

Attributes may share a domain. For instance, a student address and a professor address share the same domain of all possible addresses. In fact, the data dictionary may let a newly declared attribute inherit the characteristics of an existing attribute if the same attribute name is used. For example, the PROFESSOR and STUDENT entities may each have an attribute named ADDRESS and could therefore share a domain.

Identifiers (Primary Keys)

The ERM uses **identifiers**, that is, one or more attributes that uniquely identify each entity instance. In the relational model, such identifiers are mapped to primary keys (PKs) in tables. Identifiers are underlined in the ERD. Key attributes are also underlined in a frequently used table structure shorthand notation using the format:

TABLE NAME (KEY_ATTRIBUTE 1, ATTRIBUTE 2, ATTRIBUTE 3, . . . ATTRIBUTE K)

For example, a CAR entity may be represented by:

CAR (CAR_VIN, MOD_CODE, CAR_YEAR, CAR_COLOR)

(Each car is identified by a unique vehicle identification number, or CAR_VIN.)

Composite Identifiers

Ideally, an entity identifier is composed of only a single attribute. For example, the table in Figure 4.2 uses a single-attribute primary key named CLASS_CODE. However, it is possible to use a **composite identifier**, that is, a primary key composed of more than one attribute. For instance, the Tiny College database administrator may decide to identify each CLASS entity instance (occurrence) by using a composite primary key composed of the combination of CRS_CODE and CLASS_SECTION instead of using CLASS_CODE. Either approach uniquely identifies each entity instance. Given the current structure of the CLASS table shown in Figure 4.2, CLASS_CODE is the primary key and the combination of CRS_CODE and CLASS_SECTION is a proper candidate key. If the CLASS_CODE attribute is deleted from the CLASS entity, the candidate key (CRS_CODE and CLASS_SECTION) becomes an acceptable composite primary key.

FIGURE 4.2 The CLASS table (entity) components and contents

CLASS_CODE	CRS_CODE	CLASS_SECTION	CLASS_TIME	ROOM_CODE	PROF_NUM
10012	ACCT-211	1	MWF 8:00-8:50 a.m.	BUS311	105
10013	ACCT-211	2	MWF 9:00-9:50 a.m.	BUS200	105
10014	ACCT-211	3	TTh 2:30-3:45 p.m.	BUS252	342
10015	ACCT-212	1	MWF 10:00-10:50 a.m.	BUS311	301
10016	ACCT-212	2	Th 6:00-8:40 p.m.	BUS252	301
10017	CIS-220	1	MWF 9:00-9:50 a.m.	KLR209	228
10018	CIS-220	2	MWF 9:00-9:50 a.m.	KLR211	114
10019	CIS-220	3	MWF 10:00-10:50 a.m.	KLR209	228
10020	CIS-420	1	W 6:00-8:40 p.m.	KLR209	162
10021	QM-261	1	MWF 8:00-8:50 a.m.	KLR200	114
10022	QM-261	2	TTh 1:00-2:15 p.m.	KLR200	114
10023	QM-362	1	MWF 11:00-11:50 a.m.	KLR200	162
10024	QM-362	2	TTh 2:30-3:45 p.m.	KLR200	162
10025	MATH-243	1	Th 6:00-8:40 p.m.	DRE155	325

NOTE

Remember that Chapter 3 made a commonly accepted distinction between COURSE and CLASS. A CLASS constitutes a specific time and place of a COURSE offering. A class is defined by the course description and its time and place, or section. Consider a professor who teaches Database I, Section 2; Database I, Section 5; Database I, Section 8; and Spreadsheet II, Section 6. That instructor teaches two courses (Database I and Spreadsheet II), but four classes. Typically, the COURSE offerings are printed in a course catalog, while the CLASS offerings are printed in a class schedule for each semester, trimester, or quarter.

If the CLASS_CODE in Figure 4.2 is used as the primary key, the CLASS entity may be represented in shorthand form by:

CLASS (CLASS_CODE, CRS_CODE, CLASS_SECTION, CLASS_TIME, ROOM_CODE, PROF_NUM)

On the other hand, if CLASS_CODE is deleted, and the composite primary key is the combination of CRS_CODE and CLASS_SECTION, the CLASS entity may be represented by:

CLASS (CRS_CODE, CLASS_SECTION, CLASS_TIME, ROOM_CODE, PROF_NUM)

Note that *both* key attributes are underlined in the entity notation.

Composite and Simple Attributes

Attributes are classified as simple or composite. A **composite attribute**, not to be confused with a composite key, is an attribute that can be further subdivided to yield additional attributes. For example, the attribute ADDRESS can be subdivided into street, city, state, and zip code. Similarly, the attribute PHONE_NUMBER can be subdivided into area code and exchange number. A **simple attribute** is an attribute that cannot be subdivided. For example, age, sex, and marital status would be classified as simple attributes. To facilitate detailed queries, it is wise to change composite attributes into a series of simple attributes.

Single-Valued Attributes

A **single-valued attribute** is an attribute that can have only a single value. For example, a person can have only one Social Security number, and a manufactured part can have only one serial number. *Keep in mind that a single-valued attribute is not necessarily a simple attribute.* For instance, a part's serial number, such as SE-08-02-189935, is single-valued, but it is a composite attribute because it can be subdivided into the region in which the part was produced (SE), the plant within that region (08), the shift within the plant (02), and the part number (189935).

Multivalued Attributes

Multivalued attributes are attributes that can have many values. For instance, a person may have several college degrees, and a household may have several different phones, each with its own number. Similarly, a car's color may be subdivided into many colors (that is, colors for the roof, body, and trim). In the Chen ERM, the multivalued attributes are shown by a double line connecting the attribute to the entity. The Crow's Foot notation does not identify multivalued attributes. The ERD in Figure 4.3 contains all of the components introduced thus far. In Figure 4.3, note that CAR_VIN is the primary key, and CAR_COLOR is a multivalued attribute of the CAR entity.

FIGURE 4.3 A multivalued attribute in an entity

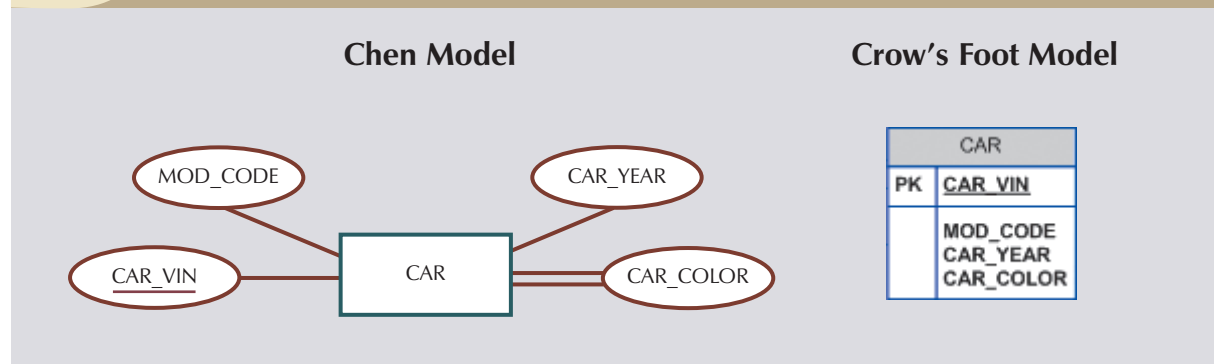

NOTE

In the ERD models in Figure 4.3, the CAR entity's foreign key (FK) has been typed as MOD_CODE. This attribute was manually added to the entity. Actually, proper use of a database modeling software will automatically produce the FK when the relationship is defined. In addition, the software will label the FK appropriately and write the FKs implementation details in a data dictionary. Therefore, when you use database modeling software like Visio Professional, *never type the FK attribute yourself*; let the software handle that task when the relationship between the entities is defined. (You can see how that's done in **Appendix A, Designing Databases with Visio Professional: A Tutorial**, in the Student Online Companion).

Implementing Multivalued Attributes

Although the conceptual model can handle M:N relationships and multivalued attributes, *you should not implement them in the RDBMS*. Remember from Chapter 3 that in the relational table, each column/row intersection represents a single data value. So if multivalued attributes exist, the designer must decide on one of two possible courses of action:

1. Within the original entity, create several new attributes, one for each of the original multivalued attribute's components. For example, the CAR entity's attribute CAR_COLOR can be split to create the new attributes CAR_TOPCOLOR, CAR_BODYCOLOR, and CAR_TRIMCOLOR, which are then assigned to the CAR entity. See Figure 4.4.

FIGURE 4.4 Splitting the multivalued attribute into new attributes

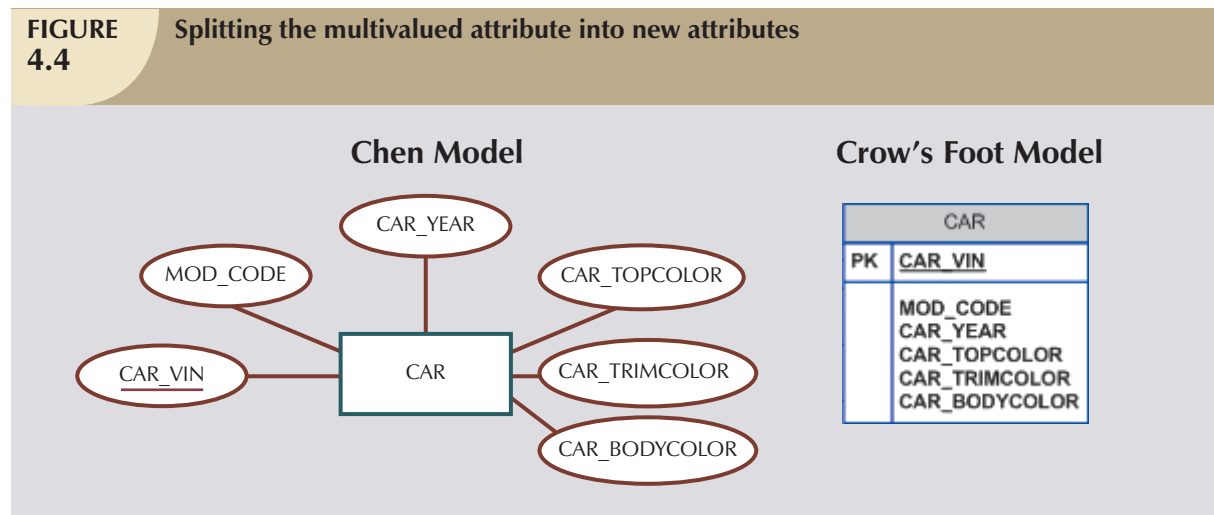

Although this solution seems to work, its adoption can lead to major structural problems in the table. For example, if additional color components—such as a logo color—are added for some cars, the table structure must be modified to accommodate the new color section. In that case, cars that do not have such color sections generate nulls for the nonexistent components, or their color entries for those sections are entered as N/A to indicate “not applicable.” (Imagine how the solution in Figure 4.4—splitting a multivalued attribute into new attributes—would cause problems when it is applied to an employee entity containing employee degrees and certifications. If some employees have 10 degrees and certifications while most have fewer or none, the number of degree/certification attributes would number 10 and most of those attribute values would be null for most of the employees.) In short, although you have seen solution 1 applied, it is not an acceptable solution.

2. Create a new entity composed of the original multivalued attribute's components. (See Figure 4.5.) The new (independent) CAR_COLOR entity is then related to the original CAR entity in a 1:M relationship. Note that such a change allows the designer to define color for different sections of the car. (See Table 4.1.) Using the

TABLE 4.1 Components of the Multivalued Attribute

SECTION	COLOR
Top	White
Body	Blue
Trim	Gold
Interior	Blue

approach illustrated in Table 4.1, you even get a fringe benefit: you are now able to assign as many colors as necessary without having to change the table structure. Note that the ERM in Figure 4.5 reflects the components listed in Table 4.1. This is the preferred way to deal with multivalued attributes. Creating a new entity in a 1:M relationship with the original entity yields several benefits: it's a more flexible, expandable solution, and it is compatible with the relational model!

FIGURE 4.5 A new entity set composed of a multivalued attribute's components

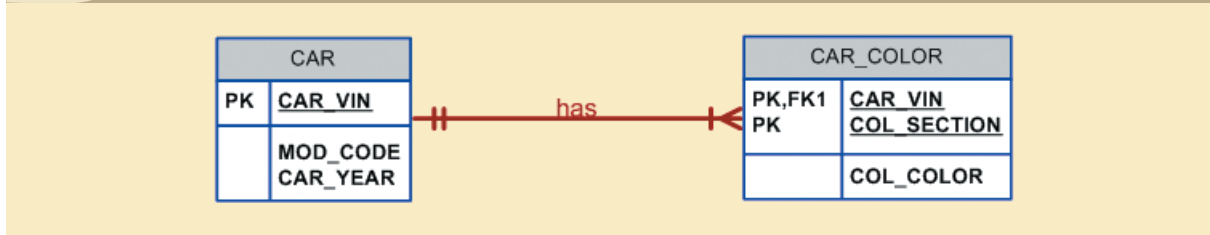

Derived Attributes

Finally, an attribute may be classified as a derived attribute. A **derived attribute** is an attribute whose value is calculated (derived) from other attributes. The derived attribute need not be physically stored within the database; instead, it can be derived by using an algorithm. For example, an employee's age, EMP_AGE, may be found by computing the integer value of the difference between the current date and the EMP_DOB. If you use Microsoft Access, you would use the formula `INT((DATE() - EMP_DOB)/365)`. In Microsoft SQL Server, you would use `SELECT DATEDIFF("YEAR", EMP_DOB, GETDATE())`; where `DATEDIFF` is a function that computes the difference between dates. The first parameter indicates the measurement, in this case, years.

If you use Oracle, you would use `SYSDATE` instead of `DATE()`. (You are assuming, of course, that the `EMP_DOB` was stored in the Julian date format.) Similarly, the total cost of an order can be derived by multiplying the quantity ordered by the unit price. Or the estimated average speed can be derived by dividing trip distance by the time spent en route. A derived attribute is indicated in the Chen notation by a dashed line connecting the attribute and the entity. See Figure 4.6. The Crow's Foot notation does not have a method for distinguishing the derived attribute from other attributes.

FIGURE 4.6 Depiction of a derived attribute

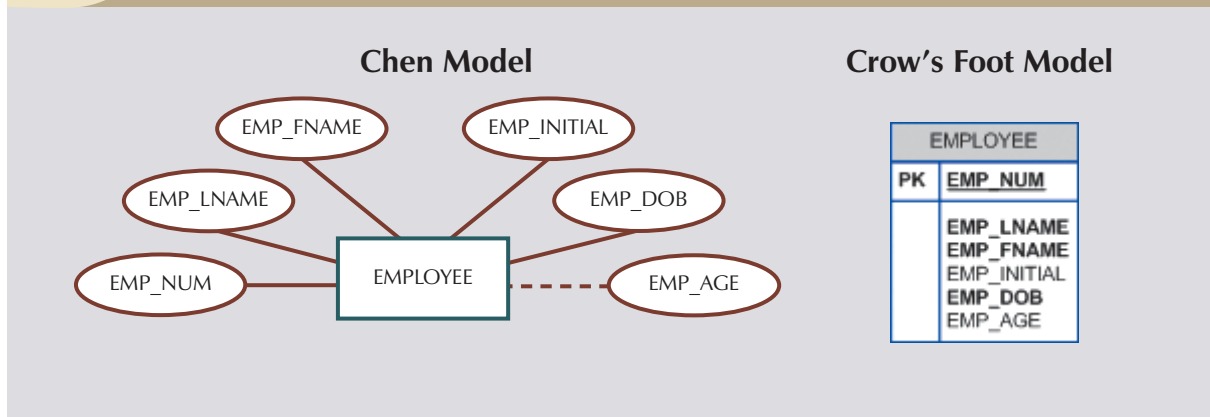

Derived attributes are sometimes referred to as *computed attributes*. A derived attribute computation can be as simple as adding two attribute values located on the same row, or it can be the result of aggregating the sum of values located on many table rows (from the same table or from a different table). The decision to store derived attributes in database tables depends on the processing requirements and the constraints placed on a particular application. The designer should be able to balance the design in accordance with such constraints. Table 4.2 shows the advantages and disadvantages of storing (or not storing) derived attributes in the database.

TABLE 4.2 Advantages and Disadvantages of Storing Derived Attributes

	DERIVED ATTRIBUTE	
	STORED	NOT STORED
Advantage	Saves CPU processing cycles Saves data access time Data value is readily available Can be used to keep track of historical data	Saves storage space Computation always yields current value
Disadvantage	Requires constant maintenance to ensure derived value is current, especially if any values used in the calculation change	Uses CPU processing cycles Increases data access time Adds coding complexity to queries

4.1.3 RELATIONSHIPS

Recall from Chapter 2 that a relationship is an association between entities. The entities that participate in a relationship are also known as **participants**, and each relationship is identified by a name that describes the relationship. The relationship name is an active or passive verb; for example, a STUDENT *takes* a CLASS, a PROFESSOR *teaches* a CLASS, a DEPARTMENT *employs* a PROFESSOR, a DIVISION *is managed by* an EMPLOYEE, and an AIRCRAFT *is flown by* a CREW.

Relationships between entities always operate in both directions. That is, to define the relationship between the entities named CUSTOMER and INVOICE, you would specify that:

- A CUSTOMER may generate many INVOICES.
- Each INVOICE is generated by one CUSTOMER.

Because you know both directions of the relationship between CUSTOMER and INVOICE, it is easy to see that this relationship can be classified as 1:M.

The relationship classification is difficult to establish if you know only one side of the relationship. For example, if you specify that:

A DIVISION is managed by one EMPLOYEE.

you don't know if the relationship is 1:1 or 1:M. Therefore, you should ask the question "Can an employee manage more than one division?" If the answer is yes, the relationship is 1:M, and the second part of the relationship is then written as:

An EMPLOYEE may manage many DIVISIONS.

If an employee cannot manage more than one division, the relationship is 1:1, and the second part of the relationship is then written as:

An EMPLOYEE may manage only one DIVISION.

4.1.4 CONNECTIVITY AND CARDINALITY

You learned in Chapter 2 that entity relationships may be classified as one-to-one, one-to-many, or many-to-many. You also learned how such relationships were depicted in the Chen and Crow's Foot notations. The term **connectivity** is used to describe the relationship classification.

Cardinality expresses the minimum and maximum number of entity occurrences associated with one occurrence of the related entity. In the ERD, cardinality is indicated by placing the appropriate numbers beside the entities, using the format (x,y). The first value represents the minimum number of associated entities, while the second value represents

the maximum number of associated entities. Some Crow's Foot ER modeling tools do not print the numeric cardinality range in the diagram; instead, you could add it as text. In Crow's Foot notation, cardinality is implied by the use of symbols in Figure 4.7. The numeric cardinality range has been added using the Visio text drawing tool.

FIGURE 4.7 Connectivity and cardinality in an ERD

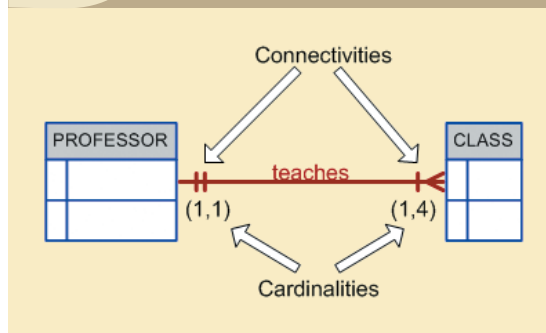

Knowing the minimum and maximum number of entity occurrences is very useful at the application software level. For example, Tiny College might want to ensure that a class is not taught unless it has at least 10 students enrolled. Similarly, if the classroom can hold only 30 students, the application software should use that cardinality to limit enrollment in the class. However, keep in mind that the DBMS cannot handle the implementation of the cardinalities at the table level—that capability is provided by the application software or by triggers. You will learn how to create and execute triggers in Chapter 8, *Advanced SQL*.

As you examine the Crow's Foot diagram in Figure 4.7, keep in mind that the cardinalities represent the number of occurrences in the *related* entity. For example, the cardinality (1,4) written next to the CLASS entity in the “PROFESSOR teaches CLASS” relationship indicates that the PROFESSOR table's primary key value occurs at least once and no more than four times as foreign key values in the CLASS table.

If the cardinality had been written as (1,N), there would be no upper limit to the number of classes a professor might teach. Similarly, the cardinality (1,1) written next to the PROFESSOR entity indicates that each class is taught by one and only one professor. That is, each CLASS entity occurrence is associated with one and only one entity occurrence in PROFESSOR.

Connectivities and cardinalities are established by very concise statements known as business rules, which were introduced in Chapter 2. Such rules, derived from a precise and detailed description of an organization's data environment, also establish the ERM's entities, attributes, relationships, connectivities, cardinalities, and constraints. Because business rules define the ERM's components, making sure that all appropriate business rules are identified is a very important part of a database designer's job.

NOTE

The placement of the cardinalities in the ER diagram is a matter of convention. The Chen notation places the cardinalities on the side of the related entity. The Crow's Foot and UML diagrams place the cardinalities next to the entity to which the cardinalities apply.



ONLINE CONTENT

Because the careful definition of complete and accurate business rules is crucial to good database design, their derivation is examined in detail in **Appendix B, The University Lab: Conceptual Design**. The modeling skills you are learning in this chapter are applied in the development of a real database design in Appendix B. The initial design shown in Appendix B is then modified in **Appendix C, The University Lab: Conceptual Design Verification, Logical Design, and Implementation**. (Both appendixes are found in the Student Online Companion.)

4.1.5 EXISTENCE DEPENDENCE

An entity is said to be **existence-dependent** if it can exist in the database only when it is associated with another related entity occurrence. In implementation terms, an entity is existence-dependent if it has a mandatory foreign key—that is, a foreign key attribute that cannot be null. For example, if an employee wants to claim one or more dependents for tax-withholding purposes, the relationship “EMPLOYEE claims DEPENDENT” would be appropriate. In that case, the DEPENDENT entity is clearly existence-dependent on the EMPLOYEE entity because it is impossible for the dependent to exist apart from the EMPLOYEE in the database.

If an entity can exist apart from one or more related entities, it is said to be **existence-independent**. (Sometimes designers refer to such an entity as a *strong* or *regular* entity.) For example, suppose that the XYZ Corporation uses parts to produce its products. Further, suppose that some of those parts are produced in-house and other parts are bought from vendors. In that scenario, it is quite possible for a PART to exist independently from a VENDOR in the relationship “PART is supplied by VENDOR,” because at least some of the parts are not supplied by a vendor. Therefore, PART is existence-independent from VENDOR.

NOTE

The relationship strength concept is not part of the original ERM. Instead, this concept applies directly to Crow’s Foot diagrams. Because Crow’s Foot diagrams are used extensively to design relational databases, it is important to understand relationship strength as it affects database implementation. The Chen ERD notation is oriented toward conceptual modeling and therefore does not distinguish between weak and strong relationships.

4.1.6 RELATIONSHIP STRENGTH

The concept of relationship strength is based on how the primary key of a related entity is defined. To implement a relationship, the primary key of one entity appears as a foreign key in the related entity. For example, the 1:M relationship between VENDOR and PRODUCT in Chapter 3, Figure 3.3, is implemented by using the VEND_CODE primary key in VENDOR as a foreign key in PRODUCT. There are times when the foreign key also is a primary key component in the related entity. For example, in Figure 4.5, the CAR entity primary key (CAR_VIN) appears as both a primary key component and a foreign key in the CAR_COLOR entity. In this section, you learn how various relationship strength decisions affect primary key arrangement in database design.

Weak (Non-identifying) Relationships

A **weak relationship**, also known as a **non-identifying relationship**, exists if the PK of the related entity does not contain a PK component of the parent entity. By default, relationships are established by having the PK of the parent entity appear as an FK on the related entity. For example, suppose that the COURSE and CLASS entities are defined as:

```
COURSE(CRS_CODE, DEPT_CODE, CRS_DESCRIPTION, CRS_CREDIT)
```

```
CLASS(CLASS_CODE, CRS_CODE, CLASS_SECTION, CLASS_TIME, ROOM_CODE, PROF_NUM)
```

In this case, a weak relationship exists between COURSE and CLASS because the CLASS_CODE is the CLASS entity’s PK, while the CRS_CODE in CLASS is only an FK. In this example, the CLASS PK did not inherit the PK component from the COURSE entity.

Figure 4.8 shows how the Crow’s Foot notation depicts a weak relationship by placing a dashed relationship line between the entities. The tables shown below the ERD illustrate how such a relationship is implemented.

FIGURE 4.8 A weak (non-identifying) relationship between COURSE and CLASS

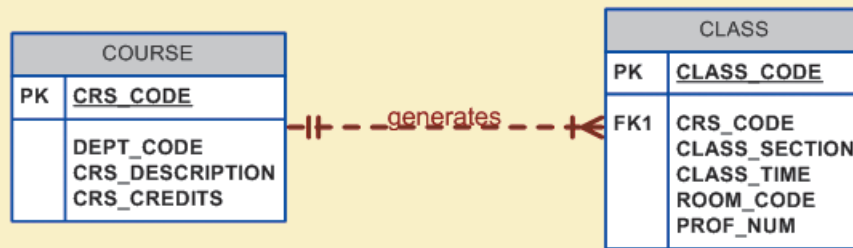

Table name: COURSE

Database name: Ch04_TinyCollege

CRS_CODE	DEPT_CODE	CRS_DESCRIPTION	CRS_CREDIT
ACCT-211	ACCT	Accounting I	3
ACCT-212	ACCT	Accounting II	3
CIS-220	CIS	Intro. to Microcomputing	3
CIS-420	CIS	Database Design and Implementation	4
MATH-243	MATH	Mathematics for Managers	3
QM-261	CIS	Intro. to Statistics	3
QM-362	CIS	Statistical Applications	4

Table name: CLASS

CLASS_CODE	CRS_CODE	CLASS_SECTION	CLASS_TIME	ROOM_CODE	PROF_NUM
10012	ACCT-211	1	MWF 8:00-8:50 a.m.	BUS311	105
10013	ACCT-211	2	MWF 9:00-9:50 a.m.	BUS200	105
10014	ACCT-211	3	TTh 2:30-3:45 p.m.	BUS252	342
10015	ACCT-212	1	MWF 10:00-10:50 a.m.	BUS311	301
10016	ACCT-212	2	Th 6:00-8:40 p.m.	BUS252	301
10017	CIS-220	1	MWF 9:00-9:50 a.m.	KLR209	228
10018	CIS-220	2	MWF 9:00-9:50 a.m.	KLR211	114
10019	CIS-220	3	MWF 10:00-10:50 a.m.	KLR209	228
10020	CIS-420	1	W 6:00-8:40 p.m.	KLR209	162
10021	QM-261	1	MWF 8:00-8:50 a.m.	KLR200	114
10022	QM-261	2	TTh 1:00-2:15 p.m.	KLR200	114
10023	QM-362	1	MWF 11:00-11:50 a.m.	KLR200	162
10024	QM-362	2	TTh 2:30-3:45 p.m.	KLR200	162
10025	MATH-243	1	Th 6:00-8:40 p.m.	DRE155	325



ONLINE CONTENT

All of the databases used to illustrate the material in this chapter are found in the Student Online Companion.

NOTE

If you are used to looking at relational diagrams such as the ones produced by Microsoft Access, you expect to see the relationship line *in the relational diagram* drawn from the PK to the FK. However, the relational diagram convention is not necessarily reflected in the ERD. In an ERD, the focus is on the entities and the relationships between them, rather than on the way those relationships are anchored graphically. You will discover that the placement of the relationship lines in a complex ERD that includes both horizontally and vertically placed entities is largely dictated by the designer's decision to improve the readability of the design. (Remember that the ERD is used for communication between the designer(s) and end users.)

Strong (Identifying) Relationships

A **strong relationship**, also known as an **identifying relationship**, exists when the PK of the related entity contains a PK component of the parent entity. For example, the definitions of the COURSE and CLASS entities

COURSE(CRS_CODE, DEPT_CODE, CRS_DESCRIPTION, CRS_CREDIT)

CLASS(CRS_CODE, CLASS_SECTION, CLASS_TIME, ROOM_CODE, PROF_NUM)

indicate that a strong relationship exists between COURSE and CLASS, because the CLASS entity's composite PK is composed of CRS_CODE + CLASS_SECTION. (Note that the CRS_CODE in CLASS is also the FK to the COURSE entity.)

The Crow's Foot notation depicts the strong (identifying) relationship with a solid line between the entities, shown in Figure 4.9. Whether the relationship between COURSE and CLASS is strong or weak depends on how the CLASS entity's primary key is defined.

FIGURE 4.9 A strong (identifying) relationship between COURSE and CLASS

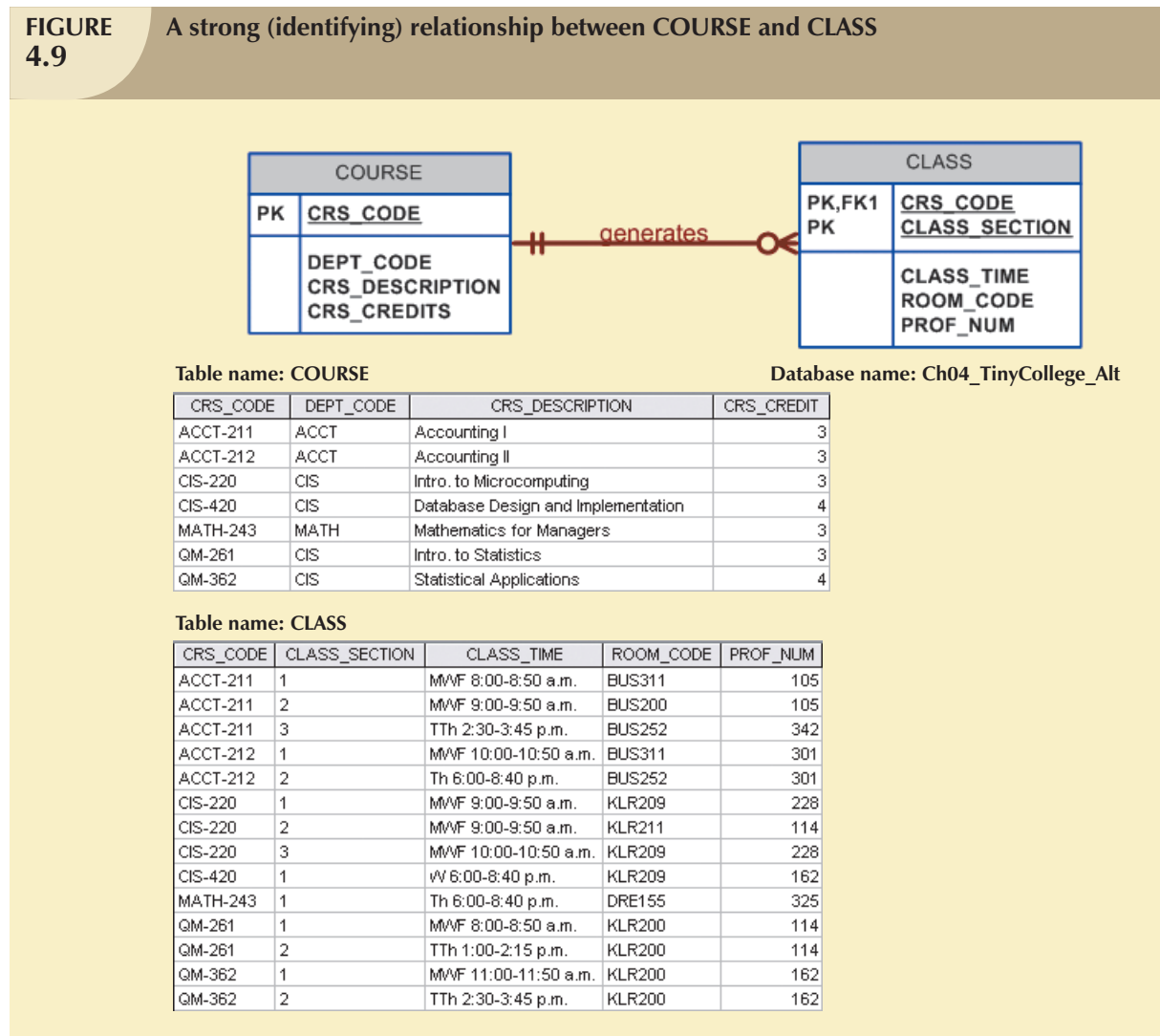

Keep in mind that the order in which the tables are created and loaded is very important. For example, in the "COURSE generates CLASS" relationship, the COURSE table must be created before the CLASS table. After all, it would not be acceptable to have the CLASS table's foreign key reference a COURSE table that did not yet exist. In

fact, you must load the data of the “1” side first in a 1:M relationship to avoid the possibility of referential integrity errors, regardless of whether the relationships are weak or strong.

As you examine Figure 4.9 you might wonder what the O symbol next to the CLASS entity signifies. You will discover the meaning of this cardinality in Section 4.1.8, Relationship Participation.

Remember that the nature of the relationship is often determined by the database designer, who must use professional judgment to determine which relationship type and strength best suits the database transaction, efficiency, and information requirements. That point will often be emphasized in detail!

4.1.7 WEAK ENTITIES

A **weak entity** is one that meets two conditions:

1. The entity is existence-dependent; that is, it cannot exist without the entity with which it has a relationship.
2. The entity has a primary key that is partially or totally derived from the parent entity in the relationship.

For example, a company insurance policy insures an employee and his/her dependents. For the purpose of describing an insurance policy, an EMPLOYEE might or might not have a DEPENDENT, but the DEPENDENT must be associated with an EMPLOYEE. Moreover, the DEPENDENT cannot exist without the EMPLOYEE; that is, a person cannot get insurance coverage as a dependent unless s(he) happens to be a dependent of an employee. DEPENDENT is the weak entity in the relationship “EMPLOYEE has DEPENDENT.”

Note that the Chen notation in Figure 4.10 identifies the weak entity by using a double-walled entity rectangle. The Crow’s Foot notation generated by Visio Professional uses the relationship line and the PK/FK designation to indicate whether the related entity is weak. A strong (identifying) relationship indicates that the related entity is weak. Such a relationship means that both conditions for the weak entity definition have been met—the related entity is existence-dependent, and the PK of the related entity contains a PK component of the parent entity. (Some versions of the Crow’s Foot ERD depict the weak entity by drawing a short line segment in each of the four corners of the weak entity box.)

Remember that the weak entity inherits part of its primary key from its strong counterpart. For example, at least part of the DEPENDENT entity’s key shown in Figure 4.10 was inherited from the EMPLOYEE entity:

EMPLOYEE (EMP_NUM, EMP_LNAME, EMP_FNAME, EMP_INITIAL, EMP_DOB, EMP_HIREDATE)

DEPENDENT (EMP_NUM, DEP_NUM, DEP_FNAME, DEP_DOB)

Figure 4.11 illustrates the implementation of the relationship between the weak entity (DEPENDENT) and its parent or strong counterpart (EMPLOYEE). Note that DEPENDENT’s primary key is composed of two attributes, EMP_NUM and DEP_NUM, and that EMP_NUM was inherited from EMPLOYEE. Given this scenario, and with the help of this relationship, you can determine:

Jeanine J. Callifante claims two dependents, Annelise and Jorge.

Keep in mind that the database designer usually determines whether an entity can be described as weak based on the business rules. An examination of the relationship between COURSE and CLASS in Figure 4.8 might cause you to conclude that CLASS is a weak entity to COURSE. After all, in Figure 4.8, it seems clear that a CLASS cannot exist without a COURSE; so there is existence dependency. For example, a student cannot enroll in the Accounting I class ACCT-211, Section 3 (CLASS_CODE 10014) unless there is an ACCT_211 course. However, note that the CLASS table’s primary key is CLASS_CODE, which is not derived from the COURSE parent entity. That is, CLASS may be represented by:

CLASS (CLASS_CODE, CRS_CODE, CLASS_SECTION, CLASS_TIME, ROOM_CODE, PROF_NUM)

FIGURE 4.10 A weak entity in an ERD

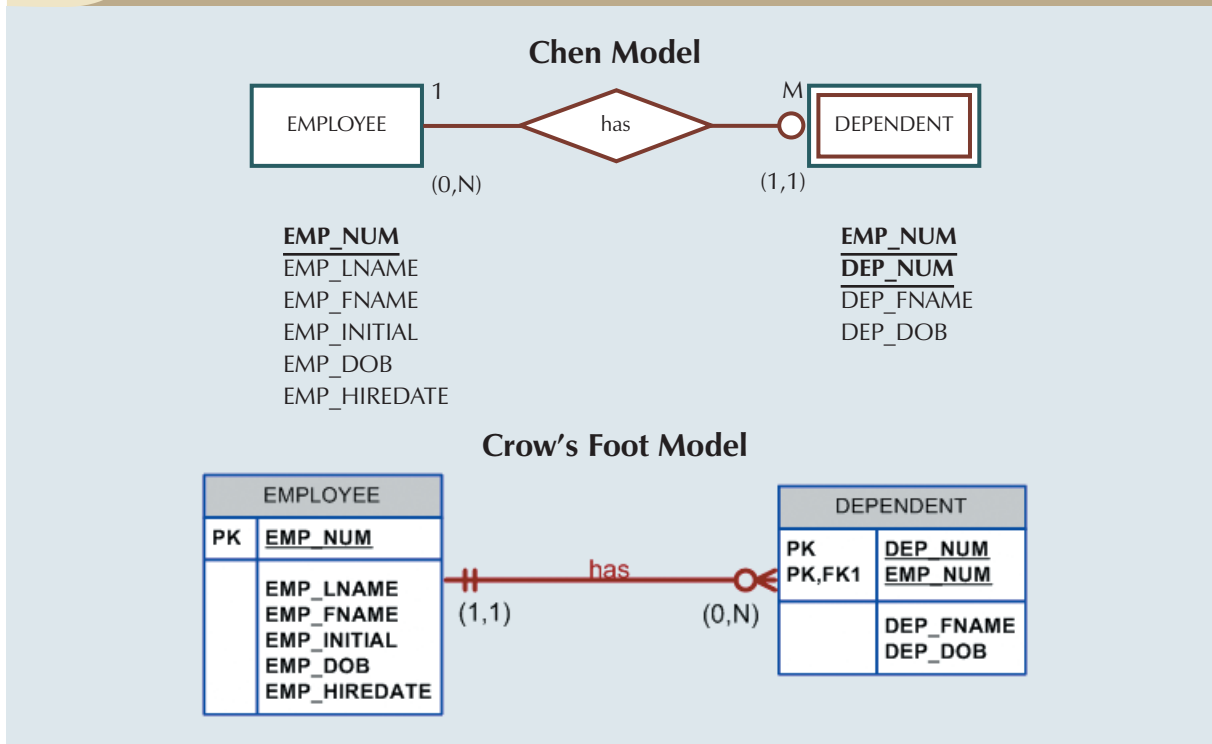

FIGURE 4.11 A weak entity in a strong relationship

Table name: EMPLOYEE Database name: Ch04_ShortCo

EMP_NUM	EMP_LNAME	EMP_FNAME	EMP_INITIAL	EMP_DOB	EMP_HIREDATE
1001	Callifante	Jeanine	J	12-Mar-64	25-May-97
1002	Smithson	William	K	23-Nov-70	28-May-97
1003	Washington	Herman	H	15-Aug-68	28-May-97
1004	Chen	Lydia	B	23-Mar-74	15-Oct-98
1005	Johnson	Melanie		28-Sep-66	20-Dec-98
1006	Ortega	Jorge	G	12-Jul-79	05-Jan-02
1007	O'Donnell	Peter	D	10-Jun-71	23-Jun-02
1008	Brzenski	Barbara	A	12-Feb-70	01-Nov-03

Table name: DEPENDENT

EMP_NUM	DEP_NUM	DEP_FNAME	DEP_DOB
1001	1	Annelise	05-Dec-97
1001	2	Jorge	30-Sep-02
1003	1	Suzanne	25-Jan-04
1006	1	Carlos	25-May-01
1008	1	Michael	19-Feb-95
1008	2	George	27-Jun-98
1008	3	Katherine	18-Aug-03

The second weak entity requirement has not been met; therefore, by definition, the CLASS entity in Figure 4.8 may not be classified as weak. On the other hand, if the CLASS entity's primary key had been defined as a composite key, composed of the combination CRS_CODE and CLASS_SECTION, CLASS could be represented by:

CLASS (CRS_CODE, CLASS_SECTION, CLASS_TIME, ROOM_CODE, PROF_NUM)

In that case, illustrated in Figure 4.9, the CLASS primary key is partially derived from COURSE because CRS_CODE is the COURSE table's primary key. Given this decision, CLASS is a weak entity by definition. (In Visio Professional Crow's Foot terms, the relationship between COURSE and CLASS is classified as strong, or identifying.) In any case, CLASS is always existence-dependent on COURSE, *whether or not it is defined as weak*.

4.1.8 RELATIONSHIP PARTICIPATION

Participation in an entity relationship is either optional or mandatory. **Optional participation** means that one entity occurrence does not *require* a corresponding entity occurrence in a particular relationship. For example, in the "COURSE generates CLASS" relationship, you noted that at least some courses do not generate a class. In other words, an entity occurrence (row) in the COURSE table does not necessarily require the existence of a corresponding entity occurrence in the CLASS table. (Remember that each entity is implemented as a table.) Therefore, the CLASS entity is considered to be *optional* to the COURSE entity. In Crow's Foot notation, an optional relationship between entities is shown by drawing a small circle (O) on the side of the optional entity, as illustrated in Figure 4.9. The existence of an *optional entity* indicates that the minimum cardinality is 0 for the optional entity. (The term *optionality* is used to label any condition in which one or more optional relationships exist.)

NOTE

Remember that the burden of establishing the relationship is always placed on the entity that contains the foreign key. In most cases, that will be the entity on the many side of the relationship.

Mandatory participation means that one entity occurrence *requires* a corresponding entity occurrence in a particular relationship. If no optionality symbol is depicted with the entity, the entity exists in a mandatory relationship with the related entity. The existence of a mandatory relationship indicates that the minimum cardinality is 1 for the mandatory entity.

NOTE

You might be tempted to conclude that relationships are weak when they occur between entities in an optional relationship and that relationships are strong when they occur between entities in a mandatory relationship. However, this conclusion is not warranted. Keep in mind that relationship participation and relationship strength do not describe the same thing. You are likely to encounter a strong relationship when one entity is optional to another. For example, the relationship between EMPLOYEE and DEPENDENT is clearly a strong one, but DEPENDENT is clearly optional to EMPLOYEE. After all, you cannot *require* employees to have dependents. And it is just as possible for a weak relationship to be established when one entity is mandatory to another. *The relationship strength depends on how the PK of the related entity is formulated, while the relationship participation depends on how the business rule is written.* For example, the business rules "Each part must be supplied by a vendor" and "A part may or may not be supplied by a vendor" create different optionalities for the same entities! Failure to understand this distinction may lead to poor design decisions that cause major problems when table rows are inserted or deleted.

Because relationship participation turns out to be a very important component of the database design process, let's examine a few more scenarios. Suppose that Tiny College employs some professors who conduct research without teaching classes. If you examine the "PROFESSOR teaches CLASS" relationship, it is quite possible for a PROFESSOR not to teach a CLASS. Therefore, CLASS is *optional* to PROFESSOR. On the other hand, a CLASS

must be taught by a PROFESSOR. Therefore, PROFESSOR is *mandatory* to CLASS. Note that the ERD model in Figure 4.12 shows the cardinality next to CLASS to be (0,3), thus indicating that a professor may teach no classes at all or as many as three classes. And each CLASS table row will reference one and only one PROFESSOR row—assuming each class is taught by one and only one professor, represented by the (1,1) cardinality next to the PROFESSOR table.

FIGURE 4.12 An optional CLASS entity in the relationship “PROFESSOR teaches CLASS”

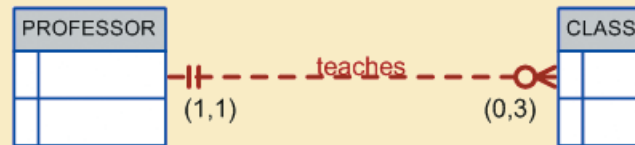

Failure to understand the distinction between *mandatory* and *optional* participation in relationships might yield designs in which awkward (and unnecessary) temporary rows (entity instances) must be created just to accommodate the creation of required entities. Therefore, it is important that you clearly understand the concepts of mandatory and optional participation.

It is also important to understand that the semantics of a problem might determine the type of participation in a relationship. For example, suppose that Tiny College offers several courses; each course has several classes. Note again the distinction between *class* and *course* in this discussion: a CLASS constitutes a specific offering (or section) of a COURSE. (Typically, courses are listed in the university’s course catalog, while classes are listed in the class schedules that students use to register for their classes.)

Analyzing the CLASS entity’s contribution to the “COURSE generates CLASS” relationship, it is easy to see that a CLASS cannot exist without a COURSE. Therefore, you can conclude that the COURSE entity is *mandatory* in the relationship. But two scenarios for the CLASS entity may be written, shown in Figures 4.13 and 4.14. The different scenarios are a function of the semantics of the problem; that is, they depend on how the relationship is defined.

FIGURE 4.13 CLASS is optional to COURSE

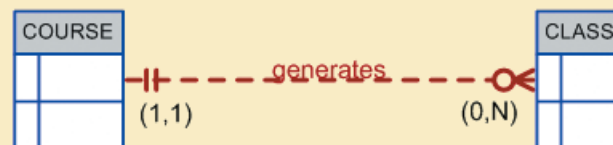
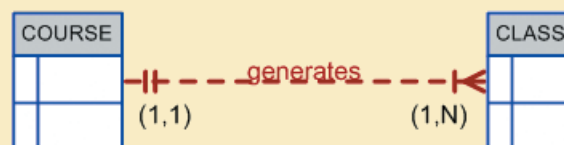

FIGURE 4.14 COURSE and CLASS in a mandatory relationship







1. *CLASS is optional.* It is possible for the department to create the entity COURSE first and then create the CLASS entity after making the teaching assignments. In the real world, such a scenario is very likely; there may be courses for which sections (classes) have not yet been defined. In fact, some courses are taught only once a year and do not generate classes each semester.
2. *CLASS is mandatory.* This condition is created by the constraint that is imposed by the semantics of the statement “Each COURSE generates one or more CLASSes.” In ER terms, each COURSE in the “generates” relationship must have at least one CLASS. Therefore, a CLASS must be created as the COURSE is created in order to comply with the semantics of the problem.

Keep in mind the practical aspects of the scenario presented in Figure 4.14. Given the semantics of this relationship, the system should not accept a course that is not associated with at least one class section. Is such a rigid environment desirable from an operational point of view? For example, when a new COURSE is created, the database first updates the COURSE table, thereby inserting a COURSE entity that does not yet have a CLASS associated with it. Naturally, the apparent problem seems to be solved when CLASS entities are inserted into the corresponding CLASS table. However, because of the mandatory relationship, the system will be in temporary violation of the business rule constraint. For practical purposes, it would be desirable to classify the CLASS as optional in order to produce a more flexible design.

Finally, as you examine the scenarios presented in Figures 4.13 and 4.14, keep in mind the role of the DBMS. To maintain data integrity, the DBMS must ensure that the “many” side (CLASS) is associated with a COURSE through the foreign key rules.

When you create a relationship in Visio, the default relationship will be mandatory on the “1” side and optional on the “many” side. Table 4.3 shows the various cardinalities that are supported by the Crow’s Foot notation.

TABLE 4.3 Crow’s Foot Symbols

CROW’S FOOT SYMBOL	CARDINALITY	COMMENT
	(0,N)	Zero or many. Many side is optional.
	(1,N)	One or many. Many side is mandatory.
	(1,1)	One and only one. 1 side is mandatory.
	(0,1)	Zero or one. 1 side is optional.

4.1.9 RELATIONSHIP DEGREE

A **relationship degree** indicates the number of entities or participants associated with a relationship. A **unary relationship** exists when an association is maintained within a single entity. A **binary relationship** exists when two entities are associated. A **ternary relationship** exists when three entities are associated. Although higher degrees exist, they are rare and are not specifically named. (For example, an association of four entities is described simply as a *four-degree relationship*.) Figure 4.15 shows these types of relationship degrees.

Unary Relationships

In the case of the unary relationship shown in Figure 4.15, an employee within the EMPLOYEE entity is the manager for one or more employees within that entity. In this case, the existence of the “manages” relationship means that EMPLOYEE requires another EMPLOYEE to be the manager—that is, EMPLOYEE has a relationship with itself. Such a relationship is known as a **recursive relationship**. The various cases of recursive relationships will be explored in Section 4.1.10.

FIGURE 4.15 Three types of relationship degree

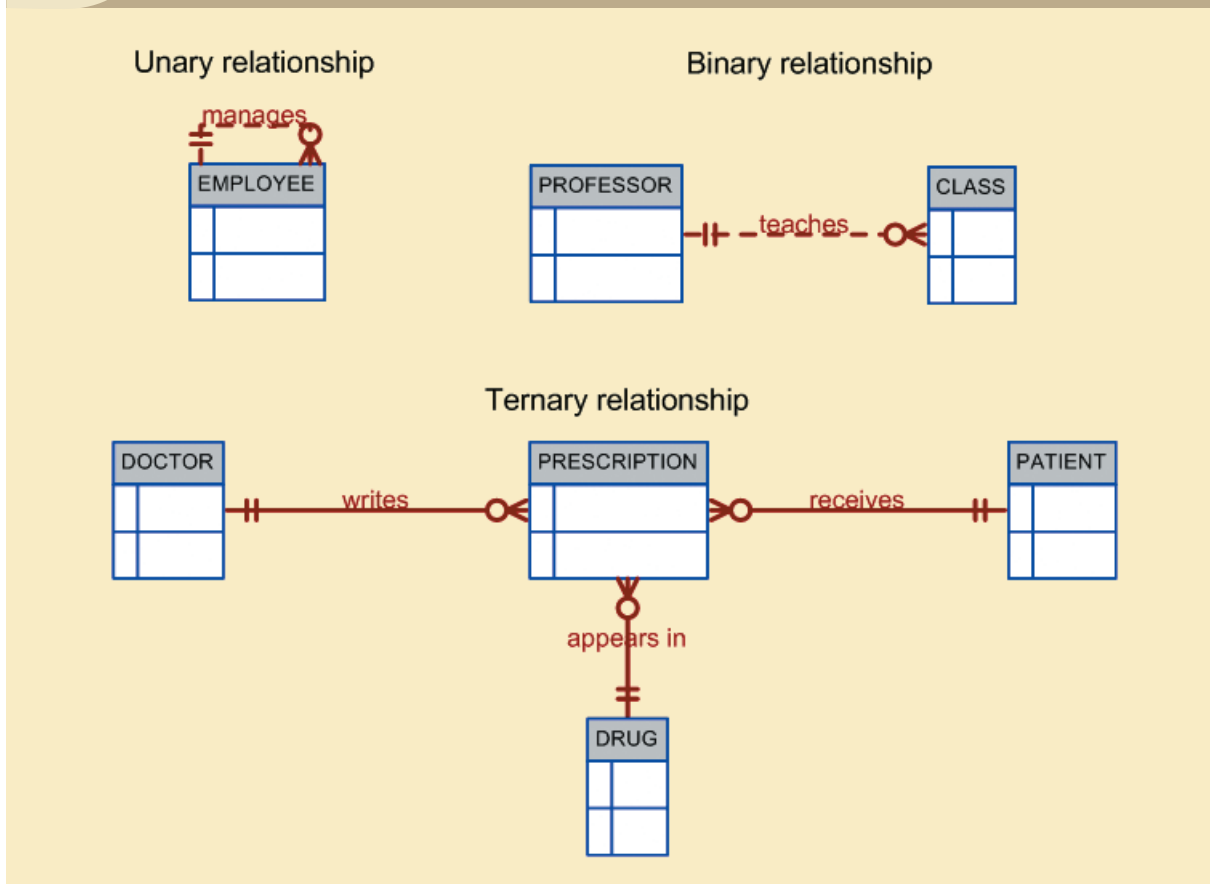

Binary Relationships

A binary relationship exists when two entities are associated in a relationship. Binary relationships are most common. In fact, to simplify the conceptual design, whenever possible, most higher-order (ternary and higher) relationships are decomposed into appropriate equivalent binary relationships. In Figure 4.15, the relationship “a PROFESSOR teaches one or more CLASSES” represents a binary relationship.

Ternary and Higher-Degree Relationships

Although most relationships are binary, the use of ternary and higher-order relationships does allow the designer some latitude regarding the semantics of a problem. A ternary relationship implies an association among three different entities. For example, note the relationships (and their consequences) in Figure 4.16, which are represented by the following business rules:

- A DOCTOR writes one or more PRESCRIPTIONs.
- A PATIENT may receive one or more PRESCRIPTIONs.
- A DRUG may appear in one or more PRESCRIPTIONs. (To simplify this example, assume that the business rule states that each prescription contains only one drug. In short, if a doctor prescribes more than one drug, a separate prescription must be written for each drug.)

As you examine the table contents in Figure 4.16, note that it is possible to track all transactions. For instance, you can tell that the first prescription was written by doctor 32445 for patient 102, using the drug DRZ.

FIGURE 4.16 The implementation of a ternary relationship

Database name: Ch04_Clinic

Table name: DRUG			Table name: PATIENT							
DRUG_CODE	DRUG_NAME	DRUG_PRICE	PAT_NUM	PAT_TITLE	PAT_LNAME	PAT_FNAME	PAT_INITIAL	PAT_DOB	PAT_AREACODE	PAT_PHONE
AF15	Afgapan-15	25.00	100	Mr.	Kolmycz	George	D	15-Jun-1942	615	324-5456
AF25	Afgapan-25	35.00	101	Ms.	Lewis	Rhonda	G	19-Mar-2005	615	324-4472
DRO	Droalene Chloride	111.89	102	Mr.	Vandam	Rhett		14-Nov-1958	901	675-8993
DRZ	Druzocholar Cryptolene	18.99	103	Ms.	Jones	Anne	M	16-Oct-1974	615	898-3456
KO15	Kolabbar Oxyhexalene	65.75	104	Mr.	Lange	John	P	08-Nov-1971	901	504-4430
OLE	Oleander-Drizapan	123.95	105	Mr.	vWilliams	Robert	D	14-Mar-1975	615	890-3220
TRYP	Tryptolac Heptadimetric	79.45	106	Mrs.	Smith	Jeanine	K	12-Feb-2003	615	324-7883
			107	Mr.	Diante	Jorge	D	21-Aug-1974	615	890-4567
			108	Mr.	vWiesenbach	Paul	R	14-Feb-1966	615	897-4358
			109	Mr.	Smith	George	K	18-Jun-1961	901	504-3339
			110	Mrs.	Genkazi	Leighla	vW	19-May-1970	901	569-0093
			111	Mr.	vWashington	Rupert	E	03-Jan-1966	615	890-4925
			112	Mr.	Johnson	Edward	E	14-May-1961	615	898-4387
			113	Ms.	Smythe	Melanie	P	15-Sep-1970	615	324-9006
			114	Ms.	Brandon	Marie	G	02-Nov-1932	901	882-0845
			115	Mrs.	Saranda	Hermine	R	25-Jul-1972	615	324-5505
			116	Mr.	Smith	George	A	08-Nov-1965	615	890-2984

Table name: DOCTOR					Table name: PRESCRIPTION				
DOC_ID	DOC_LNAME	DOC_FNAME	DOC_INITIAL	DOC_SPECIALTY	DOC_ID	PAT_NUM	DRUG_CODE	PRES_DOSAGE	PRES_DATE
29827	Sanchez	Julio	J	Dermatology	32445	102	DRZ	2 tablets every four hours -- 50 tablets total	12-Nov-07
32445	Jorgensen	Annelise	G	Neurology	32445	113	OLE	1 teaspoon with each meal -- 250 ml total	14-Nov-07
33456	Korenski	Anatoly	A	Urology	34409	101	KO15	1 tablet every six hours -- 30 tablets total	14-Nov-07
33989	LeGrande	George		Pediatrics	36221	109	DRO	2 tablets with every meal -- 60 tablets total	14-Nov-07
34409	vWashington	Dennis	F	Orthopaedics	38995	107	KO15	1 tablet every six hours -- 30 tablets total	14-Nov-07
36221	McPherson	Katye	H	Dermatology					
36712	Dreitrag	Herman	G	Psychiatry					
38995	Minh	Tran		Neurology					
40004	Chin	Ming	D	Orthopaedics					
40028	Feinstein	Denise	L	Gynecology					

4.1.10 RECURSIVE RELATIONSHIPS

As was previously mentioned, a *recursive relationship* is one in which a relationship can exist between occurrences of the same entity set. (Naturally, such a condition is found within a unary relationship.)

For example, a 1:M unary relationship can be expressed by “an EMPLOYEE may manage many EMPLOYEEs, and each EMPLOYEE is managed by one EMPLOYEE.” And as long as polygamy is not legal, a 1:1 unary relationship may be expressed by “an EMPLOYEE may be married to one and only one other EMPLOYEE.” Finally, the M:N unary relationship may be expressed by “a COURSE may be a prerequisite to many other COURSEs, and each COURSE may have many other COURSEs as prerequisites.” Those relationships are shown in Figure 4.17.

The 1:1 relationship shown in Figure 4.17 can be implemented in the single table shown in Figure 4.18. Note that you can determine that James Ramirez is married to Louise Ramirez, who is married to James Ramirez. And Anne Jones is married to Anton Shapiro, who is married to Anne Jones.

Unary relationships are common in manufacturing industries. For example, Figure 4.19 illustrates that a rotor assembly (C-130) is composed of many parts, but each part is used to create only one rotor assembly. Figure 4.19 indicates that a rotor assembly is composed of four 2.5-cm washers, two cotter pins, one 2.5-cm steel shank, four 10.25-cm rotor blades, and two 2.5-cm hex nuts. The relationship implemented in Figure 4.19 thus enables you to track each part within each rotor assembly.

FIGURE 4.17 An ER representation of recursive relationships

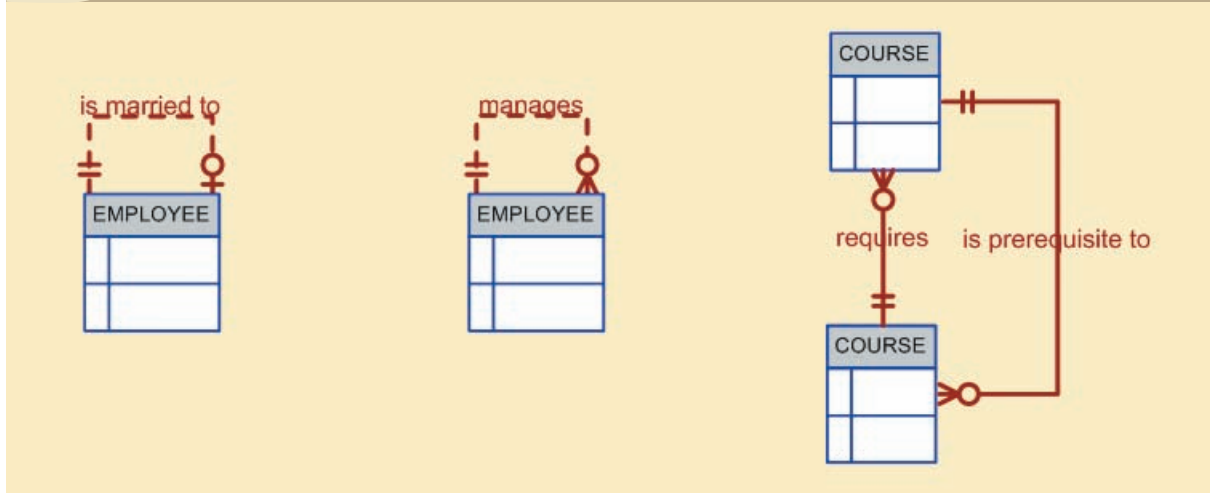

FIGURE 4.18 The 1:1 recursive relationship "EMPLOYEE is married to EMPLOYEE"

Database name: CH04_PartCo
Table name: EMPLOYEE_V1

EMP_NUM	EMP_LNAME	EMP_FNAME	EMP_SPOUSE
345	Ramirez	James	347
346	Jones	Anne	349
347	Ramirez	Louise	345
348	Delaney	Robert	
349	Shapiro	Anton	346

If a part can be used to assemble several different kinds of other parts and is itself composed of many parts, two tables are required to implement the "PART contains PART" relationship. Figure 4.20 illustrates such an environment. Parts tracking is increasingly important as managers become more aware of the legal ramifications of producing more complex output. In fact, in many industries, especially those involving aviation, full parts tracking is required by law.

FIGURE 4.19 Another unary relationship: "PART contains PART"

Table name: PART_V1 Database name: CH04_PartCo

PART_CODE	PART_DESCRIPTION	PART_IN_STOCK	PART_UNITS_NEEDED	PART_OF_PART
AA21-6	2.5 cm. washer, 1.0 mm. rim	432	4	C-130
AB-121	Cotter pin, copper	1034	2	C-130
C-130	Rotor assembly	36		
E129	2.5 cm. steel shank	128	1	C-130
X10	10.25 cm. rotor blade	345	4	C-130
X34AW	2.5 cm. hex nut	879	2	C-130

FIGURE 4.20 Implementation of the M:N recursive “PART contains PART” relationship

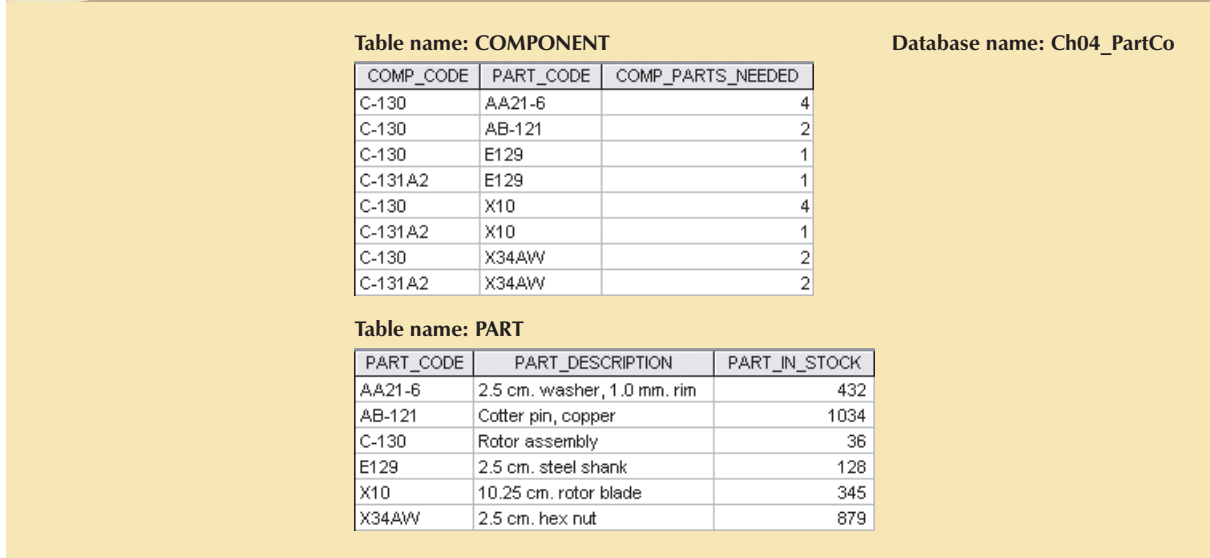

FIGURE 4.21 Implementation of the M:N “COURSE requires COURSE” recursive relationship

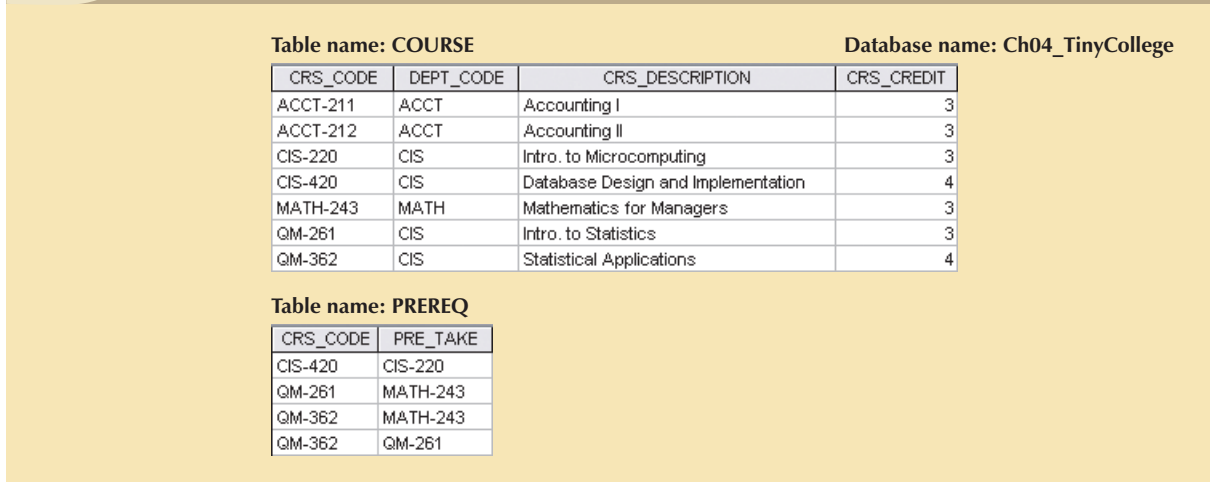
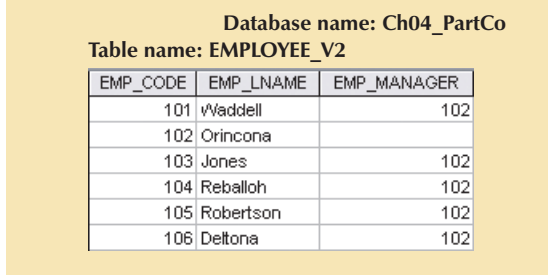

FIGURE 4.22 Implementation of the 1:M “EMPLOYEE manages EMPLOYEE” recursive relationship



The M:N recursive relationship might be more familiar in a school environment. For instance, note how the M:N “COURSE requires COURSE” relationship illustrated in Figure 4.17 is implemented in Figure 4.21. In this example, MATH-243 is a prerequisite to QM-261 and QM-362, while both MATH-243 and QM-261 are prerequisites to QM-362.

Finally, the 1:M recursive relationship “EMPLOYEE manages EMPLOYEE,” shown in Figure 4.17, is implemented in Figure 4.22.

4.1.11 ASSOCIATIVE (COMPOSITE) ENTITIES

In the original ERM described by Chen, relationships do not contain attributes. You should recall from Chapter 3 that the relational model generally requires the use of 1:M relationships. (Also, recall that the 1:1 relationship has its place, but it should be used with caution and proper justification.) If M:N relationships are encountered, you must create a bridge between the entities that display such relationships. The associative entity is used to implement a M:M relationship between two or more entities. This associative entity (also known as a *composite* or *bridge entity*) is composed of the primary keys of each of the entities to be connected. An example of such a bridge is shown in Figure 4.23. The Crow's Foot notation does not identify the composite entity as such. Instead, the composite entity is identified by the solid relationship line between the parent and child entities, thereby indicating the presence of a strong (identifying) relationship.

FIGURE 4.23 Converting the M:N relationship into two 1:M relationships

Database name: Ch04_CollegeTry

Table name: STUDENT	
STU_NUM	STU_LNAME
321452	Bowser
324257	Smithson

Table name: ENROLL		
CLASS_CODE	STU_NUM	ENROLL_GRADE
10014	321452	C
10014	324257	B
10018	321452	A
10018	324257	B
10021	321452	C
10021	324257	C

Table name: CLASS					
CLASS_CODE	CRS_CODE	CLASS_SECTION	CLASS_TIME	CLASS_ROOM	PROF_NUM
10014	ACCT-211	3	TTh 2:30-3:45 p.m.	BUS252	342
10018	CIS-220	2	MWTF 9:00-9:50 a.m.	KLR211	114
10021	QM-261	1	MWTF 8:00-8:50 a.m.	KLR200	114

Note that the composite ENROLL entity in Figure 4.23 is existence-dependent on the other two entities; the composition of the ENROLL entity is based on the primary keys of the entities that are connected by the composite entity. The composite entity may also contain additional attributes that play no role in the connective process. For example, although the entity must be composed of at least the STUDENT and CLASS primary keys, it may also include such additional attributes as grades, absences, and other data uniquely identified by the student's performance in a specific class.

Finally, keep in mind that the ENROLL table's key (CLASS_CODE and STU_NUM) is composed entirely of the primary keys of the CLASS and STUDENT tables. Therefore, no null entries are possible in the ENROLL table's key attributes.

Implementing the small database shown in Figure 4.23 requires that you define the relationships clearly. Specifically, you must know the "1" and the "M" sides of each relationship, and you must know whether the relationships are mandatory or optional. For example, note the following points:

- A class may exist (at least at the start of registration) even though it contains no students. Therefore, if you examine Figure 4.24, an optional symbol should appear on the STUDENT side of the M:N relationship between STUDENT and CLASS.

You might argue that to be classified as a STUDENT, a person must be enrolled in at least one CLASS. Therefore, CLASS is mandatory to STUDENT from a purely conceptual point of view. However, when a

FIGURE 4.24 The M:N relationship between STUDENT and CLASS

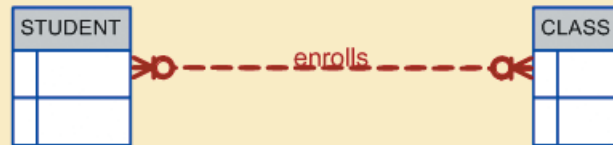

Visio does not permit the definition of a M:N relationship. To make this illustration, two 1:M relationships have been superimposed.

student is admitted to college, that student has not (yet) signed up for any classes. Therefore, *at least initially*, CLASS is optional to STUDENT. Note that the practical considerations in the data environment help dictate the use of optionalities. If CLASS is *not* optional to STUDENT—from a database point of view—a class assignment must be made when the student is admitted. But that's *not* how the process actually works, and the database design must reflect this. In short, the optionality reflects practice.

Because the M:N relationship between STUDENT and CLASS is decomposed into two 1:M relationships through ENROLL, the optionalities must be transferred to ENROLL. See Figure 4.25. In other words, it now becomes possible for a class not to occur in ENROLL if no student has signed up for that class. Because a class need not occur in ENROLL, the ENROLL entity becomes optional to CLASS. And because the ENROLL entity is created before any students have signed up for a class, the ENROLL entity is also optional to STUDENT, at least initially.

FIGURE 4.25 A composite entity in an ERD

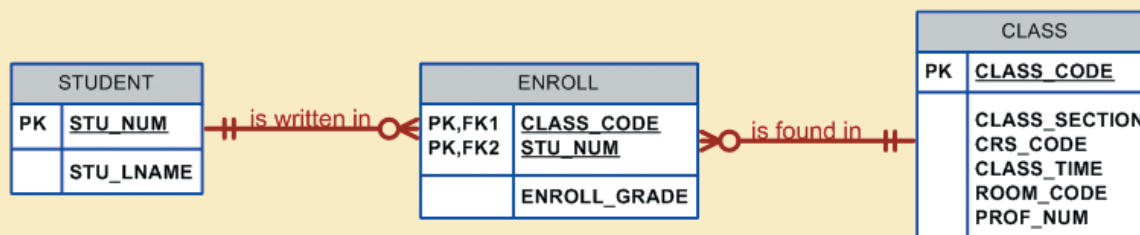

- As students begin to sign up for their classes, they will be entered into the ENROLL entity. Naturally, if a student takes more than one class, that student will occur more than once in ENROLL. For example, note that in the ENROLL table in Figure 4.23, STU_NUM = 321452 occurs three times. On the other hand, each student occurs only once in the STUDENT entity. (Note that the STUDENT table in Figure 4.23 has only one STU_NUM = 321452 entry.) Therefore, in Figure 4.25, the relationship between STUDENT and ENROLL is shown to be 1:M, with the M on the ENROLL side.
- As you can see in Figure 4.23, a class can occur more than once in the ENROLL table. For example, CLASS_CODE = 10014 occurs twice. However, CLASS_CODE = 10014 occurs only once in the CLASS table to reflect that the relationship between CLASS and ENROLL is 1:M. Note that in Figure 4.25, the M is located on the ENROLL side, while the 1 is located on the CLASS side.

4.2 DEVELOPING AN ER DIAGRAM

The process of database design is an iterative rather than a linear or sequential process. The verb *iterate* means “to do again or repeatedly.” An **iterative process** is, thus, one based on repetition of processes and procedures. Building an ERD usually involves the following activities:

- Create a detailed narrative of the organization’s description of operations.
- Identify the business rules based on the description of operations.
- Identify the main entities and relationships from the business rules.
- Develop the initial ERD.
- Identify the attributes and primary keys that adequately describe the entities.
- Revise and review the ERD.

During the review process, it is likely that additional objects, attributes, and relationships will be uncovered. Therefore, the basic ERM will be modified to incorporate the newly discovered ER components. Subsequently, another round of reviews might yield additional components or clarification of the existing diagram. The process is repeated until the end users and designers agree that the ERD is a fair representation of the organization’s activities and functions.

During the design process, the database designer does not depend simply on interviews to help define entities, attributes, and relationships. A surprising amount of information can be gathered by examining the business forms and reports that an organization uses in its daily operations.

To illustrate the use of the iterative process that ultimately yields a workable ERD, let’s start with an initial interview with the Tiny College administrators. The interview process yields the following business rules:

1. Tiny College (TC) is divided into several schools: a school of business, a school of arts and sciences, a school of education, and a school of applied sciences. Each school is administered by a dean who is a professor. Each dean can administer only one school. Therefore, a 1:1 relationship exists between PROFESSOR and SCHOOL. Note that the cardinality can be expressed by (1,1) for the entity PROFESSOR and by (1,1) for the entity SCHOOL. (The smallest number of deans per school is one, as is the largest number, and each dean is assigned to only one school.)
2. Each school is composed of several departments. For example, the school of business has an accounting department, a management/marketing department, an economics/finance department, and a computer information systems department. Note again the cardinality rules: the smallest number of departments operated by a school is one, and the largest number of departments is indeterminate (N). On the other hand, each department belongs to only a single school; thus, the cardinality is expressed by (1,1). That is, the minimum number of schools that a department belongs to is one, as is the maximum number. Figure 4.26 illustrates these first two business rules.
3. Each department may offer courses. For example, the management/marketing department offers courses such as Introduction to Management, Principles of Marketing, and Production Management. The ERD segment for this condition is shown in Figure 4.27. Note that this relationship is based on the way Tiny College operates. If, for example, Tiny College had some departments that were classified as “research only,” those departments would not offer courses; therefore, the COURSE entity would be optional to the DEPARTMENT entity.

FIGURE 4.26 The first Tiny College ERD segment

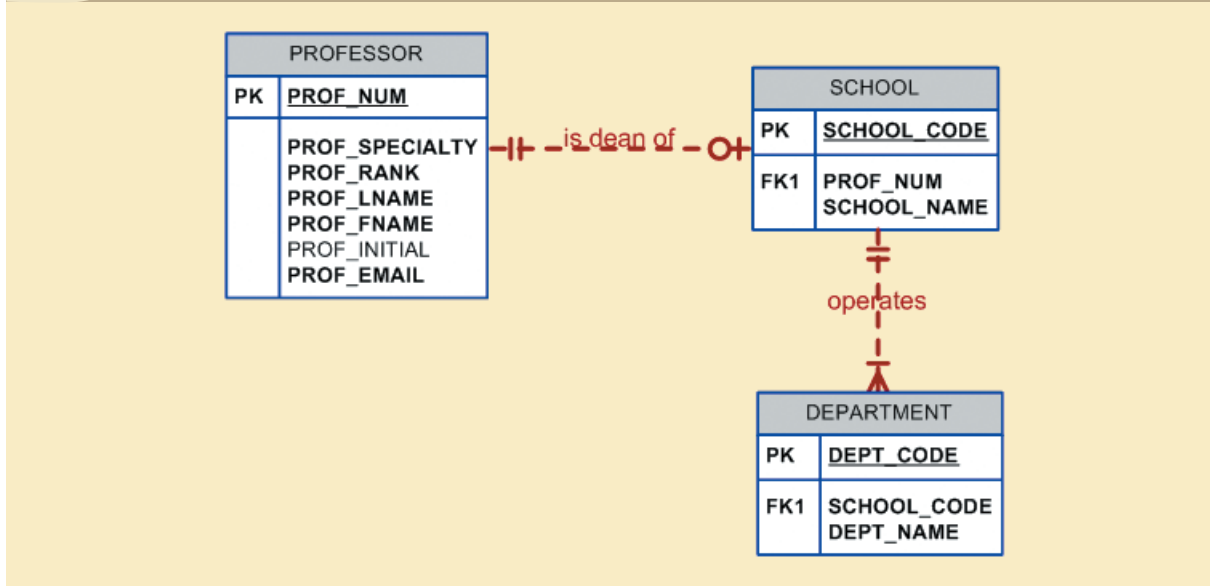

NOTE

It is again appropriate to evaluate the reason for maintaining the 1:1 relationship between PROFESSOR and SCHOOL in the “PROFESSOR is dean of SCHOOL” relationship. It is worth repeating that the existence of 1:1 relationships often indicates a misidentification of attributes as entities. In this case, the 1:1 relationship could easily be eliminated by storing the deans attributes in the SCHOOL entity. This solution also would make it easier to answer the queries, “Who is the school’s dean” and “What are that dean’s credentials?” The downside of this solution is that it requires the duplication of data that are already stored in the PROFESSOR table, thus setting the stage for anomalies. However, because each school is run by a single dean, the problem of data duplication is rather minor. The selection of one approach over another often depends on information requirements, transaction speed, and the database designer’s professional judgment. In short, do not use 1:1 relationships lightly, and make sure that each 1:1 relationship within the database design is defensible.

FIGURE 4.27 The second Tiny College ERD segment

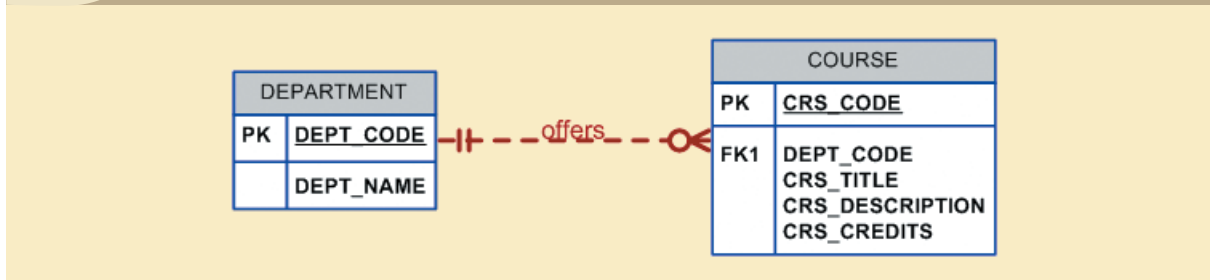

- The relationship between COURSE and CLASS was illustrated in Figure 4.9. Nevertheless, it is worth repeating that a CLASS is a section of a COURSE. That is, a department may offer several sections (classes) of the same database course. Each of those classes is taught by a professor at a given time in a given place. In short, a 1:M relationship exists between COURSE and CLASS. However, because a course may exist in Tiny College’s course catalog even when it is not offered as a class in a current class schedule, CLASS is optional to COURSE. Therefore, the relationship between COURSE and CLASS looks like Figure 4.28.

FIGURE 4.28 The third Tiny College ERD segment

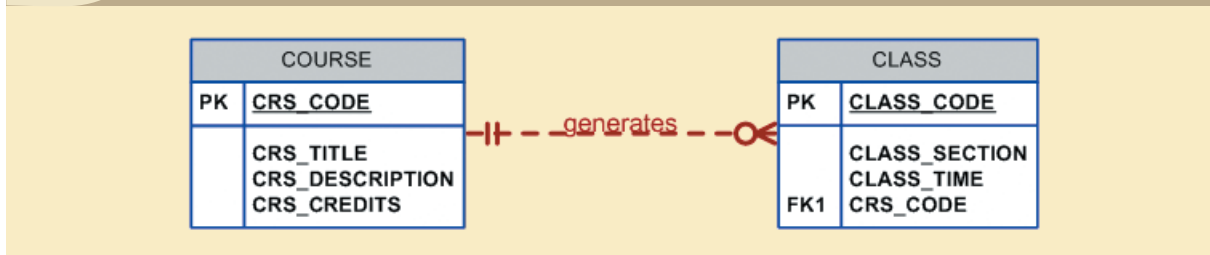

- Each department may have many professors assigned to it. One and only one of those professors chairs the department, and no professor is required to accept the chair position. Therefore, DEPARTMENT is optional to PROFESSOR in the “chairs” relationship. Those relationships are summarized in the ER segment shown in Figure 4.29.

FIGURE 4.29 The fourth Tiny College ERD segment

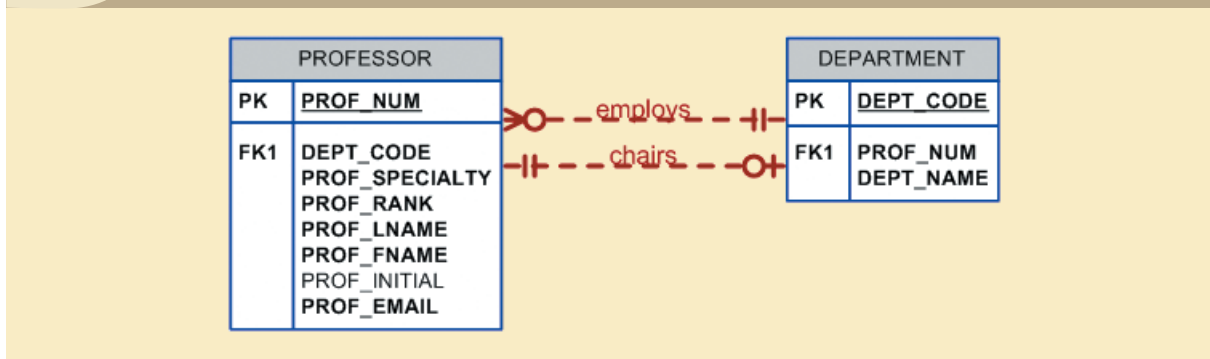

- Each professor may teach up to four classes; each class is a section of a course. A professor may also be on a research contract and teach no classes at all. The ERD segment in Figure 4.30 depicts those conditions.
- A student may enroll in several classes but takes each class only once during any given enrollment period. For example, during the current enrollment period, a student may decide to take five classes—Statistics, Accounting, English, Database, and History—but that student would not be enrolled in the same Statistics class five times during the enrollment period! Each student may enroll in up to six classes, and each class may have up to 35 students, thus creating an M:N relationship between STUDENT and CLASS. Because a CLASS can initially exist (at the start of the enrollment period) even though no students have enrolled in it, STUDENT is optional to CLASS in the M:N relationship. This M:N relationship must be divided into two 1:M relationships through the use of the ENROLL entity, shown in the ERD segment in Figure 4.31. But note that the optional symbol is shown next to ENROLL. If a class exists but has no students enrolled in it, that class doesn’t occur in the ENROLL table. Note also that the ENROLL entity is weak: it is existence-dependent, and its (composite) PK is composed of the PKs of the

FIGURE 4.30 The fifth Tiny College ERD segment

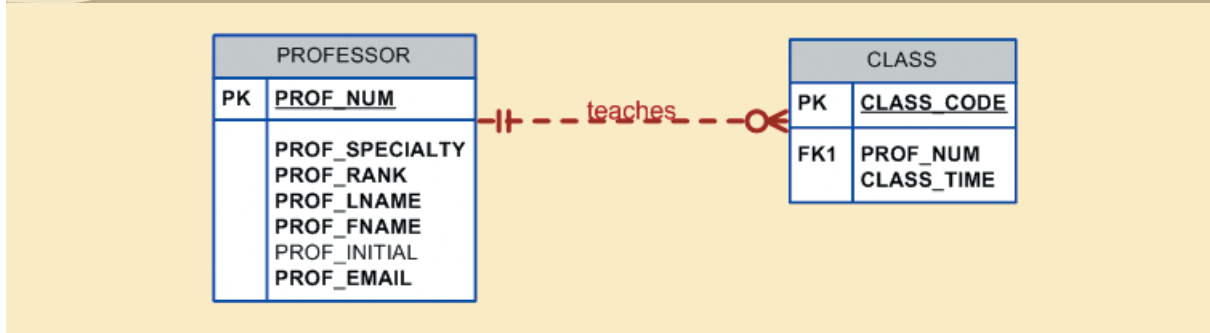

STUDENT and CLASS entities. You can add the cardinalities (0,6) and (0,35) next to the ENROLL entity to reflect the business rule constraints as shown in Figure 4.31. (Visio Professional does not automatically generate such cardinalities, but you can use a text box to accomplish that task.)

FIGURE 4.31 The sixth Tiny College ERD segment

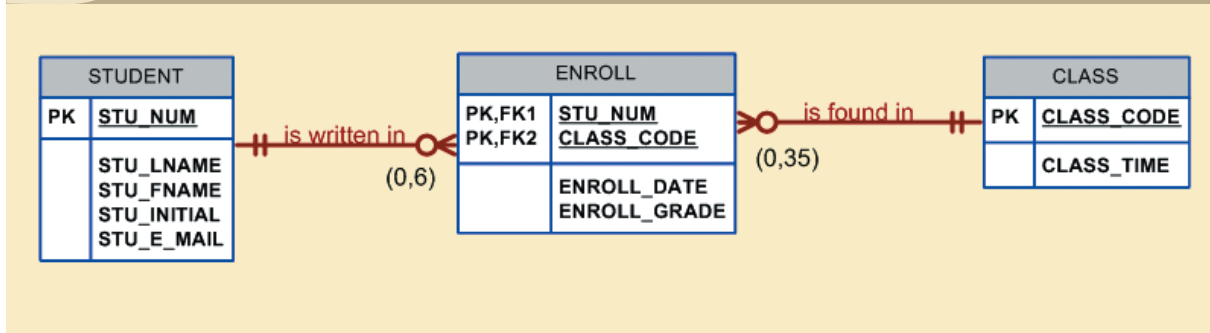

8. Each department has several (or many) students whose major is offered by that department. However, each student has only a single major and is, therefore, associated with a single department. See Figure 4.32. However, in the Tiny College environment, it is possible—at least for a while—for a student not to declare a major field of study. Such a student would not be associated with a department; therefore, DEPARTMENT is optional to STUDENT. It is worth repeating that the relationships between entities and the entities themselves reflect the organization’s operating environment. That is, the business rules define the ERD components.

FIGURE 4.32 The seventh Tiny College ERD segment

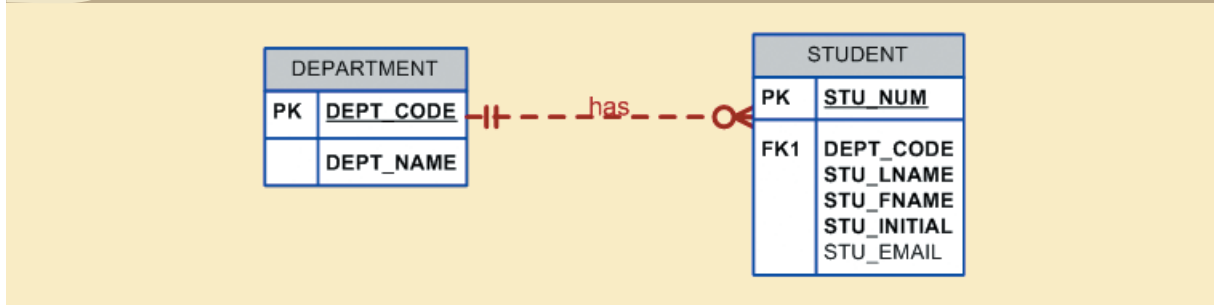

- Each student has an advisor in his or her department; each advisor counsels several students. An advisor is also a professor, but not all professors advise students. Therefore, STUDENT is optional to PROFESSOR in the “PROFESSOR advises STUDENT” relationship. See Figure 4.33.

FIGURE 4.33 The eighth Tiny College ERD segment

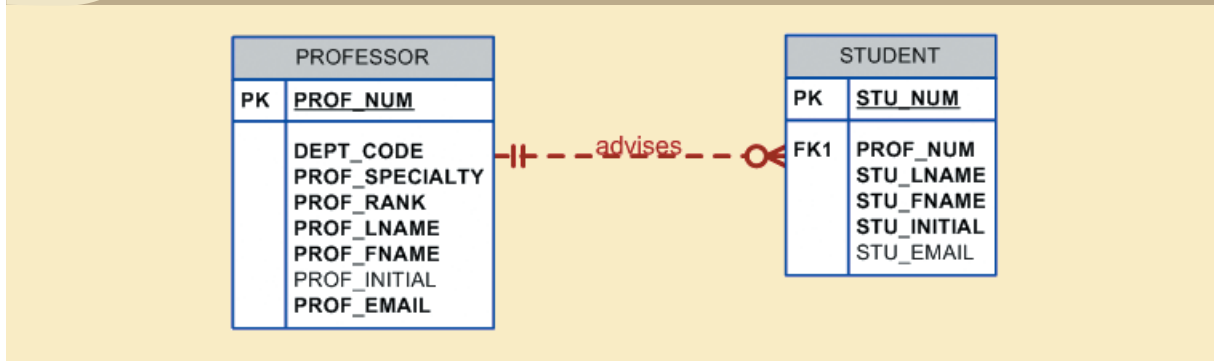

- As you can see in Figure 4.34, the CLASS entity contains a ROOM_CODE attribute. Given the naming conventions, it is clear that ROOM_CODE is an FK to another entity. Clearly, because a class is taught in a room, it is reasonable to assume that the ROOM_CODE in CLASS is the FK to an entity named ROOM. In turn, each room is located in a building. So the last Tiny College ERD is created by observing that a BUILDING can contain many ROOMs, but each ROOM is found in a single BUILDING. In this ERD segment, it is clear that some buildings do not contain (class) rooms. For example, a storage building might not contain any named rooms at all.

FIGURE 4.34 The ninth Tiny College ERD segment

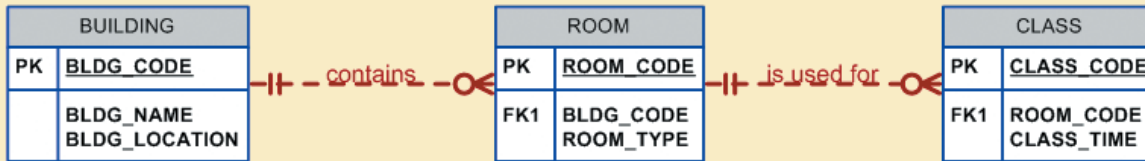

Using the preceding summary, you can identify the following entities:

- SCHOOL
- DEPARTMENT
- ENROLL (the bridge entity between STUDENT and CLASS)
- PROFESSOR
- BUILDING
- COURSE
- CLASS
- STUDENT
- ROOM

Once you have discovered the relevant entities, you can define the initial set of relationships among them. Next, you describe the entity attributes. Identifying the attributes of the entities helps you better understand the relationships among entities. Table 4.4 summarizes the ERM’s components and names the entities and their relations.

TABLE 4.4 Components of the ERM

ENTITY	RELATIONSHIP	CONNECTIVITY	ENTITY
SCHOOL	operates	1:M	DEPARTMENT
DEPARTMENT	has	1:M	STUDENT
DEPARTMENT	employs	1:M	PROFESSOR
DEPARTMENT	offers	1:M	COURSE
COURSE	generates	1:M	CLASS
PROFESSOR	is dean of	1:1	SCHOOL
PROFESSOR	chairs	1:1	DEPARTMENT
PROFESSOR	teaches	1:M	CLASS
PROFESSOR	advises	1:M	STUDENT
STUDENT	enrolls in	M:N	CLASS
BUILDING	contains	1:M	ROOM
ROOM	is used for	1:M	CLASS

Note: ENROLL is the composite entity that implements the M:N relationship “STUDENT enrolls in CLASS.”

You must also define the connectivity and cardinality for the just-discovered relations based on the business rules. However, to avoid crowding the diagram, the cardinalities are not shown. Figure 4.35 shows the Crow’s Foot ERD for Tiny College. Note that this is an implementation-ready model. Therefore it shows the ENROLL composite entity.

FIGURE 4.35 The completed Tiny College ERD

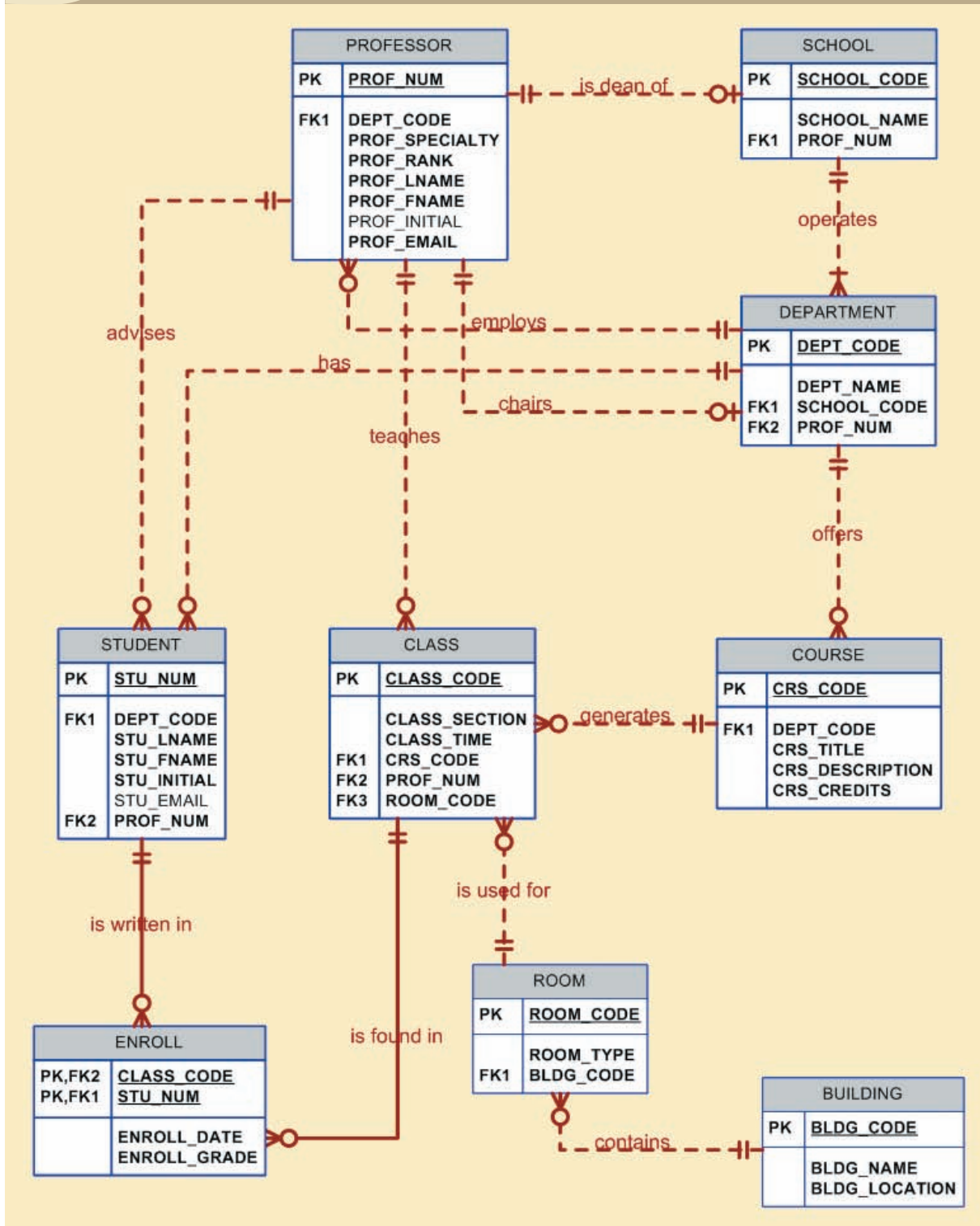

Figure 4.36 shows the conceptual UML class diagram for Tiny College. Note that this class diagram depicts the M:N relationship between STUDENT and CLASS. Figure 4.37 shows the implementation-ready UML class diagram for Tiny College (note that the ENROLL composite entity is shown in this class diagram.)

FIGURE 4.36 The conceptual UML class diagram for Tiny College

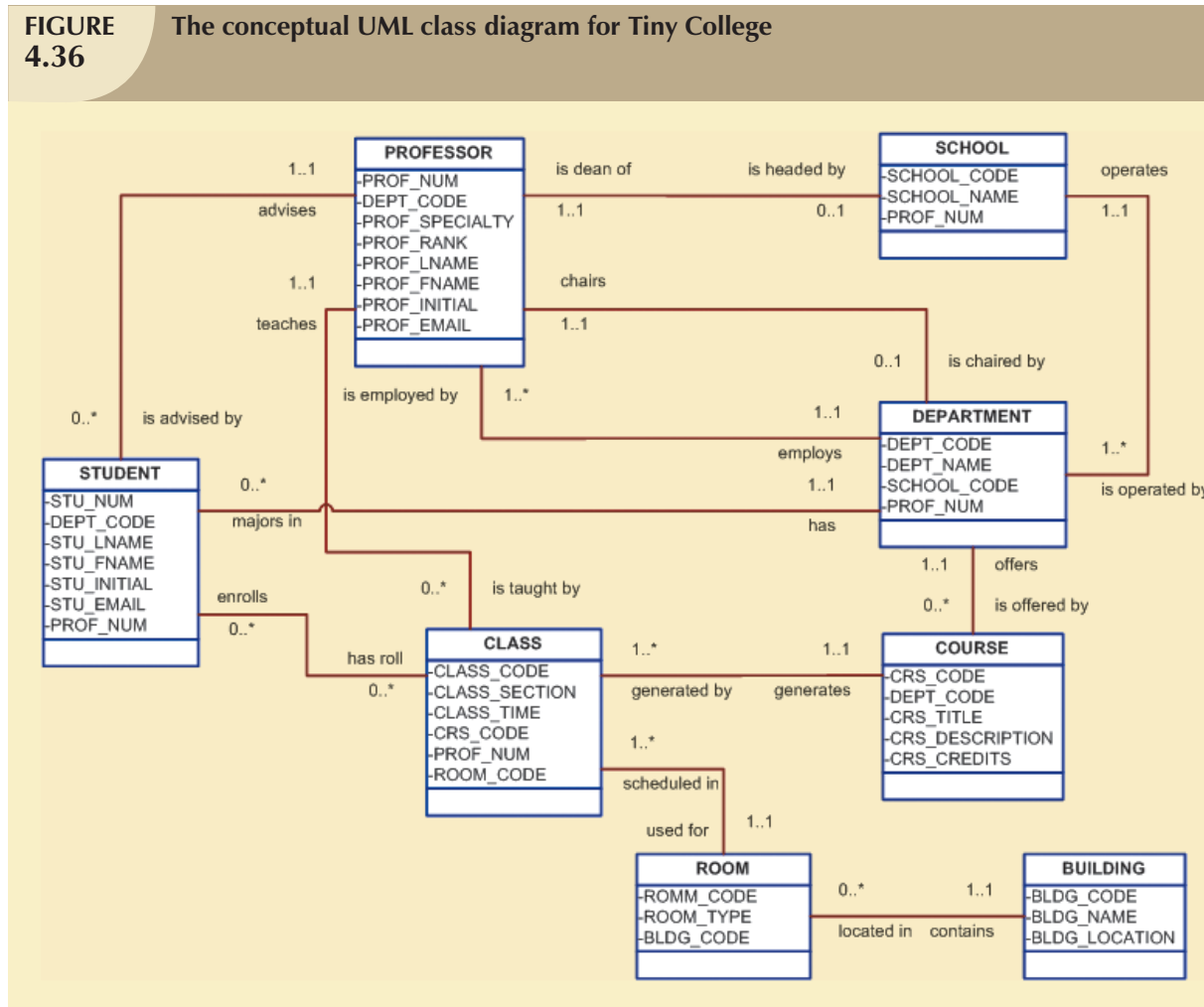
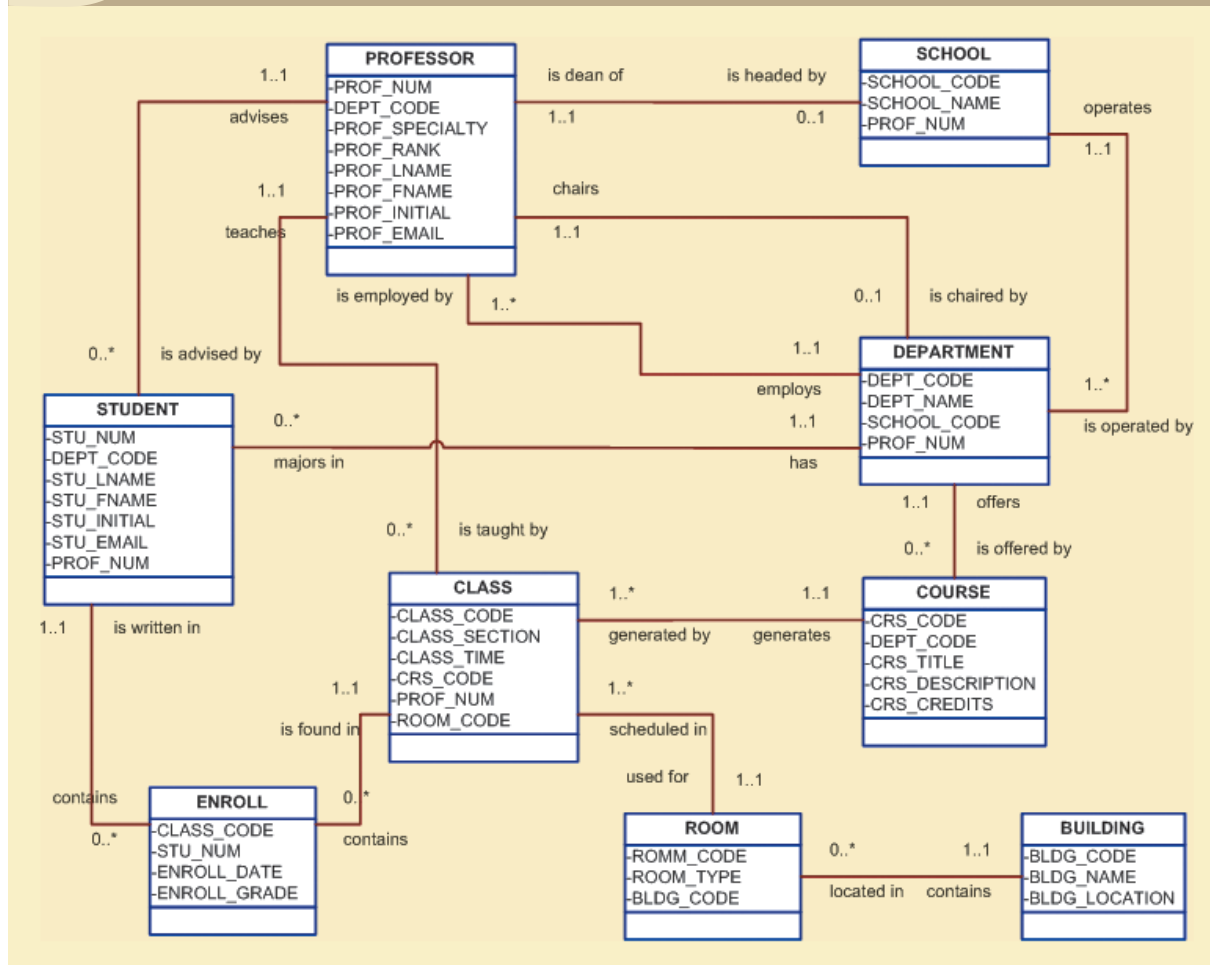

FIGURE 4.37 The implementation-ready UML class diagram for Tiny College



4.3 DATABASE DESIGN CHALLENGES: CONFLICTING GOALS

Database designers often must make design compromises that are triggered by conflicting goals, such as adherence to design standards (design elegance), processing speed, and information requirements.

- Design standards.** The database design must conform to design standards. Such standards have guided you in developing logical structures that minimize data redundancies, thereby minimizing the likelihood that destructive data anomalies will occur. You have also learned how standards prescribed avoiding nulls to the greatest extent possible. In fact, you have learned that design standards govern the presentation of all components within the database design. In short, design standards allow you to work with well-defined components and to evaluate the interaction of those components with some precision. Without design standards, it is nearly impossible to formulate a proper design process, to evaluate an existing design, or to trace the likely logical impact of changes in design.

- *Processing speed.* In many organizations, particularly those generating large numbers of transactions, high processing speeds are often a top priority in database design. High processing speed means minimal access time, which may be achieved by minimizing the number and complexity of logically desirable relationships. For example, a “perfect” design might use a 1:1 relationship to avoid nulls, while a higher transaction-speed design might combine the two tables to avoid the use of an additional relationship, using dummy entries to avoid the nulls. If the focus is on data-retrieval speed, you might also be forced to include derived attributes in the design.
- *Information requirements.* The quest for timely information might be the focus of database design. Complex information requirements may dictate data transformations, and they may expand the number of entities and attributes within the design. Therefore, the database may have to sacrifice some of its “clean” design structures and/or some of its high transaction speed to ensure maximum information generation. For example, suppose that a detailed sales report must be generated periodically. The sales report includes all invoice subtotals, taxes, and totals; even the invoice lines include subtotals. If the sales report includes hundreds of thousands (or even millions) of invoices, computing the totals, taxes, and subtotals is likely to take some time. If those computations had been made and the results had been stored as derived attributes in the INVOICE and LINE tables at the time of the transaction, the real-time transaction speed might have declined. But that loss of speed would only be noticeable if there were many simultaneous transactions. The cost of a slight loss of transaction speed at the front end and the addition of multiple derived attributes is likely to pay off when the sales reports are generated (not to mention the fact that it will be simpler to generate the queries).

A design that meets all logical requirements and design conventions is an important goal. However, if this perfect design fails to meet the customer’s transaction speed and/or information requirements, the designer will not have done a proper job from the end user’s point of view. Compromises are a fact of life in the real world of database design.

Even while focusing on the entities, attributes, relationships, and constraints, the designer should begin thinking about end-user requirements such as performance, security, shared access, and data integrity. The designer must consider processing requirements and verify that all update, retrieval, and deletion options are available. Finally, a design is of little value unless the end product is capable of delivering all specified query and reporting requirements.

You are quite likely to discover that even the best design process produces an ERD that requires further changes mandated by operational requirements. Such changes should not discourage you from using the process. ER modeling is essential in the development of a sound design that is capable of meeting the demands of adjustment and growth. Using ERDs yields perhaps the richest bonus of all: a thorough understanding of how an organization really functions.

There are occasional design and implementation problems that do not yield “clean” implementation solutions. To get a sense of the design and implementation choices a database designer faces, let’s revisit the 1:1 recursive relationship “EMPLOYEE is married to EMPLOYEE” first examined in Figure 4.18. Figure 4.38 shows three different ways of implementing such a relationship.

FIGURE 4.38 Various implementations of the 1:1 recursive relationship

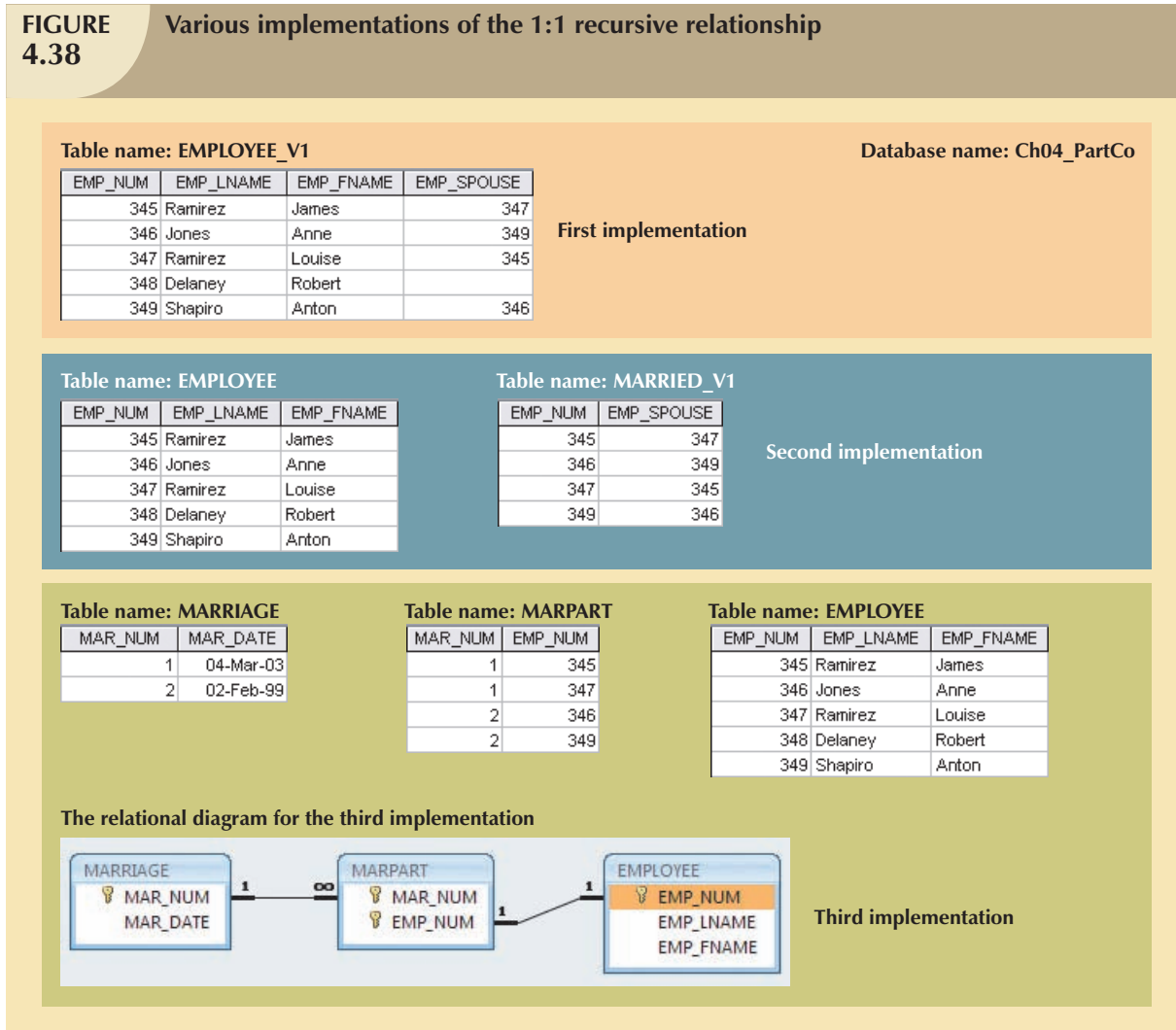

Note that the EMPLOYEE_V1 table in Figure 4.38 is likely to yield data anomalies. For example, if Anne Jones divorces Anton Shapiro, two records must be updated—by setting the respective EMP_SPOUSE values to null—to properly reflect that change. If only one record is updated, inconsistent data occur. The problem becomes even worse if several of the divorced employees then marry each other. In addition, that implementation also produces undesirable nulls for employees who are *not* married to other employees in the company.

Another approach would be to create a new entity shown as MARRIED_V1 in a 1:M relationship with EMPLOYEE. (See Figure 4.38.) This second implementation does eliminate the nulls for employees who are not married to somebody working for the same company. (Such employees would not be entered in the MARRIED_V1 table.) However, this approach still yields possible duplicate values. For example, the marriage between employees 345 and 347 may still appear twice, once as 345,347 and once as 347,345. (Since each of those permutations is unique the first time it appears, the creation of a unique index will not solve the problem.)

As you can see, the first two implementations yield several problems:

- Both solutions use synonyms. The EMPLOYEE_V1 table uses EMP_NUM and EMP_SPOUSE to refer to an employee. The MARRIED_V1 table uses the same synonyms.
- Both solutions are likely to produce inconsistent data. For example, it is possible to enter employee 345 as married to employee 347 and to enter employee 348 as married to employee 345.
- Both solutions allow data entries to show one employee married to several other employees. For example, it is possible to have data pairs such as 345,347 and 348,347 and 349,347, none of which will violate entity integrity requirements, because they are all unique.

A third approach would be to have two new entities, MARRIAGE and MARPART, in a 1:M relationship. MARPART contains the EMP_NUM foreign key to EMPLOYEE. (See the relational diagram in Figure 4.38.) This third approach would be the preferred solution in a relational environment. But even this approach requires some fine-tuning. For example, to ensure that an employee occurs only once in any given marriage, you would have to use a unique index on the EMP_NUM attribute in the MARPART table.

As you can see, a recursive 1:1 relationship yields many different solutions with varying degrees of effectiveness and adherence to basic design principles. Your job as a database designer is to use your professional judgment to yield a solution that meets the requirements imposed by business rules, processing requirements, and basic design principles.

Finally, document, document, and document! Put all design activities in writing. Then review what you've written. Documentation not only helps you stay on track during the design process, but also enables you (or those following you) to pick up the design thread when the time comes to modify the design. Although the need for documentation should be obvious, one of the most vexing problems in database and systems analysis work is that the "put it in writing" rule often is not observed in all of the design and implementation stages. The development of organizational documentation standards is a very important aspect of ensuring data compatibility and coherence.

S U M M A R Y

- The ERM uses ERDs to represent the conceptual database as viewed by the end user. The ERM's main components are entities, relationships, and attributes. The ERD also includes connectivity and cardinality notations. An ERD can also show relationship strength, relationship participation (optional or mandatory), and degree of relationship (unary, binary, ternary, etc.).
- Connectivity describes the relationship classification (1:1, 1:M, or M:N). Cardinality expresses the specific number of entity occurrences associated with an occurrence of a related entity. Connectivities and cardinalities are usually based on business rules.
- In the ERM, an M:N relationship is valid at the conceptual level. However, when implementing the ERM in a relational database, the M:N relationship must be mapped to a set of 1:M relationships through a composite entity.
- ERDs may be based on many different ERMs. However, regardless of which model is selected, the modeling logic remains the same. Because no ERM can accurately portray all real-world data and action constraints, application software must be used to augment the implementation of at least some of the business rules.
- Unified Modeling Language (UML) class diagrams are used to represent the static data structures in a data model. The symbols used in the UML class and ER diagrams are very similar. The UML class diagrams can be used to depict data models at the conceptual or implementation abstraction levels.
- Database designers, no matter how well they are able to produce designs that conform to all applicable modeling conventions, often are forced to make design compromises. Those compromises are required when end users have vital transaction speed and/or information requirements that prevent the use of "perfect" modeling logic and adherence to all modeling conventions. Therefore, database designers must use their professional judgment to determine how and to what extent the modeling conventions are subject to modification. To ensure that their professional judgments are sound, database designers must have detailed and in-depth knowledge of data-modeling conventions. It is also important to document the design process from beginning to end, which helps keep the design process on track and allows for easy modifications down the road.

K E Y T E R M S

binary relationship, 120	identifying relationship, 115	relationship degree, 120
cardinality, 111	iterative process, 127	required attribute, 105
composite attribute, 108	mandatory participation, 118	simple attribute, 108
composite identifier, 107	multivalued attribute, 108	single-valued attribute, 108
connectivity, 111	non-identifying relationship, 113	strong relationship, 115
derived attribute, 110	optional attribute, 106	ternary relationship, 120
existence-dependent, 113	optional participation, 118	unary relationship, 120
existence-independent, 113	participants, 111	weak entity, 113
identifiers, 106	recursive relationship, 120	weak relationship, 113



ONLINE CONTENT

Answers to selected Review Questions and Problems for this chapter are contained in the Student Online Companion for this book.

REVIEW QUESTIONS

1. What two conditions must be met before an entity can be classified as a weak entity? Give an example of a weak entity.
2. What is a strong (or identifying) relationship, and how is it depicted in a Crow's Foot ERD?
3. Given the business rule "an employee may have many degrees," discuss its effect on attributes, entities, and relationships. (*Hint*: Remember what a multivalued attribute is and how it might be implemented.)
4. What is a composite entity, and when is it used?
5. Suppose you are working within the framework of the conceptual model in Figure Q4.5.

FIGURE Q4.5 The conceptual model for Question 5

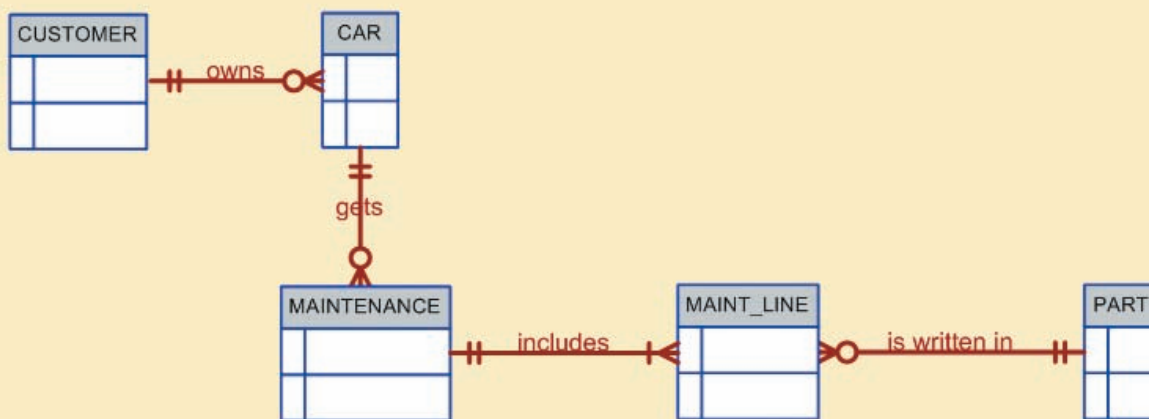

Given the conceptual model in Figure Q4.5:

- a. Write the business rules that are reflected in it.
 - b. Identify all of the cardinalities.
6. What is a recursive relationship? Give an example.
 7. How would you (graphically) identify each of the following ERM components in a Crow's Foot notation?
 - a. an entity
 - b. the cardinality (0,N)
 - c. a weak relationship
 - d. a strong relationship
 8. Discuss the difference between a composite key and a composite attribute. How would each be indicated in an ERD?
 9. What two courses of action are available to a designer encountering a multivalued attribute?
 10. What is a derived attribute? Give an example.

11. How is a relationship between entities indicated in an ERD? Give an example, using the Crow's Foot notation.
12. Discuss two ways in which the 1:M relationship between COURSE and CLASS can be implemented. (*Hint:* Think about relationship strength.)
13. How is a composite entity represented in an ERD, and what is its function? Illustrate the Crow's Foot notation.
14. What three (often conflicting) database requirements must be addressed in database design?
15. Briefly, but precisely, explain the difference between single-valued attributes and simple attributes. Give an example of each.
16. What are multivalued attributes, and how can they be handled within the database design?

The final four questions are based on the ERD in Figure Q4.17.

FIGURE Q4.17 The ERD for Questions 17–20

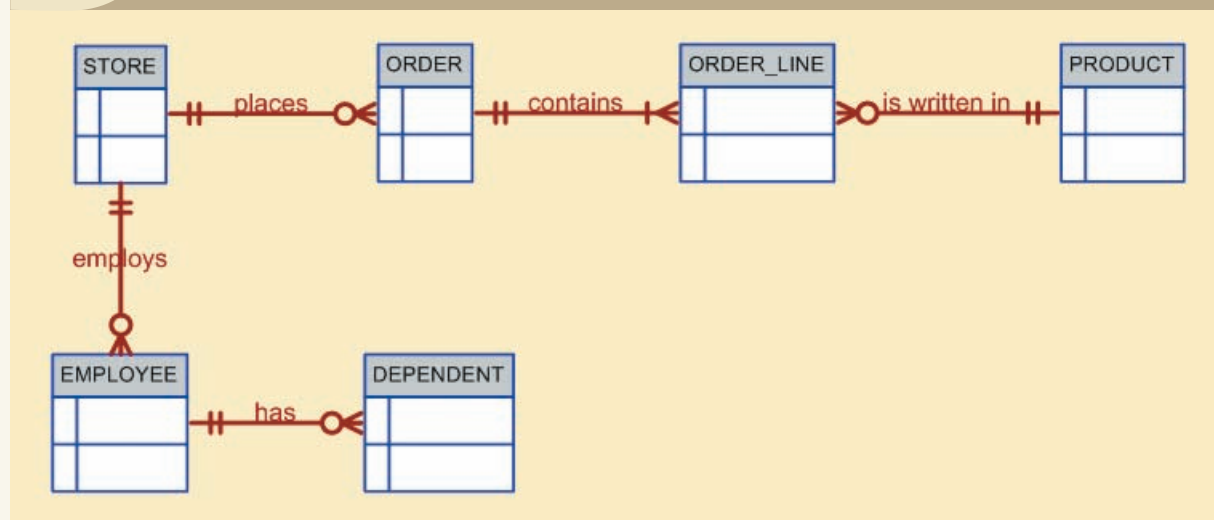

17. Write the ten cardinalities that are appropriate for this ERD.
18. Write the business rules reflected in this ERD.
19. What two attributes must be contained in the composite entity between STORE and PRODUCT? Use proper terminology in your answer.
20. Describe precisely the composition of the DEPENDENT weak entity's primary key. Use proper terminology in your answer.

P R O B L E M S

1. Given the following business rules, create the appropriate Crow's Foot ERD.
 - a. A company operates many departments.
 - b. Each department employs one or more employees.
 - c. Each of the employees might or might not have one or more dependents.
 - d. Each employee might or might not have an employment history.

2. The Hudson Engineering Group (HEG) has contacted you to create a conceptual model whose application will meet the expected database requirements for the company's training program. The HEG administrator gives you the description (see below) of the training group's operating environment.

(Hint: Some of the following sentences identify the volume of data rather than cardinalities. Can you tell which ones?)

The HEG has 12 instructors and can handle up to 30 trainees per class. HEG offers five Advanced Technology courses, each of which may generate several classes. If a class has fewer than 10 trainees, it will be canceled. Therefore, it is possible for a course not to generate any classes. Each class is taught by one instructor. Each instructor may teach up to two classes or may be assigned to do research only. Each trainee may take up to two classes per year.

Given that information, do the following:

- a. Define all of the entities and relationships. (Use Table 4.4 as your guide.)
 - b. Describe the relationship between instructor and class in terms of connectivity, cardinality, and existence-dependence.
3. Use the following business rules to create a Crow's Foot ERD. Write all appropriate connectivities and cardinalities in the ERD.
 - a. A department employs many employees, but each employee is employed by one department.
 - b. Some employees, known as "rovers," are not assigned to any department.
 - c. A division operates many departments, but each department is operated by one division.
 - d. An employee may be assigned many projects, and a project may have many employees assigned to it.
 - e. A project must have at least one employee assigned to it.
 - f. One of the employees manages each department, and each department is managed by only one employee.
 - g. One of the employees runs each division, and each division is run by only one employee.
 4. During peak periods, Temporary Employment Corporation (TEC) places temporary workers in companies. TEC's manager gives you the following description of the business:
 - TEC has a file of candidates who are willing to work.
 - If the candidate has worked before, that candidate has a specific job history. (Naturally, no job history exists if the candidate has never worked.) Each time the candidate works, one additional job history record is created.
 - Each candidate has earned several qualifications. Each qualification may be earned by more than one candidate. (For example, it is possible for more than one candidate to have earned a BBA degree or a Microsoft Network Certification. And clearly, a candidate may have earned both a BBA and a Microsoft Network Certification.)
 - TEC also has a list of companies that request temporaries.
 - Each time a company requests a temporary employee, TEC makes an entry in the Openings folder. That folder contains an opening number, a company name, required qualifications, a starting date, an anticipated ending date, and hourly pay.
 - Each opening requires only one specific or main qualification.
 - When a candidate matches the qualification, the job is assigned, and an entry is made in the Placement Record folder. That folder contains an opening number, a candidate number, the total hours worked, etc. In addition, an entry is made in the job history for the candidate.
 - An opening can be filled by many candidates, and a candidate can fill many openings.
 - TEC uses special codes to describe a candidate's qualifications for an opening. The list of codes is shown in table P4.4.

**TABLE
P4.4**

CODE	DESCRIPTION
SEC-45	Secretarial work, at least 45 words per minute
SEC-60	Secretarial work, at least 60 words per minute
CLERK	General clerking work
PRG-VB	Programmer, Visual Basic
PRG-C++	Programmer, C++
DBA-ORA	Database Administrator, Oracle
DBA-DB2	Database Administrator, IBM DB2
DBA-SQLSERV	Database Administrator, MS SQL Server
SYS-1	Systems Analyst, level 1
SYS-2	Systems Analyst, level 2
NW-NOV	Network Administrator, Novell experience
WD-CF	Web Developer, ColdFusion

TEC's management wants to keep track of the following entities:

- COMPANY
- OPENING
- QUALIFICATION
- CANDIDATE
- JOB_HISTORY
- PLACEMENT

Given that information, do the following:

- a. Draw the Crow's Foot ERDs for this enterprise.
 - b. Identify all possible relationships.
 - c. Identify the connectivity for each relationship.
 - d. Identify the mandatory/optional dependencies for the relationships.
 - e. Resolve all M:N relationships.
5. The Jonesburgh County Basketball Conference (JCBC) is an amateur basketball association. Each city in the county has one team as its representative. Each team has a maximum of 12 players and a minimum of 9 players. Each team also has up to three coaches (offensive, defensive, and physical training coaches). During the season, each team plays two games (home and visitor) against each of the other teams. Given those conditions, do the following:
- a. Identify the connectivity of each relationship.
 - b. Identify the type of dependency that exists between CITY and TEAM.
 - c. Identify the cardinality between teams and players and between teams and city.
 - d. Identify the dependency between coach and team and between team and player.
 - e. Draw the Chen and Crow's Foot ERDs to represent the JCBC database.
 - f. Draw the UML class diagram to depict the JCBC database.
6. Automata Inc. produces specialty vehicles by contract. The company operates several departments, each of which builds a particular vehicle, such as a limousine, a truck, a van, or an RV.

Before a new vehicle is built, the department places an order with the purchasing department to request specific components. Automata's purchasing department is interested in creating a database to keep track of orders and to accelerate the process of delivering materials.

The order received by the purchasing department may contain several different items. An inventory is maintained so that the most frequently requested items are delivered almost immediately. When an order comes in, it is

checked to determine whether the requested item is in inventory. If an item is not in inventory, it must be ordered from a supplier. Each item may have several suppliers.

Given that functional description of the processes encountered at Automata's purchasing department, do the following:

- a. Identify all of the main entities.
 - b. Identify all of the relations and connectivities among entities.
 - c. Identify the type of existence dependency in all the relationships.
 - d. Give at least two examples of the types of reports that can be obtained from the database.
7. Create an ERD based on the Crow's Foot notation, using the following requirements:
- An INVOICE is written by a SALESREP. Each sales representative can write many invoices, but each invoice is written by a single sales representative.
 - The INVOICE is written for a single CUSTOMER. However, each customer can have many invoices.
 - An INVOICE can include many detail lines (LINE), each of which describes one product bought by the customer.
 - The product information is stored in a PRODUCT entity.
 - The product's vendor information is found in a VENDOR entity.
8. Given the following brief summary of business rules for the ROBCOR catering service and using the Crow's Foot ER notation, draw the fully labeled ERD. Make sure you include all appropriate entities, relationships, connectivities, and cardinalities.

NOTE

Limit your ERD to entities and relationships based on the business rules shown here. In other words, do *not* add realism to your design by expanding or refining the business rules. However, make sure you include the attributes that would permit the model to be successfully implemented.

Each dinner is based on a single entree, but each entree can be served at many dinners. A guest can attend many dinners, and each dinner can be attended by many guests. Each dinner invitation can be mailed to many guests, and each guest can receive many invitations.

9. Using the Crow's Foot notation, create an ERD that can be implemented for a medical clinic, using at least the following business rules:
- a. A patient can make many appointments with one or more doctors in the clinic, and a doctor can accept appointments with many patients. However, each appointment is made with only one doctor and one patient.
 - b. Emergency cases do not require an appointment. However, for appointment management purposes, an emergency is entered in the appointment book as "unscheduled."
 - c. If kept, an appointment yields a visit with the doctor specified in the appointment. The visit yields a diagnosis and, when appropriate, treatment.
 - d. With each visit, the patient's records are updated to provide a medical history.
 - e. Each patient visit creates a bill. Each patient visit is billed by one doctor, and each doctor can bill many patients.
 - f. Each bill must be paid. However, a bill may be paid in many installments, and a payment may cover more than one bill.
 - g. A patient may pay the bill directly, or the bill may be the basis for a claim submitted to an insurance company.
 - h. If the bill is paid by an insurance company, the deductible is submitted to the patient for payment.

10. The administrators of Tiny College are so pleased with your design and implementation of their student registration/tracking system that they want you to expand the design to include the database for their motor vehicle pool. A brief description of operations follows:
- Faculty members may use the vehicles owned by Tiny College for officially sanctioned travel. For example, the vehicles may be used by faculty members to travel to off-campus learning centers, to travel to locations at which research papers are presented, to transport students to officially sanctioned locations, and to travel for public service purposes. The vehicles used for such purposes are managed by Tiny College's TFBS (Travel Far But Slowly) Center.
 - Using reservation forms, each department can reserve vehicles for its faculty, who are responsible for filling out the appropriate trip completion form at the end of a trip. The reservation form includes the expected departure date, vehicle type required, destination, and name of the authorized faculty member. The faculty member arriving to pick up a vehicle must sign a checkout form to log out the vehicle and pick up a trip completion form. (The TFBS employee who releases the vehicle for use also signs the checkout form.) The faculty member's trip completion form includes the faculty member's identification code, the vehicle's identification, the odometer readings at the start and end of the trip, maintenance complaints (if any), gallons of fuel purchased (if any), and the Tiny College credit card number used to pay for the fuel. If fuel is purchased, the credit card receipt must be stapled to the trip completion form. Upon receipt of the faculty trip completion form, the faculty member's department is billed at a mileage rate based on the vehicle type (sedan, station wagon, panel truck, minivan, or minibus) used. (*Hint: Do not use more entities than are necessary. Remember the difference between attributes and entities!*)
 - All vehicle maintenance is performed by TFBS. Each time a vehicle requires maintenance, a maintenance log entry is completed on a prenumbered maintenance log form. The maintenance log form includes the vehicle identification, a brief description of the type of maintenance required, the initial log entry date, the date on which the maintenance was completed, and the identification of the mechanic who released the vehicle back into service. (Only mechanics who have an inspection authorization may release the vehicle back into service.)
 - As soon as the log form has been initiated, the log form's number is transferred to a maintenance detail form; the log form's number is also forwarded to the parts department manager, who fills out a parts usage form on which the maintenance log number is recorded. The maintenance detail form contains separate lines for each maintenance item performed, for the parts used, and for identification of the mechanic who performed the maintenance item. When all maintenance items have been completed, the maintenance detail form is stapled to the maintenance log form, the maintenance log form's completion date is filled out, and the mechanic who releases the vehicle back into service signs the form. The stapled forms are then filed, to be used later as the source for various maintenance reports.
 - TFBS maintains a parts inventory, including oil, oil filters, air filters, and belts of various types. The parts inventory is checked daily to monitor parts usage and to reorder parts that reach the "minimum quantity on hand" level. To track parts usage, the parts manager requires each mechanic to sign out the parts that are used to perform each vehicle's maintenance; the parts manager records the maintenance log number under which the part is used.
 - Each month TFBS issues a set of reports. The reports include the mileage driven by vehicle, by department, and by faculty members within a department. In addition, various revenue reports are generated by vehicle and department. A detailed parts usage report is also filed each month. Finally, a vehicle maintenance summary is created each month.

Given that brief summary of operations, draw the appropriate (and fully labeled) ERD. Use the Chen methodology to indicate entities, relationships, connectivities, and cardinalities.

11. Given the following information, produce an ERD—based on the Crow's Foot notation—that can be implemented. Make sure you include all appropriate entities, relationships, connectivities, and cardinalities.
- EverFail company is in the oil change and lube business. Although customers bring in their cars for what is described as "quick oil changes," EverFail also replaces windshield wipers, oil filters, and air filters, subject to

customer approval. The invoice contains the charges for the oil and all parts used and a standard labor charge. When the invoice is presented to customers, they pay cash, use a credit card, or write a check. EverFail does not extend credit. EverFail's database is to be designed to keep track of all components in all transactions.

- Given the high parts usage of the business operations, EverFail must maintain careful control of its parts inventory (oil, wipers, oil filters, and air filters). Therefore, if parts reach their minimum on-hand quantity, the parts in low supply must be reordered from an appropriate vendor. EverFail maintains a vendor list, which contains vendors actually used and potential vendors.
- Periodically, based on the date of the car's service, EverFail mails updates to customers. EverFail also tracks each customer's car mileage.

NOTE

Problems 12 and 13 may be used as the basis for class projects. These problems illustrate the challenge of translating a description of operations to a set of business rules that will define the components for an ERD that can be successfully implemented. These problems can also be used as the basis for discussions about the components and contents of a proper description of operations. One of the things you must learn if you want to create databases that can be successfully implemented is to separate the generic background material from the details that directly affect database design. You must also keep in mind that many constraints cannot be incorporated into the database design; instead, such constraints are handled by the applications software. Although the description of operations in Problem 12 deals with a Web-based business, the focus should be on the *database* aspects of the design, rather than on its interface and the transaction management details. In fact, the argument can easily be made that the existence of Web-based businesses has made database design more important than ever. (You might be able to get away with a bad database design if you sell only a few items per day, but the problems of poorly designed databases are compounded as the number of transactions increases.)

12. Use the following descriptions of the operations of RC_Models Company to complete this exercise.

RC_Models Company sells its products—plastic models (aircraft, ships, and cars) and “add-on” decals for those models—through its Internet Web site, *www.rc_models.com*. Models and decals are available in scales that vary from 1/144 to 1/32.

Customers use the Web site to select the products and to pay by credit card. If a product is not currently available, it is placed on back order at the customer's discretion. (Back orders are not charged to a customer until the order is shipped.) When a customer completes a transaction, the invoice is printed and the products listed on the invoice are pulled from inventory for shipment. (The invoice includes a shipping charge.) The printed invoice is enclosed in the shipping container. The customer credit card charges are transmitted to the CC Bank, at which RC_Models Company maintains a commercial account. (*Note:* The CC Bank is *not* part of the RC_Models database.)

RC_Models Company tracks customer purchases and periodically sends out promotional materials. Because the management at RC_Models Company requires detailed information to conduct its operations, numerous reports are available. Those reports include, but are not limited to, customer purchases by product category and amount, product turnover, and revenues by product and customer. If a product has not recorded a sale within four weeks of being stocked, it is removed from inventory and scrapped.

Many of the customers on the RC_Models customer list have bought RC_Models products. However, RC_Models Company also has purchased a copy of the *FineScale Modeler* magazine subscription list to use in marketing its products to customers who have not yet bought from RC_Models Company. In addition, customer data are recorded when potential customers request product information.

RC_Models Company orders its products directly from the manufacturers. For example, the plastic models are ordered from Tamiya, Academy, Revell/Monogram, and others. Decals are ordered from Aeromaster, Tauro, WaterMark, and others. (*Note:* Not all manufacturers in the RC_Models Company database have received orders.) All orders are placed via the manufacturers' Web sites, and the order amounts are automatically handled

through RC_Models' commercial bank account with the CC Bank. Orders are automatically placed when product inventory reaches the specified minimum quantity on hand. (The number of product units ordered depends on the minimum order quantity specified for each product.)

- a. Given that brief and incomplete description of operations for RC_Models Company, write all applicable business rules to establish entities, relationships, optionalities, connectivities, and cardinalities. (*Hint: Use the following three business rules as examples, writing the remaining business rules in the same format.*)
 - A customer may generate many invoices.
 - Each invoice is generated by only one customer.
 - Some customers have not (yet) generated an invoice.
 - b. Draw the fully labeled and implementable Crow's Foot ERD based on the business rules you wrote in Part (a) of this problem. Include all entities, relationships, optionalities, connectivities, and cardinalities.
13. Use the following description of the operations of the RC_Charter2 Company to complete this exercise.

The RC_Charter2 Company operates a fleet of aircraft under the Federal Air Regulations (FAR) Part 135 (air taxi or charter) certificate, enforced by the FAA. The aircraft are available for air taxi (charter) operations within the United States and Canada.

Charter companies provide so-called "unscheduled" operations—that is, charter flights take place only after a customer reserves the use of an aircraft to fly at a customer-designated date and time to one or more customer-designated destinations, transporting passengers, cargo, or some combination of passengers and cargo. A customer can, of course, reserve many different charter flights (trips) during any time frame. However, for billing purposes, each charter trip is reserved by one and only one customer. Some of RC_Charter2's customers do not use the company's charter operations; instead, they purchase fuel, use maintenance services, or use other RC_Charter2 services. However, this database design will focus on the charter operations only.

Each charter trip yields revenue for the RC_Charter2 Company. This revenue is generated by the charges a customer pays upon the completion of a flight. The charter flight charges are a function of aircraft model used, distance flown, waiting time, special customer requirements, and crew expenses. The distance flown charges are computed by multiplying the round-trip miles by the model's charge per mile. Round-trip miles are based on the actual navigational path flown. The sample route traced in Figure P4.13 illustrates the procedure. Note that the number of round-trip miles is calculated to be $130 + 200 + 180 + 390 = 900$.

Depending on whether a customer has RC_Charter2 credit authorization, the customer may:

- Pay the entire charter bill upon the completion of the charter flight.
- Pay a part of the charter bill and charge the remainder to the account. The charge amount may not exceed the available credit.
- Charge the entire charter bill to the account. The charge amount may not exceed the available credit.

Customers may pay all or part of the existing balance for previous charter trips. Such payments may be made at any time and are not necessarily tied to a specific charter trip. The charter mileage charge includes the expense of the pilot(s) and other crew required by FAR 135. However, if customers request *additional* crew *not* required by FAR 135, those customers are charged for the crew members on an hourly basis. The hourly crew-member charge is based on each crew member's qualifications.

The database must be able to handle crew assignments. Each charter trip requires the use of an aircraft, and a crew flies each aircraft. The smaller piston engine-powered charter aircraft require a crew consisting of only a single pilot. Larger aircraft (that is, aircraft having a gross takeoff weight of 12,500 pounds or more) and jet-powered aircraft require a pilot and a copilot, while some of the larger aircraft used to transport passengers may require flight attendants as part of the crew. Some of the older aircraft require the assignment of a flight engineer, and larger cargo-carrying aircraft require the assignment of a loadmaster. In short, a crew can consist of more than one person, and not all crew members are pilots.

FIGURE P4.13 Round-trip mile determination

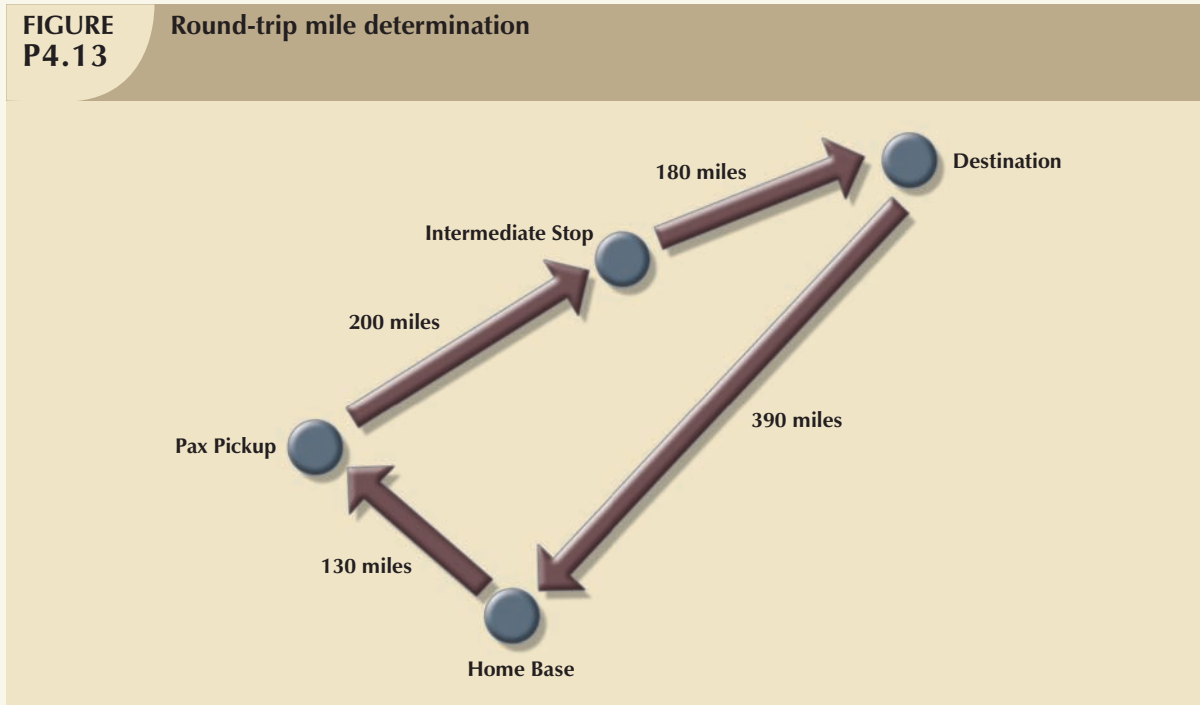

The charter flight's aircraft waiting charges are computed by multiplying the hours waited by the model's hourly waiting charge. Crew expenses are limited to meals, lodging, and ground transportation.

The RC_Charter2 database must be designed to generate a monthly summary of all charter trips, expenses, and revenues derived from the charter records. Such records are based on the data that each pilot in command is required to record for each charter trip: trip date(s) and time(s), destination(s), aircraft number, pilot (and other crew) data, distance flown, fuel usage, and other data pertinent to the charter flight. Such charter data are then used to generate monthly reports that detail revenue and operating cost information for customers, aircraft, and pilots. All pilots and other crew members are RC_Charter2 Company employees; that is, the company does not use contract pilots and crew.

FAR Part 135 operations are conducted under a strict set of requirements that govern the licensing and training of crew members. For example, pilots must have earned either a Commercial license or an Airline Transport Pilot (ATP) license. Both licenses require appropriate ratings. Ratings are specific competency requirements. For example:

- To operate a multiengine aircraft designed for takeoffs and landings on land only, the appropriate rating is MEL, or Multiengine Landplane. When a multiengine aircraft can take off and land on water, the appropriate rating is MES, or Multiengine Seaplane.
- The instrument rating is based on a demonstrated ability to conduct all flight operations with sole reference to cockpit instrumentation. The instrument rating is required to operate an aircraft under Instrument Meteorological Conditions (IMC), and all such operations are governed under FAR-specified Instrument Flight Rules (IFR). In contrast, operations conducted under "good weather" or *visual* flight conditions are based on the FAR Visual Flight Rules (VFR).
- The type rating is required for all aircraft with a takeoff weight of more than 12,500 pounds or for aircraft that are purely jet-powered. If an aircraft uses jet engines to drive propellers, that aircraft is said to be turboprop-powered. A turboprop—that is, a turbo propeller-powered aircraft—does not require a type rating unless it meets the 12,500-pound weight limitation.

Although pilot licenses and ratings are not time-limited, exercising the privilege of the license and ratings under Part 135 requires both a *current medical certificate* and a *current Part 135 checkride*. The following distinctions are important:

- The medical certificate may be Class I or Class II. The Class I medical is more stringent than the Class II, and it must be renewed every six months. The Class II medical must be renewed yearly. If the Class I medical is not renewed during the six-month period, it automatically reverts to a Class II certificate. If the Class II medical is not renewed within the specified period, it automatically reverts to a Class III medical, which is not valid for commercial flight operations.
- A Part 135 checkride is a practical flight examination that must be successfully completed every six months. The checkride includes all flight maneuvers and procedures specified in Part 135.

Nonpilot crew members must also have the proper certificates in order to meet specific job requirements. For example, loadmasters need an appropriate certificate, as do flight attendants. In addition, crew members such as loadmasters and flight attendants, who may be required in operations that involve large aircraft (more than a 12,500-pound takeoff weight and passenger configurations over 19) are also required periodically to pass a written and practical exam. The RC_Charter2 Company is required to keep a complete record of all test types, dates, and results for each crew member, as well as pilot medical certificate examination dates.

In addition, all flight crew members are required to submit to periodic drug testing; the results must be tracked, too. (Note that nonpilot crew members are not required to take pilot-specific tests such as Part 135 checkrides. Nor are pilots required to take crew tests such as loadmaster and flight attendant practical exams.) However, many crew members have licenses and/or certifications in several areas. For example, a pilot may have an ATP and a loadmaster certificate. If that pilot is assigned to be a loadmaster on a given charter flight, the loadmaster certificate is required. Similarly, a flight attendant may have earned a commercial pilot's license. Sample data formats are shown in Table P4.13.

**TABLE
P4.13**

PART A TESTS		
TEST CODE	TEST DESCRIPTION	TEST FREQUENCY
1	Part 135 Flight Check	6 months
2	Medical, Class 1	6 months
3	Medical, Class 2	12 months
4	Loadmaster Practical	12 months
5	Flight Attendant Practical	12 months
6	Drug test	Random
7	Operations, written exam	6 months

PART B RESULTS			
EMPLOYEE	TEST CODE	TEST DATE	TEST RESULT
101	1	12-Nov-07	Pass-1
103	6	23-Dec-07	Pass-1
112	4	23-Dec-07	Pass-2
103	7	11-Jan-08	Pass-1
112	7	16-Jan-08	Pass-1
101	7	16-Jan-08	Pass-1
101	6	11-Feb-08	Pass-2
125	2	15-Feb-08	Pass-1

PART C LICENSES AND CERTIFICATIONS	
LICENSE OR CERTIFICATE	LICENSE OR CERTIFICATE DESCRIPTION
ATP	Airline Transport Pilot
Comm	Commercial license
Med-1	Medical certificate, class 1
Med-2	Medical certificate, class 2
Instr	Instrument rating
MEL	Multiengine Land aircraft rating
LM	Load Master
FA	Flight Attendant

PART D LICENSES AND CERTIFICATES HELD BY EMPLOYEES		
EMPLOYEE	LICENSE OR CERTIFICATE	DATE EARNED
101	Comm	12-Nov-93
101	Instr	28-Jun-94
101	MEL	9-Aug-94
103	Comm	21-Dec-95
112	FA	23-Jun-02
103	Instr	18-Jan-96
112	LM	27-Nov-05

Pilots and other crew members must receive recurrency training appropriate to their work assignments. Recurrency training is based on an FAA-approved curriculum that is job-specific. For example, pilot recurrency training includes a review of all applicable Part 135 flight rules and regulations, weather data interpretation, company flight operations requirements, and specified flight procedures. The RC_Charter2 Company is required to keep a complete record of all recurrency training for each crew member subject to the training.

The RC_Charter2 Company is required to maintain a detailed record of all crew credentials and all training mandated by Part 135. The company must keep a complete record of each requirement and of all compliance data.

To conduct a charter flight, the company must have a properly maintained aircraft available. A pilot who meets all of the FAA's licensing and currency requirements must fly the aircraft as Pilot in Command (PIC). For those aircraft that are powered by piston engines or turboprops and have a gross takeoff weight under 12,500 pounds, single-pilot operations are permitted under Part 135 as long as a properly maintained autopilot is available. However, even if FAR Part 135 permits single-pilot operations, many customers require the presence of a copilot who is capable of conducting the flight operations under Part 135.

The RC_Charter2 operations manager anticipates the lease of turbojet-powered aircraft, and those aircraft are required to have a crew consisting of a pilot and copilot. Both pilot and copilot must meet the same Part 135 licensing, ratings, and training requirements.

The company also leases larger aircraft that exceed the 12,500-pound gross takeoff weight. Those aircraft can carry the number of passengers that requires the presence of one or more flight attendants. If those aircraft carry cargo weighing over 12,500 pounds, a loadmaster must be assigned as a crew member to supervise the loading and securing of the cargo. *The database must be designed to meet the anticipated additional charter crew assignment capability.*

- a. Given this incomplete description of operations, write all applicable business rules to establish entities, relationships, optionalities, connectivities, and cardinalities. (*Hint: Use the following five business rules as examples, writing the remaining business rules in the same format.*)
 - A customer may request many charter trips.
 - Each charter trip is requested by only one customer.
 - Some customers have not (yet) requested a charter trip.
 - An employee may be assigned to serve as a crew member on many charter trips.
 - Each charter trip may have many employees assigned to it to serve as crew members.
- b. Draw the fully labeled and implementable Crow's Foot ERD based on the business rules you wrote in Part (a) of this problem. Include all entities, relationships, optionalities, connectivities, and cardinalities.