

## **Novel Principles In The Rife Microscope**

### **And Rife's Great Secret [\[1\]](#)**

© 1998 T.E. Bearden

Substantially updated Aug. 20, 2001

#### Foreword

In the 1930s and 1940s, Royal Raymond Rife [\[1\]](#) made revolutionary discoveries in microscopy, including development of novel microscopes that could see far beyond the accustomed one-tenth wavelength limitation according to Rayleigh theory. With his microscope, he was able to "see" ultramicroscopic living forms much smaller than anything considered in the observable state. It would appear that his microscope was somehow capable of peering directly into the virtual state itself, and finding living forms at that level that were far beyond anything ever suspected by conventional science, even to this day.

Obviously this work was dramatically controversial. Rife went on to develop treatment methods and devices based on the new level of living organisms that his microscope revealed. In short, he arrived at essentially a new theory of disease, and did achieve success with his—to conventional scientists—completely unprecedented devices and methods of treating and healing. While we do not discuss his treatment methods in this paper, we do discuss the methods of Prioré, whom we believe to have used similar principles. So these discussions may shed some light

on Rife's therapeutic mechanisms also.

Rife and others reported his results in the proper scientific literature. For his efforts, he was ostracized, essentially imprisoned in a medical treatment facility, broken, and rejected by his peers. His findings were harshly ridiculed and discredited. Finally escaping from his enforced confinement, Rife lived out his remaining years and died quietly and unknown.

In the present paper it is not our purpose to address Rife's theory of disease or his treatment devices and methods. It is solely our purpose to propose a higher symmetry electrodynamics functioning of his microscope, as one possible explanation of the startling microscopy results he achieved. We will reveal what we are convinced is Rife's great secret: recursive virtual state magnification (amplification) by iterative difference frequency serial summation of vacuum engines. This is a substantial change from an earlier mechanism proposed by the present author, which proved to be in error [\[1\]](#).

We accent that this is not a "standard electrodynamics" examination of the Rife microscope; normal  $U(1)$  electrodynamics and transverse EM waves contain no mechanisms that can explain the functioning of the instrument. Accordingly, since no such explanation is contained in the usual electrodynamics, one must of necessity turn to those available electrodynamics models that are of much higher symmetry than afforded by vector and tensor algebra. To show the fit to experiments, we must also address an enormous amount of the work performed by Prioré and his colleagues. Only in such EM models and their known fit to actual experiments are the additional phenomena and principles available that can possibly explain Rife's epochal results.

Also, because of the importance of this unified field theory area, we include substantial references and additional extended discussions in the endnotes for further technical clarification. Thirty figures are added to illustrate the material.

## The Rife Microscope

The Rife microscope { [1] } ([Figure 1](#)) cannot be made to work by normal optical principles at the level utilized by Rife. With normal optics, about one-tenth wavelength is as fine an optical resolution as one can get. Since Rife went far beyond that, it should be obvious that he was using optics and electrodynamics of a *novel kind*, and of a type not yet in the conventional textbook.

We believe we are aware of the major principles used in Rife's microscope, or at least some of them, but prior to 1998 we shied away from anything to do with the scope. My major interests have been in extracting EM energy from the vacuum and in developing a new kind of medical therapy utilizing higher symmetry electrodynamics—and thus unified field theory—to directly and slowly change cellular disease or disorder back to a normal previous state. Obviously, if one is to produce a microscope that "sees" optically further into the realm of smallness than any other microscope can conventionally do (even in theory), that microscope must be functioning in a higher electrodynamics mode rather than in the conventional one.

In this paper, we will try to summarize some deep physics principles underlying the Rife microscope, at least as we see them terms of a higher symmetry EM model, and we cite some references for the bits and pieces. A more detailed explanation must wait for a future time and assistance from very high-level theorists.

## Introduction

A good hint is this: Rife ([Figure 2](#)) often painfully adjusted his microscope stages for up to *24 hours* before he finally got the instrument "focused." Immediately that shows it is not standard optical equipment. Well-made standard optics—and Rife's microscope was beautifully made—can be adjusted far more easily than that (in minutes!).

So far as we are aware, no one ever looked at the Rife work except through essentially rather orthodox electrodynamics and rather orthodox optics eyes. Normal optical theory permits resolution of about one tenth of the wavelength of the light used, and a few microscopes in the last few years have gone just a wee bit further. But none have gone anywhere to the degree of smallness that Rife reported.

In our view, the orthodox approach to explaining the operation of Rife's microscope is doomed to fail from the beginning. Even a very good scientist will fail with replication, if that approach is exclusively taken. An entire scientific team and substantial funding will not do any better, unless something technically deeper is understood and tackled from the outset. We give an overview of our approach to tackling that problem. To begin with, we must present some errors in electrodynamics and an omission in general relativity, so that we can develop the necessary background. The discussion is not simple and will require considerable development. Once the considerable background is developed, the application to the Rife microscope will be straightforward.

## Errors in Electrodynamics and Adjustments to General Relativity

First, present electrodynamics itself has serious flaws and shortcomings, and needs substantial revision [\[2\]](#). As foundations scientist Bunge points out [\[3\]](#):

*"...it is not usually acknowledged that electrodynamics, both classical and quantal, are in a sad state."*

Bunge [\[4\]](#) also said:

"... the best modern physicist is the one who acknowledges that neither classical nor quantum physics are cut and dried, both being full of holes and in need of a vigorous overhauling not only to better cover their own domains but also to join smoothly so as to produce a coherent picture of the various levels of physical reality."

The flaws in electrodynamics pass over into what has been constructed for optical theory—both linear and nonlinear—which just assumes the electrodynamics as a subset.

For our purpose, we need to clarify what modern electrodynamics does and does not say about the massless vacuum, and about the state and form of EM entities—such as potentials, fields, and waves—created in it (in *empty space*) by matter dynamics, or acting from it (from *empty space*) onto matter and causing matter dynamics.

Maxwell and all his peers believed firmly in the material ether, a thin material fluid filling all space and every crevice. To scientists at the time, not one single point in the universe was devoid of this material etheric fluid—this *thin matter*. The atom had not been discovered, the electron had not been discovered, and electricity was also considered a thin material fluid. Charge had no more meaning than “a piece of the electric fluid,” much like a cubic centimeter of water.

Faraday [\[5\]](#) believed that the EM influence in space consisted of *material lines of force which acted as taut strings under tension from some mysterious source*. He believed that EM disturbances were just the transverse wave “perturbations” of these taut strings. In his concept, Faraday omitted the string holder or other agent producing the tensile forces upon the string [\(Figure 3\)](#). He thus omitted Newton’s third law from his electrodynamics concept. He also omitted precisely half the energy, by omitting the equal-energy time-reversed EM wave that accompanies the formation of every ordinary EM wave we take account of. In a receiving copper wire antenna, for example, not only do the electrons interact with the incoming fields, but so do the protons in the nuclei—though highly damped in amplitude by the proton's large mass with respect to the mass of a disturbed Drude electron. However, the two energetic interactions (of perturbed protons and perturbed electrons) are of equal *energy* magnitude. So in the conductor, equal energy is expended to move the “lattice holes” (positrons) as is used to move the Drude

electrons, else field theory itself is falsified. Except in semiconductors, electrical engineers mostly just ignore the "disturbed lattice hole current" energy.

Maxwell deliberately captured Faraday's thinking, mathematically { [6] }, and so just *assumed* Faraday's lines of force and the "plucked tight string" transverse EM wave in the material ether { [7] } as well as the unexplained tension . The notion of the transverse EM wave in vacuum has essentially no other theoretical justification than that Faraday-Maxwell assumption and the observed "transverse waves" generated in the receiving "electric fluid in the conductor" in and on the Drude electrons. The transverse EM wave notion in vacuum was maintained only by discarding its missing antiwave that is always formed simultaneously in our transmitters and receivers (e.g., when we perturb the Drude electrons in a transmitting wire antenna, we also perturb the protons in the nuclei with the same energy. The two disturbances—proton disturbance in the nucleus and Drude electron disturbance in the Drude electron gas—perturb the local surrounding vacuum/spacetime with equal energy, so in the vacuum "virtual particle flux gas" the two perturbations are energetically equal. The receiving wire receives both perturbation waves from the vacuum; one perturbs the electrons and the other perturbs the nuclei. Since the second wave is unaccounted, the perturbation of the nuclei is just considered a "mysterious force" that always appears. In a pumped phase conjugate mirror material, e.g., we interact the waves prior to their reaching the nuclei, by multi-wave mixing. Since the "causative" but neglected second wave coming in from space does not reach the nuclei, but are redirected to form the phase conjugate replica wave produced by the pumping, *the mirror does not recoil and it does not exhibit Newtonian third law reaction*. However, since electrodynamics *omits* the EM causative wave that generates Newton's third law forces in the receiver, which in normal detection always appear, then presently electrodynamic fields are erroneously said to be devoid of Newton's third law reaction. To the contrary, the effects of that hidden, neglected EM cause of the Newtonian third law reaction do appear, either as recoil of the physical receiving antenna or as the production of the time-reverse phase conjugate replica

wave in optical pumping. But in standard electrodynamics, equal-and-opposite forces in the receiving antenna are assumed to arise "mystically" or from some hidden *electrodynamic demon*. The electrodynamic cause of Newton's third law has been lost since Maxwell wrote his theory.

Maxwell, however, was careful to point out the ad hoc nature of assuming the stress in the vacuum, and that no mechanism for it had been discovered, nor was such a mechanism contained in his theory. Specifically, Maxwell said {[\[8\]](#) }:

*“It must be carefully borne in mind that we have made only one step in the theory of the action of the medium. We have supposed it to be in a state of stress, but we have not in any way accounted for this stress, or explained how it is maintained. This step, however, seems to me to be an important one, as it explains, by the action of the consecutive parts of the medium, phenomena which were formerly supposed to be explicable only by direct action at a distance. ... I have not been able to make the next step, namely, to account by mechanical considerations for these stresses in the dielectric. I therefore leave the theory at this point, merely stating what are the other parts of the phenomenon of induction in dielectrics.”*

Indeed, we now know of electrons and their spin. The longitudinally-constrained, spinning Drude electrons in receiving wires will gyroprocess laterally in the wire when an EM disturbance from the vacuum interacts with them. ([Figure 4](#)) It is well-known that these Drude electrons are highly restrained longitudinally down the wire; the longitudinal movement is the "drift" velocity and may be nominally only a few inches per hour. The lateral precession of the longitudinally constrained, spinning Drude electrons establishes that the incoming vacuum disturbance, before its interaction with the gyroelectrons, is *longitudinal*. Else one must discard electron spin, electron gyroprocession, and

indeed the theory of gyroscopic precession itself. In our view, the EM wave *in vacuum* is longitudinal, always has been, and always will be { [9] }. It also *does not* consist of EM force fields, contrary to present classical theory. Instead, only the potentiality { [10] } for the transverse force fields—*should* the longitudinally perturbed vacuum EM entity be intercepted by a spinning charged particle and interact with it—exists in mass-free space, as pointed out by Feynman. Quoting Feynman again { [11] }:

*. "We may think of  $\mathbf{E}(x, y, z, t)$  and  $\mathbf{B}(x, y, z, t)$  as giving the forces that would be experienced at the time  $t$  by a charge located at  $(x, y, z)$ , with the condition that placing the charge there did not disturb the positions or motion of all the other charges responsible for the fields."*

Rigorously the force fields exist only in and of matter. In matter-free space, there is no force at all in what we call the "field as it exists in massfree space" { [12] }. E. g., Jackson states it this way { [13] }:

*"Most classical electrodynamicists continue to adhere to the notion that the EM force field exists as such in the vacuum, but do admit that physically measurable quantities such as force somehow involve the product of charge and field."*

But again, Jackson also states { [14] }:

*"...the thing that eventually gets measured is a force..." "At the moment, the electric field can be defined as the force per unit charge acting at a given point. It is a vector function of position, denoted by  $E$ . One must be careful in its definition, however. It is not necessarily the force that one would observe by placing one unit of charge on a pith ball and placing it in position. The reason is that one unit of charge may be so large that its presence alters appreciably the field configuration of the array. Consequently one must use a limiting process whereby the ratio of the force on the small test*



*body to the charge on it is measured for smaller and smaller amounts of charge. Experimentally, this ratio and the direction of the force will become constant as the amount of test charge is made smaller and smaller. These limiting values of magnitude and direction define the magnitude and direction of the electric field  $E$  at the point in question. In symbols we may write  $F = qE$  where  $F$  is the force,  $E$  the electric field, and  $q$  the charge. In this equation it is assumed that the charge  $q$  is located at a point, and the force and the electric field are evaluated at that point."*

As can be seen, much of the difficulty occurs because physicists continue to erroneously utilize an *equation* as if it were a *definition*. An equation defines nothing at all; it merely states that all the "things on the left" of the equality sign and all the "things on the right" have the same overall magnitudes. It does not *define* any of the things on the left or right, and so it tells us nothing at all about what anything in it *really is*. A definition requires an identity, not an equality. E.g., if we take as an identity the very equation advanced by Jackson's explanation above, we then have a definition:

$$F \equiv qE \Rightarrow E \equiv F/q$$

And now that identity clearly states that charged mass is a *component* of the **E**-field. Similar argument prevails for the **B**-field, etc.

The identity also shows that  $E$  is not the *magnitude* of the force field at all, but is its *local intensity* at any given point in the  $E$  field, in terms of force per unit point static coulomb—a force formed in, on, and of the charged mass of the coulomb. The misstatement that  $E$  represents the *magnitude of the field* is another great non sequitur. No textbook gives the calculation of the *magnitude* of the  $E$ -field, though all purport to. Instead, they all give the calculation of the *intensity* of the  $E$ -field at each point in it. There is a great difference between the magnitude of an automobile's mounted tire and its pressure per sq. inch on the pavement. In all fairness, some of the better texts do

use the term "field intensity", at least occasionally.

*As defined*, the EM force fields are effects produced in, on, and of charged matter and *only* in, on, and of charged matter. They are not at all the same effects produced in matter-free space (in the vacuum/spacetime). The EM force field (in matter) is not the same as the "massfree" E-field in massfree spacetime. Ultimately, all that exists in spacetime are *spacetime* and *changes to spacetime*.

We may accurately take the mass-free, force-free EM field to be a pattern of spacetime curvatures. The coupling of this spacetime curvature set, or any part of it, with charged mass, then constitutes an EM force field. Again, the problem is the hoary old mechanics notion of having a separate massless force acting upon a separate mass. No such thing exists in all nature, and mechanics should have been rather thoroughly overhauled long ago as a result of this horrendous *foundations of mechanics* error that is centuries old.

In present classical electrodynamics—certainly the kind taught to electrical engineers and used in the electrical engineering discipline—the EM potential {[\[15\]](#)}, field, and wave, as they truly exist in space and in the vacuum, are rigorously not prescribed at all. Instead, the effect of the "causal entity" as it exists in vacuum prior to interaction with charged mass, is used as if it were what exists in and on the charged mass as the effect of the interaction. (See [Figure 5](#), [Figure 6](#), and [Figure 7](#)). This substitution of the effect for the cause is arguably the greatest uncorrected error in classical electrodynamics today. It is a hangover from the old days of the material ether, and the refusal to change the Maxwell-Heaviside equations to eliminate that material ether assumption, once the Michelson-Morley experiments falsified it. This has long been known to foundations physicists, and to most of the better electrodynamicists as well. But it still seems to be known to very few electrical engineers!

Many attempts have been made to “modify” the standard classical electrodynamics theory, but most have failed. For some reason, most of these attempted

modifications seem to have accepted the present “matter-to-matter transform” approach ([Figure 8](#)) of present electrodynamics, failing to see that the two missing transforms of matter-to-spacetime and spacetime-to-matter ([Figure 9](#)) are in fact just general relativity itself [\[16\]](#), [\[17\]](#) } The solution for adding the missing two transforms into electrodynamics therefore may lie in “infolding” general relativity directly within electrodynamics, rather than placing the two on an equal footing. That requires the analysis of the supersystem rather than the system, a concept which will be discussed shortly. [Figure 10](#) shows the utilization of the "vacuum engine" that results from this "infolded GR" solution.

To our knowledge, the Sachs unified field theory [\[18\]](#) a,b,c,d,e} is presently the only practical unified field theory that can be directly engineered by higher symmetry electrodynamics, such as the O(3) group symmetry EM model advanced by Evans and Vigier and perfected by Evans [\[19\]](#) }. The engineering power of Sachs' theory is remarkable [\[20\]](#) }, and the O(3) electrodynamics has been shown by Evans to be an important subset of the unified electrodynamics in Sachs' theory.

Let us examine that statement a little deeper.

In classical electrodynamics the sources of all EM potentials, fields, waves, and their energies are assumed to be the charges—which are assumed to somehow act as perpetual motion machines that continuously *create and pour out* all that EM energy in the fields and potentials associated with the charge as their "source". This outpouring of 3-space energy comprising and establishing the associated potentials and fields eventually fills all space with energy. All the charges and dipoles present in the universe since shortly after its formation have done this for some 14 billion years.

Yet in classical EM—with all the existing charges in the universe implicitly assumed to continuously pour out energy into all of space, and most having done so for billions of years—inexplicably space is *then*

considered to be an emptiness having no interactive energetic exchange with the charge at all { [21] }. That of course is a non sequitur because it involves a total contradiction of the conservation of energy law. If there is no active energy in spacetime for the charged particle to receive and then output in 3-space, then the energy conservation is falsified by every charge and every dipole.

In particle physics the inactive vacuum concept is known to be quite wrong, else the charge creates energy from nothing. That would violate the most sacrosanct law in physics: that *energy can neither be created nor destroyed*. So electrodynamics—both classical and quantum, neither of which contains the solution to this *source charge problem*—is in gross violation of conservation of energy laws, because it assumes that the charge is solely the source of its associated fields and potentials and their energy { [22] } and that it accordingly creates all that energy it has poured out since the beginning of the universe.

Presently the electrical engineer implicitly assumes total violation of the conservation of energy law with every equation he writes, and is blissfully unaware of it.

Particle physicists, however, have done much better and published and incorporated their results, although inexplicably the mainstream electrodynamicists have not changed their own model accordingly. Particle physicists have known and shown for more than 40 years that (i) space is a seething inferno of EM energy { [23] }, (ii) a charge continually undergoes a violent energy exchange (see [Figure 11](#)) with the vacuum EM flux. That exchange is what a charged mass is doing, to *make* it a "charged mass", and (iii) the charge is a *broken symmetry* in that violent energetic flux of the vacuum. "Broken symmetry" means that the charge disrupts and alters part of that virtual particle flux to observable EM energy flux (see again [Figures 5, 6, and 7](#)). The charge continually absorbs virtual energy from the vacuum, radiates *some* of that absorbed energy back to the vacuum in virtual form, but *integrates and radiates the remainder* in a flow of potentially observable energy—the energy flow discovered by

Poynting { [24] } and Heaviside { [25] } after Maxwell was already deceased.

So what does the source charge really do? It coheres, transduces, and *gates* some of its virtual energy { [26] } received from the vacuum, into an EM energy flow going out in all directions in 3-space from that source charge. Contrary to present electrodynamics, this energy flow is actually longitudinal and bidirectional { [27], [28], [29], [30] }, with energy *going out in 3-space from the charge* to every point in the universe, and with energy coming from every point in the universe *back to the charge through the time domain*. But as reinterpreted { 22 b }, Whittaker { [31] } showed in 1903 that any such bidirectional EM flow of energy —reinterpreted with the input energy to the charge coming from the time-domain, and the output energy from the charge being emitted into 3-space, comprises a scalar potential. This also agrees with quantum field theory { [32] }

See [Figure 12](#). As it really exists in space, a scalar potential is a harmonic set of bidirectional EM energy flows, with the "bidirectional" EM waves being outgoing EM waves in 3-space caused by interaction with the source charge or dipole of incoming time-polarized EM waves. There is a set of outgoing EM longitudinal waves in 3-space, perfectly correlated with a set of incoming time-polarized EM waves in the time domain. Hence one time-polarized EM "causal" wave couples with one outgoing longitudinal EM wave in 3-space. It is this scalar EM wave coupling (combining) with longitudinal EM wave coupling, in a harmonic set of phase conjugate pairs, that constitutes the scalar EM potential.

In short, all EM energy in 3-space comes from the time domain.

After all, no observable persists continuously in time. Any observable is a frozen 3-space momentary snapshot of an ongoing 4-space interaction. It is the result of a  $d/dt$  operation imposed upon LLLT spacetime, to yield a momentary LLL by

$$d/dt(\text{LLLT}) \Rightarrow \text{LLL}$$

What we see as the "motion of an object in 3-space" is actually the ensemble of a continual serial iteration of such "frozen 3-space snapshots" of each observable part of the object, much as the iterative frames of a movie film are seen as a continuously moving picture.

In Whittaker's bidirectional energy flow associated with the source charge, electrodynamicists—including Whittaker himself—assumed that a point positive coulomb of charge is located at each and every point in space. ([Figure 5](#), [Figure 6](#), and [Figure 7](#)). A tiny bit of the impinging EM energy flow “from” the distant source charge {[\[33\]](#)} is geometrically intercepted and diverted by the observing/detecting point charge to streamline around it, creating a “swirl around” of diverted energy flow. As can be seen, only a tiny portion of the impinging and passing EM energy stream in 3-space is diverged into the swirl. This is rather like a small diverted whirlpool of water forming around a stable rock in a flowing river. In electrostatics the amount of energy in that “diverged whirlpool” is said to be the “collected” energy appearing upon that point charge (upon that fixed rock). That amount of energy swirled by the intercepting point coulomb at a given point in space, is then erroneously said to be the *magnitude of the potential (the magnitude of the entire river)*. It is no such thing. The small fraction of the potential that is *diverted from* the potential's flowing rivers of energy, is not that the magnitude of that potential (the magnitude of the entire set of flowing rivers themselves!) And it is certainly not “identically” the river itself! At best it is a measure of the *intensity* of the potential (the local intensity of all those internal rivers of energy flow) at that point occupied by the intercepting/diverting rock.

The point is, *as defined and used in conventional electrostatics*, the potential occurs only after the vacuum EM entity's reaction with the intercepting mass, and is defined only as the *effect* produced upon that coulomb by the causative potential's interaction. Literally, the potential (the cause) is erroneously defined as the “excitation” or “excess energy” it locally

produces as an *effect* upon a unit point intercepting/collecting charge.

Ironically, it appears that no electrodynamicist calculates the magnitude of the actual potential as it exists in vacuum-spacetime, before its interaction with charge {[34], [35]}. Its magnitude is enormous, since the potential may extend over all space, and energy can be intercepted and collected by a charge placed at any point therein, or from charges placed at every point therein.

Certainly no rigorous definition of the potential presently exists in physics; the reader is challenged to check for himself or herself. No legitimate definition *can* exist for the potential, until the little matter is resolved of its present erroneous definition only "in and on and deviated by" charged matter, contradicted by the simultaneous assumption that it does exist in mass-free space in undeviated form. What is *deviated from* the potential, is not the *potential itself*. A part of something torn out of that something at one point in itself, is not the whole. The *local effect* cannot be substituted for the *entire nonlocal cause*—only a small part of which interacts *locally*.

The EM force field is similarly defined—only for charge mass interception, and only as an *effect* produced upon the intercepting charge. (See again [Figures 5, 6, and 7](#).) A flow of water across a rock (or the wind on a rock in the desert) produces a “pileup” of fluid on the windward side, and a lesser “pileup” on the downwind side. The difference (called the “gradient”) in the energy density collected across the standard charge (rock) produces a “difference in pressure” on the rock—in other words, a force per interacting rock. That *effect* is erroneously taken to be the EM field itself, when rigorously it is only the reaction cross section of the EM field. Again, rigorously this EM field *as defined in electrodynamics* only exists as the effect that occurs upon an intercepting standard charge or "rock" {[36]}.

Since the EM wave “in space” is erroneously said to be made of varying EM fields, it too is defined only as the

effect upon the intercepting charged mass, after the vacuum EM wave entity—whatever it is—has interacted with the charge and changed the charge translationally and energetically. Specifically, the present “EM wave in vacuum” in the literature is not at all what is presented and taught in undergraduate texts, and even the standard illustration of "oscillating E-field and B-field vectors" lateral to the line of motion of the wave is horribly wrong. E.g., Dr. Robert Romer, former editor of American Journal of Physics, has taken that error to task as follows { [\[37\]](#) }:

*"...that dreadful diagram purporting to show the electric and magnetic fields of a plane wave, as a function of position (and/or time?) that besmirch the pages of almost every introductory book. ...it is a horrible diagram. 'Misleading' would be too kind a word; 'wrong' is more accurate." "...perhaps then, for historical interest, [we should] find out how that diagram came to contaminate our literature in the first place."*

The EM field and wave *as commonly regarded* are transfer functions from the source charged masses that “perturbed the vacuum medium and created an unknown kind of disturbance therein”, onto the receiving charged masses that intercept the incoming “unknown vacuum wave entity that was created” and interact with it, being translated and perturbed as a result.

This “detected” translation of the receiving charged masses (usually the interacting Drude electrons in a wire) is what our instruments detect. Indeed, the Drude electrons are highly constrained from moving longitudinally down the wire, usually moving at only a few inches per hour. They are much freer to move laterally, however, and can easily do so.

Reacting with the incoming longitudinal EM wave perturbation of local spacetime, the spin of the electron produces gyroscopic precession laterally in the wire since the electron is terribly restrained in moving



longitudinally down the wire. Since our instruments detect these *transverse electron precession waves*, that has been totally confused (since Faraday's "plucked taut string" notion of the EM wave and Maxwell's arbitrary adoption of it) as representing the incoming wave in vacuum. It does not represent the vacuum EM wave at all; the incoming wave is in fact a longitudinal EM wave in 3-space, associated with a precisely correlated longitudinal EM wave in the time-domain.

So we have answered Professor Romer's implied question. That horrible diagram came from the assumption by early electrodynamicists, before discovery of the electron or atom or nucleus, that the "transverse electric fluid waves" in the receiving wires represented actual "intercepted" fluid perturbations arriving in the material ether medium.

In summary: Using a transmitter-receiver analysis, the so-called "EM wave in vacuum" *as presently defined*, actually represents that "detected and measured electron precession wave" in and of the reacting Drude electron gas in the distant receiving wire antenna. The so-called EM force field wave in vacuum has been erroneously defined as observable matter wiggles, not vacuum virtual energy wiggles and not as spacetime-curvature changes and wiggles. So even the present notion of the EM transverse wave in space is wrong, and it has been corrupted as a pure matter-to-matter transform from the beginning { [38] }.

Somewhat less technical explanations are given by Lindsay and Margenau { [39] }, and a rigorous statement and discussion that EM force fields exist only in charged matter is given by Aharonov and Bohm { [40] }. Feynman of course said it bluntly: Only the potential for the field exists in the vacuum, should one place a unit point charge there to allow the force field to be developed (on, of, and containing the source charge itself).

Let us summarize this terrible EM foundations flaw: As classical electrodynamics presently is modeled, Maxwell and his modern followers only include equations which are mass-to-mass transformations

([Figure 8](#)). Specifically missing { [\[41\]](#) } are two other transforms: (i) the mass-to-vacuum (mass-to-spacetime) transformation (which obviously is general relativistic in nature), and (ii) the vacuum-to-mass (spacetime-to-mass) transformation (again, obviously general relativistic in nature). (See again [Figure 9](#)). When these two missing transforms are added back into electrodynamics, one has suddenly extended EM theory into a new domain. One has also *infolded* general relativity (GR) inside the present EM matter-to-matter transforms, and also included the vacuum interaction including broken symmetry in that exchange, but in an *electromagnetically engineerable manner*. In short, one has a practical, engineerable unified field theory.

Highly creative inventors such as Rife and Prioré intuitively developed apparatuses that unwittingly utilized this presently undeveloped and extended union of EM, particle physics vacuum theory, and GR. The intuition of the theorists in interpreting those revolutionary experiments and their results has very seriously lagged.

## The Supersystem Concept

To understand how extraordinary systems such as Rife's microscope works, one must understand the concept of the *supersystem*. (See [Figure 13](#)). The supersystem consists of three components, which are (1) the physical system and its dynamics, (2) the local active vacuum and its dynamics, and (3) the local curvatures of spacetime and their dynamics. All three components of the supersystem interact with one another, in nature. The second and third components of the system constitute the active environment in which the system is embedded, and with which it interacts.

Unfortunately, in standard classical electrodynamics either the system's environment is assumed to be inert, or the system is assumed to be in equilibrium in its interaction with that environment. This represents a totally arbitrary assumption that the system cannot receive and utilize any excess energy from its known

active environment. Hence the active vacuum's interaction with the system can be and is ignored by classical electromagnetics, as are the local curvatures of spacetime and their interactions with the system.

Extraordinary EM systems invariably involve the supersystem dynamics, and not just the system dynamics. *In nature*, no system analysis is complete until the supersystem interactions and their effects have been determined and analyzed.

The Rife microscope is indeed an extraordinary system using non-negligible interactions between the system and the other two components of its supersystem. Hence in our discussions, we will be examining interactions in that regime, and not just the standard electrodynamics analysis. In these discussions, we will be holding in mind not just the mass-to-mass transforms of standard electrodynamics, but two other transforms: (1) the mass-to-vacuum/spacetime transform, and (2) the vacuum/spacetime to matter transform (previously shown in [Figure 9](#)).

The reason that Rife's work has not been understood is that researchers have been unaware of the necessity for supersystem analysis. Almost all analyses of Rife's work have been merely standard classical EM analysis and thus quite insufficient. There are other examples of the standard electrodynamics model completely failing to show higher symmetry phenomenology in an inventor's work, so that his work is not understood even today. An example is provided by Tesla's patented circuits, as rigorously demonstrated by Barrett { [\[42\]](#) }. Barrett went on to improve the new functions discovered in Tesla's patents, and obtained two additional patents related to signals and signal processing { [\[43\]](#) }.

### Vacuum-Structurings as “Engines”: Key Part of the Missing Transforms

The missing mass-to-vacuum/spacetime transformation produces a massless structuring of the vacuum medium. That is a *vacuum engine* or “multiplex of specific spacetime curvatures.” (See [Figure 14](#), [Figure](#)

[15](#), [Figure 16](#), [Figure 17](#)), and [Figure 18](#). Preparing the vacuum engine is accomplished by charged matter dynamics of the source charges producing the necessary potentials, fields and waves. The charges are embedded in continual energetic exchange with the vacuum/spacetime, and moving the charges affects that exchange; it perturbs the local vacuum flux and curves the local spacetime accordingly.

The transform represents producing this vacuum engine by the vacuum-perturbing action of source charge dynamics upon the vacuum, and by *not* assuming a mystical intercepting point-charge at each point in space { [\[44\]](#) }. In the vacuum/spacetime, *only* vacuum/spacetime entities and changes to them exist. *In pure water, only water and changes to that water exist!*

So a precise dynamic structuring of the energetic vacuum (and spacetime geometry) is what charges produce when they “perturb” the vacuum medium { [\[45\]](#) }, by the presence or dynamics of their fields, longitudinal and time-polarized EM waves, or both. This “perturbed vacuum dynamics” separate from the source charges themselves comprises an engine that consists of altered longitudinal EM wave dynamics inside the internal Whittaker structure { [\[46\]](#) } of the scalar potential of the ambient vacuum. That is the same as also producing interested levels of spacetime curvatures in a *template* or specific pattern { [\[47\]](#) }.

In turn, this vacuum engine region of local curvatures and structurings in spacetime will interact upon any mass placed therein. That action is the missing *electrodynamic vacuum-to-mass transform*.

The missing electrodynamic vacuum-to-mass transformation produces direct changes and alterations in the “receiving” mass, at all levels, by the action of such a vacuum engine. As each action occurs locally in the localized receiving mass, it produces the “local effect” as the result of that “local action.” The primary causative chain (i.e., the set of “dominoes” affecting each other serially), started back at the distant source charges. One can say that we therefore have mass-to-mass *action at a distance*, via the matter-to-vacuum

and vacuum-to-mass intermediary transforms and the spatial and temporal propagation of the vacuum engines in the middle of the two { [48] }. We will shortly discuss the Whittaker structuring of the potential as a fundamental process for producing vacuum engines.

General relativists mostly concentrate upon the warping and curving of spacetime (i.e., producing a vacuum engine) by the very weak gravitational force—which is only some  $10^{-42}$  times as strong for electrons as the electric force between them. Consequently, relativists must look to huge assemblages of mass, such as in stars and other astronomical objects, for sufficient gravitationally-induced spacetime curvature to produce easily observable results. For that reason, general relativity has resisted laboratory development as an engineerable applied science. By using the far stronger EM force as the agent of spacetime curvature, and including the infolded electrodynamics inside the potential, field, and wave, general relativity then becomes engineerable and usable. But one is engineering the supersystem, not just the system.

## The Infolded Electrodynamics Inside Potentials, Fields, and Waves

As previously stated, in 1903 E. T. Whittaker, a well-known mathematical physicist, showed that a scalar potential can be mathematically decomposed into a set of peculiar EM wavepairs in a harmonic set. (Again see [Figure 12](#)) These “hidden waves” are longitudinal EM waves, arranged in conjugate pairs { [49] } with the pairs also arranged in a harmonic set. In each wavepair, there is an ordinary (forward-time) longitudinal EM wave (outgoing in 3-space from the interacting/observing charge), coupled to its phase conjugate replica (time-reversed twin).

And here lies a magic secret. Prior to interacting with a charge, the phase conjugate wave in each wavepair is in the complex domain, which means that in Minkowski space it is incoming along the fourth axis, *ict*, where the only variable is *t*. Hence this wave prior to interaction with charge does not even exist in 3-

space. Instead, it exists as a longitudinal EM wave incoming in time, so that it is a time-like flow of EM energy. (See [Figure 19](#)). After interaction with a charge, the charge absorbs the incoming time-polarized EM wave, transduces that time-energy to 3-spatial energy, and re-emits the energy as longitudinal EM waves in 3-space in all directions. "In all directions" means that for every outgoing longitudinal EM wave emitted in one direction in 3-space, another wave just like it also emitted in the other direction in 3-space. So the paired "bidirectional" EM longitudinal EM waves in 3-space, as interpreted by Whittaker, do exist as the *effect* waves caused by the incoming causal time-like longitudinal EM waves (scalar EM waves). The pairing of the causal time-polarized EM incoming wave with an outgoing effect longitudinal EM wave was not interpreted by Whittaker, but does agree with more modern quantum field theory interpretations of photon polarizations and their observability or non observability, by Mandl and Shaw {22b}.

We have corrected this "effect substituted for the cause" wave to reinterpret Whittaker's 1903 decomposition of the scalar potential, into combined biwaves where one of the biwaves is incoming in the time domain, and the other is outgoing in 3-space. That re-interpretation then allowed a solution {22a} to the problem of the source charge and its associated fields and potentials, together with their energy. Every source charge and source dipole continuously emits EM energy in 3-space, without any 3-spatial EM energy input. The input is there, but in the time-domain. This problem—resolved by the present author in 2000—has been called the most difficult problem in quantum and classical electromagnetics {30}.

Because of observed parity reversal accompanying the time-reversal operation, in his forward-time, the observer “sees”—after interacting the incoming wave with charge—the *effect* of the incoming time-reversed or phase conjugate wave (entering from the time domain) as a 3-space longitudinal EM wave leaving in the opposite spatial direction. So the basic 4-space phase conjugate longitudinal wavepair would appear to us in forward time as a “regular” time-forward

longitudinal EM wavepair in 3-space, with the two waves going outward in opposite directions. But each is accompanied by a time-polarized EM wave, else it would not be observable.

Further, there is a harmonic series of such bidirectional longitudinal wavepairs comprising the scalar potential. So the staid old electrostatic potential (i) *is not* a "scalar entity" at all { [50] }, (ii) *is* a bundle of longitudinal wavepairs, (iii) *is* an entity with a remarkable internal hidden multiwave structures and dynamics, (iv) *is* a composite of very special waves whose transverse amplitude (i.e., whose spatial energy density, which is a function of transverse amplitude squared) does not change, but whose transported time structure changes, and (v) therefore is a special kind of wave that is velocity modulated about some central velocity, and is not limited to the speed of light  $c$ . Indeed, in classical electrodynamics in the Coulomb gauge, the scalar potential is already recognized as having infinite velocity, merely appearing in space instantly at every point it occupies { [51] }.

We also state without elaboration that the active vacuum is *identically* a very huge scalar potential, as indeed is "spacetime geometry". So a unifying principle is:

$$\text{vacuum} \equiv \text{spacetime} \equiv \text{potential} \equiv \text{energy} \\ \{ [52] \}$$

Further, as a potential, the "ambient" vacuum decomposes into an incredibly rich, internal Whittaker wave structure. So then also must *spacetime* and *energy* similarly decompose. That decomposition structure is even richer when higher symmetry  $O(3)$  EM is used instead of the lower symmetry  $U(1)$  EM employed by Whittaker.

A revolution in electrodynamics has recently begun, and central to that revolution is the strong appearance of longitudinal EM waves as essentially the basis for the emerging new electrodynamics. Work by Evans { [53] }, Barrett { [54] }, Ziolkowski { [55] }, Evans { [56] }, Rodrigues { 57 }, and others is

fundamental in this respect. One part of this emerging new electrodynamics is advanced under the label of *undistorted progressive waves* (UPWs). A good summary of UPW theory is given by Rodrigues and Lu { [57] }. Even so, to date this body of work still largely ignores the internal Whittaker dynamics { [58] } inside an EM wave. The body of work—particularly the higher symmetry  $O(3)$  electrodynamics pioneered by Evans {56} inherently possesses the capability to model such structuring, since much of it utilizes a higher topology algebra such as quaternions { [59] } or even Clifford algebra { [60] }. In those higher algebras, many electrodynamic things can be done outside the operations permitted by present vector and tensor electrodynamics.

## Superpotentials and Superpotential Theory

Whittaker's 1904 paper { [61] } showed that all the “normal” electrodynamics was based on, *and created by*, the interference of scalar potential functions (i.e., by the interference of those multiwave longitudinal wavepairs and their dynamics { [62] } constituting the interfering scalar potentials.) He showed that any EM field or wave whatsoever can be replaced by two scalar potential functions—in fact, is *comprised of* those two scalar potential functions and is *created by them*. Scalar potential interferometry already creates all the “normal” EM in the textbooks anyway, and a proof has been given by Evans et al. { [63] }.

The 1904 paper by Whittaker initiated a somewhat obscure branch of electrodynamics referred to as *superpotential* theory { [64] }. Whittaker's work was further extended and augmented by later scientists such as Righi { [65] }, Debye { [66] }, Bromwich { [67] }, Nisbet { [68] }, McCrea { [69] }, etc. But even with the extended superpotential theory, without the addition of Whittaker 1903 and the substructuring “internal LW electrodynamics” one cannot understand the mechanism for what Rife was actually doing.

Rife was not using normal potentials and normal  $\mathbf{E}$  and



**H** fields—which as we discussed, only apply to observable material entities anyhow and thus could not be used to “see” far below the quantum threshold of least detectable material disturbance. His entire protocol was to get beyond those “*material interception of EM energy*” limitations. Unwittingly, Rife was using *vacuum engines*—involving structuring of the active vacuum as well as pure general relativity (GR) and pure structurings of spacetime geometry itself. He was electromagnetically using that part of GR that the GR physicists have mostly only tried to produce by use of the weak gravitational force. In GR, *the ST geometry itself is active, dynamic, energetic, and structuring!* In higher symmetry electrodynamics, *the ST geometry itself is powerfully active, dynamic, energetic, and structuring!* It is not at all just a “passive spacetime” as classical electrodynamics assumes { [\[70\]](#) }.

## Biological Systems Use the Infolded Whittaker-Type Electrodynamics

The problem in the Rife microscope is to be able to observe very subtle ST curvatures and patterns, in an optical manner. These subtle or virtual “disturbances” of local spacetime are far finer and smaller than the one-tenth wavelength optical resolution generally the limit for optical microscopes using conventional optical EM notions and “material” potentials, fields, and waves.

In short, Rife’s twofold problem was to (i) function with vacuum engines (internal structuring of the potentials) so he could penetrate to any degree of smallness, and (ii) output, in the observable state, exact visible summations and analogues of the individual structures detected in the virtual (nonobservable) state { [\[71\]](#) }.

To make the subtle vacuum engines observable on the bench, the ST curvatures and their internested patterning must be accomplished by making and assembling local curvatures of ST, via making longitudinal EM wavepairs in structural pattern assemblies. *Spacetime* is in fact just a powerful scalar

potential, or can be modeled as such, and as such Whittaker 1903 and 1904 rigorously applies, along with extensions from higher symmetry electrodynamics. By realizing that ST is identically potential, one has altered one's thinking from the standard GR theory into a correlated EM-GR theory. One has also extended GR: Not only is there a “topology” of things that can be externally *done to* a base spacetime, but there is also a hidden, vast EM topology *within* any overall base spacetime. So we now have “topologies within topologies.” This is in fact what the Russians have long called the *information content of the field*.

However, all living systems already use this "infolded" bidirectional, longitudinal wavepair EM in their ongoing living functions { [\[72\]](#) }. Just as they used frequency modulation, EM signals, EM oscillations, etc. before we even had an electrodynamics or a physics, living systems do use the infolded EM (and vacuum engines) in all their living functions, and particularly in their cellular *regeneration and restoration* (R&R) system { [\[73\]](#) }, as contrasted to their *immune* system. The immune system cells are the fighters and the debris scavengers/cleaners. They go after the hostile invaders, fight them, and usually win—littering the battlefield with the debris. Then the immune system scavenger cells clean up the residue.

But many of the body's cells will have been damaged in the fight. The immune system itself cannot heal or restore a single damaged cell, even its own! It is not a *healer*! It is a searcher, a marker, a killer, and a residue-cleaner. It contains " the troops and the combat engineer," so to speak, but not the hospitals and the doctors. All healing/restoration of living cells is done by the R&R system, not by the immune system.

A high-level overview of the immune system is given in [Figure 20](#).

No vaccine, drug, herb, vitamin, or mineral *heals* the body, although certainly they can enhance or aid the body's healing process. Each does carry its individual resident vacuum engine, and when absorbed

by the cell, this added vacuum engine contributes to the resident vacuum engine in the cell by summing with it. To restore the damaged cells back to normal (i.e., to heal), the R&R system uses a novel kind of extended electrodynamics with infolded vacuum engines, and it uses a novel kind of optical phase conjugate pumping, in the time domain rather than just 3-space. The magic “unified field theory” so long sought by scientists, has long been utilized by the regeneration and restoration system of the body in its minute-to-minute and day-to-day healing and restoring actions.

The magic "universal healing mechanism" so long evading the discovery of medical scientists is none other than the exact cellular regenerative mechanism universally used by every living organism. For the first time, we are explaining the higher symmetry electromagnetic nature of this mechanism.

Robert Becker's epochal work { [\[74\]](#) } ([Figure 21](#), [Figure 22](#)) strongly probed the electromagnetic control system directing the body's cellular regeneration and repair (R&R) system. However, he did not have available the infolded Whittaker electrodynamics. He could only utilize the grossly inadequate standard electrodynamics. Modern nonlinear phase conjugate optics had not yet been born when Becker did most of his seminal work.

Since standard EM does not incorporate infolded GR, vacuum engines, or optical pumping in the time domain, Becker could not formulate the full technical mechanism of the R&R system—which uses the *supersystem*, not just the system. But Becker did strongly point out the importance of the R&R system, both theoretically and experimentally. He found that it operated electrically, with the scalar potentials being key. He modeled the R&R system as closely as can be done with classical U(1) electromagnetics ([Figure 22](#)). He proved that cells can be *dedifferentiated* (reversed back to an earlier, more primitive state) and *redifferentiated* (time-forwarded into a more complex state) by weak DC potentials and laughably weak (picoamperes) of current. He was twice nominated for a Nobel prize for his epochal work. His method of

electromagnetic healing of otherwise intractable bone fractures ([Figure 21](#)) is utilized today in many hospitals.

In his microscope, Rife was in pursuit of optically "seeing" the infolded electrodynamics functioning of the living cells in the most minute detail—i.e., he wished to see the actual vacuum engines and their functions. Using the infolded EM, one can still "see" the cells and all their parts, but one can also go far beyond the one-tenth wavelength optical discrimination limitation and see into the virtual state dynamics. In theory, because the infolded EM is *recursive* as a function of wavelength, one can go to any limit in smallness desired—or at least to whatever limit is determined by the available technology's development at the time { [\[75\]](#) }.

Vlail Kaznachejev's novel electromagnetic induction of cellular death, disease, and damage, *at a distance*, is instructive in this respect { [\[76\]](#) }. ([Figure 23](#)) Indeed, the Russians mastered, extended, and weaponized the Kaznachejev mechanisms as disease-inducing weaponry, and slyly used it at low level on personnel in the U.S. Embassy in Moscow ([Figure 24](#)). This was done to stimulate high level officials in the U.S. government and U.S. scientific community to see if the U.S. knew of this "infolded electrodynamics and vacuum engine" technology { [\[77\]](#) }. The Russians were using GR, but by infolded EM means—so they were using a unified field theory involving higher group symmetry electrodynamics. The puzzled U.S. employed only standard U(1) symmetry electrodynamic analysis { [\[78\]](#) }, so it totally missed the entire physics of what was occurring to cause the health changes and diseases.

In GR, one is very interested in Wheeler's principle which states (slightly paraphrased):

*Mass (trapped energy) acts upon ST geometry to curve it, and curved ST acts upon mass to produce forces upon it and move it.*

This statement after Wheeler is the very essence

of general relativity. It simply states that there is a *mass-to-spacetime* dynamic transform, and also a *spacetime-to-mass* dynamic transform, as we diagrammatically showed in Figure 9.

## Understanding Vacuum Engines and Their Action

Wheeler's general relativity principle includes the missing two transforms of electro-dynamics. We are extending Wheeler's principle to the corollary form:

All levels of the structures of mass (trapped energy structures) and all levels of the structures of time (the time aspects of photon structures) act upon ST geometry to structure it in both 3-spatial energy density structuring and in time domain structuring. Producing this multilevel spatial and temporal structuring of spacetime is called "forming a vacuum engine." Both 3-spatial energy density structuring of spacetime at all levels and time structuring of spacetime at all levels, act upon mass at all levels, to produce interested templates of forces and translations and stresses.

In short, energy patterns and time patterns in 3-space act upon spacetime to produce patterned curvatures of ST geometry (vacuum engines). And conversely, patterned curvatures of spacetime geometry (vacuum engines) act upon mass to produce corresponding patterns of forces at all levels in the mass—down to and including upon the quarks and gluons in the nucleons in the atomic nuclei. We note with pleasure that the Sachs unified field theory does apply from the gluons to the entire universe, as has been shown by Sachs himself {18b}.

## Muscle and Skeleton Analogy of Interaction of Vacuum Engine and Mass

We call attention again to our analogy ([Figures 15](#), [16](#), [17](#), and [18](#)) of the interaction of a vacuum engine and mass, provided by the interaction of arm muscles and the skeletal arm bones to which they are attached. The arm muscles attach to the arm's skeletal bones, and

those bones are articulated and free to dynamically move. To the bones, the muscles are mysterious agents (analogous to vacuum engines) exerting forces upon them, and causing them to move or hold. To the muscles, the bones are positioned resisting masses for them to work upon and change their positions, and the bones exert Newtonian reaction forces back upon the muscles as the muscles apply forces to the bones. So the vacuum engines (muscles) create forces upon the resisting masses (bones) to move them, and the masses act back upon the causative vacuum engines to create antiferces in resistance.

Using this analogy, when we create a set of vacuum engines, we create a set of “mysterious muscles” that act directly upon any and all “masses” (bones) that are exposed to them. The bones then change and move until the bidirectional interaction forces are balanced (equal and opposite). This symmetry between the two missing transforms is shown in [Figure 9](#).

## The Multilevel Structuring of Time is Important

We also add the extension that dynamic structuring in the time stream also occurs from trapped time domain “time component” structuring and distribution effects, as well as dynamic structuring of the spatial energy density of the ST geometry (the vacuum).

We are speaking *relativistically* of the interaction of mass and spacetime at any and all levels of a mass, down to and including the molecules, the atoms, the atomic nuclei, the nucleons, and even the quarks comprising the nucleons (comprising the protons and neutrons). One must first clearly have this vision in mind: The dynamics of everything ongoing in that mass, down to the most minute particle dynamics and in the most minute detail (and far into the virtual state beyond the one-tenth wavelength limitation of light resolution) consists of the structurings of this "mass-ST curvature" mutual interaction.

So we know from general relativity that collections of

energy (such as mass) act directly upon spacetime, its structuring, and its dynamics at any and all levels, down to the tiniest. We know that the variations in local spacetime geometry (including in both energy and time), down to any and all levels and sizes, down to the tiniest conceivable lengths, act directly upon any and all exposed mass at that level, *no matter how tiny*.

There is no “quantum” limitation nor is there any “wavelength of light” limitation to this GR process. Total continuity applies.

## Some Characteristics of Vacuum Engines

The great advantage of a vacuum engine is that the "action" it produces upon an exposed mass, arises directly from within each point in the local spacetime in which the mass is embedded. One does not have to "start outside" and move through space and the intervening mass toward the "inside". Every point within an object occupies every point in time, a priori. From a single time-point, the vacuum engine's 3-space action enters everywhere within the object, all-at-once, and the 3-space effects proceed outward from each interior point. (See again [Figure 19](#)). Therefore even a weak vacuum engine induced by EM forces can do with ridiculous ease what the most powerful particle accelerators on Earth cannot do. The engine is already everywhere "inside" an object or particle, and working from every point in it, toward an outward direction. On the other hand, a particle accelerator is trying to build tremendous velocity of its particles so that they can "smash" their way in there, by brute force. To get ever deeper, the particle accelerator must be made ever larger, so that a "bigger hammer" is available. Also, the vacuum engine does not smash or damage any of the matter in the object, in any fashion not desired. The particle accelerator, on the other hand, is a great disruptor and may well destroy or seriously change the very object it "probes".

Further, contrary to the accelerator's "one shot for one giant amount of energy input", a vacuum engine—once formed—continually exists in that locally altered spacetime and is contained in it and is sustained by it.

Hence that locally altered spacetime—after we pay to alter it once—will continuously expend energy in the form of the action of that vacuum energy, forever, upon any mass emplaced in that local spacetime. The universe itself is furnishing the energy to do the work, via the instantaneous connection in the time domain.

That "multiply connected space" entry everywhere within an object simultaneously, is quite different from "spatial propagation of energy" through singly-connected space from outside an object to the object, striking the outside of a mass and being absorbed, producing a gross translation force upon the mass. In the "energy propagation through space" case, severe energy interaction may occur with only the absorbing part of a macroscopic mass, while the remainder of the mass is little affected or not at all. To wit, one does not get the resulting *electronuclear* alterations of the nucleus (materialization, dematerialization, transmutation, etc.) by absorbed propagated "normal" EM radiation. However, with weak EM-induced vacuum engines one can do things inside the nucleus such as easily flip quarks inside the nucleons, so that transmutations at very weak spatial energy levels are readily obtained. This in fact turned out to be the major secret of the low-energy nuclear transmutations occurring in some 600 cold fusion experiments worldwide { [79] }.

Electrodynamic force fields implicitly define primarily only translation effects upon charges or masses, in their very definitions. With normal EM, usually one will get reradiation of the absorbed energy, or partial reradiation of the absorbed energy accompanied with recoil of the absorbing mass, or no reradiation but recoil of the mass.

We took the term *vacuum engine* from Misner, Thorne, and Wheeler { [80] } and also from Nobelist T. D. Lee { [81] } who spoke of this sort of thing as *vacuum engineering*. The term is not original with us; only the novel higher symmetry electrodynamics application of the concept is original. We call the exact geometrical form of a vacuum engine a *template*. We refer to the process of internally structuring a field, wave, or



potential as *dimensioning* or *activating* or *conditioning* or *charging up* the field, wave, or potential. Russian superpotential weapon scientists call the infolded structuring itself the *information content of the field*. For further discussion of some of these terms and related concepts, the reader is referred to our website, [www.chenierye.org](http://www.chenierye.org).

Wheeler's GR principle says that, for every mass with its exact mass structural dynamics condition, there exists a corresponding exact vacuum engine template containing precise spacetime curvature structural dynamics, and interacting back upon the dynamic mass at all levels. That vacuum engine is said to be resident in the mass and continuously interacting with it (see again [Figure 13](#) on the *supersystem*).

Again, the structuring of the vacuum engine has no limitation in fineness, because spacetime is continuous. Hence it freely extends from the observable realm on down into the virtual realm. This is no more audacious than stating that virtual and observable entities occupy the same time domain simultaneously. Obviously, if one is using the structuring of time, one gathers in both those virtual structures and those observable structures, and also the exact correlation between them. This is a direct engineering application of an EM hidden variable theory, somewhat similar to that proposed by David Bohm { [\[82\]](#) }.

## Applying Vacuum Engines to Living Cells

Any normal cell already has a normal *template* of overall ST curvature due to its mass and trapped energy structures. No matter how small, every internal part of that cell has its own *subcomponent template* of subcomponent ST curvatures embedded in that overall cellular ST curvature. As the cell functions, the dynamic normal changes of that template into other related templates, is within the range of what we call "normal, healthy cellular functioning."

Any abnormal cell has an *abnormal template* and also an abnormal set of "templating" changes. In other

words, there exists a precise *vacuum engine delta* in the abnormal cell, summed to the cell's *normal vacuum engine*. The *sum engine* represents the exact vacuum engine to act on the normal cell and change it to that precise abnormal condition.

But a template depends upon the energy density structuring of the local vacuum and also the local *time* structuring—which latter is still missing from physics books, but is implicit in the nature of the photon. If one produces the necessary energy structuring and density—and the necessary time structuring and density of local ST geometry—one produces a certain vacuum engine and one also produce a certain *template of time structuring*. Time { [\[83\]](#) } has dynamic template structuring and functioning, just as does the 3-spatial energy density of ST geometry.

Indeed, the total (virtual and observable) photon interaction with a mass or particle generates the "flow of that mass or particle through time" ([Figure 25](#)).

But one *can* make vacuum engines using EM energy and structuring, rather than with normal gravitational (G) energy and structuring { [\[84\]](#) }. The advantage is that, for electrons, the EM structuring is on the order of  $10^{42}$  times as strong as the G structuring. For protons, the EM force is something like  $10^{38}$  times as strong as the G force. So by using the much stronger EM force as the “agent of ST curvature,” one can make vacuum engines that are quite strong at their local level. These engines will affect and profoundly change any exposed mass, including cellular mass—in any fashion desired, given only that one makes the appropriate vacuum engine. Again, *we are simply engineering practical but ultra-strong general relativity on the laboratory bench*, by electromagnetically engineering Wheeler's principle in an extended form.

For any physical cellular deviation from normal—any deviation whatsoever—a corresponding exact deviation (i.e., an exact delta) exists in the cell's otherwise normal vacuum engine template. This includes deviations in the genetics of the cell and everything else, not just the chemistry and gross physical structure.

Now if one could produce the negative (time-reversal) of the sum template of the resident vacuum engine and *amplify* it, one would have a powerful new type of vacuum engine. ([Figure 26](#)) It would be an exact *vacuum anti-engine* to act upon that specific diseased or abnormal condition of the cell and gradually erase the delta and bring the cell physically back to normal. The new anti-engine would operate upon all the mass of the cell, at every level no matter how small. It would change the cell's abnormal genetics back to normal genetics.

One could of course reverse cellular damage due to aging, and rejuvenate the body. It is quite doable; all that is needed are the funds, scientific team, and laboratory facilities to develop it. It is doable whenever the U.S. medical science community and the giant pharmaceutical community will allow it to be done.

One could reverse a cancer cell back to a normal cell, by applying the specific summation vacuum antiengine for the exact delta between the cancer cell and a normal cell.

One could reverse an AIDS cell back to a normal cell with normal genetics, where it no longer was an "HIV factory". An AIDS patient could be completely, quickly, and cheaply cured, the moment he or she tested HIV positive. There would be no need to wait for the debilitations of the progressing disease to appear. Not a single HIV-infected cell would be left in the body, even those resistant strains that have developed after the original infection.

One could do precisely the same thing with Ebola infections, and with the "tough" staph infections that now resist everything and are killing more than 120 thousand Americans in our hospitals every year, with the figures rising. *These are patients who did not have the disease that killed them, when they entered the hospital.*

With development of portable treatment units and mass production, one could treat and heal those millions of

mass casualties that could well erupt in one or more large U.S. city areas—e.g., from an Iraqi-sponsored terrorist biological warfare (BW) strike, using anthrax { [85] }. In 1998, we proposed a crash development of just such portable units { [86] }. With the present world situation, it is not a matter of *if* such terrorist BW strikes will be made in the U.S., it is a matter of *when* { [87] }. Since our 1998 proposal, there has now been time to have had those portable units developed and mass-produced, at a total program cost of perhaps \$100 million. Sadly, no one apparently had the foggiest notion of what was actually being proposed, and its vital importance to the survival of the nation. With a looming war in the MidEast—and with hordes of terrorist teams with biological warfare agents already infiltrated into U.S. cities and population centers—this negligence is particularly of concern at this very moment. These officially-forecast attacks on our cities by weapons of mass destruction could now be imminent, if and when the MidEast does explode into war, which appears imminent.

### The Process Has Been Experimentally Proven

A very similar thing is also what Becker { [88] } demonstrated, without considering the vacuum engine (general relativistic curvature of spacetime) effects. It is also precisely what Prioré { [89] } unwittingly did in France, with a team of renowned French scientists, to cure terminal cancers, atherosclerosis, lethal infectious diseases, etc. in laboratory animals under rigorous scientific protocols. The team also demonstrated the restoration of suppressed immune systems.

In Germany, Popp { [90] } *et al.* were also involved in studies dealing with the R&R system, but from a quantum electrodynamics viewpoint.

We can also consider the vacuum engine from a nonlinear optics view, and obtain startling extensions of both general relativity and nonlinear phase conjugate optics. That in fact is exactly what Prioré did, though he did not think in those terms. Prioré roughly created a complex set of bidirectional longitudinal EM

wavepairs—i.e., a set of “time domain pump waves.” So he produced a kind of vacuum engine that itself is a crude *anti-engine generator* when used to pump a mass such as a living cell.

Prioré unwittingly used an extension to nonlinear optical (NLO) phase conjugation *before nonlinear phase conjugate optics was even born*. Pumping diseased cells in the Prioré manner causes the formation of exact “antiengines” for the specific cellular disease or disorder to be created in the cells themselves.

First, Prioré mixed up to 17 or so EM transverse waves in a rotating plasma { [\[91\]](#) }. Today we know that such a plasma will transform transverse radiations into longitudinal radiations, and it will also phase conjugate the input waves and add their phase conjugate replicas. In short, it is a procedure for somewhat crudely making a set of longitudinal bidirectional EM wavepairs, which is required to produce a scalar potential with a deterministic internal structuring. In short, it produces a scalar potential with an internal vacuum engine template.

These infolded longitudinal biwaves are NLO pump waves of a new kind: They pump the PCM material in the time domain only. This kind of pumping is a *vacuum antiengine-making process*.

The plasma tube was surrounded by a giant coil, and a pulsed magnetic field was produced by the coil. Per Whittaker’s 1904 paper, that pulsed DC magnetic field can be decomposed into two scalar potentials. Hence we have three potentials superposing: (1) the potential function set made by Prioré in his plasma tube, and containing a selected “vacuum antiengine maker” consisting of bidirectional pump waves in the time domain, and (2 and 3) the two Whittaker potential functions comprising the DC pulsed magnetic field of the coil.

The end result of this superposition/mixing of potentials is that their “internal structures”—including their vacuum engines—also diffuse one into the other.

Fundamentally, Prioré produced what to the observer seemed just a pulsed DC magnetic field, but one in which there was a specific “vacuum engine maker” of his deliberate creation and “tailoring.” Originally by trial and error, he adjusted the 17 frequencies introduced to the plasma, thus varying the frequencies of the “infolded bidirectional pump waves” produced and infolded into the pulsed DC magnetic field carrier. In this manner he was “tuning the “vacuum antiengine-maker” content.

Again, Russian energetics weapons scientists call those vacuum engine templates the *information content of the field*. They do not refer to ordinary spectral analysis.

## Explaining the Time-Pumping Vacuum Anti-Engine Maker

Irradiating the cell (with non-ionizing radiation) containing infolded specific bidirectional longitudinal waves, precisely corresponds to pumping the cells in the time domain, rather than pumping them in the “spatial energy distribution” domain. Because of the shift of the pumping from the 3-space domain to the time domain, this constitutes a dramatic extension of phase conjugate optics. Because of the amplified phase conjugating action of the “vacuum antiengine maker” upon the vacuum engine in a mass, this also constitutes a dramatic extension of general relativity and of four-wave mixing theory. Let us explain briefly:

When one pumps a nonlinear mass [phase conjugate mirror (PCM) material] with ordinary “transverse” EM waves { [92] } (Figure 27a), one is pumping (stressing, or “squeezing and relaxing”) the mass with dynamic oscillating energy distributions in 3-space. One inputs a similar weak wave (called the “signal” wave) to the mass simultaneously. In that case, multiwave mixing theory tells us that the pumping of the PCM will cause the formation of a fourth EM wave, that is a time-reversed replica of the input “signal” EM wave. The time-reversed wave may contain up to all the energy in the pump waves, so it can be highly amplified in magnitude compared to the

input signal wave. The distortion correction theorem tells us that this time-reversed replica wave will then appear precisely superposing in space back along the exact spatial track taken by the input signal wave { [93] }.

When the pumping is shifted to the time domain by pumping with bidirectional *longitudinal* EM waves, we now are pumping the time aspects of the mass—during its iterative existence as *masstime*; see again [Figure 25](#)—rather than just pumping the spatial energy aspects. In other words, we are not pumping *spatially*, but *spatiotemporally*. We are pumping *temporally*—rhythmically squeezing (compressing) and relaxing (extending) the “density of the time interactions” producing the rate of flow of time itself. This is a totally new extension to nonlinear phase conjugate optics.

In this case, the “signal wave input” to the “time-domain-pumped” nonlinear mass PCM is just the resident vacuum engine in the local spacetime in which that PCM mass is embedded (see [Figure 27b](#)). The sickened cell's abnormal vacuum engine—consisting of the sum of the normal cellular vacuum engine and the disease delta vacuum engine—is present in the cell and is the input to the time-pumped phase conjugate mirror (cellular *masstime*). The output is the formation of an amplified time-reversed replica of that vacuum engine. In other words, an exact, amplified *vacuum antiengine* for reversing the precise abnormal condition of the mass, down to and including even the quarks in the atomic nuclei, is formed by time-domain (longitudinal EM biwave) pumping. The result or “output” is that *the entire cellular PCM mass and all its constituent parts are “time-reversed” back along their previous “track through time”, back to a previous normal physical state* { [94] }. [Figure 27b](#) illustrates this process.

So when Prioré pumped the abnormal cells, he simply time-reversed them—genetics and all—right back to their normal physical state before the abnormality arose.

The beauty of the method is that, by adjusting the input waves to the rotating plasma, Prioré could “tailor” and “tune” the pumping waves to what was needed for a particular class of disease. He used trial and error methods to arrive at the proper settings for the disease to be treated. In theory, by the Prioré method one can time reverse any mass back to an earlier physical state. This mechanism is used by the cellular control portion of the body’s regenerative and restorative (R&R) system to restore damaged cells back to normal. It is the basis for the body’s ability to heal itself!

Applied to diseased cells, the method causes the formation of specific amplified antiengines for the exact specific cellular abnormality, no matter how complex, and no matter what it is. *In applied medicine this is a revolutionary new healing and therapeutic modality*, accomplished by novel EM means, and justified by general relativity, higher symmetry electrodynamics, and longitudinal EM wave pumping in the time domain rather than classical electrodynamics and transverse EM wave pumping. Prioré’s discovery, once understood, may just be the greatest medical discovery of all time, and the discoveries of Rife and of Becker may rank a close second. The Prioré process is shown in [Figure 28](#).

The body's cellular regeneration system uses this same methodology and process. A block diagram of the operation of the body's cellular regeneration system is shown in [Figure 29](#).

## Further Principles Needed for Rife’s Microscope

In his microscope ([Figures 1](#) and [2](#)), Rife just wanted to observe the templates [\[2\]](#) corresponding to the cells, germs, viruses, etc. and all their parts, without any smallness limit. To do that, we need to (1) amplify the tiny, tiny amplitudes (actually, in the virtual state and subquantal) of the tiny vacuum engines accompanying tiny spatial locations containing living, functioning entities (no matter how small), and (2) “transduce” that amplified result into the optical spectrum, so that we



see a perfect optical analog and thus are "looking" visually at localized ST regions far smaller than the one-tenth wavelength optical resolution limit.

We need another principle to do that. Suppose that, to first order, we have an isotropic nonlinear medium. Then if we transmit a sine wave into it, pandemonium sets loose with our wave. The speed of each part of the wave in this medium is a function of the location of that part upon the wave amplitude, so the peaks move faster than the intermediate parts of the wave of lesser magnitude. The wave has "peak overtake", breakup, collapse, and all sorts of things happening to it. So a simple sine wave is not going to pass smoothly into that medium and "pass back out" coherently and nicely, and ordinary light is not going to give stable reflections from that medium!

However, if we transmit *two* sine waves simultaneously, some frequency interval apart, and then if we *pretend* that we actually transmitted their *difference* frequency, a very strange thing happens. The two individual sine waves themselves still break up and go bananas. However, that difference frequency acts as if it were a simple sine wave transmitted into a *linear* medium! So we get back out a very nice, smooth, well-behaved sine wave of the *difference* frequency, even though terrible things happened to the individual waves themselves. We can detect and use that "difference frequency" nicely.

Several very neat sonar systems presently use that sort of transmission schema in underwater work { [\[95\]](#) }. The principle applies for waves of all frequencies, for all media which can be approximated as nonlinear isotropic in nature. As we shall see, it applies to the Rife microscope also.

### Rife's Secret: Recursive Coherent Increase of the Signal-to-Noise Ratio (SNR)

To first order, without too much error we can pretend that the molecules and atoms etc. in the cells and body tissues, together with their finer components, comprise such an isotropic nonlinear medium. That's not entirely

true, of course, but it does work to an extent sufficient for our purposes. Fortunately for the Rife process, the parts that *do not* obey this isotropic rule add randomly, while the parts that *do* obey the rule add coherently. So the "signal-to-noise ratio" (SNR) increases with the increasing amplification, and one "grows" the desired signal right up out of the noise (SNR) of the parts that do not obey the isotropic medium assumption. With sufficient number of amplifier stages, in theory the SNR of even the tiniest parts can be made as large as desired { [\[96\]](#) }.

With optical functioning as in Rife's microscope, one may substitute "light gathering power" or "magnification" for the electrical term "amplifier gain".

As we stated, Whittaker in 1904 (and superpotential theory thereafter) shows us that—if we wish—any EM field, wave, and pattern can be represented by two scalar potentials. Each of these two scalar potentials is further comprised of bidirectional EM longitudinal waves, in a harmonic series, in the Whittaker 1903 manner as reinterpreted. So we can reduce any pattern, field, or wave from any assemblage of charge sources, into two potentials, and then further into two sets of bidirectional EM waves interfering with each other. That process already *makes* all conventional EM waves, fields, etc.

An EM structuring of the local vacuum-spacetime occurs by all the electrical charges in the mass of the living cell, down to and including the virtual charges exchanged in the nuclear interactions in the nucleus of the atoms. By Whittaker 1903 and superpotential theory, all of that structuring itself is a potential with an internal set of bidirectional harmonic longitudinal EM waves interfering with each other.

Further this potential is recursively organized, because the inner bidirectional EM wavepair structuring of the potential is already recursive, as can be shown by applying Whittaker-1903 and Whittaker-1904 successively and iteratively { [\[97\]](#) }. This means we get deeper and deeper interested levels of patterns that still precisely correspond to the operational

mechanisms of the lower levels. It's similar to an infinitely fractal { [\[98\]](#) } type of process.

Because this conglomerate is recursive as a function of harmonic intervals, it means that we can pick any harmonic interval we choose in the "big world" where we observe things, and we can have an exact observational representation of the dynamics of that ongoing hidden longitudinal EM wavepair interferometry in the two waves bounding that harmonic interval. Of course, the more additional harmonics we add, the better dynamics we have. The greater the number of harmonic intervals applied, the greater the gain. However, these harmonic intervals can be recursively applied using just one "macroscopic" harmonic interval, iteratively and serially applied over and over. The more iterative serial recursive application of one harmonic interval, the more the "gain" or "amplification"—in the case of a microscope, the more the *amplification*. That was Rife's real secret, finally revealed. See [Figure 30](#).

## The Difference Frequency Provides Visible Output

Rife wanted to look at very, very small things *visually*, even though those "small things" were far below the one-tenth wavelength visible light barrier. In other words, to understand the Rife microscope's visual representation of the virtual state, we need to choose the harmonic interval of the throughput so as to span the visible spectrum. Well, for optical purposes, luckily the IR and UV do exactly that. Examine the frequencies, and you will see that a harmonic interval exists from a spot in the IR to a spot in the UV, and of course the interval in between includes the entire visible spectrum. The visible spectrum in between, however, represents the observable noise that would block what we seek to have emerge in that region in our "Rife microscope", so the presence of the visible spectrum is highly undesirable. Various filters can be used to block the visible spectrum while transmitting the UV and IR regions, or one can just work in the dark or in suitably dim visible light.

Rife then applied his iterative multiple "difference frequency" lenses in serial order, one after the other. While it is doubtful that he understood the theoretical method being utilized, he certainly persisted and found how to use it. This method of iteratively summing a recursive virtual state vacuum engine "template" results in the formation of an observable state vacuum engine template. In short, it magnifies the virtual state entities and dynamics directly to observable state analogues that capture all the virtual state entities and their dynamics.

That is why, if we use special filters on your camera and flash lenses, where the filters are open in the IR and UV but opaque in the visible spectrum in between, we can often photograph the ongoing "longitudinal EM hidden biwave interferometry"—*the subtle energy or vacuum engine functioning*—of nature and of living systems, *even displaced in time*, as Trevor Constable { [99] } and Joe Gambill { [100] } (a researcher friend now deceased) demonstrated, as George Meek { [101] } demonstrated, and as Fogal { [102] } has successfully experimented with.

*Occasionally when one gets things just right, one can get pictures of the subtle invisible reality in the virtual state, going on around oneself and in one's surroundings.* With Rife-like iterative serial amplification, one can get them all the time, dependably, as with a Fogal semiconductor specially adapted for such operation. One can in fact build instruments that indirectly observe the so-called "unobservable" virtual energy state and its entities and dynamics with one-to-one correspondence.

That's a whole new "subtle physics" reality. Present physics with its assumed quantum observation limitations just has not even gone into it—primarily because physics has been focusing upon the quantized aspects of the photon (which is quantized in one aspect only—its magnetic vector potential—and not in its unquantized aspect—its scalar electrical potential!). Physics has rather ignored the unquantized (and therefore continuous from the smallest to the largest scale) time aspect of the photon { [103] }. Using the

continuous aspect of the photon, one can assemble photon “time interval” structures—and in fact one does so whenever one assembles a 3-spatial energy density structuring such as in ordinary EM theory.

Simultaneously, one has assembled a “structuring of the time domain” also, because each photon in the spatial energy density structuring consists of both time and energy as its canonical components.

All EM fields and waves, being comprised of photons, thus also carry (1) energy and energy internal structuring, and (2) time and internal time structuring. Again, this is the Russian *information content of the field*. The Russians simply understand 4-vector theory and Whittaker 1903 and 1904, and how to combine them with quantum mechanics and general relativity in a unified field theory.

The above explanation is why Kaznacheyev's { [\[104\]](#) } mitogenetic radiation { [\[105\]](#) } from his control (deliberately damaged or infected) cells would pass through a quartz window and induce the same damage (or disease) in targeted cells on the other side and otherwise environmentally shielded, but would not induce the changes through a normal window glass window. (See again [Figure 23](#)) Quartz passes the full optical spectrum from IR to UV, while window glass does not. So quartz passes the *vacuum engines* for the disease or damage, while window glass breaks them up and does not pass them as such. We stress that the vacuum engines are part of the “continuous” aspect of the photons, and so are not bound to any limitation on magnitude (either fineness or largeness) as are the quantized aspects of the photon.

For such a "far beyond the one-tenth wavelength" microscope as Rife's, one must use vacuum engines (time domain structuring, and longitudinal EM waves) and extraordinary iterative unified field theory optics, rather than the ordinary transverse EM waves and ordinary optics. The lenses must all pass at least one harmonic interval (and the same one!), to provide and utilize the “difference frequency band” needed for recursive *visual* connection to the subquantal state (the hidden virtual structures in terms of the continuity

aspects of photons). Successive stages thus "serial iteration" use the recursive principle to coherently amplify and show the vacuum engines, their dynamics, and the dynamics of deeper organizations and dynamics in the virtual state itself. Since Rife wished to "see" the results in the optical spectrum, then the two frequencies chosen for "differencing" had to bound the visible spectrum.

Rife used quartz lenses or at least very good optical glass that is open from IR to UV. That bounds the visible spectrum with a harmonic interval. Rife used multiple stages for successive coherent recursive amplification and increasing the SNR magnitude by coherent integration. One must also have some scheme for filtering out (or avoiding) too much visible spectrum light. One such scheme is to just use enough stages so that, in the new theory where the wavelength limitation is bypassed, one has amplified ("resolved") to the depth or fineness desired. The process long ago removed itself from the "normal visible light" domain, well before it reached the deeper resolution limit utilized by the definition state of the new method.

By using sufficient multiple stages in this fashion, the "tiny" virtual state vacuum engine templates passing through the IR-UV harmonic interval in a lens can be recursively summed and magnified many, many times—essentially without limit, because the phenomenon being magnified is recursive and bidirectional longitudinal in nature. It is definitely *not* normal visible light optics, and it *is not* conventional classical electrodynamics.

## Rife's Recursive "Vacuum Engine" Microscope

The Rife microscope coherently sums (and thus coherently amplifies) the virtual state vacuum engine patterns with the increasing number of stages. For the *subtle* vacuum engine templates, such an arrangement becomes a direct amplifier (magnifier), for amplifying (magnifying) the interested virtual state vacuum engine templates and their dynamic functioning, into the observable state. With a properly designed "vacuum engine" recursive microscope, one can see

inside a molecule, inside the atomic nucleus, and even inside a nucleon, given development and perfection of the process. However, at this initial stage of understanding, one can forecast that finely adjusting the various stages of an early laboratory prototype would indeed prove to be a tedious and formidable task, just as Rife reported. With further development, however, that obstacle can be removed.

What comes out the output end of such a “vacuum engine” recursive microscope, is a direct visible light *analogue* of the much more subtle ST functioning in the microscope’s highly localized viewing area. This output imaging is put together "electrically" in ways analogous to the construction of a video picture on the screen of a TV tube. Since the result emerges through an output end that still passes an entire harmonic interval bounding the visible spectrum, the amplified virtual state recursive template is not destroyed but is highly amplified and produced as an observable image and dynamics in the visible spectrum. This final "interferometry" of two *internally structured* potential functions now produces "visible light" EM fields and waves and patterns, in accord with Whittaker 1904. These visible patterns are direct analogues representing exactly the very, very minute regions far below the one-tenth wavelength limitation of ordinary optical resolution. Those regions were the regions “being focused onto” when Rife so arduously “adjusted” his microscope's multiple stages.

With Rife’s recursive magnifying microscope process, one can see direct visible analogs of what is actually far, far smaller than anything ever before seen in normal optical microscopes, or even in electron microscopes etc. Indeed, one can see directly into the virtual state itself, and observe virtual state structures. While this is unthinkable in quantum mechanics if one considers only quantized aspects of light, it is perfectly feasible if one considers the concomitant unquantized (continuous) aspects of light, and shifts to general relativity and vacuum engines to utilize the unquantized structuring of the time domain.

## Conclusion

Rife unquestionably found a way to produce visible recursive amplification and magnification of invisible virtual state dynamics and functions. We hope we have shed at least some light on the extraordinary technical mechanisms involved. This is good conceptual science, consistent with theory and some known experiments, and it certainly can be made a rigorous science and technology and mathematically modeled, using higher symmetry electrodynamics that is part of a unified field theory such as that of Sachs. The basis for all of it is in the literature already, but it is scattered widely in uncorrelated bits and pieces. It is not in the normal electrodynamics courses, nor is it in the normal optical science curriculum. And it is not taught in the normal physics curriculum. Needless to add, it is absent from the medical curriculum as well.

As an additional proposal, we tentatively suggest that this principle also may be the long-sought "hidden chaos" or "hidden order" in quantum mechanics that is known to be present, but has not yet been explained { [\[106\]](#) }. If so, then it becomes a new law of physics, with the experimental proof first demonstrated by Royal Raymond Rife.

With the conceptual technical matrix of Rife's mechanism in hand, it should be possible for a proper scientific multi-disciplinary team to redevelop and extend the Rife microscope. Marvelous new instruments will emerge, once the quantum physics conceptual blockage of continuous physics is constrained to its place as only "one view of the physics reality elephant." With the ability to directly "measure", "observe," and engineer the virtual state, a breathtaking expansion of physics will occur, dramatically extending the vacuum engineering suggested by Nobelist Lee.

If so, then Rife's tragic life will have served its noble purpose, and his intuitive insight will have been resoundingly verified. The follow-on results will have untold benefit to science and to all the human generations to come.



## NOTES AND REFERENCES

---

[1] For work on the theoretical aspects of this paper, partial financial support by A. Dreyer, R. Francis, H. Ledger, M. Peters, T. Craddock, and the Association of Distinguished American Scientists (ADAS) is gratefully acknowledged, as are helpful discussions with Dr. Bob Flowers and Dr. Myron Evans.

[2] We emphasize that Rife himself did not think in these terms.

---

[1]. (a) Some Rife-related references are: Royal R. Rife, "The filterable virus of carcinoma," Apr. 26, 1939; — "The Rife Microscopes," Apr. 28, 1939; — "Bacteria," Apr. 28, 1939; — "History of the development of a successful treatment for cancer and other viruses, bacteria, and fungi," Allied Industries, Dec. 1, 1953.

(b) Arthur Isaac Kendall and Royal Raymond Rife, "Observations on Bacillus Typhosus in its filterable state," California and Western Medicine, Ca. Med. Assoc., Dec. 1931.

(c) Arthur Isaac Kendall, "The filtration of bacteria," Science, Mar. 18, 1932.

(d) See particularly E. C. Rosenow, "Observations on filter-passing forms..." Proc. Staff Meeting of the Mayo Clinic, July 13, 1932; — "Observations with the Rife microscope of Filter-passing forms of micro-organisms," Science, Vol. 76, Aug. 26, 1932, p. 192-193; — "Microdiplococci in filtrates of natural and experimental poliomyelitic virus compared under the electron and light microscopes," Proc. Staff Meeting of the Mayo Clinic, 17(7), Feb. 18, 1942, p. 99-106; — "Observations of filter-passing forms of Eberthella Typhi (Bacillus Typhosus) and of the Streptococcus from Poliomyelitis," Proc. Staff Mtg.

Mayo Clinic 7, July 13, 1932, p. 408-413; — "Transmutations within the Streptococcus-Pneumococcus Group," J. Infective Diseases, Vol. 14, 1941.

(e) R. E. Seidel and M. Elizabeth Winter, "The new microscopes," Journal of the Franklin Institute, Feb. 1944, p. 103-129; — "Filterable bodies seen with the Rife microscope," Science Supplement, Science, Dec. 11, 1932, p. 10-11.

(f) "Is a new field about to be opened in the science of bacteriology?", Editorial, California and Western Medicine, Ca. Med. Assoc., Dec. 1931; "Powerful microscope makes very tiny objects visible," Science Newsletter, Vol. 33, Jan. 22, 1938, p. 55; "The Rife microscope or 'facts and their fate'," Reprint No. 417, The Lee Foundation for Nutritional Research, Milwaukee, Wisconsin, undated.

(g) A good lay overview is given by Christopher Bird, "What has become of the Rife microscope?", New Age Journal, Mar. 1976.

(h) See also T. E. Bearden, AIDS: Biological Warfare, Tesla Book Co., 1988, p. 267-279. The author gives a short introduction to the Rife microscope and includes some pictures. The proposed evanescent wave explanation proved to be wrong. Much additional work by the author eventually culminated in the proposed mechanism presented in the present paper.

[2]. We have one viewgraph listing some 32 flaws, errors, and shortcomings of classical electrodynamics, and there are even more than that. Additional errors are listed, for example, by important scientists such as Feynman, Wheeler, Evans, Bunge, Cornille, Barrett, and others. So a substantial number of errors in classical U(1) EM theory are well known to foundations scientists. We discuss only a minimal few in this paper.

[3]. Mario Bunge, Foundations of Physics, Springer-Verlag, New York, 1967, p. 176.

[4]. *Ibid.*, p. 182.

[5]. M. Faraday, Experimental Researches in Electricity and Magnetism. Vol. 1, Taylor and Francis, London, 1839.; Vol. 2, Richard & John E. Taylor, London, 1844; Vol. 3, Taylor and Francis, London, 1855. Reprinted by Dover in 1965. Also see M. Faraday, "On Static Electrical Inductive Action," Phil. Mag., 1843; — "Remarks on Static Induction," Proc. Roy. Inst., Feb. 12, 1858.

[6]. James Clerk Maxwell, Preface to the First Edition, A Treatise on Electricity and Magnetism, third edition, Vol. 1, Dover Publications, New York, 1954, p. viii-ix.

[7]. J. C. Maxwell, Preface to the First Edition, A Treatise on Electricity and Magnetism, third edition, Vol. 1, Dover Publications, New York, 1954, p. viii-ix. Quoting: "...before I began the study of electricity I resolved to read no mathematics on the subject till I had first read through Faraday's Experimental Researches in Electricity. ...I perceived that his method was also a mathematical one, though not exhibited in the conventional form of mathematical symbols. I also found that these methods were capable of being expressed in the ordinary mathematical forms...."

[8]. James Clerk Maxwell, A Treatise on Electricity and Magnetism, Third Edition, Vol. 1, Dover Publications, NY, 1954, p. 165-166.

[9]. Else the precessing electrons in a signal-receiving wire antenna would not precess laterally. Since their precession is at right angles to the disturbing force, the disturbance arriving from the vacuum was a longitudinal disturbance. This also agrees with Whittaker's 1903 decomposition of the scalar potential, and Mandl and Shaw's note that the combined scalar photon and longitudinal photon are observable as the instantaneous scalar potential,

while neither of them is observable individually. See citations for Whittaker and for Mandl and Shaw elsewhere in these references.

[10]. This word “potentiality” (by Feynman) is given flesh and blood in the present paper. What actually exists in the vacuum is potential and structures of potential. Vacuum, spacetime, and potential are identities. Hence we may say that the structured vacuum potentials are indeed structurings of spacetime curvature. We refer to these as *vacuum engines*, which are explained in this paper.

[11]. Richard P. Feynman, Robert B. Leighton and Matthew Sands, The Feynman Lectures on Physics, Addison-Wesley, New York, Vol. II, p. 1-3.

[12]. This is easily shown.  $F \equiv d/dt(mv)$ , which expands to  $F = (m)dv/dt + v(dm/dt)$ . Let the mass  $m$  be zero continuously, and both terms on the right go to zero, hence  $F = 0$ . That is, the force disappears because mass is a component of force. It is the use in mechanics of the separate massless force acting on a mass that is the non sequitur and to blame for this giant error in electrodynamics as a hold-over from the hoary old mechanics theory.

[13]. J. D. Jackson, Classical Electrodynamics, Second Edition, Wiley, 1975, p. 249.

[14]. Jackson, *ibid.* p. 28.

[15]. Melba Phillips, “Classical Electrodynamics,” Vol. IV: Principles of Electrodynamics and Relativity, in Encyclopedia of Physics, Edited by S. Flugge, Springer-Verlag, Berlin, 1962, p. 4. Quoting: “The utility for electrical problems of a scalar potential, first introduced in the theory of gravitation, was pointed out by Simeon Denis Poisson, Bull. Soc.

Philomatheique **3**, 388(1813). See also Mem. Institut, Pt. **1**, 1, Pt. **2**, 163 (1811). The word *potential* was introduced by George Green in 1828.”

[16]. E.g., see W. Misner, K. S. Thorne, and J. A. Wheeler, Gravitation, W. H. Freeman and Co., San Francisco, 1973, p. 5.

[17]. Two methods of dealing with this problem, and rectifying it, are the use of a topological definition of the fields in mass-free spacetime, and the use of a unified field theory where the "field in space" is not a forcefield per se, but merely a curvature or set of curvatures of spacetime. As an example, the O(3) electrodynamics largely pioneered by Evans takes the latter approach, and it is usable in directly engineering unified field theory effects.

[18]. (a). Mendel Sachs, The Field Concept in Contemporary Science, Charles C. Thomas Publishers, 1973;

(b) — General Relativity and Matter: A Spinor Field Theory from Fermis to Light-Years (Fundamental Theories of Physics), Reidel (now Kluwer), 1982 provides a great generalization of general relativity and electrodynamics reaching from the quarks and gluons to the entire universe. See also

(c) Mendel Sachs, Quantum Mechanics from General Relativity: An Approximation for a Theory of Inertia, Reidel (now Kluwer), 1986;

(d) — "Relativistic Implications in Electromagnetic Field Theory," in T. W. Barrett and D. M. Grimes, eds., Advanced Electromagnetism, World Scientific, 1995, p. 541-559. In the latter, Sachs shows that the most general expression for the field theory is in terms of spinor and quaternion variables, rather than the vector and tensor variables of the conventional expression of Maxwell's theory. This generalized expression leads to extra conservation laws and

invariants, thus increasing the predictive capacity of the theory.

(e) For a marvelous treatise for the educated layman, see M. Sachs, Relativity in Our Time: From Physics to Human Relations, Taylor & Francis, 1993.

[19]. E.g., see the several Evans' reviews in Modern Nonlinear Optics, Second Edition, Edited by M.W. Evans, Wiley, 2002 (in press). Many other  $O(3)$  electrodynamics papers are also carried in this set of three volumes, as well as in the standard literature.

[20]. Mendel Sachs, "Relativistic Implications in Electromagnetic Field Theory," *ibid.*

[21]. Without interaction with the vacuum, mass does not exhibit perfect symmetry. For a discussion, see T. D. Lee, Particle Physics and Introduction to Field Theory, Harwood Academic Publishers, New York, p. 378-389.

[22]. In both classical and quantal electrodynamics, the problem of the source charge and its associated fields and potentials—and their energy—has been considered to be the most difficult problem.

(a) For a solution to that problem, see T. E. Bearden, "Giant Negentropy from the Common Dipole," Journal of New Energy, 5(1), Summer 2000, p. 11-23. On DoE open website <http://www.ott.doe.gov/electromagnetic/papersbooks.html> and this author's website [www.cheniere.org](http://www.cheniere.org).

(b) For very powerful support of that proposed solution, see F. Mandl and G. Shaw, Quantum Field Theory, Wiley, 1984, Chapter 5. Neither the time-polarized photon nor the longitudinal photon is individually observable, yet the combination of the two is observable as the instantaneous scalar potential. The Mandl and Shaw combination of a scalar (time-polarized)

photon and a longitudinal photon is explained by Bearden as the interaction of the causal incoming scalar photon with a charge, the charge subsequently transducing the absorbed energy from the time-domain into 3-space, and re-emission of the energy as an emitted longitudinal photon in 3-space. The actual interaction provides the coupling, and clarifies which is the *cause* and which is the *effect*.

[23]. As the electrodynamicists implicitly assume, by assuming fields and potentials from all charges in the universe penetrating and existing and superposing and interfering in each cubic centimeter of space, and in fact at every point in space. But then the electrodynamicists continue to utilize a material ether assumption in their equations, embedded implicitly upon the notion of an “empty space” filled with this material ether. Tesla called it “... *one of the most remarkable and inexplicable aberrations of the scientific mind which has ever been recorded in history.*” (Nikola Tesla, "The True Wireless," Electrical Experimenter, May 1919). While that biting remark certainly did not endear him to struggling electrical scientists, it did strike uncomfortably close to the mark, and it still does.

[24]. J. H. Poynting, "On the transfer of energy in the electromagnetic field," Phil. Trans. Roy. Soc. Lond., Vol. 175, Part II, 1885, p. 343-361.

[25]. Oliver Heaviside, "Electromagnetic Induction and Its Propagation," The Electrician, 1885, 1886, 1887, and later. This is a series of 47 sections, published section by section in numerous issues of The Electrician during 1885, 1886, and 1887. See also Oliver Heaviside, "On the Forces, Stresses, and Fluxes of Energy in the Electromagnetic Field," Phil. Trans. Roy. Soc. London, 183A, 1893, p. 423-480.

[26]. By a crude analogy, one may think of the “virtual” energy of the vacuum as energy that has been disintegrated into incredibly tiny bits—each so small that the bits fade in and out of existence at an incredible rate. The spinning action of the charge may be thought of as similar to that of an old spinning wheel. The charge spins, so that it coheres some of the “virtual fibers” continually fed to it by the vacuum, into “thread-sized” portions that are emitted radially outward. So the charge “splatters back” some of the fibers as fibers, but “spins” the remainder into useful quantum-sized “threads” which are emitted in observable form.

[27]. Presently electrodynamicists are likely to specify the Poynting energy flow  $\mathbf{S}$  as  $\mathbf{S} = \mathbf{E} \times \mathbf{H}$ . However, in the vacuum (spacetime) neither  $\mathbf{E}$  nor  $\mathbf{H}$  exists as such *observed force fields*, which requires presence of charged mass. Only potentials and potential structuring of the virtual particle flux exist in the vacuum (which is after all just potential comprised of virtual particle flux). Those structurings or their analogues also exist as sets of curved spacetime regions (i.e., spacetime structurings comprising the elements of the "vacuum engine"). See E. T. Whittaker, "On the Partial Differential Equations of Mathematical Physics," Mathematische Annalen, Vol. 57, 1903, p. 333-355. Whittaker that any scalar potential decomposes into a multiplicity of longitudinal bidirectional flows of energy. This decomposition must also comprise the vacuum scalar potential, as well as the "spacetime curvature" potential.

[28]. However, Whittaker misinterpreted the *causal* phase conjugate wave (that half of his phase conjugate wavepair) as the *effect* after the wave interacts with charged mass, in which case parity is broken and the *effect* wave produced by the interaction is a longitudinal EM wave going in the opposite direction in 3-space from its "biwave" 3-space partner. The correct interpretation is that,



prior to interaction, the phase conjugate wave exists in the fourth axis of Minkowski 4-space, hence is in the time domain. It is literally a longitudinal EM wave moving on the fourth axis (in the time domain) to the interacting charge, and the other Whittaker biwave partner is the effect longitudinal EM wave emitted in 3-space by the interacting charge after it absorbs the incoming time-polarized EM wave. We point out that a longitudinal EM wave along the time axis is a time-polarized EM wave, corresponding to the known time-polarized photon in quantum field theory.

[\[29\]](#). After publication of my "Giant Negentropy" paper, I discovered very strong support for my reinterpretation of Whittaker's 1903 decomposition of the scalar potential. This support was by F. Mandl and G. Shaw, *ibid.* Mandl and Shaw give a deeper coverage of the photon polarizations. They argue that the longitudinal and scalar polarizations individually are not directly observable, but only in combination, wherein they manifest as the "instantaneous" Coulomb (i.e., electrostatic) potential. Our comment is that this argument, translated from particle terminology to wave terminology, directly fits my re-interpretation of Whittaker's 1903 decomposition of the scalar potential. However, Mandl and Shaw fail to account for their assumed interaction of the detecting/observing unit point charge to perform the perfectly correlated "combining", and thus fail to account for the absorption of the incoming *causal* time-polarized wave or photon, the transduction of that excitation energy of the charge into longitudinal EM wave/photon energy in 3-space, and the subsequent emission of that excitation energy as a perfectly correlated longitudinal EM wave in 3-space.

Thus Mandl and Shaw missed the time-excitation charging of the source charge via absorption of the "coupled" time-polarized EM wave/photon, and the subsequent decay of the time-charge excited state by emission of a 3-space

longitudinal EM wave/photon. This omitted interaction represents the discovery of nature's giant negentropy mechanism in EM energy flow, whenever 3-space energy flow symmetry is broken, as with a common dipole. So Mandl and Shaw do not account for photon (or wave) polarization transduction, where the "causal" time-polarized EM wave or photon comes in and is absorbed by the detecting charge or dipole to energetically excite it in the time-domain, then the excitation energy is re-emitted as the longitudinally polarized EM wave or photon in 3-space.

Recognition of these missing functions allowed at last a solution to the long-vexing problem of the source charge. We actually solved the problem for a source dipole, then pointed out that any "isolated" charge is a set of dipoles when its clustering virtual charges of opposite sign are considered.

[30]. The source charge problem was recognized as the most difficult problem in electrodynamics. E.g., see D. K. Sen, Fields and/or Particles, Academic Press, London and New York, 1968, p. viii. Quoting: "*The connection between the field and its source has always been and still is the most difficult problem in classical and quantum electrodynamics.*" Since our proposed solution is consistent with particle physics (broken 3-symmetry of the dipole) and with quantum field theory (combination of the time-polarized and longitudinal photon comprises the scalar EM potential), it is robust and we believe it will stand up to meticulous scrutiny.

[31]. E. T. Whittaker, 1903, *ibid.*

[32]. Mandl and Shaw, *ibid.*

[33]. Poynting only assumed that diverged part of the energy flow. Heaviside, on the other hand, showed that there is a much larger energy

flow component that misses the intercepting charges (or circuit) altogether, and is wasted. Since this means that far more EM energy flows from the terminals of a generator than the external circuit intercepts and catches, it means that all generators produce more energy flow output than the textbook states, or that Poynting assumed. In fact, as *transducers of vacuum energy*, all dipolar generators already exhibit  $COP > 1.0$ . Since no one in the 1880s could explain where such an astounding extra energy flow was coming from, Lorentz originated an integration trick to discard the nondiverged Heaviside EM energy flow component.

(a) See J. H. Poynting, "On the transfer of energy in the electromagnetic field," Philosophical Transactions of the Royal Society of London, Vol. 175, Part II, 1885, p. 343-361.

(b) See Oliver Heaviside, "Electromagnetic Induction and Its Propagation," The Electrician, 1885, 1886, 1887, and later—a series of 47 sections, published section by section in numerous issues of The Electrician during 1885, 1886, and 1887.

(c) See also Oliver Heaviside, "On the Forces, Stresses, and Fluxes of Energy in the Electromagnetic Field," Phil. Trans. Roy. Soc. London, 183A, 1893, p. 423-480.

(d) For Lorentz' trick to discard the nondiverged component, see H. A. Lorentz, Vorlesungen über Theoretische Physik an der Universität Leiden, Vol. V, Die Maxwellsche Theorie (1900-1902), Akademische Verlagsgesellschaft M.B.H., Leipzig, 1931, "Die Energie im elektromagnetischen Feld," p. 179-186. Figure 25 on p. 185 shows the Lorentz concept of integrating the Poynting vector around a closed cylindrical surface surrounding a volumetric element. This is the procedure which arbitrarily selects only a small component of the energy flow associated with a circuit—specifically, the small Poynting component striking the surface charges and being diverged into the circuit to power it—and

then treats that tiny component as the "entire" Poynting energy flow. Thereby Lorentz arbitrarily discarded all that extra Heaviside energy transport component which does not strike the circuit at all, and is just wasted.

[34]. In fact, the simple equation  $W = \phi q$ , where  $W$  is the diverged/collected energy,  $q$  is the intercepting coulomb, and  $\phi$  is the reaction cross section of the potential, shows that electrodynamicists implicitly assume the "true" causal potential to contain unlimited energy. E.g., using that equation, any desired amount  $W$  of energy can be collected from any nonzero potential  $\phi$ , no matter how small its intensity, simply by adding sufficient intercepting/collecting charges.

[35]. A back-of-the-envelope calculation for a nominal simple circuit has been made and previously presented by the present author. In the nominal circuit used, the source dipole extracts from the vacuum and sends down the outside of the attached circuit about  $10^{13}$  times as much energy as the circuit itself intercepts, diverges, and utilizes. The huge remainder is not intercepted, remains nondivergent and just passes on out into space at the speed of light.

[36]. Solving the standard equation  $\mathbf{E} = \mathbf{F}/q$  for  $\mathbf{F}$ , one has  $\mathbf{F} = \mathbf{E}q$ . Again, from any nonzero  $\mathbf{E}$ -field, no matter how small, as much force can be "gathered" and produced as one desires, merely by increasing the intercepting/collecting charge  $q$ .

[37]. Robert H. Romer, "Heat is not a noun," *American Journal of Physics*, 69(2), Feb. 2001, p. 107-109. This is an editorial discussion by the Editor of AJP of the concept of heat in thermodynamics. Heat is not a substance, not a thermodynamic function of state, and should not be used as a noun. The quotation castigating the standard "field diagram" of an EM wave in space is

from endnote 24, p. 109.

[38]. This is readily understood when one realizes that the founders of electromagnetics assumed a material ether. So to them, there was not a single point in all the universe where mass was absent! Hence the field, potential, and wave "in space" were actually the field, potential, and wave "in the material ether medium", and therefore perfectly material. Even though the Michelson-Morley experiments falsified the material ether in the 1880s, the electrodynamicists (i) never changed their classical EM equations which still to this day assume the material ether filling all space, and (ii) still implicitly mistake the transverse electron precession wave in the Drude gas in a receiving antenna as representing the assumed interception of the incoming "transverse EM wave" in that external material ether medium.

[39]. Robert Bruce Lindsay and Henry Margenau, Foundations of Physics, Dover Publications, New York, 1963, p. 283-287, and passim.

[40]. Y. Aharonov and D. Bohm, "Significance of Electromagnetic Potentials in the Quantum Theory," Physical Review, Second Series, 115(3), 1959, p. 485-491. However, Aharonov and Bohm seem to have missed the similar mass interpretation of the potential, so that they utilized the potential as massless and therefore the vacuum EM entity that is the primary cause of all EM phenomena. If one truly eliminates only the potential's effect upon the intercepting charged mass, and utilizes the non-intercepted EM entity in vacuum, one has arrived at the direct alteration of the massless spacetime geometry of general relativity. In short, suddenly one has latched onto a unified field theory, and one that is engineerable by surprising electromagnetic means.

[41]. But erroneously assumed to be present, because of Maxwell's ubiquitous use of the material ether and the continued implied material ether in the electrodynamics equations to this day.

[42]. T. W. Barrett, "Tesla's Nonlinear Oscillator-Shuttle-Circuit (OSC) Theory," Annales de la Fondation Louis de Broglie, 16(1), 1991, p. 23-41. Barrett analyzed Tesla's patented circuits in terms of quaternion electrodynamics, which is of higher symmetry than either vector or tensor algebra electrodynamics. Lo and behold, Tesla could shuttle potential energy around in his circuits at will, and that functioning would not even show up in a tensor or vector electrodynamic analysis.

[43]. T. W. Barrett, "Active Signalling Systems," U.S. Patent No. 5,486,833, Jan. 23, 1996; — Oscillator-Shuttle-Circuit (OSC) Networks for Conditioning Energy in Higher-Order Symmetry Algebraic Topological Forms and RF Phase Conjugation," U.S. Patent No. 5,493,691, Feb. 20, 1996.

[44]. As the reader can appreciate, this represents a dramatic change to the foundations of electrodynamics. It is closely allied to Sachs's unified field theory; see appropriate Sachs references in this paper.

[45]. As Dirac pointed out, the Michelson-Morley experiments of the 1880s destroyed the *material* ether assumed by Faraday and Maxwell and subsequent electrodynamicists; it *did not* destroy the ether per se. Dirac emphasized that any nonmaterial Lorentz-invariant ether is perfectly consistent with the Michelson-Morley experiments. General relativity describes the shaping and structuring of the vacuum as curvatures of spacetime geometry and clustered patterns thereof (although the latter part is essentially neglected). GR consists of the changes

of this spacetime due to the interaction of mass/trapped energy, and also the forces upon mass/trapped energy created by the interaction of such curvature-patterns of spacetime. Essentially, electrodynamics is missing just this “mass to spacetime” transform and this “spacetime to mass” transform. It is in fact missing its “infolded general relativity” dynamic internal structuring of the potential, field, and wave. KGB energetics weapon scientists call these missing transforms *the information content of the field*—which our fellows mistakenly interpret in their own flawed electrodynamics as “spectral content.” Nothing could be further from the truth.

[46]. In 1903 E. T. Whittaker showed that any scalar potential is comprised of an infinite harmonic series of bidirectional longitudinal EM waves, arranged in bidirectional wavepairs. See E. T. Whittaker, "On the Partial Differential Equations of Mathematical Physics," Mathematische Annalen, Vol. 57, 1903, p. 333-355.

[47]. General relativity usually stops short of including an “infolded” topology within its basic spacetime, and only applies an “exterior” topology to it. However, it does not exclude that capability. Spacetime is just potential identically, and also just vacuum identically. Since GR omits the infolding structure of spacetime/potential, and so does electrodynamics, it has not been possible to unify the two completely. The “bridge” across the chasm between them has been eliminated by both disciplines.

[48]. With finite propagation, this action-at-a-distance is retarded so that some time passes between the effect and the cause. Each Mandl-Shaw photon interaction—the receipt of the scalar (time-polarized) photon, and emission of 3-space longitudinal photon—is retarded by (requires) the amount of time that is transformed into 3-space energy. [Time may be regarded as 3-space

electromagnetic energy compressed by the factor  $c^2$ , with the compressed energy placed on the fourth Minkowski axis to appear as time (seconds), rather than being left in 3-space to appear as mass).

Transformation from time-domain EM energy to 3-space energy is a function of the spin of the charge, which "spins" 720 degrees, being 360 degrees in the time domain while absorbing the time-polarized EM photon energy, the being followed by 360 degrees in 3-space while it is emitting the 3-space longitudinal photon. This retardation due to transformation of the energy from the time domain to the 3-space domain is what limits the speed of light in the ambient vacuum to the finite velocity  $c$ .

However, when infinite velocity propagation occurs (as is permissible with longitudinal EM waves alone, which a priori implies no retardation), then the notion vanishes of a "cause" and an "effect" separated by a time interval. In that case, one is operating in a multiply-connected spacetime, where in theory there is no observable "length" or "time" between the "cause" event and the "effect" event. Further, one "causative" initiation point can be superposed simultaneously with multiple distant points widely separated in ordinary spacetime. In that case, putting a joule of energy into the "initiating cause" point (to the normal 3-space observer) results in the simultaneous appearance at each and every distant participating point, of one joule. To the normal "singly-connected spacetime" observer, this is a direct amplification of energy, directly from the vacuum energy itself. We have proposed this mechanism as an extension of Bohm's quantum potential utilized in his hidden variable theory of quantum mechanics. See David Bohm, "A Suggested Interpretation of the Quantum Theory in Terms of 'Hidden' Variables, I and II," Physical Review, 85(2), Jan. 15, 1952, p. 166-179 (Part I); 180-193 (Part II). Unfortunately three nations of the world have already seen fit to highly weaponize this effect, and a fourth nation is very close to



deploying such a weapon. Presently quantum potential weapons are the dominant weapons on earth, and nothing can stand against them.

[49]. By conjugate pair, we mean that the wavepair consists of an EM longitudinal wave and its time-reversed twin, precisely superposed spatially but antiphased in time. In such a wave, the transverse energy density amplitude cannot vary; instead, the wave consists of (and carries) an oscillation of the rate of flow of time, about some median speed. The median speed of a longitudinal EM wave is not confined to the speed of light in vacuum.

[50]. The value of the energy continuously collected from a steady potential, in a “swirl” around a fixed intercepting charge, is of course a fixed scalar. That, however, has nothing to do with the nature of the potential as an EM entity in massless vacuum, prior to interaction with charged mass.

[51]. J. D. Jackson, Classical Electrodynamics, Second Edition, Wiley, 1975, p. 223.

[52]. Interestingly, one also cannot produce a clear definition of *energy* in physics. A good discussion of the energy concept is given by R. B. Lindsay, "The concept of energy and its early historical development." Foundations of Physics, 1 (4), 1971, p. 383-393. Lindsay investigates the concept of energy from its early historical origin, and covers from ancient times through the 18th century. The root of the concept is the notion of invariance in the midst of change. In short, the concept consists of considering “the changing” as being “nonchanging.” In pursuing a rigorous definition of anything, one eventually arrives at a contradiction of Aristotelian logic. Ultimately one can only define something as identical to its own opposite. Geometry, e.g., models the presence of

mass as the absence of mass. Ultimately a “hard definition” is an “accursed necessity for the identity of opposites”—the centuries-old bane of the philosophers. In physics the problem is avoided by the “duality principle”—just treat an entity as either a particle or wave as necessary, and quit arguing about it! The problem is the incompleteness of Aristotelian logic itself. A solution to the “identity of opposites” problem is obtained by explicitly adding a fourth law of logic that has always been implicitly assumed in Aristotle’s three laws. For a discussion, see “A Conditional Criterion For Identity, Leading to a Fourth Law of Logic,” Appendix III to T. E. Bearden, Aids: Biological Warfare, Tesla Book Co., 1988, p. 428-443. A simple proof of the fourth law of logic is given in *ibid.*, p. 439-440.

[53]. In addition to reference 19, see Myron W. Evans, Enigmatic Photon, Vol. II, Kluwer, ISBN 0792332881. See also Apeiron, 4(2-3), Apr.-Jul. 1997, a Special B<sup>(3)</sup> Field Issue, Guest editor: Myron W. Evans. In this same issue, see the Introduction by Evans, and also his “Helicity and the Electromagnetic Field.” In the same issue, see also Jean-Pierre Vigié, “Relativistic Interpretation (with Non-Zero Photon Mass) of the Small Ether Drift Velocity Detected by Michelson, Morley, and Miller.” Barrett has also rigorously shown the reality of the B<sup>(3)</sup> field, and so the conventional closure against it is doomed to failure. The emergence of B<sup>(3)</sup> field theory will dramatically alter electrodynamics, and elevate the importance of the longitudinal EM wave. We are also much indebted to Bob Flowers for his penetrating elucidation of the background of the B<sup>(3)</sup> field in private communications, and to Myron Evans for his patient and encouraging private communications.

[54]. See particularly T. W. Barrett, "Sagnac Effect: A Consequence of Conservation of Action Due to Gauge Field Global Conformal Invariance in a Multiply-Joined Topology of Coherent Fields," in T. W. Barrett and D. M Grimes, [Eds.], Advanced Electromagnetism: Foundations, Theory,

& Applications. World Scientific, River Edge, New Jersey, 07661, 1995, p. 278-313; T. W. Barrett, "Electromagnetic Phenomena Not Explained by Maxwell's Equations," in A. Lakhtakia, (ed.): Essays on the Formal Aspects of Electromagnetic Theory, World Scientific Publishing, River Edge, NJ, 1993, p. 6-86.

[55]. Richard W. Ziolkowski, "Exact Solutions of the Wave Equation With Complex Source Locations," Journal of Mathematical Physics, 26 (4), April 1985, p. 861-863; I.M. Besieris, A.M. Shaarawi, and R. W. Ziolkowski, "A bidirectional travelling plane wave representation of exact solutions of the scalar wave equation," Journal of Mathematical Physics, 30(6), 1989, p. 1254-1269; Rod Donnelly and Richard Ziolkowski, "A method for constructing solutions of homogeneous partial differential equations: localized waves," Proceedings of the Royal Society of London A., Vol. 437, 1992, p. 673-692; — "Electromagnetic field generated by a moving point charge: A fields-only approach," American Journal of Physics, 62 (10), Oct. 1994, p. 916-922.

[56]. M. W. Evans, editor, Modern Nonlinear Optics, Wiley, 2002, 3 volumes (in press).

[57]. W. A. Rodrigues Jr. and J.-Y. Lu, "On the existence of undistorted progressive waves (UPWs) of arbitrary speeds  $0 \leq v < \infty$  in nature," Foundations of Physics, 27(3), 1997, p. 435-508; W. A. Rodrigues Jr. and J. E. Maiorino, "A unified theory for construction of arbitrary speeds ( $0 \leq v \leq \infty$ ) solutions of the relativistic wave equations," Random Operators and Stochastic Equations, Vol. 4, 1996, p. 355-400.

[58]. E. T. Whittaker, 1903, *ibid.*

[59]. Ironically, Maxwell's actual theory was some 20 quaternion-like equations in 20

unknowns, as given in "A Dynamical Theory of the Electromagnetic Field," Royal Society Transactions, Vol. CLV, 1865, p 459. Read Dec. 8, 1864. Also contained in The Scientific Papers of James Clerk Maxwell, 2 vols. bound as one, edited by W. D. Niven, Dover, New York, 1952, Vol. 1, p. 526-597. Heaviside dramatically curtailed Maxwell's theory to a vector subset of some 4 equations in 4 unknowns. Lorentz further curtailed it by effectively throwing out all Maxwell-Heaviside systems that were in disequilibrium with their active vacuum and curved spacetime environments. So after over a century, the long slumbering *environmental* dynamics for electrodynamical systems is awakening and chasing its own roots again. Long live the rise of the supersystem!

[60]. E.g., see J. Vaz Jr. and W. A. Rodrigues Jr., "Maxwell and Dirac Theories as an Already Unified Theory," Advances in Applied Clifford Algebras, Vol. 7 (S), 1997, p. 369-386. See W. A. Rodrigues, Jr. and J. Vaz Jr., "Subluminal and Superluminal Solutions in Vacuum of the Maxwell Equations and the Massless Dirac Equation," Advances in Applied Clifford Algebras, Vol. 7(S), 1997, p. 457-466.

[61]. E. T. Whittaker, 1904, *ibid.*

[62]. We strongly stress that longitudinal EM waves and their dynamics, so ignored in all except the most advanced higher symmetry electrodynamics texts, are actually the key to everything. Longitudinal EM waves already comprise, create, and structure the feeble "envelope EM waves" we presently deal with. A longitudinal EM wave is also an electrogravitational wave, and oscillates the rate of flow of time itself because of its combination with a time-polarized wave. The two combined photons have a total spin two, which is a graviton. Thus internally a graviton is revealed as a particular

dynamic between time-domain EM energy and 3-space EM energy. The longitudinal EM wave in the time domain (that is combining with the longitudinal EM wave in 3-space) is thus an oscillation of time contraction and expansion, or "pulsation" in the rate of flow of time. Very powerful gravitational effects as well as very powerful and unique electrodynamics effects can be obtained by use of longitudinal EM waves, because of the additional dynamics between the time and 3-space domains. Unwitting use of such extraordinary EM waves is how Rife and Prioré achieved such remarkable results.

[63]. M. W. Evans, P. K. Anastasovski, T. E. Bearden et al., "On Whittaker's Representation of the Electromagnetic Entity in Vacuo, Part V: The Production of Transverse Fields and Energy by Scalar Interferometry," Journal of New Energy, 4 (3), Special Issue, Winter 1999, p. 76-78.

[64]. Melba Phillips, "Classical Electrodynamics," Vol. IV: Principles of Electrodynamics and Relativity, in Encyclopedia of Physics, Edited by S. Flugge, Springer-Verlag, Berlin, 1962, p. 1-108 gives a good overall summary of the superpotential theory.

[65]. A. Righi, Nuovo Cimento, Vol. 2, No. 5, 1901, p. 104.

[66]. P. Debye, Ann. Phys., Leipzig, Vol. 30, 1909, p. 57.

[67]. Thomas John I'Anson Bromwich, An Introduction to the Theory of Infinite Series, MacMillan, London, 1908.

[68]. A. Nisbet, Physica, Vol. 21, 1955, p. 799; Proc. Roy. Soc. Lond. A, Vol. 231, 1955, p. 250.

[69]. W. H. McCrea, "Hertzian electromagnetic

potentials,” Proc. Roy. Soc. Lond. A, Vol. 240, 1957, p. 447-457.

[70]. Sachs has achieved the necessary unified field theory, broadly unifying physics from the quarks and gluons to the entire universe, and including both the active vacuum and active, locally curved spacetime. See Mendel Sachs, General Relativity and Matter: A Spinor Field Theory from Fermis to Light-Years (Fundamental Theories of Physics), Reidel (now Kluwer), 1982; — Quantum Mechanics from General Relativity: An Approximation for a Theory of Inertia, Reidel (now Kluwer), 1986. It should be obvious that, unless electrodynamics theory and general relativity theory utilize the same background spacetime, it is impossible to completely merge them, from first principles. Since classical electrodynamics artificially discards its active environment, it is electrodynamics which must be changed in order to be successfully united with general relativity. Sachs has accomplished this long-sought *engineerable* unification.

[71]. Proof that the virtual state can be coherently integrated is already furnished by every source charge in the universe, which does precisely that.

[72]. We note without elaboration that all the mind functions, even of the deepest and most unconscious nature, and even of collective species unconsciousness domains—exist electromagnetically in the infolded EM domain. The “conscious mind” is a serial processor, though extremely rapid. The unconscious is a massively parallel processor. The reason the conscious mind cannot “directly see” the unconscious is that “seeing” innumerable things in the “single snapshot” at once, just obliterates all singular discrimination because of the intense summation. Mind functions are timelike, so consist of specialized structures, functioning, and dynamics

inside the time domain. Since the infolded structuring captures this entire domain, it also involves a physics of mind and matter interaction, but as a science instead of as a mysticism. In theory vacuum engines are also possible that engineer the mind at any and all levels. We have addressed this extended physics of mind and matter reactions elsewhere and do not address it here. The Russian weapon scientists refer to this mind area (which can also be engineered by novel electrodynamic means) as psychoenergetics.

[73]. R. O. Becker and David G. Murray, "The electrical control system regulating fracture healing in amphibians," Clinical Orthopaedics and Related Research, Vol. unk, No. 73, Nov.-Dec. 1970, p. 169-198. This is the definitive technical exposition by Becker of his electrical findings about the cellular control system.

[74]. See particularly Robert O. Becker, "The direct current control system. A link between environment and organism," New York State Journal of Medicine, Vol. 62, 1962, p. 1169-1176; — and Joseph A. Spadaro, "Electrical stimulation of partial limb regeneration in mammals," Bulletin of the New York Academy of Medicine, Second Series, 48(4), May 1972, p. 627-641; — and Carlton F. Hazlewood, Abraham R. Liboff, and Jan Walleczek, Electromagnetic Applications In Medicine, NIH-OAM Electromagnetics Panel Report, Jan. 15, 1993; — "A technique for producing regenerative healing in humans," Frontier Perspectives, 1(2), Fall/Winter 1990, p. 1-2; — and Andrew A. Marino. Electromagnetism and Life, State University of New York Press, Albany, NY, 1982; — and Gary Selden, The Body Electric, William Morrow and Company, New York, 1985; — Cross Currents, Jeremy P. Tarcher, Inc., Los Angeles, 1990; — "The bioelectric field pattern in the salamander and its stimulation by an electronic analog," IRE Transactions on Medical Electronics, Vol. ME-7, July 1960, p. 202-207; —

"Some observations indicating the possibility of longitudinal charge-carrier flow in peripheral nerves," Biological Prototypes and Synthetic Systems, Plenum Press, New York, 1962, p. 31-37; — and W. Slaughter, "The longitudinal direct current gradients of spinal nerves," Nature, Vol. 196, Nov. 17, 1962, p. 675-676; — and Charles H. Bachman and Howard Friedman, "The direct current (control) system: A link between the environment and the organism," New York State Journal of Medicine, Vol. 62, April 15, 1962, p. 1169-1176; — "The direct current field: A primitive control and communication system related to growth processes," Proceedings of the XVI International Congress of Zoology, Washington, D.C., Vol. 3, 1963, p. 179-183; — "The neutral semiconduction control system and its interaction with applied electrical current and magnetic fields," Proc. 11th International Cong. Radiol., Amsterdam, Excerpta Medica Foundation, 1966, Series 105, p. 1753-1759; — "The bioelectric factors in amphibian limb regeneration," The Journal of Bone and Joint Surgery, Vol. 43-A, No. 5, July 1961, p. 643-656; — and David G. Murray, "A method for producing cellular dedifferentiation by means of very small electrical currents," Transactions, New York Academy of Sciences, 29(5), Mar. 1967, p. 606-615.

[75]. The ultimate tool for use in seeing and working with this "infolded" or "internal electrodynamics inside normal EM fields, waves, and potentials will probably be the Fogal semiconductor when it goes into production in the near future. Fogal's transistors are capable of (1) infolding the desired longitudinal EM waves inside normal EM signals (he demonstrates infolding TV signals inside pure DC potentials, and transmitting them over conductors as pure DC potentials for appreciable distance, then using his semiconductors to again extract the "infolded" hidden TV signals.

[76]. See Vlail Kaznacheyev, "Electromagnetic



Bioinformation in Intercellular Interactions," Psi Research, 1(1), Mar. 1982, p. 47-76; — *et al.*, "Distant intercellular interactions in a system of two tissue cultures," Psychoenergetic Systems, 1 (3), Mar. 1976, p. 141-142; "A Comment" by William A. McGarey, p. 143; "A Comment" by Arthur C. Hastings, p. 143-144, — *et al.*, "Apparent information transfer between two groups of cells," Psychoenergetic Systems, 1(1), Dec. 1974. See particularly Vlail P. Kaznacheyev and L. P. Mikhailova, Ultraweak Radiations in Intercellular Interactions [in Russian], Novosibirsk, 1981; "Electromagnetic Bioinformation in Intercellular Interactions," Novosibirsk, 1981 [in Russian]; V. P. Kaznacheyev, "Information Function of Ultraweak Light flows in Biological Systems," Problems in Biophysics, Novosibirsk, 1967, p. 7-18 [in Russian].

[77]. Some years ago we documented this disease-inducing "microwave radiation of the U.S. Embassy, explained its purpose and operational mechanism, and published it. E.g., see T. E. Bearden, AIDS: Biological Warfare, Tesla Book Co., Chula Vista, CA, 1988.

[78]. See Robert C. Mallieu, A Model of the Microwave Intensity Distribution Within the U.S. Embassy, Moscow 1966-1967, Report FS-80-166, Applied Physics Laboratory, Johns Hopkins University, Baltimore, Maryland, Aug. 1980. Also see Microwave Radiation at the U.S. Embassy in Moscow and Its Biological Implications: An Assessment, U.S. Department of Commerce, Doc. # NTIA-SP081-12, Mar. 1981. Also see Captain John D. LaMothe, Controlled Offensive Behavior—USSR, Report ST-CS-01-169-72, Defense Intelligence Agency, Washington, D.C. (released under FOIA). See also Captain John D. LaMothe and Mr. Louis Maire, Soviet and Czechoslovakian Parapsychology Research, Report DST-1810S-387-75, Defense Intelligence Agency, Washington, D.C. (Released under FOIA).

[79]. T. E. Bearden, "EM Corrections Enabling a Practical Unified Field Theory with Emphasis on Time-Charging Interactions of Longitudinal EM Waves," Journal of New Energy, 3(2/3), 1998, p. 12-28. A slightly updated and extended version is published in Explore, 8(6), 1998, p. 7-16.

[80]. C. W. Misner, K. S. Thorne and J. A. Wheeler, Gravitation, W.H. Freeman and Co., San Francisco, 1973, p. 5, 19-21, 71-72, 163-165, 390-391, 399; 367-369.

[81]. T. D. Lee, Particle Physics and Introduction to Field Theory, Harwood, New York, 1981. See particularly Chapter 25: Outlook, "Possibility of Vacuum Engineering," p. 824-828.

[82]. David J. Bohm, "A Suggested Interpretation of the Quantum Theory in Terms of 'Hidden' Variables, I and II," Physical Review, 85 (2), Jan. 15, 1952, p. 166-179 (Part I); 180-193 (Part II).

[83]. I.e., the rate of flow of time, or more specifically, the rate of the EM interactions with a mass or particle that generate the flow of the mass or particle through time. See Figure 25. Nobelist Lee has also shown that time is a discrete dynamical variable across all of physics, from quantum mechanics to nonrelativistic field theory, to relativistic quantum field theory. See T. D. Lee, "Can Time Be a Discrete Dynamical Variable?", Physics Letters, 122B(3, 4), Mar. 10, 1983, p. 217-220. Also in T. D. Lee, Selected Papers, Gerald Feinberg, Ed., Birkhauser, Boston, 1986, Vol. 3, p. 77-80. So we have not hesitated to consider time as any other variable, and the fourth Minkowski axis as any of the other three axes with respect to EM energy, fields, potentials, and waves.

[84]. Indeed, there is no such unique thing as "the gravitational field" anyway! The gravitational field is a conglomerate of other field energies and

functions, not a separate field of nature. See A. A. Logunov and Yu. M. Loskutov, "Nonuniqueness of the predictions of the general theory of relativity," Sov. J. Part. Nucl., 18(3), May-June 1987, p. 179. See C. W. Misner, K. S. Thorne and J. A. Wheeler, Gravitation, W.H. Freeman and Co., San Francisco, 1973, p. 399. Quoting: "*The terms 'gravitational field' and 'gravity' refer in a vague, collective sort of way to all of these entities. Another, equivalent term for them is the 'geometry of spacetime'.*" See also A. D. Sakharov, "Vacuum Quantum Fluctuations in Curved Space and the Theory of Gravitation," Soviet Physics Doklady, Vol. 12, No. 11, 1968, p. 1040-1041 [English translation.]. Finally, see our remarks under reference 62 above, particularly with respect to the proposed internal electromagnetic dynamics of the graviton.

[85]. A 1993 study by the Office of Technology Assessment, delivered to Congress, showed that a single terrorist in a small plane, with a tank of anthrax spray, and dispersing the spray as he flew around the greater Washington D.C. area on a calm night, would produce between 1 and 3 million casualties. Most of those casualties would die. So a single biological warfare (BW) strike in one U.S. metropolitan area could easily kill two million Americans. As an example, Saddam Hussein is known to have the terrorist teams and the anthrax, and he has had a decade since the Gulf war to insert additional teams and biological warfare agents into the U.S. Presently this is rated by our government as the strongest strategic threat to the U.S., after which comes nuclear strikes, followed by chemical agent strikes. Redevelopment of the Prioré approach, e.g., could easily save the lives of 90% of that nominal two million dead Americans. As matters stand now, triage would apply and almost all of those two million stricken Americans would die.

[86]. In 1998 we proposed a crash development of this kind of device in 1998, with copies to DoD,

NIH, CDC, the USAF, etc.; in T. E. Bearden, Energetics: Extensions to Physics and Advanced Technology for Medical and Military Applications, CTEC Proprietary, May 1, 1998, 200+ page inclosure to CTEC Letter, “Saving the Lives of Mass BW Casualties from Terrorist BW Strikes on U.S. Population Centers,” to Major General Thomas H. Neary, Director of Nuclear and Counterproliferation, Office of the Deputy Chief of Staff, Air and Space Operations, HQ USAF, May. 4, 1998. Also to Gen. (Ret.) Walter Busby, Deputy Secretary of Defense for Counterproliferation and Chemical and Biological Defense, March 21, 1998. Also to NIH, CDC, and several other U.S. government agencies.

DoD replied that it was not documented in the literature (a specific list of exact scientific papers reporting the results of the Prioré team's experiments and the experiments of Becker was included; no one seemed to read it). CDC and the USAF did not reply. NIH first responded (from its Policy section—read, *spin control* section) that, since I mentioned the cause of the Gulf War Disease and how it was induced, it was not a matter of their interest but of DoD's interest, and so they just shipped it to DoD and got rid of it. A second response evoked from NIH on query from my congressman (again, a response from their *policy* section) directed me to their proposals section. I don't believe a single qualified scientist even read it. DoD weakly replied that it was not documented in the literature (a specific list of citations from the hard French scientific literature, reporting the astounding results of the Prioré treatments, was included, which apparently no one read).

Not a single scientist from any agency called me to discuss the revolutionary and proven results obtained by Prioré, and documented in the attachments and in the cited literature. Sadly, it seems that no one had the foggiest notion what I was talking about, and no one much cared. My conclusion was and is that my own government bureaucrats do not give a tinker's dam about saving

millions of American casualties in the coming debacle, *if it has to be done by "out-of-the-box" methods not approved by the big drug industry.* Yet these are the same officials that readily admit the exact threat I referred to, admit that it is a matter of *when* the biological warfare attacks will occur and not *if*, and admit that right now they have no effective way to cope with it or save most of those coming millions of Americans that are going to just be dragged aside to die.

My response is that the American taxpayers are certainly not getting their money's worth from the billions they shower on our medical research community. It is unconscionable to ignore for over 30 years the demonstrated and astounding results achieved by eminent French scientists—such as Pautrizel, a world-renowned parasitologist and Courier, head of the French Academy's Biological Section, and also *Secrétaire Perpetuel* of the Academy) working with the Prioré team, in curing terminal tumors etc. in thousands of lab animals, all properly documented in the hard French scientific literature.

In my view, considering the certainty of those future American mass deaths, it is akin to high treason. Whether our scientific community realizes it or not, today's strategic war of massive strategic strikes has shifted to our civilian populace, and to our cities and mass population centers. It is our civilian populace that will sustain the greatest and most prompt casualties, and probably will receive the first massive strikes, totally by surprise.

*The first phase of WW III—delivery of the strategic weapons to their strategic targets—has already been accomplished.* Large Russian nuclear weapons are already hidden in our major cities and population centers (read Lunev's book, he tells us how they brought in these weapons), the Spetznaz teams are here to detonate them on call, multiple nations such as Iraq, Libya, and Iran already have terrorists agents in country in the U.S. with anthrax and smallpox in hand to be released, and Castro guerrillas and trained saboteurs have been trained

in Southern Mexico and infiltrated across the border into the U.S. for decades.

Whether they like it or not, U.S. scientists have thus become the major front line "soldiers" and "defenders" of our nation. And frankly, they have failed abominably in their responsibility, and most do not seem to care. For a startling and even shocking characterization of our present scientific community, the reader is referred to Daniel S. Greenberg, Science, Money, and Politics: Political Triumph and Ethical Erosion, University of Chicago Press, 2001.

[87]. As we stated, just such an attack is now officially the greatest strategic threat to the United States. Second is a nuclear attack, followed by chemical attack as a distant third. E.g., see Richard K. Betts, "The New Threat of Mass Destruction," Foreign Affairs, 77(1), Jan./Feb. 1998, p. 26-41. For the ineffectiveness of our defenses against the coming mass biological warfare strikes, see Laurie Garrett, The Coming Plague: Newly Emerging Diseases in a World Out of Balance, Farrar, Straus and Giroux, New York, 1994; — "The Nightmare of Bioterrorism," Foreign Affairs, 80(1), Jan./Feb. 2001, p. 76-89; — Betrayal of Trust: The Collapse of Global Health, Hyperion, New York, 2000.

[88]. Becker, *ibid.*

[89]. A full account of the entire Prioré affair is given in Jean-Michel Graille, Dossier Prioré: Une Nouvelle Affaire Pasteur [The Prioré Dossier: A New Pasteur Affair?], De Noel, Paris, 1984. [in French]. A summary account is given by Christopher Bird, "The Case of Antoine Prioré and His Therapeutic Machine: A Scandal in the Politics of Science," Appendix I in T.E. Bearden, AIDS: Biological Warfare, Tesla Book Co., P.O. Box 121873, Chula Vista, California 91912, 1988. Prioré's doctoral thesis (in my personal possession courtesy of Professor Courrier and the late Chris Bird), was rejected by the University of Bordeaux

when the French government suppressed the Prioré program in the mid-70s; it is A. Prioré, Guérison de la Trypanosomiase Expérimentale Aiguë et Chronique par L'action Combinée de Champs Magnétiques et D'Ondes Electromagnétiques Modulés. [Healing of intense and chronic experimental trypanosomiasis by the combined action of magnetic fields and modulated electromagnetic waves], 1973. Prioré's patents are: A. Priore, "Apparatus for producing radiations penetrating living cells," U.S. Patent No. 3,368,155, Feb. 6, 1968; — "Method of producing radiations for penetrating living cells," U.S. Patent No. 3,280,816, Oct. 25, 1966; — "Procede et dispositif de production de rayonnements utilisables notamment pour le traitement de cellules vivantes," [Procedure and Assemblage for Production of Radiation Especially Serviceable for the Treatment of Living Cells], Republique Francais Brevet d'Invention P.V. No. 899.414, No. 1,342,772, Oct. 7, 1963. Eleven years after Priore's thesis was rejected, the same university awarded a doctoral thesis to a young graduate. It is Eric Perisse, Effets des Ondes Electromagnétiques et des Champs Magnétiques sur le Cancer et la Trypanosomiase Experimentale [Effects of Electromagnetic Waves and Magnetic Fields on Cancer and Experimental Trypanosomiasis], Doctoral thesis, University of Bordeaux No. 83, March 16, 1984.

[90]. F. A. Popp *et al.*, "Biophoton Emission (Multi-Author Review)," Experientia, Vol. 44, 1988, p. 543-600; — "Biophoton emission: New evidence for coherence and DNA as a source," Cell. Biophys., Vol. 6, 1984, p. 33-52; — "Physical aspects of biophotons." Experientia, Vol. 44, 1988, p. 576-585; — Recent Advances in Biophoton Research and its Applications, World Scientific Publishing Co., New York, NY, 1992; F. A. Popp, "Photon Storage in Biological Systems," in Fritz Albert Popp *et al.*, eds., Electromagnetic Bio-Information: Proceedings of the Symposium,

Marburg, Federal Republic of Germany, Sep. 5, 1977; Urban & Schwarzenberg, Baltimore, 1979, p. 123-149.

[91]. David M. Rorvik, "Do the French have a Cure for Cancer?", Esquire Magazine, July 1975, p. 110-111, 142-149.

[92]. Arguably the best introduction to nonlinear optical phase conjugation is David M. Pepper, "Nonlinear Optical Phase Conjugation," Optical Engineering, 21(2), March/April 1982, p. 156-183. Another very good presentation is Amnon Yariv, Optical Electronics, 3rd Edition, Holt, Rinehart, and Winston, New York. 1985, Chapter 16: "Phase Conjugate Optics – Theory and Applications."

[93]. A beautiful example of this "precise backtracking" of the time-reversed wave is given in David M. Pepper, "Applications of Optical Phase Conjugation," Scientific American, 254(1), Jan. 1986, p. 74-83. See particularly the striking photographic demonstration of time reversal of disorder on p. 75.

[94]. We presented some general elements of this dramatic new extension to nonlinear optical phase conjugate pumping and to general relativity, at a graduate seminar, "On the Theory and Principles of EM Systems with  $COP > 1.0$ ", given to interested graduates and faculty of the University of Louisville, on Nov. 20, 1997.

[95]. E.g., see Owen Flynn, "Parametric arrays: A new concept for sonar," Electronic Warfare Magazine, June 1977, p. 107-112.

[96]. This method of increasing signal-to-noise ratio and pulling hidden signals right up out of the noise, is widely used in signal processing in modern radars. Often signals buried more than 100



dB below the noise level are routinely “pulled out of the noise” and detected, using various forms of coherent summation.

[97]. Any potential decomposes into multiple wavepair sets. In each hidden wavepair, each of the two waves further decomposes into two potentials. Each of *those* potentials then further decomposes into multiple wavepair sets. And so on *ad infinitum*. Or one can start with any wave, decompose it into two potentials, each of those potentials into multiple biwave sets, and so on.

[98]. “Fractal” means self-similarity at all levels, so that patterning or “decomposition” at one level is similar to that at the higher and lower levels. For good overview discussions and applications, see particularly Gregoire Nicolis, “Physics of far-from-equilibrium systems and self-organization,” and Joseph Ford, “What is chaos, that we should be mindful of it?”, both in The New Physics, Paul Davies, editor, Cambridge University Press, Cambridge and New York, 1989, p. 316-347 and 348-371 respectively. More detailed technical references are cited in each article.

[99]. See Trevor James Constable, “You, Too, Can Photograph UFOs from Airliners,” Psychic Observer and Chimes, 37(3), May-June 1977; — The Cosmic Pulse of Life, Merlin Press, Santa Ana, CA, 1976.

[100]. The present author has two beautiful ultraphotographs taken by Joe Gambill using the special filtering approach. One is a photograph of a room, but with its contents of *two weeks earlier*, showing the room prior to the time the photograph was taken. The other is of a “ghost” form—very similar to a photograph obtained by George Meek under rigorous laboratory conditions—and clearly showing the energy form of a “haunted” lady's dead husband. The *interpretation* of these photographs

is of course open to scientific dispute, but the *photographs themselves* are impeccable and real.

[101]. Meek used filters open to UV and IR but opaque to the visible spectrum, on the fluorescent lights in his laboratory. He also used similar filtering on the camera lenses and camera flashes. Under rigorous laboratory conditions, in several thousand photos of the living body Meek was able to take a few highly anomalous photos completely inexplicable by normal science. E.g., he photographed a purported “ghost” and obtained a clear shot of energy streaming associated with a living person. He also photographed the legs of a chair, right through the suddenly “missing” legs of the person sitting in the chair. Again, interpretation is open to dispute, but the photographs are rigorous and real.

[102]. Bill Fogal’s patented charge-blocking semiconductor—U.S. Patent Numbers 5,196,809 and 5,430,413—is capable under certain circumstances—and by clever adaptation—of amplifying virtual state information, in a manner somewhat similar to Rife’s methodology, but far more easily engineered. When the process works, Bill reports that a clear photograph or video camera shot can be taken right through a solid brick wall, of the hidden scenery beyond. In electrodynamics, in a dielectric absorbing or emitting EM radiation (energy), the entire dielectric participates in each absorption and emission. Emitted light from an object thus carries an astoundingly complete set of little virtual state vacuum engines rigorously representing every part of the object, no matter how small, and all the internal dynamics. This means that the light from the scene beyond the wall strikes the wall on the other side, affecting all the material in the wall, including upon the observer’s side, and inserting “dimensioning” from the scene beyond the wall. When light is emitted from the observer’s side, the information content of the field representing the scene on the far side, is also part of

the information content of the field in the light emitted from the observer side of the wall and striking the camera and the observers eyes. This “dimensioning” continues in the signals in the camera and on through attached electronic circuitry. Since Fogal’s semiconductor can process such information content of the field in the proper circuitry and under favorable circumstances, the phenomenon is therefore permissible and can be technically explained. Using his transistor to transduce the dimensioned information into the visual band, Fogal *can* view a distant scene right through an intervening wall, when he gets everything “just right.” At this stage of development, however, the process and adjustment are difficult, just as Rife experience with his microscope. We are convinced that the forthcoming advent of Fogal semiconductors will revolutionize the study and treatment of disease and bodily disorders.

[\[103\]](#). However, highly advanced electrodynamics does consider the photon with far greater complexity than nuclear engineers such as the present author were introduced to! E.g., a deep discussion of photon polarization is given in F. Mandl and G. Shaw, Quantum Field Theory, Wiley, 1984 under the heading "covariant quantization of the photon propagator" in Chapter 5. As pointed out by Bob Flowers in a private communication, Mandl and Shaw argue that the longitudinal and scalar polarizations are not directly observable, but only in combination, where the combination manifests as the "instantaneous" Coulomb (i.e., electrostatic) potential. Most such books do argue that the extra components of the photon remain hidden, as does the virtual state. In this paper we have revealed how Rife discovered a process by means of which the virtual state can be observed in great detail.

[\[104\]](#). V. P. Kaznacheyev, "Electromagnetic Bioinformation in Intercellular Interactions," Psi

Research, 1(1), Mar. 1982, p. 47-76; —  
 "Information Function of Ultraweak Light Flows in Biological Systems," in Problems in Biophysics, Novosibirsk, 1967, p. 7-18 [in Russian]; — and L. P. Mikhailova, Ultraweak Radiation in Intercellular Interactions, [in Russian], Novosibirsk, 1981; — *et al.*, "Apparent information transfer between two groups of cells," Psychoenergetic Systems, 1(3), Mar. 1976; — *et al.*, "Distant intercellular interactions in a system of two tissue cultures," Psychoenergetic Systems, 1(3), Mar. 1976, p. 141-142; "A Comment" by William A. McGarey, p. 143; "A Comment" by Arthur C. Hastings, p. 143-144.

[\[105\]](#). Mitogenetic radiation was studied prior to WW II by Gurwich (spelling varies). See A. Gurwitsch and L. Gurwitsch, "L'Analyse mitogenetique spectrale [The Analysis of the mitogenetic spectrum]," in Andre Mayer, Exposés de Physiologie, [Studies in Physiology], Hermann & Cie, Paris, 1934. Part IV. [In French]. Studies have continued by Popp and others. E.g., see F. A. Popp *et al.*, "Biophoton Emission (Multi-Author Review)," Experientia, Vol. 44, 1988, p. 543-600; — "Physical aspects of biophotons." Experientia, Vol. 44, 1988, p. 576-585; — "Biophoton emission: New evidence for coherence and DNA as a source," Cell. Biophys., Vol. 6, 1984, p. 33-52. See Fritz Albert Popp; Ke-hsueh Li, and Qiao Gu, [eds.], Recent Advances in Biophoton Research and its Applications, World Scientific Publishing Co., New York, NY, 1992.

[\[106\]](#). The conventional quantum mechanics assumes that, at the microscopic level, variation (e. g., in the probabilities assigned to interpret what is propagating in the Schrödinger equation) is assumed to be random. However, there is a problem. Big things must be made of little things. If we sum a set of "random" things based on Gibbs thermodynamics statistics, we cannot and will not get an organized "big thing" because we have

assumed total disorder (randomness) *a priori*. Adding heat does not produce cooling! So one falsifies the prevailing interpretation of quantum mechanics, whenever one observes a tree, a flower, the sun, or a human being. In short, there must exist a great unifying principle in nature of a coherent summation, from the "unobservable" virtual state to the observable state. Only in that fashion can there be an macroscopic order at all—and such macroscopic order is universally observed. We believe that the principle we have elucidated, as experimentally produced by Rife, may well be that long-sought universal ordering principle that is so sorely needed by quantum mechanics. Readers interested in the "missing quantum chaos" problem are referred to P. V. Elyutin, "The Quantum Chaos Problem," Sov. Phys. Usp., Vol. 31, No. 7, 1988, p. 597-622. Elyutin discusses the crisis in quantum mechanics because of the missing hidden order. Quantum mechanics is known to be wrong unless this order can be found, because otherwise it does not predict the ordered macroscopic universe. Other useful references are Ilya Prigogine, with T. Petrosky, "Quantum Chaos, Complex Spectral Representation and Time-Symmetry Breaking," Chaos, Solitons, and Fractals, Vol. 4, 1994, p. 311-359; and Robert Pool, "Quantum Chaos: Enigma Wrapped in a Mystery," Science, 243(4893), 1989, p. 893-895.

---

## Slide Index

[Figure 1](#). The Rife microscope.

[Figure 2](#). Royal Raymond Rife adjusts his microscope.

[Figure 3](#). Faraday omitted the string holder for his taut string, thus omitting half the electrostatics and half the energy. An equal-and-opposite Newtonian third law reaction wave always appears in our transmitters and receivers, caused by the omitted wave.

[Figure 4](#). Drude gas gyroelectrons in the receiving antenna precess laterally, providing the detected transverse wave and proving the vacuum disturbance wave to be longitudinal.

[Figure 5](#). The magnitude of the causal potential in massfree space is erroneously defined.

[Figure 6](#). Fields and potentials are erroneously defined as what is diverted from them.

[Figure 7](#). The defined magnitude of the field is erroneous and is the field intensity.

[Figure 8](#). Matter-to-matter transform.

[Figure 9](#). The missing matter-to-spacetime and spacetime-to-matter transforms.

[Figure 10](#). Vacuum engine utilization.

[Figure 11](#). A charge is continuously in violent energy exchange with the active vacuum.

[Figure 12](#). Whittaker's biwave decomposition of the scalar potential, and its reinterpretation.

[Figure 13](#). The Supersystem and its components.

[Figure 14](#). Vacuum engine (cartoon representation).

[Figure 15](#). First vacuum engine analogy of arm muscle and bone.

[Figure 16](#). Second vacuum engine analogy of arm bone and muscle.

[Figure 17](#). Third vacuum engine analogy.

[Figure 18](#). Fourth vacuum engine analogy.

[Figure 19](#). Time-like flow of EM energy into 3-space.

[Figure 20](#). Block diagram of the immune system.

[Figure 21](#). Becker's electromagnetic healing of otherwise intractable bone fractures.

[Figure 22](#). Becker's block diagram of the cellular control system.

[Figure 23](#). Kaznachev's electromagnetic induction of cellular death and disease, at a distance.

[Figure 24](#). Microwave radiation of the U.S. Embassy in Moscow.

[Figure 25](#). Mechanism generating the flow of a mass through time.

[Figure 26](#). Vacuum antiengine for a specific disease condition.

[Figure 27](#). Pumping with transverse and longitudinal EM waves.

[Figure 28](#). Block diagram of the Prioré process.

[Figure 29](#). Block diagram of the operation of the body's cellular regenerative system.

[Figure 30](#). Rife's great secret: Recursive iterative serial amplification by a single harmonic interval difference frequency.

[Help support this work](#)

# [The Tom Bearden Website](#)

## Rife's Microscope

### Table of Photographs

(Thanks to the donor of these photographs, who wishes to remain anonymous)

1. [Rife's Universal Microscope](#)
2. [Eyepiece Details](#)
3. [Chart for Calculating Parallax of Lens System](#)
4. [Diagram - Wide Angle Apochromatic Microscope Objective Lens](#)
5. [Universal Focus - Photographic Lens](#)
6. [Light Passage of Dove Prism](#)



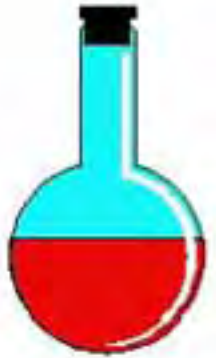
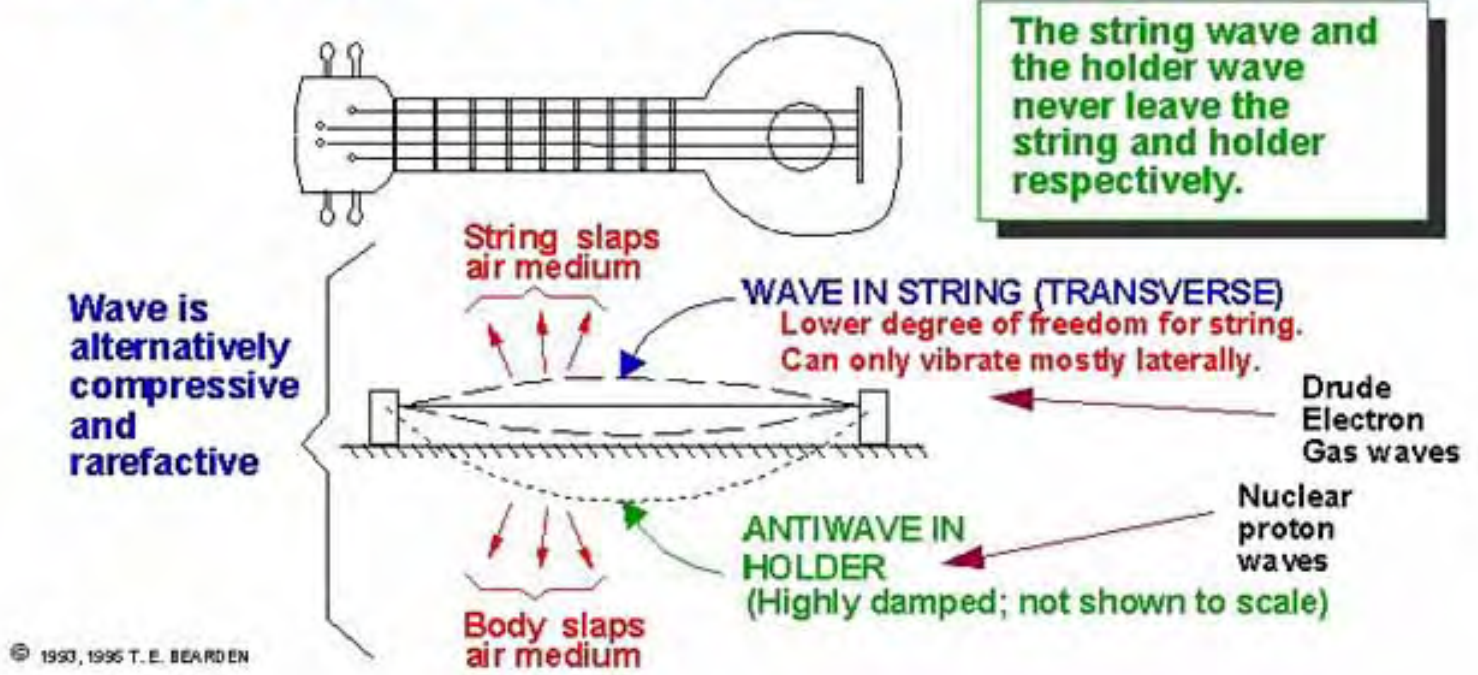

Figure 1. Rife's microscope.



Figure 2. Royal Raymond Rife adjusts his microscope.

# Air medium disturbances generated when air is perturbed by a plucked taut string



**Figure 3. Analogy of the "taut string holder" omitted by Faraday.**  
This omitted half the electrodynamics (including in Maxwell's capture of Faraday's notion) and half the EM energy. An equal and opposite Newtonian 3rd law reaction does appear in our transmitters and receivers.

# Flow of current and energy into, through, and along a conductor

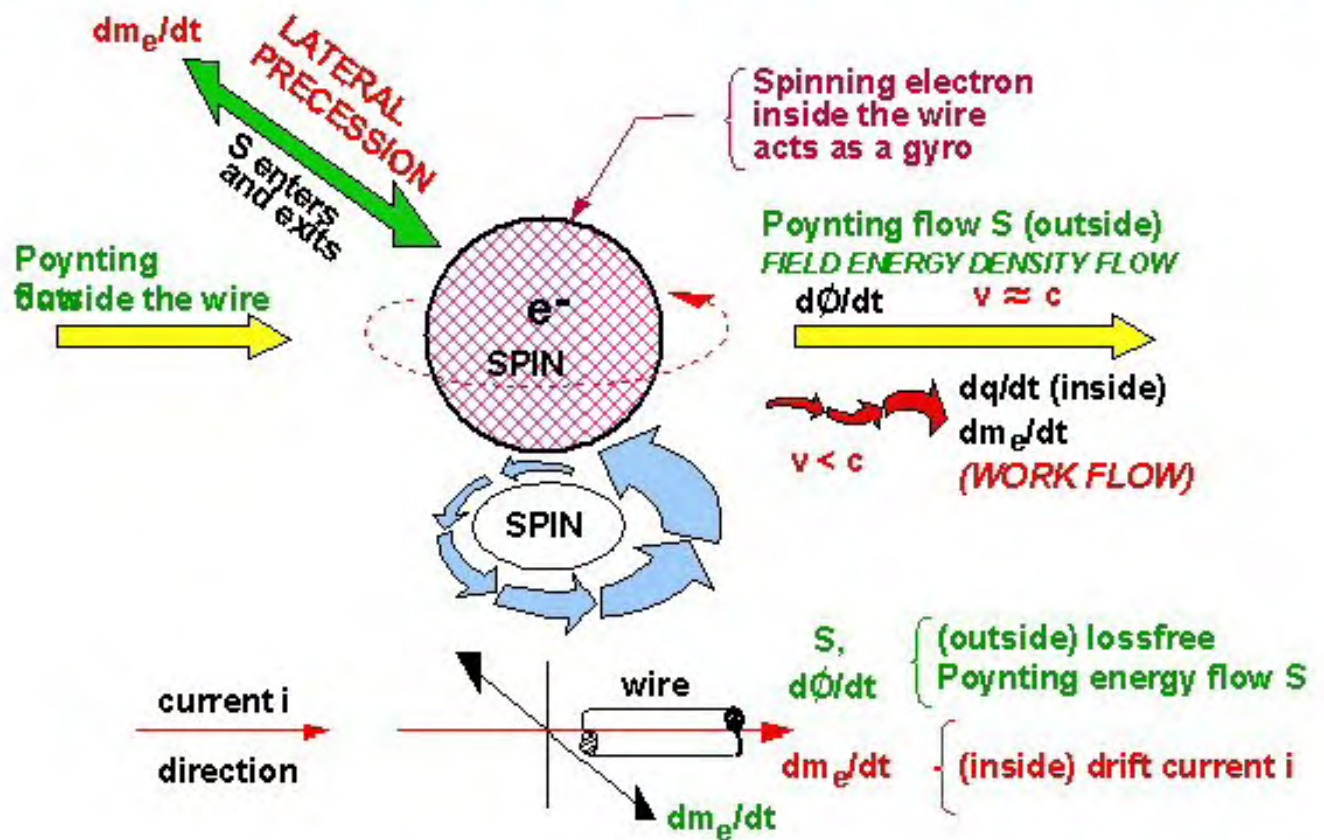

Figure 4. Receiving gyroelectrons precess laterally, providing the detected transverse wave and proving the incoming vacuum disturbance to be longitudinal.

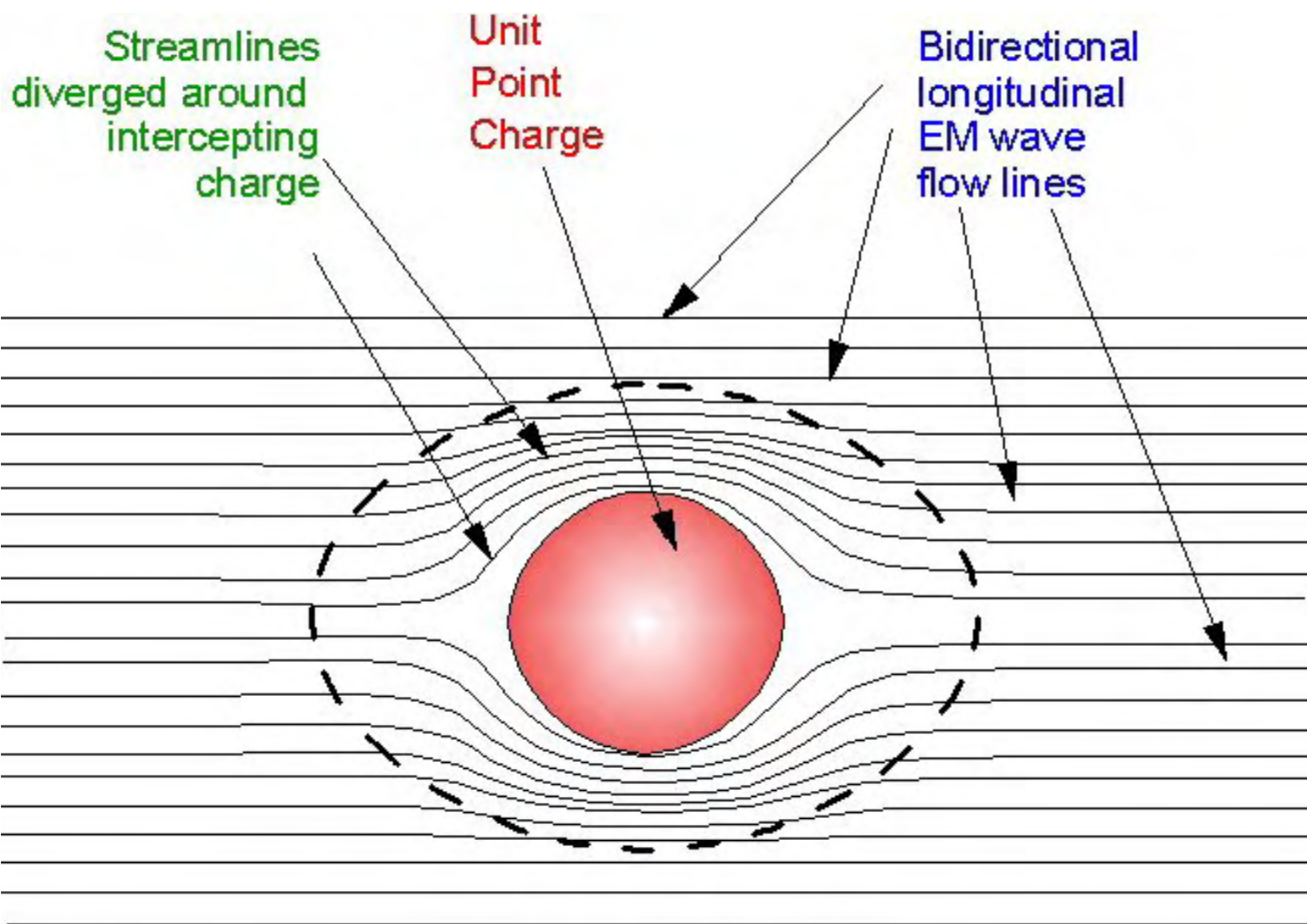

Figure 5. The defined "magnitude of the potential" is not such at all, but is the magnitude of the energy in the diverged flow streamlining around a unit point charge at each point in space where the potential is present.

Electrodynamics has nothing to say about what exists in the vacuum in the absence of mass.

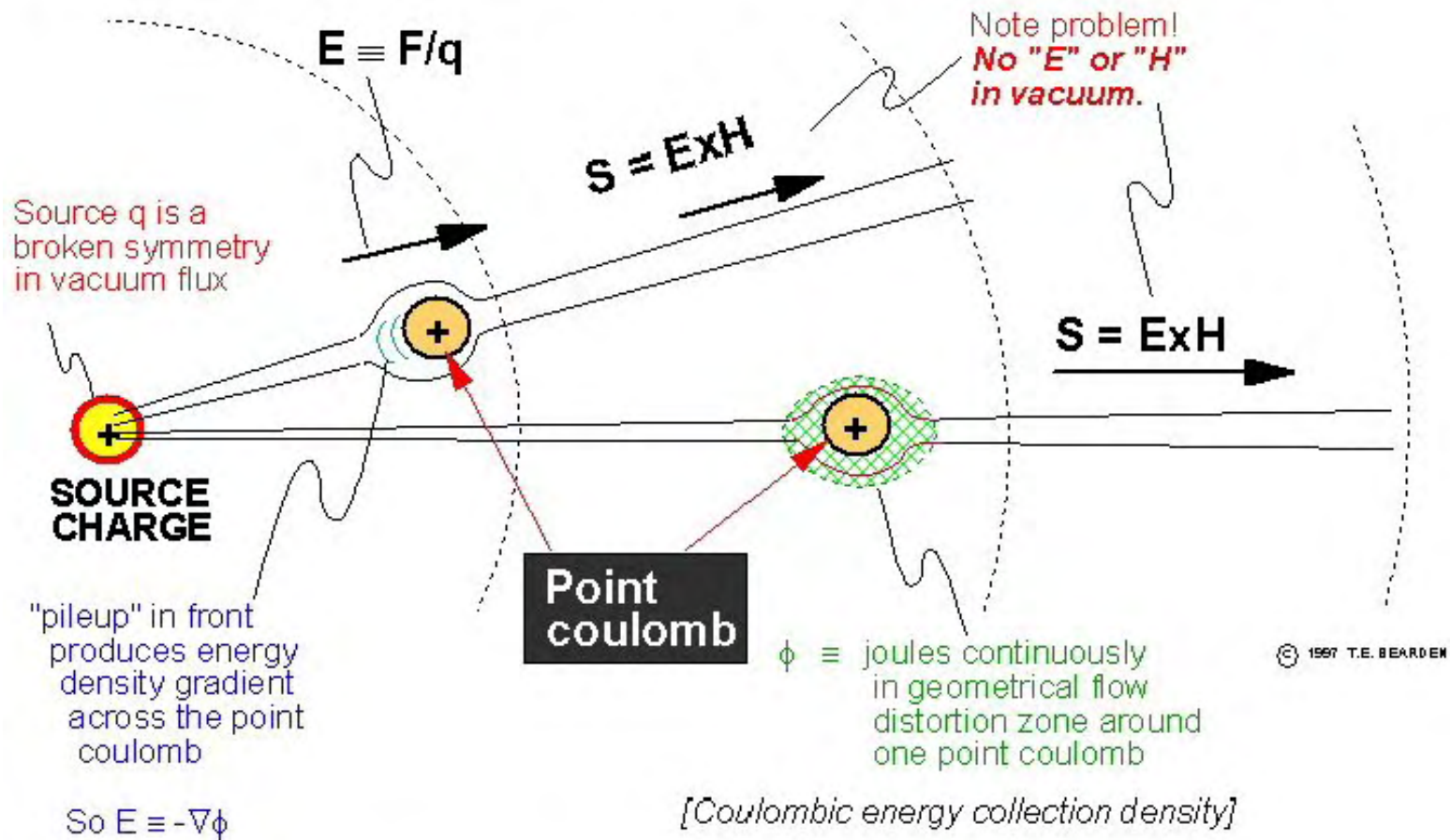

Figure 6. Fields and potentials are defined in terms of the Poynting disruption of the overall energy flow from the source charge, about an intercepting and "collecting" charge. Rigorously, *as defined* E and H exist only in and on charged matter. The magnitude of the diverted water swinging around a fixed rock in a river, is not the magnitude of the river.

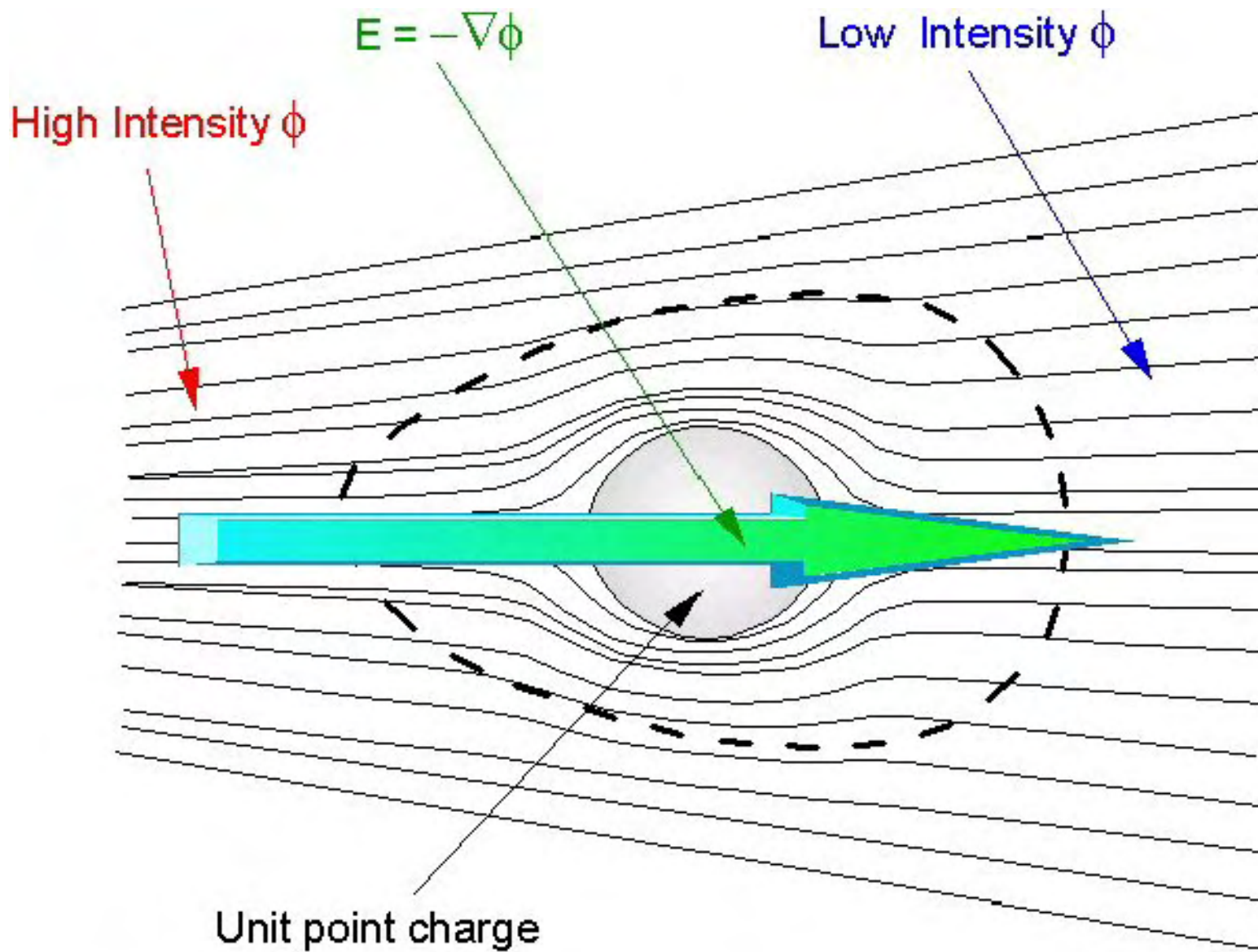

Figure 7. The defined "magnitude of the field" depends on the change in intensity of the flows comprising the potential. The E-field is oriented from high (pressure) in the flow to low (pressure) in energy density over a unit length.

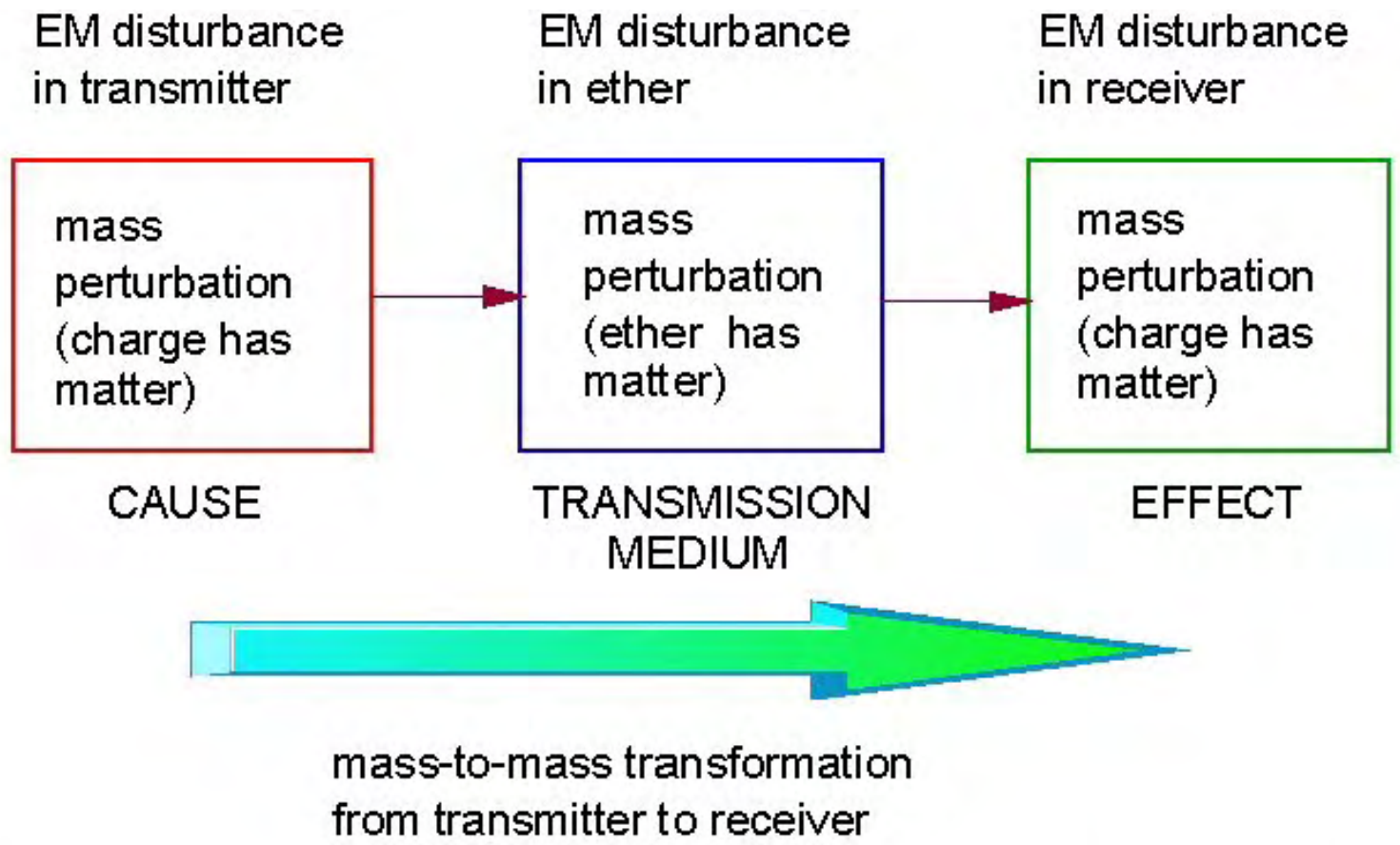
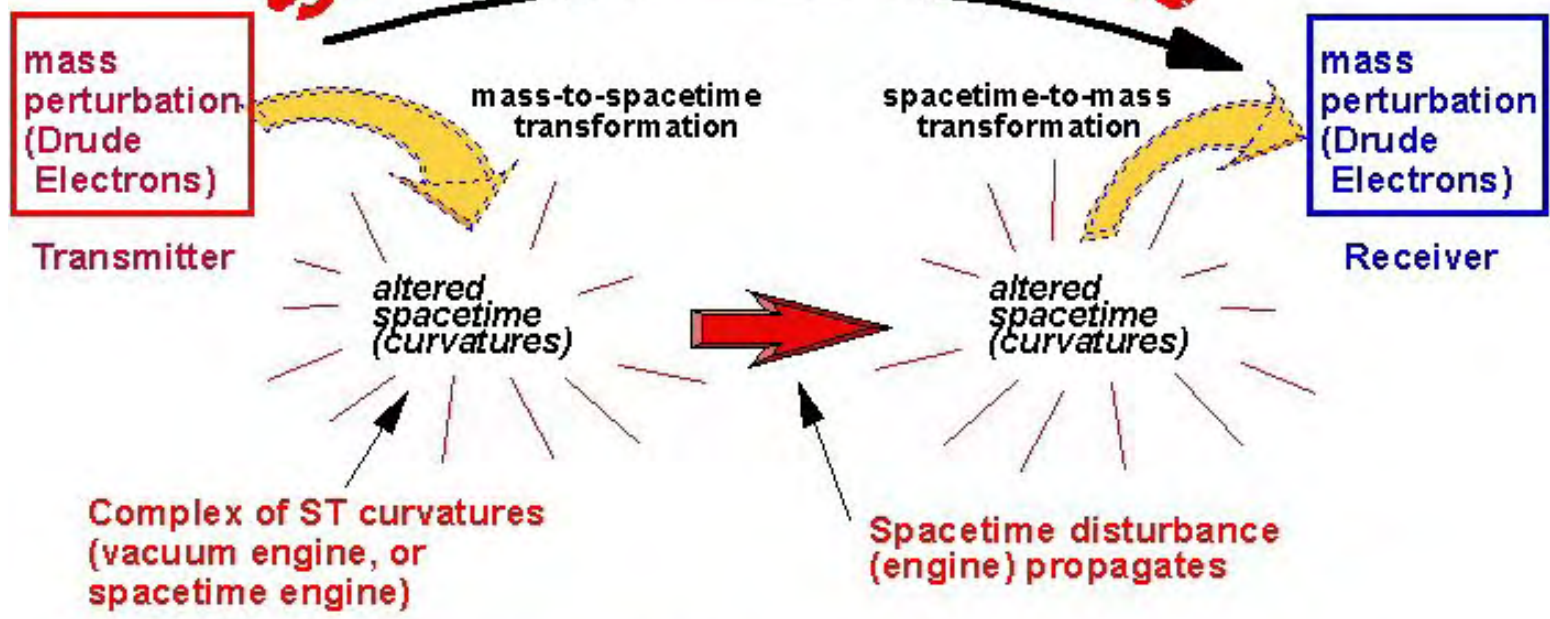

Figure 8. Maxwell's theory assumed a matter-to-matter transform from cause to effect.



# ST curvatures propagate



The mass-to-mass transform contains two hidden infolded transforms: (i) the mass-to-spacetime transform and (ii) the spacetime-to-mass transform. What is transmitted and propagates in space is a spacetime perturbation.

Figure 9. Maxwell's matter-to-matter transform contains two hidden transforms: (1) matter-to-spacetime, and (2) spacetime-to-matter.

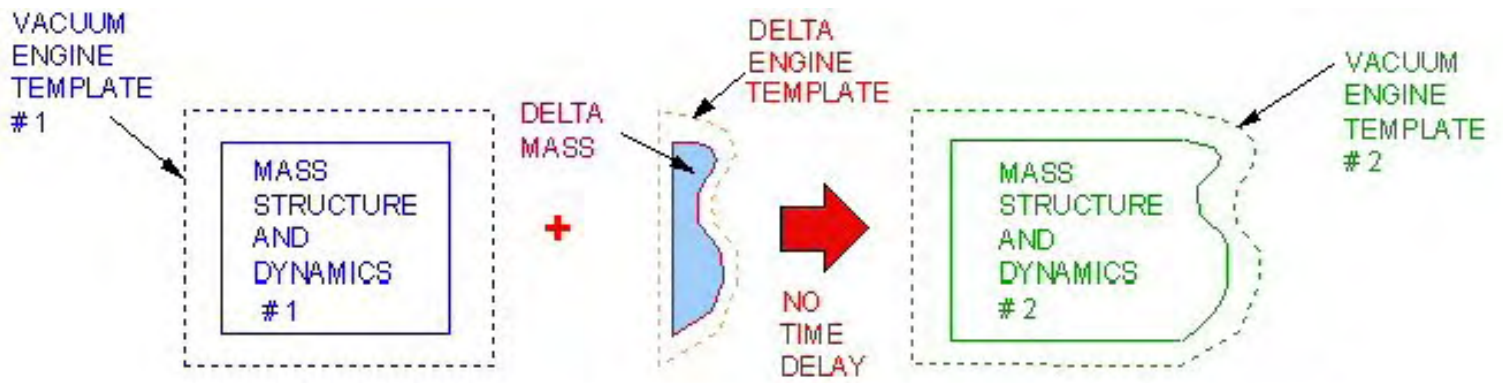

Conventional way that bulk vacuum engines are added by adding mass. Also, fields alone may be utilized as "powerful translators" without finesse.

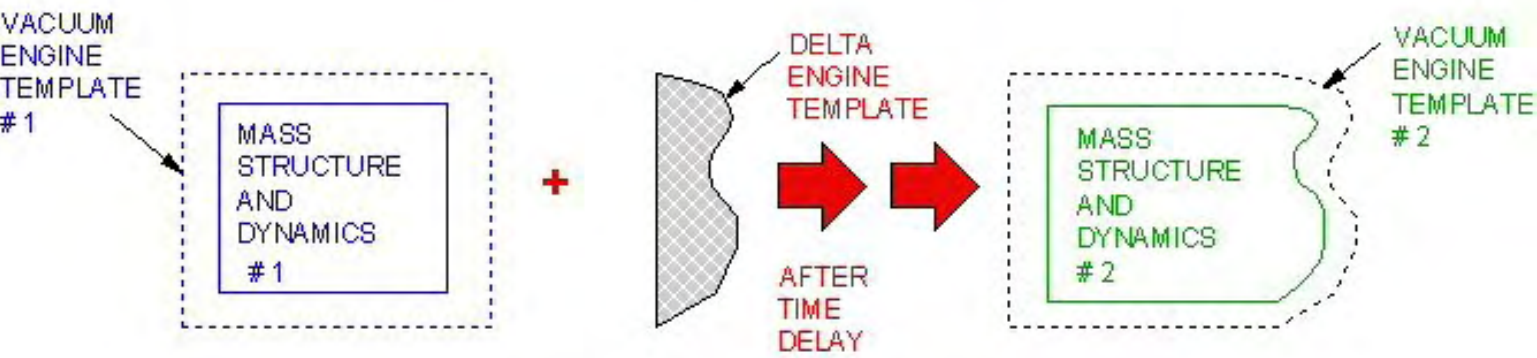

Adding the vacuum engine without fields or masses. First the internal hidden engines of the target are changed, producing a structured template, which gradually changes the mass at all levels.

© 1994 T.E. BEARDEN

Figure 10. Vacuum engines and their utilization.

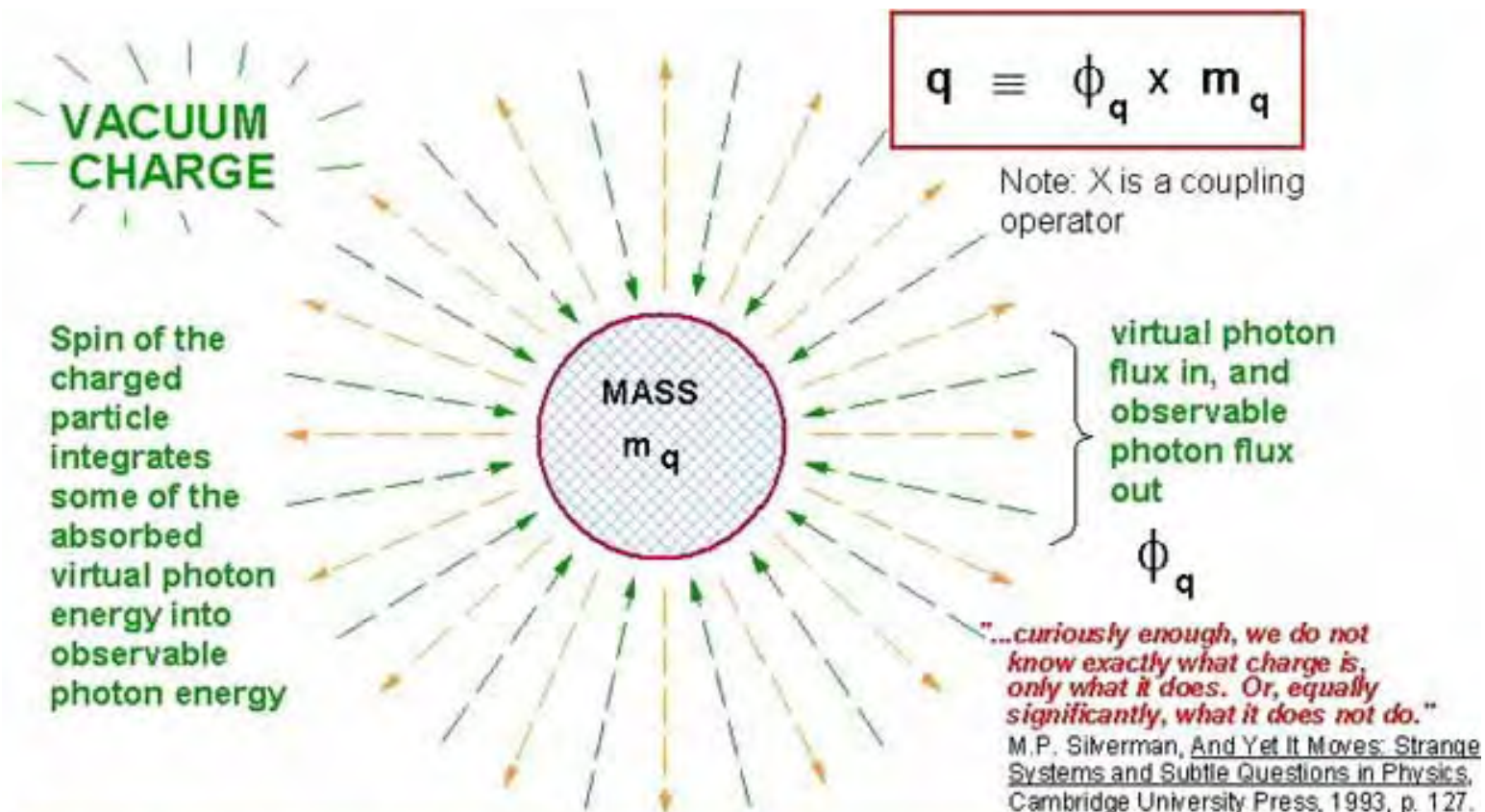

**An electric charge Q is a broken 3-symmetry. The mass of the charge continuously and violently absorbs virtual photons from the surrounding vacuum, and integrates some of them to observable EM longitudinal photons which it emits in 3-space.**

**Figure 11. A charged particle continuously absorbs virtual energy from the vacuum, integrates some of it into observable energy, and pours out this observable EM energy in 3-space in all directions.**

# Composition of the scalar potential $\phi$

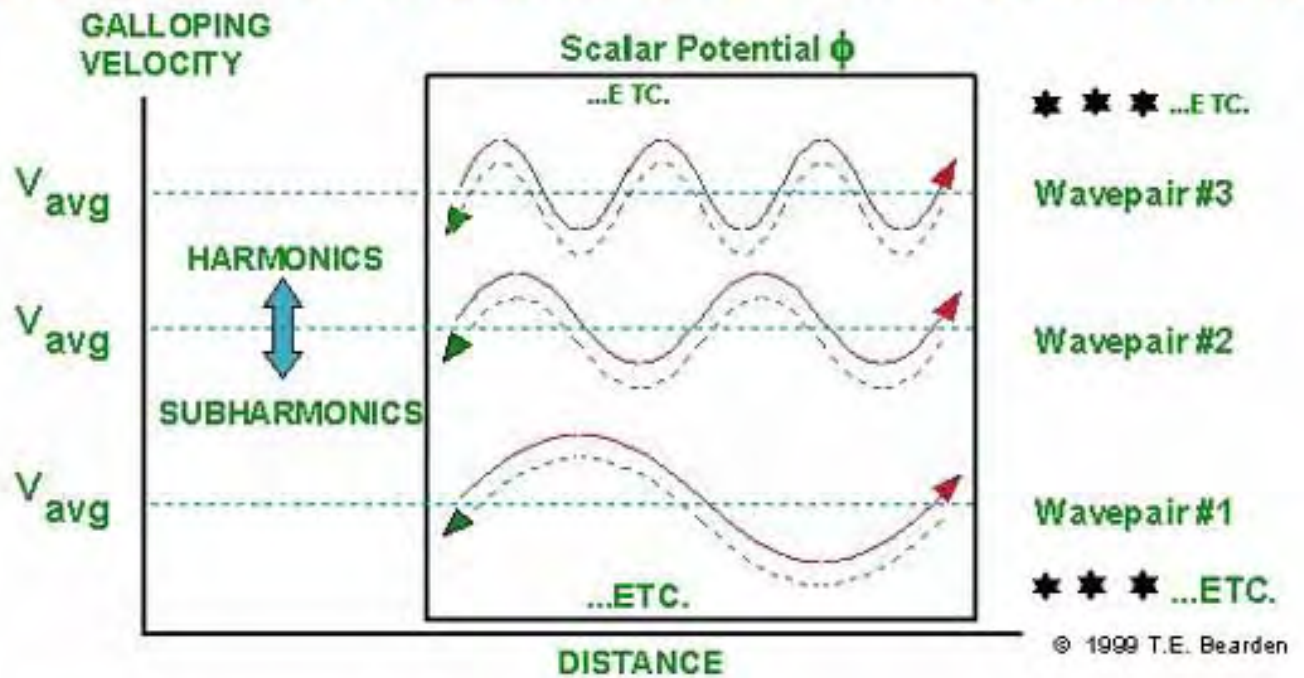

A harmonic set of bidirectional longitudinal EM wavepairs in 3-space. Unseen here is the time-polarized EM wave in the time domain, which reacts with the source charge to produce the 3-space biwave potential.

**Figure 12.** The potential as observed or detected is a harmonic set of bidirectional longitudinal EM waves in 3-space. That is, this potential is the "effect" of transduction of an incoming time-polarized EM wave interacting with the source charge.

# The supersystem concept

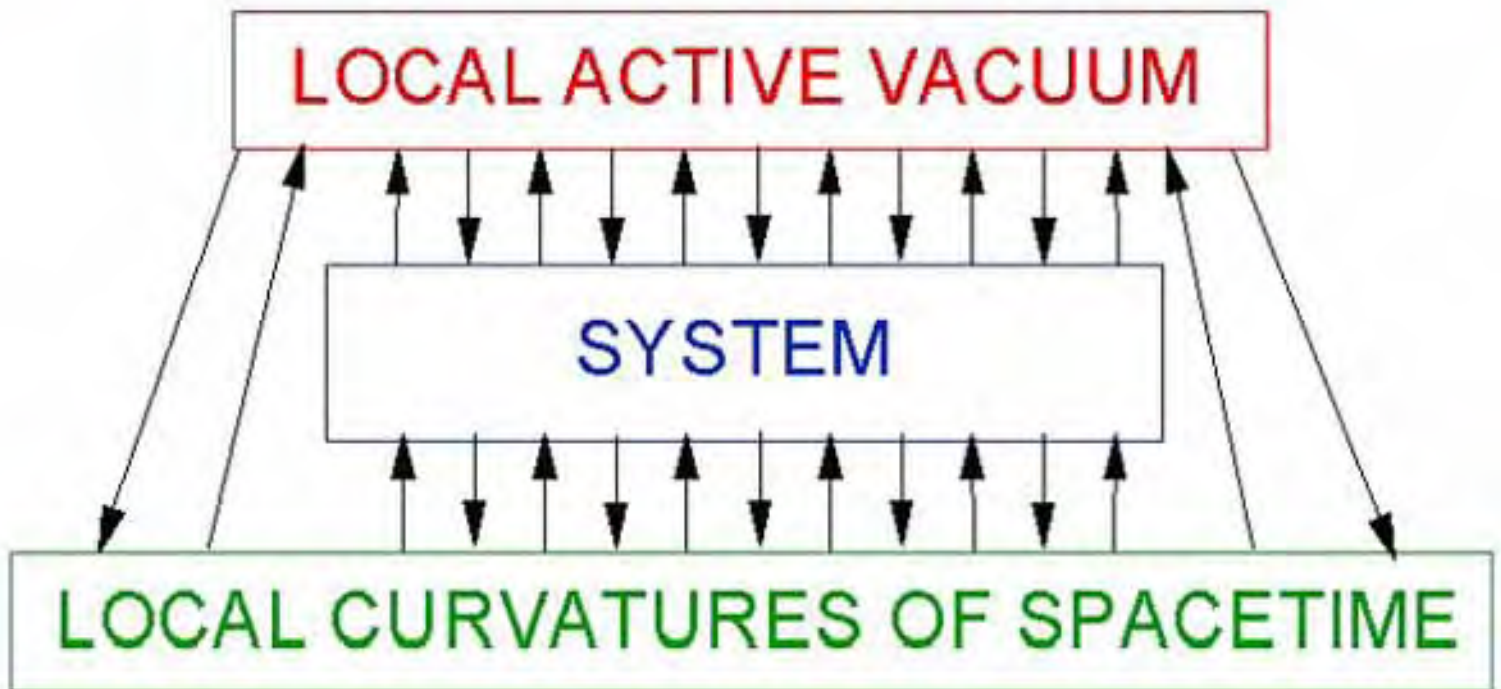

Figure 13. Concept of the supersystem and its interacting components.

# Vacuum engine: Working spacetime demons

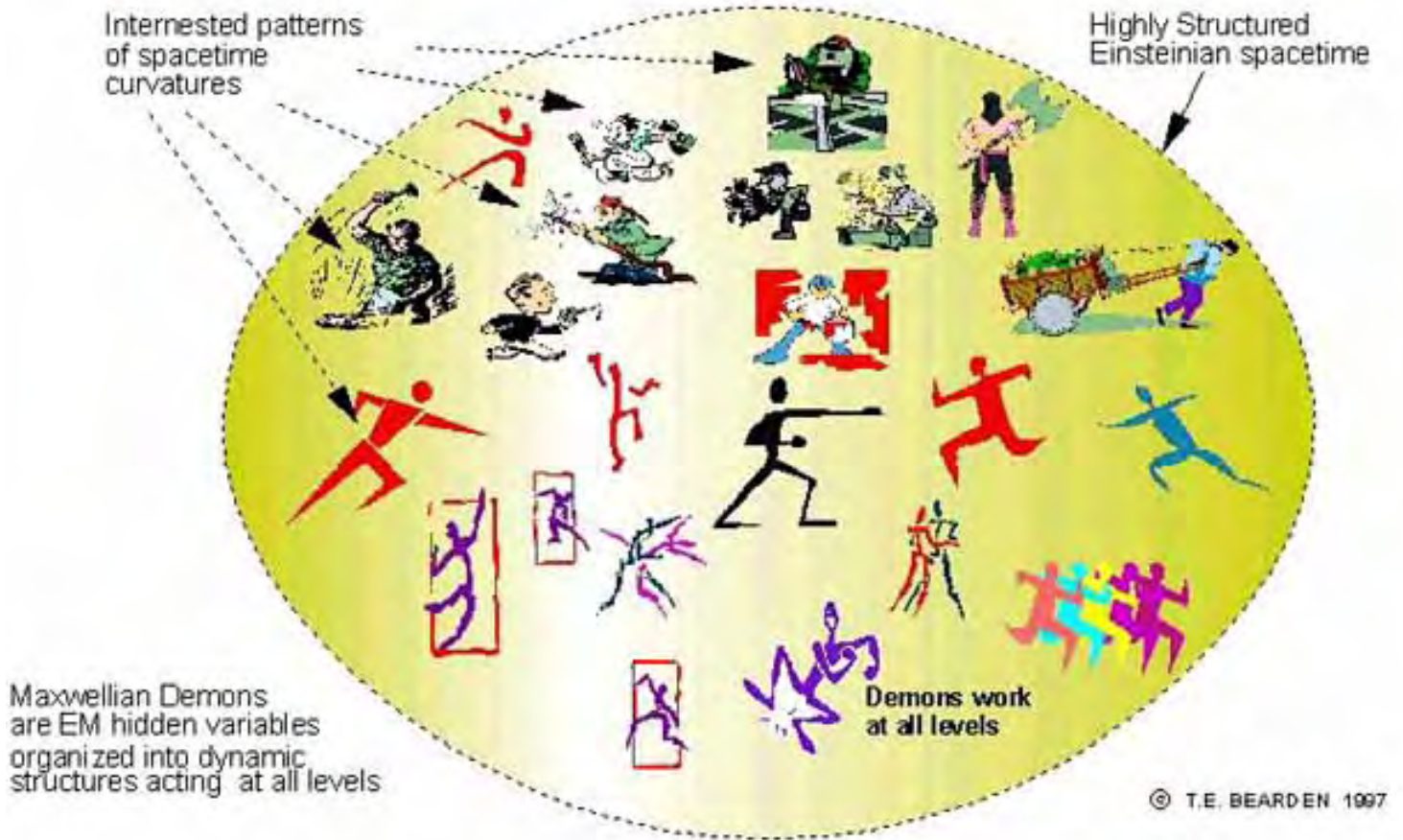

Figure 14. A vacuum engine is a set of spacetime demons working upon a mass system and its motion through time, at every level.

# MTW's\* general relativity principle

- Space acts on matter, telling it how to move.
- In turn, matter reacts back on space, telling it how to curve."

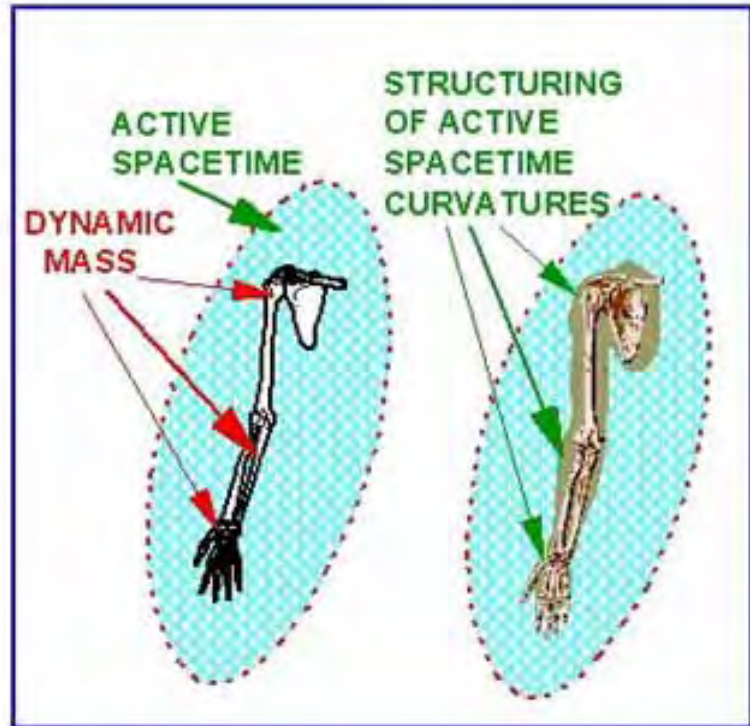

Figure 15. General relativity principle of Misner, Thorne, and Wheeler (MTW).

# Extended General Relativity Principle

- All levels of energy structures and all levels of time structures mold spacetime geometry.
- The "pattern" is called a *template* for a vacuum engine (spacetime curvature engine).
- Spatial and temporal structurings of the engine act upon mass at all levels.
- This produces a template of forces, for precise translations and stresses within the mass at all levels. The forces exist in both time and 3-space.

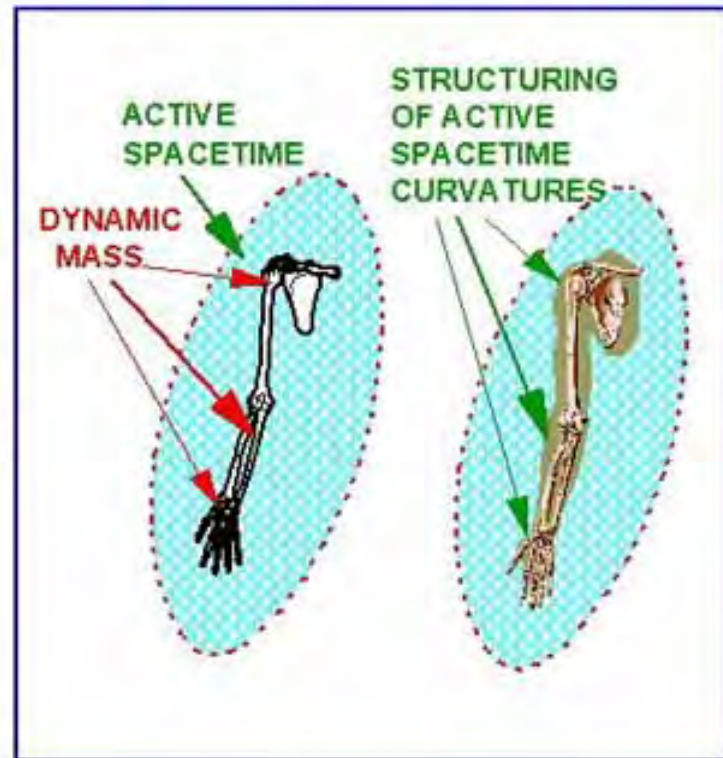

Figure 16. The principle of general relativity extended to include the vacuum engine.



# Active spacetime and a specific vacuum engine

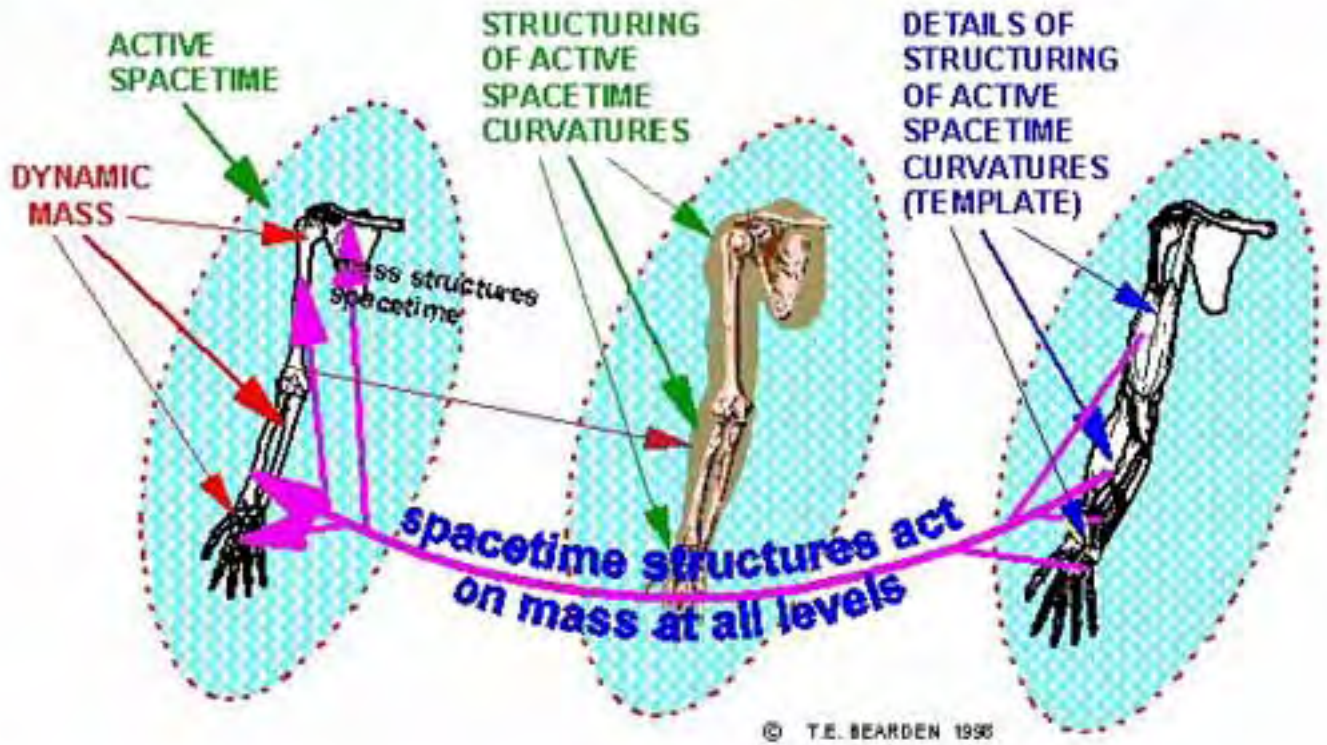
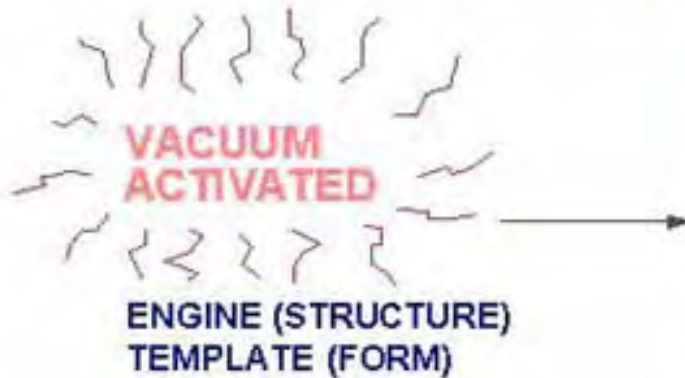

Figure 17. Active spacetime and a specific vacuum engine (spacetime curvature engine).



- \* INFORMATION RECEIVED
- \* ANY OVERT PHYSICAL ACTION MUST BE TAKEN BY CELL ITSELF

**A. Cell must do the action itself; vacuum energy exchange is passive. Energy or fuel for doing the action must be added to cell externally.**



- \* "INFORMATION" ITSELF ACTS
- \* VACUUM GRADIENTS CHANGE ALL PARTS AND CHARACTERISTICS OF CELL, INCLUDING GENETICS

**B. Cell is acted upon; vacuum energy exchange does the specific action. No energy or fuel for doing the action need be added to cell externally.**

Figure 18. Signal versus vacuum engine, as in Priore's cellular reversal.

# All EM energy in 3-space freely comes from the time domain

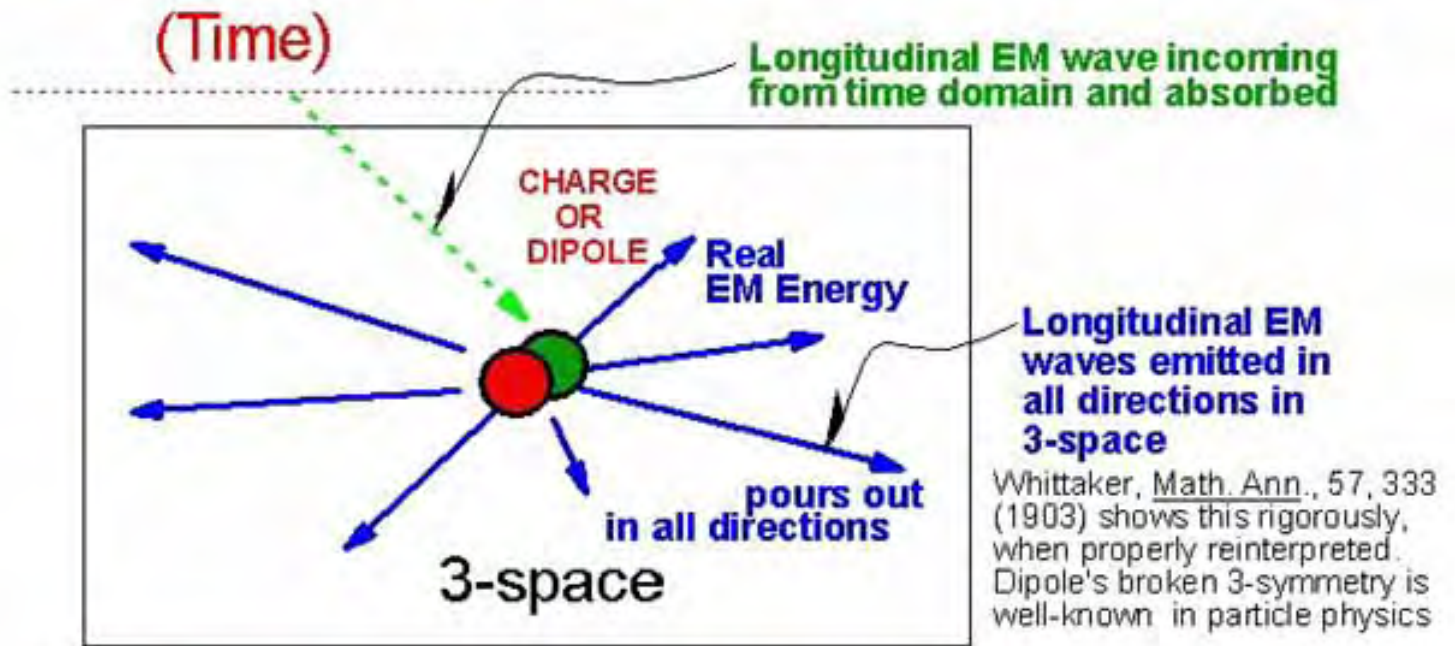

Note: Whittaker (and others) interpreted the phase conjugate half set of LWs after interaction with the charges of the dipole, and as a 3-space effect rather than the time-domain cause. This fundamental non sequitur has just been repeated since then.

Figure 19. All EM energy in the 3-space potential comes from the time-domain.

# THE IMMUNE SYSTEM

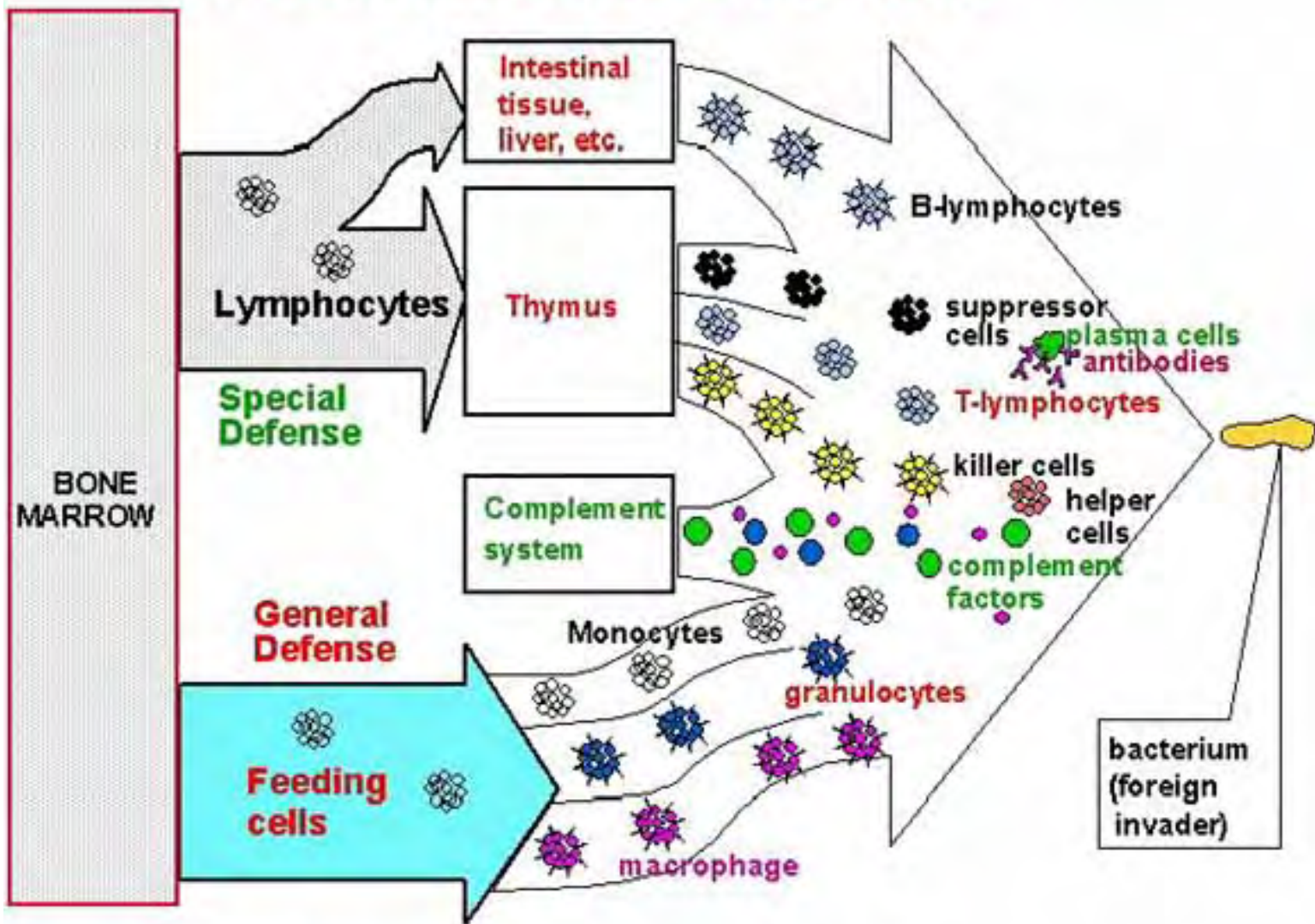

Figure 20. Immune system block diagram.

# Becker's bone fracture healing

- Tiny DC currents (picoamperes)
- Pulsed DC current can be utilized
- Pulsed magnetic fields may be utilized

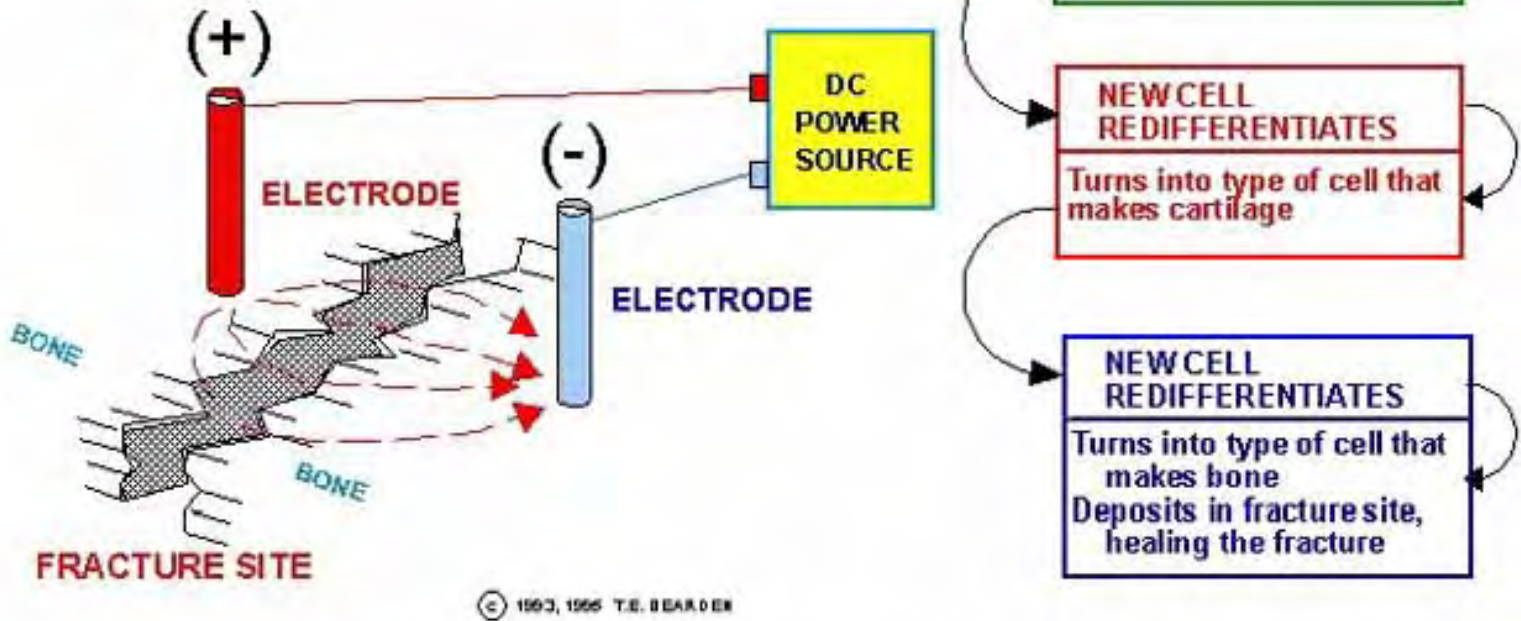
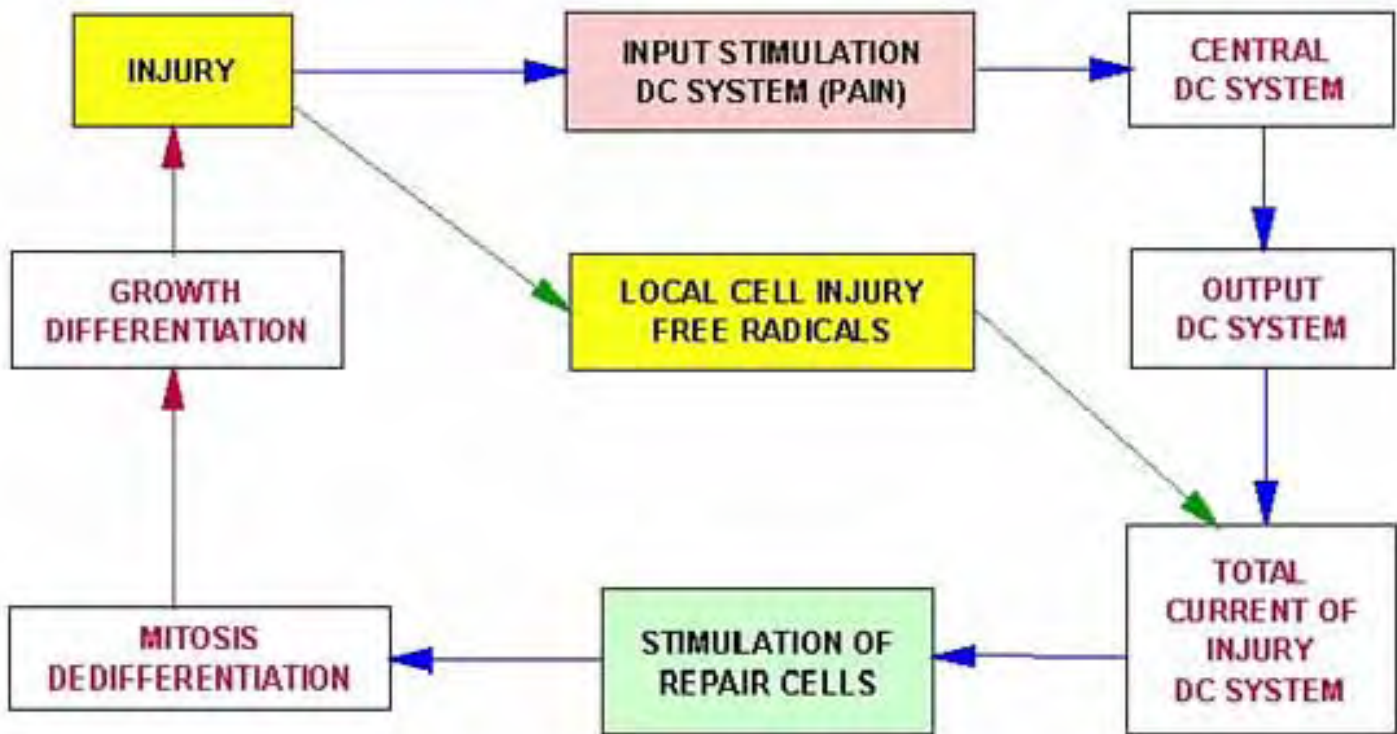

Figure 21. Becker's electrodynamic healing of otherwise intractable bone fractures, using weak potentials across the fracture site.

# Becker's theoretical DC control system involved with response to injury



\*Robert O. Becker, "The significance of bioelectrical potentials," *Bioelectrochemistry and Bienergetics*, Vol. 1, 1974, p. 191.

Figure 22. Becker's block diagram of DC control system involved with response to injury.

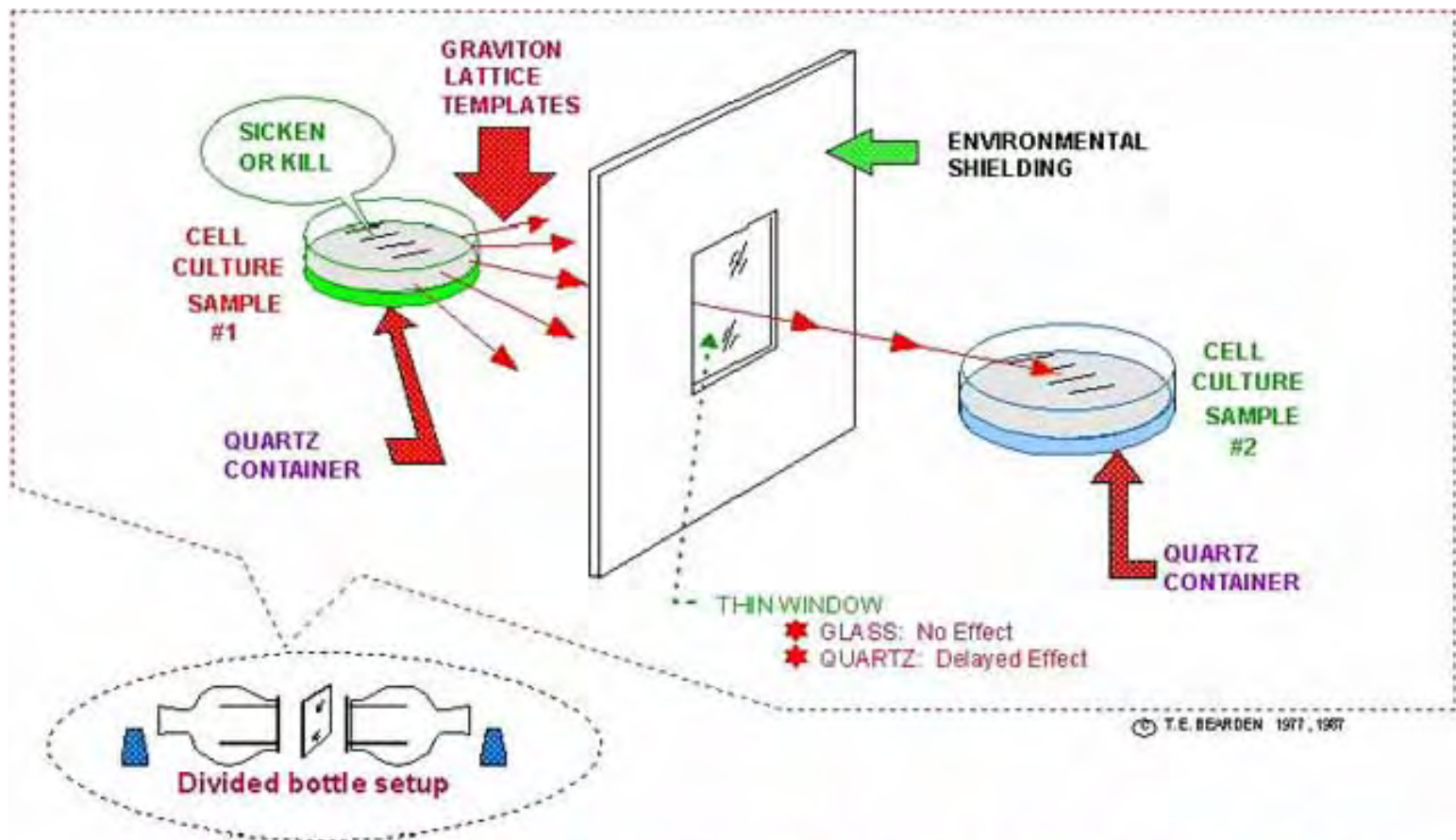

*Note: Minimum lattice is one harmonic interval: IR to UV is such a minimum G-lattice.*

Figure 23. Kaznacheyev's induction of cellular disease and disorder at a distance, using novel electromagnetic means.

## BACKGROUND

Former U.S. Embassy in Moscow.



- Began in latter 1950s
- Discovered on VP Nixon's trip
- Initially thought to be *nuclear* radiation (Discovered w/Geiger counter?)
- High level target -- U.S. Ambassador
- Guarantees personal attention of:
  - U.S. Ambassador to USSR
  - U.S. President
  - NSA, CIA, DIA, NSC, etc.
  - Top consulting scientists
  - Leading U.S. scientific institutions
- Two U.S. Ambassadors died, another sickened
- Anomalous health changes in personnel, only in zero-field (zero pot'l gradient) areas!
- Four U.S. Presidents requested Soviets cease
  - Cut from 18 watts/sq cm to 2
  - Then again increased
- No one could understand what was going on
- Aluminum screens were placed over windows
- Moscow was declared a hazardous duty zone

© 1995, 1997 T.E. BEARDEN

Figure 24. Russian "microwave" radiation of the U.S. Embassy in Moscow.



# Mechanism generating the flow of a mass through time

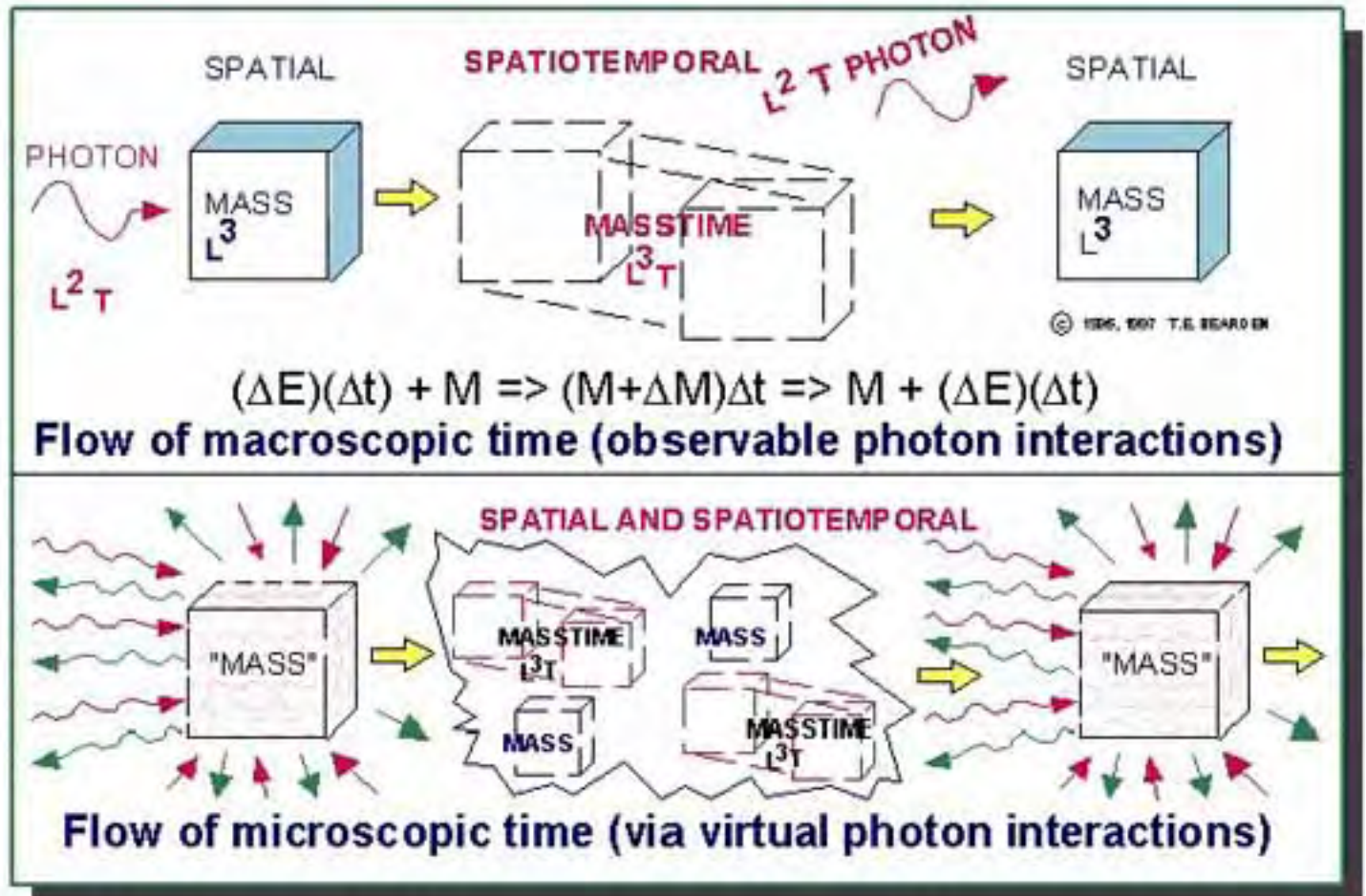
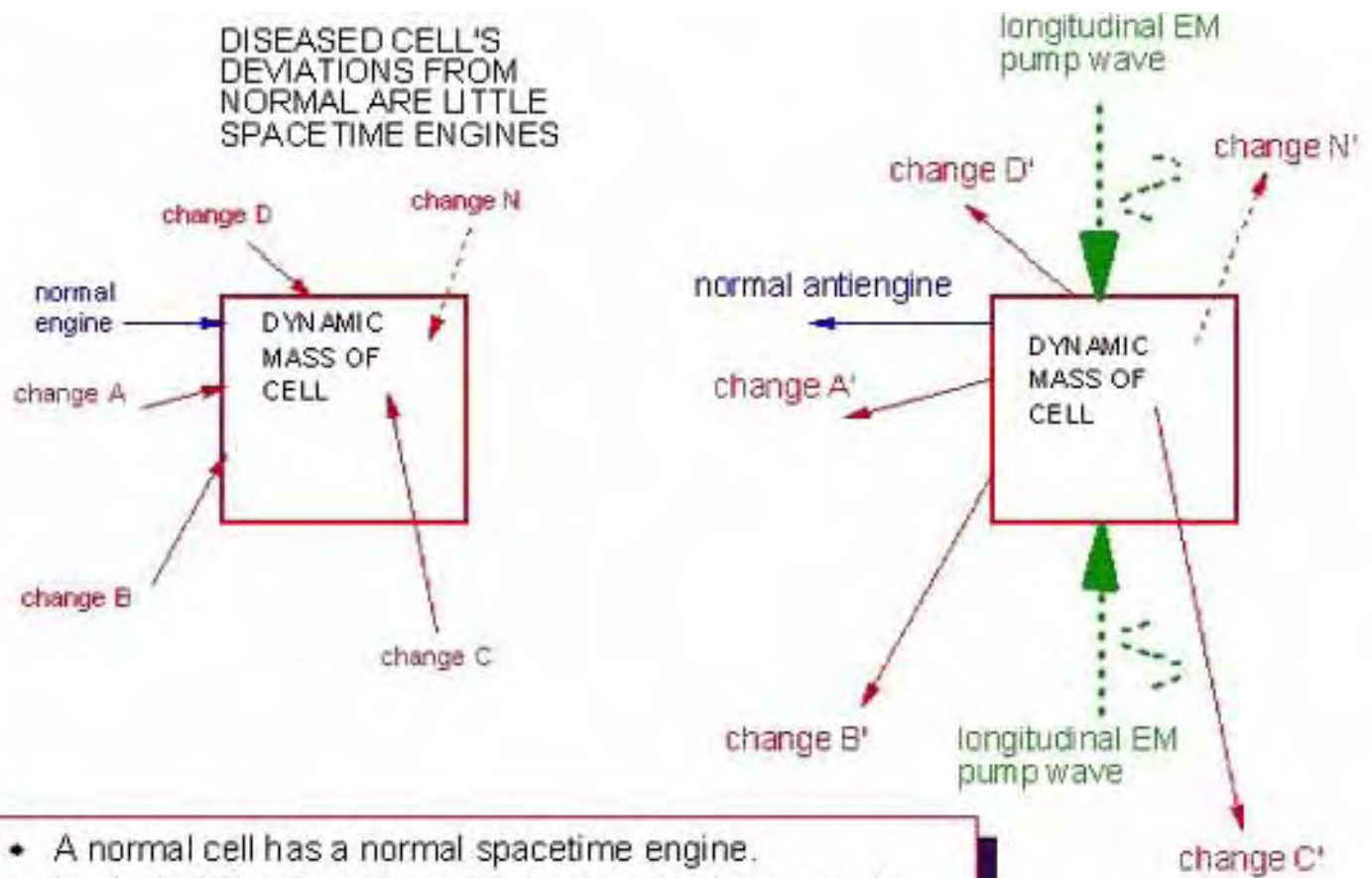

Figure 25. Mechanism generating the flow of a mass through time.



- A normal cell has a normal spacetime engine.
- Each deviation from the normal engine is also an engine.
- Pumping with longitudinal EM waves creates amplified antiengines for the normal engine and all deviant engines.
- This set of anti-engines precisely reverses the cell back to a previous physical state, prior to the deviations.

© T.E. BEARDEN 2001

Figure 26. Producing a specific anti-engine for a specific cellular disease condition.

# A DRAMATIC EXTENSION TO NONLINEAR OPTICAL PUMPING

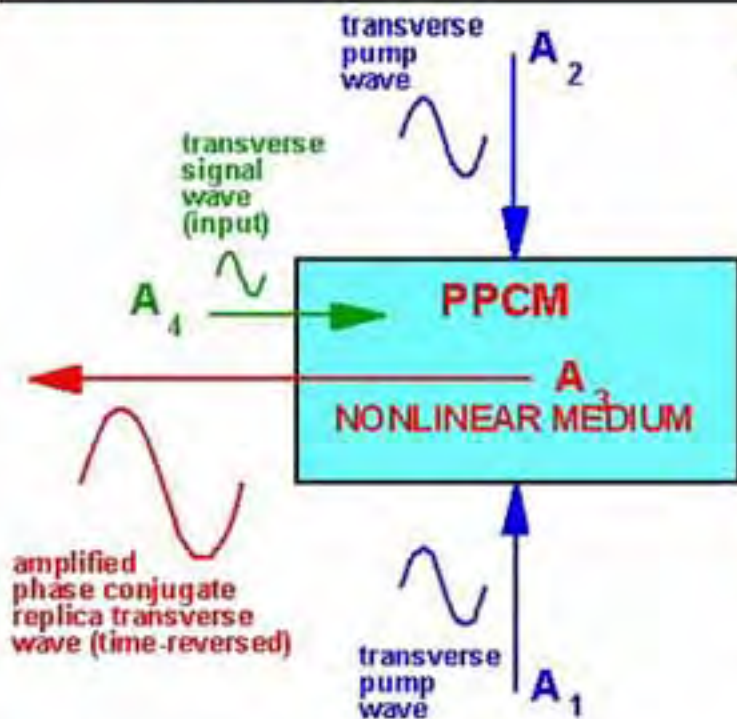

a. Pumping with transverse EM waves produces a time-reversed wave.

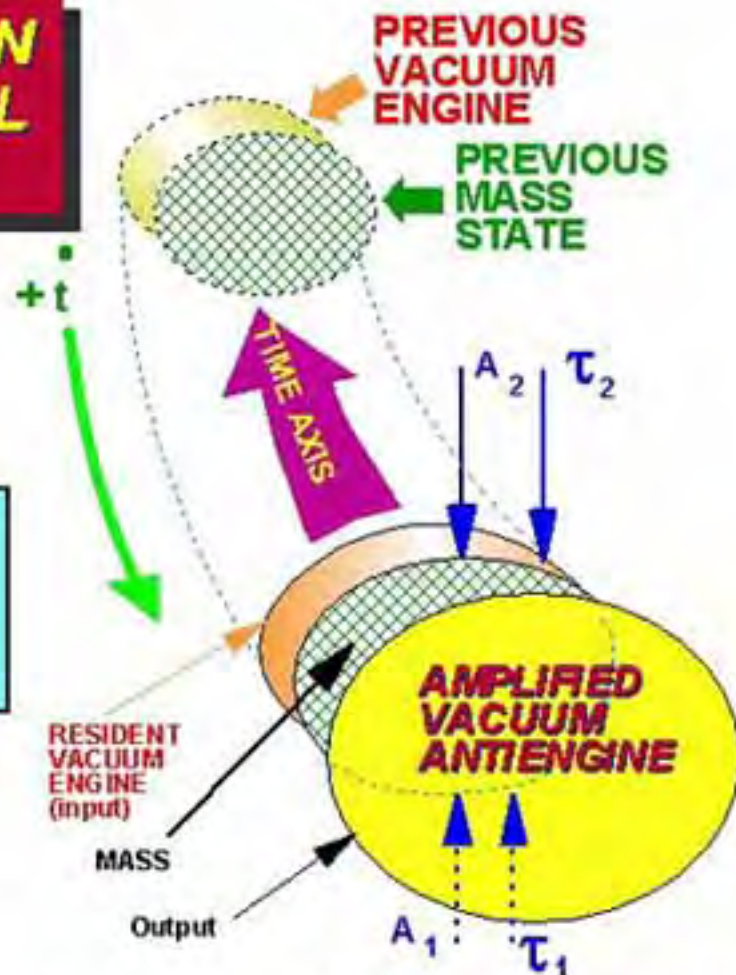

b. Pumping with longitudinal EM waves  $A_1$  and  $A_2$  time-reverses the mass itself.

Figure 27. Pumping with longitudinal EM waves  $A$  also pumps in the time domain with time-polarized EM waves  $\tau$ . This time-reverses a macroscopic mass and its dynamics.

# Prioré's therapeutic methodology

*Time-reverses the cells back to normal state*

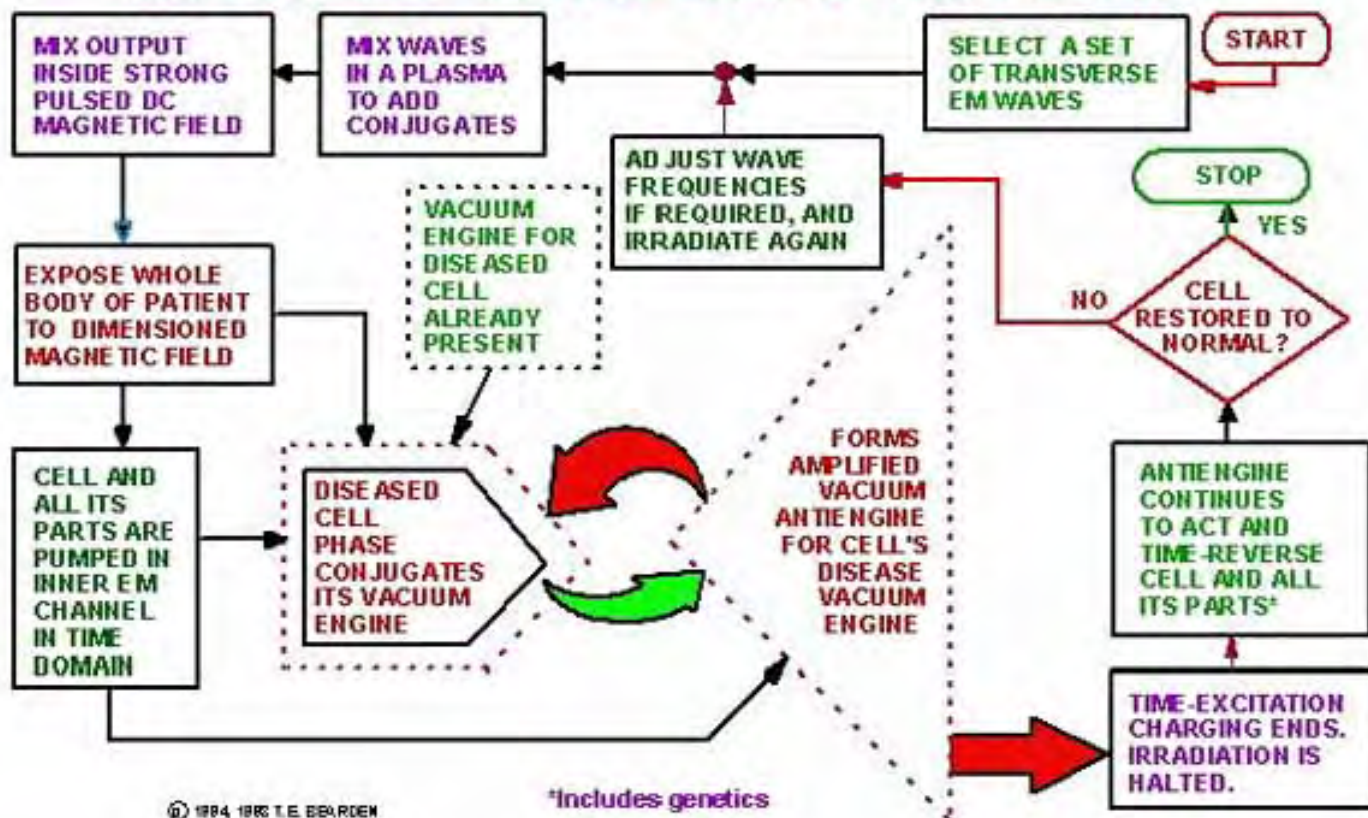

Figure 28. Block diagram of operation of Prioré's methodology.

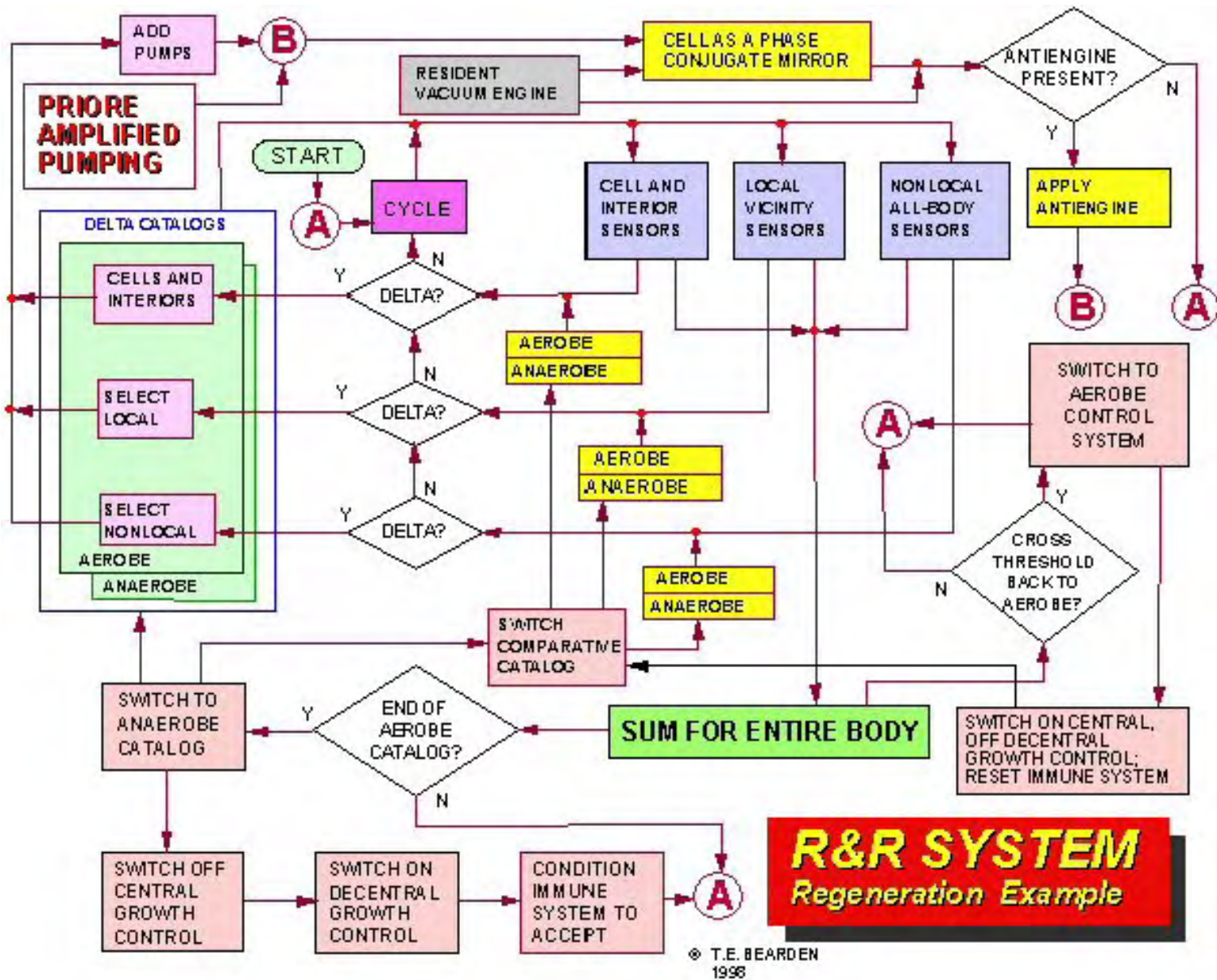

Figure 29. Block diagram of the cellular regeneration system and its overall operation (by the present author).

# Rife's great secret: Recursive magnification by iterative serial summation of vacuum engines

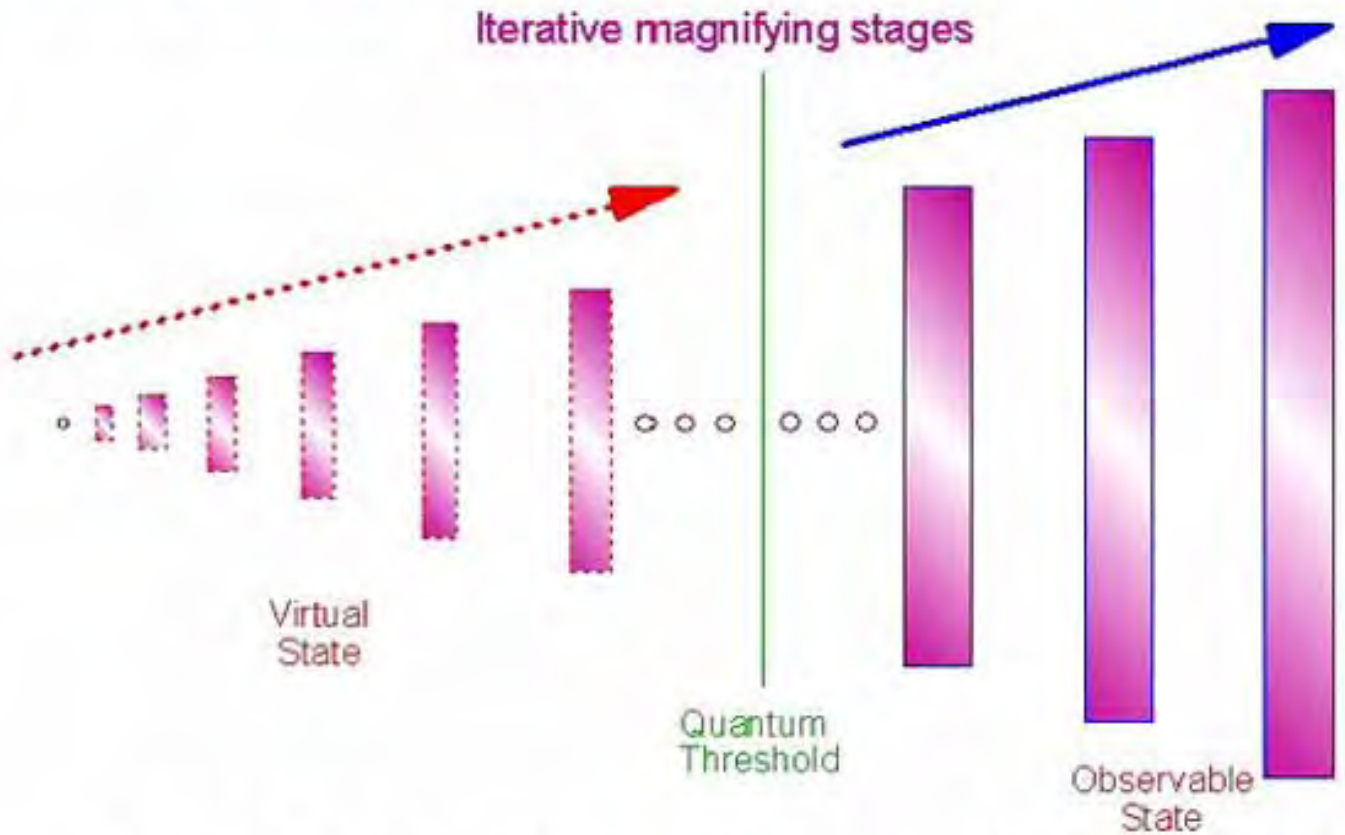

Figure 30. Rife's great secret: Recursive magnification of the virtual state vacuum engines and their dynamics to the observable state.