

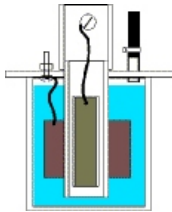

Creative SCIENCE

& Research

Copyright 2002 - 2004 Creative Science & Research



PO BOX 557 New Albany, IN. 47151 USA

Information Big Brother & the Oil Companies do not want you to know!

Fuel From WATER

PART 1

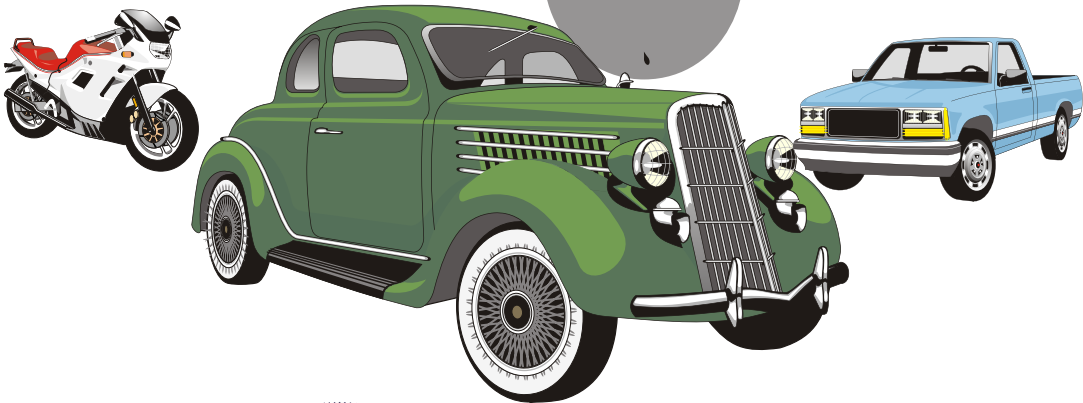

Time is running out

Run your car, truck or home generator with water!

www.FuellessPower.com



The Basic's Electrolysis Of Water

Try this simple and basic experiment to split water into flammable gases, Hydrogen and Oxygen. You will need tap water, an empty fish aquarium, 2 - 8 oz glass, 2, # 16 copper wire (insulated and bare at both of the ends), and Salt, baking soda or vinegar for the electrolyte. Fill the tank with tap water. As shown.

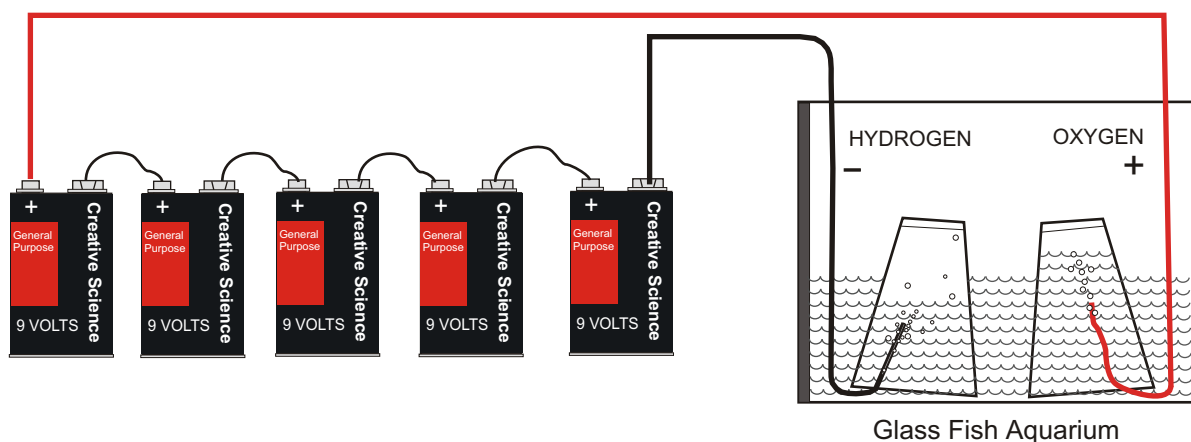

Glass Fish Aquarium

Add about one part salt or baking soda to 20 parts water(does not have to be exact), Stir well. Fill both glasses with the water and then stand them up straight in the water with a small tilt as shown in drawing. Connect the 5 batteries in series using alligator clips and wires from Radio Shack. You can use and experiment with higher voltages - vs - higher amperages, also try pulsing the positive on and off very quickly using a small hobby motor Switch set up. Solder a bead of solder to the end of motor shaft and use a micro switch, so as the motor turns the bead of solder on the shaft, It turns on and off the micro switch. Try different RPMS to find which works best, or I should say which RPM will produce the most Hydrogen in 60 seconds. You can make the process work even faster by connecting carbon rods from C- cell batteries to the ends of the wires in the glasses. When you connect the batteries you will see tiny bubbles of gas form on the negative wire first then the positive wire. The negative wire will give the most, it is the Hydrogen gas. As the bubbles accumulate, they will push the water out of the glasses. Again at the negative electrode there will be more accumulation of gas than at the positive electrode. The gas at the negative pole is hydrogen and the gas at the positive electrode is oxygen, pure oxygen. The electric current separates the molecules of water into two elements which are 2 hydrogen atoms and one oxygen atom. The process is called electrolysis. Electrolysis is an amazing even that still leaves me speechless thinking about how awesome atoms electrically work!

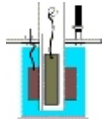

Free Energy from Water

Water can not burn unless the atoms that make up water are split into a gas(s).

H₂O: Water is made up of 2 parts hydrogen and one part oxygen. Hydrogen is the most flammable gas known to mankind and can be very dangerous if not handled right. You can run any type of gasoline engine on hydrogen and oxygen gas, Which would include your car, Truck, lawn mower, gas powered weed eater, airplane engines, etc....

An engines intake must first be redesigned to except the hydrogen gas fumes safely into the carburetor area without back burning, that is burning back into the hydrogen gas line or container and possibly causing an explosion or fire. There are a few safety rules, but once you get the hang of it Hydrogen can be safe to use. The safest way to use hydrogen is not to store it but to produce it on demand at the carburetor area.

Think about it, You simply fill your gas tank up with water instead of gasoline, the gas pump pushes it up to the carb area where it is first taken into a separation safety box, the hydrogen and oxygen is then separated and directed into the intake carb system, where it ignites (just the same as a gasoline vapor would) and causes the pistons to move and operate the car or vehicle.

We suggest that you first experiment, test and store small quantities in a propane tank and convert your small lawn mower engine first before trying to tackle anything bigger. *Always put safety first.*
Keep gas away from flames, sparks and static electricity.

If you are interested in running your car on hydrogen, you will need to buy a conversion propane kit or have a natural gas company convert your car to run on natural gas or propane. In many cities and states this has already been done and has been going on for many years. If I am right you should be able to run hydrogen through the gas valve system rather than using natural gas or propane. Make sure you have a shut off valve if you decide to run your car from hydrogen storage tanks, which we do not recommend, because it is highly explosive more than gasoline. It is best to study and build our Fuel from water part 2 which is simply a US Patent for car conversions etc.. We also recommend that you study how a propane or natural gas out door grill works before attempting to use hydrogen. Study all of the safety warnings in your outdoor propane grill instruction booklet as well. Take apart your grill and study how the output valve holes are made etc.. They have there own special design so that the gas does not back burn into the line or tank.

HOME GENERATOR SYSTEMS!

You may want to use the hydrogen gas to run a home generator system that you may already have or are looking to purchase to run your home. We recommend storage tank use in this case. As long as the Hydrogen storage tank(s) are well away from your home. The reason that storing hydrogen tanks in your car is a big No! No! Is because if a car should hit your storage tank area you are toast!

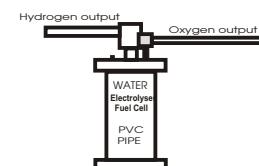

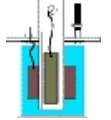

WARNING PLEASE READ FIRST!

Leaking hydrogen could cause an explosion! Make sure all lines are tight and secure before transporting the gas. Vent the newly made oxygen at least 30 feet or more from the hydrogen.

Keep all flames and sparks away from the hydrogen lines and electrolyser fuel cells when it is in operation. Do not smoke on or around project area. Make sure all electrical connections are well insulated with rubber or other insulating material. Keep gas away from static electricity, heat or flames of any kind! Keep work area safe for uneducated adults as well as children, meaning anyone who does not know gas safety rules as well as low voltage and high voltage safety rules.

You Build at your own risk. We are not responsible for anything in these plans.

Your local library should have more on this subject, Hydrogen gases, natural gases, Propane gases, we strongly suggest that you study all you can about how to store and assemble gas lines and storage tanks for these gases. Again Keep your Hydrogen fuel cell plant away from your home adults and children. Hydrogen is more flammable than gasoline or any other gas vapor that we know of in the entire world.

We thank you for purchasing these plans, it will help in our efforts in getting the good news of free energy to the open public (which are very blind to the fact that free energy devices even exist).

Fuel From Water (Part One)

How it works: Hydrogen can be made endlessly from water which the world has a far greater abundance of than it does fossil fuels. The oceans are full of water. There are many different methods in which you can use to produce and make hydrogen from water. Hydrogen fuel has been called the "Forever fuel!" When hydrogen is burned water is produced from the exhaust output of the engine or other. Water vapor is the main product of the hydrogen and oxygen burning event. If every car in America would use this endless fuel we would have no air pollution problems, The cancer rate would drop, our food products would taste better because of less pollution in the air which is destroying our farm foods, etc... Hydrogen can also be made from water in an endless water to fuel, fuel to water cycle... Hydrogen has the most energy per unit weight of any fuel in the world, about three times that of gasoline. Hydrogen is nontoxic and can safely be transported in pipe lines for home and industries. Hydrogen dissipates very quickly in the air which minimizes explosion hazards.

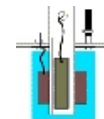

Fuel From Water

(Part One)

Hydrogen does have some disadvantages but when you compare it to any other, it is clean and an endless amount of fuel for any home or car owner. One disadvantage to using hydrogen is that it has a higher flameability rate when mixed with air than compared to other fuels. This means that it will burn at much lower concentrations than any other fuel. (*But as much as we love the fuel from water concept as a pure alternative energy source, we still strongly recommend the use of our Fuelless Engine as well as our Fuelless Gravity engine to meet your alternative energy needs!*)

More of the disadvantages of using hydrogen are in storing it. It is not good to store in your car or any other vehicle, but can be safely stored on your property away from your house to run a generator or to cook or heat your home with. Again the storing of hydrogen is more complex compared to other gaseous fuels.

Hydrogen has a low energy content on a volume basis. (about one third that of gasoline!) Storage devices are bulky. But a high flame velocity and low ignition energy give hydrogen an advantage in engine performance, but again presents special safety problems,. There are also other safety advantages, in general, hydrogen is no more dangerous than other fuels if proper storage and safety rules are followed.

Hydrogen makes up 90% of the atoms in the universe! It is abundant in space with an average of about one hydrogen atom per cubic centimeter, On earth the hydrogen gas makes up about 0.2% of the atmosphere.

But getting back to the point.....

How is it made?

Hydrogen can be produced by passing an electric DC current through water, (low or high voltages). This method separates the 2 hydrogen atoms from the one oxygen atom in the water, in a process called ELECTROLYSIS. Hydrogen on earth is chemically combined with other elements such as oxygen which forms what we all know as water!

About 2 billion cubic meters of hydrogen is produced in the USA every year by our government and industries as well as our customers. (*We have sold thousands of these plans*)

WARNING!

You can not copy or duplicate these plans in anyway shape or form! Without written permission from Creative Science & Research Copyright 2003 - 2004

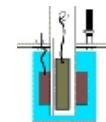

Splitting Water (Electrolysis)

Electrolysis is a process of producing hydrogen and oxygen by using DC electricity in water. Two hydrogen atoms and one oxygen are electrically attracted in a molecule of water (H_2O). When an electric dc current passes through water the chemical bond breaks down. The result is two positively charged hydrogen atoms and one negatively charged oxygen ion.

If two oppositely charged electrodes are inserted into the water and a current is passed between them. The negative oxygen ions migrate to the positive electrode which is called the ANODE, While the positively charged hydrogen ions are attracted to the negative electrode (The Cathode) Half as much oxygen as hydrogen is produced. Electrons are transferred from the anode to the cathode.

The electrical resistance of pure water is high But you can lower this resistance by adding one or all of the following to the water. A SALT LIKE SODIUM CHLORIDE, AN ACID SUCH AS SULFURIC ACID OR A BASE SUCH AS HYDROXIDE

Salts tend to corrode metals, platinum and phosphoric acid can be used together, but this is expensive, potassiumhydroxide with nickel-iron (**stainless steel**) **electrodes provides the best performance and cost**, 4 water molecules are decomposed into 8 positively charged hydrogen ions and 4 negatively charged oxygen ions. each oxygen ion then attaches to one hydrogen ion to form 4 hydrogen ions stay behind, each of them combine w/ 4 electrons emitted at the cathode to form 4 complete hydrogen atoms. Since hydrogen atoms combine in pairs the 4 hydrogen atoms combine into 2 hydrogen molecules (H_2). The 4 negatively charged hydroxyl ions are attracted to the positive electrode. The electrolyte allows the ions to be drawn to the anode by increasing the conductivity of the water.

Separators

Electrolysers consist of 4 things: a container, an electrolyte, an anode (The Positive Electrode), a cathode (The negative electrode), and a separator. The electrolyte consists of water and a chemical that you add to it to allow the conducting of current. You can use a salt or an acid such as in batteries, The current passes between the electrodes. The separator is placed between the electrodes. It allows the current to pass through but prevents the hydrogen and oxygen generated by the electrolysis process to mix. **If both of the hydrogen and the oxygen were allowed to mix during the electrolysis process you would be at high risk of an explosion, mixtures of between 4 to 75 hydrogen in air 4 to 94 of hydrogen in pure oxygen are explosive.**

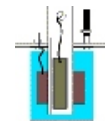

Electrolysers are designed with separators between the anode and the cathode to keep the hydrogen and oxygen from mixing and also to allow ions to be transferred in the liquid electrolyte, because of this the space between electrodes should be minimized, the separator should be made to withstand the liquids and not let the gases pass through it. you can use materials such as fiber cloth or rubber cloth.

Conventional electrolysers operate at temperatures of 167 to 176 degrees F with current densities of around 2 kiloamps per square meter, voltage requirements fall within 1.9 to 2 volts dc range. The required energy input is 4.8 kwh per cubic meter of hydrogen produced. A home-made electrolyser is about 50 percent efficient, A certain number of watt hours of electricity is converted into about half as many watt-hours of hydrogen. **ELECTROLYSER DESIGN** A good homemade electrolyser will cost you \$200 or less,

Directions

Use only Distilled water, chlorine in city water corrodes the electrodes, you can use rain water, or save the city water in a large container and let it sit for 48 hrs. The electrolyte is 20 to 30 KOH in distilled water. As a 2nd choice baking soda may be used, It requires 4 volts but is safer to use. Use 6 teaspoons per gallon.

Electrode material: stainless steel or nickel containing stainless steel, must be porous like a screen door. holes can be less than that like a car oil filter or such just to give you an idea,

Electric input: 3-4 volts per

cell, 3 to 10 amps. increased current increases gas output.

(*You may want to experiment with higher voltages! Use a plexi glass lexan wall to protect yourself*).

DRAWING 7 is a cross section of an electrolyser. (note you can make as many of these as you want, the more the better). drawing 7 shows the basic components of the cell. Note that a non-conducting sleeve separates the cathode from the anode, The 2 electrodes should have equal surface area. The sleeve prevents the hydrogen from combining with the oxygen. **The 2 gases must be kept apart to avoid an explosion hazard, Virtually any nonmetallic container may be used so as long as the gas is not allowed to build up with in the electrolyser and generate high pressure.** You can use a car battery as your dc source. warning: leaking hydrogen could cause an explosion, vent the oxygen at least 30 to 50' from the hydrogen.

keep all flames and sparks away from the electrolyser when in use. insulate all electrical connections to prevent sparking. If you experiment with higher dc voltages please be careful, test the maximum voltages one can use before being a hazard. use safety walls. protective eye and ear gear, wear rubber gloves when working with high voltage. It would be safer to start out using 9 volt batteries connected in series.

You build at your own risk!

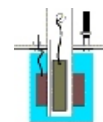

A One Cell Electrolyser

Splits The Water - Separates Hydrogen From Oxygen in Water.

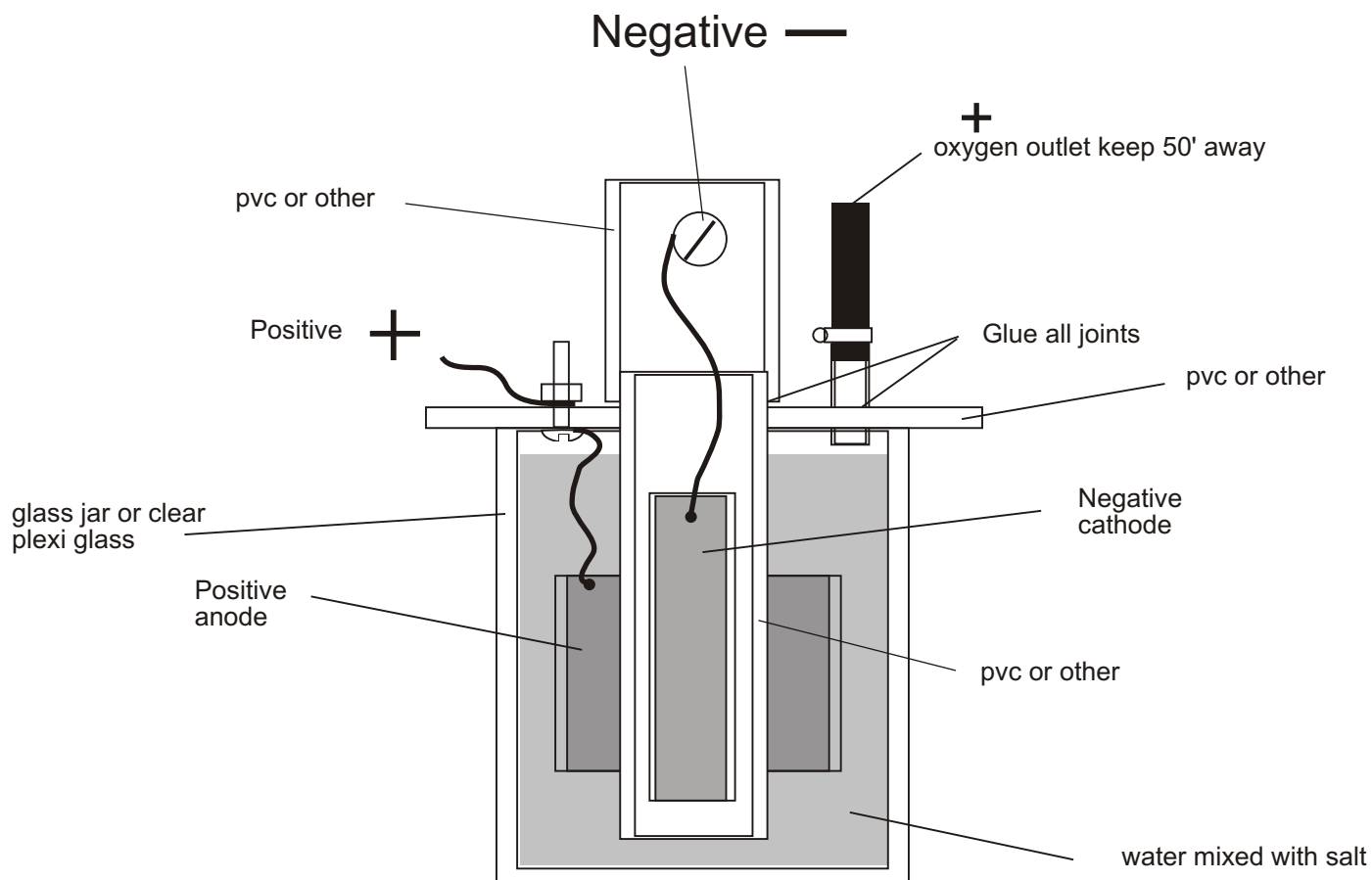

Drawing 7

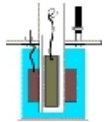

A One Cell Electrolyser

Splits The Water - Separates Hydrogen From Oxygen in Water.

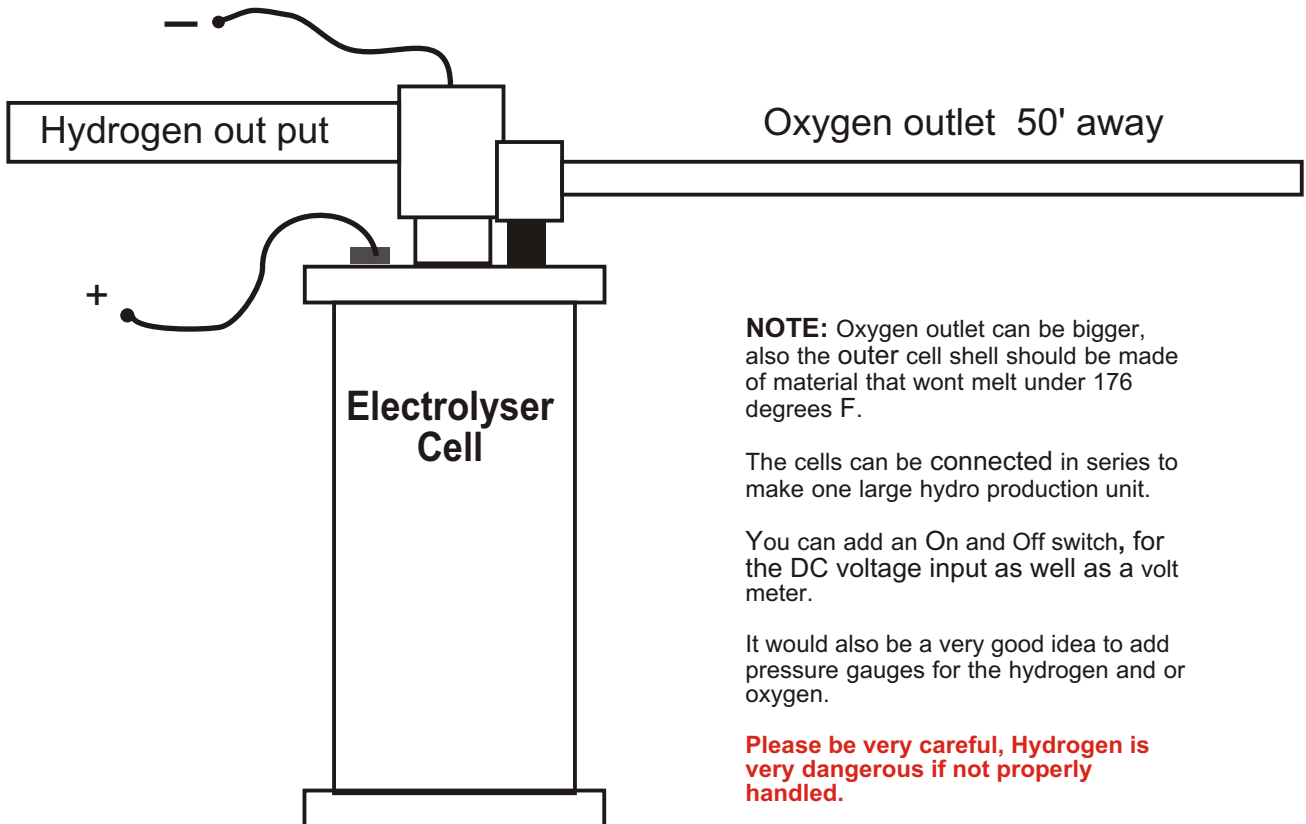

NOTE: Oxygen outlet can be bigger, also the outer cell shell should be made of material that wont melt under 176 degrees F.

The cells can be connected in series to make one large hydro production unit.

You can add an On and Off switch, for the DC voltage input as well as a volt meter.

It would also be a very good idea to add pressure gauges for the hydrogen and or oxygen.

Please be very careful, Hydrogen is very dangerous if not properly handled.

Keep away from flames, sparks and heat!

Drawing 8

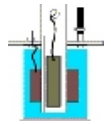

A One Cell Electrolyser

Splits The Water - Separates Hydrogen From Oxygen in Water.

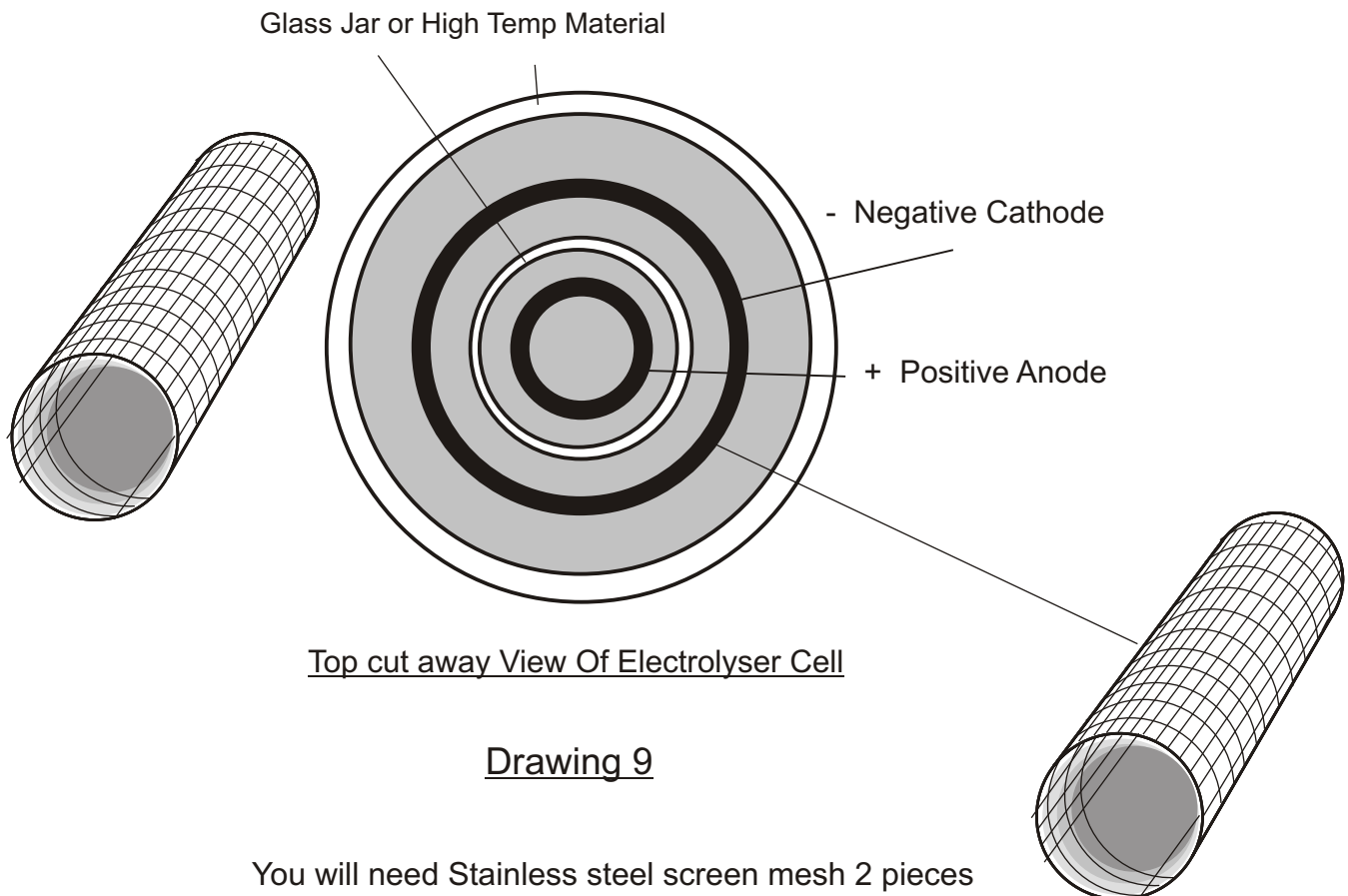

Drawing 9

You will need Stainless steel screen mesh 2 pieces of the same size and shape. It is best to use Stainless steel because it will not corrode. Screen can be purchased at:
www.SmallParts.com

For quick experiments, copper or steel screen can be used, If you use copper pipe drill hundreds of holes the the pipe.

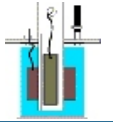

Supplies

Polyimide (For short term testing)

When thin walls, tight tolerances and high strength are required, Polyimide is the material of choice. Polyimide is in the select group of "super polymers" and is now available in micro and miniature tubing sizes from Small Parts.

Our tubing has a thermal rating of 450°F (220°C) for continuous use application with a dielectric constant of 3.4. This material is considered a benchmark for polymers in electrical insulation applications. This tubing exhibits exceptional dimensional stability and has very high burst pressure ratings. Excellent column strength and high stiffness has proven to provide good push and torque properties making polyimide tubing an excellent choice for catheters that are guided through the body's vascular system.

Other uses include high strength, temperature and chemical resistant push rod tubes, and miniature structural matrices. This tubing can be steam, gamma or EtO sterilized and has excellent chemical resistance. Polyimide tubing can be bonded with cyanoacrylates, UV and room temperature cure epoxies.



Www.SmallParts.com

Polyimide may be great for Temporary test gas outlets. For high pressure and longer lasting gas lines use natural gas steel pipe Source: Hardware store



Shut off valves etc.. From..... Source: www.SmallParts.com



Glass or plastic mason jars are great for cell containers. If you use glass the top must be drilled by a glass cutter. Metal tops or plastic tops maybe much easier.

Source: www.ebottles.com www.specialtybottle.com or your local hardware store.

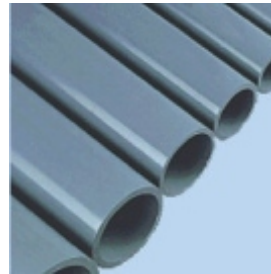

Polypropylene pipe Sch 80 May be great for center anode cathode separator.

Www.usplastic.com 1-800-809-4217

2" diameter \$3.46 per ft #32035

rated at: 180 degrees F

Or your Local hardware store might carry PVC hot water pipe. We never have tried the hot water pipe but it should work. Rated at: about 170 degrees F.

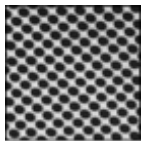

PMX-045

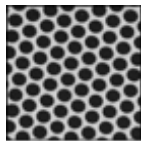

PMX-062

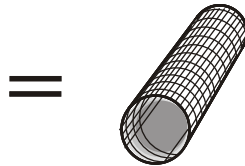

PERFORATED METAL / Stainless Steel

As a screening medium, Perforated Metal has many advantages... Its holes are accurate and uniform in size, shape and spacing... Its surface is smooth, firm, easily cleaned and sterilized.

In general use, perforated **Stainless Steel** is not only decorative, but is strong and corrosion resistant for shielding, ventilating and acoustical work of many kinds. Stainless Steel Type 304 requires very little maintenance.

Supplied 12" wide in one and two foot lengths. Larger sizes available. For a quotation call 1-800-339-2116

Source: www.SmallParts.com



Construction

The better the seal and amount of pressure your cell container can take the better, You can search the web for industrial containers as well. I do not see why a person could not use a stainless steel container, which would be your Positive plate, and use a stainless steel mesh or porous plate for your Negative Cathode. Remember the higher the voltage the more space is required between the plates, you do not want to get an arc or spark of any kind inside or outside of your cell. For testing purposes lets construct a small mason jar container and PVC type cell.

The following mason jar fuel cell has not been fully tested and could leak, it is only for test purposes only.

MASON JAR FUEL CELL

Lets start with a ½ gallon mason jar, you can purchase them at your local Hardware store, if not go to www.Masonjars.biz or use a search engine to search for keywords: Mason Jars.... The top is made of thin metal and is best if you cut out an extra piece of 1/8 steel or metal and glue to the top of the lid with special lock tight metal glue or 2 ton epoxy comes in 2 parts, be sure to sand off any paint from the jar lid so the glue will stick to the lid. Now all you need to do is to drill 3 small holes, a qty of 2 - to about 1/4 or ½" in diameter, (It is your choice what size air or gas fittings you want to use), to fit your gas fittings. these fittings can be purchased at any hardware store. They are like bolts with threads on the outside for the nuts and the inside is hollow for the gases to flow through, your gas tubing will fit here. Simply think of this cell in the way of producing natural gas, and that being the case, your local hardware store will have many parts readily available, designed for natural gas, such as fittings and gas flexible tubing etc... When attaching your fittings to the lid be sure to use: "clear Silicone 2 sealant" to seal all cracks. Cut PVC high temp pipe to the length of your mason jar being sure to leave about a 1" space at the bottom. Cut PVC 1/8" thick -O Rings the same inner diameter as the pipe and glue them one on each end, The -O rings are to keep your metal mesh in place. Now cut about a 2" Diameter piece of 1/4" PVC sheet or to the exact inner diameter of the top of the mason jar. (It must fit very close and tightly.) Now at this point you will need to center and glue your PVC high temp pipe to the 2" x 1/4" diameter PVC sheet. Once dry, drill 3 holes to fit your fittings. You can use one long center fitting for the neg or drill and glue a small ½" PVC pipe to the center and up through the outer metal lid. Remember all cracks must be glued! Now guide your Negative wire with a small alligator clip on the end down through the ½" PVC and attach to your metal screen. The screen is very easy to make, simply cut the amount you need and roll it up and fit it into the inside -O rings of the 2 " high temp pipe. You can glue the PVC sheets to the glass using the Silicone. See Drawing 10 on the next page, hopefully it will help you a little more.

The positive metal mesh can be done the same way as the neg or can simply hang loose inside of the jar. (it is best to secure it) Now attach all your wiring and your positive wiring post and connect both gas tubing to your gas outlets and secure with hose clamps.



Mason Jar Cell

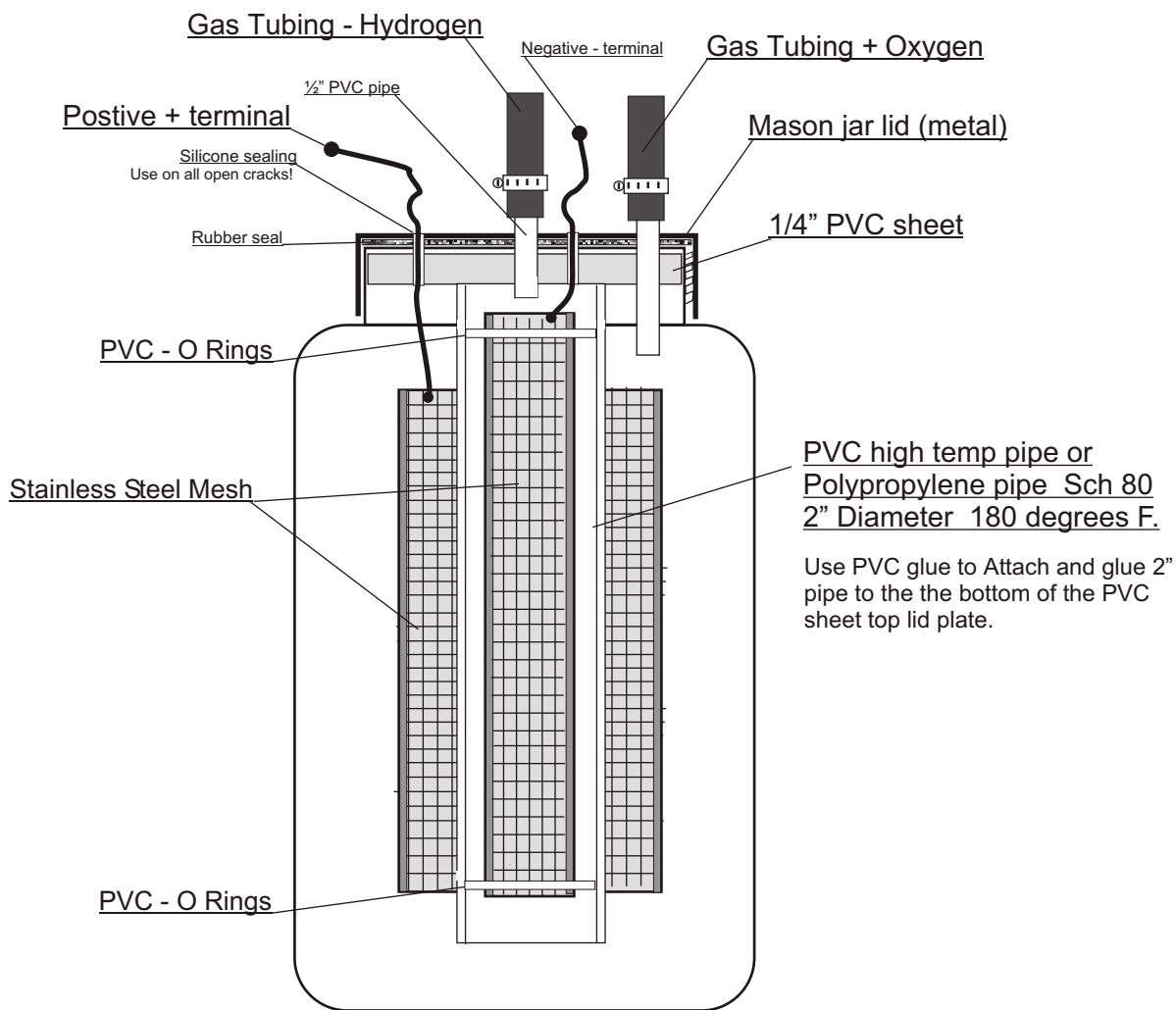

For low gas pressures



Model 78B Cell

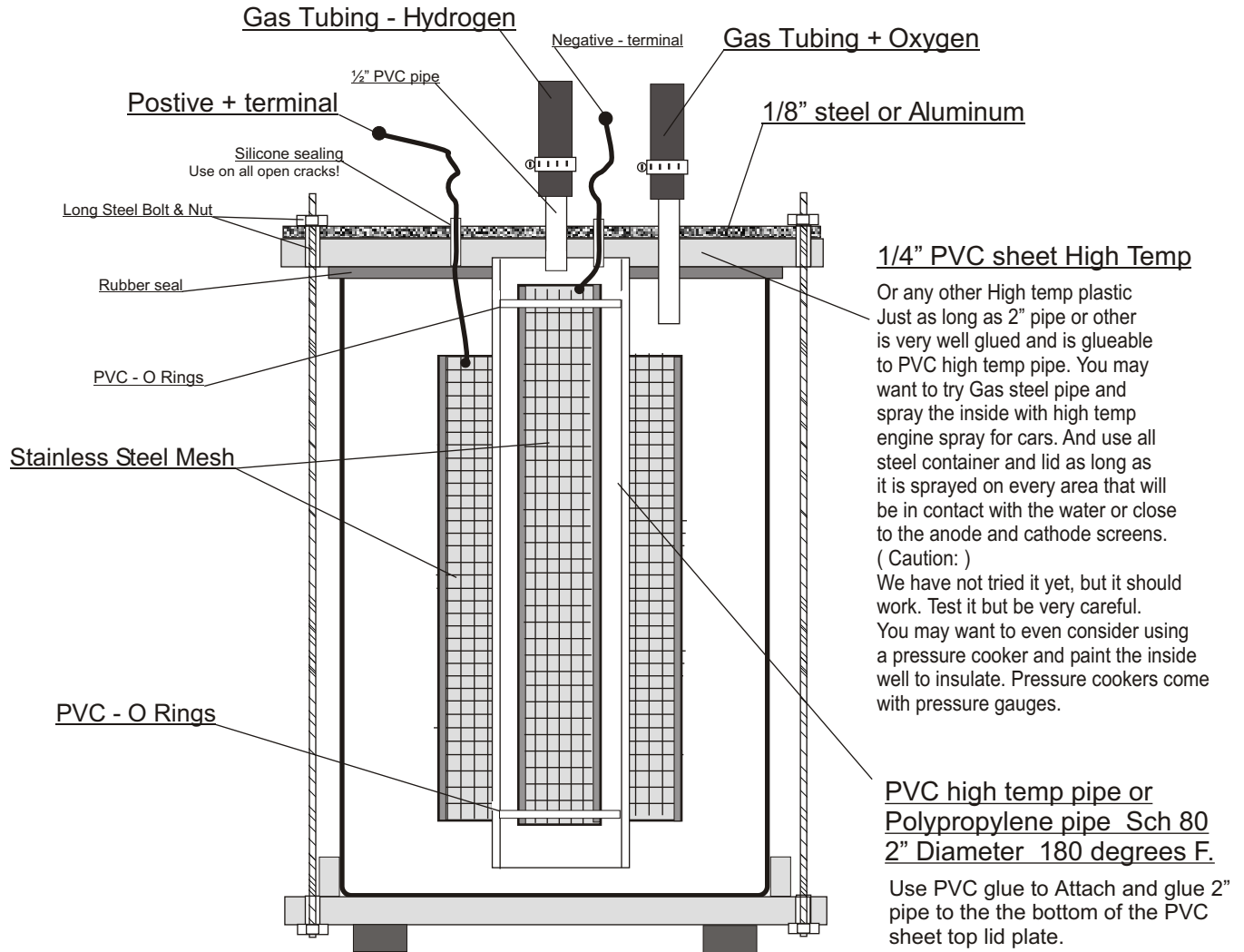

For Higher gas pressures

"Please notice we have not experimented much at all with Fuel from water, but we have bench tested small cells, We have been involved in other free energy projects of research and development!... Anyway, when you have free energy electric motors it's hard to get motivated to work on Fuel from water, **The use of hydrogen as a energy alternative is way behind the times.**"

Thanks
"Dave Waggoner"



Model 78B Cell

NOTICE! You build these models at your own risk! Even though we have engineered and designed them, we have not yet tested them! They should work. Any feed back or finished photos you would like us to share to our customers please send them in. We can use your name if you like to give you the credit. We are always looking for other researchers that we can trust to work with us.

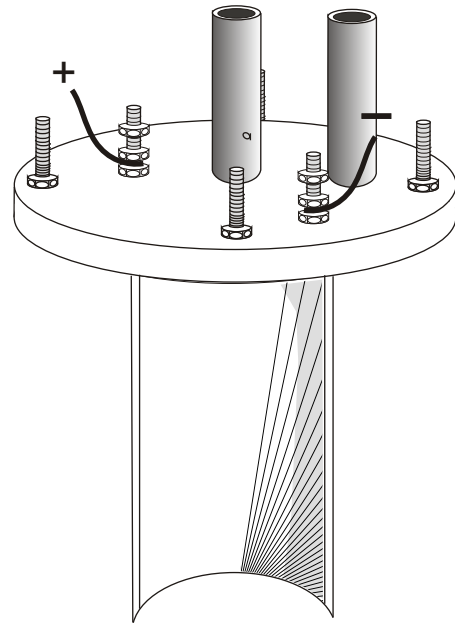
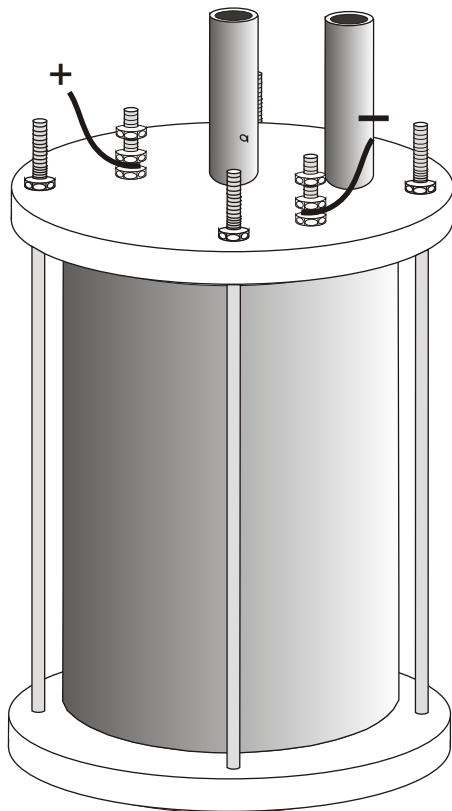

Cut away view of 2" D PVC high temp pipe

For Higher gas pressures



Adding the Electrolyte

The Electrolyte is the water and baking soda mixture or what ever you choose to use, If you don't have an Ohm Meter than get one. With your Ohm Meter you will need to measure the electrical resistance of the electrolyte. Add your baking soda or potassium Hydroxide until the resistance equals 0.3 ohms, or a 30 % solution. Which ever comes first. PLEASE NOTE THAT THE HIGHER THE CURRENT YOU USE FOR YOUR CELL THE LESS ELECTROLYTE YOU WILL NEED TO USE IN IT. (add less baking soda.)

WARNING: When the electrolyser (cell) is first used, Hydrogen and Oxygen may be mixed. Discard the first hour's production.

WARNING: Place the electrolyser at a safe distance from habitable buildings. Change the electrolyte every 1,000 hours of use. Ground all circuits. Keep feet dry when touching the electrolyser.

OUTPUT: At 100 efficiency/ and at 12 volts and 40 amps/ 480 watts (0.6 horse power) per hour of hydrogen fuel is produced, efficiency is usually about 50% This means that output is one-half of what it would be if the unit were 100 % efficient,

The design on page 6 may be scaled up for higher output by increasing the height and width of the electrolyser container, The area of the electrodes, or by increasing the number of cells. Larger designs that use higher current may use cooling fins around the celts so that a blower may dissipate the heat more rapidly to avoid damage to the electrolyte materials.

If 115 volts AC is used for electrolysis/ Then a transformer and a diode rectifier must be used to change the AC house current to DC current and to step it down to 2 volts with boosted amperage. Using an independent source of electricity such as one of our fuel-less engine's / generator or a solar panel system. The electrical out put can be 100% efficient.

A HIGH PRESSURE CELL: The following is a description of a high pressure electrolyser. It is designed to operate at 485 degree's. The gap between the electrodes is 0.12 inch, It uses sanded nickle electrodes to increase surface area, 30 to 50 KOH electrolyte mixture and 1.7 volts per cell, The anode and cathode are made of metal screens covered with oxide ceramic. These are corrosion resistant and have a high hydraulic resistance with small pores. This feature eliminates the passing of large amounts of gas bubbles. Using higher temperature's such as this/ plastics can not be used/ they will melt. In these bodies and tubings the tubings are made of steel-lined with nickle because nickle does not absorb hydrogen as many other metals do. steel is needed for it's strength but it can not come in contact with the hydrogen, the electrodes are made of coarse screen.

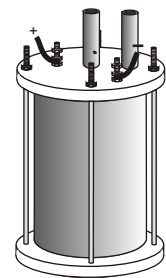



HYDROGEN fuel is being studied and applied in virtually every way in which conventional fuels are used, in domestic and commercial use for:

'COOKING * WATER & SPACE HEATING * COOLING AND REFRIGERATION "LIGHTING 'TRANSPORTATION * FARMING AND GENERATING ELECTRICITY.

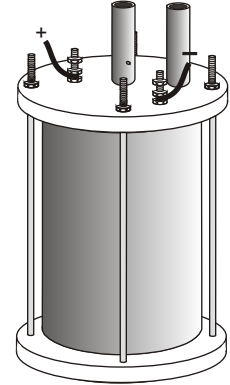

"In all these applications, it is far superior to conventional fuels and other synthetic alternatives more pick up and power for your car" " Dave "

With the demand for energy increasing world wide, 4 times faster than the population. New energy sources must be found, at Creative Science we have found that free energy is everywhere Solar Cell Technology is a wonderful source of free energy but our Fuelless Engine / free energy motor technology is the better source than both Hydrogen and Solar or wind alternatives.

If you don't have our catalog and you would like information on our fuelless engines then please write to us:

Creative Science P.O. Box, New Albany, IN. 47150

I'm telling you, GET THESE PLANS WHILE YOU STILL CAN! 1,000 of these free energy machines are already in secrete use by many back yard mechanics and scientist from all over the country.

To sum it all up: In this pref. discussion on hydrogen from water we have tried to give you a quick idea and look at the complexity and danger's of making your own hydrogen in your back yard. Yes it can be done and has been done by many, but why waste your time on it? (other than it can be a fun science experiment) sure you can make your own weather balloons because hydrogen is lighter than helium as well as many other fun projects.

Hope we have enlightened you on the subject of hydrogen. Many people and the government are trying to push the world into using it. Why? when we have Fuelless machines to give us free energy. Free energy devices have been suppressed for many years as far back as the 1900's. Nikola Tesla was one of the first to discovery it I believe. Will free energy be allowed on the open market soon? I do not know, but I do know that it must come slowly so we will not hurt our econmony. Free energy devices such as ours must be slowly introduced to the world by people like you, building them and keeping the information highly confidential!