

Efficient Power Supply Suitable For Inductive Loads

## **Engineering Report Gray Pat. no. 4,595,975**

by

**Mr. Gary Magratten**

26901 Ridge Rd.  
Willits CA 95490  
ph: 707-459-1435  
fax:707-459-9298

### **Table of Contents**

#### ***Introduction***

Circuit Section 1. Battery to the Transformer

Circuit Section 2. Transformer to Full Wave Bridge.

Circuit Section 3. From Full Wave Bridge; to the Capacitor#1; to the Conversion Element Switching Tube (CSET); to the Load; to the Capacitor #2 to the Battery.

Subsection 3A. From the Full Wave Bridge to the Capacitor#1 Subsection 3B. From Capacitor#1 to the Conversion Element Switching Tube. (CSET)

Subsection 3C. From the CSET to the Load to Capacitor#2 Subsection 3D. From Capacitor #2 to the Battery.

Circuit Section 4. Battery Charging Circuit.

Circuit Section 5. Chopper - Vibrator Circuit

Circuit Section 6. Low-Voltage Switching Circuit

Subsection 6A. Mechanical Switching

Subsection 6B. Solid State Switching

Subsection 6C. Laser Diode – Photo transistor Switching

Circuit Section 7. Conversion Element Switching Tube [CSET]

Circuit Section 8. Load.

Circuit Section 9. Spark Overshoot Device.

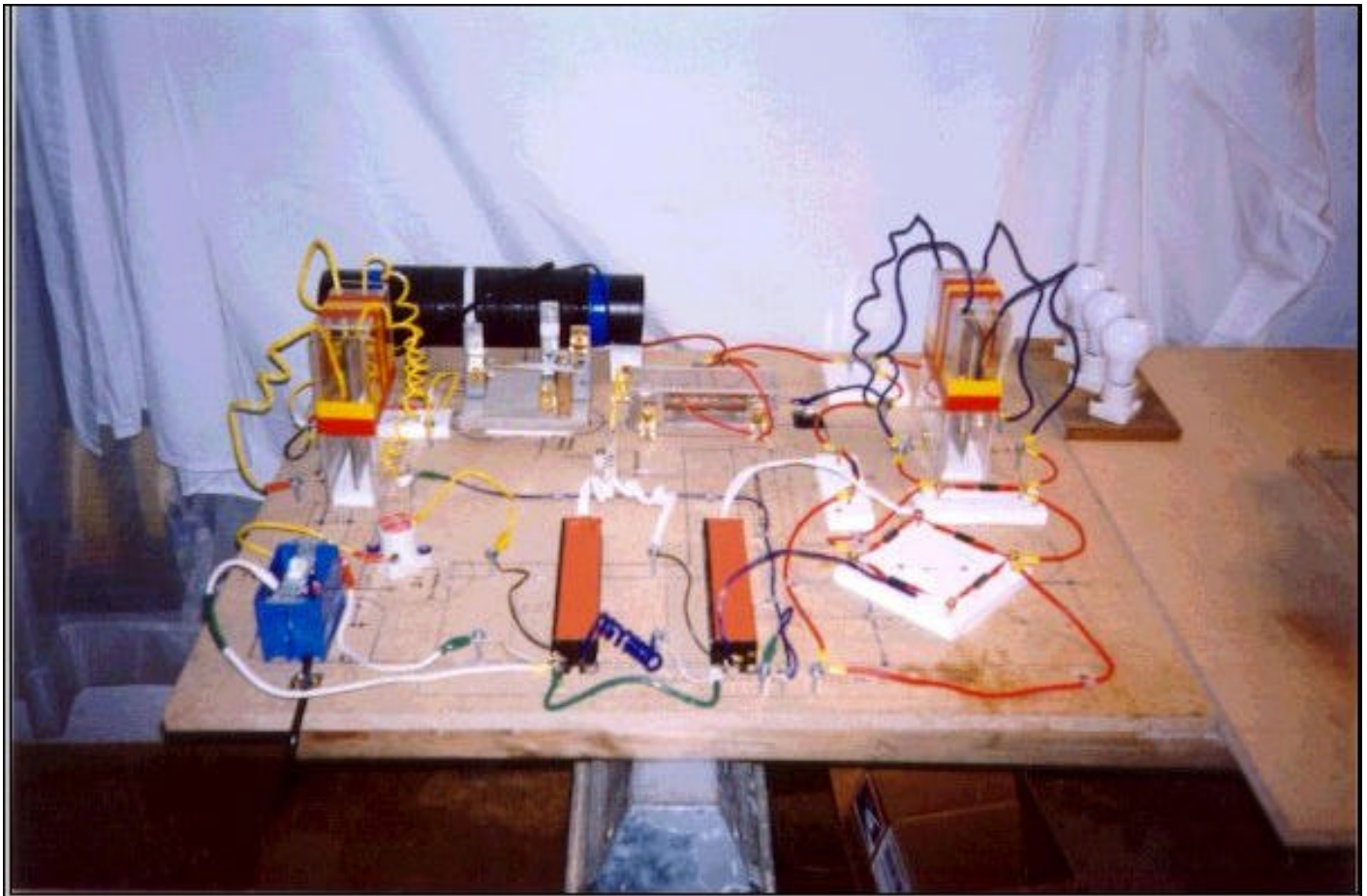

## INTRODUCTION

The purpose of this report is to provide the circuit analysis, working drawings, component specifications and component manufactures for Mr. Edwin Gray's patent number 4,595,975 - Efficient Power Supply Suitable for Inductive Loads.

This information is for **SCIENTIFIC RESEARCH** only in order to more fully understand the scientific principles demonstrated by Gray's pat no. 4,595,975.

In the spirit of open information and cooperation between scientist, researchers and business professionals, this information is open to the public and may be reproduced and distributed by anyone for the purpose of providing scientific research information

**WARNING! Gray's Circuit pat. no. 4,595,975 contains a very HIGH POWER CAPACITOR**

**that is DANGEROUS! Experimentation with this circuit requires at least the formal education of a licensed electrician. If you perform research with this circuit,**

**YOU DO SO AT YOUR OWN RISK. Follow all standard safety precautions and use a proper laboratory to conduct testing.**

**If you follow the instructions, the circuit will work. I have confirmed this with actual test runs. It is my sincere hope that clean, efficient means to generate electricity will evolve from this information for the benefit of everyone. Mr Gary Magratten**

A. 110 VOLTS AC.  
15 AMP

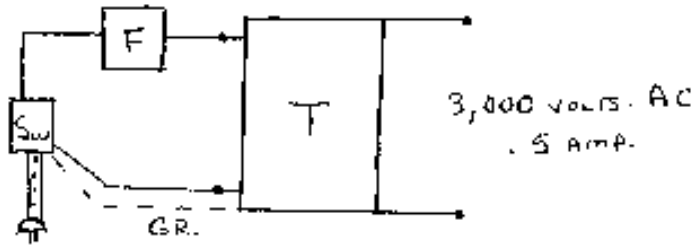

B.

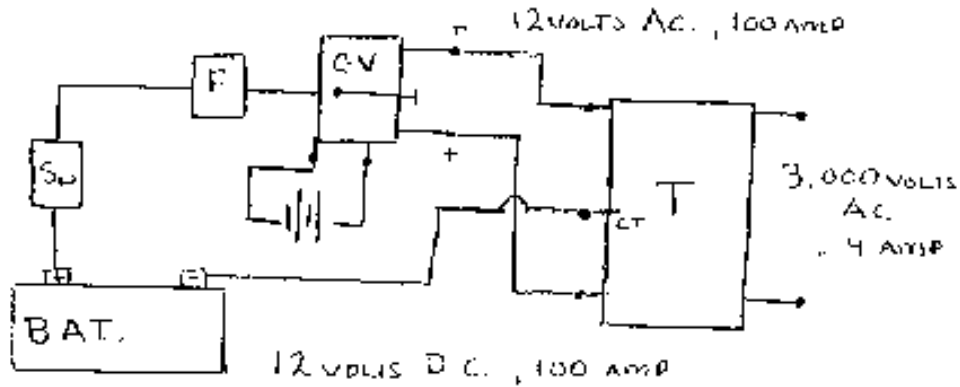

C.

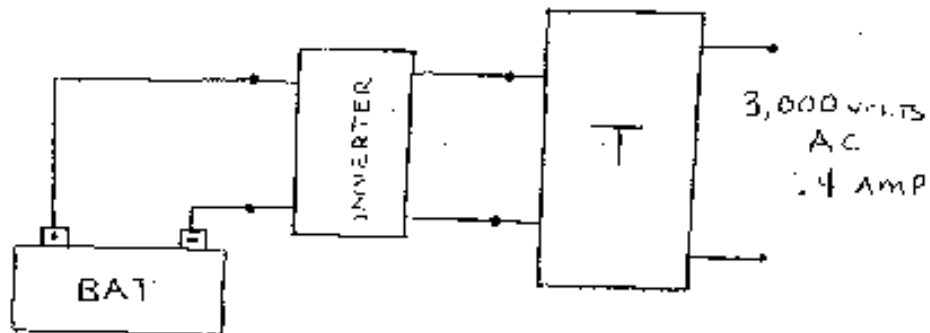

## **Circuit Section 1. Battery to transformer:**

The batteries should be deep cycle golf cart batteries, 12 volts and under 200 A hrs Use true deep cycle batteries. Automotive batteries are designed for high current for a short period of time. Deep cycle batteries provide steady current and can handle repeated recharging. A deep cycle battery rated at 200 A hrs should deliver 10 amps of current for 20 hrs.

There are three ways to accomplish this section of the circuit. Working drawing no.1 show all three ways. First, and easiest for research is the use of 110 AC house current at 15 amps to the primary of a transformer and a 3,000 volt, .5 amp AC secondary. The second is a 12 volt battery, DC, to a chopper-vibrator which produces 12 volt AC for the transformer. The design of the chopper-vibrator will be described separately later. This requires a special transformer with a 12 volt AC at 100 amps to the primary. The primary side also requires a center tap. The secondary is 3,000 volts and .5 amps AC. The third, is to use a deep cycle battery 12 volts, 100 amps and an inverter to form 110 AC at 11 amps. The transformer should then be rated at 110 volts at 11 amps on the primary and 3,000 volts and .4 amps. Include a switch and a fuse into the circuit as shown on the working drawings.



**Circuit #2 - Transformer to Full Wave Bridge:**

From the secondary of the transformer there is 3,000 volts and .5 amps alternating current. The full wave bridge converts the alternating current to direct current pulses. Position the diodes of the bridge for a positive terminal close to the transformer and the negative terminal away from the battery. To build a full wave bridge you can use four diodes or a one piece full wave bridge unit. The rating of the diodes is 8,000 PIV (peak inverse voltage) and .5 amp forward current.

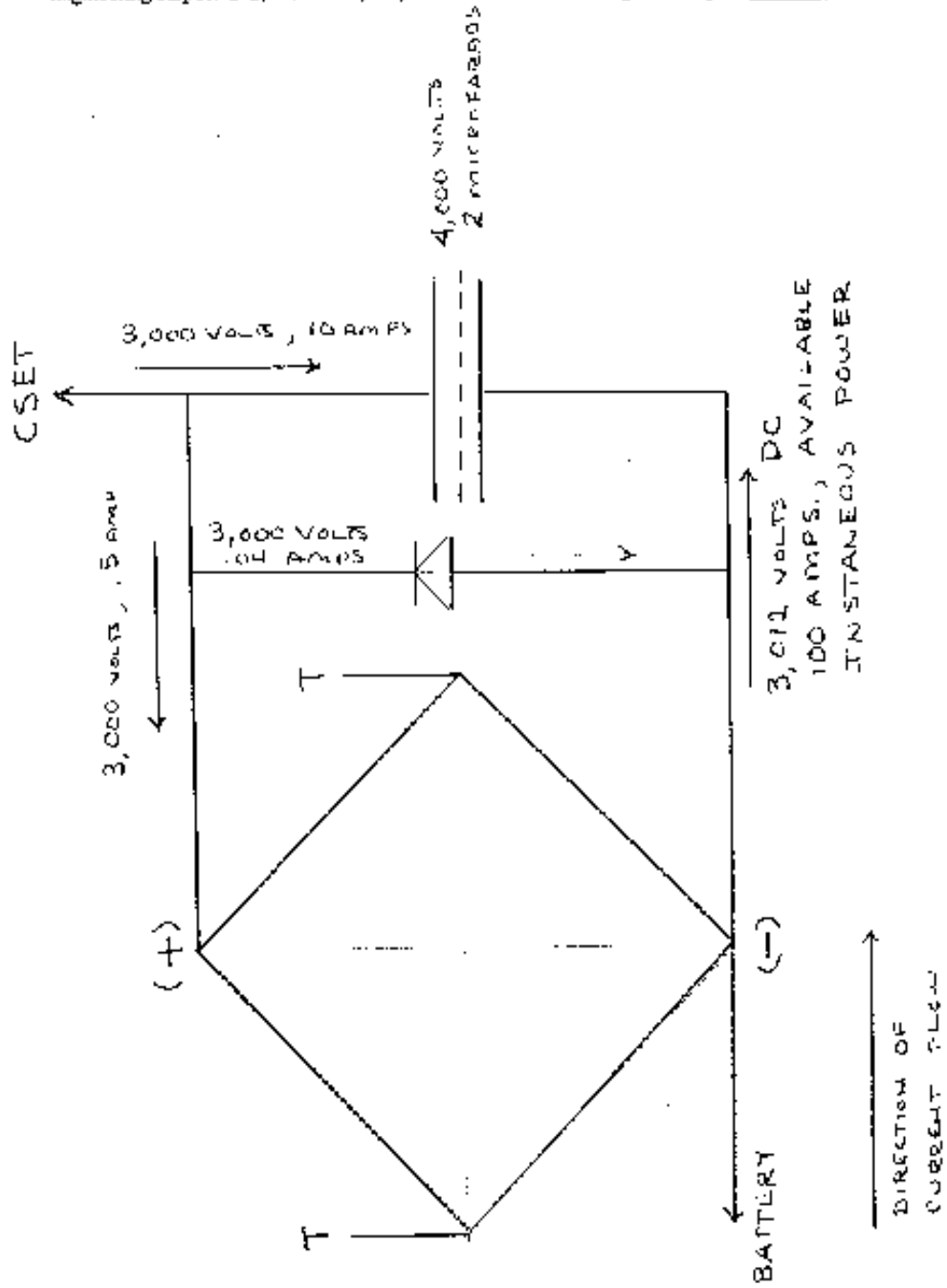

## Capacitor #1:

In subsection 3A the full wave bridge can be treated as a direct current source with a positive terminal and a negative terminal. The voltage available is 3,000 volts at .5 amps. The positive terminal of the full wave bridge is connected to the positive side of Capacitor #1.

The negative terminal of the full wave bridge is connected to the negative side of Capacitor #1. The positive terminal of the capacitor is directly connected to the high-voltage anode of the CSET.

The negative terminal of the battery is connected to the negative terminal of the full wave bridge. Then the negative terminal of the full wave bridge is connected to the negative side of Capacitor #1.

### **THIS IS VERY IMPORTANT. THE 3,000volts**

**.5 amp DIRECT CURRENT IS COUPLED WITH THE 12volt, 100 amps AVAILABLE FROM THE**

**BATTERY. THIS GIVES A 300 Kva CHARGE TO CAPACITOR #1. THIS IS VERY HIGH POWER**

and DANGEROUS!

I found this difficult to understand but the technical discussion from Mr. Richard Hackenburger ( Mr. Gray's electrical engineer clearly shows ZS6Kva of instantaneous power available from Capacitor #1.) Careful examination of the wiring diagram will confirm this statement. Pulses of direct current are built up (technically called RAMPING) on capacitor #1 to be available for the arc in the CSET.



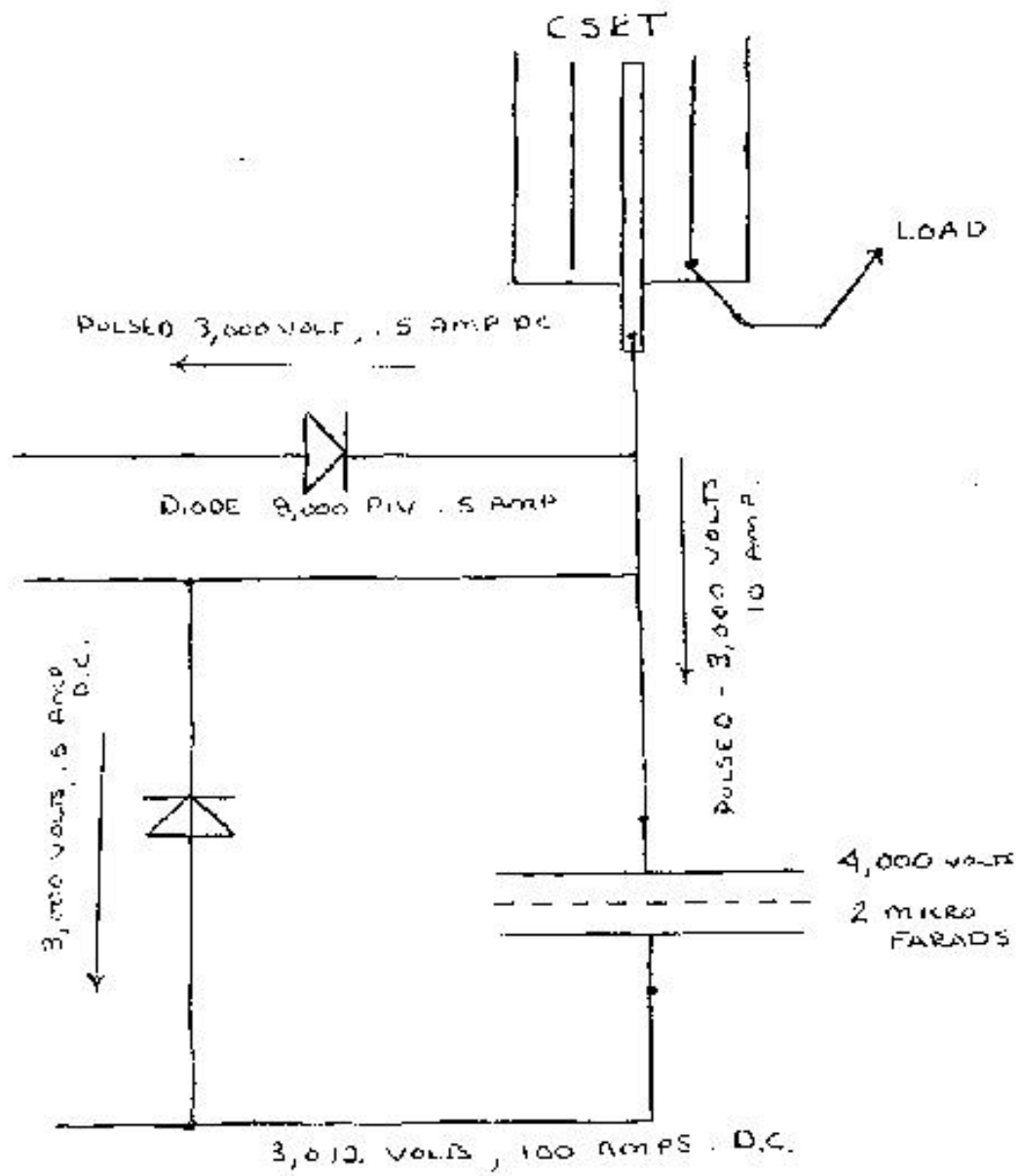

-----  
Capacitor #1 to the high-voltage anode of the CSET. The positive side of  
Capacitor # 1 is coupled directly to the high-voltage anode of the  
CSET. Use #10 stranded copper wire with standard insulation and electrical tape  
to prevent contact with this HIGH POWER section of the circuit. The high-voltage  
anode is 3/16" zinc plated steel rod. This will be discussed in detail in the  
CSET section.

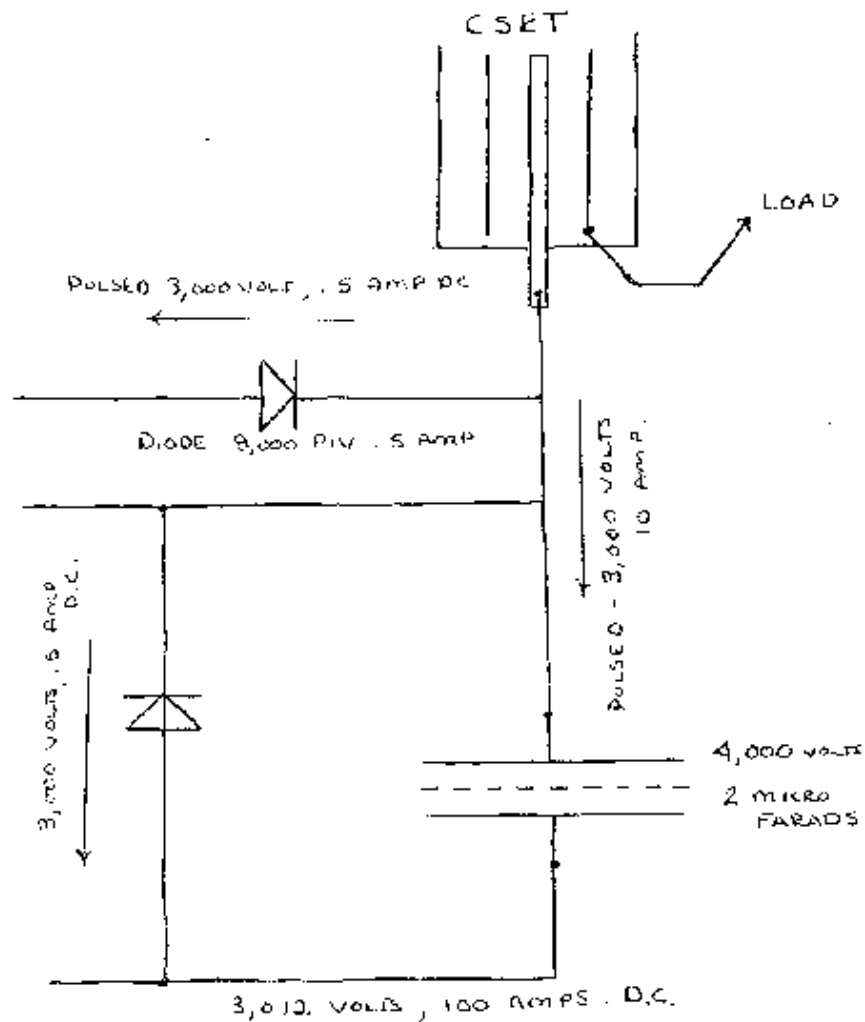

Circuit Subsection 3C. From the collector grids of the CSET to the Load to the plate of Capacitor #2.

**THIS SECTION IS UNUSUAL AND THEREFORE DIFFICULT TO**

***COMPREHEND, PLEASE HAVE PATIENCE!***

The wave form of this section of the circuit is very unusual. This may be what was termed "Cold Electricity". I have to do laboratory test to verify this explanation. Circuit Subsection 3C extends from the collector plates in the CSET to the Load to the Capacitor #2.

The LOAD and the CSET will be treated a separate subjects. The collector plates are exposed to the high-voltage anode 3,000 volt positive potential when the circuit switch on the low voltage side of the CSET is open. The 3,000 volt positive potential draws electrons to the collector plates from the circuit.

When the switch is quickly closed then reopened [.00005 sec] an ARC forms in the spark gap between the low voltage anode's available current and the high voltage anode 3,000 volt positive potential. When an ARC is formed it is commonly accepted knowledge that the atmosphere is ionized to form positive ions and negative ions[ free electrons].

When the ARC occurs, The Electrons Give Up Quanta or Photons of Electromagnetic Radiation. This is evidenced by the flame like discharge of visible light. This release of EMR or Radiant Event induces a current in the collector plates. This is the Photoelectric Effect to which the discovery is accredited to A, Einstien,

The ARC charges the copper tubes( collector grids 34A and 34 B ) at the end near the spark gap.

The charge moves down the tube to the wire that is located at the end of the

-----, -----  
Once again the switch is open and the 3,000 volt positive potential returns to the high voltage anode, and the process begins again. Think of the circuit that extends from the collector plates through the LOAD to the Capacitor #2 plate as a column of fluid in a pipe, that is first stressed or subjected to suction, then compressed by pressure, in a repetitive manner. in the same manner the circuit is stressed then compressed with short duration, high-voltage, high-current energy spikes.

A single energy spike is capable of repelling like charged electromagnets with great force. This is how the motor was powered.

As the instantaneous energy spike travels through the load an EMF is produced about the inductor, be they electromagnets or a transformer.

When the energy spike ceases, the EMF is absorbed back into the inductor and on to the Capacitor #2 which is a coupling capacitor in that it draws current from the positive terminal of the battery thus recharging the battery.

CAPACITOR #2 to BATTERY.

a) 3,000 VOLTS [ .25 ] AMPS

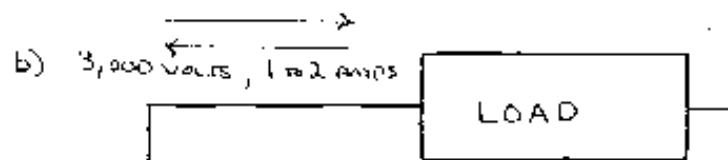

CAPACITOR  
4,000 VOLTS  
2 MICRO  
FARADS

plate C  
-----  
plate B

DIODE - 8,000 PIV  
.5 AMP

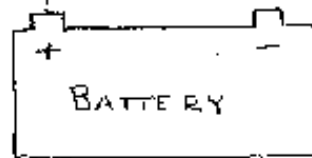

This section of the circuit extends from the plate of Capacitor #2 to the positive terminal of the battery. According to the patent the CEME is transferred through Capacitor #2 to recharge the battery.

**I am going to propose a slight change in the design. This is the only place where I deviate from the patent and the schematic as originally presented. [I would also like to state that during my efforts to reconstruct this circuit, I wasted a many hours trying to second guess the information and take short cuts. The message here is to follow the patent and the schematic, the device does work.]**

The change in the design is the introduction of a diode from one plate of the capacitor to the other with the forward current flow in the direction of the LOAD. **I have NOT TESTED THIS YET.** Here is the reason for the proposed change in the design. Capacitor #2 is a coupling capacitor in that it conducts alternating-current but blocks the transmission of steady direct current. For the sake of analysis let us say that pulsed direct current can be treated the same as alternating current with respect to the capacitor#2 in that the changing value of voltage and current are coupled through the dielectric.

When the low-voltage switch of the commutator is open, no power is flowing in the circuit. The high-voltage anode is at a charged state of 3,000 volts. This draws electrons to the collector plates from the plate of the capacitor #2.

The deficit of electrons on Plate C of the capacitor#2 becomes a positive potential. The plate B of capacitor #2 becomes negatively charged by drawing electrons from the positive terminal of the battery. **This is the same way a battery charger works.**

By introducing a high current diode from plate B to Plate C of Capacitor#2, a one-way-path is created for the current drawn from the positive terminal of the battery.

When the commutator switch is closed and power is flowing in the circuit an **ARC** is created from the low voltage anode to the high voltage anode. This **ARC** [EMR or Radiant Energy] is absorbed by the collector grids 34a and 34b.

This pulse of power induces a spike of energy [**high-voltage, high-current, short duration pulse** I through the wire back to plate C of capacitor #2, which had a positive potential.

The power pulse arrives on the plate C and distributes electrons on the plate. These electrons can travel no further than the plate because the diode prevents the transfer of electrons to plate B.

The commutator switch is opened and the high-voltage potential returns to the high-voltage anode of the CSET.

The cycle repeats itself and electrons are drawn to the collector plates by the high positive potential of the high- voltage anode. The introduction of a **HIGH CURRENT DIODE** from plate B to plate C creates a one-way-path for current to be drawn from the positive terminal of the battery to allow the battery to be recharged.

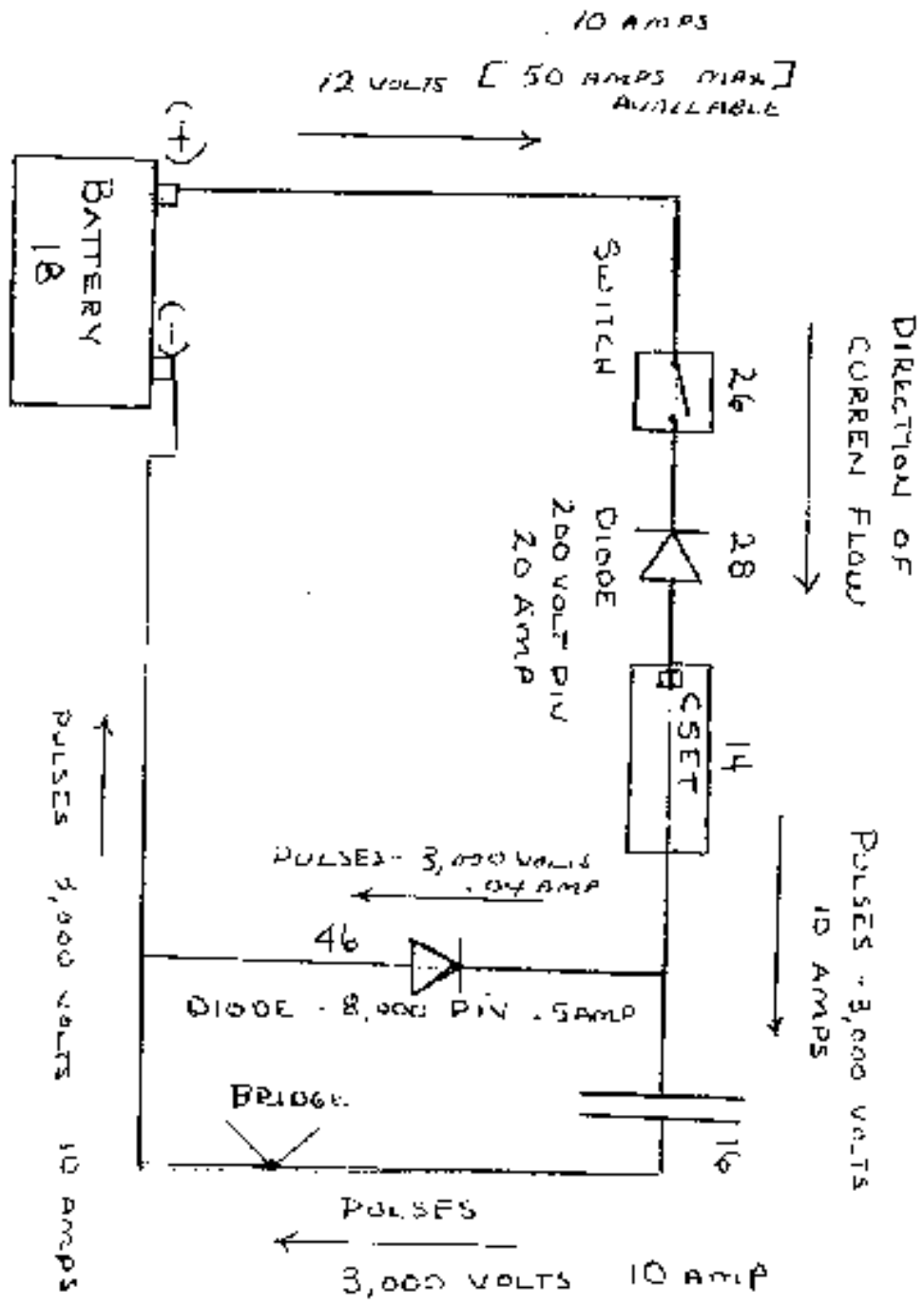



### **CURRENT FLOW IN BATTERY CHARGING CIRCUIT**

THIS SECTION IS NOT EXPLAINED BY THE PATENT. SIMPLY TRACING THE CURRENT FLOW WILL VERIFY THIS ANALYSIS.

**The battery charging circuit extends from the positive terminal of the battery through the commutator; through the triode; to the low voltage anode; across the spark gap; to the high voltage anode; to DIODE 46; to the negative terminal of the battery.**

IT IS CRITICAL TO THE UNDERSTANDING OF HOW THIS CIRCUIT WORKS TO COMPREHEND THE DIRECTION OF CURRENT FLOW IN THIS SECTION OF THE CIRCUIT! THE CURRENT FLOW IS FROM THE POSITIVE TERMINAL OF THE BATTERY THROUGH THIS CIRCUIT TO THE NEGATIVE TERMINAL OF THE BATTERY! THIS IS OPPOSITE THE NORMAL DIRECTION OF A DIRECT

### ***CURRENT CIRCUIT. THINK OF IT THE SAME AS A BATTERY CHARGER.***

**Current is drawn from the positive terminal of the battery through the TRIODE through the CSET to the high -voltage anode and then to the plate of capacitor#1.**

The 3,000 volt positive potential overcomes the 12 volt positive potential at the terminal of the battery. Most of the current is delivered to the plate of capacitor#1.

The 12 volt negative potential provided by the negative terminal of the battery draws a small portion of the current through DIODE 46 back to the battery to provide a pulsed recharging current. The current directed back to the battery through **DIODE 46** is probably only .04 amps.

**A MUCH LARGER PULSE IS CREATED ON THE BACK PLATE OF CAPACITOR #1 THAT IS WIRED**

**BACK TO THE NEGATIVE TERMINAL OF THE BATTERY TO PRODUCE A RECHARGING CURRENT.**

When **ARC OVER** occurs at the spark gap in the CSET, a pulse of current is directed to the high-voltage positive potential developed on the plate of capacitor #1 facing the CSET.

Capacitor #1 is a coupling capacitor in that it transfers the power pulse. This pulse of current repels electrons from the other plate of capacitor#1 forming a current pulse back to the battery of about 10 amps [ depending on the current available from the low voltage anode at the time of ARC OVER.]

**This Is the Primary Means By Which the Battery is Recharged While Driving the**

CHOPPER - VIBRATOR CIRCUIT

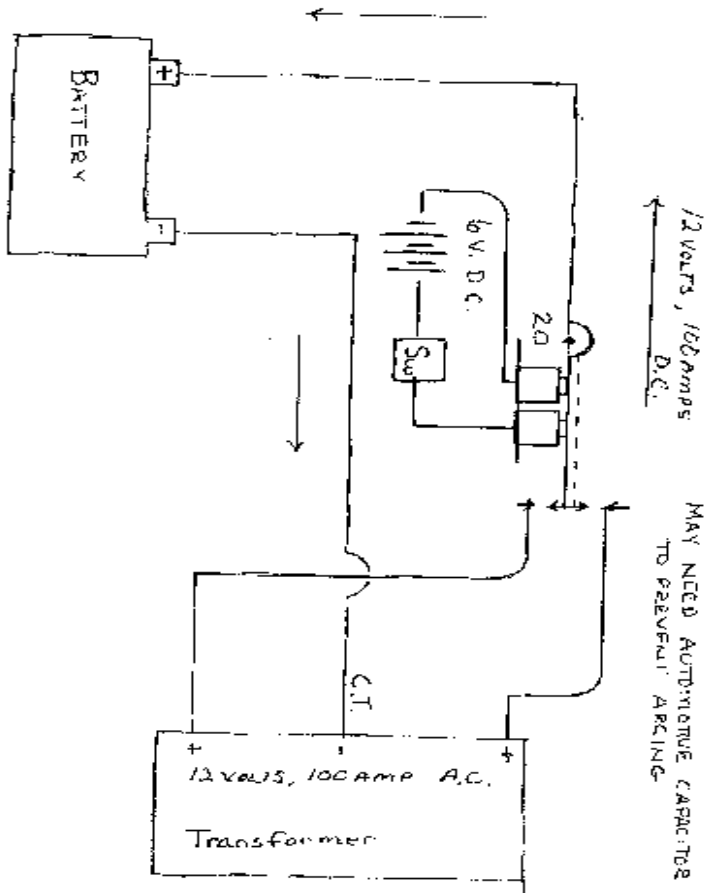

## **Load Circuit.**

### **Circuit Section 5. Chopper-Vibrator Circuit.**

If you use a 12 volt battery for the primary energy source to drive the transformer, then the 12 volts direct current must be changed to 12 volts alternating current as an alternating current is necessary to power an inductor.

A simple chopper- vibrator constructed from a common alarm bell available at any hardware store can be used.

An Alarm bell consist of two small electromagnets and a spring held lever. The contacts make and break the circuit to switch the circuit at a very low frequency. Please look at the working drawing, Circuit Section 5WD. As stated before, you can power the transformer with 110 house current or a 12 volt battery to an inverter and then on to the transformer.

If you use 12 volts DC and the chopper-vibrator to form 12 volts AC , you must use a transformer that has a center tap on the primary side. Johnson Electric Coil Co. is familiar with the design. Ask to talk with Ms. Beth Bockes, design engineer.

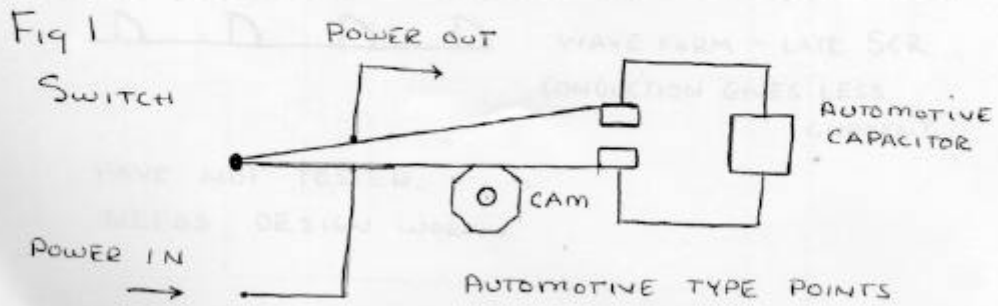
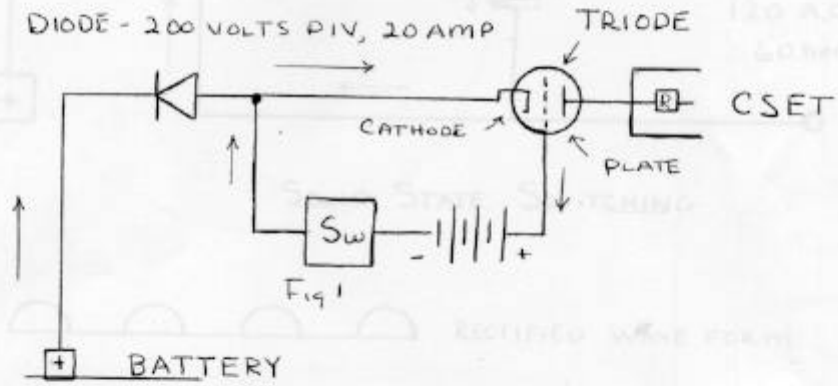
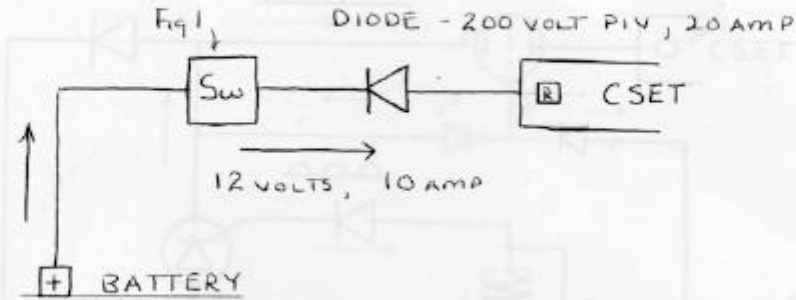

DURATION .0005 SEC.  
FREQUENCY 120 PULSES/SEC.  
MOTOR RPM 3600

This circuit creates the short duration [0.005 sec.] current pulse necessary for the formation of the ARC in the CSET. There are many ways to accomplish this.

You can use a TRIODE or a FAST-RECOVERY DIODE.

If you use a fast-recovery diode, you can place mechanical switching in the circuit line from the positive terminal of the battery to the diode.

If you use a triode, you must control the grid of the triode with a separate circuit.

**MAKE SURE THE TRIODE OR THE DIODE IS INSTALLED IN THE DIRECTION OF THE CURRENT**

**FLOW WHICH IS FROM THE POSITIVE TERMINAL OF THE BATTERY TO THE CSET.**  
With a

**TRIODE, the cathode goes to the pos. terminal of the battery and the plate goes to the CSET. With a high current fast recovery DIODE, the cathode goes to the pos. terminal of the battery and the anode goes to the CSET.**

If the intended purpose of the LOAD is a Gray type motor, then one PULSE of power is required to repel like pole electromagnets arranged slightly offset from each other.

If the intended purpose of the LOAD is to run a direct current system, the LOAD could be a deep cycle battery from which current is drawn to power a circuit.

If the LOAD is standard type AC, 60 hertz, lights and electrical equipment then a step-down transformer that provides narrow pulsed direct current of a duration around .0005 sec. at a frequency of 120 pulses per sec. is suggested.

**THE KEY HERE IS TO DESIGN THE WAVE FORM TO MEET THE NEEDS OF THE EQUIPMENT YOU**

**ARE TRYING TO POWER.**

I have only run a mechanical switch made of a simple electric motor, a cam and a set of points connected to a diode. I performed two successful test runs.

**MANY PEOPLE HAVE ASKED, " WHY DON'T YOU TRY THIS?". Here is why.**

**FROM THE MAGNITUDE OF THE POWER DISCHARGE IN THE CSET, I REALIZED THAT SAFETY**

**REQUIRES ANY FUTHER TEST RUNS BE DONE IN IN A LABORATORY WITH QUALIFIED HELP.**

I am negotiating with a laboratory now, but because of the cost it may be months before the laboratory, test equipment and qualified personnel are organized and funded.

This is HIGH -VOLTAGE, HIGH-CURRENT PULSES OF ELECTRICAL POWER CONVERTED TO

**ELECTROMAGNETIC RADIATION** of unknown frequency and therefore DANGEROUS. All known methods of generating electrical energy are dangerous but we know what we are working with. This is research, PROCEED CAREFULLY and SAFELY.

Here are three ways to a accomplish the switching. The first is a mechanical switch consisting of an octagonal cam (nut) mounted on a motor shaft and a set of automotive points.

If you place the mechanical switching in the circuit line then an automotive type capacitor across the points may be helpful to prevent arcing. If you use mechanical switching to control the grid of a triode, then the capacitor is probably not necessary.

Circuit Subsection 6A. A mechanical switch consisting of a motor, a octagonal cam a set of automotive points. See working drawing. To achieve the .0005 sec

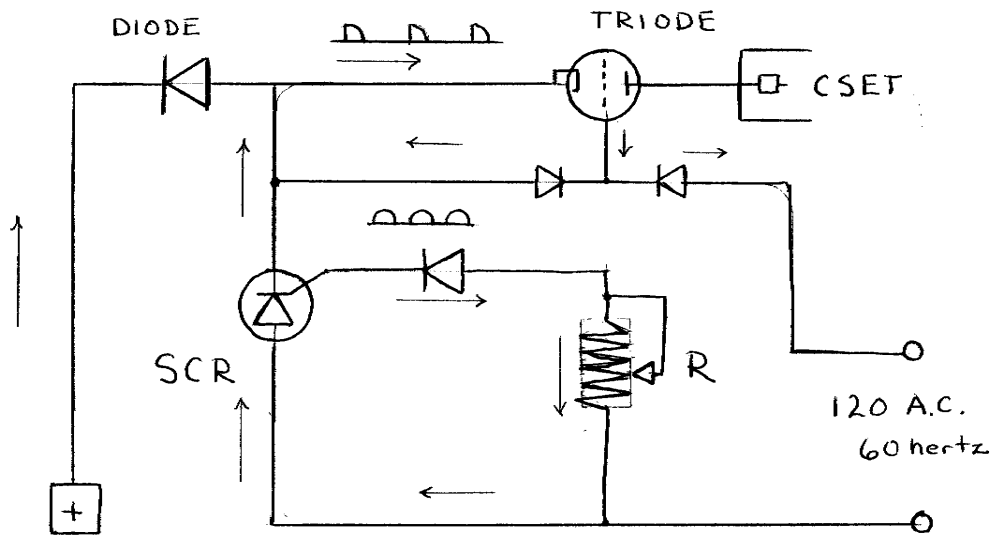

SOLID STATE SWITCHING

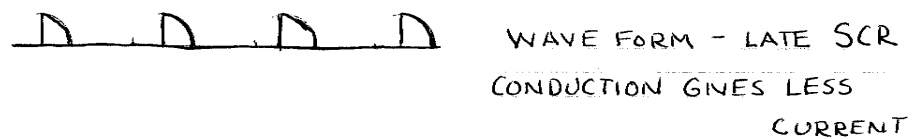

HAVE NOT TESTED.  
NEEDS DESIGN WORK.

**Circuit Subsection 6B. Solid State Switching.**

THIS HAS NOT BEEN TESTED. This circuit controls the grid of the triode with a diode, a variable resistor and a low current AC power source. The AC is rectified to form a pulsed DC by the diode. The SCR clips the pulse to create a narrow pulsed direct current wave form. The variable resistor defines the width

LASER SWITCHING — [NOT TESTED]  
 (I THINK THIS HAS GREAT POTENTIAL.)

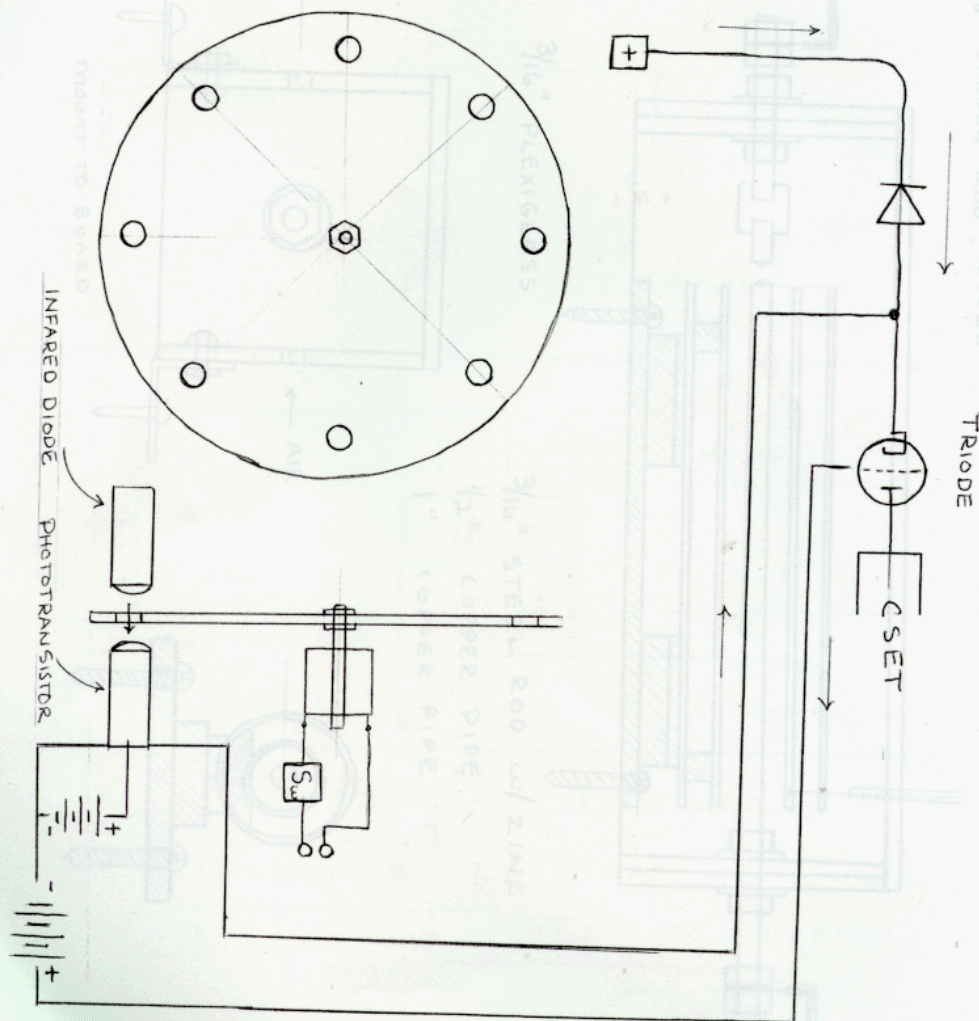

### Circuit Subsection 6C. Laser Switching.

#### ***THIS HAS NOT BEEN TESTED.***

This switching circuit consist of a infared light emitting diode and a phototransistor.

They are positioned on the opposite sides of a revolving disk powered by a motor. Located on the disk are holes  $3/16$ " in diameter equally positioned 30 degrees apart at a 4" radius on the disk. A motor rotates the disk at 1800 rpms (approximately). The holes on the disk allow the infared beam of light to trigger the base of the phototransistor. The diameter of the hole, the position on the disk and the rpm of the motor can be adjusted to create any pulsed DC

## CONVERSION SWITCHING ELEMENT TUBE - CSET

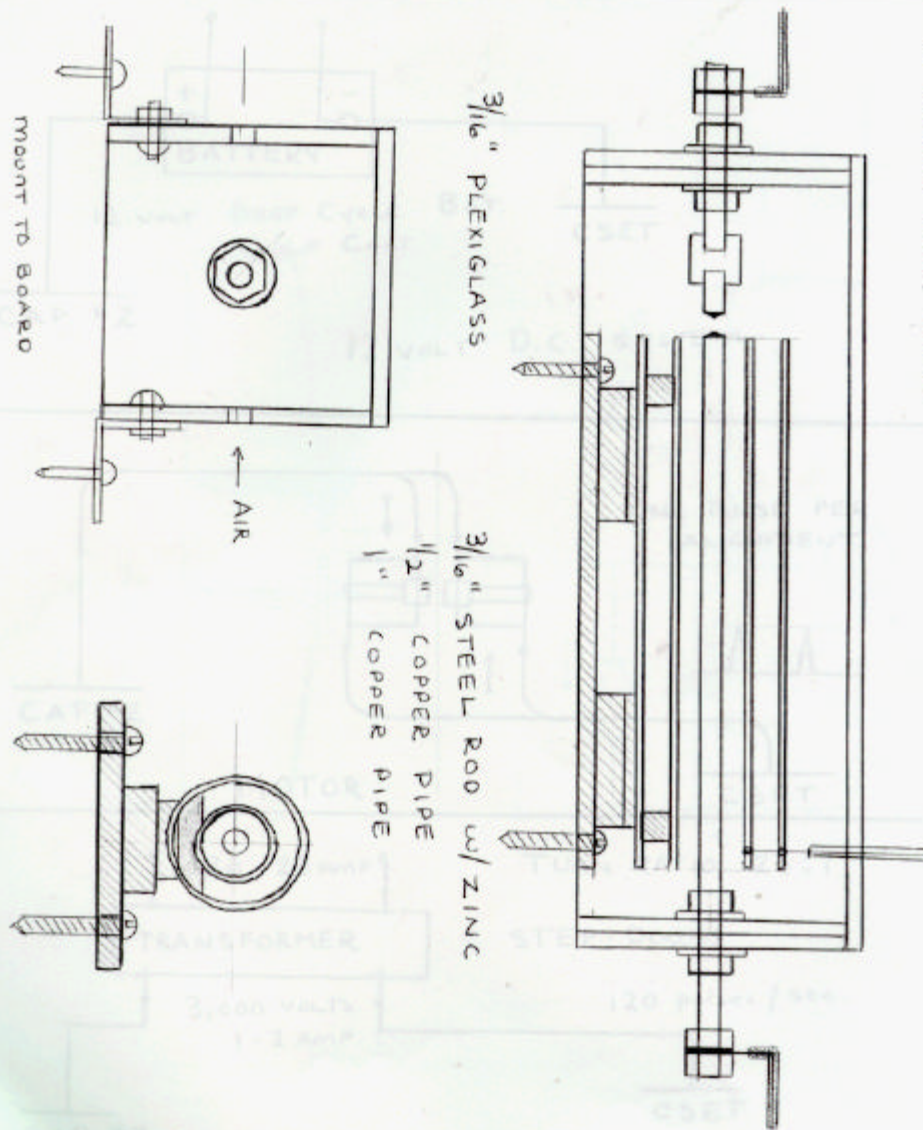
R :  $\frac{3}{8}$ " CARBON ROD, 300  $\Omega$ **Circuit Section 7. Conversion Element Switching Tube. CSET**

Before I explain the mechanics of the C SET, I would like to explain the principles that make the operation of the CSET possible. If we clearly understand how something works then the mechanics become very easy.

When the switch on the low voltage side of the CSET is open, the high voltage anode has a 3,000 volt positive potential. This draws electrons to the collector plates 34a and 34b.

When the switch is closed, current from the low voltage anode jumps the spark gap to the high voltage anode forming an ARC. An electric ARC does two things. First, it ionizes the air molecules to form positive and negative ions. Negative ions are free electrons. The high voltage positive potential anode picks up these free electrons. They are delivered to the negative terminal of the battery in the form of recharging pulses of power.

This gives the circuit a GAIN or increase in electrical energy. The second thing



is absorbed by the collector plates in the CSET. This is called the photoelectric effect [see A. Einstein - photoelectric effect]. Quanta or photons of EMR transfer their energy to the electrons in the copper collector plates. The pulse of EMR creates a pulse of electric power that travels across the collector plates to the wire terminal at the end of the plates. The wire transmits the power pulse to the load. At the same time, a BUNCH of electrons from the low voltage anode hit the high voltage anode and travel across the steel rod.

This negates the 3,000 volt positive potential on the high voltage anode thus repelling the electrons that were drawn to the collector plates. The combined effect is the creation of an instantaneous high-voltage, high-current energy pulse delivered to the LOAD.

The CSET requires AIR for the ionization of the atmosphere. Look at Gray's motor patent and you will find that an air supply was delivered to insure proper conditions for arc-over.

In a technical discussion issued by Richard Hackenberger, Mr. Gray's electrical engineer,

Mr. Hackenberger states that the disassociation of air molecules to form positive ions and negative ions is a key principle by which the gain in the circuit occurs. Quantum physics explains that when an electron is freed from its energy shell a quanta of EMR is released. [see Quantum Physics - Bohr I. It may be that the CSET was an vacuum tube.

The possibility will be included in future testing. All evidence points to the importance of AIR to form the ARC necessary to produce the EMR that induces the current in the collector plates.

The construction of the CSET is fairly simple. I consist of a plexiglass housing that allows air to reach the spark gap.

The high voltage anode and the low voltage anode are 3/16" steel rod, zinc plated. The collector plates are 1/2" by 4" copper pipe and 1" by 4" copper pipe.

Spacers are scrap plexiglass held in place with super glue. I drilled holes in the collector grids. [

The collector grids may function better if there are no holes.]

The resistive element in the low voltage anode was not incorporated in the tests. I am going to include a resistive element made of 3/8" carbon rod as shown in the patent drawings of the CSET.

I am designing the resistive element for 300 ohms based on the assumption that there is 50 amps available from the positive terminal of the battery that can be drawn in a reverse current.

A 300 ohm resistor would limit the current to a 10 amp range. I am hoping that this will help bring the magnitude of the discharge into a containable range for the size of the CSET elements.

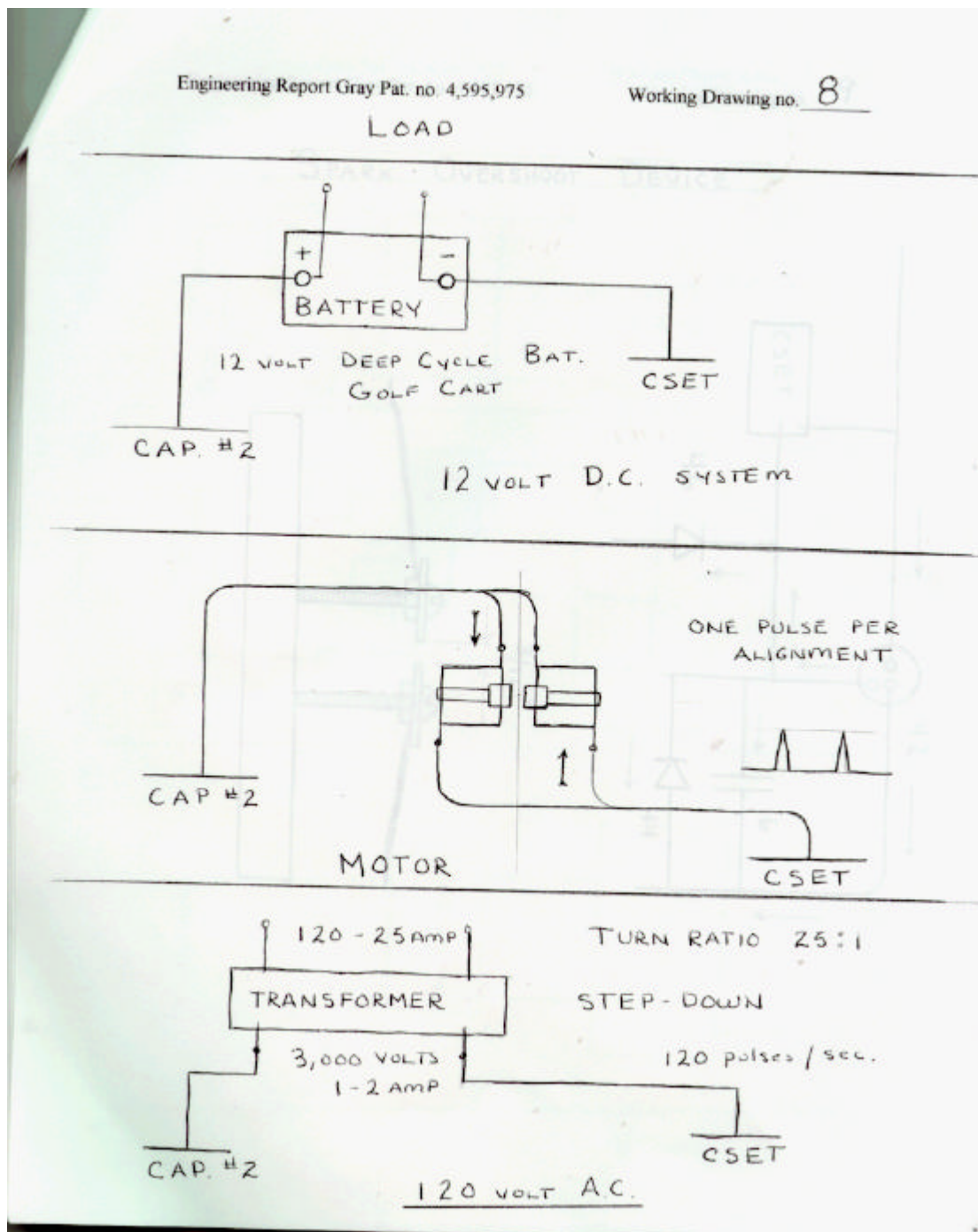

## Circuit Section 8. Load

The Load or actually the means by which the Load (being the equipment to be powered by the circuit) is transferred is dependent upon the requirements of the equipment being powered. I would like to quote the Abstract from pat.4,595,975.

“When adapted to present day direct-current or alternating-current devices the LOAD could be a BATTERY or CAPACITOR to enhance the productivity of electrical energy.”

Consider three different types of LOADS. A pulsed DC motor, a direct current circuit of 12 volts and an 110 AC circuit of lights or standard AC, 60 hertz equipment. In the case of a pulsed DC motor such as the one designed by Mr. Gray, one energy pulse repels like pole electromagnets arranged in a slightly offset manner.

Therefore the motor can be driven directly from the pulsed DC generated by the CSET if the pulse is timed with the alignment of the electromagnets. [please see motor patent, I]

If the Load is a 12 volt DC circuit, then a battery could be placed in circuit

[haven't tried it yet] I am trying to drive a motor I designed based upon Gray's principles.

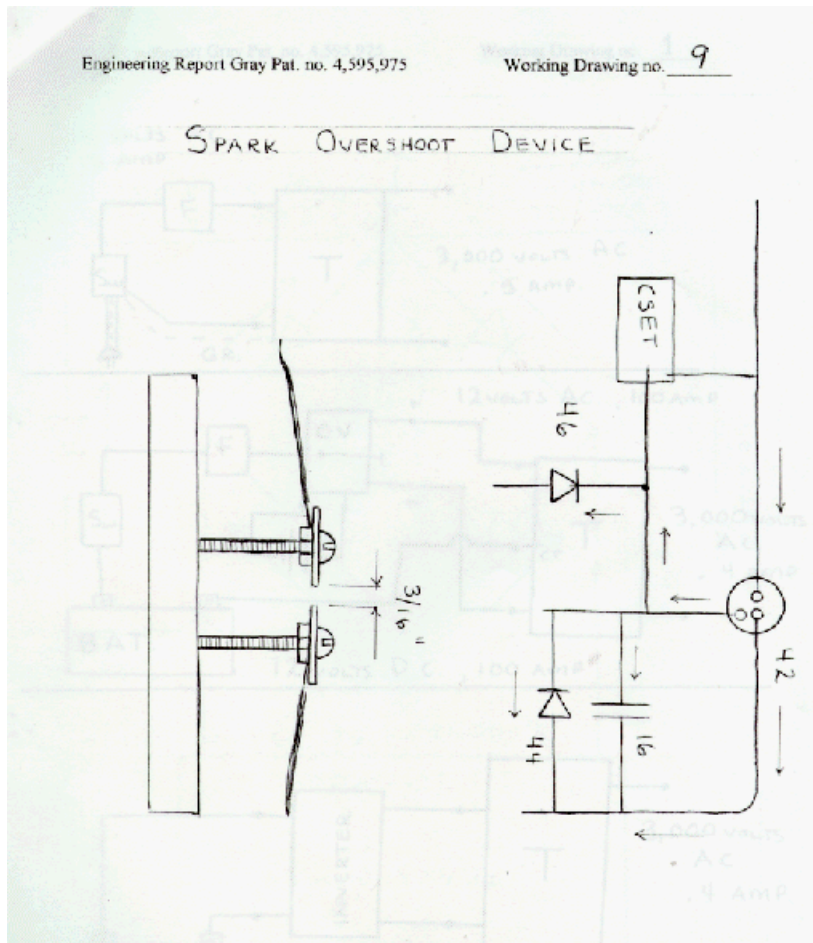

## Circuit Section 9: Spark Overshoot Device

The spark overshoot device is a safety value for the CSET. If the energy pulse exceeds the design parameters of maximum allowable voltage, then arc over occurs and the excess energy is recycled back into the high-voltage circuit to be adsorbed by the capacitor #1 and the battery. Spark gap is 3/16", See Working Drawings.

Patent Rights:

Efficient Power Supply Suitable for Inductive Loads was patented by Mr. Edwin Gray in 1986. Mr. Gray passed away in 1989. Rumour has it [from his wife, he disappeared. To my knowledge he still holds the rights to the patent ? If you are interested in manufacturing this device you should try to seek permission from any controlling interest of the patent. We all are aware of the fact that we now stand at the edge of a world war and/or terrorist attacks motivated in part by the need for energy. It is definitely in the best interest of the United States of America to develop new energy sources as quickly as possible. Technological information travels so fast today that if we in the United States take a day off, an other country will bring this to market by tomorrow. I personally think that there is a social responsibility to bring this to market. If someone does hold the patent rights, then it would seem that a fair and

June 17, 2003. Patent rights expire in 17 years unless other legal action is taken.

Parts List and United States America suppliers

### **TRANSFORMER:**

Johnson Electric Coils Co. 1-800-826-9741, 1-715-627-4367 821 Watson Street,

Antigo, Wisconsin 54409-2753

contact: Ms. Beth Bockes ext. 309

part: a) 110 volt, 15 amp primary / 3,000 volt .5amp secondary

b) 12 volt, 100 amp primary / 3,000 volt .4 amp secondary

### **DIODES & BRIDGE. HIGH VOLTAGE:**

HVCA 1-732-938-4499

P.O.Box 2245 , Farmingdale, N.J. 07727

part: fast recovery diodes; UX-FOB 8,000 PIV, .5 amp

ultra fast bridge; 2HVFVB8KBUF 8,000 Ply, .5 amp

### **CAPACITORS:**

#### **By Cap 1-800-322-9227 contact: Ken**

5505 North Walcut Ave., Chicago Ill. 60640

part: Capacitor #1 - 4,000 volts , 2 microfarads

Capacitor #2 - [talk to Ken J still running calcs.

### **TRIODE:**

#### **Parts Express 1-800-338-0531**

725 Pleasant Valley Drive, Springboro, OH 45066-1158

part: Svetlana 5V81 1-10, part no. 072-5 19

**HIGH CURRENT DIODE:** Mouser 1-800-346-6873

1000 N. Main Street, Mansfield TX 76063-15 14

part: 526-NTE6240 ultra fast, dual center tap, carbon cathode, 200 volt PIV, 20

amp forward current, 150 amp surge.

also (laser diode and photo transistor for laser switch- soon to be designed)

**Resistor: 300 ohms - 3/8" carbon rod**

**Batteries: Deep Cycle Golf Cart**

**Low-Voltage Switching: motor with octagonal cam, automotive points,**

**duration .0005 sec., 3600 rpm on motor - 120 pulses per Sec.**

**CSET: 3/16" plexiglass, 3/16" steel rod zinc plate, 3/16" spark gap, 1/2" by 4"**

**copper pipe, U" by 4" copper pipe, spacers- scrap plexiglass**

### **CONCLUSION**

This Engineering Report would never have been possible if it were not for the genius of Peter Lindemann, D. Sc.. His research connecting the work of Nicola Tesla and Edwin Gray is a brilliant contribution to the application of theoretical physics for the solution of world energy problems.

Those who break new ground are rarely acknowledged by the established scientific or higher education community until long after research becomes history. Kepler, Columbus, Einstein, Rutherford, Tesla, Gray and many others painfully encountered resistance to new research. The message here is not to be discouraged. If you know that the basic theory is correct, then never give up

-----  
congratulations, you are working on the actual generation of electrical power

based on Quantum Physics. Here are some areas that need consideration;

BREMSSTRAHLUNG: “breaking radiation” The radiation emitted by electrons slowed down in matter. [free electrons entering a steel high-voltage anode] [Bunching]

PAIR PRODUCTION: The formation of a positron and an electron when electromagnetic energy interacts with matter.

PHOTOIONIZATION: The ionization of a gas by light or other electromagnetic radiation; the photons must possess enough energy to detach one or more outer electrons from the gas atoms.

PHOTOCONDUCTION: The absorption of EMR by electrons in matter whereby the electrons are brought to the range of energy levels at which they move freely to conduct electricity.

BREAKDOWN: When electrons are accelerated to high velocity by the electric field at the [spark gap] and produce other free electrons by ionization collision with atoms. These free electrons are similarly accelerated by the field and in turn cause other ionizations. The avalanche process leads to a very large current. Study the work of Tesla, Gray, Dr. Lindemann, Plank, Einstein and Bohr. Let us all work hard to make this technology available to everyone in a useful and constructive manner.

Engineering Report Gray Pat no. 4,595,975

Conclusion

Engineering Report Gray Pat, no. 4,595,975

Mr Gary Magratten

This information by Mr Gary Magratten and is reproduced by energy21 with many thanks to the fore mention Gary Magratten

Additional information on this device can be found at

[http://www.Fortunecity.com/greenfield/bp/16/the\\_answer.htm](http://www.Fortunecity.com/greenfield/bp/16/the_answer.htm)

If you have found this article of interest you may care to check out related articles on the Edwin Gray devices on the Encyclopedia of Free energy on CD where you find also other devices like this described as well in greater detail



Complete ordering details for the FREE ENERGY ENCYCLOPEDIA can be found at <http://angelfire.com/ak/egel/ver2.html>

or

<http://www.Fortunecity.com/greenfield/bp/16/ver2.html>

**The basic ordering information though is as follows:**

**Make Payment Please in the following amounts and in these currencies only**

**The Encyclopedia of Free Energy**

**Cost \$35 Dollars US (Cash)**

**\$45 Euro Dollars (cash)**

**\$50 Dollars Australian (Australian Cheque ) or Australian Money order also acceptable(for Australia resident customers only)**

**\$55 New Zealand dollars**

**\$50 Canadian Dollars**

**This payment includes airmail postage to your address worldwide.**

**Please send order and payment to**

**Geoff Egel**

**18 Sturt Street**

**Loxton 5333**

**South Australia Australia**



