

Membranes for Industrial Wastewater Recovery and Re-use

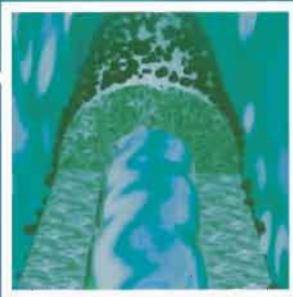

Edited by
**Simon Judd and
Bruce Jefferson**

Membranes for Industrial Wastewater Recovery and Re-use

To Claire, Oliver and Samuel

Membranes for Industrial Wastewater Recovery and Re-use

Edited by:
Simon Judd and Bruce Jefferson



UK	Elsevier Science Ltd, The Boulevard, Langford Lane, Kidlington, Oxford OX5 1GB, UK
USA	Elsevier Science Inc, 360 Park Avenue South, New York, NY 10010-1710, USA
JAPAN	Elsevier Japan, Tsunashima Building Annex, 3-20-12 Yushima, Bunkyo-ku, Tokyo 113, Japan

Copyright © 2003 Elsevier Ltd.

All rights reserved. No part of this publication may be reproduced, stored in a retrieval system or transmitted in any form or by any means: electronic, electrostatic, magnetic tape, mechanical, photocopying, recording or otherwise, without prior permission in writing from the publishers.

British Library Cataloguing in Publication Data

Membranes for industrial wastewater recovery and re-use

1. Water reuse 2. Membranes (Technology) 3. Water – Purification – Reverse osmosis process

I. Judd, Simon II. Jefferson, Bruce

628.1'674

ISBN 1856173895

Library of Congress Cataloging-in-Publication Data

Judd, Simon

Membranes for industrial wastewater recovery and re-use / Simon Judd and Bruce Jefferson.

p. cm.

Includes bibliographical references and index.

ISBN 1-85617-389-5

1. Sewage–Purification. 2. Factory and trade waste–Purification. 3. Membranes (Technology) 4. Water reuse. I. Jefferson, Bruce. II. Title.

TD754.J83 2003

628.3'52–dc21

2003040757

No responsibility is assumed by the Publisher for any injury and/or damage to persons or property as a matter of products liability, negligence or otherwise, or from any use or operation of any methods, products, instructions or ideas contained in the material herein.

Published by

Elsevier Advanced Technology, The Boulevard, Langford Lane, Kidlington Oxford OX5 1GB, UK

Tel.: +44(0) 1865 843000

Fax: +44(0) 1865 843971

Typeset by Variorum Publishing Ltd, Lancaster and Rugby

Printed and bound in Great Britain by Biddles Ltd, Guildford and King's Lynn

Contents

	Preface	ix
	Contributors	xiii
Chapter 1	Introduction	
1.1	1.1 Water reuse motivations and barriers	2
1.2	Industrial water	4
1.3	Membrane technology	7
Chapter 2	Membrane technology	
2.1	The membrane	14
2.1.1	Membrane and membrane process definition	14
2.1.2	Membrane structure	14
2.1.3	Membrane materials and their manufacture	17
2.1.4	Membrane configurations	23
2.2	The process fundamentals	32
2.2.1	Process performance definitions	32
2.2.2	The driving force	34
2.2.3	Factors opposing the driving force	34
2.2.4	Critical flux	39
2.3	The theory	40
2.3.1	Membrane mass transfer control	41
2.3.2	Fouling/cake layer mass transfer control	43
2.4	Process design and operation	52
2.4.1	Staging	52
2.4.2	Specific energy demand	55
2.4.3	Fouling and pretreatment	59
2.4.4	Backwashing and cleaning	66
	References	70

Chapter 3 Industrial waters

3.1	The power industry: water requirements for power generation and cooling water	76
3.1.1	Water demand by the power industry	76
3.1.2	Overview of cooling water systems	77
3.1.3	Overview of boiler feedwater systems	80
3.1.4	Sources of water used for	80
3.1.5	Water quality comparisons	81
3.1.6	Optimisation of water use in recirculating cooling systems	85
3.1.7	Cooling tower water quality issues	88
3.1.8	Governing legislation and guidelines	93
3.1.9	Volumes and quality of aqueous process waste streams	94
3.1.10	Current reuse practices and opportunities	95
	References	100
3.2	The pulp and paper industry	102
3.2.1	Introduction	102
3.2.2	Pulping and paper manufacturing processes	104
3.2.3	Effluent volumes and quality	106
3.2.4	Current water and effluent purification systems and governing legislation	113
3.2.5	Membranes in the pulp and paper industry	115
3.2.6	Conclusions	125
	Acknowledgements	125
	References	125
3.3	The textile industry	132
3.3.1	Categories of textile processing operations	132
3.3.2	Effluents from textile processing unit operations	133
3.3.3	Process water quality requirements	143
3.3.4	Legislation	144
3.3.5	Conventional treatment	146
3.3.6	Demand management	148
3.3.7	Reuse practice and opportunities	149
	References	154
3.4	The beverage industry	159
3.4.1	Point of use recycling opportunities	159
3.4.2	End of pipe recovery opportunities	160
	References	163
3.5	Pure waters in the pharmaceutical industry	163
3.5.1	Background	163
3.5.2	Water quality standards	164
3.5.3	Volumes and quality of aqueous process and waste streams	167
3.5.4	Reuse opportunities	169

Chapter 4 System design aids

4.1	Computer-aided design for reverse osmosis plant	172
4.1.1	Introduction	172
4.1.2	Key elements of the reverse osmosis process	172
4.1.3	RO design software	176
4.1.4	Cost calculation	182
4.1.5	Overview	183
	References	186
4.2	Water pinch analysis	186
4.2.1	Introduction	186
4.2.2	Water pinch: the history	187
4.2.3	Methodology	187
4.2.4	Computed solutions	191
4.2.5	Software tools currently available	197
4.2.6	Case study: water pinch and implementation of regeneration techniques	201
4.2.7	Conclusion	209
	References	209
4.3	Design examples	213
4.3.1	Problem in reverse osmosis: film theory and energy demand	213
4.3.2	Problem in reverse osmosis: array design	216
4.3.3	Problem in reverse osmosis: CAD array design	217
4.3.4	Problem in electrodialysis: energy demand	220
4.3.5	Problem in submerged membrane filtration design	223

Chapter 5 Case studies

5.1	Flag Fen high-purity water production plant (UK)	228
5.1.1	Background	228
5.1.2	Description of plant	228
5.1.3	Performance	230
5.2	Eraring Power Station: purification of secondary sewage for boiler feedwater (Australia)	232
5.2.1	Background	232
5.2.2	Description of plant	233
5.2.3	Performance	235
5.3	Doswell combined cycle power plant: zero liquid discharge (USA)	237
5.3.1	Background	237
5.3.2	Description of system	238
5.3.3	Performance	240
5.4	VHP Ughelen: paper mill water recycling (Netherlands)	241
5.4.1	Background	241
5.4.2	Description of system	242

	5.4.3	Performance	243
5.5		Kronospan Ltd: medium-density fibreboard wash water recycling (UK)	244
	5.5.1	Background	244
	5.5.2	Description of plant	245
	5.5.3	Performance	246
5.6		M-Real Kirkniemi paper mill (Finland)	248
	5.6.1	Background	248
	5.6.2	Description of plant	248
	5.6.3	Performance	249
5.7		T. Forsell and Son: dyewaste water recycling plant (UK)	250
	5.7.1	Background	250
	5.7.2	Description of plant	251
	5.7.3	Performance	253
5.8		N food plant wastewater treatment and recycling plant (Japan)	254
	5.8.1	Background	254
	5.8.2	Description of plant	255
	5.8.3	Performance	256
5.9		Pasfrost vegetable processing plant (Belgium)	257
	5.9.1	Background	257
	5.9.2	Description of plant	258
	5.9.3	Performance	259
5.10		Automotive water recycling (Germany)	262
	5.10.1	Background	262
	5.10.2	Plant description	263
	5.10.3	Performance	264
5.11		NEC Semiconductors: microelectronics wastewater reclamation (UK)	265
	5.11.1	Background	265
	5.11.2	Description of plant	267
	5.11.3	Performance	268
5.12		Discussion	269
5.13		Reference material	276

Preface

In setting out to produce a book on any given subject, the primary questions to be answered are: “What should we write about?” and “Who’s going to buy it?”. These questions are obviously interlinked.

The subject area of this book is well defined in the title: membrane technology and its application to industrial water recycling. There can be little doubt of the importance of recycling of water contaminated by industrial activity, and it is hoped that the introduction to this book (Chapter 1) sufficiently emphasises this point. Stresses imposed on freshwater supplies continue to grow and environmental legislation relating to discharges becomes ever more rigorous. Given that technologies for water purification are tending to become more efficient and generally cost-effective, it is inevitable that recovery and reuse of effluent will be more widespread in the future. It is also the case that membrane processes play a pivotal role in many reclamation and reuse schemes in industry. Their application across all industrial sectors has increased exponentially over the last twenty years and there is little sign of this growth abating.

Since the subject is very extensive the amount of detail is largely determined by the target readership, which relates to the second key question. This is rather vexing matter, not least because potential readers are well served by a number excellent texts on membrane processes and technologies (Table 1) as well as a growing number on water reclamation and reuse (Table 2). Neither of these tables is comprehensive, and it can always be argued that there is really nothing new to write about.

So, who might buy this book? What function is this book meant to serve? Perhaps it is as well to outline what the book is not. The book is not meant to be a comprehensive treatise on membrane processes and technologies, although an outline of these areas is provided (Chapter 2) with reference to membrane materials, modules, and processes along with governing equations for use in system design. For more comprehensive information than that provided the interested reader may seek out such tomes as those produced by Ho and Sirkar, Rautenbach and Albrecht, and Scott (Table 1). Moreover, many of the industrial process applications in which membranes find employment, such as the biotechnology and food industries, are only briefly discussed with reference to a

Table 1 Recent membrane textbooks

Author(s)/editor(s)	Title	Publisher	Date
Nunes and Peinemann	Membrane Technology in the Chemical Industry	Wiley-VCH	2001
Stephenson, Judd, Jefferson and Brindle	Membrane Bioreactors for Wastewater Treatment	IWA Publishing	2000
Hillis	Membrane Technology in Water and Wastewater Treatment	Royal Society of Chemistry	2000
Radecki, Crittenden, Shonnard and Bullock	Emerging Separation and Separative Reaction Technologies for Process Waste Reduction	American Institute of Chemical Engineers	1999
Cheryan	Ultrafiltration and Microfiltration Handbook	Technomic	1998
Scott	Handbook of Industrial Membranes, 2nd edn	Elsevier	1998
Mallevalle, Odendaal and Wiesner	Water Treatment Membrane Processes	McGraw-Hill	1996
Amjad	Reverse Osmosis	Van Nostrand Reinhold	1993
Ito and Sirkar	Membrane Handbook, 2nd edn	Van Nostrand Reinhold	1992

Table 2 Recent water recycling textbooks

Author/editor	Title	Publisher	Date
Lens, Pol. Wilderer and Asano	Water recycling and resource recovery in industry: analysis, technology and implementation	IWA publishing	2002
Mann and Liu	Industrial water reuse and wastewater minimization	McGraw-Hill	1999
Asano	Wastewater reclamation and reuse	Technomic	1998
Rows and Abdel-Magid	Handbook of wastewater reclamation and reuse	CRC press	1995
USGA	Wastewater reuse for golf course irrigation	Lewis publishers	1994

few specific industrial sectors (Chapter 3). Again, industrial process applications are reasonably well documented in Cheryan (for filtration processes), Amjad (reverse osmosis) and otherwise the general texts previously mentioned.

It is also the case that the book does not provide much detail of domestic or municipal schemes, where water is either recycled within buildings or reclaimed from municipal wastewater treatment plant and reused for extensive schemes such as irrigation and aquifer recharge. There is also no discussion of sustainability as a concept, or any of the related topics pertaining to environmental impact and more holistic topics. Again, the interested reader is

already very well served in such areas, and in particular extensive systems, by the seminal work of Asano and the recent eclectic publication by Lens *et al.* (Table 2). Finally, although the principles of water pinch analysis are described in Section 4.2, this is only to enable an understanding of how it can be used. Once again, there are other texts available that comprehensively describe the methodology and its derivation (Mann and Lui).

It is hoped by the editors, however, that anyone interested in industrial wastewater recycling, including problem holders and membrane suppliers as well as students and academics studying in this area, will find this book useful. In particular, the book is meant to provide a practical aid to those readers with an interest in actually selecting, installing and/or designing systems for recovering and reusing industrial effluent. To this end, there is one chapter dedicated to design (Chapter 4), and in particular computer-aided design, based on commercial packages, of reverse osmosis arrays (Section 4.1) and water networks (Section 4.2). There are also eleven individual case studies, covering a range of applications, which are discussed with reference to design and operational facets of the water recycling treatment schemes (Chapter 5). Whilst not all industrial sectors where water recovery and reuse takes place are covered in this book (it is extremely difficult to extract all information pertaining to industrial water quality, let alone water reuse) as much detailed as has been made available is reported in the book. Lastly, the book is very much biased towards engineering practice, rather than scientific study. Data pertaining to membrane process performance in Chapters 3 and, more especially, Chapter 5, are based almost entirely on existing pilot or full-scale systems, rather than bench-scale studies or theoretical predictions.

As with any piece of work the editors would welcome any comments from readers, critical or otherwise, and our contact details are included in the following section.

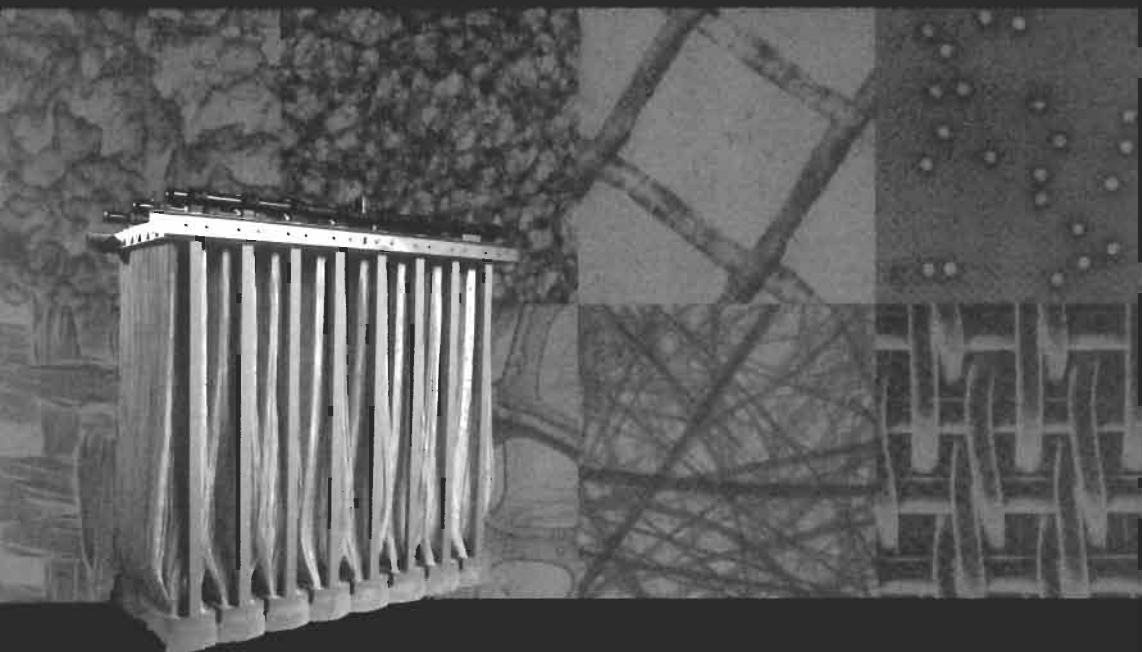

your filtration and separation library:

- **filtration+separation** magazine
- **filtration industry analyst** and **membrane technology** newsletters
- **market reports** – profile of the international membrane industry: market prospects to 2005; profile of the international filtration and separation industry: market prospects to 2006
- **books** – nanofiltration: principles and applications, membranes for industrial wastewater recovery and re-use, handbook of filter media, filters and filtration handbook, filtration – equipment selection, modelling and process simulation

Contributors

The editors

Simon Judd

Dr Judd is a Reader in Water Sciences at Cranfield University with over 15 years' experience of industrial and academic R&D, having spent three years in nuclear waste management and two years in forensic science. In his current post he has conducted research into a wide range of chemical and, principally, membrane processes as applied to water and wastewater treatment. Topics have included municipal and domestic wastewater treatment and reuse using membrane bioreactors, nanofiltration of dye waste for water recovery and scale mitigation in reverse osmosis for flux enhancement. He has contributed to and co-authored a number of books on both water recovery and reuse and membrane processes, and has published extensively in peer-reviewed journals. Dr Judd also manages swimming pool water treatment research activities, and chairs the Membrane Academia Industry Network (MAIN), a UK research council-sponsored initiative to encourage dissemination of information between the industrial and academic communities in the UK.

Contact: s.j.judd@cranfield.ac.uk

Bruce Jefferson

Dr Jefferson is a Senior Research Fellow at the School of Water Sciences at Cranfield University following graduation from the Department of Chemical Engineering, Loughborough University. In his current post he has conducted research into general physical and, more specifically, membrane processes for a wide range of applications within both urban and industrial environments. He has contributed to and co-authored a number of books on both water recovery and reuse and membrane processes, and has published extensively in peer-reviewed journals. Dr Jefferson has also presented papers at and chaired numerous sessions on the subject of water recycling, and he is a member of the IWA specialist group committee on advanced treatment/membrane processes.

Contact: b.jefferson@cranfield.ac.uk



SJ and BJ.

The editors would like to convey their sincere thanks to the co-authors and other contributors to this book, details of whom are given below.

The co-authors

Danielle Baetens

Dr Baetens graduated in 1991 as a civil engineer in chemistry at the University of Ghent, obtaining a PhD at the faculty of Agricultural Engineering, also in Ghent, in 2000. The PhD concerned modelling of biological phosphorus removal in wastewater. Between 1991 and 1998 Dr Baetens worked at the University of Ghent as assistant at the faculty of civil engineering on the treatment of air pollution and wastewater treatment. Since 1999 she has worked at Vito (Flemish Institute for Technological Research), where she project is co-ordinator of the project group on process optimisation.

Contact: danielle.baetens@vito.be

Etienne Brauns

Etienne Brauns graduated as a Metallurgical Civil Engineer at KU Leuven in Belgium in 1976. He thereafter stayed at KU Leuven to contribute as a researcher to a program on shape memory alloys, joining the Belgian national nuclear research centre SCK-CEN in 1985. In 1990 all non-nuclear research at SCK-CEN was transferred to Vito, founded in that year by the Flemish government. As a researcher at Vito he originally continued R&D activities on technical and electro ceramics for sensor applications. He has subsequently focused on membrane research and currently works on pressure-driven and electro-dialytic membrane processes, and water recycling.

Contact: etienne.brauns@vito.be

Mike Carney

Mike Carney qualified from Birmingham University with a First in chemical engineering and then undertook an MSc in water resources technology. He worked as a process design engineer for Paterson Candy and Schweppes where he was responsible for water and effluent treatment worldwide. As Technical Director of a water treatment contractor, he was responsible for the design of numerous food and beverage water and effluent treatment plants worldwide. Now working as an independent consultant at Vale Water Services Ltd, he specialises in the same food and beverage field. He is a Fellow of the Institution of Chemical Engineers.

Contact: vale.water@compuserve.com

John Hutcheson

Dr Hutcheson is currently General Manager of Pharmaceuticals at Christ Kennicott with extensive expertise in pure and ultrapure water treatment system design. On gaining a PhD in organic synthetic chemistry in 1980 he spent three years working in downstream processing at Beecham Pharmaceuticals followed by a short tenure at Millipore before becoming a founding member of Ionpure Technologies Ltd. He transferred to Kinetics in 2000, joining Christ Kennicott in 2002. He has authored a number of papers and presented at international conferences and courses on aspects of water purification.

Contact: john.hutcheson@christwt.co.uk

Audrey Levine

Audrey Levine is an Associate Professor of Civil and Environmental Engineering at the University of South Florida. She holds a BS degree in biology from Bates College (Lewiston, Maine), an MS degree in public health from Tulane University and a PhD in civil engineering from the University of California at Davis. Prior to joining the faculty at USF she was a faculty member at Utah State University (1994–1998), New Jersey Institute of Technology (1992–1994) and Iowa State University (1985–1992). She is actively involved in research and teaching related to wastewater reclamation and reuse, water distribution systems, potable water treatment, corrosion control and water quality issues. She is currently working on projects related to pathogen reduction through wastewater treatment, the fate of pharmaceuticals in reclaimed water systems and distillation of reclaimed water.

Contact: levine@eng.usf.edu

Jutta Nuortila-Jokinen

Professor Nuortila-Jokinen obtained her MSc in polymer chemistry at Helsinki University in 1988. Since 1987 she has worked in the Laboratory of MemPo, the Laboratory of Membrane Technology and Technical Polymer Chemistry at Lappeenranta University of Technology (LUT), as Research Assistant, Researcher and Associate Professor. She received her doctorate at LUT in 1997 before joining the Cleantech 2000 project (1997–2000) as Research Professor. She is currently working as Senior Fellow funded by the Academy of Finland

(2000–2005). She has published around 60 scientific papers, and is a member of the European Working Party on Membrane Science.

Contact: ijnj@lut.fi

The contributors

In addition to the co-authors there are a number of contributors to this book who have provided specific information, in particular for the case studies detailed in Chapter 5.

Name	Affiliation and address	Web address and contact
Alasdair Donn	PCI Membrane Systems, Laverstock Mill, Whitchurch, Hampshire, RG28 7NR, UK	www.pcimem.com alasdair.donn@pcimem.com
Bruce Durham	Alternative Water Resource, Vivendi Water, Wirksworth, Derbyshire, DEP 4EP, UK	www.vivendewater.com bruce.durham@vivendewater.com
Robert P. Allison	Ionics, Incorporated, 65 Grove Street, Watertown, MA 02472, USA	www.ionics.com rallison@ionics.co.uk
Devinder Chabba	Esmil Process Systems, Westfields, London Road, High Wycombe, HP11 1HA, UK	www.esmil.co.uk sales@esmil.co.uk
Timo Sutela	Metso PaperChem Oy, PO Box 83, 21201 Raisio, Finland	www.metso.com timo.sutela@metso.com
Hans Raemaekers	Triqua, Vadaring 7, PO box 132, NL-6700, AC Wageningen, The Netherlands	www.triqua.nl hansraemaekers@triqua.nl
John Murrer	Anglian Water Technology Group, Thorpe Wood House, Thorpe Wood, Peterborough, Cambridgeshire, PE3 6WT, UK	www.anglianwater.com jmurrer@anglianwater.co.uk
Darren Morrison	Mitsubishi Corporation (UK) PLC, Mid City Place, 71 High Holborn, London, WC1V 6BA, UK	www.mrc.co.jp/english/ darren.r.morrison@mitsubishicorp.com
David Holmes	Ultra tech, Wychbury House, 73c Stevens Road, Stourbridge, West Midlands, DY9 0XW, UK	www.orelis.com/uk/home.orelis.asp ultra.tech@btinternet.com
Hans Wouters	Paques Astraco, PO Box 52, 8560 AB Balk, The Netherlands	www.paques.nl/ h.wouters@paques.nl

Chapter 1

Introduction

Simon Judd
School of Water Sciences, Cranfield University

1.1 Water reuse motivations and barriers

The motivations for recycling of wastewater are manifold. Most often stated are those pertaining to increasing pressures on water resources. Reuse of wastewater conserves the supply of freshwater, and this presents clear advantages with respect to environmental protection. More pragmatically, wastewater reuse may result directly from legislation, which can constrain the discharge of polluted water by making this option onerous or else forbid such discharges altogether, or it may simply be favoured economically regardless of regulatory stipulations.

It is also the case that reuse itself is an emotive issue, and perhaps particularly so in the case of water. For domestic water recycling, that is recycling of water for non-contact domestic use such as toilet flushing or irrigation, public perception issues can outweigh the technical ones in terms of barriers to imposition. Key to this are the matters of ownership and identity. Studies have demonstrated that people are generally prepared to reuse water if it derives entirely from their own household, i.e. if they know where it has been. They are rather less prepared to use water if it is identified as deriving from some other source such as, for example, their neighbour's house (Jeffrey, 2002). Curiously, the complete loss of identity, such as arises either from large-scale community schemes, and indeed from conventional water supply via municipal works and intermediate environmental water bodies such as rivers, reservoirs and aquifers, is also perceived as being acceptable.

In reviewing the water reuse opportunities in industry, it is important to make the distinction between *reclamation* and *recycling*. Reclamation is the recovery and treatment of water to make it available for reuse; recycling is the recovery and reuse (whether or not subject to treatment) to and from a discrete operation. The development of water reclamation and reuse dates back centuries but modern day legislation probably dates back to 1956 in Japan, when the Industrial Water Law was introduced to restrict the use of groundwater by the rapidly growing Japanese industry, and Californian legislation leading to the adoption of the Federal Water Pollution Control Act of 1972 (Cologne, 1998). The drive for conservation of freshwater supplies has led to the development in some parts of the world, and in arid regions of the USA in particular, of large-scale community schemes in which water "recovered" from a municipal works is directly used for specific duties. In Japan, where sewerage services are limited and/or expensive, there has been a proliferation of in-building recycling schemes. For all such schemes, the key to the successful implementation of the reuse scheme is user acceptance and, ultimately, the assessment of risk.

Risk analysis, specifically to human health (Sakaji and Funamizu, 1998), plays a key function in municipal or in-building reuse schemes because of the implications of system failure for human health. Recycling of greywater (i.e. water used for washing) within a building, for example, is only likely to be acceptable if there is only a very minor risk to human health, predominantly from pathogenic microorganisms, arising from failure of the reuse system or some component of it. This imposes a limit both on the required rigour of the

repurification plant and, more directly, on the reuse options. Hence, reclaimed greywater for reuse in buildings is invariably employed exclusively for toilet flushing, where the risk to human health through exposure to the contaminated water is considered minimal. Large-scale municipal wastewater reclamation and reuse schemes are predominantly aquifer recharge, such as the well-established, flagship Water Factory 21 plant in Orange County, California (Wesner, 1987) or turf grass irrigation schemes.

In the case of industrial water recycling the issue is notionally more straightforward. As long as recycling can reliably and cost-effectively provide water of a quality appropriate to its designated use, then there should be no barrier to its introduction and deposition of the existing freshwater supply. Of course, and as already mentioned, the cost benefit may be largely or wholly determined by statutory requirements: there are, for example, a number of power plants throughout the world that have a zero liquid discharge imposed upon their operation (Section 5.3). Under such extreme conditions, wastewater recovery and reuse is no longer an option but an absolute necessity – and inevitably incurs cost penalties due to solid waste generation and energy expenditure. In other cases, the decision to recycle is motivated entirely by economics; the total cost of purification to provide a water of a quality commensurate with or better than that of the freshwater supply is perceived as being less than the total cost of freshwater and waste discharge. Perception in this instance relates entirely to the acceptance of the technology, rather than to the use of water employed for duties considered unsavoury.

Given the apparently less restrictive constraints imposed on the recycling of industrial wastewater compared to that of domestic wastewater, it is perhaps surprising that the former has received far more attention, has attained a much higher profile and has achieved more widespread implementation than the latter. There exist a number of domestic and municipal wastewater recycling schemes, from single households through to large buildings, as well as municipal or industrial wastewater reclamation for irrigation. Similarly, a number of municipal wastewater reclamation schemes exist whereby the polished effluent is reused for cooling, which represents around two-thirds of all industrial water use, or other activities demanding low-grade process water such as for washing or transporting. Direct “closed-loop” industrial water recycling, whilst limited in technical and economic viability in many instances, is nonetheless attracting greater interest and being more widely applied. Indeed, it is already established practice for specific industrial processes where other resources are recovered in addition to the water, such as pulp solids in paper manufacturing (Sections 3.2.5 and 5.4–5.6) and paint pigments (Section 5.10) in electrophoretic painting.

Two factors mitigate against widespread “closed-loop” industrial effluent reuse. Firstly, most industrial processes involve a number of individual operations that give rise to wastewaters of a certain compositional range. These individual effluent streams are generally combined to give a wastewater whose resultant temporal variation in quality is immense, representing a significant challenge to any treatment process that is to provide water of a reliably high quality. Secondly, it is invariably the case that conventional sewage treatment

works have the capacity to treat these industrial waters simply by virtue of blending with domestic water, significantly dampening the effects of broad temporal variations in quality and the concomitant shock loads of specific problem contaminants that arise. In other words, existing municipal wastewater treatment works are often able to cope with industrial effluents at a cost that is considered reasonable. The loss of the industrial effluent biological and hydraulic load from a sewage treatment works designed to accept it may even cause operational problems. Moreover, a municipal water supplier is able to provide mains water of a quality consistent enough to be reliably employed in most industrial processes. A reduction in mains water consumption and effluent discharge has a negative impact on the revenue of the water supplier and sewer operator companies, who are often one and the same company. Given these implications, it is prudent to consider industrial water usage and discharge as a whole.

1.2 Industrial water

Industry accounts for about a quarter of all water consumption, and there is hardly any industry that does not use large volumes of water (Table 1.1). Although some industries abstract water from rivers and boreholes, much of the water used by industry is taken from public water supplies, and has therefore been treated to potable quality standards. This means that it is often of better quality with respect to microbial levels but nonetheless requires further purification to reduce the mineral and organic materials content according to the specific duty to which it is to be put (Tables 1.2 and 1.3). Although water consumption has actually decreased over the last 15 years in some regions of the world (Table 1.4), the price of supply and discharge has risen substantially over the same period. According to figures for the UK, the average cost of water supply and sewerage services to unmetered customers has more than trebled in the last

Table 1.1 Approximate water demand for various industrial sectors

Industry	Water demand
Paper	29 m ³ /t paper produced ^a
Newspaper	9 m ³ /t paper produced ^b
Brewing	10–15 m ³ /m ³ beer ^b
Dairy	140 m ³ /m ³ milk ^b
Sugar	8 m ³ /t sugar ^b
Automotive	450 m ³ /car (metal production) ^b
Automotive	760 m ³ /car (tyre production) ^b
Dying	100 m ³ /t fabric processed
Soap	2 m ³ /t soap produced
Power	3 m ³ /MWh for steam; 60 m ³ /MWh for cooling

^aEU figure (Pauly, 2001).

^bGleick, 2000.

Table 1.2 Generalised industrial water quality standards

Class:	3	4	5	6	7	8	9
Type:	Softened	Dealkalised	Deionised	Purified	Apyrogenic	High purity	Ultrapure
Conductivity, $\mu\text{S}/\text{cm}$			20	5	5	0.1	0.06
Resistivity, $\text{M}\Omega \text{ cm}$			0.05	0.2	0.2	10	18
TDS, mg/l			< 10	< 1	< 1	0.5	0.005
pH			5.0–9.5	6.0–8.5	6.0–8.5	6.5–7.5	
LSI	-1 to +1	-1 to +1					
Hardness, mg/l CaCO_3	< 20		0.1	< 0.1	< 0.1		0.001
Alkalinity, mg/l CaCO_3		< 30					0.001
Ions, mg/l							0.001
Silica, mg/l			0.5	0.1	0.1	< 0.01	0.002
TSS, mg/l			< 0.1	< 0.1	< 0.1	< 0.1	ND
Turbidity, NTU			< 0.5				
SDI			< 5	< 3	< 3	< 1	< 0.5
Particle count, no./ml				1	1	1	0.1
COD, mg/l				< 0.1	< 0.1		
TOC, mg/l							0.05
Microorganisms, cfu/ml				< 10	< 1	< 1	< 1
Pyrogens, EU/ml					< 0.25		< 0.25

15 years from £1.48 [\$2.12] in 1984–85 to £4.90 [\$7.94] in 1999–2000 (Water UK, 2000). In more arid regions of the world the figure is higher: between 1980 and 1995 water costs increased by more than an order of magnitude in California (Mannapperema *et al.*, 1993). It is clearly of some cost benefit to acquire a source of water that is commensurate with the quality demanded for its end use, without increasing freshwater demand or discharging waste to sewer. The economic viability of existing municipal effluent reclamation is then very much dependent on the match between the effluent water quality and that demanded by the duty.

A whole industry has built up around the above key concept. *Pinch* analysis has conventionally been employed to maximise heat transfer efficiency within an industrial process. *Water pinch* analysis (Baetens, 2002; Section 4.2) is simply pinch analysis based on water quality and volumes, i.e. based solely on mass rather than heat. As such, it is simply an extension of a simple water audit. On the other hand, water pinch analytical tools have not yet reached a level of sophistication where water purification unit processes can be incorporated, since the performance of such processes can rarely be reliably predicted.

Volumes of water used are actually extremely dependent upon the policy of the company or the individual factory regarding water management, and in particular their housekeeping. Housekeeping relates to the way individual unit

Table 1.3 General water quality requirements for specific duties

Use	Industry	Application	Quality
Fire fighting	All		1 (natural)
Irrigation	Agriculture		1 (river)
Domestic	Offices	Drinking water	2 (potable)
	Hotels/catering	Down services	2/3
	Healthcare	Laundries	3
Steam raising	Process industries	Heating	3/4
		Steam stripping	3/4
		High-pressure steam	5
		Turbine drive	8
Heat transfer	Power generation		
	Manufacturing	Closed heating and cooling systems	3/4
	Process industries	Open recirculatory cooling systems	3/4
	Offices	Air conditioning	5
Process water	Hotels/catering		
	Healthcare		
	Heavy chemicals	Product washing	2/3
	Fine chemicals	Solvent	4
	Food/soft drinks	Bottle/container washing	5
	Brewing	Cleaning in place (CIP)	2
	Pharmaceuticals		6/7
	Metal finishing		5
	Photographic		5
	Laboratories		8
Product	Semiconductor	Ultrapure water	9
	Food/soft drinks	Product quality	4
	Brewing	Shelf life	2/4
	Pharmaceuticals	Parenterals	7
	Cosmetics	Lotions/liquids/topicals	5/6

Table 1.4 Specific water consumption, litres per capita per day, across Europe (Water UK, 2000)

Country	Household and small business		Industry and others		Total	
	1980	1997	1980	1997	1980	1997
Austria	155	160	100	77	255	237
Belgium	104	118	59	42	163	160
Denmark	165	136	96	70	261	206
Finland		155		97		252
France	109	151	58	51	167	205
Germany	139	130	52	54	167	205
Hungary	110	104	107	49	217	153
Italy	211	228	69	58	280	286
Luxembourg	183	172	76	81	259	253
Netherlands	142	166	37	43	179	209
Spain	157	145	58	95	215	240
Sweden	195	188	120	69	315	257
UK	154		100		254	324

operations within the factory are conducted so as, in this instance, to limit the freshwater demand. Actual examples of demand management, reuse and recycling (Table 1.5) demonstrate that the degree of sophistication of the solution to achieve a significant cost benefit depends upon the existing state of water management.

It is apparent from Tables 1.2 and 1.3 that the quality of water demanded by industry varies considerably from one duty to another. There exist certain determinants, such as the Silt Density Index or SDI (Section 2.4.3), which are of critical importance for some applications but are meaningless in others. Moreover, it is generally the case that the volume of water demanded varies inversely with that of its purity across any one industrial sector. For example, according to the figures in Table 1.1, about 20 times as much water – making up around 90% of the total water demand of the plant – is used for cooling in power generation as that required for boiler feed, which demands a “high-purity” water. Such water can only be produced through a combination of adsorptive and membrane separation processes. Water for once-through, non-intrusive cooling, on the other hand, may not be required to meet any specification based on chemical and biological constituents, needing only to be below a certain temperature.

For some industrial processes the quality of the discharged water does not substantially differ from that of the feedwater. Cooling towers, for example, concentrate the water as a result of the evaporative cooling process, but do not add significantly, if at all, to the chemical loading rate, in terms of mass flow rate of solutes, of the effluent. For most industrial sectors, however, there is a significant pollutant load resulting from their activity. As already stated, the large temporal variation in effluent water quality can preclude water recovery and reuse in many cases due to the high cost of treatment to produce water of a reliable quality, particularly by the more established non-barrier technologies where treatment process performance varies with hydraulic and/or pollutant load. On the other hand, membrane processes, which can offer a highly selective barrier to the water being processed, are far more robust to changes in feedwater quality and can provide water of reliably high quality.

1.3 Membrane technology

Membrane processes are designed to carry out physical or physicochemical separations. Although most membrane applications are water based, there also exist gas–liquid and gas–gas separation processes, although these are more recent developments and have not yet achieved widespread implementation. In terms of membrane sales, the most important application by far is hemodialysis, as carried out in kidney dialysis machines: almost half of all membrane sales are accounted for by this one application. The development of membrane-based bulk water and wastewater treatment processes, as defined in Table 1.6, is nonetheless significant, since they offer three clear advantages over conventional techniques:

Table 1.5 Examples of water management, UK

Type	Application	Scenario	Solution	Cost benefit
Audit	Cellophane production	750 m ³ /day of water unaccounted for	Fix leak	£100 000 p.a. saving [\$141 580]*
Audit	Laboratory	Mains water used for single-pass cooling. 12 m ³ /day	Fit cooler (£2000)[\$2831]*	6 month payback
Housekeeping	Resin factory	Wash water contaminated by spillages from point sources	Fit drip trays to point sources	Effluent COD reduced by 75%. £3000 p.a. saving [\$4217]*
Housekeeping	Plating plant	Significant drag out of chemicals from plating bath into rinse bath	Improve drainage around plating bath	Reduced rinsewater contamination. £1000 p.a. saving [\$1416]*
Reuse	Plating plant	0.4 m ³ /h mains water fed to three rinsing baths in parallel, 1.2 m ³ /h in total	Use counter-current serial flow to all three baths	50% water saving. £1500 p.a. [\$2124]*
Recycling	Cadmium plating	Zero discharge of cadmium imposed by regulator	Installation of deionisation plant to recover cadmium and water from effluent	12 month payback

* Based on rate of 1.4158, 02/06/2002.

Table 1.6 Membrane processes

Process	Usual objective
Microfiltration (MF)	Removal of suspended solids, including microorganisms
Ultrafiltration (UF)	Removal of both large, dissolved solute molecules and suspended colloidal particles
Nanofiltration (NF)	(Selective) removal of multivalent ions and certain charged or polar molecules
Reverse osmosis (RO)	Removal of inorganic ions
Electrodialysis (ED) and dialysis	(Selective) extraction of ions from water and/or concentration of these ions in the waste stream
Pervaporation (PV)	(Selective) extraction of molecular gas and/or volatile solutes
Gas transfer (GT)	Transfer of molecular gas into or out of water

1. Separation is achieved without requiring a phase change, and is therefore more energetically efficient than distillation.

2. Little or no accumulation takes place in the process which therefore operates continuously under steady-state condition without necessitating regeneration cycles, unlike adsorptive separation processes.

3. Little or no chemical addition is required, unlike conventional clarification which generally relies on the addition of chemical coagulants and flocculants.

Membrane technology development as a whole began with the first high-performance reverse osmosis membrane produced by in the early 1960s (Loeb and Sourirajan, 1963), which led to the installation of large seawater desalination plant in arid regions of the world. Since that time, growth in the total quantity of membranes sold with reference to the water treatment capacity provided has increased exponentially with time, with growth in microfiltration and ultrafiltration technologies over the last decade of the twentieth century being particularly pronounced (Fig. 1.1). There has been a corresponding exponential decrease in membrane costs with installed membrane plant capacity, as reflected in data from an established hollow fibre microfiltration membrane (Fig. 1.2). The increasing stringency of water quality guidelines and standards being introduced for municipal water treatment, for example the European Union Urban Waste Water Treatment Directive (UWWTD) and the position taken by the UK Drinking Water Inspectorate regarding cryptosporidia, portend continued growth in this sector for membrane technology. Indeed, the EU wastewater treatment membrane market is predicted to increase by an average annual growth rate of 5.9% to \$250 million in 2006 (BCC, 2002).

Application of membrane processes within the industrial sector is also widespread and well established in many instances. Reverse osmosis and ultrafiltration, for example, are both widely used within the pharmaceutical industry to remove pyrogens in the provision of water for injection (WFI). These processes are also essential in providing ultrapure water in semiconductor fabrication plant, where ultrafiltration is used for removing colloidal material and reverse osmosis both for primary deionisation (followed by polishing using

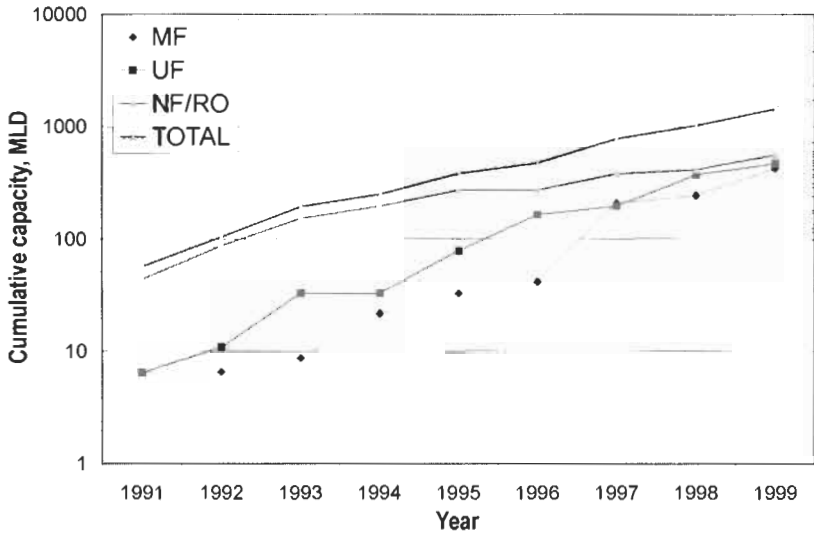

Figure 1.1 Total membrane sales with respect to water treatment capacity (by kind permission of Vivendi)

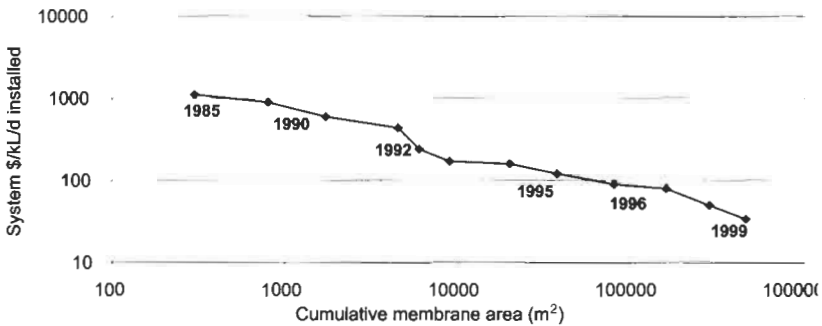

Figure 1.2 Membrane costs vs. installed membrane area ("Memcor" microfiltration plant) (courtesy of Vivendi)

an ion-exchange process) and for polishing the rinse water. Cartridge microfilters are routinely used for the removal of extraneous suspended solids from boiler feedwaters. Although rather less well established, membranes are also used for the treatment of industrial effluents for discharge. Possibly the most recently developed and successfully implemented membrane process for wastewater treatment is the submerged membrane bioreactor, which is applied to both municipal and industrial effluents for the removal of dissolved organic material. Market penetration of this technology has followed much the same trend as that of the more established microfiltration process (Fig. 1.3).

The use of membranes specifically for industrial wastewater reclamation and reuse has generally been constrained by the costs involved. Having said this, advances in membrane technology, and notably significant improvements in its

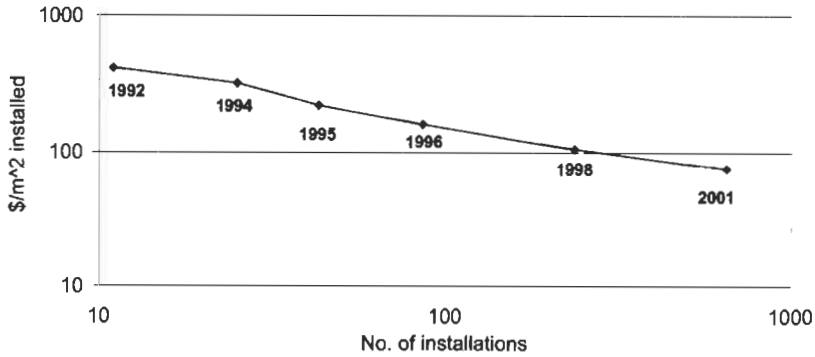

Figure 1.3 Microfiltration membrane costs vs. number of installations ("Kubota" membrane bioreactor plant) (from information provided by Kubota)

efficiency and cost effectiveness, greatly increase the competitiveness of recycling over discharge. Existing examples of closed-loop water recovery and reuse, invariably based on membrane technology, suggest that payback periods as low as 18 months are achievable, the timescale obviously being very sensitive to supply and discharge costs. Given the continuing downward pressure on costs (Figs. 1.2 and 1.3) and the increasingly severe stresses on freshwater supplies, it seems likely that membranes will be used ever more widely for water recycling within the industrial sector.

References

- Bactens, D. (2002). Water pinch analysis: minimisation of water and wastewater in the process industry. In Lens, P., Hulshoff Pol, L., Wilderer, P. and Asano, T. (eds.) *Water recycling and resource recovery in industry*. IWA Publishing, London, pp. 203–251.
- BCC (2002). *Advanced waste water treatment for global markets*. Business Communications Company Inc., Norwalk, CT.
- Cologne, G. (1998). Legal aspects of water reclamation. In Asano, T. (ed.) *Wastewater reclamation and reuse*. Technomic, Lancaster, Basel, p. 1397.
- Gleick, P. H. (2000). *The world's water 2000–2001, the biennial report on freshwater resources*. Island Press, Washington, USA.
- Jeffrey, P. (2002). Influence of technology scale and location on public attitudes to in-house water recycling in England and Wales. *CIWEM Journal* (in press).
- Loeb, S. and Sourirajan R. (1963). Seawater demineralisation by means of an osmotic membrane. *Advances in Chemistry Series*, **38**, 117.
- Mannapperema, J. D., Yates, E. D. and Singh, R. P. (1993). Survey of water use in the California food processing industry. *Proceedings of the Food Industry Environmental Conference*, Los Angeles, CA.

Pauly, D. P. (2001). Kidney technology for whitewater treatment. *Paper Technology*, **42**, 29.

Sakaji, R. H. and Funamizu, N. (1998). Microbial risk assessment and its role in the development of wastewater reclamation policy. In Asano, T. (ed.) *Wastewater reclamation and reuse*. Technomic, Lancaster, Basel, pp. 705–756.

Water UK (2000). *Waterfacts 2000*. Water UK, London.

Wesner, G. M. (1987). Historical review of Water Factory 21 Orange County Water District wastewater reclamation and groundwater recharge program. Report to OCWD.

Chapter 2

Membrane technology

Simon Judd
School of Water Sciences, Cranfield University

2.1 The membrane

2.1.1 Membrane and membrane process definition

There are a number of definitions of the word “membrane”, which can vary considerably in comprehensiveness and clarity. It is a very widely used term, and can mean anything from a cell wall to damp proofing material. Three definitions, arbitrarily chosen from pertinent technical literature from the last 20 years are provided below:

- “An intervening phase separating two phases and/or acting as an active or passive barrier to the transport of matter between phases” – the European Society of Membrane Science and Technology (now the European Membrane Society).
- “An interphase separating two homogenous phases and affecting the transport of different chemical components in a very specific way” – Prof. Heine Strathmann, former Head of the Department of Membrane Technology, University of Twente.
- “A material through which one type of substance can pass more readily than others, thus presenting the basis of a separation process” – Prof. George Solt, former Director of the School of Water Sciences, Cranfield.

For the purposes of this discussion of membrane technology for wastewater treatment, Solt’s definition can be considered adequate: it is that property of the membrane which permits the separation of components in and/or from water that is of key interest. For many processes the membrane acts to reject the pollutants, which may be suspended or dissolved, and allow the “purified” water through it. In some cases, however, the membrane may act so as to extract pollutants from the wastewater, or else transfer specific components (such as oxygen) into it. Currently employed extractive processes include electrodialysis (ED), dialysis, pervaporation (PV) and gas transfer (GT). In these cases the membrane is employed to allow selective permeation of specific components dissolved in the water. Of far more industrial importance, however, are the filtration processes of reverse osmosis (RO), nanofiltration (NF), ultrafiltration (UF) and microfiltration (MF). In these processes it is the bulk water that passes through the membrane under an applied pressure, leaving the pollutants in concentrated form on the unpermeated side of the membrane. If hemodialytic applications are ignored, then the pressure-driven filtration processes account for around 75% of the remaining membrane sales, almost all of these due to aqueous separation applications in municipal and industrial water treatment.

2.1.2 Membrane structure

Although membrane materials vary vastly according to chemical composition and process type, the principal objectives in membrane manufacture are always the same. An ideal material will:

- have reasonable mechanical strength,
- maintain a high throughput, and
- be selective for the desired permeate constituent.

These last two parameters are mutually counteractive, since a high degree of selectivity is normally only achievable using a membrane having small pores and thus an inherently high hydraulic resistance (or low permeability). The permeability also increases with increasing density of pores, and the overall membrane resistance is directly proportional to its thickness (in accordance with Darcy's law). Finally, selectivity will be compromised by a broad pore size distribution. An optimum physical structure for any membrane material is thus:

- a thin layer of material,
- a narrow range of pore size, and
- a high porosity.

Membrane materials can be categorised as either *dense* or *porous*, and by the mechanism by which separation is actually achieved (Table 2.1). Separation by dense membranes relies to some extent on physicochemical interactions between the permeating components and the membrane material, and relate to separation processes having the highest selectivity (Fig. 2.1). Porous membranes, on the other hand, achieve separation mechanically by size exclusion (i.e. sieving), where the rejected material may be either dissolved or suspended depending on its size relative to that of the pore. Since some membranes exhibit properties that can be associated with more than one process type, the boundaries between the adjacent membrane processes in Fig. 2.1 are somewhat nebulous. For example, IUPAC (1985) state that the upper and lower boundary limits for mesopores, as are characteristic of a UF membrane, are 2 and 50 nm. According to Kesting (1989), however, these boundaries are at 1 and 20 nm, respectively.

Whilst microfiltration membranes are assigned a characteristic pore size, the exact value of which is dependent on the method of measurement, ultrafiltration membranes are mostly rated on the basis of the size of the smallest molecule the membrane can be expected to reject. This is routinely expressed as the molecular weight cut-off (MWCO) in daltons (i.e. grams per mole). As the precise relationship between MWCO and pore size is obviously dependent on the physical and chemical nature of the solute molecule, precise cross-referencing is impossible. The actual pore size of nanofiltration and reverse osmosis membranes is of little practical consequence, since there are other mechanisms more dominant than simple sieving that determine membrane performance. The purification performance of these membranes can only be rated according to their actual demonstrated permselectivity, i.e. the extent of the rejection of key contaminants by the membrane, under some defined set of conditions. Nanofiltration membranes, which have a charge rejection component, are generally designed to be selective for multivalent rather than univalent ions. Reverse osmosis membranes are designed to reject all species other than water.

Table 2.1 Dense and porous membranes for water treatment (adapted from Stephenson et al., 2000)

Dense	Porous
Membrane separation processes	
<i>Reverse osmosis (RO)</i>	<i>Ultrafiltration (UF)</i>
Separation achieved by virtue of differing solubility and diffusion rates of water (solvent) and solutes in water.	Separation by sieving through mesopores (2–50 nm) ^a .
<i>Electrodialysis (ED)</i>	<i>Microfiltration (MF)</i>
Separation achieved by virtue of differing ionic size, charge and charge density of solute ions, using ion-exchange membranes.	Separation of suspended solids from water by sieving through macropores (> 50 nm) ^a .
<i>Pervaporation (PV)</i>	<i>Gas transfer (GT)</i>
Same mechanism as RO but with the (volatile) solute partially vaporised in the membrane by partially vacuumating the permeate.	Gas transferred under a partial pressure gradient into or out of water in molecular form.
<i>Nanofiltration (NF)</i>	
Formerly called leaky reverse osmosis. Separation achieved through combination of charge rejection, solubility–diffusion and sieving through micropores (< 2 nm).	
Membrane materials	
Limited to polymeric materials.	Both polymeric and inorganic materials available.

^a IUPAC (1985).

although they are unable to offer a significant barrier to dissolved gases and certain low-molecular-weight organic molecules.

Membranes may also be categorised according to the material composition, which is either organic (polymeric) or inorganic (ceramic or metallic), or on the basis of their physical structure, i.e. their morphology. The membrane morphology is dependent on the exact nature of the material and/or the way in which it is processed. In general, however, membranes employed in pressure-driven processes tend to be anisotropic: they have symmetry in a single direction, and hence are often referred to as asymmetric, such that their pore size varies with membrane depth (Fig. 2.2). This arises out of the requirement for a thin permselective layer (or skin) to minimise the hydraulic resistance, the porous support providing minimal resistance and acting purely to provide the necessary mechanical strength. For integral (i.e. single, non-composite material) asymmetric polymeric membranes, such as the one shown in Fig. 2.2a, the skin is normally 2–5 µm in thickness.

Flat sheet reverse osmosis membranes have an additional ultrathin active layer, less than 0.5 µm in thickness, attached to the anisotropic substrate to produce a thin-film composite (TFC) membrane (Fig. 2.3). This ultrathin layer provides the required permselectivity, rejecting all charged species and permitting only the passage of water and small organic molecules. On the other hand, ion exchange membranes, which are also dense by definition, are essentially homogeneous. These membranes comprise a three-dimensional array of fixed ionogenic sites (i.e. functional groups capable of dissociating to form charged species) which facilitate transport of either cations or anions

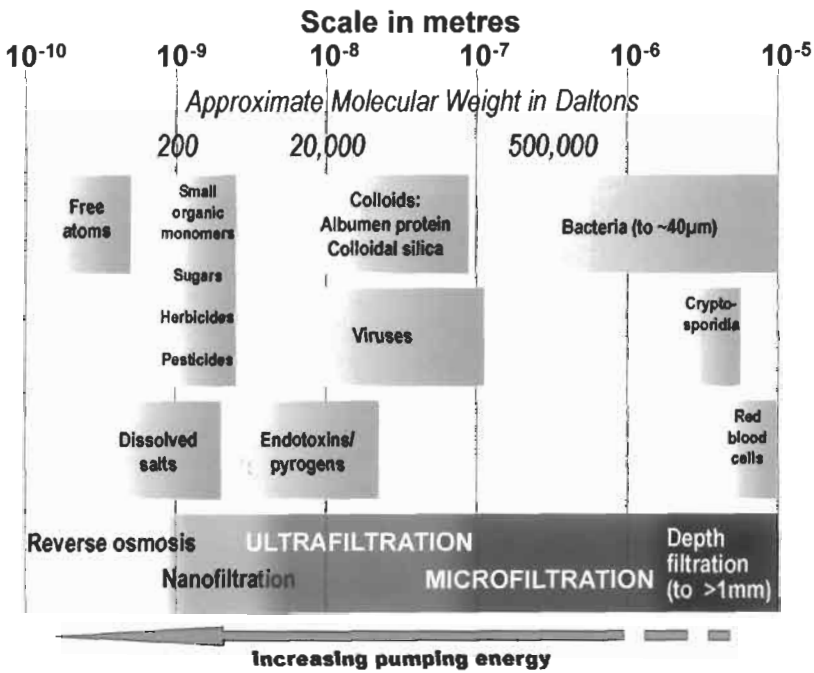

Figure 2.1 Membrane separation processes overview (from Stephenson et al., 2000, reproduced with permission)

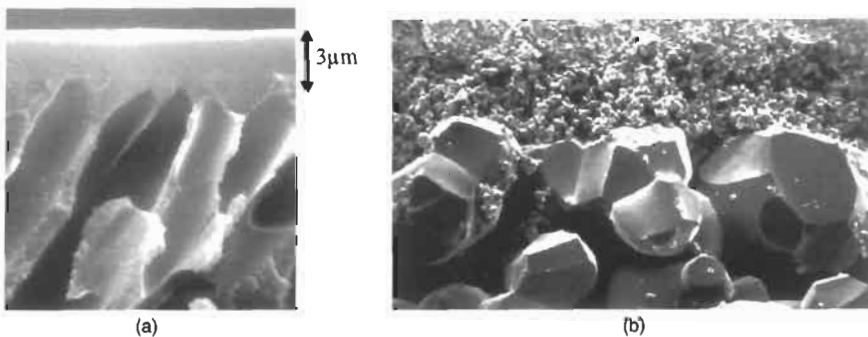

Figure 2.2 Anisotropic UF membranes: (a) polymeric (thickness of "skin" indicated), and (b) ceramic (by kind permission of Ionpure)

through the membrane. Certain porous membranes are also homogeneous, but these tend to have a correspondingly low permeability.

2.1.3 Membrane materials and their manufacture

Membrane manufacture ostensibly concerns the production of a permeable material at a reasonable cost. The membrane cost is dependent on not only the

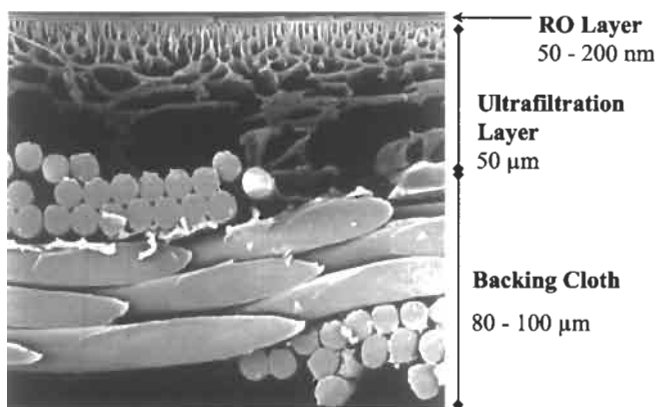

Figure 2.3 Composite RO membrane structure (FT 30, Film-Tec)

raw material but also on the ease with which pores of the desired size or size distribution can be introduced. This can vary considerably from one material to the next according to the method used and the corresponding precision of the pore size distribution (or degree of isoporosity).

The range of available membrane materials employed in water and wastewater treatment is very broad, and they vary rather more widely in chemical composition than in bulk morphology. Membranes can be produced by stretching, sub-atomic particle bombardment combined with etching and, in the case of ceramic materials, sintering (Table 2.2). These membranes are formed by the pressing and sintering of fine powders onto a pre-prepared porous support, which can produce pore diameters down to around 2 μm, followed by sol-gel processes to produce successive deposits of progressively finer porous layers down to a minimum pore size of around 3 nm. Ceramic nanofiltration membranes, however, have only recently arrived in the marketplace. The production process tends to be very expensive if a highly selective membrane layer of even thickness and narrow pore size distribution is to be produced. The cost of microfiltration or ultrafiltration membranes derived from titanium and/or zirconium usually exceeds \$1000 per m², although there appears to be some progress in producing low-cost ceramic membranes. At the opposite end of the spectrum are simple, homogenous polymeric membranes produced by extrusion (stretching) of partially crystalline sheets perpendicular to the orientation of the crystallites, possibly with the assistance of a fibrulating agent. Such materials cost less than \$1 per m² to produce, since the process can be made continuous, and the cost of the membrane module is then determined almost entirely by the module fabrication cost. However, such membranes are limited in their permeability, isoporosity and mechanical strength.

Supported liquid membranes (SLMs) have not yet been produced on a commercial scale, and currently appear to be more appropriate to gas separations where the improved mass transport of gases through liquids over that attainable in solids becomes important. SLMs currently being developed for

Table 2.2 Membrane materials by type

Membrane	Manufacturing procedure	Applications
Ceramic	Pressing, sintering of fine powders followed by sol-gel coating	MF, UF, Aggressive and/or highly fouling media
Stretched polymers	Stretching of partially crystalline foil	MF, Aggressive media, sterile filtration, medical technology
Track-etched polymers	Radiation followed by acid etching	MF (polycarbonate (PC) or polyethylene terephthalate (PET) materials). Analytical and medical chemistry, sterile filtration
Supported liquid	Formation of liquid film in inert polymer matrix	Gas separations, carrier-mediated transport
Integral asymmetric, microporous	Phase inversion	MF, UF, NF, GT
Composite asymmetric, microporous	Application of thin film to integral asymmetric microporous membrane to produce TFC	NF, RO, PV
Ion exchange	Functionalisation of polymer material	ED

liquid separations usually comprise a high-viscosity, hydrophobic liquid immobilised in a polymer matrix. The supported liquid may contain a *carrier*, a component that reacts chemically and reversibly with the desired component in the liquid mixture and thereby assists its transport through the membrane.

By far the most significant of the polymeric membranes applied to the water industry are those produced by phase inversion (Table 2.3), a fabrication process which produces an anisotropic material which may then be used as a substrate for a TFC membrane. The ultrathin surface layer of a TFC RO or NF membrane is invariably either a polyamide (usually aromatic) or some co-polymer blend based on polyamide. The permselectivity and throughput of such membranes is then critically dependent upon the precise polymers selected and the fabrication method used. For example, Filmtec (part of the Dow Chemical Company) produce both a reverse osmosis membrane (the FT-30) and a series of nanofiltration membrane materials (NF45, NF70 and NF90) which are all based on aromatic polyamide, yet the permeability and salt rejection capability of these membranes varies considerably.

The phase inversion process involves dissolving the polymer in a suitable solvent and then casting it in a film, less than 1 mm thick, and then adding another liquid to precipitate the polymer. The membrane skin forms at the interface between the solvent and the second liquid, in which the membrane is only sparingly soluble. Careful choice of the solvent and non-solvent liquids, concentration of the polymer, temperature and reaction times can produce the desired physical membrane characteristics.

Most polymeric materials are resistant to moderate pH swings, the principal exception being cellulose acetate, but most have limited resistance to organic solvents. Only PTFE and PVDF can be considered highly stable in this regard. The main limitation of the more robust polymeric materials, in terms of resistance to

Table 2.3 Commercially available phase inversion polymeric membrane materials

Polymer ^a	Advantages	Disadvantages	Process ^b
CA	Chlorine resistant Inexpensive More fouling resistant than PA	Susceptible to alkaline hydrolysis at pH > 6 Susceptible to biodegradation Limited thermal and chemical stability Limited permselectivity (~95% rejection) Slightly lower permeability	RO , NF, UF
PA	More all-round stability than CA More permselectivity than CA	Very limited chlorine tolerance (<0.1 mg l ⁻¹)	RO , NF
PAN	High resistance to hydrolysis High resistance to oxidation	Hydrophobic Requires copolymers to make less brittle	UF, RO substr.
PSU, PES	Very good all-round stability Mechanically strong	Hydrophobic	UF, RO substr.
PVDF, PTFE	Extremely high chemical stability High thermal stability	Highly hydrophobic Limited mechanical stability Limited intrinsic permeability Expensive	UF, MF
PEI	High chemical stability Very high thermal stability Mechanically strong	Hydrophobic Less solvent resistant than PVDF Poorer alkaline stability than PSU or PAN	UF , RO substr.
PP	Inexpensive	Hydrophobic	UF, MF

^a CA, cellulose acetate (predominantly di- or tri-acetate); PA, polyamide (aromatic); PAN, polyacrylonitrile; PSU, polysulphone; PES, poly(ether sulphone); PVDF, poly(vinylidene fluoride); PTFE, polytetrafluoroethane; PEI, polyetherimide; PP, polypropylene.

^b Most usual application in bold type.

oxidative attack and hydrolytic degradation promoted by extremes of pH, is their hydrophobicity. This makes them very susceptible to non-specific adsorption of hydrophobic contaminants in the water, which reduce the permeability of the membrane. This phenomenon, termed fouling, imposes a very significant constraint on the operation of all membrane processes. Much developmental work has been conducted in producing chemically and mechanically robust membranes with hydrophilic surfaces that are therefore less susceptible to fouling by common natural hydrophobic materials such as proteins.

Surface modification can take place by four recognised routes:

- chemical oxidation,
- organic chemical reaction,
- plasma treatment, and
- grafting.

Chemical oxidation, using standard oxidative chemicals such as chromic or nitric acid, converts surface groups such as alkenes and esters to hydroxyl and

carboxylate groups, respectively, which are more hydrophilic and normally negatively charged. Oxidative chemicals can also be used to promote grafting of hydrophilic monomers onto the membrane surface. Plasma treatment involves the generation of a plasma by continuous electrical discharge in a gas containing oxygen or water (to produce oxygen-containing functional groups), or nitrogen, ammonia or amines (to produce nitrogen-containing functional groups). Plasma treatment offers the advantages of being fairly controllable, since the reaction conditions can be adjusted to produce the required degree of reaction, and demands no hazardous liquids.

Chemical reaction and grafting add an organic layer to the surface of the polymer, rather than functionalising it in the way that the above oxidative reactions do. The surface can also be modified by specific organic chemical reactions which rely on the chemical reactivity of the polymer. Polysulphone, for example, will react with chloroether to produce the ortho-chloromethylated polymer (Guiver *et al.*, 1993). Polymer grafting can be promoted chemically or thermally but more usually involves irradiation in the presence of a suitable initiator and, invariably, vinyl or acrylic monomers.

Ion exchange membranes, whose most important property is permeability to counter-ions and impermeability to co-ions, can be produced either by functionalisation of a membrane, as mentioned above, or by immobilising powdered ion exchange resins in an inert resin matrix. Functionalisation produces a homogenous material that, as with many membranes, requires fixing on a suitable material to give it mechanical strength. The powder immobilisation method is relatively inexpensive but the materials produced are heterogeneous, less selective for counter-ions and have inferior mass transport properties than the equivalent more expensive homogeneous materials.

Recent developments: membrane materials

The search for new membrane materials with superior properties with respect to permeability and resistance to chemical, thermal and biological attack is ongoing. Of greatest interest is fouling resistance, and this demands the development of membranes with a low affinity to pre-identified foulants in the feedstock. The ease with which this can be achieved is to a large extent dependent on the heterogeneity of the feedwater matrix, since the membrane surface cannot be modified so as to be able to repel contaminants of different charges and hydrophobicities. In general natural foulants tend to carry a negative charge, which then demands that the membrane also carries a negative charge to repel the foulant. It should be pointed out, however, that some filters are surface modified to carry a positive charge (e.g. the Pall "Posidyne" nylon-based filter) to attract negatively charged suspended materials, but these filters are actually depth filters designed to retain particles rather than reject them.

One application that has received a great deal of interest is the removal of natural organic matter (NOM) from upland surface waters for potable water production using nanofiltration membranes. NOM contains a number of different fractions of which humic acids are one. Humic acids, which contain phenolic and carboxylate functional groups, tend to be negatively charged in

neutral solutions, such that a highly negatively charged membrane would be expected to repel these contaminants allowing operation at higher fluxes than would normally be attainable without fouling. This has focused attention upon highly negatively charged membranes and, in particular, blends of sulphonated poly(ether ether ketone) (SPEEK) or sulphonated poly(ether ether sulphone) (SPEES) with polysulphone or polyethersulphone, respectively (Bowen *et al.*, 2001; Knoell *et al.*, 1999). These membranes are likely to be commercialised within the next five years.

Another important constraint on the application of membranes to industrial process waters is their resistance both to extreme pH conditions and, more especially, key organic solvents. A few porous membrane materials, notably PTFE and PVDF, are intrinsically resistant to attack from both chlorinated and hydroxylated or carboxylated organic solvents, whereas PSU, PES and PEI will withstand some organic solvents but not chlorinated reagents like chloroform. Recently, a range of organic nanofiltration membranes (SelRO[®], commercialised by Koch) have become available that can apparently be employed in pure, non-chlorinated organic solvents. These membranes are probably a modified cross-linked PAN material. Details of other solvent-resistant UF and NF membranes either recently available or under development are provided by Nunes and Peinemann (2001), and this information is summarised in Table 2.4.

So far as ceramic filters are concerned, there is a general drive to increase their competitiveness by reducing costs to allow them to be sold at less than \$1000 per m², although it is still the case that such a price is only attainable for large bulk orders. However, very recently the opportunities offered by extrusion of certain ceramic materials have started to be explored, for example by Ceramem, allowing the production of membrane materials of much lower cost (Section 2.1.4). Perhaps the most intriguing of the ceramic filters, however, is the Anopore filter. This is produced by electro-oxidation of aluminium to produce an almost perfect honeycomb structure with an extremely narrow pore size distribution and a surface porosity of up to 50%. This porosity value compares well with the similarly homoporous Nuclepore membranes, produced by neutron bombardment followed by track-etching of polyethylene terephthalate.

Table 2.4 Solvent-resistant UF and NF membranes, new or under development (taken from Nunes and Peinemann, 2001)

Material	Application	Supplier(s) or developer(s)	Stability
Hydrophilic PAN	NF	Koch SelRO [®]	DMF, NMP, DMSO resistant; 0–14 pH, 70°C
-	NF	Desal D-series, Osmonics	35% H ₂ SO ₄ , 25% H ₃ PO ₄
-	NF	Somicon/Nitto	15% NaOH, 60°C, pH < 1
PVDF/Cellul.	UF/NF	Dow Danmark Etna	pH 1–12
PI	UF	Nitto, Bend Research	-
PEEK	UF	Dow, Ionics	-
PAEK/PEI	UF	Bend Research	-

which is no more than 14% porous. Unfortunately, the membrane thickness of 60 μm makes the hydraulic resistance of the Anopore membranes relatively high and, more crucially, they can currently only be produced in small batches as disc filters for use in the laboratory.

2.1.4 Membrane configurations

A membrane is only useful if it takes a form which allows water or pollutants to pass through it. The configuration of the membrane, i.e. its geometry and the way it is mounted and oriented in relation to the flow of water, is crucial in determining the overall process performance. Other practical considerations concern the way in which the membrane elements, i.e. the individual discrete membrane units themselves, are housed to produce modules, the complete vessels through which the water flows. The optimum membrane configuration is one that has the following characteristics:

- (a) a high membrane area to module bulk volume ratio
- (b) a high degree of turbulence for mass transfer promotion on the feed side
- (c) a low energy expenditure per unit product water volume
- (d) a low cost per unit membrane area
- (e) a design that facilitates cleaning
- (f) a design that permits modularisation.

All membrane module designs, by definition, permit modularisation (f), and this presents one of the attractive features of membrane processes *per se*. However, some of the remaining listed characteristics are mutually exclusive. For example, promoting turbulence (b) results in an increase in the energy expenditure (c). Direct mechanical cleaning of the membrane (e) is only possible on comparatively low area:volume units (a) where the membrane is accessible. Such module designs inevitably increase the total cost per unit membrane area (d). Finally, it is not possible to produce a high membrane area to module bulk volume ratio without producing a unit having narrow feed channels, which will then adversely affect turbulence promotion.

There are five principal configurations currently employed in membrane processes, which all have various practical benefits and limitations (Table 2.5). The configurations are based on either a planar or cylindrical geometry and comprise:

- Pleated filter cartridge
- Plate-and-frame
- Spiral wound
- Tubular
- Hollow fibre

Of the flat plate geometries the lowest cost is the pleated filter cartridge (Fig. 2.4), used exclusively in microfiltration and designed as a relatively inexpensive

Table 2.5 Membrane configurations

Configuration	Area/vol. ratio (m ² /m ³)	Cost	Turbulence promotion	Backflushable?	Application ^a
Pleated cartridge	500–1 500	Very low	Very poor	No	DEMF, low TSS waters
Plate-and-frame	100–300 ^b	High	Fair	No	ED , UF, RO
Spiral wound	800–1 200	Low	Poor	No	RO , NF, UF
Tubular	150–300	Very high	Very good	No	CFMF, high TSS waters
Capillary tube ^c	1 500–5 000	Low	Good	Yes	UF
Hollow fibre ^d	10 000–20 000	Very low	Very poor	Yes	MF , RO

^a Most important application in bold type; DE = dead-end, CF = cross-flow.

^b Can be 2/m³ for a cassette.

^c Capillary tube used in UF: water flows from inside to outside the tubes.

^d Hollow fibre used in MF and RO: water flows from outside to inside the tubes.

disposable unit to be employed for polishing relatively pure waters. Pleated media provide a high area to volume ratio and also ensure the minimum number of sealing operations, i.e. a side seal and two end seals. The construction is such that the loss of filter area at the folds of the pleat is avoided by using a suitably designed membrane separator. The configuration is suitable for both organic polymeric media and porous metal media, the latter having a minimum pore size of around 2 µm. For these filters, and for other membrane modules applied to pure waters, key design parameters are integrity testability, sterilisability and, most importantly, propensity to leach contaminants from the module or unload retained particles from the filter medium.

Plate-and-frame modules comprise rectangular or (pseudo) circular flat sheet membranes with separators and/or support plates. The modules can be pressure sealed, such as with electro dialysis stacks, or be designed as cassettes. Cassettes allow membrane elements to be inserted and removed individually without the necessity of partially dismantling the module. They are, however, limited to low-pressure operation, and hence to microfiltration or ultrafiltration processes. An example is the Kubota membrane, employed exclusively in a membrane bioreactor (Fig. 2.5). This technology operates at transmembrane pressures as low as 0.05 bar, and therefore does not demand as robust a construction as a pressure-sealed unit would provide. The membrane element comprises two rectangular sheets, 0.4 m × 0.8 m, heat sealed at the perimeters to a plastic frame. The elements are inserted into a cassette holding up to 150 elements, with the permeate collected from inside each one individually.

An example of a circular pressure-sealed module is the Rochem reverse osmosis module (Fig. 2.6). This module employs support plates of 200–400 mm diameter and 5 mm thick at the outside edge. The plate surfaces are covered with tiny protuberances that promote turbulence as the water flows over them. Sandwiched between adjacent plates is a membrane element comprising two membrane sheets, heat sealed at the edges and separated by a thin plastic mesh. The feed is introduced at the top of the stack and flows radially outward at the top

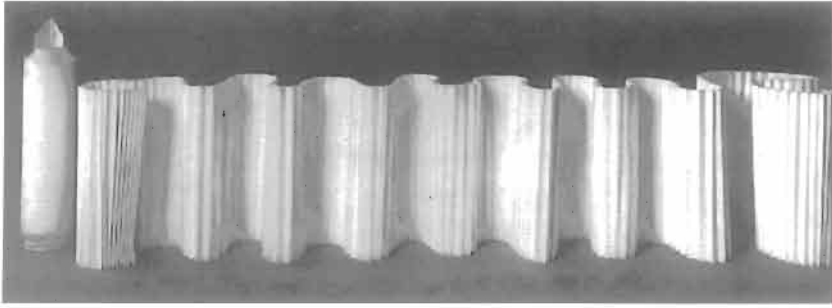

Figure 2.4 Pleated cartridge filter membrane (by kind permission of Pall)



Figure 2.5 Kubota MF cassette

of the membrane element and radially inwards at the bottom whilst a fraction of the flow permeates the membrane to form the product water inside the element. The retentate, i.e. the rejected concentrated water from a single elemental stage, is then transferred to the next element. There may be hundreds of elements in a single stack, producing a very long retentate flow path and allowing commensurately high conversions, i.e. percentage formation of product water from feed water. This module can also be configured for each element to be arranged in series rather than in parallel, giving very short retentate flow paths, which reduce concentration polarisation-exacerbated fouling (Section 2.2.3) to some extent.

Examples of rectangular pressure-sealed plate-and-frame modules are the Rhodia-Orelis PLAEIDE UF/MF module (Fig. 2.7) and electro dialysis stacks (Fig. 2.8). The latter are all based on a plate-and-frame design since the process relies

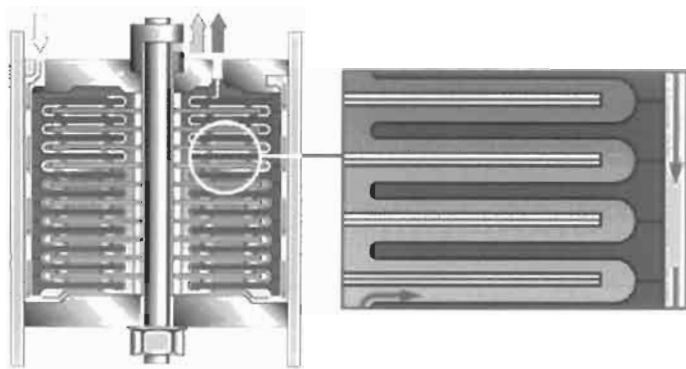

Figure 2.6 Rochem stacked disc RO module, detailing fluid path

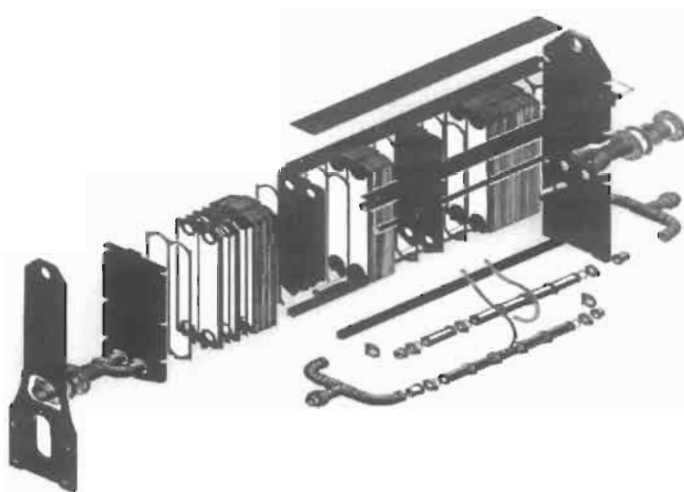

Figure 2.7 Rhodia Orelis PLAEIDE MF membrane module

on transport of ions through the membranes under the action of an electric field and this configuration presents the simplest means of exposing a large membrane area to an orthogonal electric field. Electrodialysis is simply a combination of electrolysis and ion-selective permeation. If a potential difference (voltage) is applied across a solution of ions they are transported through the solution by electromigration, giving rise to the flow of a current. If ion-selective membranes are then placed in the solution then only the counter-ions are allowed to pass through the membrane via the oppositely charged pores in membrane material. The placement of alternate cation and anion selective membranes (Fig. 2.8) produces compartments or cells in which the salts are alternately concentrated and demineralised by the action of the applied voltage and the resulting flow of current.

The nature of the ED process makes for a module that is somewhat complex in design, and is thus comparatively expensive, and which has to be hand

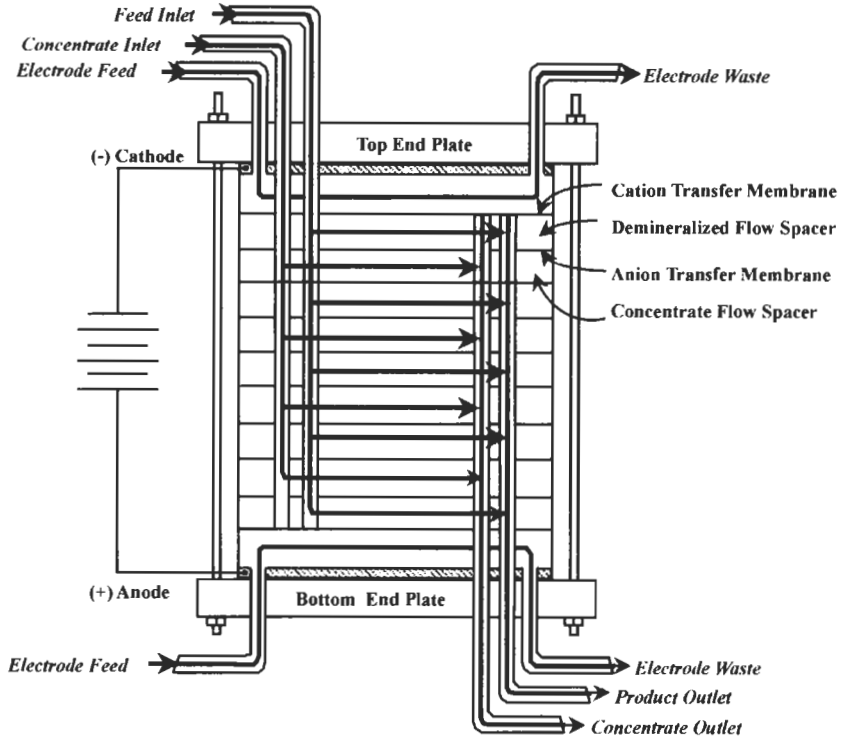

Figure 2.8 Electro dialysis stack (by kind permission of Ionics)

assembled. By the same token, the design allows both membrane sheets and the spacers that separate them to be removed and replaced on an individual basis. Indeed, ED suppliers are able to tailor the membrane spacer to the feedwater specification and the duty to which the technology is being put, allowing a degree of flexibility that other membrane module designs are unable to provide (Section 2.4.2). Ceramic rectangular pressure-sealed plate-and-frame modules also exist, an example being the K eram module by TAMI.

Spirally wound membranes (Fig. 2.9) have the advantage of simple and robust construction whilst providing a reasonable membrane area per unit volume, and find use in reverse osmosis and nanofiltration plant. As with many membrane modules, the membrane element comprises two membranes sandwiched together, in this case forming a rectangular "bag" sealed on three sides. The open side is presented to a central perforated tube which collects the permeate product from inside the membrane element. The membrane element is rolled up to produce a spiral which forms a cylindrical shape, one end of which is presented to the feedwater. The fluid path length then equates to the length of the cylinder, and spacers are used to maintain separation of the membrane leaves both in the retentate, where the spacers also serve the important task of turbulence promotion, and in the permeate channels. A number of membrane elements, up to seven for very large plant, can make up a single module by

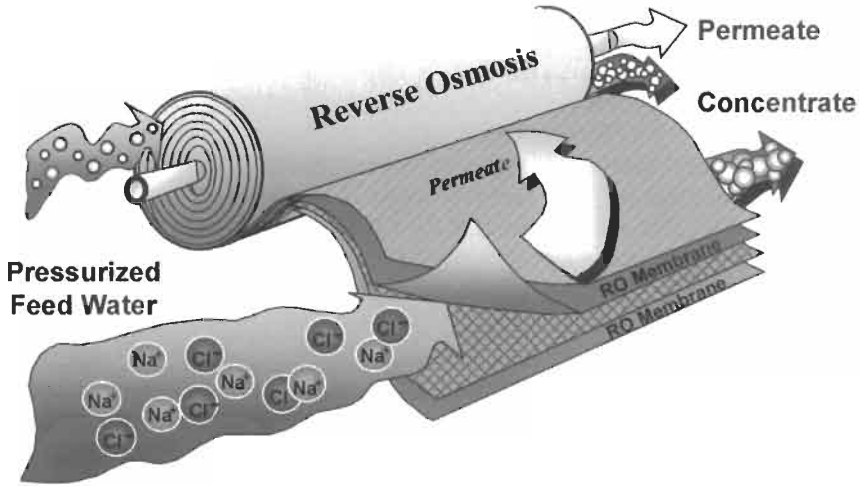

Figure 2.9 Spiral-wound module, schematic showing flow streams (by kind permission of Ionics)

linking the retentate streams in series and placing the module in an appropriate pressure vessel.

Tubular modules provide a modest surface area to volume ratio, and thus the highest cost per unit area of all cylindrical membrane geometries, but also provide potentially the greatest turbulence promotion and the best access to the membrane surface. Both these factors tend to favour this configuration for highly fouling matrices. If the tube diameter is sufficiently large it is possible to mechanically clean the membranes in place, as is carried out with the FYNE[®] nanofiltration process developed by PCI Membranes. This process uses foam balls to wipe the inner surface of the membrane tubes once fouled, thus minimising the use of chemicals for this duty. Commercially available modules are mainly multi-channel (Fig. 2.10), with mechanical support required for the polymeric tubes. The ceramic tubes tend to have a lower packing density due to their monolith construction: the tubes comprise cylindrical holes bored into a solid ceramic support. The brittle nature of the ceramic material imposes a lower limit on the tube wall thickness, tending to increase the overall membrane hydraulic resistance over that of a comparable polymeric membrane.

The inherent radial mechanical strength of a tube increases with decreasing diameter, such that at a certain diameter the tube becomes self-supporting. This is the case for capillary tubes and hollow fibres. The highest packing densities are obtained from hollow fibre membrane modules (Fig. 2.11). These can have inner diameters as small as 10 µm for particularly fine fibres (hence hollow fine fibres, or HFF), which therefore give the highest packing densities and so the lowest cost. The module is of a very simple construction. The bundle of fibres is simply bent double and the ends potted and exposed at one end of the tube into which they are inserted. Hollow fibre modules operate out-to-in, such that the skin is formed on the outer membrane surface. Capillary fibres modules, which are slightly larger filaments, are operated in-to-out with the skin therefore formed on



Figure 2.10 Tubular UF modules: (a) polymeric (PCI Membranes), and (b) ceramic (Kerasep[®], by Rhodia Orelis)

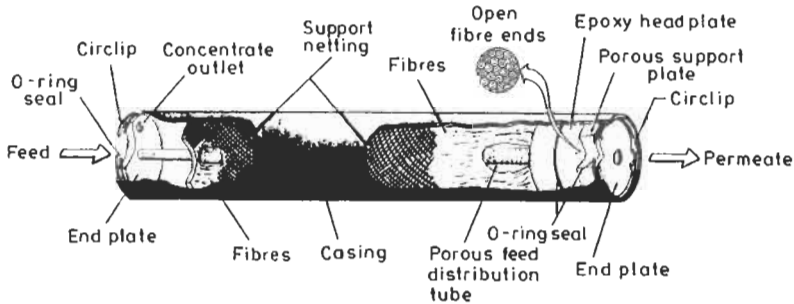

Figure 2.11 Hollow fibre module

the internal surface. This allows more control of the hydrodynamics, but the operational pressure is then limited by the mechanical strength of the fibres, which relates to the wall thickness. However, both capillary fibres and hollow fibres can be backflushed (i.e. the flow reversed to wash the foulant from the membrane surface). This is particularly crucial for hollow fibres, where the lack of hydrodynamic control is such that fouling is inevitable and a periodic backflush cycle is essential to maintain a reasonable permeability. Backflushing can be enhanced by simultaneous air sparging, as is the case with the Memcor system.

Recent developments: module configurations

There has been very little development in terms of novel membrane geometries over the last few years: virtually all membrane elements are configured as either planar or cylindrical. A noteworthy development is the newer 27-channel Kerasep[®] ceramic membrane element produced by Rhodia Orelis, which provides almost 40% more membrane area per unit volume than their conventional cylindrical 19-channel tubular monolith. Each channel is a 120° segment, such that the walls dividing a cluster of three channels are planar. This allows a greater membrane area without compromising mechanical strength. There has also been a tendency to try and produce less expensive modules either by using alternative materials or designs that are less complicated in

manufacture. Hence, some companies have started producing cassettes alongside their pressure-sealed module products.

One noteworthy recently development concerns ceramic membranes. As already stated, the onus is on suppliers of these membranes to reduce costs to make them economically competitive with the much less expensive polymeric materials. It appears that this might be achievable by extruding ceramic membrane substrates to produce channels of rectangular geometry (Fig. 2.12). The cost of these membranes, produced from silicon carbide substrate monolith coated with titania, alumina or zirconia, can be as low as \$100 per m² for narrow-membrane channels (2 mm).

Another fairly recent development is the use of aeration combined with submerged membrane systems. Submerged (or immersed) membrane systems, where large-area membrane filtration modules are submerged in a tank and the permeate removed at very low transmembrane pressures, were originally developed for membrane bioreactors (MBRs) by companies like Kubota and Zenon in the late 1980s as an alternative to the more conventional sidestream (or external) filtration systems. MBRs are an example of a hybrid process, in this case combining the activated sludge aerobic biotreatment process with membrane filtration (Stephenson *et al.*, 2000). The high fouling propensity of the sludge liquor being filtered, which can have a suspended concentration of up to 20 g l⁻¹, demands a high degree of turbulence promotion to enhance the flux. In the submerged system turbulence promotion is provided by coarse bubble aeration. It has been shown by a number of researchers (Ghosh and Cui, 1999; Mercier *et al.*, 1997; Cabassud *et al.*, 1997) that air-water two-phase flow can substantially enhance the membrane flux over that attained by single-phase

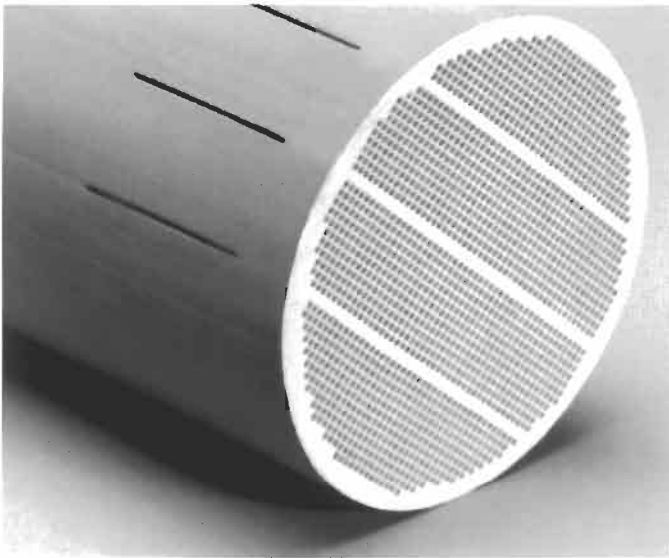

Figure 2.12 Ceramem silicon carbide monolith substrate (reproduced with permission)

pumped liquid flow. Such has been the success of the application of coarse aeration to submerged MBR systems in municipal and industrial effluent treatment that submerged aerated systems are now starting to be applied to largely abiotic pure water systems.

Another significant innovation is the mechanically enhanced, high-shear processes. These actually employ conventional stacked disc modules, but the module is made considerably more effective by actually moving the membrane in relation to the flowing liquid. These products, which include vibratory shear enhanced processing (VSEP[®], marketed by New Logic, the similar Vibrating Membrane Filter, or VMF[®], marketed by Pall) and the Valmet-Flootek CR[®] membrane processes (Fig. 2.13), enhance the flux through a UF or MF membrane by imposing a shear at or close to its surface. Since the throughput of all membrane processes operating under steady-state conditions is ultimately dictated by shear rate (Section 2.2.2), very substantial increases in throughput are attainable through this modification. These systems are generally considered to be too energy intensive for application to anything other than high-added-value process waters, but all have been employed for resource recovery.

The systems work in different ways in achieving the high shear rates desired. The VSEP process imposes an oscillatory motion on the whole module, moving it just a few degrees around the axis at a rate of around 45 s^{-1} . It is claimed that this imposes a shear rate at the membrane of $150\,000 \text{ s}^{-1}$, about ten times that attainable from conventional cross-flow filtration (Section 2.2.1). Although usually applied to a stacked disc filter, because the V-Sep system involves the mechanical agitation of the entire membrane module it can also be applied to other membrane configurations. The VMF system employs a similar high-frequency vibration. The CR filter employs rotors above each membrane element in the stacked disc, and is thus integral to the membrane module. The angular

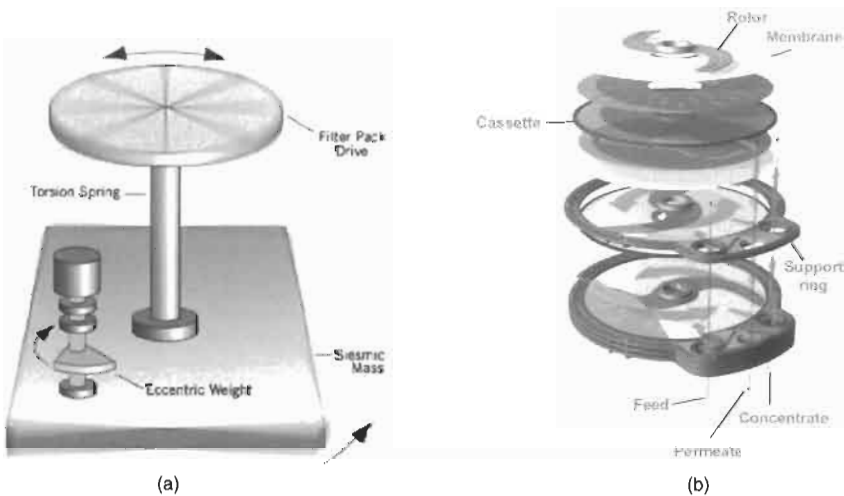

Figure 2.13 High-shear processes: (a) VSEP[®] resonating drive system (on which the membrane module sits), and (b) CR filter

velocity of the rotor is around $10\text{--}15\text{ m s}^{-1}$, depending on the diameter of the membrane cell. Both the VSEP and CR ultrafiltration processes have been successfully applied to liquors of high suspended solids content (Sections 3.2.5 and 5.6), achieving concentrate streams in excess of 5% solids in some cases.

Other turbulence promotion modifications to modules are still largely at the developmental stage. These include intermittent jets, in which the feed is pumped coaxially through a membrane tube at fixed intervals through a nozzle. The abrupt change in velocity produces a toroidal vortex, increasing the flux by up to 2.5 times for granular suspensions such as bentonite clay (Arroyo and Fonade, 1993). Pulsed flow has also received much attention (Gupta *et al.*, 1985, 1992; Rodgers and Sparks, 1993; Bertram *et al.*, 1993). In this mode, pulses of flow are generated in the feed or permeate channel, again creating large temporal changes in the velocity gradient. A simpler alternative for turbulence promotion is the use of simple inserts in tubes. This is also not practised commercially, despite the many publications in this area, as reviewed by Gupta *et al.* (1995), Belfort *et al.* (1994) and others.

Finally, a process that has significantly extended the capability of electro dialysis is the electrodeionisation (EDI), also called continuous deionisation (CDI), process commercialised by Vivendi Ionpure and Ionics. In this process the diluate cells of the electro dialysis stack are filled with ion exchange resin beads. The resin effectively aids the transport of ions from the diluate to the concentrate cells by providing a conducting pathway. This results in extremely effective removal of all charged species in the diluate cell, producing a product water of a quality comparable to that from a twin-bed deionisation process but offering the advantage of being continuous.

2.2 The process fundamentals

2.2.1 Process performance definitions

Flux

The key elements of any membrane process are the influence of the following parameters on the overall permeate *flux*:

- the membrane resistance,
- the operational driving force per unit membrane area,
- the hydrodynamic conditions at the membrane–liquid interface, and
- the fouling and subsequent cleaning of the membrane surface.

The flux is the quantity of material passing through a unit area of membrane per unit time. This means that it takes SI units of $\text{m}^3\text{ m}^{-2}\text{ s}^{-1}$, or simply m s^{-1} , and is occasionally referred to as the permeate velocity. Other non-SI units used are $\text{l m}^{-2}\text{ h}^{-1}$ (or “LMH”) and m^3 per day, which tend to give more accessible

numbers: membranes generally operate at fluxes between 10 and 1000 LMH. The flux relates directly to the driving force (Section 2.2.2) and the total resistance offered by the membrane and the interfacial region adjacent to it.

Conversion

In membrane processes there are three possible streams: a feed, a retentate and a permeate stream. The retentate stream is unpermeated product. If there is no retentate stream then operation is termed dead-end or full-flow (Fig. 2.14a). Such operation is normally restricted to either low-solids water, as for cartridge filtration of boiler feedwater or ultrafiltration for apyrogenic pure water production, or cyclic operation with frequent backwashing, such for most microfiltration and ultrafiltration membrane plant for municipal water treatment. For waters having a significant solids loading and/or membranes of limited permeability (dense membranes), it is not desirable to try and convert all of the feed to permeate product in a single passage through a module. In such cases, cross-flow operation is employed (Fig. 2.14b) whereby some of the feedwater is collected as a concentrate (or retentate) stream. This expedites the removal of accumulated materials from the membrane–solution interfacial region provided by the scouring action of the retentate flowing over the membrane surface.

The combination of the flux and the total membrane area determine the conversion or recovery of the process. The conversion, normally expressed as a percentage Θ , is the amount of the feed that is recovered as permeate. Thus, for a concentration C and flow Q in feed, retentate and permeate (Fig. 2.15), a simple mass balance dictates that:

$$Q = Q_P + Q_R \quad (2.1)$$

$$QC = Q_P C_P + Q_R C_R \quad (2.2)$$

where % recovery or conversion is given by:

$$\Theta = Q_P/Q \quad (2.3)$$

and the subscripts P and R refer to permeate and retentate, respectively.

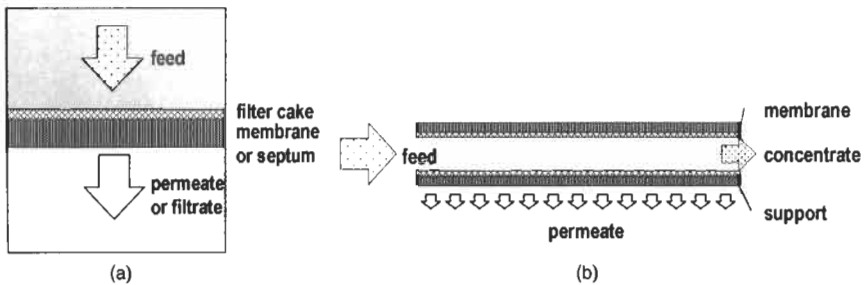

Figure 2.14 (a) Dead-end and (b) cross-flow filtration

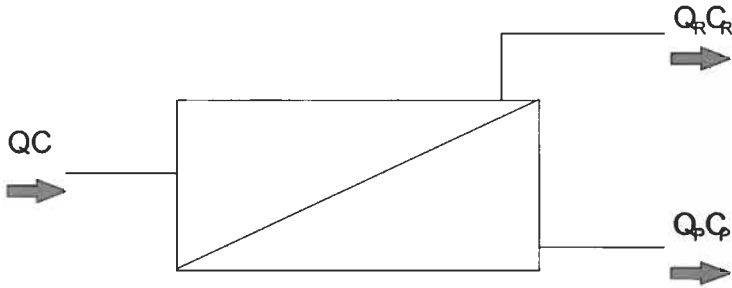

Figure 2.15 Membrane module mass balance

Rejection

The permselective property of the membrane is normally quantified as the *rejection* where:

$$R = 100 \% (1 - C_p/C) \quad (2.4)$$

It is possible to have negative rejection values if the membrane is selective for specific contaminants, as would be the case for an extractive membrane system.

2.2.2 The driving force

The driving force for the process may be a transmembrane pressure gradient, as with filtration and reverse osmosis (Fig. 2.16), a concentration gradient, as with dialysis, or electromotive, as with electrodialysis. In almost all pressure-driven membrane processes applied to water treatment the desired permeate is water, such that the *retained* or *rejected* material (the *retentate*) is concentrated. In extractive and electrodialytic operations the permeate is the dissolved solute and the retentate the product water. For extractive systems the driving force is a concentration gradient, whereas for electrodialysis an applied potential difference is employed to move dissolved ions through electromigration.

Since the flux and driving force are interrelated, either one can be fixed for design purposes. It is usual to fix the value of the flux and then determine the appropriate value for the transmembrane pressure for pressure-driven processes. An analogous situation arises in the determination of operational parameter values for electrodialysis, where the appropriate operating current density is normally fixed and the voltage determined accordingly. The actual flux or current density value chosen depends upon the desired operating regime.

2.2.3 Factors opposing the driving force

The overall resistance at the membrane–solution interface is increased by a number of factors which each place a constraint on the design and operation of membrane process plant:

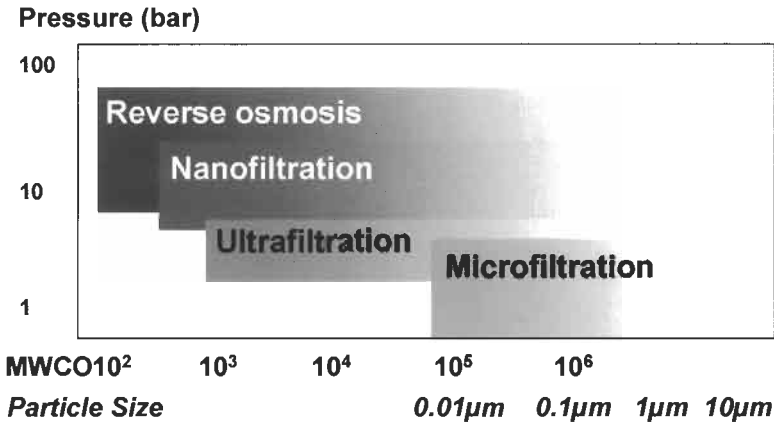

Figure 2.16 Normal ranges of transmembrane pressure values for membrane processes

- the concentration of rejected solute, as in RO and UF, or permeated ions, as in ED, near the membrane surface,
- the depletion of ions near the membrane surface, as with ED,
- the precipitation of sparingly soluble macromolecular species (gel layer formation, as in UF) or salts (scaling, as in RO) at the membrane surface, and
- the accumulation of retained solids on the membrane (cake layer formation, as in MF).

All of the above contribute to membrane fouling. Fouling can take place through a number of physicochemical and biological mechanisms which all relate to increased deposition of solid material onto the membrane surface (also referred to as blinding) and within the membrane structure (pore restriction or pore plugging/occlusion). This is to be distinguished from clogging, which is the filling of the membrane channels with solids due to poor hydrodynamic performance. Fouling may be both temporary (removed by washing) and permanent (removed only by use of chemicals). Since it is intimately related to concentration polarisation, under certain limiting conditions its effects can be determined from a simple theoretical approach (Section 2.3.2). However, fouling by individual components tends to be specific to membrane material and application.

The membrane resistance is fixed, unless its overall permeability is reduced by components in the feed water permanently adsorbing onto or into the membrane. The resistance imparted by the interfacial region is, on the other hand, dependent upon the total amount of fouling material residing in the region. This in turn depends upon both the thickness of the interface, the feedwater composition (and specifically its foulant content) and the flux through the membrane. The feedwater matrix and the process operating conditions thus largely determine process performance.

In the case of a dead-end filtration process, the resistance increases according to the thickness of the cake formed on the membrane, which would be expected to be proportional to the total volume of filtrate passed. For cross-flow processes, this deposition continues until the adhesive forces binding the cake to the membrane are balanced by the scouring forces of the liquid passing over the membrane. All other things being equal, a cross-flow filtration process would be expected to attain steady-state conditions. In practice, only pseudo-steady-state (or stabilised) conditions are attained due to the unavoidable deposition or adsorption of fouling material.

Concentration polarisation

Concentration polarisation (CP) is the term used to describe the tendency of the solute to accumulate at the membrane–solution interface within a concentration boundary layer, or liquid film (Fig. 2.17). This layer contains near-stagnant liquid, since at the membrane surface itself the liquid velocity must be zero. This implies that the only mode of transport within this layer is diffusion, which is around two orders of magnitude slower than convective transport in the bulk liquid region. Rejected materials thus build up in the region adjacent to the membrane, increasing their concentration over the bulk value, at a rate that increases exponentially with increasing flux (Section 2.3.2). The thickness of the boundary layer, on the other hand, is determined entirely by the system hydrodynamics, decreasing in thickness when turbulence is promoted.

For pressure-driven processes, the greater the flux, the greater the build-up of solute at the interface; the greater the solute build-up, the higher the concentration gradient; the steeper the concentration gradient, the faster the diffusion. Under normal steady-state operating conditions there is a balance between those forces transporting the water and constituents within it towards, through and away from the membrane. This balance is determined by CP. CP also raises the effective osmotic pressure at the membrane–solution interface, increasing the required transmembrane pressure for operation. It is thus always

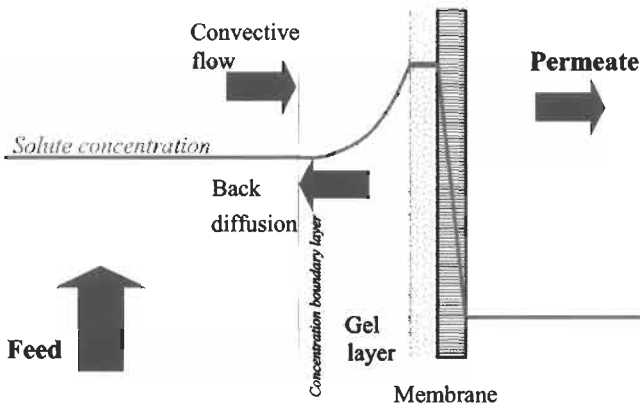

Figure 2.17 Concentration polarisation

desirable to suppress CP by promoting turbulence and/or operating at a flux below that at which CP starts to become significant.

CP effects on specific processes are summarised in Table 2.6. All membrane processes are subject to CP, but it is only in specific cases where certain CP phenomena become significant. The importance of elevation of osmotic pressure depends upon the concentration of the rejected solute in the feedwater, since osmotic pressure is directly related to ion concentration by the van't Hoff equation (Section 2.3.9). Thus for nanofiltration processes, where only part of the feedwater ion content is affected by CP, the osmotic pressure elevation effects are commensurately smaller than for RO which rejects ions almost quantitatively. CP also increases the permeation of the rejected materials through the membrane because of the increase in the transmembrane concentration gradient generated. This can affect the permeate water purity, although the effect is minor. The increase in concentration from the bulk solution to the membrane surface can also change the selectivity of the membrane, particularly for nanofiltration, although again the effect is not generally significant.

Scaling presents a more substantial limitation to operation under conditions of CP. Both RO and NF are subject to scaling by divalent salts formed through the CP of ions contributing to hardness. In ultrafiltration, precipitation of sparingly soluble organic solutes produces a gel layer whose permeability and permselectivity often differs from that of the membrane on which it sits. This gel, or dynamic, layer then determines the process performance with respect to both the hydraulics and the product water quality.

In the case of electrodialysis, the effect of polarisation in the liquid film is to deplete ions in that region as ions are extracted through the membrane faster than they arrive at the interface from the bulk solution (Fig. 2.18). Depletion of the permeating ion has two principal effects:

- the electrical resistance increases, and
- the concentration of the permeating ion at the membrane surface of the depletion side decreases to a level that approaches that of the innate water dissociation products (hydroxide and hydrogen ions).

Table 2.6 Concentration polarisation effects

Process	Osmotic pressure elevation	Electrical resistance elevation	Scaling	Gel layer formation	Selectivity change
RO	X		X	X	(X) ^a
NF	(X) ^a	–	X	X	(X) ^a
ED	–	X ²	(X) ^a	–	X ^b
UF	–	–	–	X	–
MF	–	–	–	–	–

^a More marginal effect.

^b Depletion polarisation.

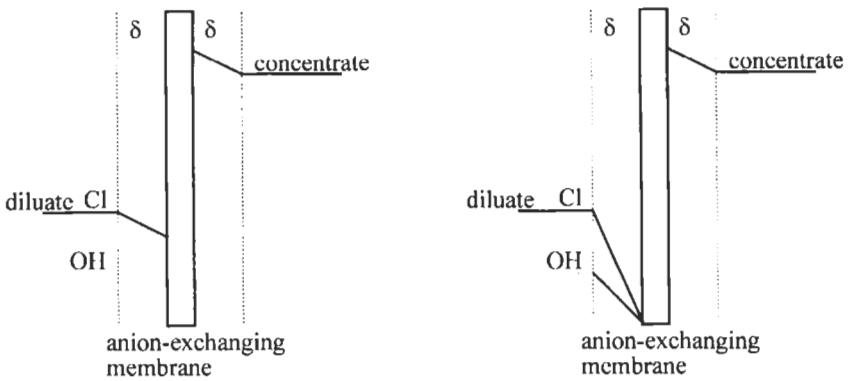

Figure 2.18 Depletion polarisation in electrodialysis

Because the membranes used in electrodialysis are generally non-selective for counter-ions, water product ions can pass through the membrane under severe depletion conditions. This phenomenon tends to take place at the anion exchanging membrane because this ion exchange material catalyses the dissociation of water (water splitting) at the low ionic strengths prevailing in the depleted region. The local hydroxide concentration is then effectively increasing and so increasing the passage of hydroxide through the membrane in preference to the contaminant ion (normally chloride). This decreases the electrical efficiency of the process, but more importantly increases the pH on the permeate side of the membrane (the concentrate stream, in this case) which promotes precipitation of hardness salts. CP thus promotes scaling in all dense membrane processes, through the underlying mechanisms differ between pressure-driven and extractive processes. Whilst CP places an upper limit on the flux employed in pressure-driven processes, in the case of electrodialysis its effect is to limit the degree of desalination attainable from a single passage through the stack to below 50%. This is because the rate of desalination is dictated by the current, which is the same at the stack inlet and outlet. It follows that if a sufficient current is applied to remove 50% of the ions at the inlet of the stack, the limiting condition of zero concentration will be reached at the stack outlet on the diluate side.

The relationship between driving force and polarisation in pressure-driven membrane separation processes can be summarised as follows:

- The flow through a given type of membrane varies as the membrane area and the net applied driving force; and the power consumption is proportional to the driving force, and inversely proportional to the membrane area installed. This is analogous to electrical conduction, where the current varies with the cross-sectional area of copper in the cable and with the applied voltage, and the power loss in the cable varies with the voltage loss and inversely with the area.
- The selective nature of the process means that rejected material remains on the membrane surface. Cross-flow operation affords some limitation to

the extent to which rejected material accumulates in the interfacial region.

These two factors are, of course, interlinked: a high driving force yields high flux and a high rate of rejected material collecting on the membrane surface, which then needs to be dispersed rapidly if the process is not to grind to a halt. In extractive and dialytic processes, CP tends to deplete the permeating species at the membrane, which in electrodialysis has the effect of increasing electrical resistance and decreasing permselectivity.

2.2.4 Critical flux

The critical flux concept was originally presented by Field *et al.* (1995). These authors stated that: "The critical flux hypothesis for microfiltration is that on start-up there exists a flux below which a decline of flux with time does not occur; above it, fouling is observed". Two distinct forms of the concept have been defined. In the strong form, the flux obtained during sub-critical flux is equated to the clean water flux obtained under the same conditions. However, clean water fluxes are rarely attained for most real feedwaters due to irreversible adsorption of some solutes. In the alternative weak form, the sub-critical flux is the flux rapidly established and maintained during the start-up of the filtration, but does not necessarily equate to the clean water flux. Alternatively, stable filtration operation, i.e. stable permeability for an extended period of time, has been defined as sub-critical operation even when preceded by an initial decline in flux (Howell, 1995). Such conditions would be expected to lead to lower critical flux values than those obtained for absolutely constant permeability operation (i.e. from $t=0$), however, since an initial permeability decline implies foulant deposition.

A number of slightly different manifestations of sub-critical flux operation have been proposed, largely depending on the method employed. The most microscopically precise definition equates the critical flux to that flux below which no deposition of colloidal matter takes place. Kwon and Vigneswaran (1998) equated the critical flux to the lift velocity as defined by lateral migration theory (Table 2.12: Section 2.3.2), as introduced by Green and Belfort (1980). This rigorous definition is difficult to apply because of the relative complexity of the determination of the lift velocity, particularly for heterogeneous matrices. On the other hand, experimental determination of critical flux by direct observation of material deposition onto the membrane has been conducted using model homodispersed suspensions of polystyrene latex particles (Kwon and Vigneswaran, 1998), and some authors have also used mass balance determinations (Kwon *et al.*, 2000).

Given the limitations of applying particle hydrodynamics to the identification of the critical flux in real systems, recourse generally has to be made to experimental determination. By plotting flux against the transmembrane pressure it is possible to observe the transition between the linearly pressure-dependent flux and the onset of fouling, where deviation from linearity

commences. The flux at this transition has been termed “secondary critical flux” (Bouhabila *et al.*, 1998). However, whilst potentially useful in providing a guide value for the appropriate operating flux, the absolute value of the critical flux obtained by this method is likely to be dependent on the exact method employed and, specifically, the rate at which the flux is varied with time. A common practice is to incrementally increase the flux for a fixed duration for each increment, giving a stable TMP at low flux but an ever-increasing rate of TMP increase at higher fluxes. This flux-step method defines the highest flux for which TMP remains stable as the critical flux. This method is preferred over the TMP-step method since the former provides a better control of the flow of material deposition on the membrane surface, as the convective flow of solute towards the membrane is constant during the run (Defrance and Jaffrin, 1999a). However, no single protocol has been agreed for critical flux measurement, making comparison of reported data difficult. It is also becoming apparent that irreversible fouling can take place at operation below the critical flux (Cho and Fane, 2002).

2.3 The theory

There are essentially two approaches to describing mass transport in membrane processes. The simplest is to add the hydraulic resistance of the membrane to that of the cake or fouling layer to determine the relationship between the flux and pressure through simple empirical Darcian relationships. This approach relies on a knowledge of the resistance of both membrane and fouling/cake layer. The membrane resistance can be determined either directly from *ex situ* experimental measurements using pure water or, in the case of porous membranes, through well-understood fluid physics relationships. Provided the cake or fouling layer can be measured empirically, and assumptions can be made about the effect of operation on the bulk membrane permeability, resistance theory can be usefully applied to determine hydraulic relationships without recourse to further theoretical development. It is, indeed, common practice to refer to the membrane and cake or fouling layer resistance when defining filtration operation. Other cake filtration empirical models are based on deposition of solids within the membrane pores, thus accounting for the change in the permeability with time but more as a diagnostic tool than for predictive purposes.

The development of predictive models for membrane mass transfer from first principles is much more problematic and relies on mathematical description of the system hydrodynamics, membrane structure and feedwater matrix. It is only under specific limiting conditions that simple analytical expressions can be used with complete impunity (for example dense, homogeneous, i.e. non-porous membranes where the water content of the membrane is small, or isoporous, non-adsorptive uncharged membranes). Hence, the combination of solution-diffusion and sieving mechanisms (or more specifically capillary flow), as exists in nanofiltration processes, substantially complicates the mathematical description. Moreover, no simple fundamental analytical expressions can account for fouling, in particular internal or permanent fouling where adhesive

forces become important. Instead, simple experimental measurements are used to assess the fouling propensity of feedwaters for specific membrane processes, and dense membrane processes in particular (Section 2.4.3).

Notwithstanding the difficulties involved, a number of models have been presented to define the operational determinants of various membrane processes. To describe the derivation of each of these in detail would be beyond the scope of this review since the outcomes, i.e. the ultimate analytical expressions generated, are often specific to the process under consideration and the assumptions made. The starting point for the theoretical development of water and solute flows through a dense membrane varies according to the relative importance placed of solution–diffusion, sorption, pore flow and electrical charge. Most of the mathematical derivations of system hydrodynamics for cross-flow operation are based on *film theory* (which incorporates the *concentration polarisation model*). Film theory assumes the interfacial region mass transport to be determined by the degree of concentration polarisation, which can then be calculated from the fluid cross-flow, the permeate flux and the solute diffusivity.

2.3.1 Membrane mass transfer control

Under the simplest operational conditions, the resistance to flow is offered entirely by the membrane. For porous membrane systems, the flux can be expressed as:

$$J = \frac{\Delta p}{\mu R_m} \quad (2.5)$$

where J is the flux in m s^{-1} , Δp is the transmembrane pressure, μ is the fluid viscosity and R_m is the resistance of the membrane in m kg^{-1} . For microporous membranes, specifically those used for microfiltration, the Hagen–Poiseuille equation may be considered applicable for a permeate undergoing laminar flow through cylindrical pores. The resistance R_m then equates to:

$$R_m = \frac{K(1 - \varepsilon_m)^2 S_m^2 l_m}{\varepsilon_m^3} \quad (2.6)$$

where ε is the porosity (or voidage), S_m the pore surface area to volume ratio and l_m the membrane thickness. K is a constant equal to 2 for perfectly cylindrical pores but changes for other geometries. It is apparent from Equation (2.5) that temperature has a profound impact upon the flux through the viscosity, which increases by around 3% for each degree drop in temperature below 25°C.

For dense membranes a number of expressions have been developed (Table 2.7) which are derived from a variety of approaches:

- solution–diffusion,
- sorption–capillary flow,
- Donnan equilibrium,

Table 2.7 Dense membrane rejection expressions based on different models (based on Bhattacharyya and Williams, 1992)

Approach	Rejection ^a	Reference
Solution-diffusion	$\left(1 + \frac{K_S}{K_W} \left(\frac{1}{\Delta P - \Delta \pi}\right)\right)^{-1}$	Lonsdale <i>et al.</i> (1965)
Solution-diffusion imperfection	$\left(1 + \frac{K_S}{K_W} \left(\frac{1}{\Delta P - \Delta \pi}\right) - \frac{K_1}{K_W} \left(\frac{\Delta P}{\Delta P - \Delta \pi}\right)\right)^{-1}$	Sherwood <i>et al.</i> (1967)
Surface force pore flow	$1 - \frac{\int_0^1 C_s v_p r_p dr_p}{\int_0^1 v_p r_p dr_p}$	Matsuura and Sourirajan (1981); Sourirajan and Matsuura (1985)
Donnan equilibrium	$1 - \left(y^y \left(\frac{C_z}{Q_m}\right)^y \left(\frac{\gamma}{\gamma_m}\right)^{y-z}\right)^{1/2}$	Bhattacharyya and Chen (1986)

^a b_r , dimensionless frictional force (frictional force acting on solute in pore vs. that acting on solute in bulk solution); C_w , concentration of water in the membrane; C_s , $\exp(v_r)/[1 + (\exp v_r - 1)(b_r/\exp \Phi_r)]$; ΔC_s , solute concentration difference across the membrane = $C_{s1} - C_{s2}$; $C_{s1,s2}$, solute concentration on feed, permeate side of membrane; C_z , concentration of co-ion in bulk solution; D_w , (Brownian) diffusion coefficient of water in the membrane; D_s , (Brownian) diffusion coefficient of solute in the membrane; K_w , water permeability in the membrane, $D_w C_w V_w / RT$; K_s , solute permeability in the membrane, $D_s \kappa_s$; K_1 , empirical coefficient; Q_m , charge capacity of membrane; R , gas constant; r_p , dimensionless radial distance (r/r_p); T , absolute temperature; v_r , dimensionless radial velocity ($v_{(r=r)}/v_{(r=0)}$); V_w , partial molar volume of water; y, z , charge on species y (the co-ion) and z (counter-ion) respectively; $Y_H Z_z$ ($Y^{Z^1} + Z^Y$); γ, γ_m , activity coefficients in solution and membrane respectively; membrane thickness; κ_s , solute distribution coefficient; p , osmotic pressure; Φ_r , dimensionless electrostatic or van der Waals forces parameter.

- extended Nernst-Planck equation, and
- irreversible thermodynamics.

Pure solution-diffusion is based upon the assumption that both the solute and solvent (i.e. water) dissolve in a homogenous non-porous membrane and then diffuse across it as discrete (uncoupled) materials. The overall rate of transfer (i.e. flux) of each, and thus the purity of the permeate product, depends upon their relative solubilities and diffusivities (Lonsdale *et al.*, 1965):

$$\text{Solvent (water) flux: } \frac{K_w}{\lambda} (\Delta P - \Delta \pi) \tag{2.7}$$

$$\text{Solute (salt) flux: } \frac{K_s}{\lambda} (\Delta C_s) \tag{2.8}$$

where ΔP and $\Delta \pi$, respectively, represent the applied transmembrane and osmotic pressures, ΔC_s is the solute concentration difference across the membrane, K_w and K_s represent the water and solute permeabilities in the membrane and λ is the membrane thickness. The ratios K_w/λ and K_s/λ are

normally denoted A and B , respectively. According to this approach, the transport of solute is not directly related to transmembrane pressure.

The osmotic pressure Π is given by the well-known van't Hoff equation:

$$\Pi = yRT \sum C_i \quad (2.9)$$

where R is the gas constant, T the absolute temperature, $\sum C_i$ the total concentration of individual solute ions and y the osmotic coefficient accounting for non-ideal behaviour. The coefficient y normally takes a value between 0.7 in concentrated solutions and unity at infinite dilution, and equates to the mean of the activity coefficients of the dissolved ions and the degree of dissociation. However, the relationship between Π and C is rarely linear, as Equation (2.9) suggests, due to departure from ideality at high concentrations.

The simple solution–diffusion model can be extended to account for pore flow by adding an extra empirical coefficient to the water and solute flux expressions. Use of the model is, however, constrained by the necessity of determining this coefficient experimentally. The model can also be extended to allow coupling of solute and solvent flows, although this also introduces empirical constants.

Pore flow models assume that the membrane is microporous with cylindrical pores. The membrane material is assumed to preferentially adsorb water, as a monolayer, both within the pores and at the surface. The water is then transported across the membrane at a rate depending upon chemical interaction, frictional and diffusive forces. The expression can be modified to account for steric and electrostatic effects, and can take account of the pore size distribution of the membrane. Charged pores tend to increase the effective viscosity of the water in the pores due to electroviscous effects, but these effects alone do not appear to account for reported charged membrane permeability changes with ionic strength and pH.

The Donnan equilibrium model takes account of solute charge and membrane charge which, through repulsion of co-ions and attraction of counter-ions, creates a Donnan potential at the membrane surface. This has the effect of repelling co-ions and, since electroneutrality must be preserved, counter-ions are also rejected. This approach applies to both electro dialysis and nanofiltration and can provide qualitative trends, but does not allow a quantitative description of nanofiltration since it does not take account of diffusive and convective transport. The extended Nernst–Planck equation has also been used to describe transport in charged membranes, but with similar limitations.

2.3.2 Fouling/cake layer mass transfer control

Resistance model: cake filtration

The simplest way of accounting for the additional resistance offered by the material accumulating in the interfacial region is to simply add its resistance R_c (the cake layer resistance) to that of the membrane, such that Equation (2.5) becomes:

$$J = \frac{\Delta p}{\mu(R_m + R_c)} \quad (2.10)$$

where, in the case of dead-end operation, R_c is time dependent. However, this simple equation is only useful if there is prior knowledge concerning the hydraulics of the cake or fouling layer. In the model case of the development of an incompressible cake of homodispersed granular material the cake resistance follows the same form as Equation (2.6):

$$R_c = \frac{K'(1 - \varepsilon_c)^2 S_c^2 l_c}{\varepsilon_c^3} \quad (2.11)$$

where the symbols refer to the same parameters as before with reference to the filter cake. In this case, however, K' takes a value of 5 for spherical (or neo-spherical) geometry (Grace, 1956), and the equation – or more usually the pressure gradient form derived from it – represents an expression of the well-known Kozeny–Carman equation.

Whilst the above equations may be used to calculate the total resistance to filtration, their use is constrained by a number of simplifying assumptions:

- flow is considered only in the direction orthogonal to the membrane: tangential movement is ignored,
- suspended particles are assumed homodispersed (i.e. all the same size, shape) and neutrally buoyant (i.e. non-sedimenting),
- particles are considered incompressible,
- the filter cake is also considered incompressible,
- cake porosity, hence permeability, is assumed to be independent of time, and
- migration of particles through the cake with time is ignored.

In fact, filtration can be characterised on the basis of more than just cake filtration behaviour. Four filtration models, originally developed for dead-end filtration (Grace, 1956), have been proposed to describe the initial flux decline. All models imply a dependence of flux decline on the ratio of the particle size to the pore diameter (Table 2.8). The standard blocking and cake filtration models appear most suited to predicting initial flux decline during colloid filtration (Visvanathan and Ben Aim, 1989) or protein filtration (Bowen *et al.*, 1995). According to Bowen and co-workers, four consecutive steps had been defined: (1) blockage of the smallest pores, (2) coverage of the larger pores inner surface, (3) superimposition of particles and direct blockage of larger pore and (4) creation of the cake layer. All of the models contain empirically derived parameters (A and B in Table 2.8), although some have been refined to incorporate other key determinants (Table 2.9). On the other hand, a number of empirical and largely heuristic expressions have been proposed for particular matrices and/or applications, for example the filtration of activated sludge by membrane bioreactors (Table 2.10). Classical dead-end filtration models can be

adapted for cross-flow operation if the proportion of undeposited solute material can be calculated.

The expressions listed in Table 2.10 illustrate a common difficulty in describing filtration behaviour. Even for a supposedly generic matrix (mixed liquor), the innate heterogeneity and diversity in composition of real feedwater matrices forbids the formulation of general equations describing filtration behaviour, even under steady-state conditions. Different key water quality determinants (chemical oxygen demand, dissolved organic carbon and mixed liquor (volatile) suspended solids) have been identified as the basis for quantifying fouling propensity and dynamic behaviour. Most recent publications of experimental studies of MBR processes make little or no reference to dynamic modelling, with data interpretation being substantially limited to reporting of hydraulic resistance values (Choo and Lee, 1996; Chang and Lee, 1998; Defrance and Jaffrin, 1999b). The more global semi-empirical models that have been developed (Nagaoka *et al.*, 1998), as with many other semi-empirical models in this area, rely on specific hydraulic resistance data which is likely to be specific to the system under investigation.

Dead-end filtration theory is thus to a very large extent limited by the accuracy of the representation of the interaction between the solids and the membrane material. The same also applies to cross-flow filtration. However, for dense membrane processes where the water can be considered to be a continuum with no complicating solid-liquid interactions, modelling from first principles of the resistance offered by the membrane-solution interface, due to concentration polarisation, is possible.

Classical concentration polarisation model

As already stated (Section 2.2.3), concentration polarisation describes the tendency of the solute to build up in the membrane solution interfacial region, and the extent to which this occurs depends on:

Table 2.8 Empirical dead-end filtration equations (from Chang *et al.*, 2002)

Approach	Physical cause	Description	Equation ^a
Cake filtration	Boundary layer resistance	Deposit of particles larger than the membrane pore size onto the membrane surface	$t/V = AV + B$
Complete blocking	Pore blocking	Occlusion of pores by particles with no particle superimposition	$-\ln(J/J_0) = At + B$
Intermediate blocking	Long-term adsorption	Occlusion of pores by particles with particle superimposition	$1/J = At + B$
Standard blocking	Direct adsorption	Deposit of particles smaller than the membrane pore size onto the pore walls, reducing the pore size	$t/V = At + B$

^a A, B, constants (value dependent upon cake and system characteristics); V, cumulative volume of permeate at time t; J_0 , J, flux initially and at time t respectively.

Table 2.9 Expressions developed to describe, for dynamic behaviour, dead-end and cross-flow filtration

Model	Equation ^a	Reference
<i>Dead-end filtration</i>		
Pore blocking model	$J = J_0 \exp\left(\frac{-a_{b1}J_0A}{n_p}\right)t$	Hermia (1982)
Pore constriction model	$J = \frac{J_0}{\left(1 + \frac{a_{pore}J_0}{n_p\pi\delta_m r_p^2}t\right)^2}$	Hermia (1982)
Cake formation model	$J = \left(\frac{1 + 2a_{dep}R'_c C_b A \Delta P}{\eta_s R_m^2 t}\right)^{1/2}$	Hermia (1982)
<i>Cross-flow filtration</i>		
Shear-induced diffusion from thick layers	$J = J_0 \left(1 + \frac{2J_0 R'_c C}{R_m (C_c - C)}t\right)^{-1/2}$	Romero and Davis (1988)
Brownian diffusion from thick layers	$\langle J \rangle = 1.31 \left(\frac{D^2 \gamma_0}{L}\right)^{1/3} \left(\frac{C_c}{C} - 1\right)^{1/3} \text{ for } t \mu t_{ss}$ $\langle J \rangle = \frac{1}{L} \left[\int_0^{X(t)} J_{ss}(x) dx - [L - X(t)]J(t) \right] \text{ for } t < t_{ss}$ $X(t) = 4.81(D^2 \gamma_0) \left(\frac{C_c}{C} - 1\right) \left(\frac{C}{C_c}\right)^{1/2} \left(\frac{R'_c t}{\Delta P - \Delta P_c}\right)^{-3/2}$ $\Delta P_c = \frac{3kT}{4\pi r^3} N_V$ $J(t) = \left(\frac{\Delta P - \Delta P_c}{R_m}\right) \left(1 + \frac{2R'_c(\Delta P - \Delta P_c)}{R_m^2} \frac{C}{C_c} t\right)^{-1/2}$	Song (1998), after Song and Elimelech (1995)

^a a_{b1} , no. of pores blocked per filtrate volume passed; a_{pore} , foulant volume deposited within pores per filtrate volume passed; a_{dep} , fraction of foulant depositing on membrane; A , filter area. J_0 , J , J_{ss} , flux initially, at time t , at equilibrium; n_p , no. of pores; r_p , pore radius; R_m , membrane resistance; (P , operating pressure difference; (P_c , critical pressure difference (pressure required for cake to form); t , filtration time; t_{ss} , steady-state filtration time (time after which flux is constant); X , distance of the front of the dynamic layer from the entrance; η_0 , bulk suspension viscosity.

- the propensity of the rejected (solute) species to diffuse (i.e. their diffusivity),
- the notional thickness of the stagnant region, and
- the rate at which solute species are added to the stagnant region.

The first of these relates to the solute itself, and principally to its size. The latter two factors, on the other hand, are determined mainly by operating conditions. The thickness of the stagnant region (δ) can be determined from:

Table 2.10 Empirical filtration expressions for activated sludge

Application/derivation	Expression ^a	Reference
Protein	$J = \frac{\Delta P}{\eta_0 [R_m + R'_c M_c^* (1 - e^{-k_1 t}) + R'_{b1} \overline{M_{b1}}]}$	Fane (1986)
–	$J = \frac{\Delta P}{\eta_0 (k_2 U^{-2.5} + k_3) \overline{R'_c U}}$	Fane (1986)
Classical cake filtration	$J = \frac{\Delta P}{\mu (R_m + \alpha C_{MLSS})}$	Chang <i>et al.</i> (2001); Shimizu <i>et al.</i> (1993)
Concentration polarisation	$J = a \cdot b \log C_{DOC}$	Ishiguro <i>et al.</i> (1994)
Sidestream MBR	$J = \frac{\Delta P}{\mu (R_m + 84.3 \Delta P C_{MLSS}^{0.926} C_{COD}^{1.37} \mu^{0.376})}$	Sato and Ishii (1991)
Sidestream MBR	$J = J_0 \exp\left(\frac{k \text{Re}(C_{MLSS} - C_{MLVSS})}{C_{MLVSS}}\right)$	Krauth and Staab (1993)
HF submerged MBR	$J = k U_a \phi C_{MLSS}^{0.5}$	Shimizu <i>et al.</i> (1996)

^a *a*, *b*, *k*, empirical constants; *C*, concentration; *J*₀, initial flux; *k*_{1,2,3}, empirical first-order rate constants; *M*_{b1}, boundary layer cake deposit; *M*_c^{*}, maximum cake deposit (mass per unit area); *R'*_{b1}, specific boundary layer resistance; *U*_a, approach velocity; *φ*, membrane geometric hindrance factor (membrane geometry dependent). Subscripts: COD, chemical oxygen demand; DOC, dissolved organic carbon; ML(V)SS, mixed liquor (volatile) suspended solids.

- the physical properties of the liquid, which for most water treatment processes change only marginally with chemical water quality and can normally be accurately expressed as a function of temperature,
- the shape and size of the flow channels within the module, and
- the mean velocity of liquid flowing through the channels.

The rate at which ions accumulate in the stagnant film is simply determined by the flux and the rejection. Therefore, provided the system is well defined, the degree of concentration polarisation can be calculated and its effects on the operation of the membrane process assessed. Mathematical description proceeds by conducting a material balance at the membrane, where the build-up of solute at the interface is countered by the diffusive flux of solute away from membrane. This essentially entails the balancing of four fluxes:

- back diffusion of solute away from the membrane by Fick’s first law of diffusion, which states that the diffusion rate is proportional to the concentration gradient,
- convective transport of the solute to the membrane,
- convective diffusion of the solute through the membrane, and
- convective diffusion of permeate through membrane.

Assuming a one-dimensional system (i.e. no longitudinal mass transfer) and a constant value *δ* for the boundary layer thickness (Fig. 2.18), the concentration polarisation under steady-state conditions based on film theory can be defined as:

$$J = \frac{D}{\delta} \ln\left(\frac{C^*}{C}\right) \quad (2.12)$$

where D is the diffusion coefficient in $\text{m}^2 \text{s}^{-1}$ and C^* and C are the respective concentrations at the membrane surface and in the bulk solution. The ratio C^*/C is a critical term, sometimes denoted φ or β , and referred to as the concentration polarisation parameter or index. Note that Equation (2.12) includes no pressure term, although the transmembrane pressure is inferred by the flux value. In the case of gel layer formation, the term C^* equates to the concentration of solute in the gel layer, for which some experimentally determined values have been reported for specific components (Cheryan, 1998).

Determination of the flux from Equation (2.12) relies on knowledge of the solute diffusivity, the boundary layer thickness and the solute concentration at the membrane surface. If the solute comprises dissolved ions or small molecules, as would be the case for pressure-driven dense membrane processes, then D is simply given by the Stokes–Einstein equation:

$$D = \frac{2k_B T}{3\pi\mu r_p} \quad (2.13)$$

where k_B is the Boltzmann constant, T is absolute temperature and r_p is the solute radius.

Conventionally, the ratio D/δ is assigned the mass transfer coefficient k and the various operational and performance determinants expressed in terms of the non-dimensionalised groups of Sh (Sherwood number), Re (Reynolds number) and Sc (Schmidt number):

$$J = k \ln(C^*/C) \quad (2.14)$$

$$k = \text{Sh}D/d \quad (2.15)$$

$$\text{Sh} = a\text{Re}^b \text{Sc}(d/L)^n \quad (2.16)$$

$$\text{Re} = \rho U d / \mu \quad (2.17)$$

$$\text{Sc} = \mu / \rho D \quad (2.18)$$

where ρ is the fluid density, U its velocity, d and L the hydraulic dimension and length of the membrane and a , b , c and n are constants. The hydraulic dimension d is equal to four times the ratio of the channel cross-section to its perimeter, and is thus equal to the diameter of a tube or twice the height of a wide parallel flow channel.

Appropriate values for a , b , c and n , based on Newtonian behaviour, are given in Table 2.11. The solution for laminar flow and Brownian diffusive transport is attributed to L ev eque (L ev eque, 1928; Porter, 1972). The L ev eque solution assumes channel flow with completely impermeable boundaries, and is thus strictly only applicable to membrane permeation systems with a permeate flux

much smaller than the cross-flow velocity, which is normally the case in cross-flow membrane systems. However, all membrane elements include a spacer that provides a degree of turbulence promotion, which can be accounted for through the inclusion of additional terms in Equation (2.16) containing parameters characterising the spacer. An example, which incorporates a term in the spacer mesh width parameter m (Chiolle *et al.*, 1978), is included in Table 2.11.

Expressions can also be presented in terms of the shear rate γ (Table 2.12). The shear rate is given by the ratio of the cross-flow velocity U to the hydraulic dimension and is geometry dependent. For parallel flow channels of height h its maximum value is given by:

$$\gamma_0 = 6U/h \tag{2.19}$$

For tubes of diameter d the equivalent expression is:

$$\gamma_0 = 8U/d \tag{2.20}$$

The impact of concentration polarisation on process operation depends upon the process. For pressure-driven processes the main impacts are on feedwater osmotic pressure and scalant levels, since both will increase by a factor of up to $\phi/(1 - \theta)$ overall. The osmotic pressure effect raises the required applied pressure to maintain the target flux in accordance with Equation (2.7), whereas the increase in scalant levels may produce precipitation of these salts. This demands an appropriate choice of process operating conditions (Section 2.4.2).

In the case of extractive processes, and electro dialysis specifically, polarisation depletes the ions in the boundary layer and places an upper limit on the operating current density, and so on the operating current (Section 2.4.2). The current density attained under this condition is known as the limiting current density I_{lim} :

$$I_{lim} \sim 2kCF \tag{2.21}$$

where k is the mass transfer coefficient given by Equations (2.15)–(2.18), C is the bulk equivalent concentration (in eq m^{-3}) of the diluate (i.e. the desalinated product) and F is the Faraday constant, which takes a value of $96\,500 \text{ C eq}^{-1}$.

Table 2.11 Examples of empirical and semi-empirical values of constants in Equation (2.16)

Flow	Characteristic constants				Additional term
	a	b	c	n	
<i>Open channel</i>					
Turbulent	0.023 or 0.065	0.875	0.25	0	
	0.04	0.75	0.33	0	
Laminar (L�ev�eque)	1.62 or 1.86	0.33	0.33	0.33	
<i>Filled channel</i>					
Intermediate flow	1.065	0.5	0.33	0.5	$(1/6m)^{0.5}$

Table 2.12 Governing equations: steady-state expressions for the length-averaged permeate flux

Model	Equation ^a	Reference
Lévéque solution: laminar flow, Brownian diffusive transport, $J \perp U$	$\langle J \rangle = 0.807 \left(\frac{D_B^2 \gamma_0}{L} \right)^{1/3} \ln \left(\frac{C^*}{C} \right)$	Porter (1972), after Lévéque (1928)
Similarity solution for laminar flow, Brownian diffusive transport, $J \rightarrow U$	$\langle J \rangle = 1.31 \left(\frac{D_B^2 \gamma_0 C^*}{CL} \right)^{1/3}$	Davis and Sherwood (1990) Romero and Davis (1988)
Fully developed turbulent flow	$\langle J \rangle = 0.023 \left(\frac{U^{0.8} D_B^{0.67}}{d^{0.2} \nu^{0.47}} \right)^{1/3} \ln \left(\frac{C^*}{C} \right)$	Porter (1972)
Lévéque solution for shear-induced diffusion (based on $D_S = 0.03r^2\gamma_0$)	$\langle J \rangle = 0.078 \left(\frac{r^4}{L} \right)^{1/3} \gamma_0 \ln \left(\frac{C^*}{C} \right)$	Zydney and Colton (1986), after Ecstein <i>et al.</i> (1977)
Similarity solution for shear-induced diffusion (based on $C^* \sim 0.6$ by volume and $C < 0.1$ by volume)	$\langle J \rangle = 0.072 \gamma_0 \left(\frac{r^4 C^*}{CL} \right)^{1/3}$	Davis and Sherwood (1990)
Integral model for shear-induced diffusion from thick layers (based on $D_S(C)$)	$\langle J \rangle = 1.31 \gamma_0 \eta(C) \left(\frac{r^4 Q_{cr}(C)}{LC} \right)^{1/3}$	Romero and Davis (1988)
Inertial lift velocity (based on thin layers, such that $J = v_L$)	$J = \frac{0.036r^3\gamma^2}{16\nu_0}$	Drew <i>et al.</i> (1991)
Surface transport	$\langle J \rangle = 2.4r\gamma_0 (r^2 R'_c)^{2/5} \cot \theta$	Song and Elimelech (1995)

^a D_B , D_S , diffusion coefficient for Brownian and shear-induced diffusion respectively; γ_0 , maximum shear rate; C^* , C , concentration at the membrane-solution interface and the bulk retentate solution respectively; C , dimensionless concentration; L , membrane elemental length; U , cross-flow velocity; ν , kinematic viscosity (η/ρ); r , particle radius; $\eta(C)$, concentration-dependent dimensionless viscosity; $Q_{cr}(C)$, concentration-dependent excess particle flux; R'_c , specific cake resistance ($R_c/\text{cake thickness}$); v_L , inertial lift velocity; $\cot \theta$, surface morphology parameter.

Modified concentration polarisation model

Complications arise in the concentration polarisation model when it is applied to systems in which colloidal and/or suspended material is present and accumulates in the hydrodynamic boundary layer. In such cases Newtonian behaviour cannot be assumed within or at the outer boundary of the stagnant film, and the deviation from classic film theory increases with increasing solute concentration in the boundary layer. This implies that a correction for non-Newtonian behaviour is needed to account for the local solute concentration-dependent changes in:

- viscosity of the fluid,
- diffusivity of the solute, and
- permeability of the cake.

Some of the analytical expressions developed for the equilibrium length-averaged flux are included in Table 2.12. The solution varies according to the approach taken and the assumptions made, but the general trend is for transport of solute away from the membrane to be much higher than that predicted by Brownian diffusion. This changes the degree of dependency of flux on both cross-flow velocity (and so shear rate, according to Equations (2.18) and (2.19)) and particle size changes significantly from the Brownian diffusion L ev eque model if either shear-induced diffusion or inertial lift are included. For example, flux dependency on cross-flow changes from $U^{0.33}$ proportionality to direct proportionality for shear-induced diffusion (Zydney and Colton, 1986) or U^2 for inertial lift (Drew *et al.*, 1991). Kim and Park (1999) based their prediction of critical flux conditions on shear-induced diffusion.

A comprehensive, and complex, solution for equilibrium flux in CFMF has been presented by Romero and Davis (1988). This model accounts the effects of shear-induced diffusion on a non-uniform filter cake whose thickness increases with axial membrane (channel) distance. This is considerably more complex than the model for thin cake deposits (Zydney and Colton, 1986), where a uniform cake deposit over the whole membrane area is envisaged, and requires that the solute concentration dependency of viscosity and diffusivity be predetermined. More recently, the Romero and Davis model has been slightly simplified by basing the cake layer resistance on the Kozeny–Carman equation (Ould-Driss *et al.*, 2000).

Practical verification of modified models

Experimental studies on model colloidal or particulate systems have shown close agreement between experimentally measured steady-state flux data and those predicted from shear-induced diffusive mass transport theory for ideal systems, such as latex, blood, bacterial and fractionated clay suspensions (Zydney and Colton, 1986). The model of Kim and Park (1999) for predicting critical flux, again based on shear-induced diffusion, appears to corroborate well with experimental data from calcium carbonate filtration, the critical flux increasing linearly with particle size. Inertial lift, on the other hand, would appear to be restricted in importance to high shear rates and/or large particles (Davis, 1992).

The shear-induced diffusion model for thick cake layers (Romero and Davis, 1988, 1990) was found to give a reasonable representation of both dynamic and steady-state behaviour for both rectangular channels and ceramic tubular membranes challenged with homodispersed spheres of 0.45–1.37 μm (Romero and Davis, 1991). Ould-Driss *et al.* (2000), using a slightly simplified adaptation of the Romero and Davis model, also found reasonable agreement between theoretical and experimental steady-state flux for their trials on the less idealised system of granular calcium carbonate. Agreement was only obtained, however,

after allowance was made for differing mean particle size of the cake layer and the bulk suspension, which required experimental verification. A similar limitation appears to apply to the Song model (Song and Elimelech, 1995): an excellent fit with theoretically predicted flux was obtained for CFMF of 0.06 μm homodispersed colloidal silica once the specific cake resistance R'_c and the cake concentration C_c had been surmised (Wang and Song, 1999).

It is generally the case that the modified concentration polarisation models developed to define dynamic and steady-state behaviour during microfiltration are very sensitive to key parameters pertaining to particle transport and the hydraulic resistance of the cake. These parameters are either only calculable for highly idealised systems or else must be determined empirically. For real feedwaters, which may be physically, chemically and biologically complex, and the useful employment of these models for predictive purposes is probably restricted to defining trends. Even then, there are pronounced differences in reported data. For example for a single matrix of bovine blood, flux dependency on cross-flow appears to vary from $U^{0.47}$ to direct proportionality (Cheryan, 1998). Moreover, there appears to be a paucity of mechanistic information on fouling and dynamic behaviour of key heterogeneous matrices, such as natural organic matter (NOM) in surface waters or biomass in membrane bioreactor liquors, that could be used to form the basis of a predictive model.

2.4 Process design and operation

Key elements of process design that contribute to costs are:

- staging,
- power consumption,
- fouling and pre-treatment, and
- backflushing and cleaning.

Staging is of critical importance in large-scale dense membrane processes, i.e. reverse osmosis, nanofiltration and electrodialysis. Fouling is ubiquitous throughout the entire gamut of membrane technologies, but pretreatment to suppress or ameliorate fouling is only routinely practised in dense membrane processes. Backwashing is always carried out when the module design permits this, and cleaning is an essential part of membrane plant operation.

2.4.1 Staging

For most dense membrane processes the conversion of feed into product is limited either by the membrane area or the rate of extraction attainable by passage through a single module. It is for this reason that most reverse osmosis and electrodialysis technologies employ staging, the use of sequential stages to produce more product than that attainable by a single passage.

In reverse osmosis and nanofiltration even the largest membrane elements cannot normally achieve a recovery of much more than 20%, and the onset of concentration polarisation and the scaling this produces normally limits the conversion to well below this figure. It is therefore normal for them to be placed in series, with the retentate stream from one element being passed on to the feed stream of the next (Fig. 2.19). As many as eight or nine elements may be placed in a single module, and the resultant retentate flow exiting the module is then given by (from Equation (2.3)):

$$Q_R = Q(1 - \Theta)^n \tag{2.22}$$

where Q is the feed flow rate, Θ the conversion per element and n the number of elements per module.

As the water flows along the length of a module the overall conversion is increased until there may come a point at which the element is running well below capacity. For example if, in Fig. 2.19, the conversion is 16% per element then the flow in stream 8 will be $(1 - 0.16)^4 \sim 0.5$ that of the feed. Under such

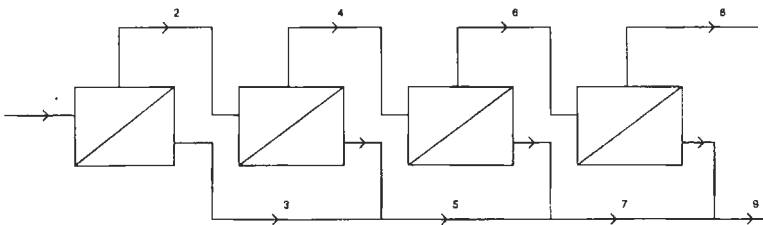

Figure 2.19 Retentate flow (streams 2, 4, 6 and 8) through a reverse osmosis module

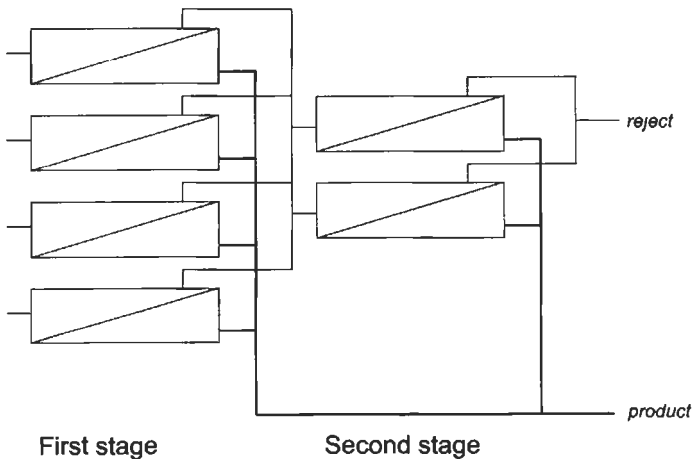

Figure 2.20 Schematic of a 4:2 reverse osmosis array

circumstances, it is advantageous to combine streams from modules operating in parallel in order to maximise utilisation of the membrane elements, such that an array of modules is produced (Fig. 2.20). This is known as staging, and is very common in the RO treatment of thin to light brackish waters where the retentate solution osmotic pressure does not become excessive through its concentration along the length of the module.

It is not necessarily feasible or desirable for the retentate to be staged in order to maximise the overall recovery. For high-salinity feedwaters, typically seawater where osmotic pressures in the region of tens of bar prevail, further concentration of these waters would demand uneconomically large operating pressures. For these and other waters permeate staging is employed, and the retentate from the second stage is returned to the feed of the first stage to produce a so-called twin pass system (Fig. 2.21). Twin pass systems also find use in high-purity water production.

Staging in electrodialysis differs from reverse osmosis in that further desalting of a solution that has already been desalinated by a maximum of 50% for a single passage through the stack, as constrained by the limiting condition imposed by depletion polarisation (Section 2.3.2), demands either increasing the volumetric flow, and/or reducing the current passed. Since the current passed is directly proportional to the total equivalent amount of ions transferred (Section 2.4.2), the simplest way of achieving additional desalination is by simply directing the product from the first passage through half the number of cell pairs in the second passage, thereby doubling the flow rate whilst leaving the current constant. This is known as hydraulic staging (Fig. 2.22). If further desalination is required, it may become expedient to reduce the current across the stack. This is referred to as electrical staging. It is normal to combine hydraulic with electrical staging to achieve reasonable desalination levels.

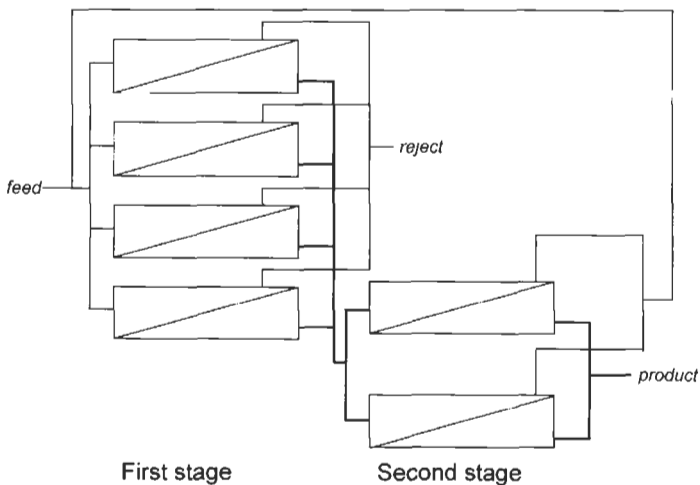

Figure 2.21 *Twin-pass RO system (permeate staged)*

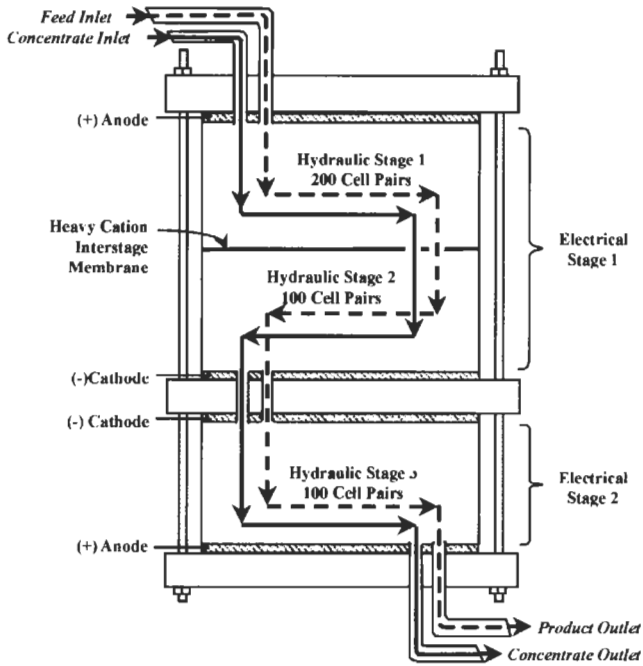

Figure 2.22 Example of staging in electrodialysis

2.4.2 Specific energy demand

Pressure-driven processes

The energy consumption of any pressure-driven process operating continuously is given by product of the pressure and flow, thus the total energy consumption per unit mass of permeate product, ignoring pumping efficiency, is given by:

$$E = \frac{1}{\rho(\Theta)} \sum \Delta P + \frac{W_{el}}{M} \quad (2.23)$$

where ρ is the permeate density, W_{el} the supplementary plant electrical energy consumption (e.g. for instrumentation and aeration or other turbulence promotion methods) and M the mass flow of permeate. $\sum \Delta P$ represents the sum of the individual pressure changes, which can include the pressure drop across the membrane ΔP_m , as given by Equation (2.5), the concentrate–permeate osmotic pressure difference $\Delta \Pi^*$, from Equation (2.9), the hydraulic losses ΔP_{losses} associated with forcing the retentate through the membrane channels and the pressure derived from the various contributions to membrane fouling. In the case of reverse osmosis, the total pressure for an individual membrane module is given by:

$$\Delta P_{\text{total}} = \mu J R_m \theta + Q_F (1 - \theta) \frac{dP}{dQ} + \frac{yRT \sum C_i}{1 - \theta} \quad (2.24)$$

where Q_F is the feed flow rate to the module and fouling is ignored. In Equation (2.24), the pressure losses per unit flow through the membrane channels on the retentate side are represented by dP/dQ . This factor can be estimated from the Hagen–Poiseuille equation, but is normally obtainable from the membrane supplier. An allowance can be made for fouling through an empirical correction factor. The rate of fouling in most reverse osmosis applications is normally low, since fouling is routinely suppressed by appropriate pretreatment based on chemical addition (Section 2.4.3).

In the case of filtration, the osmotic pressure term (the last term in Equation (2.24)) does not apply but the effects of cake formation and fouling on operating pressure cannot be ignored. Large-scale dead-end filtration plant operates with a backflush cycle actuated either at fixed intervals or when the membrane permeability has decreased to some pre-identified level. Since the backflush invariably fails to entirely recover the original membrane permeability, a more rigorous cleaning cycle, usually involving aggressive chemicals, is initiated again either at fixed intervals or when once the permeability of the backflushed membrane has declined to some other level. The calculation of energy consumption per unit volume must therefore incorporate the effects of downtime, specifically the energy consumption of the backflush and duration of the backflush and cleaning cycles (Section 4.3.5). Since backflushing is normally at 3–4 times the forward-flow flux, the energy expenditure per unit time is commensurately higher.

Dead-end filtration plant may be operated at either constant pressure or at constant flux (Fig. 2.23). In both cases trends in permeability decay over the backflush cycle, as reflected by flux decline at constant pressure operation (Fig. 2.23a) or pressure increase at constant flux operation (Fig. 2.23b), is exponential or pseudo-exponential, although the exact trend is dependent on the relative contributions of cake filtration, pore blocking and adsorption (Table 2.8). For filtration of solids forming an incompressible cake, on the other

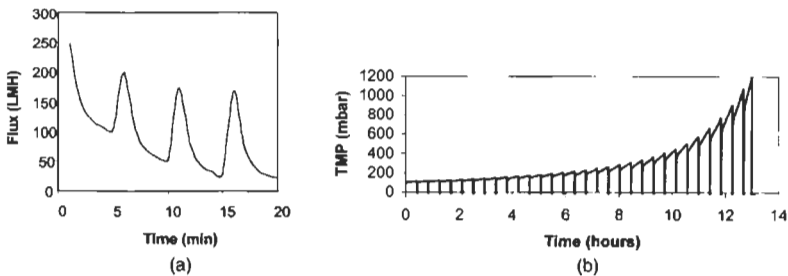

Figure 2.23 Dead-end filtration: (a) constant pressure (declining flux over backflush cycle) and (b) constant flux (increasing pressure over backflush cycle)

hand, the trend is linear for constant flux operation. The trend in the residual membrane permeability, that is the permeability of the "permanently fouled" membrane as reflected in the trend in the minima for the backflush cycles in Fig. 2.22, also tends to be exponential or pseudo-exponential. Whether constant flux or constant pressure operation, the mean energy consumption relates to the mean membrane permeability over a cleaning cycle.

Electrodialysis

In electrodialysis the total power consumption is the product of the voltage and the current. Since the voltage relates directly to the current by the resistance according to Ohm's law, the specific energy demand is critically dependent upon the current and electrical resistance. The applied current i is directly proportional to the total equivalent quantity of counter-ions or co-ions extracted:

$$i = \frac{QF\Delta C}{N\xi} \quad (2.25)$$

where Q is the flow through the stack, F is the Faraday constant, ΔC is the change in the diluate concentration in eq m^{-3} from inlet to outlet, N is the number of cell pairs (the number of desalinating or concentrating cells in the stack) and ξ is the current efficiency (normally 85–95%). The energy demand is then given by:

$$E = i^2 R / \Theta Q \quad (2.26)$$

where R is the overall electrical resistance in ohms, and relates to the cell pair resistance R_{CP} :

$$R = R_{CP} N \quad (2.27)$$

If scaling can be overcome and the path length can be extended by staging the principal constraint placed on the recovery Θ in Equation (2.26) is from electrodialysis reversal (see below). Because there is no osmotic pressure limitation in electrodialysis, and because the concentrate and diluate streams can be completely segregated, further efficiencies are obtained by recycling of the concentrate stream, which then decreases both the concentrate waste volume and the electrical resistance across the stack. For large-scale systems, recoveries in excess of 80% are normal.

The cell pair electrical resistance is given by:

$$R_{CP} = R_{conc} + R_{dil} + R_{CEM} + R_{AEM} \quad (2.28)$$

where the subscripts conc and dil refer to the concentrate and diluate compartments and CEM and AEM refer to the cation and anion exchanging membranes. The concentrate resistance is normally no more than 20% of the

diluate resistance and the resistance of the ion exchange membranes, although determined to some extent by the salt concentration, is normally low – between 2 and 10 $\Omega \text{ cm}^2$ for most commercial ion exchange membranes in 0.5 eq m^{-3} NaCl (Strathmann, 1984). It therefore follows that the main contribution to the electrical resistance is from the diluate cell.

The specific energy demand is increased, by 5–10%, by electro dialysis reversal (EDR) operation. In this operational mode, which is very common in ED applications, the current is periodically reversed such that the concentrated stream becomes the diluate stream and vice versa. This adds to process complexity and reduces recovery but also virtually eliminates problems with scaling, since reversing the polarity of the electrodes produces a concomitant pH shift that suppresses the build-up of scale during the high-pH cathode electrode compartment.

Ancillary mass transfer promotion

Mass transfer can be promoted simply through changing the spacer material. Membrane spacers for ED technologies are either sheet flow, which promote plug flow of the water throughout the width of the channel, or tortuous path, which provide an extended path length and thus a greater linear flow velocity for the same volumetric throughput (Fig. 2.24). Tortuous path spacers yield higher Reynolds numbers but at the expense of a higher pressure drop across the stack. Most commercial ED systems are now based on sheet flow spacers.

Certain technologies use additional devices to promote mass transfer. Examples include the mechanically enhanced, high-shear processes (Section 2.1.4) which employ motors to increase the shear at or near the membrane surface. The additional energy consumption of such devices relates directly the shear applied, and a key part of the design of such devices is optimisation so as to impart the maximum shear for the minimum energy expenditure. As already stated (Section 2.1.4), coarse bubble aeration may also be employed to enhance mass transfer and in immersed membrane processes, such as the submerged membrane bioreactor (Stephenson *et al.*, 2000). In such cases it represents a significant, sometimes the most significant, contribution to the overall energy demand and is dependent on the air flow rate, the nozzle diameter and the submersion depth. Other turbulence promotion devices, such as pulsed and vortex flow (Section 2.1.4) have yet to be commercialised.

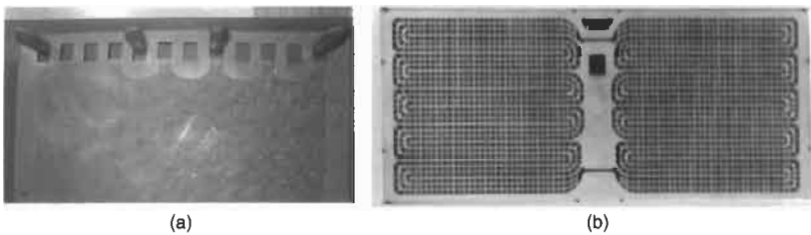

Figure 2.24 Electro dialysis spacers: (a) sheet flow (Eurodia) and (b) tortuous path (Ionics)

2.4.3 Fouling and pretreatment

Pretreatment is required to suppress fouling and/or clogging of membranes, or else to remove chemically aggressive constituents such as chlorine. Clogging of membrane channels by solid matter can, to some extent, be controlled hydrodynamically, for a cross-flow process, or by the appropriate backflush regime for a dead-end process. It is only for certain filtration processes and/or specific duties, such as filtration of municipal or laundry wastewater, that pretreatment to remove gross solids may be critical. In these examples it is the filamentous matter that causes a problem, as it can form large aggregates which can become tangled with hollow fibres or otherwise clog the membrane channels and, for an immersed system, the aerators. Submerged membrane bioreactors for sewage treatment thus routinely employ fine screens and/or microstrainers to remove these materials.

Pretreatment of membrane filtration feedwaters can be analogous to that employed for depth filtration. An example is the use of coagulants to assist in the removal of natural organic matter (NOM) from upland surface waters. Precoagulation increases overall NOM removal, thereby reducing the propensity to form trihalomethanes, as well as producing a more permeable and less adherent filter cake (Judd and Hillis, 2001).

The requirement for pretreatment is determined by the feedwater concentration of:

- suspended solids, and colloidal matter in particular,
- scalants (sparingly soluble dissolved salts), and
- microorganisms and nutrients.

The physical manifestation of these are briefly described in Table 2.13. Appropriate pretreatment technology can normally only be identified through pilot plant trials or through reference to appropriate case studies. However, in

Table 2.13 Physical manifestation of foulants

Foulant	Symptoms
Silt/carbon fines	Element may be stained with brown or black material at the inlet and exhibit low permeate flow. Higher flow and very poor rejection may occur in later stages due to irreparable damage to the membrane by abrasive particles.
Carbonate scale, suspended silica	Usually on tap water or brackish water elements only. The element may be noticeably heavier than normal, and will exhibit low permeate flow and poor salt rejection.
Iron fouling	Rust colouring, possibly originating from iron pipework, at inlet of element. Element will exhibit low permeate flow and poor salt rejection.
Biological growth	Element may have strong odour, possible mould growth and will exhibit low permeate flow whilst maintaining a high salt rejection, which can increase with decreasing flux.

the case of pressure-driven dense membrane processes (reverse osmosis and nanofiltration), pretreatment is both critical and to some extent predictable from the feedwater quality – specifically from derived indices pertaining to colloidal particles and calcium carbonate scalant. Proscriptive methods for measuring fouling propensity are available (ASTM D4189, D3739, D4582, D4692, D4993), and in the following sections pretreatment requirements for reverse osmosis are discussed. A discussion of cleaning methods for fouled membranes follows in Section 2.4.4.

Suspended solids

Suspended solids in the feed can accumulate at the membrane surface to an extent dependent upon the degree of turbulence provided by the cross-flow. Gross suspended solids are readily removed by pre-filtration using cartridge filters (Section 2.1.4) which may or may not be preceded by depth (e.g. sand) filtration. Colloidal matter, derived from aluminium silicate (clays), iron colloids, organic materials, etc., is less readily removed. Colloids introduce problems in membrane processes only when coagulation of the suspended colloidal particles takes place in the membrane. Pretreatment is thus designed either to remove the colloidal particles or else stabilise them to prevent their coagulation during permeation.

The fouling nature of a water is best determined by the Fouling Index or Silt Density Index (SDI), which measure the rate at which a membrane's pores plug. Standard test kits are available for determining SDI values. The test, a standard empirical test described in the reference literature (ASTM D4189), involves passing water at constant pressure (typically 2 bar) through a standard 0.45 μm -rated filter. The time t_i taken to collect a given volume of water, typically 100 ml, from the clean filter is measured. Filtration is continued for a pre-set time (t_f), usually 15 minutes, and the time (t_r) taken to collect a second sample of the same volume is measured. The SDI is then given by:

$$\text{SDI} = \frac{100(1 - t_i/t_r)}{t_f} \quad (2.29)$$

Suppliers of spiral wound RO and NF modules will normally specify an SDI value below 5. Waters of higher SDI values must be pretreated either chemically to stabilise the colloid, normally by addition of chemicals although occasionally softening can be used to stabilise the colloid by removing colloid-destabilising divalent species, or by some solid-liquid separation process to remove suspended material. Softening is unlikely to be economically viable on this basis alone, but in reducing the divalent ion level the scaling propensity of the water is also reduced which then allows operation at a higher conversion. Physical separation may demand pre-coagulation to increase the particle size and ensure retention of the suspended solids by the filter. For some applications where the feedwater contains natural organic matter the RO process may be preceded by fine microfiltration or even ultrafiltration.

Scalants and scaling indices

Scalants are low-solubility salts whose precipitation onto the membrane is promoted by the conversion of water into permeate and further encouraged in pressure-driven dense membrane processes both by concentration polarisation and the pH shift produced by carbon dioxide permeation. The scale formed can reduce the membrane permeability and permselectivity. As with colloidal and particulate fouling, scaling is also a problem in membrane filtration processes. Any water containing calcium carbonate close to or beyond its thermodynamic saturation limit, as is the case for many dairy and pharmaceutical effluents, can produce calcite (the most common crystal form of calcium carbonate) at the membrane surface.

Scale formation propensity is usually apparent from chemical thermodynamics, and specifically the solubility product K_s (Table 2.14), although it can never be unequivocally predicted. The solubility product represents the maximum value of the product of the molar concentrations of the two component ions of the salt. If the solubility is exceeded then the salt will precipitate. The general rule of thumb to avoid precipitation is that the ionic product should not exceed 80% of the solubility product. The appropriate constants for thermodynamic equilibria appropriate to some of the more common scalants, such as salts of the divalent alkaline earth elements of magnesium, calcium and barium, are normally included in CAD packages for designing RO arrays (Section 4.1). The thermodynamic relationships include, in the case of calcium carbonate formation, data pertaining to hydrolysis. The significance of this is outlined below.

Calcium carbonate is very insoluble in water and readily precipitates to form a scale on pipework, heat transfer surfaces and membranes. The equilibrium constant for the dissolution reaction is represented by:

$$K_s = [\text{Ca}^{2+}][\text{CO}_3^{2-}] \quad (2.30)$$

and so:

$$[\text{CO}_3^{2-}] = K_s/[\text{Ca}^{2+}] \quad (2.31)$$

When carbon dioxide dissolves in water it forms carbonic acid, which dissociates producing acid and bicarbonate ions thus:



This is the origin of the pH shift in reverse osmosis. Because the membrane allows free passage of carbon dioxide, the $\text{CO}_2/\text{HCO}_3^-$ ratio in the permeate is high and that of the retentate low. Since, according to Equation (2.32), the acid (i.e. H^+) concentration relates directly to the $\text{CO}_2/\text{HCO}_3^-$ ratio, the retentate pH is correspondingly high whilst that of the permeate is low.

Bicarbonate ions further dissociate to carbonate:



Table 2.14 Solubility products for some common scalants at 20°C

Salt	Formula	Solubility product, K_s
Aluminium hydroxide	$Al(OH)_3$	8.5×10^{-23}
Barium sulphate	$BaSO_4$	9.2×10^{-11}
Calcium carbonate	$CaCO_3$	4.8×10^{-9}
Calcium fluoride	CaF_2	3.2×10^{-11}
Calcium hydrogen phosphate	$CaHPO_4$	2.0×10^{-7}
Calcium hydroxide	$Ca(OH)_2$	8×10^{-6}
Calcium sulphate	$CaSO_4$	2.3×10^{-4}
Cadmium sulphide	CdS	1.4×10^{-28}
Cobalt sulphide	CoS	3.0×10^{-26}
Chromium hydroxide	$Cr(OH)_3$	2.9×10^{-29}
Copper sulphide	CuS	1.0×10^{-44}
Dolomite	$CaMg(CO_3)_2$	6.8×10^{-18}
Ferrous hydroxide	$Fe(OH)_2$	4.8×10^{-16}
Ferric hydroxide	$Fe(OH)_3$	3.8×10^{-38}
Ferrous sulphide	FeS	4.0×10^{-19}
Lead sulphide	PbS	5.0×10^{-29}
Manganese hydroxide	$Mn(OH)_2$	4.0×10^{-14}
Manganese sulphide	MnS	1.4×10^{-15}
Magnesium ammonium phosphate	$MgNH_4PO_4$	2.2×10^{-13}
Magnesium carbonate	$MgCO_3$	1.0×10^{-5}
Magnesium hydroxide	$Mg(OH)_2$	3.4×10^{-11}
Mercuric bromide	Hg_2Br_2	5.2×10^{-23}
Mercuric chloride	Hg_2Cl_2	3.5×10^{-18}
Mercuric sulphide	Hg_2S	1.0×10^{-45}
Nickel hydroxide	$Ni(OH)_2$	8.7×10^{-19}
Nickel sulphide	$AgBr$	7.7×10^{-13}
Silver chloride	$AgCl$	1.5×10^{-10}
Silver sulphide	Ag_2S	1.6×10^{-49}
Zinc hydroxide	$Zn(OH)_2$	1.0×10^{-17}
Zinc sulphide	ZnS	1.0×10^{-23}

for which the equilibrium constant is:

$$K_2 = [H^+][CO_3^{2-}]/[HCO_3^-] \quad (2.34)$$

and so:

$$[CO_3^{2-}] = K_2[HCO_3^-]/[H^+] \quad (2.35)$$

Equations (2.31) and (2.35) can be combined to give:

$$[H^+] = K_2[Ca^{2+}][HCO_3^-]/K_s \quad (2.36)$$

Thus:

$$pH_s = (pK_2 - pK_s) + pCa + pAlk \quad (2.37)$$

where Alk represents the molar bicarbonate concentration or alkalinity. In this equation the term pH_s represents the pH at which the water is in equilibrium with calcium carbonate, and is thus sometimes referred to as the saturation pH. The value of $(pK_2 - pK_s)$ is dependent on temperature and ionic strength.

The Langelier Saturation Index is defined as:

$$LSI = pH - pH_s \tag{2.38}$$

where pH is the actual measured pH of the water and pH_s is the calculated value. The LSI effectively measures the degree to which the water is either supersaturated or undersaturated with calcium carbonate, and thus its propensity for forming scale (ASTM D3739). A negative LSI indicates a corrosive water that will dissolve calcium carbonate scale and a positive LSI indicates a scale-forming one. The LSI is widely used and there are several nomograms available for rapid calculation (Fig. 2.25).

Whilst the LSI is a good predictor of scaling it is a bit unreliable in the range -1 to +1 and gives no indication of the relative scaling potential. The Ryznar Stability Index gives more quantifiable results and is defined as follows:

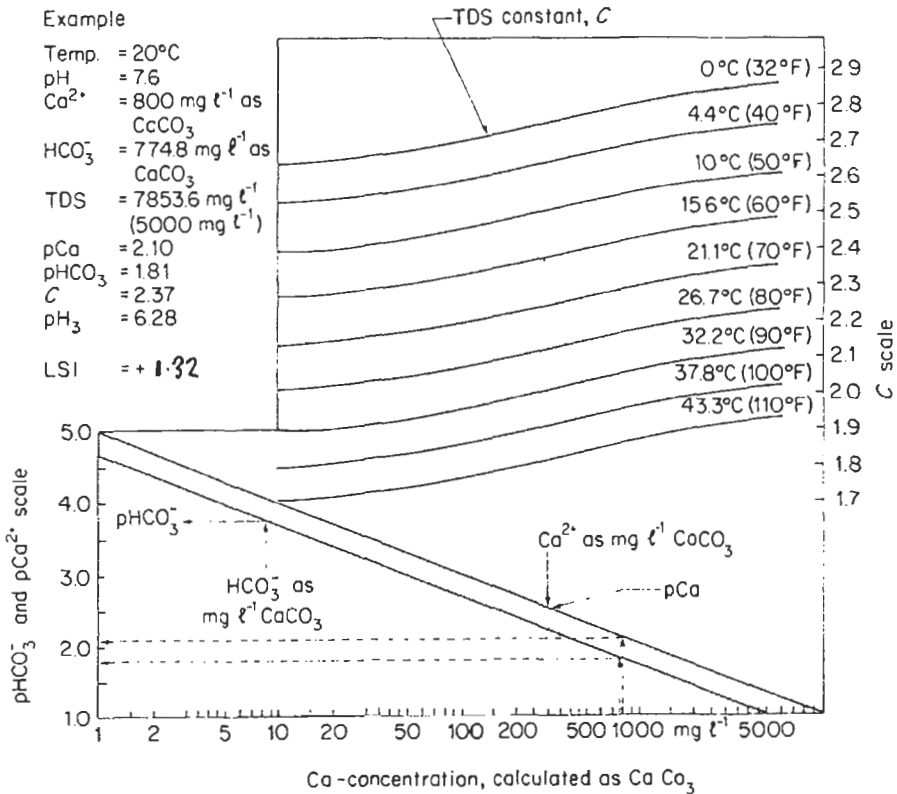
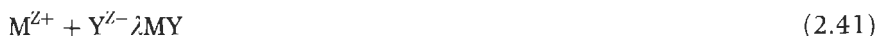

Figure 2.25 Langelier Scaling Index nomogram

$$\text{RSI} = 2\text{pH}_s - \text{pH} \quad (2.39)$$

An RSI of 7 indicates a water more or less at equilibrium. As the value falls the water becomes more scaling and as it rises the water becomes more corrosive. The Langelier and Ryznar saturation indices can be used to predict scaling in most waters but they become unreliable when the total dissolved solids content approaches 5000 mg l⁻¹. Above this level the Stiff and Davis index (ASTM D4582) or a similar method must be adopted.

Not all scale-forming compounds have a pH-dependent deposition. Some scalants have simple chemistry, analogous to that given in Equation (2.30):



or



Scalars having the chemistry represented by Equation (2.39) are mainly the sulphates of magnesium, barium and strontium (ASTMD4692).

The simplest means of preventing scale formation in RO systems is to operate at a conversion sufficiently low that the reject stream is not so concentrated that solubility problems are encountered. This, of course, has economic implications for the operation of the plant that may be unacceptable, and in such cases some form of scale prevention must be used. Where calcium carbonate or some other hydrolysable scalant is the main problem, i.e. those salts containing hydroxide (OH⁻) and carbonate (CO₃²⁻) which therefore have associated pH-dependent solubility due to hydrolysis reactions (i.e. reaction with acid, H⁺) of these anions, it is often possible to adjust the LSI by acid dosing. This converts bicarbonate into carbon dioxide which can be removed by degassing of either the feed or the permeate. Depending on whether hydrochloric or sulphuric acid is used there will be an increase in sulphate or chloride concentration. Increasing the sulphate may give rise to calcium sulphate precipitation.

Scale-inhibiting chemicals can be used to delay precipitation of some salts by interfering with the crystallization process forming microcrystals which do not cause fouling and which will not show significant agglomeration at least until the concentrate stream has left the RO unit. Most of the commercially available chemicals work well on calcium carbonate, provided that the LSI in the concentrate stream is less than +2, but less well on other salts. The most established scale inhibitors are termed "glassy polyphosphates", typically sodium hexametaphosphate (Calgon[®]). These work by absorbing into the nanoscopic protonuclei forming during the incipient stages of precipitation and destabilising the subsequent crystal nuclei. They are not the most effective chemicals for the application and revert quite quickly in solution to orthophosphate, producing calcium phosphate sludge which can cause blocking of separators and small bore pipes. Since the development of Calgon, more

effective threshold chemicals, including phosphonates, have become available. Polycarboxylic acids, such as polyacrylates and polymalonates, operate by blocking crystal growth sites preventing the growth of nuclei into crystals whilst chelating chemicals react with potentially insoluble cations like calcium to form a soluble complex. Dosage rates are typically of the order of $5\text{--}10\text{ mg l}^{-1}$ and, whilst some indication of the efficacy of these reagents may arise from the scale inhibition mechanism, it is generally the case that only pilot trials yield reliable information as to their suitability for a particular duty.

Where scale-inhibiting chemicals are unable to cope with the concentrations involved, and where chemical dosing is to be avoided for some reason, then pretreatment of the water is necessary to remove the scale-forming salts. This may be by sodium cycle ion exchange softening, ion exchange dealkalisation, lime or lime-soda softening or even a nanofiltration process if divalent ions are to be selectively removed. Some scalants are particularly recalcitrant. Dissolved (or "active") silica, evaluated using ASTM D4993, is not readily removed by pretreatment and there are proprietary reagents that have been developed specifically to inhibit its precipitation. However, modern RO membranes are reasonably tolerant, and raw environmental waters rarely require more than filtration and dosing as pretreatment for membrane permeation.

Microorganisms and nutrients

Bacteria are ubiquitous and thrive in the high surface area environment of a reverse osmosis membrane element, where they form biofilms. They are naturally transported towards the membrane surface under the force of the permeate flow, and are supplied with nutrients both from the feedwater and, under some circumstances, the pretreatment chemicals. Reports of the latter, as discussed by Flemming (1992), include flocculants (Graham *et al.*, 1989), phosphorus-containing scale inhibition chemicals (Ahmed and Alansari, 1989), sodium thiosulphate, as used for quenching chlorine (Winters and Isquith, 1979), and even chlorine itself, which was found to degrade organic matter sufficiently for it to become biologically assimilable (Applegate *et al.*, 1986). Although they can form substantial biofilm layers in potable and wastewater applications, bacteria require only an extremely low nutrient load to survive in biofilms and can exist even in ultrapure water systems, where their management becomes particularly vexing. Biofilm formation is thus unavoidable in most membrane operations, and it is likely that all membrane fouling is associated with biofilm formation, although the biofilm itself is not necessarily onerous.

Biofilm formation results from the rapid formation of an organic film, normally within the first few minutes of operation, followed by microbial adhesion and further entrapment of dissolved and suspended solid matter which co-deposits with the microorganisms. The conditioning film can be existing organic matter from the feedwater, such as NOM, or microbial products, namely extracellular polymeric substances (EPS). The rate of microbial deposition and the overall biofilm thickness depend on hydrodynamics, with biofilm thickness apparently decreasing with increasing turbulence (Ridgeway, 1988). Other key factors

include the membrane material and feedwater bacterial and nutrient concentration (Characklis and Marshall, 1990).

The principle effect of biofilm formation on membrane process performance is to reduce membrane permeability. In the case of cellulosic membranes the bacteria may ingest the membrane itself, causing irreversible degradation and significant loss of salt rejection. Since the elimination of biofouling is only possible through complete removal of microorganisms, the only convenient effective pretreatment is dosing with a liquid biocide. However, the most effective of these (chlorine and its compounds) are oxidative and will degrade most reverse osmosis membranes, the principal exception to this being cellulosic materials. UV irradiation, and even pre-sterilisation, are of limited efficacy since they generally are unable to completely prevent biofilm formation and cannot act directly upon the biofilm once it has formed. The main emphasis, therefore, is on control of the biofilm (where possible), and on its periodic removal through an appropriate cleaning protocol.

Organic matter

There are essentially three key categories of organic foulants:

- proteins,
- carbohydrates, and
- fats, oils and grease (FOG).

As with biological matter, pretreatment to remove organic matter is rarely feasible, and it is more usual to adopt an appropriate backflush and, in particular, cleaning strategy so as to ameliorate the worst effects of organic fouling. Proteins and carbohydrates form a part of the extracellular polymeric substances (EPS), as well as natural organic matter (NOM). Proteins may be colloidal or dissolved, and are least soluble at their isoelectric point, which tends to arise at pH values of 4–5. Their removal is therefore most effective at extremes of pH. Carbohydrates include starches, polysaccharides, and fibrous and pectin materials. Fouling by these materials is very sensitive to flux, and their removal sensitive to the precise cleaning protocol adopted. FOG forms part of the suspended matter, and is particularly problematic since these substances generally have a high affinity for the more hydrophobic membranes, and polysulphone in particular, and are not readily removed by normal backflushing and cleaning methods. Their effective removal is normally only achievable at high temperatures and/or by the use of organic solvents. Organic solvents are only an option for ceramic or highly inert polymeric membranes (Section 2.1.3).

A summary of foulant impacts and pretreatment options for reverse osmosis are listed in Table 2.15.

2.4.4 Backflushing and cleaning

An essential distinction must be made between the intermittent backflush cycle, in which the fouled membrane is physically cleaned by flowing the product

Table 2.15 Common foulants and their pretreatment, reverse osmosis

Foulant	Effect on performance	Pretreatment
Suspended solids	Decrease in permeability, normally in first stage	< 2 mg l ⁻¹ : 5 µm cartridge filter; > 2 mg l ⁻¹ : multimedia deep-bed filter Cross-flow microfiltration
Organic and inorganic colloidal matter, SDI > 5	As above	Ultrafiltration Precoat filtration Multi media deep bed filtration In-line coagulation and filtration Softening
Alkaline scales: CaCO ₃	Decrease in salt rejection and slight decrease in permeability, normally in final stage	LSI < 2: threshold inhibitor dosing; LSI > 2: acid addition; LSI π 2: ion exchange or lime-soda softening
Active silica	As above	Lime-soda softening with MgO Alkali dosing Heat
Permanent hardness	As above	Scale inhibitor dosing, ion exchange softening, lime-soda softening
Sulphate scales, e.g. CaSO ₄	As above	Threshold inhibitors
Metal oxide (iron and manganese)	As above	Aeration and filtration, dissolved air flotation (DAF), catalytic oxidation (greensand filtration), chemical oxidation and filtration
Free chlorine	Permanent loss of rejection due to degradation of membrane ^a	Activated carbon, chemical reducing agent
Dissolved organics, e.g. NOM, EPS, anionic detergents	Rapid decrease in permeability	Adsorption (GAC), flotation
Biological matter	Decrease in permeability	Chlorination/dechlorination, UV (+ microfiltration)

^a Non-chlorine-resistant materials.

permeate water in the reverse direction through the membrane, and the cleaning cycle in which the membrane is invariably chemically treated for a more extended period. Whilst both backflushing and cleaning are routinely and advantageously employed to recover some of the flux, nonetheless incur a cost penalty through:

- the energy consumption,
- the loss of product water,
- the downtime, and
- the use of hazardous chemicals.

The energy consumption relates to the hydraulic resistance, as discussed in Section 2.4.2. The loss of product water arises because of its use for both backflushing and cleaning, and can be significant. For example, a 20 s backflush

every 12 minutes, as might be appropriate for a dead-end filtration of a municipal wastewater, incurs a loss of 8% of the product water if the backflush flow is three times that of the forward flow. The cleaning cycle employs less product water and generally a shorter percentage downtime but demands the use of acidic, caustic and/or oxidative chemicals and so produces extra transport and handling problems and generates a waste stream which may not be so readily disposed of as the backwash water. Cleaning, of course, also incurs the additional cost of both the cleaning reagent(s) and system.

Cleaning chemicals generally fall into one of seven categories, with some overlap between them:

- Acids
- Alkalis
- Chelants
- Enzymes
- Surfactants
- Biocides
- Oxidants

A wide variety of proprietary formulated membrane cleaning products have been developed and marketed mainly by the membrane suppliers but also by other companies, with the number of products proliferating over the last decade or so. Notwithstanding these commercial developments, many membrane plant operators still tend to employ conventional generic cleaning chemicals and formulations (Table 2.16). It is also the case that cleaning solutions tend to be employed on a reactive rather than routine preventative basis. It is generally the case that employing cleaning once fouling of the membrane has become severe is less effective than routine maintenance cleaning which removes incipient fouling. Also, in many cases no single cleaning reagent will recover the flux entirely, and it is often advantageous to use a combination of cleaning reagents in sequence.

Table 2.16 Common foulants and appropriate cleaning solutions, reverse osmosis

Foulant	Cleaning solution
Calcium carbonate	Hydrochloric acid pH 4
Calcium, barium sulphate	2% citric acid ammoniated to pH 4
Metal oxides	2% citric acid ammoniated to pH 8
Silica	EDTA sodium salt, pH 7–8
Organics	2% citric acid ammoniated to pH 4
Biological fouling	1% sodium hyposulphite
	Caustic soda pH 11
	Caustic soda pH 11
	Alkaline detergent
	1% formaldehyde
	Hypochlorite

Acid cleaners are generally used for inorganic scale removal, principally calcium carbonate and ferric hydroxide. Reagents employed include conventional low-cost inorganic acids (sulphuric, hydrochloric, nitric and, less commonly, phosphoric) and organic acids (citric, oxalic, acetic and sulphamic). The stronger, in terms of acid strength per equivalent concentration, inorganic acids are correspondingly more effective than the weaker organic salts but are also more corrosive and potentially more damaging to the membrane element, module or plant pipework. Careful pH control is therefore necessary, with pH values above 2 being maintained for most applications. Citric acid solutions, which have historically been employed for scale removal, must be ammoniated and adjusted to a pH of 4 to avoid complexation with the ferrous ion, since this can precipitate and blind the membrane. Oxalic acid is particularly effective against iron, but forms a calcium salt of limited solubility. Some organic acids act through chelation, i.e. through the formation of stable complexes with multivalent metal cations. The most commonly used chelants are ethylene diamine tetracetic acid (EDTA), phosphonocarboxylic acid, gluconic acid, citric acid and various polymers that have a chelating ability. Of these EDTA, as a hexadentate ligand, is significantly the stronger but also has adverse health effects.

Alkaline cleaners, primarily caustic soda, are employed for the removal of organic acid foulants, including proteins, and silica. The solution may need buffering with bicarbonate or phosphate to maintain the pH, however, and the addition of surfactants can improve the detergency action of the alkaline solution. It is common to combine caustic with acid cleaning and other cleaning chemicals, applied sequentially, to maximise the flux recovery. Surfactants themselves can be non-ionic (e.g. ethylene oxide), anionic (soaps and alkylsulphonates) or cationic (quaternary ammonium compounds or QACs). QACs, which are also bacteriostatic (i.e. prevent the growth of bacteria), cannot be used with membranes with a high surface concentration of carboxylate ions, such as polyamide thin-film composites, due to irreversible complexation. Non-ionic surfactants may also exhibit this behaviour, though to a lesser extent.

Enzymic cleaners are effective against many biodegradable organic foulants, such as proteins, and are chemically non-aggressive. They are, however, also slow acting and expensive, and so are generally only employed when other cleaning chemicals have failed. Since they are also proteins in themselves, an additional alkaline chemical clean is required to remove any residue.

The most commonly used biocide is chlorine, although aromatic polyamide membranes are degraded by chlorine and other oxidants. Generally chlorine levels of around 10 ppm are sufficient for routine sanitisation following a chemical clean, but concentrations of 100 ppm may be used for specific bactericidal duties such as pyrogen removal. Chlorine is generally employed as a sodium hypochlorite solution, adjusted to a pH of 10–11 to reduce its chemical aggressiveness, though this also reduces its bactericidal potency. A 2–3% formaldehyde solution can also be used for sanitisation, and this reagent is also used at lower concentrations (0.5–1%) for storing membranes as an alternative to the more potent hypochlorite. However, it must be removed by thorough

rinsing prior to membrane operation due to its propensity for complexation with proteins. Other chemical bactericidal reagents that have been employed, and may be included in proprietary formulations, include QACs, acidified metabisulphite, hydrogen peroxide and peroxyacetic acid, the latter being generated from hydrogen peroxide and peracetic acid. Some membranes, notably fluorinated polymers and ceramic membranes, are steam sterilisable.

Most membrane plant is designed to allow cleaning in place (CIP). Fouled cross-flow membranes systems are cleaned by recirculating a cleaning solution around the concentrate side of the module by means of a small tank and circulating pump. Each membrane module, or bank of modules if an entire bank is to be cleaned at once, is normally provided with cleaning connections to allow this. The connections are usually three-way L-port ball valves so that connecting the cleaning solution circulation system automatically isolates the module(s) from the high-pressure feed system. In dead-end systems CIP entails pumping the cleaning solution in the reverse direction, i.e. from the permeate to the retentate side. Submerged systems can also be cleaned *ex situ* by placing the entire module in a tank containing the cleaning fluid.

The cleaning tank for an RO plant normally has a working volume equal to the volume of the (empty) pressure tube(s) to be cleaned plus the volume of the associated pipework. Tanks are typically of GRP or polypropylene, depending on the cleaning chemical being used, and fitted with an electrically powered stirrer. The circulation pump is normally rated to deliver a flow velocity of 0.06–0.08 m s⁻¹ at a pressure 1.2–4 bar, the exact pressure being dependent upon the number of elements in the module. Precise recommended cleaning protocols vary, with some suppliers recommending a 15–30 minute soak. It is normally desirable for this stream to be fitted with a 5 µm filter upstream of the pressure vessels. Disinfection can be carried out in the same way but with a higher pressure (up to about 10 bar) to ensure that the disinfecting solution penetrates to the permeate side of the membrane.

References

Ahmed, S.P. and Alansari, M.S. (1989). Biological fouling and control at RAS Abu Jarjur RO plant – a new approach. *Desalination*, **74**, 69–84.

Applegate, L.E., Erkenbrecher, C.W. and Winters, H. (1986). Monitoring control of biological activity in Permasep seawater RO plants. *Desalination*, **65**, 331–359.

Arroyo and Fonade, C. (1993), Use of intermittent jets to enhance flux in crossflow filtration. *J. Membrane Sci.*, **80**, 117–129.

ASTM D3739, Standard practice for calculation and adjustment of the Langelier saturation index for reverse osmosis.

ASTM D4189, Standard test method for Silt Density Index (SDI) of water.

ASTM D4582. Standard practice for calculation and adjustment of the Stiff and Davis stability index for reverse osmosis.

ASTM D4692, Standard practice for calculation and adjustment of sulfate scaling salts (CaSO_4 , SrSO_4 and BaSO_4) for reverse osmosis.

ASTM D4993, Standard practice for calculation and adjustment of silica scaling for reverse osmosis.

Belfort, G., Davis, R.H. and Zydney, A.L. (1994). The behaviour of suspension and macromolecular solutions in crossflow microfiltration. *J. Membrane Sci.*, **96**, 1–58.

Bertram, C.D., Hoogland, M.R., Li, H., Odell, R.A. and Fane, A.G. (1993). Flux enhancement in crossflow microfiltration using a collapsible-tube pulsation generator. *J. Membrane Sci.*, **84**, 279–292.

Bhattacharyya, D. and Williams, M.E. (1992). Reverse osmosis: theory. In Ho, W.S.W. and Sirkar, K.K. (eds.) *Membrane Handbook*. Nostrand Reinhold, New York, pp. 269–280.

Bouhabila, E.H., Ben Aim, R. and Buisson, H. (1998). Microfiltration of activated sludge using submerged membrane with aior bubbling. *Desalination*, **118**, 315–322.

Bowen, W.R., Calvo, J.I. and Hernandez, A. (1995). Steps of membrane blocking in flux decline during protein microfiltration. *J. Membrane Sci.*, **101**, 153–165.

Bowen, W.R., Doneva, A.D. and Yin, H.-B. (2001). Separation of humic acid from a model surface water with PSU/SPEEK blend UF/NF membranes. *J. Membrane Sci.*, **206**, 417–429.

Cabassud, C., Laborie, S. and Lainé, J.M. (1997). How slug flow can enhance the ultrafiltration flux in organic hollow fibres. *J. Membrane Sci.*, **128**, 93.

Chang, I.-S., Le-Clech, P., Jefferson, B. and Judd, S.J. (2002). Membrane fouling in membrane bioreactors for wastewater treatment. *Environ. Eng. Sci.* (in press).

Chang I.S., Bag S.O. and Lee C.H. (2001). Effects of membrane fouling on solute rejection during membrane filtration of activated sludge. *Process Biochemistry*, **36**(8–9), 855–860.

Chang, I.-S. and Lee, C.-H. (1998). Membrane filtration characteristics in membrane coupled activated sludge system – the effect of physiological states of activated sludge on membrane fouling. *Desalination*, **120**, 221–233.

Characklis, W.G. and Marshall, K.C. (1990). *Biofilms*. Wiley.

Cheryan, M. (1998). *Ultrafiltration and microfiltration handbook*. Technomic, Basel, pp. 138–152.

Chiolle, A., Gianotti, G., Gramando, M. and Parrini, G. (1978). Mathematical model of reverse osmosis in parallel channels with turbulence promoting nets. *Desalination*, **26**, 3–16.

Cho, B.D. and Fane, A.G. (2002). Fouling transients in nominally sub-critical flux operation of a membrane bioreactor. *J. Membrane Sci.* (in press).

Choo, K.-H. and Lee, C.-H. (1996). Membrane fouling mechanisms in the membrane-coupled anaerobic bioreactor. *Wat. Res.*, **30**, 1771–1780.

Davis, R.H. (1992). Theory for crossflow microfiltration. In Ho, W.S.W. and Sirkar, K.K. (eds.) *Membrane handbook*. Nostrand Reinhold, New York, pp. 483–505.

Davis, R.H. and Sherwood, J.D. (1990). A similarity solution for steady-state crossflow microfiltration. *Chem. Eng. Sci.*, **45**, 3203–3209.

Defrance, L. and Jaffrin, M.Y. (1999a). Reversibility of activated sludge filtration. *J. Membrane Sci.*, **152**, 203–210.

Defrance, L. and Jaffrin, M.Y. (1999b). Reversibility of fouling formed in activated sludge filtration. *J. Membrane Sci.*, **157**, 73–84.

Drew, D.A., Schonberg, J.A. and Belfort, G. (1991). Lateral inertial migration of a small sphere in fast laminar flow through a membrane duct. *Chem. Eng. Sci.*, **46**, 3219–3244.

Ecstein, E.C., Bailey, P.G. and Shapiro, A.H. (1977). Self-diffusion of particles in shear flow of suspension. *J. Fluid Mech.*, **79**, 191–208.

Fane, A.G. (1986). Ultrafiltration: factors influencing flux and rejection. *Prog. Filt. Sep.*, **4**, 101–179.

Field, R.W., Wu, D., Howell, J.A. and Gupta, B.B. (1995). Critical flux concept for microfiltration fouling. *J. Membrane Sci.*, **100**, 259–272.

Fleming, H.C. (1992). Mechanistic aspects of reverse osmosis membrane biofouling and prevention. In Amjad, Z. (ed.) *Reverse osmosis membrane technology, water chemistry and industrial applications*. Nostrand Reinhold, New York.

Ghosh R. and Cui Z.F. (1999). Mass transfer in gas-sparged ultrafiltration: upward slug flow in tubular membranes. *J. Membrane Sci.*, **162**, 91–102.

Grace, H.P. (1956). Resistance and compressibility of filter cakes. *Chem. Eng. Prog.*, **49**, 303–318.

Graham, S.I., Reitx, R.L. and Hickman, C.E. (1989). Improving reverse osmosis performance through periodic cleaning. *Desalination*, **74**, 113–124.

Green, G. and Belfort, G. (1980). Fouling of ultrafiltration membranes: lateral migration and the particle trajectory model. *Desalination*, **35**, 129–147.

Guiver, M. D., Black, P., Tam, C. M. and Deslandes, Y. (1993). Functionalised PSU membranes by heterogeneous lithiation. *J. Appl. Polymer Sci.*, **48**, 1597.

Gupta, B.B., Banplain, P. and Jaffrin, M.Y. (1992). Permeate flux enhancement by pressure and flow pulsations in microfiltration with mineral membranes. *J. Membrane Sci.*, **70**, 257.

Gupta, B.B., Ding, L.H. and Jaffrin, M.Y. (1985). In Nose, Y., Kjellstrand, C. and Ivanovich, P. (eds.) *Progress in Artificial Organs*. ISAO Press, Cleveland, p. 891.

Gupta, B.B., Howell, J. A., Wu, D. and Field, R.W. (1995). Critical flux concept for microfiltration fouling. *J. Membrane Sci.*, **100**, 259–272.

Hermia, J. (1982). Constant pressure blocking filtration laws: application to power-law non-Newtonian fluids. *Trans. Inst. Chem. Eng.*, **60**, 183.

Howell, J.A. (1995). Subcritical flux operation of microfiltration. *J. Membrane Sci.*, **107**, 165–171.

Ishiguro, K., Imai, K. and Sawada, S. (1994). Effects of biological treatment conditions on permeate flux of UF membrane in a membrane/activated sludge wastewater treatment system. *Desalination*, **98**, 119–126.

IUPAC (1985). Reporting physisorption data. *Pure Appl. Chem.*, **57**, 603.

Judd, S.J. and Hillis, P. (2001). Coagulation pretreatment for crossflow microfiltration of upland waters. *Wat. Res.*, **35**, 2895–2904.

Keating, R.E. (1989). The nature of pores in integrally skinned phase inversion membranes. In Matsuura, T. and Sourijan, S. (eds.) *Advances in reverse osmosis and ultrafiltration*. National Research Council of Canada, pp. 1–13.

Kim, S. and Park, H. (1999). Prediction of critical flux conditions in crossflow microfiltration using a concentration polarisation model. *Proc. Membrane Technology in Environmental Management*, Tokyo, 1–4 Nov., pp. 186–193.

Knoell, T., Safarik, J., Cormack, T., Riley, R., Lin, S.W. and Ridgeway, H. (1999). Biofouling potentials of microporous polysulphone membranes containing a sulphonated polyether-ethersulphone polyethersulphone block copolymer: correlation of membrane surface properties with bacterial attachment. *J. Membrane Sci.*, **157**, 117–138.

Krauth, K.H. and Staab, K.F. (1993). Pressurized bioreactor with membrane filtration for wastewater treatment. *Wat. Res.* **27**, 405–411.

Kwon, D.Y. and Vigneswaran, S. (1998). Influence of particle size and surface charge on critical flux of crossflow microfiltration. *Wat. Sci. Technol.*, **38**, 481–488.

Kwon, D.Y., Vigneswaran, S., Fane, A.G. and Ben Aim, R. (2000). Experimental determination of critical flux in cross flow microfiltration. *Separation and Purification Tech.*, **19**, 169–181.

Lévêque, J.A. (1928). Les lois de la transmission de chaleur par convection. *Ann. Mines*, **13**, 305–382.

Lonsdale, H.K., Merten, U. and Riley R.L. (1965). Transport properties of cellulose acetate osmotic membranes. *J. Appl. Polym. Sci.*, **9**, 1341.

Matsuura, T. and Sourirajan, S. (1981). Reverse osmosis transport through capillary pores under the influence of surface forces. *Ind. Eng. Chem. Process Des. Dev.*, **20**, 273.

Mercier, M., Fonade, C. and Lafforgue-Delmorme, C. (1997). How slug flow can enhance the ultrafiltration flux of mineral tubular membranes. *J. Membrane Sci.*, **128**, 103.

Nunes, S.P. and Peinemann, K.V. (2001). *Membrane technology in the chemical industry*. Wiley, Weinheim.

Ould-Driss, A., Jaffrin, M.Y., Si-Hassen, D. and Neggaz, Y. (2000). Effect of cake thickness and particle polydispersity on prediction of permeate flux in microfiltration of particulate suspensions by a hydrodynamic diffusion model. *J. Membrane Sci.*, **164**, 211–227.

Porter, M.C. (1972). Concentration polarisation with membrane ultrafiltration. *Ind. Eng. Chem. Prod. Res. Dev.*, **11**, 233–248.

Ridgeway, H.F. (1988). Microbial adhesion and biofouling on reverse osmosis membranes. In Parekh, B.S. (ed.) *Reverse osmosis technology*. Marcel Dekker, New York, pp. 429–481.

Rodgers, V.G.J. and Sparks, H.E. (1993). Effects of solution properties on polarization redevelopment and flux in pressure pulsed ultrafiltration. *J. Membrane Sci.*, **78**, 163.

Romero, C.A. and Davis, R.H. (1988). Global model of crossflow microfiltration based on hydrodynamic particle diffusion. *J. Membrane Sci.*, **39**, 157–185.

Romero, C.A. and Davis, R.H. (1990). Transient model of crossflow microfiltration. *Chem. Eng. Sci.*, **45**, 13–25.

Romero, C.A. and Davis, R.H. (1991). Experimental verification of the shear-induced hydrodynamic diffusion model of crossflow microfiltration. *J. Membrane Sci.*, **62**, 249–273.

Sato, T. and Ishii, Y. (1991). Effects of activated sludge properties on water flux of ultrafiltration membrane used for human excrement treatment. *Wat. Sci. Tech.*, **23**, 1601–1608.

Sherwood, T., Brian, P. and Fisher, R. (1967). Desalination by reverse osmosis. *Ind. Eng. Chem. Fundam.*, **6**, 2.

Shimizu, Y., Shimodera, K.I. and Watanabe, A. (1993). Cross flow microfiltration of bacterial cells. *J. Fermentation and Bioengineering*, **76**, 493–500.

Shimizu, Y., Okuno, Y.I., Uryu, K., Ohtsubo, S. and Watanabe, A. (1996). Filtration characteristics of hollow fiber microfiltration membranes used in membrane bioreactor for domestic wastewater treatment. *Wat. Res.*, **30**, 2385–2392.

Song, L. and Elimelech M. (1995). Theory of concentration polarization in crossflow microfiltration. *J. Chem. Soc. Faraday Trans.*, **91**, 3389–3398.

Sourirajan, S. and Matsuura, T. (1985). Reverse osmosis/ultrafiltration principles. National Research Council of Canada, Ottawa.

Stephenson, T., Judd, S.J., Jefferson, B. and Brindle, K. (2000). Membrane bioreactors in wastewater treatment. IAW Publishing, London.

Strathmann, H. (1984). Ion-exchange membranes in industrial separation processes. *J. Sep. Process Technol.*, **5**, 1–13.

Visvanathan, C. and Ben Aim, R. (1989). Studies on colloidal membrane fouling mechanisms in crossflow microfiltration. *J. Membrane Sci.*, **45**, 3–15.

Wang, L. and Song, L. (1999). Flux decline in crossflow microfiltration and ultrafiltration: experimental verification of fouling dynamics. *J. Membrane Sci.*, **160**, 41–50.

Winters, H. and Isquith, I.R. (1979). In-plant microfouling in desalination. *Desalination*, **30**, 337–399.

Zydney, A.L. and Colton, C.K. (1986). A concentration polarisation model for the filtrate flux in crossflow microfiltration of particulate suspensions. *Chem. Eng. Commun.*, **47**, 1–27.

Chapter 3

Industrial waters

3.1 The power industry

Audrey Levine
University of South Florida

3.2 The pulp and paper industry

Jutta Nuortila-Jokinen, Mika Mänttari and Marianne Nyström
Lappeenranta University of Technology

3.3 The textile industry

Simon Judd
School of Water Sciences, Cranfield University

3.4 The beverage industry

Mike Carney
Vale Water Services Ltd

3.5 Pure waters in the pharmaceutical industry

John Hutcheson
Christ Kennicott Water Technology Ltd

3.1 The power industry: water requirements for power generation and cooling water

3.1.1 Water demand by the power industry

In industrialized nations significant quantities of water are needed for power generation and cooling applications, greatly exceeding the quantities of water used for all other purposes (Fig. 3.1). For example, in the USA thermoelectric power generation accounts for about 47% of the $5.5 \times 10^{11} \text{ m}^3$ of water that is consumed annually (Solley *et al.*, 1998). A major water use is for condenser and reactor cooling in steam–electric power plants. For power plants equipped with wet towers for steam condensation, the evaporation of water in the cooling tower can account for up to two-thirds of the total plant water use. Other applications for cooling water include air conditioning systems, food and beverage manufacture, meat and dairy industries, chemical manufacturers, and petroleum refineries (Asano and Levine, 1998).

On a global basis, it has been estimated that about 10 000 GW of new electrical generating capacity will be required by 2050 (Powicki, 2002). Fresh water is an essential resource for the production of electricity, as it is needed for high-purity steam, condensate cooling, and miscellaneous operations including dust suppression. While the net water requirements depend on the distribution of energy sources (nuclear, fossil fuel, waste-to-energy, hydropower, solar, wind, etc.), it is obvious that energy production is dependent on water availability. In addition to projected increases in energy and associated water requirements, liquid discharges from industrial water users are subjected to increasingly stringent requirements in many locations. In the future, it is likely that many thermoelectric power generation facilities will be required to comply with so-called zero liquid discharge (ZLD) requirements to meet long-term watershed

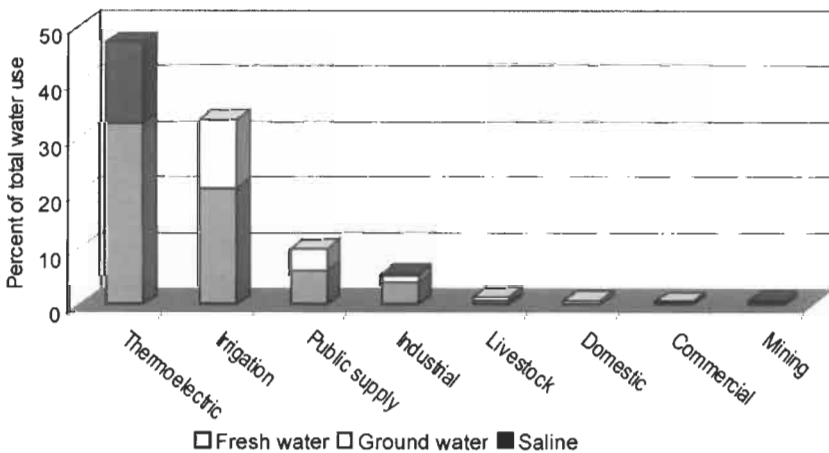

Figure 3.1 Water use in the USA (data from Solley *et al.*, 1998)

protection goals, particularly in environmentally sensitive locations (Crook *et al.*, 1994; Puckorius, 1997). It is thus important to develop more efficient approaches to management of water in the thermoelectric power industry.

Over the past decade, recurring water shortages coupled with more rigorous water quality requirements have prompted a re-examination of current cooling water practices. Water availability poses challenges to the siting of new power production facilities. In addition, a growing water resource management trend worldwide is to prioritise the use of water based on water quality and availability. Where appropriate, the emphasis is on preserving the highest quality water sources for potable water applications by using secondary sources for applications that have less stringent water quality requirements. As is evident from Fig. 3.1, efforts to reduce the quantity of water used for thermoelectric power generation can have a direct impact on balancing the distribution of water resources. This section aims to discuss the potential for using reclaimed water as a water source for cooling operations. A description of cooling water applications is given, water quality requirements are discussed and treatment alternatives presented. Some existing examples of cooling operations using reclaimed water are also given.

3.1.2 Overview of cooling water systems

Thermoelectric power plants typically derive energy from heat-generating fuels, such as nuclear fuel, coal, oil, natural gas, municipal solid waste, or refuse-derived fuel. The heat is used to produce steam in a boiler. The steam passes through a turbine and is then condensed back to water and pumped back to the boiler to repeat the cycle. The turbine drives a generator that produces electricity. Steam turbines extract power from steam as it passes from high-pressure and high-temperature conditions at the inlet to low-pressure and low-temperature conditions at the outlet. The outlet pressure is a function of the temperature of the cooling water used to absorb heat and reject it from the condenser (Asano *et al.*, 1988; Burger, 1979; Kemmer, 1988).

The water requirements for power plants are based on providing water for cooling and water as a source of steam in boilers. Typically, higher quality water is needed for boiler feed water as compared to cooling water. In general, cooling systems function to remove excess heat from heat sources. A cooling tower acts as a heat exchanger by driving ambient air through falling water, causing some of the warmed water to evaporate, thereby dissipating heat and providing cooling. The cooler water is then circulated back to the equipment that needs cooling. In thermoelectric power plants, cooling water is used to remove heat from the turbine exhaust and condense it back to liquid prior to its return to the steam generator.

Cooling tower operations consist of evaporative condensation and exchange of heat. Latent heat of vapourisation is released from the air and water mixture, resulting in evaporation of water at a rate dependent on the temperature and pressure. The amount of heat consumed is about 2.3 kJ g^{-1} of water evaporated. For each 5.5°C of cooling, about 1.2% of the water is released from the cooling

tower to the atmosphere as hot moist vapour. Evaporative cooling systems provide air flow either through natural draft or mechanical draft systems. Typically, natural draft systems are hyperbolic towers (> 50 m high) with air flow rates of about $2000 \text{ m}^3 \text{ min}^{-1}$ (Kemmer, 1988; Puckorius and Hess, 1991; State of California, 1980). Density gradients between the less dense heated air and the more dense cool ambient air result in positive air flow.

Mechanical draft systems employ fans to move air through the towers either through forced draft (fans at the bottom of the tower) or induced draft (fans at the top of the tower to pull air up through the tower). Rotating fans are used to pull cool, dry air into the tower at a rate of about $600\text{--}750 \text{ m}^3$ air per m^3 recirculating water. Warmed heat exchanger water is pumped to the top of the tower where it descends through the rising air stream. Packing material inside the tower breaks up the water flow to improve the contact efficiency between the air and water. A fraction of the water evaporates and leaves the tower as vapour. Mechanical draft cooling towers (Fig. 3.2) tend to have vapour plumes that are about 30% shorter than those produced by natural draft towers, thus reducing the need for plume abatement.

A variety of types of cooling systems are used, depending on the application and water availability (Table 3.1). Cooling water can be used once and returned to its original source (once-through cooling) or reused in an open recirculating



Figure 3.2 Vapour plume from cooling system at McKay Bay waste-to-energy facility, Tampa, Florida

Table 3.1 Comparison of water use in cooling systems (Asano *et al.*, 1988; Blackson and Moreland, 1988; Burger, 1979; Kemmer, 1988; State of California, 1980; Tay and Chui, 1991)

Type	Application	Water source	Water use
Once-through non-contact cooling	Large power facilities or refineries adjacent to a water source	Fresh, saline, or reclaimed water	75–225 m ³ MWh ⁻¹ . Evaporative consumption: 0.5–2%
Direct contact cooling	Processing of inert material when chemical reaction quenching needed, such as in primary metals industry	Freshwater; degree of purification related to process conditions	Depends on process
Non-contact, open, recirculating cooling	Widely used where water resources are limited and alternative water sources such as reclaimed water are available (such as inland regions)	Fresh, saline, or reclaimed water	0.5–4 m ³ MWh ⁻¹ . Evaporative consumption: 80–95%
Closed recirculating system	Water circulated in closed loop with negligible evaporation or exposure to atmosphere: Used for critical cooling applications	Ultrapure water	Water velocities: 1–1.5 m s ⁻¹ Evaporative consumption: < 5%

cooling system where process heat from the warmed water is transferred to the air via evaporation so that the water can be reused. Process cooling is accomplished through indirect contact of the process streams and cooling water in heat exchangers. Closed recirculating systems consume minimal water, but require higher purity water to prevent operational problems. Therefore, due to the economics of providing supplemental water treatment, closed recirculating systems are only used in cases where cooling efficiency is critical, such as in steel production and microelectronics. Currently, on a global basis, the majority of thermoelectric power plants rely on either once-through cooling or open recirculating cooling systems. The degree of water treatment required for cooling water applications depends on the system. Typically, minimal treatment is required for once-through cooling, whereas scale and corrosion control are needed for open recirculating systems. Closed recirculating systems require control of salts and minerals, similar to requirements for boiler operation.

In once-through processes, heat is transferred to water which is then returned to its source. For once-through cooling systems, the cooling water inlet temperature is the temperature of the source water, whereas the outlet temperature is 5–25°C higher than the inlet. Thus discharge of this water can introduce temperature gradients within the receiving water if inadequate mixing is available. Recirculating systems transfer the heat from the warmed water to the air through evaporation; therefore, outlet temperature and inlet temperatures are similar. As shown in Table 3.1, recirculating systems require less than 10% of the quantity of water used in once-through cooling systems. The reduction in water use has an impact upon the volume of water discharged from the cooling system and results in a net decrease in the quantity of thermal discharges.

3.1.3 Overview of boiler feedwater systems

An integral component of thermoelectric power production is the use of boilers to vapourise water into high-purity steam that is used to drive turbines. The operating pressure of a boiler influences the heat transfer rates, with higher pressures yielding rates of over $21 \text{ kJ m}^{-2} \text{ h}^{-1}$. Materials used for boilers include mild steel, copper alloys (admiralty brass or copper-nickel), or stainless steel (Kemmer, 1988). Cooling water either flows through the tubes (tubeside cooling) or through the shell and around the tubes. The two major types of boiler designs that are in widespread use include firetube and watertube systems. The firetube boilers tend to be used in boilers that generate less than 68 000 of steam per hour, whereas the watertube boilers tend to have a higher output. The overall efficiency of a boiler is related to the effectiveness of contacting water with the source of heat (i.e. coal, gas, oil, etc.).

Firetube boilers consist of a bundle of tubes set into a water drum. Water circulates around the outside of the tubes where it changes to steam and rises to the top of the drum and exits through a steam header. In watertube boilers, water circulates inside the tubes and the flame and hot combustion gases flow across the outside of the tubes. Steam forms on the heated side of the tubes producing a steam-water mixture that is less dense than the water on the unheated sides. Water circulation occurs either through density differentials or is controlled using a pump. The use of mechanical circulation provides more consistent control, particularly at high pressures where the density of steam and water are similar (Kemmer, 1988).

3.1.4 Sources of water used for cooling operations and boiler feedwater

Water used for cooling operations can come from a variety of sources including surface water (streams, lakes, or impoundments), groundwater, seawater, estuarine water, or reclaimed water. In selecting a water source, the major requirement is that an adequate supply of water is available to accomplish cooling. The water quality of the source dictates the need for pre-treatment and the feasibility of recycling the water with or without sidestream treatment. Water quality also influences the economic feasibility of using the water source for boiler feedwater or closed recirculating systems (Baron *et al.*, 2000; Wijesinghe *et al.*, 1996).

Because of the wide range of water sources that can be employed for cooling operations, water quality guidelines have been developed (Crook *et al.*, 1994). A summary of these guidelines is given in Table 3.2 for cooling and boiler water. Water quality guidelines are based on prevention or minimisation of corrosion, scale or fouling. Boiler water quality requirements are more stringent than those for cooling water due to the relatively higher temperature and pressure conditions needed for steam production. In general, boilers that operate under higher temperature and pressure conditions require higher quality feedwater, particularly if the heat source is in direct contact with the tube, as in watertube designs. To prevent operational problems it is important to control the salt content of boiler water, as generally indicated by the conductivity, which then generally

Table 3.2 Water quality guidelines for cooling and boiler feedwater, and water quality associated with estuarine and reclaimed water

Water quality parameter (all as mg l ⁻¹ unless otherwise stated)	Cooling water ^a	Boiler e feedwater ^{a,b}	Estuarine water ^c	Reclaimed water ^d
Conventional parameters				
Alkalinity, mg l ⁻¹ as CaCO ₃	350	40–350	880–140	100–400
Hardness, mg l ⁻¹ as CaCO ₃	600	0.07–350	4300–5800	90–150
pH	6.9–9.0	7–10	7.5–8.6	6.6–7.5
Total dissolved solids	500	200–700	19 000–24 000	400–950
TSS	100	0.5–10	1–50	1–14
Turbidity, NTU	50		1–100	0.5–3
Organics				
C-BOD ₅ ^e	25	1–50	1–30	
COD ^f	75	1–5	5–100	20–80
Nutrients				
Ammonia, mg l ⁻¹ as N	1	0.1	0.1–5	0.2–50
Phosphate, mg l ⁻¹ as P	4		0.1–5	2–60
Dissolved minerals				
Aluminium	0.1	0.01–5	0.008–0.65	< 0.1
Bicarbonate	24	48–170	110–160	20–200
Chloride	500	Variable	13 000–18 000	125–173
Iron	0.5	0.05–1	0.001–0.009	0.9–3
Manganese	0.5	0.01–0.3	< 1	< 1
Silica	50	0.7–30	0.2–2	9–34
Sulphate	200	Variable	1700–2300	50–500

^a Adapted from Crook *et al.* (1994).

^b Range is based on boiler operating pressures.

^c Water quality representative of Tampa Bay, Florida.

^d Water quality representative of wastewater reclamation facilities producing water for irrigation and cooling.

^e Five-day carbonaceous biochemical oxygen demand.

^f Chemical oxygen demand.

determines the operational pressure (Fig. 3.3). Under low pressures, boilers can tolerate conductivity levels over 5000 $\mu\text{S cm}^{-1}$. However, as the operating pressure increases, the salt concentration becomes more critical. Thus, system design is based on the composition of the water available for use as boiler water.

Other critical water quality components for boiler water include alkalinity, silica, iron, manganese and copper (Fig. 3.4). Two operational problems are associated with high levels of alkalinity. As the water temperature increases, carbon dioxide is released increasing the potential for corrosion. In addition, carbonates can contribute to foaming that leads to deposits in the superheater, reheater and/or turbines (Puckorius, 1997; Troscinski and Watson, 1970; Vanderpool, 2001).

3.1.5 Water quality comparisons

For the purpose of comparison, water quality characteristics of estuarine water and reclaimed water are included in Table 3.2. Water quality associated with

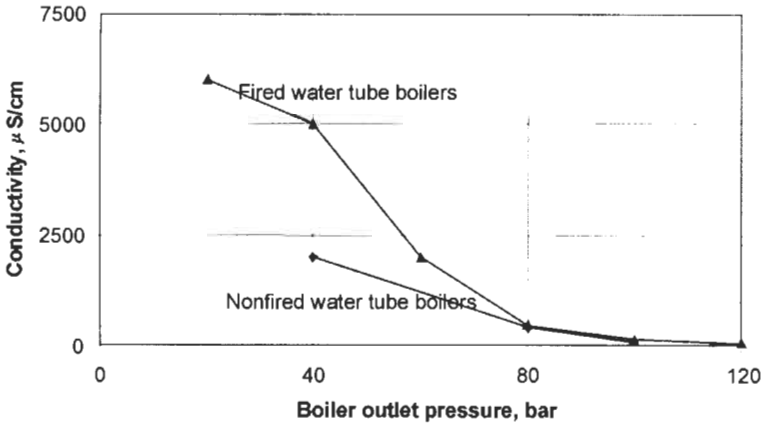

Figure 3.3 Influence of boiler outlet pressure and type of boiler on recommended limits of conductivity in boiler feedwater

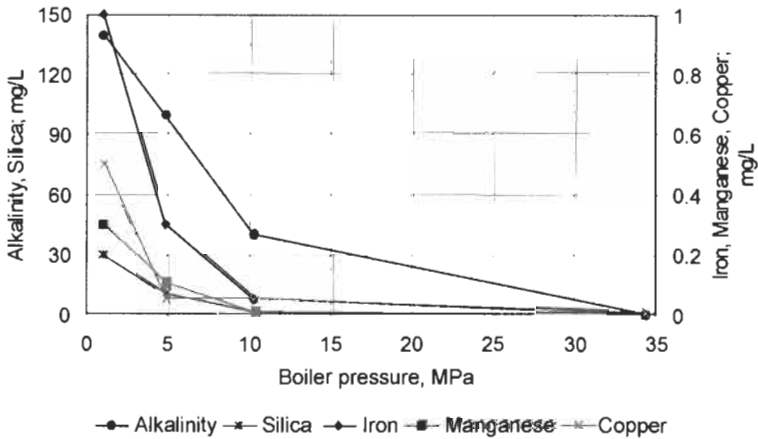

Figure 3.4 Influence of boiler outlet pressure on recommended limits of alkalinity, silica, iron, manganese, and copper in boiler feedwater

freshwater sources, such as surface water or groundwater, is dependent on the local geohydrology, but would normally be similar to reclaimed water. As shown, there are differences in the content of nutrients, organics, and salts among the water sources. Seawater has higher levels of dissolved minerals than estuarine water.

The suitability of a water source for use in recirculating water systems as compared to once-through non-contact cooling is related to water quality and water availability. High levels of dissolved minerals and/or can demand additional treatment to prevent scale formation. For example, cooling systems that rely on estuarine or seawater tend to be non-recirculating, unless it is economical to provide on-site treatment for control of dissolved solids.

Typically, when reclaimed water is considered as a water source for cooling water, alternative sources such as surface water, groundwater, estuarine, or seawater may also be available locally. Thus the incentives for using reclaimed water are specific to the situation. When reclaimed water is used in lieu of surface or groundwater, the higher quality water sources can be preserved for other applications, such as drinking water. On the other hand, when reclaimed water is used in lieu of estuarine or seawater the impetus is usually related to discharge limitations.

Depending on the water source, water quality can vary seasonally. Groundwater tends to have fairly consistent characteristics, whereas the quality of surface water, estuarine water, seawater, and reclaimed water can be influenced by patterns of rainfall, runoff and evaporation, leading to significant seasonal variations in oxygen demand and suspended material (Fig. 3.5), nutrient levels (Fig. 3.6) and chloride (Fig. 3.7). Although water quality is source specific, the variation in wastewater characteristics and treatment alternatives means that similar trends arise with all reclaimed water sources.

Levels of dissolved minerals associated with estuarine water are shown for sodium and chloride in Fig. 3.8 and for calcium, magnesium, potassium, and sulphate in Fig. 3.9. Dissolved solids levels in estuarine waters are almost two orders of magnitude higher and sulphate and magnesium levels one order of magnitude higher than those levels associated with freshwater or reclaimed water. Typically, the mineral content of seawater can be two- to three-fold higher than that associated with estuarine waters. These water quality characteristics influence the extent of treatment required to allow for use of recirculating systems.

Another characteristic of reclaimed water that is different from fresh or saline water sources is the potential presence of a disinfectant residual. Reclaimed water is treated to meet requirements pertaining to microbiological safety. As such, disinfection is a key component of the treatment system. When chlorine is used for this duty, residual chlorine is usually present in the reclaimed

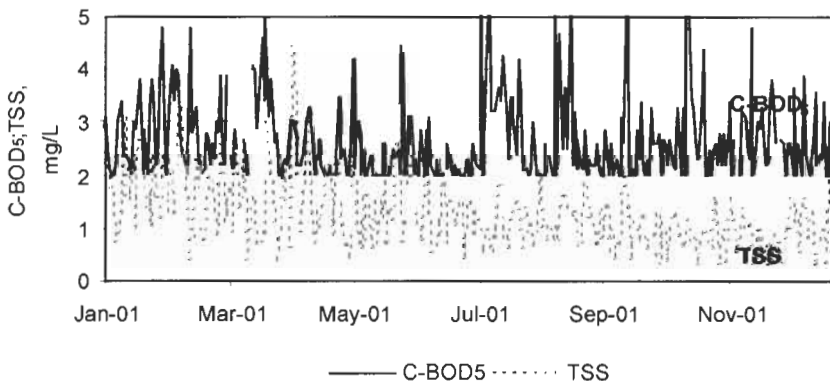

Figure 3.5 Seasonal variations in five-day carbonaceous biochemical oxygen demand (C-BOD₅) and suspended solids (TSS) for a reclaimed water (data from St. Petersburg, Florida)

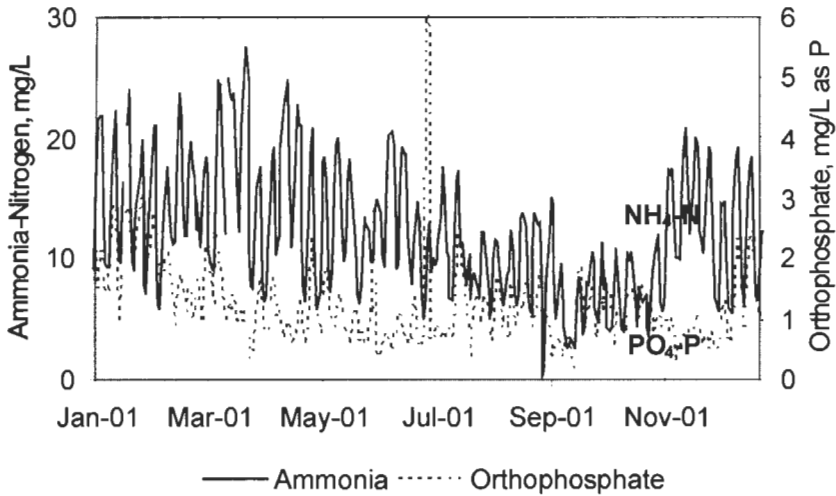

Figure 3.6 Seasonal variations in ammonia ($\text{NH}_4\text{-N}$) and orthophosphate ($\text{PO}_4\text{-P}$) for a reclaimed water without nutrient removal (data from St. Petersburg, Florida)

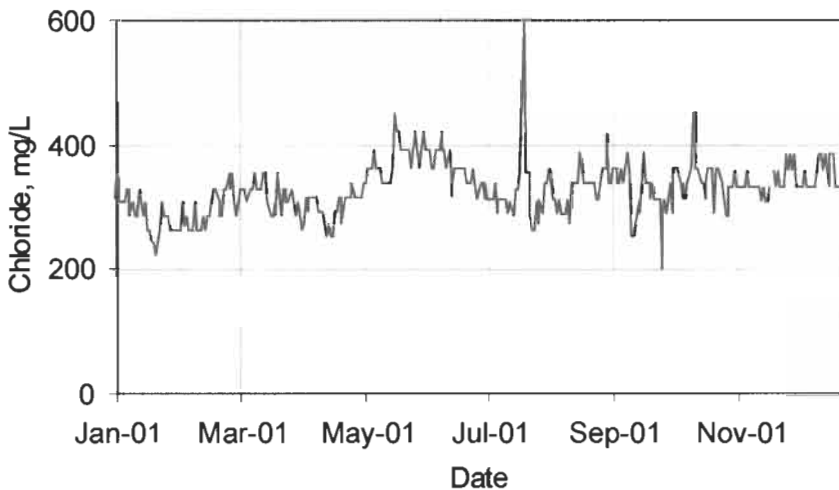

Figure 3.7 Seasonal variations in chloride levels for a reclaimed water (data from St. Petersburg, Florida)

water. For cooling water applications, the presence of this residual disinfectant can act as a biocide and help to prevent biological fouling of the cooling system. There is also little seasonal variation in total residual chlorine (Fig. 3.10), provided chlorine is automatically dosed on demand through feedback control. Chlorine levels associated with reclaimed water thus depend on the operating practices of a given facility and, therefore, may differ from the trends shown in Fig. 3.10. In cases where disinfection is accomplished using ultraviolet (UV) irradiation or ozonation, residual disinfectants will not be present in the reclaimed water (Levine *et al.*, 2002).

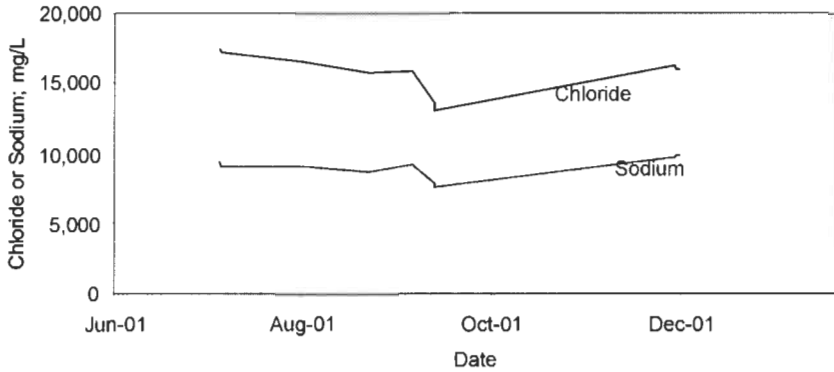

Figure 3.8 Comparison of chloride and sodium levels in estuarine water (data from Tampa Bay, Florida)

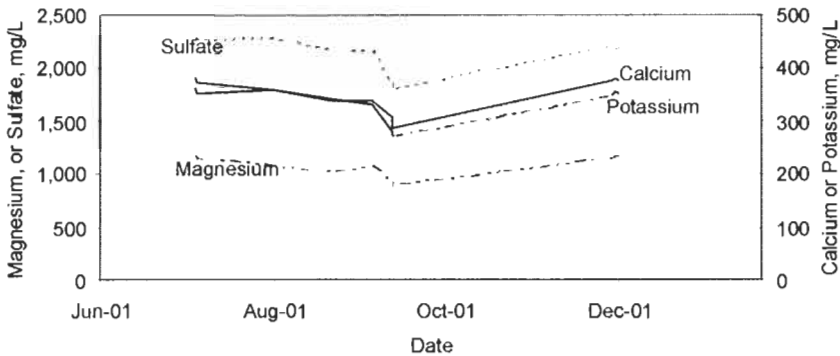

Figure 3.9 Comparison of calcium, magnesium, potassium, and sulphate levels in estuarine water (data from Tampa Bay, Florida)

3.1.6 Optimisation of water use in recirculating cooling systems

Optimisation of water use in recirculating cooling towers is based on the quality of water entering and leaving the system. As water evaporates, dissolved constituents and salts become more concentrated in the liquid stream. The water quality of the recirculating stream must be controlled to prevent operational problems such as development of deposits on heat exchanger surfaces (scaling), corrosion, or biological fouling. To control the quality of the recirculating stream, water is removed as blowdown water, and to compensate for loss of water through blowdown, evaporation and drift water is added to the recirculating stream as make-up water (Table 3.3). Drift occurs when the water droplets become entrained in the discharge air stream; evaporation is from air passing through the cooling water and absorbing heat and mass; blowdown is the imposed bleed-off of water to reduce the concentration of contaminants. Continuous blowdown is the continuous removal of water, whereas intermittent blowdown is initiated manually or by feedback based on water quality. These same concepts apply to management of water quality for boiler systems (Asano *et al.*, 1988, Burger, 1979; Kemmer, 1988; Puckorius and Hess, 1991).

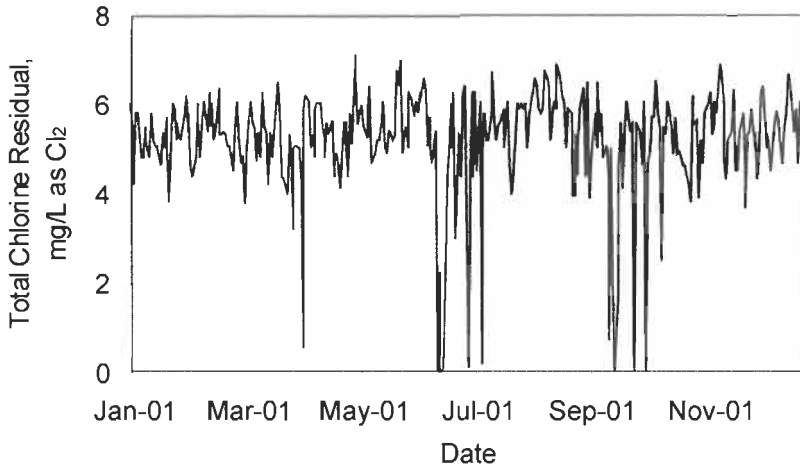

Figure 3.10 Seasonal variations in reclaimed water chlorine residuals (data from St. Petersburg, Florida)

To operate recirculating systems efficiently, it is important to prevent deposition (scaling) or fouling within the tower or heat exchangers. Water quality characteristics relating to mineral precipitation include calcium, magnesium, sulphate, phosphate, silica, pH, and alkalinity. As water evaporates, the concentration of dissolved constituents increases to the point where the solubility limit of mineral precipitates is exceeded within the recirculating water, particularly for carbonate scales at elevated temperatures. The solubility of mineral precipitates can be controlled by manipulating the pH of the recirculating water, addition of scale-control chemicals, and/or replacement of a portion of the recirculating water with less concentrated water. The considerations are thus identical to those of the operation of reverse osmosis plant (Section 2.4.3).

The quantity of water that must be removed as blowdown water can be calculated from a mass balance. The ratio of the concentration of a constituent in water to its concentration in the make-up water is called the cycles of concentration or concentration ratio, R_C , where:

$$R_C = C_b/C_m \quad (3.1)$$

From an operations and water conservation perspective, it is desirable to have as high a R_C value as possible. In general, the optimum R_C is based on the chemical composition of the water and the solubility of the dissolved minerals. In some cases the R_C is limited by calcium precipitation, such as calcium sulphate or phosphate. In other cases R_C is limited by silica, magnesium, or other minerals. Thus, the characteristics of the make-up or source water can influence the maximum feasible R_C . Once the R_C is determined, it can be used to determine the required make-up flow:

Table 3.3 Summary of terms used to define flows through recirculating cooling towers

Flow component	Definition	Flow rate, $\text{m}^3 \text{h}^{-1}$	Concentration of dissolved constituent(s), mg l^{-1}
Recirculating water	Flow rate of water that is recirculating in tower	Q_R	C_R
Blowdown	Flow rate of water deliberately removed from system to limit salt build-up	Q_b	$C_b = C_R$
Evaporation	Water lost to atmosphere due to evaporation: $\sim 2\%$ of recirculating water flow per 10°C temperature drop	$Q_e = Q_T \Delta T / 700$	$C_e = 0$
Drift	Water lost due to entrainment in wind. When salt or brackish water is used, drift may contain high concentrations of salts and/or minerals that can deposit on crops, soils, or structures	$Q_d \sim 0.2\%$ for old units; $Q_d < 0.005\%$ for efficient designs	$C_d = C_R$
Make-up water	Flow rate of water added to flow stream to replace water by evaporation, drift and blowdown	$Q_m = Q_e + Q_d + Q_b + Q_l$	$C_m = C_{\text{source water}}$
Other losses	Losses of water due to leaks	Q_l	$C_l = C_R$
System capacity	Total volume of water in system	V	
Temperature differential	Difference between average water temperature following evaporation and average water temperature returning to tower	$\Delta T = T_{\text{inflow}} - T_{\text{return}}, ^\circ\text{C}$	
Cycle time	Time required for water to travel around circulating loop	$t_c = V / Q_R$	
Holding time index	The half-life of chemicals added to the system	$t_{1/2} = (\ln 2) \times V \times (R_C - 1) / E$	

$$Q_m = R_C \times Q_b \quad (3.2)$$

The extent of recirculation can be increased by using chemical treatments either to adjust the pH of the water or to sequester minerals and prevent deposition, in the same way as reagents are used to ameliorate scaling in reverse osmosis plant (Table 2.15). In most cases, the R_C is optimised based on water availability, water quality, and treatment costs. Typically, evaporative recirculating cooling towers that use reclaimed water operate with R_C values ranging from 1 to 3. An advantage of higher R_C values is that reduced quantities of make-up water are required and there is less blowdown water to be treated or discharged. It should be noted that the concentration of dissolved constituents in the blowdown water increases with increasing R_C . Therefore, one trade-off associated with higher R_C levels is the increasing costs of disposal or treatment of the blowdown water.

The impact of recirculation on water quality in a recirculating cooling system using reclaimed water as a source water is shown in Fig. 3.11. This system is operated with a R_C of about 2. A comparison of the conductivity of the source water to that of the recirculating stream reveals that the concentration of dissolved solids increases about two-fold in this system. When blowdown water is removed from this system it is returned to the wastewater reclamation facility. Higher R_C values for this source would yield a blowdown water with a higher salt content that might preclude discharge to the wastewater reclamation facility.

3.1.7 Cooling tower water quality issues

Industrial cooling tower operations are susceptible to four potential water quality problems: (1) scaling, (2) biological growth, (3) fouling of the heat

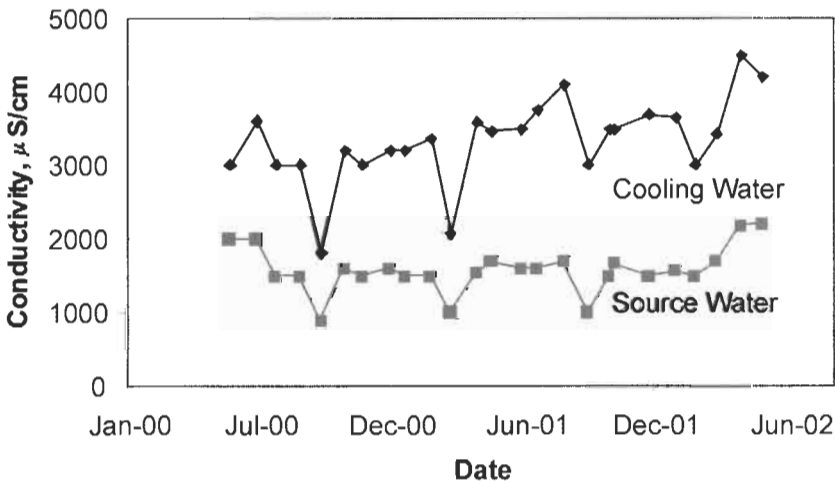

Figure 3.11 Comparison of the conductivity of source water and recirculated water for a cooling system operated by Raytheon Corporation in St. Petersburg, Florida (Knighton, 2002)

exchangers and condensers and (4) metallic corrosion. These water quality problems can result from any water source (fresh, reclaimed, or salt) unless appropriate preventive measures are incorporated into the cooling water system. Definitions of each cooling water quality issue are given below. Chemicals such as chlorine and chelating agents are added to prevent biofouling and inhibit mineral build-up. As the water volume is reduced through evaporation and drift, the concentration of these chemicals and their by-products increases. Cooling towers can also contain chemicals from the ambient air.

Scaling

Scaling refers to the formation of mineral deposits, usually on hot surfaces, which can compromise heat exchanger efficiency. As with dense membrane processes, calcium deposits (calcium carbonate, calcium sulphate and calcium phosphate) are the predominant form of scale. Such deposits are somewhat heterogeneous in nature (Fig. 3.12) and their accumulation on the surfaces of heat exchangers can reduce the heat transfer efficiency, causing overheating of metal and, ultimately, boiler tube failure. In addition, the presence of deposits can provide habitats for the growth of microorganisms within the cooling system. Magnesium scales (magnesium carbonate and phosphate) can cause a similar problem. Silica scales are particularly problematic, since silica is largely insoluble and forms very tenacious deposits. Silica can volatilise at the high temperatures of boiler systems and become entrained in the steam (Dyson, 2001; Troscinski and Watson, 1970; Vanderpool, 2001). As the steam cools within the turbine, the silica can crystallise on the turbine nozzles or blades leading to increased frictional resistance and reduced steam velocities. Because the deposits are not uniformly distributed, the turbine rotors become imbalanced and produce excessive vibrations.

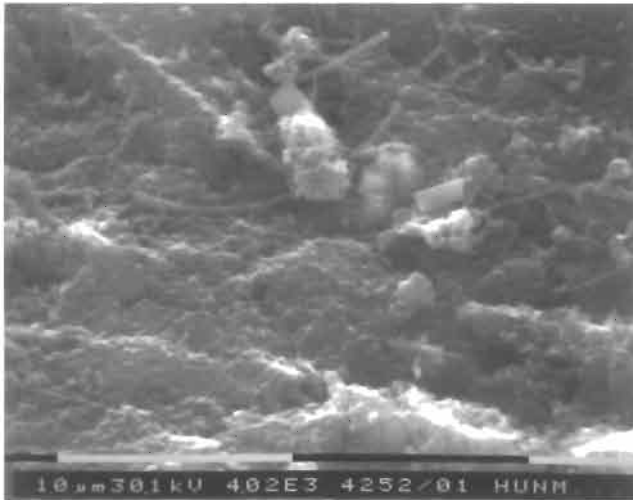

Figure 3.12 Electron micrograph of calcium deposit from cooling tower operations. The length of the white bar represents 10 μm

Scale composition depends on the relative mineral content of the recirculating stream. A summary of solubility constants associated with common mineral precipitates has been presented in Table 2.14. While the chemical content of each system has been a function of the source water and the R_C , it is possible to apply chemical equilibrium models, such as Argo Analyser (Fig. 4.7) to evaluate the potential for scale formation. As a first approximation, the solubility relationships can be used to identify the chemical constituents that are likely to form deposits. Typically, when reclaimed water is used as a source water, the first calcium salt to precipitate is calcium phosphate unless the water has been pre-treated for phosphorus removal.

Scale control can be accomplished through chemical precipitation followed by solids removal (sedimentation, filtration, etc.) to reduce the concentration of minerals in the recirculating stream. Chemicals used to promote upstream precipitation include lime, caustic soda, alum, and various formulations of organic or inorganic polymers. Acidification or addition of scale inhibitors can control scaling by increasing the solubility of minerals in the recirculating stream. Phosphate specifically can be removed biologically, and multivalent ions may be removed by ion exchange.

The solubility of mineral precipitates that form from hydroxides, phosphates, or carbonates typically increases with decreasing pH. To prevent scale formation, the pH of the water is reduced to about 7 using sulphuric acid. The additional sulphate and lower pII convert calcium and magnesium carbonates into more soluble sulphate compounds. It is important to control the amount of acid added to maintain some residual alkalinity in the system, since excess acid can cause accelerated corrosion. Acids used to control pH of the recirculating stream include sulphuric, hydrochloric, and citric acids. Alternatively gases can be used to acidify the water such as carbon or sulphur dioxide. Chemical chelators such as ethylenediamine tetraacetic acid (EDTA) and polymeric inorganic phosphates can also be added, often in-line (Fig. 3.13), to increase the solubility of scale forming constituents.

Biological growth

The warm, moist environment in cooling towers coupled with the availability of nitrogen, phosphorus, and organics provides an ideal environment for microbial growth. Typically, microbial growth results in biofilm formation and fouling, in which microbial products encourage the attachment and growth of heterogeneous deposits containing both microorganisms and inert materials, on heat exchanger surfaces. These biofilms then interfere with heat transfer and water flow. During extended operating periods, portions of the biofilm slough off of the surface. This microbial biomass contains particles and other debris that can settle, further inhibiting effective heat transfer. Some types of microorganisms release corrosive by-products during their growth such as organic acids (e.g. acetic) or inorganic acids (e.g. hydrogen sulphide) leading to microbially induced corrosion (MIC), a phenomenon exacerbated by standing water conditions.

Bacteria that may be present in cooling water include *Pseudomonas*, *Klebsiella*, *Enterobacter*, *Acinetobacter*, *Bacillus*, *Aeromonas*, and *Legionella* (Adams *et al.*,



Figure 3.13 In-line addition of sulphuric acid to a recirculating cooling system in St. Petersburg, Florida

1978; Wiatr, 2002). Once a biofilm forms, it provides a protective habitat for microorganisms (Fig. 3.14). Biocides can be used to control biofilms as part of the internal chemical treatment process, the type and required dosage depending on the organic and nutrient content of the make-up water. The most commonly used biocide is chlorine, though other chemical approaches are also effective. Ozone is a powerful biocide effective for control of bacteria, viruses, and protozoa, but can exacerbate problems of scale adhesion since by-products from the oxidation of biofilms can serve as binding agents for scale on heat exchanger surfaces.

When reclaimed water is used for cooling, the assurance of adequate disinfection is a primary concern to protect the health of workers and individuals exposed to aerosols from the cooling towers. The disinfection requirements for the use of reclaimed water in cooling towers are site specific and based on the potential for exposure to aerosols from cooling operations and prevention of biofilm growth. Limited data are available on relative quantities of microorganisms in recirculating cooling systems. Pathogen survival depends on the source water quality, pretreatment mechanisms, and the type and dosages of biocides used in the facility (Levine *et al.*, 2002). While there are no universal standards, the most frequently monitored bacteria include total and faecal coliforms and *Legionella pneumophila*. Typically disease outbreaks are associated with levels over 1000 cfu (colony forming units) per ml in cooling towers. A comparison of the levels of *Legionella pneumophila* in recirculated cooling water is shown in Fig. 3.15. This facility uses a pro-active approach by conducting quarterly monitoring. Typical values range from non-detectable to 300 cfu ml⁻¹. Monitoring can provide insight into the effectiveness of disinfection practices.

Water velocities below 0.3 m s⁻¹ and temperatures over 50°C tend to promote biofilm formation and the associated fouling reactions. Control of fouling is

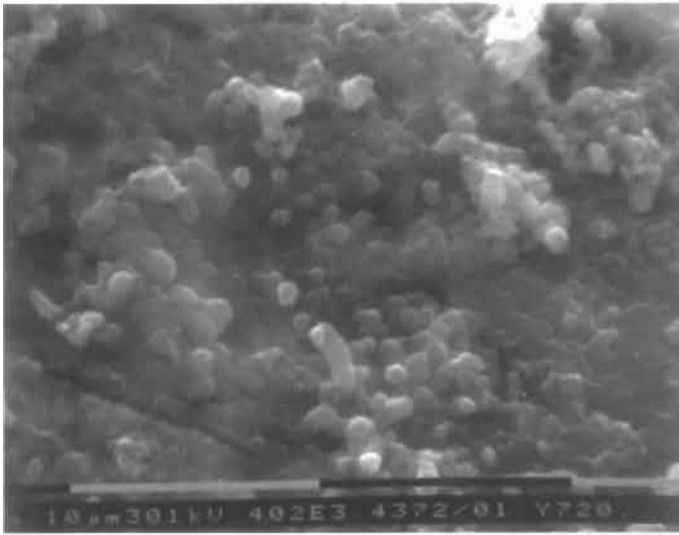

Figure 3.14 Electron micrograph of biofilm structure. The length of the white bar represents 10 μm

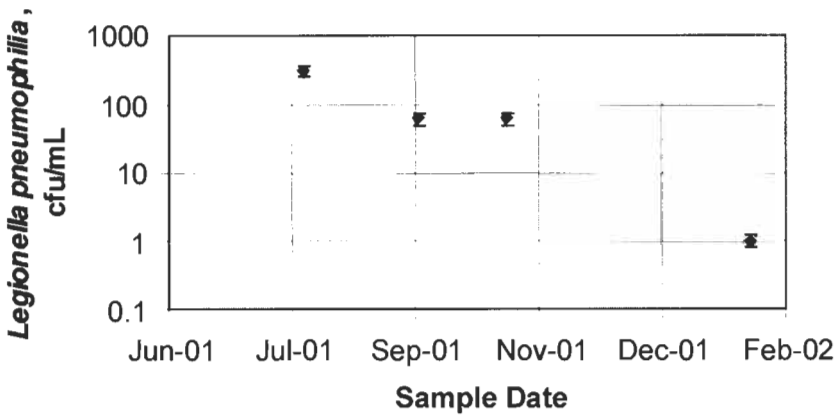

Figure 3.15 Seasonal variations in *Legionella pneumophila* in cooling water (data from Raytheon Corporation in St. Petersburg, Florida)

achieved by the addition of chemical dispersants to prevent particles from aggregating and subsequently settling. Also, a secondary benefit of chemical coagulation and filtration processes is the removal of some contaminants that contribute to fouling.

The critical part played by biofouling in determining wastewater reuse capability has been recognised in extensive studies carried out in Grangemouth, Scotland (Glen, 2002). Grangemouth is one of the largest industrial complexes in the UK, with major petrochemical industries concentrated in a small area. Water consumption is 26 million m^3 per year, costing business around \$24 m per annum at (2002 dollars), with one of the main uses being for heat exchange

systems. To assess fouling propensity of possible feedwater sources the National Engineering Laboratory based at Grangemouth have developed device for assessing biofilm formation through thermal resistance measurements. Results so far have revealed fouling rates of recovered municipal effluent to be generally higher than other sources, such as canal water, and highly dependent on flow velocity. On the other hand, examples exist of employing membrane treatment for the production of boiler feedwater from secondary municipal effluent (Section 5.1).

Metallic corrosion

In cooling systems, corrosion can occur when an electrical potential between dissimilar metal surfaces is created. The corrosion cell consists of an anode, where oxidation of one metal occurs, and a cathode, where reduction of another metal takes place. The presence of dissolved minerals can accelerate the corrosion reaction. Dissolved oxygen and certain metals (manganese, iron, and aluminium), which can arise in cooling intakes depending on the water source (Salvito *et al.*, 2001), promote corrosion because of their relatively high oxidation potentials.

Mild steel and copper alloys are used extensively in heat exchanger systems due to their excellent heat transfer capabilities. However, the build-up of minerals in cooling water tends to be aggressive towards these materials. Analysis of corrosion is complex due to the interplay of water quality variables that can either induce or prevent corrosion. A summary of water quality determinants significant for corrosion control is given in Table 3.4. The corrosion potential of cooling water can be controlled by the addition of chemical corrosion inhibitors. The concentration of chemicals in the recirculating stream, increases with increasing R_C and may require removal from blowdown water prior to discharge.

3.1.8 Governing legislation and guidelines

Regulatory requirements and industrial guidelines relating to the use of water for cooling and boiler applications are fairly localised. In the USA regulatory requirements address water intake structures, air emissions, and discharge of blowdown water. Currently, under Section 316(b) of the Clean Water Act, it has been proposed to implement more stringent protection measures at water intake structures to protect fish, shellfish, and other aquatic life (USEPA, 2002a). This proposed regulation could lead to the need for retrofitting of once-through cooling water intakes and ultimately lead to increased use of recirculating systems.

Airborne emissions from coal-fired power plants and waste-to-energy facilities are a subject of increasing scrutiny in urban environments. Increased emissions control requirements coupled with uncertainties about the long-term availability of fossil fuels may result in changes in the distribution of energy sources. As coal-fired plants are displaced by alternative fuels, changes will also occur in the quantities of cooling water required. It has been estimated that conversion from coal-fired power plants to alternative fuels could reduce evaporative consumption by 25% (Powicki, 2002).

Table 3.4 Water quality variables of importance for controlling corrosion

Parameter, optimum range	Rationale
Alkalinity, consistency	Variations in concentration can influence formation of metal carbonate complexes and result in increased metal release.
Ammonia, 0 mg l ⁻¹	Can complex with metals, increasing solubility and metal release, and can also promote biological growth and biocorrosion. Corrosive to copper alloys causing metal loss and stress corrosion cracking at levels greater than 2 mg l ⁻¹ as N. Reduces effectiveness of chlorine through chloramine formation. Increases with cycles of concentration.
Calcium, consistency	Can form calcite on pipe walls, possibly preventing corrosion. Variations in water quality promotes dissolution of scales and thus metal release.
Chloride, consistency	Can increase corrosion rates under conditions of low dissolved oxygen. Can form complexes with metals increasing solubility and metal release. Influences corrosion of most metals including mild steel, copper, stainless steel. Chlorides over 200 mg l ⁻¹ can cause stress corrosion cracking and/or pitting corrosion.
Dissolved oxygen, consistency	Can serve as an electron acceptor for corrosion reactions. However it also reacts to form protective oxide layers that prevent corrosion. Localized differences can promote corrosion.
Iron, consistency	Can combine with phosphate and can also deactivate polymers used to inhibit calcium phosphate scaling.
Magnesium, consistency	Can interfere with deposition of calcium complexes on pipe wall.
Organic carbon (TOC), consistency	Can coat pipe surfaces and prevent metal release. It can also form metal complexes and increase metal release and can promote biological growth and biocorrosion.
Orthophosphate, 0.5–5 mg l ⁻¹ as PO ₄	Can form a passivating layer on the internal surface of heat exchangers.
pH, 7.3–7.8 pH units	Acidity increases metal solubility and promotes CO ₂ liberation from alkalinity. pH may be locally higher at pipe surface due to OH ⁻ generation.
Silica, below 150 ppm	Can act to passivate surfaces, depending on the concentration, thus decreasing the potential for metal release. Total silica refers to colloidal and ionic silica in water. Polymeric silica is non-reactive but it can revert to silica monomers after heating in boiler water.
Sulphate, consistency	Can interfere with formation of some scales, thus increasing the potential for metal release.
Temperature, consistency	Corrosion rates increase with increasing temperature. Influences solubility, rates of microbiological activity, water density and associated mixing efficiency.

3.1.9 Volumes and quality of aqueous process waste streams

Aqueous process waste streams include blowdown water from cooling operations and boilers. The quantity of water generated is related to operational variables including the source of the make-up water and the cycles of

concentration. Treatment requirements depend on discharge requirements or incentives for reuse of the water. Typically discharge standards are based on pH, temperature, C-BOD₅, TSS, toxic substances, and dissolved solids.

Several approaches are used for treatment of water associated with thermoelectric power generation depending on the source of the cooling and boiler water, the type of cooling system, and the discharge requirements. The characteristics of the water used for make-up dictate the need for supplemental treatment. Only minimal levels of treatment are normally required for once-through cooling systems. The main water quality objective is to prevent scaling, corrosion or fouling. Because of the relatively short contact time and relatively low temperatures, effective cooling can be accomplished using chemical amendments to act as corrosion and scale inhibitors. One of the factors limiting the use of chemical amendments for once-through systems is that the water is typically discharged back to the environment. Thus, the type of chemicals that are used must meet local water quality requirements for discharges (Piller and Coupe, 2001).

Recirculating systems are more vulnerable to scaling, corrosion and fouling due to accumulation of solutes. Thus, treatment objectives are targeted at reducing the mineral, nutrient, and/or organic content of the make-up water. Management practices for the blowdown water include discharge to a wastewater reclamation facility, blending with other waste streams, or treatment either to recover the water for reuse or to meet discharge requirements through the use of various biological and physicochemical processes (Table 3.5). Historically, the predominant treatment systems have been chemical-based treatments including lime softening and chemical precipitation using metal salts. Recently, the use of ion exchange, membrane systems, and thermal processes has become more cost-competitive. The new generation of treatment technologies, largely membrane based, have the advantage of producing a high-quality product water that can be reused for duties such as boiler feedwater (Sections 5.1 and 5.2). Disposal of brines and waste streams arising from these processes remains a challenge, however, and if zero liquid discharge is demanded recourse is inevitably made to evaporation, sometimes preceded by electrodialysis (Section 5.3).

3.1.10 Current reuse practices and opportunities

The extent to which reclaimed water is used for cooling water and boiler water applications depends on several factors. Firstly, the reclaimed water source must be within a practical distance from the industrial, ideally less than 50 km. Secondly, economic and environmental factors should be favourable for the use of reclaimed water. The key issues are the relative availability/scarcity of alternative sources of cooling water. In addition to the need for water, when the use of once-through cooling is limited by regulatory or discharge requirements reclaimed water can become a viable alternative. To date, the use of reclaimed water is fairly well accepted throughout the world, and some examples are summarised in Table 3.6.

Table 3.5 Treatment options for controlling salts and nutrients in make-up and blowdown water

Treatment goal(s)	Treatment approach	Description	Treatment application			Limitations
			Cooling tower make-up water	Blowdown water	Boiler make-up water	
Reduce scale-forming potential, remove phosphorus, increase pH	Lime softening	Use of lime to precipitate cations, metals, and phosphorus from solution	X	X		Chloride and sulphate ion pairs can limit precipitation of calcium carbonate. Sludge requires treatment/disposal Need source of heat. Sludge requires treatment/disposal Not effective in high salt conditions
	Hot process softening	Use of lime and soda ash under elevated temperature conditions	X	X		
Removal/conversion of nitrogen; removal of phosphorus	Biological nutrient removal	Combination of aerobic, anoxic, and anaerobic processes to optimise conversion of organic and ammonia nitrogen to molecular nitrogen (N ₂) and removal of phosphorus	X			Sludge requires disposal/treatment
	Coagulation and precipitation	Use of aluminium or iron salts to promote precipitation of phosphorus	X			
Removal of calcium, magnesium, iron, ammonium, nitrate, and other dissolved ions	Ion exchange	Exchange of ions between an exchange resin and water using a flow-through reactor	X	X	X	Regenerant requires disposal
	Electrodialysis reversal (Section 2.4.2)	Membrane-based process using an electric field to separate ionic constituents across alternating anion-selective and cation-semi-permeable membranes		X	X	Requires conductivity > 4000 mS cm ⁻¹ . Not effective for non-ionised species such as silica, ammonia, and carbon dioxide

Table 3.5 (continued)

Treatment goal(s)	Treatment approach	Description	Treatment application			Limitations
			Cooling tower make-up water	Blowdown water	Boiler make-up water	
Removal of dissolved solids, organics, pathogens	Reverse osmosis	Membrane system to separate ions from solution based on reversing osmotic pressure differentials		X	X	Potential for fouling of RO membranes. Brine requires treatment/disposal
	Nanofiltration and ultrafiltration	Pressure-driven membrane processes to remove constituents based on charge and molecular size		X	X	Potential for fouling of membranes. Reject stream requires treatment/disposal

Table 3.6 Examples of the use of reclaimed water for cooling or boiler applications

Facility (Reference)	Application	Method	Water (Power) offset
Palo Verde nuclear power plant, Arizona (Blackson and Moreland, 1998)	Cooling water for 3800 MW nuclear power plant using nitrified reclaimed water with supplemental chemical treatment: softening, phosphorus removal, pH adjustment, and chlorination	Recirculating cooling towers with 18–23 cycles of concentration; zero liquid discharge; evaporation ponds for blowdown water	> 250 000 m ³ d ⁻¹
Chevron Oil Refinery, Oakland, California (Puckorius, 1997)	Refinery cooling water using reclaimed water with supplemental lime treatment, filtration, and disinfection	Recirculating cooling tower	17 000 m ³ d ⁻¹
Lockheed-Martin Electronics operation, Ocala, Florida	Cooling water for production of electronics assemblies and secondary cooling of HVAC using manufacturing process wastewater treated with hydrogen peroxide and ozone	Counter current cooling towers	6800 m ³ d ⁻¹
Bergen generating facility, Bergen County, New Jersey (Puckorius, 1997)	Cooling water for 625 MW thermoelectric power plant using reclaimed water treated with biocide, acid, and polymer	Recirculation cooling; blowdown discharged to sanitary sewer	5400 m ³ d ⁻¹
City of Tampa waste-to-energy facility, Tampa, Florida	22 MW facility. Processes 1000 tons per day	Two cell recirculating evaporative cooling tower. Blowdown water is discharged to wastewater treatment plant	2200 m ³ d ⁻¹
Oil refinery, Singapore	Oil refinery using reclaimed water treated with acid, scale inhibitor, dispersant, and corrosion inhibitors	Once-through cooling of 32 water-cooled pumps and two recirculating cooling towers	1600 m ³ d ⁻¹
Flag Fen, UK	Dual membrane MF: 28 modules, 0.1 µm pore size; RO: 4:2 array; 80% recovery	Boiler feedwater using polished municipal	1200 m ³ d ⁻¹

Table 3.6 (continued)

Facility (Reference)	Application	Method	Water (Power) offset
Guadalupe power plant, Guadalupe County, Texas (Prato <i>et al.</i> , 2001)	Natural gas, 1000 MW. Make-up water treated by softening; blowdown treated by evaporation, crystallization and EDI to produce boiler feedwater	Recirculating cooling tower	820 m ³ d ⁻¹
Raytheon Corporation, St. Petersburg, Florida	Air conditioning cooling towers	Three recirculating cooling towers	500 m ³ d ⁻¹
PECO Energy nuclear generating station, Limerick, Pennsylvania (PECO, 2002)	Cooling water for 1200 MW nuclear power plant	Recirculation cooling system with 3–6 cycles of concentrations	(0.85 m ³ MWh ⁻¹)
International Microelectronics, North San Jose, California (USEPA, 2002b)	Water used to cool equipment for microelectronics manufacture	Closed loop cooling system with circulating chilled	18–28 m ³ d ⁻¹

It is evident that as membrane technologies advance and the efficiency of removing salts and other impurities from water increases, the use of reclaimed water for cooling and boiler applications will increase. A promising opportunity is the development of cost-effective treatment systems for treatment of blowdown water from cooling and boiler applications to produce high-quality water for make-up water or other applications. Three case studies relating to power plants are detailed in Sections 5.1–5.3.

References

Adams, A.P., Garbett, M., Rees, H.B. and Lewis, B.G. (1978). Bacterial aerosols from cooling towers. *J. Water Pollution Control Federation*, **50**, 2362–2369.

Asano, T. and Levine, A.D. (1998). Wastewater reclamation, recycling, and reuse: an introduction. In Asano, T. (ed.) *Wastewater reclamation and reuse*. Technomic, Lancaster, Basel, pp. 1–56.

Asano, T., Mujeriego, R. and Parker, J.D. (1988). Evaluation of industrial cooling systems using reclaimed municipal wastewater. *Water Sci. Technol.*, **20**, 163–174.

Baron, C., Equihua, L.O. and Mestre, J.P. (2000). B.O.O. case: water management project for the use of reclaimed wastewater and desalted seawater for the Antonio Dovali Jaime refinery, Salina Cruz, Oaxaca, Mexico. *Water Sci. Technol.*, **24**, 29–36.

Blackson, D.E. and Moreland, J.L. (1998). Wastewater reclamation and reuse for cooling towers at the Palo Verde nuclear generating station. In Asano, T. (ed.) *Wastewater reclamation and reuse*. Technomic, Lancaster, Basel, pp. 1143–1162.

Burger, R. (1979). *Cooling tower technology: maintenance, upgrading and rebuilding*. Cooling Tower Institute, Houston, TX.

Crook, J., Okum, D.A., Pincince, A.B. and McKee, I. (1994). *Water reuse*, Project no. 92-WRE-1. Water Environment Research Foundation.

Dyson, M. (2001). How can colloidal silica and TOC reduction increase the lifecycle of power stations? *Power*, November, 41–46.

Glen, N. (2002). Industrial water reuse experience at Grangemouth. *Proc. 2nd International Conference on Industrial Wastewater Recovery and Reuse (IWRR2)*, Cranfield, pp. 1–12.

Kemmer, F.N. (1988). *The Nalco water handbook*. McGraw-Hill, New York.

Knighton, J. (2002). *Personnel communication*. Raytheon Corporation.

Levine, A.D., McLaughlin, M.R., Rose, J.B., Chivukula, V. and Harwood, V.J. (2002). Factors influencing pathogen removal in wastewater reclamation and reuse facilities. *Disinfection 2002*, Water Environment Federation, paper 5B.

Piller, D. and Coupe, D. (2001). Cooling water: environmental and economic benefits from using a yellow metal corrosion inhibitor. *Ultrapure Water*, November, 33–40.

Powicki, C.R. (2002). The water imperative: quantifying the relations. *EPRI Journal*, July.

Prato, T., Muller, R. and Alvarez, F. (2001). EDI applications in polishing evaporator product water at a Texas power plant, pp. 48–51.

Puckorius, P.R. (1997) Monitoring requirements for refinery cooling system reuse water, MP, May, 42–47.

Puckorius, P.R. and Hess, R.T. (1991) Wastewater reuse for industrial cooling water systems. *Industrial Water Treatment*, **23**(5), 43–48.

Salvito, D.T., Allen, H.E., Parkhurst, B.R. and Warren-Hicks, W.J. (2001). Comparison of trace metals in the intake and discharge water of power plants using clean techniques. *Water Environment Research*, **73**(1), 24–29.

Solley, W.B., Pierce, R.R. and Perlman, H.A. (1998). Estimated use of water in the United States in 1995, US Geological Survey Circular 1200. US Government Printing Office.

State of California (1980). Evaluation of industrial cooling systems using reclaimed municipal wastewater: applications for potential users. California State Water Resources Control Board Office of Water Recycling, November, Sacramento, CA.

Tay, J. and Chui, P (1991) Reclaimed wastewater for industrial application. *Water Science and Technology*, **24**(9), 153–160.

Troscinski, E.S. and Watson, R.G. (1970). Controlling deposits in cooling water systems. *Chemical Engineering*, March, 9.

USEPA (2002a). Cooling water intake structures at large existing power plants. EPA-821-F-02-003.

USEPA (2002b). Water reuse. <http://www.epa.gov/ow/you.reuse1.html> (accessed 3 February 2003).

Vanderpool, D.P. (2001). Cooling towers: saturation index calculations for cooling water using common spreadsheet programs. *Ultrapure Water*, October, 55–63.

Wiatr, C.I. (2002) Detection and eradication of a non-*Legionella* pathogen in a cooling water system. *Analyst*.

Wijesinghe, B., Kaye, R.B. and Fell, C.J.D. (1996). Reuse of treated sewage effluent for cooling water make-up: a feasibility study and a pilot plant study. *Water Science and Technology*, **33**(11), 363–369.

3.2 The pulp and paper industry

3.2.1 Introduction

Pulp and paper production in the world is localised in countries with natural forest resources (Figs. 3.16 and 3.17). Thus most paper products are manufactured in the USA, Canada, China, Europe, Korea and Brazil. In spite of the growing popularity of the internet and electronic journals, global pulp and paper production is steadily increasing at the same rate as gross domestic product in the world. In 1998 the world production of pulp and paper was estimated to exceed 300 million tonnes for the first time.

The pulp used for paper products is either chemical or mechanical pulp, or recovered paper. The paper products, in which the different pulps are used in varying proportions, can be divided in the following paper grade groups (Zippel, 2001):

- Newsprint
- Fine paper ("wood-free paper")
- Magazine paper ("wood-containing paper")
- Tissue
- Packaging paper (liner and fluting)
- Multiply board

In addition to different pulps, different fillers and/or coating materials, such as pigments, are used. A survey of 100 German paper mills showed that the raw materials in papermaking were (Zippel, 2001):

- Chemical pulp – 21%
- Mechanical pulp – 14%
- Recovered paper – 43%
- Filler, pigments – 16%
- Water – 6%

The proportions, however, vary depending on the location of the paper mill and on the paper grade produced.

Even though water constitutes only 6% of the raw materials used in paper making, its importance is significantly enhanced by its role as a carrier of raw materials through the paper making process before the paper machine drying section. The water quality has a direct effect on process operability and product quality.

The specific freshwater consumption for the pulp and paper industry is defined as the amount of freshwater used for the manufacturing process, taken from external sources, related to the air-dry net weight material produced as finished or intermediate rolls. During the twentieth century the specific fresh water consumption has fallen dramatically from around 300 m³/t (i.e. m³ per tonne) at

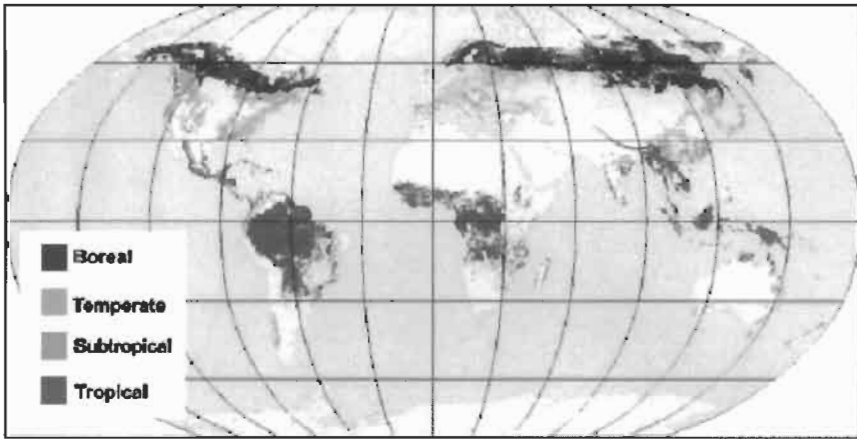

Figure 3.16 Forest resources in the world (FAO, 2000)

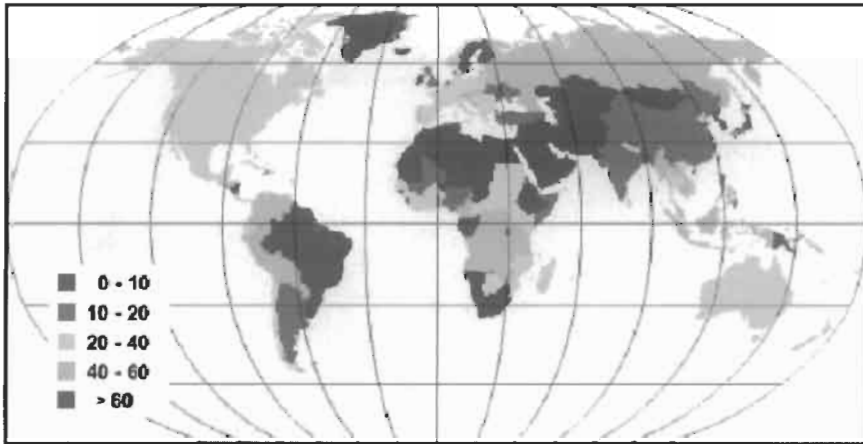

Figure 3.17 Proportion of forest by country as percentage of land area (FAO, 2000)

the turn of the century to between 20 and 30 m³/te today. Naturally, an important factor affecting the water consumption is the paper grade as well as the technical age of the paper machine: the more modern the paper machine, the lower the freshwater consumption.

Traditionally flotation and evaporation have been widely used as separation and purification techniques in the pulp and paper industry. Since the 1980s membrane filtration has also been adapted to these applications. Moreover, along with increasing knowledge and better membranes and modules, membrane filtration has gradually become a more attractive option through its versatility, intensity (low footprint), and significantly lower energy consumption compared to evaporation.

3.2.2 *Pulping and paper manufacturing processes*

Wood is a renewable resource that consists mainly of cellulose (45%), hemicellulose (30%) and lignin (25%). Lignin is the resinous material that binds the cellulose fibres together. In addition, wood has less than 5% of substances like terpenes, resins and fatty oils and acids. Wood for papermaking has to be *debarked* using a large, rotating drum that agitates the logs and allows the bark to be stripped by the abrasive action of the neighbouring logs. The logs are then *chipped* using a large rotating blade prior to pulping.

The *pulping process* (Table 3.7) separates the cellulose and hemicellulose from the lignin and removes other tree oils and resins. The remaining fibres are used to produce the paper. There are two main pulping processes, *chemical pulping* and *mechanical pulping*. Chemical pulping produces very pure cellulose fibres, and is the most common form of pulping worldwide. In *Kraft pulping*, also called the *sulphate process*, the wood chips are heated in sodium hydroxide and sodium sulphide to produce a strong dark brown pulp. Because of the dark colour of the resulting pulp, Kraft fibres require considerable bleaching to make them usable. Kraft pulping is a highly efficient process for removing lignin and resins in softwoods while still producing a high-quality pulp. Wood wastes are burned for fuel and more than 95% of the pulping chemicals are recovered for reuse. In the *sulphite process*, less commonly used for pulping than the Kraft process but still widely used in Central Europe, the chips are heated in sulphuric acid. Recovery of the pulping chemicals is less well developed than for the Kraft process.

In mechanical pulping the debarked logs are forced against a grinding stone or rotating metal disks. As much as 95% of the wood resource is turned into pulp though this action, since the lignin and tree resins remain in the pulp (unlike Kraft pulping in which the yield is only 45–50%). The high lignin content in the pulp causes it to darken when exposed to sunlight. In mechanical pulping the chips can also be steam treated to soften them prior to grinding, a process known as *thermomechanical pulping* (TMP). In *chemothermomechanical pulping* (CTMP) the wood chips are soaked with sulphur-based chemicals prior to steaming to expedite the extraction of lignin and resin from the wood. Mechanical pulp is used for lower grade papers, such as newsprint and telephone directories, as well as for coated papers.

Bleaching is used to purify and clean the pulp. Bleaching removes lignin, which affects the purity of the fibre. Kraft mills use mainly chlorine dioxide or other strong oxidants, such as oxygen, ozone or hydrogen peroxide, to bleach pulp while most mechanical pulp bleaching operations employ hydrogen peroxide. Chlorine gas is still used in some old mills, particularly in USA, but due to its tendency to form polychlorinated organic compounds it has been mostly abandoned as a bleaching agent. Mechanical pulp is most often bleached with hydrogen peroxide or with thiosulphate.

Recovered paper is used as fibre source in papermaking, particularly in regions where the population density is very high. Worldwide, over 95 million tonnes of paper are recovered each year to be made into recycled paper and paperboard, contributing more than a third of the total fibre used to make the world's paper

Table 3.7 Comparison of mechanical and chemical pulping processes (Kroesa, 1990)

	Mechanical pulping		Chemical pulping	
Process	Groundwood log is pressed against a grindstone	CTMP ^a wood chips are vapour-heated and chemically treated before grinding	Sulphate Wood chips are boiled in caustic soda	Sulphite Wood chips are boiled in sulphuric acid
Lignin	Much lignin left in pulp, turns dark when exposed to light		Little lignin left, remains white after bleaching	
Fibre make-up	Yellow torn fibres, very weak	Slightly yellow, more whole fibres, fairly strong	Dark brown whole fibres, very strong	Light brown whole fibres, strong, soft
Pulp yield	0.9–0.95 t pulp/t wood		0.45–0.5 t pulp/t wood	
Bleaching	Hydrogen peroxide		Chlorine/chlorine dioxide, sometimes oxygen, hydrogen peroxide	
Electrical energy	2000 kWh/t		1150 kWh/t	1000 kWh/tonne
Steam energy	n/a		5200 kWh/t	4400 kWh/t
Water	10 000–15 000 gallons/t		35 000–45 000 gallons/t	

^a Chemothermomechanical pulping.

(TAPPI, 2000). At the mill site the recovered, sorted paper is stored, and the paper is re-pulped, screened and cleaned. The printing ink and “stickies” (sticky materials like glue residue and adhesives) are removed in the de-inking process. After de-inking the pulp is refined and, if needed, bleached using hydrogen peroxide, chlorine dioxide, and/or oxygen.

Paper manufacturing involves three stages: *stock preparation*, *pressing*, and *thermal drying*. During stock preparation, wood fibre is mixed with a 1% solution of minerals in water and the water drained from the stock to form a web of paper. In the next step, pressing, the paper is squeezed between rollers and a felt (a large mat of nylon and polyester filaments) to produce a material generally containing 40–50% water. In the third step water is removed by thermal drying to produce paper containing 2–6% water. If size (a starch or starch-like substance used to modify the surface properties of the paper) is to be used a size press coating consisting of starch and minerals is put onto the paper next. Following this the paper is dried once again before finally being wound into a large roll. The surface of the paper is often modified by coating to improve the print quality: the paper is passed under a blade that deposits a homogeneous coating onto its surface. Different kinds of pigments and adhesives are used for different grades of paper. *Supercalendering*, used for some grades to make the paper glossy and smooth, employs a number of large rollers to simultaneously press and heat the paper. *Sheet converting* is the final stage of papermaking, in which the rolls of paper may be cut into individual sheets.

Pulp and paper mills can be either discrete production units or form an integral process. The water consumption differs between non-integrated and integrated

mills. In a non-integrated paper mill, the purchased pulp is the major fibre source and is delivered at 90% solids. In an integrated paper mill, pulp from the pulp mill is stored at about 12–16 wt% solids. In both cases the web leaves the press section at about 40–46% solids content. Consequently, there is a net demand for mill water in a non-integrated paper mill and a net surplus of water in an integrated mill. However, exchange of water between the pulp and paper operations in an integrated mill can change the situation, even though such exchange is nowadays minimised. The production of mechanical pulp always exerts the greatest water demand.

3.2.3 Effluent volumes and quality

Over the years production techniques have been modified and made more efficient and cost effective. Thus the process itself, the paper grade and the technical age of the mill are all key factors when the effluent volumes and quality are considered. They also naturally depend very strongly on the pulping process and on the type of raw materials as well as on the paper grade to be produced (Table 3.8).

Pulping

In debarking significant amounts of bark, fibres and dissolved organic substances are released into the water. The debarking effluent is also toxic, since some of the compounds found in bark are water soluble and heavily toxic. Thus dry debarking or separate treatment is commonly practised, when possible.

In the Kraft chemical pulping process (Fig. 3.18) dissolved organic substances, mainly polysaccharides and lignin, are released in the cooking process. Organic lignin compounds with spent *white liquor* (the main components of which are Na_2S and NaOH , the pH level being around 14) form the black liquor that is removed from the washing stage. In the bleaching stage, the first alkaline extraction, E1, extracts organic lignin compounds along with polysaccharides from the pulp. When chlorine-based bleaching agents, such as elementary

Table 3.8 Examples of major raw materials used for manufacturing of different types of paper (EIPPCB, 2001)

Paper grade	Major raw materials used ^a
Newsprint	No added new fillers; few added chemicals; sometimes pigments added; very little colour; uses mechanical pulp or RCF
Kraft wrapping	No added fillers; coloured; uses mainly unbleached kraft pulp
Kraftliner or testliner	No added fillers; uses unbleached kraft pulp and RCF or only RCF
Board	All fibre types including RCF
Writing and printing	All grades of fibre, mainly bleached; fillers; sizes; colours; brighteners; may be coated
Tissue	No added fillers; wet strength additives; uses chemical pulp + RCF in different mixtures
Speciality papers	The pulp used can vary considerably in type and quality

^a RCF, recovered fibre.

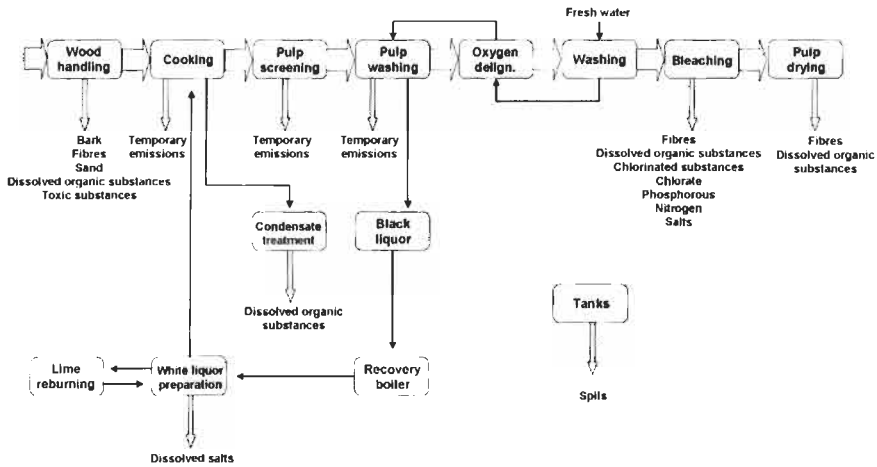

Figure 3.18 Emissions to water from a kraft pulp mill (EIPPCB, 2001)

chlorine or chlorine dioxide, are used some chlorinated substances are formed in bleaching. They are measured as AOX, i.e. adsorbable organic halogens. Some nutrients (phosphorus and nitrogen) as well as salts are also released during the bleaching operation.

An example of effluent stream quality for a modern softwood Kraft pulp mill is shown in Table 3.9 (Myrén, 1993). It is apparent from these data that the bleach plant is the major producer of effluent. However, even though the volume of the wood room effluent, i.e. from de-barking, is only about 5% of the total volume, it is nonetheless the most toxic effluent and constitutes 10% of the colour load in the total effluent. Moreover, conventional wastewater treatment by the activated sludge (AS) process removes only around half of the COD, AOX and phosphorus load from the effluent and leaves the colour substantially unremoved. From this it may be concluded that the colour is mostly formed by long-chain organics that are not well digested by the activated sludge plant. The specific characteristics of the effluents depend on the pulping process (Table 3.10). The characteristics also vary from mill to mill and thus no unambiguous conclusions regarding quality all the pulp mill effluents can be drawn.

Paper making

The specific freshwater consumption of a paper mill (and, by implication, the effluent volume generated) is strongly dependent on the paper grade produced and on the technical age of the paper machine (Table 3.11), as well as the availability and price of freshwater. In general, mill water is needed for showers in the paper machine wire and press section, dilution of chemicals, and process water makeup for level control in the tanks (Table 3.12).

Paper mills using chemical or mechanical pulp (virgin fibre)

As mentioned earlier the water consumption and effluent quality depend on, amongst other things, the age of the mill. The non-integrated wood-free fine

Table 3.9 Effluents from a modern softwood kraft pulp mill (Myréen, 1993)

Source	Flow (m ³ /ADt)	COD (kg/ADt)	AOX (kg/ADt)	P (kg/ADt)	Colour (%)
Wood room (debarking)	2	5		9	10
Fibre line	1	5			20
Bleach plant	30	25	1.0	36	40
Recovery system	2	5			
Spills etc.	5	8			30
From mill	40	48	1.0	45	100
After AS treatment	40	22	0.5	20	100

ADt, air dried tonne.

paper mill, with a production of over 1 million tonnes p.a., shown in Table 3.13, represents an example of modern paper making technology with low effluent pollutant levels and low water consumption. The range of emissions can be extremely broad, as shown in the case of the tissue mill also shown in Table 3.13. Both of these paper grades use bleached chemical pulp as their major component.

Chemical pulp is much cleaner than mechanical pulp as a raw material due to the many washing stages the pulp undergoes before entering the paper machine water system. Mechanical pulp transports, amongst other things, significant amounts of pollutants, mainly so-called “anionic trash”, to the paper machine water circuit. The anionic trash is detrimental, causing operational problems in the paper machine and reducing the efficiency of additives such as retention aids (reagents added to aid the retention of constituents in the paper). In the case of peroxide-bleached Norway spruce (*Picea abies*) TMP, most of the anionic trash comprises anionic galacturonic acid-rich hemicelluloses, i.e. polygalacturonic acids (Thornton *et al.*, 1993).

In mechanical pulp production the effluents result mainly from various thickening processes (e.g. thickener and pressing filtrates) indicated as water sources in Fig. 3.19. These water fractions are usually collected to form pulp mill white water (circulation water). This water typically consists of wood-originating substances (such as resin and fatty acids and other lipophilic extractives), lignin, sugars, polysaccharides, simple organic acids and salts. The concentrations are usually lower in the white water than in the different filtrates. Some matrix characteristics are shown in Table 3.14, which indicates the effect of peroxide bleaching, most often used for mechanical pulp, on the levels of dissolved and colloidal substances (DCS).

In a modern integrated (mechanical) pulp and paper mill (Fig. 3.19) the freshwater is taken in as *wire section*, this being the flat belt of metal or plastic mesh on which the paper web is dewatered (point B in Fig. 3.19), *shower water*. The water removed from the web in the paper machine is collected in the *wire pit* (point C in Fig. 3.19), and forms the white water from the paper machine. In most of the modern paper mills the white water is treated with a disc filter. In older mills, and especially in Central Europe, white water is treated by microflotation. The aim of the treatment is to recover fibre and to remove

Table 3.10 Different pulping effluents and their flows and quality (EIPPCB, 2001)

Process		Effluent volume/flow (m ³ /ADt)	BOD ₅ (kg/ADt)	COD (kg/ADt)	AOX (kg/ADt)	TSS (kg/ADt)	Tot-N (kg/ADt)	Tot-P (g/ADt)
Debarking	Wet debarking and press	3–10	5–15	20–30		n/a	n/a	25–35
	Dry debarking and press	0.5–2.5	0.5–2.5	1–10		n/a	n/a	10–20
Kraft mill	Unbleached pulp	20–80	1–20	7–50		0.2–15	0.1–1	3–40
	Bleached pulp	30–110	0.2–40	4–90	0–2	0.2–10	0.1–0.8	5–90
Sulphite pulping	Bleached and unbleached	40–100	0.5–75	10–190	0–1	1.7–10	0.18–1	15–150
Mechanical pulping	Groundwood	5–15	8.5–10	20–30		n/a	0.08–0.1	20–25
	TMP	4–10	13–22	50–80		n/a	0.1–0.13	30–40
	CTMP	15–50	17–30	60–100		n/a	0.11–0.14	35–45
	Bleached CTMP		25–0	80–130		n/a	0.13–0.4	50–60

n/a, not available; ADt, air dried tonne.

Table 3.11 Specific freshwater consumption in modern paper mills (Sundholm, 2000; Weise *et al.*, 2000)

Paper grade in general	Typical example	Water consumption (m ³ /t)
Newsprint		5–15
	<i>Pulp mill and newsprint line</i>	9
Wood-free fine paper		5–10
Supercalandered (SC) paper		10–15
Lightweight coated (LWC) paper		10–20
	<i>Pulp mill and LWC line</i>	11
Tissue		5–15
	<i>Paper machine and process</i>	12
Liner and fluting		5–15
	<i>Pulp and testliner mill</i>	5
Multiple board		8–15
	<i>Board line</i>	10

Table 3.12 Freshwater consumption in papermaking (Edelmann, 1999a; Haavanlammi, 1999)

Unit operation water use, m ³ /t	Printing paper grades	Newspaper grades
Total fresh water consumption	16–26	27
Paper machine showers	6–7	5
Dilution/preparation of chemicals	2–3	3
Makeup waters in pulp production	2–3	
Cooling of process equipment	3–10	10
Sealing waters	1	6
Power plant	2–3	
Miscellaneous (washing, sealing etc.)		3

suspended solids from the water. The modern disc filters produce three filtrates; *cloudy*, *clear* and *superclear* filtrate. The cloudy filtrate is usually directed back to the stock preparation, but the clear and superclear filtrates are either reused – e.g. as wire section shower water – or discarded as effluents, depending on their suspended solids content and on the paper grade produced. In the worst case the clear filtrate can constitute more than a half of the total effluent load of a paper mill. The main prerequisite for recycling the clear or the superclear filtrate in the process is that they are practically free of suspended solids.

The clear filtrate from the paper machine consists of suspended solids, dissolved and colloidal substances originating from wood, and salts. In addition, the clear filtrate also contains traces of all the paper making chemicals added to the process. If the paper machine produces coated paper grades, the traces of the coating colour ingredients are also found in the clear filtrate. These include various pigments and latices. It should be noted that white water quality varies significantly between machines and, in some cases, no significant difference is seen between the clear and superclear filtrates.

Table 3.13 Consumption and emission levels of the biggest non-integrated wood-free fine paper mill in Europe and a typical tissue mill (EIPPCB, 2001)

	Fresh water demand (m ³ /t)	Wastewater flow (m ³ /t)	COD (kg/t, mg/l)	BOD ₅ (kg/t, mg/l)	AOX (g/t, mg/l)	TSS (kg/t, mg/l)	N (g/t, mg/l)	Tot-P (g/t, mg/l)
Wood-free fine paper	6	4.5	0.44, 97	0.11, 24	7, 0.15	0.14, 30	41.9, 2 (inorganic)	3, 0.8
Tissue mill	7–100	6–100	2–6 ^a	1–2 ^a	5–15 ^a	1–3 ^a	6–100 ^a (total)	1–30 ^a

^a After wastewater treatment plant.

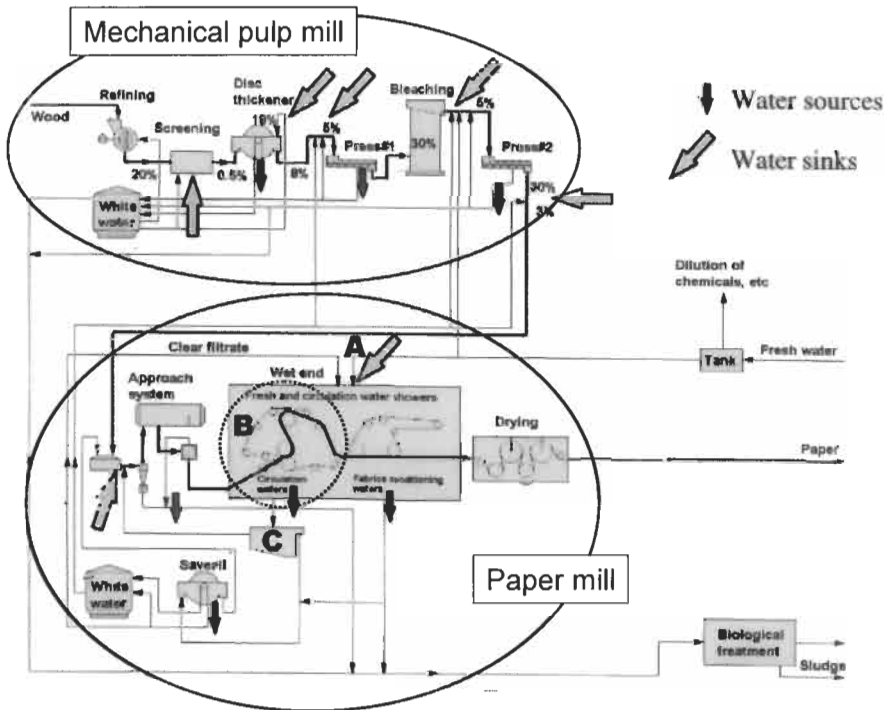

Figure 3.19 Water circulation system for a modern integrated mechanical pulp and paper mill showing water sources and sinks. The numbers indicate the pulp concentration in different points of the process. A = shower water taken into the wire section of the paper machine, B = wire section, C = wire pit (courtesy of K. Edelmann (Edelmann, 1999b))

Paper mills using recovered fibre

Recovered paper (RCF) has become more popular as a raw material in paper making, especially in the regions where the population density is high and paper collection systems are working efficiently. For example, out of the 6.5 Mt of paper and board manufactured in the UK in 1998, 4.7 Mt was raw material

Table 3.14 Characteristics of mechanical pulp (thermomechanical pulp, TMP, (Thornton, 1993)) and mechanical pulp mill water fractions: groundwood mill circulation water (Huuhilo *et al.*, 2002) and plug screw feeder pressate from semi-chemical mechanical pulp mill (SCMP) (Dal-Cin *et al.*, 1995)

Parameter	Unit	Groundwood mill circulation water ^a		SCMP mill pressate ^d	Thermomechanical pulp ^b	
		Average	Range	Plug screw feeder pressate	DCS ^c unbleached	DCS ^c bleached
Temperature	°C	63	50–70		60	60
pH		5.3	4.8–6.1	5.7		
Conductivity	µS/cm	905		5100	700	5800
Cationic demand	µeq/l				100	360
Colour	PtCo	364	222–555			
Suspended solids	mg/l	460	250–1300	1700		
Dissolved solids	mg/l			12 600		
Soluble COD	mg/l	1400	1100–1750			
Total organic carbon	mg/l	500		5670	214	288
Dissolved organic carbon	mg/l	510	300–750			
Extracted UV280 nm	abs.	2.6	1.7–3.7			
Lignin-like COD	mg/l	220	150–320			
Lignin + other aromatics COD	mg/l	420	300–550			
Lignin soluble	mg/l			2400		
Lignin insoluble	mg/l			1900		
Sugar COD	mg/l	300	190–540			
Carbohydrates	mg/l			2680	209	136
Lipophilic extractives	mg/l	16	11–26		50	45
Resin and fatty acids	mg/l			432		
Neutral hydrophobics	mg/l				37	20
Acidic hydrophobics	mg/l				67	90
Lignans	mg/l	63	42–80		23	6
Volatile acids	mg/l			920		
Acetic acid	mg/l				10	200
Formic acid	mg/l				1	35
Ca ²⁺	mg/l	19	11–28			
Cl ⁻	mg/l	6	4–9			
SO ₄ ²⁺	mg/l	246	153–395			

^a Analysed from mill samples.^b Analysed from supernatant resulting from pulp agitated in clean water (60°C) and centrifuged in laboratory.^c DCS, dissolved and colloidal substances.

supplied by waste paper merchants (British Recovered Paper Association, 2002). For comparison, out of the 14.4 million tonnes of paper and board manufactured in Finland in 2001, 0.7 Mt of recovered fibre used as raw material equates to 5%. However, 90% of the paper produced in Finland is exported and, within Finland, around two-thirds of the paper and board used is recovered, i.e. 14 kg per capita per annum. The global average for paper and board recovery and reuse is around 40% (Finnish Forest Industries Federation, 2002).

Recovered paper loads the water circuit of paper mills with a variety of adhesives. Colloidal, dissolved, finely dispersed or water-soluble adhesives originating from recovered fibre are called *secondary stickies* because they agglomerate only later in the finished stock through chemical reaction, or else they appear only on the paper machine thus causing severe problems. In addition, the alkaline de-inking procedure and a high temperature promote dissolution of adhesives in the circulation water (Zippel, 2001). It has been estimated that the total amount of adhesives in DIP (de-inked pulp) is 7 kg/t of paper, 70 times the maximum permitted level of sticky material allowed in white paper manufactured from DIP (0.1 kg/t; Zippel, 2001). Volume and quality data for water from stock preparation of different paper grades using recovered fibre are shown in Table 3.15.

3.2.4 Current water and effluent purification systems and governing legislation

Driving forces for effluent treatment in the pulp and paper industry can be categorised as follows:

- Environmental legislation
- Better economy
- Local demands, for example lack of water resources
- Customer demand

The environmental legislation in the pulp and paper industry is likely to undergo profound changes within the next few years. The EU Directive on Integrated Pollution Prevention and Control (IPPC) includes a BAT reference document, BREF, which refers to the pulp and paper industry. This came into force in 1999 for greenfield mills, and will apply to existing mills from 2007. The

Table 3.15 Emission levels for stock preparation of different paper grades using recovered paper (EIPPCB, 2001)

	Recovered paper quality	Water flow (m ³ /t paper)	TSS (mg/l)	COD (kg/t, mg/l)	AOX (g/t, mg/l)
Packaging paper	Sorted mixed paper and boars, recovered paper from stores	0–4	Below 200	27–36, 6750–9000	< 4, 1
Newsprint	De-inkable recovered paper (50:50 newsprint and magazines)	8–16	Below 200	17–27, 1700–2700	< 10, 1
LWC/SC paper	De-inkable recovered paper (50:50 newsprint and magazines)	8–16	Below 200	17–27, 1700–2700	< 10, 1
Tissue paper and market pulp	De-inkable recovered paper (50:50 newsprint and magazines); wood-free office recovered paper	8–16	Below 200	26–35, 2600–3500	< 10, 1

BREF stipulates, amongst other things, permitted effluent loads and, for the first time, effluent flows for different kinds of pulp and paper mills. The directive also includes a list of candidate techniques and practises (under BAT, best available technology, Tables 3.16 and 3.17) recognised as being able to achieve the mandatory effluent loads.

The effluent loads allowed according to the IPPC directive are extremely rigorous. In particular, target levels for nitrogen and phosphorus cannot be achieved by use of conventional external (end-of-pipe) biological treatment alone. The allowed effluent flows, on the other hand, necessitate counter current water circulation systems and internal water recycling, also stated in the IPPC directive and aimed at minimising freshwater consumption.

The focus of the internal water purification used today has been mainly on the removal of suspended solids by mechanical filtration (e.g. disc filter), flotation or chemical precipitation. Flotation (or flotation combined with sand filtration, so-called flotation filtration) has been successfully used to remove suspended solids and to recover fibres, fillers and fines from the white water. However, flotation tanks generally demand a lot of floor space and the process is fairly energy intensive. The cost and the filtrate quality are very dependent on the chemicals used, which are usually expensive. Flotation is used to a large extent in mills using recovered paper as raw material. Chemical precipitation is also used within the paper machine white water treatment system. The aim is to improve the first-pass retention in the wire section and, at the same time, the suspended solids content is reduced in the white water. However, chemicals are usually expensive and the doses required can be large. Moreover, overdosing of

Table 3.16 BAT requirements for mechanical pulp mills (EIPPCB, 2001)

Mill type	Flow (m ³ /t)	COD (kg/t)	BOD (kg/t)	TSS (kg/t)	AOX (kg/t)	Tot N (kg/t)	Tot P (kg/t)
Non-integrated CTMP mills (contribution of pulping only)	15–20	10–20	0.5–1	0.5–1	–	0.1–0.2	0.005–0.01
Integrated mechanical pulp and paper mills (e.g. newsprint, LWC ^a and SC ^a paper mills)	12–20	2–5	0.2–0.5	0.2–0.5	< 0.01	0.04–0.1	0.004–0.01

^a LWC, lightweight coated; SC, supercalendered.

Table 3.17 BAT demands for pulp and paper mills using chemical pulp (EIPPCB, 2001)

Paper type	Flow (m ³ /t)	COD (kg/t)	BOD (kg/t)	TSS (kg/t)	AOX (kg/t)	Tot N (kg/t)	Tot P (kg/t)
Uncoated fine paper	10–15	0.5–2	0.15–0.25	0.2–0.4	< 0.005	0.003–0.01	0.05–0.2
Coated fine paper	10–15	0.5–1.5	0.15–0.25	0.2–0.4	< 0.005	0.003–0.01	0.05–0.2
Tissue	10–15	0.4–1.5	0.15–0.4	0.2–0.4	< 0.01	0.003–0.01	0.05–0.25

chemicals can interfere with the sensitive chemical equilibrium in the wet processing.

Suspended solids-free process water or effluent is not always sufficiently clean for recycling purposes. When the freshwater consumption is reduced the water circulation system becomes enriched in dissolved and colloidal substances (DCS), which causes several problems within the process operation and/or in the paper product. High levels of dissolved organics result in enhanced bacterial growth in the system, possibly producing odour problems in the paper product and increasing BOD and colour levels in the effluent streams. Enrichment of multivalent ions also produces problems of scaling (carbonates and silicates) and corrosion (sulphates, chlorides, Fe^{2+} and Al^{3+}) which tend to arise after extended periods of operation under conditions of low freshwater use. Also, brightness reversion can be caused by dissolved inorganic materials such as Fe^{2+} . Problems of enrichment of the DCS in the white water system can be substantially ameliorated through advanced purification methods, such as ultrafiltration (UF), as will be shown later.

The stress imposed on water resources has forced the mills to seek ways to efficiently treat their effluents to freshwater quality levels of purity. For example, the total mill effluents treated by biological and membrane processes (Bentley, 1999; Webb, 1999) or evaporation (Stevenson, 1992) have been successfully used to supplement freshwater supplies. However, coating colour effluents have proved problematic to treat because they are not degraded by biological processes and, as a result of this, chemical precipitation has been widely employed. This produces a solid waste that must be landfilled. During the 1990s concentration of coating colour effluents by UF became more common, mainly for economic reasons: UF costs have decreased whereas landfill disposal costs have increased. In the IPPC directive UF treatment of the coating colour effluents is now stated as a BAT technology.

3.2.5 Membranes in the pulp and paper industry

There has been increased interest in membrane filtration applications in the pulp and paper industry over the last 15–20 years, for reasons already stated above as well as in Section 1. Membrane processes offer a high level of purification coupled with a low footprint and relatively low energy consumption, especially when compared with the competing desalination technology of evaporation.

Existing full-scale membrane plants

The first full-scale reverse osmosis plant was installed in the white water system of a board machine of Green Bay Packaging Inc. in the USA in 1974 (Macleod, 1974). Later when the water balance of the board machine changed the RO plant became redundant. Since the 1980s tubular module ultrafilters have been successfully adopted for such purposes as concentration and fractionation of spent sulphite liquor (Anon., 1982; PCI Membrane Systems, 1988), deresination (Paterson Candy, 1987) and bleaching effluent treatment (Haagensen, 1982; Okamoto *et al.*, 1985; Jönsson, 1987; Wickström, 1997). An early example of

the use of ultrafiltration is the tubular ultrafiltration plant at Borregaard sulphite pulp mill in Norway, which has been used to process spent sulphite liquor since 1981 (Table 3.18). The UF concentrate contains high molar mass fractions of lignosulphonates and small amounts of sugar and salts. The concentrate is used for vanillin production.

To meet the emission levels stated by legislation or to improve the efficiency of the external biological treatment some specific effluents, e.g. bleaching effluents with high COD loads, have been separately pre-treated prior to biotreatment. For these reasons several ultrafiltration plants were installed in the early 1980s to treat the first alkaline stage effluent, E1, from the bleaching process (Haagensen, 1982; Okamoto *et al.*, 1985; Jönsson, 1987). For example, in the Taio Paper Co. mill the COD reduction obtained was 79%, equating to 5.5 t d⁻¹. This was enough to meet the emission level and the efficiency of the biological effluent treatment plant was significantly increased. The concentrate was incinerated with the black liquor. The average permeate flux of the polysulphone UF membranes used for the 3.5 million litres per day (MLD) plant was about 100 l m⁻² h⁻¹ (LMH), giving a total membrane area requirement of 1480 m².

Even though the processes using tubular membranes perform well, they do so at a substantial cost. The packing density of the tubular membranes is relatively low (Table 2.5) such that membrane plants based on this modular configuration have a relatively large footprint. In addition, fluxes attainable from tubular membranes are limited by the high fouling propensity of the liquids arising.

The cross-rotational (CR) filter (Section 2.1.4, Fig. 2.12), originally developed by ABB Flootek, Sweden (now Metso PaperChem, Finland), entered the market in the late 1980s. It was shortly adapted for mill-scale ultrafiltration applications, such as treatment of bleaching effluents and board machine white water as well

Table 3.18 Ultrafiltration of spent sulphite liquor at Borregaard Industries, Norway (PCI Membrane Systems, 1988)

Parameter	Details/value	
Membrane	BX1, PCI Membrane Systems	
Total membrane area, m ²	1120	
Process design	2 lines with 6 stages in series with diafiltration	
Feed flow, m ³ h ⁻¹	50	
Concentrate flow, m ³ h ⁻¹	16	
Solids content, %	Feed	12
	Concentrate	22
Pressure, bar	10–15	
Cross-flow velocity	High	
Temperature, °C	60–65	
pH	4.2–4.5	
Washing	Alkaline detergent daily for 2 hours	
Relative costs	Membranes	65%
	Energy	26%
	Mechanical spare parts	6%
	Chemicals	3%

as concentration of coating colour. The filter normally operates at low pressures – as low as 0.8 bar – with the main energy demand being mechanical, between 3 and 5 kWh m⁻³. As a stacked disc system, the module imposes a lower footprint than tubular systems whilst achieving higher fluxes.

Four CR ultrafilters were successfully used in 1988–1992 at MoDo Husum sulphate pulp mill in Sweden to treat the E1/O bleaching effluent (Jönsson and Trägårdh, 1990). The membrane area of one filter was 50 m² and its capacity 50 m³ h⁻¹, giving a flux of 1000 LMH. The concentration factor was 15, the pressure 0.2–0.8 bar and temperature 50–60°C. Hoechst PES25 polyethersulphone UF membranes with a MWCO of 25 kDa were used. The concentrate was incinerated and the permeate was directed to the external biological treatment plant.

CR filters were also installed in 1989 at Rottneros Board Svaneholm in Sweden to treat board machine white water (Jönsson, 1990; Gavelin, 1991; Anon., 1996). Two CR1000 filters (membrane area 100 m² and membrane cut-off 100 kDa) are used to treat the white water removing 3 t d⁻¹ of suspended solids. The permeate is directed back to the board machine and the retentate is first concentrated in an evaporator and then burned together with the stripped bark. The content of suspended solids in the white water has been reduced from 5 to 2% and the downtime associated with machine cleaning and maintenance reduced. Also, the efficiency of the secondary treatment plant has been increased due to the lower organic loading. The energy consumption is 6–8 kWh m⁻³ of permeate. Successful pilot tests with UF for white water treatment have also been carried out at Stora Kabel (Kothe and Schroth, 1999) and StoraEnso Uetersen (Kluter, 1999; Huhtamäki *et al.*, 2002). For the UF plant the payback time calculated on the basis of the pilot trials in Stora Kabel is 4.9 years and the internal rate of return 21%. The cost for fresh water and wastewater is about \$0.5 per m³. Through recycling, and thus the reduction in freshwater consumption, about \$0.15 per m³ is saved. A recent example of the mill scale application of a CR filter to the treatment of paper mill circulation water (Tepler *et al.*, 1998) is detailed in Section 5.6.

As with other industrial sectors, the cost benefit of the water recycling plant is substantially improved if other resources are simultaneously recovered for reuse. In paper mills producing, for example, coated high-quality printing papers, such as lightweight coated LWC paper grades, a significant amount of coating colour is discharged in the effluent. Moreover, the waste coating colour adheres to equipment, which then requires frequent cleaning. This represents a significant economical loss, as well as the colour in the effluent being an environmental issue. In many mills coating colour effluents are still treated with precipitation and the solid waste then landfilled. By employing ultrafiltration colour components in the coating colour kitchen effluent stream can be recycled, along with the water. The dilute effluents are concentrated with ultrafiltration membranes to an appropriate total solids content after which the retentate is used in the preparation of fresh coating colour. The permeate can be used for dilution or washing purposes in the coating colour kitchen. The payback time of such membrane plants is less than a year depending on the price of the coating

colour raw materials. Today, there are about 25 CR plants (Anon., 1996; Kenny, 1997; Nygård *et al.*, 1998; Alho *et al.*, 1998; Sutela, 2002) and several tubular membrane plants (Camatta, 1992; Stuffer, 1996; GAW, 2002) worldwide treating coating colour effluents (Fig. 3.20).

In a zero effluent discharge (ZLD) mill producing linerboard at the McKinley Paper plant in New Mexico, a waste stream of $3.2 \text{ m}^3 \text{ t}^{-1}$ paper produced is cleaned using membranes following extensive pretreatment including dissolved air flotation and activated sludge treatment (Bentley, 1999; Webb, 1999; Fig. 3.21). Following the activated sludge plant the clarified water is treated by continuous microfiltration (CMF) using hollow fibre (HF) modules (Vivendi Memcor) operating out-to-in. The particles or foulants, which adhere to the outside surface of the hollow fibres, are then removed by combining the backflush cycle with air sparging. It is only rigorous pretreatment that allows the use of HF modules, which would normally not be appropriate for pulp and paper applications due to the high solids loading. The MF permeate is further treated with reverse osmosis (RO) using brackish water elements, generating 0.7 m^3 water per tonne of paper to the mill. The membrane processes are followed by mechanical vapour recompression, MVR, evaporation, which regenerates another 0.4 m^3 water t^{-1} of paper to the mill. This leaves only 0.8 m^3 water t^{-1} paper to be taken in as make-up water – 25% of the total demand.

Reverse osmosis has also been used to treat wood plant effluent in the production of medium density fibreboard, or MDF (Finnemore and Hackney, 2000). The wood plant effluent is firstly flocculated and filtered in a filter press. The water is then treated with a multimedia filter prior to RO. The concentrate can be reused in production and the permeate is treated with a carbon filter before recirculation to the process main stream. The COD content of the influent to the filter press is $24\,000 \text{ mg l}^{-1}$, and is reduced to 7000 mg l^{-1} after the filter

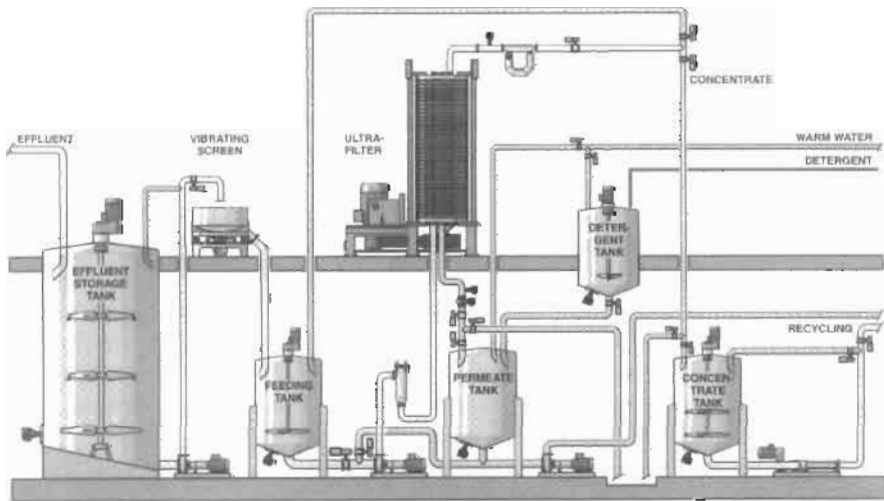

Figure 3.20 Ultrafiltration plant treating coating colour effluent (Mäkinen, 2000)

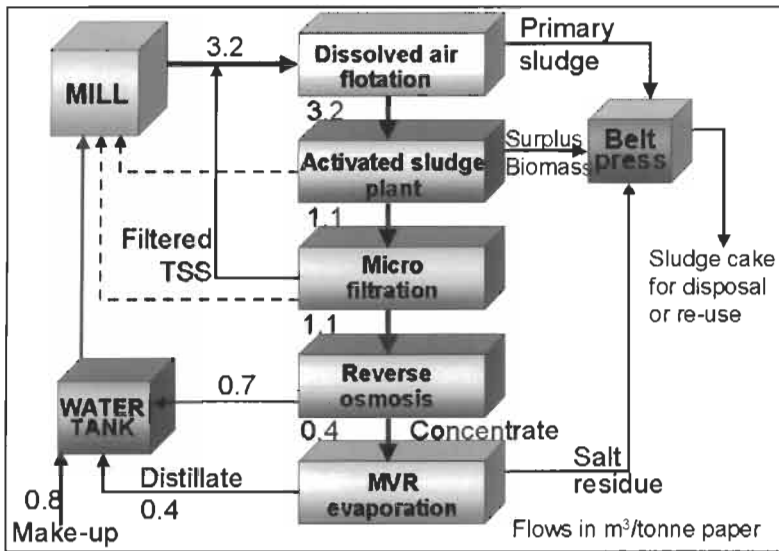

Figure 3.21 Water treatment system in a recycled linerboard mill, McKinley Paper Ltd, New Mexico (courtesy of L. Webb, Envirocell (Webb, 1999))

press and 100 mg l^{-1} in the RO permeate. Thus the RO removes 98–99% of the COD in the original wood room effluent. In this case the RO process was found to be significantly cheaper than any other treatment methods. This was because the plant is mechanical, including only a few process stages thus reducing the capital investment cost compared to other systems such as evaporators or biological systems. Operating costs are substantially lower than those of the traditional treatment technologies as outputs can be recycled or reused thereby reducing the volumes and generating financial benefits from reduced effluent disposal and freshwater demand. In addition, there is no generation of by-products, such as waste activated sludge. Thus the costs for the RO membrane process are only around \$1.5 per m^3 ultimate disposal; the biological and evaporative processes would have respectively cost, in this case, £5 and £15 per m^3 , based on ultimate disposal.

One of the first nanofiltration (NF) plants to be employed in the pulp and paper industry was reported by Lien and Simonis (1995). This 10 MLD plant located in the Pacific rim for cleaning paper mill and total effluent, produced from newsprint, printing paper and de-inked pulping operations, employs spiral wound NF modules (Osmonics). As with any dense membrane process, extensive pretreatment is required (Fig. 3.22) to reduce the fouling propensity of the water. The cleaning cycle time is over two weeks.

In the 1990s another high-shear membrane module, the VSEP filter (vibrating shear enhanced processing filter; Section 2.1.4, Fig. 2.12) entered the market. Existing mill-scale applications of the VSEP filter in the pulp and paper industry include weak black liquor, box plant effluent, and MDF wastewater treatment

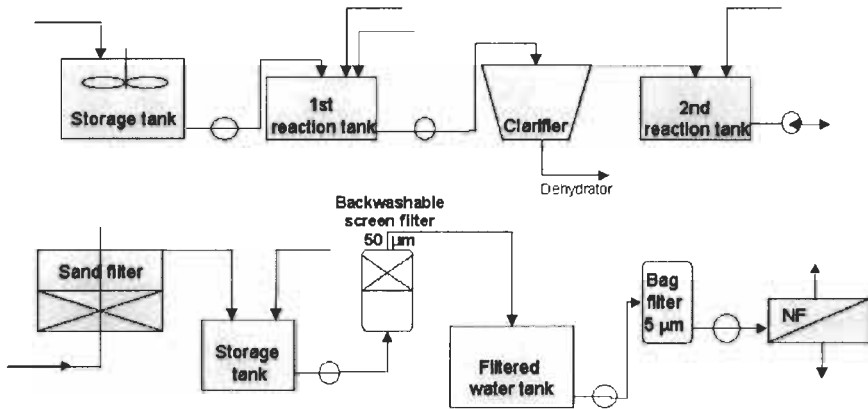

Figure 3.22 Schematic flow sheet of a paper mill spiral-wound nanofiltration process (Lien and Simonis, 1995), Osmonics, Inc.

(New Logic Int., 2002; Johnson, 2002) and as well as recycle mill effluent treatment (Monroe, 1997; New Logic Int., 2002).

Bench- and pilot-scale research

As already mentioned, implementation of membrane technology within the pulp and paper industrial sector accelerated in the early 1990s, with the development of less expensive membrane materials, more robust modules and more sophisticated technologies such CR and VSEP filters. A concomitant acceleration in research activity took place at this time, focused on the treatment of bleaching effluents and the closing of a bleaching plant water cycle (Jönsson *et al.*, 1988; Jönsson, 1989; Jönsson and Petersson, 1989; Afonso and de Pinho, 1991; Luque *et al.*, 1994; de Pinho *et al.*, 1995, 1998; Rosa and de Pinho, 1995; Geraldés and de Pinho, 1995; Fälth *et al.*, 1999, 2000, 2001a, 2001b). Another area of interest has been the filtrates and circulation waters originating from mechanical pulp production (Beaudoin *et al.*, 1992; Paleologou, 1994; Salovius *et al.*, 1993; Konishi *et al.*, 1998; Edelmann, 2001), and paper mill white water and total effluent have also been intensively studied (Nuortila-Jokinen, *et al.*, 1995a, 1995b; Nuortila-Jokinen and Nyström, 1996; Mänttari and Takeshita, 1997; Nuortila-Jokinen, 1997; Mänttari *et al.*, 1997, 1998; Kuide and Yamamoto, 1999; Mänttari *et al.*, 1999; Huuhilo *et al.*, 2001). Studies have also been conducted on the concentration of coating colour effluents (Jönsson *et al.*, 1996; Singh *et al.*, 1997, 1999; Takeshita, 1997; Kuide and Yamamoto, 1999; Nuortila-Jokinen and Nyström, 2000).

Pulp and paper mill process waters and effluents have a very high fouling propensity, such that the most effective membrane material for these applications seem to be highly hydrophilic, almost uncharged regenerated cellulose. For the coating colour effluents, on the other hand, the more hydrophobic membranes are preferred (Singh *et al.*, 1997, 1999; Nuortila-Jokinen and Nyström, 2000).

In addition to the membrane material, the module structure and the operating parameters have a significant impact on membrane process performance. In general the higher the shear rate at the membrane surface, the higher the flux and the lower the fouling rate. The cross-flow velocity should exceed 4 m s^{-1} (Jönsson and Wimmerstedt, 1985) in a tubular membrane and 3.2 m s^{-1} in flat sheet module to avoid fouling (Mänttari *et al.*, 1998). As already stated (Section 2.1.4), in the high-shear modules such as the CR and the VSEP filters the rotation speed and the vibration amplitude have a direct impact on the flux (Figs. 3.23 and 3.24).

The concept of critical flux (Section 2.2.4) has been introduced for nanofiltration of pulp and paper waters by Mänttari and Nyström (2000), with respect to the spiral-wound DS-5DK membrane (Osmonics). The efficacy of operation below the critical flux has been clearly demonstrated in the M-Real Kirkniemi case described in Section 5.6. Because the CR filters are operated at 0.8 bar, which yields fluxes well below the critical flux (depends on the membrane and we have not measured it in the CR only in the VSEP and C30F) for the membranes, hardly any fouling has arisen for this plant. The membranes are washed only once a week as a part of the routine operational procedure, rather than on demand. The VSEP filter operates with almost no fouling in nanofiltration applications (Fig. 3.25) whereas ultrafiltration membranes are usually readily fouled in the VSEP filter.

The main foulants arising from diagnosis of membranes that have been used for the treatment of mechanical pulp and paper mill waters are resins, fatty acids and other wood extractives, sugars, and metal ion coagulated organic matter (Carlsson *et al.*, 1998; Ramamurthy *et al.*, 1995; Nuortila-Jokinen, 1997; Huuhilo *et al.*, 2001). The adsorption of such materials is increased at higher membrane hydrophobicities (Fig. 3.26).

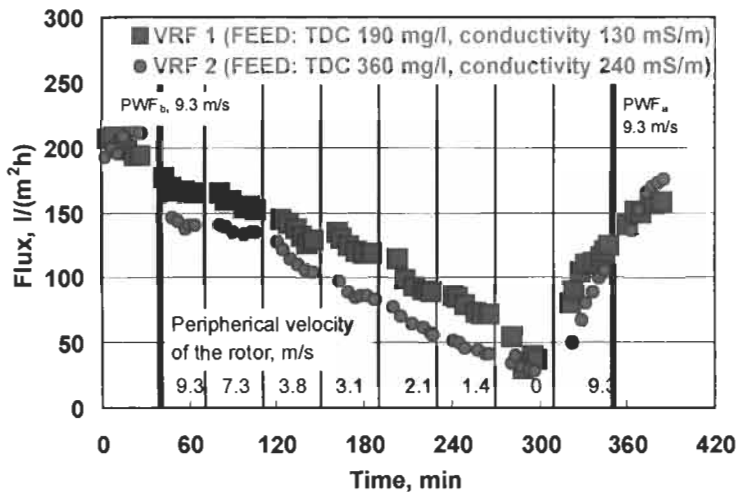

Figure 3.23 Effect of rotor blade tip speed in the CR filter on the permeate flux for the filtration of acidic clear filtrate from a paper machine. NF200 membrane from Dow-Film Tec, pH 4.9, 35°C, 10 bar TMP

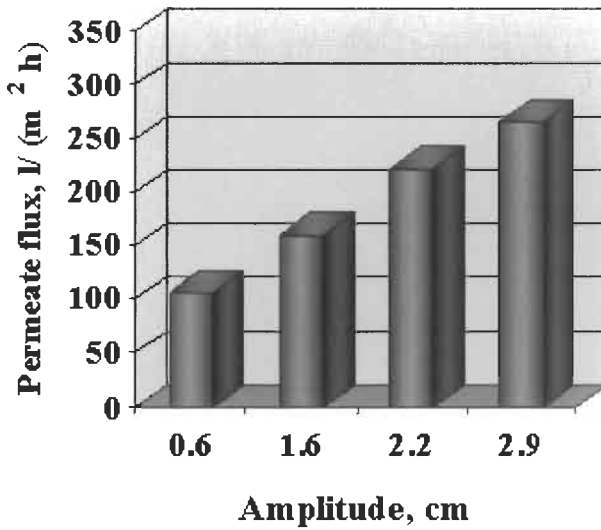

Figure 3.24 Effect of amplitude in the VSEP L filter on permeate flux for the filtration of sedimented groundwood mill circulation water. C30F ultrafiltration membrane from Nadir Filtration, pH 5, 50°C, 2 bar TMP

The membrane surface charge along with that of the feed water constituents has a great influence on membrane process operation. As with much natural organic matter, most of the substances of wood origin in paper mill effluents are negatively charged at higher pH through dissociation yielding, for example, phenolic or carboxylate organic anions. On the other hand, the process pH in paper making is either acidic (pH 4–5) or neutral (pH 7–8). At the lower pH values solutes become associated, such that electrostatic repulsion between them and the membrane surface may be substantially decreased. As seen in Fig. 3.27, at neutral pH values (nCF, neutral clear filtrate, pH 7) the flux remains more or less stable, but in acidic solutions (aCF, acid clear filtrate, pH 5) the flux declines steeply with concentration (or volume reduction) factor because of the increased acidity of the retentate with increasing retentate concentration. As the volume reduction factor approaches 8, the flux decreases to zero.

Compounds originating from the wood itself are not as onerous to the membrane purification process as the chemicals added to the manufacturing process, even though they are found at very low concentrations in the paper mill waters. This is probably due to the fact that many of these chemicals carry a predominantly positive charge or else are surface active. In addition, coating colour pigments, such as clay (kaolin), which enter the paper machine water circuit through the use of broke (i.e. paper makers own waste paper created during the paper making process) have been observed from electron microscopic analysis to form dense layers on the membrane surface. Cationic retention aids or fillers, such as cationic starch, also tend to adsorb on the membrane to form a gel-like layer under pressure.

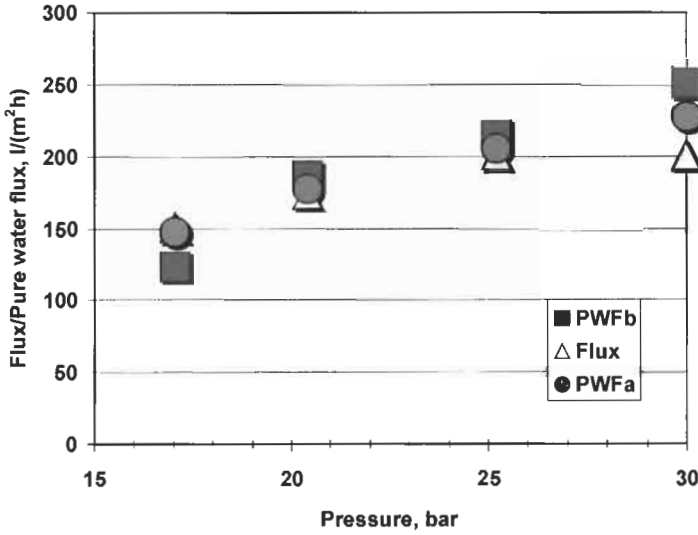

Figure 3.25 Nanofiltration of paper machine clear filtrate with PVD-1 membrane in a VSEP L-filter. Membrane area 465 cm², pH 7, amplitude 32 mm, temperature 30–40°C. The fluxes are recalculated to 35°C. PWF_b = pure water flux before filtration, PWF_a = pure water flux after filtration (Huuhilo et al., 2001)

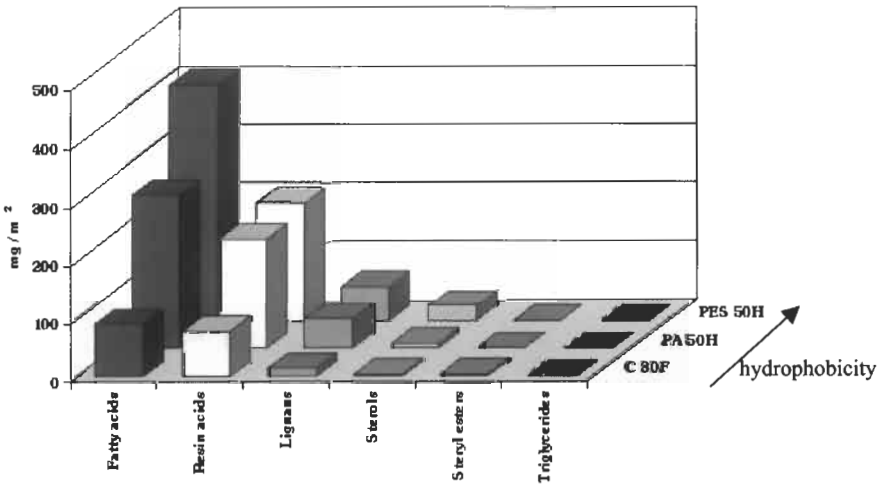

Figure 3.26 Amounts of different extractives found in the membranes C30F, PA50H and PES50H after UF of grinding room circulation water (Huuhilo et al., 2001)

The particle shape has a significant impact on membrane flux (Fig. 3.28a). Microfiltration of the coating colour components with a 0.1 µm Teflon Tyvar (Tetratex) membrane reveals that the round calcium carbonate (CaCO₃) particles (usually ground limestone or marble) yield a considerably higher flux than plate-like particles such as clay and talc. Further, the hydrophobic talc gives a higher flux than clay, whose particles tend to be positively charged under

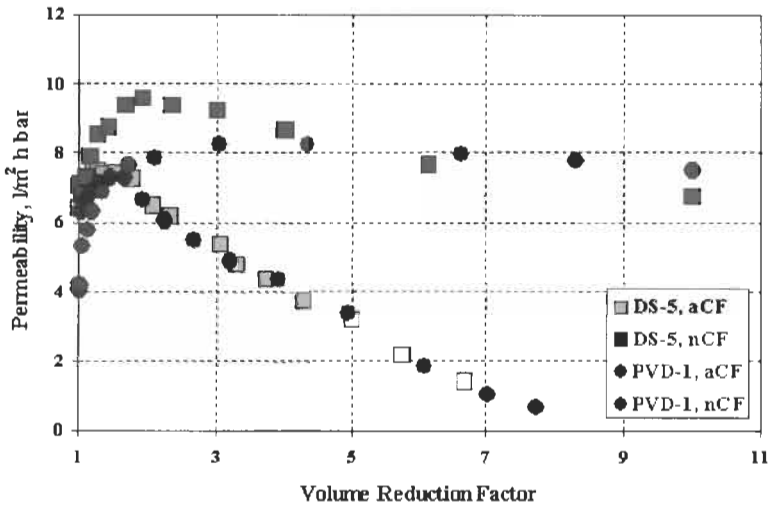

Figure 3.27 Effect of pH on nanofiltration flux with two different membranes, DS-5 and PVD-1 (Hydranautics; Nuortila-Jokinen, 1997). aCF = acidic clear filtrate, nCF = neutral clear filtrate, VSEP filter

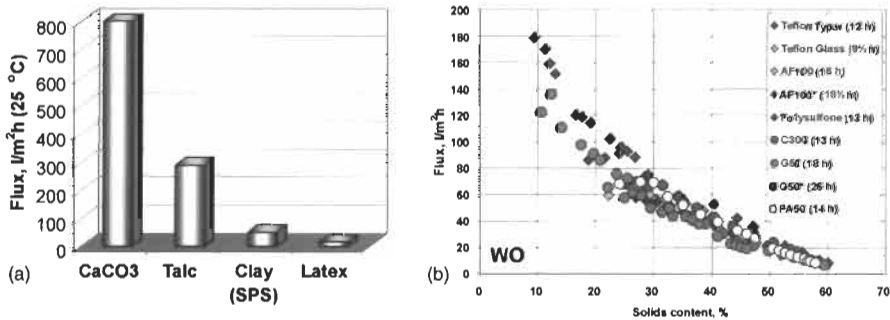

Figure 3.28 (a) Microfiltration of coating colour components; VSEP L, 465 cm², Teflon Typar 0.1 μm (TetraTec), pressure 6.9–20.7 bar, amplitude 2–2.5 cm. (b) Concentration of wet offset (WO) coating colour, VSEP L, 465 cm², various membranes, pressure 6.9–27.6 bar, amplitude 1.9–3.2 cm. Fluxes recalculated to 40°C (Nuortila-Jokinen and Nyström, 2000)

the normal paper process operating conditions. This is due to the hydrophobic–hydrophobic interaction between the talc and the Teflon membrane; i.e. repulsion between the hydrophobic particle and surface. However, when these particles are mixed with other coating colour raw materials, the effect of charge and hydrophobicity are greatly ameliorated, presumably because of aggregation and adsorptive reactions between of particles and solutes (Fig. 3.28b).

As with almost all industrial effluents, the variability of the water quality presents a significant challenge to the membrane material and module. This demands that the membrane technology must be robust to extreme conditions of, in particular, temperature and pH, as well as being tolerant of shock loads. It

can also be beneficial to include pretreatment to remove key foulants. Various biological treatment processes have been assessed for this duty, and have proved to be very effective in removing low molar mass organic substances from the feed water (Pauly, 2000; Tardif and Hall, 1997; Dufresne *et al.*, 1998; Nuortila-Jokinen *et al.*, 1999; Suvilampi *et al.*, 1999; Huuhilo *et al.*, 2002). Foulants can also be chemically bonded to form flocs through the addition of flocculating chemicals, such as retention aids, fixatives and coagulants, thus preventing them from interacting with the membrane (Nuortila-Jokinen *et al.*, 1998). In addition, ozonation (Nuortila-Jokinen and Nyström, 2001) and electro dialysis (Geraldes and de Pinho, 1995) have also been trialled.

3.2.6 Conclusions

The pulp and paper industry is a complex one with many different kinds of mills, products and processes. Effluents therefore vary significantly in quality depending on the process from which they originate. Due to this complexity the requirements of water and effluent treatment at the different points of the manufacturing process vary significantly. However, it is evident that there is a great demand for an effective separation process, not the least due to the increasing rigour of environmental legislation and its enforcement.

Membrane technologies have been demonstrated as being appropriate for many water recycling duties within the pulp and paper industry. Existing treatment schemes for concentration and fractionation of spent sulphite liquor, deresination and bleaching effluent treatment by ultrafiltration include both conventional tubular modules and high-shear systems. Membranes are particularly advantageous when recovery of both chemical reagents and clarified water is possible. It is likely that future membrane materials and modules tolerant of temperatures close to 100°C and providing high fluxes with low fouling propensity will be developed, and that the ongoing downward pressure on membrane costs will continue to increase the economic competitiveness of this technology for water recycling applications within the industry.

Acknowledgements

The authors wish to thank the Academy of Finland for financial support. Colleagues at the Laboratory of Membrane Technology and Technical Polymer Chemistry at Lappeenranta University of Technology are warmly thanked for their co-operation over the years. Membrane and module as well as chemical manufacturers are acknowledged for kindly giving us their products to test.

References

Afonso, M.D. and de Pinho, M.N. (1991). Membrane separation processes in pulp and paper production. *Filtration Sep.*, **28**, 42–44.

Alho, J., Roitto, I., Nygård, S. and Hietanen, S. (1998). A review on coating effluent treatment by ultrafiltration. Second EcoPaperTech. international conference on economy and ecology in papermaking technology, Helsinki, June, pp. 219–231.

Anon. (1982). How to filter out a better lye. *Pulp Pap. Int.*, **24**, 40.

Anon. (1996). Two examples of membrane filtering with CR filters. Flootek company brochure, Raisio Flootek and Raisio Engineering, Malmö, Sweden.

Beaudoin, L., Lavallée, H.-C., Buisson, H. and Zaidi, A. (1992). Utilisation des technologies d'ultrafiltration et de nanofiltration pour le traitement d'effluents papetiers. *Sci. Tech. de l'Eau*, **25**, 486.

Bentley, D.J. (1999). Mill report: McKinley Paper goes from zero to success in less than four years. *TAPPI J.*, **82**, 59.

British Recovered Paper Association (2002). Waste paper recovery: the facts. <http://www.recycledpaper.org.uk/recovery.htm>, 24 May 2002.

Camatta, R. (1992). Effluent treatment by ultrafiltration. *Pap. Carton Cellul.*, **41**, 33–36.

Carlsson, D.J., Dal-Cin, M.M., Black P. and Lick, C.N. (1998). A surface spectroscopic study of membranes fouled by pulp mill effluent. *J. Membrane Sci.*, **142**, 1–11.

Dal-Cin, M.M., Striez, C.N., Tweddle, T.A., Capes, C.E., McLellan, F. and Buisson, H. (1995). Effect of adsorptive fouling on membrane performance: case study with a pulp mill effluent. *Desalination*, **101**, 155.

Dufresne, R., Lavallee, H.C., Lebrun, R.-E. and Lo, S.-N. (1998). Comparison of performance between membrane bioreactor and activated sludge system for the treatment of pulping process wastewaters. *TAPPI J.*, **81**, 131.

Edelmann, K. (1999a). Water management in papermaking. Conference on Towards Closed Water Systems in Papermaking, Arnhem, the Netherlands, 2 February 1999.

Edelmann, K. (1999b). Closed water circulations and environmental issues in paper production. PI '99, Copenhagen, March, pp. 189–203.

Edelmann, K. (2001). Final report on CACTUS technology program. Technology Development Centre (TEKES), Finland. CD-ROM. ISBN 952-457-028-9.

EIPPCB (European Integrated Pollution and Prevention Control Bureau) (2001). Integrated pollution prevention and control (ICCP). Best available techniques in the pulp and paper industry. <http://eippcb.jrc.es/pages/Factivities.htm>, 24 May 2002.

FAO (2000). Global forest resources assessment 2000. Main report, FAO Forestry Paper 140, ISSN 0258-6150. <http://www.fao.org/forestry/fo/fra/main/index.jsp>, 24 May 2002.

Finnemore, S. and Hackney, T. (2000). Zero discharge at Kronospan Mill: recent advances in wood pulp effluent treatment. *Pap. Technol.*, **41**, 29.

Finnish Forest Industries Federation (2002). Use of recovered paper and board as raw material in Finland 2001, <http://english.forestindustries.fi>, 24 May 2002.

Fälth, F., Jönsson, A.-S. and Wimmerstedt, R. (1999). Membrane filtration – how will it affect the bleach plant? 6th international conference on new available technologies, Stockholm, Sweden, June, pp. 181–188.

Fälth, F., Jönsson, A.-S., Brinck, B. and Wimmerstedt, R. (2000). Ultrafiltration of bleach plant filtrate when using evaporation condensate as washing liquor. *TAPPI J.*, **83**, 1.

Fälth, F., Jönsson, A.-S. and Wimmerstedt, R. (2001a). Ultrafiltration of effluents from chlorine-free, kraft pulp bleach plants. *Desalination*, **133**, 155.

Fälth, F., Pfromm, P.H. and Bryant, P.S. (2001b). Ultrafiltration of E1 stage effluent for partial closure of the bleach plant. *Pulp Pap. Can.*, **102**, 46.

Gavelin, G. (1991). Membrane filtration for purification and reuse of process water (in Swedish). *Svensk Papperstidn.*, **94**, 35.

GAW (2002). New coating colour kitchen for Asia Pulp & Paper. GAW press report. <http://www.gaw.at/englisch/presse/f15-pre.htm>, 18 Sept. 2002.

Geraldes, V. and de Pinho, N.M. (1995). Process water recovery from pulp bleaching effluents by an NF/ED hybrid process. *J. Membrane Sci.*, **102**, 209.

Haagensen, U.H. (1982). Case Sanyo Pulp, Iwakuni, Japan; ultrafiltration of kraft bleach effluent. *De Danske Sukkerfabrikker*.

Haavanlammi, T. (1999). Advanced paper mill water system. AEL-METSKO/Insko-seminar: Closed water circuits in paper mill, P907105/99 IV, Vantaa, Finland, December.

Huhtamäki, M., Sutela, T. and Siivonen, M. (2002). New water management concepts for paper and board mill water recycling and effluent treatment. *Int. Papwirtsch.*, **12**, T200.

Huuhilo, T., Suvilampi, J., Puro, L., Rintala, J., Mänttari, M., Nuortila-Jokinen, J. and Nyström, M. (2002). Internal treatment of pulp and paper mill process waters with a high temperature aerobic biofilm process combined with ultrafiltration and/or nanofiltration. *Paperi ja Puu (Paper and Timber)*, **84**, 50.

Huuhilo, T., Väisänen, P., Nuortila-Jokinen, J. and Nyström, M. (2001). Influence of shear enhanced membrane filtration of an integrated pulp & paper mill circulation water. *Desalination*, **141**, 245–258.

Johnson, G. (2002). Personal communication.

Jönsson, A.-S. and Wimmerstedt, R. (1985). The application of membrane technology in pulp and paper industry. *Desalination*, **53**, 181–196.

Jönsson, A.-S. (1987). Ultrafiltration of bleach plant effluent. *Nord. Pulp Pap. Res. J.*, **2**, 23.

Jönsson, A. S., Blomgren, Y. and Petersson, E. (1988). Influence of pH and surfactants on ultrafiltration membranes during treatment of bleach plant effluent. *Nord. Pulp Pap. Res. J.*, **4**, 159–163.

Jönsson, A.-S. (1989). Treatment of effluent from alkali extraction with ultrafiltration and reverse osmosis. *Nord. Pulp Pap. Res. J.*, **4**, 33.

Jönsson, A.-S. and Petersson, E. (1989). Treatment of C-stage and E-stage bleaching plant effluent by ultrafiltration. *Nord. Pulp Pap. Res. J.*, **4**, 184.

Jönsson, A.-S. (1990). Membrane technique – applications in the forest industry. *Svensk Papperstidn.*, **93**, 32–34; 37–38.

Jönsson, A.-S. and Trägårdh, G., (1990). Ultrafiltration applications. *Desalination*, **77**, 135.

Jönsson, A. S., Jönsson, C., Teppler, M., Tomani, P. and Wannstrom, S. (1996). Recovery of dilute paper coating colour effluents by ultrafiltration. *Filtration Sep.*, **33**, 453.

Kenny, J. (1997). PM 7 aims to make the grade in a difficult market. *Pulp Pap. Int.*, **39**, 36.

Kluter, E.E. (1999). Reduzierung von Frishwasser durch Nierentechnologie (in German). 1st PTS CTP Symposium Environmental Technologies, I. Demel and H.-J. Öller (eds.), Munich, PTS Symposium WU-SY 908 8.

Konishi, Y., Takata, K., Tanida, K. and Takeo, Y. (1998). VSEP: vibratory enhanced processing – application of VSEP for pulp and paper industry. *Jpn Tappi J.*, **52**, 33.

Kothe, K.-D. and Schroth D. (1999). Reduction of fresh water consumption of the paper machine with the CR membrane technology. *Wochenbl. Papierfabr.*, **127**, 19.

Kroesa, R. (1990). The Greenpeace guide to paper. Vancouver Greenpeace Office, p. 56.

Kuide, Y. and Yamamoto, K. (1999). Application of VSEP for pulp and paper industry. *Jpn Tappi J.*, **53**, 76.

Lien, L. and Simonis, D. (1995). Case histories of two large nanofiltration systems reclaiming effluent from the pulp and paper mills for reuse. Proc. TAPPI 1995 Int. Environmental Conference, TAPPI Press, Atlanta, GA, Book 2, pp. 1023–1027.

Luque, S., Alvarez, J.R., Rodriguez, M. and Coca, J. (1994). Kraft black liquor fractionation by ultrafiltration. *Pulping Conference*, San Diego, CA, 6–10 Nov. 1994, TAPPI Press, Atlanta, GA, Book 2, pp. 507–511.

Macleod, M. (1974). Mill achieves maximum reuse of water with reverse osmosis. *Pulp Pap.*, **48**(12), 62.

Mäkinen, M. (2000). Coating colour preparation. In E. Lehtinen (ed.) *Papermaking science and technology: Vol. 11. Pigment coating and surface sizing of paper*. Gummerus, Jyväskylä, Finland, pp. 319–386.

Mänttäre, M. and Takeshita, M. (1997). Evaluation of nanofiltration membranes for filtration of paper mill total effluent. *Filt. Sep.*, **34**, 275.

Mänttäre, M., Nuortila-Jokinen, J. and Nyström, M. (1997). Influence of filtration conditions on the efficiency of NF membranes in the filtration of paper mill total effluent. *J. Membrane Sci.*, **137**, 187–199.

Mänttäre, M., Nuortila-Jokinen, J. and Nyström, M. (1998). Filtration of paper mill effluents using nanofiltration membranes. *International Symposium on Filtration and Separation*, Las Palmas, De Gran Canaria, Spain, 19–20 February.

Mänttäre, M., Martin, H., Nuortila-Jokinen, J. and Nyström, M. (1999). Using a spiral wound nanofiltration element for the filtration of paper mill effluents; pretreatment and fouling. *Adv. Environmental Res.*, **3**, 202.

Mänttari, M. and Nyström, M. (2000). Critical flux in NF of high molar mass polysaccharides and effluents from the paper industry. *J. Membrane Sci.* **170**, 257.

Monroe, M. (1997). VSEP: a new approach for treating effluent from recycle mills. *Prog. Paper Recycling*, **6**, 19.

Myréen, B. (1993). Closed loops in forest industry (in Finnish). Teollisuuden Ympäristötekniikan päivä, Helsinki, Finland.

New Logic Int. (2002). <http://www.vsep.com>, 3 June 2002.

Nuortila-Jokinen, J., Söderberg, P. and Nyström, M. (1995a). UF and NF pilot scale studies on internal purification of paper mill make-up waters. TAPPI 1995 Int. Environmental Conference, 7–10 May 1995. TAPPI Press, Atlanta, GA, Book 2, pp. 847–859.

Nuortila-Jokinen, J., Marin, P. and Nyström, M. (1995b). UF and NF as internal purification methods for the make-up waters of a neutral MFC paper machine. In R. Bowen, R.W. Field, J.A. Howell (eds.) *Proc. Euromembrane '95*. European Society for Membrane Science and Technology, Anthony Rowe Ltd, UK, Vol. I, pp. 521–524.

Nuortila-Jokinen, J. and Nyström, M. (1996). Comparison of membrane separation processes in the internal purification of paper mill water. *J. Membrane Sci.* **119**, 99–115.

Nuortila-Jokinen, J. (1997). Choice of optimal membrane processes for economical treatment of paper machine clear filtrate. Doctoral thesis, Research papers 58. Lappeenranta University of Technology, Lappeenranta, Finland.

Nuortila-Jokinen, J., Kuparinen, A. and Nyström, M. (1998). Tailoring an economical membrane process for internal purification in the paper industry. *Desalination*, **119**, 11–19.

Nuortila-Jokinen, J., Heikkinen, J. and Wasenius, C.-O. (1999). A study on biologically enhanced membrane filtration in a pulp and paper application. *ICOM '99*, Toronto, June, p. 80.

Nuortila-Jokinen, J. and Nyström, M. (2000). Membrane filtration of coating colour effluent. 8th World Filtration Conference, Brighton, March, Vol. 2, pp. 1007–1010.

Nuortila-Jokinen, J. and Nyström, M. (2001). Closing pulp and paper mill water circuits with membrane filtration. *Advanced Membrane Technology*, Barga, Italy, 14–19 Oct. 2001

Nygård, S., Hietanen, S., Alho, J. and Roitto, I. (1998). Coating chemical regeneration by ultrafiltration. 1998 Coating/Papermakers Conference, New Orleans, LA, 4–6 May 1998. TAPPI Press, Atlanta, GA, Book 2, pp 715–729.

Okamoto, H., Mizuhara, M., Numata, Y., Nakagome, K., Ochiimi, T. and Kuroda, A. (1985). Treatment of paper plant waste waters by ultrafiltration. a case history. *ACS Symp. Ser.* 281.

Paleologou, M., Cloutier, J.-N., Ramamurthy, P., Berry, R.M., Azarniouch, M.K. and Dorica, J. (1994). Membrane technologies for pulp and paper applications. *Pulp Pap. Can.*, **95**(10), 36.

Paterson Candy Int. Membrane Systems (1987). Pulp deresination by ultrafiltration at MoDoCell. PCI Membrane Systems TP RO 87.1, Laverstoke Mill, UK.

Pauly, D. (2000). Kidney technology: new ways for integrated process water cleaning in mills using waste paper. 3rd PTS Symposium, Stickies in recycling of waste papers for paper making, Munich, Germany, 13–14 Nov. 2000. Papiertechnische Stiftung, Munich, Germany.

PCI Membrane Systems (1988). Recovery of lignosulfonate fractions by ultrafiltration at Borregaard Industries. PCI Membrane Systems TP RO 88.1, Laverstoke Mill, UK.

de Pinho, M.N., Geraldés, V., Rosa, M.J., Afonso, D., Ganho, R., Gaeta, S., Figueira, H., Taborda, F., Creusen, R., Hanemaaijer, J., Amblard, P., Gavach, C. and Guisard, C. (1995). Water recovery from bleached pulp effluents. 1995 International Environmental Conference, Atlanta, GA, 7–10 May 1995. TAPPI Press, Atlanta, GA, Book 2, pp. 883–892.

de Pinho, M.N., Minhalma, M., Rosa, M.J. and Taborda, F. (1998). Integration of flotation/ultrafiltration for treatment of bleached pulp effluent. International environmental conference and exhibit, Vancouver, Canada, 5–8 April 1998. TAPPI Press, Atlanta, GA, Book 1, pp. 319–327 (ISBN 0-89852-713-9).

Ramamurthy, P., Poole, R. and Dorica, J.G. (1995). Fouling of ultrafiltration membranes during threatment of CTMP screw press filtrates. *J. Pulp Paper Sci.*, **21**(2), J50.

Rosa, M.J. and de Pinho, M.N. (1995). The role of ultrafiltration and nanofiltration on the minimisation of the environmental impact of bleached pulp effluents. *J. Membrane Sci.*, **102**, 155–161.

Salovius, L., Söderman, J., Teppler, M. and Jantunen, E. (1993). The zero effluent paper mill. 18th Int. Mechanical Pulping Conference, Oslo, Norway, 15–17 June 1993. Book 3, pp. 433–448.

Singh, S., Ramamurthy, P. and Matsuura, T. (1997). Treatment of excess white-water and coating plant effluent by modified polyethersulfone ultrafiltration membrane. 1997 Environmental conference and exhibit, Minneapolis, MN, 5–7 May 1997. TAPPI Press, Atlanta, GA, Book 2, pp. 881–898.

Singh, S., Matsuura, T. and Ramamunthy, P. (1999). Treatment of coating plant effluent with an ultrafiltration membrane. *Tappi J.*, **82**(4), 146.

Stevenson, S. (1992). Meadow Lake's zero effluent is good news for Millar Western. *Pulp Pap. Can.*, **93**(10), 13.

Stuffer, P. (1996). Ultrafiltration opens up new avenues to reduced environmental impact of coating processes. *Wochenbl. Papierfabr.*, **124**(13), 598.

Sundholm, P. (2000). Mill operations in production of main paper and board grades. In Paulapuro, H. (ed.) *Papermaking science and technology: Vol. 8: Papermaking, Part 1, Stock preparation and wet end*. Gummerus, Jyväskylä, Finland, pp. 11–55.

Sutela, T. (2002). Metso PaperChem Oy. Oral information, 17 Sept., Finland.

Suvilampi, J., Huuhilo, T., Puro, L., Rintala, J., Nuortila-Jokinen, J. and Nyström, M. (1999). Closing water circuits in pulp and paper mills: internal thermophilic purification using suspended carrier aerobic biofilm process combines with membrane filtration. 4th International Conference on Pulp and Paper Industry, Paperex '99, New Delhi, India, 13–16 Dec., pp. 605–609.

Takehita, Y. (1997). Water treatment method based on membrane technology. 1997 Japan TAPPI annual meeting, Tokyo, Japan, 11–14 Nov. Japan TAPPI, Tokyo, Japan, pp. 435–444.

TAPPI (2001). Paper University: Earthanswers – why recycle? <http://www.tappi.org/paperu/allaboutpaper/earthanswers/Whyrec5.htm>, 3 June 2002

Tardif, O. and Hall, E.R. (1997). Comparison between ultrafiltration and membrane biological reactor treatment for closure of mechanical newsprint mills. 1997 Environmental conference and exhibit, Minneapolis, MN, 5–7 May. TAPPI Press, Atlanta, GA, Book 1, pp. 315–325 (ISBN 0-89852-688-4).

Teppler, M., Bergdahl, J., Paatero, J., Damen, H. and Milichovsky, M. (1998). The treatment and use of waste water on the paper machine. *Pap. Celul.*, **53**(7–8), 167.

Thornton, J. (1993). Dissolved and colloidal substances in the production of wood-containing paper. Doctoral thesis, Abo Akademi University, Turku, Finland.

Thornton, J., Ekman, R., Holmbom, B. and Eckerman, C. (1993). Release of potential “anionic trash” in peroxide bleaching of mechanical pulp. *Paperi ja Puu (Paper and Timber)*, **75**(6), 426.

Webb, L. (1999). IPPC steps up to BAT. *Pulp Pap. Int.*, **41**(4), 29.

Weise, U., Terho, J. and Paulapuro, H. (2000). Stock and water systems of the paper machine. In Paulapuro, H. (ed). *Papermaking science and technology: Vol. 8. Papermaking, Part 1, Stock preparation and wet end*. Gummerus, Jyväskylä, Finland, pp. 123–190.

Zippel, F. (2001). *Water management in paper mills*. Herbrechtingen-Bolheim, Germany, 2nd edition (ISBN 3000082476).

3.3 The textile industry

3.3.1 Categories of textile processing operations

Textile industry processes comprise those which convert natural (e.g. cotton, wool, silk, etc.) and synthetic (e.g. viscose, polyester, acrylic) fibres into fabrics and other products. Four key activities can be identified within this industrial sector (Mattioli *et al.*, 2002):

- the treatment of raw materials (preparation/production of textile fibres/yarns),
- the production of knitted/woven fabrics,
- the finishing of fabrics (i.e. changing some physical property of the fabric to meet the end use requirement), and
- production of products (e.g. garments, carpets, etc) from the fabric.

In 1998 world trade in textiles was worth approximately \$370 billion, or about 6.3% of global merchandise trade (WTO, 1998). USA textile exports account for \$19 billion and imports, principally from Mexico and China, around \$77b. Around 60% of textile production takes place in Europe (29%) and the Americas, with most of the remaining production taking place in Asia (Stengg, 2001). Within the European Union, which is characterised by a large number of small-to-medium enterprises, Italy accounts for 31% of all textile and clothing manufacturing activities – more than double that of the UK (15%), Germany (14%) or France (13%). Most of this activity is accounted for by clothing manufacture.

A number of textile manufacturing processes are chemical wet processing operations necessary to properly prepare, purify, colour or finish the product. This results in the production of wastewater whose pollution load arises not only from the removal of impurities from the raw materials but also from the residual chemical reagents used for processing. The freshwater demand is specific to the type of textile processing operation, the type of material or final product and the specific machine or technique used. However, the water demand for wet processing operations is invariably high (Table 3.19), more than 5000 m³ day⁻¹ for a large mill. The industry is thus perceived as generating large volumes of effluent which are extremely variable in composition and pollution load, the variability arising from the diversity in the types of transformation processes used and the wide range of chemicals involved.

Identifying suitable pollution abatement or water recycling technologies is made difficult by the combining of effluent streams from individual operations, resulting in large variations in effluent chemical composition. Clearly, candidate waste treatment techniques need to be dedicated to individual process effluents, rather than the combined discharge, in order to be reliable and effective. However, this is made extremely difficult in real plants by the sheer number of individual processes contributing to the pollutant load on the combined effluent

Table 3.19 Typical water usage, l kg⁻¹ of product, in textile wet processing of woven fabrics (EPA, 1997)

Subcategory	Minimum	Median	Maximum
Simple processing	12.5	78.4	275.2
Complex processing	10.8	86.7	276.9
Complex processing plus desizing	5.0	113.4	507.9

stream. Effluent reclamation and reuse thus only becomes viable for individual wastewater streams, where the compositional variability is reduced, and/or in cases where either the discharge consents are stringent (or else the discharge costs high) or the treated effluent has some added value. Both these criteria are pertinent to dyeing wastewater streams, where the possibility exists both to recover chemicals and recycle the treated wastewater (Diaper *et al.*, 1996).

As a rudimentary simplification the USEPA grouped the industry into nine categories in promulgating its guidelines (EPA, 1982). Table 3.20 gives effluent characteristics for the seven most important of categories, these being:

- raw wool scouring,
- yarn and fabric manufacturing,
- wool finishing,
- woven fabric finishing,
- knitted fabric finishing,
- carpet finishing, and
- stock and yarn dyeing and finishing.

It should be stressed that the figures quoted in Table 3.20 are average figures for complete processes which may entail a number of individual unit operations. Since many textile processing operations are batch, there are broad temporal variations in effluent quality. Variations also arise even within specific individual operations due to the different designs of the actual technology being used. The selection of suitable strategies for pollution abatement and/or water recycling even for specific unit operations is therefore not straightforward, and has to be considered on a case-by-case basis. On the other hand, and in common with most industrial effluent recycling problems:

- recycling is simplified by segregation of the various waste streams, and
- membrane technologies offer the most promise of all candidate treatment processes on the basis of the treated water quality being largely independent of the feedwater quality.

3.3.2 Effluents from textile processing unit operations

The complete textile manufacturing process involves a number of individual unit operations, each generating effluents of substantially different qualities. For

Table 3.20 Textile processing categories and effluent characteristics (EPA, 1978, 1997)

Parameters	Categories ^a						
	1	2	3	4	5	6	7
BOD/COD	0.2	0.29	0.35	0.54	0.35	0.3	0.31
BOD (mg/l)	6000	300	350	650	350	300	250
TSS (mg/l)	8000	130	200	300	300	120	75
COD (mg/l)	30 000	1040	1000	1200	1000	1000	800
Oil and grease (mg/l)	5500	–	–	14	53	–	–
Total chrome (mg/l)	0.05	4	0.014	0.04	0.05	0.42	0.27
Phenol (mg/l)	1.5	0.5	–	0.04	0.24	0.13	0.12
Sulphide (mg/l)	0.2	0.1	8.0	3.0	0.2	0.14	0.09
Colour (Δ DMI) ^b	2000	1000	–	325	400	600	600
pH	8.0	7.0	10	10	8.0	8.0	11
Temperature (°C)	28	62	21	37	39	20	38
Water usage (l/kg)							
Minimum	4	33	111	5	20	8	3
Median	12	–	284	113	83	47	100
Maximum	78	–	657	507	378	163	557

^a Categories description: 1, raw wool scouring; 2, yarn and fabric manufacturing; 3, wool finishing; 4, woven fabric finishing; 5, knitted fabric finishing; 6, carpet finishing; 7, stock and yarn dyeing and finishing.

^b Δ DMI (American Dye Manufacturers Institute) colour values result from a special procedure for determination of colour in dyeing wastewaters (Allen *et al.*, 1972; Little, 1978).

example, a woven cotton fabric finishing mill (Fig. 3.29) will typically have processes for preparing the material (which will include some or all of the processes of singeing, desizing, scouring/washing, mercerising and bleaching), colouring it (dyeing and printing) and then fixing these colouring reagents mechanically and/or chemically. The process can thus generate up to six different liquid effluents which are conventionally combined to yield an effluent quality similar to that listed under Category 4 in Table 3.20, and discharged to sewer. However, since some components, and dyes in particular, are not readily removed by conventional municipal wastewater treatment, which is based largely on primary sedimentation followed by biological treatment, surcharges or supplementary consents may be in place for discharges of certain textile effluents. A specific UK example of discharge consents based on colour, and specifically UV absorption, imposed by the regulatory body (the Environment Agency) is given in Section 5.7.

Detailed technical descriptions of the most usual operations within the textile industry have been reported by many authors (Cooper, 1978; Nolan, 1972; OECD, 1981), along with effluent water quality data, which generally relates directly to the water at the end of the batch operation which is then discharged. However, many conventional wastewater quality determinants such as COD, TOC, TDS and TSS generally go unreported. Values for other parameters, taken from Cooper (1978), are reported in Table 3.21 along with some water consumption values. The values are subject to considerable variation arising

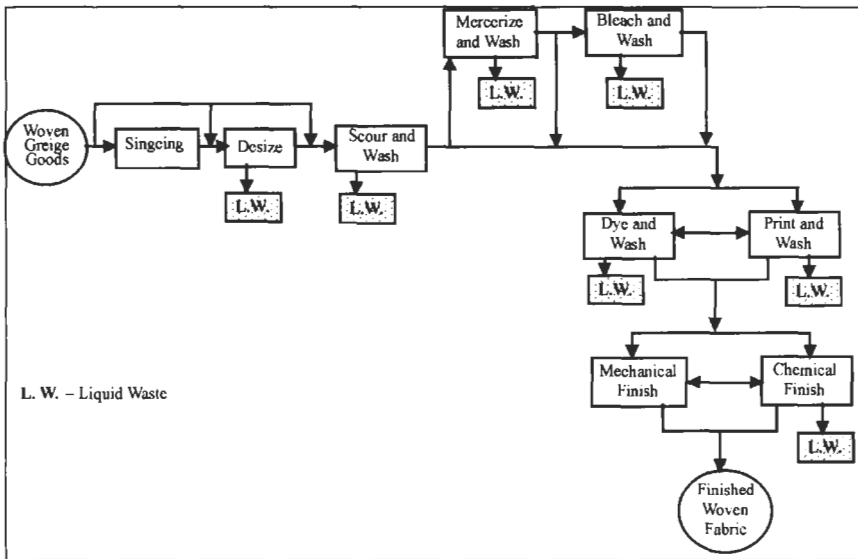

Figure 3.29 Manufacturing processes of woven cotton fabric finishing mills (from Correia et al., 1995)

from differences in design of the specific process technology. For example, beck dyeing with reactive dyes, at around 38 l water per kg fabric, can demand almost 10 times as much water as continuous dyeing with vat dyes (ETBPP, 1997). The data in Table 3.21 thus relate to expected or most probable pollution loads resulting from each wet chemical unit operation in the textile manufacturing process, and do not incorporate the whole range of water qualities that may be encountered in practice. A more comprehensive listing of individual chemical components arising in specific effluent streams is given in Table 3.23.

Specific wet processes used in textile manufacturing are briefly described below. Non-wet processing techniques, such as singeing, printing, mechanical finishing, weaving and fabrication do not give rise to significant quantities of liquid effluent.

Sizing

In the transformation of raw materials to textile products sizing is usually the first process in which wet processing is involved. Substances such as starch, modified starch, polyvinyl alcohol, polyvinyl acetate, carboxymethyl cellulose and gums are applied to the warp in order to increase its tensile strength and smoothness. During this operation wastewater results from the cleaning of sizing boxes, rolls, size mixer and sizing area. Their volume is low but, depending on the recipe used, can contain high levels of BOD, COD and TSS (Cooper, 1978). In the case of 100% synthetic warps sizing, if used, is usually carried out with synthetic polymers. Yarns for use as knitted fabrics are treated with lubricants (mineral, vegetable or ester-type oils) or waxes rather than sizes.

Table 3.21 Pollution loads of textile wet operations (from Cooper, 1978)

Fibre	Process	pH	BOD (mg/l)	S (mg/l)	Water use (l/kg)
Cotton	Desizing	—	1700–5200	16 000–32 000	3–9
	Scouring or kiering	10–13	50–2900	7600–17 400	26–43
	Bleaching	8.5–9.6	90–1700	2300–14 400	3–124
	Mercerising	5.5–9.5	45–65	600–1900	232–308
	Dyeing	5–10	11–1800	500–14 100	8–300
	Scouring	9–14	30 000–40 000	1129–64 448	46–100
Wool	Dyeing	4.8–8	380–2200	3855–8315	16–22
	Washing	7.3–10.3	4000–11 455	4830–19 267	334–835
	Neutralisation	1.9–9	28	1241–4830	104–131
Nylon	Bleaching	6	390	908	3–22
	Scouring	10.4	1360	1882	50–67
	Dyeing	8.4	368	641	17–33
	Scouring	9.7	2190	1874	50–67
Acrylic	Dyeing	1.5–3.7	175–2000	833–1968	17–33
	Final scour	7.1	668	1191	67–83
	Scouring	—	500–800	—	25–42
Polyester	Dyeing	—	480–27 000	—	17–33
	Final scour	—	650	—	17–33
Viscose	Scouring and Dyeing	8.5	2832	3334	17–33
	Salt bath	6.8	58	4890	4–13
Acetate	Scouring and Dyeing	9.3	2000	1778	33–50

Desizing

Desizing removes the substance applied to the yarn in the sizing operation by hydrolysing the size into a soluble form. The methods of desizing, and therefore the wastewater characteristics, vary according to the size used (Table 3.22). Desizing can be as simple as hot washing with detergents for synthetic sizes or more complicated, for example enzyme-augmented degradation, for starch and modified starch (PRG, 1983; Nolan, 1972; OECD, 1981). The pollution load of desizing effluents results from surfactants, enzymes, acids or alkalis used in the size recipes, as well as the sizes themselves (Smith, 1989). The generated wastewater can be the largest contributor to the BOD and TS in a mill effluent (Nolan, 1972), as indicated in Table 3.21. However, if sizing is carried out using synthetic materials BOD and TSS reductions of up to 90% can be achieved on desizing (Smith, 1989).

Scouring

Scouring can be performed on both natural and synthetic materials to remove residual reagents. The intensity of the scouring process is dependent on the type of material. Cotton is scoured to remove natural waxes, pectins, spinning oils and other non-cellulosic components using hot alkaline solutions (caustic soda and soda ash) containing detergents or soaps. Herbicides, insecticides, defoliant and desiccants used in the growing of cotton, along with fungicides, such as pentachlorephenols used to prevent mildew during storage and transportation, can also arise in scouring effluents. Cotton scouring waste liquors are thus chemically aggressive and may be toxic. Their solids content,

Table 3.22 Pollution load from desizing of 50:50 polyester/cotton (PRG, 1983)

Desizing	pH	BOD (mg/l)	TSS (mg/l)	TDS (mg/l)	Oil/grease (mg/l)
Enzyme starch	6-8	3078	6155	1583	288
Polyvinyl alcohol	6-8	200	400	4029	192
Carboxymethyl cellulose	6-8	314	400	4349	751

resulting from the alkali and from impurities in the raw cotton material, is generally high (Table 3.22). Along with desizing, cotton scouring generates very high BOD concentrations. These two processes thus make by far the greatest contribution to effluent BOD in the wet phase processing of cotton goods (Nolan, 1972; Smith, 1989). When synthetic sizes are used desizing and scouring are usually carried out in a single operation. Since synthetic fibres are free from chemical impurities, 100% synthetic fabrics (woven or knitted) require only light scouring in order to remove sizes and lubricants. The process is not normally a significant source of organic or suspended solids pollution. In cases where desizing, scouring and dyeing are performed simultaneously, effluent with an increased pollution load results (Table 3.21).

Raw wool scouring is the highest-polluting operation within the textile industry (Table 3.20). The large volumes of effluent and high levels of contaminants generated by this operation have made it an area of the industry of key concern, and much work has been carried out in this area towards abatement of pollution from this process (BTTG, 1992; Nolan, 1972; OECD, 1981). The pollution load results from impurities present in the raw wool, (wax, urine, faeces, vegetable and mineral dirt, and parasite-control chemicals) together with soap, detergent and alkali used during the scouring and washing processes. The use of some of the more onerous organochlorine chemicals in sheep dipping has been restricted by legislation in recent years, but there remain chemicals such as organophosphates that are still used and so arise in raw wool scouring effluents (Shaw, 1994a,b). Due to their non-biodegradability or toxicity, many impurities in scouring effluents (Table 3.23), such as antistatic agents (synthetic fibres), pesticides, cotton waxes and wool grease or wax, can pose problems in the operation of biological treatment systems. Scouring of woollen goods is generally duplicated downstream to remove added substances. These include oils and weaving sizes or lubricants, which are removed using detergents.

Bleaching

Bleaching removes the natural yellow hue of cotton, increasing its whiteness. This operation is generally required if the finished fabric is to be white or dyed a light colour. It is usually carried out by chemical oxidation with sodium hypochlorite or hydrogen peroxide. Auxiliary chemicals such as sulphuric acid, hydrochloric acid, caustic soda, sodium bisulphite, surfactants and

Table 3.23 Pollutants from textile wet processing operations (Corriea *et al.*, 1995; data from OECD, 1981)

Process/fibres	Substances		Organic (biodegradability) ^a
	Inorganic		
<i>Desizing</i>			
Cotton	Na ⁺	SO ₄ ²⁻	Carboxymethyl cellulose (SB); Enzymes (A); Fats (SB);
Linen	Ca ²⁺	Cl ⁻	Hemicelluloses (A); Modified starches (B); Non-ionic
Viscose	NH ₄ ⁺		surfactants (A); Oils (SB); Starch (B); Waxes (SB)
Silk	Na ⁺	CO ₃ ²⁻	Carboxymethyl cellulose (SB); Enzymes (A); Fats (SB);
Acetates	NH ₄ ⁺	PO ₄ ³⁻	Gelatine (A); Oils (SB); Polymeric sizes (NB);
Synthetics			Polyvinyl alcohol (A); Starch (B); Waxes (SB)
<i>Scouring</i>			
Cotton	Na ⁺		Anionic surfactants (A); Cotton waxes (NB); Fats (SB);
		CO ₃ ²⁻	Glycerol (B); Hemicelluloses (A); Non-ionic
		PO ₄ ³⁻	surfactants (A); Peptic matter (A); Sizes (A); Soaps
			(A); Starch (A)
Viscose	Na ⁺	CO ₃ ²⁻	Anionic detergents (B); Fats (SB); Non-ionic
Acetates		PO ₄ ³⁻	detergents (B); Oils (SB); Sizes (B); Soaps (B);
			Waxes (SB)
Synthetics	Na ⁺	CO ₃ ²⁻	Anionic surfactants (A); Anti static agents (NB); Fats
		PO ₄ ³⁻	(SB); Non-ionic surfactants (A); Oils (SB); Petroleum
			spirit (A); Sizes (B); Soaps (A); Waxes (SB)
Wool (yarn and fabric)	Na ⁺	CO ₃ ²⁻	Anionic detergents (A); Glycol (SB); Mineral oils (SB);
	NH ₄ ⁺	O ₄ ³⁻	Non-ionic detergents (A); Soaps (A)
Wool (loose fibre)	Na ⁺	CO ₃ ²⁻	Acetate (B); Anionic surfactants (A); Formate (B);
	NH ₄ ⁺	PO ₄ ³⁻	Nitrogenous matter (U); Soaps (A); Suint (A); Wool
	K ⁻	Cl	grease (SB); Wool wax (SB)
	Ca ²⁺		
<i>Bleaching</i>			
Cotton		ClO	Formate (B)
Linen	Na ⁺	Cl ⁻	
Viscose	NH ₄ ⁺	O ₂ ²⁻	
Jute		F ⁻	
		SiO ₃ ²⁻	
Acetates		SiO ₃ ²⁻	
		PO ₄ ³⁻	
		F ⁻	
Wool	Na ⁺	O ₂ ²⁻	Oxalate (B)
<i>Mercerising</i>			
Cotton	Na ⁺ NH ₄ ⁺	CO ₃ ²⁻ -SO ₄ ²⁻	Alcohol sulphates (A); Anionic surfactants (A);
Linen			Cresols (A); Cyclohexanol (A)
<i>Carbonising</i>			
Wool	Al ³⁺		Suint (A); Surfactants (A); Wool grease (SB)
	Mn ²⁺	SO ₄ ²⁻	
<i>Fulling</i>			
Wool	Na ⁺	CO ₃ ²⁻	Acetate (B); Formate (B); Soaps (A); Suint (A); Wool
		SO ₄ ²⁻	grease (SB)

Table 3.23 (continued)

Process/fibres	Substances		Organic (biodegradability) ^a
	Inorganic		
<i>Dyeing</i>			
Cotton	Na ⁺ Cr ³⁺	CO ₃ ²⁻ F ⁻	β-Naphthol (A); Acetate (B); Amides of naphtholic acid (B); Anionic dispersing agents (A); Anionic surfactants (A); Cationic fixing agents (NB); Chloramines (SB); Formaldehyde (A); Formate (B); Nitroamines (SB); Non-ionic surfactants; Residual dyes (NB); Soaps (A); Soluble oils (SB); Sulphated oils (A); Tannic acid (A); Tartrate (B); Urea (B)
Viscose	Cu ²⁺	NO ₂ ⁻ O ₂ ²⁻	
Linen	Sb ³⁺ K ⁺ NH ₄ ⁺	S ²⁻ S ₂ O ₃ ²⁻ SO ₃ ²⁻ SO ₄ ²⁻	
Wool	Na ⁺ K ⁺ NH ₄ ⁺ Cr ³⁺ Cu ²⁺ Al ³⁺ Sb ³⁺	SO ₄ ²⁻ SO ₃ ²⁻ CO ₃ ²⁻ Cl ⁻	Acetate (B); Dispersing agents (U); Formate (B); Lactate (B); Residual dyes (NB); Sulphonated oils (A); Tartrate (B)
Polyamide	Na ⁺	CO ₃ ²⁻ Cl ⁻	Acetate (B); Formate (B); Polyamide oligoines (U); Residual dyes (NB); Sulphonated oils (A)
Acrylic	Na ⁺ Cu ²⁺ NH ₄ ⁺	SO ₄ ²⁻	Acetate (B); Aromatic amines (A); Formate (B); Levelling agents (U); Phenolic compounds (A); Residual dyes (NB); Retardants (U); Surfactants (A); Thioreia dioxide (A)
Polyester	Na ⁺ NH ₄ ⁺	S ₄ O ₆ ²⁻ ClO ⁻ NO ₃ Cl ⁻ SO ₃ ²⁻	Acetate (B); Anionic surfactants (A); Anti static agents (NB); Dispersing agents (A); Dye carriers (SB); EDTA (NB); Ethylene oxide condensates (U); Formate (B); Mineral oils (SB); Non-ionic surfactants (A); Residual dyes (NB); Soaps (A); Solvents (A)
<i>Fireproofing</i>			
Cotton	NH ₄ ⁺	PO ₄ ³⁻	Chlorinated rubber (NB); Melamine resin (NB); Synthetic resin binders (U); Tetrabishydroxymethylphosphonium chloride (U); Thiorea resin (NB)
Wool	Na ⁺ Sb ³⁺ Ti ²⁺	B Cl ⁻ ; Br ⁻ NO ₃ ⁻ ; F ⁻	
<i>Mothproofing</i>			
Wool	Na ⁺ K ⁺ ; Al ³⁺	F ⁻	Chlorinated compounds (NB); Formate (B); Pentachlorophenol laurate (NB)
<i>Waterproofing</i>			
Cotton	Na ⁺	Cl ⁻	Acetate (B); Dispersing agents (U); Fluoroacrylic esters (U); Formate (B); Gelatine (B); Melamine resins (NB); Paraffin wax (NB); Silicone resins (NB); Stearamidemethyl pyridinium chloride (NB); Stearate (B); Titanates (NB)
Linen	K ⁺	SO ₄ ²⁻	
Wool	Al ³⁺		

^a B, biodegradable; A, biodegradable after acclimatisation; U, unknown; NB, non-biodegradable; SB, slowly degradable.

chelating agents are generally used during bleaching or in the final rinses, contributing to the pollution load (Cooper, 1978; Nolan, 1972). Bleaching wastewater usually has a high solids content with low to moderate BOD levels (Table 3.21). The dissolved oxygen content of these effluents may be raised by the decomposition of hydrogen peroxide (Porter, 1990), but residual hydrogen

peroxide can cause toxicity problems in biological treatment processes (Cooper, 1978). Only light bleaching, if any, is required when processing 100% synthetic or woollen goods, and the generated wastewater is not a significant source of pollution in such cases (Nolan, 1972).

Mercerising

Mercerisation is performed almost exclusively on pure cotton fabrics, which are treated by a concentrated caustic bath and a final acid wash to neutralise them. Its purpose is to give lustre and also to increase dye affinity and tensile strength. Mercerisation wastewaters have low BOD and total solids levels but are highly alkaline prior to neutralisation (Cooper, 1978; Nolan, 1972). The low BOD content arises from surfactants and penetrating agents used as auxiliary chemicals (Table 3.21).

Carbonising

Carbonisation is performed on woollen items to remove traces of vegetable matter. The process can be carried out either in conjunction with raw scouring or at the fabric processing stage, depending on the level of impurities and the end use of the wool (Cooper, 1978; OECD, 1981). Carbonising consists of soaking the material in dilute sulphuric acid followed by neutralisation with sodium carbonate. The material is then dried and the brittle cellulosic matter mechanically removed. The generally low levels of organic materials in carbonisation effluents are due to vegetable matter, whilst the acid treatment yields high levels of dissolved solids. Performing carbonisation in conjunction with raw wool scouring leads to a reduction in the total pollution load of the scouring waste stream (OECD, 1981).

Fulling

Fulling stabilises woollen fabrics and gives them a thicker and more compact appearance. It is carried out with soda ash or sulphuric acid in the presence of detergents, sequestering agents, metallic catalysts and hydrogen peroxide in conjunction with mechanical agitation (Nolan, 1972; OECD, 1981). The fulling solution is then drained and the treated product extensively washed to remove the remaining chemicals. Fulling wastes in combination with effluents generated by subsequent washing operations present, after raw wool scouring, the largest source of BOD in wool processing wastewaters (Cooper, 1978; Nolan, 1972). Most of the BOD arises from soap, detergents and lubricants and oils added to the wool during the production process.

Dyeing

Dyeing is carried out to add colour to fabrics or yarn. Identification of generic types of dyeing wastewaters is complicated by the diversity of both the dye chemistry and the operational modes of the dyeing process itself. Although rarely toxic, these wastewaters demand special consideration since they are arguably the most problematic of all textile wastewaters, for a number of reasons:

- they are produced in large volumes (around 100–150 l kg⁻¹ textile product for the average dyeing and rinsing operation),
- they are not readily biodegradable, such that conventional municipal wastewater treatment plant will generally remove only around 20–30% of colour associated with synthetic dyes, and
- they require removal to very low levels prior to discharge if consents based on colour are in place.

Dyes are generally small molecules comprising two key components: the chromophores, responsible for the colour, and the auxochromes, which can not only supplement the chromophore but also render the molecule soluble in water and give enhanced affinity toward the fibres (Trotman, 1984). A large number of dyes are reported in specialised literature (Colour Index, 1987). These can be classified both by their chemical structure or their application to the fibre type (Table 3.24). Dyes may also be classified on the basis of their solubility: soluble dyes include acid, mordant, metal complex, direct, basic and reactive dyes; and insoluble dyes include azoic, sulphur, vat and disperse dyes. An alternative dye classification that refers to colour removal technologies (Treffry-Goatley and Buckley, 1991) places the various classes of dyes (with respect to their application) into three groups depending on their state in solution and on the type of charge the dye acquires. Each group can be associated with potential colour-removal methods (Table 3.25).

Complex chemical and/or physical mechanisms govern the adsorption and retention of dyes by fibres. The adsorptive strength, levelling and retention are controlled by several factors such as time, temperature, pH, and auxiliary chemicals (Nunn, 1979; Trotman, 1984; Preston, 1986; Shore, 1990). A large range of substances other than dyes, auxiliary chemicals used in the dyeing process, can be found in a dye effluent at any one time. The effluent composition and colour is further complicated by the fact that both dye fixation rates (Table 3.26) and liquor ratios (the volume of dye solution per weight of goods) vary, and different dye classes may be used for a single dyeing operation (Shore, 1990; Horning, 1978). Moreover, continuous operation yields smaller volumes of more concentrated dyewaste than batch operation, equating to typically a four-fold factorial difference with respect to dye concentration and a 2.5-fold difference in volume (Glover and Hill, 1993), some typical batch process effluent data being given in Table 3.27.

Chemical finishing

Chemical finishing processes include processes designed to change the optical, tactile, mechanical strength or dirt-releasing properties of the textile. Optical finishes can either brighten or deluster the textile (NCDNER, 1995; OECD, 1981). Softeners and abrasion-resistant finishes are added to improve the feel or increase the ability of the textile to resist abrasion and tearing. Absorbent and soil release finishes alter the surface tension and other properties to increase water absorbency or improve soil release. Physical stabilisation and crease-resistant finishes, which may include formaldehyde-based resin finishes,

Table 3.24 Classification of dyes by use and chemical nature (Colour Index, 1987)

Chemical class ^a	Colour index number	Fibre type/dye class															
		Cellulosic					Protein		Cellulose ester		Polyamide		Polyester		Polyacrylic		
		Direct	Sulphur	Azoic	Vat	Reactive	Acid	Mordant	Disperse	Acid	Disperse	Basic	Disperse	Basic	Acid	Disperse	Basic
Nitroso	10000-10299						X	X	X	X	X			X		X	X
Nitro	10300-10999						X	X	X	X	X			X		X	X
Azo	11000-36999	X				X	X	X	X	X	X			X	X	X	X
Azoic	37000-39999			X													
Stilbene	40000-40799	X				X											
Carotenoid	40800-40999	X				X											
Triarylmethane	42000-44999					X	X		X		X		X	X			X
Xanthene	45000-45999					X	X		X		X		X	X			X
Acridine	46000-46999		X								X		X				X
Quinoline	47000-47999	X				X		X	X	X	X	X	X	X	X		X
Methine	48000-48999	X									X		X				X
Thiazole	49000-49399		X		X		X				X		X				X
Azine	50000-50999		X			X			X		X		X	X			X
Oxazine	51000-51999	X	X				X				X		X				X
Thiazine	52000-52999		X		X						X		X				X
Sulphur	53000-54999		X		X												
Anthraquinone	58000-72999	X			X	X	X	X	X	X	X	X	X	X	X	X	X
Indigoid	73000-73999				X		X			X				X			
Phthalocyanine	74000-74999	X	X	X	X	X	X		X		X		X	X			X

^a Does not include all chemical classes.

Table 3.25 Dye classification with respect to colour removal (Treffry-Goatley and Buckley, 1991)

Classification	Dye class	Charge/solution state	Technology
Group I	Disperse	Negatively charged	Coagulation Membrane Oxidation
	Azoic	Colloidal	
Group A	Vat	Anionic Soluble	Adsorption Ion exchange Membrane Oxidation
	Sulphur		
	Acid		
	Reactive		
	Direct		
Group C	Mordant	Cationic Soluble	Adsorption Ion exchange Membrane Oxidation
	Metal complex		
	Basic		

Table 3.26 Percentage unfixd dye for different dye types and applications (ETBP, 1997)

Fibre	Dye type	Unfixd dye, %
Wool and nylon	Acid/reactive dyes for wool	7–20
	Pre-metallised	2–7
	Chromic	1–2
Cotton and viscose	Azoic	5–10
	Reactive	20–50
	Direct	5–20
	Pigment	1
	Vat	5–20
	Sulphur	30–40
Polyester	Disperse	8–20
Acrylic	Modified	2–3

stabilise cellulosic fibres to laundering and shrinkage, imparting permanent press properties to fabrics. Finishing processes generally involve impregnation of the fabric using a padding and mangle technique followed by a fixation step by heat. Subsequent washing may be carried out to remove residual chemicals. Whilst low in volume, the effluents from these finishing operations are extremely variable in composition and can contain toxic organic substances such as pentachlorophenols and ethylchlorophosphates (Table 3.23).

3.3.3 Process water quality requirements

It is generally the case that, in common with many industrial activities, textile processing makes use of mains water whose quality is therefore stipulated by statutory regulations for drinking water. However, water is also provided by abstraction from ground, lake and river water – options made more attractive by

Table 3.27 Characteristics of dyeing effluents (Horning, 1978)

Dye	Fibre	Colour (ADMI)	BOD (mg/l)	TOC (mg/l)	TSS (mg/l)	TDS (mg/l)	pH
Acid	Polyamide	4000	240	315	14	2028	5.1
Mordant	Wool	3200	135	210	9	1086	4.0
1:2 Metal complex	Polyamide	370	570	400	5	3945	6.8
Basic	Acrylic	5600	210	255	13	1469	4.5
Basic	Polyester	1300	1470	1120	4	1360	5.0
Direct	Viscose	12 500	15	140	26	2669	6.6
Direct (cooper treated)	Cotton	525	87	135	41	2763	5.0
Reactive (batch)	Cotton	3890	0	150	32	12 500	11.2
Reactive (continuous)	Cotton	1390	102	230	9	691	9.1
Azoic	Cotton	2415	200	170	387	10 900	9.3
Sulphur (continuous)	Cotton	450	990	400	34	2000	3.7
Vat	Cotton	1910	294	265	41	3945	11.8
Disperse (high temp.)	Polyester	1245	198	360	76	1700	10.2
Disperse (Atmosf. dyeing)	Polyester	315	234	300	39	914	7.8
Disperse	Polyester (carpet)	215	159	240	101	771	7.1
Disperse	Polyamide (carpet)	100	78	130	14	396	8.3
Disperse/acid/basic (continuous)	Polyamide (carpet)	130	160	49	258	6.5	
Disperse/acid/basic (batch)	Polyamide (carpet)	210	42	130	8	450	6.7
Disperse/vat (continuous)	Cotton/polyester	365	360	350	9	691	9.1

the spiralling costs of mains water. Guide values for key water quality determinants are included in Table 3.28 (Mattioli *et al.*, 2002), which includes process water quality data for three operational textile finishing plants in the Como and Prato textile production areas of Italy. It is evident from these guide values that the water quality requirement is less rigorous than that demanded for drinking water by European Union legislation, which additionally has to be bacteriologically safe, such that tertiary-treated wastewater is apparently suitable for reuse (Section 3.1.7).

3.3.4 Legislation

USA

The most important environmental regulation affecting the textile industry in the USA is the Clean Water Act. In 1982 the US Environmental Protection Agency (EPA) promulgated effluent guidelines for the textile manufacturing point source category. The Textile Mills Point Source Category effluent guidelines are listed under 40 CFR (Code of Federal Regulations) Part 410. Part 410 is divided into nine subparts, each applying to a different textile manufacturing subcategory as outlined below. Each subpart contains effluent limitations, new source performance standards (NSPS), and pre-treatment standards. The definition of Subpart D for the woven fabric includes desizing,

Table 3.28 Average process water quality for textile finishing (Mattioli *et al.*, 2002)

Parameter	Lake	Ground	Reclaimed ^a	Guide value
TSS, mg/l	< 1	10	22	10
COD, mg/l	< 10	30	53	30
UV abs. 420 nm	< 0.001	< 0.001	0.02	0.01
pH	7.8	7.5	7.7	7–8
Conductivity, $\mu\text{S}/\text{cm}$	290	200	1600	1800

^a Reclaimed from tertiary-treated wastewater (Section 3.1.7).

bleaching, mercerising, dyeing, printing, resin treatment water proofing, flame proofing, soil repellency application, and special finish application.

Effluent limitations representing the degree of effluent reduction attainable by using either best practicable control technologies (BPT), or best available technologies (BAT) are given for all subcategories. BPTs are used for discharges from existing point sources to control conventional and non-conventional pollutants as well as some priority pollutants. BATs are used to control priority pollutants and non-conventional pollutants when directly discharged into environmental waters. BPT limits for BOD, COD, TSS, sulphide, phenol, total chromium, and pH are set for every category (Subpart), with the exception of Subpart C (Low Water Use Processing Subcategory). Each subpart, with the exception again of Subpart C, also has BAT limits for COD, sulphide, phenols, and total chromium. New source performance standards (NSPS) for BOD, COD, TSS, sulphide, phenols, total chromium, and pH are set for each subcategory. However, for the woven fabric finishing subcategory (Subpart D), the NSPSs are divided into process-specific standards that differ according to the manufacturing operation. The NSPS levels (Table 3.29) are based on mass emission rather than concentration.

The USEPA has also recently developed values for factors related to effluent generation load factors (i.e. mass flow of pollutant per based on unit production) to enable estimation of the effluent load from different textile mills (Table 3.30). In the absence of actual data, these estimates provide some guideline to estimate the extent of environmental impact. Existing textile mills, on the other hand, are able to use this data for benchmarking.

Europe

European legislation is less prescriptive than that of the USEPA, but nonetheless is based on the same principle of BAT. The key European directive is 96/61 Integrated Pollution Prevention and Control, which requires both industrial plant operators and regulators to take an integrated, holistic view of the pollution and resource demand potential of the installation. Central to this approach is appropriate preventative measures against pollution, specifically through the application of the BAT principle to improve environmental performance (Dulio, 2001). It is then left to the individual member states to define BATs, but these must obviously focus on waste minimisation and, ultimately, closed-loop options for industrial water use.

Table 3.29 NSPSs for liquid effluents from cotton woven fabric finishing: 30 day average (1 day maximum) in kg/MT of product (EPA, 1997)

Process	BOD	COD	TSS	Sulphide	Phenol	Chromium	pH
Simple	1.7 (3.3)	26.9 (41.7)	3.9 (8.8)	0.1 (0.2)	0.05 (0.1)	0.05 (0.1)	(6–9)
Complex	1.9 (3.7)	44.2 (68.7)	6.4 (14.4)	0.1 (0.2)	0.05 (0.1)	0.05 (0.1)	(6–9)
Desizing	2.8 (5.5)	38.3 (59.5)	6.9 (15.6)	0.1 (0.2)	0.05 (0.1)	0.05 (0.1)	(6–9)

Table 3.30 Pollutant load in kg m⁻³, median values, from woven fabric finishing (UNEP, 1992)

Sub-category	BOD	COD	TSS	Oil and grease	Phenol	Cr	Sulphide
Simple processing	22.6	92.4	8.0	9.1	8.2	4.3	7.6
Complex processing	32.7	110.6	9.6	3.8	7.7	2.6	12.5
Complex processing plus desizing	45.1	122.6	14.8	4.1	13.1	20.9	N ^a

^a N, sufficient data not available to report.

There exist examples of regulatory bodies imposing discharge consents relating to textile processing activities. One of these concerns the Wigston sewage treatment works in the Severn Trent region of the UK, to which a number of dyehouses were discharging coloured effluents. This resulted in the sewage treatment works, which was of conventional design, discharging coloured effluent into the River Sence. The Environment Agency imposed colour consent limits on the works, which Severn Trent Water, the sewerage operator, passed on to the five dyehouses discharging to the sewage treatment works. This dramatically influenced the economics of effluent recycling, as is explained in the case study in Section 5.7.

3.3.5 Conventional treatment

Conventional technologies for textile wastewater treatment mainly comprise biological treatment, precipitation, coagulation/flocculation, flotation, oxidation and adsorption (Table 3.31), and have recently been reviewed (Vandevivere *et al.*, 1998; Slokar and Le Marechal, 1998; Rott and Minke, 1999; Delée *et al.*, 2002). Since the bulk of the COD for many textile wastewaters is biodegradable most textile effluents are discharged to sewer, sometimes following rudimentary aerobic biological treatment. For high COD loads, such as those arising from desizing of starch or wool washing and scouring, anaerobic pretreatment can be employed (Sacks and Buckley, 1999; Shaw *et al.*, 2002; Delée *et al.*, 2002), although this appears not to have reached commercial scale. Coagulation, often followed by sand filtration, is also extensively used.

The problems imposed by dyewaste, however, are particularly vexing. Biodegradability studies have indicated the feasibility of reducing the BOD and

Table 3.31 Technologies for textile effluent treatment (adapted from Vandevivere *et al.*, 1998)

Process	Stage	Status	Performance	Limitations
<i>Biodegradation</i>				
Activated sludge	Main treatment	Widely used	Bulk COD removal; partial nitrification	High residual COD, ammonia, colour
Sequential anaerobic-aerobic	Main treatment	Few reports of full-scale use	Better COD and colour removal than AS alone	High residual COD, colour
Fixed bed	Main treatment	Pilot trials in China	Better COD and colour removal than AS	Some residual colour
Fungi/H ₂ O ₂	Main treatment	Bench-scale	Full decolourisation	
<i>Physicochemical treatment</i>				
Coagulation-flocculation	Pre-, main or post-treatment	Extensive use	Almost full decolourisation; water reuse	Unreliable performance; sludge disposal
Adsorption	Pre- or post-treatment	Bench- to full-scale depending on adsorbent	Water reuse with newer adsorbents	Sludge disposal or adsorbent regeneration
Membrane filtration	Main or post-treatment	Extensive use in South Africa	Reliable performance; water reuse	Concentrate management
<i>Oxidation</i>				
Ozonation	Post-treatment	Full-scale	Full decolourisation; water reuse	Expensive; aldehydes formed
Fenton's reagent	Pre-treatment	Several full-scale plant in South Africa	Full decolourisation	
Photocatalysis	Post-treatment	Pilot-scale	Near complete colour removal	For final polishing only
Electrolysis	Pre-treatment	Pilot-scale	Full decolourisation	Foaming; limited electrode life

COD or TOC of dyeing wastewaters by biological treatment (Horning, 1978; Pagga and Brown, 1986; Willmot *et al.*, 1998; Lorenço *et al.*, 2001). Biological colour removal is low, however, unless extended retention times (2–3 days) are employed, since most dye molecules are not biodegradable. The partial treatment of dyes by conventional biological processes is attributed to precipitation (in the case of sparingly soluble dyes) or adsorption on the sludge (Porter and Snider, 1976; Weeter and Hodgson, 1975). Reactive and acid dyes, on the other hand, are not adsorbed on biological sludge to any great degree (Hitz *et al.*, 1978; Slokar and Le Marechal, 1998). The problem of colour from reactive dyes in dyeing effluents is further aggravated by their high commercial popularity and generally low fixation rates (as low as 50% for cotton and viscose fibres) relative to other dye classes. Thus, even though they form only around 2% of the COD in dyewaste, they present the most intractable of problems.

Several physicochemical colour removal methods have been employed at full-scale over the years (Table 3.31). Many studies have focused on ozonation (Lin and Lin, 1993; Perkowski *et al.*, 1996; Matsui, 1996) and advanced oxidation (Solozhenkho *et al.*, 1995; Lin and Peng, 1996) which reliably decolourise a wide range of dyewastes, although there has also been some notable success using the proprietary zeolite-based adsorbent Macrosorb. Having said this, all treatments present particular disadvantages. Advanced oxidation is high in capital and/or operating costs and may create mutagenic products. Coagulation creates significant quantities of sludge, as does powdered activated carbon. Adsorption and ion exchange are generally low in capacity, necessitating large quantities of materials. Also, and in common with membrane processes, they produce a concentrated regenerant product or else, in the case of granular activated carbon, demand an expensive regeneration process. Finally, no single process is universally effective against all dye chemicals – although reverse osmosis is certainly the most effective decolouring and desalting process against the most diverse range of dyewastes, and has been successfully employed for recycling (Buckley, 1992). Crucially, only dense membrane processes offer the opportunity to remove dissolved solids (Section 3.1.7), which would otherwise accumulate for any chemical treatment process).

3.3.6 Demand management

Given the exigencies of textile wastewater treatment, and of dyewaste in particular, it is unsurprising that much effort in cost and environmental impact reduction within the industry has been directed at reducing water and chemicals consumption. There are a large number of documented examples of cost savings in textile fabrication facilities through basic low-cost process modification and effective, less profligate water use. Simple reuse of process water from dyeing, rinsing and bleaching operations without further treatment, as proscribed through water auditing techniques such as pinch analysis (Section 4.2), can provide substantial cost benefits (Table 3.32). There are many other examples of cost savings made through substitution of process chemicals for ones less environmentally onerous (such as starch with PVA/acrylates and soaps with

Table 3.32 Process modification cost benefit examples (EPA, 1997; ETPB, 1997)

Company	Action	Cost benefit
Lancashire medical textile company	Elimination of two wash cycles from bleaching process	£1700 reduction in effluent costs
Americal Corporation	Extension of length of dyeing time by 15 minutes to improve exhaustion	60% decrease in BOD and COD; 20% drop in FOG; 98% drop in NH ₃ -N. \$35 000 decrease p.a.
Adams-Millis Co.	Reuse of dyebath for nylon hosiery in rotary drum dyeing machines	35% decrease in water use (\$0.04/kg product)
Bigelow Carpets	Cycling of dyebath water between pairs of dyeing machines to allow reuse over 20 cycles	\$60 000 p.a., plus reduction in effluent BOD and colour
A yarn finishing company	Reuse of rinsewater three times following mercerising, with evaporation to recover caustic Na ₂ CO ₃	Reduction of 80% TSS, 55% COD and 70% in Na ₂ CO ₃ in effluent (and so HCl for neutralisation). \$189 000 p.a. (1 year payback)
North Carolina facility	Bleach bath reuse	50% reduction in effluent COD
Lancashire medical textile company	Recycling of last rinse from beam-and-winch bleaching operation	£2700 p.a.
Wigan dyehouse	Reuse of effluent from bleaching for scouring wash	£10 700 p.a. in effluent disposal and water consumption reduction

synthetic detergents, in both cases to reduce effluent BOD levels), and reuse of other process waters, such as coolant (ETPB, 1997). None of these measures, however, can substantially reduce wastewater discharge to the extent possible through effluent recycling.

3.3.7 Reuse practice and opportunities

Reclamation and reuse

Given the capital intensive nature of ozonation, which represents arguably the most reliable and established decolourisation process, it is perhaps unsurprising that there exist examples of centralised wastewater treatment facilities based on ozonation (Churchley, 1994; Mattioli *et al.*, 2002). For one region, the Como province of northern Italy, there exist two sewage treatment works (Bulgarograsso STW and Fino Mornasco STW) designed to treat wastewater of which around 50% originates from industrial activity and, of this, over 90% from textile processing operations. Both plants, which have a combined capacity of 100 000 m³ per day, are based on conventional primary and secondary treatment with ozonation tertiary treatment following pretreatment either by sand filtration or coagulation/flocculation with lamella settling. Further polishing of the effluent from these works using fixed-film granular activated carbon, i.e. biologically activated carbon or BAC, produced water of a quality found to be suitable for silk degumming and dyeing (Mattioli *et al.*, 2002). Although not extensive, the trial appears to demonstrate the feasibility of recycling of dyewaste that has undergone ozonation tertiary treatment.

Recycling

The textile processes providing the most propitious conditions for application of membranes are fabric coating, desizing, scouring and dyeing. They have been successfully employed at full scale in all these areas for the last 20 years in South Africa, and more recently in other countries.

For two of these operations both the water and the concentrate are reusable. Fabric coating makes use of latex, a relatively expensive chemical, which arises in low concentrations in the effluent as an emulsion, with droplet sizes down to 0.05 μm . The use of ultrafiltration for latex and water recovery allows substantial recovery of the emulsified latex (Groves *et al.*, 1978). The main limitation appears to be from the stability of the latex. Coagulation of the latex on the membrane produces a deposit that can only be removed using appropriate organic solvents and is then no longer recoverable. On the other hand, latex stability can be improved through dosing with appropriate surfactants (Cheryan, 1998). Recovery of synthetic size (polyvinyl alcohol and polyacrylate) is also possible using UF (Porter, 1998), with original reports of successful pilot-scale trials dating back to 1980 (Groves and Buckley, 1980). In this instance the elevated effluent temperature (75°C) both increases the permeate flux and also increases the cost benefit through recovering energy as heat.

Wool scouring produces a high-BOD effluent (Table 3.20) containing detergents, suspended solids, fats, oils and grease (FOG) which can be treated biologically and/or by dissolved air flotation. The use of ultrafiltration, operating at 8–10 bar, permits substantial concentration of the major pollutants in the retentate stream. The concentration factor is typically ~ 7 , producing a retentate very high in organics (10–35 wt% COD). The longest established wool scouring UF plant in Europe is in Norway (Bilstad *et al.*, 1994). This UF plant has been operational since 1989 and achieves > 80% COD removal, nonetheless leaving a filtrate still too high in COD for recycling. An interesting recent development is the emergence of membrane bioreactors for this duty. A zenon hollow fibre submerged MBR has been installed for treating a 13 $\text{m}^3 \text{h}^{-1}$ flow of 3500–5000 mg l^{-1} COD wool scouring wastewater in the UK (Bennett, 2000). Polishing of the effluent by a two-stage reverse osmosis concentrator process, which includes interstage pumping, which is designed to attain an overall recovery of 85% (75% from the first stage and 50% from the second). No performance data has been reported for this system, however.

Reviews of the use of membranes for dyewaste treatment have been presented by a number of authors (Buckley, 1992; Cooper, 1993; Diaper *et al.*, 1996). Although not all membrane applications relate specifically to recycling, it is apparent from the performance attainable in terms of rejection and product water quality (Tables 3.33 and 3.34) that recycling of the permeate is possible in many cases. At least two of the more recent studies (Marcucci *et al.*, 2001; Sójka-Ledakowicz *et al.*, 1998) listed in Table 3.34 have incorporated testing of the recovered water for dyeing. In both cases, it was concluded that the more selective reverse osmosis process was required for a reusable water product.

Dyewaste is characteristically high in dissolved solids and low in suspended solids, with colour arising from exhausted dye (Table 3.20). It is of interest to

Table 3.33 Publications on membranes for dyestuff removal (from Diaper *et al.*, 1996)

Reference	Dye type	Removal process used	Scale, flow (m ³ /day) or membrane area (m ²)	Permeate flux (l/m ² h)	Dyestuff reused	% colour rejection	Permeate reused?	% salt rejection	% water recovery
Buckley (1992)	reactive	NF	0.56 m ² membrane area	33	No	>99	No	80	
Buckley (1992)	soluble and colloidal	dynamic-formed UF	256 m ² membrane area		No	>95	Yes		85
Buckley (1992)	disperse	MF	40 m ³ /day	50	No		Yes		
Treffry-Goatley and Buckley (1993)	soluble and colloidal	MF		15	No	81			
		RO			No	91–94	Yes	98	85–95
Gacta and Pedele (1991)		NF	pilot scale		No		Yes	50	90
Calabro <i>et al.</i> (1991)	Bayer Levalix: red/blue	membrane distillation	lab scale	variable	No				
Majewska-Nowak <i>et al.</i> (1984)	acid orange, methyl red, direct red, direct green, reactive yellow, eriochrome black	UF, polysulphone membranes	15.9 × 10 ⁻⁴ m ² membrane area	2.1–8.3		95–100 ^a			
Majewska-Nowak <i>et al.</i> (1989)	direct green, direct black meta, eriochrome black T	UF, polysulphone membranes	81.2 × 10 ⁻⁴ m ² membrane area	33.3–41.7		>97 ^b		10–20	
Porter (1990)	indigo	UF	full scale		Yes	100	No		>97
Townsend <i>et al.</i> (1992)	direct, vat, disperse and reactive	UF	plant scale	33	No	95	Yes		
Treffry-Goatley and Buckley (1991)	insoluble and anionic acid, metal complex, direct, basic and reactive	RO 2-stage RO	150 m ³ /day 40 m ³ /day		No	90–94	Yes Yes	96	
Majewska-Nowak <i>et al.</i> (1984)	direct meta black	UF, polysulphone membranes	15.9 × 10 ⁻⁴ m ² membrane area	5.8				90–100 ^c	
Porter and Goodman (1984)	direct, disperse, acid basic and reactive	NF, ZrO-PAA on sintered stainless steel	139 m ² membrane area		Yes (partial)	97	Yes		90
Bal <i>et al.</i> (1991)	Ultrazone blue	UF, polyacrylate membrane	lab	83		75–80			

(Table continued on next page)

Table 3.33 (continued)

Reference	Dye type	Removal process used	Scale, flow (m ³ /day) or membrane area (m ²)	Permeate flux (l/m ² h)	Dyestuff reused	% colour rejection	Permeate reused?	% salt rejection	% water recovery
Calabro <i>et al.</i> (1990)	Bayer Levafix; red, blue and red violet	RO	5 m ² membrane area	22–27	No	100			85–95
Watters <i>et al.</i> (1991)	total dyehouse waste stream	UF	0.11 m ² membrane area	27.5–370		34–93			
Majewska-Nowak (1989)	Analogues: direct green, methyl orange, eriochrome black. Actual effluent: direct navy blue, direct violet, direct brown, helion black	UF: polysulphone polysulphone/poly-methyl methacrylate membranes	33.2 × 10 ⁻⁴ m ² , 81.2 × 10 ⁻⁴ m ² membrane area	3.75–5.0, 14.6–39.6		97, 80		12.9–15.4, 8.2–15.3	

^a For dyes with molecular weight > 800.

^b For dyes with molecular weight > 780.

^c For dyes with molecular weight > 739.

Table 3.34 Recent publications on membranes for dyestuff removal

Reference	Dye or matrix	Removal process	Membrane area (m ²)	Permeate flux (l/m ² h)	Colour rejection (or COD)	Permeate reused?	% salt rejection
Akbari <i>et al.</i> (2002)	Acid, direct, disperse, reactive	NF (bespoke)	0.00132	6–18 at 1–4 bar	87–100%	No	~10
Bes-Pia <i>et al.</i> (2002)	Real effluent	Pre-coag, UF, NF (NF70, Film-Tec)	0.009	60 at 1.5 bar, UF: 22, NF	> 97% (COD)	No	85%
Yen <i>et al.</i> (2002)	Real effluent	RO: Film-Tec TW30-1812-50	0.0017	40–60 at 15–45°C, 14 bar; 12–60 at 3.4–14 bar, 45°C	72–98% at 3.4–14 bar, 45–15°C	No	85–98% at 3.4–14 bar and 45–15°C
Voigt <i>et al.</i> (2001)	Real effluent	TiO ₂ NF, MWCO 450 Da	5.1	39–215 at 6–25 bar; 12–60 at CFV 2.5–5 m/s, 15 bar	70–100%	No	
Marlucci <i>et al.</i> (2001); Ciardelli <i>et al.</i> (2001)	Real effluent	PVDF UF, MWCO 70k Da; Osmonics NF, DL4040F SW, 130–300 Da, Film-Tec RO	Single element	–	90% by RO, 0% by UF	Yes (for RO – NF insufficient for reuse)	40% (NF)
Sójka-Ledakowicza <i>et al.</i> (1998)	Analogue and real effluent	Desalination Systems NF (180 MWCO) and RO	0.0081	–	98.7 vs. 99.7, NF vs. RO	Yes	20 vs. 80%, NF vs. RO

retain the dissolved chemicals whilst removing colour down to very low levels. Ultrafiltration membrane processes allow selective recovery of sparingly soluble dyes, such as indigo, but downstream reverse osmosis is then usually required to remove soluble dyes (Cheryan, 1998; Woerner *et al.*, 1996; Marcucci *et al.*, 2001; Sójka-Ledakowicz *et al.*, 1998). Having said this, some interesting results have been reported by Porter and his various co-workers whereby low molecular weight anionic dyes were found to be substantially rejected by a titanium dioxide microfiltration membrane (Zhang, 1996; Porter and Gomes, 2000). This was attributed to charge rejection, and charged UF membranes have been successfully employed in South Africa for selectively recovering water and dissolved salts (Erswell *et al.*, 1988).

Most operating membrane-based dyewaste recovery and reuse systems ultimately make use of reverse osmosis or nanofiltration to decolourise. Payback periods are invariably long even where freshwater costs are high, although two bench-scale studies have reported calculated operating costs of between \$0.5 and \$1 per m³ product (Voigt *et al.*, 2001; Ciardelli *et al.*, 2001). For two South Africa installations the payback ranges from just less than three years for an NF process (Buckley, 1992), to over seven years for a system combining ceramic UF with RO (Short, 1993). A payback period of 1.37 years was quoted for a UF/NF plant in North Carolina (NCDENR, 1995), although no further detail was given. Given the continuing downward pressure on membrane costs, the increasing stringency of environmental regulations worldwide and the history of the employment of membranes for textile wastewater treatment and recycling in certain regions of the world, and South Africa in particular, it seems inevitable that the use of membranes for this duty will become more widespread in years to come.

References

- Allen, W., Prescott, W.B., Derby Jr, R.E., Garland, C.E., Peret, J.M. and Saltzman, M. (1972). Determination of color of water and wastewater by means of ADMI color values. Proc. 28th Ind. Waste Conf., Purdue University, Lafayette, IN, pp. 661–675.
- Akbari, A., Desclaux, S., Remigy, J.C. and Aptel, P. (2002). Treatment of textile dye effluents using a new photografted nanofiltration membrane. *Desalination*, **149**, 101–107.
- Bal, A.S., Malewar, C.G. and Vaidya, A.N. (1991). Development of non-cellulosic membranes for wastewater treatment. *Desalination*, **83**, 325–330.
- Bennett, A.R. (2000). Recovery of wool scouring effluent utilising membrane bioreactor (MBR) technology as part of the activated sludge system followed by two-stage reverse osmosis (RO) membrane concentration. In Hillis, P. (ed.) *Membrane technology in water and wastewater treatment*, Specialist publication 249, RSC, pp. 219–225.
- Bes-Piá, A., Mendoza-Roca, J.A., Alcaina-Miranda, M.I., Iborra-Clar, A. and Iborra-Clar, M.I. (2002). Reuse of wastewater of the textile industry after its

treatment with a combination of physicochemical treatment and membrane technologies. *Desalination*, **149**, 169–174.

Bilstad, T., Espedal, E. and Madland, M. (1994). Membrane separation of wool scour effluent. *Water Sci. Technol.*, **29**, 251–256.

BTTG (1992). Water management and effluent treatment in wool scouring industry. British Textile Technology Group, UK.

Buckley, C.A. (1992). Membrane technology for the treatment of dyehouse effluents. *Wat. Sci. Technol.*, **25**, 203–209.

Calabro, V., Pantano, G., Kang, G., Molinari, R. and Drioli, E. (1990). Experimental study on integrated membrane processes in the treatment of solutions simulating textile effluents. Energy and exergy analysis. *Desalination*, **78**, 257–277.

Calabro, V., Drioli, E. and Matera, F. (1991). Membrane distillation in the textile wastewater treatment. *Desalination*, **83**, 209–224.

Cheryan, M. (1998). *Ultrafiltration and microfiltration handbook*. Technomic, Basel, pp. 388–393.

Churchley, J.H. (1994). Removal of dyewaste colour from sewage effluent – the use of a full-scale ozone plant. **30**, 275–284.

Ciardelli, G., Corsi, L. and Marcucci, M. (2001). Membrane separation for wastewater reuse in the textile industry. *Resources, Conservation and Recycling*, **31**, 189–197.

Colour Index, 3rd Revision (1987). Society of Dyers and Colourists (UK) and the American Association of Textile Chemists and Colourists (USA).

Cooper, S.G. (1978). *The textile industry, environmental control and energy conservation*. Noyes Data Co., Park Ridge, NJ.

Cooper, P. (1993). Removing colour from dyehouse wastewaters – a critical review of technology available. *J. Soc. Dyers and Colourists*, **109**, 97–100.

Delée, W., O'Neill, C., Hawkes, F.R. and Pinheiro, H.M. (2002). Anaerobic treatment of textile effluents: a review. *J. Chem. Technol. Biotechnol.*, **73**, 323–355.

Diaper, C., Correia, V.M. and Judd, S.J. (1996). The use of membranes for the recycling of water and chemicals from dyehouse effluents; an economic assessment. *J. Soc. Dyers and Colourists*, **112**, 273–282.

Dulio, V. (2001). *Integrated pollution prevention and control (IPPC) – reference document on best available techniques for the textile industry*. Draft document.

EPA (1978). *Textile processing industry*, EPA-625/778-002. US Environmental Protection Agency, Washington.

EPA (1982). *The Textile Mills Point Source Category effluent guidelines*. 40 CFR Part 410.

EPA (1997). *Profile of the textile industry*, EPA-310-R-97-009. US Environmental Protection Agency, Washington.

Erswell, A., Brouckaert, C.J. and Buckley, C.A. (1988). The reuse of reactive dye liquors using charged ultrafiltration membrane technology. *Desalination*, **70**, 157–167.

ETBPP (1997). Water and chemical use in the textile dyeing and finishing industry. Guidance note GG62.

Gaeta, S.N. and Fedele, U. (1991). Recovery of water and auxiliary chemicals from effluents of textile dyehouses. *Desalination*, **83**, 183–193.

Glover, B. and Hill, L. (1993). Waste minimization in the dyehouse. *Textile Chemist and Colorist*, **25**, 15.

Groves, G.R. and Buckley, C.A. (1980). Treatment of textile effluents by membrane separation processes. In *Proc. 7th Int. Symp. on Fresh Water from the Sea*. Eur. Fed. Chem. Eng., **2**, 249–257.

Groves, G.R. and Buckley, C.A., and Dalton, G.L. (1978). Textile size and water recovery by means of ultrafiltration. *Prog. Wat. Tech.*, **10**, 269–277.

Hitz, H.R., Huber, W. and Reed, R.H. (1978). The adsorption of dyes on activated sludge. *J. Soc. Dyers and Colourists*, **92**, 71.

Horning, R.H. (1978). Textile dyeing wastewaters: characterization and treatment. US Department of Commerce, National Technical Information Service (PB-285 115).

Lin, S.H. and Lin, C.M. (1993). Treatment of textile waste effluents by ozonation and chemical coagulation. *Water Res.*, **27**, 1743–1748.

Lin, S.H. and Peng, C.F. (1996). A continuous treatment of textile wastewater by combined coagulation, electrochemical oxidation and activated sludge. *Water Res.*, **30**, 587–592.

Little, L.W. (1978). Measurement of color in textile dyeing wastewater. *Proc. Symp. Textile Ind. Technol.*, Williamsburg, VA, pp. 307–310.

Lorenço, N.D, Noucis, J.M. and Pinheiro, H.M. (2001). Effect of some operational parameters on textile dye biodegradation in a sequential batch reactor. *J. Biotechnol.*, **89**, 163–174.

Majewska-Nowak, K. (1989). Synthesis and properties of polysulphone membranes. *Desalination*, **71**, 83–95.

Majewska-Nowak, K. and Winnicki, T. (1984). The usability of polysulphone membranes for removal of organic dyes from aqueous solutions. *Studies in Environmental Science*, **23**, 387.

Majewska-Nowak, K., Winnicki, T. and Wisniewski, J. (1989) Synthesis and properties of polysulphone membranes. *Desalination*, **71**, 127.

Marcucci, M., Nosenzo, G., Capannelli, G., Ciabatti, I., Corrieri, D. and Ciardelli, G. (2001). Treatment and reuse of textile effluents based on new ultrafiltration and other membrane technologies. *Desalination*, **138**, 75–82.

Matsui, M. (1996). Ozonation. In Riefe, A. and Freeman, H. (eds.) *Environmental chemistries of dyes and pigments*. Wiley, London.

Mattioli, D., Malpei, F., Bortone, G. and Rozzi, A. (2002). Water minimisation and reuse in the textile industry. In Lens, P., Hulshoff Pol, L., Wilderer, P. and Asano, T. (eds.) *Water recycling and resource recovery in industry*. IWA Publishing, London, pp. 545–584.

NCDNER (1995). Case study: Sara Lee Knit Products, North Carolina Department of Environment and Natural Resources.

Nolan, W.F. (1972). Analysis of water pollution abatement in the textile industry. MSc thesis, Clemson University, Clemson, USA.

Nunn, D.M. (1979). The dyeing of synthetic polymers and acetate fibres. Dyers Comp. Pub. Trust.

OECD (1981). Emission control in the textile industry. Organisation for Economic Cooperation and Development, Paris.

Pagga, N. and Brown, D. (1986). The degradation of dyestuff: Part II. Behaviour of dyestuffs in aerobic biodegradation tests. *Chemosphere*, **15**, 479.

Perkowski, J., Kos, L. and Ledakowicz, S. (1996). Application of ozone in textile wastewater treatment. *Ozone Sci. Eng.*, **18**, 73–85.

Porter, J.J. (1990). Membrane filtration techniques used for recovery of dyes, chemicals and energy. *Am. Dyestuff Rep.*, **22**, 21.

Porter, J.J. (1998). Recovery of polyvinyl alcohol and hot water from the textile wastewater using thermally stable membranes. *J. Membrane Sci.*, **151**, 45–53.

Porter, J.J. and Goodman, G.A. (1984). Recovery of hot water, dyes and auxiliary chemicals from textile waste streams. *Desalination*, **49**, 185–192.

Porter, J.J. and Gomes, A.C. (2000). The rejection of anionic dyes and salt from water solutions using a polypropylene microfilter. *Desalination*, **128**, 81–90.

Porter, J.J. and Snider, E.H. (1976). Long-term biodegradability of textile chemicals. *J. Water Poll. Control Fed.*, **48**, 2198.

Preston, C. (1986). The dyeing of cellulosic fibres. Dyers Comp. Pub. Trust.

PRG (1983). A guide for the planning, design and implementation of wastewater treatment plants in the textile industry: Part 1. Closed loop treatment/recycle system for textile sizing/desizing effluents. Pollution Research Group, Pretoria, South Africa.

Rott, U. and Minke, R. (1999). Overview of wastewater treatment and recycling in the textile processing industry. *Wat. Sci. Technol.*, **40**(1), 137–144.

Sacks, J. and Buckley, C.A. (1999). Anaerobic treatment of textile size effluent. **40**(1), 177–182.

Shaw, T. (1994a). Agricultural chemicals in raw wool and the wool textile industry. *J. Inst. Water Env. Management*, **8**, 287.

Shaw, T. (1994b). Mothproofing agents in UK wool textile effluents. *J. Inst. Water Env. Management*, **8**, 393.

Shaw, C.B., Carliell, C.M. and Wheatley, A.D. (2002). Anaerobic/aerobic treatment of coloured textile effluents using sequencing batch reactors. *Water Research*, **36**, 1993–2001.

Shore, J. (1990). Colorants and auxiliaries. Organic chemistry and application properties: Vol. 2. Auxiliaries. Society of Dyers and Colourists, UK.

Short, C.L. (1993). Decoloring dyewaste. *Membrane Industry News*, Westford, MA, November.

Slokar, Y.M. and Le Marechal, A.M. (1998). Methods of decoloration of textile wastewaters. *Dyes and Pigments*, **37**, 335–356.

Smith, B. (1989). Pollutant source reduction: Part I. An overview. *American Dyestuff Reporter*, **78**(3), 28.

Sójka-Ledakowicza, J., Koprowskia, T., Machnowskia, W. and Knudsen H.H. (1998). Membrane filtration of textile dyehouse wastewater for technological water reuse. *Desalination*, **119**, 1–9.

Solozhenkho, E.G., Soboleva, N.M. and Goncharuk, V.V. (1995). Decolourisation of azodye solutions by Fenton's oxidation. *Water Res.*, **29**, 2206–2210.

Stengg, W. (2001). The textile and clothing industry in the EU. *Enterprise papers* no. 2.

Townsend, R.B., Neytzell-de Wilde, F.G., Buckley, C.A., Turpie, D.W.F. and Steenkamp (1992). Use of dynamic membranes for the treatment of effluents arising from wool scouring and textile dyeing effluents. *Water SA*, **18**, 81–86.

Treffry-Goatley, K. and Buckley, C.A. (1991). Survey of methods available for removing textile colour from waste water treatment works discharge. Proceedings of the 2nd Biennial Conference/Exhibition, Water Institute of Southern Africa, World Trade Center, Kempton Park, South Africa, May.

Treffry-Goatley, K. and Buckley, C.A. (1993). The application of nanofiltration membranes to the treatment of industrial effluent and process streams. *Filtration and Separation*, **30**, 63–66.

Trotman, E.R. (1984). *Dyeing and chemical technology of textile fibres*. Wiley Interscience, USA, 6th edition.

UNEP (1992). *Textile industry and the environment*. Technical Report No. 16, United Nations Environment Programme.

Vandevivere P.C., Bianchi, R. and Verstraete (1998). Treatment of reuse of wastewater from the textile wet-processing industry: review of emerging technologies. *J. Chem. Technol. Biotechnol.* **72**, 289–302.

Voigt, I., Stahn, A.M., Wöhner, S., Junghans, A., Rost, J. and Voigt, W. (2001). Integrated cleaning of coloured waste water by ceramic NF membranes. *Sep. Purification Technol.*, **25**, 509–512.

Watters, J.C., Biagtan, E. and Senler, O. (1991). Ultrafiltration of a textile plant effluent. *Separation Sci. Technol.*, **26**, 1295–1313.

Weeter, D. and Hodgson, A. (1975). Alternatives for biological waste treatment of dye wastewaters. *American Dyestuff Reporter*, **66**, 32.

Willmott, N., Guthrie, J. and Nelson, G. (1998). The biotechnology approach to colour removal. *J. Soc. Dyers and Colourists*, **114**, 38–41.

Woerner, D.L., Farias, L. and Hunter, W. (1996). Utilization of membrane filtration for dyebath reuse and pollution prevention. In *Proc. Workshop on Membranes and Filtration Systems*, Hilton Head, SC, February, pp. 140–151.

WTO (1998). *World Trade Organisation report*.

Yen, H.Y., Kang, S.-F. and Yang, M.-H. (2002). Separation of textile effluents by polyamide membrane for reuse. *Polymer Testing*, **21**, 539–543.

Zhang, S. (1996). Filtration studies of sodium nitrate and Direct Red 2 dye using asymmetric titanium dioxide membranes on porous ceramic tubes. *NAMS '96*, Ottawa, 18–22 May, p. 49.

3.4 The beverage industry

The food and beverage industries are major consumers of water, with the beverage industry in particular consuming as much as 10–12 tonnes of water per tonne of product – or even more for brewing. The majority of water consumed in this industry is used in washing and cleaning operations, and as such represents significant opportunities for reclaim and recycling. Global water usage within the two sectors is difficult to define, but some available data for beverage production (Table 3.35) suggest global usage of around two billion (i.e. thousand million) tonnes of water per annum. The food industry in the USA alone consumes 4 billion tonnes of water per annum – 50% more than the second largest user, the pulp and paper industry (Levine and Asano, 2002).

The food and beverage industries do not generally reuse or recycle water which is either used in or comes into contact with the product. This is primarily a marketing and public perception issue in the same way as recycling of sewage effluent for potable water has significant consumer acceptance problems (Section 1.1). Since a significant amount of water in the industry does not go into the product, opportunities still exist for water reuse and the quality of water required for use in the product is not normally of concern for recycling. However, the water quality demanded for washing the product or product containers purposes is usually of potable standard, and there is still a reluctance to use recycled water even for these duties. Recycled water must be either recycled at the point of use to avoid additional contamination or recycled to non-product uses, such as utilities (usually power generation and heat transfer) and washing. Fortunately, because food, dairy and, in particular, brewing processes are energy intensive, the utility water consumption in boilers and coolers is quite high and can demand up to twice as much water as the primary production process.

3.4.1 Point of use recycling opportunities

Bottle washers

In the dairy and beverage industries the bottle washer is a significant user of water, and most washers have a make-up water flow rate to the final rinse of about 10–20 m³ h⁻¹ (which equates to 250 ml per bottle). A proportion of this water is used to pre-rinse the bottles but a significant part of this final rinse water is discharged to drain. The water is generally low in turbidity with a pH of about 10.5 and a conductivity of about 2500 µS cm⁻¹.

Table 3.35 Global water use, beverage industry

	Volume, m ³ p.a.	Global water use, m ³ p.a.	Average weight ratio
Soft drinks	380 000 000	1 140 000 000	3
Breweries	136 000 000	952 000 000	7

Several systems have been used to recycle this water, with various degrees of water product purity. Filtration, pH adjustment and chlorination does not address the high TDS and demands a constant bleed: the treated water quality does not meet potable guidelines and consequently this system has only been used in the event of severe water shortages. Carbon dioxide addition, dealkalisation by ion exchange and UV sterilisation represents an improvement over filtration-based methods and has been implemented in some German facilities. Filtration followed by pH correction and reverse osmosis has been used only in very few installations because of the high capital and operating cost, and can only be justified where both the water and effluent costs are high.

In the majority of cases the water from the final rinse can be used virtually untreated in applications such as crate washers and as pasteuriser make-up after cooling. In addition the water can be collected and used for floor washing. Because the cost of treatment in these cases is negligible, most of the reclaim applications adopt these procedures.

A recent example of water recycling and reuse is at the Coca Cola Amatil plant in New South Wales (Environment Australia, 2001). Two simple recycling initiatives have been undertaken at this plant, the first involving reuse of the backwash water and the second the reuse of container rinse water. Interestingly, the first of these, which recovers around $200 \text{ m}^3 \text{ day}^{-1}$ of backwash water from the sand and carbon filters, appears to be blended with the mains water and reused in the manufacturing process. The blend is maintained at less than 1:5 recovered:mains water. The payback time for the recycling system, which comprises pipework and a backwash water recovery tank, is estimated to be around two years. The recovered container rinse water, on the other hand, is used in the evaporative cooling towers following filtration. About $16 \text{ m}^3 \text{ day}^{-1}$ is recovered for this duty.

Caustic recovery

In the majority of food and beverage applications a large amount of caustic soda is used for bottle washing and CIP (clean in place) applications. The disposal of the spent caustic solution is problematic and expensive. In most cases the effectiveness of the caustic solution is assessed by assaying for carbonate contamination or dirt content; when these levels reach a certain limit the solution is disposed of. The caustic content may still be quite high, however, and nanofiltration membranes have been developed (Koch and PCI Memtech) to clean and concentrate the spent caustic solution. The process plant for this duty is quite expensive, and the economics are such that the plant is only justified if the caustic volume used and cost of its disposal are both very high.

Bottle or can pasteurisers

An improperly balanced pasteuriser can use a large amounts of water which is often discharged direct to drain. In most cases this water can be recycled back to the pasteuriser directly after cooling and filtration. Checks must be made on product contamination in the case of bottle pasteurisers.

Maltings steep water

A significant amount of water is used as steep water in maltings, where the water is used to soak the barley. The effluent contains a high concentration of organics, making it expensive to dispose of. Trials at several maltings have shown that nanofiltration membranes or some types of reverse osmosis membranes can produce water suitable for reuse (PCI Memtech). The cost of the effluent disposal is not reduced, however, as the organic loading rate from the retentate stream to drain remains the same.

Milk processing/condensate

Membranes have been used for many years in the dairy industry for process separation applications (Cheryan, 1998). Across the whole food industrial sector dairy applications probably account for the largest proportion of installed membrane capacity. Indeed, it is the selectivity of the membrane filtration processes, in terms of retentate molecular size, which allows fractionation of milk to produce cream and skimmed milk by microfiltration and protein from lactose by ultrafiltration. Since a key membrane property is its thermal stability, generally to around 50–55°C to permit operation at lower fluid viscosities, and chemical stability, to permit more aggressive chemical cleaning and sanitation, polysulphone, polyethersulphone or PVDF membranes (Table 2.3) are generally used.

The use of membranes for other applications such as condensate recovery is now an established technology. In powdered milk production facilities a large amount of steam is used for evaporation purposes, and the condensate recovered from the evaporators is both hot and relatively pure. This makes it ideal for make-up water for the boilers. To remove the organic contaminants special high-temperature reverse osmosis membranes (Duratherm Excel by Desal) are used and the reverse osmosis plants are equipped with sophisticated CIP systems to clean the units on a daily basis.

Other applications

Other membrane applications have been used in various industries for effluent reduction and product recovery. These include cross-flow microfiltration for beer recovery from tank bottoms (Vivendi Memcor) and vibrating membranes for beer recovery from spent yeast processing (Pall VMF[®], Section 2.1.4). These applications can normally be economically justified from savings based not on water but on product recovery and reuse.

3.4.2 End of pipe recovery opportunities

As mentioned in previous sections, once the effluent has been mixed and the risk of contamination has increased, the potential uses of the water are reduced. Effluent from most UK food and beverage industries is discharged direct to sewer and the associated costs paid. To recycle effluent would first involve an effluent treatment plant, generally employing primary biotreatment for high organic loadings with downstream polishing using depth and/or membrane filters,

possibly preceded by coagulation. In many cases such an option is only marginally economically viable given the current level of effluent charges, cost of plant maintenance and the incentives provided by water companies to keep discharging to drain. However, having treated the effluent to a reasonable level, the costs of treating to a standard suitable for recycling and thereby avoiding water costs often shifts the economics in favour of the plant recycling option.

The economic case is further enhanced if (as in the case of the food and drinks industry) the water is reused in high-quality applications such as boiler feed. This is because the quality of water produced by an RO plant is generally of a higher quality, with reference to key parameters such as hardness, silica and total dissolved solids, than mains water. It is almost certain that the company will already have to treat the mains water separately for boiler use. Often the quality of the RO recycled water will be better than the current feedwater and so that savings in boiler chemicals and heat can be made. When all of these factors are evaluated, the economic case for effluent treatment and recycling may be justified. Several effluent recovery and reuse plants have already been installed in the UK, and it is likely that once the treatment and pretreatment regimes have been established and proved many more will follow.

General aspects of plant design and operation

Many plants have used biological treatment plants with filtration and chlorination prior to cellulose acetate-based reverse osmosis. This can work successfully providing the level of filtration (sometimes dual media filtration) is sufficient. The cellulose acetate (CA) membranes are less prone to fouling and can tolerate a chlorine residual (Table 2.3), so biological fouling is reduced. Unfortunately CA membranes are not as widely used within the industry because of higher power costs, and lower rejections and pH tolerance. Composite polyamide membranes are more commonly used and can be used successfully, but pretreatment becomes more critical since they are more prone to fouling than CA membranes. In a few plants employing tertiary media filtration severe problems have been encountered in maintaining the flux within the RO plant. In most cases either a membrane biological treatment process (i.e. a membrane bioreactor, MBR) is required or alternatively ultrafiltration must be used as the basic pretreatment step. The UF configuration and cleaning regime will depend on the upstream process, as determined by pilot trials.

With an effective UF plant or an MBR as pretreatment, the use of polyamide RO membranes should not cause a problem. It is advisable however to use much higher fouling allowances (such as 30–50%), such that the pump pressures are significantly higher than design projections based on osmotic pressure alone. It has been found in some plants that following initial organic fouling the membrane flux drops to a sustainable level. This must be allowed for in the plant design, and can normally be determined by pilot trials.

Biological fouling can normally be controlled by biocide addition. This can be carried out periodically on line using a non-oxidising biocide, but can only be employed if, as in most cases, the water is not being used for potable applications. In some cases chloramine formation has been used successfully to protect the

membranes. In this case pH control is critical, since at higher pH levels chloramine dissociation takes place resulting in damage to the membrane.

References

Cheryan, M. (1998). *Ultrafiltration and microfiltration handbook*. Technomic, Basel, pp. 349–369.

Environment Australia (2001). *Cleaner production – recovery and reuse of filter backwash water – Coca-cola Amatil (NSW) Pty Ltd*. Environment Australia web site, www.ea.gov.au/industry/eecp/case-studies/cca.html (Accessed February 2003).

Levine, A.D. and Asano, T. (2002). *Water reclamation, recycling and reuse in industry*. In Lens, P., Hulshoff Pol, L., Wilderer, P. and Asano, T. (eds.) *Water recycling and resource recovery in industry*. IWA Publishing, London, pp. 29–52.

3.5 Pure waters in the pharmaceutical industry

3.5.1 Background

The pharmaceutical industry is a global one with multinational companies carrying out research and development activities, clinical trials and production on different continents and supplying the products to virtually every country of the world. The industry is relatively unaffected by the “bear” and “bull” markets that typically exert a dramatic effect on other high-technology industries, such as electronics. The market for pharmaceutical products continues to grow as new drugs are developed to treat more and more previously untreatable conditions. This development is being sustained or even accelerated by the new biotechnology-based products passing through clinical trials and coming onto the market.

A pharmaceutical company uses water for many different purposes, many of these being unrelated to the pharmaceutical activities of the company. For such general applications for water, such as for boiler feed, heat transfer, toilet flushing, showering, laundering, fire control, etc., recycle and reuse considerations are no different to those within other industrial sectors: they are applications that require a water feed and generate an effluent stream, and may or may not be suitable applications for utilising recovered water based on water quality, quantity and processing costs. However, there is nothing about these applications that is changed by their being carried out within a pharmaceutical organisation.

Water is used extensively in the pharmaceutical industry and it is the most frequently used ingredient of pharmaceutical preparations. There are a wide range of products and intermediate products that require a reliable supply of water during their manufacture, including:

- bulk pharmaceutical compounds/active pharmaceutical intermediates (APIs),
- over-the-counter (OTC) products – cough medicines, paracetamol, contact lens cleaners, etc.,
- prescription medicines (tablets, ointments, creams, liquids),
- “health” foods (vitamin tables, energy drinks),
- “cosmeceuticals” (antiseptic ointments, concealers),
- aerosols/inhalers, and
- injectable drugs.

The importance of water and water quality was increased enormously by the introduction of parenteral (injection and intravenous infusion) therapy. Water may be a raw material, a process intermediate, a product ingredient, or even the product itself. Its wide use in many areas related to the production and control of medicines demands that manufacturers pay very close attention to process water quality. Further, apart from “mechanical” errors such as mistakes in labelling of products, final product recalls for problems which can be related back to the water used in production of the drug accounts for the next largest group of product recalls.

In planning and operating a pharmaceutical water system the following are a few of the areas that must be considered:

- overall requirements for water,
- specifications and purification methods to be adopted,
- installation and validation of water systems,
- routine quality monitoring requirements, and
- capital and operating costs.

3.5.2 Water quality standards

The quality of materials used in the manufacture of pharmaceutical products are all defined in pharmacopoeias. The main pharmacopoeias referred to today are the European Pharmacopoeia (EP), the United States Pharmacopoeia (USP 25) and the Japanese Pharmacopoeia (JP). The standards defined in these pharmacopoeias are all enforceable in law and all manufacturers of pharmaceutical products are regularly subjected to inspection by medicines inspectors from countries where they have a licence to sell their products. These inspections are carried out to ensure that the manufacturers are meeting the quality and production requirements defined in their product licences, as defined in the pharmacopoeias and as required for compliance with *current good manufacturing practice* (cGMP). A company failing to meet these standards may be given a warning letter from the inspection authorities and a defined length of time to rectify the problems. If this does not take place within the stipulated time limit the company may have their licence(s) withdrawn until such time that the problem is resolved.

Water is unique within all the pharmacopoeias in that it is the only material commonly used by pharmaceutical companies which not only has quality standards defined but production methods are also defined. Two main water qualities are defined as Purified Water (PW, Table 3.36) and Water for Injections (WFI, Table 3.37). The definitions of the quality standards, the production methods for these and the monitoring methods vary slightly between the different pharmacopoeias.

According to the European Pharmacopoeia 2000, Purified Water is water for the preparation of medicines other than those that are required to be both sterile and apyrogenic, unless otherwise justified and authorised. Definitions are given in the EP for PW in bulk and in containers. Purified water in bulk is used as an excipient in the preparation of non-sterile products and as a starting material in the preparation of water for injection and pharmaceutical-grade pure steam. It is also used for rinsing purposes (cleaning of containers) and in the preparation of cleaning solutions. Purified water in containers is purified water in bulk that has been filled and stored in conditions designed to assure the required microbiological quality. It must be free from any added substances. Although very specific stipulations concerning PW quality (Table 3.36) and quality control are given, all process technologies are permitted for its production. In the

Table 3.36 Purified Water (PW)

Parameter	Unit	USP 25	Ph. Eur. (bulk)
TOC	ppb C	500	500
Conductivity	$\mu\text{S}/\text{cm}$ at 20°C	–	< 4.3
Conductivity	$\mu\text{S}/\text{cm}$ at 25°C	< 1.3	–
Nitrate (NO_3)	ppm	–	< 0.2
Heavy metals	ppm as Pb	–	< 0.1
Aerobic bacteria	CFU/ml	< 100 ^a	< 100

^a Determined by membrane filtration, using agar medium B.

Table 3.37 Water for Injection (WFI)

Parameter	Unit	USP 25	Ph. Eur. (bulk)
TOC	ppb C	500	500
Conductivity	$\mu\text{S}/\text{cm}$ at 20°C	–	< 1.1
Conductivity	$\mu\text{S}/\text{cm}$ at 25°C	< 1.3	–
Dry residue	%	–	< 0.001
Nitrate (NO_3)	ppm	–	< 0.2
Heavy metals	ppm as Pb	–	< 0.1
Aerobic bacteria	CFU/ml	< 10 ^a	< 10
Bacterial endotoxins	EU/ml	< 0.25	< 0.25

^a Determined by membrane filtration, using agar medium B.

USP 25, there is similarly no stipulation of process for PW production. Organic carbon measurement can be by TOC, a combustion-based instrumental method, or by permanganate value (PV).

Sterilised water for injection is used for dissolving or diluting substances or preparations for parenteral administration. Water for injection in bulk is used in the manufacture of parenteral and ophthalmic products. It is also used for final rinsing of containers (e.g. primary packaging materials) and manufacture of these products. In addition to stipulations concerning quality (Table 3.37) and quality control, the EP 2000 stipulates that the water must be produced by distillation. The USP 25, on the other hand, permits both distillation and reverse osmosis.

Potable water, or water intended for human consumption, is also used as feedwater for the production of purified water. Potable water may be used to rinse product-contacting surfaces of equipment. Treated potable water has the same uses as potable water and water intended for human consumption but has been treated to reduce its microbial content. Finally, highly purified water (non-compendial water) is used in the preparation of medicinal products where bacterial endotoxins need to be controlled, except where water for injection is required. Current methods for the preparation include double-pass reverse osmosis, reverse osmosis combined with ultrafiltration and distillation.

While the purity levels specified for PW and WFI are not as high as those required in industries such as electronics and power station water systems (Table 1.1), the control of the quality and the documentation related to the system are of paramount importance. In an extreme case, if the quality of water is not achieved a patient may ultimately die when being treated with medication manufactured using that water. Consequently, the pharmaceutical industry invests enormous sums of money to "validate" water systems, a process that continues throughout the life of each water system.

Given that control of product water quality is crucial in this industry, control of feedwater quality is similarly important. The USP includes a section that gives general information on water for pharmaceutical purposes. This section describes different types of water used, i.e. Drinking Water, Purified Water, Sterile Purified Water, Water for Injection, Sterile Water for Injection, Bacteriostatic Water for Injection, Sterile Water for Irrigation and Sterile Water for Inhalation. It begins with the statement that the feedwater used for pharmaceutical preparations needs to be of potable water quality, meeting the requirements of the National Primary Drinking Water Regulations (NPDWR) (40 CFR 141) issued by the Environmental Protection Agency (EPA), since this "ensures the absence of coliforms". It is also pointed out, however, that meeting the National Drinking Water Regulations does not rule out the presence of other microorganisms, which, while not considered a major public health concern could, if present, constitute a hazard or be considered undesirable in a drug substance or formulated product.

The stipulation of compliance with the national potable water standards is critical, and effectively severely constrains recycling opportunities. This ensures that the level of impurities, inorganic, organic and bacterial, that can be present

in the water are defined and controlled. In most pharmaceutical facilities municipally supplied drinking water is used as the raw material. In a few facilities local borehole water, or sometimes river water, is used as the starting material but this must be monitored and tested to show it meets the standards required for drinking water.

3.5.3 Volumes and quality of aqueous process and waste streams

Within a pharmaceutical facility there are a wide range of process-related aqueous effluent streams. Firstly there are effluent streams from the water purification process itself. Since these mostly contain the concentrated impurities present in the drinking water supply it is unlikely that such streams would be suitable for recycling within the water treatment system since this would lead to accumulation of impurities, but they may be employed in other site applications. The typical waste streams are back-washings from regeneration cycles on multimedia filters, organic scavengers and water softeners. In a pharmaceutical water system it is common practice to remove hardness from the water by passing the feed water through a cation resin exchanger in the sodium form to exchange hardness ions (calcium and magnesium) with sodium. Consequently, the RO reject water will normally be softened filtered water with a conductivity up to four times that of the potable mains feed. Depending on the feedwater conductivity this water may be suitable for use for similar applications as those of recovered grey water, although it cannot be reclaimed within the water treatment system.

Water that may be suitable for recycling within the water treatment system is that which is sent to drain from a final polishing unit, for example the drain stream from an electrodeionisation (EDI) unit (Section 2.1.4), where the level of concentrated impurities is still less than that present in the mains feed supply. The other source may be from water that is sent to drain when the system is in internal recycle. Unlike many applications, a pharmaceutical system is typically designed to have all water in continuous motion with internal recycle loops on the pre-treatment and the purification sections of the plant as well as the final distribution loop. This is because the biofilm growth varies inversely with water velocity: continuous motion of the water suppresses the creation of bacterial colonies or biofilms on the pipe making it easier to maintain control of the microbiological levels. This high-purity water is recirculated and becomes the feed stream to the RO system, such that the reject water is still of a high quality and would be suitable for reclaim back to the start of the water system. The only potential problem with reclaiming this water is that the heat input from the RO pump would also be recovered, such that the temperature of water in the system would gradually increase. This may ultimately result in either a cooling unit or dumping of water to reduce the temperature.

Clean in place (CIP) cycle effluent, depending on the type and stage of the CIP process, may contain significant quantities of product residues and detergents from the first rinse cycle or else could contain virtually pure water from final rinse. Most CIP systems employ a series of cleaning procedures operated at

different temperatures and/or using different cleaning chemicals depending on the residues that need to be removed from the equipment. All cleaning cycles normal finish with one or more rinses using drinking water then a final rinse using PW or WFI.

Finally, water may be “dumped” from the system periodically as part of a standard procedure. Until quite recently it was standard practice for all WFI to be “dumped” after 24 hours if it was not used in production so that all water could be classed as “freshly produced”. This procedure is not commonly followed now but where it is carried out the water being dumped is of a much higher quality than the drinking water used to produce more WFI. Water is also dumped to regulate the load on the sanitiser where sanitisation by heating to 80°C is conducted. Such water is also of a much higher quality than the mains water used as the feed for the purification system.

In the UK and Ireland the majority of the PW and WFI water systems produce water at between 500 and 5000 l h⁻¹, although there are some notable exceptions where generation rates are significantly higher. There is often a PW and sometimes a WFI water system installed in each building on a large site: one UK pharmaceutical site has approximately 30 PW and WFI water systems on a single site. On smaller sites one generation plant can supply a number of buildings or manufacturing areas via distribution pipework systems.

Since every production process is different, requiring different volumes of water, producing different quantities of effluent with different levels and types of contaminant, it is not possible to estimate typical water usage figures. However, to illustrate the water volumes that might typically be involved a hypothetical system can be considered.

PW and WFI systems in Europe are typically based on generation flow rates of 0.5–5 m³ h⁻¹. There are some notable exceptions utilising higher flow rates and typical system sizes in America also tend to be higher. This hypothetical system is based on a PW production rate of 3000 l h⁻¹ and 1000 l h⁻¹ WFI, with a daily process usage of 24 000 l of PW and 8000 l of WFI. The PW system will operate continuous in recirculating mode when no water is being made up to the storage vessel while the WFI still will operate in a stop/start mode. The approximate quantities and qualities of effluent will be in the ranges shown in Table 3.38.

Based on these approximate estimated volumes the maximum volume of effluent water that could be reclaimed is around 31 m³ day⁻¹. If the water were passed to a purpose-built reclaim system this volume would rise to around 70 m³ day⁻¹. In practice the water that arises from some of the more contaminated CIP rinses would probably not be reclaimed.

If the main technology used in the reclaim system is reverse osmosis then the likely maximum quantity of reclaimed water which could be returned to the purification system as “raw” water would be around 23 m³, based on a recovery of 75% from the RO treatment plant. Based on current costs of around £1.6 per m³ (\$2.57 per m³) for purchase of potable water and disposal of effluent water, reclaiming this quantity of water would save only around £37 [\$59.5] per day. The operating costs associated with the reclaim system, including maintaining the validation documentation necessary, is estimated to be over £50 [\$80.4] per

Table 3.38 Representative data for effluent water generation

Source	Flow (m ³ day ⁻¹)	Comments/assumptions	Effluent water quality
PW generation	11	RO reject while water is made up to PW storage vessel	1200 µS cm ⁻¹
	13	RO reject while system is on recycle	75 µS cm ⁻¹ ^a
	3	EDI waste stream	200 µS cm ⁻¹ ^a
	4	Pretreatment regeneration/backwash	High salt and contaminant content
<i>Total</i>	<i>31</i>		
CIP, PW	12	Assume half of PW is used for final clean rinse stage	5 µS cm ⁻¹ ^a
CIP, process water	24	Initial cleaning cycles – main contain residual product, cleaning chemicals, etc.	300–1500 µS cm ⁻¹
<i>Total</i>	<i>36</i>		
WFI	0.8	10% blowdown over 8 hours	10 µS cm ⁻¹ at 90°C ^a
CIP, WFI	2	From the final rinse stages using WFI water	5 µS cm ⁻¹ ^a
<i>Total</i>	<i>2.8</i>		

Feed water conductivity assumed to be 300 µS cm⁻¹.

^a Candidate water for reclaim within water treatment plant: 30.8 m³ day⁻¹ in total, 54 µS cm⁻¹.

day based on electrical usage, maintenance labour, microbiological testing, chemical testing and validation activities. The operating cost of the reclaim system would thus almost certainly exceed the potential saving, even without considering recovery of capital cost, for a small system such as this. Consequently, even without the barrier imposed by the pharmacopoeia specifications and the views of government inspectors prohibiting the use of any starting material other than drinking water, there is unlikely to be an economic justification for reusing effluent water from the process. Any such water would need to be combined with other effluent water from non-process applications on site to make a dedicated reclaim system economically attractive. On the other hand, reuse of some of the more dilute streams, specifically some of the CIP streams and any other high-purity effluent streams within the existing purification scheme would be much more likely to be cost effective.

3.5.4 Reuse opportunities

There appear to be no examples of any facility using recycled plant/process effluent water treated to bring it up to the quality of drinking water and then being used as the feed stream to produce PW or WFI and, under the current regulations, there are no obvious reuse opportunities in the pharmaceutical sector. One UK facility, based in a very remote rural location, submitted a proposal to the Medicines Control Agency (MCA) in the UK for a facility that included effluent recycling plant and they were told that this was not acceptable to the inspection authorities. Since no local effluent facilities existed all their plant effluent had to be collected and removed from site by tanker because of this decision. This situation, which is global, may change if regulations are relaxed

Table 3.39 Highly purified water (non-compendial water)

Parameter	Units	USP 25	Ph. Eur. (bulk)
TOC	ppb C	–	500
Conductivity	$\mu\text{S}/\text{cm}$ at 20°C	–	< 1.1
Aerobic bacteria	CFU/ml	–	< 10
Bacterial endotoxins	EU/ml	–	< 0.25

and costs of water and effluent disposal increase, the latter being almost inevitable.

It is nonetheless technically possible to reuse effluent at present to generate a usable feed stream, especially given that around 45% of the wastewater is likely to have an aggregate conductivity of well below $100 \mu\text{S cm}^{-1}$, based on the data given in Table 3.39, and would thus actually dilute the mains water supply. Much of the effluent produced from pharmaceutical processes has a limited range of contaminants, namely only trace levels of the products being manufactured and very low levels of salts and organics. Also, this effluent is much better characterised and controlled than typical municipal-supplied drinking water, since PW and WFI waters are very low in dissolved matter and the exact nature of the impurities added are known. Consequently, it should be possible to specifically monitor and, if necessary, selectively remove individual impurities introduced from the production environment into the effluent to ensure that the reclaimed water consistently meets the drinking water standard.

For example, PW typically has a conductivity $< 1 \mu\text{S cm}^{-1}$, i.e. a total dissolved solids concentration of around 0.5 mg l^{-1} . This content is largely made up of sodium and chloride ions with traces of potassium, fluoride and other small molecular weight ions. If this water is used in the final rinse of a process vessel the only contaminants added will be residual quantities of the products being manufactured, generally at levels $< 1 \text{ mg l}^{-1}$. The actual quantities of these products will be accurately measured and recorded as part of the validation of the CIP process but will obviously vary between applications. The impurities from other waste streams will generally be the same as those present in the feed water but at much lower levels, and can be measured using the same analytical methods as are used for potable water.

Water continues to be the most commonly used chemical in most pharmaceutical operations and also continues to be one of the most problematic. One of the largest causes for product recalls are water-related issues, and such an environment imposes a considerable barrier to water recycling. If there is also no strong economic driving force, regardless of the technical feasibility of water recycling, it is unlikely to happen in this industry in the near future.

Chapter 4

System design aids

4.1 Computer-aided design for reverse osmosis plant

Etienne Brauns
VITO

4.2 Water pinch analysis

Danielle Baetens
VITO

4.3 Design examples

Simon Judd
School of Water Sciences, Cranfield University

4.1 Computer-aided design for reverse osmosis plant

4.1.1 Introduction

It has already been pointed out (Section 2.3.2) that modelling of filtration processes is not feasible on a universal basis, and that only reverse osmosis can be modelled on the basis of solution–diffusion. In such a case, modelling is possible using simple analytical expressions provided the water can be treated as a continuum essentially free of the more complex interactions introduced by the presence of dispersed particles, solute precipitation effects (gel layer formation) and/or biological activity at the membrane–solution interface. As a result of these complicating factors, which relate largely to porous membrane processes, computer-aided design (CAD) software is currently available only for reverse osmosis membranes and modules. The software packages are based on a series of calculations that enable the estimation of the RO array design and operation. It is instructive to review these CAD packages, which are produced by RO membrane manufacturers and suppliers based on their own products, with a view to ascertaining their general usefulness and limitations (Brauns, 2001).

4.1.2 Key elements of the reverse osmosis process

Modelling of the reverse osmosis process relies on accurate mathematical representation of:

- the osmotic pressure,
- concentration polarisation, and
- the hydraulic resistance offered by the membrane and the membrane channels.

As already discussed (Section 2.3.1), the pressure required to drive a reverse osmosis process relates both to the permeability of the membrane and the osmotic pressure. The osmotic pressure is solute concentration related, and can be very high for highly saline solutions: the osmotic pressure for seawater (35 g l⁻¹ NaCl) is around 27 bar. No flow of water takes place unless this pressure is exceeded. At moderate concentration values, osmotic pressure varies almost linearly with concentration for many univalent salts, including sodium chloride, according to the van't Hoff equation (Chapter 2, Equation (2.9)). In this equation y depends on the degree of dissociation of the salt. Non-linear correlations of Π with C have been fitted to Taylor series and power relationships:

$$\Pi = RT(y_1C_1 + y_2C_2 + \dots) \quad (4.1)$$

$$\Pi = yRTC^n \quad (4.2)$$

Any one of the above relationships may be employed in existing RO design software.

Concentration polarisation (CP) can be quantified from film theory (Section 2.3.2, Equations (2.14)–(2.18)), and its effect on osmotic pressure and scale formation respectively determined from the van't Hoff equation (or the above modifications thereof) and equilibrium thermodynamics expressions for precipitation (Section 2.4.3). Whilst the effect on osmotic pressure can be calculated with reasonable accuracy, the actual scale deposition rate cannot. This is because the simple expressions outlined in Section 2.4.3 are derived from equilibrium thermodynamics and cannot account for the very wide variations in the scaling kinetics that exist. Indeed, it is quite common for some scalants to remain dissolved at concentrations well beyond the theoretical saturation limit determined from the solubility constant K_s (Table 2.14), in a supersaturated state, even without the addition of threshold inhibitors (Table 2.15) to suppress nucleation.

In principle, film theory also permits the optimisation of both the retentate flow rate and the design of the spacer material in the spiral-wound RO element. However, in practice the choice of RO spacer material is dictated to a large extent by cost and, in any case, is not one that can be made by the RO process designer but by the membrane supplier. Similarly, although turbulence, and hence mass transfer, is promoted by a high cross-flow velocity, a practical limit is placed on the retentate flow rate by the construction of the spiral-wound element, which can only withstand a certain maximum hydraulic loading without risk of failure. Failure can be manifested through a phenomenon known as “telescoping”, where the centre of the element is pushed axially outwards by the force of the flow. Since the specific resistance (i.e. the hydraulic resistance per unit length) offered by the membrane channel is constant along the length of the membrane element, the limit on retentate flow rate implies a limit on both the inlet pressure and the pressure drop across the element. For large elements, 1 m long, the maximum pressure drop is normally much less than 1 bar.

Most RO filtration systems are based on the spiral-wound configuration, a noteworthy exception being the Monsanto Prism[®] hollow fibre membrane. The largest of the spiral-wound elements are 8 inch (about 0.2 m) in outer diameter and 40 inch (about 1 m) in length, with newer membrane elements being 1.5 m long. Membrane elements are mounted inside pressure vessels in which they are connected sequentially to give a module length of up to 8 m or more for an 8-element module. These modules can then be arranged in parallel and/or in series to produce a matrix, or array (Section 2.4.1), of membranes with a sufficient total membrane surface area to obtain a specified total permeate flow and permeate quality at an acceptable cost.

Both the appropriate number of elements in the module and the arrangement of modules in the array to obtain volumetric flow information can be arrived at through a simple mass balance (Section 4.3.2) provided the conversion Θ per membrane element can be assumed constant. However, since (a) Θ must necessarily be a function of both the transmembrane pressure (TMP) and the osmotic pressure π , and so of the solute concentration, and (b) the solute flux through the membrane and the fouling propensity are both critically important, a simple water balance is normally insufficient. To obtain water quality

information a mass balance of the solutes is necessary. This is considerably more complex than the water balance solution, which is obtained analytically using Equation (2.22), because of the interrelationship between TMP, Θ and π , and the complicating influence of concentration polarisation (Section 2.2.3). This means that the impacts of the individual design parameters on operation (Table 4.1) are largely interdependent, and that the array design solution is then only obtainable iteratively.

To enable these array design calculations to be carried out, RO design software packages are available for specific RO membrane products. Such software enables the designer to simulate operation of any RO array under any set of operating conditions. These packages (Table 4.2) are intended to allow the user to produce an RO array design from base information, such as the required product flow rate, overall process conversion and feedwater characteristics. The membrane suppliers offer their own RO software to the (prospective) customer gratis. Specific software from universities is also available, or else is under development, at institutions such as RWTH Aachen and Saarland University in Germany, University of Wales Swansea in the UK and the European Institute of Membranes at the University of Montpellier in France. Some of these groups are developing software for nanofiltration.

The starting point for all design packages is the feedwater composition. Whilst data for the principal ions may be available, this is not always the case for some scalant components, such as barium or silicate. These ions form extremely insoluble precipitates, such that they may be close to saturation even at very low concentrations. Most feedwaters, and industrial effluents in particular, are subject to temporal fluctuations in composition, and this has to be accounted for

Table 4.1 RO design parameters

Parameter	Impact ^a
Feedwater composition	Osmotic pressure, scaling , membrane stability, permeate quality
Feedwater pH	Scaling , membrane stability
Feedwater temperature	Flux , membrane stability
Permeate flux	Transmembrane pressure, concentration polarisation, fouling , pressure loss
Cross-flow velocity	Concentration polarisation, fouling , pressure loss
Membrane material	Membrane stability, permeate quality , fouling

^a Primary or most important in bold type.

Table 4.2 Relevant RO design software

Company	Membrane name	RO software
Dow	Filmtec	Rosa
Hydranautics	Hydranautics	Rodesign, Rodata
Koch	Koch (Fluid Systems)	Ropro, Costpro
Osmonics	Osmonics, Desal	WinFlows
Toray, Ropur, Trisep	Toray, Ropur, Trisep	WinCarol, 2p flows

when entering data into the design package. It is also invariably the case that experimentally-determined ionic composition data do not yield an electrically balanced specification. RO design software packages tolerate, to a certain extent, an ion imbalance in the feed composition. Exceeding some predetermined limit of this imbalance normally prompts a request to artificially adapt the total ion balance by compensation (anion or cation). The total ion balance is then usually corrected through the addition of sodium cations or chloride anions, since these ions do not have a substantial impact upon the RO process design and operation. Aggregate aspecific determinants, such as total organic carbon and total dissolved solids, cannot normally be usefully entered into the design package. Most design packages allow entry of data for the most common scalants, such as the sulphates or carbonates of calcium, magnesium, barium, strontium and iron, but not the more unusual compounds, such as sulphides of many divalent metals, that can arise in some industrial effluents (Table 2.14).

The composition of the feed determines both osmotic pressure and scaling propensity. These are increased both by the conversion, the ratio of permeate to feed flow, and the degree of concentration polarisation (CP). In most software packages a limit is placed on the CP coefficient (normally denoted as β -coefficient). For example, for the RoPro package produced by Koch-Fluid Systems the maximum β -coefficient value is 1.13. This limit is based on experience, rather than anything derived from first principles. A warning is normally given when the retentate scalant concentration exceeds its equilibrium solubility limit, demanding remedial measures in the form of appropriate pretreatment (Section 2.4.3) or else reduced flux.

Other specific feedwater quality determinants of importance are the pH and temperature. The feed pH is of particular significance since it has an impact upon both scaling propensity and membrane integrity (see below). Precipitation of hydrolysable scalants is suppressed at low pH levels and most RO CAD packages allow for pretreatment with acid or base. The feedwater temperature has a direct impact upon the permeate flux through the viscosity (Section 2.3.1), as well as on scalant solubility and biological growth. Calcium carbonate solubility and biological growth both decrease with increasing temperature, whereas the viscosity (and hence the overall permeability) increases. Since the latter is normally the most important temperature effect, it is crucial, when designing the plant, to base the design on the lowest temperatures likely to be encountered.

Membrane stability has already been discussed (Section 2.1.3). Reverse osmosis membrane materials are all polymeric and have varying levels of chemical stability. The two membranes materials most frequently employed are cellulose acetate (low cost, chlorine resistant but limited rejection and subject to alkaline hydrolysis at pH levels above 6) and aromatic polyamide (high rejection, resistant to hydrolysis but more expensive and susceptible to oxidation by chlorination). The choice of both the membrane material and module will obviously depend upon the application, since parameters such as requirement for sanitisation, feedwater temperature and pH fluctuations and fouling propensity can be critical.

The system hydraulic resistance has a significant impact on the specific energy demand (i.e. the energy consumption per unit permeate product volume). High retentate flow rates reduce concentration polarisation, and hence may be expected to increase the flux, but also increase the pressure drop along the length of the membrane element. A high retentate flow rate is associated with a large transmembrane pressure (TMP), and hence a higher flux and recovery. However, this results in an increase in CP. Clearly, there is a balance to be struck between the pressure and the membrane area requirement, such that the flux is not unreasonably high at the module inlet and the cross-flow velocity not reasonably low at the outlet.

It is normal practice to provide a high membrane area by linking several membrane elements in a single module, and by staging (Section 2.4.1) when the retentate flow decreases by 33 or, more usually, 50%. Many RO plant comprise so-called "2-1" arrays, where the flow entering the second stage of the array is half that of the first stage. Staging reduces the membrane area requirement but can also lead to substantial retentate pressure losses. An intermediate pump may then be required to increase the feed pressure to the second stage; this process is sometimes referred to as a "two stage concentrator" where, in this instance, the stage may include sub-stages.

Another way of increasing the overall recovery is to recycle a fraction of the retentate to the feed inlet port of the bank, producing what is normally referred to as a "single pass with recycle" process configuration. This increases the retentate flow rate as a result of combining the recycle stream with the feed stream, such that it is possible to increase the recovery while still maintaining the same degree of concentration polarisation. However, the increase in the retentate concentration has a negative impact on both the scaling propensity and the permeate water quality. It is also possible to treat the permeate from the first stage, producing a "twin pass" system (Fig. 2.21).

4.1.3 RO design software

The design of an RO plant involves the adequate specification of parameter values and an appropriate choice of process design. As a result of the multitude of parameters, complex interactions and different design variants, it is not possible to produce RO software able to automatically produce the ideal RO design for a specific application. The design process essentially proceeds by trial-and-error through selection of different types of membranes, design variants and operating parameter values, with the software package indicating when the selected design is unreasonable and (usually) identifying the cause. The packages therefore all demand a rudimentary understanding of the RO process and the effect of the design parameters. Provided this is the case, the packages are normally quite user-friendly and perhaps even didactic in construction. Most have an input "wizard" that guides the user through each of the design elements in sequence. The individual inputs are listed below.

Feedwater quality

The quality of the feedwater(s), comprises composition, pH and temperature, a typical window (from Rodesign by Hydranautics) being shown in Fig. 4.1. Most design packages allow entry of concentrations as either mg/l (i.e. ppm) or meq/l with some also incorporating "ppm as CaCO₃". Only the most common ions are included, however. Hence, any other ions that need to be added to the feedwater specification must have their permselectivity properties entered. If no such rejection data is available, and they can only realistically be obtained through experimental measurement, then there is nothing to be gained by adding them to the specification. All major suppliers' packages will prompt if correction of the analysis with sodium or chloride is required to attain electroneutrality. A number of different feedwater streams can be specified for most of the design packages.

Flows and conversion

Flow rates and/or the overall conversion is also a required input (Fig. 4.2, from RoPro by Koch-Fluid Systems). Flow rates can be entered in both imperial and metric units, and it is usual to specify one of the flow rates (feed or product) and the recovery. Some packages allow for bypassing of the membrane array by part of the feedwater. Most of them have a simple percentage fouling allowance that the user can enter to correct for a lower, more conservative estimate of permeate flux when calculating the design.

Project		Code		Feed		Date		
Project Z		CODE Y		Wastewater				
pH	8.00	Turb	0.0	E cond	5767	uS/cm	CO2	48.6
Temp	12.5	C	SOI	3.0	15min	H2S	0.0	ppm
Ca	36.0	ppm		1.80	meq	Cl3	15.0	ppm
Mg	25.0	ppm		2.06	meq	HCO3	2214.0	ppm
Na	989.0	ppm		43.00	meq	SO4	100.0	ppm
K	626.0	ppm		16.05	meq	Cl	581.0	ppm
NH4	3.0	ppm		0.17	meq	F	4.0	ppm
Ba	0.012	ppm		0.00	meq	NO3	170.0	ppm
Se	6.000	ppm		0.14	meq	SO2	30.0	ppm
Total positive		63.21		meq		Autobalance		Total negative
Calculated TDS		4799		ppm		Ionic strength		0.055
CaSO4 saturation		0.5		%		BaSO4 saturation		17.6
Silica saturation		26.1		%		SrSO4 saturation		4.8
Saturation Index		1.0		Langgitter		Osmotic pressure		38.1
								psi

Figure 4.1 Feedwater quality dialogue box (Rodesign, Hydranautics)

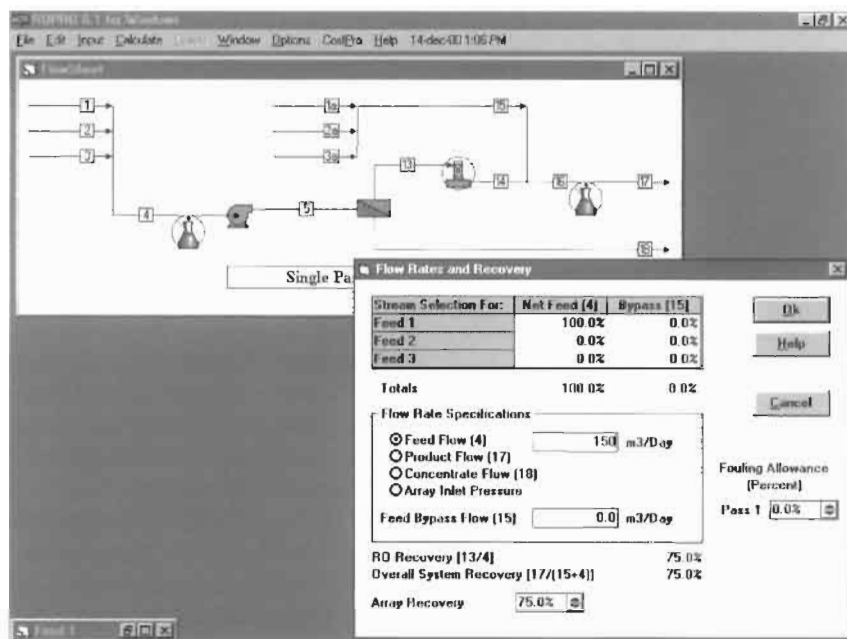

Figure 4.2 Flow specification dialogue box (ROPRO, Koch-Fluid Systems)

Process design variant

The process design variant (single pass, twin pass, etc.) normally has to be specified at the start of the design process, and can be selected from a drop-down menu or a dialogue window. The default selected is always the simple single-pass plant. Obviously, the more complex the process design, the more information required to be entered. Fig. 4.3 shows a two-stage concentrator RO plant dialogue window.

Array design

The core of the RO process is the design of the array, in which the number of stages and trains (i.e. rows of modules) must be defined. The definition of a single stage, or bank, includes the number of pressure vessels (i.e. modules), the number of membranes in each vessel and the membrane type. The latter can range from low-selectivity, low-cost softening membranes to the more permselective membranes used for seawater desalination. It is not possible, and not sensible, to specify more than one membrane type in a single pressure vessel or bank, although different membranes may be selected for different stages. Membrane type is selected from drop-down menus that, of course, offer membrane materials specific to the membrane supplier. In some cases, such as ROPRO by Koch, the user can enter an approximate design flux, such that the array can be calculated from this figure, the overall recovery and the properties of the membrane selected. Otherwise, a preliminary value for the number of elements per module can be calculated from the overall required permeate flow

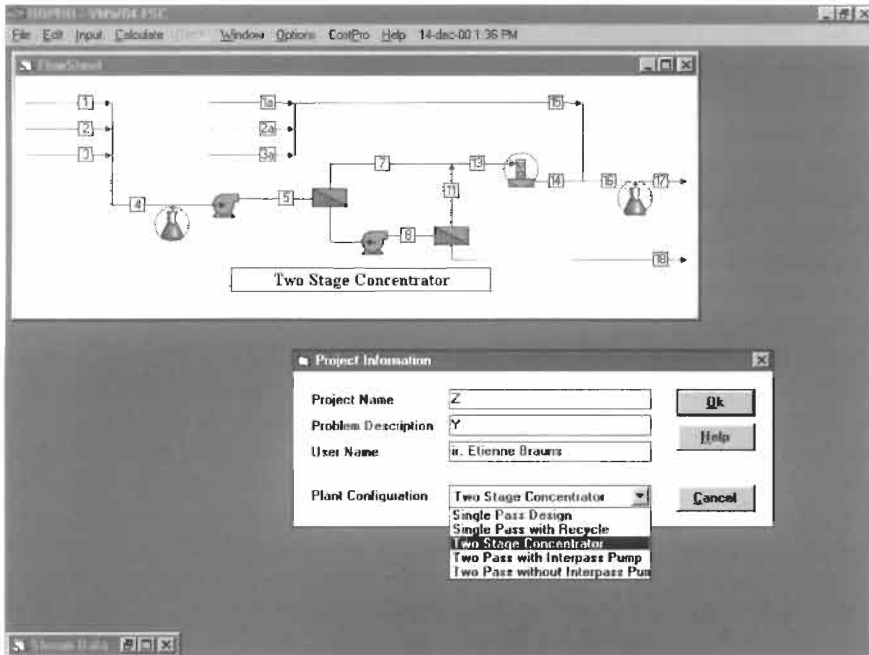

Figure 4.3 Process design dialogue box (ROPRO, Koch-Fluid Systems)

and the nominal permeate flow per membrane, as specified by a RO CAD package's specific dialogue window or simply the membrane specification sheet. The element specification can be quite detailed: The Osmonics Winflows package (Fig. 4.4) allows stipulation of element age to account for deteriorating hydraulic performance with age.

Pretreatment and post-treatment

Pretreatment selection is usually limited to the selection of acids (sulphuric or hydrochloric) or bases (caustic soda) to adjust the scaling index value (Fig. 4.5), according to the principles outlined in Section 2.4.3. It is normal practice to ignore pretreatment for the first trial run of the CAD and then add the appropriate amount of acid or base according to the scaling index value automatically calculated by the software. Similarly, post-treatment, which can take the form of pH adjustment and/or degassing to remove the dissolved CO_2 down to some selected value, is usually carried out following the first run.

When all necessary input values have been entered, the software is ready to perform a first calculation. The software calculates and presents data for the composition of the different sub-streams plus all hydraulic data (flow and pressure) for all parts of the array (Fig. 4.6). The designer is then able to analyse the results and adjust the operating conditions so as to optimise the system and/or attain the target permeate water quality. This may demand several runs, and the solution ultimately obtained through iteration. The software packages produce a dialogue box indicating warnings (amounting to errors or

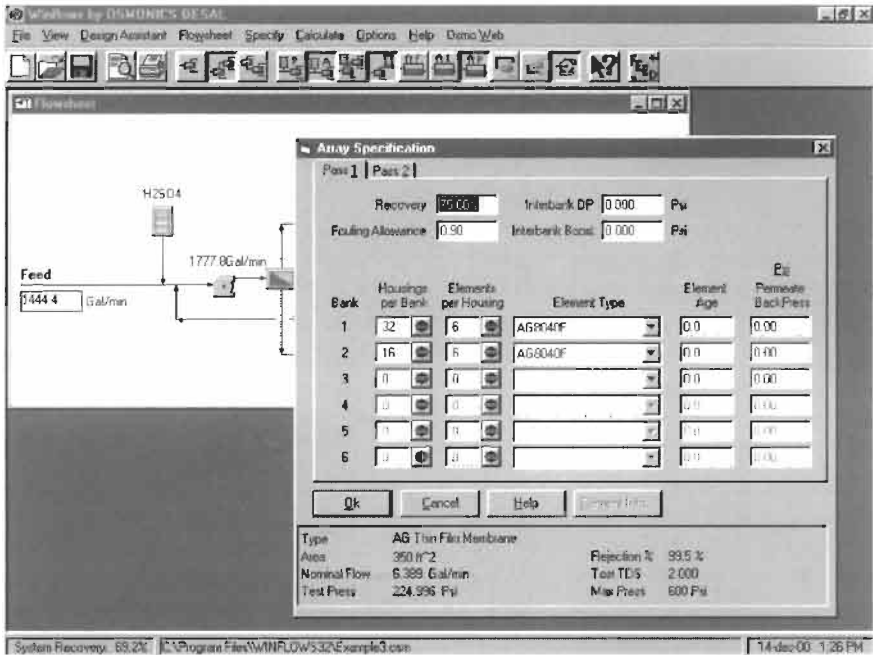

Figure 4.4 Array design dialogue box (Winflows, Osmonics)

incompatibilities in the design), and these can be attended to directly. For example, if the solubility limit of calcium carbonate has been exceeded, acid may be added as pretreatment. If the membrane module is hydraulically overloaded more membranes can be added. If the design selected is entirely inappropriate, calculation of the parameters (which relies on convergence) may not be possible and the software will then produce a warning and halt.

An optimised RO system design is generally considered to be one for which the lowest specific energy demand is incurred and/or the lowest membrane area is demanded at the highest recovery, although these parameters obviously imply a trade-off between operating and capital costs. Although there is no one method of performing the iterative procedure to obtain the optimised system, a few general points can be made:

(i) A high CP level, always greatest at the module exit, should be avoided: a warning is given when the β -coefficient value in the last membrane of a pressure vessel exceeds the pre-set maximum value. CP can be reduced by increasing the cross-flow velocity and/or reducing the flux. A number of options exist in this regard:

- reduction of overall recovery
- addition of a stage
- increase of feed flow

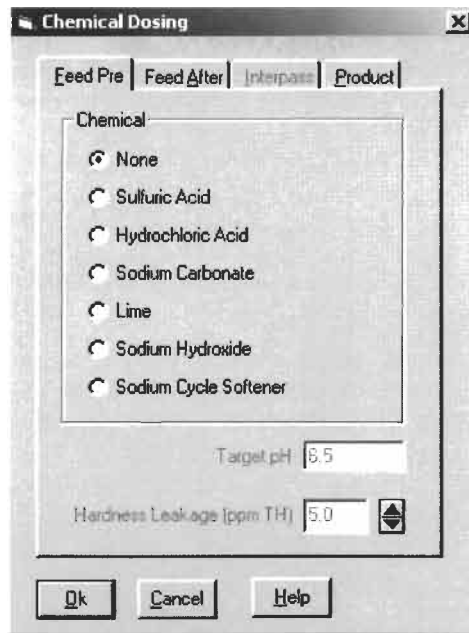

Figure 4.5 Pretreatment dialogue box (ROPRO, Koch-Fluid Systems)

- reduction of the number of pressure vessels per bank whilst increasing the number of membranes per pressure vessel
- recycling of part of the concentrate
- decreasing the element size.

(ii) Permeate quality changes with recovery. In principle, solute diffusion increases with higher recoveries but permeate flux also increases. These synergistic phenomena mean that permeate quality can increase until some specific recovery value, beyond which it may decrease again. It is rarely the case that the highest permeate water quality, as may be demanded by, for example, microprocessor applications, coincides with the highest recovery.

(iii) The specific energy demand increases with increasing recovery.

(iv) Calcium carbonate scaling can be very substantially reduced through pretreatment by acid dosing or hardness removal, allowing much greater recoveries and thus demanding smaller membrane areas. Hardness reduction can be achieved by classical chemical softening, by ion exchange or lime dosing, or by blending the feedwater with some of the permeate product.

(v) Scaling by non-hydrolysable scalants (Table 2.14) can be suppressed through the use of appropriate scale inhibitors. Dedicated software from anti-scalant chemical suppliers is available (Fig. 4.7) and can be used in parallel with the RO software to calculate scaling propensity of the chemically treated water. Scaling from these contaminants is otherwise reduced only by their removal or by reducing CP.

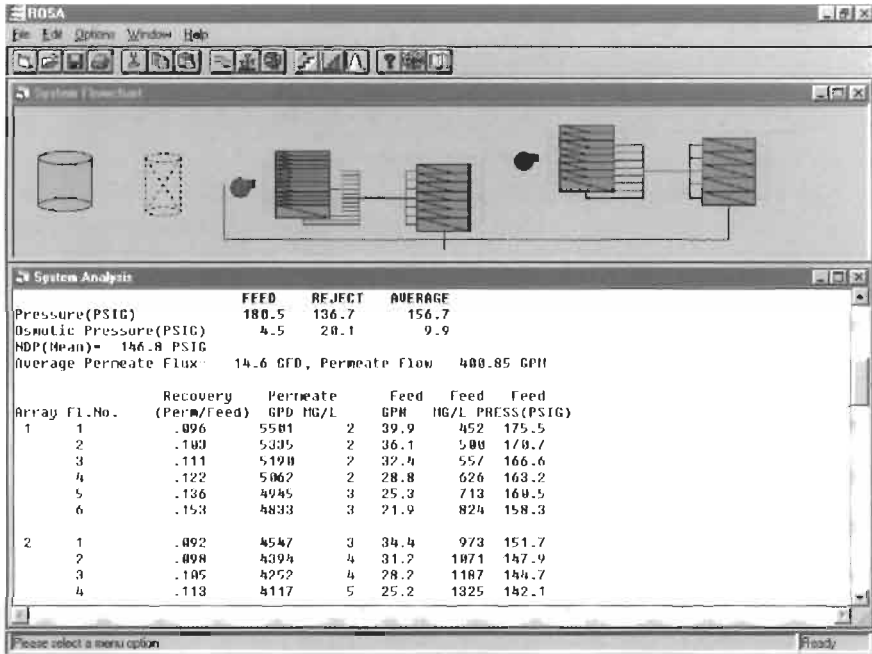

Figure 4.6 Calculated array water quality and hydraulic data (ROSA, FilmTec)

4.1.4 Cost calculation

Some RO software packages (Koch, Hydranautics) include a provision for costing, which extracts such cost items as capital costs, pumping energy demand, membrane replacement and chemical dosing, automatically from the design file. Pumping energy costs, for example, relate directly to the system hydraulics. Other specific data, such as labour costs, anti-scalant and cleaning chemical unit prices, amortisation, overheads and maintenance, must be entered by the user. Figure 4.8 illustrates the CostPro software (Koch), which permits fairly comprehensive costing of the RO design. Care must be taken when using such packages, since the cost can be sensitive to assumptions made about such things as membrane life, period of capital amortisation and interest rate. On the other hand, the CostPro software allows a direct cost comparison of two candidate designs.

Cost is also very dependent on the scale of operation. Higher specific costs, i.e. cost prices per m³ permeate product, result from smaller plants due to the relatively high capital and maintenance costs, the latter pertaining to labour. A more useful basis for specific cost may thus be the cost per unit time, which is inversely related to the amortisation period and increases with increasing interest rate. Given the sensitivity of costs to maintenance requirements, cleaning frequency, membrane and plant life, interest rates and residual value, it is prudent to compute costs based on a range of assumed values for these parameters which are, of course, largely beyond the designer's control.

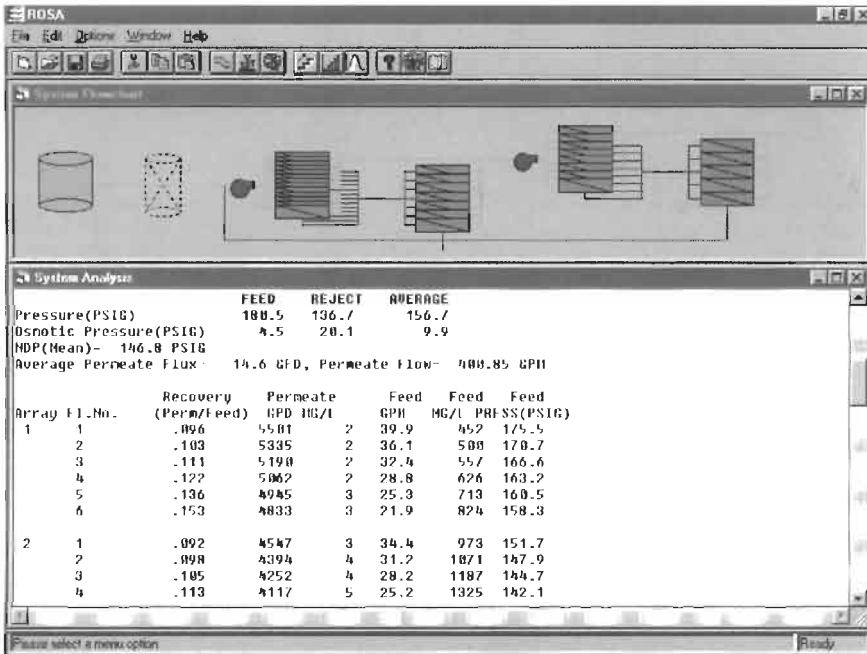

Figure 4.7 Scaling indices (Argo Analyzer, Betz-Dearbon)

4.1.5 Overview

Whilst RO CAD packages have become increasingly sophisticated and also more user friendly, more versatile and more widely available over the years (Table 4.3), it should be stressed that they cannot provide an alternative to pilot trials. Indeed, all suppliers emphasise that their software is intended to expedite design, rather than provide absolute values for the key process performance parameters with respect to the system hydraulics and permeate product water quality. None of the existing design packages are able to predict organic fouling or equate this, even by approximation, to some measurable feedwater quality determinant such as TOC. It is such determinants that have an impact upon crucial parameters as the pretreatment requirement, frequency and nature of membrane cleaning and membrane life. On the other hand, these CAD packages provide the option of designing a complete RO plant under what could be considered optimum conditions of zero permanent fouling. In practice a more conservative process design and/or operation may well be called for.

One obvious constraint on the use of commercial software packages is their limitation both to reverse osmosis and the suppliers' own products. Several generic RO, and more recently NF, design software packages have been developed over the years by academic and independent research groups worldwide. An example of a pragmatic MS Visual Basic[®]-based software approach to handle the design and cost calculations for single pass cross-flow, feed and bleed and semi dead-end filtration systems, applicable to all types of

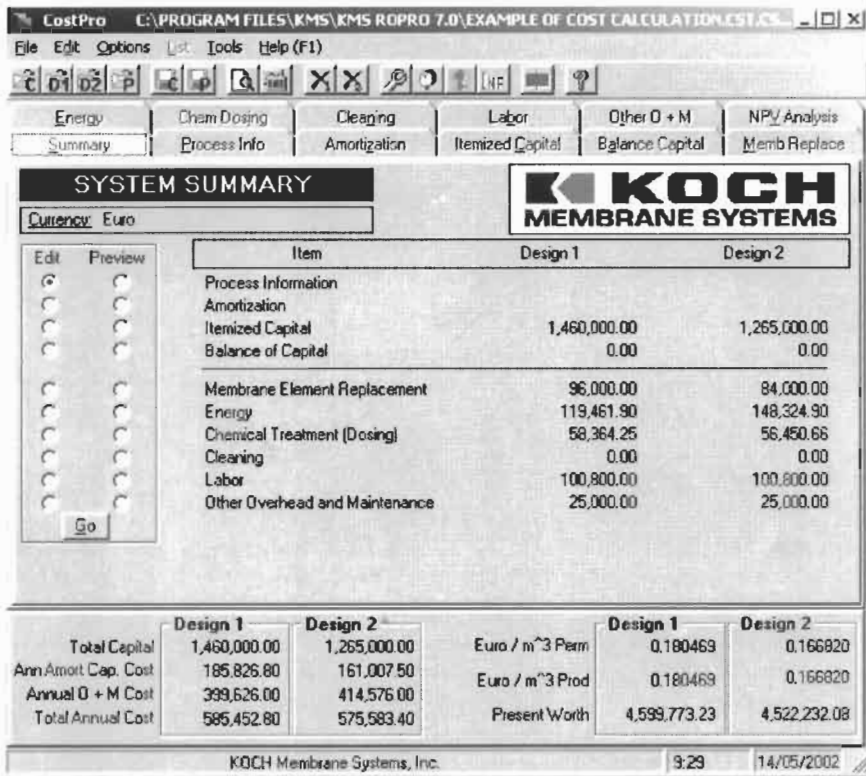

Figure 4.8 Cost analysis (CostPro, Koch-Fluid Systems)

membranes, is that of Vito. Three (β -version) programs have been written, creating an interactive environment with predefined dialogue windows and allowing the user to handle in a systematic way the numerous filtration parameters (Brauns *et al.*, 2002). The software allows the calculation of both the design of the installation and its global cost or cost per unit permeate product. The absence of accurate universal membrane filtration models, with the obvious exception of RO, is compensated for by enabling the input of basic filtration values, such as, for example, permeate flux or feed pressure, from a datasheet. As a result the software user is able to implement in a suitable spreadsheet a preferred calculation (model) or extrapolation method based on real experimental data to produce basic filtration input values that later can be imported into the Visual Basic[®] program. This pragmatic approach allows the user to provide the appropriate basic filtration data, and is totally flexible with regards to membrane process and technology. On the other hand, it relies on available hydraulic data (i.e. flux vs. TMP correlations, pressure loss data, etc.) to be usable.

Given the current widespread activity in membrane process modelling, it seems likely that more CAD packages for porous membrane processes will be

Table 4.3 Summary of RO CAD package capability

Parameter	Fluid Systems ROPRO	Film-Tec ROSA	Hydronics ROdesign	Osmonics Winflows
<i>Feedwater and flows</i>				
Ions	K ⁺ , Na ⁺ , NH ₄ ⁺ , Ba ²⁺ , Ca ²⁺ , Mg ²⁺ , Sr ²⁺ , Cl ⁻ , F ⁻ , HCO ₃ ⁻ , NO ₃ ⁻ , SO ₄ ²⁻ , SiO ₂			
Other constituents	Fe ²⁺ , Mn ²⁺ , CO ₃ ²⁻		CO ₃ ²⁻	Fe ²⁺ , Mn ²⁺ , CO ₃ ²⁻
Addition of further constituents?	Y	N	N	N
Blending?	Y	Y	Y	N
<i>Process design</i>				
Designs		Once-through, twin pass, recycle		
Other designs	Two-st. concentrator			Two-st. concentrator
<i>Array design</i>				
Different elements per bank/stage?	N/Y	N/Y	Y/Y	N/Y
Design flux input?	Y	N	N	N
<i>Pretreatment</i>				
Acid/base?	Y	Y	Y	Y
Other anti-scalants?	N	N	N	N
<i>Post-treatment</i>				
Acid/base	Y	N	Y	Y
Degassing	Y	N	Y	Y
<i>Design limits</i>				
β _{max} (CP parameter)	1.13	Not given	1.20	Not given
ΔP _{loss, max} (telescoping)	Membrane specs	Membrane specs	Membrane specs	Membrane specs
ISI indication/warning?	Y	Y	Y	Y
Nominal flux	Membrane specs	Membrane specs	Membrane specs	Membrane specs
<i>Wizards</i>				
Input wizard?	Y	Y	N	Y
Array wizard?	Y	N	N	N
Costings?	Y	N	Y	Y
<i>Help files</i>				
Data referencing?	Y	Y	Y	Y

commercialised within the next few years. As with most CAD packages, these will rely on experimental data for validation purposes and their usefulness is likely to be closely linked to the extent to which they can represent fouling. Whilst immense progress has been made in understanding fouling mechanisms over the last 20 years or so, successful prediction of fouling in porous processes through a consideration of the operating conditions and the membrane and feedwater matrix characteristics is largely limited to model, single-component feedwaters.

References

Brauns, E. (2001). Calculation of cross-flow reverse osmosis at your desk. *Desalination and Water Reuse*, **10**(4), 18–25.

Brauns, E., Doyen, W., Dotremont, C., Van Hoof, E. and Genné, I. (2002). A pragmatic cost calculation and design software tool for pressure driven membrane filtration systems. *Desalination and Water Reuse*, **12**(1), 40–44.

4.2 Water pinch analysis

4.2.1 Introduction

As is apparent from the example industrial sectors discussed in Chapter 2, the use of water within and its discharge from an industrial site can be very complex. Minimising water consumption is obviously desirable on environmental and economic grounds, but it becomes very difficult to determine the extent to which this can be done without endangering product quality. The complexity is compounded not only by ignorance of water volumes involved, but also of water quality with respect to key pollutants. The latter can relate both to effluents generated and process water quality demanded by specific processes. Such basic issues have to be addressed ahead of any assessment of water purification technologies, since such purification may not even be necessary. Moreover, the problem of assessment of water demand, discharge and quality is generally compounded by the disparate knowledge base for individual water-consuming processes throughout the company. Clearly an overview is required encompassing all unit operations demanding and discharging water throughout any one site. This information can then be used to form the basis of what is referred to as pinch analysis which, when applied to water systems, is usually referred to as water pinch.

In the following sections the water pinch concept is discussed in detail, and practical methods for its application outlined. Water pinch provides a means of determining the theoretical minimal overall water consumption for a site with different processes, as well as indicating the requirements of a purification technology based on a specific scenario. Although the concepts of water pinch might seem relatively simple, applying them under real process constraints demands a comprehensive knowledge of the overall industrial process to which it is applied. Moreover, as many parameters are involved and interrelationships between the various process streams can be very complex, it is apparent that dedicated software is necessary to expedite the application of the methodology. The latter is widely available although, as with the reverse osmosis software discussed in Section 4.1, the software is merely a tool rather than providing a process solution.

4.2.2 Water pinch: the history

The pinch concept was developed at the Department of Process Integration at the University of Manchester Institute of Science and Technology (UMIST), UK, in 1970 as a method to reduce energy demand by recovering or transferring heat by employing heat exchangers at critical junctures of a process. This pinch concept was then taken and applied to processes using water. The fundamental theoretical formulations for the application of the pinch concept to wastewater problems were amongst others pioneered by El-Halwagi and co-workers (1992, 1995), Smith and co-workers (1991a,b, 1994, 1996) including Kuo and Smith (1997, 1998), Alva-Argáez *et al.* (1998a,b) and Wang and Smith (1994a,b, 1995). A large number of studies applying the concept of water pinch have since been performed. Mathematical programming approaches have been formulated (e.g. Rossiter and Nath, 1995; Doyle and Smith, 1997), and several software tools are now available (Section 4.2.3). Two such software tools are WaterTarget[®], a commercial software provided by Linnhoff March – a division of KBC Process Technology Limited – and Water, a package provided by UMIST to the members of its own research consortium. In the following sections, these software tools will also be referred to as the LM and UMIST software. WaterTarget[®] is a software suite comprising WaterTracker[™] and WaterPinch[™]. Whereas the latter is the heart of the program for defining the optimal water network, the first is used to set up the water balance. In the following sections, the program will be referred to as WaterTarget[®], although WaterPinch[™] is the part used and elaborated on. The graphical plot used in WaterTarget[®] does not represent concentration versus mass load, but concentration versus flow rate. This methodology and the interpretation of the curves generated can be found in Buehner and Rossiter (1996).

4.2.3 Methodology

Every problem definition begins with accurately identifying every unit operation using and producing water, including processes as well as utility operations such as steam production. The existing water network is thus obtained and, for given measured flow rates, the water balance can be checked. The accuracy of this balance determines to a great extent the result and usefulness of a pinch analysis. Indeed, a substantial imbalance of water would strongly indicate either unaccounted for water-consuming unit operations, leaks, and/or an ignorance of flow rates through some or all of the selected units. A water pinch analysis can only usefully proceed if the imbalance is less than 10%.

Relaxing the inlet and outlet concentration

It is most often assumed, in the first instance, that all processes are fed with pure water, such that the minimum water usage is obtained through summing the flow rates through all the units. It is necessary to stipulate, for all units, the maximum inlet and outlet concentrations for the different contaminants of

interest. A contaminant, in this context, is defined as any property of the water that prevents its direct reuse, and can thus include heat content (i.e. temperature) as well as the usual physicochemical attributes such as suspended solids, acidity and hardness. Increasing the allowable influent concentration results, in general, in an increased effluent concentration. In most cases basic rules can be applied to determine the maximum allowable effluent concentration and, as such, the maximum allowable inlet concentrations, based around such fundamental properties as mass transfer, solubility of scalants, corrosivity and (organic) fouling. This *relaxing* of concentrations allows flow rates to be determined that are most appropriate for efficient water use.

The limiting water flow rate concept (limiting water line)

An important difference can be observed between two basic precepts concerning flow rate. The flow rate may either be fixed at some value or can be assumed to take on some limiting value whereby the maximum allowable inlet and outlet concentrations are obtained according assumptions or measurements made based on deterioration of water quality through a unit. In Fig. 4.9 these approaches are presented for a simple single-contaminant case. The physicochemical properties of the process and of the equipment allow a maximum inlet and effluent concentration of 50 ppm and 150 ppm respectively. However, when increasing the inlet concentration up to 50 ppm, and keeping to the existing flow rate of 2 t/h, the maximum effluent concentration is not reached for this fixed flow rate. Permitting a variable flow rate for the process considered allows the maximum effluent concentration to be reached. The water pinch methodology was initially presented as a problem without flow rate

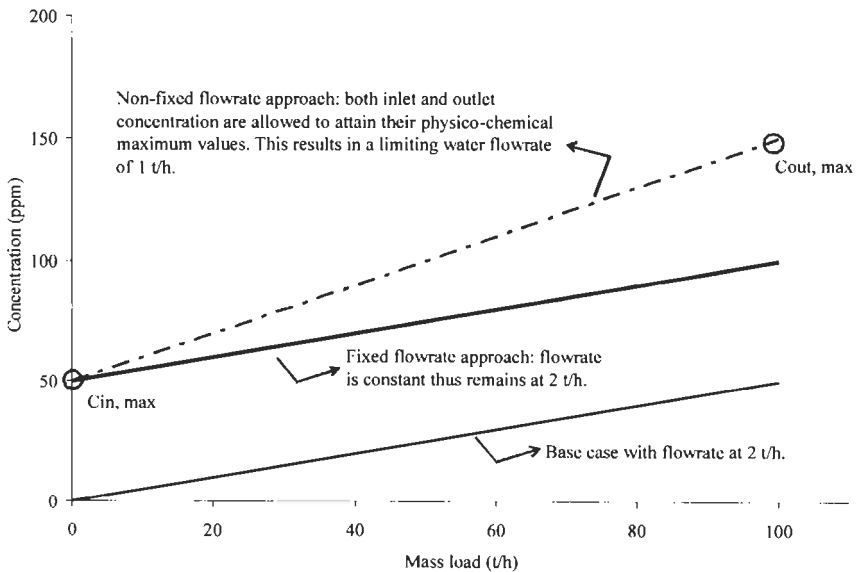

Figure 4.9 Constant flow rate and the limiting flow rate approach

constraints (Wang and Smith, 1994a) and later extended to fixed flow rate (Wang and Smith, 1995) since this situation is most common in process industries. However, the original methodology can be extended to processes with flow rate constraints.

The limiting composite line

Consider an example scheme with three processes (P1 to P3) and two contaminants (C1 and C2). It is assumed, for all processes, that the limiting flow rates and the initial flow rates are the same for the relaxed case, and that the flows have been optimised. Data for the example are provided in Table 4.4.

The pinch methodology begins with the construction of the *limiting composite line*. To this purpose separate limiting water profiles (solid, fine lines) are plotted from the data in Table 4.4 as a concentration versus mass load diagrams for both contaminants (Figs. 4.10 and 4.11). From Fig. 4.10 four concentration intervals can be distinguished (0–25; 25–50; 50–100; 100–150 mg/l) for C1, whereas only two intervals can be distinguished for C2 (Fig. 4.11) at 0–50 and 100–150 mg/l. In each concentration interval, a line is then constructed between the point at lowest mass load and concentration and the highest, such that limiting composite curves are obtained for both contaminants (solid, thick lines). For both contaminants the minimum flow rate through the overall scheme can now be determined by drawing a line that at no point bisects the limiting composite line. This line is called the *water supply line*, the inverse of the slope being the overall *limiting flow rate*. In this case, for both contaminants the water supply line only touches the composite curve at the end point. This point called the *pinch point*.

From Figs. 4.10 and 4.11 it is observed that two limiting flow rates are obtained: 2.67 t/h for C1 and 2.33 t/h for C2. In general, the theory of water pinch is presented in articles and textbooks as a single-contaminant case. Indeed, it is not possible to consider more than one contaminant since concentration shifting, as proposed by Wang and Smith (1994a) is required when targetting a multiple contaminant case. This entails a very lengthy and complex procedure. Although a two-contaminant case has been assumed to illustrate the method

Table 4.4 Water data for example 1 after relaxation of the contaminants

	Mass load (g/h)	C1 _{in,max} (ppm)	C1 _{out,max} (ppm)	Limiting flow rate (t/h)
Process 1 (P1)	100	0	50	2
Process 2 (P2)	100	25	125	1
Process 3 (P3)	200	100	150	4
	Mass load	C2 _{in,max}	C2 _{out,max}	Limiting flow rate (t/h)
Process 1 (P1)	100	0	50	2
Process 2 (P2)	50	100	150	1
Process 3 (P3)	200	100	150	4

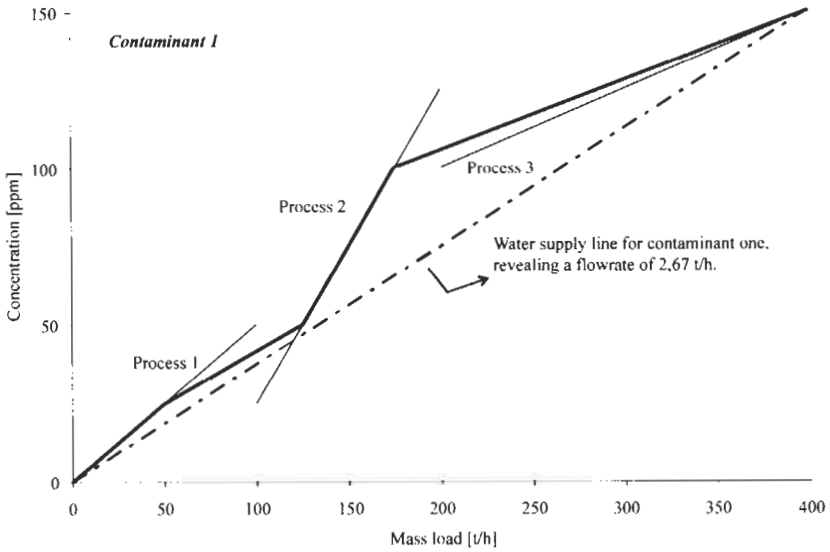

Figure 4.10 Construction of the water supply line for contaminant 1

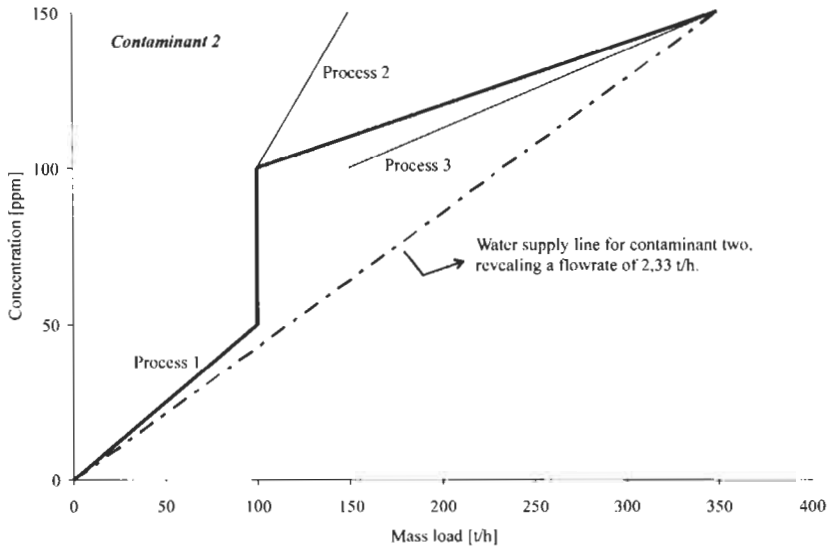

Figure 4.11 Construction of the water supply line for contaminant 2

and its application, nearly all practical cases concern multiple-contaminant matrices. It should be stressed that, although applicable for this case, it is not generally the case that the overall target flow rate, based on all contaminants in a multiple-contaminant system, corresponds to the highest value flow rate observed when constructing the water supply lines.

4.2.4 Computed solutions

For the simple scenario given in Table 4.4, implementation of both LM and UMIST software provides the same limiting flow rate, corresponding to the theoretical limit. However, the networks proposed by the two different software packages differ (Figs. 4.12 and 4.13). Indeed, by allowing a variable flow rate through the process, the UMIST software Water, which allows both approaches (i.e. fixed and non-fixed flow rates) projects flow rates lower than the limiting ones. Using the LM WaterTarget[®] software, based on flow rates fixed at the limiting value, the individual flow rates in the processes remain the same. To achieve the same target flow rate, but constraining to a fixed process flow rate, WaterTarget[®] proposes a network where part of the effluent of Process 2 and 3 is recycled and used as influent for those processes (Fig. 4.12). As such the overall flow rates through all the individual processes remains constant. The network proposed by Water looks the same as the WaterTarget[®] one, although providing no recycling and thus allowing a reduced flow rate through the third process.

This example shows that whether or not the flow rate through the process is constrained at a fixed value, the target minimum flow rate remains the same and both software tools provide a possible water network achieving the target. Moreover, when the results of the optimisation indicate recycling of the outlet back to the inlet of the process, this suggests the possibility of lowering the flow rate through the process.

Since the two approaches result in a different network, the inlet and outlet concentrations of the individual processes will also differ (Table 4.5). By not constraining the individual process flow rates, lower inlet concentrations from the Water solution are obtained compared to those from the fixed flow rate approach of WaterTarget[®]. However, since the final effluent is produced by Process 3, the effluent concentration of this process is the same for both approaches.

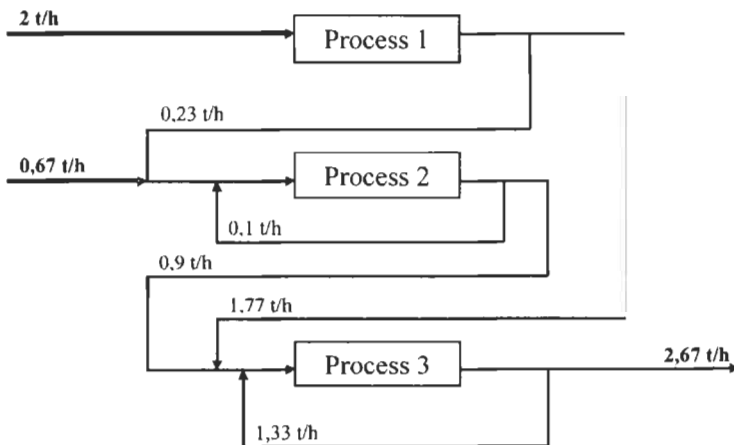

Figure 4.12 Network proposed by WaterTarget[®] to achieve the target for example 1

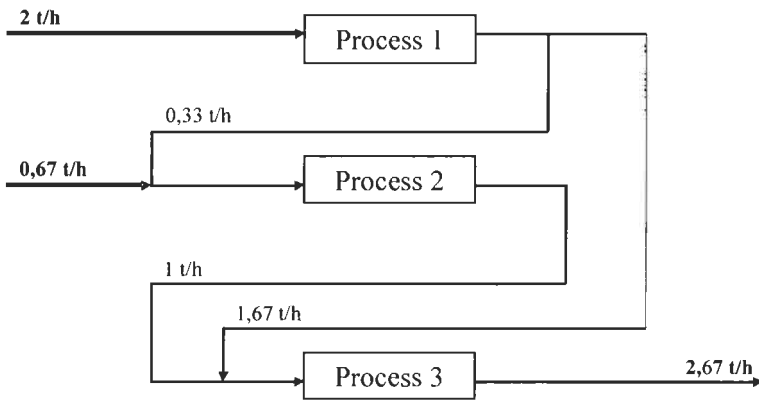

Figure 4.13 Network proposed by Water to achieve the target for example 1

Table 4.5 Inlet and outlet concentrations for the processes

	Contaminant 1		Contaminant 2	
	C1 _{in} (ppm)	C1 _{out} (ppm)	C2 _{in} (ppm)	C2 _{out} (ppm)
<i>WaterTarget</i> ^{3c}				
Process 1 (P1)	0	50	0	50
Process 2 (P2)	24	124	18.5	68.5
Process 3 (P3)	100	150	81	131
<i>Water</i>				
Process 1 (P1)	0	50	0	50
Process 2 (P2)	17	117	17	67
Process 3 (P3)	75	150	56	131

Further decreasing the minimum flow rate

As shown above, the graphical presentation of the problem provides a method of determining the minimum flow rate, taking into account the prevailing constraints. The task of any engineer dealing with water saving must now be to search for ways to further reduce the water consumption. The graphical presentation provides an aid in attaining this goal. (The graphical plot used in *WaterTarget*^{3c} does not represent concentration versus mass load, but concentration versus flow rate. This methodology and the interpretation of the curves generated can be found in Buehner and Rossiter (1996).)

A decrease in the overall water usage implies an increase in the slope of the water supply line. To achieve this for a single-contaminant scenario it can be observed from Fig. 4.10 that the maximum effluent concentration of Process 3 should be allowed to increase since, provided the inlet concentration is unchanged, the slope of the limiting water line for this process will increase when not constraining the flow rate. As such, the slope of the dotted line, representing the water supply line, will increase resulting in a lower target. For the example presented, however, the gain is only minor. Indeed, one

immediately observes that the slope of the limiting composite curve can only increase to the point at which the line touches the composite curve at the point (125, 50). As such, the effluent concentration can only be allowed to increase up to 160 ppm, resulting in an overall target of 2.5 t/h. The limiting composite curve for the new problem is presented along with the water supply line and the pinch point in Fig. 4.14. It is observed that further increasing the effluent concentration of Process 3 provides no further advantage.

Whereas Water provides a graphical presentation of the composite curves, thus allowing the engineer to tackle the problem graphically, WaterTarget[™] provides a visual representation. Performing a so-called inlet *sensitivity analysis*, WaterTarget[™] pinpoints those processes and contaminants that may be adjusted so as to achieve an improved target. The result of this sensitivity analysis, which essentially corresponds to the graphical analysis described previously, is presented as a bar chart of cost saving in \$/h per unit ppm concentration change for each contaminant (Fig. 4.15). For the example given in this section, the software advises the engineer that it is beneficial to increase the inlet concentration of Contaminant 1 in Process 3. For this simple case, the bar chart is perhaps not necessary. For a more complex case, however, it provides a more accessible illustration of the system data. Indeed, whilst the theory is only valid for a single-contaminant problem, the sensitivity analysis applies to multiple-contaminant cases.

As already observed, the different approaches of fixed and non-fixed flow rates provide different solutions. To permit an increased effluent concentration from Process 3 and maintain a constant flow rate through the process, the inlet concentration must be allowed to increase for the fixed flow rate approach. If

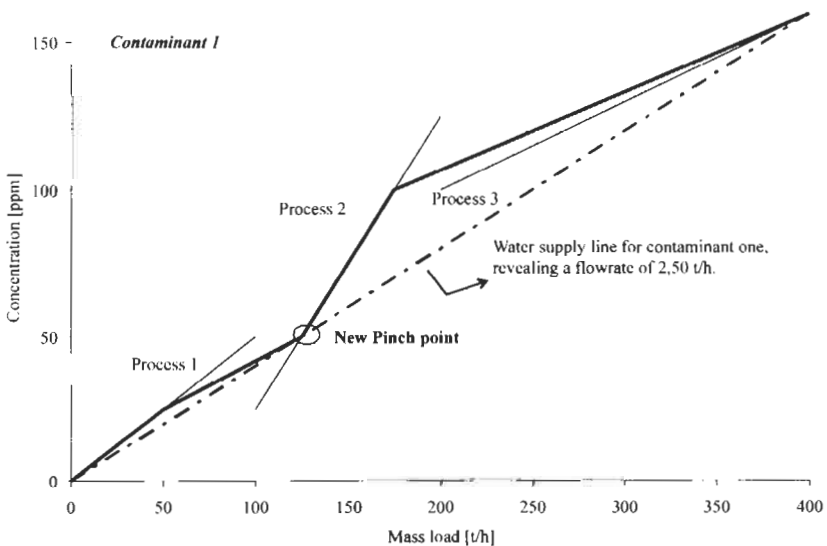

Figure 4.14 Construction of water supply line for Contaminant 1 after relaxing the effluent concentration for Process 3

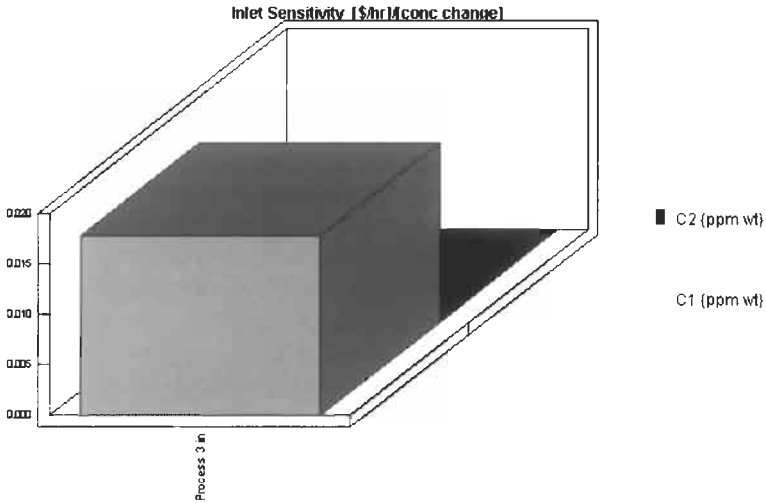

Figure 4.15 Sensitivity analysis graphically presented by WaterTarget™

increasing this influent concentration is not permitted, no further reduction of the flow rate is possible. However, as shown above, the difference between the results obtained using Water and WaterTarget™ concern only the stream recycle presented in the solution provided by WaterTarget™. Since this recycle is an indication to the engineer that lowering the overall flow rate through the process is beneficial and would lower the inlet concentration to the process, a higher influent concentration could be entered and the recycled stream dispensed with. This would lower the flow rate through one or more of the processes whilst still providing a solution that complies with the original constraints. The LM software does not provide a means of helping the engineer to tackle this problem, but experienced designers may choose to use this option.

From Fig. 4.14 it is evident that further decreasing the overall water usage is only possible by shifting the pinch point to higher concentrations. To achieve this, the only possible solution is to increase the inlet concentration of Process 2. Indeed, changing the parameters of Process 1 or 3 will not alter the position of the pinch point. In general processes above the pinch point should not be considered since they do not influence it at all; for processes below the pinch point the system should be analysed to identify which process or processes have a positive influence on the overall water demand.

To further develop the methodology for a multiple contaminant case, the solution provided by WaterTarget™ (where both inlet and effluent concentrations from Process 3 are adjusted to maintain the constant flow rate) is further developed. It is assumed that after careful examination the effluent concentration is allowed to increase up to 190 ppm, and thus the influent concentration forced to increase by the same amount to 140 ppm. The bar chart (Fig. 4.16) now indicates that the inlet concentration of C1 of Process 2 should be altered. (The representation may appear somewhat confusing if one is not well

acquainted with the software: it might be deduced that altering the inlet concentration of C2 to Process 1 is more beneficial, but the negative sensitivity for C1 in the same process provides an indication that this option is not beneficial. Indeed, changing C2 has no influence in this case.) The bar chart representation for the inlet sensitivity accounts for both the inlet and outlet concentrations. The negative concentration indicated in the figure implies that it is beneficial to lower the inlet concentration, which results from an analysis of the outlet concentration. Since the inlet and outlet are coupled the software advises a change in inlet concentration since this is more practical.

In allowing the inlet concentration of C1 of Process 2 to increase up to 37.5 ppm and the effluent concentration to 137.5 ppm, and concomitantly allowing C1 in Process 3 to increase up to 200 ppm, WaterTarget[®] indicates a target of 2.33 t/h. This value can, in this case, easily be explained using the graphical presentation of the UMIST software. Indeed, according to Fig. 4.17 a target of 2.25 t/h can be achieved for C1. However, this is not the overall target as the target set for C2 indicates a flow rate of 2.33 t/h, slightly higher than the one for C1. Therefore the overall target is 2.33 t/h. The process of identifying the minimum flow rate proceeds through an investigation of C2 (Fig. 4.18), and continues until no further adjustments to inlet and outlet concentrations can usefully be made.

In Figs. 4.19 and 4.20 water networks are presented for the WaterTarget[®] and Water models respectively. The fixed flow rate approach of WaterTarget[®] again produces a network with internal recycles, whereas Water proposes a lower flow rate through the process. As stated above, the net result for the latter is a lower inlet concentration to the processes (Table 4.6) with, in the case of Process 3, a C1 value which is below the original value of 100 ppm compared with a value of 121 ppm obtained from the WaterTarget[®] analysis. One is

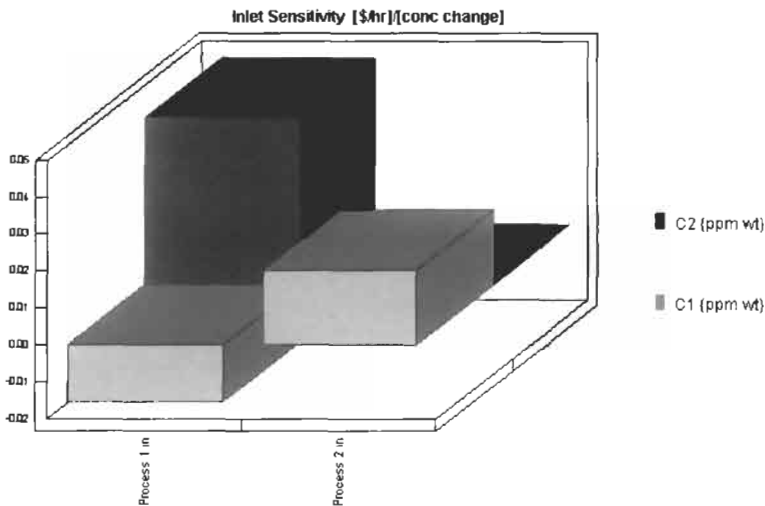

Figure 4.16 Bar chart representation after relaxation for C1 in Process 3

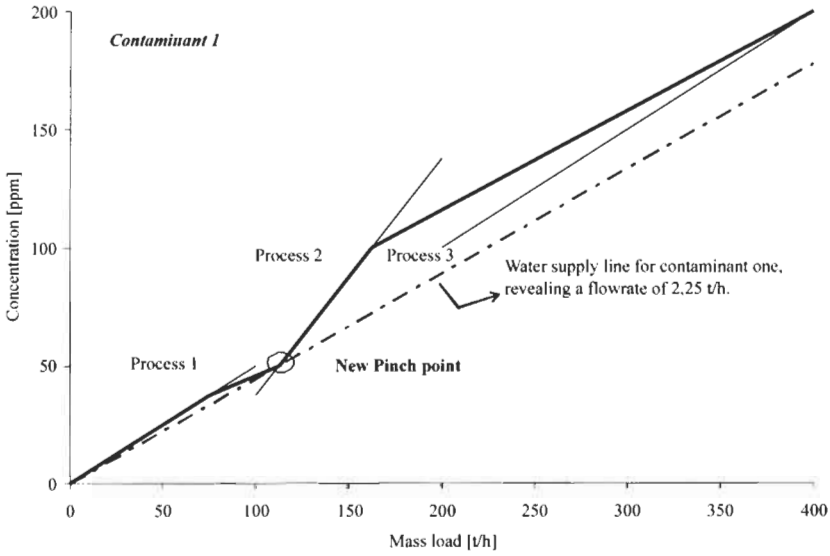

Figure 4.17 Water supply line for C1 after relaxing the effluent concentration for P3 and the influent and effluent concentrations for P2

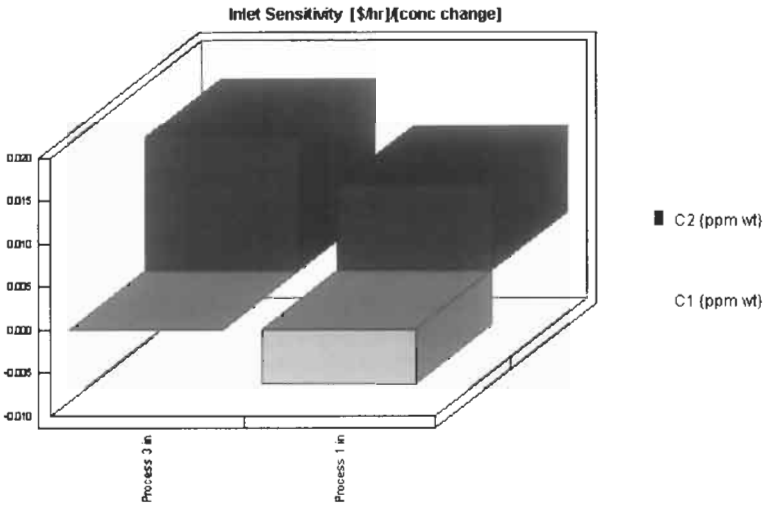

Figure 4.18 Bar chart after relaxation for C1 in Processes 2 and 3

therefore confronted with the options of a change in either inlet concentration or flow rate.

It is important to stress at this point that water pinch provides a systematic approach for modelling an existing water network, rather than a single solution to a problem. The available software provides a useful tool for the engineer in the decision-making process, but identifying the actual minimum flow rate is an

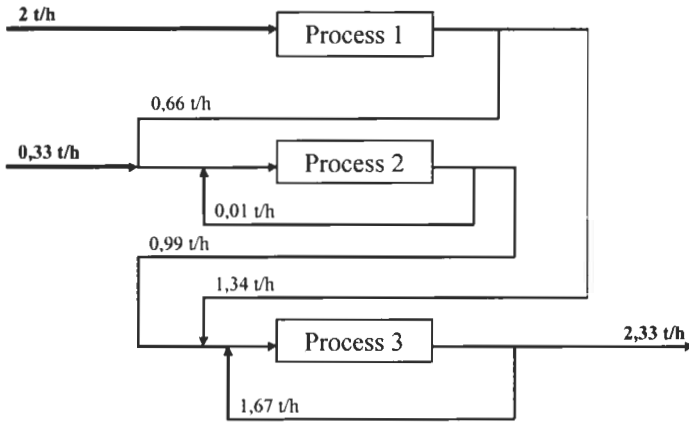

Figure 4.19 Network proposed by WaterTarget[™] to achieve the target for example 1 after relaxing C1 for P2 and P3

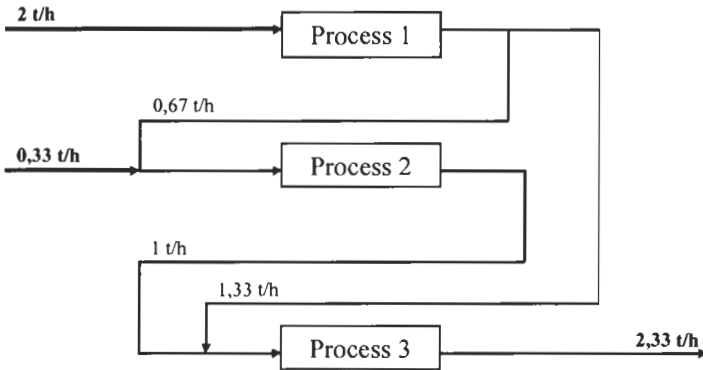

Figure 4.20 Network proposed by Water to achieve the target for example 1 after relaxing C1 for P2 and P3

iterative process. In the following paragraph an example is presented where it is assumed these first steps to determine the maximum inlet and outlet concentration have been fully examined.

4.2.5 Software tools currently available

As is already evident, application of water pinch methodology is simple for a single-contaminant process scheme and/or only water usage is to be considered without taking into account possible purification processes, discharge limits, or costs linked to water management and purification. Pinch methodology was originally developed as a research tool to help develop different scenarios for minimising water consumption for industrial case studies. With the expansion of water pinch as a design aid, commercial software packages have been developed.

Currently, there are at least four commercial software packages available: WaterTarget[®] commercialised by Linnhoff March a division of KBC Process

Table 4.6 Resulting inlet and outlet concentration for the processes after relaxing C1 for P2 and P3

	Contaminant 1		Contaminant 2	
	C1 _{in} (ppm)	C1 _{out} (ppm)	C2 _{in} (ppm)	C2 _{out} (ppm)
<i>WaterTarget</i> [®]				
Process 1 (P1)	0	50	0	50
Process 2 (P2)	34	134	34	83
Process 3 (P3)	121	171	100	150
<i>Water</i>				
Process 1 (P1)	0	50	0	50
Process 2 (P2)	33	33	133	83
Process 3 (P3)	86	172	64	150

Technology limited (further referred to as LM software), Aspen Water[®] commercialised by Aspen Technology, Water provided by UMIST to the members of its Research Consortium and Water Close[®] commercialised by American Process with an emphasis on mills (American Process Inc, 2002; Retsina and Rouzinou, 2002).

Aspen Water[®] supports the work flow at each stage of the design, addressing the total problem including process, utility and treatment systems. The company is able to call upon its library of standard water-using unit operation including boilers, evaporators, cooling towers, vessels, reactors and heat exchangers, as well as purification technologies such as membrane processes. The flow-sheeting structure allows users to develop new unit operation models for their own specialised application. Moreover, using Aspen Water[®] allows the water chemistry to be modelled using the Aspen Properties[®] physical property system. Additionally, using the Aspen Equation Modeler[®], dynamic simulation is possible. Lourens (2002) provides an example of an industrial study performed using Aspen Water[®].

The capability of WaterTarget[®] is comparable to that of Aspen Water[®] but it does not have the functionalities of a library containing different unit operations and treatment techniques. Simplified linear equations are provided to calculate the effluent concentration in unit operations based on the influent concentration and simplified treatment units are provided to mimic the processes involved. It is assumed the effluent concentration is inferred from the influent concentration and a single removal ratio determined for a specific contaminant. Cost functions are linearly dependent on the flow rate.

The project builder of WaterTarget[®] (Fig. 4.21) allows different contaminants to be selected, preferably limited to five in number, the processes to be defined, the sources (mains water, ground water, etc.) and sinks (sewer, surface water, etc.) to be identified and treatment techniques to be selected. Any constraints on the system design can be imposed via the Bounds editor (Fig. 4.22). Several types of bounds may be inserted, for example restriction on flow rates, costs of connection of one process to another, or any

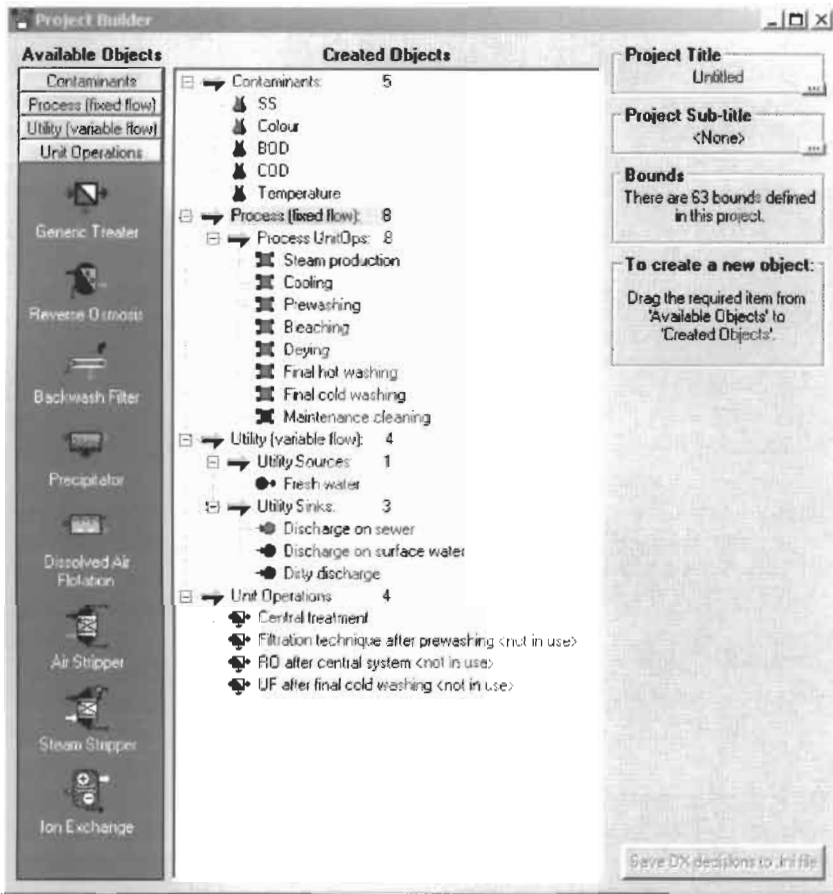

Figure 4.21 Project builder used in WaterTarget[®]

other logistical limitation. The water network obtained with the software is presented by means of a table, indicating all selected connections between sinks and sources. A visual presentation of the water network is not provided in WaterTarget[®], unlike Aspen Water[™] and Water, Water, although being a research tool, does provide a graphical presentation of the network, thus allowing a very quick and easy assessment of the effect of changing constraints of the design.

Although the methodology for energy pinch was first extended by the UMIST Process Integration group to water systems, the software developed by this group has not really developed far beyond the research tool stage, although the Water software is in a continual state of development with new features being added regularly. Against this, Aspen Technology and Linnhoff March both entered the market in 1999 with more user-friendly software than that of the UMIST group, both groups having benefited from membership of the UMIST research

Sinks / Sources	Steam production in [100,00]	Cooling in [350,00]	Prewashing in [150,00]	Bleaching in [50,00]	Dyeing in [300,00]	Final hot washing in [50,00]	Final cold washing in [200,00]	Maintenance cleaning in [150,00]
Steam production out [0]	0							
Cooling out [350,00]		350.00						
Prewashing out [150,00]			150.00					
Bleaching out [50,00]				50.00				
Dyeing out [300,00]					300.00			
Final hot washing out [50,00]						50.00		
Final cold washing out [200,00]							200.00	
Maintenance cleaning out [150,00]								150.00
Fresh water [-INF]								

Figure 4.22 Bounds editor used in WaterTarget¹⁸

consortium which provides the latest information on the latest developments regarding the methodology itself.

Apart from the commercial software tools, several researchers have developed their own software tools, mainly from the mid-1990s onwards. This has arisen as much out of financial prudence as much as anything else, since commercial packages are both expensive and limited in that they do not allow the algorithms to be adapted. The simulation tool Matlab has been used by the Pollution Research Group at the University of Natal to formulate the problem and to design the water network in a power plant (Brouckaert *et al.*, 2002). This formulation has been adapted by Majozzi (1999) for batch processes. The group is also using this approach to optimise reagent recovery and water use in industrial processes. The software tool developed by the group to this purpose has yet to be commercialised (Giannada *et al.*, 2002).

At the Technical University Hamburg-Harburg a water pinch software package, Wado¹⁸, was developed with emphasis on the treatment system including the selection of reasonable treatment operations for purification (or *regeneration*) purposes (Ullmer *et al.*, 2002). A software package (WaterDesign) for calculating minimum water usage for a single contaminant problem was provided along with a textbook (Mann and Liu, 1999). A Portuguese research group has developed its own software in using Microsoft Visual Basic, implementing the methodology of Wang and Smith (1994) with improvements including multiple pinch analysis, regeneration reuse targeting, taking into account water purification technology (Castro *et al.*, 1999). According to the authors' article, the software is continually under development. At the University of Oklahoma the pinch concept was extended to account for heat and mass exchanger networks (Bagajewicz, 2002). Many other research groups and independent research institutions, such as CEVI in Denmark (Anderson *et al.*, 2002), have produced their own CAD packages, and it is most likely that at least some of these will be commercialised at some stage.

Programming

The solution of a water demand problem based on pinch methodology essentially has two components: a proper routine that formulates the problem and accounts for the superstructure and a robust optimisation package to solve the highly non-linear equations. Optimisation demands the solution of highly non-linear equations. Indeed, the pinch problem is fundamentally non-linear with discrete decisions (complexity, number of connections, etc.), generally demanding solution by MINLP algorithms (Mixed-Integer Non-Linear Programming). For WaterTarget[®] it can be observed that in running the optimisation procedure, GAMS (General Algebraic Modeling System; GAMS, 2002) is called upon as a solver. The commercial solvers used are OSL (MILP) and MINOS (NLP), whereas the algorithm used to solve the MINLP is proprietary. As for Water, the problem is decomposed into a linear approximation (MILP) followed by a non-linear (NLP) solver. Gianadda *et al.* (2002) use the UMIST approach, breaking down the problem into a MILP followed by NLP using CONOPT as the solver to deal with the NLP problem. The optimisation problem has been solved by Ullmer *et al.* (2002) by using a MINLP algorithm developed by Lassahn and Gruhn (2002). XPRESS-MP[®] solves the MILP problem; the remaining NLP problem is solved by LSQRG2[®]. At the Rzeszów University of Technology (Poland) an adaptive random search (ARS) optimisation method was developed to design the optimal wastewater reuse network containing a small or medium number of water-using processes (Poplewski *et al.*, 2002). To overcome the limited number of processes, further investigations are planned. Shafiei *et al.* (2002) propose an alternative approach by coupling genetic algorithms with mathematical programming and evaluating the solutions obtained by process simulation.

Solving the highly non-linear problem forces the user, and thus the software developer, to carefully examine the solution to ensure that the solution provided is not a local but a global minimum. However, due to the non-linearity there is no guarantee the solution is a global one. Using many different initial conditions appropriate to the system being examined and searching the optimum value is an indication of how well the global optimum has been reached. The process of thoroughly checking this often makes the calculation lengthy, especially when many contaminants, regeneration techniques and constraints are considered. The software should indicate whether a local, a presumed global or no optimum has been reached.

4.2.6 Case study: water pinch and implementation of regeneration techniques

As already stated, water pinch is a methodology to determine the minimum water usage as an overall target and, as such, does not take into account the minimum total cost and compliance with effluent discharge consents. A case study is presented where a water network is determined, achieving minimum water usage at minimum total cost. The example is based on the WaterTarget[®] software package, this being a package that allows a total system design to be developed, including compliance with the final effluent discharge limits. The theory behind the methodology incorporating regeneration techniques and final

effluent treatment can be found in El-Halwagi (1992) and Wang *et al.* (1994b). The case study illustrates the importance of software tools, comprising the water pinch methodology, to provide ideas promoting an integrated approach. It will be shown that, using available data from different purification techniques, the software package reveals the most cost-effective selection of segregated purification techniques and end-of-pipe treatment both to comply with the stringent effluent standards and to minimise the overall water consumption. The program allows the insertion of as many purification techniques as is desired, since it is not known in advance which purification technologies or the combination thereof provide the greatest cost benefit.

The textile process

Textile processing has been discussed in Section 2.3. It consists of many different steps, nearly all of them generating wastewater. The amount and composition of these individual effluent streams depends on many different factors, including the processed fabric and the process used (Bisschops, 2002). Due to more stringent effluent constraints and the increasing cost of water usage, much effort has been devoted to minimising water usage and improving product recovery in the textile industry.

A general flowchart of a textile manufacturing process comprises (Bisschops, 2002):

- *Desizing* with high BOD, COD and SS effluent concentrations,
- *Scouring/washing* with high BOD, COD, SS effluent concentrations,
- *Bleaching* with low BOD, high COD and solids effluent concentrations,
- *Singeing* where only cooling water is needed,
- *Cotton mercerising* with low BOD and SS effluent concentrations,
- *Dyeing* with very high COD and high SS effluent concentrations, with BOD levels dependent upon dye biodegradability,
- *Printing* with very high COD and high SS effluent concentrations and BOD levels dependent upon dye biodegradability, and
- *Finishing* where waters vary widely according to the type of finishing process and information regarding effluent concentrations and flow rates are scarce.

Apart from the water usage in these different process steps, water is used in the process for washing after pretreatment steps, after dyeing and after some finishing steps. Water is used for utilities such as raising steam, general cooling and maintenance.

Process data

The pure water source available for the processes is groundwater having the following specification with respect to six key contaminants:

- 5 ppm SS,
- 10 Pt-Co colour,

- 5 ppm BOD₅,
- 10 ppm COD,
- 0 ppm salt, and
- temperature of 12°C.

The cost price of this water is set at €0.1 per m³.

Flow rates and effluent concentrations used are listed in Table 4.7. The process layout has been simplified and, although most textile manufacturing processes are operated batchwise, the process is presented as a continuous one. The implications that need to be taken into account to transpose the results to the true batchwise operation are elaborated later.

For most processes the influent water quality has to be very high (equivalent to groundwater quality) since substances present in the process water can have an adverse impact on final product quality. Unfortunately, the exact requirements for wastewater reuse are not very clear and very few publications are available (Bisschops, 2002). For the purpose of the case study it is assumed that prior evaluation and discussion with the plant engineers, have established the maximum inlet concentrations and that no further relaxation is possible. The values used for the purpose of this example are shown in Table 4.8.

Wastewater data

The maximum values for discharge to the sewer system are set at: 100 ppm SS, 200 ppm BOD, 800 ppm COD, 1 500 Pt-Co for colour and 30°C, with no limits for salt. The limits for discharge on the surface water are set at: 60 ppm SS, 25 ppm BOD, 125 ppm COD, 100 Pt-Co for colour and 30°C, again with no limits set for salt.

Table 4.7 Flow rates and effluent concentration for the processes in textile manufacturing (Bisschops, 2002; and others)

	Flow (t/d)	SS (ppm)	Colour (Pt-Co)	BOD (ppm)	COD (ppm)	Salt	Temp. ^a (°C)
Steam production	100	20	50	5	30	5	30
Cooling	350	5	10	5	10	0	40
Desizing	100	100	200	2700	11 000	2	35
Prewashing	150	100	100	50	200	1	35
Bleaching	50	7900	500	200	8500	3	35
Mercerising	50	1250	200	55	100	1	35
Dyeing	300	190	4750	1400	1600	4	35
Printing	60	9500	10 000	5000	50 000	4	20
Final hot washing	50	50	200	20	50	1	35
Final cold washing	200	50	200	20	50	1	15
Maintenance	150	100	150	20	100	1	35
Total	1560						

^a It is assumed that cooling of the process baths lowers effluent temperature to 45°C. Due to a lag time in the installation before reaching the central wastewater treatment plant, the effluent temperature is taken at 35°C.

Table 4.8 Maximum influent concentration for the processes in textile manufacturing

	SS (ppm)	Colour (Pt-Co)	BOD (ppm)	COD (ppm)	Salt	Temp. (°C)
Steam production	5	10	5	10	0	25
Cooling ^a	5	10	5	10	0	12
Desizing	5	100	100	200	0	60
Prewashing	50	2000	100	400	2	40
Bleaching	5	10	5	10	0	60
Mercerising	5	10	5	10	0	60
Dyeing	5	10	5	10	0	60
Printing	5	10	5	10	0	60
Final hot washing	5	10	5	10	1	60
Final cold washing	5	10	5	10	1	25
Maintenance	100	2500	200	400	4	60

^aThe influent concentrations for cooling are set this strict to allow for later reuse of the resulting hot water for all steps in the manufacturing process.

Water discharged to the sewer system is set at a cost of €1 per m³, and to surface water (on meeting discharge consents) cost of €0.1 per m³. In reality the levies for discharge both on the sewer system and the surface water depend on the pollutant load in the effluent. Such a complex relationship cannot, however, be used in the software and instead fixed values must be used. Recalculation after optimisation is necessary to properly account for this.

The concentrated stream from the central wastewater treatment plant and the concentrated polluted streams from individual purification techniques can be treated separately in dedicated treatment facilities outside the textile company at a cost price of €100 per m³.

Purification techniques

Amongst the purification techniques (Schönberger, 1998) two important groups can be distinguished:

- processes capable of recovering of one or more of the reagents for reuse in the manufacturing processes, many of them also producing a highly purified effluent water which can easily be reused, and
- processes capable of recovering water for reuse purposes.

Data are summarised in Tables 4.9 and 4.10.

Selected purification techniques and cost data for these comprise the following.

Ultrafiltration for recovery of sizing agent (European Commission, 2001). The process is assumed to recover both the sizing agent, which can be reused in the process, and good-quality effluent water for reuse. *Capital cost* for a 100 m³ day⁻¹ plant is around €1.2 million, including the UF plant, an equalisation tank, start-up and miscellaneous. Eventually a prefiltration step has to be accounted for. Savings up to €0.7 million per year due to product recovery

Table 4.9 Removal efficiency (%) for the proposed purification techniques

	SS	Colour	BOD	COD	Salt	T
UF for recovery of sizing agent	100	75	95	90	95	Cst
Filtration after prewashing	65	0	40	50	50	Cst
Three stage evaporation for recovery of alkali from mercerising	100	100	100	100	100	50
Membrane treatment for recovery of wastewater from printing paste	100	95	95	90	85	Cst
Membrane treatment for recovery of wastewater from final washing	95	60	85	90	85	Cst
Centralised biological WWTP ^a	99	90	100	95	10	15
RO for the treated wastewater	100	100	100	100	100	Cst

^a Removal efficiency by the centralised WWTP will largely depend on the final effluent quality for treatment. If, for example, the printing paste is to be treated in the WWTP as well, COD removal will be much lower. These water-insoluble compounds are substantially undegraded biologically, and are removed only by adsorption onto the sludge. Such removal and other special cases are not accounted for in this study.

Table 4.10 Water recovery ratio for the proposed purification techniques

	Water recovery (%)
UF for recovery of sizing agent	87
Filtration after prewashing	97
Evaporation for recovery of alkali from mercerising	97
Membrane for recovery of wastewater from printing paste	90
Membrane for recovery of wastewater from final washing	95
Centralised biological WWTP	90
RO for the treated wastewater	85

alone can be achieved. Therefore the capital cost is assumed to be entirely recovered by the sizing agent recovery. *Operating cost* is assumed to be €0.1 per m³, the figure being substantially reduced by the economic savings from the product recovery. It is assumed that a reusable effluent is provided at the same price as that of groundwater.

Filtration after prewashing. *Capital cost* is assumed to be €0.1 per m³ (10-year depreciation period at an interest rate of 0%) for a self-cleaning rotary filter or a pressurised microfiltration membrane with a capacity of 150 m³ day⁻¹. *Operating cost* is assumed to be €0.1 per m³.

Three-stage evaporation for recovery of alkali from mercerising (European Commission, 2001). The process produces a concentrated lye (alkali) which can be reused in the process, and also provides a good quality effluent water for reuse. *Capital cost* depends on the plant size and the purification technique applied after evaporation to obtain a concentrated lye, which can be reused in the process, and typically varies between €0.2 million and €0.8 million. Due to product lye recovery the payback time can be less than one year, and the capital cost is therefore ignored in this study as it was for the ultrafiltration unit for recovery of

sizing agent. *Operating cost* is assumed to be €0.1 per m³, based on the same assumption of a cost recovery as the UF plant.

Membrane treatment for recovery of wastewater from printing paste (European Commission, 2001). *Capital cost* for a 60 m³ day⁻¹ plant is €0.82 per m³ based on a 10-year depreciation period at an interest rate of 0%. The installation comprises coagulation/precipitation pretreatment followed by a microfiltration unit using a polypropylene membrane and a tube settler to remove the suspended solids. *Operating cost*, including external disposal of the concentrate, the principal contribution to opex, is about €4 per m³.

Membrane treatment for recovery of wastewater from final washing. *Capital cost* is assumed to be €0.33 per m³ for an ultrafiltration installation of 250 m³ day⁻¹. *Operating cost* is assumed to be €0.25 per m³.

Centralised biological wastewater treatment plant (European Commission, 2001). *Capital cost* is taken at €1.25 per m³ for a 2500 m³ day⁻¹ plant (10-year depreciation at an interest rate of 6.88%). The investment cost given in the paper (European Commission, 2001) was €1.50 per m³, although this included further purification (by reverse osmosis) of the effluent for reuse. The plant comprises equalisation, neutralisation, and activated sludge treatment in a special system of loop reactors and clarifiers, adsorption to remove dyestuffs, flocculation/precipitation and removal of sludge, and filtration in a fixed-bed gravel filter to remove suspended solids. Also included is the treatment of the sludge in a thickener and decanter and thermal regeneration in a rotary kiln. *Operating cost* is taken at €0.6 per m³, based on the above, including ash disposal and ignoring heat recovery.

Reverse osmosis for polishing the treated wastewater (European Commission, 2001). *Capital cost* is taken at €0.25 per m³ for a 1500 m³ day⁻¹ plant. Investment comprises the reverse osmosis plant consisting of 10 modules containing 4 spiral membrane elements each. Included is a storage tank conditioned with ozone to control biological growth. *Operating cost* is taken at €0.1 per m³.

Results

Base case: targeted minimum flow rate, discharge to sewer. For the base case it is assumed the company is required to meet stricter consents for discharge to sewer. In the first instance a large central wastewater treatment plant can be envisaged for the treatment of the overall wastewater.

The result of the base case reveals that 1210 m³ day⁻¹ of fresh water is needed with all effluent from the cooling process being recycled (350 m³ day⁻¹ waste from a 1560 m³ day⁻¹ feed). No other effluents are identified for reuse taking into account minimum operating cost. The effluent of the central wastewater treatment plant meets the strict discharge consents for both SS and BOD. Only 378 m³ day⁻¹ needs to be treated in the central plant, the remaining effluents being discharged directly to sewer. The daily cost of this base case is €6387, 60% of this being due to the external treatment of the concentrated waste.

Scenario 1: targeted minimum flow rate, all purification techniques permitted. For this case it is presumed the company was seeking alternative ways of minimising the

overall cost. All purification techniques previously outlined are permitted and the pinch methodology is used to target the optimal solution.

As is already obvious from Section 4.2.4, recovery of the sizing agent and recovery of alkali with simultaneous recovery of a purified water is economically very beneficial, with water available at good quality at the cost price of groundwater. Looking at the proposed target ($1016 \text{ m}^3 \text{ day}^{-1}$ of freshwater), the water network suggested is operated at a cost price of €4819, lower than the base case. The target is achieved by implementing the membrane technique for treatment of the printing paste. The final effluent is discharged to the sewer system without implementing other purification processes to achieve a wastewater that can be discharged at a lower cost to the surface water. One of the flow rates suggested is very small and transpires to be an internal recycle for one process. The question of whether or not the overall water flow through the process should be lowered can then be addressed.

As can be seen in Table 4.11 for several processes multiple inlet streams should be connected. This often implies additional cost, not yet accounted for by the analysis, for pipework, storage tanks and control. It is advisable to ignore these costs when embarking on the analysis, since they make the problem too complex. When the optimum network is selected these additional costs can be added manually or can be taken into account in the program.

Scenario 3: targeted minimum flow rate when all treatments are allowed but discharge on surface water is imposed. The limits set for the discharge to surface waters are much stricter than those for discharge to sewer. When the company is faced with these stricter values, proper solutions have to be accounted for. Using the software for the case study and restricting discharges to surface water yields a daily operational cost of €6551. The solution indicates that the constraints can only be met when allowing good quality water, i.e. the outlet of the RO installation, to be discharged to the surface water. Indeed, the RO is essential for the strict regulations set to be met. It is observed that this good quality water is not being reused in the process. Careful examination of the problem reveals this is due to the low cost of the fresh water! Indeed, should the company be forced to cut down on the groundwater use, tap water with additional treatment to reduce the hardness, has to be used. A higher price of this water source would make the RO installation competitive.

Remarks

When critically evaluating the case study it is apparent that not all of the contaminants behave in a way that is consistent with necessary assumptions made in the pinch analyses. Indeed, it is assumed by the program that, for each contaminant, there is a linear relationship between the measurable concentration and the actual mass per unit volume when different streams are combined. For colour, this is not always valid. When running the program it is observed that, depending on the initial conditions, the software sometimes provides a solution that is indicated not to be the optimal one. Running the software again with different initial values can result in the optimal solution.

Table 4.11 Proposed water network to achieve the target set for Scenario 1

From	To	Flow (t/d)
<i>From process . . .</i>	<i>. . . to process</i>	
Cooling out	Dyeing in	248.50
Cooling out	Final hot washing in	1.50
Cooling out	Desizing in	100.00
Prewashing out	Maintenance in	44.87
Dyeing out	Maintenance in	13.26
Final hot washing out	Prewashing in	50.00
Final cold washing out	Prewashing in	11.60
Maintenance out	Maintenance in	
<i>From utility . . .</i>	<i>. . . to process</i>	
Fresh water	Steam production in	100.00
Fresh water	Cooling in	350.00
Fresh water	Prewashing in	88.40
Fresh water	Bleaching in	50.00
Fresh water	Dyeing in	51.50
Fresh water	Final cold cleaning in	200.00
Fresh water	Maintenance cleaning in	65.76
Fresh water	Mercerising in	50.00
Fresh water	Printing in	60.00
UF for size recover clean	Maintenance in	25.84
Evaporation for alkali recovery clean	Final hot washing in	48.50
<i>From process . . .</i>	<i>. . . to utility</i>	
Steam production out	Discharge to sewer	100.00
Prewashing out	Discharge to sewer	105.13
Bleaching out	Discharge to sewer	3.09
Bleaching out	Centralised WWTP	46.91
Dyeing out	Discharge to sewer	97.09
Dyeing out	Centralised WWTP	189.65
Final cold cleaning out	Discharge to sewer	188.40
Maintenance out	Discharge to sewer	149.73
Desizing out	UF for size recovery inlet	100.00
Mercerising out	Evaporation for alkali recovery in	50.00
Printing out	Membrane for printing paste in	60.00
<i>From utility . . .</i>	<i>. . . to utility</i>	
UF for size recover clean	Discharge to sewer	61.16
UF for size recover dirty	Recovered product	13.00
Evaporation for alkali recovery dirty	Recovered product	1.50
Membrane for printing paste clean	Discharge to sewer	54.00
Membrane for printing paste dirty	Centralised WWTP inlet	6.00
Centralised WWTP clean	Discharge on sewer	218.30
Centralised WWTP dirty	Dirty discharge	24.26

From the author's own observation, it appears to be more productive to start with initial conditions which are randomly selected, thus not necessarily close to the optimum.

The water pinch methodology described in Sections 4.2.1–4.2.4 was restricted to targeting the minimum flow rate reusing effluent streams without prior treatment. The methodology, however, also allows the identification of those processes for which treatment of the effluent prior to reuse should be

considered. For the case study, as presented above, it is assumed that the methodology is applicable. However, it is often beneficial, in practical cases, to insert additional purification methods in the software. The software then provides an accurate solution, and a decision must then be made as to whether it should be implemented.

Although the case study is limited to the textile process, it should be stressed that the pinch methodology applies across all industrial sectors and all plant sizes, from large power generation (Selby and Tvedt, 1998) and paper fabrication (Shafiei *et al.*, 2002) plants to relatively small-scale operations within the pharmaceutical and food industries (Thevendiraraj *et al.*, 2001). However, it is apparent both from examination of the literature and from personal contact with engineering firms and research institutes, that real values indicating targeted water usage and/or achieved water usage are very difficult to find, largely due to their commercial sensitivity. Moreover, it is very often difficult to be sure that the indicated result has actually been implemented. However, it can be stated that water savings of at least 20–60% are achievable through applying water pinch, as revealed from some of the references cited below.

4.2.7 Conclusion

Software is currently available, based on the water pinch methodology, that allows one to target the minimal water usage at minimal cost, taking into account different constraints. Although the methodology is simple when considering only one contaminant, no purification techniques and no costs, the methodology requires a skilled engineer or researcher to unravel the whole concept when taking into account all these elements. Fortunately, the software currently available provides a means for process engineers and researchers to tackle these problems without necessitating a fundamental understanding of the underlying concepts. The software provides a guide that helps the user through the different steps. Moreover, it is obvious that the software can easily be used to evaluate many different scenarios and investigate the influence of many parameters. However, the software tool should not be considered as a plug-and-play direct answer to the problem. Indeed, without proper insight into the methodology, processes might be overlooked that play an important role in reducing the overall water consumption. Identifying solutions that reduce water consumption at the lowest total cost demands the combined skills of both the process engineers of the problem holder and experts in water pinch methodology.

References

Alva-Argáez, A., Kokossis, A.C. and Smith, R. (1998a). An integrated design approach for wastewater minimisation: theory and applications. IChemE Research Event, Newcastle, 7–8 April.

Alva-Argáez, A., Kokossis, A.C. and Smith, R. (1998b). Wastewater minimisation of industrial systems using an integrated approach. *Computers Chem. Eng.*, **22**, S741–S744.

American Process Inc. (2002). Water Close[®]. Is there a reason to save water on your mill, <http://www.americanprocess.com/documents/WaterClose.pdf>.

Andersen, M., Kristensen, G.H. and Wenzel, H. (2002). Tools for evaluation of water reuse. 2nd International Conference on Industrial Wastewater Recycling and Reuse (IWRR2), Cranfield University, July.

Bagajewicz, M.J. (2002). Final report: Chemical plant wastewater reuse and zero discharge cycles, <http://es.epa.gov/ncer/finl/grants/96/sust/bagajewicz.html>.

Bisschops, I. (2002). Textile wastewater characterisation, a literature review. Internal report of a European project (TOWEF0). Limited information available at <http://spring.bologna.enea.it/towef0/>.

Brouckaert, C.J., Schneider, J., Mansfield, M. and Buckley, C.A. (2002). Water pinch analysis as a transparent tool for the co-regulation of industrial processes. Proceedings of the Biennial Conference of the Water Institute of Southern Africa (WISA) (www.wrc.org.z).

Buckley, C.A., Brouckaert, C.J. and Renken, G. E. (2000). Wastewater reuse, the South African experience. *Wat. Sci. Tech.*, **41**, 157–163.

Buehner, F.W. and Rossiter, A.P. (1996). Minimize waste and managing process design. *Chmetech*, 64–72.

Castro, P., Mato, H., Fernandes, M.C. and Nunes, P. (1999). AquoMin: waste minimisation software. Proceedings of the 2nd Conference on Process Integration, Modeling and Optimisation for Energy Saving and Pollution Reduction (PRES '99), Budapest, Hungary, pp. 205–210.

Doyle, S.J. and Smith, R. (1997). Targetting water reuse with multiple contaminants. *Trans IChemE*, **75**(B), 181–189.

European Commission (2001). Reference document on best available techniques for the textile industry. Report from the Institute for Prospective Technological Studies, Technologies for Sustainable Development, European IPPC bureau (<http://eippcb.jrc.es>).

El-Halwagi, M.M. (1992). Synthesis of reverse osmosis networks for waste minimisation. *AIChE J.*, **38**(8), 1185.

El-Halwagi, M.M. and Stanley, C. (1995). In Rossiter, A.P. (ed) Waste minimisation. McGraw Hill, New York, pp. 15–16.

GAMS (2002). The GAMS system, <http://www.gams.com/docs/intro.htm>.

Gianadda, P., Brouckaert, C.J. and Buckley, C.A. (2002). Process water pinch analysis guides water, reagent and effluent management – selected case studies from the chloralkali industry. Proceedings of the Biennial Conference of the Water Institute of Southern Africa (WISA) (www.wrc.org.z).

Kuo, W.-C.J. and Smith, R. (1997). Effluent treatment system design. *Chem. Eng. Sci.*, **52**, 4273–4290.

Kuo, W.-C.J. and Smith, R. (1998). Design of water-using systems involving regeneration. *Trans IChemE*, **76**(B), 94–114.

Lassahn, A. and Gruhn, G. (2002). Optimization of industrial process water systems. Proceedings of the 3rd Conference on Process Integration, Modeling and Optimisation for Energy Saving and Pollution Reduction (PRES '00), Prague, Budapest.

Lourens, A. (2002). The application of water pinch at a petrochemical industry. Proceedings of the Biennial Conference of the water Institute of Southern Africa (WISA) (www.wrc.org.z).

Majozi, T. (1999). The application of pinch technology as a strategic tool for rational management of water and effluent in an agrochemical industry. MSc Eng dissertation, Pollution Research Group, School of Chemical Engineering, University of Natal, Durban, South Africa.

Mann, J.G. and Liu, Y.A. (1999). Industrial water reuse and wastewater minimisation. McGraw Hill.

Poplewski, G., Jezowski, J. and Jezowska, A. (2002). Optimal wastewater reuse networks design by adaptive random search optimization. Proceedings of the 5th Conference on Process Integration, Modeling and Optimisation for Energy Saving and Pollution Reduction (PRES '02), Prague, Budapest.

Retsina, T. and Rouzinou, S. (2002). Examples of practical application of process integration in pulp and paper mills. Proceedings of the 5th Conference on Process Integration, Modeling and Optimisation for Energy Saving and Pollution Reduction (PRES '02), Prague, Budapest.

Rossiter, A.P. and Nath, R. (1995). Wastewater minimisation using nonlinear programming. In Rossiter, A.P. (ed.) Waste minimisation through process design. McGraw-Hill, Chap. 17.

Schönberger, H. (1998). Best available techniques (BAT) for the reduction of wastewater pollution in textile finishing industry. Proceedings of the Advanced Wastewater Treatment, Recycling and Reuse (AWT98) Conference, Milan. 14–16 September.

Selby, K.A. and Tvedt, T.J. (1998). Water reuse for electric utility and cogeneration plants – important consideration. *Chemical Treatment*, 37–41.

Shafiei, S., Domenech, S. and Paris, J. (2002). System closure in an integrated newsprint mill, practical application of genetic algorithms. Proceedings of the 5th Conference on Process Integration, Modeling and Optimisation for Energy Saving and Pollution Reduction (PRES '02), Prague, Budapest.

Smith, R. and Petela, E.A. (1991a). Waste minimisation in the process industries: Part 1. The problem. *The Chemical Engineer*, **506**, 24–25.

Smith, R. and Petela, E.A. (1991b). Waste minimisation in the process industries: Part 2. Reactors. *The Chemical Engineer*, **509/510**, 17–23.

Smith, R. (1994). WaterPinch. In *Chemical process design*, McGraw Hill.

Smith, R., Petela, E.A. and Wang, Y.-P. (1994). Water water everywhere. *The Chemical Engineer*, **565**, 21–24.

Smith, R., Petela, E.A. and Howells, J. (1996). Breaking a design philosophy. *The Chemical Engineer*, **606**, 21–23.

Thevendiraraj, S., Klemes, J., Paz, D., Aso, G. and Cardenas, G. (2001). Water and wastewater minimisation study of a citrus plant. Proceedings of the 4th

Conference on Process Integration, Modeling and Optimisation for Energy Saving and Pollution Reduction (PRES '01), Florence, Italy, pp. 149–154.

Ullmer, C., Kunde, N., Lassahn, A., Gruhn, G., Schulze, K. and Wado T.M. (2002). Water design optimization – methodology and software for the synthesis of process water systems. Proceedings of the 5th Conference on Process Integration, Modeling and Optimisation for Energy Saving and Pollution Reduction (PRES '02), Prague, Budapest.

Wang, Y.-P. and Smith, R. (1994a). Wastewater minimisation. *Chem. Eng. Sci.*, **49**(7), 981–1006.

Wang, Y.-P. and Smith, R. (1994b). Design of distributed effluent treatment systems. *Chem. Eng. Sci.*, **49**, 3127–3145.

Wang, Y.-P. and Smith, R. (1995). Wastewater minimization with flow rate constraints. *Trans IChemE*, **73**(A), 889–904.

4.3 Design examples

4.3.1 Problem in reverse osmosis: film theory and energy demand

A maximum concentration polarisation parameter value of 1.14 is recommended for operation of a membrane element of the following specifications:

- Length (L): 1 m
- Channel thickness (h): 0.8 mm
- Membrane area (A): 36 m²
- Spacer mesh width (m): 0.6 mm

It can additionally be assumed that the ion diffusion coefficient is $8 \times 10^{-10} \text{ m}^2 \text{ s}^{-1}$, and the fluid viscosity and density values are $1.15 \times 10^{-3} \text{ kg m}^{-1} \text{ s}^{-1}$ and 1000 kg m^{-3} respectively.

If the element operates at a mean flux of 21 LMH, what is the minimum feed flow rate and what conversion does this yield?

If:

(a) the hydraulic losses amount to 1.15 bar per m/s cross-flow velocity per m path length.

(b) the membrane resistance is 8.5×10^{13} per m.

(c) the feedwater contains 850 mg l⁻¹ sodium chloride, and

(d) the membrane has a rejection of 98%, the water temperature is 15°C and $\eta = 0.9$

what feed pressure is required, and what energy demand does this equate to for a pumping efficiency of 40%?

Solution

Film theory states that the flux J and concentration polarisation parameter ϕ (i.e. c^*/c) are related by (Equation (2.14)):

$$J = k \ln \phi$$

The mass transfer coefficient is thus:

$$k = \frac{J}{\ln \phi} = \frac{21 / (1000 \times 60 \times 60)}{\ln 1.14} = \frac{5.83 \times 10^{-6}}{0.131} = 4.45 \times 10^{-5} \text{ m/s}$$

The Sherwood number, according to Equation (2.15), is then:

$$\text{Sh} = \frac{kd}{D} = \frac{4.45 \times 10^{-5} \times 1.6 \times 10^{-3}}{8 \times 10^{-10}} = 89.0$$

since, for a parallel flow channel, d is equal to twice the channel thickness h .

According to the expression derived for filled channels by Chiolle *et al.* (1978), Table 2.11 and Equation (2.15), the Sherwood number correlates to the Reynolds and Schmidt numbers Re and Sc respectively according to:

$$Sh = 1.065Re^{0.5}Sc^{0.33}\{d/(6Lm)\}^{0.5}$$

and from Equations (2.17) and (2.18):

$$Re = \rho Ud/\mu = 10^3 \times U \times 1.6 \times 10^{-3}/(1.15 \times 10^{-3}) = 1391U$$

$$Sc = \mu/\rho D = 1.15 \times 10^{-3}/(10^3 \times 8 \times 10^{-10}) = 1438$$

The Reynolds number can then be calculated as:

$$Re = \left(\frac{89}{1.065 \times 1438^{0.33} \left(\frac{1.6}{6 \times 1 \times 0.6} \right)^{0.5}} \right)^2 = 129$$

It follows that the (retentate) cross-flow approach velocity is:

$$U = 129/1391 = 0.0927 \text{ m/s}$$

The volumetric flow Q at this flow velocity relates to the channel cross-sectional area, given by $d \times A/(2L)$:

$$Q = U \times d \times A/(2L) = 0.0927 \times 0.8 \times 10^{-3} \times (36/2 \times 1) \times 60 \times 60 \\ = 4.81 \text{ m}^3/\text{h}$$

If this is assumed to relate to the flow at the retentate outlet, where concentration polarisation is greatest, then the feed flow will be higher than this due to conversion. The total volumetric flow of permeate is given by:

$$Q_{\text{permeate}} = J \times \text{area} = (21/1000) \times 36 = 0.76 \text{ m}^3/\text{h}$$

The feed flow is then given by:

$$Q_{\text{feed}} = 4.81 + 0.76 = 5.57 \text{ m}^3/\text{h}$$

and the conversion is thus:

$$\Theta = 100 \times 0.76/5.57 = 13.6\%$$

This is within the normal range of 7–17% quoted for a typical brackish water 40-inch membrane element. However, the production rate is considerably lower

than the flows of up to $1.6 \text{ m}^3/\text{h}$ attainable in practice for elements of this size, suggesting that mass transfer promotion is greater in real systems. This is partly accounted for by the higher cross-flows at the element inlet, but is most likely to be due to assumptions made about the respective values of the spacer mesh width and the diffusion coefficient. The calculation is extremely sensitive to both these values.

The feed pressure can be estimated from resistance theory, whereby:

- the hydraulic losses across the retentate side, and
- the transmembrane pressure

are calculated from the retentate channel hydraulic resistance and the membrane resistance R_m (Equation (2.5)). The feed pressure is further increased by the effect of concentration polarisation, since:

$$\text{TMP} = J \times R_m \times \mu + \Delta\Pi^*$$

where

$$\begin{aligned} JR_m\mu &= 5.83 \times 10^{-6} \times 8.5 \times 10^{13} \times 1.15 \times 10^{-3} = 5.70 \times 10^5 \text{ Pa} \\ &= 5.7 \text{ bar} \end{aligned}$$

and

$$\begin{aligned} \Delta\Pi^* &= \varphi\Delta\Pi \\ \Delta\Pi &= yRT\Sigma\Delta C_i \end{aligned}$$

where $\Delta\Pi$ is the maximum osmotic pressure difference across the membrane (from Equation (2.9)) modified for concentration polarisation and conversion.

So:

$$\begin{aligned} \Delta\Pi &= 1.14 \times 0.9 \times 8.314 \times (273 + 15) \times 2 \times 0.98 \times (850/58.5) \\ &= 69\,960 \text{ Pa} \end{aligned}$$

Thus

$$\Delta\Pi^* = 1.14 \times 69\,960 = 7.98 \times 10^4 \text{ Pa}$$

And so

$$\frac{\Delta\Pi^*}{(1-\theta)} = \frac{7.98 \times 10^4}{(1-0.136)} = 9.24 \times 10^4 \text{ Pa} = 0.924 \text{ bar}$$

Therefore

$$\text{TMP} = (5.70 + 0.92) = 6.62 \text{ bar}$$

Now hydraulic losses across the retentate are given by

$$\Delta p_{\text{losses}} = 1.15 U_L \text{ bar for } U_m \text{ m/s and } L_m \text{ m}$$

where U is the mean retentate velocity

$$U = \frac{0.0927}{2} \left(\frac{1}{1 - 0.136} + 1 \right) = 0.100 \text{ m/s}$$

So

$$\Delta p_{\text{losses}} = 1.15 \times 0.100 \times 1 = 0.115 \text{ bar}$$

Thus, total pressure is given by $\text{TMP} + \Delta p_{\text{loss}} = 6.74 \text{ bar}$.

According to Equation (2.23), the hydraulic energy demand per kg product is given by:

$$E = (1/\rho\Theta)\Delta P$$

Converting to kWh per m^3 product:

$$\begin{aligned} E &= \frac{1000}{60 \times 60 \times 1000 \times \rho\Theta} \Delta P = \frac{2.78 \times 10^{-7}}{\Theta} \Delta P \\ &= \frac{2.78 \times 10^{-7}}{0.136} 6.74 \times 10^5 = 1.38 \end{aligned}$$

For a pumping efficiency of 40%, this figure becomes 3.44 kWh m^{-3} .

4.3.2 Problem in reverse osmosis: array design

If elements of the specification given in the previous problem are to be used to achieve an overall conversion of at least 75% within an array, what array design can be used to deliver 35 l/s permeate product and what would be the specific energy demand?

Solution

For a conversion of 75%, the feed and permeate flows are related by:

$$Q_F = Q_P/0.75 = 35/0.75 \text{ l/s} = 46.7 \text{ l/s} = 168 \text{ m}^3/\text{h}$$

The overall conversion of 75% suggests a 2:1 array, since conversion of 50% at each stage produces 25% conversion overall. The retentate flow from the module Q_R is then half of the feed flow Q_F .

If the relationship given in Equation (2.3) is extended to a number of elements in series, then the retentate flow Q_R is related to the feed flow Q_F and the number of elements per module n by:

$$Q_R = Q_F(1 - \Theta)^n$$

Hence:

$$n = \frac{\log(Q_R/Q_F)}{\log(1 - \Theta)}$$

If a feed flow of 5.6 m³/h and a mean conversion of 13.6% per element is assumed then:

- Total number of rows = 168/5.6 = 30, and
- Elements per module = $\log 0.5/\log 0.864 = 4.74 \sim 5$.

Hence, an array comprising 30 rows of modules in the first stage and 15 in the second stage is needed, each module containing 5 elements. This would then give an overall recovery of:

$$\Theta = 1 - \Theta^{n(\text{overall})} = 1 - 0.864^{10} = 76.8\%$$

Although 2:1 arrays are most common, it is also possible to employ a 3:2 array, which in this case would be 30:20:10. A third stage would be required to obtain the overall conversion of 75%, but the elements per module demanded to achieve 33% conversion for the first two stages would be less:

$$\text{Elements per module, stages 1 and 2} = \log 0.667/\log 0.864 = 2.77 \sim 3$$

Stage 3 would then demand 4 elements per module to achieve the target overall recovery, since n_{overall} should still be 10 across the whole array.

A comparison of the two schemes (see below) reveals that the 2:1 array employs 15 fewer modules, but that the 3:2 array uses 35 fewer elements. Since the pressure vessels are expensive and extra pipework is demanded by having a third stage, the 2:1 array would usually be preferred on the basis of capital costs. On the other hand, there is a greater decrease in flow velocity across the module for the 2:1 array which inevitably leads to greater hydraulic loading at the front of the module and/or greater concentration polarisation at the back.

Scheme	No. of modules	No. of elements
2 stages (2:1 array)	45	225
2 stages (3:2 array)	60	190

The specific energy demand relates to the total pressure and conversion, as before. The total pressure drop across the retentate is given by:

$$\Delta P_{\text{retent}} = 1.15 \times U_{\text{mean}} \times (L \times n)$$

where n is the number of elements across the module. Estimation of the mean retentate flow velocity presents a problem. If the velocity at the outlet must be kept above 0.927 m/s to suppress CP then this implies that the module inlet velocity must be double this value, assuming 50% conversion, giving a mean velocity of $(3/2) \times 0.0927 = 0.139$ m/s. However, maintaining this velocity would necessitate an increase in the retentate flow through the module, which would then reduce the conversion unless this flow increase were to be produced by retentate recirculation. For the purposes of this calculation a mean retentate velocity of 0.139 m/s is assumed, notwithstanding the above implications.

$$\Delta P_{\text{retent}} = 1.15 \times 0.139 \times (10 \times 1) = 1.60 \text{ bar}$$

The maximum osmotic pressure difference is given as before by:

$$\frac{\Delta \Pi^*}{1 - \Theta} = \frac{1.14 \times 70\,000}{(1 - 0.768)} = 344\,000 \text{ Pa} = 3.44 \text{ bar}$$

Thus, the total pressure, including the pressure drop due to the membrane itself, is:

$$P = 5.70 + 1.60 + 3.44 = 10.7 \text{ bar}$$

and the specific energy consumption in kWh m⁻³ product is

$$E = \frac{2.78 \times 10^{-7}}{\Theta} \Delta P = \frac{2.78 \times 10^{-7}}{0.768} 10.7 \times 10^5 = 0.391$$

For a pumping efficiency of 40%, this figure becomes 0.978 kWh m⁻³, considerably lower than the single element case because of the increased conversion and minimal extra energy expenditure.

4.3.3 Problem in reverse osmosis: CAD array design

Produce a complete array design based on the previous design specification for a feedwater of the following composition: 200 mg l⁻¹ hardness "as CaCO₃", 150 mg l⁻¹ alkalinity "as CaCO₃", 75 mg l⁻¹ sulphate, ~1200 mg l⁻¹ total dissolved solids, pH 7.5, temperature 15°C, with an overall rejection of at least 98% and a product water pH of ~7.0.

Solution

As already stated (Section 4.1), all of the leading RO manufacturers produce CAD packages which allow the designer to produce a complete array design for any specified combination of feed and product water quality. The key design parameters for any RO CAD package are as follows:

- feed or product water quality and quantity.
- membrane type, which then determines the flux and pressure, and
- conversion.

All of these parameters must be entered into the design before the array can be optimised, usually through iteration.

The comprehensiveness, level of sophistication, and user-friendliness of the design package varies from one manufacturer to the next. However, all these packages have been developed to help the designer produce an array design as easily as possible, *using the manufacturer's own RO membrane products*. Hence the information pertaining to mass transfer of dissolved solids and water across the membrane is specific to the membrane products listed within the package. Apart from the way in which the design information is set out, this is the main difference between the available packages.

The *ROPRO* package (Version 7) is the proprietary CAD program produced by the suppliers of the *Fluid Systems* RO membranes. *ROPRO* offers a number of overall design configurations and options, such as bypass, pre- and post-acid/base dosing and degassing, and has a comprehensive "help" file. It also has an ancillary costing facility. Most of the *ROPRO* features are self-evident from the main flowsheet schematic, which has active regions for the pre-treatment, array and post-treatment processes, as well as for the stream compositions. Any of these can be checked at any point.

The quickest route to designing the plant is as follows:

1. Use the **Input Wizard** (on the **Input** menu) to enter all the data (ignoring pre-dosing for now)
2. Once the array design screen is reached, the **Array Wizard** should be used and an estimate of the flux made from the information given for the membrane element selected.
3. When all the data has been entered, the large **GO** button on the menu bar can be clicked to reveal the results.

The next screen informs the user where the design fails, either through figures shown in *red* for the scaling indices or through a **Warnings** prompt in the light blue box. A further screen appears when the **Warnings** button is pressed. Having read the warnings, the array design can be adjusted accordingly.

A few common remedial measures are as follows:

- RO membranes tend to scale-up on the concentrate side of the membrane. The only option offered by this package for ameliorating this problem is acid dosing.
- The flux chosen is critical. Too high a value causes an overlarge operating pressure and scaling problems. Too low a flux means that the system is hydraulically unbalanced and not optimised.
- The number of elements in each module can be adjusted, but the default value is normally quite reasonable.

The full details of the design may be viewed at any time from the **File** menu (**Preview All**) or by the short-cut key command Ctrl V.

For the problem specified it must be assumed that the hardness is all as calcium and the alkalinity as bicarbonate, so that these can be directly entered into the **Feed Analysis** screen. Composition values must be entered in the appropriate units (mg/l or mg/l as CaCO₃ in this case). An estimate of the sodium or chloride concentration is needed to complete the analysis and achieve the target TDS of 1200 mg/l. The package automatically adjusts the specification with the counter-ion (i.e. chloride or sodium ions) to obtain electroneutrality.

On the following **pH Adjustment** screen the required pH to which the water feeding into the array must be entered. It is simpler to do this once the scaling propensity (via the Langelier Scaling Index, LSI) has been calculated. On the following **Flow Rates and Recovery** menu the product flow rate (3024 m³/day and the recovery (75%) must be entered.

Next screen is the **Membrane Array Configuration**, which includes an **Array Wizard** that allows an estimate of the flux to be entered. RO membranes will normally operate at a flux of between 20 and 50 LMH, depending on the degree of fouling. Membrane elements can be selected from the left-hand drop-down menu and modules from the right hand one. For this large flow rate, a large membrane module is appropriate (prefix "8" for 8-inch diameter modules and MAG for the largest membrane element area). Having entered a flux value, the preliminary design is complete and the GO button can be pressed.

If a fairly conservative flux of 25 LMH is chosen for the array design, the only error arising will be from the scaling propensity of the water. This can be corrected by acid addition to being the LSI below zero. Again, trial and error is required for this, and through iteration it can be established that adjusting the pH to around 6.1–6.3 (depending on the membrane selected) by pre-dosing with either sulphuric or hydrochloric acid is sufficient.

The product water quality must then be checked to establish if 98% rejection has been achieved (i.e. the permeate product TDS is no more than 24 mg/l, 2% of the feed TDS of 1200 mg/l) and that the pH is around 7. The permeate product pH is always acidic due to the unrestricted permeation of carbon dioxide, which can be removed by stripping and/or neutralised by lime or caustic dosing. In reality, the controlling the product pH to 7 following CO₂ stripping would be extremely difficult for such a low TDS water. The permeate TDS can also, of course, be altered by membrane selection. Selection, once again, proceeds by trial and error – and more than one option is possible. A possible design is detailed below.

Pretreatment: Dosing to pH 6.2 with 93.2% sulphuric acid at 376.3 kg/day

Membrane: TFC 8832HR-575MAG

Array: 10:5 2-stage array, 4 elements/module (60 elements total)

Post-treatment: Degassing to 5 mg/l dissolved carbon dioxide (dosing to pH 7 with sodium hydroxide)

Spec. energy dem.: 215 kW for 126 m³/h flow, 1.71 kWh m⁻³.

4.3.4 Problem in electro dialysis: energy demand

A light brackish water of the specification below requires demineralisation using a 500 cell pair, 1×0.75 m electro dialysis stack for potable water production: Na^+ , 830 ppm; Cl^- , 1530 ppm; Ca^{2+} , 100 ppm, SO_4^{2-} , 50 ppm; Mg^{2+} , 60 ppm; HCO_3^- , 120 ppm.

It is desired that the sodium content be halved. If the ED softens at twice the rate of desalination according to first order kinetics, and the process operates with an overall current efficiency of 95%, calculate (a) the total current required, and (b) the specific energy demand in kWh m^{-3} for a conversion of 85% and an average production rate of $500 \text{ m}^3/\text{day}$ desalinated water. How would the specific energy demand change if a further stage were added to yield a 75% desalinated product?

Assume specific cell pair area resistance is given by: $r \text{ (ohms cm}^2\text{)} = 10 + (10^4 / C_{\text{ave}})$, C_{ave} being the average concentration in meq l^{-1} of the diluate stream passing through the stack.

Solution

Electro dialysis demands a knowledge of the concentration of charge, since this can be directly related to the current demanded by the Faraday equation. Thus all concentrations must be converted to meq/l by dividing by the molar weight and multiplying by the charge:

	mg/l	meq/l		mg/l	meq/l
Na^+	830	36	Cl^-	1530	43
Ca^{2+}	100	5	SO_4^{2-}	50	1
Mg^{2+}	60	5	HCO_3^-	120	2
Total		46			46

Since one unit of charge will shift a cation and an anion simultaneously, the calculation of the current is based on the total cations or anions removed and not the sum of both.

If hardness (i.e. Ca^{2+} and Mg^{2+}) is removed at twice the rate of sodium according to first order kinetics, then:

$$\text{Rate of removal} = -kc \text{ for first-order kinetics}$$

$$\ln(C/C_0)_{\text{hardness}} = 2 \ln(C/C_0)_{\text{salinity}}$$

where C and C_0 are the outlet and inlet concentrations respectively and k is the first-order rate constant. Thus, the residual/influent hardness is (residual/influent salinity)².

The composition of the desalinated product in meq/l can then be calculated along with the amount of material removed (ΔC) and the average concentration of the diluate (C_{ave}) respectively from the difference and average of the inlet and desalinated product streams:

	C_n	C	ΔC	C_{ave}
Na ⁺	36	18	18	27
Ca ²⁺	5	1.25	3.75	3.13
Mg ²⁺	5	1.25	3.75	3.13
Totals	46	20.5	25.5	33.2

From Equation (2.25), the current is given by:

$$i = \frac{QF\Delta C}{N\xi} = \frac{500 \times 96\,500 \times 25.5}{24 \times 60 \times 60 \times 500 \times 0.95} = 30 \text{ A}$$

From Equation (2.26):

$$E = i^2 R / \Theta Q$$

where R is the ED stack resistance in ohms and can be obtained from the cell pair area resistance, the projected membrane area and the number of cell pairs:

$$R = \frac{rN}{A} = \frac{(10 + 10^4/33.2) \times 500}{1 \times 0.75 \times 10^4} = 20.7 \text{ } \Omega$$

So, the energy demand in kWh per m³ of product at 85% conversion is:

$$E = \frac{30^2 \times 20.7 \times 24}{0.85 \times 500 \times 1000} = 1.05$$

Desalination of 75% can be achieved by hydraulic staging (Section 2.4.1), whereby the number of cell pairs is halved and the flow doubled to permit the same current to remove half the quantity of ions as that removed at the first stage. The energy demand for 75% desalination is thus 1.5 times that for 50% desalination at 1.57 kWh m⁻³ for the transfer of ion alone. Pumping of the water, for a pressure drop of 2.5 bar across the stack, adds an additional 0.2 kWh m⁻³, making a total energy demand of 1.77 kWh m⁻³.

It is interesting to compare the relative energy demands of the reverse osmosis (from Section 4.3.1) and electrodialysis processes, which have been calculated on roughly the same basis. For the examples given the specific energy demand values for each process are about the same only if 50% desalination is acceptable, in which case the RO energy demand could be halved by 50:50 blending with feedwater. On the other hand, 85% recovery is readily attainable with the ED, whereas 75% is the maximum possible from a 2-stage RO process. The membrane process choice for light brackish waters such as these may therefore ultimately be made on the basis of both capital cost and specific technical facets of the process (product water purity, operability, footprint, etc.), rather than simply on running costs.

4.3.5 Problem in submerged membrane filtration design

A dead-end hollow fibre submerged microfiltration membrane module having a membrane area A_m of 46 m^2 is being used to provide a flow of $600 \text{ m}^3 \text{ day}^{-1}$. The process operates at a flux J of $32 \text{ l m}^{-2} \text{ h}^{-1}$ and an aeration rate Q_a of $50 \text{ m}^3 \text{ h}^{-1}$ per module, and the water viscosity is around $1.15 \times 10^{-3} \text{ Pa s}$.

The resistance of the cleaned membrane is $7 \times 10^{11} \text{ m}^{-1}$. As a result of fouling by the suspended matter, the operational (reversible) fouling resistance R_{rev} increases by $1.55 \times 10^{11} \text{ m}^{-1}$ per minute. The residual (irreversible) fouling resistance R_{irr} increases at an average of $5.4 \times 10^9 \text{ m}^{-1}$ per minute over the entire cleaning cycle (i.e. the period between chemical cleans), and the system is chemically cleaned once a pressure of 1 bar is reached.

Backwashing (with permeate) at three times the operating flux for 20 seconds every 12 minutes completely removes the reversible fouling. Cleaning in place by flushing with hypochlorite for 10 minutes and then soaking for a further 40 minutes removes the irreversible fouling.

Calculate (a) the cleaning cycle time, and so (b) the total minimum membrane area requirement and (c) the capital cost, assuming CAPEX, $\text{£k} = \text{£}80 + \text{membrane cost}/150$ given that the membranes cost $\text{£}40$ per m^2 .

The aeration energy demand (kWh per m^3 permeate) is related to the aerator flow by:

$$E_a = 0.02Q_a/JA_m, \text{ for } Q_a > 25 \text{ m}^3 \text{ h}^{-1}$$

under the operating conditions outlined, Q_a , J and A_m taking SI units. If electrical costs are 8p per kWh, what is the total electrical energy demand? How significantly is this affected by the backflush energy demand?

Solution

The solution proceeds through determination of the pressure changes and operational cycle times from Equation (2.10), and using Equation (2.23) to determine pumping energy demand and then adding the aeration energy to this. The figures must be adjusted to account for downtime and loss of permeate used for backflushing.

The pressure profile is depicted in Fig. 4.23. The filtration backflush cycle pressure change ΔP_b can be calculated from the rate of increase in the reversible fouling resistance, $R_r = 1.55 \times 10^{11} \text{ m}^{-1} \text{ min}^{-1}$, and from Equation (2.10):

$$P_b = \mu J (R_m + R_r + R_{ir})$$

where R_m , R_r , and R_{ir} refer to the hydraulic resistances of the membrane, reversible fouling component and irreversible fouling component respectively. $R_r = \underline{R}_r t_r$ if the resistance increases linearly with time. Given that $R_{ir} \ll R_r$ over the course of a backflush cycle, the change in pressure over the cycle is:

$$\Delta P_b \approx \mu J \underline{R}_r t_r$$

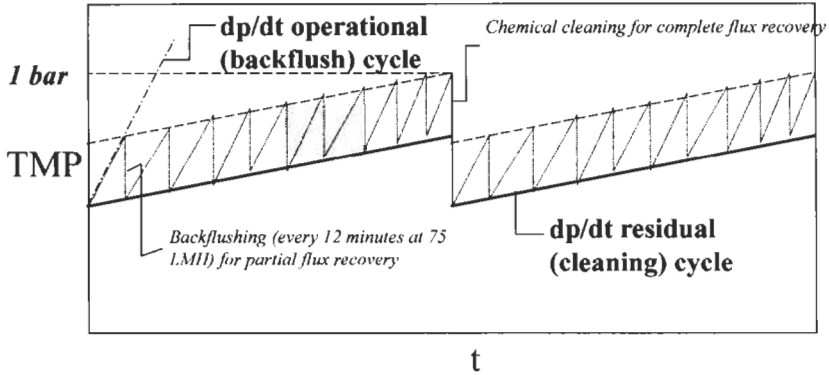

Figure 4.23 Pressure profile for submerged filtration

So, converting flux to SI units and employing the appropriate viscosity value for 15°C:

$$\begin{aligned} \Delta P_b &= 1.15 \times 10^{-3} \times 6.94 \times 10^{-6} \times 1.55 \times 10^{11} \times 12/10^5 \text{ bar} \\ &= 0.148 \text{ bar} \end{aligned}$$

The cleaning cycle time is also obtained from Equation (2.10). In this case the maximum pressure is given as 1 bar (10^5 Pa) and $\mu J R_r$ has already been calculated as 0.148 bar. Thus:

$$\mu J (R_m + R_{ir}) = 10^5 - 1480 = 9.85 \times 10^4$$

$$R_{ir} t_{ir} = 9.85 \times 10^5 / \mu J - R_m$$

So,

$$\begin{aligned} t_{ir} &= \frac{1}{5.4 \times 10^9} \left(\frac{9.85 \times 10^4}{1.15 \times 10^{-3} \times 6.94 \times 10^{-6} - 7 \times 10^{11}} - 7 \times 10^{11} \right) \\ &= 2160 \text{ minutes (36 hours)}. \end{aligned}$$

Note that if the value for the irreversible fouling rate R_{ir} had applied only to the filtration cycle itself, then t_{ir} would be extended by $100 \times 0.33/12.33 = 2.7\%$ – the ratio of the backflush period t_b (0.33 min) to the total backflush cycle time $t_r + t_b$ (12 + 0.33 min).

The required feed flow rate is dictated by the product flow rate and total downtime. The downtime t_D , over the course of a complete cycle is given by the sum of the cleaning period t_c and backflush periods:

$$\begin{aligned} t_D &= t_c + t_b \times t_{ir} / (t_r + t_b) = 50 + 0.33 \times 2160 / 12.33 \\ &= 108 \text{ min (1.8 h) over the 36 hour cleaning cycle} \end{aligned}$$

At a product flow Q_p of 600 m³ per day, this downtime is associated with a volume of:

$$V_D = t_D \times Q_p / t_{ir} = 108 \times 600 / 2160 = 30 \text{ m}^3 \text{ day}^{-1}$$

The total volume demand is further increased by the use of permeate product for backflushing for 20 seconds at three times the flux every 12 minutes which, ignoring the cleaning downtime, equates to a volume demand of:

$$\begin{aligned} V_{\text{backf}} &= Q_p \times (3 \times 0.33 / 12.33) \times (1 - t_c / t_{ir}) \\ &= 600 \times 0.0811 \times (1 - 50 / 2160) = 47.5 \text{ m}^3 \text{ day}^{-1} \end{aligned}$$

where the $(1 - t_c / t_{ir})$ factor accounts for the cleaning period over which no backflushing takes place.

So, the total volume demand, or feed flow, is:

$$Q_f = 600 + 30 + 47.5 = 678 \text{ m}^3 \text{ day}^{-1}$$

which implies a conversion of 88%.

For a flux J of $25 \text{ l m}^{-2} \text{ h}^{-1}$, the membrane area required is:

$$A = 678 \times 1000 / (25 \times 24) = 1130 \text{ m}^2$$

Thus the total number of membrane modules required is:

$$N = A / A_m = 1130 / 46 = 24.6$$

which implies 25 membrane modules are required. The capital cost, for membrane costs of £40 per m^2 , is then given by:

$$\text{CAPEX, } \pounds \text{k} = \pounds 80 + 25 \times 40 \times 46 / 150 = \pounds 386 \text{ K}$$

Operational costs are obtained from the pumping and aeration energy demands. According to Equation (2.23), and based on a 40% pumping efficiency, the liquid pumping energy demand E_p in kWh per m^3 permeate relates directly to the average TMP (in Pa) over the whole cycle:

$$E_p (\text{kWh m}^{-3}) = P_{\text{ave}} / (0.4 \times 1000 \times 60 \times 60) = P_{\text{ave, op.}} / 2.16 \times 10^6$$

where $P_{\text{ave}} = (P_{\text{max}} + P_{\text{min}}) / 2 = (10^5 + \mu / R_m) / 2 = 52800 \text{ Pa}$.

The pumping demand energy (operating cycle) is thus given by:

$$E_p = 52800 / 2.16 \times 10^6 = 0.024 \text{ kWh m}^{-3}$$

At 8p/kWh, this relates to a cost of £0.002 per m^3 .

Aeration energy demand is given by:

$$E_A = 0.02 Q_a / JA = 0.02 \times 50 / (25 \times 10^{-3} \times 46) = 0.87 \text{ kWh m}^{-3}$$

which relates to a cost of £0.070 per m^3 .

The above costs do not include the energy demanded by the backflush process. Clearly, based on the data given, backflushing cannot not impact significantly on the total energy demand of the submerged membrane process since it amounts to only around one-twelfth of the pumping energy demand of the operating cycle, which itself contributes less than 3% to the total energy demand. Backflushing does, on the other hand, increase the membrane area requirement due to downtime, as has been demonstrated above.

These examples demonstrate the general principles of design. As the disparate answers from the energy demand calculation by Film Theory (4.3.1) and RO CAD (4.3.3) suggest, basic assumptions made about fundamental properties of the system can profoundly influence the answer obtained. Accurate information on performance, both hydraulic and water purification, demands pilot trials and/or pertinent data from existing full-scale installations. Such data is given in Chapter 5.

Chapter 5

Case studies

Bruce Jefferson
School of Water Sciences, Cranfield University

5.1 Flag Fen high-purity water production plant (UK)

5.1.1 Background

To many the UK is perceived as a water-rich country but the actual situation is geospecific with annual rainfall ranging from up to 1600 mm in the north and west to as low as 550 mm in the south and east. Similar amounts and temporal distributions of rainfall are found in countries such as Israel where water is viewed as a commodity and recycling is commonplace. Since the 1990s legislation has required huge investment in coastal sites to improve effluent quality prior to discharge. Unlike inland water discharges, coastal waters are a lost commodity which offers the potential for reuse without downstream impacts on the water demand balance of the inland areas. Specifically, with further treatment the coastal discharges could prove an excellent source of industrial water intake. Not only does this provide a reliable source of water to the industrial client but alleviates a commensurate amount of potable water stress on the public supply.

Anglian Water Group (AWG) is the water and sewerage operator for a region of the UK in the east of the country and suffers from some of the lowest annual rainfall in the country. Increasing population growth within the AWG supply region has led the company to look at the strategic benefits of the use of coastal discharges. A survey of potential industrial partners was conducted based on the following criteria:

- Proximity to a sewage works
- Proximity to a coastal discharge
- Non-food industry
- Need for significant amounts of ultrapure water
- Long asset life (> 10 years)

One of the ideal candidates was identified as the power station in Peterborough owned by Texas Utilities (TXU). The station is located adjacent to Flag Fen sewage works which treats the majority of the flow from Peterborough. Negotiations between TXU and Alpheus Environmental (a wholly owned subsidiary of AWG) determined the contractual and expected product water quality from the advanced treatment works that would supply the power station (Table 5.1). The plant was built in the spring of 2000 and started operating in the summer.

5.1.2 Description of plant

The initial process selection was controlled by the requirement to produce high purity water with a conductivity of $70 \mu\text{S cm}^{-1}$ which restricted the final stage to a reverse osmosis plant. The real challenge of the project concerned the pretreatment to the RO plant which had to provide a robust feed water from a

Table 5.1 Contractual water quality

Parameter	Units	Contractual	Expected
Conductivity	$\mu\text{S cm}^{-1}$	70	50
Silica dissolved	$\text{mg l}^{-1} \text{SiO}_2$	1	0.5
Sodium	$\text{mg l}^{-1} \text{Na}$	20	15
Calcium	$\text{mg l}^{-1} \text{CaCO}_3$	5	2
TOC	$\text{mg l}^{-1} \text{C}$	2.5	< 2
Polysaccharides	$\mu\text{g l}^{-1}$	100	50

sewage effluent which has a naturally variable effluent quality. A similar situation exists in the USA at Water Factory 21 where a multiple treatment train is used. This comprises of pH adjustment to 10, coagulation, super chlorination, clarification, depth filtration, pH adjustment to 6 and finally dechlorination. This approach suffers from a number of drawbacks including a large chemical use, large footprint and high operating costs. The original process train also included activated carbon but was discontinued due to fines coming out of the filter beds and blocking the RO tubes. As an alternative to the above, AWG investigated the use of microfiltration membranes. Previous research had shown membrane processes to be a suitable unit operation for the removal of solids, bacteria and microorganisms capable of robustly producing a silt density index below 2. Four commercial systems were tested including the specific pre screening requirements which ranged from 1 mm screens to sand filters ($\sim 50 \mu\text{m}$ equivalent screen).

The final process train selected consisted of a pre-screen, microfiltration plant and a reverse osmosis plant (Fig. 5.1). Wastewater from the screens and the microfiltration plant is returned to the head of the sewage works. Concentrate disposal is achieved by dilution with final effluent from the sewage works in the final effluent chamber and discharged into the tidal section of the river Nene.

Pre-screens

Appropriate pre-screening was found to be important to ensure suitable operability of the plant. Assessment of the different options resulted in a Hydrotech HDF 830 drum screen being installed. The screen removes solids larger than $150 \mu\text{m}$ and has a self-cleaning facility to remove the retained solids by back flushing with screen effluent. The screen is manufactured from stainless steel with a polyester cloth insert material. To ensure constant flow to the membrane plant the screens were fitted with variable speed pumps which controlled the level in the screened water tank.

Microfiltration

The screened effluent then passes to the microfiltration plant. The plant comprises two parallel streams, each containing 17 modules. Each module contains 50 m^2 of PVDF hollow fibre membrane operating in a semi dead-end mode with the flow from outside to in. The membrane material is rated with a nominal pore size of $0.1 \mu\text{m}$ and fabricated into individual membrane units with

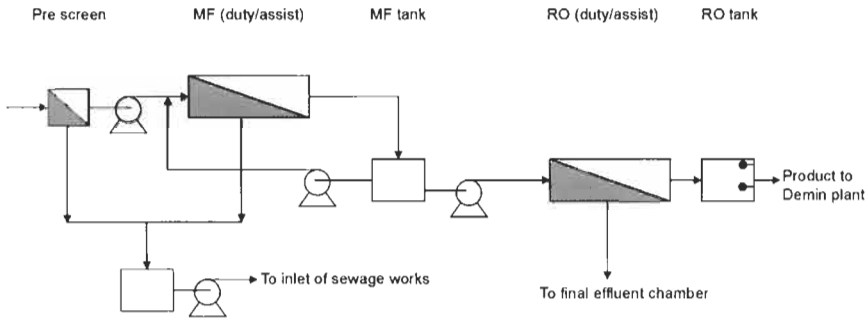

Figure 5.1 Process flow diagram for Flag Fen

a height of 2000 mm and an outside diameter of 150 mm. The plant has a total membrane area of 1700 m² and can produce up to 1500 m³ d⁻¹ (Table 5.20). The membranes are operated at an average flux of 30.5 LMH and a transmembrane pressure range between 0.4 and 3 bar yielding an overall recovery of 90%. Membrane fouling is controlled through a sequence of cleaning cycles. An automatic air/water backwash is conducted every 12 minutes for 90 seconds. In addition each stream is chemically cleaned with a hypochlorite and pH adjustment for 90 minutes every 14 days through an automatic cleaning in place (CIP) system. Membrane integrity is monitored by particle counters and turbidity with additional pressure decay tests conducted periodically.

Reverse osmosis

The final stage of the treatment train is two parallel reverse osmosis units arranged in a 4:2 array. The membranes are polyamide spiral-wound modules supplied by Koch Membrane Systems (UK) and are rated at a molecule weight cut off of 200 kDa. The plant contains a total membrane area of 1451 m² and is designed to produce up to 1200 m³ d⁻¹ of high-purity water at a recovery of approximately 80%. The membranes operate at a pressure range between 6 and 16 bar producing an average flux of 34.5 LMH. Membrane cleaning is triggered by a 15% reduction in the monitored variables and when necessary initiates a 360-minute clean with high and low pH solutions to remove both organic and inorganic fouling. Membrane integrity is monitored by checking conductivity of the membrane banks and individual pressure vessels.

5.1.3 Performance

The major challenge with using a sewage effluent as the feed to a high-purity treatment plant is the natural variation in its quality which varies both seasonally and throughout the day. Flag Fen produces an effluent water quality with a mean BOD₅ of 10 mg l⁻¹, COD of 51.3 mg l⁻¹ and a total suspended solids concentration of 17 mg l⁻¹. The quality is variable with a peak to mean ratio of

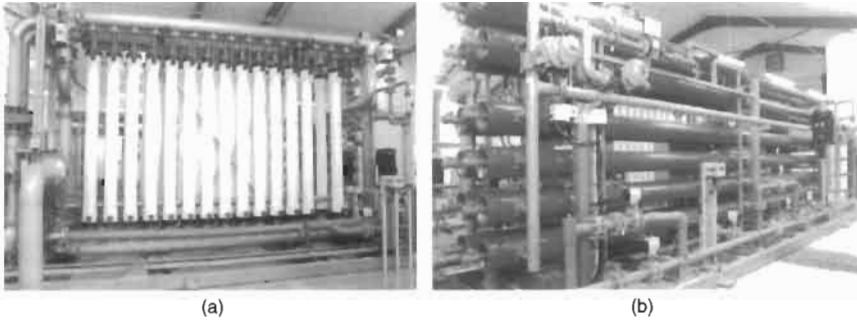

Figure 5.2 (a) Microfiltration and (b) reverse osmosis pilot plants at Flag Fen

3.7 for suspended solids and 3.3 for BOD₅. Smaller variations are observed for COD (2.2) and total phosphorus (1.5). Seasonal variations occur due to a vegetable processing factory that discharges effluent of very different quality depending on the food being processed.

The permeate quality from both membrane plants was both reliable and in line with previous values found from pilot plant work. Feed quality to the RO plant can show large variation with rainfall; for instance, a conductivity of between 800 and 1200 $\mu\text{S cm}^{-1}$. Permeate quality from the RO plant is 38.5 $\mu\text{S cm}^{-1}$ representing a rejection of 96.7% on average. Overall rejection of TDS is 93% with specific rejections of sodium and calcium of 95 and 99% respectively (Table 5.20).

The main issue of concern was membrane fouling reducing output from the MF plant and increasing pressure on the feed stream of the RO plant. Initial operation of the plant showed excellent water quality but high RO fouling rates. The RO feed pressure increased at a rate of 1 bar per hour at worst due to rapid build up of calcium phosphate. Changes to upstream operation has effectively controlled the problem and membrane cleaning is now required every 6 months on average.

The Flag Fen plant is currently operating well and exceeding the target water qualities set down in the original negotiations. The quality of the delivered water has enabled ultrapure water production at the power station to increase by 20%. Coupled to this is a reduction of over 90% in the costs of ion exchange regeneration due to an increase in the operating cycle of the twin bed demineralisation plant from 8 to 60 hours. Overall, 1250 m³ of tap water per day have been saved which has reduced the station's total water use by 11%. Client receptivity to the scheme is very high as supply is guaranteed and operating costs decreased. The high-purity water plant cost around £1 000 000 (\$1 524 000) and each membrane stage has an operating cost of 7.5p m⁻³ (\$0.11 m⁻³). The success of the scheme has attracted media attention and the project has won a number of prestigious awards including the 2000 Water UK/Environment Agency water, the 2001 IChemE innovation efficiency award and the 2001 Green apple award.

5.2 Eraring Power Station: purification of secondary sewage for boiler feedwater (Australia)

5.2.1 Background

Pacific Power's Eraring plant is a 4×660 MW coal-fired power station, situated on Lake Macquarie which provides about 25% of the power requirement to New South Wales. The power station utilises salt water from the lake for condenser cooling with all other water supplied as potable by Hunter Water Corporation. Prior to 1988 potable water usage was almost 8.5 Ml d^{-1} and represented one of the three largest costs to the power station. To reduce costs a water audit was conducted to identify the major areas of use. After engineering modifications the water use was reduced to 4 Ml d^{-1} :

- In the chemical control room, where various water samples are automatically analysed, the supply was modified from using potable water to using recirculating auxiliary cooling water.
- In the ash and dust system, gland sealing water was changed over from potable water to salt water. This increased costs in the ash and dust area but the saving in water costs overshadowed the increased maintenance.
- The wash down systems were modified to small high pressure nozzles.

The audit indicated that significant savings could be made if another supply of process water could be found. A source became available when the Hunter Sewage Project upgrade of the local Dora Creek sewage treatment plant was initiated. As part of the upgrade a new wastewater treatment plant was to be built at Dora Creek which is approximately 6 km south of the power station. The sewage effluent was to be pumped under Lake Macquarie to an extended ocean outfall. The discharge pipeline was due to pass close to the power station and so reuse became an option.

Following a detailed review period, a deed of agreement was signed between Pacific Power and Hunter Water Corporation for a guaranteed 15-year period. During this period Pacific Power must accept all secondary effluent up to a maximum of 5.2 Ml d^{-1} . The effluent quality from the Dora Creek sewage works (Table 5.2) means that additional treatment is required prior to use at the power plant. The principal use of processed water is for demineraliser feed with the remaining flow being used for other water applications on site:

- Demineralising plant (1.5 Ml d^{-1})
- Auxiliary cooling towers (1 Ml d^{-1})
- Wash down water
- Fire services
- Ash disposal system ($1-1.5 \text{ Ml d}^{-1}$)

Table 5.2 Specifications for water quality

Parameter	Maximum value
Suspended solids (mg l^{-1})	< 1
Silt density index	< 3
Reovirus (100 ml^{-1})	Nil
Enterovirus (100 ml^{-1})	Nil
Total coliforms (100 ml^{-1})	< 10
Faecal coliforms (100 ml^{-1})	< 1
Faecal streptococci (100 ml^{-1})	< 1

Demineralising feed water has two requirements. The first is that the water must not contain any organic matter that will foul the ion exchange resin, particularly anion resin. The second is that the TDS should not impose any additional load on the plant over that of domestic feedwater. Benefits can be easily obtained if the TDS is in fact lower than the original supply as it can significantly reduce costs through fewer regenerations of the demineraliser plant. A prime requirement for all end uses, and one required by the New South Wales Environmental Protection Agency, is that the water be disinfected (Table 5.2). A number of technologies were considered including ponding, wetlands and UV disinfection but all required additional treatment before the water was suitable for reuse at the plant and so membranes were ultimately used.

5.2.2 Description of plant

Secondary effluent is supplied from the Dora Creek sewage treatment plant and is initially stored in a 8 Ml holding tank before being transferred to the treatment plant. The flow is supplied at a rate of 3.5 Ml d^{-1} and blended with tertiary effluent from the station's sewage works and contaminated plant water which has had the oil and grit removed. The flow then passes through a motorised screen before being pumped to the microfiltration plant (Fig. 5.3).

Filtrate from the MF plant is dosed with sodium hypochlorite en route to a storage tank to control biological growth. Sulphuric acid (4%) is also added to reduce pH and minimise hydrolysis of the RO membrane. Water is then pumped from the storage tank, dosed with anti-scalant, and screened through a $5 \mu\text{m}$ disposable cartridge filter before passing to the RO plant. Permeate is pumped to a degasser unit before being fed preferentially to the demineraliser plant because of its low TDS. The RO reject stream is dosed with ferrous chloride before being passed to the station's ash dam together with waste from the demineraliser plant and the wastewater sump.

Microfiltration

The microfiltration plant incorporates two parallel streams each containing 90 modules. Each module houses 15 m^2 of polypropylene hollow fibre membrane supplied by Memcor and rated at a nominal pore size of $0.2 \mu\text{m}$. The plant

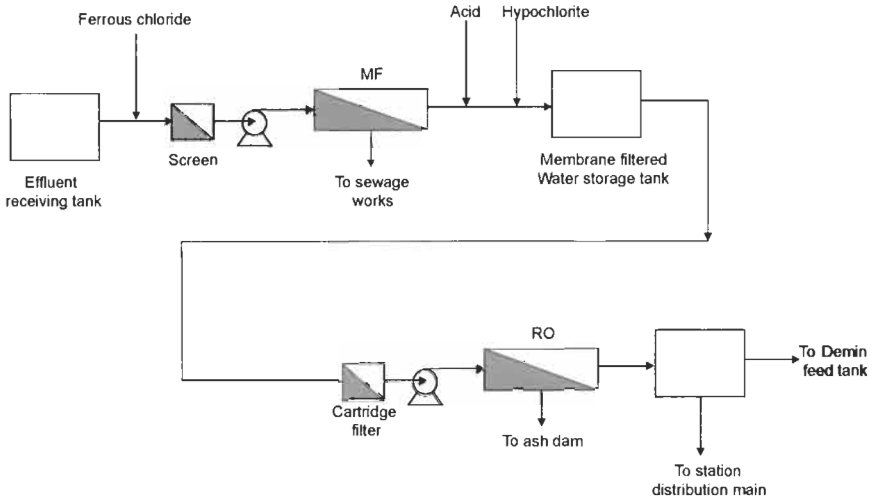

Figure 5.3 Process flow diagram for Eraring water reuse treatment facility

contains a total membrane area of 2700 m^2 and is designed to treat 5.2 Ml d^{-1} at an overall recovery of 90%. The membranes are supplied by pumps operated at a pressure of 450 kPa (4.5 bar) which delivers an average flux of 72 LMH (calculated from data above). Membrane fouling is controlled through a sequence of cleaning cycles and is triggered on either TMP or differential pressure. The membranes are initially drained and then high pressure air (600 kPa (6 bar)) is blown through the membranes to loosen attached material followed by a back pulse of permeate. The backflush cycle occurs between every 17 and 60 minutes depending on fouling. In addition, every 200 service hours a CIP is carried out with caustic soda (1%) and a detergent. The cleaning solution is reused on average for 10 cycles before being replaced. Membrane integrity of an array is monitored through an automatic pressure decay test which is carried out every 24 service hours. When necessary the individual module can then be identified through a sonic test (out of service). Air is supplied at 100 kPa (1 bar) and if noise is detected the individual module is isolated from the array. When necessary to ensure production the modules are pin repaired where any broken fibres are plugged using a stainless steel pin at both ends of the module.

The final stage of the treatment train is two parallel reverse osmosis units arranged initially in a 6:3 array (later converted to a 10:4 array). The membranes are cellulose acetate spiral wound modules and are rated at a 98% salt rejection. The plant is designed to produce up to 3.75 Ml d^{-1} of high-purity water at a recovery of approximately 80%. The membranes operate at a pressure range between 1500 and 3500 kPa (15–35 bar) producing an average flux of 13 gfd (22 LMH). The plant is monitored in terms of the normalised permeate flow (temperature, pressure and concentration) and under normal operation is measured at $13\text{--}151 \text{ s}^{-1}$. Chemical cleaning is triggered by a reduction of 15% in the normalised flow rate.



Figure 5.4 (a) Microfiltration and (b) reverse osmosis pilot plants at Eraring power station

5.2.3 Performance

The plant is reported to have performed well since its installation and has resulted in significant water savings. The percentage of reclaimed water used has increased gradually from 5.2% during installation in 1994 to 56.7% in 1998 such that up to February 1999 the plant has used a total of 2 333 Ml of reclaimed water. In 1999, potable water use at the site was 1.8 Ml d⁻¹ and this is expected to be ultimately reduced to 400 kl d⁻¹ by 2010 when the duration of the deed of agreement is complete.

The treatment performance is indicated by a reduction in BOD₅ from 20 to 50 to less than 1 mg l⁻¹ across the whole plant (Table 5.20). The equivalent removal for turbidity is from 50 to <0.1 NTU and for Faecal coliforms from <10⁶ to <1. RO permeate is also low in dissolved solids with a permeate concentration of specific ions of 32 mg l⁻¹ (Cl), 2.2 mg l⁻¹ (Si), 17.8 mg l⁻¹ (Na) and 0.5 mg l⁻¹ (Ca). The low levels of dissolved solids have increased demineraliser cation operation capacity from 2176 m³ with potable water to 4792 m³ with reuse water and anion operation capacity from 2113 m³ to 3472 m³ respectively before requiring a regeneration.

The main operational concerns have been periods of increased membrane fouling. At one stage the MF plant was not responding to the cleaning cycle. Diagnosis revealed manganese fouling was occurring which was completely ameliorated with a citric acid (*citriclean*) clean. Similarly, at one stage RO cleaning frequency increased dramatically. The problem was linked to organic fouling which decreased naturally as indicated by reduced chlorine demand and ammonia levels in the plant. If the problem occurs again a chlorine chemical clean is planned to oxidise the organic layer. An important aspect of the scheme has been gaining employee acceptance of using reclaimed water. To allay fears and concerns regular testing for bacteria and viruses is reported and personal protective equipment (ppe) and covers for equipment is supplied were appropriate.

The water reclamation plant originally required a total capital cost of AUD\$4.5 million (\$3.34 million) in 1994 of which AUD\$4 million (\$2.96 million) was construction and commissioning and AUD\$0.5 million (\$0.37 million) was required for segregating the potable and reclaimed water supplies. A further

AUD\$180 000 (\$133 560) was required to upgrade the throughput from 2.5 Ml d^{-1} to 3.75 Ml d^{-1} in December 1998.

The operating costs of the schemes consists of chemicals, spare parts, analytical costs, effluent supply and the service agreement payments (Table 5.3). The chemical costs are generated from cleaning the MF plant (17.5%), RO pretreatment (58%), RO cleaning (1%) and reject treatment (14%). The overall opex has remained relatively stable during the initial 5 years of operation where increasing spares costs have been balanced by reduced supply and contract charges as the plant output increases. The service contract is negotiated at the end of 1999 when it is expected to increase and so impact on the overall opex of the plant.

The reclamation plant generates two major savings for Pacific Power. Firstly saving based on reduced potable water use on site which increased from AUD\$78 500 (\$58 247) in 1994/95 to AUD\$726 200 (\$433 904) in 1998/99 (Table 5.4). The savings are expected to continue to increase once the plant is at full capacity, generating an annual saving of AUD\$1 100 000 (\$588 720). An

Table 5.3 Production costs (AUD\$ m^{-3})

	1994/95	1995/96	1996/97	1997/98	1998/99
Analytical	0	0.086	0.061	0.039	0.035
Spares	0	0	0.003	0.052	0.048
Contract	0.107	0.099	0.07	0.045	0.041
Chemicals	0.208	0.05	0.107	0.102	0.093
Supply	0.017	0.014	0.01	0.006	0.006
Total	0.332	0.249	0.251	0.244	0.223
Total (\$ m^{-3})	0.246	0.185	0.195	0.180	0.133

Currency conversion ($\times 0.5975$ – 0.778) based on 12 August 1994–1998 figures (<http://www.oanda.com/convert/fxhistory> (accessed November 2002)).

Table 5.4 Cash balance of reclamation plant

	1994/95	1995/96	1996/97	1997/98	1998/99
Reclaimed water (Ml)	96	360	509	791	876
Saving (AUD\$)	78 500	294 500	416 400	647 000	726 200
Demin. regeneration (no.)	51	182	176	176	180
Saving (AUD\$)	26 800	74 000	90 000	87 000	80 000
Total saving (AUD\$)	105 300	368 500	506 400	734 000	806 200
Total saving (\$)	78 132	274 090	394 080	543 160	481 704
Total cost (AUD\$)	44 238	124 420	177 329	267 889	271 316
Net saving (AUD\$)	61 062	244 080	329 071	466 111	534 884
Net saving (\$)	45 308	181 546	256 214	344 933	319 539

Currency conversion ($\times 0.5975$ – 0.778) based on 12 August 1994–1998 figures (<http://www.oanda.com/convert/fxhistory> (accessed November 2002)). Total costs based on reclaimed water amount and quoted cost per m^{-3} and recoveries of 80% and 90% across the MF and RO respectively.

additional benefit is a reduction in operating cost of the demineralising plant through a reduced number of regenerations. The saving predicted when the plant is at full capacity is AUD\$100 000 (\$53 520) generating a total annual saving of AUD\$1 200 000 (\$642 240).

The fixed cost of supply from the deed of agreement is a crucial aspect of the economics as it generates significant cost reductions over the period of the deed. The expected payback period on current numbers is between 6 and 7 years enabling 8–9 years of annual saving of around AUD\$1 200 000 (\$642 240) as profit. The total saving over the period of the deed equates to AUD\$11 100 000 (\$5 940 720). The deed agreement was possible as Hunter Water Corporation saved AUD\$2 700 000 (\$1 445 040) in expenditure on disposal pipeline.

5.3 Doswell combined cycle power plant: zero liquid discharge (USA)

5.3.1 Background

The Doswell combined cycle facility is a 660 MW power plant owned by Doswell Limited Partnership and operated by Bechtel and is one of the largest independent power plants in the USA. The plant is designed for dispatchable load operation working mainly on weekdays during the winter and summer and contains two parallel units which share a common water treatment plant. The plant is designed to burn natural gas and has been in operation since July 1991.

A major concern about the plant was potential limitations on water supply and wastewater discharges issued by the local government of Hanover, Virginia. To address these issues the company decided to minimise water use and recycle wastewater. As part of this process a number of conservation and reuse measures were implemented at the site:

- Air-cooled condensers were installed instead of the typical wet cooling towers to eliminate water losses through evaporation and dramatically reduce wastewater production.
- Dry hybrid burners were installed that limited NO_x formation without the need for water or steam injection.
- Potable water demand was reduced to a minimum by utilising sewage effluent from the local wastewater treatment facility.
- Any wastewater generated at the site was recycled through a zero liquid discharge (ZLD) facility.

A key unit process of ZLD is vapour compression evaporation which can recover about 95% of the waste stream as distillate. The remaining flow is then converted into solids in a crystalliser/dewatering device. However, the process is very expensive when flows are high and/or low in dissolved solids. Consequently, the company investigated the possibility of pre-concentrating the flow with

membrane technologies. Ultimately, a combination of electro dialysis reversal (EDR) and reverse osmosis was adopted to pretreat the waste flows prior to evaporation.

5.3.2 Description of system

The water treatment plant is made up of three integrated treatment systems designed to meet boiler feed water/steam purity and a ZLD requirement (Fig. 5.5):

- Raw water pretreatment
- Boiler feedwater (make up water) treatment
- Wastewater treatment

The plant takes water from both the wastewater and potable water facilities at Hanover county and discharges only solids in the form of filter cakes from both the pretreatment and wastewater treatment plants.

Raw water pretreatment

The raw water pretreatment plant is designed principally for solids removal from the incoming Hanover county sewage effluent (grey water), backwash water and wastewater from the oily water collection system. Raw water enters a coagulation/flocculation chamber followed by a clarifier and dual media depth filters. Backwash water from the filters is periodically returned to the clarifier. Clarifier sludge is dosed with polymer before being thickened and then sent to the filter press for dewatering. The cake is sent to landfill and the recovered water returned to the clarifier.

Make up water treatment

Treated raw water is mixed with potable water and pumped to the boiler feedwater treatment system. The system is designed to remove 99% of the

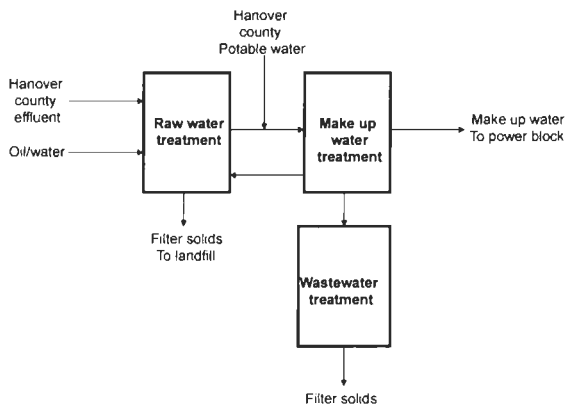

Figure 5.5 ZLD strategy at Doswell combined cycle power plant

dissolved minerals and provide high-purity water to the boiler. The mixed water flows through a reverse osmosis plant operating at a recovery of 80% and an average salt rejection of 95%. Permeate from the RO mixes with product water from both the waste RO unit and the distillate from the brine evaporator/crystalliser situated in the wastewater treatment plant. The combined flow then enters a degasifier, to remove carbon dioxide, and a mixed bed demineraliser. The mixed bed plant consists of two 100% capacity ion exchange vessels which remove the final 5% of the dissolved salts. The ion exchange beds process 2 200 000 gallons (8 327 m³) before being regenerated. Waste from the process is pH adjusted and combined with the RO reject before being pumped to the wastewater treatment plant.

Wastewater treatment

The wastewater treatment plant is designed to treat 250 gpm (56.8 m³ h⁻¹) of which 66% is recovered by the membrane processes and the rest through the brine evaporator/crystalliser unit (Fig. 5.6). The wastewater flow is generated by make-up RO reject (64%) (from make-up water plant), power block blowdown (22%) and mixed bed regenerate waste (14%). The combined wastewater flow initially passes through two 100% flow dual media anthracite/sand depth filters operating in a duty standby/backwash mode. Filter permeate is then treated in an EDR unit containing micron feed filters and three 50% capacity membrane stacks. Each parallel line contains 3 stacks in series consisting of 500 pairs of cation- and anion-selective membranes. The EDR unit is designed to recover 84% of the flow with the remaining 16% being sent to the brine tank. The EDR unit includes acid injection for pH control, anti-scalant and clean in place systems to control fouling. The three stages in each stack are operated at voltages of 299, 344, and 264 V with corresponding currents of 17, 11 and 4.8 amps

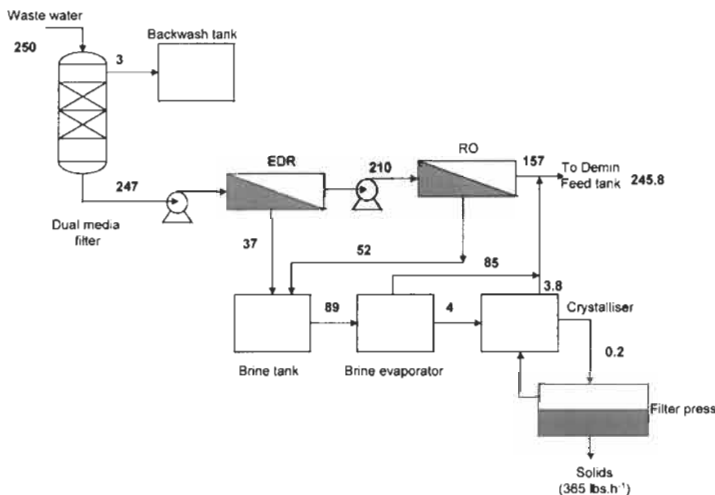

Figure 5.6 Process flow diagram of wastewater treatment plant including a mass balance (gpm) based on 24 average during continuous operation

respectively. The feed pump discharges at a pressure of 81 psi (5.6 bar) with a differential pressure across the stacks of 14 psi (0.96 bar) on the positive side and 18 psi (1.24 bar) on the negative.

The flow then enters a reverse osmosis plant containing three parallel streams designed at 50% flow enabling continuous operation. Each stream contains 24 cellulose acetate membranes arranged in a 4:2 array. The plant operates at an overall recovery of 75% and a salt rejection of 95%. Permeate is pumped to the demineralisation storage tank and reject is sent to the brine storage tank where it is mixed with the EDR reject.

Treatment of the brine is conducted in a vertical tube, falling film evaporator driven by vapour compression. Wastewater is pH adjusted to between 5.5 and 6 and then heated to boiling point and deaerated. Hot brine then enters the evaporator sump where it mixes with recirculating brine slurry which is pumped to the top of 2 inch (50.8 mm) heat transfer tubes. As the slurry falls a small portion of the water evaporates and condenses on the outside of the heat transfer tubes. The brine evaporator recovers 95% of the flow which is passed on to the demineralisation feed tank with a water quality of less than 10 ppm TDS. The 5% concentrated brine then enters a crystalliser where a further 95% of the remaining water is recovered. The stream is finally sent to a filter press and dewatered to a 20% moisture content sludge which is disposed of off site.

5.3.3 Performance

Inclusion of the EDR/RO pretreatment stage reduces the design flow of the brine evaporator from 247 gpm ($56 \text{ m}^3 \text{ h}^{-1}$) to 89 gpm ($20.2 \text{ m}^3 \text{ h}^{-1}$). The EDR unit



Figure 5.7 *Ionics Aquamite XX EDR unit for Doswell combined cycle facility*

effectively reduces the concentration of all dissolved ions in the flow (Table 5.5). Total dissolved solids are reduced from 1612 mg l⁻¹ to 217 mg l⁻¹, generating a concentrated stream of 10910 mg l⁻¹. Specific ionic removals range from 47% (fluoride) to 96% (magnesium).

Evaporation is a key unit process in achieving ZLDs due to its ability to operate at high recovery rates from very high TDS waste streams. The technology is however very expensive and as such an economic driver exists for pre concentrating the flow in systems like the EDR/RO described above. The EDR/RO system cost \$750 000 to install and resulted in a 64% reduction in the required capacity of the brine evaporator. The reduction in required capacity of brine treatment results in a saving of \$900 000 in capital and \$682 day⁻¹ in operational costs (including EDR/RO costs) (\$240 000 year⁻¹). The EDR/RO costs (Table 5.6) include replacement membranes for the EDR in 10 years and the RO in 2 years. The operating costs of the process equate to \$0.12 per 1000 gallon (\$0.03 m⁻³) for the EDR and \$0.1 per 1000 gallons (\$0.026 m⁻³) for the RO. Additional costs savings are made from recycling clean water which reduces costs and make up water demand.

5.4 VHP Ugchelen: paper mill water recycling (Netherlands)

5.4.1 Background

VHP security paper mill owned by Ugchelen BV, located in Apeldoorn (Netherlands), produces bank notes and other security papers. The paper mill uses cotton as its raw material which it bleaches with hydrogen peroxide at a temperature of approximately 100°C and pH values between 11 and 12. The process uses a total of 100 m³ of water per ton of paper which at the plant's

Table 5.5 Example performance data for the EDR unit

Parameter	Feed	Product	Brine
Calcium (mg l ⁻¹)	23	1.2	159
Magnesium (mg l ⁻¹)	4	0.17	25
Sodium (mg l ⁻¹)	504	69	3510
Potassium (mg l ⁻¹)	21	2	160
Barium (mg l ⁻¹)	0.021	<0.002	0.16
Bicarbonate (mg l ⁻¹)	80	38	207
Sulphate (mg l ⁻¹)	898	57	6248
Chloride (mg l ⁻¹)	153	38	821
Fluoride (mg l ⁻¹)	1.13	0.59	4.1
Nitrate (mg l ⁻¹)	82	12.8	137
TDS (mg l ⁻¹)	1612	217	10910
Conductivity	2398	333	13592
pH	6.7	6.5	7.2
Total hardness (mg l ⁻¹)	75	3.5	490
TOC (mg l ⁻¹)	6.2	4.3	22.6

Table 5.6 Cost balance for different brine treatment options (based on 1990 data)

Cost	250 gpm evaporator	90 gpm evaporator	Crystalliser	EDR/RO system
Capital and installation (\$)	3 600 000	1 950 000	1 370 000	750 000
Energy (\$ day ⁻¹)	1471	535	148	300
Maintenance (\$ day ⁻¹)	100	54	38	

production rate of 5000 tons per year equates to a water usage of 500 000 m³ year⁻¹. The production process results in a high strength wastewater (COD = 4390 mg l⁻¹) at a temperature of 75–85°C and a high pH. Traditionally the effluent from this process has been discharged into the sewer and the water supplied from a local spring requiring 1.5 × 10⁶ m³ of gas to heat it to the required temperature annually.

European legislation is increasing regularly such that paper mills are being forced to minimise their energy and water consumption. The driver for reuse in this case was the combination of compliance with current and near-future legislation together with the financial benefits of reduced water intake, discharge costs and gas supply. One of the most important issues in this specific case was the reuse of both the water and heat from the process.

5.4.2 Description of system

Flow from the production facility initially enters a storage tank prior to passing on to a dissolved air flotation plant at a rate of 10 m³ h⁻¹ (Fig. 5.9). Bubble production is achieved by releasing a super saturated solution of water and carbon dioxide-rich air. This has the added benefit of controlling the pH such that at a ratio of 7 m³ of gas to every 1 m³ of wastewater the pH decreases from 11 to 8.2.

The flow then enters a side-stream membrane bioreactor with a working volume of 200 m³ and a hydraulic retention time of 22 hours. The bioreactor is operated at a MLSS of approximately 20 000 mg l⁻¹, equating to a sludge production of less than 0.02 kgSS d⁻¹. The bioreactor is configured with a side stream loop of 8 mm tubular PVDF membranes rated at a pore size of 0.04 µm. The MBR is designed to treat an average flow of 9 m³ h⁻¹ and contains 82.5 m² of membrane configured in 3 trains of 6 modules. The membranes are operated at a mean TMP of 3.5 bar delivering a mean flux of 120 LMH at a cross-flow velocity of 3.5 m s⁻¹. The membranes have not required cleaning in the first year of operation but when necessary they will be cleaned by a mixture of anionic and cationic surfactants. The membranes have an expected life of 3 years but with the minimal cleaning required so far it is hoped this may be significantly extended.

The plant includes an internal heat exchange loop whereby hot incoming flow is cooled to the required temperature for bio treatment whilst at the same time increasing the temperature of the product water stream. This has a direct benefit of reducing the heat required to produce water at the required temperature for processing the raw cotton.

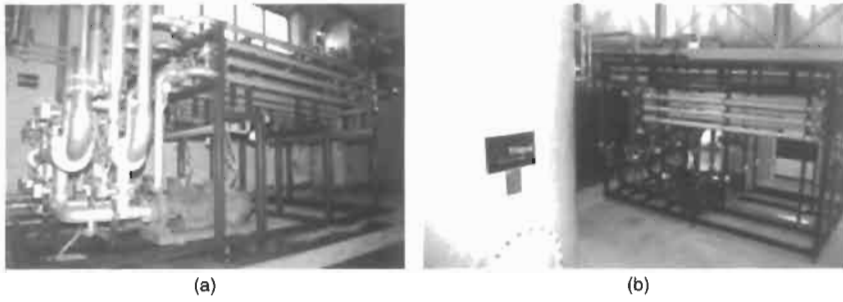

Figure 5.8 (a) Heat exchange loop (b) membrane bioreactor

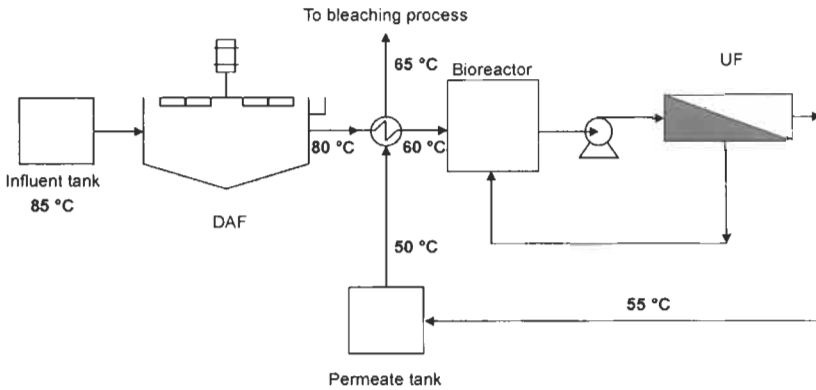

Figure 5.9 Process flow diagram for paper mill water recycling plant at Apeldoorn

5.4.3 Performance

The initial phase of the work included a pilot-scale investigation of thermophilic MBRs for treatment of the wastewater. The performance of the bioreactor was seen to be temperature-dependent with an optimum performance of over 85% removal of COD occurring at 50°C. This equates to an effluent concentration of 600 mg l⁻¹. The effluent was then tested for its suitability for reuse at the plant and was seen to increase the bleaching requirement by 10% compared to the use of groundwater.

The full-scale plant went into operation in 2001 and effluent results for the first 100 days of operation have indicated that even better performance is possible with an effluent COD ranging between 450 and 500 mg l⁻¹ with the reactor temperature at 60°C. Furthermore, COD values are still decreasing indicating that the biomass could still be adapting to the specific conditions of the reactor. The effluent is currently used for 80–90% of the bleaching process without any noticeable deterioration in the product quality.

The utilisation of a reuse system at the site has had significant impact of the flows of fresh and wastewater. The freshwater intake for bleaching has decreased by 80% from 10 to 2 m³ ton⁻¹ which equates to an annual saving in freshwater

of 40 000 m³. The internal heating loop has reduced gas consumption by 20% from 660 m³ ton⁻¹ to 520 m³ ton⁻¹ producing an overall saving in gas of 700 000 m³. Total wastewater discharged from the sites has halved to a population equivalent of 5000 p.e. which generates a saving of €227 000 per year (\$226 000).

5.5 Kronospan Ltd: medium-density fibreboard wash water recycling (UK)

5.5.1 Background

The production of medium-density fibreboard (MDF) involves a number of simple but large-scale operations. Forest thinning and sawmill residues are debarked and chipped before being washed to remove residual dirt and grit from the wood. The fibres are then steam-softened, cooked and refined between two flat plates and finally mixed with resin to produce the fibreboard.

An example facility is at Chirk in North Wales where Kronospan UK manufacture chipboard, MDF, melamine-faced boards and sawn timber. The plant produces 47 800 m³ of MDF effluent per year of which the majority is associated with the washing and refining stages of production. The quantity of excess water generated during the process depends on the moisture content of the wood and can range from 400 l per tonne of bone dry wood processed in the summer to up to 600 l in the winter. The characteristics of the effluent are high COD and high suspended solids of which cellulose, lignins and resin acids are key components.

Prior to 1995 the effluent was tankered off site at a cost of £9.8 tonne⁻¹ (\$14.72 tonne⁻¹). The company was not only concerned about the cost of this option but also the risk to production if the tankers failed to arrive as the site could only store one day's effluent. A decision was made to incorporate on-site treatment at the production facility which should meet the following aims:

- Low capital cost/rapid investment payback
- Optimum product/resource recovery
- Effluent reduction, recycling and reuse
- Long-term environmental compliance
- Easy to upgrade modular system

The site contained an existing conventional biological treatment train comprising a dissolved air flotation unit followed by an activated sludge plant. Problems with effluent reliability and limited resource recovery due to the poor effluent quality led to the search for an alternative solution. Ultimately, a treatment train containing membranes was installed in June 1995, which offered the potential for zero discharge of the wash water effluent.

5.5.2 Description of plant

The effluent treatment plant treats all the MDF effluent generated within the production facility. Excess flow is stored prior to it being pumped into the treatment plant. The plant consists of multiple treatment stages combining physicochemical processes with membrane technology (Fig. 5.10). Water entering the plant is initially dosed with a polyelectrolyte and flocculated. The flocculated suspension is then pumped into a plate and frame filter press from which a 45–50% dry solids cake is recovered. The filter cake can be burnt in the boiler or re-used in chipboard production. The filtrate passes through a dual media depth filter before entering a four-stage reverse osmosis plant. Permeate from the membrane plant is polished through an activated carbon bed before being reused on site for boiler feed. Concentrate from the membrane plant is returned to the resin make up tank and backflush/wash water from the sand filter and filter press are combined and returned to the head of the treatment works.

Pretreatment

Polyelectrolyte is dosed up to a rate of 500 mg l^{-1} into the flow and then flocculated in a 15 m^3 tank with a residence time of 30 min. The project included the development of a new polyelectrolyte specifically designed for the needs of MDF effluent. The flocculated suspension then passes to a 55-plate filter press at up to $50 \text{ m}^3 \text{ h}^{-1}$ and 6 bar (treating an average flow of $30 \text{ m}^3 \text{ h}^{-1}$). The press (Fig. 5.11a) produces up to 2 m^3 of 45–50% solids cake per batch. Filtrate from filter press then passes to a dual media depth filter containing sand and anthracite. The filter operates at a design velocity of $6 \text{ m}^3 \text{ m}^2 \text{ h}^{-1}$ and requires cleaning with a combined air scour and water backwash which results in a water

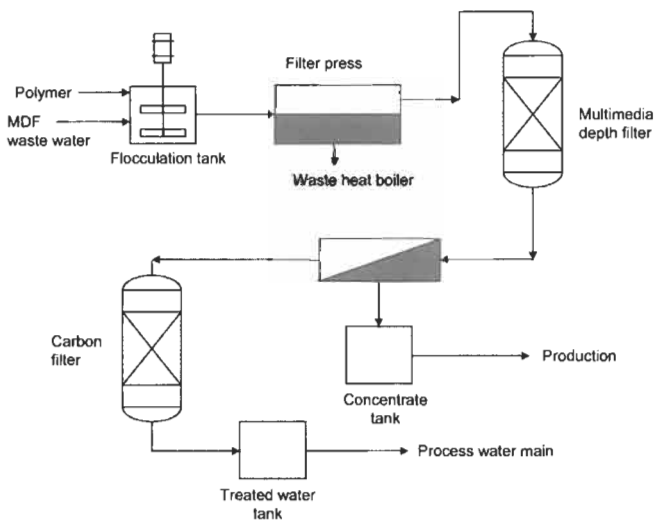

Figure 5.10 Process flow diagram for Kronospan zero discharge and recovery plant

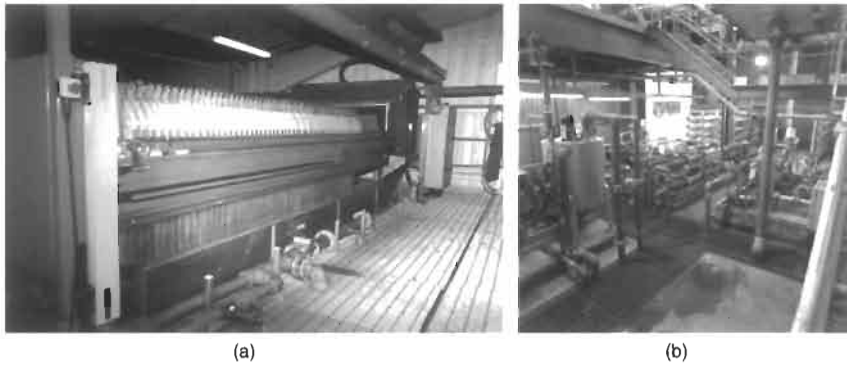

Figure 5.11 (a) Filter press and (b) overall scheme at Chirk treatment facility

recovery across the bed of 98–99%. Finally the flow passes through a 5 μm cartridge filter to remove any gross solids and filter grains that might pass through the bed.

Reverse osmosis

The centre of the treatment plant is a single stream reverse osmosis plant configured in a four-stage feed and bleed array, each with its own cross-flow recirculation pump. The membranes are polyamide 8040 spiral-wound modules developed with Osmonics. The plant contains a total membrane area of 1856 m^2 and is designed to produce up to 450 $\text{m}^3 \text{d}^{-1}$ at a recovery of 90%. The membranes operate at a mean transmembrane pressure of 25 bar producing an average flux of 14 LMH at a temperature of 25–30°C. Membrane cleaning is accomplished by 30 minute cycles of either hot water or caustic soda/proprietary high-pH cleaning agents which are initiated every day and twice a week respectively.

Carbon filter

The final stage of the treatment train is an activated carbon filter with a working capacity of 12.5 m^3 . The bed is operated at a design empty bed contact time of 30 minutes.

5.5.3 Performance

The plant has been successfully operated since 1995 and has proved the ability of the plant to recover all solid and liquid outputs thus generating near-zero discharge. A mass balance across the process demonstrates the concept (Fig. 5.12) with water losses occurring only in the final product and from the driers in the evaporation stage of production. The RO concentrate contains cellulose and lignins which are returned for use in the resin binder. The filter press produces 480 tonnes y^{-1} of dry solids which are burnt in the boiler or reused as feedstock at the front end of the chipboard production line as a 45–50% dry solids cake. Some 659 tonnes of water enter the production process with 78% lost during the

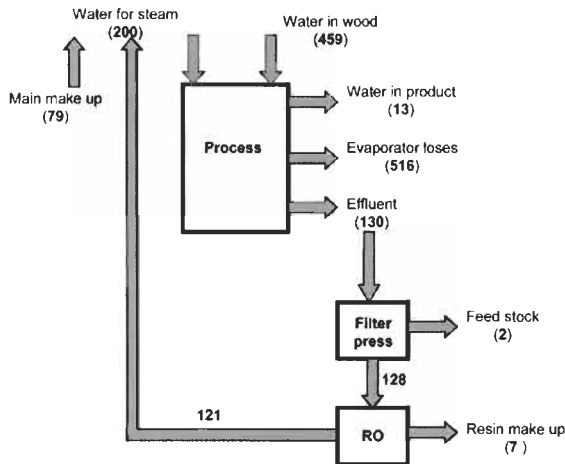

Figure 5.12 Water mass balance for MDF plant in tonnes per day (1998 data)

drying process and 18% recycled from the effluent treatment plant which goes to make up 60% of the boiler feedwater.

The two main water quality parameters measured through the plant are COD and suspended solids. Some 65% of the COD is removed prior to the membrane plant with the permeate containing 1% of the raw effluent value and the final product water < 1% after carbon polishing. Overall the COD of the plant has been reduced from an influent concentration of 20 000 mg l⁻¹ down to < 200 mg l⁻¹ post activated carbon. Almost all the suspended solids are removed in the filter press with a residual of less than 1 mg l⁻¹ entering the RO stage. Suspended solids in the RO permeates are below limits of detection and the total dissolved solids –1. The product water quality is very soft with a total hardness concentration of 1 mg l⁻¹ and 0.5 mg l⁻¹ (Ca) (Table 5.20) and contains negligible concentrations of silica or sulphate making the water suitable for reuse in the (low-pressure) boiler house for steam.

The treatment plant was built under a lease-purchase agreement where Kronospan made an initial payment of £200 000 (\$310 200) in February 1996 and a final payment of £200 000 (\$325 000) in February 1999. Under the contract, Esmil operated the plant for a monthly fee of £22 000 (\$33 528; 1998) ensuring the treatment of all wash water effluent to meet Kronospan's water quality objectives, up to an agreed daily maximum. The plant generates an annual saving of £251 740 (\$383 365) of which the majority was generated from the avoidance of tankering the effluent away (91%) (Table 5.7). Actual recycling on the plant produces the remaining savings of which 5.6% come from reduced mains water and 3.4% by recovery of raw material. The payback period for the initial payment was less than 10 months and Esmil continued to operate the plant until autumn of 2002 when Kronospan took over responsibility.

The scheme was the first plant worldwide to apply such an approach to MDF effluent and subsequent plants have been installed across Europe. The scheme at

Table 5.7 Cost sheet for MDF wastewater recycling plant (as of 1998)

	Annual cost, £ (\$)	Annual saving, £ (\$)
Supplier operator charge	264 000 (430 320)	
Avoidance of tankers charges		468 500 (763 655)
Reduced mains water charge		29 480 (48 052)
Raw material recovery		17 760 (28 948)
Total	264 000 (430 320)	515 740 (840 656)

Currency conversion ($\times 1.63$) based on 12 August 1998 figures (<http://www.oanda.com/convert/fxhistory>, accessed November 2002).

Chirk led in part to Esmil being awarded both the Queen's award for environmental achievement (UK) and the department of trade and industry (DTI, UK) award for best environmental practice.

5.6 M-Real Kirkniemi paper mill (Finland)

5.6.1 Background

M-Real's (formerly Metsa Serla) paper mill at Kirkniemi, Finland, is one of the largest integrated paper mills in Scandinavia producing over 350 000 tons of fine paper, 350 000 tons of magazine paper and its own SGW, PRMP pulp every year. M-Real prides itself on being a leader in forest industry environmental protection and was the first to introduce a biological treatment plant to process wastewater in Finland. In 1994 the white water loop was closed with the integration of membrane technology. As a consequence, freshwater intake at the Kirkniemi mill now stands at a record low level of less than 1400 gallons ton^{-1} product ($5.3 \text{ m}^3 \text{ ton}^{-1}$).

5.6.2 Description of plant

At full capacity the plant processes $1400 \text{ gallons min}^{-1}$ ($200 \text{ m}^3 \text{ h}^{-1}$) of which 60–70% is reused for shower waters and dilution water for paper machine chemicals. The remaining 30–40% is further treated and used for warm water replacement. The flow initially passes through a screen to the UF feed tank from where it is pumped to the main UF plant (Fig. 5.13).

The UF plant contains 9 cross-rotational (CR) ultrafiltration membranes arranged in a 5:3:1 array (Fig. 5.14). The membranes are regenerated cellulose, polysulphone stack disc modules supplied by Nadir Filtration GmbH and are rated at a molecule weight cut-off of 30 kDa. The plant contains a total membrane area of 720 m^2 and is designed to treat $216 \text{ m}^3 \text{ h}^{-1}$ at an equivalent approximate recovery of 90–95%. The membranes operate at an average pressure of 0.8 bar producing an average flux of 300 LMH (range 250–500 LMH)

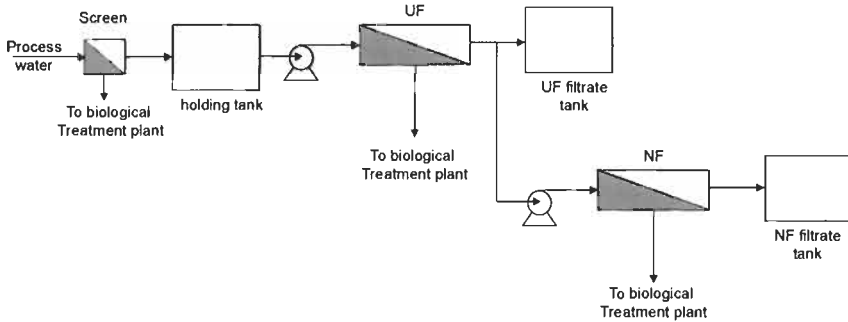

Figure 5.13 Process flow diagram of Kirknemi white water recycling plant

at a cross-flow velocity of 13 m s^{-1} . Fouling control in the cross-rotational membrane unit is achieved by rotors between all membrane stacks thus generating shear directly at the membrane's surface. Membrane cleaning is conducted by a combination of acid and alkaline detergents every 5 days for a duration of 60 minutes. Concentrate from the stacks is combined and sent to the biological treatment plant prior to discharge.

Permeate from the UF plant then is split into two streams with 30–40% of the flow being sent for further treatment in a nanofiltration plant. The plant contains a total membrane area of 900 m^2 and is designed to process $30\text{--}40 \text{ m}^3 \text{ h}^{-1}$ at a temperature of $58\text{--}60^\circ\text{C}$ and an overall recovery of 80%. The membranes are polyamide/polysulphone spiral-wound modules and are rated at a salt rejection of 50%. The membranes operate at a TMP of 9 bar which delivers a mean flux of $30\text{--}40 \text{ LMH}$. Membrane cleaning is conducted every 3 days with an alkaline detergent and every week with an acid detergent. The membrane life of the plant is in excess of 2 years.

5.6.3 Performance

The UF plant effectively removes all suspended solids and colloidal materials from the feed (Table 5.20). COD removal is only 15% but the final water quality is suitable for dilution water for paper machine chemicals. The use of the ultrafiltration plant has not only reduced freshwater intake but has improved maintenance and repair of the paper machines which may be due to the fact that the water is free from suspended solids and microorganisms. The cross-rotational UF plant incurs an energy demand of 1.5 kW m^{-3} which equates to an operating cost of $\text{€}0.12 \text{ m}^{-3}$ ($\text{\$}0.12 \text{ m}^{-3}$).

The white water contains sugars, fatty acids and other wood extracts which all exhibit a high fouling propensity. A key aspect of the scheme has been the identification and development of a membrane system that can effectively operate with such a feed flow. The use of highly hydrophilic, almost uncharged regenerated cellulose membranes has had a significant influence on the efficacy of the technology to this application. Operation of the system has been below the critical flux such that only gradual fouling of dissolved species rather than rapid



Figure 5.14 CR membranes at Kirkniemi

fouling of suspended solids occurs. This has resulted in cleaning strategies based on routine maintenance procedures rather than on demand and as such offers the potential for further reductions in opex as confidence grows about the limits of the system.

5.7 T. Forsell and Son: dyewaste water recycling plant (UK)

5.7.1 Background

Thomas Forsell and Son Ltd is a family owned and run textile mill founded in the centre of Leicester in 1850, moving to South Wigston (south of the city) in 1963. The main basis of the company is the production of dyed and spun woollen and worsted yarns for the Ministry of Defence. Due to the need for the final product to retain its colour over prolonged periods the dyes are often highly stable chemical compounds which are poorly biodegradable. The dyes tend to have poor fixation properties with as much as 50% of the dye being passed to the effluent. Traditionally, the textile house has discharged the effluent, including the dye, to the sewer for downstream treatment at the local sewage works at South Wigston. Dye removal through typical sewage works is low and so the final effluent typically remains high in colour. In January 1996 the Environment Agency imposed colour consents on Severn Trent discharges to the river Sense at sewage works such as South Wigston STW (Table 5.8). The cost of upgrading South Wigston to comply with the new consents was estimated at £1–2.5 m⁻³ (\$1.55–3.87 m⁻³). Consequently, Severn Trent passed these consents on to the

Table 5.8 Colour consents

Wavelength (nm)	Colour absorbency	
	Consent	Typical effluent
500	<0.057	0.094
550	<0.053	0.084
600	<0.047	0.070
650	<0.047	0.055

individual textile companies including T. Forsell and Son Ltd together with four other discharges in the area.

The textile plant processes 10 Mg of yarn per day producing a total of 400 m³ of effluent. The effluent typically exceeds the colour consent by between 20 and 80% and contains high concentrations of chromium. The cost to meet the consent is sufficiently high that recovery and reuse of the water becomes a viable economic consideration. The company then embarked on a pilot study to establish the most appropriate technology. The criteria outlined were the ability to produce reusable water (based on colour and chrome) and the robustness to withstand the natural fluctuations in water quality. Four options were tested:

- Flocculation
- Biological treatment
- Advanced oxidation
- Reverse osmosis

Flocculation is probably the most popular form of effluent treatment in the textile industry. The system trialled at T. Forsell and Son utilised a synthetic organic clay with a high anion exchange capacity. The system was relatively simple and suitable for colour removal but was unable to reduce the chromium concentration below 3 ppm. The biological system comprised an aerobic reactor coupled with UV and hydrogen peroxide capable of removing 80% of the COD. The plant was relatively inexpensive at £150 000 (\$232 650) but was unable to remove chromium. The third option was chemical oxidation with ferrous sulphate, hydrogen peroxide, sulphuric acid and lime. The process effectively removed chromium but retained a high salt concentration in the product water. In all the options the final product water was unsuitable for reuse and so not economically feasible. Ultimately a membrane-based technology was selected as it enabled reuse of the water and hence recovery of the spent capital.

5.7.2 Description of plant

The process train is relatively simple with minimal pretreatment required ahead of the reverse osmosis unit (Fig. 5.15). The flow initially passes through a 20 µm screen prior to being pumped to the RO plant. Concentrate from the process is treated with appropriate chemicals and the generated sludge separated out from

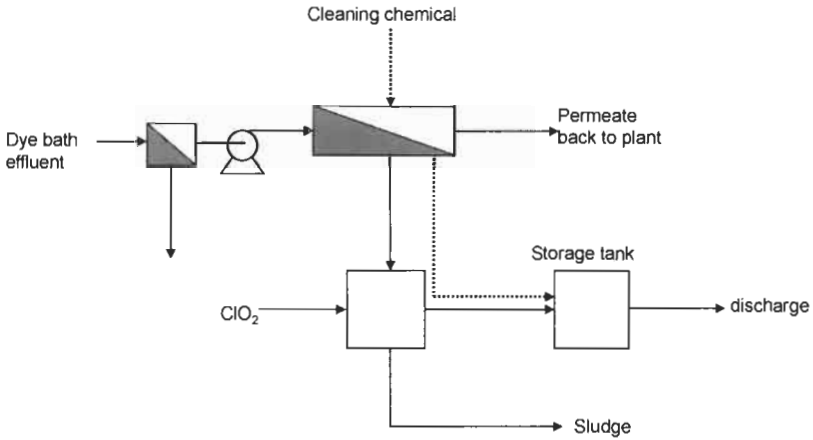

Figure 5.15 Process flow diagram for Forsell and Sons Ltd dye bath waste recycling plant



Figure 5.16 Reverse osmosis plant at Forsell and Sons Ltd

the liquor before being transferred into a 24 hour storage tank. The spent cleaning chemicals are blended with the treated concentrate prior to discharge into the local watercourse. Sludge from the site is stored and tankered away for disposal.

The main treatment stage is two RO streams. The membranes are spiral-wound polysulphone modules supplied by Osmonics. The plant contains a total surface area of 1152 m² and treats a flow of 480 m³ d⁻¹ at a temperature of 60°C. The membranes operate at a mean TMP of 25 bar which delivers a mean flux of 16.5 LMH. The plant is operated for 20 hours per day, 5 days a week and 48 weeks a year. The remaining 4 hours per day are assigned to membrane cleaning

which consists of a sodium hydroxide soak at pH 10.5 resulting in a spent chemical flow of $40 \text{ m}^3 \text{ d}^{-1}$.

The major challenge with the plant was connected to concentrate disposal which had to remove both colour and chromium from the concentrated brine prior to discharge. A number of techniques were explored including electrolytic treatment, chemical oxidation, chemical reduction and flocculation. Both the electrolytic and chemical reduction techniques were not successfully implemented at this site probably due to other contaminants in the flow. Ultimately, the most successful option was the use of chlorine dioxide as a chemical oxidant. The chemical destroys the chromophore and hence decolourises the water whilst simultaneously releasing the Cr(III). *Colfloc* flocculent was then used to aid the physical separation of the insoluble chromium from the flow. In total the plant produces $20 \text{ m}^3 \text{ d}^{-1}$ of concentrate which requires 10 kg d^{-1} of chlorine dioxide (0.5 g l^{-1}) to effectively treat it prior to transport to the storage tank and ultimately disposal.

Once the plant was operational and the discharge volume was significantly reduced Forsell and Sons were able to re-negotiate the consent limits based on a reduce flow of $30 \text{ m}^3 \text{ d}^{-1}$ (Table 5.9). The changes had considerable impact in terms of COD, Cr and Zn as it greatly reduced the need to treat the concentrate. Most importantly concentrate levels of heavy metals were below the new discharge consents and so no treatment of these components was necessary. The impact on the process was to reduce the chemical demand of the plant by removing the need for a flocculent.

5.7.3 Performance

The mill is no longer operational but the wastewater recovery plant was successfully operated for over two years recovering 95% of the water as RO permeate which was then reused within the plant. It produced an overall removal of 80.5% COD and 59% total dissolved solids with complete removal of suspended solids. Colour removal was almost complete with absorbance below

Table 5.9 Change in consent limit at Forsell and Sons Ltd

Parameter	Original consent	New consent
Flow ($\text{m}^3 \text{ d}^{-1}$)	227	30
Rate ($\text{m}^3 \text{ h}^{-1}$)	7	7
pH	6–10	6–10
SS (mg l^{-1})	1000	700
COD (mg l^{-1})	3000	9000
Cr (mg l^{-1})	10	15
Zn (mg l^{-1})	5	10
Colour at 500 nm	0.057	0.431
Colour at 550 nm	0.053	0.401
Colour at 600 nm	0.047	0.356
Colour at 650 nm	0.047	0.356

0.001 across all the consented wavelengths. Heavy metal removal was also very good with chromium concentration reducing from 0.75 to less than 0.02 mg l⁻¹.

The installation of the plant was required by changes to discharge consents but the ability to recycle water within the plant provided a number of economic advantages to ensure the scheme became financially viable. Major savings were achieved in the cost of softened mains water (by 95%) and the reduction of effluent charges. A less obvious saving was made by the reduction in heat demand achieved by recycling the previously heated water within the process. The capital cost of the schemes was £275 000 (\$448 800) in 1998 and the annual net saving on the reuse plant was £142 635 (\$232 780) resulting in a payback time of 1.9 years (Table 5.10). The company ceased production in March 2001 at which point the quarterly effluent bill had reduced from £12 481 (\$17 723), prior to the reuse plant, down to £640 (\$908). Overall the decision to install the plant resulted in a profit to the company of £182 067 (\$258 535) over its operational life.

5.8 N food plant wastewater treatment and recycling plant (Japan)

5.8.1 Background

Yokosuka city, situated in the Kanagawa Prefecture has no nearby rivers and as such water is supplied from water treatment plants situated on the Sagami river a distance of 30 km away. N company is a producer of frozen foods (such as Chinese and Japanese dishes) and is situated within Yokosuka city and so

Table 5.10 Cost sheet for dye bath reuse scheme (as of 1999)

	Annual cost. £ (\$)	Annual saving. £ (\$)
Membrane replacement	29 714 (47 806)	
Pre filter opex	1 408 (2 265)	
Labour	5 760 (9 267)	
Power	22 464 (36 142)	
Water	2 661 (4 281)	
Cleaning chemical	960 (1 544)	
Maintenance	3 679 (5 919)	
Chlorine dioxide treatment	37 058 (59 622)	
Total opex £ m ³	1.07 (1.72)	
Effluent disposal		60 015 (96 558)
Water		68 874 (119 811)
Water softening		9 316 (14 988)
Colour charge		56 828 (91 430)
Water heating		50 307 (80 938)
Total	103 705 (166 850)	246 340 (396 336)

Currency conversion ($\times 1.608$) based on 12 August 1999 figures (<http://www.oanda.com/convert/fxhistory> (accessed November 2002)).

is constantly looking for ways to reduce its water consumption whilst maintaining product quality. A number of approaches have been considered to reduce water demand:

- Rainwater recycling
- Well water supply
- Refrigerator and subfloor condensation recycling
- Wastewater recycling

The final preference was for wastewater recycling as it provided the most secure source of water available to the plant. Three applications were identified for the water including pre washing of product materials, cooling units and floor washing and boiler feedwater. The projected demand for each application was 40 tonnes day⁻¹ which was anticipated to require 140 tonnes day⁻¹ in total of untreated wastewater to allow for losses during recovery.

5.8.2 Description of plant

Wastewater is collected and treated in pre existing rotating biological contactors before passing to the primary aeration tank and then onto the submerged membrane bioreactor. The permeate is disinfected and stored in the grey water tank from where it is either pumped for direct use in the cooling tower and the washing system or diverted to a reverse osmosis plant for further treatment prior to use as boiler feed water (Fig. 5.17).

Pretreatment

The flow initially passes through a pre-existing RBC unit followed by a drum filter to remove trash components from the sewage and biomass.

MBR

The primary aeration tank (100 m³) and MBR (50 m³) are interconnected to provide a hydraulic residence time of 24 hours which equates to a BOD loading rate of 1 kg BOD m⁻¹ d⁻¹. The biomass is periodically wasted to maintain the mixed liquor concentration within the range 8–12 g l⁻¹ which equates to a

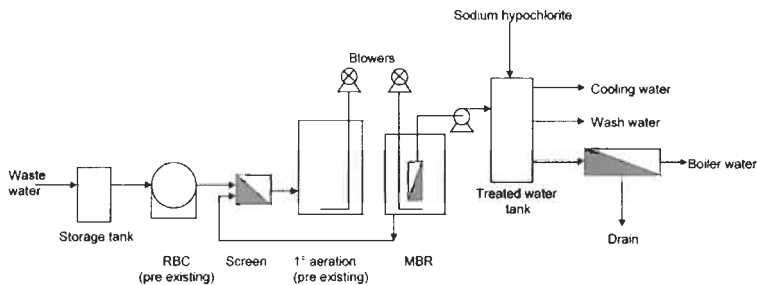

Figure 5.17 Process flow diagram for N-Plant recycling treatment plant

sludge retention time of 20 days. This range of mixed liquor concentration is well known to provide optimal performance of the MBR system and is necessary to reduce operational problems that occur at either lower or higher values.

The membrane bioreactor plant (Fig. 5.18) consists of a suspended growth bioreactor into which six double-tier membrane modules are submerged providing a total membrane area of 960 m². The membranes are hydrophilic polyethylene hollow fibres rated at a pore size of 0.1 µm. The system is designed to treat 140 m³ d⁻¹ under a constant flux of 5 LMH. Flow through the membranes is generated by a combination of hydraulic head and permeate suction providing a total transmembrane pressure of between 25 and 40 kPa (0.25–0.4 bar) depending on the level of fouling. Fouling control is achieved by a combination of air scour over the membrane fibres and periods of intermittent operation which relaxes the fouled layer and enables the air scour to remove more material. Chemical cleaning is required every six months by an overnight soak in 0.1% sodium hypochlorite and 4% sodium hydroxide solution. The membranes have as yet not required replacement during the 4 years of operation.

Reverse osmosis

The final stage of the treatment train is a reverse osmosis plant arranged in a 2:2:1 array. The membranes are polyamide spiral-wound modules supplied by Toray. The plant contains a total membrane area of 70 m² and operates at a flux of 24 LMH equating to an overall recovery of 67%. Chemical cleaning occurs once a month by means of a chemical feed washing with a solution of ethanol (15%) at pH 12.

5.8.3 Performance

The treatment plant went online in May 1998 and is still being used today to supply both wash water and boiler feed. The MBR plant effectively removes the majority of the organic and suspended pollution found in the wastewater. The BOD is reduced from 2240 mg l⁻¹ in the feed to less than 1 mg l⁻¹ in the MBR



Figure 5.18 (a) Outside view of water tank and (b) MBR at N-food treatment plant

permeate (Table 5.20). Suspended solids and *n*-hexane extractable compounds are similarly reduced from 1120 and 475 mg l⁻¹ to less than 1 mg l⁻¹ respectively. The final RO stage produces a permeate with a final conductivity of 125 µS cm⁻¹.

Combined water and sewerage charges in the city of Yokosuka are ¥607 m⁻³ (\$4.15 m⁻³). The plant operates for 260 days per year and so the installation and operation of the reuse plant results in a direct saving (Table 5.11) of ¥20 338 000 (\$139 315) per annum with an additional ¥1 400 000 (\$9590) saved through reduced chemical demands on the boiler system. The total annual costs of running the additional treatment technology is ¥5 406 300 (\$37 033) resulting in a net annual saving of ¥14 931 700 (\$102 282). The cost of the plant is covered by offsetting ¥3 000 000 (\$20 550) per year as depreciation on the plant over its projected lifetime yielding a true annual saving of ¥11 931 700 (\$81 732).

5.9 Pasfrost vegetable processing plant (Belgium)

5.9.1 Background

Pasfrost, located in Passchendaele, western Belgium, is a vegetable processing company producing 65 000 tonnes of deep-frozen vegetables per year. The plant processes a wide variety of vegetables depending on the season ranging from squashes and leaf crops in the summer to root vegetables in the winter. Process water is used at the site for a range of activities such as washing/rinsing, blanching, steam peeling, caustic peeling and cooling.

Traditionally, water is supplied from groundwater sources that are bacteriologically safe and require no treatment prior to use. However, economic development in the region has led to increasing pressures on the ground water sources resulting in the need to abstract from wells over 300 m deep. The quality

Table 5.11 Cost sheet for wastewater treatment reuse plant (as of 1998)

	Annual cost (Y)	Annual saving (Y)
MBR energy (120 m ³ d ⁻¹)	925 500 (6339)	
MBR membrane (120 m ³ d ⁻¹)	3 600 000 (24 660)	
RO energy (40 m ³ d ⁻¹)	280 800 (1923)	
RO membrane (40 m ³ d ⁻¹)	600 000 (4110)	
Total opex (Y m ⁻³)	205.8 (1.4)	
Reduced water charges		9 469 200 (64 864)
Reduced sewage charges		9 469 200 (64 864)
Reduction in boiler chemical costs		1 400 000 (9590)
Total	5 406 300 (37 033)	20 338 000 (139 315)

Currency conversion ($\times 0.00685$) based on 12 August 1998 figures (<http://www.oanda.com/convert/fxhistory> (accessed November 2002)).

of the groundwater has also deteriorated (Table 5.12) such that the Flemish government has forced companies in the region to severely reduce abstraction volumes.

To maintain production and enable any future expansions requires both conservation and reuse to be considered. Specific items adopted at the Pasfrost site include:

- Partial reuse of wash water for low-grade application which has decreased the specific water use from 5 down to 3.5 m³ tonne⁻¹ of product.
- Steam peeling instead of caustic peeling to reduce the salt concentration in the waste water.
- Anaerobic pretreatment and extension of aerobic treatment producing a more stable effluent suitable for further treatment and reuse.

By reusing treated wastewater the groundwater demand has been reduced by 50%, equating to a specific water consumption of 2 m³ tonne⁻¹ of product. Specific concerns with the requirements of a reclamation plant were the need to handle feedwaters with highly variable organics levels, minimise operational costs and achieve high membrane life expectancy. A core element to the design of the reclamation facility was the ability to deliver a constant quality feed to the advanced treatment processes.

Overall, introduction of the reuse options has reduced the groundwater requirement to 100 000 m³ y⁻¹ with 200 000 m³ y⁻¹ coming from reuse of partially-treated wastewater and 100 000 m³ y⁻¹ from the advanced water treatment plant (Fig. 5.19). Discharge from the site is 100 000 m³ y⁻¹ of which 50% is evaporation and 50% is discharge from the treatment works.

5.9.2 Description of plant

The flow initially passes through a screen and a heat exchanger to raise the average temperature from 20 to 30°C as a pretreatment for the anaerobic stage. The anaerobic reactor is a 5000 m³ UASB operated at a specific loading rate of 3–6 kg COD m⁻³ d⁻¹ enabling a total of 30 000 kg COD to be treated per day. The produced biogas is used for heating the incoming flow and has an equivalent steam rating of 70 tonnes day⁻¹ based on the production of 5000–6000 m³ d⁻¹ of biogas during high loads.

Table 5.12 Groundwater quality and guidelines for drinking water quality

Parameter	Groundwater	WHO guidelines
pH	8.3	6.5–8.5
SO ₄ ²⁻ (mg l ⁻¹)	126	400
HCO ₃ ⁻ (mg l ⁻¹)	552	
Cl ⁻ (mg l ⁻¹)	550	250
Conductivity (mS cm ⁻¹)	2.6	0.25
TH (mmol l ⁻¹)	0.3	

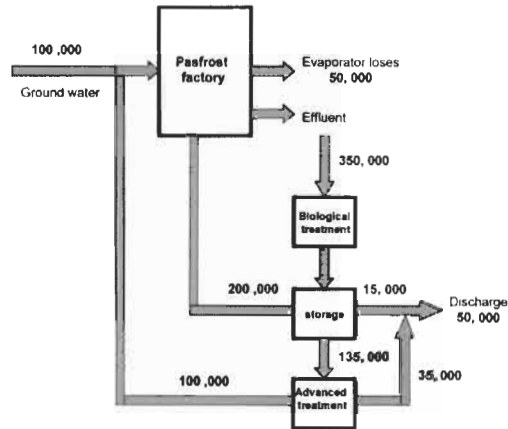

Figure 5.19 Mass balance around Pasfrost reclamation facility (data in $\text{m}^3 \text{year}^{-1}$)

The flow is then passed to a $11\,000 \text{ m}^3$ activated sludge plant operated at a specific loading rate of $0.1 \text{ kg COD kg VSS}^{-1} \text{ day}^{-1}$ to polish and re-aerate the flow. After sedimentation the effluent is treated in two serial steps by ASTRASAND[®] up flow monomedia continuous depth filters. The first set of filters act as a roughing stage and comprise two 5 m^2 filter beds operating at a hydraulic filtration velocity of $10 \text{ m}^3 \text{ m}^{-2} \text{ h}^{-1}$. The second stage incorporates a polymer dose to help flocculate and capture the remaining solids as they pass through two 10 m^2 filters.

Flow is either directly pumped after chlorination for second-grade operations such as machine washing and cooling or is pumped to the membrane filtration treatment plant. The first membrane stage is a semi dead-end hollow fibre ultrafiltration membrane plant supplied by Norit X-flow designed to deliver an overall flow of $40 \text{ m}^3 \text{ h}^{-1}$ (Fig. 5.21). The hydrophilic membranes are manufactured out of PES/PVP blend and have a pore size rating of 50 kDa . The membranes operate over a pressure range of 0.3 to 1 bar which delivers a mean flux of 45 LMH . Cleaning of the membranes occurs by a periodic backflush of permeate and a regular chemical clean.

The final stage of treatment is a two-stage reverse osmosis plant containing spiral-wound neutrally-charged polyamide LFC1 membranes supplied by Hydraunautics. The plant is designed to deliver a net production of $20 \text{ m}^3 \text{ h}^{-1}$ at a recovery of 70% . The membranes operate over a pressure range of 8 – 10 bar , delivering a mean flux of 30 LMH . As an extra precaution the permeate is passed through a UV plant to ensure the water is sterile. The final effluent is then mixed with the ground water and pumped into the production process. RO concentrate is discharged with the excess flow.

5.9.3 Performance

The plant has been operated since mid-2000 and has suffered no overall problems with effluent quality. Incoming wastewater is ultimately reduced in

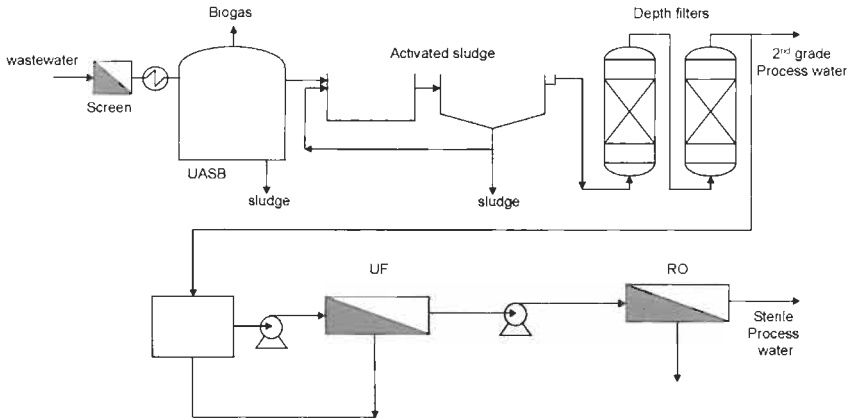

Figure 5.20 Process flow diagram of the Pasfrost water recycling plant

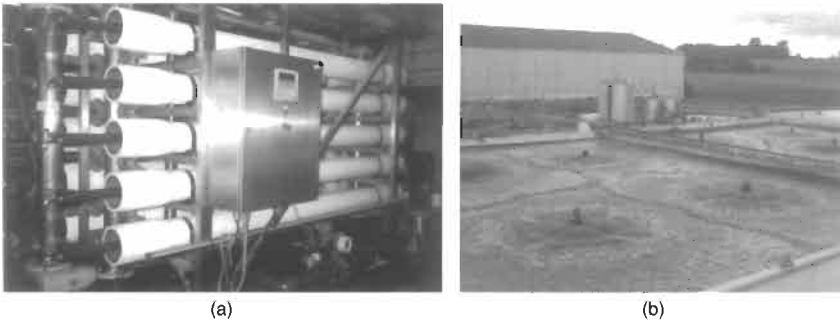

Figure 5.21 (a) Ultrafiltration and (b) bioreactors at Pasfrost

COD concentration from $12\,000\text{ mg l}^{-1}$ to a non-detectable level by the treatment train (Table 5.13). Final product water quality also shows non-detectable levels of turbidity and coliform concentrations. The recycle water contains a lower concentration of conductivity, iron and total hardness but is slightly higher in $\text{NH}_4^+\text{-N}$ and HCO_3^- compared to the existing groundwater.

The main operational difficulty has been in maintaining flux rates through the UF plant throughout the year. During winter periods (vegetables and Schorseneer) UF fluxes deteriorate to 50% of the design flow. Diagnostics of the membrane surface reveal spots attributable to a variety of humic acids. Chemical cleaning protocols have been changed to use enzymatic cleaners but the overall problem remains. During the winter period the water consumption is reduced and so it was decided to operate at reduced fluxes, which seem to ameliorate the problem. In the summer the UF fluxes can be increased to 50–60 LMH and as a consequence RO capacity has been increased by 40% to $30\text{ m}^3\text{ h}^{-1}$ without additional investment in UF plant.

Operation during the initial phase of the project has yielded a net plant flow of $20\text{ m}^3\text{ h}^{-1}$ while the infrastructure is designed to produce $40\text{ m}^3\text{ h}^{-1}$ and so lost

Table 5.13 Typical water quality profile through the Pasfrost treatment plant

Parameter	Wastewater	Post anaerobic	Post aerobic	Post filters	Post RO/UV	Groundwater
COD (mg l ⁻¹)	12 000	1200	114		0	0
pH	8.5	7	8.3	8.2	5.5	8.3
Total P (mg l ⁻¹)			34	34	< 0.5	< 0.5
NH ₄ ⁺ -N (mg l ⁻¹)			< 2	< 2	< 2	0.17
Fe (mg l ⁻¹)					0.03	0.23
TH (mmol l ⁻¹)			1	1	> 0.3	0.3
HCO ₃ ⁻ (g l ⁻¹)			2.9	2.9	< 0.3	< 0.1
Conductivity (mS cm ⁻¹)	4.3		4.3	4.2	0.15	2.6
Turbidity (NTU)			16	4.3	0	
CFU (ml ⁻¹)					0	0
E-coli (ml ⁻¹)					0	0

Table 5.14 Balance of operating costs at the Pasfrost site

Cost	Design, € m ⁻³ (\$ m ⁻³)	Actual, € m ⁻³ (\$ m ⁻³)
Depreciation on investment	0.49 (0.48)	0.49 (0.48)
Depreciation on membranes	0.14 (0.14)	0.14 (0.14)
Chemicals	0.17 (0.17)	0.07 (0.07)
Energy	0.07 (0.07)	0.03 (0.03)
Maintenance/operation	0.08 (0.08)	0.06 (0.06)
Total	0.95 (0.947)	0.79 (0.787)

Currency conversion ($\times 0.99739$) based on 12 August 2002 figures (<http://www.oanda.com/convert/fxhistory> (accessed November 2002)).

capital is expected. The operating costs of the plant during Phase One has been evaluated after two years of operation (Table 5.14) with a total opex of €0.79 m³ (\$0.78 m³) including plant depreciation and €0.16 m³ (\$0.16 m³) without. The actual opex are lower, if compared to design predictions, which is due to the introduction of steam peeling which has reduced the need for pH correction. In fact during some periods of the year no pH correction is required at all. The other factor has been improved stability of UF operation whilst the TMP remains below 0.5 bar. Annual production is currently 150 000 m³ which represents a saving of €24 000 (\$23 900) compared to the original design predictions.

The introduction of the reuse scheme enabled Pasfrost to further extend its production volume, without increasing the specific water costs. As the legislation for groundwater abstraction becomes more stringent the focus will be on increasing the water reuse volume to even higher levels (60–70% of intake). Without the reuse scheme the present production volume would only have been possible if drinking water was used, which needs to be softened on-site. Taking into account the extra drinking water intake and the extra waste water discharge volume, this would result in an additional cost of €0.30–0.40 per m³ in comparison to the actual present specific costs.

5.10 Automotive water recycling (Germany)

5.10.1 Background

The automotive industry requires large volumes of water and chemicals in the production of finished cars and trucks. The majority of the water is associated with the pretreatment and electrocoating stages where the car bodies need to be cleaned prior to the different stages of production, and includes a rinse between each step.

The application of membrane technology within the electrocoating process is widespread. In fact, the process would not be viable without ultrafiltration which has been used for more than 20 years to extract rinsing solutions from paint. The integration of the technology has numerous drivers such as a need to remove drag out paint before stoving, almost total recovery of the paint and the avoidance of effluent problems. In part this has been integral to the development of electropainting techniques and so has become part of the core process rather than additional technology that needs to be justified. This places the industry in a different position from many of the others which are currently considering membrane technology. However, uptake of membranes to other parts of the pretreatment and electrocoating stages has been considerably slower. The result is that still heavy water demands are placed on production with up to 500 m³ of process water being required per car. In more recent times economic drivers have required the industry to examine the potential to reduce costs of both effluent treatment and chemicals consumption. Two applications where this is becoming more established is in removal of oil from the pretreatment cleaners at the start of the production and recycling and recovery of paint from the final rinse water at the end. The economic benefits are to a large extent country-specific due to differences in the available water and the disposal options for the effluent. However, the post-paint rinse water offers the most obvious benefits due to the recovery of high-value paint and so will be examined further.

Once the electrophoretic painting is complete drag out is removed from the car bodies by rinsing with ultrafiltration permeate extracted from the paint. A final deionised water rinse is then applied to remove final paint traces and salts which may otherwise reduce product quality (Fig. 5.22). The wastewater produced from this process contains paint solids which have to be treated in the liquid effluent line prior to discharge and the solids disposed as a contaminated waste. A number of techniques have been tried to reduce demand on water and effluent and to recover lost paint:

1. Extension of UF rinsing
2. Extraction of RO permeate from UF
3. Treatment of post-paint rinse water by UF

Extension of using UF permeate for the entire rinse period and thus replacing the deionised water (option 1) potentially has shortcomings as the permeate still

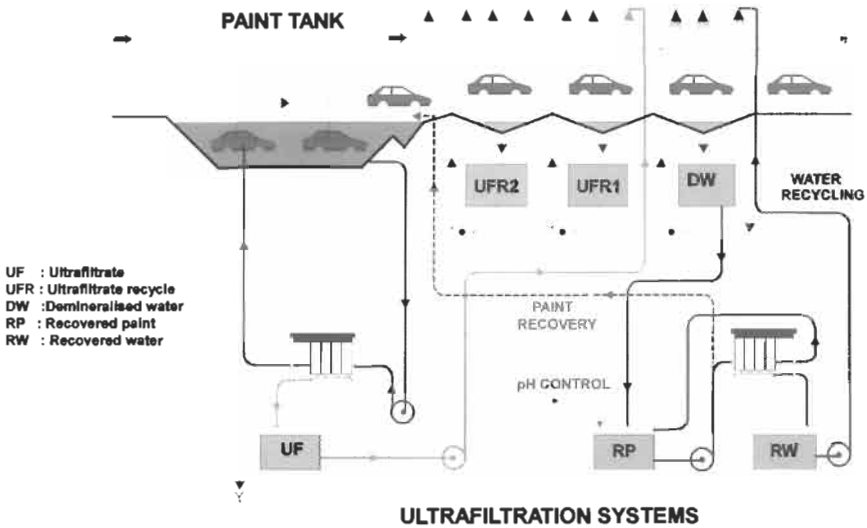

Figure 5.22 Cathodic electrocoat line with UF rinsing and rinse water recovery

retains salts and other soluble impurities. Potential stability problems could arise when subsequent paint layers are coated, resulting in a poor quality finish. The impurities can be removed by utilising reverse osmosis membranes to further purify the rinse water (option 2). However, the feed to the RO system is likely to have a high fouling propensity making the option technically undesirable. In both options, additional UF permeate is required and this is a relatively expensive option since less paint is recovered than in the primary UF rinsing. Ultimately, a separate recycling loop was selected which involves recycling of the post-paint rinse water and recovery of paint (option 3). An additional benefit of option 3 is that a small concentration of solvent builds up within the loop which improves the efficacy of the rinsing solution over that of deionised water.

5.10.2 Plant description

The treatment train comprises a treatment tank, a recirculation pump and an ultrafiltration module (Fig. 5.23). Used water-containing paint particles are retained by the membrane and concentrated in the treatment tank. When the concentration in the treatment tank is sufficient the contents are pumped to the electrocoat tank replacing make-up water. This is important to the success of the scheme as it represents a recovery of valuable paint product.

The ultrafiltration modules are acrylonitrile plate-and-frame membranes (Fig. 2.7) supplied by Rhodia Orelis rated at a molecular weight cut off of 50 kDa. The plant contains a total membrane area of 55 m² and is designed to treat a flow of 192 m³ d⁻¹ at a temperature of 40°C. The membranes are operated over a TMP range of 1–3 bar delivering a flux range of 145–300 LMH at a cross flow velocity of 2.6 m s⁻¹. Cleaning occurs approximately every 3–4 months and involves a 300-minute cleaning cycle with organic acid and solvents. The operation of the

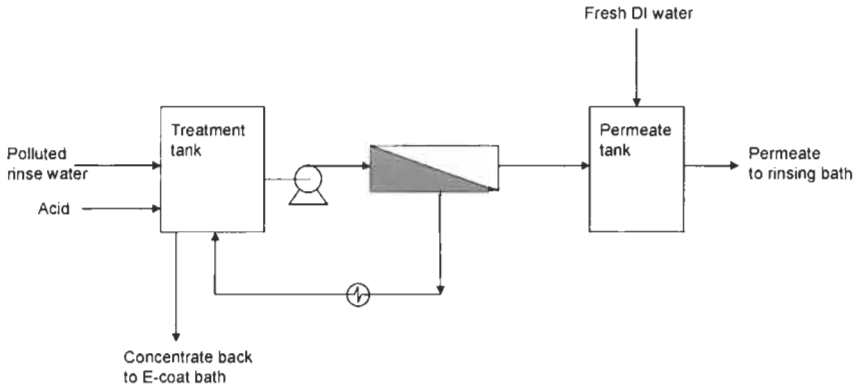

Figure 5.23 *Process flow diagram of post paint water recycling system*

plant results in a membrane replacement life of over 3 years. Membrane integrity is checked during both manufacture and operation. During manufacture membrane quality is monitored using air permeability tests. During operation, permeate quality is monitored by a combination of visual inspection and on-line turbidity meters. Any individual permeate tubes seen to be passing retentate are removed from the collector and diverted back to the treatment tank and so there is no need to make interventions for incidental damage.

5.10.3 Performance

The plant operates within the required specifications for recycling water and recovering paint. The main operational concern with the system is the stability of the paint solids which would otherwise coat the membrane, a problem which is controlled by pH adjustment. Bacteria contamination is also a problem due to the close contact of the rinse water with air. Growth is controlled through the use of paint-compatible biocide, but ultimately the membranes may need mechanically cleaning by hand.

The high water demand of the process and the ability to recover valuable paint make the recycling scheme very favourable economically. The plant reduces the requirement for water and effluent treatment by 60 000 m³ y⁻¹ resulting in a €327 000 (\$326 146) saving. Some 18 600 kg y⁻¹ of paint are also recovered representing 22% of the total annual saving accrued from the plant. The remaining saving are in labour costs associated with having to clean the rinse water tank less regularly. The major cost of running the plant is energy to run the pumps and cooling circuit which equates to a total annual energy demand of 324 000 kWh. The remaining costs are due to membrane cleaning and replacement resulting in a total opex of €0.36 m⁻³ (\$0.355 m⁻³). The plant cost a capital outlay of €270 000 (\$269 000) with a further €24 000 (\$23 600) required for first year financing. The annual net cash flow is €435 000 (\$433 900) resulting in a pay back period of less than 8 months. Although the economic success of the plant is country-specific a similar scheme in the UK

Table 5.15 Cost sheet for post paint rinse water reuse plant (as of 2002)

	Annual cost, € (\$)	Annual saving, € (\$)
Energy	16 500 (16 456)	
Membrane cleaning	5 500 (5485)	
Recovered paint		100 000 (99 739)
Water and effluent		327 000 (326 146)
Labour		30 000 (29 921)
Total	22 000 (21 942)	457 000 (455 807)

Currency conversion ($\times 0.99739$) based on 12 August 2002 figures (<http://www.oanda.com/convert/fxhistory> (accessed November 2002)).

would have a payback period in the region of 13 months due to the reduced water prices.

5.11 NEC Semiconductors: microelectronics wastewater reclamation (UK)

5.11.1 Background

NEC Semiconductors (UK) Ltd, Livingston, was formed in 1982 as part of the NEC Corporation and was originally assigned for assembly and testing before expanding into manufacture. The fabrication facility produces several millions chips per month and has the largest operational clean room floor area in Europe (dated 1999). NEC incorporates reclamation and reuse within its business strategy achieving ISO 14001 accreditation in December 1991. Included in the strategy is both reduced chemical consumption and waste recycling. For instance, reduction in machine bath volume and photo-resist dispensing volumes generated significant savings in hydrofluoric acid (£40 000 (\$62 040)). Materials such as cardboard, paper, plastics, acids and reject silicon wafers are also recycled. For instance, the waste silicon is used in aluminium production acting as a strengthening agent for the final product.

The initial driver for water recycling was to ensure sufficient water resources at facilities where external water was limited. The experience gained at these sites has led to reclaim plants operating at sites where water is plentiful and inexpensive. In such cases the driver for reuse is to reduce operating and capital costs of water supply with the added benefits of environmental preservation and associated publicity. Reclamation at some sites has even extended to ZLD (zero liquid discharge).

The majority of the DI water required at the production facility is used in the wet bench machines in the clean room where the silicon wafers pass through at various stages during production. The wet benches consist of a concentrated acid bath, for etching, followed by a series of rinse baths. The wafers are initially lowered into the acid bath for a preset time to achieve the required etch depth.

Afterwards the wafers are placed in a constantly overflowing deionised (DI) water bath and then onto a second rinse stage before moving onto the next stage of production. The DI water can be either hot or cold, depending on the acid bath temperature, and is drained separately from the bench before being pumped to the treatment facility.

Transistor gate sizes can be smaller than 2 μm and as such any ions or the particles remaining on the silicon wafers can cause short circuits. Consequently the DI water quality standards need to ensure high-purity water (Table 5.16).

Raw water supply to the production facility is high in organics due to the moorland intake and highly variable due to limited treatment at the local water treatment works. Consequently the potable water intake requires a large number of treatment processes prior to entering the DI production facility (Fig. 5.24). In fact, the front end of the works is similar to an advanced potable water works with coagulation-DAF and dual media depth filters to remove solids and activated carbon to remove organics and chlorine. Following the GAC is an anionic organic scavenger resin bed, a cartridge filter and then finally a reverse osmosis plant. The efficacy of the GAC in removing chlorine is essential to protect the resin and RO membrane from oxidation. The organic scavenger resin is regenerated on site with brine and caustic solution and contains two streams allowing for maintenance and regeneration.

The water then enters the DI plant which is split into primary and polishing stages. In the primary stage the water passes through a sequence of cation–anion–cation ion exchange beds, a 10 μm cartridge filter to remove resin and precipitated organics and a 254 nm UV plant. Following the UV stage the water is filtered through a 3-stage RO plant arranged in a 7:3:2 array. The permeate is de-aerated prior to being pumped to the polishing stage of production. In the final stage the water passes through a cooler, 185 nm UV and UF membrane filtration plant before being put into the supply ring main. Total production of ultra pure water is 200 $\text{m}^3 \text{h}^{-1}$ at an overall recovery rate of 71%.

In comparison to the intake raw water the DI waste water is very low in organics and solids and so requires relatively less treatment to produce a water of sufficient quality to enter the primary DI production stage. The main difference between the water sources is the very low cation and bacteria count in the reclaim water (Table 5.17). This is to be expected as the reclaim water is generated from the DI baths, which follow high-purity acid baths. Importantly,

Table 5.16 Water quality standards for DI water

Parameter	Standard
Resistivity	18 $\text{M}\Omega \text{cm}^{-2}$
Particles ($> 0.05 \mu\text{m}$)	$< 5 \text{ml}^{-1}$
Bacteria	$< 1 \text{l}^{-1}$
TOC	$< 2 \mu\text{g l}^{-1}$
DO	$< 50 \mu\text{g l}^{-1}$
Metals	$< 0.01 \mu\text{g l}^{-1}$

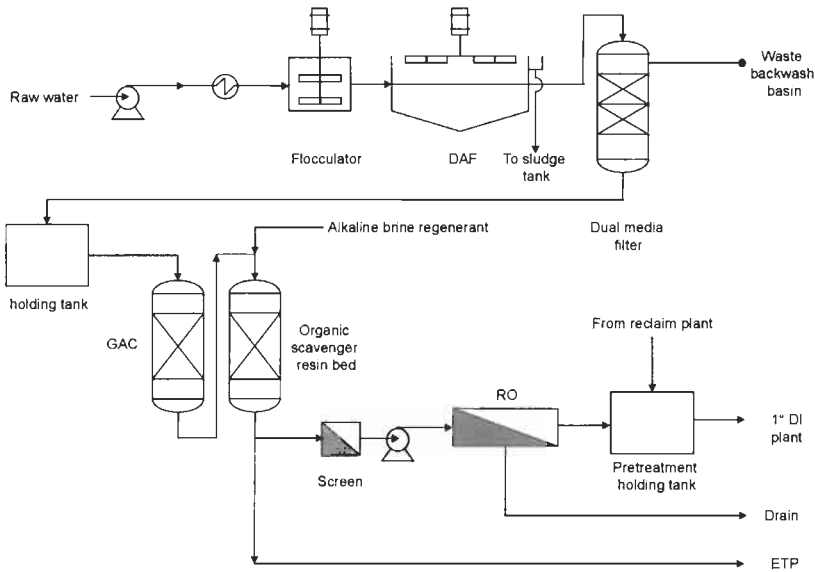

Figure 5.24 Process flow diagram of raw water pretreatment facility

as the baths are situated in the clean rooms no contamination is picked up from the atmosphere. The reclaim water does, however, contain much higher concentrations of sulphate from sulphuric acid remaining on the wafers.

An important aspect of the scheme is that the use of reclaimed water does not affect product quality in any way. To ensure this, reclaimed water is monitored in terms of TOC and conductivity prior to being pumped to the primary DI production stage. Any waste above the allowable levels is rejected and passes to the effluent treatment plant. The plant was originally designed to accept water below $300 \mu\text{S cm}^{-1}$ but has had to increase this to $600 \mu\text{S cm}^{-1}$ to increase the amount of water through the reclaim plant.

5.11.2 Description of plant

The reclaim water is essentially deionised water with sulphate anions added; no cation removal is therefore required and the process flow sheet reflects this (Fig. 5.25). Reclaim water is pumped at a rate of $140 \text{ m}^3 \text{ d}^{-1}$ through a 14 m^3 activated carbon bed (diameter = 2.8 m, height = 3.05 m) for the removal of hydrogen peroxide which can be present in some of the baths. This is necessary to protect the downstream processes from oxidation. After the adsorption bed the water passes through a 2.2 m diameter weak anion exchange bed with a WBV of 5.2 m^3 . The anion bed removes free ions of sulphate, phosphate and fluoride. The anion resin is regenerated with a caustic solution after a preset number of bed volumes have been treated or the pH falls below pH 6.

The water then passes through a $10 \mu\text{m}$ filter to remove any resin beads or activated carbon particles. An UV lamp operating at a wavelength of 185 nm

Table 5.17 Reclaim and raw water quality (parameters requiring treatment in bold type)

Parameter	Reclaim water		Raw water	
	Min.	Max.	Min.	Max.
Bacteria (cells l ⁻¹)	5	735	2000	94 000
Conductivity (μS cm ⁻¹)	250	600	44	179
Silica (mg l ⁻¹)	0.5	32	0.903	0.73
Iron (mg l ⁻¹)	0.01	0.1	0.01	0.1
Sodium (mg l ⁻¹)	0.004	4.9	1.34	7.4
Alkalinity (mg l ⁻¹)	0	0	3	147
Calcium (mg l ⁻¹)	0.01	0.67	7.2	8.9
Potassium (mg l ⁻¹)	0.01	0.73	0.37	0.66
Magnesium (mg l ⁻¹)	0.01	0.07	1.02	1.6
Chloride (mg l ⁻¹)	0.02	19.8	11	13
Phosphate (mg l ⁻¹)	0.05	2.05		
Sulphate (mg l ⁻¹)	30	110	4	5
Nitrate (mg l ⁻¹)	0.13	1.2	1.11	1.8
Fluoride (mg l ⁻¹)	1	15.5	0.1	0.13

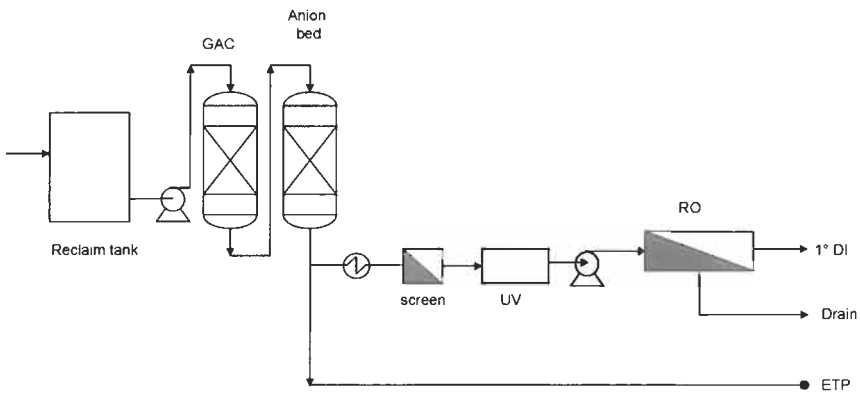

Figure 5.25 Process flow diagram of the reclaim treatment facility at NEC Semiconductors Ltd

then sterilises the water and removes any trace organics remaining in the flow. The final stage of the treatment is a reverse osmosis plant consisting of 8 inch × 8 inch modules each fitted with four elements and arranged in a 5:2:1 array. The plant operates at a 90% recovery generating 130 m³ h⁻¹ of treated reclaim water.

5.11.3 Performance

Water enters the reclaim plant with a conductivity of 600 μS cm⁻¹. The weak anion bed reduces the conductivity to 25 μS cm⁻¹ which is then further reduced through the RO plant to a final value of 3 μS cm⁻¹. The water then mixes with the treated raw water before being passed onto the DI production facility where

water is ultimately produced with a resistivity of $18.2 \text{ M}\Omega \text{ cm}^{-2}$. Some 58% of the high-purity water is reclaimed and recycled to the ultrapure water plant. The remaining water is sent to the effluent treatment facility with the RO concentrate and the brine regenerate. Under these conditions 54% of the production flow is generated from recycled flow.

Included in the reclamation strategy is the utilisation of waste heat through a heat exchange network. Hot reclaim drains are used to preheat the supply of high purity DI. This represents a huge energy saving by increasing the cold DI from 25 to 55°C, and has a dual benefit as it cools the wastewater prior to being treated in the reclaim plant.

There is a significant financial saving from using reclaim water as 83% of the treatment cost is associated with bringing raw water on site and then disposing of it (Table 5.18). The reclaim water costs only 12% that of treating raw water generating a saving of 20% on the total operating and maintenance budget for the DI water treatment plant. The main economic decision is concerned with determining the amount of reclaim water to recycle. Zero reclaim incurs high operational costs due to raw water price but 100% reclaim incurs excessive additional up front capital investment. Between the two extremes is an economic optimum, which depends largely on the utility cost of the local region (Fig. 5.26). In order for the reclaim percentage to increase the cost curve needs to change such that the capital cost in relation to the raw water/discharge costs will decrease. The major barrier to this is the rapid changes that can occur in microprocessor production which means new chemical pollutant can be generated which the original plant is incapable of treating.

5.12 Discussion

The case studies featured have not only demonstrated that reuse of industrial waste water is technically feasible but economically viable. In all cases the installation of a membrane system for recycling water has resulted in an overall saving to the company involved. Annual savings have ranged from \$102 282 to \$642 240 (Table 5.19) and have paid back the initial capital from within 8 months (automotive) to 6 years (power). The most cost-effective of the schemes has been the automotive plant (internal loop) which generates an annual return

Table 5.18 Water treatment cost breakdown

	Raw water	Reclaim water
Raw water (%)	67.2	0
Electricity (%)	13.4	9.41
Chemicals (%)	3.2	2.28
Discharge (%)	16.1	0
Total (%)	100	11.7

Excludes labour and media replacement.

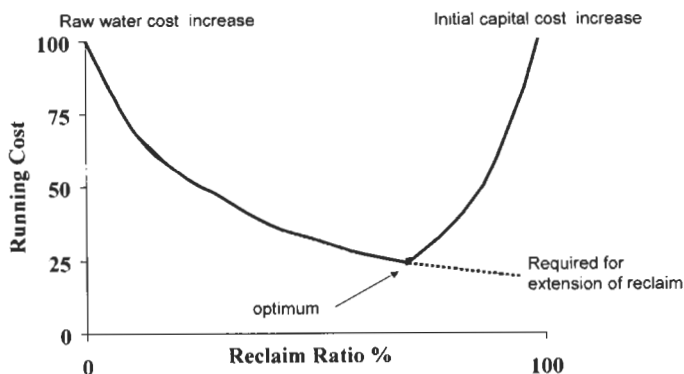

Figure 5.26 Balance of costs versus % of water recovered

Table 5.19 Summary of case studies

Industry	Flow rate (m ³ d ⁻¹)	Specific flux (LMH bar ⁻¹)	Capital investment (\$)	Annual saving (\$)
Power (2000)	1200	3.63 (RO)	1 524 000	—
Power (1994)	3750	0.88 (RO)	3 340 000	642 240
Power (1991)	1363	—	750 000	240 000
Paper (2001)	216	34.3 (UF)	—	226 391 ^a
MDF (1995)	400	0.56 (RO)	635 200	383 365
Paper (1994)	5184	375 (UF)	—	—
Textile (1996)	480	0.66 (RO)	448 635	232 780
Food (1996)	140	15.4 (MF)	—	102 282
Food (2000)	685	3.3 (RO)	—	—
Automotive (2000)	192	111 (UF)	293 223	433 864

^a Data in scheme not complete.

on investment of 147% equating to a profit of \$2259 m⁻³ d⁻¹. The least profitable of the schemes has been the power station at Eraring (external loop) which generates an annual return on investment of 19.2% equating to a profit rate of \$171 m⁻³ d⁻¹.

The savings have been generated from a number of sources in addition to the direct benefit of using less external (potable) water. In the case of the power stations, recycling has decreased the number of regenerations required in the demineraliser plant either reducing operating costs (Eraring) and/or increasing capacity (Flag Fen). In other cases recovery of raw materials has increased the profit margins, such as paint (Germany) and pulp solids (Chirk). Perhaps a less obvious saving has been in energy savings by recycling hot water streams and so reducing the heat requirement at the site (Livingston, South Wigston, Apeldoorn).

However, the driver for reuse is not always directly a financial one. In the majority of case studies outlined here the original interest in reclamation was

generated from an indirect financial driver such as changes to legislation (textile, food) or a need to secure sufficient water supplies. For instance, in the case of the textile plant, legislation imposed a treatment requirement on the plant. Once money had to be spent to comply with the legislation, the benefits of ensuring the water could be recycled became important as otherwise the capital expenditure could not be recovered. The regulation requirements can go as far as zero liquid discharge, in which case reuse is a necessity rather than an option. In such cases, the driver is to reduce overall treatment costs (Doswell). However, in a number of the schemes the driver has been directly one of reducing operating costs of which water supply can be a major component (Eraring, Livingston).

The selection of membranes in the reclamation process train has occurred in a number of ways. In some industries either membrane technology is already used (Germany, Livingston) or the plant involves similar levels of technology (Eraring). At other schemes the use of membranes has been a radically new development (South Wigston). The familiarity with the technology appears to be in part linked to the need for indirect financial drivers to exist before reuse is considered. This is probably because a high degree of confidence is required in the technology designed for reclaiming the water, since it cannot be allowed to adversely affect core production quality.

As expected it is difficult to draw commonalities from a broad range of industries. However, a number of points can be concluded. The key facet of the reclamation system in all cases has been its ability to withstand variations in the wastewater quality, whilst producing a water quality suitable for reuse. Effluent quality from membranes is usually very good, such that the main concern is achieving sufficient throughput without incurring excessive cost. This is reflected in the level of pretreatment required from the different schemes. In cases where simple closed loops are being generated the pretreatment requirement is minimal (as in the automotive industry). However, in situations such as the reuse of secondary effluent and other wastes with high fouling propensities, more involved pretreatment is required. In some cases this involves two membrane stages and in other cases more traditional pretreatment (such as coagulation followed by depth filtration).

Overall, the case studies have shown the suitability of membrane technologies in particular for industrial effluent recovery and reuse. The ability to produce reclaimed water of sufficient quality is clear. However, the throughputs are quite different between the schemes. For instance, comparing the specific fluxes of the four RO schemes described reveals a range between 0.56 and 3.63 LMH bar⁻¹ reflecting the differences in the RO feed water matrices. This demonstrates that each scheme is in part unique, potentially involving problems that have not been encountered in other industries. Moreover a common problem with potential industrial reuse schemes is a paucity of data describing the water quality and hence the design limits. Table 5.20 clearly illustrates this point where in some cases little or no water quality data are known in actual operating schemes. Although easily remedied, data paucity remains a major barrier to uptake of not only membranes for reuse but any treatment technology.

Table 5.20A Membrane characteristics

Parameter	Application									
	Power	Power	Power	Pulp+ paper	MDF	Pulp+ paper	Textile	Food	Food	Automotive
Name of installation	Flag Fen (MF)	Flag Fen (RO)	Eraring	Apeldoorn	Chirk	Kirkniemi	South Wigston	Kanagawa Prefecture	Passchendaale	Germany
Company	Alpheus Environmental	Alpheus Environmental	Vivendi	Triqua BV	Esmil Process Systems	Metso PaperChem Oy	PCI Membranes	Mitsubshi Rayon Co Ltd	Paques	Rhodia Orelis
Membrane geometry	Hollow fibre	Spiral wound	Spiral wound	Tube	Spiral wound	CR filter (flat sheet)	Spiral wound	Hollow fibre	Hollow fibre	Plate
Height (mm)	2000	1524	1016	-	1000	-	-	486	2600	900
Width (mm)	1.3 (OD)	-	-	-	-	-	-	48	1300	310
Diameter (mm)	150	200	216	8	200	1000	-	798	200	1.6
Supplier	PALL filtration	Koch	-	-	Osmonics	Nadir Filtration GmbH	PCI Membranes	Mitsubshi Rayon Co Ltd	X-flow	Rhodia Orelis
Membrane area (m ²)	1700	1451	-	-	2022	720	1152	960	700	0.35 per plate
Surface area per module (m ²)	50	52	-	-	31.6	80	-	160	35	55
Material	PVDF	Polyamide	Cellulose acetate	PVDF	Polyamide	Regenerated cellulose polysulphone	Polysulphone	Polyethylene	PES/PVP	Acrylonitrile
Pore size (µm)	0.1	-	-	0.04	-	-	-	0.1	-	-
Material cut-off (kDa)	-	200	98% salt rejection	-	-	30-100	-	-	50	50
Surface charge	-	-	-	-	Anionic	Slightly negative	-	Anionic (nearly 0)	-	Positive
Hydrophobicity	Hydrophilic	Hydrophobic	-	Hydrophilic	-	Hydrophilic	-	Hydrophilic	Hydrophilic	Hydrophilic
No. of streams	2	2	2	-	-	1	2	1	-	1
Modules per stream	17	4:2 array	10:4 array	-	-	5:3:1 array	-	6	-	1

Table 5.20B Operation and cleaning

Parameter	Application									
	Power	Power	Power	Pulp+ paper	MDF	Pulp+ paper	Textile	Food	Food	Automotive
Name of installation	Flag Fen (MF)	Flag Fen (RO)	Eraring	Apeldoorn	Chirk	Kirkniemi	South Wigston	Kanagawa Prefecture	Passchendaele	Germany
Plant capacity (m ³ d ⁻¹)	1500	1200	3750	216	400	5184	480	140	685	192
Temperature (°C)	16	16		60	25-30	55-60	60	-	14-22	40
Flux range (LMH)	24-37	35-41		100-120		250-500	-	-	40-45	145-300
Mean flux (LMH)	30.5	34.5	2.2	120	15	300	16.5	-	42	-
TMP range (bar)	0.4-3	6-16	15-35	-	-	-	-	2.5-4	0.3-0.6	1-3
Mean TMP (bar)	1.3	9.5	25	3.5	30	0.8	25	-	0.4	-
Backflush duration (min)	1.5	-	n.a.	-	-	n.a.	-	n.a.	0.8	-
Backflush frequency (min)	12	-	n.a.	-	-	n.a.	-	n.a.	15	-
Backflush fluid	Air/water	-	n.a.	-	-	n.a.	-	n.a.	Water	-
Cleaning cycle duration (min)	90	360	-	-	30	60	-	Overnight	-	300
Cleaning frequency	14 days	6 months	-	-	1 day, 3 days	5 days	4 h day ⁻¹	6 months	Variable	3-4 months
Cleaning chemicals	Hypochlorite+ high pH	High + low pH		Anionic/ionic surfactants	Caustic soda, proprietary high-pH reagent	Alkaline and acid detergent for membrane cleaning		Sodium hypochlorite+ NaOH	HCl + NaOCl	Organic acid+ solvent, NaOCl+ membrane conditioner
Flow per module (m ³ h ⁻¹)	1.69					-		0.5	1.42	-
Cross-flow velocity (m s ⁻¹)	-			4.5		13			-	2.6
Membrane replacement (years)	7	5	-	3	1.5	1.5	2	>5	>3	3+

(Table continued on next page)

Table 20B (continued)

Parameter	Application									
	Power	Power	Power	Pulp+ paper	MDF	Pulp+ paper	Textile	Food	Food	Automotive
Conversion (%)	90	80	80	-	90	95	-	-	80	-
Power consumption (kW m ⁻³)	0.055	0.4	-	-	Low	1.5	-	-	Low	4
Operating costs (S m ⁻³)	0.11	0.11	0.133	-	Competitive	0.12	-	-	-	-

LMH≡1 m² h⁻¹.

Table 5.20C Performance

Parameter	Application									
	Power	Power	Power	Pulp + paper	MDF	Pulp + paper	Textile	Food	Food	Automotive
Name of installation	Flag Fen (MF)	Flag Fen (RO)	Eraring	Apeldoorn	Chirk	Kirkniemi	South Wigston	Kanagawa Prefecture	Passchendaelc	Germany
COD _[in-out] (ppm)	51.3	-	-	-	8000 ^c → < 200	15%	2000 → 390	-	114	-
BOD _[in-out] (ppm)	10	-	20 → < 5	-	2500 → < 100	-	-	2240 → < 1	-	-
Total N _[in-out] (ppm)	0.4	-	-	-	-	-	-	-	439	-
Total P _[in-out] (ppm)	4.26 → 3.9	-	-	-	-	-	-	1120 → < 1	-	-
SS _[in-out] (ppm)	16 → < 2	-	-	-	-	100%	-	-	40	-
Turbidity _[in-out] (NTU)	-	-	50 → < 0.1	-	-	100%	-	-	→ 0	-
Colour _[in-out] (abs)	-	-	-	-	-	-	0.12 → < 0.001	-	-	-
Coliforms _[in-out] (cfu 100ml ⁻¹)	-	-	10 ⁶ → < 1	-	-	100%	-	-	100%	-
TDS _[in-out] (ppm)	-	765 → 51	-	-	1050* → 50*	-	1380 → 567	2200	-	-
TSS _[in-out] (ppm)	-	< 2 → < 2	-	-	< 1 → < 0.05	-	55 → 0	-	-	-
TOC _[in-out] (ppm)	-	8.86 → 0.83	-	-	-	-	-	-	-	-
pH _[in-out]	-	6.82 → 5.77	6.9	-	4.5 → 4.2	-	6.1 → 6.3	-	8.5	-
Resistivity _[in-out]	-	-	-	-	-	-	-	-	-	-
Hardness _[in-out] (ppm)	-	344 ^b → 22 ^b	110 →	-	150 ^u → < 1 ^u 50 ^b → 0.5 ^b	-	-	-	-	-
Alkalinity _[in-out]	-	137 ^l → 16 ^l	95 →	-	-	-	-	-	-	-
Silica _[in-out] (ppm)	-	12.8 → 0.25	6.5 → 2.6	-	40 → 0.2	-	-	-	-	-
SO ₄ _[in-out] (ppm)	-	-	70 → 2.2	-	70 → 0.2	-	-	-	-	-
Na _[in-out] (mg Na l ⁻¹)	-	102 → 4.7	90 → 17.8	-	-	-	-	-	-	-
Ca _[in-out] (mg Ca l ⁻¹)	-	103 → 0.8	30 → 0.5	-	-	-	-	-	-	-
P _[in-out] (mg P l ⁻¹)	-	3.9 → 0.16	1 →	-	-	-	-	-	-	-

Calcium: ^a total, ^b calcium; chlorine: ^c total, ^d free; alkalinity: ^e total, ^f HCO₃; ^g conductivity.

5.13 Reference material

These case studies have been researched by discussion with the end client and/or the supplier combined with information found on the internet or in published articles. The following list includes all sources except direct discussion as outlined in the Acknowledgements section. Web pages referenced were accessed on 12 November 2002.

Bell, C. (1999). Water reclaim in the microelectronics industry. IWRR1, Proc. 1st Internal Conference on Industrial Water Recycling and Reuse, Cranfield University, 24 November, p. 5.

Craig, G. (1999). The Eraring experience: four years on. IQPC Conference on Water Recycling and Effluent Re-use, London, 26–27 April, p. 18.

Donn, A. (2002). Effluent treatment in the textile industry. Company literature. PCI Membranes, Laverstoke Mill, Whitchurch, UK, p. 6.

Finnemore, S. (1997). An economic miracle. Timber and the environment. *TJ* Supplement, March, 22–23.

Hill, R. (2002). Personal communication.

Holmes, D. (2002). Water and chemical recovery in the German automotive industry. IWRR2, Proc. 2nd International Meeting on Industrial Reuse and Recovery, Cranfield University, 17 July, p. 8.

Jefferson, B., Bell, C. and Judd, S. (2002). Water recycling in the microprocessor industry. 3rd IWA World Water Congress – integrated management – key to sustainable water, Workshop: Eco effective approaches to sustainable water use in water intensive industries, Melbourne, Australia, 7–12 April.

Lewis, R. (2002). Personal communication.

Masson, M. and Deans, G. (1996) Membrane filtration and reverse osmosis purification of sewage: secondary effluent for re-use at Eraring power station. *Desalination*, **106**, 11–15.

Murrer, J. (2002). Flag Fen high purity water production plant. IWRR2, Proc. 2nd International Meeting on Industrial Reuse and Recovery, Cranfield University, 17 July, p. 6.

Ramackers, J.P.C., van Dijk, L., Lumpe, C., Verstrachten, E. and Joore, L. (2001). Thermophilic membrane bioreactors in the paper industry – a successful key to in mill water treatment. *Paper Technology*, February, 32–40.

Seigworth, A., Ludlum, R. and Reahl, E. (1994). Integrating membrane processes with evaporation to achieve economical zero liquid discharge at the Doswell combined cycle facility. Proc. ADA Biennial Conference, Palm Beach, FL, 11–15 September, p. 4.

Shimono, T. (1999). The cost reducing effect by wastewater treatment and recycling system with membrane separation technology. Company literature. Mitsubishi Rayon Co. Ltd, 6-41, Konan 1-Chrome, Minatoku, Tokyo, Japan.

Wakeling, A. (1999a). The textile industry. Proc. 1st Internal Conference on Industrial Water Recycling and Reuse, Cranfield University, 24 November 1999, p. 5.

Wakeling, A. (1999b). Personal communication.

Wouters, H. (2002). Partial effluent reuse in the food industry. IWRR2. Proc. 2nd International Meeting on Industrial Reuse and Recovery, Cranfield University, 17 July 2002, p. 7.

Web page. Case history – pulp and paper water recovery. Available from: <http://www.komline.com/products.services/filtration/CRFilter.html>.

Web page. Effluent reuse for power generation: Pacific Power Eraring power station. Available from: <http://www.environmental-center.com/articles/articles727/artcile727.htm>.

Web page. Food plant wastewater treatment and recycling system. Available from: <http://www.mrc.co.jp/dep/str/>.

Web page. Paper mill industry. Available from: <http://www.triqu.nl>.

Web page. Purification of secondary sewage for boiler feed water. Available at: <http://www.eidn.com.au/eraring.html>.

Web page. The year in review. Available from: <http://pp.nsw.gov.au/annual/review1.html>.

Web page. Crossflow membrane technology for effluent recovery and reuse in the textile industry. Available from: <http://michaeljevons.members.beeb.net/textiles.htm>.

Web page. The Ionics wastewater solution – zero liquid discharge. Available from: <http://www.ionics.com/Markets/Power/Doswell.htm>.

Web page. Flag Fen high purity water production scheme. A major step towards a sustainable future. Available from: <http://www.devon.gov.uk/greenapple/reference/page2.html>.

Web page. Turning sewage effluent into clean water. Available from: <http://www.pp.nsw.gov.au/enprod/water/>.

Web page. Cross rotational membrane filtration. Available from: <http://www.komline.com/Products.Services/Filtration/CRFilter.html#Anchor-APPLICATION>.

Web Page. Effluent reuse for power generation: Pacific Power Eraring power station. Available from: <http://www.environmental-center.com/articles/article727/article727.htm>.

Web page. Effluent reuse in power generation. Available from: <http://www.emcentre.com/unepweb/tec.case/gas.40/house/h1.htm>.

Web page. NEC. Available from: <http://www.necscotland.com/env1.html>.

Web page. Natural solutions Paques. Available from: <http://www.b3portal.nl/paques.uk/index.htm>.

Web page. PCI membranes. Available from: <http://www.pcimem.com/>.

Web page. Triqua process and water technologies. Available from: <http://www.triqua.nl/>.

Index

A

acetates 138, 139
acetic acid 69, 90, 112
acid baths 265, 266
acid cleaners 68, 69, 249, 273
acid dosing 64, 90, 239
acidified metabisulphite 70
acidity 188
acrylic fibres 143
acrylic monomers 21
acrylonitrile membranes 263, 272
activated carbon 67, 148, 149, 229, 245, 246, 266, 267
activated sludge (AS) processes 30, 44, 107, 119, 147, 148, 206, 244, 259
Adams-Millis Co. 149
adhesives 105, 113
adsorption 7, 45, 56, 67, 121, 122, 124, 141, 146–148, 267
aeration 30–31, 58, 67. *see also* activated sludge (AS) processes
aerosols 91
air conditioning 6, 76
air sparging 118
aldehydes 147
algorithms for pinch problem 201
alkaline cleaners 68, 69, 249, 273
alkalinity 5, 81, 217, 275
 cooling and boiler feedwater 81, 86, 90, 94, 275
alkylsulphonates 69
Alpheus Environmental 228, 272
alum 90
alumina 30
aluminium 22, 60, 62, 81, 93, 115, 265
Americal Corporation 149
American Process 198
ammonia 81, 94, 96
ammonium 69, 70, 96
anaerobic treatment 146, 147, 258
Anglian Water Group (AWG) 228
anionic dyes 154
anionic trash 108

anisotropic membranes 16, 17, 19
Anopore filter 22
antistatic agents 137, 138, 139
AOX (adsorbable organic halogens) 107, 108, 109, 113, 114, 204
Apeldoorn, Netherlands 241–244, 270–275
apyrogenic water 5
Argo Analyser 90
arid regions 2, 5, 9
Arizona (Palo Verde nuclear power plant) 98
Aspen Equation Modeler[®] 198
Aspen Properties[®] 198
Aspen Technology 198, 199
Aspen Water[®] (software) 198
ASTM, and fouling propensity 60, 61, 64, 65
ASTRASAND filters 259
asymmetric membranes 16, 19
Australia 160, 232–237, 270
Austria 6
automotive industry 4, 262–265, 269–275

B

backflushing 52, 56–57, 59, 66–67, 222–225
 food and beverage industry 273
 power industry 234, 273
 pulp and paper industry 245
 see also cleaning
 backflushing water 160, 167
bacteria 17, 51, 65–66, 264, 266
 automotive industry 264
 pharmaceutical industry 165, 170
 power industry 90–91, 229, 235
 pulp and paper industry 115
bactericides 69–70
barium 61, 62, 64, 68, 175, 241
Bechtel 237
Belgium 6, 257–261
Bend Research 22
Bergen generating facility (New Jersey) 98
beverage industry 4, 76, 159–163
bicarbonate 69, 81, 241
Bigelow Carpets 149
biochemical oxygen demand *see* BOD

- biocides 66, 68, 69–70, 84, 91
 biodegradability 138–139, 141, 146–148, 202, 250
 biofilms/biofouling 65–66, 89, 90–93, 162–163, 167, 265
 biological matter 58, 67, 68
 in cooling and boiler feedwater 84, 85, 88, 90–93, 233
 see also organic matter
 biological treatment
 of food washing waste 255–257
 of pulping effluent 115, 116, 119, 248
 of textile process effluent 140, 146–148, 150, 206, 251
 black liquor 106, 116, 119
 bleaching of pulp 104, 105, 106–107, 108, 109, 241, 243
 effluent treatment 115, 116, 120, 125, 241–244
 bleaching of textiles 137–140, 145, 202, 204, 241–244
 process modifications 148, 149
 blinding 35, 96
 blocking models 44–45
 blood 17, 51, 52
 blowdown water 85–88, 93, 94–95, 96–99, 100, 169
 BOI
 cooling and boiler feedwater 81, 95, 230–231, 235, 275
 food and beverage industry 255, 257, 275
 pulp and paper industry 109, 114, 115, 275
 textile industry 134, 135–140, 145, 146, 149, 150, 202–203, 204, 206
 boiler feedwater 10, 33, 77, 80–81
 food and beverage industry 159, 161, 162, 255
 from municipal effluent 93, 228–241
 pulp and paper industry 247
 Borregaard sulphite pulp mill (Norway) 116
 bottle washers 159–60
 boundary layer 45, 48, 49, 50–51
 Bounds editor 198–199
 Brazil 102
 brewing industry 4, 159, 161
 brightness reversion 115
 brine 239–240, 253, 266, 269
- C**
 C30F filter 121, 122, 123
 CAD *see* computer-aided design
 cadmium 8, 62
 cake layer 40–41, 43–51, 56
 accumulation 35, 35–36, 56
 mass transfer control 43–52
 calcite 61
 calcium 83, 86, 89, 94, 96, 112, 229, 241, 275
 calcium carbonate scalant 51–52, 60, 61, 62, 64, 67, 68, 89, 96, 175, 181
 calcium fluoride 62
 calcium hydroxide 62
 calcium phosphate scalants 62, 89, 231
 calcium sulphate scalant 62, 64, 68, 86, 89
 calcium sulphide 62
 Calgon (sodium hexametaphosphate) 64–65
 California 2, 3, 98, 99, 229
 Canada 102
 capillary fibre modules 28–29
 capillary flow modelling 40–41
 carbohydrates 66, 112
 carbon, organic *see* TOC
 carbon dioxide acidifier 90
 carbon dioxide permeation 61, 81, 160, 220, 242
 carbon dioxide removal 96, 179, 220, 239
 carbon filters *see* activated carbon
 carbon fines 59, 229
 carbonate scale 59, 60, 61, 64, 67, 68, 81, 86, 89, 90, 115, 175
 carbonising 138, 140
 carboxylates 21, 69, 122
 carboxymethyl cellulose 135, 138
 carriers 19
 cartridge filters 10, 24–25, 33, 60, 67, 246, 266
 cartridge microfilters, boiler feedwaters 10, 33
 cassettes 24, 30
 catalytic oxidation 67
 caustic soda 68, 69, 179
 food and beverage industry 160
 microelectronics industry 266
 power industry 90, 234
 pulp and paper industry 105, 246, 273
 textile industry 136, 137, 140
 cellophane production 8
 cellulosic fibres 143
 cellulosic matter 104, 140, 244, 246
 cellulosic membranes 66, 120, 162, 248, 249, 272
 cellulose acetate (CA) 19, 20, 22, 162, 175, 234, 240, 272
 Ceramen 22
 ceramic membranes 16, 17, 18, 19, 22–23, 30, 70, 154
 ceramic tubes 28
 CEVI 200
 chelants/chelators 68, 69, 89, 90, 139
 chemical dispersants 91–92
 chemical finishing of textiles 141–143
 chemical oxidation 20–21, 67, 137, 251, 253
 chemical oxygen demand *see* COD
 chemical pulping processes 102, 104, 105, 108, 114–115
 chemical reduction 253
 chemicals industry 6, 19, 76, 92–93, 209
 chemothermomechanical pulping (CTMP) 104, 105, 109, 114
 Chevron Oil Refinery (Oakland, CA) 98
 China 102, 132, 147
 Chirk, North Wales 244–248, 270–275
 chloramine 162–163
 chloride 81, 83, 94, 115, 170, 241

- chlorinated compounds 139
 chlorinated rubber 139
 chlorination 67, 160, 162, 229, 259
 chlorine 20, 22, 65, 66, 67, 69–70, 89, 91, 235, 266
 bleaching of pulp 104, 105, 106–107
 in mechanical pulp water 112
 residual 83–84, 162
 chlorine dioxide 104, 105, 107, 253
 chloramines 139
 chloroether 21
 chloroform 22
 chromium 62, 134, 145, 146, 251–254
 CIP (clean in place) 6, 28, 70, 160, 161, 167–168, 169, 170, 230, 239, *see also* cleaning
 circulation water *see* white water
 citric acid 68, 69, 90, 235
 clarification 206, 229, 238
 clays 32, 51, 60, 122, 123, 251
 cleaning 28, 32, 52, 56–57, 66–70
 automotive industry 262, 263–264, 273
 food and beverage industry 256, 259, 260, 273
 power industry 234, 235, 236, 273
 pulp and paper industry 117, 121, 246, 249, 250, 273
 textile industry 252–253, 273
 see also backwashing; CIP
 clogging 35, 59
 closed-loop recycling 3–4, 11, 79, 99, 145, 167, 206, 248, 261, 269, 271
 coagulation 59, 67, 271
 food and beverage industry 162
 microelectronics industry 266
 power industry 96, 229, 238
 pulp and paper industry 125
 textile industry 146–148, 206
 coarse bubble aeration 30–31, 58
 coating materials 102, 105, 110, 115, 117–118, 120, 122–124, 150, *see also* dyeing
 industry: pigments
 cobalt sulphide 62
 Coca Cola Amatil plant (Australia) 160
 COD 5, 81, 275
 cooling and boiler feedwater 81, 230–231
 food and beverage industry 258, 260, 275
 pulp and paper industry 107–109, 111–114, 116, 118–119, 243, 244, 247, 249, 275
 textile industry 134–135, 145–148, 150, 202–203, 204, 251, 253, 275
 Cofloc 253
 coliforms 91, 166, 233, 235, 275
 colloidal material 9, 17, 44, 50, 51–52, 60, 67, 113, 249, *see also* dissolved and colloidal material
 colour 107, 108, 112, 204, 275
 discharge consents 134, 141, 145, 250, 253, 275
 see also coating materials; dyeing; pigments
 composite membranes 16, 19
 computer-aided design, for RO 61, 172–186, 217–220, 222, *see also* software
 concentration gradient 34, 36
 concentration polarisation (CP) 36–39, 45–51, 53, 61
 classical model 41, 45–50
 coefficient 175
 modified model 50–51
 in software design 172, 173, 174, 175, 176, 180, 181, 213
 concentration ratio 86–88, 93
 condensate cooling 76, 161, 232, 237
 conductivity 5
 food and beverage industry 231, 260
 microelectronics 267, 268
 pharmaceutical industry 165, 167, 170
 power industry 229
 pulp and paper industry 112, 241, 275
 continuous deionisation (CDI) 32
 continuous microfiltration (CMF) 51, 118
 conversion 33
 cooling 3, 6, 7, 76–79, 85–100, 159, 160, 204, 232, 255
 copper 62, 81, 93
 corrosion 80, 81, 85, 89, 90, 93, 95, 115, 188
 Costpro software 174, 182
 costs 4–5, 269–271, 274
 automotive industry 264
 backflushing and cleaning 67–68, 69, 234
 EDR/RO system for zero liquid discharge 241
 food and beverage industry 160, 161–162, 257, 258, 260–261
 membrane materials and manufacture 17–18, 22, 175
 membrane use 10–11
 microelectronics industry 265, 269
 pulp and paper industry 116, 117, 119, 125, 242–244, 247
 of purification 3, 235–237, 269
 recirculating water treatment 88, 116, 117
 software for costing 182, 198, 202
 textile industry 148–149, 154, 203–207, 254
 cotton 136–137, 138, 139, 140, 143, 146, 202, 241–244
 CR (cross-rotational) filter 31–32, 116–117, 118, 121, 248, 272
 cresols 138
 critical flux 39–40, 51, 121, 249
 cross-flow operation 33, 36, 45, 51
 and fouling 59, 67, 121
 and polarisation 38–39
 cross-flow velocity 174, 176, 180, 214, 242, 249, 263, 273
 cross-rotational filter *see* CR filter
 cryptosporidia 9, 17
 current density 34
 cycles of concentration 86–88
 cyclohexanol 138

D

DAF *see* dissolved air flotation

- dairy industry 4, 61, 76, 159, 161
DCS *see* dissolved and colloidal substances
dead-end operation 33, 36, 44–45
 cleaning 70
 design example 222–225
 and fouling 56–57, 59
 semi dead-end mode 229, 259
dealkalisation 5, 160, 207
debarking 104, 106, 107, 109
dechlorination *see* chlorine
deep bed/depth filtration 60, 67, 229, 238, 239,
 245, 259, 266, 271
deionisation 5, 8, 9, 263, 265–269, *see also*
 electrodeionisation
demineraliser feedwater 232–233, 239, 240,
 270
Denmark 6, 200
dense membranes 15, 16, 52, 61, 119
depth filtration *see* deep bed/depth filtration
deresination 115, 125, 266, 267
Desal 22, 161, 174
desalination 9, 38, 54, 178, 220–222
Desalination Systems 153
design examples 213–225, *see also* computer-
 aided design
desizing 136, 138, 144, 146, 150, 202, 204,
 207
detergents 67, 68
 pharmaceutical industry 167
 power industry 234
 pulp and paper industry 249, 273
 textile industry 136, 138, 140, 149, 150
dialysis 7, 9, 14, 39, *see also* electro dialysis
diffusion 36, 46, 47, 48, 51, 181
disc (mechanical) filtration 108–110, 114
disinfection 70, 83–84, 91, 233
dissociation 122, 172
dissolved air flotation (DAF) 67, 118, 244,
 266
dissolved and colloidal substances (DCS) 108,
 110, 112, 115, *see also* colloidal material
dissolved organic material 10, 17, 112
dissolved oxygen 94, 139
dissolved solids 81, 83, 95, 97, 112, 134, 140,
 235, *see also* TDS
distillation 166
dolomite 62
domestic water 2, 3, 6
Donnan equilibrium model 41, 42, 43
Dora Creek wastewater treatment plant
 (Australia) 232
Dowell combined cycle power plant (USA)
 237–241, 271–275
Dow 22, 121, 174
Dow Danmark Etna 22
drift water 85, 87
driving force 32, 34–349
“dumped” water 168
Duratherm Excel 161
dyeing industry 4, 139, 140–141, 145, 146–
 148, 149
 case study 250–254
 effluent 133–134, 141, 150–154, 202
 in water pinch case study 202, 203, 204,
 206, 208
- E**
EDTA (ethylene diamine tetracetic acid) 68, 69,
 90
electro-oxidation 22
electrodeionisation (EDI) 32, 99, 167, 169
electrodialysis (ED) 9, 14, 16, 19, 26–27, 34,
 35, 43, 95, 125
 and concentration polarisation 37–38, 49
 design example 220–222
 energy demand 57–58
 modules 24, 25–27, 32
 spacers 58
 staging 52, 54
electrodialysis reversal (EDR) 58, 96, 238, 239–
 241
electrolysis 147, 253
electroneutrality 177
electrophoretic painting 3, 262–265
energy demand 55–58, 67, 103, 176, 181, 187
 in design examples 213–217, 220–222, 225
environmental awards 231, 248
environmental legislation and guidelines
 pulp and paper industry 113–114
 textile industry 133, 144–146, 154
 see also legislation and guidelines
environmental preservation 265
enzymes 136, 138
enzymic cleaners 68, 69, 260
EPS (extracellular polymeric substances) 65,
 66, 67
equilibrium chemical models 90
equilibrium thermodynamics 61–64, 173, 175
Eraring Power Station (Australia) 232–237,
 270–275
Esmil Process Systems 247, 248, 272
estuarine water use in power industry 80–84
etching 18, 19, 22–23, 265
ethylchlorophosphates 143
ethylene diamine tetracetic acid (EDTA) 68, 69,
 90
ethylene oxides 69, 139
Europe 6, 9
 pharmaceutical industry 164, 165
 pulp and paper industry 102, 108, 112, 117,
 241–244
 textile industry 132, 144–146
 see also European Union
European Institute of Membranes 174
European Membrane Society 14
European Pharmacopoeia (EP) 164, 165, 166,
 170
European Union
 Integrated Pollution Prevention and Control
 (IPPC) Directive 113
 potable water 144
 and textile industry 132, 145, 146

- Urban Waste Water Treatment Directive (UWWTD) 9
- evaporation 85, 87, 88, 93, 95, 160, 237–241
dairy industry 161
pulp and paper industry 103, 115, 117, 119
- extracellular polymeric substances (EPS) 65, 66, 67
- extractive processes 38, 39, 49
- extrusion (stretching) 18, 19
- F**
- Faraday equation 220
- fats, oils and grease (FOG) 66, 138, 150, *see also* oil and grease
- fatty acids 108, 112, 121, 123, 249
- feed 33, 53
- feedwater
composition 174–175, 185, 217
pH 174, 175, 177
quality 177
temperature 174, 175, 177
- Fenton's reagent 147
- fibre, in pulping process 105, 108
- fibre membranes 28–29
- fibres (MDF) production 118–119, 244–248
- fibrous materials 66
- filamentous material 59
- fillers 102, 122
- film theory 41, 47, 173, 213
- FilmTec 19, 121, 153, 174, 182, 185
- finishing of textiles 141–143, 145, 146, 202
- Finland 6, 112, 121, 248–250
- fireproofing/flameproofing of textiles 139, 145
- Flag Fen (UK) 98, 228–231, 270–275
- flat sheet membranes 16–17, 121
- flocculation 65, 118, 125, 146, 147, 238, 245, 251, 253, 259
- Florida 98, 99
- flotation
pulp and paper industry 103, 108, 114, 118, 242, 244
textile effluent 146, 150
- flow rates
case studies 273
design examples 213–216
modelling 188–197
- Fluid Systems *see* Koch
- fluoride 170, 241, 267
- fluorinated polymers 70
- fluoroacrylic esters 139
- flux 32–33, 34, 36–37, 39, 48, 51, 121, 122, 174, 176, 271
decline 44
and particle shape 123–124
range 273
in software design 174, 176, 178, 180–181
see also critical flux
- foam balls 28
- foaming 81
- food industry 4, 6, 76, 159, 161, 209
case studies 254–261, 270–275
- forest resources 102, 248
- formaldehyde 68, 69–70, 139, 141
- formate 138, 139
- formic acid 112
- Forsell, T. and Son Ltd 250–254
- fouling 19, 20, 28, 32, 35, 52, 56–57, 59–66, 188, 230
allowance 177
in case studies 230, 231, 235
cooling and boiler feedwater 80–81, 90–93, 95
and critical flux 39–40
design example 222
food and beverage industry 256
mass transfer control 43–52
and modelling 40–41, 174, 177, 183, 185, 188
propensity 45, 60, 120, 125, 173, 175, 249, 271
pulp and paper effluent 108, 113, 115, 116, 118, 120, 121–125, 249–250
resistance 20, 21, 223
see also specific foulants
- France 6, 132, 174
- full-flow operation 33
- filling 138, 140
- functionalisation 19, 21
- fungicides 136, 147
- FYNE nanofiltration process 28
- G**
- gas separations 18, 19, 233
- gas transfer (GT) 9, 14, 16, 19
- gaseous water acidifiers 90
- gel layer formation 35, 37, 48, 122, 172
- gelatine 138, 139
- Germany
automotive industry 262–265, 270–275
bottle washing wastewater recycling 160
paper mills 102
software production 174, 200
textile industry 132
water consumption 6
- gluconic acid 69
- glue residue 105
- glycerol 138
- glycol 138
- grafting 20, 21
- Grangemouth biofouling studies 92–93
- Green Bay Packaging Inc (USA) 115
- groundwater 80, 83, 242, 243, 257–258, 259, 261
- Guadalupe power plant (Texas) 99
- gums 135, 149
- H**
- Hagen-Poiseuille equation 41, 56
- Hamburg-Harburg Technical University 200
- hardness 5, 38, 67, 81, 188, 217, 221
food and beverage industry 162, 260
pharmaceutical industry 167

power industry 81, 275
 pulp and paper industry 241, 247, 275
 textile industry 207
 heat exchange 6, 242, 244, 258, 269, 270
 heavy metals 8, 165, 253–254
 hemicelluloses 104, 108, 138
 hemodialysis 7, 14
 herbicides 17, 136
 high-purity steam 76
 high-purity water 5, 54, 166, 167, 170
 case studies 228–237, 266–269
 high-shear *see* shear enhanced processing
 holding time index 87
 hollow fibre modules 23, 28–29, 118, 150, 173,
 222, 229, 233, 256, 259, 272
 homogeneous membranes 16–17
 humic acids 21–22, 260
 Hungary 6
 Hunter Sewage Project (Australia) 232
 Hydranautics 174, 177, 182, 259
 hydraulic resistance 40, 45, 52, 67, 172, 176,
 215, *see also* membrane resistance
 hydraulic staging 54, 221
 hydrochloric acid 68, 69, 90, 137, 179, 219,
 273
 hydrofluoric acid 265
 hydrogen peroxide 70, 251, 267
 bleaching of pulp 104, 105, 108
 bleaching of textiles 137, 139–140, 241
 hydrogen sulphide 90
 hydrolysis reactions 64, 233
 hydrophilic membranes 22, 120, 249, 256,
 259, 272
 hydrophobic membranes 120, 272
 hydrophobicity 20, 21, 112, 120, 121, 123–
 124, 272
 Hydrotech 229
 hydroxides 90
 hypochlorite 68, 69, 137, 222, 230, 273. *see*
 also sodium hypochlorite

I
 immersed membrane systems 58, 59, 70, 222,
 see also submerged membrane bioreactors
 incineration 116, 117, 246
 International Microelectronics (North San Jose,
 CA) 99
 ion balance 175
 ion depletion 35, 37–38
 ion exchange 65, 90, 95, 96, 167, 231, 239,
 266, 267
 ion exchange dealkalisation 65, 160
 ion exchange membranes 10, 16–17, 19
 ion exchange resin 233
 ion exchange resin beads 32
 ionic product 61
 Ionics 22, 28, 32
 Ionpure 17, 32
 ions 5, 15, 26
 iron 58, 60, 62, 69, 81, 175, 260
 compounds 62, 69, 115, 251, 233

cooling and boiler feedwater 81, 93, 94, 96
 pulp effluent 115
 irradiation 21, *see also* UV radiation
 irrigation 2, 3, 6
 Italy 6, 132, 144, 149
 IUPAC 15

J

Japan 2, 254–257, 270–275
 Japanese Pharmacopocia (JP) 164
 jute 138

K

Kanagawa Prefecture (Japan) 254–257, 270–
 275
 kaolin 122
 KBC Process Technology Ltd 187
 Kéram module 27
 Kerasep ceramic membrane element 29
 kidney dialysis 7
 Kirkniemi (Finland) 121, 248–250, 270–275
 Koch 22, 160, 174, 177, 178, 181, 182, 218,
 230, 272
 Korea 102
 Kozeny-Carman equation 44, 51
 Kraft pulping process 104, 106–107, 109
 Kronospan Ltd (UK) 244, 247
 Kubota 11, 24, 30

L

laboratories 6, 8, 23
 Lancashire medical textile company 149
 landfill 115, 117, 238
 Langelier Saturation Index (LSI) 5, 63, 64, 185,
 219
 latex 51, 110, 150
 laundries 6, 59
 lead sulphide 62
 Legionella 90, 91
 legislation and guidelines 2, 3, 271
 cooling and boiler feedwater 93
 food and beverage industry 258, 261
 pharmaceutical industry 164–166
 pulp and paper industry 113–115, 242
 textile industry 133, 144–146, 154, 250,
 253, 271
 Lévêque solution 48–49, 50, 51
 lignins 104, 105, 106, 108, 112, 123, 244, 246
 lignosulphonates 116
 lime/lime-soda softening 65, 67, 90, 95, 96,
 251
 limiting flow rate concept 188–197
 linen 138, 139
 Linnhoff March (LM) software *see* WaterTarget[®]
 lipophilic extractives 108, 112
 Livingston (NEC Semiconductors (UK) Ltd) 265–
 269, 270, 271
 LM (Linnhoff March) software *see* WaterTarget[®]
 Lockheed-Martin Electronics operation (Ocala,
 FL) 98
 LSI *see* Langelier Saturation Index

- lubricants 135, 137, 140
Luxembourg 6
- M**
- M-Real Kirkniemi paper mill (Finland) 121, 248–250, 270–275
McKinley Paper plant (New Mexico) 118
Macrosorb 148
magnesium 83, 86, 89, 90, 94, 96, 241
magnesium salts 61, 62, 64, 89, 90, 175
make-up water 85, 87, 94, 96–98, 238–239,
 see also boiler feedwater
maltings steep water 161
manganese 62, 81, 93, 235
mass balance 33, 86, 173–174, 246
 and critical flux 39
mass transfer control 41–52
mass transfer promotion 58, 173
mass transfer theory and modelling 40–41, 188
Matlab simulation tool 200
MBRs *see* membrane bioreactors
MDF (medium density fibreboard) production
 118–119, 244–248
meat industry 76
mechanical pulping processes 102, 104, 105,
 106, 108–110, 109, 112, 114, 120
medical applications 6, 19, 149, 164, 166
melamine resins 139
membrane
 definition 14
 configurations 23–32
 manufacture 17–23
 mass transfer control 41–3
 materials 15–23, 174
 morphology 16
 permeability 40, 56–57, 66, 67, 172
 processes 7–11, 14
 resistance 15, 32, 35
 stability/integrity 20, 174, 175, 230, 234,
 264
 structure 14–17
membrane bioreactors (MBRs) 30–31, 44, 45,
 46, 47, 52, 162, 242–243, *see also* submerged
 membrane bioreactors
Memcor 10, 118, 161, 233
mercerising 138, 140, 145, 149, 202, 204, 205
mercuric salts 62
metallic catalysts 140
metallic corrosion *see* corrosion
metallic membranes 16, 24
metallic scalant 67, 68
metals industries 6, 8, 79
Metso 272
Mexico 132
microbially induced corrosion (MIC) 90
microbiological safety 83–84, 167
microelectronics industry 6, 9–10, 79, 99, 265–
 269, 270, 271
microfiltration (MF) 9, 10, 11, 14, 17, 19, 20,
 51, 60
 beverage industry 161
 boiler feedwater 10, 235
 and concentration polarisation 37
 continuous (CMF) 118
 design example 222–225
 membranes for 15, 16, 18, 19, 23–24
 municipal water treatment 33, 229–230,
 233–235
 textile process 151–154, 206
microflotation 108
microorganisms 2, 5, 65–66, 90, 91, 166, 229,
 249
microstrainers 59
mineral salts
 cooling and boiler feedwater 81, 82, 83, 86,
 88, 89–90, 95
 formation 37, 38, 61–65, 107
 rejection 19, 67, 239, 249
 see also scalants
Mitsubishi Rayon Co Ltd 272
models, for mass transfer in membrane
 processes 40–41, 172, *see also* water pinch
 analysis
modified starches 135, 136, 138
MoDo Husum sulphate pulp mill (Sweden) 117
molecular weight cut-off (MWCO) 15, 117, 153
Monsanto Prism 173
mothproofing 139
municipal effluent 2–3, 10, 31, 33, 59
 reclamation and reuse 93, 98, 228–237
 treatment of industrial water 3–4
MWCO *see* molecular weight cut-off
- N**
- N food plant (Japan) 254–257, 270–275
Nadir Filtration GmbH 122, 248, 272
nanofiltration (NF) 9, 14, 17, 20, 40, 43
 for caustic recovery 160
 ceramic membranes 18
 and concentration polarisation 37
 design software 174, 183
 dyestuff removal 151–154
 and fouling 60
 make-up and blowdown water 97
 maltings steep water 161
 membranes for 15, 16, 19, 22, 27
 potable water 21–22
 pulp and paper industry 119, 121, 249
 staging 52, 53
naphthol 139
Natal University Pollution Research Group 200
natural gas power station 237–241
natural organic matter (NOM) 21, 22, 52, 59,
 60, 65, 66, 67, 122, *see also* organic matter
NEC Semiconductors (UK) Ltd (Livingston) 265–
 269
Nernst-Planck equation 42
Netherlands 6, 241–244
New Jersey (Bergen generating facility) 98
New Logic 31
New Mexico (McKinley Paper plant) 118
NF200 membrane 121

nickel salts 62
 nitrate 96, 165, 241
 nitric acid 69
 nitrogen 96, 107, 109, 114, 204, 275
 Nitto 22
 NOM *see* natural organic matter
 Norit X-flow 259, 272
 North Carolina 149, 154
 Norway 116, 150
 Norway spruce (*Picea abies*) pulping 108
 nuclear power stations 98, 99
 Nuclepore membranes 22–23
 nutrients 65, 81, 82, 83, 91, 95, 96, 107
 nylon fibres 143
 nylon-based filter 21

O

oil and grease 134, 136, 137, 140, 146, *see also*
 fats, oil and grease
 Oklahoma University 200
 once-through cooling systems 78, 79, 93, 95,
 98
 ophthalmic products 166
 optimisation, pinch methodology 201, 206–
 209
 organic acid cleaners 69
 organic acid foulants 69, 90, 235
 organic carbon *see* TOC
 organic matter 60, 66, 67, 68, 81
 food and beverage industry 161
 microelectronics industry 266
 power industry 81, 82, 91, 95, 97, 233, 256
 pulp and paper industry 108, 121, 125
see also biological matter; natural organic
 matter (NOM)
 organic nanofiltration membranes 22
 organic polymeric media 24
 organic solvents 22, 66, 150
 organochlorine chemicals 137
 organophosphates 137
 ortho-chloromethylated polymer 21
 orthophosphates 94
 Osmonics 22, 119, 121, 153, 174, 179, 185,
 246, 251, 272
 osmotic pressure 37, 43, 54, 172, 173, 174,
 175
 oxalate 138
 oxalic acid 69
 oxidants 67, 68, 69, 104, 105
 oxidation 20–21, 91, 93, 146–148, 251, 266,
 267. *see also* chemical oxidation
 ozonation 84, 91, 104, 125, 147, 148, 149,
 206

P

PA 5011 membrane 123
 Pacific Power 232, 236
 packaging 115, 159–160, 166
 paint *see* coating materials; pigments
 Pall 21, 31, 161, 272
 Palo Verde nuclear power plant (AZ) 98

paper industry 3, 4, 105–106, 113, 241–244
 industrial water demand 4
 product types 102, 106, 108, 113, 117, 241
see also recovered paper
 Paques 272
 paraffin wax 139
 parasite-control chemicals 137
 particle bombardment 18, 22
 particle count 5, 230
 particle shape 123–124
 particle size 51
 particle transport 52. *see also* mass transfer
 Pasfrost vegetable processing plant
 (Passchendaele, Belgium) 257–261
 pasteurisers 160
 pathogen removal 97
 PCI Membranes 28, 272
 PCI Memtech 160, 161
 PECO Energy nuclear generating station
 (Pennsylvania) 99
 pectins 66, 136
 PEEK 22
 Pennsylvania, PECO Energy nuclear generating
 station 99
 pentachlorephenols 136, 138, 143
 peptic matter 138
 permanganate value (PV) 166
 permeability 15, 19, 37, *see also* membrane
 permeability
 permeate flux 174, 175, 177, 181. *see also* flux
 permeate quality 174, 181, 231
 permeate stream 33
 permselectivity 15, 16, 19, 20, 34, 177, 178
 gel layer 37
 peroxyacetic acid 70
 pervaporation (PV) 9, 14, 16, 19
 PES 50H membrane 123
 pesticides 17, 137
 PET 19, 22–23
 Peterborough (UK) 228
 petrochemical industry 76, 92–93, 98, 209
 petroleum spirit 138
 pH 5, 19–20, 22, 38, 174, 175, 273, 275
 automotive industry 264
 food and beverage industry 160, 162, 163,
 261, 275
 and fouling 58, 61, 63, 64, 69
 power industry 81, 86, 88, 90, 94, 96, 229,
 230, 239, 240, 241, 275
 pulp and paper industry 106, 112, 122, 242,
 275
 in software design 174, 175, 179, 217
 textile process effluent 134, 145, 146, 275
 pharmaceutical industry 6, 9, 61, 163–170,
 209
 phase inversion process 19
 phenols 122, 134, 139, 145, 146
 phosphates 69, 81, 86, 89, 90, 94, 267
 phosphonates 65
 phosphonocarboxylic acid 69
 phosphoric acid 69

- phosphorus 65, 90, 96, 107, 108, 109, 114, 204, 275
- photocatalysis 147
- pigments 3, 102, 105, 110, 262–265, 270. *see also* coating materials
- pinch analysis 5, 186, 187, 199. *see also* water pinch
- pinch point 189, 194
- PLA/IDE UF/MF module 25–26
- plasma treatment 20, 21
- plate-and-frame modules 23, 24–27, 245, 263, 272
- plating plant 8
- Poland 201
- polishing 9–10, 24, 98, 149, 150, 161, 167, 247, 259, 266
- pollution control 14, 93, 144–146. *see also* environmental legislation
- polyacrylates 65, 150, 151
- polyacrylonitrile (PAN) 20, 22
- polyamide membrane materials 19, 69, 162, 230, 246, 256, 259, 272
- aromatic 19, 20, 69, 175
- polyamide textiles 139
- polyaramide/polysulphone 249
- polyaryletherketone (PAEK) 22
- polycarbonate (PC) 19
- polycarboxylic acids 65
- polyelectrolytes 245
- polyester fibres 139, 143
- poly(ether ether ketone) (PEEK) 22
- poly(ether sulphone) (PES) 20, 22, 259
- polyetherimide (PEI) 20, 22
- polyethersulphone 22, 117
- polyethylene membranes 256, 272
- polyethylene terephthalate (PET) 19, 22–23
- polygalacturonic acids 108
- polyimide (PI) 22
- polymalonates 65
- polymeric dosing 90, 259
- polymeric membranes 16, 17, 19–21, 24, 28, 175
- polymeric sizing 135, 138
- polymethyl methacrylate membranes 152
- polyphosphates 64
- polypropylene (PP) 20, 206, 233
- polysaccharides 66, 106, 108, 229
- polysulphone (PSU) 20, 21, 22, 66, 116, 151, 152, 248, 249, 251, 272
- polytetrafluoroethane (PTFE) 19, 20, 22
- polyvinyl acetate 135
- polyvinyl alcohol 135, 138, 150
- poly(vinylidene fluoride) (PVDF) 19, 20, 22, 153, 229, 242, 272
- polyvinylpyrrolidone (PVP) 259, 272
- pore blocking 35, 45, 56
- pore flow models 42, 43
- pore size 15, 16, 18, 272
- porous membranes 15, 16, 17, 19, 22, 24
- Portugal 200
- Posidyne nylon-based filter 21
- potable water 143, 144, 166, 266
- reserves 77
- treatment 21, 166
- potassium 83, 170, 241
- power industry 4, 76–101
- case studies 228–241, 270, 275
- legislation and guidelines 3, 6, 93
- see also* boiler feedwater: cooling systems
- PP (polypropylene) 20, 206, 233
- pre-sterilisation 66
- precipitation 146–148
- precoagulation 59
- predictive models for mass transfer 40–41
- pressing process 19
- pressure decay tests 230, 234
- pressure-driven processes 16, 38–39, 48, 49, 55–57, 60, 61
- pressure-sealed modules 24–26
- pretreatment 52, 59–60, 65, 66, 67, 175, 185, 271
- cooling and boiler feedwater 80, 90, 228–229, 238
- food and beverage industry 162, 255
- software design 175, 179–180, 219–220
- textile processes 146, 202, 251
- wood and pulp effluent 116, 118–119, 125, 245–246
- printing, of textiles 135, 145, 202, 204, 206
- printing ink 105, 113, 119
- process design and operation 52–70, 176–178
- process performance, definitions 32–34
- process water quality requirements 6
- proteins 17, 20, 44, 47, 66, 69
- PTFE 19, 20, 22
- pulp and paper industry 3, 4, 102–131
- case studies 241–250, 270–275
- pulping process 104, 106–107
- pulsed flow 32, 58
- purified water (PW) 5, 6, 7, 165–170
- purity 7, 24. *see also* water for injection: water quality
- PVDF *see* poly(vinylidene fluoride)
- PVP 259, 272
- pyrogens 5, 9, 69
- Q**
- quaternary ammonium compounds (QAC) 69, 70
- R**
- Raytheon Corporation (St Petersburg, FL) 99
- recirculating systems 78–79, 85–90, 93, 95, 98, 99
- reclamation and reuse 2–4, 95, 269–271
- microelectronics industry 265–269
- power industry 77–84, 91, 93, 95–100, 228–237
- textile industry 148, 149
- see also* recycling
- recovered paper (RCF) 102, 104–105, 111, 113, 114

- recovery 2, 31, 33, 53, 181. *see also* reclamation and reuse
- recycling 2–3, 191, 194, 195
 food and beverage industry 159–163, 254–261
 microelectronics industry 265–269
 pharmaceutical industry 163, 166–167, 168–170
 plating plants 8
 pulp and paper industry 114, 115, 119, 241–244, 248–250
 textile industry 132–133, 146–154, 204–209, 250–254
see also closed-loop recycling; municipal effluent; reclamation and reuse
- rejection 34
- resin factory 8
- resin removal 115, 125, 266, 267
- resins
 pulp and paper processes 108, 112, 115, 121, 123, 125, 244, 245, 246
 textile processes 141, 145
- resistance of interfacial region 35–36, 43–45.
see also cake layer
- resistance of membrane *see* membrane resistance
- resistivity 5, 266, 269, 275
- retentate stream 33, 53, 176
- retention aids 108, 122, 125
- reuse 2–3, 200, 269–271
 of heat 241–244
see also municipal effluent; reclamation and reuse
- reverse osmosis (RO) 9, 14, 15–17, 19, 20, 34
 cleaning tanks 70
 computer-aided design for plant 172–186
 and concentration polarisation 37
 design examples 213–220, 222
 double-pass 166
 energy demand 55–56
 food and beverage industry 160, 161, 162, 256, 257, 259, 260
 and fouling 55, 56, 66, 162
 high temperature 161
 leaky RO 16
 make-up and blowdown water 97
 membranes for 15–17, 19
 pharmaceutical industry 165, 167, 169
 pulp and paper industry 115, 118–119, 245–248
 and scaling 60, 61, 64, 65
 semiconductor industry 266, 268
 software 61, 172–186, 217–220, 222
 staging 52–54
 substrates 20
 textile effluent 148, 150–154, 206, 208, 251–254
- Reynolds number (Re) 48, 58, 214
- Rhodia-Orelis 25–26, 29, 263, 272
- risk analysis 2–3
 municipal reuse 2–3
- Rochem reverse osmosis module 24, 26
- Rodata software 174
- ROdesign software 174, 177, 185
- ROPRO software 174, 175, 177, 178, 181, 218
- Ropur 174
- ROSA software 174, 182, 185
- Rottneros Board Svaneholm (Sweden) 117
- RWTH Aachen 174
- Ryznar Stability Index (RSI) 63–64
- Rzeszów University of Technology (Poland) 201
- S**
- Saarland University (Germany) 174
- saturation pH 63
- scalants and scaling indices 35, 37–38, 58, 61–65, 115, 174, 175. *see also* specific scalants
- scale formation propensity 61–64, 90, 173, 175, 176, 181
- scale prevention 62, 64–65, 181, 239
 in cooling and boiler feedwater 80, 82, 85, 86, 87, 88, 89–90, 95, 96, 233
- Schmid number (Sc) 48, 214
- scouring 136–137, 138, 140, 146, 150, 202
- screens 59, 229, 233, 251, 258
- SDI (Silt Density Index) 5, 6, 60, 229, 233
- seawater 80, 82, 83
 desalination 9, 54, 178
- SelRO 22
- semiconductor industry 6, 9–10, 265–269, 270, 271
- sensitivity analysis 193
- Severn Trent Water 146, 250
- sewage treatment 2, 3–4. *see also* municipal effluent
- shear rate 49, 51, 121
- shear-enhanced processing 31–32, 58, 119–120, 121, 125
- shear-induced diffusion 50, 51–52
- Sherwood number (Sh) 48, 213–214
- sieving 15, 40
- silica 5, 17, 52, 59, 65, 67, 68, 69, 162, 275
 cooling and boiler feedwater 81, 86, 89, 94, 96, 229, 247, 275
 pulp effluent 115
- silicon carbide substrate 30
- silicon waste recycling 265
- silicone resins 139
- silk 138, 149
- silt 59
- Silt Density Index (SDI) 5, 6, 60, 229, 233
- silver salts 62
- Singapore oil refinery 98
- singeing 135, 202
- single pass with recycle 176
- sintering 18, 19
- sizes 105, 135, 136, 137, 150. *see also* desizing
- soap industry 4
- soaps 69, 136, 140, 148–149
- sodium 83, 170, 229, 241, 275
- sodium bisulphite 137
- sodium carbonate 136, 140, 149

- sodium chloride 172, 204, 232, *see also*
desalination
- sodium hexametaphosphate (Calgon) 64–65
- sodium hydroxide 106, 253, 273
- sodium hypochlorite 69, 137, 233, 273, *see also*
hypochlorite
- sodium hyposulphate 68
- sodium sulphide 106
- sodium thiosulphate 65, 104
- softening 5, 60, 65, 67, 96, 167, 254, 261, *see also*
lime
- software
designs for RO 61, 172–186, 217–220, 222
water pinch analysis 186–212
- sol-gel processes 18, 19
- solubility 61, 62, 90, 173, 175, 188
- solution-diffusion model 40–41, 42–43, 172
- solvents 22, 66, 139, 150
- Somicon 22
- sonic tests 234
- sorption-capillary flow 41
- South Africa 147, 150, 154, 200
- South Wigston (UK) 250–254, 270–275
- spacers 58, 173
- Spain 6
- SPEEK *see* sulphonated poly(ether ether ketone)
- SPEES *see* sulphonated poly(ether ether sulphone)
- spiral-wound membranes 27–28, 60
food and beverage industry 256, 259
power industry 230, 234, 272
pulp and paper industry 119, 121, 249, 272
textile industry 252, 272
- staging 52–54, 176, 178, 221
- stagnant region 46–47, 50, *see also* boundary
layer
- starches 66, 122, 135, 136, 138, 146, 148, *see also*
sizes
- statutory requirements, 3, *see also* legislation
- steam raising 6, *see also* boiler feedwater
- steam sterilisation 70
- steam in textile manufacture 204
- stearates 139
- steel 93, 151
- sterilisation 19, 66, 259, 268
- sterols 123
- steryl esters 123
- sticky residues in recovered paper 105, 113
- Stiff and Davis Index 64
- Stokes-Einstein equation 48
- Stora Kabel 117
- StoraEnso Uetersen 117
- streptococci 233
- stretching (extrusion) 18, 19
- strontium 64, 175
- submerged membrane bioreactors (SMBR) 10,
11, 24, 30–31, 46, 58, 59, 150, 255–256, *see also*
immersed membrane systems
- substrates 20, 30
- sugars 17, 108, 112, 116, 121, 249
- suint 138
- sulphate 64, 65, 67, 83, 175, 275
cooling and boiler feedwater 81, 86, 89, 90,
94, 241, 247, 275
pulp effluent 115, 275
semiconductor industry 267
- sulphate pulping process 104, 105, 117
- sulphides 134, 145, 146, 175
- sulphite pulping process 104, 105, 109, 115,
116, 125
- sulphonated poly(ether ether ketone) *see* SPEEK
22
- sulphonated poly(ether ether sulphone) *see*
SPEES 22
- sulphur dioxide acidifier 90
- sulphuric acid 69, 90, 105, 137, 140, 179, 233,
251, 267
- supported liquid membranes (SLMs) 18–19
- surfactants 68, 69, 136, 137, 150, 242, 273
- suspended solids 60, 67
food and beverage industry 256–257, 275
microelectronics industry 266
power industry 229, 233, 249, 275
pulp and paper industry 110, 112, 114, 117,
244, 275
textile industry 150, 202, 204, 206, 253
see also TSS
- Swansea (University of Wales) 174
- Sweden 6, 117
- synthetic textiles 135, 138, 140
- T**
- Taio Paper Co. 116
- talca 123–124
- TAMI 27
- Tampa waste-to-energy facility (Florida) 98
- tartrate 139
- TDS 5, 175, 217, 219–220, 222
food and beverage industry 160, 162, 275
power industry 231, 233, 240–241, 275
pulp and paper industry 275
textile industry 134, 253, 275
see also dissolved solids
- Teflon Tynar (Tetratec) membrane 123–124
- temperature 87, 94, 204, 273
- Texas (Guadalupe power plant) 99
- Texas Utilities (TXU) 228
- textile industry 132–158
dye/water recycling case study 250–
254, 270–275
water pinch case study 201–209
- TFC *see* thin-film composite (TFC) layer
- thermomechanical pulping (TMP) 104, 108,
109
- thin-film composite (TFC) layer 16, 19, 69
- thiosulphate 65, 104
- threshold inhibitors 67, 173
- titanates 139
- titanium 30
- titanium 18
- titanium dioxide microfiltration membrane 153,
154

- TOC 5, 175, 183
 microelectronics industry 266, 267
 pharmaceutical industry 165, 166, 170
 power industry 94, 229, 241, 275
 textile industry 134, 148
- Toray 174, 256
- toxics 95, 136, 137, 140, 143, 165, 170
- track-etched polymers 19, 22–23
- transmembrane pressure (TMP) 34, 36, 41, 42, 48, 173–174, 176, 215
 automotive plant 263, 273
 food industry 273
 power industry 234, 256, 273
 pulp and paper industry 242, 246, 249, 273
- trihalomethanes 59
- Triqua BV 272
- TriSep 174
- TSS 5, 275
 cooling and boiler feedwater 81, 95
 pulp and paper industry 109, 113, 114, 275
 reclaimed water 81, 95, 230–231
 textile processes 134, 135, 136, 145, 146, 204, 275
see also suspended solids
- tubular modules 23, 28, 115–116, 118, 121, 125, 242, 272
- turbidity 5, 81, 235, 275
- turbulence, and biofilm thickness 65
- turbulence promotion 23, 24, 28, 30–32, 37, 58, 173
- twin pass system 54, 176
- U**
- UJK 4–5, 6, 9
 automotive industry 264–265
 Flag Fen high-purity water production plant 98, 228–231
 food and beverage industry 161, 162
 Kronospan Ltd 244
 pharmaceutical industry 168, 169
 pulp and paper industry 111–112, 244–248
 RO software 174
 semiconductor industry 265–269, 270, 271
 textile industry 132, 146, 150, 250–254
- ultrafiltration (UF) 9, 14, 17, 19, 20, 33, 60, 67
 automotive industry 262–265
 and concentration polarisation 37
 food and beverage industry 161, 162, 259, 260, 261
 make-up and blowdown water 97
 membranes for 15, 16, 17, 18, 19, 22, 24
 pharmaceutical industry 166
 in pulp and paper industry 115–118, 125, 248–250
 semiconductor industry 266
 textile process 150–154, 204–205, 206
 and VSEP filter 121
- ultrapure water 5, 6, 9–10, 266, 269
- UMIST (Department of Process Integration) 187, 199–200, *see also* Water (UMIST software)
- urea 139
- USA 2, 3, 229
 pharmaceutical industry 164, 166, 168
 Pharmacopocia (USP) 164, 166
 power industry 91, 93, 98, 99, 237–241
 pulp and paper industry 102, 104, 115, 118
 textile industry 132, 133, 144–145, 149, 154
- UV (ultraviolet) processes 66, 67, 84, 160, 251, 266, 267–268
- V**
- Valmet-Flootek CR filter 31–32, 116–117
- vanillin 116
- van't Hoff equation 37, 43, 172, 173
- vapour compression evaporation 237–241
- VHP security paper mill (Netherlands) 241–244
- Vibrating Membrane Filter (VMF) 31, 32, 161
- Vibratory Shear Enhanced Processing *see* VSEP
- vinyl 21
- viruses 17, 91, 233, 235
- viscose 138, 139, 143
- Visual Basic-based software 183–184, 200
- Vito 184
- Vivendi 10, 272
- Vivendi Ionpure 32
- Vivendi Memcor 118, 161
- VMF (Vibrating Membrane Filter) 31, 32, 161
- vortex flow 32, 58
- VSEP (Vibratory Shear Enhanced Processing) 31, 32, 119–120, 121, 123, 124
- W**
- Wado[®] software 200
- Water (UMIST software) 187, 193, 194, 195, 198, 199
 water auditing 8, 148, 232
 water balance 173–174, 187
 Water Close[®] (software) 198
 Water Factory 21 plant (Orange County, CA) 3, 229
 water for injection (WFI) 9, 165–170
 water management 5–7, 8
 water pinch analysis 5, 148, 186, 212
 textile process case study 201–209
 water quality 6–7, 80–84, 95, 164–167, *see also* legislation and guidelines
 water saving 192–195
 water shortages 77
 water splitting 38
 WaterDesign software 200
 waterproofing 139, 145
 WaterTarget[®] software 187, 191–199, 201
 waxes 135, 136, 137, 138
 white liquor 106
 white water (circulation water) 108–110, 114, 116, 117, 120, 248, 249
 Wigan dyehouse (UK) 149
 Wigston sewage treatment works 146
 WinCarol software 174
 WinFlows software 174, 179, 185

wood 104, 122
wood plant effluent 118–119
wool 137, 138, 139, 140, 143, 146, 150

Y

Yokosuka (Japan) 254–257

Z

Zenon 30
zeolite 148
zero liquid discharge (ZLD) 3, 8, 76–77, 95,
118, 271
 case studies 237–241, 244–248, 265, 269,
 271
zinc 62, 253
zirconium 18, 30, 151

There are increasing environmental and political pressures on industry to clean up the water which it uses in many processes and to re-use this water where possible. The development of specialised membranes has meant that such recycling and re-use is now possible in several industries.

In 'Membranes for Industrial Wastewater Recovery and Re-use' the editors have assembled a group of specialist contributors to produce a comprehensive account of membrane technology, industrial water quality, commercial membrane systems and case study examples, together making the definitive book on this topic.

This book will be an important source for engineers/chemical engineers responsible for the use and recycling of water within plant, membrane designers and manufacturers for industry, plus end-users of membranes in the water, food, beverage, pharmaceutical, oil, textile, pulp and paper industries.

ALSO OF INTEREST:

Schaefer, A.I., Fane, A.G. and Waite, T.D., 2003.
Nanofiltration: Principles and Applications. ISBN: 1856174050

Purchas, D., and Sutherland, K., 2002.
Handbook of Filter Media 2nd Edn.
ISBN: 1856173755

Membrane Technology. A newsletter covering all aspects of the international membrane industry. ISSN: 09582118

ISBN 1 85617 389 5

ISBN 1-85617-389-5



9 781856 173896 >