

SCALAR WAVE TECHNOLOGY

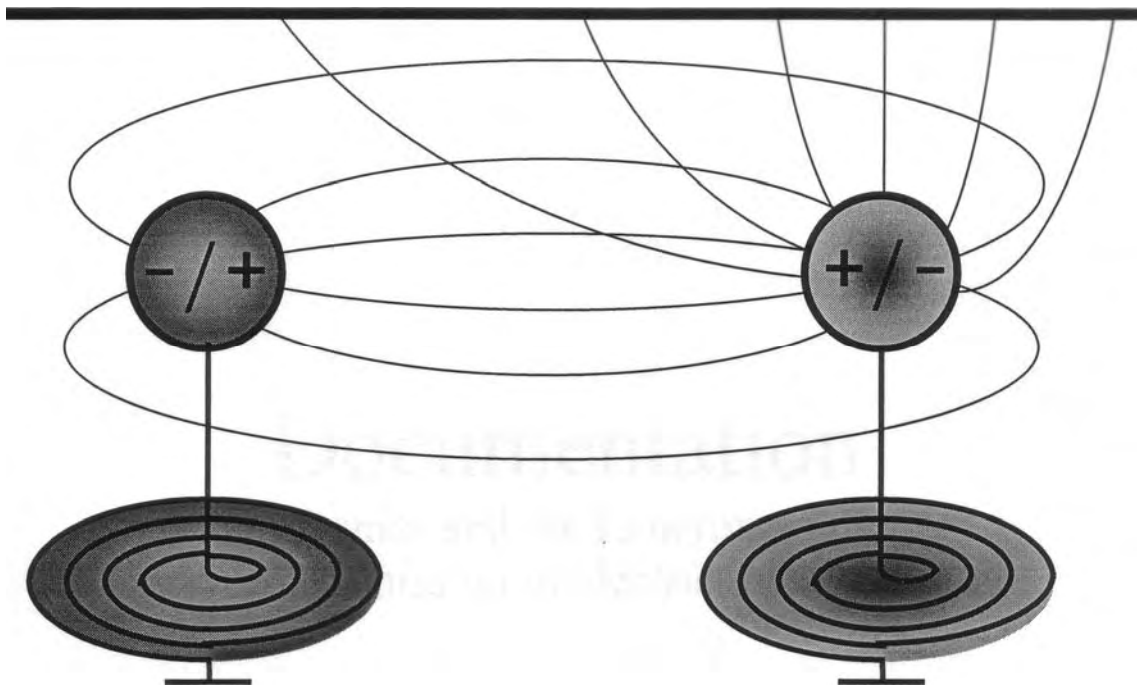

Documentation

for the Experimental-Kit
to the transmission of electrical scalar waves



Preface for the documentation

When the speech is about "free energy", if efficiencies over one hundred per cent are promised or inventors show up with perfect structural drawings for a Perpetuum mobile, then doubts are justified. All too often incorrect power measurements mislead or an energy resource is unnoticed along-used. Responsible scientists accept therefore appropriate statements only after own examination, and if they can reproduce the measurements at any time personally with their familiar measuring instruments. For this circumstance the Demo- and the Experimentation kit should make allowance.

All doubter can and should reproduce my experiments. They should not experience from the media of any results, but rather gain the experiences with the electrical scalar wave transmission by themselves. Tesla already accomplished the same experiments one hundred years before with very high voltages and with steered spark gaps. Since more energy at the receiver arrived than the transmitter had delivered already at that time, Tesla called the transmitter „Magnifying transmitter". Unfortunately his plant in Colorado Springs was too complex and too expensive, than that any university could afford it at that time. The results of the measurements remained unconfirmed as consequence.

No scientist in the world is entitled to doubt the results won by Tesla as if he has repeated them 1:1 and is able to prove the opposite. That was been omitted down to the present day. The negative proof will be not possible at all, and ignorance is not a recognized science methodology!

1. Notes to the demo kit

The experiment for scalar wave transmission can be purchased as demonstration kit or in an extended version as experimentation kit. The notes to the demo kit are applicable for both versions. With the kit all statements of Tesla can be examined. Owing to modern technical aids, the expenditure could have been reduced substantially. Today everything fits into a suitcase.

Numerous parameters determine function and periodic resonance of the scalar transmission, like wire length, wire thickness, isolation, direction of winding and diameter of the coils. Only with identically parameters a perfect reproducibility of the results can be ensured. Due to this insight I forbear from the publication of a tinkering guidance, since the reproducibility would be dependent on the skill of the respective home constructor. The reliability would suffer from it. Finally it concerns the discovery and proof of a new physical principle, and not extra tuition for physical laymen.

In the aluminium suit case all accessories in addition to the pancake coils are contained, which are necessary for operation. That does not only have a practical sense. If an operator wants to abandon the waveform generator for example, because he an appropriate waveform generator already in his laboratory, which works up to 20 MHz, it is not guaranteed that this one is able to supply a sufficient current. The experiences of individuals are comprehensible, if all experimenters use the same generator.

Each buyer of a scalar wave transmission kit, who sends a test log to the publishing house, gets the protocols of other experimenters in return for his effort. Interested owner of a kit can order these protocols extra. To ensure that additional deliveries are possible, the delivery takes place in a binder.

To all, who want to deliver test logs. I have the request to arrange these as unitary as possible. They will be revised by publishing house, if the case may be. They are to be brief containing all essential facts, so that each reader is able to reconstruct the experiment with his kit. The number of possible experiments is almost unlimited. It concerns a new, still extensively unexplored kind of wave propagation, so that there is still much to discover. What worth is a discovery, from which only the discoverer knows something?

The publishing house has made it to its business, to spread each important discovery or experience with personal denomination of the experimenter in written form. Protocols are delivered in chronological order according to the time of the post office entrance by the publishing house. They can be rearranged thematically, e.g. by technical, physical or biologically relevant characteristics of the used scalar waves.

2. Notes to the experimentation kit

The experimentation kit contains additionally a frequency counter as well as four further pancake coils with double or half wire length. The waveform generator is besides in an extended range and in different wave forms adjustable. It is assumed, that primarily physicists, engineers and in the measuring technique experienced persons will be interested in the experimentation kit. They can reconstruct naturally with their kit all experiments of the demo set and receive also the same documentation. Furthermore the set offers all adjustment possibilities, which are familiar to them from other laboratory instruments. For instrumentation interferences, in order to be able to measure for example current and voltage, specially monitoring sockets are equipped.

The demo kit has no such measuring comfort. It is also suitable for operators, who are inexperienced in instrumentation. Among the buyers are physicians, lawyers, therapists, environmentalists, teachers, politicians and journalists. In short, it is meant for everyone, who wants to convince himself or others of the existence of electrical scalar waves. Therefore the waveform generator is limited in range of adjustment and a pure sine form is predetermined.

It is assumed, that the set is purchased primarily for own study and demonstration purposes. Nevertheless some experiments are conceivable, which go beyond the given repertoire to study biological reactions or medical influences for example. For customers, for whom the demo kit should not be sufficient any longer, the publishing house offers to extend the kit to an experimentation set. In this case the suit case with the complete kit must be sent back to the publishing house with all documents. The printed circuit boards are refitted by hand and the control panel of the waveform generator is extended, additionally to the frequency counter and the four decks, cables etc.. The coils with the spherical electrodes can be ordered individually, if necessary.

3. Aspects of the experimental research

Whom the fever of research has infected, will anyway continue to build and tinker own devices and wound coils, until he knows everything, what his spirit of research wants to know. My set will be able to give only the initial start-up to them. With them and with all experimenters I wish myself a constructional and close co-operation. Only if all forces, interested in progress, pull in one direction, the ignorance against one hundred years old historical facts and the arrogance of the established sciences will be overcome with the worthwhile goal of the entrance into an environmental compatible scalar wave technology.

A physical proof is only complete if the result of a theoretical derivation could experience its confirmation by the results of practical measurements. For the measured values in individual cases surely any auxiliary explanations would be possible, if each experiment is regarded individually, and some one is satisfied at that point already. The interpretation of the near field is such an auxiliary explanation for example, which is answered by the fact, that the experiment still operates with the tenfold near field distance.

The large coherence remains hidden when working with auxiliary explanations. Therefore a theory is necessary, which includes all aspects of scalar waves and shows all characteristics correctly and completely.

Such a field theory did not exist, because I was forced to look for a suitable.

4. Aspects of an appropriate vortex physics

A most important new component of the field description is the vortex of the electrical field discovered by me 1990, which I, according to the fluid mechanic, called „potential vortex" ^{<i>}. These field vortexes are able to carry an impulse. They will spread in space as longitudinal shock wave and will possess all characteristics of a scalar wave. From the point of view of my books the available documentation forms an instrumentation addition. Reciprocal, my books can be surely a large assistance for the experimenter.

The fundamentals of vortex physics, as they are published in no textbook, are to be found in the 1. part of my book series „electromagnetic environmental compatibility". It deals with the „casuals, phenomena and scientific consequences" of potential vortexes of the electrical field ^{<ii>}.

<i>: K. Meyl: Potentialwirbel Band 1, INDEL Verlagsabteilung Villingen-Schwenningen, 1. Auflage 1990, ISBN 3-9802 542-1-6

<ii>: K. Meyl: Elektromagnetische Umweltvertraglichkeit, Teil 1: Ursachen, Phänomene und naturwissenschaftliche Konsequenzen, Vorlesungsumdruck. INDEL Verlagsabteilung Villingen-Schwenningen. 1996. 3.Aufl. 1998,

The second part of the book series affiliate to this book and carries the subtitle: "free energy and the reciprocal effect of the neutrinos". It concerns with priority the energetic aspect of scalar waves, constructional details, as like as questions around a practical utilization^{<i>}. The function mode of the pancake coil already addressed in the first part is went through with a fine-tooth comb in the second part. The field theory from the first part is developed further likewise and brought in relationship with existing constructions.

5. About the setting up of the documentation

The derivation of the scalar wave from the wave equation with the discussion of the characteristics and the consequences of information techniques, substantial to understand the experiment, is only in the third part of the book series „Electromagnetic Environmental Compatibility“^{<ii>}. For the English-language area are the three volumes of „Electromagnetic Environmental Compatibility" published as a book with the title „Scalar waves" ^{<iii>}.

Naturally the core of the documentation are the guidance's to the experiments, which are to be regarded at the same time as samples for further test logs.

For the execution of the experiments I may wish you still much success and a quite good degree of efficiency.

Villingen Schwenningen in June 2000

- <i>: K. Meyl: Elektromagnetische Umweltvertraglichkeit, Teil 2: Freie Energie und die Wechselwirkung der Neutrinos. Umdruck zum energietechnischen Seminar. INDEL Verlagsabteilung 1998. 3. erweiterte Auflage 1999
- <ii>: K. Meyl: Elektromagnetische Umweltvertraglichkeit, Teil 3: Skalanwellen und die informationstechnische Nutzung. Umdruck zum informationstechnischen Seminar. INDEL Verlagsabteilung 1. Auflage 2002, ISBN 3-9802542-7-5
- <iii>: K. Meyl: Scalar Waves: From an extended vortex and field theory to a technical, biological and historical use of longitudinal waves. Edition belonging to the seminar (part 1 - 3) "Electromagnetic Environmental compatibility". INDEL publishing house department 1st edition (2003), 654 pages ISBN 3-9802 542-4-0

6. Table of Content

Chapter

V.	Preface for the documentation.....	III
V.1	Notes to the demo kit	III
V.2	Notes to the experimentation kit	IV
V.3	Aspects of the experimental research	IV
V.4	Aspects of an appropriate vortex physics	V
V.5	About the setting up of the documentation	VI
V.6	Table of Content	VII
	Experiments for scalar wave transmission	1
0.1	Introduction	1
0-2	Included in delivery: Demo-kit	1
0.3	Description of the pancake coils	2
0.4	Description of the waveform generator (Demo-kit)	4
0.5	Included in delivery: experimentation kit	5
0.6	Description of the waveform generator (experimentation kit version).....	5
0.7	Description of the frequency counter (experimentation kit)	6
0.8	Safety instructions	6
1.	Experiment: Transfer of energy	7
1.1	Experimentator	7
1.2	Place and date	7
1.3	To the status of physics of electromagnetic waves (according to Hertz).....	7
1.4	Expectation according to the scalar wave theory by Konstantin Meyl	7
1.5	Experimental setup.....	7
1.6	Carrying out the experiment	8
1.7	Interpretation of the experimental results	9
1.8	Conclusion	10
1.9	Consequences	10
1.10	Utilities	10
2.	Experiment: Feedback	11
2.1	Experimentator	11
2.2	Place and date	11
2.3	To the status of physics of electromagnetic waves (according to Hertz).....	11
2.4	Expectation according to the scalar wave theory by Konstantin Meyl	11
2.5	Experimental setup	11
2.6	Carrying out the experiment	11
2.7	Interpretation of the experimental results	11
2.8	Conclusion.....	12
2.9	Consequences	12
2.10	Utilities	12
3.	Experiment: Proof of free energy	
3.1	Experimentator.....	
3.2	Place and date	13
3.3	To the status of physics of electromagnetic waves (according to Hertz).....	13
3.4	Expectation according to the scalar wave theory by Konstantin Meyl	13

3.5	Experimental setup and carrying out the experiment.....	13
3.6	Interpretation of the experimental results.....	13
3.7	High frequency measurements	14
3.8	Interpretation of the high frequency' measurements.....	14
3.9	Circuit analyzer measurements.....	14
3.10	Interpretation of test results of the DC measurements.....	15
3.11	Conclusion.....	15
3.12	Consequences	16
3.13	Utilities	16
4.	Experiment: Superluminal velocity.....	17
4.1	Experimentator	17
4.2	Place and date	17
4.3	To the status of physics of electromagnetic waves (according to Hertz)	17
4.4	Expectation according to the scalar wave theory by Konstantin Meyl.....	17
4.5	Experimental setup	17
4.6	Carrying out the experiment.....	17
4.7	Interpretation of the experimental results.....	18
4.8	Conclusion	18
4.9	Consequences	18
4.10	Utilities.....	18
5.	Experiment: Ineffective Faraday cage	19
5.1	Experimentator.....	19
5.2	Place and date	19
5.3	To the status of physics of electromagnetic waves (according to Hertz).....	19
5.4	Expectation according to the scalar wave theory by Konstantin Meyl.....	19
5.5	Experimental setup	19
5.6	Carrying out the experiment	21
5.7	Interpretation of the experimental results.....	21
5.8	Conclusion	21
5.9	Consequences.....	21
5.10	Utilities.....	22
6.	Experiment: Refutation of the near field interpretation	23
6.1	Experimentator	23
6.2	Place and date	23
6.3	To the status of physics of electromagnetic waves (according to Hertz).....	23
6.4	Expectation according to the scalar wave theory by Konstantin Meyl	23
6.5	Experimental setup	23
6.6	Carrying out the experiment	23
6.7	Interpretation of the experimental results.....	23
6.8	Conclusion.....	23
6.9	Consequences.....	24
6.10	Utilities.....	24
7.	Experiments with the experimentation kit.....	25

Experiments for scalar wave transmission

0.1 Introduction

The wireless transfer of energy as scalar wave radiation goes back on Nikola Tesla. From him originated the patent No. 649.621 on 15.5.1900: Apparatus for transmission of Electrical Energy. Unfortunately his equipment was extremely large and expensive, so that no copies had been provided and the ingenious technology could extract itself from the field of vision and the consciousness of the public. Many sceptics however are to be convinced only, if they have their own copy, at which they personally can make measurements and experiments. A new technology will only become public and can assert itself if it is carried beyond the scientific facilities and education centres into the public.

The lost believed technology is taken up again with the kit. By using a modern waveform generator in place of a spark gap generator, with an operating voltage of few volts in stead of 600 kilovolts a miniaturization of the device succeeded, at which all characteristics indicated by Tesla and still some more can be introduced and examined experimentally. Today, nearly 100 years later a scalar wave transmission device fits into a suitcase and is purchasable for everyone.

All assembly groups and component parts necessary for the experiments are included in delivery, as well as the aluminium suitcase, which is used as shielding cage. Thus a high degree of reproducibility is guaranteed. The demo kit is particularly suitable for non-technicians to open them the possibility of a successful execution of the experiment. For technicians and hobbyists a more extensive experimentation kit is offered. It is particularly important for comparison purposes that everyone does work with the same generator, because the empiric reports will be published in an anthology, which should encourage other experimentators to reproduce some of them.

0.2 Included in delivery: Demo-kit

- 1 waveform generator (preset)
- 2 Tesla-pancake coils
- 2 spherical electrodes with connecting lead and plastic columns
- 1 connecting cable with pin plugs on both sides
- 1 wall power supply (18V, 500mA) with connector plug
- 2 shorting plugs
- 1 documentation

0.3 Description of the pancake coils

The pancake coil which is spiral from the inside outward wound according to Tesla, is part of an air cored transformer. The couple coil consists of five turns and is on the lower surface of the plate. It can be modified, if necessary, whereby a abbreviation to 4 turns is possible, which can lead to a stronger accentuation of the scalar wave components (fig. 1).

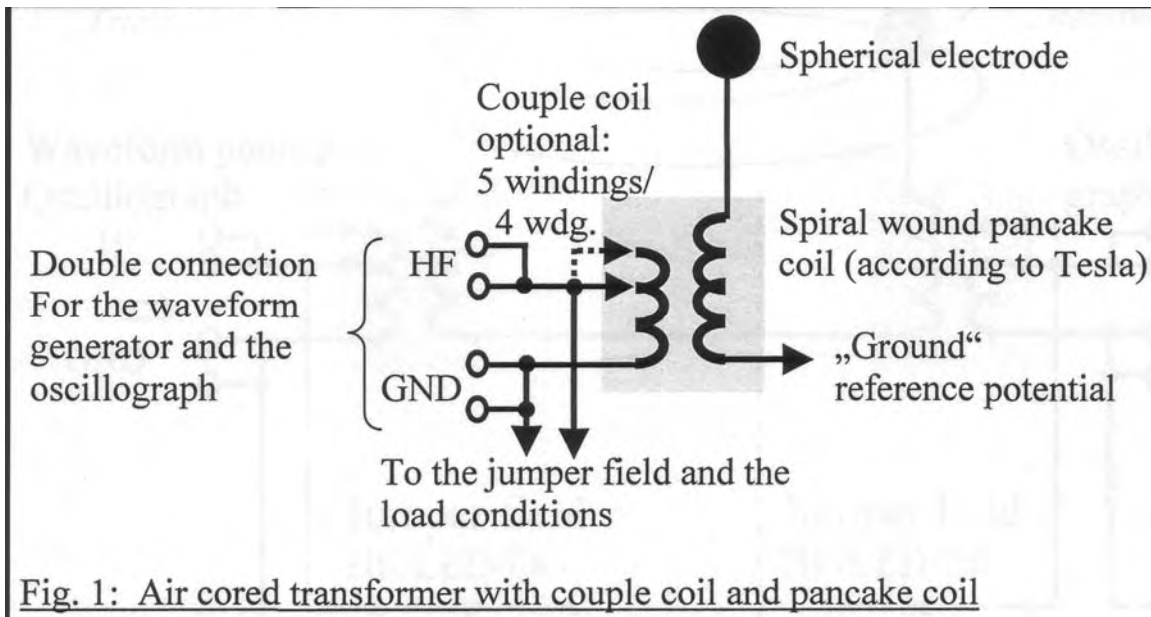

Fig. 1: Air cored transformer with couple coil and pancake coil

The two ends of the coil are connected with the sockets "Generator". On the transmitter side the signal is injected, while on the receiver side an unloaded no-load operation measurement can be made if no jumper is set.

Within the jumper field three different load conditions are selectable.

1. "LED" the two light emitting diodes are fed, which are antiparallely switched, so that one shows the positive half wave and the other the negative half wave of the supply voltage.
2. "HF" the couple coil is loaded with a 100 ohm resistance. At the sockets "HF Messung" the potential gradient over the resistance can be looked at with an oscillograph.
3. "DC" the high frequency signal first becomes rectified in a bridge rectifier and abraded in two condensers (100 nF and 4.7 uF). The load resistance is here 100 ohms. The voltage signal exhibits no more ripple, therefore it is possible in this jumper position to measure conventional with a usual DC voltage circuit analyzer (in position DC). On the topside of the plate is the spiral wound pancake coil. The inner pin is connected with the spherical electrode, and the outside end ("grounding") serves as potential equalization between transmitter and receiver. It forms a common reference potential, which is usually called ground.

Scalar wave transmission with two identical pancake coils:

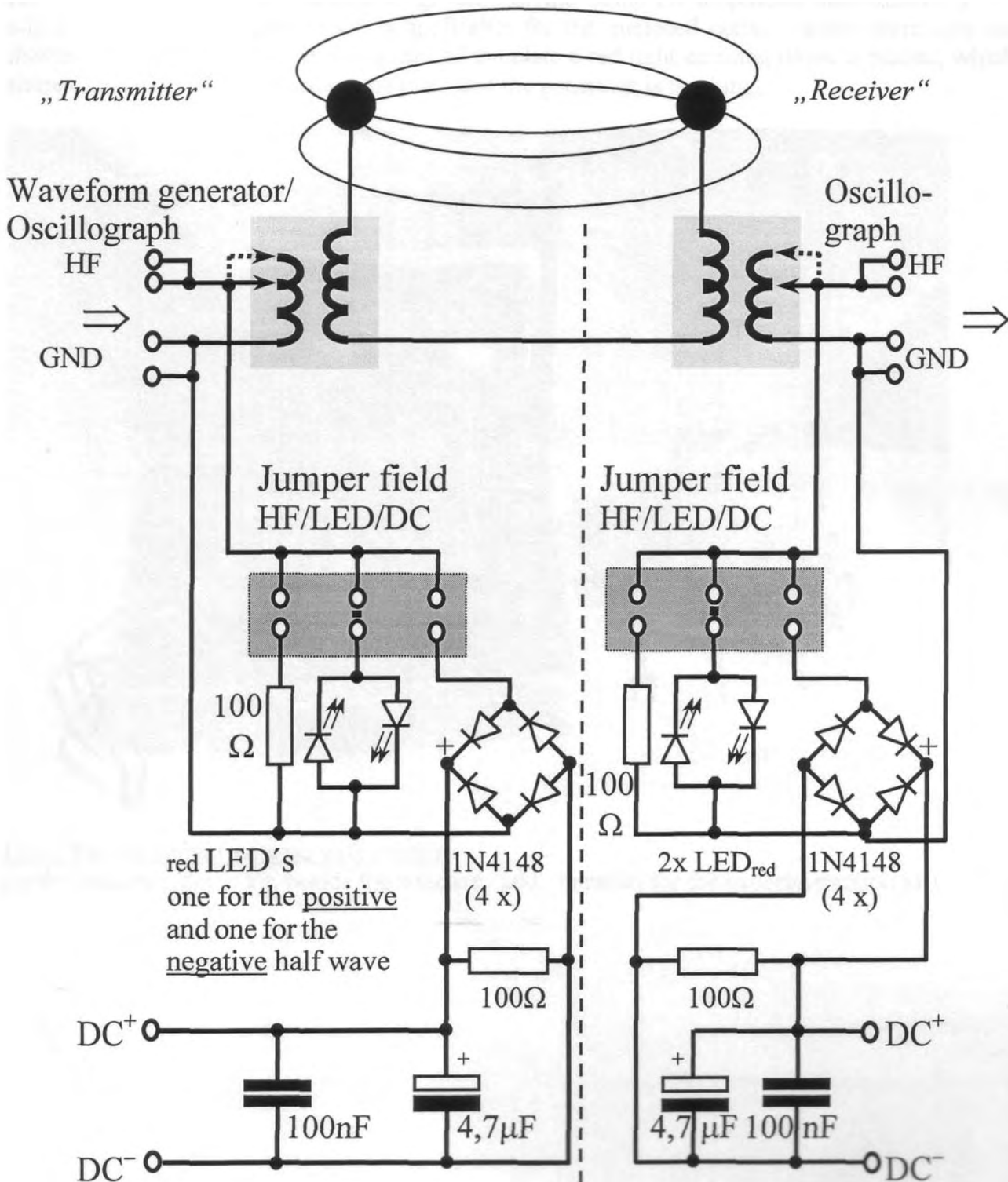

Circuit analyzer connection: Transmitter voltage and/or Receiver voltage

Fig. 2: Connection diagram of the pancake coils - air cored transformers

0.4 Description of the waveform generator

The circuit board of the demo-kit is only partly equipped and the waveform generator preset. As wave form the sine function is given. In the demo-kit amplitude and frequency are adjustable within a range, which is applicable for the enclosed coils. Faulty operations are thereby nearly impossible. In the centre of the plate a red light emitting diode is placed, which shines, if voltage is impressed on the plate and the generator is working.

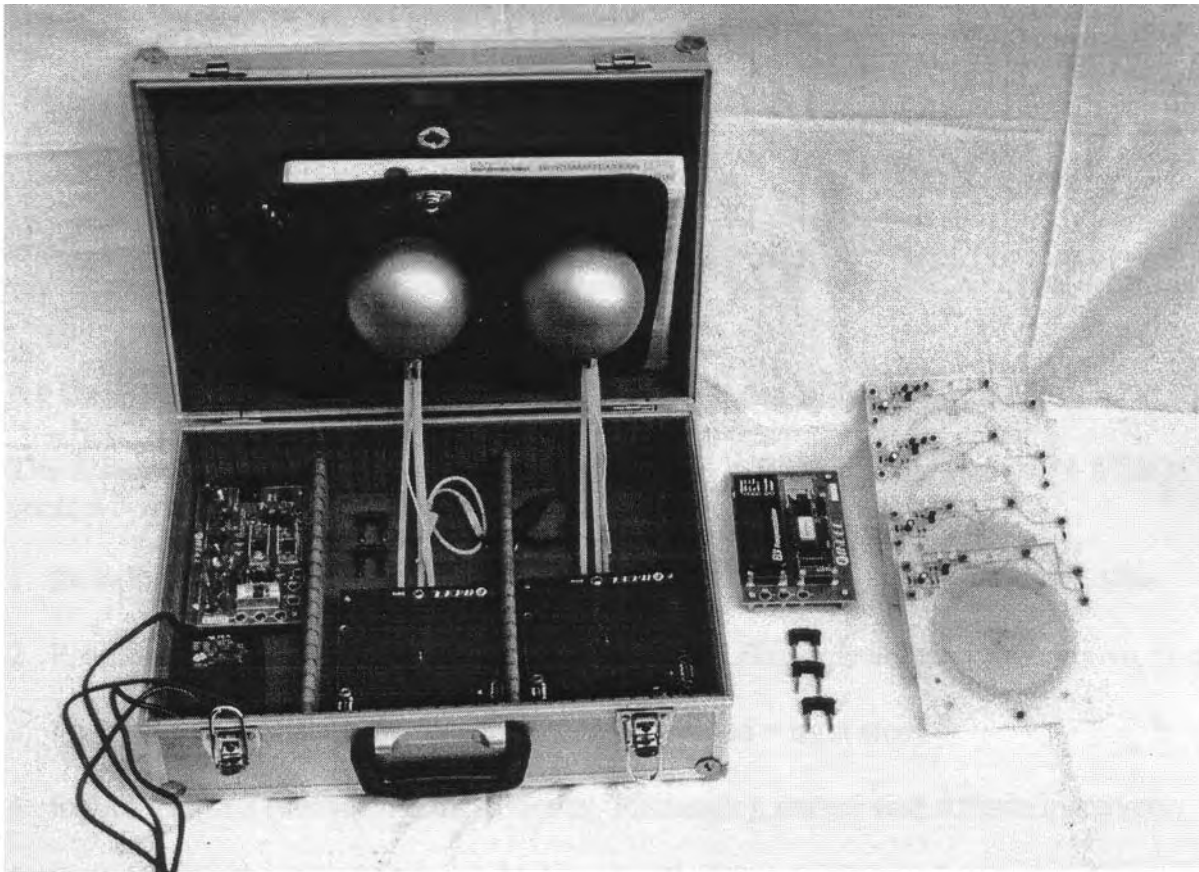

Fig.3: the aluminium suitcase with content
(in the suitcase: demo kit, beside the suitcase: add. material for the experimentation kit)

0.5 Included in delivery: experimentation kit (Fig.3)

Additional to the demo kit:

- 1 frequency counter
- (1 waveform generator unlike to the demo kit freely adjustable)
- (2 Tesla-pancake coils like in the demo kit)
- 2 Tesla-pancake coils with double wire-length
- 2 Tesla-pancake coils with half wire-length
- (2 spherical electrodes with connecting lead and plastic columns)
- 4 connecting cables with pin plugs on both sides (instead of 1 cable)
- (1 wall power supply (18V, 500mA) with connector plug)
- 1 Battery adapter
- 5 shorting plugs (instead of 2)
- (1 documentation)
- 1 collecting file with empiric reports

0.6 Description of the waveform generator (experimentation kit version)

The full-equipped waveform generator is adjustable in a large range (0,2 to 14 MHz). On the control board 7 buttons lie side by side. These are from left to the right:

1. Switch: form 1 (above: Rectangle/Triangle - down: Sine); Normal attitude: Sine
2. Potentiometer: pulse-width is only in position Rect./Triangle active (form1 above, f2 down)
3. Potentiometer: Amplitude (normally fully untwisted = right stop)
4. Switch: form 2 (above: Triangle; down: Rectangle); during sine attitude inactively
5. Switch: Frequency range (above: high range HI; down: low range LO); normal attitude: HI
6. Potentiometer: Frequency roughly adjustable
7. Potentiometer: Frequency finely adjustable (normally in central position)

The frequency range is preselected with a switch (HI / LO), and with two potentiometers "rough" and "fine" steplessly adjusted. Thereto the "fine" potentiometer is appropriately brought in central position, while with the "rough" potentiometer the correct point is searched and with the "fine" potentiometer readjusted. Also on the plate mounted is a high frequency power driver.

0.7 Description of the frequency counter (experimentation kit)

With the frequency counter also a period measurement or an event counting can be made apart from the frequency measurement. Thereto the jumper 1 and 2 must be set accordingly. The function-table is imprinted on the plate. Also the gate time is selectable with the jumpers 3 to 5.

0.8 Safety instructions

The entire arrangement is operated by the enclosed low-voltage wall power supply with test seal (respectively batteries) and thus with a low and harmless operating voltage. A danger of an electric shock is therefore impossible with the original kit (and the provided wall power supply). Nevertheless it is to be made certain that short-circuits (e.g. by metallic objects or lines) on the plates are avoided. This can entail the overheating of components or the destruction of the device. Besides no liability for damage of any kind is assumed, which was caused due to inappropriate treatment and/or use and/or the use of other respectively additional components, not contained in the kit and their combination with the kit!

Experiments with scalar wave transmission

1st experiment, subject: Energy transfer

1.1 Experimentator: Prof. Dr.-Ing. Konstantin Meyl

1.2 Place and date: D-78112 St. Georgen, 21st of June 2000

1.3 To the status of physics of electromagnetic waves (according to Heinrich Hertz)

It is a physical law, after which the field strength of waves according to Hertz (radio communication and radio waves) decreases with the square of the distance. If the distance between transmitters and receivers is doubled, then thereby the power of the receiver decreases to a quarter.

1.4 Expectation according to the scalar wave theory by Konstantin Meyl

The wave equation says that beside the wave according to Hertz still another further wave, the scalar wave, must exist. In contrast to the wave according to Hertz, the scalar wave spreads not with constant speed, and also not evenly in all directions. Only a middle velocity of propagation can be indicated, which can deviate from light speed substantially. A scalar wave aligns itself with the receiver, were the streamlines of the field bundles themselves again. Without dispersion the received power in case of resonance should correspond approximately to the sent power. Therefore it should be possible to transmit both: information and energy.

1.5 Experimental setup

For carrying out the experiment each spherical electrode is installed over a pancake coil, as the three legs are tucked into the three holes in the plate and the wire down hanging in the centre is connected with the centre of the pancake coil. (Fig. 2)

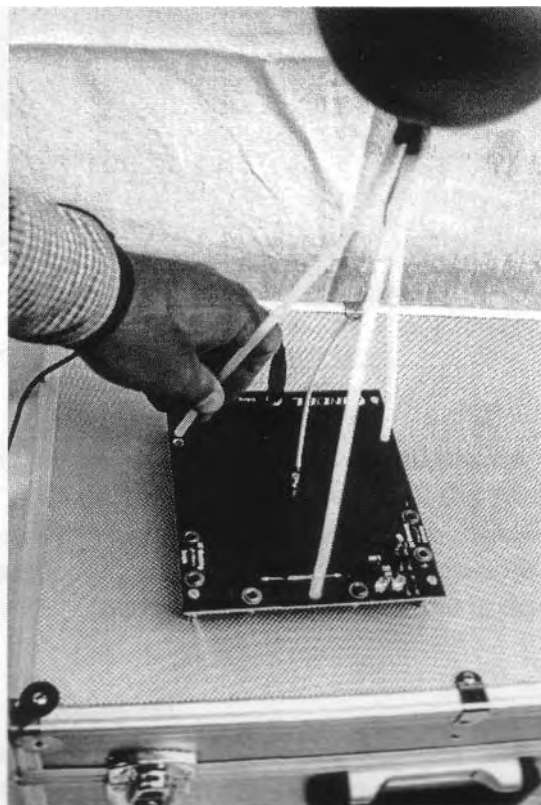
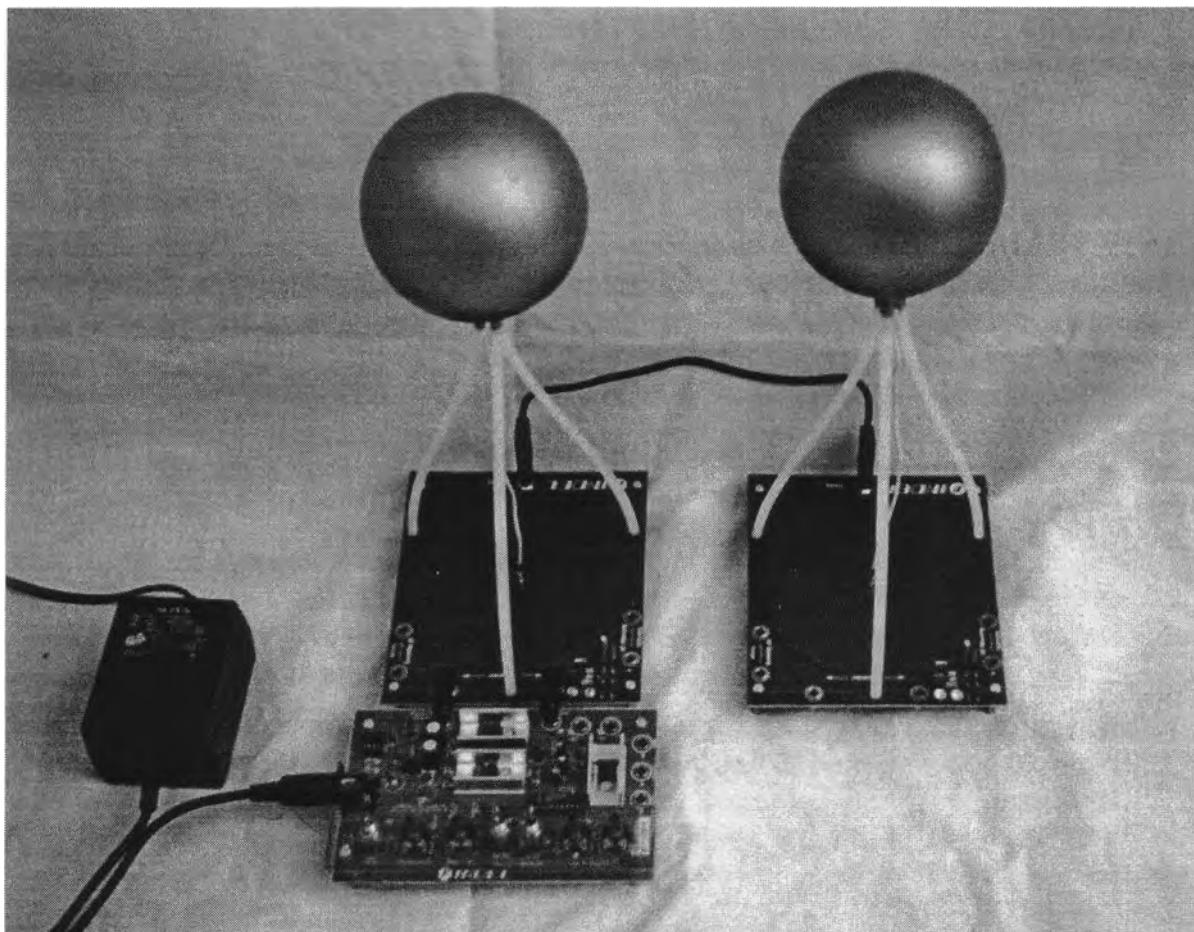

Fig.4: Installation of the spherical electrode above the pancake coil

Now the waveform generator must be attached with the help of two short circuiting plugs to the couple coil of the pancake coil. These coil works as transmitter in this system. Now the connection of the provided wall power supply is put into the socket designated for it on the waveform generator plate and connected with a 230V wall outlet. The red control lamp signals that voltage is impressed on the plate and that the generator is working.



wall power supply waveform generator 2 pancake coils with attached electrodes

Fig. 5: Connection of the waveform generator to one of the two pancake coils.

The other pancake coil with mounted spherical electrode is used as receiver and loaded with the light emitting diodes. The jumper must be put both on the transmitter, and on the receiver on position LED. The distance between transmitter and receiver should be selected first consciously quite small (approx. 50 cm). The points of grounding, that are the outside ends of the pancake coils, are to be connected by a laboratory cable. 6 meters black cable is designated for it.

1.6 Carrying out the experiment

It can be assumed, that the frequency controller is not in the right position first and no self-resonance is reached. The amplitude controller is untwisted, until the threshold voltage of the light emitting diodes is crossed by 2 V and the LEDs on the transmitter plate brightly shine.

Now, the "rough" frequency controller ("fine" potentiometer in central position, sine form, amplitude fully untwisted, frequency range: HI) is adjusted, until the on the receiver mounted light emitting diodes begins to shine. The power maximum is set, when the light emitting diodes shine brightest. The shining of the receiver diodes proves that a energy transmission

takes place. If the one LED should shine somewhat more brightly as the other one, then this signals a little unbalance of the sinusoidal supply voltage, because the positive half wave is used by one - and the negative half wave by the other diode. This can be during an asymmetrical load.

The distance between transmitter and receiver can now be increased. The distance can be quadrupled for example, as the receiver is continually pulled away from the transmitter. It could be that now on the receiver side less or nothing at all can be recognized, which is a corollary of the changed resonance frequency of the system due to the larger distance. This has to be compensated by adjusting the controller, until an power maximum is to be observed. The small lamp will shine as brightly as in the experiment with the small distance, which contradicts the law of square declension of the received energy conditional on the larger distance.

1.7 Interpretation of the experimental results

According guidelines of Tesla transmitter and receiver are operated grounded. The better the grounding and the better the coupling over the grounding connection, the more simply it is to find the point of resonance. The grounding wire used within the experiment is therefore primarily an easement for the operator. This can be determined very fast, as a worse connection is tried out e.g. over the central heating, over the earthing contact of the power line or with a direct connection to earth outside. It can come to the fact that at such a grounding inadvertently still different more "receivers" (e.g. biological systems) hang, which go into resonance and withdraw the transmitter's energy.

This problem can be avoided by connecting the points of grounding by a cable directly. Even if the grounding connection should be understood as conductor, then, for a closed electric circuit, the other conductor is missed. That is formed in this experiment by the transmission line. The Shining of the small lamps proves that energy has been transmitted.

If it would have been waves according to Hertz, only the sixteenth part of the power might have arrived by the quadrupled distance. $(1/4)^2 = (1/16)$. Whereas it can be observed that the received power with increasing distance does not decrease. For very large distances it might happen that the resonance is missed and the oscillation fades out. If several receivers go into resonance, it comes to an allocation of the emitted power or more distant receivers receive less power respectively.

1.8 Conclusion

The experiment impressively proves that it cannot concern waves, according to Hertz. The power transmission shown is in principle not possible with the waves, according to Hertz. Whereas scalar waves are capable of a loss less transfer of energy, wherefore the experiment is to be regarded as proof for the existence of scalar waves.

1.9 Consequences

If a transmitter is operated openly, without a receiver that absorbs the energy, the danger exists that the transmitter "looks" for any receiver itself and that could be a biological system. Any humans, who go coincidentally into resonance, would now absorb the sent energy or a certain quantity of it. This is comparable with a positive pole, from which electrical flux lines emanate and which is searching for its negative pole. Here the electrical flux lines will end, as well if the distance is very large. As well known the range is theoretically infinite. In contrast to the example, the case of resonance concerns only swinging poles, which swing with the adjusted frequency constantly between plus and minus.

As long as the power consumption by humans is not measured, an acute danger of electromagnetic pollution exists. Apart from the employment for medical purposes, the operation of scalar wave transmitters is to be rejected, which abuses humans as a receiver. It is to be made certain that the sent power is completely received i. e. collected and applied to a consumer load.

If we reduce the amplitude of the waveform generator so far that the light emitting diodes on the transmitter side shine not more brightly as those on the receiver side we can be safe that no biological effect will arise. If more energy is transmitted, as the receiver can absorb, further receivers should be switched in addition so that no vagabonding stray fields appear, which could be absorbed by biological systems. The optimal point is found, if during the reduction of the transmission amplitude, the receiver just begins to react with a reduction of the received energy.

1.10 Utilities:

Demo kit. (Fig. 6)
Using the experimentation kit: pancake coil with middle wire length

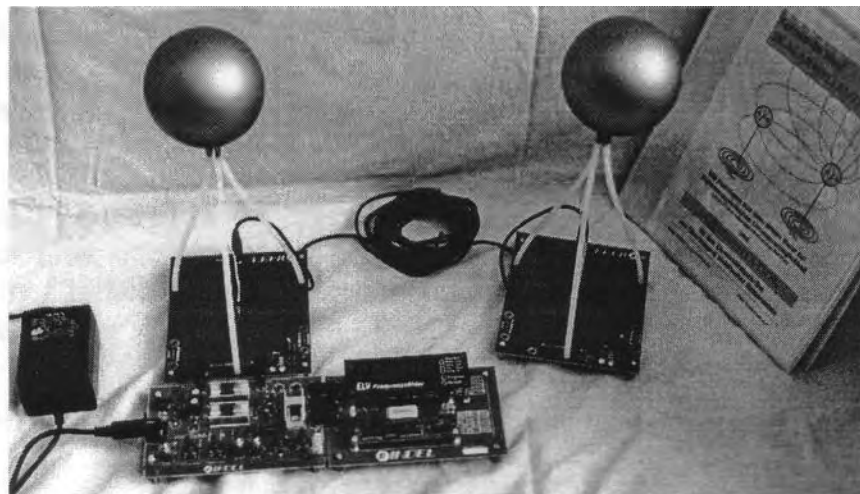

Fig.6: Basic set up of the wireless transfer of energy device
(here shown with attached frequency counter from the experimentation kit)

2nd experiment, subject: Feedback (from receiver to transmitter)

2.1 Experimentator: Prof. Dr.-Ing. Konstantin Meyl

2.2 Place and date: D-78112 St. Georgen, 21st of June 2000

2.3 To the status of physics of electromagnetic waves (according to Heinrich Hertz)

Terrestrial radio stations cannot determine on their transmitted power, how many listeners they have. There is no feedback from the receiver to the transmitter. If the effects in the experiment would be caused by radio waves (thus as the waves, according to Hertz), it might not be able to determine at the transmitter whether a receiver is attached or not.

2.4 Expectation according to the scalar wave theory by Konstantin Meyl

Scalar waves spread not evenly but are the result of a resonance between transmitter and receiver. And in such a way power is only deducted, if an appropriate receiver goes into resonance with the transmitter. That means, that there should have to be a direct feedback from the receiver to the transmitter.

2.5 Experimental setup

To be able to observe possible feedback, the point of resonance must be found again first. This is adjusted, if on the receiver the major peak can be observed and the LED's shine most brightly. The experimental setup is in the first instance the same (like 1.5: The waveform generator is attached on one side over two shorting plugs to the couple coil. This teslacoil functions as transmitter. The cable connection is plugged at the outside end of both teslacoils and the waveform generator is attached to the wall power supply). After this is done the amplitude controller has to be fully untwisted (in the clockwise direction up to the limit stop) and the frequency is slowly adjusted with the frequency controller and the light emitting diodes at the receiver are thereby observed. If the major peak should not be able to be determined clearly, it is recommended to reduce the voltage with the amplitude controller. Thus the major peak appears no longer so bright, but can be distinguished clearly from the auxiliary peaks.

2.6 Carrying out the experiment

After finding the major peak, the amplitude controller is turned back so far that the light emitting diodes on the transmitter side do not shine any longer, while the light emitting diodes on the receiver side still shine. If the cable connection is carefully unplugged, the light emitting diodes installed onto the transmitter side shine again. The LED's, installed on the receiver side, extinguish.

2.7 Interpretation of experiment results

The same effect arises, if the frequency at the waveform generator is adjusted. In this case the receivers LED's go out, while the LED's at the transmitter light up, because the resonance frequency is left and therefore no more power arrives at the receiver.

The light emitting diodes on the transmitter side give information about the power taken off from any receivers. If the brightness changes if the ground wire is connected from the transmitter to a heating element, it can be examined whether unwanted receivers possibly exist.

For example if the brightness decreases, if the experimenter touches the ground wire of the transmitter, he is now the receiver.

2.8 Conclusion

There is a feedback from the receiver to the transmitter, as can be observed here. With the transmission of radio waves no such feedback should be determined. Only with resonance between transmitter and receiver, scalar waves are developed. If the transmitter is unplugged or the generator frequency changes and leaves so the conditions of resonance, no more energy is transferred.

2.9 Consequences

Numerous interhuman effects are based on the principle shown in the feedback from the receiver to the transmitter. They are in this way for the first time physically modelled. At the same time it becomes clear that the as esoteric classified coherences are nothing else than scalar wave effects. These effects are wrongfully designated as para-science, because scalar waves are still unknown to the scientific world. The feedback shown in the experiment proves the existence of scalar waves!

2.10 Utilities:

Demo kit like in experiment 1.

Using the experimentation kit: pancake coil "A" with middle wire length

3rd experiment, subject: Proof of free energy

3.1 Experimentator: Prof. Dr.-Ing. Konstantin Meyl

3.2 Place and date: D-78112 St. Georgen, 21st of June 2000

3.3 To the status of physics of electromagnetic waves (according to Heinrich Hertz)

It is a physical law, after which the field strength decreases with the square of the distance. As consequence of the law received power is generally smaller than the transmitted. The field strength continues to decrease quadratically with the distance.

3.4 Expectation according to the scalar wave theory by Konstantin Meyl

The transmission with scalar waves has no power attrition during transmission (quod vide 1st experiment). The dielectric between the two spherical electrodes is open and therefore able to interrelate with scalar wave fields from the environment. If such fields with appropriate frequency and phase position are present, efficiencies from over 100 % are not to be excluded, even expectable. Finally, it concerns an open system!

3.5 Experimental setup and carrying out the experiment

The transmission circuit is adjusted as described in experiment 2. The LED's at the transmitter coil are to be out, while at the receiving coil they have to shine. Further look first for the resonant frequency please (receivers shines) and then the amplitude has to be accordingly reduced. Subsequently, with the frequency controller, check again whether it is the correct point. There is the possibility that the receiver lamps light up at several frequency values, but only at the correct value the feedback to the transmitter is so strong that the transmitter lamps fade out completely.

3.6 Interpretation of the experimental results

Both coils should be identical (same numbers of turns, same wire length, same couple coil). Thus makes sure that the inductively coupled voltage should be larger than the receiptable under normal conditions. As a matter of fact it is vice versa. On the receiver side values over the threshold voltage of the LED (2 V) are reached, while on the transmitter side they are not, because the LED's on the receiver side shine, whether on the transmitter side they do not. The load by the LED's is identical in both cases, so that the higher voltage leads compellingly to a higher current and a higher power. That is, it will more power be received than the transmitter delivers.

3.7 High frequency measurements

If the appropriate measuring technique is available, the into the transmission coil fed high frequency power and the received high frequency power can be measured directly. In addition a short laboratory cable replaces the shorting plug between waveform generator and the pancake coil and the current signal is measured with current measuring pliers (for high frequency measurements). The jumper is brought in central position. Thus the connector sockets on the left side are activated, where the voltage measurement can take place. Due to the fact that between current and voltage a phase angle arises, the instantaneous values must be multiplied with one another (the Scope must support this computation!). This results in a likewise sinusoidal output curve with double frequency, whose average value can be consulted as measure for the fed power.

The high frequency measurement on the receiver side takes place completely similarly. The jumper is put in central position and the voltage is measured. A resistor of 100 ohms is recommended as load. With the current-measuring pliers the current flowing through the load resistor is measured. By optimal impedance matching of the load resistance and with appropriate reduction of the amplitude the efficiency can be increased still further.

3.8 Interpretation of the high frequency measurements

Efficiencies of approximate 500% are measured. An appropriate measurement with a 200 MHz power measuring device is printed in the 2nd book from the book series "electromagnetic environmental compatibility" in chapter 19.11. A control survey took place at the technical university of Clausthal at the 6th of July 2000. In the Institut for electrical engineering an efficiency was measured with two Tektronix measuring devices, which averages 1000%. For the large astonishment of the research workers, the received Power at the middle pancake coil of the experimentation kit was ten times the power, which was transmitted.

3.9 Circuit analyzer measurements

Not each Institute has the necessary equipment, in order to be able to make high frequency power measurements. That applies especially to private researchers and schools. For this group, the third jumper position on the coil plates was designed (DC load). In this position the high frequency signal is applied to a bridge rectifier, and a condenser is loaded with the rectified voltage. On the right side of the plate are two sockets, at which DC voltage is impressed. It can be assumed that nearly everyone has a simple multimeter, which indicates the voltage level in DC position. The load resistor of 100 ohms is already on the plate, so that the converted power $U^2/100$ ohm can be made directly out off the voltage measurement.

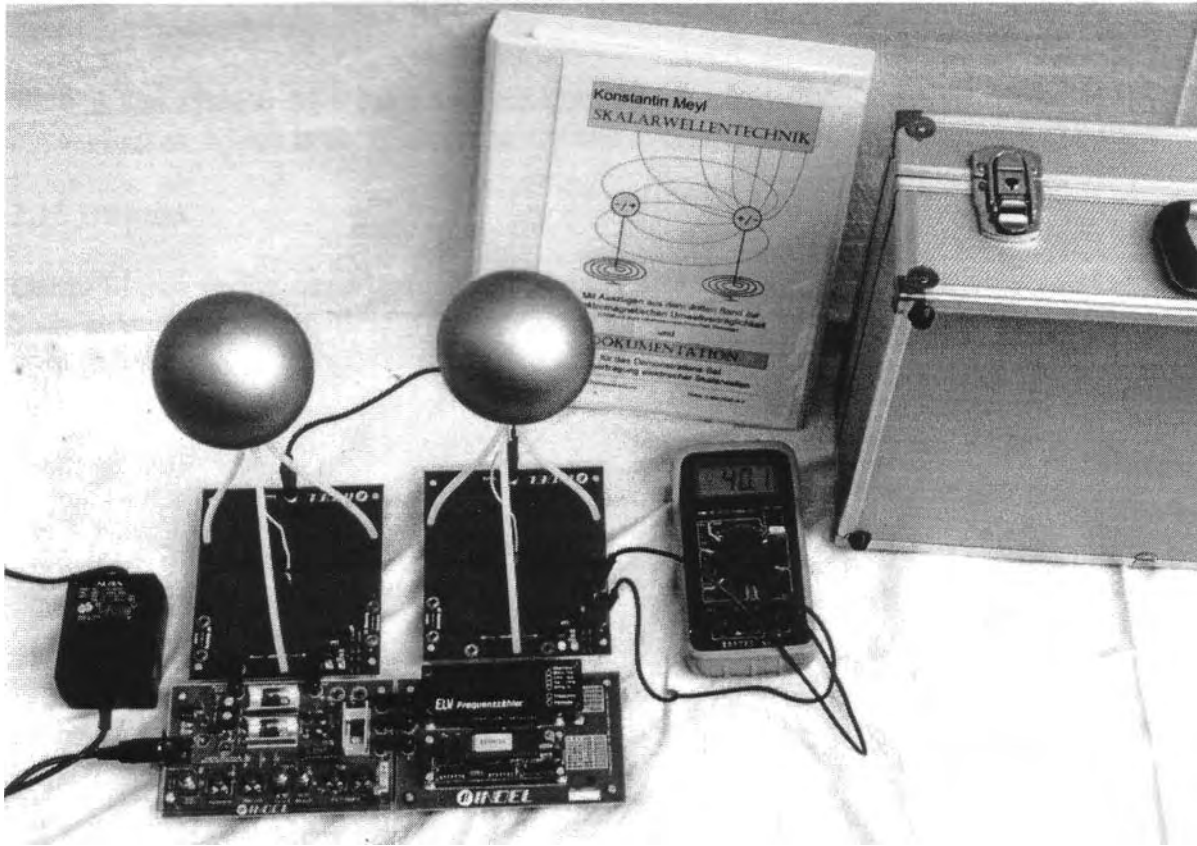

Fig.7: DC measurement with circuit analyzer (jumper position: DC load)

The measurement on the receiver plate is conducted in the same way. It is recommended to work with two circuit analyzers at the same time. Then the calibration of the favourable amplitude and finding the correct resonant frequency is more easily. Typical voltage levels are 400 mV on the receiver side, while the values are at the same time on the transmitter side are 100 mV's. (Fig. 7)

3.10 Interpretation of test results of the DC measurements

Naturally a simple DC measurement cannot replace a high frequency measurement, but for a tendency it is always good for. The current measurement is abandoned, but it can be assumed that a higher voltage at the same resistor will entail also a higher current (Ohm's law). If the DC voltage at the receiver is higher than the voltage at the transmitter, a so-called Over Unity effect must be present, and then the efficiency is over 100 %. An increase of the voltage around the factor 1.4 means already a duplication of power, since the percentage of the voltages is squarely responsible for the increase of power.

3.11 Conclusion

The transmitter modulates the surrounding field. The receiver absorbs beside the sent power scalar waves from the environment in the case of resonance. The transmission circuit proves the existence of free energy. Tesla possibly even measured that the received power continues to increase, if the distance to the transmitter is increased. Consistently and ambitiously he was. he planned a global power grid with scalar wave transmitters, which he called "Magnifying transmitters". For than reason Nikola Tesla is considered as the father of free energy.

3.12 Consequences

Here is the chance of a new and environmental compatible form of energy revealed to the experimenter, which is present constantly and everywhere and only waiting to be used.

3.13 Utilities

Demo kit, as in the experiment No. 1 with purely optical control, or two voltmeters (DC) or high frequency power measuring devices. Using the experimentation kit: Coil with middle wire length.

4th experiment, subject: **Superluminal Velocity**

4.1 Experimentator: Prof. Dr.-Ing. Konstantin Meyl

4.2 Place and date: D-78112 St. Georgen, 21st of June 2000

4.3 To the status of physics of electromagnetic waves (according to Heinrich Hertz)

From the equations of the field, the magnetomotive force and the induction law, Maxwell calculated 150 years ago a wave, which constantly spreads with the dimension "C" which is the speed of light. Albert Einstein postulated, after all measurements seemed to confirm this, C as the highest possible and permissible signal transmission speed. As long as only the wave, according to Hertz is considered, which is a lateral wave and swings transversal, this assumption is applicable. Since only this wave component is nowadays used, it is assumed that anywhere in the universe the light cannot be faster as 300,000 km/s. From the unproven experience set an imperative became, which is raised from some scientists in misjudging the connections into the rank of a law.

4.4 Expectation according to the scalar wave theory by Konstantin Meyl

The scalar wave, as longitudinal wave, only has a middle propagation speed, for which no limit exists. It can be faster, even substantially faster than the light. Antitype for this experiment is again Nikola Tesla, who had measured already more than 100 years ago superluminal velocity and over that, he made fun of Einstein, who was in his eyes an unrealistic theoretician. Tesla had sent from his experimental transmitter in Colorado Springs a scalar wave signal around the earth and had determined a standing wave resonance with 12 cycles per second. He wrote that he could regain the node of oscillation on the ground plate in his laboratory in case of resonance.

For the waves, according to Hertz, the Schumann-resonance is approx. 7.8 cycles per second. From the percentage of the resonance frequencies Tesla calculated the speed of the scalar wave emitted by him to $12/7.8 = 1.5$. His wave, concludes Tesla, must therefore have spread with a factor 1,5 of the speed of light.

4.5 Experimental setup

The experimental setup is the same as in the last experiment. For a quantitative evaluation a frequency counter should be attached. The connection takes place at the waveform generator at the sockets "sync" for the synchronisation signal and at mass (GND = ground). The frequency counter included in delivery of the experimentation kit is via a third connection with 5 V operating voltage supplied. The display shows the frequency in MHz.

4.6 Carrying out the experiment

Possibly somebody has already noticed the fact that when tuning up at the frequency controller of the waveform generator the light emitting diodes on the receiver plate light up several times, albeit with different brightness. So far only the point with maximum brightness had been evaluated. The for scalar waves typical and in the first three experiments determined features arise here. It is particularly salient, that the transmission lamps fade out, while those on the receiver side light up, if resonance is adjusted.

If the frequency controller is further turned to the left (amplitude controller fully untwisted), another setting can be found, at which the receiver lamps shine. This time the transmitter is not

aware of that. The transmitter lamps continue to shine completely unaffected, what from the conclusion is to be drawn that this time no power is withdrawn. It has to be the wave, according to Hertz. For checking purposes the grounding on the transmitter coil is unplugged and plugged again. Whereas the receiver lamps fade out and shine, respectively. On the transmitter however no reaction can be recognized. The brightness of the lamps does not change at all.

4.7 Interpretation of the experiment

The missing feedback on the transmitter is an indication for radio waves, which only in close range can bring the receiver lamps to shine (law of the square-distance). Further indications are that at this point the receiver lamps do not shine more brightly than those of the transmitter and the degree of efficiency generally is below 100 %. If the distance to the transmitter is increased, the received power slowly fades out. Finally the transmitter can be put into a Faraday cage. The receiver lamps fade out immediately. Mostly it is sufficient to hold the hand before the receiver electrode in order to prevent the reception. Observations should be taken alternating at the two points of resonance, because particularly the direct comparison of the measured wave characteristics at the two points makes it clear, that with the low frequency (4-5 MHz) wave, according to Hertz is used, while with the high frequency (6-7 MHz) the scalar wave, according to Tesla is used.

4.8 Conclusion

The coil length and thus the wavelength were not changed, so that from a frequency change a change of the propagation speed follows directly. Both stand in direct proportionality to each other. If the frequency of the scalar wave is higher than those of radio waves, so that the frequency controller must be turned further toward the clockwise direction, then this wave is faster than light.

If a frequency counter is attached, it is recommended to note the two frequencies and compute afterwards the percentage of the larger (longitudinal) to the lower (transversal) frequency. The result is undoubtful: The scalar wave signal is approximately 1.4 to 1.6 times faster, than the electromagnetic radio wave. (typical values with the middle coil length are: Frequency of the scalar wave 6.7 MHz/radio wave 4.5 MHz =1.5 C/C the scalar wave has the factor 1.5 of light speed).

4.9 Consequences

Scalar waves are modulatable and can carry information. Therefore the acceptance, that light speed is the highest border for signal transmission, as Einstein insisted, is to be contradicted. It is still the correctly accomplished experiment that is able to show the physical reality and not any devious assumptions of a theoretical physicist.

4.10 Utilities

Demo kit, like in the experiment No. 1. Using the experimentation kit: first the coil with the middle wire length is used. With the other two coil sets the experiments can be repeated.

5th experiment, subject: Ineffective Faraday cage

5.1 Experimentator: Prof. Dr.-Ing. Konstantin Meyl

5.2 Place and date: D-78112 St. Georgen, 21st of June 2000

5.3 To the status of physics of electromagnetic waves (according to Heinrich Hertz)

The Faraday cage is based on the principle that the inside of an electroconductive body remains field-free. It is used, in order to shield radio waves. Provided that the electromagnetic wave only consists of waves, according to Hertz, nothing may penetrate a Faraday cage. If the transmitter is outside, the inside of the cage is allegedly field-free. Is the transmitter inside the cage, e.g. a microwave oven, no wave should be provable outside.

5.4 Expectation according to the scalar wave theory by Konstantin Meyl

The scalar wave has characteristics, which empower it to penetrate a Faraday cage. The scalar wave is able to tunnel. It must be only sufficiently fast. Furthermore a resonance between transmitter and receiver is required.

5.5 Experimental setup

For this experiment we need a Faraday's cage, into the transmitter is to be put. For that, the provided metal suitcase is suitable, which is opened and placed unfold on a side. The transmitter is put with the attached spherical electrode into the suitcase (fig. 6). The shorting plugs are replaced by short laboratory cables in this case, which connect the transmitter with the waveform generator through the gap. We connect the ground on the plate with the connection inside the suitcase. The ground wire to the receiver is plugged from outside into the intended metal socket.

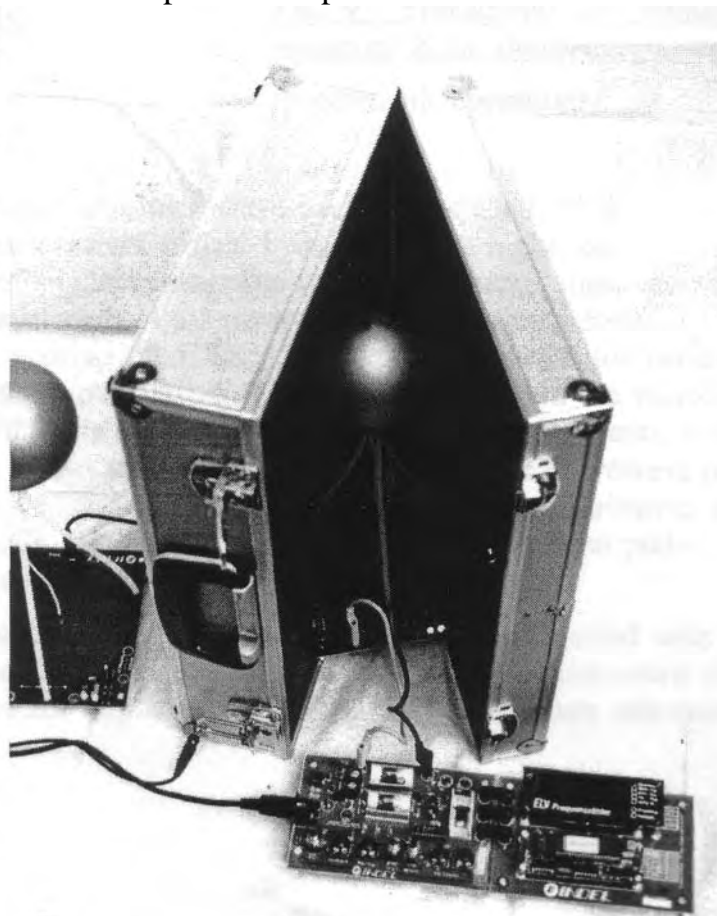

Fig. 8: The transmitter in the aluminium suitcases
(frequency generator and counter externally)

With another variant (fig. 9 and 10) the waveform generator is also put into the suitcase. Now the frequency must be adjusted through the opened gap, which demands some skill. If the hand is withdrawn and if the suitcase is closed, the point of resonance may not adjust itself in such a manner that the small lamps at the receiver fade out again. Therefore the above variant is preferred.



Fig. 9: Transmitter and frequency generator in the aluminum suit-case
(problematic operation!)

In addition, a hamster cage made of metal or a microwave oven can be used. It is advised to pay attention, that lattice cages possess a certain critical frequency. The higher the frequency and therefore shorter the wavelength of an electromagnetic wave is, the closer must the lattice bars of the cage lie together. The wavelength of microwaves is approximately 5 millimeters. That corresponds to a frequency of approx. 60 GHz. The waveform generator produces frequencies of 1-20 MHz. Thus at least a percentage of the wavelengths from the waveform generator to the microwave oven of 3000:1 is given. That means, for our experiments, a cage with 3000 times larger lattice spacings would actually be sufficient. Using the microwave oven as shielding cage, which is proved for high frequency impermeability, our experiments with relatively low frequencies are on the safe side. The power plug should have been pulled and the oven must not be activated in any case.

The cable connection has to be plugged into the receiver and has to be connected with the transmitter, which has to be electroconductive connected to the cage (using a microwave oven for example, with the help of an alligator clip at metal parts). The aluminium suit-case is equipped with sockets on both sides.

5.6 Carrying out the experiment

The amplitude controller is fully untwisted. It does not care whether the transmitter LED shines. Arbitrative for the success of the experiment is the fact alone whether a chance exists to bring the receiver LED to shine. For this purpose the frequency controller of the waveform generator is adjusted, till on the receiver side a maximum can be observed.

Who has doubts, the line cord to the waveform generator can radiate any high frequency, can use a 9-volt-battery in stead of the wall power supply , which is accommodated also in the cage. If the cage is closed, no more cable usher into the cage in this case. Only the cage itself is connected from outside with the receiving coil and from inside with the transmitter coil. Now the caged transmitter can swing as much as it wants. Outside of the cage nothing at all might arrive, according to educational books.

5.7 Interpretation of the experiment

If the lower frequency (the wave, according to Hertz) is adjusted, it is obviously recognizable that the smallest shielding leads already to the fact that the receiver lamps fade out. The higher frequency during a scalar wave transmission behaves substantially more resistant. A gap in the door or a cable, which leads out the suitcase, is adequate for a perfect coupling. In equally the small lamps on the receiver plate shine within a hamster cage or with a mouse lattice almost unimpressed. All previous experiments can be repeated and it is incidental that a transfer of energy, a feedback and even an increase in output are possible. Attention is payed to, that the resonant frequency between transmitters and receivers is affected by the cage, which makes a readjusting of the frequency necessary. The cage increases the surface and thus the capacity, so that the resonant frequency drops on substantially lower value (typical 4 to 5 MHz using the middle coil).

5.8 Conclusion

If the Faraday cage is not too close meshed, it does not represent a considerable barrier for the transfer of energy. Substantially at this result is the circumstance that a signal can escape from the cage. So somewhat is measurable, which may not be. This experiment reveals a completely substantial characteristic of the scalar wave.

5.9 Consequences

If the Faraday cage cannot affect scalar waves, no possibility is known to shield the scalar component of a wave. If during tunnel experiments the waves are confronted with a barrier, which should be actually insurmountable and if, albeit of this fact, signals behind the tunnel are measured, which are besides faster, as expected, then a scalar wave is received without doubt, (e.g. Professor Nimtz, 2nd physical Institute of the University of Cologne)

If architects sell their customers shielding mats against electromagnetic pollution, these mats shield only radio waves and no scalar waves. Which of both waves is biologically active and responsible for the electromagnetic pollution, has to be ascertained.

If somebody seeks shelter from scalar wave radiation, a scalar wave receiver is recommended, which is in resonance with the jammer and absorbs the sent energy. Whether such a device actually functions, can be recognized by the fact that a measurable output is perceivable: A small lamp shines or a component becomes hot.

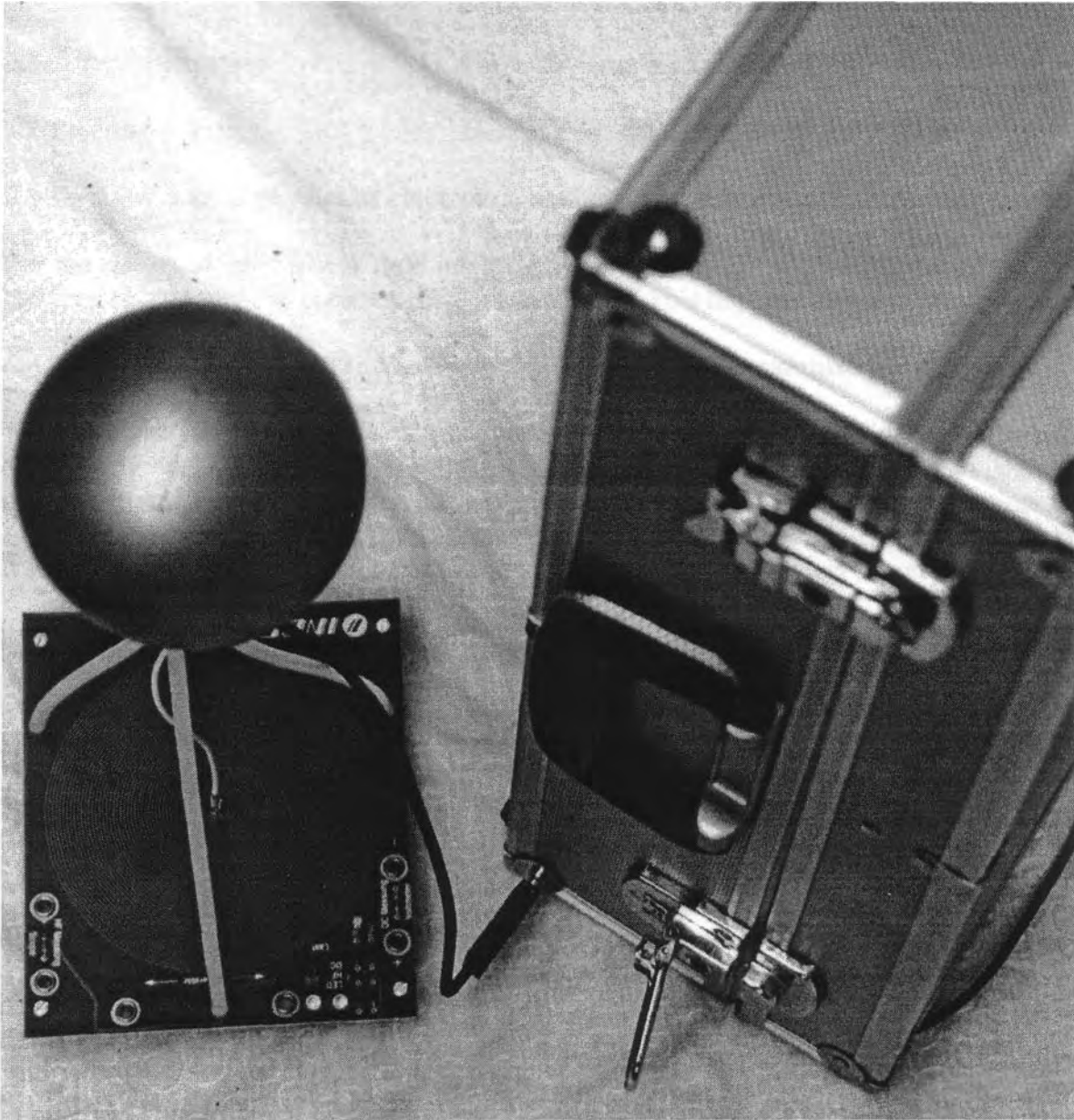

Fig. 10: The closed aluminium suit-case with externally connected receiver

5.10 Utilities

Demo kit, like in experiment 1, additional the aluminium suit case as Faraday cage.

Using the faraday cage, the experiments 1 to 4 are repeatable.

6th experiment, subject: Refutation of the near field interpretation

6.1 Experimentator: Prof. Dr.-Ing. Konstantin Meyl

6.2 Place and date: D-78112 St. Georgen, 1st of July 2000

6.3 To the status of physics of electromagnetic waves (according to Heinrich Hertz)

For the refutation of the near field interpretation, it has to be calculated first, at which distance between transmitter and receiver the near field ends. This happens at $\lambda/2\pi$.

6.4 Expectation according to the scalar wave theory by Konstantin Meyl

At 7 MHz it might therefore not be possible any longer, to bring a small lamp to shine, particularly because the near field is the scalar wave component. However, the computation of the near field and its range always takes place on the assumption of propagation with light speed. Scalar-wave can, against the doctrine, be faster. So that, according to the theory of Meyl, it can be expected that the transmission of energy is still possible over larger distance.

6.5 Experimental setup

The transmission circuit is set like in the experiments 1 to 3. The frequency is adjusted to the point of maximum luminosity of the receivers LED. The LED's on the transmitter side are unimportant for this experiment.

6.6 Carrying out the experiment

The connecting cable, which is designated by Tesla as "grounding", is lengthened to more than 6 meters by an extension cord. The frequency is tracked and the maximum value has to be checked.

6.7 Interpretation of the experiment

It was always possible so far and the measurements will confirm it, that with distances of more than 6 meters the light emitting diodes on the receiver can be brought to light. Thus it has been shown that still outside of the near field a transfer of energy is possible. The finding of the maximum becomes more difficult. The longer the connection cable or the more potential receivers are connected (for example the heating installation or a water pipe), the rather the oscillation breaks away or the resonance breaks down. Then, immediately, no receipt is possible any longer. After such a break the distance must to be shortened, till the resonance is present. After than, the distance between receiver and transmitter can be extended again. In the course of the lecture "alternative electrical engineering", students increased the distance to 60 meters and made measurements.

6.8 Conclusion

As it is possible to receive the full transmitted power, even at the tenfold distance, a frequently mentioned argument of high frequency technology is disposed of once and for all.

The experiment can be expanded, if necessary, with the goal of showing the standing wave character as proof for the existence of longitudinal waves. As long as power is consumed, the

lines of flux are bundled at the receiver, whereby the standing wave character is lost. It is therefore recommended, that no jumper is set. Only measurement-devices with very high resistance, an oscillograph for example, should be used to control the voltage impressed at the coupling coil of the receiver. If the distance between the transmitter and the receiver is varied, the chance to proof the standing wave character exists by locating the nodal points.

6.9 Consequences

The near field of an antenna is the scalar component of a wave, whereas the scalar wave, vice versa, is more than the near field! It is an electrical longitudinal wave, which propagates towards the pointer of the electrical field.

6.10 Utilities

Demo kit, as in the experiment No. 1. Extension cords with different length. Using the experimentation kit: Coil with middle wire length.

7. Experiments with the experimentation kit

First only the coil with the middle wire length was used in the experimentation kit. But still two further coil sets are provided, on the one hand a coil with the double wire length, recognizable by the high number of turns, on the other hand a coil with the half wire length. Using these coils, the experiments 1 to 5 can be repeated. Additional harmonic wave experiments are possible by combining the different coils. In this case attention should be paid to the fact that with the number of windings also the transmission ratio of the air cored transformer changes. The couple coil is identical at all variants with 5 windings. It can be modified, if necessary, on the lower surface, whereby an abbreviation to 4 turns is possible.

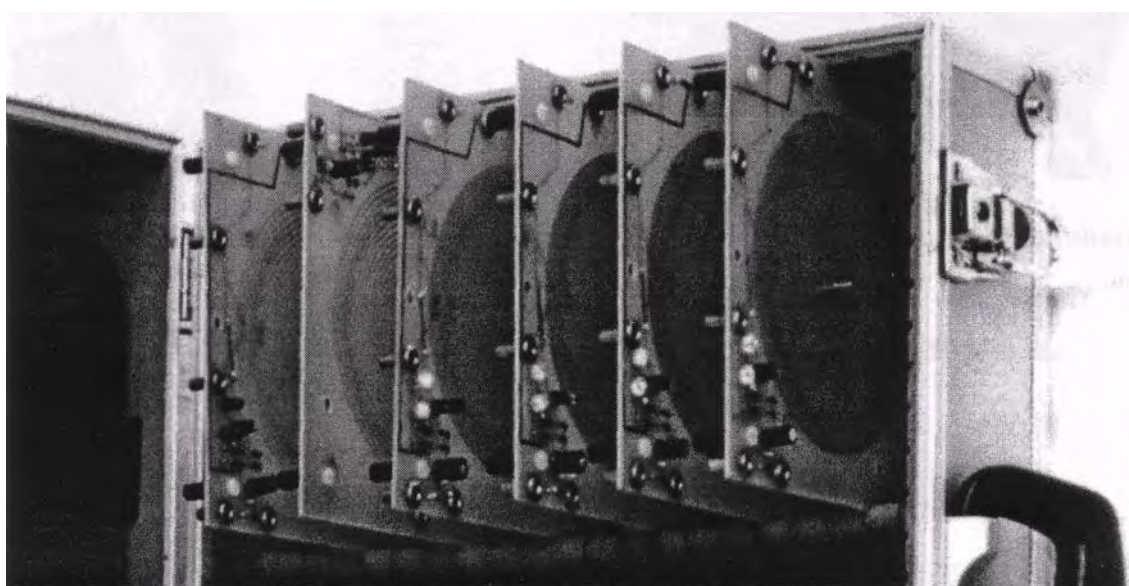
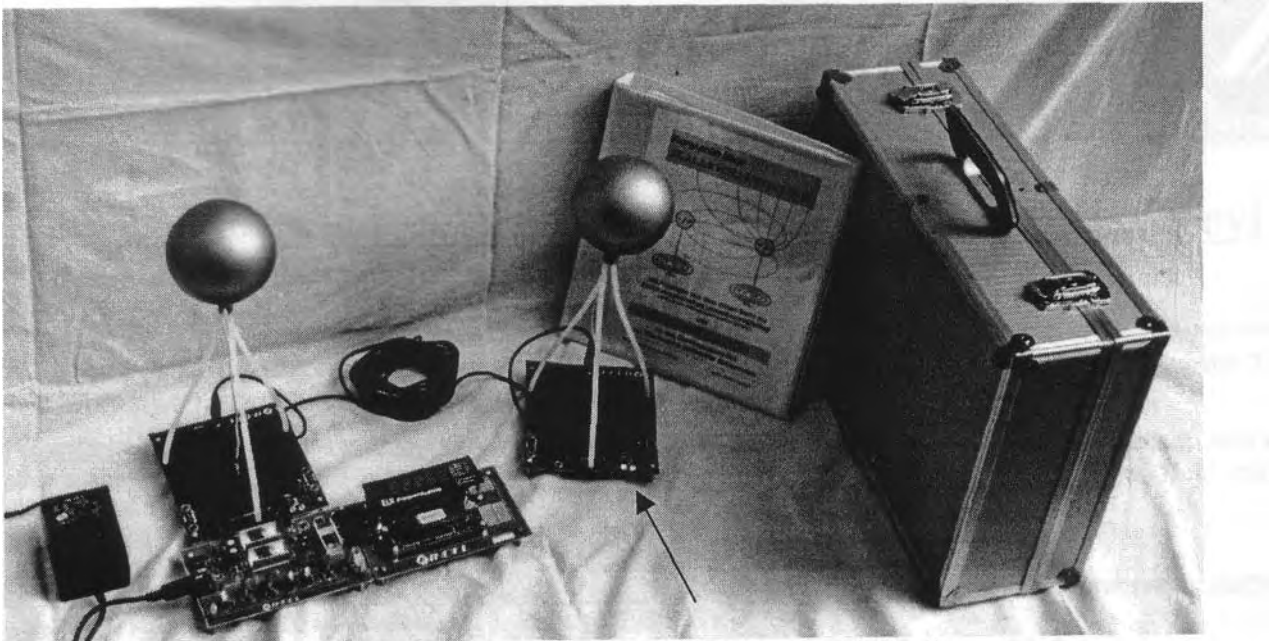

Fig.11: Three pairs differently wound pancake coils.

The waveform generator is only preset at the demo kit. The experimentation kit offers further adjustment possibilities. By turning-over the two switches form 1 and 2 to rectangle, the harmonic content can be significantly increased, which pulse-width is stepless adjustable. That can be helpful for experiments with mixed groups of coils, e.g. with a transmitter (high number of turns) and with two receivers (middle coil length).

Here is the fantasy of the experimenter in demand. Please write your own protocols and arrange them, given in the sample. We will try to reconstruct the experiment according to your description. We will, as the case may be with additions, collect your protocols together with others. We will send those protocols in a file to all buyers, who made own protocols. With this measure an incentive for own experiments is given and the feedback, which is important for us, has been motivated. For those, who do not deliver protocols, the collecting file and additional instructions are purchasable. Till the completion is finished, it can take some years. About stock availability, contents, extent and the price we will up-to-date inform on our homepage.



wall po- transmitter (LED off) receiver (2 LED's are shining!)
wer supply waveform generator + frequency counter documentation + aluminium suit- case

Fig. 12: The Receiver is draining visibly electrical power from the Transmitter.



First Transfer Center of Scalar Wave Technology

SCALARWAVEDEVICE

*A further developing of the worlds first and very successful experimental-kit
in a case with open work area above the Tesla-coil*

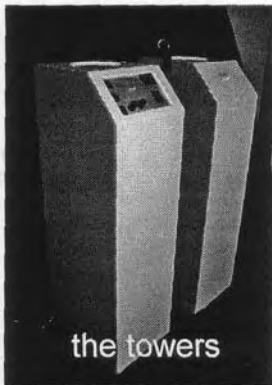

especially developed for biological-technical experiments.

The demand of the scientific world for reproducibility of the experiments has been satisfied with the construction which is based on Tesla's ideas and the disposal of the demo-kit (800€) and the experimental-kit (1400€). Inspired by six at any time reproducible main experiments of the special characteristics of scalar wave transmissions from the book „Scalar Wave Technology“ several researchers did some further experimentation, mainly interested in the biological properties of the scalar wave. Especially these researchers demanded a specifically for their research projects improved type of construction, because they experienced some handling difficulties with the more open test arrangement.



So this was the reason for developing our scalar wave device (Skalarwellengerät) SWG-A (prize: 3950 €). Every device is handmade and consists of two columnar cases, which contain the antennas and electronic. The built-in timer is very functional and easy to use – as the rest of the device. You just have to connect the two towers with the connection cable and plug in the power supply unit in order to start your experiments.



A very special ability of the scalar wave device is the circular and patent Tesla coil, which is accessible from above. Within this area you can place substances with biological information directly in the field of the pancake coil. So that were the required specifications of the scalarwave-researchers for further experiencing of the biological-technical properties and their desire to modulate „biological information“ to the carrier wave.

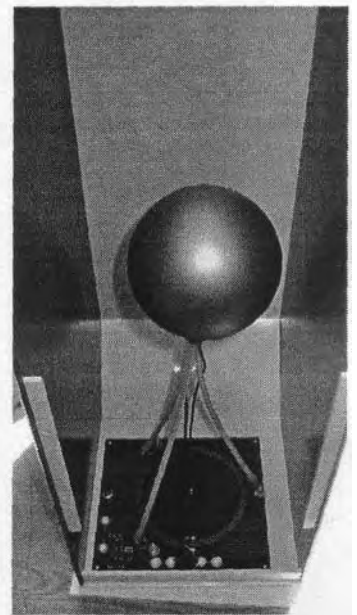

- timer on
- always on
- frequency adjustment
- amplitude adjustment
- resonance indicator
- time pre-select

We ask for understanding that we will not write own experimentation guide within the field of biology as electronics manufacturers. We are building these devices in terms of our customers and would like to wish all the researchers out there many successful experiences with this brand new 'Skalarwellengerät' "SWG-A" for the welfare of human and science.

Your Team

Of the First Transfer Center of Scalar Wave Technology

To order:

www.etzs.de ; bestellung@etzs.de
Tel.:+49(0)7724-1770 ; Fax:+49(0)7724-9486720
(delivering time 1 month)