



THE JOURNAL OF BORDERLAND RESEARCH

Volume LVIII

Annual for 2004

PERCEPTION & PHYSICS

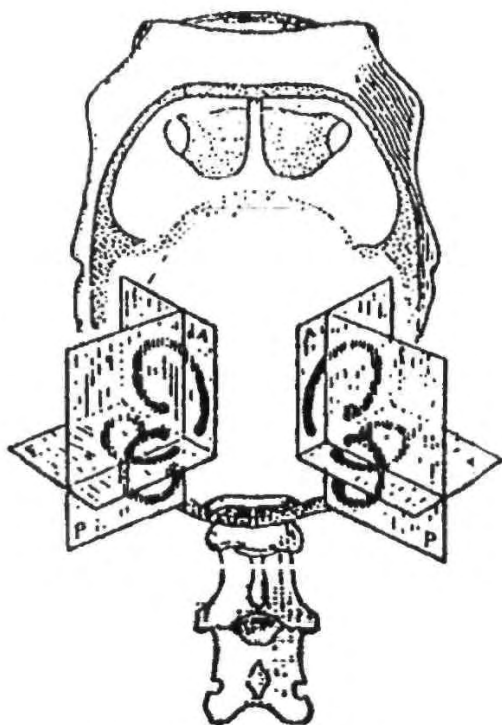



"We have actually touched the Borderland where Matter and Force seem to merge into one another, the shadowy realm between the known and the unknown..."

I venture to think that the greatest scientific problems of the future will find their solution in this Borderland, and even beyond; here, it seems to me, lie Ultimate realities, subtle, far reaching, wonderful."

- Sir William Crookes, 1879

THE JOURNAL OF BORDERLAND

RESEARCH

VOLUME LVIII ANNUAL FOR 2004

FEATURED ARTICLES IN THIS ISSUE:

THE PROBLEM OF INSTINCT
OR SPECIAL SENSE IN ANIMALS
GEORGES LAKHOVSKY6

THE ROLE AND SCOPE OF THE
RADIESTHETIC FACULTY IN THE
MODERN WORLD
A.T. WESTLAKE14.

SELECTIONS FROM
"PHYSICAL RADIESTHESIE"
PIERRE BEASSE..... 26

THE BORDERLAND EXPERIMENTER
EXPANDING PERCEPTION
JAMES BORGES, BSRA 35

MEDITATION
AND RESONANCE EFFECTS
RICHARD ALAN MILLER38

TOWARD A PHYSICAL FOUNDATION
FOR PSI PHENOMENA
ERVIN LAZLO.....45

SUBTLE ENERGIES
DR. WILLIAM A. TILLER 50

ENERGY FIELDS AND
THE HUMAN BODY-PART II
WILLIAM TILLER PH. D..... 56

SUBTLE MAGNETISM A FIFTH FORCE?
BURYL PAYNE68

NEW ASPECTS
OF THE BERMUDA TRIANGLE
MELVIN ERICKSON..... 72

THE UNDERGROUND RACES
RAMON NATAILI76

FROM ALCHEMY
TO ECOTECHNOLOGY
A COMMENT ON VICTOR SCHAUBERGER'S
"THE DETRHOEMENT OF SCIENCE"
JAMES BORGES, BSRA 78

THOUGHTS ON THE NON-USE OF
BORDERLAND KNOWLEDGE
THE PUNDIT CURMUDGEON/E.D. O'BRIAN...85

THE BORDERLAND BOOK REVIEW
ONG'S HAT, THE BEGINNING90

ANTIQUITIES OF THE ILLUMINATI
THE MANDAEANS
JONATHAN SELLERS, BSRA91

CLIPS, QUOTES, & COMMENTS
LUCIUS FARISH..... 119

THE PROBLEM OF INSTINCT OR SPECIAL SENSE IN ANIMALS

The Secret of Life, Chapter One

By Georges Lakhovsky

General Considerations

The nature of instinct of special sense which naturalists have studied in animals is, without doubt, one of the most puzzling and complex problems confronting the modern physiologist.

It reflects, under its most strange and least explored aspects, the whole problem of life. Yet, in spite of great difficulties in the field of observation, accurate data on the subject matter have been recorded from time to time. In this matter, the experimental method is practically restricted to direct observation, and more often than not laboratory experiments are out of the question.

Various hypotheses have been advanced to explain the observed and controlled results, but it would seem that up to the present no general theory has yet been enunciated which would cover all the available data and at the same time give a logical and comprehensive explanation.

In this connection the uninterrupted progress of science is suggestive of certain new ideas which have enabled me to elaborate my theory of the origin of life and of radiation in relation to living beings, forming the subject of the present work which began to appear from 1923 onwards in various periodicals.

The Instinct of Orientation

At the outset I devoted my attention to investigating the causes of the ease with which certain animals succeeded in finding their bearings so unerringly during the longest voyages. Such are carrier pigeons, which return to their dove-cot after having flown a few hundred miles. Another example is migrating birds, which fly in a straight line day and night, speeding across the seas toward a definite destination that they cannot possibly perceive, partly because of their limited visual powers and partly because of the curvature of the earth's surface. They emigrate to feed on insects that they can no longer find in our latitudes at the approach of winter.

Some say that this is sheer instinct, while others prefer to call it special sense, but neither term explains the riddle. I hold that in science nothing should be mysterious. Such terms as instinct and special sense merely mask our ignorance and it should be possible to account for everything.

It seems more and more evident, as the following observations make it clear, that the sense of direction originates from special radiations of ultra short wavelength, emitted by birds and insects themselves.

Carrier Pigeons. We have all heard of the truly wonderful powers of orientation possessed by carrier pigeons. Although the faculty is innate it never the less requires a cer-

tain training before it is fully developed.

After the bird has risen in the air and circled round a few times, this faculty of orientation enables it without hesitation, even at night to fly towards its dove-cot, which is sometimes far away.

I have noticed the prevalence of this phenomenon and have ventured to give an explanation of it in the present work: all birds about to undertake long migration voyages (wild ducks, wild water-fowls, swallows, etc.) invariably describe, like carrier pigeons, a series of orbits in the air before starting on their final flight.

A most interesting observation made on July 2nd, 1924, at the radio station of Paterna, near Valencia (Spain), came to my notice. A flock of pigeons had just been released near an aerial of this station at the time of transmission. It was then observed that these birds could not manage to find their bearings and kept flying in a circular fashion, as if completely disoriented. This experiment was repeated several times and always reduced the same result, that is to say the disappearance, or rather a very marked perturbation of the sense of direction in carrier pigeons under the influence of electromagnetic waves.

These experiments were taken up again at Paterna, at the radio station of Valencia, under the control of the Spanish military authorities, and also at Kreuznach (Germany). The Spanish carrier pigeon service installed a military carrier pigeon station at Valencia, at a distance of about 8 kilometers from the radio station of Paterna. At the time of the experiment in question pigeons were released one by one at regular intervals of three minutes near the station while transmission was taking place continuously. It was observed that all the pigeons began to fly by circling round for some time, but without succeeding

in finding their bearings as they usually do after having flown around a few times. In spite of the change in wavelength in the course of transmission, no return to the normal condition was observed, so long as the transmission occurred, and lasted more than half an hour, no pigeons succeeded in flying in a definite direction. It is important to note that barely a few minutes after the transmission was over the released pigeons flew towards their dove-cot without the least hesitation, even those which had taken part in the first experiment.

Another series of experiments which took place on November 7th, 1926, in the same locality produced the same result.

The original experiments at Paterna put investigators on their mettle, for they could not understand the relation between the instinct of pigeons and the transmission of electromagnetic waves. The German technicians hastened to verify and control Casamajor's observations. In March 1926, they initiated a series of experiments similar to those carried out in Kreuznach, the conditions, however were different and more rigorous. A site was chosen so that the dove-cot and the radio station were diametrically opposed. Consequently this station was situated exactly as the crow flies on the course that the pigeon were bound to take. On arriving near the radio station it was noticed that the pigeons changed their flight, they were losing their bearings and appeared to be definitely disoriented. They did not succeed in resuming their course towards the dove-cot until their flying had brought them outside the intense electromagnetic field surrounding the aerial of the radio station.

It is noteworthy that the simplest explanation of this phenomenon does not seem to have occurred to any of the Spanish, French, and German experimenters, namely that

electromagnetic induction on the pigeons directive organs. They were all baffled by the significance of the phenomenon which they attributed to a curious anomaly they could not explain.

Nocturnal Birds

The Bat. The observations made on carrier pigeons appear to hold good for nocturnal birds also. It seems, a priori, that the sensibility of these birds to electromagnetic waves in general is different from that of diurnal birds by virtue of their special adaptation to light or darkness. These two species of birds, however, show a common feature, they feed on the same insects.

We are led to believe, as we shall see later, that they are attracted to their prey by radiations emitted by these insects. There is little doubt that daylight has an influence on the propagation of these variations. If the sunlight absorbs them, as it does in the case of wireless waves, nocturnal birds (various species of owls) should go hunting at night because their sensibility to reception, so far as these radiations are concerned, is less developed than diurnal birds. Conversely, if sunlight increases the amplitude of radiations, as seems to be the case for waves measuring several meters, then it is the excess of intensity of the radiations which would prevent nocturnal birds to go hunting during the day.

In this matter of sensibility of reception to special radiations, one is justified in assuming the existence of correlative differences in the organs of sight, as observed in diurnal and nocturnal birds. Among nocturnal birds, let us take the bat as an example. It is commonly believed that it is to the acuity of the senses of hearing and smell that that bat owes its ability of approaching its prey whose least movements it can detect, thanks to the vibrations of air reaching its ears. This hy-

pothesis may be admissible under certain conditions such as the calm atmosphere of the countryside. In Paris I have often watched bats from my balcony, on racing days, amid the uproar of a great crowd and the noise of thousands of cars setting up vibrations in the air, saturated with the products of petrol combustion. Amid this deafening din and vitiated atmosphere it is neither the sense of smell nor the hearing that guides bats straight towards insects (cockchafers, moths, etc.), which they catch as easily as in the undisturbed silence of the countryside.

The bat is thus most probably attracted to these insects by the radiations they emit, which are not influenced by noise nor petrol fumes.

Lemmings. This is another extraordinary example, the lemming, a kind of field-mouse whose habitat is in Scandinavian regions. The famous Swedish naturalist, Linnaeus, gave us an account of their peculiar expeditions.

"At the approach of sever cold weather and sometimes without any apparent reason, lemmings leave their natural habitat in the high mountains of Norway in order to make a long voyage to the sea. The emigrating throng, consisting of myriads of individuals, trots in a straight line across all obstacles with out ever letting itself be diverged from its goal. While proceeding Indian file they trace rectilinear parallel furrows, two fingers deep and several yards apart. They devour anything, obstructing their passage, such as herbs and roots. Nothing diverts them from their route. If a man should come across their path they run between his legs. If they meet a haystack, they gnaw their way through; if it should be a rock, they go round it in a semicircle and resume their straight course. Should a lake impede their

progress they swim across in a straight line, whatever size it may be. Is a boat in the way? They climb over it and dive into the water on the other side. A strong current in the river does not stop them, even at the risk of annihilation"

Is it possible that these animals are guided in their straight course by their sense of smell or hearing? They perceive smells and noises coming from all directions. Is it not simpler to suggest that these lemmings, although feeding on roots and seeds, and needing an occasional addition of small fishes, travel towards the sea, guided by the radiations emanating from the shoals of fishes upon which they feed? Further more, glowworms, microorganisms in decomposing meat, fire flies, etc., emit luminous radiations. And so, too, with certain animalcules whose presence in innumerable masses makes the sea phosphorescent it is also common knowledge that certain fishes known as torpedo fishes, give off electricity.

Thus an elementary intuitive generalization would seem to establish the fact that certain animals emit radiations which we cannot perceive, but whose effects are far reaching.

Role of Semi-circular Canals in Birds and of Antenna in Insects

Some naturalists have stated that the semi-circular canals of the ear, in many species, are endowed with special directing properties. If these organs are removed the birds invariably lose their sense of equilibrium and turn round and round, as though stupefied and incapable of taking a definite direction. Assuredly here is an interesting observation. But another observation of the highest importance has been made by scientists. The fluid contained in the semi-circular canals would appear to be particularly sensitive to

the influence of an electromagnetic field while the walls of the canals consist of insulating material. Now any wireless transmitter creates a variable electromagnetic field whose action makes itself felt at considerable distances. In view of the fact we may ask our-

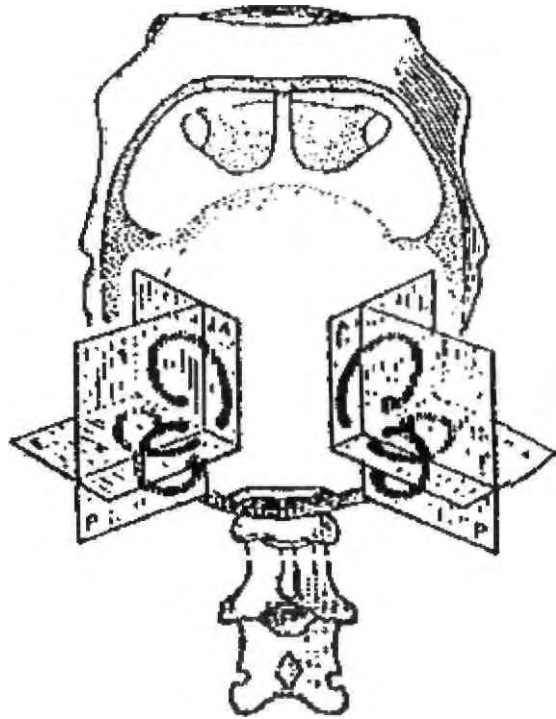

selves whether a great number of living creatures do not obtain their bearings through the agency of waves similar to those transmitted by radio stations. The semi-circular canals are susceptible of playing the role of a radiogoniometric receiver, a kind of wireless directional receiving apparatus. The very conformation of the semi-circular canals appears to support this hypothesis. They are arranged in three planes, each of which is at right angles to the other so that in the semi-circular canals the three planes of space are represented. Such a scheme constitutes a system of co-ordinates, necessary and adequate to determine the po-

sition of a point in space, or in the case under consideration, the position of a bird in the atmosphere, or yet the position of an insect in relation to the bird.

Animals on general, and birds in particular, do not move in a horizontal plane but in three dimensional space and the semi-circular canals have been devised accordingly.

The conducting fluids contained in these canals constitutes a directional receiving circuit completed by an accessory circuit in the form of a pliable spiral (self-conductance and tuning capacity)

In the strange world of insects many of them possess minute antenna enabling them to follow their course in a straight line towards relatively distant points. Nature does nothing in vain; these antenna would seem to exist only for the purpose of receiving radiations.

The similarity between the antenna of the insects and the aerials of radio stations is striking, by his similarity, however, is not as simple as it would appear at first sight. Owing to their relatively considerable dimensions in relation to the emitted radiations, the antenna of insects function in the manner of harmonics of a far higher scale than their fundamental wavelength.

Nocturnal Experiments with the Great Peacock butterfly. Let us consider, by way of example, the bombyx, in the light of observation made by Fabre in his work entitled "maeurs des insects." In the laboratory, soon after the emergence of a female from the chrysalis, Fabre observed that, at night, a whole swarm of males invaded the place, which leads us to suppose that this female was endowed with a certain "nocturnal capacity." Fabre also pointed out the difficulties of access to his laboratory surrounded by a multitude of trees. In spite of these obstacles the males al-

ways succeeded in reaching the female. The following day the same phenomenon was observed; it all seemed as if the sense of smell were guiding the moths. Fabre then gives an account which shatter this hypothesis.

In the first place, the moths of this species, known as the Giant Peacock, are well nigh impossible to found under normal circumstances. Thus the males must have come from a very distant site. Sound, light and sense of smell are out of the question, for the moth makes straight for the cage in spite of the variety of scents intentionally diffused by the experimenter in order to lead the insects astray. The factor of place memory may be ruled out as irrelevant.

Fabre also remarked that the moths were traveling in the same direction as the wind. It follows that if they had been guided by the sense of smell they would have to soar with the wind in order to catch the scented air. Diurnal Experiments with the Oak-bombyx.

In order to ascertain the influence of sunlight Fabre experimented in full daylight by studying the habits of the oak-bombyx, whose diurnal activities are more pronounced. But this insect, like the Great Peacock, is not to be found in the region where Fabre was working. How are we to account for the fact that it was able to come from its distant habitat? The male hurried along and found the female locked in a drawer or under a framework covered by cloth. In spite of the nauseating substances placed there by the experimenter.

According to Fabre, the following experiment would seem to confirm the olfactory sense hypothesis.

"I placed the female in a bell-glass and gave her a slender oak twig with withered leaves as a support. On the glass was the set upon a table facing the open window. On entering

the room the moths could not fail to see the prisoner as she was placed directly in their way. They tray, containing a layer of sand, where the female had passed the preceding morning and night, covered with a piece of wire gauze, was in my way. Without premeditation I placed it at the corner at the other end of the room, on the floor, in a corner where but little light could penetrate, about ten steps away from the window.

The outcome of these preparations completely upset my notions. None of the arriving insects stopped at the bell-glass where the female was plainly to be seen in full daylight. They passed on as though indifferent. Not a glance, nothing to put one on the track. They all flew to the further end of the room into the dark corner where I had placed the tray and the bell-glass. They all alighted to the wire dome... all the afternoon, until sunset, the moths danced about the empty cage a saraband which the real presence of the female would normally evoke... Finally they departed, but not all. There were some who would not go, as if held there by some magical force. Truly a strange result. The moths collected where there was apparently nothing... What had deceived them? All the preceding night and all the morning the female had remained under the wire gauze cover, sometimes clinging to the wirework, sometimes resting on the sand in the tray. Whatever she touched, above all, apparently, with her distended abdomen, was impregnated, following a long contact, with certain emanations. This was her lure, her love-philter. This it was that revolutionized the insect world. The sand retained these emanations or some time and diffused the effluvia in turn. Thus it is the olfactory sense that guides the moths and warns them afar off... The irresistible philter requires time for its elaborations. I imagine it as an exhalation

which is gradually given off and saturates whatever in is contact with the motionless body of the female... With these data in hand and unexpected information resulting from them, I varied the experiments, but all pointed in the same direction. In the morning I placed the female under he wire-gauze cover; for support an oak twig was provided. There, motionless, as if dead, she lay for hours, buried under a cluster of leaves which then would be impregnated with her emanations. When the hour of the daily inspection drew near, I removed he twig and put in on a chair not far from the open window. I left the female under the bell-glass, plainly ex-

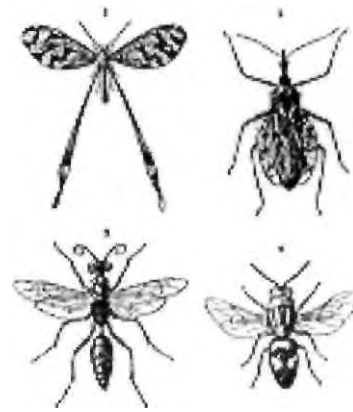

posed on the table in the middle of the room. The moths arrived as usual... they hesitated... they were still searching. Finally they found something, and what did they find? Just the twig... With their wings rapidly fluttering they alighted on the foliage exploring it all over, propping, raising and displacing it until at last the twig fell on the ground. Nonetheless they continued probing between the leaves."

From his experiments Fabre concluded that these moths were endowed with a sense of smell very different from ours and characteristic of their species.

Fabre's conclusion fails to satisfy me.

The act of smelling is dependent on mate-

rial particles which excite the olfactory sense, but the diffusion of these particles is limited to a short radius in the atmosphere. Thus it is not due to these particles that the moths were enabled to fly long distances.

I thought it fit, therefore, to repeat these experiments.

In my view, what attracts the males towards the female in the case of the Great Peacock and the Bombyx, is not the splendor of her colored mantle and her velvet wings, nor is it the odoriferous particles. It is rather the infinitesimal particles given off by her ovaries, microorganic cells radiating according to a scale of determined wavelengths and exciting the males desire of procreation.

This hypothesis is confirmed by the following experiment which I carried out myself.

New Experiments with the Oak-bombyx. After the emergence of the female from the chrysalis, a host of males rushed from all directions. After having left during the night this female lying on a leaf of cotton wool, I removed her the following day at noon. Then I placed, at a distance of 5 meters from the female, the cotton-wool leaf on which the males came to rest again.

I repeated this experiment after this time having dipped the cotton wool in a solution of pure alcohol, and observed the males stopped coming. The same result was obtained when the corrosive sublimate was used instead of alcohol. Now, neither pure alcohol nor corrosive sublimate could have had the least effect on the odoriferous effluvia. On the other hand these solutions had destroyed by sterilization the living cells which gave off the radiation that attracted the moths.

Burying-beetles (*Necrophorus*). The activities of these beetles on the decomposing bodies of dead rats and birds also appear in my theory.

As some naturalists have remarked, these insects play a hygienic part in the economy of nature, in the fields and woods; they scavenge upon death for the benefit of life. They belong to a certain species of insects which attack dead bodies and devour them until they have restored into the cycle of life this inanimate organic matter. The burying -beetle is essentially a grave digger, sometimes

traveling long distances to reach the dead bodies of rats and birds which it buried by various degrees into the earth so that they may ultimately serve as food for its offspring destined to be born on the same site.

The extraordinary social life of these beetles might be described at length. Let us confine ourselves to a characteristic which is relevant to our theory, the fact that they know how to direct themselves across great distances towards the dead bodies of rats and birds.

Is it likely that they are guided by the sense of smell? If dead bodies give off odors, the odoriferous particles cannot be diffused beyond a range of a few meters. This hypothesis is inadmissible, in the case of burying -beetles, as in other cases, in view of the great distances that have to be covered.

It is also important to observe that the beetles do not appear until eight to ten days after the death of birds and rats, when their bodies are in a state of decomposition.

It would seem, therefore, that it is the microorganisms arising out of this decomposition and oscillation according to a determined scale of wavelengths, which direct the burying-beetles or their offspring towards their food.

PLANETARY ASSOCIATION for CLEAN ENERGY

The PLANETARY ASSOCIATION for CLEAN ENERGY, Incorporated is a non-profit, charitable corporation whose objects are to facilitate the discovery, research, development, demonstration and evaluation of clean energy systems. The Learned Society also stewards the planning, coordination and implementation of clean energy systems on a planetary, continental, regional, local and individual scale. The term, "energy" can have application in the physical and metaphysical senses, throughout the range of scale described above. The term, "clean energy" can be understood to describe systems that draw on natural supply, which are of universal technological application and which do not cause polluting residue. In the process of facilitation, the Association sees the responsibility of serving as a monitor and alerter of "unclean energy systems."

The Role and Scope of the Radiesthetic Faculty in the Modern World

By AT. Westlake

(A Lecture given at the Congress of the British Society of Dowsers held at Malvern, 5th May, 1972)

It is I believe salutary to step back, so to speak, from time to time and survey the whole field of study and activities in which we as the Society of Dowsers are engaged, to see what we have accomplished, what we are doing at present, and what should be our contribution to the future.

The last time I made an attempt to do this was 1955, when at the Congress that year I gave, perhaps rashly, a paper on the Future of Radiesthesia, and in the light of what had in fact happened I am glad to see that I was not too bad a prophet.

My reason for attempting a similar survey 17 years later, under the present title, is because I believe we have still not realized the full significance of what we in the B.S.D. have banded together to practice and promote in these modern times.

It is still my belief, even more so than in 1955, that we have a great contribution to make, a contribution much greater than we envisage or imagine, as we are in fact in possession of a vital key which would unlock many doors of apparently insoluble modern problems, especially world-wide pollution in its many forms.

This key is the Radiesthetic Faculty, and the development of its full potentialities and their practical use and application which go far beyond the traditional finding of water, mineral ores and oil.

But let us start at the beginning.

The phenomenon of dowsing is very ancient. Neolithic man probably knew all about its practical use especially for sacred

structures, and the ancient Egyptians certainly did; but it was not until A.D. 1240 that we have any reference in European writings, and the first reference in England was in 638 in a book written in Latin by Robert Fludd entitled *Philosophic Moysayko*, followed next year by a certain Gabriel Platts who wrote about "A Discovery of Subterranean Treasure. The operation with the *Virgula Divina* is thus to be performed — I cut a rod of Hassel, I tied it to my staff in the middle with a strong thread so that it did hang even, and carried it up and down the mountains and it guided me to a vein of lead ore." Dowsing during these times was always regarded as something mysterious, even magickal and certainly having no rational explanation, and the movement of the rod attributable to either God or the Devil, or some baser spirits. Since that date although dowsing was well known both on the Continent and in this country it was not until the end of the 19th century that any systematic study was made of it, but in 1897 Prof. William Barrett, F.R.S., published a paper in the *Proceedings of the Society for Psychical Research* entitled "On the so-called Diving Rod or *Virgula Divina*— a scientific and historical research as to the existence and practical value of a peculiar faculty allegedly to exist in certain persons locally known as dowsing, with letters from 208 correspondents describing 140 cases of water-finding by 46 professionals and 38 amateur dowsers in 256 localities". And he made a further contribution to the Proceed-

ings in 1900 "On the so-called Diving Rod- a psycho-physical research on a peculiar faculty alleged to exist in certain persons locally known as dowzers, together with appendices by Ernest Westlake [my father] on the geological aspects of dowsing". The role and scope at this time were almost entirely confined to water and mineral ore dowsing, but the publication of these papers made dowsing for the first time a legitimate subject for scientific study. Subsequently they were added to and made into a book form published in 1926 under the title *The Diving Rod*.

The next milestone in England was the inauguration of the B.S.D. in 1933, and if you look at the early numbers of the journal you will see that the first object of the newly formed society was "to encourage the study of all matters connected with the perception of radiation by the human organism with or without instruments." Very wisely the founders, of whom Col. Bell was the leading spirit, did not define what was meant or included under the phrase "perception of radiation", but made the scope of the society as wide and inclusive as possible. I am sure that this has enabled the B.S.D. to have such success as it has had during the 39 years of its existence, as it has thankfully remained undifferentiated and has not become specialized.

Fortunately the founders also recognized at the beginning that the society was not just concerned with finding water or mineral deposits, but with "all matter connected with the perception of radiation by the human organism" which, in other words, is what I mean by the title of this lecture, "The role and scope of the radiesthetic faculty", as the phenomena of all forms and aspects of dowsing and completely dependent on the radiesthetic faculty and its right and proper func-

tioning. Their foresight is of considerable importance as it has made possible developments which I regard as crucial in view of the intractable problems of the modern world. At the beginning the Society and its members were mainly concerned with the traditional form of this perception in the phenomena of Rhabdomanancy - to use the old term for dowsing - which is defined "as the use of the diving rod especially for discovering subterranean water or ore".

But in the early days of the Society were filled with controversy between those who believed dowsing was purely a physical phenomena and could be explained in terms of modern physics, particularly electro-magnetism, and those who held it to be primarily a psychic phenomena. The late Mr. Maby, that indefatigable researcher, was a great advocate of the physical school of thought and indeed he is said that once one departed from the physical "all is chaos, confusion, subjectivity, and nonsense". But he did a great service to dowsing in insisting on the physical aspect which he set out to do in his book *The Physics of the Diving Rod* published in 1949; as it cleared the decks, so to speak. For it was essential first to determine the nature and extent of this physical aspect before it was possible to make a real advance in what may be regarded as the true idiom of the subject.

Maby's mistake was not in what he affirmed but in what he denied, in thinking that because the radiesthetic faculty could detect physical radiations that anything else belonged to divination and was not dowsing as he understood it and that exploration was necessarily unscientific and subjective. At the time he had a good deal of justification for his views, as the techniques and the required instruments to explore the supersensible side were not understood and thus not used, even though they could probably been available.

But it was gradually realized, by no less authority than Sir William Barret, that the attempt to account for dowsing on physical grounds alone must be abandoned; and indeed it is fortunate, for if physical radiesthesia were indeed all, we should be in sight of the end of dowsing for water, minerals, and oil as it is abundantly clear that in the purely material field the dowser will probably be superseded by the development of ultra sensitive instruments capable of picking up and analyzing all material radiations.

Nevertheless apart from Maby's and Franklin's research works little progress had been made by 1953 in other fundamental research, so much so that such an accomplished dowser as the late Major Pogson, when asked whether there has been any major advance in technique and results in the last 30 years, said he was bound to admit there had been none.

Round this time, as I recount in the Pattern of Health, I met Mr. W.O. Wood and had a remarkable association with him until his death in the autumn of 1957. I have found that he was all out for action, as he was clear that if ever we were going to solve the mystery of radiesthesia, we should have to enlarge and reorientate our ideas and concepts in a very vital and fundamental way. The physical and materialistic outlook is not good enough. It is valid as far as it goes, as we have seen in Maby's work for example, but beyond that is a vast world which is as once scientific and religious can be only understood in the light of "spiritual science", to use Rudolf Steiner's term.

The action he was after, in the light of this, he finally instituted in the winter of 1954-55 during an intense cold spell, and proved to be an exploration in depth of the radiesthetic technique now called Q & A, which I will consider more fully later on.

The main outcome of this work apart from its intrinsic value was that it brought him recognition as being a sound researcher and he was asked to give the lecture following the Annual General Meeting of the B.S.D. in 1955. He chose as his subject " Observations of some Problems facing the Society". As an outside observer he said he had a feeling for some time that the B.S.D. was not realizing its potentials or possibilities and had fallen into a state of scientific stagnation. Let me quote this passage from his lecture:

"The most important feature is the dowser's apparent unwillingness to tackle the full scope of the gift of sensitivity, and his tendency to restrict his thought to what has been described as the hewing of wood and the drawing of water. The thinking public are now well aware that the range of sensitivity cannot thus be circumscribed. The problems facing mankind are greater than the locating of wells and matching of remedies—plumbing and plastering, so to speak—and we have to come to grips with the issues of our times and face realities as they are. It is necessary that the sights of the dowser be raised in line with those of science and philosophy—so a problem is presented: whether the urgency and magnitude of the factors facing man do not force upon the dowser the choice between widening the scope of his activities, or rejection as having failed to provide for the full flowering of the gift entrusted to him—for the principles the dowsers seek are known to others, who seek in turn the means of proving them. The dowser has the means of proving them, but appears these days to be blind to the principles."

But there was already at this time one important exception, viz., in the field of medical dowsing, or radiesthesia as it came to be known from its French origin.

Starting as far back as the turn of the cen-

tury, radiesthesia had already been practiced by many French priests, notably the Abbés Bouley and Mermet, and by other accomplished technicians such as Turrene, Lesourd, Bovis and many others.

Knowledge of all this promising work came, in due course, to England, and six years after the founding of the B.S.D., the Medical Society for the Study of Radiesthesia was started in 1939 by Dr. Guyon Richards. He gathered round him a remarkable group of qualified medical men as well as some outstanding lay members. The society remained very active and alive for many years in spite of the loss of the founder Dr. Guyon Richards in 1946, followed by six others of the original group between then and 1952. Some years later it shed its lay associate members, since when, while still alive, it has ceased to be active.

Fortunately one member of the original group—Dr. George Laurence—has not only carried on and is still with us, but during the fifties and sixties developed and worked out a technique of diagnosis and treatment arising from clinical research work and assessment which is now known as Psionic Medicine embracing, among other things, McDonagh's Unitary Theory of Disease and Hahnemann's Theory of Chronic Disease, the latest work on DNA and RNA and some aspects of Steiner's Spiritual Science, but all depending on the functioning of the radiesthetic faculty. In 1969 the Psionic Medical Society was formed with both medical and lay membership, to foster and promote this new approach to the science and art of healing, which discovers, by the use of the radiesthetic faculty, the really basic cause or causes lying at the root of disorder or disease, and then treats these by radiesthetically indicated homoeopathic remedies—real creative medicine. In this it has been gratifyingly success-

ful, and with a technique of the simplest—a pendulum, a diagnostic chart, and actual witnesses, these latter to give greater reliability to the readings.

So in the field there has been much research and definite basic progress thanks to the full use of the radiesthetic faculty.

But medical dowsing also had an influx from a completely different source, this time from Dr. Albert Abrams whom Sir James Barr described as "by far the greatest genius the medical profession has produced for half a century". He produced, after an incredible amount of research and fortuitous good luck, his famous "Box", from which was developed in due course the Drown diagnostic and treatment instruments, and latter those of de la Warr, which later in turn gave birth to Radionics—instrumental radiesthesia—and the Radionic Association formed in 1943 "to assist scientific investigation, and the propagation of its findings". Unfortunately as had happened with straight forward water divining, understanding was badly hampered by the desire to explain the phenomena in terms of orthodox physics and to get the approval of orthodox science, and even when the later the Association was re-formed as a breakaway from the de la Warr setup, and took a new lease of life, it was, in its early days still bogged down in gadgets and gadgetry, and the true nature of the phenomena and this form of diagnosis and healing largely missed. But gradually the unique role of the radiesthetic faculty has been recognized as will be clear when we come to the technique of Q&A.

But apart from the development of medical dowsing in its two forms of radiesthesia and radionics there seemed to be a state of relative stagnation on the dowsing front and wider implications of Wood's warnings remained unheeded.

It appeared to me at this time that the important thing which must be done was to switch our attention from the mechanics of dowsing to the one factor essential to the phenomenon however it was operated, viz., the dowsing faculty; and so in 1959, at the Congress held in July, I read a paper entitled "The Radiesthetic Faculty" which was an attempt to understand the essential nature and function of this mysterious sense.

I do not propose now to go over my findings which can in any case you can find in Chap. XII of the Pattern of Health and my later thoughts on the subject in Chap. XVI of Life Threatened, but let me quote this summary:

"I believe that the rediscovery of the radiesthetic faculty in these modern times is not fortuitous, but that it has been vouchsafed to us by Providence to enable us to cope with the difficult and dangerous stage in human development which lies immediately ahead, for it gives indirect access to the supersensible world, more particularly to the etheric, thus raising our level of consciousness and extending our awareness and knowledge the faculty should be regarded as a special and peculiar sense halfway between our ordinary physical senses which apprehend the material world, and our to-be-developed future occult senses which, in due course, will apprehend the supersensible world direct."

It is moreover a faculty which can operate on various levels, particularly the subconscious of Huna Low Self level, but also the on the superconscious or Huna Higher Self level and higher ones still, according to the requirements of the situation and the training, discipline and knowledgeableness of the operator. This will I hope become clear when we come to discuss Q&A.

In my book Life Threatened, written some

years later, I discussed again what I thought was the modus operandi of the faculty and suggested, I imagined with good reason that the proprioceptive nervous system was directly involved, but further work would suggest that this was erroneous and that the working sequence is—etheric formative forces->red blood cells->the circulatory blood->the automatic nervous system->voluntary muscles->the movement of the pendulum. This said, let us go back to Wood's lecture. If he at that time felt strongly that the problems of 1955 needed "the full scope of the dowser's sensitivity", to use his own words, the need must be greater today with the vast and additional problems of 1972. Let us consider some of those to which it would appear we can make a very special and probably unique contribution to their understanding and solution in these modern times and one moreover now acceptable, if recent books like Arthur Koestler's The Roots of Coincidence and Edward Russell's Design for Destiny are any indication of public interest and concern. Here is a tentative list, but one which can and doubtless will be added to.

1. The search for water, oil, and mineral deposits. This is the well-known traditional field of dowsing and has in fact been, and still is, well covered though not as much as it should be by both professional and amateur dowsers.
2. Archaeological exploration. A more limited field at present but of considerable and increasing importance for historical research and the recovery of vanished prehistoric remains.
3. Architectural uses, such as site dowsing, in which must be include detection of harmful earth rays and detection of cavities, pipes, and drains etc. No dwelling should be

built until the site has been properly dowsed. Also the actual building material are important, and also the substances used in the furniture; steel for example, dulls the brain—it is a mineral hypnotic.

4. The locating of law breakers and criminals, missing persons, dead bodies, and lost or buried property and money. Increasingly important with the great increase in crime of late years. Should be used far more than it is in civil and criminal cases needing such aid.
5. Agricultural and horticultural uses. In such thing as the determination of optimum soil conditions, seed fertility and germination, plant health, and of good husbandry in general including the value of all additives and wholesomeness in all foods whether natural, manufactured, processed, or artificial and synthetic.
6. Personality assessment, by measurement of "brain radiation" as discovered and used by Dr. Oscar Brunler. It has manifold uses, educational and industrially, in estimation of talents, attitudes, personality problems and mental potential, etc.
7. Medical and Veterinary application. Apart from water diving, medicine has received most radiesthetic attention as I have already pointed out, but there are still innumerable problems to solve, and the only answer to many of them is in Psionic Medicine both diagnostically and therapeutically. Already enough is known to change the whole pattern of medical treatment but the public is being deprived by entrenched orthodoxy of this help and knowledge and of what

can be done both curatively and prophylactically. In veterinarian practice, if used more extensively it would undoubtedly help to prevent the gradual deterioration of vitality, stamina and resistance in farm and domestic animals.

8. Homoeopathy. The introduction of radiesthesia into the practice of homoeopathy would unquestionably mean a great revival in homoeopathic medicine, either as its own specialty or more sensibly in the form of a comprehensive medicine such as Psionic Medicine. Radiesthesia in this context solves the vexed and difficult question of remedy selection and potency.
9. Here we come to our dilemma—the whole vast problem of pollution and contamination particularly in its subtle and more intangible aspects of the present ubiquitous paratoxic environment in which we all now have to live or exist. Radiesthesia can be of inestimable value in giving us the knowledge and techniques of how to detect and deal with the subtle poisoning of all the polluting factors, for as Dr. Weinberg, Head of Oakridge Atomic Energy Establishment—the Harwell of America—said publicly; " The problems at One Rad are not amenable to the scientific method. Other approaches are necessary." He tables those questions which are beyond investigation with present assay methods as "trans-scientific." Psionic Medicine already provides one of those "other approaches" for dealing with effects in humans and animals; and doubtless other approaches, using the ra-

diesthetic faculty to discover them, will also be forthcoming. 10. And so to the last in our list-Question and Answer. Q&A. In which the operator must learn to use faculties of intellect and intuition, applying either at will and never confusing them—the intellect for the formulation of questions and the evaluation of answers, and the intuition and the radiesthetic faculty, to obtain the truth. Q&A. is eminently the instrument of scientific radiesthetic research. This I regard as the most important use of the radiesthetic faculty as it provides a bridge between two worlds—the sensible and the supersensible.

The elements of seeking and finding are of course inherent in all radiesthetic and dowsing work, but it is only in Q&A. that they become a deliberate technique, and there is conscious "asking".

As far as I know the first recorded use of the radiesthetic faculty in this way for deliberate research was carried out in 1956 by the group whose activities I recorded in my book *Pattern of Health*, Chap. XII—The Search of the Pattern of Health. The success of the group was undoubtedly largely due, in the first place, to Mr. Wood whom I described as "an ideal question-master"; "His skill at his was quite remarkable, as he had exceptional flair for framing precise and correct wording of the question, and followed it up with exactly the right supplementaries. He had a quick and agile mind, yet at the same time it was under the control of his highly informed reason. An ideal combination".

Those of you who have read the *Pattern of Health*, particularly the chapter in question, will know the invaluable insights which were

vouchsafed us at his time particularly in regard to the levels of consciousness on which the radiesthetic faculty operates, and the fact that "pattern" appeared to be of great importance in this work, which in this instance emerged in the seven healing patterns, of which three—the diamond, the Celtic Cross and the Star of Bethlehem—gave such remarkable therapeutic results. The conditions governing the use of Q&A were also worked out.

But there the matter rested and has remained dormant for some years now, as with the death of Mr. Wood in 1957 the group dispersed and no further group research was done.

Just recently however it has blossomed forth again in an enhanced form in the work of two talented researchers in the radionic and radiesthetic fields of study. The first is Mrs. Jane Wilcox (now Chairman of the Radionic Association) who most fortunately was able to draw on the experience and informed advice of Major Blythe Praeger (one of the members of the original group) and who proved to be a very apt pupil. So much so that at the recent conference of the Association in March this year she gave the closing lecture in titled "Question and Answer", with the intriguing sub-title of "A Bridge Between Two Worlds". This was cast in the form of query and answer, her husband asking the questions. This proved to be an outstanding contribution. All who were fortunate enough to hear it felt that here was a great advance in our understanding of the role and scope of the radiesthetic faculty.

What impressed me particularly was that her own investigation of the technique confirmed our original findings, but also produced some most important additions; for example she started off originally simply to

improve the reliability of her own radionic healing work but found, to quote her:

"...That the whole process of the art of Q&A. is a vastly larger subject than a means of obtaining specific information in any one specialized field. I see it as a means of integrating the personality and of learning how to construct a bridge between the conscious and unconscious worlds in relation to life as a whole. In short that Q&A can be used as a process of self-development."

Understanding and integrating herself as a personality she found necessitated the awareness of her subconscious - the Low Self in Huna philosophy- that as it can be a good servant but a bad master, it had to be properly instructed and disciplined, otherwise it gave the answer that it thought the conscious self wanted, or else it played up, or in some instances gave false answers, for unconscious emotional reasons.

But equally and more importantly it meant a recognition and realization of the existence of the super-conscious or Huna High Self, how to contact it and how to differentiate between the roles and functions of the two selves; as well as the relationship of the conscious of Middle Self to the other two, and the need for the acquisition above all else, in this relationship, of clear and responsible thinking.

The construction of the "bridge" required:-

1. A mode and code of communication i.e. the movements of the pendulum and their interpretation.
2. The nature and formulation of the questions to be asked which requires
 - a. Finding out in any given case whether the question is legitimate e.g. idle curiosity is out, questions about the future, and inadequate

formulation due to insufficient knowledge.

- b. If it is legitimate, the need for clear and precise thinking base on adequate knowledge so that there is no ambiguity or double meaning which in its turn means
 - c. Finding the right words to exactly express the thought. This requires a large vocabulary, and English with its richness of language and abundant synonyms is ideal for this purpose, and the book which is essential is Roget's Thesaurus; and to help in this task of exact selection, Q&A can be legitimately used.
3. The answer then requires intellectual assessment as to whether it makes sense of not, if it does this will lead to other questions and the elucidation of the given problem. Or it may make nonsense or there may be no answer at all. If this latter, Mrs. Wilcox says that at the beginning she looks for interfering emanations usually paranormal, but gradually came to realize that was too facile an interpretation and that it meant something was to be learnt, that, what she called the "teaching element" of the High Self was trying to draw her attention to something important and thereby broaden her ability to understand the truth. She found in this situation she had to ask four questions.
- a. Am I allowed to ask this question?
 - b. Am I asking the wrong question?
 - c. Are 'You' trying to teach me something?
 - d. Do I need to ask a subsidiary question before you can answer me?
4. It is necessary to realize that the answer may come from two levels, from the subconscious or the super-

consciousness. Apart from the nature of the content of the answers there is an essential difference which one comes to recognize—the answer from the super-conscious sources have, to quote Mrs. Wilcox: "an authenticity and simplicity of quality which just does have a true ring about it". But on this level 'ask and ye shall receive' holds good, but you must ask; but clarity of thought in framing questions is a must—neither source can answer muddled questions."

5. Finally the most vital realization of all is, according to Mrs. Wilcox, "that no help will be forthcoming unless and until one has first done one's very best to answer the question by utilizing one's natural gifts and faculties".

The second researcher in the field is Mr. Malcolm Rae who interestingly enough came to Radionics from a life of wide experience both in commerce and business. But being a very practical and inventive type he thought at first that advance would come from improved and more sophisticated radionic instruments, and in fact he produced a very successful 40 dial one. But he soon came to see that it was not so much this that he wanted, as an improved human operator whose essential requisites are:

1. That he or she is a seeker after truth.
 2. Has a trained and disciplined intellect.
 3. Has a wide and varied knowledge.
 4. Has a well developed and trained radiesthetic faculty.
 5. Has a simple instrumental technique.
- And that the research undertaken should be based on real problems confronting the investigator whether in medical work or indeed in all the other fields already men-

tioned.

As I find myself in a difficulty in trying to record this work, far as more supersensible knowledge has come through it is constantly changing in both form and content in order to incorporate the additional truth revealed. Such advances come about as a result of pegging away at the cases he is treating which do not respond to treatment, and thus the endeavor to find out why; what has been missed; had there been a wrong interpretation; or does the problem require looking at from a new angle?

But in this way a truer and truer pattern of healing has begun to emerge with proportionally less and less failures. This however has required a very flexible approach and the rethinking of a number of things, e.g. the real nature of those mysterious radionic rates, as well as many other things apparently accepted as gospel.

In February of this year he gave a paper to the Medical Society for the Study of Radiesthesia entitled Radiesthesia and Thought, which is an excellent example of how, employing the radiesthetic faculty in the technique of Q&A it can be used as the instrument par excellence in basic scientific radiesthetic research.

He found that one of the first essentials is to distinguish between truth, i.e. facts, and opinion, and he suggests that if the usual intellectual assessment of relative truth is used it is very difficult to do this, but using radiesthetic assessment the task is far more sure and conclusive. This he found could be done by a suitable designed truth chart on a base of magnetic rubber, which latter tends to reduce the interference of the intellect.

Working with this and Q&A it has been possible to determine certain fundamental axioms such as, and I quote Malcolm Rae: "Everything in the universe, as far as I

know, consists of a system of energies operating within boundaries. The boundaries describe structure and the energies describe the functioning within the structure." This led to the concept, and I quote again: Any deviating from the planned function of anything in the universe is caused by an alteration in the pattern of boundaries and energies. Any detrimental deviation is due to the displacement of a boundary, and a displaced boundary becomes a barrier. The introduction of a barrier into a system of boundaries and energy flows tends to turn all boundaries into barriers and all energies into stresses."

As the radiesthetic faculty would appear to detect boundaries and/or barriers it can then be used to measure the difference between a boundary and a barrier and this would represent the degree of deviation from normality or health." This difference or deviation can be expressed in mathematical terms in what would appear to be sets of co-ordinates of a very complex nature, and in the case of Man involving six sets on the given frame of reference which can be determined radiesthetically in detail, and which describes all facets of Man in his environment.

This introduction of mathematics is very interesting for as Canon Glazeswki in a paper entitled "The Human Field in Medical Problems" said, and I quote:

In 1946 Prof. Mayer Ibach from the medical faculty of Hamburg University came to see me and spent five hours in discussion, insisting that math should somehow be introduced into medical problems. He was at the time, as he said to me, writing a history of medicine, and that whenever math was used in this branch of knowledge, medicine was rap-

idly developing, and has declined in its absence. It was for both of us a problem how this could be effected properly." Malcolm Rae has it seems provided an answer.

These sets of co-ordinates would appear to be the old radionic rates in a new and vastly more accurate form and frame of reference. But Malcolm Rae has gone further and has investigated how this whole process appears to work in a human being.

We are born, according to him, and I quote:

"With an enormous number of sets of co-ordinates related to the many requirements of living on this planet, and we add them subsequently by the experience of living."

These co-ordinates can be activated when conscious attention is focused on them, but and I quote:

"Conscious mentation could not compute the required combinations of co-ordinates (and thus relative intensities) rapidly enough to sustain life in an environment which is liable to almost instantaneous change; and whatever it is in the subconscious that serves this purpose, in combination with the sets of co-ordinates available to it, is plainly able to achieve feats of mathematics which would confound our most sophisticated computers tended most by their programmers. Radiesthetic Q and A yielded, firstly that which is responsible for energizing the appropriate co-ordinates to sustain life within those changes of environment which man was designed to withstand, it's a Principle; and secondly, that the most accurate verbal description of it is 'the Essential Simplicity'."

And he comments:

What an inspiring description that

is-the essential simplicity-the simplest and thus most efficient employment of man's essence in conducting the behavior of his substance!"

These two, i.e. "Attention" in the conscious and "Essential Simplicity" in the subconscious as designed by the Creator, should work perfectly together in harmony but since we are human beings we are constantly interfering and upsetting the programming. "The attempts of the 'essential simplicity' to cause the individual to take such steps as are required for the bodily well being, and to avoid those that are detrimental to it-culminate in complexities of compensation dis-integrative to the wholeness of man."

In the light of all this, "therapy" becomes clear, and I quote: "In man, a boundary which has become a barrier, once it is correctly measured, may be treated with the appropriate corrective message in the form of a remedial pattern carried by an oral remedy is projected from a suitable instrument." This is where homoeopathy with its potentization comes into its own, as it provides the correct therapeutic patterns which are necessary to once more restore wholeness.

This is only the barest and I fear, inadequate outline of this important paper, which of course contains more than I have mentioned, so it should be read in full, as these results of years of research work, appear to be basic truths as measured by the truth chart. There is a part of a prayer by Thomas Aquinas which runs like this: "Grant me penetration to understand, capacity to retain, method and facility in study, subtlety in interpretation and abundant grace of expression" which expresses what Rudolf Steiner saw as necessary to modern times and I quote: that "... it is not by mystical experience which divorces itself from reason and de-

spises logic, that man returns to his spiritual heritage, but by the path of pure, concentrated thinking in which logic is never contradicted."

Jane Wilcox and Malcolm Rae would not have arrived at these important discoveries and conclusions if they had not exercised increasingly clear, precise and exact thinking—the formulation of true thoughts—in all this Q&A work. Their aim was the pursuit of truth, and so they learnt to ask creatively for the truth and therefore received it, obeying the injunction "Ask and it shall be given unto you."

But there is still a difficulty.

"Two Thousand years ago, Christ initiated human feeling and devotion into faith in the spirit-world and in the reality of man's spiritual destiny, and so made possible the evolution of his ego-consciousness and the development of his powers of thought. Today He would make possible for him the recovery in clear knowledge and understanding of his true spirit-heritage, by initiating his thinking into direct spirit experience. The redemption of thinking is the completion of the spirit-initiation of mankind by Christ."

I put it there because I felt it to be profoundly true and of the greatest importance, yet I could not see that any but a very small minority could attain to sense-free thinking which was said to be requisite if this was to be done and which only adepts such as Steiner could accomplish. It seems to rule out the vast majority of us, bogged down as we are in our material values and ways of thought, and yet it seems essential we should try, so that we too could discover, to quote Steiner "that besides powers and possibilities of thinking as an instrument of knowledge it had functions of which man had lost all knowledge, viz., a creative function—that it operated as a creative formative force in the

life of man both in the spiritual and physical world".

In meditating upon all this it came to me that perhaps in the technique of Q&A we had already been given an answer, that all who practice Q&A in spirit and truth are in fact bringing about the redemption of thinking and recovering its lost creative functions, with all the incredible consequences for good that would ensue, such as complete transformation of science so that it becomes "a science of Reality, which would embrace both material science and spiritual science in one majestic whole—a true science of the cosmos."

So maybe in the end the ultimate role and scope of the radiesthetic faculty in the modern world is the redemption of thinking— a bridge between two worlds.

Let me end this with a quotation from my book *The Pattern of Health* written in 1961 in which I appear to have foretold the role and scope of the radiesthetic faculty, as it had unfolded in the last 11 years:

"All human thinking, since the Fall of Man, is liable to error and untruth, only through the Spirit of Truth can we be preserved in this materialistic age from falsehood and destructive thinking. "God hath chosen the foolish things of the world to confound the wise and God hath chosen the weak things of the world to confound the mighty; "And base things of the world, and things which are despised, hath God chosen, yea, and things which are not, to bring to naught things that are.' "In the eyes of the world Radiesthesia is a thing of no account compared with , say, nuclear or astro-physics or atomic research, and yet, as I have tried to show, it can, when properly understood, open us to mysteries both in this world and the

world invisible. It can reveal to us the truth in so far as our finite minds can comprehend it.

"I believe profoundly that it is the privilege of Radiesthesia to make its very special and, in some ways, unique contribution to the reintegration of material science and spiritual science, and to that restoration of wholeness of vision and outlook, of feeling and thinking which is the task of this age."

Selections from "Physical Radiesthesie"

By Pierre Beasse

Chapter 2

III. SPECIFIC RAYS OF BODIES

We owe to the studies of Engineer Voillaume and to his remarkable critical sense the satisfactory elements we possess on the specific radiation of simple bodies.

We may conclude from those studies:

1. As well as Hertzian heat and light waves, the specific radiance of a body is really an electro-magnetic wave, with all its properties.
2. This radiation is not simple, but compound in the case of a simple body determined by a beam of radiation the dispersion of which is easily contained, and whose wave-lengths correspond to each of the spectral lines of the body optically determined. Those lines which are in limited number in the case of visible rays, are on the contrary fairly numerous in ultraviolet
3. The pendulum gyrating positively above the electro-positive bodies and negatively above the electro-negative ones, the gyrating direction constitutes a real specific property for each body, which M. Voillaume has called the polarity of the body
4. Specific rays reflect and refract as light-waves; thus, bodies have for those waves indices of refraction as transparent bodies have for light.
5. As rays of light, they produce phenomena of interference and diffraction.

Synthesis of specific waves: By a method of description of which was given in "La Balance Pendulaire de Precision", M. Voillaume has succeeded in effecting the synthesis of the specific waves of

bodies. The artificial radiations thus obtained have the same characteristic as those radiated by the imitated body (sequence adjustment, fundamental



ray, etc.). The results of that synthesis seem to constitute an indisputable proof of the veracity of the preceding conclusions.

Carriers of specific waves: M. Voillaume has ascertained that the range of specific waves radiated by bodies was very short (only a few millimeters, a little more in some parts). In order to be propagated at a distance, those radiations need a powerful carrier wave. These we find in nature are electric, magnetic, nervous waves, etc. The carrier of a radio-active radiance, which is very penetrating, may also be artificially produced.

The range and penetration of the specific waves are carried depends on those of the carrier-wave.

The rays with an electric carrier are stopped by insulating matters (glass, cardboard, silk, paper, gutta-percha, porcelain, etc.): the rays with only a magnetic carrier are stopped by iron, the rays of a nervous carrier, by porcelain or cellophane, the radio-active rays by lead, and rays with light-carriers by opaque bodies.

Radiation of compound or complex bodies:
Compound bodies or complex bodies emit the specific radiations of each simple body belonging to their composition. They emit also special radiations, which probably result from the composition of the vibratory motions of their elementary radiations.

Accompanying rays: We have spoken above of carrier waves, which carry another radiation and enable it to penetrate through screens which would normally have stopped it. The telephone, with or without a wire gives us examples of carrier waves supporting carried waves.

But there exist numerous cases of radiation in juxtaposition without any connection between them, moving in parallel directions, and at the same time, and emitted by the same source.

Those waves are called accompanying waves one of the other. Sunlight gives us an example of a ray of light accompanied with many radiations of a different nature, calorific rays, chemical rays (I), etc.

IV NERVOUS INDUCTION

The human body, as we shall see in Chapter VII, emits a certain number of different radiations which have been studied by M. Voillaume the wave-lengths of which are very similar (about ten microns) and situated in the infrared zone.

Many of those different radiations under different names have long been known to dowsers, whose prospection is thus facilitated.

When those radiations meet a body, or the rays it emits (reflected or refracted rays) they

are used as support by the specific waves they touch, and bring it back to the human receptor.

ANTENNA RAY (see figure 17): When, with a pendulum adjusted for a body, you move the left hand, horizontally stretched, in different directions, the nervous rays emitted by the tip of the fingers, when they are in the

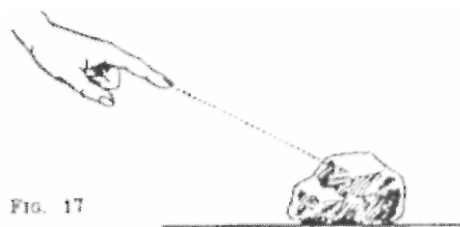

direction of this body, and at proper length, bring back the specific rays emitted, causing the gyration of the pendulum. Those rays are called antenna rays.

In that phenomenon there is undoubtedly attraction and deviation of the existing radiations, and perhaps production by the inducement of new rays. Precise experiments in the laboratory are necessary to ascertain it.

We may catch the rays of a body by directing the left hand a few meters above its horizontal surface, and intercepting its rays at a maximum angle of 45° and 13.5° .

In the same way, if we ask an assistant to place on the vertical of a body a porcelain plate, and if we stretch the hand in the direction of the reflected beam, the pendulum will gyrate every time we meet the beam, even if we turn our back to the body.

It shows that if, in prospecting, the ray of antenna gives indications on the relative proximity of the body sought, it may give on its actual place only vague indications, which must all be checked, and confirmed by other methods as it may have caught a remanence or any other radiesthetic image.

If we stretch the left hand towards a radies-

thetic field (ray of union, paraboloid of sensitivity, etc.) the adjusted pendulum will (1) not gyrate. It would be different if the hand came into the field, and was directly catching the vibrations.

As with every electromagnetic wave, the nervous ray, which is supported by the ray of antenna, can be reflected or refracted. It gets through certain screens like cardboard and silk, and reflects the specific rays; but is completely blocked by porcelain.

The reach of the hand may be lengthened by a stick or a point which the latter case permits the eliminations of parasitic radiations of feeble intensity and certain images.

CAPITAL RAY: The capital ray was first noticed by Abbe Mermet. It is produced in the same conditions as the aerial ray, and in the same manner. It is produced by the meeting of a body (or its direct or deviated emissions) with nervous rays which start from the eyes of the operator.

When a pendulum is adjusted on a body, every time we gaze at it or direct our looks on its vertical or on the rays at 45° or 135° emitted by it, the pendulum gyrates. It will swing when we look in another direction.

The capital ray is very useful for the dowser, whose interest is to look at the body on which he is working. By catching in that way a greater quantity of rays, he increases considerably his sensibility. This advice is especially recommended for the beginners. The capital ray is produced even when the eyes are fixed on the place occupied by the body in an opaque box, but permeable to nervous rays.

MENTAL RAY: When we think of an object, the E.M. (Electro-Magnetic) wave consecutive to this motion of the brain due to the action of the intellect, automatically di-

rects itself towards this object and, as in the two proceeding cases, brings back the specific waves.

Let us for instance adjust our pendulum on silver, and let us put a coin of this metal on the table, and shut our eyes. We shall find that whenever we think of the coin, the pendulum gyrates; and that on the contrary, it swings as soon as we think of another object. M. Voillaume, who has made a special study of that ray, has determined its starting points, which vary according to the position of the body under consideration with relation to that of the operator, one of them being, in most cases, a particular point of his temple which is nearer the body.

He has been able to reflect, refract, and polarize the ray, the properties of which are no more questioned nowadays. If we think of an object enclosed in a space which is not permeable to specific rays, but open to infra-red rays, the pendulum ad-

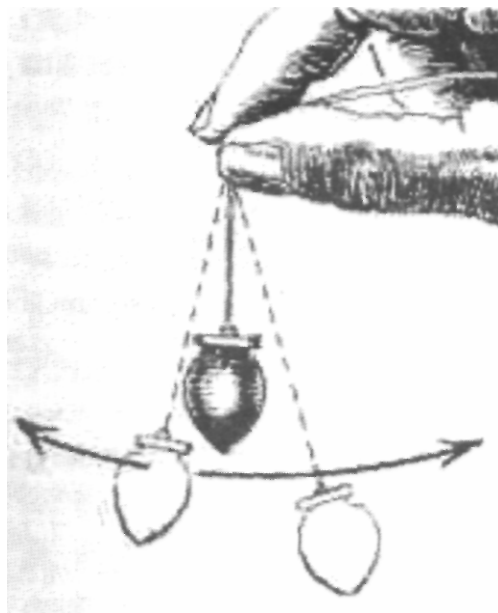

justed on that object will gyrate. If on the contrary, we hide the object with a porcelain screen, the mental ray, not being able to reach it, the pendulum will swing.

IV. PHENOMENA OF SERIES

A pendulum being adjusted for a determined body if we place it above that body, it will start gyrating. If we give it a jerk, or if we raise it vertically, it stops; then starts gyrating again. After a certain number of interruptions of the gyrating (the number being constant for each body) it stops gyrating and begins to swing in a fixed direction, which is that of the fundamental ray of the body.

The number of jerks which determines the complete stop of the gyration is called the objective serial figure of the body. The series is positive if the pendulum gyrates in the positive direction, and negative in the reverse case.

One may also (and it is a process used by Major Gorceix) determine the objective serial figure in the following way.

Place the forefinger of the left hand above the body; the pendulum adjusted to it gyrates; bring down the finger, and place it in contact with the body; the pendulum swings. Raise the finger, then bring it down so as to obtain an alternating series of gyrations and oscillations. When the quantity of gyrations has reached the serial figure, the pendulum refuses to gyrate, and swings in the fundamental plane, as in the preceding case.

The serial figure, and the direction of gyration are constant for a determined body and an operator with a given polarity. For a right-handed man the electro-positive bodies have positive series. For a left-handed man the signs are inverted.

In order to avoid errors which might proceed either from the impregnation of the pendulum, or from previous operations, one must carefully clasp both hands before determining the series.

"Particular Number" of Radiation: We have used the expression objective serial figure in order not to brake with an established terminology. But it is quite obvious that the expression, which denotes a special number, applying essentially to a determined radiation, is inaccurate. Until we can know definitely the factor which causes its appearance, it would be more logical to call it, provisionally "particular number" of that radiation.

That number, which is already manifested by many phenomena, occurs in the subjective processes for the research of the serial figure. Certain of them, with very few exceptions, permit to discover it exactly; others give it in a form of its multiples, or of a more complicated relation. The studies of Colonel de Marsay indicate that, in all cases, the same operator may obtain with completely different detectors, completely distinct subjective results.

In this case, instead of trying to find, by empiric process, an entirely subjective number, it is infinitely simpler to determine the "particular number" itself of a source of emissions, by superposing near this source red or white squares of cardboards. If n cardboards turn the gyration of an adjusted pendulum into an oscillation, $n-1$ will be the particular number of the observed radiation.

It is to be noticed that the gyration of the pendulum will take place in the direction of the fundamental plane of that radiation.

Chapter 3

VERTICLE RAYS AND RAYS WITH A FIXED INCLINATION

Under the action of the electric field of the earth, any body emits

1. On all surfaces and both in the direction of the zenith and in the opposite direction, a thick bundle of vertical rays.

2. On a special line of that surface, two thin sheets of rays with the respective inclination of 45° and 135° on the vertical.

If the body is of very small dimensions, if it is reduced theoretically to a physical point (which is the case for a milligramme of buried gold) the inclined radiation which we have just mentioned develops along the generating lines of a double cone of revolution with a vertical axis having that point for its vertex.

If, instead, of a physical point, the object is a disk, a cylinder, or a solid revolution with a vertical axis placed on a horizontal table, the emission radiates in two frustums of a cone of revolution each having as its basis the circle constituted by the middle of the disk or the apparent horizontal outline of the solid revolution.

If we deal with a body of different shape and position (let us add, however that its shape must be simple, and almost continuous) the laws of that double emission seem to be liable to be expressed as follows:

1. The vertical emissions is
 1. The vertical emission is produced on its whole surface, in two solid sheets and in two opposite directions.
 2. The emissions inclined at 45° and 135° develops in thin sheets along the apparent horizontal outline of the body. It takes the shape of two opposed ruled surfaces, having as common directors the aforesaid outline, and for generating line the straight lines in contact with this director, and with an inclination of 45° and 135° , in a plane which is perpendicular to the surface of the body.
 3. That apparent outline is, at the same time, the geometrical locus of the points of separation of the vertical rays with opposite directions.

4. If the body, instead of having a simple and nearly continuous shape, has many successive swellings, it must be considered from the point of view of its radiation, as the superposition of several independent bodies having their own emissions.
5. Lastly, if, in the perpendicularity in which we consider it, it offers protuberances, handles, ears, etc., forming prominences on the horizontal projection, those protuberances are the object of a complementary radiation, which is added to the normal radiation of the body.

A. Vertical rays

In the account which he has given in 1934, at the Congress of Radiesthesie of Lausanne, M. Voillaume explains that, in consequence of the vertical electric currents, principally currents of conduction due to the action of the electric field of the earth, and also the ionization of the air, each body emits vertical rays which are perceived and exactly localized by the pendulum.

For instance, it suffices to place a pendulum adjusted for silver over a silver coin, and give it a slight swing for the oscillation to the completely transformed to a gyration.

Carrier: Those radiations have an electrical carrier, as is easy to verify through the process of identification which have been indicated in a previous section (a carrier with a negative polarity for rays with an upward direction, a carrier with a positive polarity for rays with a downward direction.)

Under the action of that current, the waves may reach, sometimes, a great height, the limit probably depends on the actual intensity of those currents, and perhaps, also, of the mass of the radiating bodies. During experiments on board an airplane, M. de

France has been able to detect up to a height of 2,500 meters (2733 yards) vertical waves emanating from streams, or from electric lines of high tension.

The radiations at 45° and 135° have both electric and magnetic carriers.

B. Rays with a fixed inclination

The magnetic field of the earth which, in a special direction fixed for each substance, is the cause of the emissions of the fundamental ray, which we shall study further on, also acts in other directions.

According to the terms of the aforementioned report, if we examine a body under the influence of the two fields of the earth—electric and magnetic—we can see that the way in which their effects compound gives birth to the formation of special fields which carry the waves in a fixed direction.

Let us indeed study the radiations of a body which has the shape of a solid revolution, say a regular urn, to take a concrete example. Let us place the urn on a table which is perfectly horizontal.

We shall find that two electric fields develop, one in the upper part, the other in the lower part of the object, both having the shape of two conical frustra with rectilinear lines of force, reaching up to a direction of 45° in the first case, and starting from that of 135° in the other case. The lines at 45° and 135° which form the common limits of the two fields have both electric and magnetic carriers.

In addition to those rays and to the vertical rays M. Voillaume has identified other rays with a fixed inclination, that we shall try and identify on our urn.

1. In each of the two electric fields, upper and lower, six conical surfaces at an equal angular distance, forming

zones of emissions with an electrical carrier separated with zones of interference.

2. In the magnetic field which separates the two electrical fields, six other similar conical surfaces magnetic carrier, separated— as the former —by zones of interference. Those cones are more and more open, till, at the end, they become identical with a horizontal plane and produce an emission in that direction.

C. How to detect the normal radiation of a body

According to what has been said, in order to perceive the normal radiation of a body at which we are looking we must, first, adjust the pendulum on one of the radiations of its specific beam. We may work either with a merely experimental adjusting, or with a more precise adjusting. The pendulum being once adjusted should be placed in such a way that the hanging point of the string is on the vertical of the body. The slight swinging that we shall then give to it will immediately be transformed into a gyration.

CONTACT WITH THE FOREFINGER:

The forefinger of the left hand may also be placed in contact with the body. Acting as conductors, the nerves of the hand will conduct the waves to our nerve centers the instantaneous impression of which will determine the reflex which produces the reaction of the pendulum.

III. PHENOMENON OF THE FUNDAMENTAL RAY

Each simple body emits, under the form of a sheet situated in a vertical plane, a radiation in a special direction which character-

izes it. That ray, discovered by Abbe Mermet, has been called by him fundamental ray; and the plane in which it propagates, the fundamental plane of the body. The pendulum adjusted on a body swings intensely in the fundamental plane of that body, and seems subjected to a kind of attraction that keeps it in that plane.

In order to strictly accurate, from a geometrical point of view, the term fundamental plane should be applied only to an object of infinitesimal dimensions. For an object of appreciable dimensions, it designates the medial plane of a kind of box with vertical sides which constitutes the field which the fundamental rays propagate. That field, the width of which is equal to that of the body, is limited in height by horizontal planes, and in length by vertical planes; the one which stands nearest the object tangent to the fields. Its dimensions depend on the emitting body. It is crossed by specific rays of the object which have a magnetic carrier.

USE OF THE FUNDAMENTAL RAY:

Supplementary to the adjustment and the series, the fundamental ray permits to identify a body or a radiation. As for the series, we shall see that its orientation is the same, whatever the particular wave length of the distinct radiations of the bundle of emissions of a body that we were using to obtain it. We shall draw an identical conclusion.

DETERMINATION OF THE FUNDAMENTAL RAY:

The fundamental ray can be only determined by means of a neutral pendulum. To determine its fundamental ray, one moves round the body, and close to it, with a pendulum adjusted on the substance of that body. As soon as the pendulum enters the

fundamental plane, the direction of which is thus very clearly indicated.

HYPOTHESIS ON THE DETERMINING CAUSE OF THE PHENOMENON OF THE FUNDAMENTAL RAY:

First the fact that the phenomena of the fundamental ray does not constitute a special property of a substance, but on the contrary that of an electromagnetic wave (electricity, magnetism, radioactivity, noxious rays, waves of living beings, waves of diseases, specific waves of simple bodies, etc., etc.); secondly, the fact that the pendulum shows clearly a reaction not only in its direction but also in an other direction which is perpendicular to it

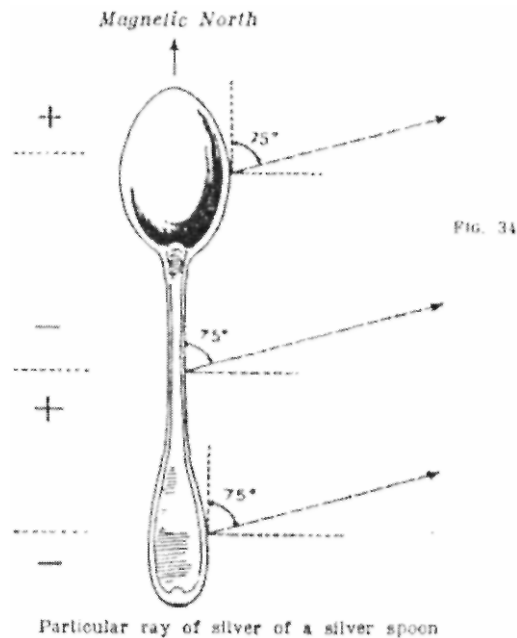

induce us to for the hypothesis that the orientation of the fundamental plane would be that of one of the opposite directions in the magnetic field of the vertical waves.

V. PARTICULAR RAYS OF SIMPLE BODIES

In these conditions, if α is the orientation of the fundamental ray, taken in a clock wise direction starting from the magnetic North, of a determined wave, the direction of the electric field of the corresponding vertical wave would be perpendicular to it. If the wave is negative, $\alpha + 90^\circ$ would be the direction of the second reaction of the Schumfell, and if it is positive, it would be $\alpha + 270^\circ$. In fact, it is with these characters that the second reaction appears.

Experience shows, in fact that, whatever may be the polarity of the wave, it is always in a direction of $\alpha + 90^\circ$ that this second reaction is produced. It also permits to see that two radiations with a same wavelength but inverse polarity have fundamental rays making an angle of 180° .

Although our hypothesis seems to rest on a serious basis, we only give it under all reserve, hoping that laboratory experimentation will permit one day, either to verify or to invalidate it definitively.

To sum up what has been said and what will be said further on, we shall add that the fundamental plane is a vertical plane in which specific waves of a determined substance, of that of a bundle of radiations propagate, with a particular intensity, but in one direction, starting from the radiation source.

It is the field of the fundamental plane the principle property of which is to be a space through which travel the specific waves of the object with a magnetic carrier, and also of the α rays (radio-active), with a limited length, which many dowsers, believe to be emitted under an angle which is consistent for a determined substance.

Simple bodies emit, in a fixed azimuth, and in a constant angle with the horizontal plane, a specific radiation, almost filliform. The name of "particular ray" of that substance has been given to that ray, the position of it being typical for every substance. It has for carrier an uncommonly penetrating radiation (π rays) which make it sensible to the hand.

Those π rays are accompanied by Θ rays.

Certain authors have been guilty of confusion between the particular ray and the fundamental ray, which has nothing in common with it.

The fundamental rays develop inside a field of circulation limited by vertical planes, whose dimension may be very considerable (fundamental field plane).

The particular ray, on the contrary, is emitted by a point of the periphery of the body, in the shape of a conical frustrum having a very acute angle at its vertex, and which is very near a cylinder. It is a kind of tube with a limited length.

Thus, while the fundamental ray of silver has an orientation of 90° from the magnetic North, its particular ray is oriented at 75° , and at an angle of 35° with the ground plane. If we place the hand so as to meet the particular ray of silver of a silver coin of ten francs, we shall feel, at the point of contact, a sensation of stiffness, which, if the experiment is prolonged, will extend, till it produces a stiffness in the movement in the fingers. If we place, instead of the silver coin, a bigger mass of silver, a spoon for instance, the stiffness will increase, and the numbness will extend up to the shoulder.

In the alloy of several metals, we shall naturally find as many particular rays as there are

distinct substances. To determine the characteristics of the particular ray of a simple body, it is easier to prepare a thin fragment of the substance which contains it. This sample is placed on the middle of a piece of paper fixed on a table. The pendulum being adjusted on the π ray, one searches, with an acute point selector, the point of issue of the ray which is then marked on the paper. On the direction of

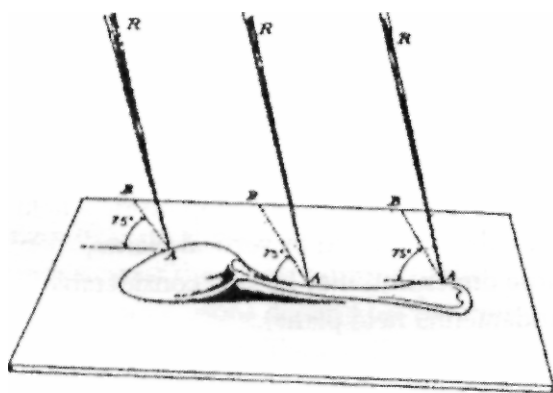

FIG 35

that ray which had been roughly located, a vertical sheet of paper is placed, upon which is inscribed the contact point of the ray, and also the projection of that point on the table. The three points thus marked permit to obtain at once the orientating and the inclination that we want. For the adjustment of the pendulum on π ray, one of the following millimetric numbers must be used: they are calculated for a black spherical pendulum, highly sensitive, weighing 42 grams:

77 millimeters 50 (3 ins. 056) - 131 millimeters 40 (5 ins. 179) - 167 millimeters 90 (6 ins. 613).

The emission of π rays seems due to a phenomenon of a magnetic nature.

We give on figure 34 the disposition of the particular rays the two sides of a silver spoon, oriented from the magnetic North to South.

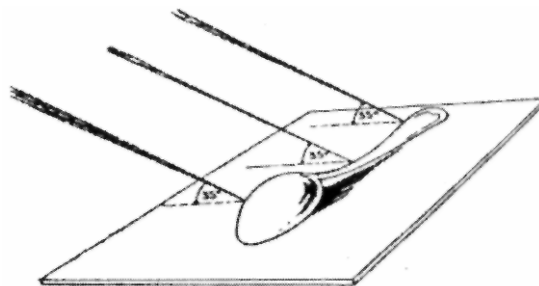

FIG. 36

When studying it closely, one finds that, from the magnetic point of view, this spoon constitutes a whole composed of two magnets.

To the left of the spoon (see figure 34) the changes of polarity of the magnetic charges are given by the signs + and -. The two magnets are soldered, and opposed by their poles of inverse sign I the middle of the spoon. The dotted lines are the lines of change of polarity of the charges of those two magnets.

75° is the azimuth, on figure 35, which is the angle of the magnetic North with the horizontal projection of the ray.

The three rays are parallel (with the same direction: 75° and the same angle with the table: 35°).

Yet, the three masses being different, the π rays which issue from them have a different volume.

The above figure attempts to show each of the three rays with a smaller, medium, and larger volume.

π rays start from a particular point of the neutral line which separates each of the two magnetic polarities which are opposed.

THE BORDERLAND EXPERIMENTER

Expanding Perception

By James Borges, BSRA

Our only real tool on the Borderlands of Science is our perception. It's common to view the teachers and healers of Radionics as special. Well, they are special but no more so than the rest of us. These pioneers have by chance or genetics had an advantage perceiving the invisible realms of vibration. The natural ability to detect vibrations in these individuals was some how heightened. Many times these individuals learned to train their talents and focus their perceptions with meditation and other techniques they acquired from the Mystery Schools

It is the path of technique and training that even the most insensitive person will develop the natural senses. The human nervous system was built to detect radiations of an extremely subtle nature. It is hard wired into the survival system of our bodies. The nervous system is sensitive to the cells pulsating, the atoms revolving, and to the rhythms of the etheric. We can identify even the radiation of particular atomic structures like gold or liver tissue, it merely takes experience and practice.

We will here outline two experiments that will train the nervous system to detect both gold and liver tissue. If the experiments are strictly adhered to over time the results will get better and better. The evidence is the gradual improvement of the ability to detect the presence of a particular energy structure i.e. gold, tissue, or even auras and such subtle fields. Through these exercises and experiments you will become familiar with the sense of success, and also that of failure, you

will learn to listen to your nervous system and muscular system interacting with the vital forces, subtle manifestations, and all forms of physical vibrations.

You can use a pendulum, Cameron Aura Meter, or L-rods for the experiments; whatever tool you are most comfortable with. The tool is just a focus for information from the nervous system, it is transduced into very subtle electro-muscular responses which cause the tools to move. The skill is in using your nervous system to perceive the radiations, eventually the tools will be cast aside as the perceptions become heightened.

For the first exercise you will need a gold coin, three or more envelopes and card board to slide into each envelope. You can get a Year 2000 gold dollar from any bank without much trouble. Cut three or more strips of cardboard so that all are exactly equal and that they fit inside the envelopes. On one of the pieces of cardboard cut a round hole in just the top layer of the cardboard just large enough to insert the gold dollar. Tape over the gold dollar to keep it in place, it should be a flat surface. Put it in the envelope and put a tiny dot on just one side. Put the other two cardboards into the envelopes. Seal all three envelopes.

Shuffle the envelopes till you have forgotten which is which and place them on the floor. You can try many variations; place one in each direction, place them all in same direction, etc. Now determine which envelope contains the gold coin. Be sure to keep notes of your observations. Determine the best set

up and then stick to it for a while until you get better and better at it. The second exercise is to give a practical experiment in medical radiesthesia. We can detect the radiations of particular tissues. To determine if a organ is unhealthy it seems that some time should be spent getting to know that frequency of radiation, only then we can determine if an organ is diseased or about to become so. This second exercise needs a hunk of liver from a chicken or from a cow, three bowls, and three cardboard covers that cover the bowls. Place the liver in one of the bowls. For this it is best to have someone else shuffle the bowls, as you can feel the weight difference. (You have a good friend who will help you shuffle raw liver in a bowl) Determine with what ever instrument you have chosen, which bowl has the liver. Over time you will be able to detect liver vibrations. While these are dead cells the atomic structure is intact as long as the liver is fresh. Our attempt to see if we could determine how long liver tissue had been dead was a bit gross and had to be tossed before we could get any real idea.

Dowsing Clips

<http://www.hlla.com/reference/dowsing.html>

Dowsers have frequently conducted experiments at dowsing conventions in which they passed electricity through ground, and found they could easily pick up the resulting electromagnetic energies. Scientists have identified three sensors that can pick up this electromagnetic information. One is near or in the pituitary gland (in the brain), and there is one on each adrenal gland (near each kidney). The theory is that by comparing the information from these three internal sensory points, the brain can determine both the distance and direction of an electromagnetic-source without our conscious awareness-much in the way the brain uses the two eyes to calculate how far away an object is, another thing the brain does without us consciously

thinking about it.
[http://www.connect.ab.ca/~tylosky/-](http://www.connect.ab.ca/~tylosky/)

Divining rods and all common dowsing devices, are the simplest forms of electroscopes. The bent rod for example is just a variation of Gilbert's straw needle electroscope. The divining rods are charged with static electricity from the dowser's own body. This static electricity can be seen quite adequately with a simple millivolt meter. This voltage is measured between the hands of the dowser, to measure this voltage accurately a diff amp should be used at the input to the voltmeter, "this eliminates stray signals which are common to both hands". The amount of voltage will vary depending on the person. A good dowser will have a high reading, "above 100 mv" while a poor dowser may read as low as,"0 mv.". For males the right hand is usually a negative polarity, and the left hand is positive in polarity. These

The Shadow of Tesla's Death Ray Grows Longer

By Gaston Burrige, B.S.R.A.

Journal of Borderland Research Vol XIV No.2 July-1958

Nobody knows what electricity is. We have learned quite a bit about how to make it work for us. We know something of how to guide it from place to place. A few of the things it may do and won't do for us have been uncovered, but we must learn what it is! If we do not know what electricity is, then neither do we know what lightning is, for lightning is believed to be electricity. There are several kinds of lightning - forked, sheet, and ball or globe lightning. Of these three, globe lightning is the greatest riddle. And perhaps, woe betide us!

The great Nikola Tesla spoke about a "death ray" apparatus he was working on. Science smiled, and behind a lifted hand remarked of how Tesla's age was beginning to show. It has always been interesting to me to note that as some great men's minds mature, how much closer to the "fantastic" they appear to approach. Oh, if we could only approach it yet closer! I have continually maintained man has never created anything basic which Nature has not done a long time before, one way or another. So far, I have not had to eat my words. I will be glad to make a meal of them anytime!

Lightning is Nature's death ray. It has been calculated that there is no full second of time in our 24-hour day that does not experience a lightning discharge somewhere on Earth! And a flash of lightning can last from 1/10,000 of a second to a full second long. That amounts to practically a steady electrical charge.

If Nature has a reason for discharging lightning as she does- other than a difference in potentials between two points- and if she has a means of directing the charge to fulfill that reason, other than the difference of the same potentials, then these reasons have entirely escaped our Science's detection. Science says it is all "chance." Be that as it may - poor observation, lazy intellect, or actuality - when lightning strikes, considerable happens-and contrary to the "old saying," lightning frequently does strike the same place twice- and more than twice!

Of all lightning, the globe lightning is possessed of the greatest fury. Ball lightning is nature's most potent death ray - bearing the surest and most sudden results, and being the least understood of all lightning types-even at General Electric, where the great Steinmetz built huge lightning machines to study its effects so he might learn to protect power lines and plants against it. Presently globe lightning is thought to be "a 'lump' of extremely high temperature plasma held in a state of a short-term balance of electromagnetic forces." The use of the word "plasma" here should not be confused with the word's ordinary use pertaining to blood. In this case the word means a "gas of electrons and ions in a magneto-hydrodynamic effect at about 30,000 degrees Fahrenheit!" These are 64 dollar words meaning- "This big bear's tail we have hold of just now is sure slick!"

In this day of missiles carrying hydrogen-bomb warheads, and anti-missiles which seek these kind of missiles hoping to explode

them before they explode themselves, we are not surprised to learn that Russia is interested in artificial ball lightning as an anti-missile defense. (Page Gertrude Stein!) According to Dr. Alpert Parry, writing in the "Missiles & Rockets" magazine for April and June 1958, the Soviets have been thinking along these lines since 1940. But the trouble is, we are pretty sure that they have been doing more than just thinking! How much more is the big question. This is another place where we have to let out our belts instead of drawing them in!

Not long ago a Soviet plane was struck by natural ball lightning. Meager reports are that Russian scientists "swarmed over the remains like flies over honey." But what they found is as dark a secret as that which our own Air Force really thinks about UFO's!

According to Dr. Parry's story, Russian Scientist, George Babat, experimented with methods of creating artificial lightning of the globe type until he was successful. This success took place in the Svettana plant at Leningrad. After Babat passed away, his work was continued on by Professor Peter Kapitsa, one of Russia's top atomic and hydrogen experts. Kapitsa is said to have found a hypothesis having to do with the physical laws governing ball lightning, and perhaps it's guidance.

Of course, Soviet writers say that this force will be used only as a peaceful means in doing their work, such as "cutting into the ground to open new mine shafts at a fabulous speed and at the same time leaving the shaft walls smooth!" But those on the outside looking in, wonder.

It will be recalled that Tesla in the early 1930's claimed to have perfected (in his own mind at least) a death ray machine capable of stopping an army of 100,000 men 150 miles away, or a whole fleet of planes at the same

distance.

U.S. Scientists, most acquainted with research in electrical currents at extremely high potentials, shake their heads back and forth at the possibility at directing ball lightning to a target in our atmosphere or in space. Quite often when scientists shake their heads that way it does not mean that something is necessarily impossible, but they hope you will think this is what they mean - and perhaps go away and leave them alone with their slide rules and test tubes. Too, often scientists are not understood, hence misquoted. They don't like being misunderstood or misquoted. I cannot blame them. Again, they know much knowledge-but not always just what knowledge- is "classified" in the United States, and again they do not wish to give any opportunity to be put on the mat! Again, I cannot blame them.

As an aside to this matter, it is impossible that ball lightning, while perhaps incapable of being directed into the atmosphere by itself, could ride on or with a "carrier wave," or within a "tube of force," fragile as it may appear now, such as Mr. Camron with his own ray gun? Silly as this may sound here, is it, in reality, any sillier sounding than Tesla's own "Alternating current system with its rotating magnetic fields" sounded when he first propounded it 70 years ago to his superiors? They told him then it could not possibly work!

Once globe lighting has been observed it is not easily forgotten. Often it is a ball six or eight inches in diameter, green like burning copper, or with lavender tinge. It goes bowling along on the top of a power wire, but generally in no great hurry. Other times it hangs from the bottom side of the wire like a monorail. Frequently it acts as if it were hunting for something, seeming to examine

(Continued on page 120)

Meditation and Resonance Effects

By Richard Alan Miller (aka Philo Stone)

(This paper is from THE HOLISTIC QABALAH, a series of 12 books, written by Richard and Iona Miller. It has also appeared in print in "Psychedelic Monographs and Essays," Volume Four, Summer 1989)

ABSTRACT: The use of psychedelics or empathogens traditionally involves effectual traits or nuances which can parallel endogenous mystical or cybernetic landscapes. This piece presents an introduction to current descriptions common throughout all three fields. A promise of increased comprehension so far as metaphor, symbol and effect surrounding these and other cross-correlative fields is reviewed and annotated.

"...If the manas is to preform its proper task of controlling senses, it must reflect the ideal pattern that is laid up in the heavens of Buddhi. Only when that pattern is reflected in its mirror has it the standard of reference by which to judge... nor should we think that the possession of such a divine standard by which to judge attainment is far above us; one to which we may aspire in some dim future. Here and now the Pattern is within us."

Sri Krishna Prem

Theoretically, the practice of meditation is intended to withdraw the personal mind from its persistent preoccupation with external affairs. It can be seen as a form of training for the mind in switching from matter to psyche. There is a purpose. It is to prepare the personal nature so that it is able to reflect and express its relationship with the Universal Self.

Throughout history there have been a number of techniques used to achieve a meditative state. The most often used first step is a form of rhythmic breathing. If done correctly, a sequence of strong and unusual body reactions occur. These also will eventually trigger unusual psychological states via a type of resonance effect. A closer examination of these resonance-relationships yields information useful in improving the meditation.

Perhaps an example clarifies this: When a subject is totally relaxed and has achieved a deep meditative state, a slow, rhythmic sine

wave pattern can be registered by a cardiograph-type sensing device. What is being measured is a standing wave in the aorta. There is a heart-aorta resonating oscillator which affects other parts of the body, including the brain.

Resonance occurs when the natural vibration frequency of a body is greatly amplified by vibrations at the same frequency from another body. Oscillators alter the environment in a periodic manner. When in a deep meditative state the regular movement of the body indicates that a standing wave is set up in the vascular system, specifically in the aorta. This standing wave affects several other resonate systems in the body, all of which are driven by this large signal.

A paper by Paul F.J. New, and several current papers, indicate the presence of a major resonate cavity oscillator located between the heart and the bifurcation, where the aorta divides itself. When the timing of the pressure pulses travel down the aorta coincide (in phase) with the reflected pressure pulse, a

standing wave is achieved. When this frequency approaches 7 Hz, a progressively amplified wave form is created by resonance, resulting in a large oscillation affecting every other circuit in the body tuned to this frequency.

There is a resonance relationship to this frequency with standing waves on the Earth's crust. If we assume that the spherical crust of the Earth represents a condenser, then the frequency of resonance can be calculated on the basis of the equation:

$$\text{Resonance frequency} = C/7.3R^2$$

Where C is the velocity of propagation of electromagnetic waves;

and

R = radius of the Earth.

This frequency has been shown to be 6.4 Hz.

Thus, a harmonic frequency corresponding to the pulsation of the electrical charge of the Earth is present in heart/aorta.

The brain may be considered as a piezoelectric gel (3), one converting physical vibrations into electrical ones. Although the body movement from this heart/aorta resonance is relatively small, 0.003-0.009 mm., the head is a dense and tight structure. By moving up and down, the skull accelerates the brain with mild impacts. These acoustical plane waves are reflected from the cranial vault and are focused upon the third and lateral ventricles. A hierarchy of frequencies couple this 7 Hz body movement to the higher frequencies in the ventricles.

"That which is that bright within the heart; in that this man resides, innate with mind transcending death, with brilliance innate."
—Taittiriya Upanishad

In the book Biomedical Engineering Systems 4, Chapter 7 is a major work entitled

"Toward A View of Man", by Manfred Clynes. Clynes is a medical doctor working at the Research Center in Rockman State Hospital, Orangeburg, New York. This work is considered a breakthrough in the fields of psychology and medicine, known today as the field of psychobiology (biocybernetics).

Clynes took a number of volunteers and shaved their heads, placing a series of electrodes in rosette patterns or various regions of the brain. These included the temporal, frontal lobe section and occipital region. In this way, not only were the brain frequencies monitored, but directional shifts in these frequencies could also be determined by the geometry of the electrodes on the skull.

The original purpose of Clynes' work was to find out how precision and order exist in brain processes; to discover what is inherently programmed in man and how he might make use of the inherent programs.

These individuals were given a number of images (form) and colors to concentrate on while their brain was monitored by computers. Recording from opposite pairs of electrodes simultaneously, he obtained views of the electrical activity from different angles: mathematically, a spatial differentiation of the electric vector. What was happening literally was a mapping of consciousness. A number of very important observations were made:

1. Certain qualities and relationships were of great importance to the computer than such quantitative factors such as intensity. This meant that the brain's systems of identification are based on differences, rather than intensity of the signal.

2. Thin lines were found to produce characteristic evoked potentials, irrespective of size. The form itself is transduced into another form in the brain space time which can be

measured. There is a one-to-one correspondence between the visual form of the stimulus, the response form in the brain, and the perception. This is, perhaps, the first physical description of the field of an archetype. It is a geometrical structuring and has uniqueness.

3. The process of inhibition is as important for transducing the external world as is excitation. Concentrating on specific lines of geometry does not constitute the changing stimulus, but their steady presence systematically and radically alters the response to another changing stimulus.

4. Changes in intensity of a single color produce very simple response shape. Light and darkness (as opposites) show no evidence of being different values of the same variable. Rather, they seem to be the result of stimulating and also of inhibiting different receptors. This, the evoked potentials to light and darkness in no way may be said to be positive and negative, respectively. White, for example, appears in this view as the result of mutual inhibition of color.

5. These experiments clearly imply an inherent form of organization and not a random learning of nerve nets. It is possible to mentally recognize and perceive the stimulus within the first portion of the invoked potential. Portions responding (in the brain) which occur later than 0.3 sec. are seen as systematic processes, or tuned circuits to those responses to specific in-coming stimulus. This is a form of resonance in the brain to specific geometry. This could also lead to the formation of memory.

6. Every perception has a unique counterpart as a space-time code form in the brain. These space-time shapes are evidence of relationships between the external world and its representation in the brain. They act like keys to "unlock" specific parts of our brain, often be-

ing observed below psychological threshold levels (subliminal).

Clynes literally mapped fields in the human brain. A computer was able to identify and reproduce those geometrical figures from what that human was concentrating on, either as a geometric form or color. The individual did not even have to look at the pattern but simply concentrate "in his mind's eye." A standing wave means that the wave is not changed, but is holding itself steady in one certain geometrical thought.

If quantum mechanical properties of matter are actually the conscious property of matter, then one would predict that all phenomena where quantum wave explanations are important, the phenomena could be interpreted better in terms of consciousness. (5)

Our planet is surrounded by a layer of electrically charged particles called the ionosphere. The lower layer of the Ionosphere starts about 80 km. from the Earth. This charged layer is known to reflect radio waves.

Since this is a highly charged layer, the Ionosphere forms a so-called capacitor with the Earth. This means that there is a difference in electrical potential between the two, the Earth being negatively charged and the ionosphere being positively charged. This potential varies some but is around 200 volts/m.

This is a fundamental type of electrical generator. The solar winds, interacting with the upper atmosphere rotation, act as a collector and brushes of a generator. The lower atmosphere can be seen as a storage battery for this gradient potential.

This electrostatic around the Earth can be viewed as a stiff jelly. When our bodies move and vibrate, these movements are transmitted to the environment. These fields not only impinge on our body but they also affect the charges inside our body. When we are standing on the ground, under normal conditions,

we are grounded. Our body then acts as a sink for the electrostatic field and we actually distort the force lines somewhat.

Our body also has its own electrostatic field about itself. These field-lines are the result of the various biochemical reactions in the body. This resultant bio-field couples us to the isoelectric field of the planet. A "tuned system" consists of at least two oscillators of identical resonance frequencies. If one of the oscillators starts emitting, the other will be activated by the signal very shortly. Because the coupling is ideal, they will respond to the tiniest signals and begin to resonate.

In 1957, W.O. Schumann (6) calculated the Earth-ionosphere cavity resonance frequencies. His works were updated over the years and the figure now used is at 7.5 Hz. As indicated previously, the micro motion of the body is about 6.8 to 7.5Hz.

It is obvious that when one is in deep meditation, it is possible for the human being and the planet system to start resonating. There is a transfer of energy. It is no coincidence that this frequency is in the theta region of brainwaves, the state of maximum regeneration.

Information is embodied in a field, rather than just being a field. A field is thus an abstract quantity of information; relationships between this point and that point in the universe.

Astral temples are set up to evoke a certain correspondence effect, like a resonance. These temples are like a physical matrix, one with specific geometrical form and color. The visualization, in turn sets up a particular EM resonance in the brain. The reverberation pattern is most explicit. Clarity is all important. Distortion minimizes the resonance effect and reduces any amplification to connecting other "tuned" oscillators in the

body.

Techniques of extending this harmonious resonance have been known for thousands of years. These are the different meditative techniques. Most slow down the metabolic rate of the body so that much less oxygen is required to keep the body going.

As one becomes proficient in meditation, the breathing becomes so gentle as not to disturb the resonate state of the aorta. An automatic process develops in which the lungs and the diaphragm regulates the heart-aorta system so as to keep them well-tuned. This helps extend the resonant behavior even with shallow breathing.

In conclusion, the following points should be made regarding the resonant effects available through meditation:

1. There is a heart/aorta resonance which links up with a number of other critical oscillators, including several in the brain. It starts at the heart.
2. Specific geometries or geometrical mandalas (form and color) create resonance effects in the brain. The pattern is repeated in the brain.
3. Specific geometrical systems can be used as "keys" to access those specific archetypes. Access occurs to the psyche.
4. This linking of resonant cavity oscillators can be seen to form a common thread, going from Hadit (DNA-RNA helix) to Nuit (galactic hydrogen-helium field).
5. By "tuning" one's meditation, it is possible to amplify and have access to the other resonant systems, in and out of the body.

The Human organism has usually been regarded as a complex arrangement of chemical elements and compounds. The quantity and structure of these variables are our reference points for states of health. This is the area of biochemistry and biochemical analysis.

An equally valid approach is to regard the human organism as an aggregation of electromagnetic fields which are constantly interacting and changing as are their biological equivalents. It has been shown that the human system is an emitter of electromagnetic radiations.(7)

All biological processes are a function of electromagnetic field interactions. EM fields are the connecting link between the world of form and resonant patterns.

The patterns are arbitrary forms which are non-physical. Archetypal forms are based on inherent characteristics and correspondences. This provides a basis for what we would call resonant phenomena in archetypal systems. EM fields embody or store gestalts, patterns of information.

An archetype may then be seen as a specific geometrical system of standing waves occurring in the brain as a space-time shape ("key").

In living organisms, opposites receive their structure of symmetry from particular combinations of spatial and temporal aspects. Like reins on a horse, each of the opposites of the psychological pair has its own place. This geometric property makes them capable of being opposites. The activity of each arm determines the quantity; the spatial identity of the rein determines the quality. There is no monotonic (or linear) transition from one to the other passing through zero.

A human being, immersed in the galactic hydrogen-helium field, may also utilize the pulsing feedback between man and the galaxy to build up the resonance effects, much like we would tune a radio. These primary frequencies are multiples of the base frequency 7 Hz.

These four nucleotides provide resonant frequencies for alpha, theta, and delta (the characteristic brain states going from con-

sciousness to deep sleep: 14-2 Hz.). This resonance relationship can be seen to link with helium inside the body at various chemical sites.

The bridge connecting the solar system resonances and the brain frequencies seem to reside in the DNA-RNA helix.

In a paper by Oliver Reiser (8) from the University of Pittsburgh, a relationship is developed between the four helium cores in an atomic nucleus and the matrix forms on the DNA and RNA. Reiser describes them as "radiation belts of thought," the four "nucleotides" enter into the dynamics of these nuclear properties. A spheron is a nuclear constituent roughly spherical in shape and spaced in concentric layers.

The platonic solids are the five regular solids described by Pythagoras, now seen to form all crystal formations. These forms later became the basis of the mathematics known as group theory. The so-called "resonances" were specific combinations of five regular solids geometry.

"Helions" is Pauling's term for spherons (9) when he modeled the helium in the sun, the heliosphere around the Earth, and the hydrogen-helium plasma of the galactic disc. An optically activated molecule, such as helium, contains an electron which is coerced into a helical path by electric field. This one-sided spiral is maintained in the intermolecular transport through protein molecules. Note that the protein units of "spherical viruses" are packed symmetrically, in accordance with the pattern of cubic symmetry.

Once more we find our way back to Pathagoras and the Platonic solids!

FOOTNOTES

1. Paul F.J. New, "Arterial Stationary Waves," American Journal of Roentgenology, Vol. 97, no. 2, pp 488-499.

2. Symposium of Psychotronics, Prague, Czechoslovakia, Sept. 25, 1970. Paraphysical Laboratory Publication, Downton, Wiltshire, England.

3. When certain crystals are stressed, they produce an electrical current. This phenomena is known as the piezoelectric effect. The physical body can be seen to be composed of liquid crystals and amorphous semiconductors (the gel). When the body is stressed by a force such as heartbeat, it presses the brain on the skull and current is produced.

4. Biomedical Engineering Systems, McGraw-Hill Books, N.Y., 1970.

5. Cochran, Andrew A., "Relationships Between Quantum Physics and Biology," Foundations of Physics, Vol. 1, pp 235-250, 1971.

6. Schumann, W., "Elektrische Eigenschwingungen des Hohlraumes Erde-Luft-Ionosphere," Zeitschrift fur Angewandte Physik, Vol. 9, 373-378, 1957.

7. Presman, A., Electromagnetic Fields and Life, Plenum Press, 1970.

8. Reiser, Oliver L., Cosmic Humanism and World Unity, Diagram LI1, p 463, and Diagram LIV, p 465.

9. Pauling, Linus, "The Close-Packed-Spheron Theory of Nuclear Fission," Science, Vol. 150, pp 297-305, 1965.

REFERENCES

Ambrose, E.J., Osborne, J.S., and Stuart, P. R. Structure and properties of the cell surface complex. In Liquid Crystals and Ordered Fluids (Johnson, J.F. and Porter, R., eds.). New York: Plenum, 1970.

Becker, R.O. The effect of magnetic fields upon the central nervous system. Medical Electronics and Biological Engineering, 1963, 1, 293-303.

Becker, R.O. Electromagnetic forces and life process. Technology Review, December,

1972.

Bernal, J.O. General discussion. Transactions of the Faraday Society, 1933, 29, 1082.

Blair, Lawrence. Rhythms of Vision, New York, Warner Books, 1975.

Brown, F.A., Jr. Electrical and magnetic sensitivity: Some orientational influences on nonvisual, terrestrial electromagnetic fields. Annals, New York Academy of Science, 1971, 188, 224-241.

Bulkley, D.H. An Electromagnetic Model for Dynamic Turnover and the Continuous Self-Replication of Biological Macromolecules, Rogue Press, 1973.

Burr, H.S. and Northrup, F.S.C. The electrodynamic theory of life. Quarterly Review of Biology, 1935, 10, 322-333.

Elliot, H.C. Neural tube and spinal cord in Textbook of Neuroanatomy, Philadelphia, J. B. Lippincott Co., 1963.

Fowler, R.H. and Bernal, J.D. Note on the pseudo-crystalline structure of water. Transactions of the Faraday Society, 1933, 29, 1049.

Fredericksz, V. and Zolina, V. Forces causing the orientation of an anisotropic liquid. Transactions of the Faraday Society, 1933, 29, 944.

French, Vernon, Bryont, P.J. and Bryont, S. V. Pattern regulation in epimorphic fields, Science, September 10, 1976, 969-981.

Garrison, W. Destiny and geomagnetism. Popular Electronics, July 1971.

Koestler, A. The Roots of Coincidence. New York: Random House, 1972.

LeShan, L.A. Toward a general theory of the paranormal. Parapsychological Monographs, 1969, no. 9.

Lund, E.J. Bioelectric Fields and Growth. Austin: University of Texas Press, 1945.

McGinnes, J.E. Mobility gaps: A mechanism for band gaps in melanins. Science, 1972, 177, 896-897.

McKenna, T.J. and McKenna, D.J. Organismic thought in *The Invisible Landscape*. New York: Seabury Press, 1975.

Miller, R.A., Webb, B., Dickson, D. Holographic concept of reality. *Psychoenergetic Systems*, 1975, Vol. 1, 55-62.

Muses, C.A. On the modification of random fluctuations by a target-seeking process utilizing random energies. *Bio-Medical Computing*, 1970, 1, 75-80.

Needham, J. The hierarchial continuity of biological order. *Order and Life*, 1936, 1, 109-168.

Presman, A.S. *Electromagnetic Fields and Life*. New York: Plenum. 1970.

Pullman, B. and Pullman, A. *Quantum Biochemistry*. New York: Interscience.

Purett, L. Magnetic reversals and biological extinctions. *Science News*, 1971, 100, 287-302.

Ravitz, L. Electromagnetic field monitoring of changing state-function, including hypnotic states. *Journal of the American Society of Psychosomatic Dentistry and Medicine*, 1970, 17, 199-129.

Szent-Gyorgyi, A. *Bioenergetics*. New York: Academic Press, 1957.

Szent-Gyorgyi, A. *Introduction to a Submolecular Biology*. New York: Academic Press, 1960.

Szent-Gyorgyi, A. *Electronic Biology and Cancer*, New York, Marcel Dekker inc., 1976.

Thorn, R. *Structural Stability and Morphogenesis*. Massachusetts, W.A. Benjamin Press, 1975.

Tien, H.C. Pattern recognition and psychosynthesis. *American Journal of Psychotherapy*, 1969, 23, 53-66.

Van Iterson, G., Jr. A simple arrangement to demonstrate liquid crystals. *Transactions of the Faraday Society*, 1933, 29, 915-919.

Wheeler, J.A. *Geometrodynamics. Lectures*,

TOWARD A PHYSICAL FOUNDATION FOR PSI PHENOMENA

The 1994 J. B. Rhine Lecture, delivered at the 37th Annual
Convention of the American Parapsychological Association, Amsterdam, 8 August 1994.
Ervin Laszlo The General Evolution Research Group Montescudaio (Pisa), Italy
(http://www.newciv.org/ISSS_Primer/seminarn.html)

We are seeking for the simplest possible
scheme of thought that will bind together
the observed facts.

Albert Einstein, *The World As I See It*
(1934)

If the quantum vacuum is to be identified
with the field that carries the effects associ-
ated with psi, its virtual energies must inter-
act with matter in the universe, including the
matter lodged in the brain of human beings.
The indicated interaction calls for two kinds
of propagations in the vacuum. One kind
constitutes the known charged particles that
make up the matter-component of the uni-
verse. The other kind, however, calls for an
innovation in theory: for postulating that
also scalar waves propagate within the super-
dense virtual-energy field of the vacuum. Sca-
lars, in ordinary vector analysis represent a
quantity that is completely defined by magni-
tude alone, without reference to displace-
ment.

Waves of this purely 'informational' (rather
than 'force') kind have been discovered by
Nikola Tesla at the turn of the century. They
are longitudinal waves, like sound waves,
contrasting with electromagnetic waves,
which are transverse. Scalars may exist at the
level of the quantum vacuum, where they
would be generated by the motion of charge
particles. In this view the motion of electro-
magnetically charged particles in the vacuum
approximates the action of a monopole an-

tenna: it alternately charges and discharges
local regions of the vacuum's virtual-particle
gas. Quantal motion thus triggers scalar
waves in the vacuum, and these propagate by
alternately compressing and rarefying its vir-
tual-particle gas. The scalar waves generated
in the vacuum modify the self-regenerating
cosmological feedback cycle outlined by Har-
old Puthoff. (Puthoff 1989) In Puthoffs feed-
back cycle interaction between the zero-point
field (ZPF) and charged particles results in an
exchange such that there is no average trans-
fer of energy in any direction at any fre-
quency. However, given the propagation of
scalars in the vacuum, the energy field with
which charged particles achieve local dy-
namic equilibrium becomes inhomogeneous
and anisotropic - the fluctuations generated
in the vacuum by the motion of the particles
translate into the local equilibria generated
between the particles and the ZPF. In this
process the interference patterns created by
the motion of charged particles modify the
local topology of the vacuum, and the modi-
fied vacuum field modifies in turn the mo-
tion of the particles. (Laszlo 1993, 1994)
The translation process instantiated in the
interaction between particles and the scalar
spectrum of the vacuum amounts to a two-
way Fourier transformation between objects
in space and time, and their waveform
equivalents. Fourier showed that any three-
dimensional pattern can be analyzed into a
set of regular, periodic oscillations that differ
only in frequency, amplitude, and phase.

Specific waveforms can be exact representations - 'Fourier-transforms' - of spatiotemporal objects. For example, when a vessel creates waves on the surface of the sea, it creates Fourier-transforms of its impact on the waters of the sea. This is precisely what may happen when charged particles trace their trajectories in space and time: they leave their Fourier-transforms in the virtual particle gas of the quantum vacuum.

The interaction of vessels with the sea is a dynamic metaphor of the above two-way translation process. H. C. Yuan and B. M. Lake have found that the surface of the sea is surprisingly information-rich. (Yuan and Lake, 1977) When its wave-patterns are subjected to mathematical analysis, it discloses information on the passage of ships, the direction of wind, the effect of shorelines, and other factors. The interfering wave-patterns may be conserved for hours and sometimes for days, after the vessels that created them have passed. Though ultimately they dissipate, eroded by the combined action of gravity, wind, and shorelines, as long as the wave-patterns persist, they provide information on the events that occurred at the sea's surface. But the waves created by vessels on the surface do more than create information regarding their own motion: they also inform - literally 'in-form' - the motion of other vessels. All vessels that traverse the wake that spreads out behind a given vessel are rocked by those waves; in this sense the motion of the 'wake-creating vessel' is translated into the motion of the 'wave-rocked vessels.' The medium that transmits the effects is the surface of the sea: it interconnects the wave-creating with the wave-rocked vessels. And, as all vessels both create waves and are rocked by them, the sea interconnects the motion of all vessels on its surface.

Inasmuch as the quantum vacuum inter-

connects the motion of the events that occur in space and time, it functions as a holographic field that encodes the particulars of their motion and transmits them to 'in-form' the motion of other events. There is no immediate indication, however, that this interconnection would be of the anomalous variety that is characteristic of psi. (Psi, as researchers well know, implies signals that are space- and time-transcending, that is, instantaneous for spatially distant objects and indifferent as to the time when the signalled events took place.) Yet a deeper analysis shows that the signals transmitted through the vacuum field are precisely of the psi variety. The reasons for this are first, because information in that field is holographic (that is, distributed and thus simultaneously available at distinct locations), and second, because the propagation of the holographic interference patterns is quasi-instantaneous.

The latter statement is contrary to the tenets of mainstream physics; it needs further substantiation. Consider, then, that electromagnetic waves propagate in the vacuum with a maximum velocity currently estimated at 299,748 +/- 15 km/sec. Relativity theory does not specify a physical reason for this finite magnitude: c functions as a basic axiom. However, if Silvertooth is right and c varies with the motion of the observer relative to the light source, the value of c can be ascribed to the finite electromagnetic permeability of the medium in which photons propagate. In that event c states a physical factor in the universe: its magnitude is inversely proportional to the square-root of the product of the vacuum's electric and magnetic permeability: $c = 1/\sqrt{\epsilon_0 \mu_0}$.

So much for the propagation of photons, which are electromagnetic wave-packets travelling in spacetime. What about scalars then? Scalars are neither 'light' nor 'matter' - they

are longitudinally propagating fluctuations below the energy-threshold of particle pair-creation (which is estimated at 6×10^{-27} erg/sec). Calculations by Thomas Bearden indicate that the propagation of scalar waves is a function of the vacuum's local electrostatic scalar potential. (Bearden, 1983) Because of the increase in vacuum flux density through the accumulation of charged masses, this potential is variable. It is higher in regions of dense mass, in or near stars and planets, and lower in deep space. Hence scalars propagate at speeds independent of the value of c . In the matter-dense region near the surface of the Earth they may reach velocities indistinguishably close to infinity. We now have the basic properties of an interactive holographic field that encodes the particulars of the spatiotemporal motion of objects, and quasi-instantaneously transmits the corresponding wave-function to other objects in the planetary environment. This, as psi researchers will readily appreciate, could provide a physical foundation for a certain range of psi phenomena - telepathic and telesomatic transference, lifetime recall in NDEs, past-life experiences, distance diagnosis and psychic healing, among others. The exploration of these phenomena as possible vacuum effects is a task I have undertaken elsewhere. (Laszlo 1993, 1994) I shall not enter on it here, but limit myself to indicating the physiological mechanisms that would underlie the brain's interaction with scalars waves of vacuum origin.

In the brain a staggering number of dendrites fire ions, each of which constitutes a minute electric field vector. Thus the cerebral hemispheres may act as specialized scalar interferometers, so that action potentials within the neural nets may be significantly affected by the scalar topology of the vacuum. This could alter the initial condition of

the nets, and the alterations may be amplified by the chaotic attractors that govern cerebral processes. Chaos in the brain is a recent but well established fact: the cognitive centers of the brain are permanently in a state characterized by chaos. Vast collections of neurons shift abruptly and simultaneously from one complex activity pattern to another in response to extremely fine variations. Within the ten billion neurons of the brain, each with an average of twenty thousand interconnections, the action potential of the smallest neuronal cluster creates a 'butterfly effect' that triggers massive gravitation towards one or another of the chaotic attractors. These attractors could amplify vacuum-level fluctuations and produce observable effects on the brain's information-processing structures.

Further evidence may be marshalled in support of the hypothesis of vacuum/brain interaction. Holographic functions in the brain require coherent nonlinear interaction between neuronal networks and/or pre- and post-synaptic neurons. In biological systems coherent interactions have been noted within molecules, between molecules, as well as among dipole clusters in distinct cellular and anatomical structures. In the past such phenomena have been explained in terms of long-range electromagnetic correlations between physically separated oscillating electric dipoles. Recently, however, an alternative explanation has surfaced. The new concept makes reference to the Josephson effect, a spontaneous correlation obtaining between physically separated superconductors. Josephson effects have also been found in living streams, where they function as a factor of intercellular coherence. (Del Giudice et al. 1989)

According to quantum field theory, Josephson junctions generate fields of quantum po-

tentials (consisting of a magnetic vector potential and an electrostatic scalar potential), which in turn modulate the connection between the correlated superconductors or cellular systems. Such fields may mediate communication between physically separate assemblies of neurons in the brain. Spectral patterns of specific frequency associated with nerve firings would impart information to the field, and the field in turn would impose coherence on the ongoing nerve firings. (Psaltis et al. 1990) Current findings indicate that fields of quantum potentials constitute an underlying regulatory system that alters non-synaptic communication between assemblies of neurons and could thus affect even higher brain functions. (Rein 1993)

Summary and conclusions

Psi is a bona fide datum of scientific research, but so far it has remained mainly a datum. Scientific understanding of the phenomenon requires connecting the datum uncovered in psi research with the observations that furnish the empirical component of theories in the natural sciences. In light of the considerations advanced here, the conceptual framework required to connect psi with theories in the contemporary natural sciences calls in turn for a field capable of transmitting information beyond the scientifically recognized limits of space and time. If the concept of such a field is not to remain an ad hoc postulate, we need to identify it with fields, or field-like continua, already known to science. The most likely choice in this regard is the quantum vacuum, a highly anomalous universal energy realm that is both the originating source and the ultimate destination of matter in the universe. Research on this field discloses significant evidence that it transmits a variety of effects that affect the behavior of matter. Complex matter-energy systems in the ultrasensitive

states of chaos could amplify vacuum-level fluctuations into significant inputs to behavior. The human brain, of which the cognitive centers are in a constant and pronounced state of chaos, could receive and amplify such signals, and when not repressed by left-hemispheric sensors, the signals could penetrate to consciousness. The conscious or unconscious signals would yield the phenomena investigated in psi research.

The above concepts are offered not as a definitive solution to the problem of finding a scientifically acceptable explanation for psi, but as a working hypothesis to be tested and elaborated in collaborative research between psi researchers, and workers in physics, biology, neurophysiology, and related scientific disciplines.

REFERENCES

- Bearden, Thomas E. (1983). *Toward a new Electromagnetics*, Tesla Book Co. Del Giudice, Doglia, E. Milani, S. M. Smith, C. W. and Vitiello, (1989). 'Magnetic flux quantization and Josephson behaviour in living systems.' *Physica Scripta* 40, 786-791
- Einstein, Albert (1934). *The World As I See It*, New York: Covici Friede
- Fine, B. J. (1990). *Meta-analysis and bias*. *Science* 250, 494
- Haisch, Bernhard (1994). Alfonso Rueda, and H. E. Puthoff, 'Inertia as a zero-point-field Lorentz force,' *Physical Review A*, 49.2
- Ives, Herbert (1938). 'Light signals sent around a closed path,' *Journal of the Optical Society of America*, Vol. 28 -, (1951). 'Revisions of the Lorentz transformations,' *Proceedings of the American Philosophical Society*, 95 -, (1949). 'Lorentz-type transformations as derived from performable rod and clock operations,' *Journal of the Optical Society of America*, Vol. 39

-, (1950). 'Extrapolation from the Michelson-Morley experiment,' *Journal of the Optical Society of America*, 40

Laszlo, Ervin (1994). *Cosmic Connections: Toward a Unified Evolutionary Science of Matter, Life, and Mind*, (in preparation)

Laszlo, Ervin (1993). *The Creative Cosmos*. Edinburgh: Floris Books.

Michelson, A. A. (1881). 'The Relative Motion of the Earth and the Luminiferous Ether,' *American Journal of Science*, 22, 120-129

Sagnac, George (1913). 'The luminiferous ether demonstrated by the effect of the relative motion of the ether in an interferometer in uniform rotation,' *Comptes Rendus de l'Academie des Sciences, Paris*, Vol. 157

Silvertooth, Ernest W. (1987). 'Experimental detection of the ether,' *Speculations in Science and Technology*, Vol. 10; - , (1989). 'Motion through the ether,' *Electronics and Wireless World*

-, (1992). 'A new Michelson-Morley experiment,' *Physics Essays*, Vol. 5

Psaltis, D., Brady, D., Gu, X. G. et al. (1990). 'Holography in artificial neural networks.' *Nature* 343, p. 235

Puthoff, Harold A. (1989). 'Source of vacuum electromagnetic zero-point energy,' *Physical Review A*, 40.9

Rein, G. (1993). 'Modulation of neurotransmitter function by quantum fields,' *Planetary Association for Clean Energy* 6,4

Targ, Russell (1994). 'What I see when I close my eyes,' *Journal of Scientific Exploration*, 8,1 (1994), p. 117

Yuan, H. C. and Lake, B. M. (1977). 'Nonlinear deep waves,' in *The Significance of Nonlinearity in the Natural Sciences*. Kursunoglu, A. Perlmutter, and L. F. Scott, (eds.), Plenum, New York

Subtle Energies

By Dr. William A. Tiller

Science & Medicine

May/June 1999

Volume 6, Number 3

Dr. William A. Tiller joined the Stanford University faculty as Professor of Physics in 1964 after nine years with Westinghouse Research Laboratory. He became Professor Emeritus in 1992 in order to devote himself to research in solid state physics and materials science as well as in his avocational field, psychoenergetics. He holds several patents, and he has written four books and more than 300 papers.

There is now a large body of experimental data in the general area of psychoenergetics associated with the directed focus of human intention. Remote influence experiments with healers, remote viewing experiments, investigations of psychokinetics, clairvoyance, homeopathy, and other phenomena confound the established picture of natural laws but attest to the existence of processes requiring the involvement of emotional, mental, spiritual, and other inadequately understood domains of nature.

Because these domains are incompletely understood, they might best be grouped into a category called "subtle energies." Future research may delineate and distinguish the various characteristics of these energies and their usefulness in medicine. For now, subtle energies can be defined as all those energies beyond those presently acknowledged in physics. Four kinds of force are conventionally considered to be responsible for all the observable phenomena in the universe: the strong and weak nuclear forces, the electromagnetic force, and the gravitational force. Subtle energies and the subtle

forces they generate are not necessarily strong or weak with respect to the established forces, but they are difficult to nail down with the standard protocols of today's science. It is useful to reflect for a moment on what the science of physics is able to do and not able to do. Physics attempts to develop a relative framework of quantitative understanding that is internally consistent across all the various observable phenomena of nature. Physics is not able to provide absolute truth.

Periodically, the prevailing model of physics is unable to provide internal consistency when incorporating new sets of experimental observations. The choice is then to either deny that the new observations are valid or expand the model of nature sufficiently to allow natural incorporation of the new data. Such a revision in the standard model was required when quantum and relativity phenomena had to be accounted for. Today, the majority of the physics community is in a state of denial with respect to psychoenergetic phenomena. The present model is so neat, powerful, and comfortable that many people feel it would be a shame to have to disturb it. However, evolution moves on, in spite of prevailing paradigms.

A body of compelling experimental data is required to nudge the prevailing professional mind-set out of a long-standing rut and into a more fruitful perspective. To encourage the process, I describe here a half dozen experiments dealing with directed human intention. Each experiment indicated robust

manifestations in physical reality of phenomena that are quite inexplicable within the prevailing physics model of nature. I was involved with five of these experiments and can vouch for the care and effort invested in them.

In the 1970's, I carried out a series of experiments. I with a man who had the ability to so energize a camera and its film that whenever he took a picture while he was experiencing a certain feeling in his seventh cervical and fourth thoracic vertebrae, some striking anomaly would appear in the photograph. His held intention during the picture-taking process was, he said, "to reveal God's universe." My experiments used two cameras, one of them sensitized by keeping it close to the subject's body for several days. Both cameras were mounted on the same tripod and tripped with a single shutter release. Ordinary color film was used and was processed by its manufacturer, and the subject was never allowed to touch the film. Often, though not always, pictures taken with the sensitized camera showed one or more people as if they were partially transparent, or translucent, while pictures from the unsensitized camera appeared normal. It was also possible for the sensitized camera to take pictures through its lens cap.

Examples of paired photographs from the dual camera study. The photograph at the right was taken with the sensitized camera. My interpretation of this phenomenon is that (1) some radiations exist in nature that can travel through materials that are opaque to visible light; (2) because of some unknown quality inherent in the subject's energy field, these radiations can be detected by the film in the sensitized camera; (3) some time is required for the camera placed in this special energy field to acquire its anomalous capability; and (4) the anomalous capacity leaks

away in about an hour unless continuously pumped by the energy field of the subject.

In a second set of studies, an AC voltage at 450 Hz was applied to dielectric coated electrodes that bounded a 2 mm layer of gas in a sandwich-like gas discharge device. The voltage peak was kept 10 to 15% below the breakdown threshold for the gas, and electron "microavalanches" passing through the gas were monitored by a pulse counter that could be set to count any pulse over a predetermined size. Typically, the pulse counter was set so as to just miss the largest microavalanches traveling across the gas. Thus the system was poised but yielding a zero count for many hours until a human subject attempted to influence it. Most of a thousand or so experimental runs involved a person holding his hands about six inches from the device and intending to increase the count rate. Over a five-minute period, the number of recorded pulses was often in the range of 50,000.

If the subject's hands were not held near the device but the intention was still to increase the rate, total counts could be increased from zero to the range of 10,000 to 20,000 within five minutes. If the subject's intention was directed away from the device by being focused on a different mental task, no change in the count rate occurred.

The gas discharge experimental setup comprised a high-fidelity, high-voltage power source, the gas discharge device, and a monitoring system. This schematic illustration shows electron avalanches passing through the gas, a typical oscilloscope tracing of total electron avalanche current vs. time, and a plot of the count rate as a function of time during an experimental run.

I decided that (1) people manifest a heretofore undetected energy that has the property of increasing both electron microavalanche

size and number in a nearby gas discharge system; (2) a person can direct the flow of this energy in a chosen direction; and (3) the mind-electron interaction can be effective over appreciable distances.

Elmer Green and his associates at the Menninger Clinic devised a simulated healing experiment involving an accomplished healer in a specially designed environment within a larger room. The healer, wired to a variety of electrophysiological measurement instruments, stood or sat on an electrically insulated framework placed within four large, square copper walls, one in front, one behind, one above, and one below. Electrically insulated electrometers simultaneously recorded the voltages of these four walls plus that from an electrode placed on the healer's earlobe.

In the copper-walled meditation room, four pairs of insulated copper and aluminum panels float in electrical space around a research chair, which also floats electrically, insulated from the "down" panel by glass construction blocks. Signals from the subject's body and from the four copper walls are fed into electrometers, and data from all channels are forwarded to polygraphs, digitizers, and a computer. The graph below shows an example of simultaneous body and wall potentials.

Instead of the expected 10 or 15 mV baseline reading with 1-mV ripples that are typical of the human body, it was observed that the healer's body voltage often plunged by 30 to 300 volts and then returned to baseline within 0.5 to 10 seconds. This astoundingly large body voltage pulse is about 100,000 times normal, and correlated pulses of 1 to 5 volts appeared on each of the four copper walls. In a 30-minute session, the healer manifested 15 of these anomalously large pulses.

From this experiment, I generated a theoretical model of a non-observable subtle energy pulse emitted at some location in the healer's body, transduced through a series of stages, and manifest as an electric dipole pulse at a specific location in the body. With this, I was able to make a quantitative analysis of the data from the 15 pulses.

In 13 of the 15 pulses the place of origin was the lower abdomen. The dipole was predicted to extend from the ear (negative charge end) to the feet (positive charge end), but only a small current had to flow for a short time to achieve the result. Such a current flow is much less than typically observed when any two different acupuncture points on the body are connected.

For the other two of the anomalous pulses, it was necessary to propose the formation of two simultaneous electric dipole pulses to account for the different type of data observed, and the location of the second dipole was predicted to be in the head.

What I deduced from this study was that (1) the healer's intention to heal can manifest ultimately as large, observable electric voltage pulses in physical reality; (2) some medium exists that couples the non-observable subtle energy to an observable physical energy; and (3) a precise mathematical analysis can be generated to concretize this elusive concept.

The fourth experiment was carried out at the Institute of HeartMath about five years ago and involved the psychokinetic act of remotely winding or unwinding DNA strands on soluble DNA particles in aqueous solution by accomplished practitioners of the heart focus technique called "freeze-frame." The average winding state of the DNA molecules was determined using ultraviolet absorption spectroscopy. The mode of heart function was determined from the practitio-

ner's electrocardiogram.

The freeze-frame technique consists of consciously disengaging mental and emotional reactions to external and internal events and shifting the center of attention from the brain and the emotions to the physical area of the heart while focusing on someone or something to love or sincerely appreciate. These heart-focused feelings produce profound changes in the practitioner's heart rate variability, connoting an ordered mode of heart function that entrains other key body processes so that, overall, a type of body coherence is attained.

Abrupt changes were seen in heart rate variability, pulse transit time, and respiratory rate after a practitioner entered the freeze-frame state. Heart rate variability is shown as an example of how Fourier transforms of these real-time plots showed entrainment of all three data signatures to a narrow region around the baroreflex frequency, 0.1 to 0.15 Hz.

Using five trained practitioners for a total of 10 trials on different days, heart rate variability plots were used to indicate when a practitioner was in an entrained state. While holding a vial of DNA solution in the left hand, the practitioner was asked to focus on the water and intentionally alter the DNA's state of winding for a period of five minutes. There was a statistically significant difference in the intentionally treated water compared to controls.

It was interesting to note that for this study, the necessary and sufficient conditions for success were twofold: (1) the practitioner had to be in an ordered mode of heart function, and (2) the practitioner had to intend to influence the DNA's winding state. If either of these conditions was absent, then there was a negligible change in the UV absorbance of the DNA solution.

What can be deduced from this study is not only that intention is important in producing such a psychokinetic effect but that (1) the physiological state of the practitioner plays a key role in the process, and (2) the inner self-management discipline developed by these practitioners allowed easy entry into this state of body coherence, which in turn provided multiple electrical and chemical benefits for the body.

The fifth experiment involves the conscious cognition of objects, terrain, atmospheric conditions, and so forth, located hundreds to thousands of miles away, given only the coordinates of the location. This experiment, originally conceived by Ingo Swann and given the name "remote viewing," was refined and perfected by him in association with Hal Puthoff and Russell Targ at Stanford Research International. For government service remote viewers, successful completion of a training program required a minimum of 85% accuracy with respect to the coordinates of 20 blind targets. In some cases time coordinates, past or future, were also involved.

A more familiar mode of remote viewing involves the ability to "tune in" to a specific individual and view a specific remote locality through that individual's eyes. This mode of remote viewing ability is more easily acquired and has been replicated in many laboratories around the world.

What one can deduce from this study is that the understanding of information acquisition by developed people is woefully inadequate because some of it appears to involve processes functioning outside of space-time.

The last experiment to be described here is currently ongoing. Unfamiliar with the previously described experiments, conventional science would deny that people could meaningfully interact with experiments through their focused intentions, and even less so via

an intermediary electronic device. Within the framework of this general experiment, I have selected three specific target experiments and found the present paradigm to be fallacious.

For each target experiment, one starts with two identical physical devices, isolates them from each other using electrically grounded Faraday cages, and "charges" one of them with the specific intention for the particular experiment, the other serving as the control. This charging process involved the services of four highly qualified meditators to imprint the device with the specific intention. The devices were then wrapped in aluminum foil, stored in their Faraday cages until shipping time, and sent about 2000 miles to a laboratory where the actual target experiments were conducted by others over the course of two or three months.

pH vs. time during the operation of an intention-imprinted electronic device.

The specific intention for experiment 6a was to change the hydrogen ion concentration of water by a factor of 10 (one pH unit). Changes produced were in the range of 0.5 to 1 pH unit. For experiment 6b, the specific intention was to increase the ratio of ATP to ADP in developing fruit fly larvae so as to significantly reduce their development time. Here, statistically significant differences (10 to 15%) in development time and , energy metabolism were observed under a variety of experimental circumstances. For experiment 6c, the specific intention was to increase the thermodynamic activity of a specific liver enzyme, alkaline phosphatase, and again statistically significant results were produced.

Continued research with these water target experiments is revealing that (a) the local environment of the experiment is becoming

conditioned so as to allow more ready response to the "prime directive" of the specific intention and (b) a form of local coherence develops that manifests as strong correlations between simultaneous multiple test site data, even when the test sites are as much as 900 feet apart.

What can be deduced from this study is that (1) people with sufficient training, inner self-management, and coherence appear to be able to imprint a specific intention into an electronic device; (2) such a device can retain its intention charge for several months; (3) the prime directive of the device's intention charge appears to activate a previously undetected thermodynamic potential in nature that modifies existing physical processes in inorganic and organic materials as well as simple life forms so as to enhance the vector of change stipulated by the intention; (4) this overall process seems to involve some form of coherence in space-time; and (5) this local coherence grows in time with continued use of the target devices.

It is still early days with respect to this type of experimentation. With only about two years' experience with these three target experiments to date, much has yet to be learned.

At least seven unique and important conclusions can be drawn from these six experiments:

1. Directed human intention can have robust effects in physical reality.
2. The magnitude of the intention-generated physical effects increases with continued inner self-management practice and thus growing coherence of the human source.
3. Directed intention must be considered as a thermodynamic potential and a significant experimental variable in any future paradigm concerning natural law.
4. Energies function in the universe that defy

the present physical domain perspective and can be directed by sufficiently developed people.

5. Simple electronic systems can serve as a long-lasting host for these special energies and intentions. Such devices can broadcast their prime directive, which in turn appears to act as a controlling element in the physical processes needed to fulfill the prime directive.

6. Structure appears to exist in nature beyond the current view of space-time, and developed people have the capacity to access valuable information from such nonspatially and nontemporally limited channels.

7. The structure of space-time appears to adapt to continued use of intention-imprinted electronic devices and to develop coherence-like properties.

These conclusions, I expect, will significantly impact any efforts to model the structure of the universe in a way that will allow these psychoenergetic phenomena to comfortably coexist with currently accepted phenomena in a more useful "world view."

For today's medicine, this new data sheds strong light on the so-called placebo effect. The prevailing medical view is that nothing real has occurred and that any improvement is delusional. In Herbert Benson's work among patients receiving a variety of treatments they believed in, but for which medicine finds no physiological basis, treatments were effective 70% to 90% of the time. However, when physicians doubted whether these treatments worked, their effectiveness dropped to 30% to 40%.

Similar belief-related success was observed in Stewart Wolf's work with women who experienced persistent nausea and vomiting during pregnancy. Sensors were positioned in their stomachs so that contractions could be recorded. Next, they were given a drug

that they were told would cure their nausea. In fact, they were given ipecac. However, because of their belief, the women reversed the laboratory-proven action of the drug, and their measured stomach contractions dampened down to negligible values.

From these studies and many more like them, it can be seen that belief fuels expectations, and expectations in turn marshal intention at both unconscious and often conscious levels to fulfill the expectations. The six experiments described here tend to both scientifically validate that perspective and also illuminate some of the factors involved. For future medicine, once the presently prevailing mind-set is bypassed, a remarkably powerful technology waits to be unfolded in the service of the healing arts. There are also some serious limitations in the present physics paradigm that need to be corrected with a new model having sufficient predictive power to accommodate comfortably both the old data and the new unfolding data.

FOR MORE INFORMATION

William A. Tiller: *Science and Human Transformation: Subtle energies, intentionality, and consciousness.* Pavior Publishing, 1997.

Ingo Swann: *To Kiss the Earth Goodbye.* Hawthorne Books, 1976.

Herbert Benson and Marc Stark: *Timeless Healing: The power and biology of belief.* New York, Scribner, 1996.

William A. Tiller, R. McCraty, and M. Atkinson: *Cardiac coherence: A new noninvasive measure of autonomic nervous system order.* *Alternative Therapies* 2:52, 1996.

W. E. Dibble, Jr., and William A. Tiller: *Electronic device-mediated pH changes in water.* *Journal for Scientific Exploration*, 1999.

Energy Fields and the Human Body, Part II

By William A. Tiller Ph.D.

In this paper, I first project a model of substance so that we may have a framework wherein we can start understanding how many of the non-physical energies discussed in Part I come into play and begin to interact with each other and with the physical. Then, after that, I want to go on and discuss some experiments related to the Cayce impedance device, the wet cell appliance and other devices of a similar nature.

A. Theoretical Model of Substance

First, let me make clear what I mean by model. A model can be thought of as a working hypothesis. It is a conceptual framework from which we can start to try and understand some aspect of nature. It is a target at which we can start throwing experiments. In the beginning, it is the first discrimination of ideas into some format or structure that gives one a feeling that he is starting to meaningfully grapple with the particular unknown area under consideration. As one begins to model the phenomenon, he is able to formulate the right kind of experiments for testing the hypotheses, and then can perform the experiments and can obtain feedback of new and pertinent information. This allows one to check out whether a particular aspect of the model is correct and to subsequently make corrective changes all through the model as need be as time goes by. However, to do this, one must have a place to start. Thus, models, to me, are like the rungs of a ladder from which one climbs from one level of understanding to another. Most of the

models are eventually wrong in detail, but they serve the tremendous function of allowing one to climb from one position of understanding of the universe to a more enlightened position of understanding.

Now, the discussion of Part I shows that our present understanding of human energy fields is inadequate to account for these new phenomena. So many things seem to happen that are not explicable in terms of electromagnetic energy or sonic energy that, by trying to squeeze all these new aspects into that very small mold, we will get lost (because they just will not fit). Thus, the place where I have started is to take the yogi philosophy of the seven principles operating in man and hypothesize that this really means that there are seven different levels of substance (unique substance); that these different substances have different types of configurations (1). They obey entirely different kinds of laws-unique types of laws-and they have unique characteristics of radiation (absorption and emission). I further postulate that they operate in different kinds of space-time frames in the universe and so are distinct from each other. The seven levels of substance, then, from the coarsest going towards the finest are: (1) the physical level that we are familiar with; (2) the etheric level (the Russians call this the bioplasmic body or the energy body; some people call it the pre-physical body); (3) the astral level; (4) there are three levels of mind: instinctive, intellectual and spiritual mind and (5) another distinct level which is spirit.

There is considered to be a level beyond these seven, which shall be called the Divine. However, relative to all that I think we will be capable of perceiving for a very long period in the course of human evolution, we may think just in terms of the seven levels of

substance.

These seven substances interpenetrate each other in nature and may interact with each other. They, through the polarity principle, form atoms and molecules and configurations of these. One can apply the metaphysical principle: "As above, so below; as below, so above", and realize that what we see in the physical may be used as a model and this same kind of modeling understanding may be extrapolated through the other levels of substance, differing somewhat in detail from the physical, and we may begin conceptually to grapple with these other levels. The substances interpenetrate, and their relationship may be visualized by considering the situation in our own bodies. To visualize our seven bodies, think of seven transparent sheets of paper and, on these sheets, using particular pens of different colors, draw circuitry of one color on one and on another draw circuitry of another color, and so on through the seven colors. Then, put these sheets all together and look through them, and you will see an organization of substance at the various levels within the bodies of man. That, basically, is the model I wish to project.

In general, these substances do not interact with each other too strongly. However, they can be brought into interaction with each other through the agency of mind, and it is really at the point of mind that one can bring about changes in the organization of structure in these various levels of substance. That is, through mind forces, one can create a pattern, and that pattern then acts as a force field which applies to the next level of substance. In turn, that force field is a force for organizing the atoms and molecules into configurations at that level of substance. That pattern of substance at the etheric level,

then, is in a particular state of organization and it has its own radiation field - its own force field if you like - and that force field, then, is a field for the organization of matter at the next level of substance - the physical level of substance. These etheric forces, then, bring about the coalescence and organization of matter at the physical level of substance.

Here, we see something that I have chosen to call the "ratchet" effect; one can see an action beginning at the mind level and working its way down through to produce an effect on the physical level (and vice versa).

As an aid to visualizing this model, consider fig. 1 (Not Shown) and recall the radiation patterns discussed in Part I (the characteristic pattern of emission and absorption of energy from a substance). For these seven levels of substance it is meaningful to draw a plot of the intensity of the radiation versus its frequency. Now, the thing we have to realize is that this particular representation of fig. 1 is purely for coming into contact with the idea and is not a scientifically correct representation, since these levels of substance represent entirely different kinds of energy, entirely different kinds of physical laws, and they really should be represented on different axes; i.e., different coordinate vectors of phase space. That would be a more proper way to do it. And, in fact, along any one of these coordinates, there may be many different kinds of energy that should be represented (just like electromagnetic, sonic, gravity, etc., energies in the physical). But, at least for us to conceptually see the simplest outlines of the model, it is worthwhile to represent it this way: the physical, etheric, astral, mind levels and the spiritual level on one axis. Through focusing attention on the mind and spirit levels, here we see the true essence of man. This is the indestructible reality of man and

is the on-going man. These levels of energy function (or appear to function) in a non-space, non-time frame of reference, that is, the patterns of intelligence (in that frame of reference) are not represented on coordinates which relate to space and time.

The astral function is largely as a containment vehicle, it appears, to keep this human essence in a compact form between incarnations. Looking further to the left, we come down to the temporal reality associated with this kind of physical existence; i.e., a vehicle that is suitable for experience in this earth plane (the etheric level and the physical level). In the case of the physical, we have the space-time frame, which is the Einsteinian frame, which we know a great deal about. The etheric level is a companion level and it operates again in a space-time frame but in a different space-time frame from the physical, and yet these two are complementary. That is, as time goes on, for the physical the potential decreases and entropy increases, whereas for the etheric we have the reverse situation (the potential increases and entropy decreases). A characteristic of the physical frame is one of disorder. A characteristic of the etheric frame is one of the organizations of matter. The physical is primarily characterized by electric effects. The etheric is primarily characterized by magnetic effects.

This is the way in which I have come to look at these various energies; i.e., that there are radiations associated with these different levels, and these radiations give rise to the phenomena that we can call psychoenergetics. The majority of these phenomena deal with the etheric vehicle. That is, we have a sensory system in this vehicle which connects us to the psychoenergetic phenomena just as our five physical senses connect us to physical phenomena.

I want to draw your minds back to the picture of the cut leaf of Part I (figure 10). There, we saw the pattern of the physical leaf, and we saw some energy effects associated with the part that was cut away. I mentioned in Part I that this was like a force field from another level of substance. It was, in my model, from the etheric level. This force field was like a hologram. Now, let me expand on that idea for a minute. A hologram, basically, is a pattern of coherent energy and that pattern has a three-dimensional character in a space-time frame and it represents particular information.

In my model, God created the universe, and He created it as a hologram (1)! The first hologram beyond the Divine was a hologram of spirit substance which organized itself and the organization, at that level, had coherent radiation centers which radiated a pattern which was a hologram at the spirit-mind level. Then the substance organization at this level occurred which, in turn contained coherent radiation sources which led to the radiation patterns for organization of the intellectual mind. That, in turn, led to organization and coherent radiation to form a hologram for the organization of instinctive mind, and so on down the line. I think we saw the first and simplest representation of this with the cut leaf experiment. That is why I think it is so important to see, in fact, some evidence of the hologram penetrating to the physical level from the etheric level. (Note: this experimental result has not yet been reproduced in this country.)

Now, there are several things that are important to note about a hologram. One is that if you take any piece of the hologram, you may recreate the entire hologram, and it is through this that we can understand what was meant when Cayce said: "Man within

man is all representation of the universe. Within a cell of man is a representation of the entire universe-within an atom is a representation. If, in fact, the hologram model of the universe is correct, then this is exactly what we should expect. A second thing that is important to note about this hologram, if this is the way creation took place, is that the Divine pattern produced initially created patterns at the mind level of Nature for the development of man in a harmonious way. This results from the coherence in the energy pattern. However, man has free will and, if with that free will, he polarizes from an ego-mind aspect, he creates mental patterns, which are not consistent with those initially set, and they do not reinforce them. This, then, produces an anomaly or disharmony in the initial pattern and that disharmony in the initial mind pattern affects both the individual and mankind in general so that disease really would start here. That is, the thoughts that one creates within himself and within society at large generated patterns at the mind level of Nature. Those patterns are superimposed upon the existing Divine pattern. They then produce cause and effect relationships all the way down through the various levels of substance, and so we see that our illness, in fact, eventually becomes manifest from the altered mind patterns through the ratchet effect - first to effects at the etheric level and then, ultimately, at the physical level. Here, then, we see it openly as disease at the physical level and, if we begin to sense the etheric level, we will see it also as disease at that level. So what is the way to cure it? Even though we bring about medical changes at the physical level, we do little at these deeper levels so that the disease will eventually recur. We would be a better doctor if we could produce correction at the etheric level because then the cure would last

longer. However, it will not be permanent because we have not altered the basic hologram at the mind and spiritual level. We have to change at the mind and spirit levels to change the mental patterns so that we can produce, if you like, an annihilation of disharmonious elements at this level of the hologram. Then, Nature will just go forward in its harmonious way and man will not create and manifest disease

Let us consider the physical and etheric levels just for a moment before I switch to my next topic. Think of these, if you like, as a type of transformer association with the etheric as the primary, and the physical as the secondary. The primary circuit always contains the greater quantity of energy, and secondary circuit manifests a stepped-down condition, so that there is less energy generally. In the physical energy circuit, we see the acupuncture meridians. There is, I anticipate, an analogous circuitry at the etheric level of the system. I am not quite sure of its pattern yet, but anticipate that there is an inductive coupling between these two companion circuits. Perhaps the one aspect of this relationship that we know most about is that in the physical body we see the endocrine glands as being the important spiritual centers (energy centers) of the body, and have come to learn how strongly their functioning relates to the whole chemical and physiological functioning of the body. At the etheric level we have heard for such a long time about the chakras. The chakras and the endocrines appear to be at the same spatial location within the body, and my feeling is that they act as coupled or companion glands; i.e., as chakra-endocrine pairs, and we should begin to think of them as a type of transformer or transducer, if you like.

In fig. 2, we see the location of the various

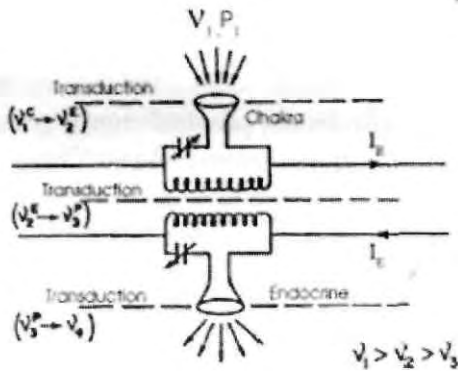
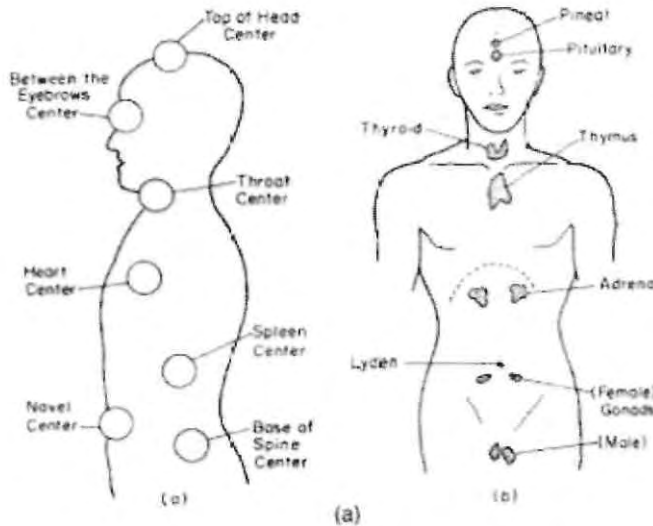

chakras and we see the endocrine glands located basically at the same physical location. In fig. 3, we have a representation of a chakra-endocrine pair as a tuned circuit via which one may tap energy from the Cosmos. One can tune this circuit to absorb energy and produce current flow in the etheric circuit; i.e., some type of current, whatever it is. There is thought to be inductive coupling of some sort between the etheric body and the physical body that produces various energy currents in the physical body and the transmission of energy out into Nature, both directly from the physical body and back through to the etheric level, and then out

into the environment. Figure 4 illustrates a front view of the chakra network in the body. (2) Figure 5 illustrates a side view of the chakra system. We see that, although the chakras have their centers located as indicated in fig. 4, their seats or root stems appear to be in the locations closely related to those of the endocrine system. In fig. 6, we note the types of psychoenergetic phenomena associated with each center.

The next step in the progression of our understanding relates to the various psychic manifestations of psychokinesis, telepathy, and so on. For this, I anticipate that we must begin thinking of these chakra-endocrine pairs as coupled units and operating very much in what I would call a laser mode, that is, one must start thinking of these various centers working in synchronization with each other to manifest coherent energy and then radiation from these centers. Thus, if we want to investigate these phenomena, we

must monitor the body in such a way that we are reading energy changes from these centers.

The lasing aspect of these centers is very important to understand. If one takes a ten-watt bulb, we know there is only a small amount of illumination radiated from the bulb. It, indeed, sheds some light, but it is not a great amount of light, and that is because the conventional light that we use is incoherent, and its energy content is not very effective for illumination purposes. Incoherence means that the rays of light are all out of phase with each other, so they cancel, and we get what is called destructive interference

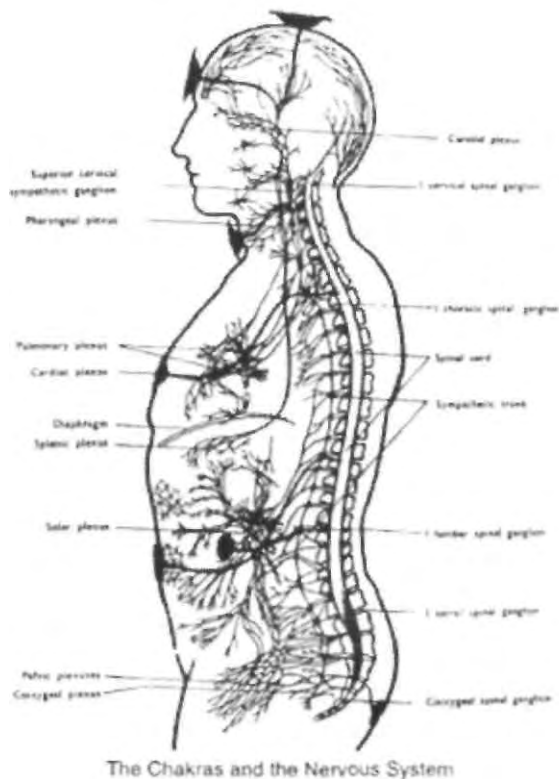

The Chakras and the Nervous System



of the light waves. Thus, although one gets some illumination, he does not get much. However, if one can arrange for those individual photons of light to all be in phase, then he obtains constructive interference of the light waves; i.e., the resultant wave becomes very large in amplitude. When that happens, you have a laser; you have coherent light and that same ten-watt bulb can now produce an energy intensity over an area of about one square inch that is far greater than that found at the surface of the sun. This is a far more effective use of the energy! From that same total energy, the same basic stuff, by rearranging it in the right way to make it more coherent, one is able to develop a fantastic tool capable of doing many things. That's what I think happens here in the body!

I propose that the manifesting of psychoenergetic phenomena associated with taking the primary energies in the body and making them coherent. In my modeling, I suspect that if we took all the energy in a single human body and made it coherent, there would be at least enough energy to create our entire universe at the physical level. You see, the basic energy is already there; it is just that it is in an incoherent form, and our job is to make it coherent. This we do by developing attunement with Nature through our meditation, our thoughts, and our actions. That is when these powers become manifested, and they are manifested through these various mechanisms. Some people seem to have a head start via the structure of their genes, but others can catch up and surpass by muscle building at these internal levels of self.

B. Some Devices for Circulating Non-Physical Energies in the Body

I want to turn to the discussion of the Cayce impedance device (it is called the radio-active device), the wet cell, a circuit by Eeman which is similar to that, and a circuit that I have been working with which is similar to and simpler than all of them, but which has similar functions. Let me first consider the radioactive appliance illustrated in fig. 7. (Not Shown)

The radioactive appliance is basically a capacitive energy storage type device made of powdered charcoal, steel plates, glass and carbon. I do not understand the details of its functioning yet. To fully understand, one must begin to think in terms of action at the etheric level. That is where most of the energy changes are manifesting. There is only a small amount of action taking place at the physical level, and even these are very difficult to detect.

Figure 8 (Not Shown) shows us how the particular device is arranged in a circuit; i.e., the radioactive device. It is put in a container surrounded by ice and water and, neglecting this for the moment, is connected to a pair of electrodes, one copper and one nickel, which are attached to various points in the body. This leads to the subjective feeling of energy flow within the body. (5) One feels a sense of relaxation in the body although, when one attempts to measure it through conventional electrical procedures, significant direct electrical signals have not been detected (a decrease in electrostatic potential between the base of the spine and the base of the neck has been detected),

In this circuit one also can place a solution jar containing particular solutions, which

leads to an effect on the body. To begin to understand this, one must think in terms of an energy flowing through the wires. Primarily, I anticipate that there is a need for an electrical energy flow at the physical level. Since these are nickel and copper electrodes in fig. 8 and the circuit passes through the body, the device probably uses an electrical potential that comes from the body itself; i. e., from the acupuncture points. These are dissimilar electrodes and, as noted in Part I, you are bound to get a small electrical potential of the order of 50-100 millivolts driving this circuit. Think of this circuit, if you like, in the simple electrical terms of inductance, capacitance and resistance in that you would have some natural oscillating frequency at the physical level. In my modeling, the physical electrical energy flow is just to get the more subtle but more powerful non-physical energies flowing at the other levels of substance in the body. Returning now to the solution jar, as the current (various types) moves through (at various levels of substance), a range of vibratory quality from those chemicals in the solution jar is picked up to modulate the current waves and they are introduced into the body. More will be said about this below.

In fig. 9 (Not Shown), we have the wet cell appliance. (5) Basically, it is a type of battery but with the strangest electrolyte you ever saw. However, it is still a battery and it has a particular output voltage (about a volt and a half), and it is also connected through the solution to the electrodes, which are then applied to specific places of the body. I think these two devices do an essentially similar thing. However, this particular device has its own internal power source, whereas the other one is powered by the body, not completely through the acupuncture points, but

partially. The function of the wet cell is, I postulate, to obtain a larger energy density flow than is possible with the radioactive appliance. The larger current flow produces several important effects. It produces a stronger realigning force at the etheric level for the molecules to be realigned to the appropriate pattern. Secondly, because you have a larger current density you can more readily break down resistant energy block or barriers. The first device is much more subtle, whereas this device is much stronger and is needed for those individuals who are deeper into the pathology and so have organizations of substance at both etheric and physical levels that are, let us say, strongly scattering the primary wave energies. Thus, the wet cell device can exert a much stronger reorganizing force than the impedance device, but they have a very similar general function.

Now, there undoubtedly will be many other aspects to these devices that we will learn about with time; we are just crawling at this stage and I do not have a comfortable feeling that I presently know all the important aspects of these devices. I have only just begun my study so that this is merely a progress report of thinking rather than of experimentation at this stage.

At this point, it would be beneficial to quote something of what Cayce had to say about these devices and then we can consider a bit of interpretation. (1) Cayce says that this energy given by the appliance device is in the nature of radio vibration as will give to the nerve energy of the nerve systems, both of the cerebrospinal and the sympathetic, that proper vibration as will create new energy in the system. [Reading #5623-11

(2) This works with the vibratory influences

of the bodily force itself. Hence, it is a magnet, a radio magnet that applies or supplies of the very vibratory forces of the bodily functions that which produces the coordination of the activity of the nervous system as related to the actions of the cerebrospinal and sympathetic or vegetative nerve system by its application to the body in the ways and manners that produce in the central nervous system as they reach the extremities an influence of a vibration that affects the glandular system in re-ionizing the body) recharging and revitalizing the body. [Reading #1800-28]

(3) For here in this appliance (the wet cell) the charge is built in the instrument to be discharged in the body while in the radioactive appliance the body builds the charge to be discharged through the instrument into other portions of the body [Reading #1800-28]

(4) Then the action is as this; an excess in one by a unison of electronic agencies may be forced to assist that one deficient. That one deficient may receive sufficient of electronic agents, vibrations to the body, to increase and assist the body in gaining its perfect equilibrium. [Reading #1800-4]

Now, the functioning of the devices, as I see it from the point of view of my modeling, is that we are dealing with balancing of the acupuncture meridians. In one case, the radioactive appliance sets up an oscillatory energy pattern in the body causing current flow out of some acupuncture points and current input into others, very much on a microscale (probably below 1 microampere of current at the physical level). This continual flow, this gentle oscillation, is bringing about a balancing of the energy circuits, and that is what Cayce was talking about - an equalization

process, the taking from one meridian and giving to another. An important aspect of the radioactive appliance is that it utilizes basic body energies that set the entire process in motion through the acupuncture points (the potential sources); the wet cell has its own internal energy source.

With respect to the solution jar effect, this is very similar to the kind of things one sees in homeopathy or in radionics. That is, for healing, it is not so important to have the physical substance present, or even the etheric; rather, it is important to have the vibratory quality of the substance. When the current flows through the solution, if there is good coupling between these, then the energy stream which is passing into the excitation circuit of the body picks up the vibratory quality of whatever is in the solution jar and it moves this quality into the body along the circuit paths of the various currents. If there are centers within the body, or molecules which absorb and radiate in the frequency band of these vibratory qualities (recall Part I where it was shown that the natural resonant frequency of a particular electron transition involves not only radiation in that frequency range but also absorption), then, if the current is passing through that particular area and it has this harmonious wave pattern pinned on it, the elements of that area will just absorb the resonant wave patterns. The elements, molecules or glands will gain, in fact, the value that they would have gained from the minerals themselves. Thus, the function of the solution jar is to serve as a current modulation device.

A few instructions for the use of these devices should be noted here; one is directed to references, 5 and 6 for more complete instructions. With respect to the radioactive appliance, it is stated: "Mark the terminals

and always attach the same terminal first to the body." [Again, it is a question of polarity.] "Leave the appliance attached to the body for not less than 20 minutes or more than an hour at one time. It is preferable to remain quiet and relaxed by lying down during the treatment. Attachments are made as follows: First day, right wrist and left ankle. Second day, left wrist and right ankle. Third day, left ankle and right wrist. Fourth day, right ankle and left wrist. Then you repeat this about three or four times." [It is basically to balance the polarities in the body.] "In terms of the elements in the solution jar, you can use gold chloride and that supplies nerve energies for rebuilding nerves. Put in spirits of camphor and that supplies healing forces. You can put in Atomidine and that supplies cleansing of the body." These chemicals are useful for everyone. My feeling is that this is a very good way for everyone to develop both curative and preventative medicine.

Eeman (4) developed a circuit that could be used as either a relaxation or a tension circuit. This is illustrated in fig. 10 and consists of an individual plus copper mats and copper wires. The head and the right hand are found to be of one polarity. Let's call it the negative polarity. The base of the spine and the left hand are found to be of the opposite polarity - positive polarity. The individual is aligned along the magnetic flux line with head to the north and feet to the south (feet crossed). If he is right-handed and connected this way, he will just relax in this particular circuit, and this brings about a balancing of energies in his body. If you reverse the hand connections then you build a tension circuit which right-handed people find almost unbearable after a little while. If the individual is left-handed, the situation is reversed.

Figure 11 shows how one can hook up two

people in the series arrangement so that there is an energy circuit which flows through both individuals. Figure 12 shows a variety of connections - a series or parallel arrangement in which you can place a group of people. Eeman ⁽⁴⁾ found that you can have emitters, you can have resistors, you can have conductors, and you can have relayers as people-types in your group. Thus, the order in which you arrange people in the circuit becomes rather important in terms of the magnitude of energy flow in the circuit. Basically, energy flows in the circuit, which may break down the barriers to energy flow located in certain individuals, if the emitter strength is high enough and, eventually, this energy loop operates like an amplifier to increase the energy of everyone in the circuit. The loop closes on itself and the energy just keeps circling around the loop bringing about balance and equalization of primary body energies.

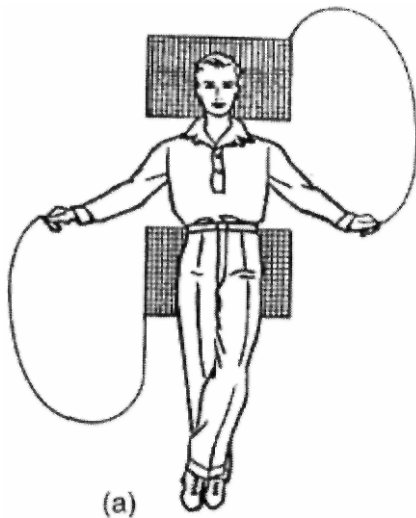

In fig. 13, we note that Eeman also placed a solution jar in the circuit in certain cases. He placed various drugs and such in a solution jar and found characteristic effects in the pa-

tients as a result of having used the solution jar in the circuit.

In the experiments I have personally carried out with this type of circuit, I have used a slightly simpler device than the Eeman's circuit, but quite similar in nature. I noted the strong subjective feeling of energy flowing through my body, sometimes quite intensely in certain parts of the body, and I feel greatly relaxed (less mentally scattered) for about six hours after one-half hour in the relaxation circuit. Two things appear to be relevant here. One is that I have a friend who is a clairvoyant and who can see some circuitry of the body and some energy patterns. He described the situation to me as I put myself in the relaxation circuit. I was very tired and mentally exhausted when I started. He said first that he saw a point of light in my left shoulder and then in my left hip, and then some energy streamers flowing between the two. Next, after a few minutes, a point of light appeared at my right shoulder and then energy streamers flowed across the torso of the body, then energy started to flow up and down portions of the leg and eventually my right hip was lighted. The right hip seemed to be the slowest region to get going. Eventually, the whole body was a rosy glow of light to his sight. He observed a continual flow of energy patterns on the body. Subjectively, I was feeling the same type of energy changes and these correlated quite strongly with what he was able to see using his special vision. I felt, of course, much better after doing this, and I now make a regular practice of using this circuit when tired. It greatly extends the length of my effective working day.

The second aspect that seems relevant here is that before I ever worked with this circuit, I found that when I laid down horizontally on the bed and deeply relaxed and mentally

moved energy up and down my body and around rhythmically (moving it out through my feet, up through my head, out through various centers, in through various centers and around my body). In fact, felt the same kind of sensations as I felt in the circuit and received the same or similar kinds of results. Thus, a suggestion of what is going on here is that we have something like a continual charging and discharging in various parts of the system and energy patterns are moving over the body. In the case of the radioactive appliance, the wet cell or Eeman's device, this energy starts moving by the agency of some electrical or electromagnetic energy motion. This energy motion very quickly couples, via the ratchet effect, with the deeper and stronger energies of the body, and these start moving. Eventually, we have energy swirls traveling over the body, producing equalization of the meridians and other body energy circuits and, again through the ratchet effect, we must expect to have these kinds of phenomena going on at all energy levels up through the mental level. Thus, we obtain what is called a relaxation, a decrease of tension, a decrease of disharmonious organization of the bodies and a better alignment with the natural forces at all levels up to and probably including the spiritual level.

An interesting experiment to perform will be to monitor the acupuncture points for the central nervous system and see, in fact, if a resistance or current change occurs when this kind of circuit relaxation is used so that we can begin to see what happens when one puts a person into the relaxation circuit and switches, unbeknownst to him, to a tension connection and back and forth. In this way one would hope to obtain various kinds of physiological readouts that are meaningful to the conventional scientific community. We

have to do that at this point in time. We must bring the data to that level. That is where our general understanding is, and I feel that we are at the point of being able to start doing some meaningful experiments. There are many indications that tell us that there are special energies involved here which will be of tremendous therapeutic value to the body and thus to all of life because of our manifested expression when we are feeling good instead of lousy. I think we can really start now. We now have a few tools, not many as yet nor are they well understood; however, there are some that will let us transform this information to a level of understanding that is meaningful to our society. As we start such experiments, we will begin to see deeper and deeper into these aspects of Nature, and all the hidden treasures that are never anticipated in the initial model are in store for us just below the surface of our present understanding.

References

1. W. A. Tiller; "Radionics, Radiesthesia and Physics" (Academy of Parapsychology and Medicine Symposium of October 30, 1971 on "The Varieties of Healing Experience" - 314A Second Street, Los Altos, California 94022)
2. C. W. Leadbeater; "The Chakras " (The Theosophical Publishing House, London, 1969)
3. A. E. Powell; "The Etheric Double" (The Theosophical Publishing House, London, 1960)
4. L. E. Eeman; "Co-operative Healing" (Frederick Muller Ltd., London, 1947)
5. E. E. Cayce; "Two Electrical Appliances Described in the Edgar Cayce Readings" (A.R.E. Press, Virginia Beach, 1969)
6. Instruction Booklet for Use of the Wet Cell Appliance (Medical Research Division, Edgar Cayce Foundation)

Books by Dr. William A Tiller Ph.D.

Conscious Acts of Creation, The Emergence of a New Physics
William A. Tiller Ph.D., Walter E. Dibble Jr., Ph.D., Michael J. Kohane Ph.D.

"The Power of Human Intention to Robustly Influence Physical Reality
Intention-Induced Raising of local Symmetry in the Substratum of Space Heralds a New Period for Both Physics and Human Evolution."

Not everyone will understand this book but everyone should still have a copy on the bookshelf. This is the advanced research we all which we could perform but are limited for one reason or another. This book represents some of the most advanced research in the fields of borderland sciences ever released to the public. The authors detail many experiments and protocols they use to examine the physical action that consciousness has on shaping physical reality.

The wonderful thing about this book is that it is designed for the skeptic and for the individual struggling with their Academia worldview. While most borderland scientists do not have this problem this book is a great mind opening experience worth the read. This book is bound to break barriers that have long kept the subtle energies a taboo and forbidden voodoo science. Scientific models of quantum consciousness that are founded on good science and not idle speculation are here and just in the nick of time. I have confidence that the frank manner in which the paradigm shift is confronted in this book that this information will be assimilated in no time at all.

Science and Human Transformation
Subtle Energies, Intentionality and Consciousness
William A. Tiller Ph.D.

This great book was written in 1997 and is very accessible material. It outlines the science behind the body's subtle energy fields. Dr. Tiller writes, "This book is meant for everyone, although many may consider it appears to technical for them. However, if they are able to persevere in the reading, to just get the over all sense of what is presented without trying to understand everything in detail the first trip through, they will find great benefit from exposure to the material." I have to agree whole-heartedly. Fashioning a Multidimensional Model, Body Radiations, Antennas And Auras, and Intentional Development of the Body's Extended Sensory System are just a few of the chapters in this pinnacle of Borderland scholarship.

Subtle Magnetism - A Fifth Force?

Experiments and Theories

By Buryl Payne

PsychoPhysics Labs

Capitola, California

A number of experi-

ments have been done which show that another force besides classical electromagnetism exists, especially around living organisms. Although the individual experiments seem anomalous and fragmented, partially because of different terminology, they do form a coherent whole and substantiate the existence of a fifth force related to magnetism, but different from it.

Animal Magnetism was the name given it by Anton Mesmer centuries ago. He knew it was something different from the magnetism connected with lodestones. He also thought there was something akin to animal magnetism around the Sun and planets which affected humans and plants called 'chi', 'prana', 'vital force' and a variety of other names in other languages, it has tantalized researchers for years, challenging them to detect and measure it. People have looked for this subtle force with tools used for detecting the known electric or magnetic forces; this has been misleading; an attempt to put it into the classical framework when it is different. Small forces have been detected, but the subtle magnetic force is perhaps a million times larger and is easily detected with a simple device.

One of the earliest published articles on subtle magnetism appeared in the English medical journal, *Lancet*, in 1922. Dr. C. Ross, a physician in England, described an instrument which reacted to the proximity of a body or was set in motion by vision.

In 1977 Walter Pescka in Germany pre-

sented a paper at a symposium describing a force he found present around the body which couldn't be explained by classical physics. He used a torsion balance and called it a kinetobaric effect.

In the late 70's the writer found that a simple frame hung by a thread about eye level over a person's head would rotate a few degrees. Initially the frames had magnets on them and it was noticed the magnitude of the force was larger when more magnets were used. It was also observed that the frames rotated more during geomagnetic storms, more for children than adults, and more for healthy person than one who is ill. In general, healers induced more motion on the hanging frames. Small hanging frames in glass bottles were also constructed which showed this effect. My observations showed a spin force to be present around plants as well as humans.

Various models of this device, called 'the biofield meter' were put on the market in the 80's; demonstrations were made at several scientific meetings or conferences, two local newspapers gave it a full page coverage and two TV stations showed the device demonstrated in action.

In the 80's a Hungarian physicist, George Egely, discovered a light 'wheel' mounted on a low friction pin bearing, would rotate when people put their hands around it. He markets this device as the Egely wheel.

In the 80's, a Danish scientist, Dr. Bjoorn Vlistigk, reported he had discovered a 'human energy spin field' surrounding all living persons. He built a huge pyramid struc-

ture, geared its rotation up, and obtained useful energy from the spin force, according to the account published in a newspaper.

In 2001, Ron Hruby, a retired NASA engineer, made a simple frame detector and found that when a small group ten miles distant, concentrated on healing a subject sitting within the detector, changes in the amplitude of rotation occurred 18 times out of 18 trials, or 100% correlation!

Some Russian scientists also discovered the presence of spin forces which did not fit in with the current notions of electromagnetism. They call these forces, 'torsion fields' There are over 70 references to experiments, mostly in Russian. One experiment indicates a propagation velocity of torsion fields as being very much faster than light. There is even a torsion field generator that can be purchased from a Russian company.

TOWARDS A THEORY OF SUBTLE MAGNETISM

Given these, and other experimental observations, not mentioned in this brief article what can be said towards formulating a sensible theory?

First let's unmask the words. The term 'magnetism' was acquired centuries ago. Now, in the 21st century, more sensitive instruments, and many other discoveries, suggest more descriptive terminology. When some electrons in iron atoms align their spin axes, the phenomena we call magnetism become manifest. It is always there, but not observable by our everyday devices such as a compass, magnetometer, or a rotating coil.

The direction of the force from a magnet continuously changes at different places around a magnet. The force does not change, only the

DIRECTION changes, although technically writing, the term 'force' as used in physics, includes direction as well as amplitude. This change in direction will cause a tiny magnet, or electron or other charged particle, if near a much larger one, to twist on its axis to align with the larger one and, if moving, to spin or spiral around the larger one. Free electrons, moving nearby a number of spin-organized electrons (a big magnet) will be diverted off course, or even caused to move in an orbit or spiral around. It's as if the organized spins of electrons on their axes, act at a distance to bring nearby electrons into a macro spin or orbit around the magnet.

Physicists made up the term magnetic field to simplify their calculations, but this is a further abstraction from the term "force", a handy word to cover ignorance and satisfy minds who live at the verbal level. A more descriptive term for magnetism might be organized electron spins.

The direction of the force is into the surface at one end and out of it at the other of a chunk of iron that has some of its electrons in the iron atoms magnetized. These two end directions are called north or south magnetic polarity. The force directions elsewhere around a piece of 'magnetized' iron are not named.

Now what about subtle magnetism? In my experiments I have observed a rotational force around the body for any kind of frame that is hung over the body. Lightweight objects free to move (dangling by a string) near the body also will rotate or attempt to do so, if the string is long enough. One astronaut is reported to have said that when he was outside the space craft small objects rotated around him.

Therefore subtle magnetism may be another type of spin, perhaps more general than electron magnetism. Does it diminish

with distance in the same manner as iron magnetism? Apparently not; it may follow a different mathematical rule than the inverse square formula. And it also may travel faster, as some Russian experiments seem to indicate. The existence of a force which travels faster than light will require a revision of Einstein's theories, and a rethinking of some of the experiments based on quantum theory, now interpreted as showing non-locality effects, or instantaneous action-at-a-distance. Perhaps subtle magnetism could be equivalent to spin around protons, atoms, or molecules. Tesla spoke about a higher octave of magnetism and stated that magnetism was present around all matter.

Subtle magnetism appears to be another kind of spin, perhaps spin around protons, atoms, or molecules? In the human body and other living organisms, atoms and molecules are organized to a high degree. This may appear as a spin force around the body as a whole. Usually the spin force moves objects clockwise as seen from the top of the head looking down. Near the new or full moon and at times of geomagnetic storms the direction reverses.

Does the planet as a whole have a spin force? Does this resonate with the spin force or subtle magnetism of people? Observations with hanging frames tend to support that inference, but more experimental work needs to be done.

Does the Sun possess a subtle magnetic field? Probably, Anton Mesmer thought so. Subtle magnetism may also be another term for a vortex. Vortex theories were popular in physics over 100 years ago.

It may be that a vortex pattern comes first, and a living entity is guided by it. When one is ill, the organization is disrupted. Ordinary magnetic forces seem to help a person reorganize cells and tissues that have lost their naturally healthy or proper form. This too, suggests a connection between ordinary iron mag-

netism and subtle magnetism. Hands on treatment, directed intention, or sometimes merely the nearby presence of another person who is in good health helps an ill person regain the healthy organization they formerly had. This may be a result of direct transfer of information or force from the subtle magnetic aura of one person to another.

When subtle magnetism is called a spin force, it is immediately noticed that every particle from electrons to galaxies spins. Spin is a universal property of matter, perhaps larger in amplitude in living organisms.

Spin, taken as a fifth force, is a complement to gravity (not antigravity), is connected with electric forces, and with living matter. (All matter, having spin, may be alive to some extent by this definition.)

The accompanying table shows a possible relation between the spin force (subtle magnetism) and the other forces of physics.

For more detailed descriptions, clear enough to build a subtle magnetic detector out of sticks and a few magnets, see the chapter III in *THE BODY MAGNETIC*, by Buryl Payne. Or look at the spin section on the web at buryl.com

New Aspects of the Bermuda Triangle

By Melvin Erickson

In recent history, the Bermuda Triangle has been a center of debate. Many people contend that something in that area destroys ships and planes. The description from Satan's Sauna and the Devil's Triangle by Al Snyder is very good: "The Triangle's personality is alternately mild and terrifying. Beneath clear waters lie many "blue holes." These areas fill with water, creating a funneling effect resulting wildly swirling water on the surface - whirlpools - which are sometimes capable of dragging sea craft under. Glowing spews of white water, perhaps even seen by Columbus, leap out of the water with a hidden and mysterious force which could break up all types of seagoing vessels or even low-flying planes. Sudden rampaging

storms, mysterious calms, eerie fogs and a strong ocean current also contribute to the Triangle's treacherous reputation, as men, planes and ships completely disappear and vanish forever - without a trace." Numerous theories have been espoused to explain the destruction of various types of crafts entering this area. Some scientists theorize that there is nothing special in this area to cause the destruction but that the destruction is being caused by small intense storms that occur randomly over the Earth's surface.

The Bermuda Triangle exists in a part of the ocean where ocean currents flow in a counter-coriolis direction. There are six major ocean currents around the world with type of current flow. In each area there are

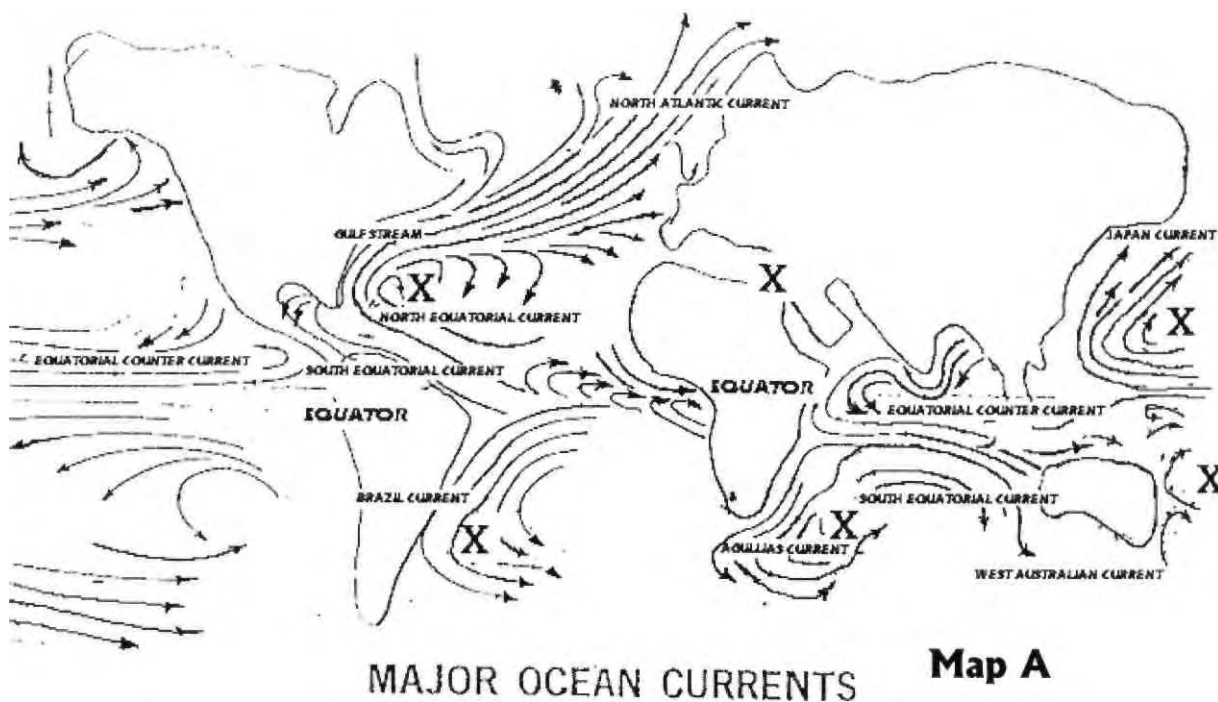

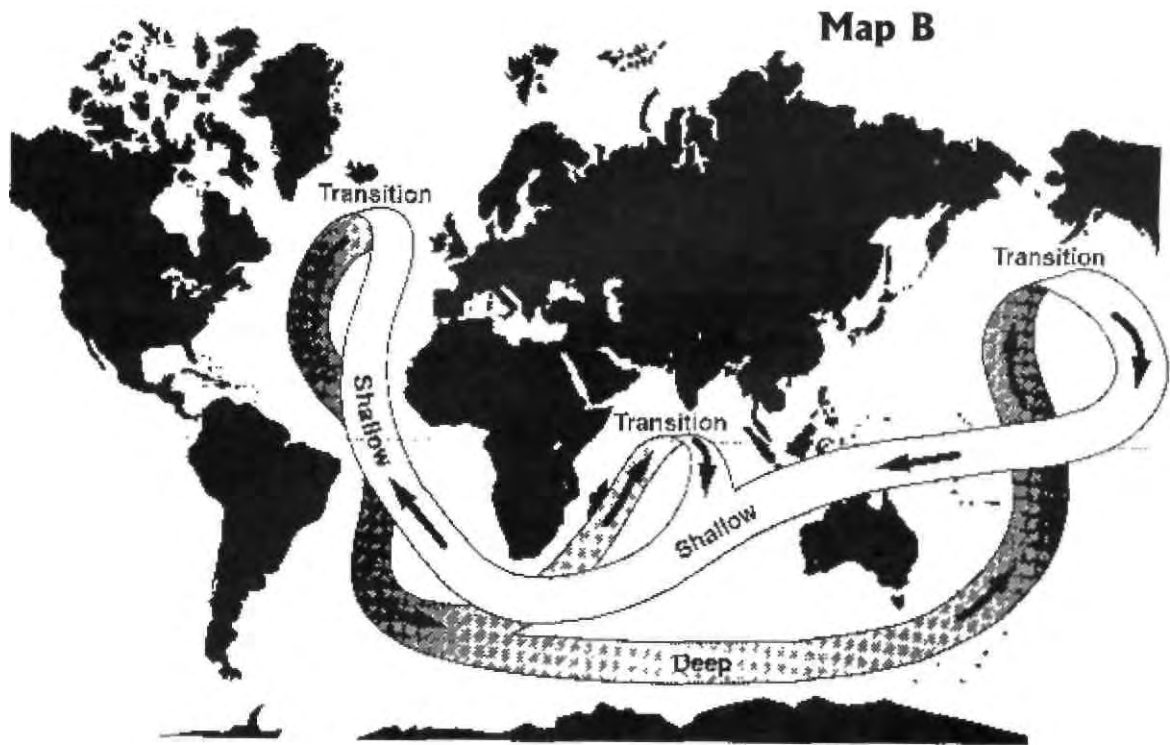

smaller areas of intensity where the most disappearances occur. Al Snyder adds, "Also, the Triangle is one of the areas in the world (another is the "Devil's Sea" southeast of Japan) where compass needles also point to true North (geographic North) and not to magnetic north. This factor can lead pilots and seafarers well off course if not accounted for-and perhaps it is not surprising then-that at these two opposite points of the globe air and sea travelers seem to make a sudden, mysterious rendezvous with fate." The six major ocean currents around the world with counter-coriolis type of current flow have been marked with small "X's" on Map A. There is some contention that the geometric pattern produced by the arrangement of the "X's" on the earth has some significance. The Coriolis force is produced by the rotation of the Earth. It causes the spin in hurricanes, tornados, and typhoons. The spin is clockwise in the southern hemisphere and

counterclockwise in the northern hemispheres.

All practical devices and processes lose some energy in the form of heat. The heat buildup will be smaller in the ocean currents that flow in the pro coriolis direction, while it will be larger in the counter coriolis direction.

Ocean currents, for the most part, flow in large vortexes in the ocean, (see Map A) and are complex in nature with crosscurrents at the surface and at various depths, (see map B). Analysis of the data in maps C and D shows that there is a greater build up of heat in the depths of the ocean where the currents flow on the counter coriolis direction rather than in a pro coriolis direction. On the other hand the surface level of the oceans show no heat build up. For Example, in the Bermuda triangle, maps C and D show an average temperature of 18 (degrees) in the depths of the center of the Bermuda

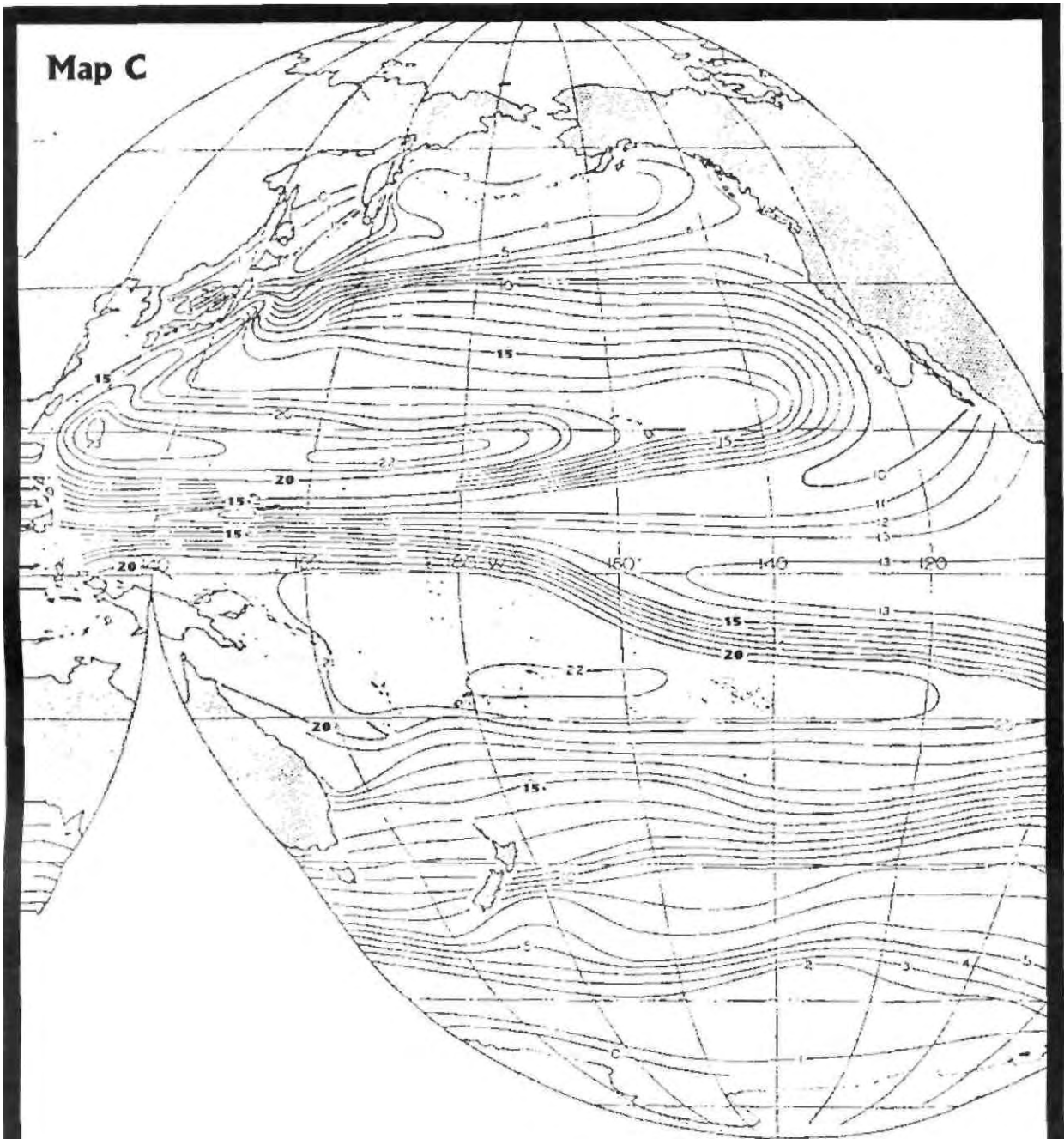

In addition to comprising Gaia's major blood vessels, this global scale circulation of waters is believed to transport climate signals from subpolar to subtropical waters in the form of long-term, but subtle, temperature changes. That to say, temperature signals are carries through Gaia's major blood vessels in a manner similar to the way a hormone is carried by the human blood stream to the appropriate tissue. Although thermal changes in the oceanic conveyer belt can and do occur anywhere along its global trek, freshwater injected into North America by melting ice sheets and the continental runoff is the most likely candidate for the planetary "endocrine gland." In addition to transporting climate signals, the oceans are able to retain a "memory" of the planets recent (i.e. tens to hundreds of years) climate using these encoded temperature changes to induce and then to record the Earth's climate regime." "Universal Water", West Marrin, Ph.D., Inner Ocean, Maui, HI,2002

Map C



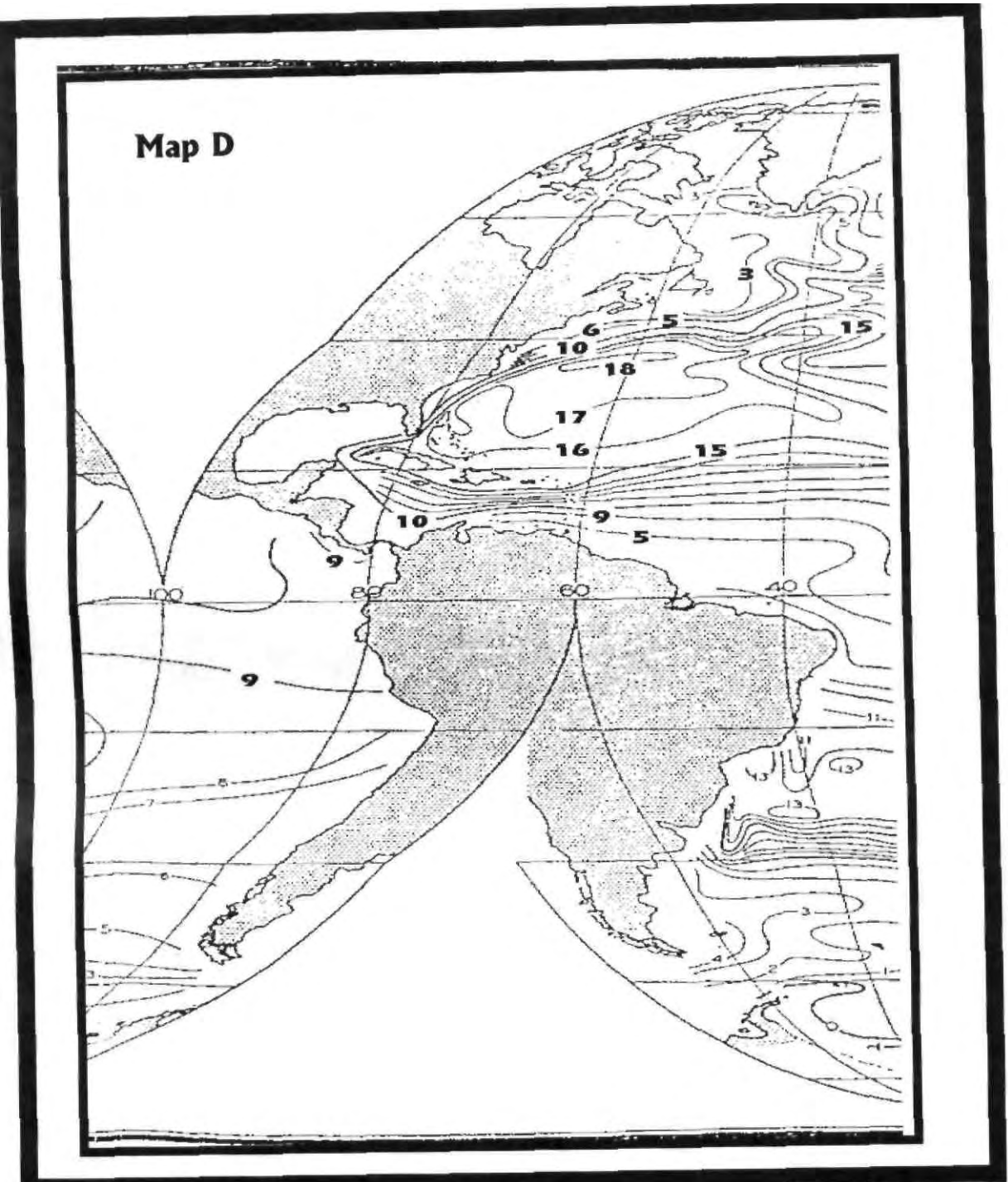

Triangle and 6 degrees at the edge making a three to one difference. At the center of the Bermuda Triangle on the surface the temperature is 29 degrees and the temperature at the depths is 24. This shows that the surface temperature is greatly reduced at the surface by the evaporation of water and heat radiation into the atmosphere. Since it takes only a few degrees of change to affect the weather, it is my hypothesis that this causes the weather patterns in the Bermuda Triangle.

The Underground Races

By Ramon Nataili

Vol. XIV No. 1 May-June 1958

(This communication was received through the mediumship of Mark Probert, and was apparently occasioned by a conversation between M. P. and Myself concerning the book, "Phantom of the Poles", by William Reed. Nataili was an Italian astronomer of the 16th century and has pursued the same science during his life in the astral).—M.L.

Well, you do indeed live inside of a ball, as Koresh teaches, but it is not a ball or shell of dense matter but of etheric substance. Each universe creates its own ball or shell. As for space, it is unlimited.

(Q.) Yes, sir, we do (live on the exterior of a dense globe).

(Q.) No, your worlds is not an oblate sphere; it is shaped much like a top. This is a large subject.

(Q.) Yes, indeed, there are vast underground regions (caverns) that stretch from equatorial Africa to the north pole, and also to Venezuela in the southern tip, in the region north off Loreto. These caverns will explain to you the mysterious disappearance of whole races from time to time (such as the Maya or pre-Mayas). I can't give you very much now-this is a difficult communication mode for me. This is Ramon Nataili. I am going to experiment with this method of working (i.e. clair-audience.) But I'm not side stepping your questions.

(Q.) re size of underground population) I would say several millions. Oh, yes, they are humans. Yes, there is some contact, but mainly through their secret organizations. These people as a whole are much more healthy than those of the surface.

(Q.) The reasons they entered the caverns originally, was that they discovered that the upper atmosphere was teeming with disease germs (and other harmful elements).

(Q.) These people as a whole know little or nothing about your surface life. Such knowledge is in the hands of the higher teachers.

(Q.) Yes, in some parts of the underground world people possess a high degree of culture.

(Q.) Yes, there are openings in Mexico, and one in the region of Alberta, Canada. Many of the sudden appearances of strange looking animals are explained by these facts.

(Q.) Yes, there is an opening in the region of the Bering Straits.

(Q.) Yes, it is true that surface waters, enter the earth, and this inflowing current is one of the main causes of fluctuation of the magnetic fields - the magnetic poles.

(Q.) Most of the caverns lie at 10 to 20 thousand feet below the surface. It is true that there are warm (even tropical) areas near the poles. They are walled in by ice and mountains. Yes, there is open water, and the ocean stream flows into the earth. It becomes warm from the abundant heat of the interior- it is almost boiling at some points.

(Q.) The aurora is caused by an electromagnetic phenomenon ...Some caverns were destroyed when Atlantis went under.

(Q.) Yes, the story is theoretically possible. Olaf Jensen could have been carried into the interior of his boat, and most careful navigation could have emerged at the South Pole. A whole fleet could enter the earth so far as that is concerned. I'll try to tell you more later and then you will understand better.

From Alchemy to Ecotechnology

A comment on Victor Schauberger's,

"The Dethronement of Science"

By James Borges, BSRA

The tradition of Borderland Sciences is based on the methods used in antiquity before the Dark Ages of Civilization. It was the science that raised the Pyramids in Egypt and in Mexico. It was the science that is hinted at in the Vedas. It was the science that brought about a Golden Age of humanity in all areas of the world. Then there arose a new class of rulers who were pragmatic and materialistic, whose dim consciousness then suppressed Borderland Sciences and the Dark Ages were begun. The Golden Age had led to an expansion of the individual that was not conducive to tightly controlled fundamentalist society. The Dark Ages gave birth to the secret mystery school of Alchemy. The tradition of the borderland scientist would continue to persist in small laboratories until it would blossom again in profound thinkers like Swedenborg, Goethe, Schauberger and Tesla. The flame of the lamp grows steadily brighter and casts away the darkness. The shadows flicker and as the Truth is slowly revealed the walls will rumble as Materialistic Science is tumbled from its throne.

The Dethronement Of Science

From Implosion Magazine No. 50 9 Written by
Victor Schauberger in May 1955

"The teachings of the Tabula Smaragdina were incised into the hardest precious stone - the emerald. Handed down to us from antiquity, they preach that a happy and healthy existence is dependent on the naturalesque intermixture of the stuff of Heaven and Earth. The progeny of this

marriage between exalted atmospheric and geospheric ethericities is water, the blood of the Earth. This ur-source of life comes into being when the ethericities of the Earth bind with those of Heaven. For this the maternal forces and energies must be more powerful than the incident fertilizing substances, for of the process takes place in reverse order, then fire is created."

Schauberger is of the same mystic tradition of Goethe. The depths of perception employed in the western mystery tradition had profound influences on both these borderland scientists. The use of alchemical and eidetic imagery stirs the very foundation of consciousness and is deeply expressed in the worldview of these great thinkers. Like Goethe, Schauberger takes us into the realm of inner perception to demonstrate before our "minds-eye" the interchange between the ethericities of Earth and Heaven. From this powerful kernel of imagery Schauberger will expand and emanate practical ideas and applications. This is the tradition of Borderland Science; the initial investigations are done internally in the perceptions and ideas of the experimenter. From this borderland, practical ideas emerge and are developed. The tendency of Borderland Scientists to speculate on the long term evolution of an idea is based on method. All life begins as a simple form and gradually grows more complex. Once an idea is taken into the perceptions and fully integrated it takes on a life of its own, it reveals the potentials inherent in its form. As if time is sped up, the border-

land perception is one of utter wholeness. Those without this perception tend to mock the leaps the scientist makes with their claims for the future. It would seem silly to speak of building a bridge when a tree is just a sapling if a person had never seen a tree before, but in time the tree will grow and the person will understand how it could be used to build a bridge. Schauberger like all borderland scientists relies heavily on the inner perceptions to conceive the inner processes of nature.

"The art of increasing and qualitatively improving water has been so thoroughly lost over the millennia that today no one knows what water actually is. How it comes into being, how it deteriorates or how it dies and subsides is still a mystery. If the degeneration and disappearance of water cannot be successfully halted, the earth will turn into a treeless desert. The whole of civilization is threatened! The survival or disappearance of humanity is thus at stake. We are concerned here with neither politics, nor racism, nor an invention in the usual sense of the word, but with the question: what is more important for evolution and development, water or fire? This is what it is all about, and nothing else! Everything else must retreat far into the background. Without water there is no habitat and no life!

Most people know that machines are indirectly driven by fire. Entirely unknown, however, is that energy can be achieved far more simply and cheaply through the artificial production of water. Furthermore, growth can be promoted, increased and ennobled in the process. Therefore not only will the problem of an independent existence be solved, but in the future there will be no shortage of raw materials provided the mixture of heavenly and earthly essence can be naturally fostered. This involves the industrial duplication of 'photo-synthesis', which is conditional on the possibility of energizing the hydrocarbons. With this discovery (which the University of California has so far sought in vain) all armed conflict will be unnecessary. In future no

sane individual will allow himself to be drawn into a war merely to satisfy power-mongers.

All robbery will likewise cease once everything is available in superabundance, for with the artificial production of water, vast tracts of desert can be restored to their former fertility and provide living space for the ever-increasing mass of humanity. There will no longer be the need to exploit this ancient art for the purposes of war. Whether the disturbance of the water-balance happened out of ignorance or to maintain the economic status quo, through the iniquitous world-wide traffic in foodstuffs and raw materials, cannot be addressed here.

The fact is that, as today's technology has progressed, the point has been reached where the proliferation of cancer is not only universal, but apparently unstoppable. For this reason the only solution is to put an end to the self-deception by reintroducing practices that promote the natural treatment of water. All this has nothing to do with science for it involves the diametric reversal of the methods applied by today's fire-sitting technology, a technology that should be considered the true causative agent of cancer.

Perhaps it is necessary for the misery and privation of humanity to become so intense, before it is finally recognized that science, as the guiding force of humanity, has made a disastrous blunder by implementing reversed energetic interactions between basic elements. In consequence, any possibility of resuscitating Nature's principal formative substance, reduced protein, was brought to a halt. It was thus inevitable that the process of decay would become so rife in both air and water. This exemplifies the disastrous errors in motion and excitation made by a science founded on unnatural principles."

Schauberger is expressing a vital lesson in alchemy. He is illustrating the how the qualities of water promote life and those of fire promote death. Schauberger is not afraid to contrast the terrifying specter of extinction that is the result of misguided science with optimistic speculations of the future if we

can dethrone science as we know it. By contrasting the 'unnatural principles' with his own observations, Shauger gives a glimpse at the breadth of thinking required to synthesize science with natural principles. The principles put forward by Shauger show how nature is "a constantly self-changing interaction triggered by constant fluctuations in temperature", this become clear by contrast to the self-annihilation breed by modern technology. The Borderland Scientists often use contrast in very emotional terms. There is some degree of sorrow when the projections of ideas are made in the inner perceptions and followed out to perfection and it becomes clear to the scientist that our world is sadly going in the wrong direction. Shauger never dwells on the negative but always pushes past with an idea for healing and change, a wonderful example for the doom and gloom radio hosts and ilk.

"The Nobel Prize winner, Otto Warburg, proposed in a scientific journal that the formation of cancer cells was caused by a deficiency of oxygen. A healthy cell is supplied with oxygen by the blood and uses it to process nutrients, thereby acquiring life-energy. However, Warburg has now asserted that the cell receives too little oxygen. As a result the lactic acid becomes thoroughly fermented, the cell grows and divides more rapidly and in the process turns into a cancer cell. This is also confirmed by Professor Domagk. Both researchers, however, made a crucial mistake. They failed to see that it makes a considerable difference whether modified or unmodified oxygen enters the blood. Modified oxygen is formed when it is filtered by the lungs. Only then can it be taken up by fructigenic ethericities via the bloodstream, which on their part have been purified by the filters of the intestines.

If this process of purification is in any way disturbed, then an oxygen deficiency results, leading to suffocation and putrefaction of the unfertil-

ized ethericities of protein. This is the answer to the riddle. This is where a yawning gap in scientific knowledge lies and without its closure cancer cannot be cured. Nature precludes the use of one and the same form of energy for different purposes.

Hence the report continues; "Those afflicted by cancer and whose lives are threatened by this terrible disease will read of Warburg's findings with resignation. Moreover, they will demand to know why the oxygen deficiency has not been prevented. According to Warburg, in this way the incidence of cancer could be reduced too fraction of its present state if the cells of the body could be protected from chronic damage. How this was supposed to happen, however, he was unable to say."

Dr. Liebmann, director of the Biological Research Institute in Munich, held that this involved the disturbance of the biological equilibrium. He overlooked the fact, however, that a state of equilibrium would necessarily imply a developmental standstill. In reality, it is a question of the disturbance of animating rhythm. There is no such thing as a rigid conformity with natural law, but only a constantly self-changing interaction triggered off by constant fluctuations of temperature. If these are regulated so as to ensure that a predominance of recreative (refreshing) influences of temperature is maintained, then the enormous problem of more and more people and less and less food will be solved.

There are two fundamentally different types of motion, both in principle and nature, which respectively initiate different kinds of excitation in bipolar mixtures of basic elements. In this connection, water, the physically first born and the very blood of the Earth, plays the role of the mediator in both natural and unnatural energetic synthesis. At the same time it is also the recorder of changes in potential that have already occurred. From this it can be determined what form of energy prevails in this natural accumulator.

The decisive factor here is that contemporary technology is only aware of and only uses those methods of conveying or moving various media which initiate a reactive increase in pressure and heat. These methods will here be termed

'techno-academic', because they are taught in all academies, universities, high schools and technical colleges. Albert Einstein used them to create a form of energy destructive of all Creation. With this, modern technology has achieved a the peak of performance in self-annihilation and turned itself into an absurdity.

From transmissions from ancient times, it is quite clear that those peoples of Indo-Germanic origin or Aryan culture favored a different form of mass-motion. They over-stimulated it, however, and disrupted the unstable state of equilibrium in the other direction. This resulted in whole sections of the Earth being torn upwards (the cataclysm of Atlantis). They strayed from the golden middle way. Existence or non-existence is dependent on the rhythmical dynamics of bipolar forces. We can see this in the alternation of night and day which serves the constant improvement and perfection of the processes of reproduction and higher evolution.

Formative forms of motion are hallmarked by the development of an atomic negative pressure. Professor Ernst Ferdinand Sauerbruch, a surgeon, discovered it in 1908. He realized that without the existence of negative pressure between the lung surfaces and the pleura, any inhalation and exhalation of diffuse (purified and exalted) precipitates of solar energy (chemically termed oxygen) would be impossible. In other words, there would be no re-spire-ation (fertilizing) of digested, nutritive ethericities, which in exalted form enter the hermetically sealed blood or sap by way of diffusion. Unfortunately Professor Sauerbruch failed to see that this force, which internally bonds (emulsifies) the ethericities of fructigenic and seminal matter, is the diamagnetism discovered by Michael Faraday in 1845. Diamagnetism is also known as healing magnetism, animal magnetism or mesmerism - an ism that science views with disfavor. It manifests itself in a similar fashion to the pressural atomic forces that move a dowsing rod. Like the previously mentioned magnetism, this later force can neither be measured nor weighed exactly and is hence rejected by science.

There are some forms of energy that are known

to alter the values indicated by measuring instruments and on occasion actually to contradict them. Thus it would appear, for example, that the speed of light is constant and therefore invariable. The same also holds true for the so-called acceleration of free fall, because there is no measuring device that can differentiate between specific and absolute weight. In terms of physical mass, the former is to be construed as breathing (animated), whereas the latter is to be understood as less-breathing, the almost-lifeless.

Before Galileo arrived on the scene with his discoveries, the theories of Aristotle held sway and it was believed that providing there were no disturbing influences, heavier bodies fell faster than lighter ones. That this was actually related to the different fall-velocities of bodies having either specific or absolute weights was completely disregarded. These constantly vary according to state of their intrinsic qualities. If sufficient qualigen is concentrated in water, for example, then gravity can be partially overcome. Speculative thinkers will be unable to understand this, however, unless they observe Nature's instructive examples very closely."

Shauberger stresses the importance of close observation of Nature. It is his experiences in Nature while deep in contemplative trance that he learned the mysteries of Levitation by watching the salmon leap up waterfalls. Like Goethe before him, from the inner worlds of perception he brought forth ideas that can be scientifically investigated. His inner perceptions of motion were drawn from countless hours of observing the flow of natural water. Able to recognize forces such as Diamagnetism in nature within his own inner perceptions Shauberger has been able to move forward in spite of the difficulties faced with trying to measure these borderland energies. This point cannot be over-emphasized in this journal. It is the ability to perceive ideas and unfold them that is the

primary skill and tool of the Borderland Scientist. Most tools, instruments and math of the science lab will do us no good.

Further evidence of Schauberger's influence from Goethe and the Western Mystery School is the unique explanation for the destruction of Atlantis. Like all great thinkers Schauberger extends the tradition, by a brilliant use of mystic history. The insight into the misuse of the very forces he is promoting is the kind of balanced insight that his training in the mysteries has brought out. The dangers of unbalanced duality are a key element in the education of the Mystery Schools.

"It must be stated at the outset that in this case the decisive but previously overlooked concentration of qualigen is only possible with the aid of radial axial motion. Every medium becomes heavier if it is unable to breath and its life removed. His occurs immediately if excessive influences of heat and pressure are brought to bear by the opposite form of motion. In this case the diamagnetic, or adsuctional force (namely Professor Warburg's life-energy) and otherwise known as levitational force by people of ancient cultures, is lost.

If the importance of the formative, synthesizing and levitating force, produced by centripetal motion only, had been recognized for what it is, then the tragic error made by Newton and Leibnitz would have been avoided. They believed that life could be comprehended with great precision through the methodology of mathematics (integral and differential calculus). It is this erroneous reasoning that the whole world has to thank for that evil that Albert Einstein foisted upon us through the exploitation of an all-destroying atomic energy. A simple experiment demonstrates the a predominantly axially-radially moved (and therefore de-animated) water begins to breath again and to rise upwards autonomously, when certain pre-conditions it is simply made to move planetarily. All forms of growth and more highly-evolved

forms of life draw in diffuse (purified and exalted) oxygen. When unpurified oxygen is impressed from without, disorder and cancer come into being, because cancer is an entity that has been expelled from a state of order.

If pure, nitrogen-free oxygen is forced into the lungs of a child over too long a period, then it goes blind. Adults are threatened with an incurable lung inflammation. At high altitudes the more thoroughly the Sun in-presses the body with unpurified energies, the sooner the blood and sap begin to decompose. The same also applies in forestry, when for the sake of greater quantity and rapidity of rotation, shade-demanding trees, which have far too thin a layer of protective bark, are exposed to direct sunlight, producing unhealthy, 'light-induced' growth. This also happens if forests are excessively thinned. However, if a forest floor that has lain for centuries in protective shade, is warmed above +9C by excessive clear-felling and thinning, then reforestation is only possible with deep-rooted, light demanding species. Such reforestation is fraught with enormous problems. The young plants have first to grow under the scalding light of the sun until they are large enough to provide the ground with new protective shade. Wholesale karst development (erosion) can only be prevented where the slope is not too steep and the solar radiation is not excessive.

Almost all monocultivated, plantation forests originate from this ignorance. They can therefore quite properly be described as cancer-prone. They lack diamagnetic, adsuctional and insuctional force and can no longer produce fertile seeds. As in the case with the remaining, once-cleared, old-growth forests, they too can be considered lost if the present methods of forestry are not drastically and quickly altered. Today's fertile soils and whatever water still remains are already over-acidified and polluted to such a degree that there can be no recovery without radical remedial measures.

In Nature everything is reversible. The last hope for restoring the natural order of things lies in the mechanical production of diamagnetism which comes about in the opposite way to the

present generation of electricity. The idea of generating life giving energy mechanically and restoring water's life-force and ability to breathe may sound fantastic. Yet, the behavior of water itself shows us how this comes about, as it sinks lifelessly back into the womb of the Earth only to rise upwards again as noble water in mountain springs. The reason this has been impossible to copy this natural process so far is simply because the enabling form of motion was unknown. People mistakenly believe the earth's rotation to be circular. With circular motion, however, no negative pressure or drop in temperature can be achieved.

Since the present way of looking at things is founded on a false world-view, humanity has set foot on the road of an unstoppable, regressive proliferation of cancer. As long as the meditative substances water and air continue to be moved incorrectly with the exclusive use of centrifugence any production of qualigen or increase and improvement of water and growth will be impossible. Qualigen can only be produced with cold systems of flow, in which the more thoroughly atomized the substances (sediments) contained in the water become, the more powerful the life-energies."

"Here it should be again stressed that if the media of earth, air and water are moved centrifugally, then reactive, decentrating forces evolve from the resultant unnatural intermixture of bipolar concentrates. These also develop if any medium is over-illuminated and/or overwarmed by unpurified (unfiltered) solar radiation. It can therefore be stated that in this case the pressure and heat associated with it increase by the square of the speed of motion. In both cases, however, the resistance to motion also increases - that is a retroactive force evolves which, viewed ecologically, represents a decomposive energy or its other form, cancer. In this instance matter is rendered lifeless. Oxidizing processes follow, and since the levitative forces have been reduced, matter becomes specifically heavier. Red-hot iron, for example, is heavier than cold iron. Einstein was right in his deduction that mass - the concentrate of basic elements - was dependent on velocity. However, it is the type of motion that

determines whether decentrating or concentrating forces arise. In the first case pressure and heat are produced and in the second, a negative pressure (vacuum), which intensifies by the square of the centripetally-in-winding orbital velocity."

Introducing a new Alchemical Technology, or Ecotechnology, Shauberger explains how the basics of radial axial motion will produce qualigens, quality-enhancing life forces. Ecotechnology is based on movement, centripetal forces, adsuctional or insuctional. The type of motion determines whether decentrating or concentrating forces arise. Ecotechnology makes use of the same forces of nature that Alchemy described in its hidden terms. Still requiring a terminology of its own Ecotechnology shows how the Sun interacts with the elements of water and air, shows how the damage done by fire can only be cured by the forces of water. Ecotechnology glimpses the purification process in nature and also the exact processes of decay. Through an understanding of these processes, we see the possibility of restoring the decay and damage done to the earth by pollution with life-giving energy mechanically generated.

"In this way it is therefore possible to transform ordinary air at room temperature into chemically pure water in a fraction of a second. This is associated with a 1,700-fold decrease in volume, through which an atomic negative pressure evolves, whose attractive force is stronger than any explosive pressure. The precipitation of rain-water described above therefore explains the production of rain in any quantity without the formation of thunderstorms. Such water can be converted into the noblest mountain spring water, provided it is moved planetarily for a short period, as happens in the womb of Mother Earth."

Ecotechnology that transforms air into water is the natural extension and evolution of

the Alchemical tradition into our modern times. By adhering to the principles of Hermes Trismegistus and the Emerald Tablet (As Above, So Below) Ecotechnology simulates the geometry and motions of Earth. It is through these cold systems of flow that the damage done to the earth by over heating from unpurified solar energy can be balanced and healed. In the Hermetic Tradition of Alchemy, in the process of emanation Fire and Water combined to make Air. With Ecotechnology this is recognized and the balance between Fire and Water is engineered with radial axial movement of Air that produces diamagnetism or healing forces and creates qualigens.

"The technologist of to say has been taught to think logically, but not bio-ecologically. Therefore it is particularly difficult for him to appreciate the possibilities that ecotechnology offers towards the re-establishment of the proper and natural order of things, which has been disturbed at its most fundamental level. The time has come to free humanity from its dependence on coal and oil by creating those differences in potential that can be converted into kinetic energy. Since coal and oil will be exhausted in the foreseeable future, nuclear fission will be all that remains to banish the specter of energy shortages. This is the greatest delusion of all, however, because the radiation and waste accruing from the atomic energy will gradually contaminate the air we breath to such an extant that the mere inhaling of it will be lethal. Humanity therefore stands at an historical crossroad - but in all probability it will continue to develop its present technology and dig its own grave. Then one day, thousands of years hence, the perhaps few remaining survivors will speak of the technical stupidity of their forbearers and shake their heads over the artifacts of a godforsaken science in whose programmed destruction took first place. Science can still be dethroned, however, through reversal of present principles. Instead of

air pollution, ecotechnical air purification. Instead of the collapse of quality, the rise of quality. Founded as it is on rigid and dogmatic laws, contemporary science must therefore be prohibited by the fastest means possible."

Translation by Callum Coats, Ecotechnology.



The Pundit Curmudgeon

Thoughts On The Non'Use Of Borderland Knowledge

E.D. O'Brian, © 2002

With few exceptions the readers of this and other Borderland publications do not seem to be significantly concerned with the acceptance of this and other somewhat related publications into the main stream of the world's complex, entwined, political, religious, social, economic and technological composite "system" embracing all of its inhabitants. All of us should be adamant that this knowledge be impartially evaluated and, if it passes such evaluation, be promptly placed in use. Why isn't this occurring?

Probably no two individuals will agree on any sort of a response to this question. Those of us who express concern with information coming within the scope of "borderland" technology and knowledge are not even united by any consistently accepted definition of what does and what does not come within the scope of these designations.

Information coming within the scope of these terms is somewhat related to pornography in that most people have a reasonable concept as to what it is but can't verbally define what it is.

As a practical matter for at least the purposes of this discussion borderland views and can be defined as including anything which is not widely accepted as being true and correct by at least the majority of those constituting the dominant part of the complex "system" or society in which inhumanity resides. One can legitimately argue over the relative merits of this or any other proposed

definition of borderland knowledge.

In effect those of us inhabiting the world can be considered to be composed of a series of overlapping, ill defined groups. Defining these is important to understand who is on the borderland. The largest group in the world is composed of those who accept from what they hear from others throughout their lives without spending any significant time in thinking and analyzing the content of such hearsay. A second group consists of those who, in one way or another have adequate political, religious, social, economic or technological power sufficient to motivate them to at least maintain and normally to advance or acquire additional power of the same or another type. The third and last of these groups includes those who are sufficiently dissatisfied so as to be prone to strive for any sort of change which will improve their status.

Those in the field of borderland knowledge fall into this last classification. Unfortunately those concerned with collecting such knowledge and information seem to be much more occupied with the accumulation of information of such a character that there is at best an extremely limited chance that it will be accepted into the prevalent "system" in which we live than they are in getting the collected material generally accepted. In general the members of this last restricted group are more concerned with the development or accumulation of borderland information or in attempting to keep up with new developments in such knowledge and do not have the time or money or acuity necessary to get anything outside of the mainstream of hu-

man activity accepted into the mainstream of useful knowledge. All too often they also lack the skills necessary to achieve the acceptance of a significantly new or revived concept. Frequently they are defeated in such activities before they start because of a very understandable fear of not being compensated for their efforts.

No one ever seems to have ever done a through job of considering these and all of the other factors involved in efforts to graduate new developments from the borderland of knowledge into at least grudging toleration by the mainstream of civilization. If such a new development is only incrementally different from what is already generally accepted or known it may not qualify for borderland status and will not normally face all of the obstacles to widespread acceptance which can be placed in the way against the acceptance of any sort of change. Any such new development running counter to generally accepted information or economic or other "vested" interests as referred to in the preceding is almost universally at least tarnished with a borderland or borderline or worse label.

Few realize that the acceptance of any type of such expansions in human knowledge is not only contingent upon influencing or changing mental attitudes or patterns and classical economic and other traditional factors including inertia but is also often blocked or at least hindered by a morass of laws, regulations, contracts, vested customs and the like. Even when it appears to be wide spread concurrence in the desirability of change these barriers can be and normally are powerful and often apparently insurmountable opponents of change. Normally the significance these essentially governmental type restraints will tend to decrease when the change is not overly significant. A re-

lated concept is that the greater the departure of a new concept or development from the usual norms in the field of the concept the greater the probability that the departure is of a borderland or borderline character.

A matter of more or less common knowledge and of concern to all who use municipal water supplies illustrates these considerations. This relates to the use of chlorine gas to "purify" domestic water. Nearly everyone living in an industrialized society is believed to know that this gas is highly objectionable. It is undesirable because of both its toxicity and the usual concerns related to using an ecologically obnoxious gas. It reacts with compounds often found in water to produce reaction products which are known to be or are at least assumed to be detrimental to human health.

There seems to be no valid technical reason as to why nations such as the USA continue to chlorinate domestic water supplies when these undesirable aspects of this practice are well known and, in addition, when it is reasonably well established that water can be rendered suitable for normal uses in other ways. Information as to the living contaminants in the usual untreated water so as to render it "safe" for use is well established. There is good reason to believe that the energy from simple ferrite permanent magnets can be effectively used to kill or attenuate the usual "bad things" surviving in untreated water supplies.

It would be a waste to amplify this list with other known and proposed replacements for chlorination since the noted three alternatives illustrate the accuracy of the preceding conclusionary statements. They are particularly desirable for this purpose since they indicate different "levels" of closeness to acceptability of the borderland technologies specifically embraced within this discussion.

In effect such levels can be compared with imaginary distances between specific borderland knowledge or information and the not physically apparent demarcation line between the acceptance or the rejection of such knowledge or information.

Ozone has long been recognized as an effective oxidizing agent and has occasionally been used in water purification. In spite of this the average individual is apparently somewhat concerned about its use for this purpose for any one or more of several reasons. The view is often expressed that it must be bad because of all of the damage it causes in the outer atmosphere. It clearly has almost advanced from a borderline status into a state of acceptability even though many regard this treatment as still being of a dubious nature.

As opposed to this the use of silver in water purification still remains firmly in that portion of borderland territory adjacent to acceptability in spite of its wide spread acceptability to allotropic or drug oriented medicine as a historically acceptable water purification agent. The fact that it is occasionally used for this purpose in connection with another expedient such as distillation seems immaterial to any consideration of it as a replacement for the villain chlorine.

The third of these expedients concerning the use of comparatively weak magnetic energy has apparently been completely overlooked because of the fact that it is contrary to generally accepted beliefs relative to weak magnetic fields being of little if any utility. Who ever heard of doing in anything of material significance other than locating a direction with comparatively weak magnetic energy? Although few realize it this topic has been both implied and specifically discussed in print. This last of the three types of treatment being discussed clearly is effectively an-

chored in the purgatory of borderland technology.

While the preceding illustrations of various ways of treating ways of water are valuable as indicating that in effect there are ways of gauging the relative unacceptability of borderland subject matter they do not effectively suggest a major factor touching on any consideration of all of them - the subject of economics, particularly as it pertains to the normal conduct of those who stand a chance of being affected by any economically significant change. This relates to the well-known normal action or inaction of those who would be affected by any such change so as to avoid anything which might lessen their financial or other interests except in such situations that they believe that such change might be beneficial to these interests.

Inertia either based on laziness or a desire to avoid anything detrimental cooperate to prove this point. When more than inactivity is considered necessary to avoid developments such as those which might graduate from the borderland field those having significant financial interests in thwarting these changes will almost always fight their adoption with every fair and foul means available. Thus, those having significant investments in the field of making chlorine gas and derivatives of it capable of being used in purifying water can almost always be expected to fight any change relating to the replacement of the use of this gas and its related compounds by using any means available to them regardless of the whether or not such a change may be advantageous to society as a whole. Success in such activity avoids the possibility of having to junk existing production and distribution facilities and clearly escapes the largely unknowns in investing in replacement technology.

No one should assume from this that greed

for both property and status is the only reason for the lack of acceptance of much significant technology. A major factor preserving the non-use of borderland knowledge is frequently just plain ignorance. At one time when the writer was consulting an internist something came up relative to the use of magnetic energy to expedite the healing of a bone fracture. He stated that he had no knowledge of this topic and expressed his doubts as to the operative character of any such treatment. After being given copies of publications on this topic relating to work at the hospital affiliated with the medical school he had attended before he attended it that he had never heard of this subject matter before.

It is tempting and usually discerning to go over known borderland knowledge whenever one consults an allopathic practitioner. This is easily illustrated. Following heart by-pass surgery performed on me a few months ago without my conscious knowledge I asked an attending cardiologist why chelation therapy was not used prior to surgery in an effort to avoid the latter. The answer was not that such therapy would not have been effective but instead was that it was not "approved". There is no question about the safety of such treatment. It is routinely used "officially" to treat lead poisoning and probably otherwise to remove undesired debris and presumably debris like compositions from the blood stream.

Perhaps it is erroneous to conclude that the chelation therapy which the writer either correctly or incorrectly believes would have been effective in avoiding surgery was withheld from him by extremely competent, well meaning individuals who knew or should have known of the effectiveness of this alternative treatment. Is this alternative condemned to remain a pariah from the borderland world? And if so, why? There is more

than ample reason for blaming the cozy relationship between drug oriented allotropic medicine and a legal system seeming to primarily favor the accumulation of drug company profits and an almost de jure financial monopoly on the practice of this type of medicine. Of course this conclusion can be attacked on the ground that it is an oversimplification of a very complex topic involving how far our social system should "protect" individuals in even situations in which it is highly questionable if they need such protection.

While it can be questioned it seems that it can hardly be questioned that allotropic medicine ignores using borderland knowledge even in situations when no harm would come from its use and when there would essentially be no or at worse very little cost involved. The writer's recovery from the noted operation illustrates this point. After waking from the surgery I was rather uncomfortable and beset with all sorts of disturbing thoughts. It occurred to me that in the past when mental difficulties of this type had occurred that I had been able to dissipate them promptly by listening to "good" music. My request for this non invasive, non drug oriented "treatment" was refused.

Apparently it was fine for me to get further disturbed - as I frequently do - by watching a TV since such a set was made available to me in my room but it was not possible for me to get assistance in relaxing without the use of an appropriate drug. To me this indicates that the use of music to assist the mind in dealing with significant mental stress is not a part of "approved" therapy. Haven't the minions of allotropic medicine ever heard of the benefits of much music in assisting the body as detailed in the book *The Mozart Effect* by Campbell (© 1997) and in many other references?

Apparently the answer is "no", but it is equally possible that they have heard of such results and assumed that they were not accurate because they were not accompanied by the blessing of the U.S. Food and Drug Administration and the allotropically oriented American Medical Association. In either event the result is the same - musical therapy can be considered to be an occult aspect of borderland technology and information. Some drastic changes in "civilized" society are needed so that people can benefit from knowledge which is presently outside of the main stream of the prevalent social structure and the vested interests within it.

Books and Videos

by Eric Dollard

THEORY OF WIRELESS POWER

Eric P. Dollard.

This paper contains many essential formulae and supporting data necessary to understand the Transmission of Electrical Energy Without Wires. Discusses and diagrams the Marconi Wireless station based at Bolinas, California, circa 1919. Unlike many erroneous modern theories of how Tesla achieved his goal, this paper is based on real work with a Tesla Magnifying Transmitter.

DIELECTRIC & MAGNETIC DISCHARGES IN ELECTRICAL WINDINGS

Eric P. Dollard.

Dollard's work on the relationship of the dielectric and electromagnetic aspects of electricity is the most important breakthrough in modern day electrical research providing real avenues of research into Tesla's secrets. Contains Electrical Oscillations in Antennas and Induction Coils by John Miller, 1919, one of the few articles containing equations useful to the design of Tesla Coils.

CONDENSED INTRODUCTION TO TESLA TRANSFORMERS

Eric P. Dollard.

An abstract of the theory and construction techniques of Tesla Transformers written by one of the most brilliant modern day researchers into High Frequency Electricity as pioneered by Tesla and Steinmetz. Contains the article Capacity by Fritz Lowenstein, assistant to Tesla in his research.

SYMBOLIC REPRESENTATION OF THE GENERALIZED ELECTRIC WAVE

Eric P. Dollard.

Extension of the theory of versor operators and imaginary numbers to represent complex oscillating waves such as those encountered in the researches of Nikola Tesla and everywhere in Nature. Theory of Free Electricity produced by rotating apparatus such as variable reluctance devices. Waves flowing backwards in time are explored.

SYMBOLIC REPRESENTATION OF ALTERNATING ELECTRIC WAVES

Eric P. Dollard.

Introduction to the FOUR QUADRANT THEORY of Alternating Current which allows engineering of Tesla's inventions. Provides a more complete understanding of the use of versor operators (degrees of rotation), necessary to the understanding of the rotating magnetic field. The process of the production of electrical energy using the neglected QUADRANTS OF GROWTH is brought about.

Tesla's Longitudinal Electricity Video

A laboratory demonstration video with Eric P. Dollard & Peter Lindemann. If you've ever wondered if there is more to a Tesla coil than just making big sparks then watch this video. You will see experiments on: The One-Wire Electrical Transmission System; The Wireless Power Transmission System; Transmission of Direct Current Through Space; and, a novel form of electric light which attracts material objects but repels a human hand! . Eric Dollard reintroduces the "pancake" Tesla Coils in a series of experiments taken directly from Tesla's work. Construction details are given. If you want to do some exciting, exploratory work into Tesla's theories then this video will certainly give you a good start.

Transverse and Longitudinal

Electric Waves Video

A laboratory demonstration with Eric P. Dollard

Eric demonstrates the reality of longitudinal waves and their application to the natural transmission of electricity. A Multi-Factor Orgone Detector is demonstrated indicating a relationship between dielectricity and orgone. A competent researcher can duplicate the experiments on this video from the information given.

Nikola Tesla:

Lectures, Patents & Articles

Nikola Tesla (1956).

This is one of the finest Tesla reference books available. Documents are taken from the Tesla Museum and Beograd University. Lectures on A New System of Alternate Currents of Very High Frequency & Their Application to Methods of Artificial Illumination; On Light & Other High Frequency Phenomena; High Frequency Oscillators for Motors. 9 Patents for Transmission of Electric Power; 6 Patents for Lighting; 17 Patents for High Frequency Apparatus and Circuit Controllers; 12 Patents - Radio; ; 7 - Turbines & Similar Apparatus; . Also 24 Articles and an Autobiographical Article. A must have for the serious Tesla enthusiast.

THE BORDERLAND BOOK REVIEW

Ong's Hat, The Beginning

Every Borderland Scientist interested in consciousness and physics must read "Ong's Hat, The Beginning" by Joseph Matheny. This is the classic "true-story" told as science fiction or is it science fiction told as a true story? Ong's Hat has the added twist as having gained the reputation of being a "living novel". One feels as if they are incorporated into the story, indescribably linked. Peter Moon describes a living book in the introduction as "a book which interfaces and interacts with the reader in much the same way that a virtual reality game would interface and interact with a player. It is a book which challenges and evolves much the way that life adapts to the environment with evolution" I can attest to this. I was deeply impressed by the web site when I found it late one night, the time travel aspects were very well laid out and the premise was so delightfully plausible. This was the most exciting material I had read since the Shaver Mysteries. Later that month I discovered a copy of the original Incunabula catalog while searching the archives. What was a distant conspiracy rant was getting closer to home. A few months later after telling everyone who would listen about this strange deposit of high weirdness and slightly veiled illumination I received an e-mail with an interview with Alexandra Bruce further describing the Ong's Hat mystery. This modern myth is one of the most important new ideas to come along to alternative science and the consciousness movement in a very long time.

Ong's Hat, The Beginning has reprinted

the complete Incunabula catalog and also included interviews and background information that is essential. There is also a black and white version of the on-line comic book format that is part of the internet incunabula experience. This book is worth having on your shelf even if you have read it on-line. And for the Old Guard this book is a perfect opportunity not to miss an exciting new myth that is gaining popularity on the internet at a rate only possible in the Twenty-first century.

"You have been searching for us without knowing it, following oblique references in crudely Xeroxed marginal "samisdat" publications, crackpot mystical pamphlets, mail order courses...a paper trail and a coded series of rumors spread at street level...and the propagation of certain acts against the Planetary Work Machine and Consensus Reality...or perhaps through obscure mimeographed technical papers on the edges of "chaos science"...through pirate computer networks...or even through pure synchronicity and the pursuit of dreams.

In any case we know something about you, your interests, deeds and desires, works and days...and we know your address.

Otherwise...you would not be reading this brochure..."

[Http://www.incunabula.com](http://www.incunabula.com)

Antiquities of the Illuminati The Wise Men of John: The Mandaean.



By Jonathan Sellers, BSRA

Taken from The Brethren of the Gift, Courtesy of Antiquities of the Illuminati

1. Preliminary Notes

WHILE the Elkesaites form a connecting link in the Johannite Tradition that proved its value in our inquiry, they weren't called by the name of Johannites. This, too, is important, because at the time the Legend of the Templars would have been circulated, there would have to be something connecting the name of Saint John with a particular sect. A sect of Sabians of St. John, or Christians of St. John, for example .

The Elkesaites, Essenes, and Ebionites were little known in the 18th Century. Practically all that was known about them was that they were sects which the heresiologists didn't understand, therefore they were condemned outright as either inventions, or as heathen sects. They were not known as Johannites, properly speaking. (1) Of these, the Elkesaites alone bore the designation of Sabian. But there is an older sect, which answers, at least in the European reports about them, to the name "Christians of St. John." These are the Mandaean, the Mandai Iyahi, or the Wise Men of John.

This is perhaps the most mysterious sect that has ever existed. Its very existence spits

in the face of "traditional" orthodox religions. That is the key to their longevity and their ability to survive despite the great odds against their doing so. The evidence we possess suggests that they are the oldest surviving sect from antiquity. Zoroastrianism is out, since what exists of it is based upon the Sassanid Magi Cultus. Judaism is out, since what we have in Judaism is based on the Rabbinic cultus, or Rabbanim, which at best can be traced only as far back as the end of the Second Temple. Christianity and Islam are out, for obvious reasons. Buddhism and Hinduism are good competitors, but even there, what we have in either of these groups today, does not possess any direct ancestry, at least in the same manner as the Madaeans do.

In short, it is in the Madaean religion that we see a cultus which defies time itself. (2) EnKi, we have seen, instituted the first Order of Scientists, called the Wise Men, (3) at least 88,000 years ago according to The Code of the Eternal. (4) Over time, the priesthood in Sumer, at Eridu and elsewhere survived. When the Sumerian empire collapsed circa 2000 B. C. E., the Nefilim sought a safer haven. Although we shall deal

with this important phase in the history of ideas in another place, (5) it is important here, to briefly comment upon it.

According to the story unfolded in *The Earth Chronicles*, (6) and indeed in the texts upon which *The Earth Chronicles* is based, Enki's lands were in the African continent. To Enki belonged Ethiopia. To Marduk, Egypt proper. To DuMuZi, Nubia. To Ninagal, the area coinciding to that reaching from Kenya to Lake Nyasaland. Gibil received Rhodesia, Zimbabwe, and surrounding areas. To Nergal was given the southernmost region, where he and his consort Ereshkigal built the Palace of the Underworld. This is where the idea of the Underworld came from in the first place. All lands below a certain line, south of the equator, were known as the Underworld, or the Lower World, because the main area of operation was in the middle region, and the lands of the Gods were always in the upper region, or Upper World. It is as simple as that, even though we are still told to accept pie in the sky explanations.

The Mandaean claim their ancestors came to Southern Babylonia from Africa. (7) More specifically, 60,000 saints came out of "the land of Pharaoh", two hundred and forty years after the appearance of the true Messiah.

In the Mandaean cultus, we see a survival of the Chaldean Magi, modified by some Jewish, some Persian, and some Ophite beliefs and practices. We must qualify this, because there are those who will say that this is mere nonsense.

The Jewish priesthood as we know it to exist at the time of the Second Temple, received all or most of its material, not from the Desert Tabernacle, but from the Priesthood at Babylon. At that time, the Chaldeans had taken over the Priesthood at Babylon.

The Chaldeans came to Babylonia from Southern Arabia, in what is known as Saba.

This is where the name Sabaeans originally derives.

Also, the Jewish priesthood derived all or most of its dualism from the Persians.

A mixture between the Chaldean cultus, the Persian cultus, and the Hebrew cultus resulted in the Jewish Priesthood.

By the time that the Jewish Priesthood split up, and one group withdrew to the desert region, in the Transjordan area, a lot of schismatic sects arose, and flourished, well past the destruction of the Second Temple at or around 70 c.e.

It is known that many of these groups evolved into the Elkesaites, Sampsaeans, and Ebionites, as we have demonstrated in a previous section.

It is also known that while the Ophite Gnosis for the most part came from Asia Minor, Syria, and Samaria (aka "Little Sumer"), a great deal of it fused together with some of these schismatic Jewish sects.

After all, these sects held that it was the fault of the Jews for being so obstinate, that they lost Jerusalem. Therefore, Jehovah and the Jews became symbols of the enemy to these heretical Jewish Sects, and to all the other Gnostic sects as well. The "maguffin" in this case was not in being recognized as the true and authentic, orthodox version of the reality presented to this race's collective nervous system. The "maguffin" was that small, embattled, and highly contested piece of prize real estate we know as Jerusalem, and the Priesthood responsible for communicating with God, directly, during the festival known as the Day of Atonement, and the land surrounding it. It is still contested today.

By the time the Madaeans came into being as a distinct movement, it would only be natural for them to view Moses and Jesus as false prophets, since their missions had not

been fulfilled, and only led to more bloodshed and misery.

Also, to hail the Pharaoh and the Egyptians who were drowned in the Red Sea as saints, shows that the Mandaean priests responsible for developing their literature had a vitriolic sense of humor, the same kind of vitriolic sense of humor that the people responsible for creating the Ophite stories possessed. And, too, the same sort of vitriolic sense of humor any and all true saints possess.

The Chaldeans migrated to Babylonia from Southern Arabia sometime in the 9th to 8th Centuries b.c.e.

The Madaeans were called by the Muslims "Sabians" after the fact that the former were a baptist sect. Could there be any connection between the Sabian Madaeans and the Sabaeans? (8)

Yes, because the Chaldeans migrated from Saba. Now we get to another hot potato. (9) One of the texts in the Necronomicon, which does, in fact, bear some resemblance to some characteristics in the Mandaean religion as described by the Encyclopaedists and by scholars like Rudolph, is called "The Magan Text."

Although Magan is traditionally associated (these days) with the Sinai Peninsula, it was not so a long time ago. Magan was once referred to Arabia Foelix, where the Sabaeans existed.

"The verses here following come from the secret text of some of the priests of a cult which is all that is left of the Old Faith that existed before Babylon was built..." (10)

If this is an authentic text, and the Book's efficacy proves it is more than a mere pipe dream of H. P. Lovecraft, then it might have been taken down by the Mad Arab, or someone like him, at the time stated.

Certainly, as we have mentioned previously, there are indications that books of this sort

existed or were fabled to have existed, at Damascus, and at other key places, at the time in question.

Also interesting is the fact that the planets play an important part in the rituals in the Necro. The Madaeans consider the planetary spirits to be evil spirits, leading their people away from the true God, while the author(s) of the Necro. regard the planetary deities as important entities worthy of worship. This might seem contradictory, but it is evident that there are similarities too close to be simply dismissed.

The evil entities, and, too, the concept of evil, in both the Necro., and in the Mandaean Mythos are so similar, that we can only say that they derive from the same source. We're not simply talking about Serpents and Goat headed men with horns, or she-devils. We are speaking of the concept of pure evil. The force that is the exact reverse of all that is truly beautiful and good, and just, which is personified best in Egyptian deities like Hathor, and in Sumerian deities like EnKi, Ninharsag, and to some extent, love goddesses like Inanna.

Sixty years ago, the hell creatures were brought forth from the pit in which they had been chained for many centuries, and the two major competing Ideologies of the 20th century were foisted upon humankind as a result.

We are speaking, of course, of both Nazism and Communism, at least the Communism of Stalin, the ugliness that Soviet Russia really was, and all Soviet Bloc countries; and the utter ugliness that Nazi Germany was. Unfortunately it wasn't capped and contained like it should have been, it was recruited by the United States. But that is for a different story.

We might be considered pedestrian for dealing with a text like the Necro., along

with our reliance upon works such as Sitchin's writings and Baigent, Leigh, and Lincoln, but... there is much more to the story than wishing it would go away.

Recently, Picknett and Prince produced a work on the U. S. Military uses of Psi, during the 1970s c.e., [The Stargate Conspiracy] and this came under fire by various persons. These conspiracies don't exist, goes the logic. Perhaps not, but the links and connections exist, and that cannot be denied. The players might be dead or retired, or insane by now, but the links in the causal chain are there, and they have caused their effects to be felt.

So, by our relying on materials produced by so-called popular sources, or seemingly dubious sources, so called, we are only compounding the error. Perhaps we should just explain everything away using a Joseph Campbell style model, that everything is a part of the psyche and nothing more. Balderdash to that! The historical connections exist, and we are here to lay them before the reader, or at least drop a few hints.

When we are told that the Mad Arab was in Damascus, it reminds us of the statement that Christian Rosenkreuz travelled to Damascus in order to seek the wisdom of the Wise Men of Damkar.

People have often mistaken Damkar to be Damascus, and still do to this day. In fact, the eminent Jocelyn Godwin, in a paper we saw on the Internet, quoting her, makes this error. It is a real error, because Damkar was (and still is) a real place on the map. Damkar is to be found on an Abraham Ortelius map, and its location is near Sa'na in Saba. Damkar was, then, in Saba, where Magan was. And the material in the Necronomicon corresponds to the R+C grade hierarchy, if one studies it.

The Magan Text contains variant forms of some of the most important ceremonial

myths acted out each year by the Priests. (See, for example, our pieces, Akitu, and Duku and Atonement.) The Book of the Fifty Names is but a continuation of the Enuma Elish from the Magan Text, in grimoire format. The Descent of Inanna is perhaps the ancestor of all Initiation schema that exist or have existed on this planet.

It is unfortunate that the editors of the Necronomicon have labored to tie the book with the Yezidis. Not that the Yezidis aren't important. We shall get to them later on in this work.

If a connection were to exist between the Necro ., and the Yezidis, an even closer one exists in the case of the Mandaeans. Be that as it may, the close connection is not close enough. It is likely that the compilers read up on the subject matter that was available. See the Bibliography in the introductory section of that work to see what I mean.

The Chaldaean Magi are the originators of the Magick Book. From them came the Nergal Priests of Cutha, (11) and the Priests of Opis, on the Tigris. This last named group, migrated northwest, at the time of the Persian Conquest, settling first in Phrygia, then Pergamum, then Rome, ultimately transferring the powers of their Priesthood to the Roman State Religion, at or around 133 B. C.E.

The Nergals and their fellow Priests and Magi brought the antique Johannite Tradition to Palestine, when they colonized Samaria, for that is where the first usage of the name shows up, not as John, but as Dosti, or Dostai, which later became known as Dositheos, Greek for Jonathan. It can also be found as al-Dustan. We have amply discussed the etymology of the name John (and the real name on which it is based, i.e., Jonathan) in the Qadosh section above.

The Gnosis got a firm footing first in

Samaria, and, in Asia Minor, most notably in Phrygia. This is why. No other factor can satisfactorily explain it. The only other acceptable explanation is that both areas witnessed a huge influx of exiled Hebrews. The 10 Tribes of Israel, in Samaria, as the Northern Kingdom. Later, at the time of their exile, a lot of them travelled to Asia Minor, and settled in Phrygia and other countries.

So, we have, from the Chaldaean Magi, three distinct groupings:

1. The Samaritan Current (DOSITHEOS, SIMON, etc.)
2. The Phrygian Current (Naassenes, Ophites, even the Roman State Religion)
3. The Sabaeans, the Mandaeans (and related groups), the Yezidis and the Harrani-ans.

It has been necessary to dwell a little upon the roots of the Mandaeans, because we shall see that not only are they a faithful survival of certain important Gnostic currents, but also of the Chaldaean Magi. (12) They are an Ancestor Cultus.

In them we can see traces of what the Gnosis was, before it became the Gnosis. While the Portuguese missionaries who encountered them tried to identify them with John the Baptist, on account of their Baptismal rites, and the name of John the Baptist in their sacred texts, we are convinced that the origins of the Baptist sect which John originally belonged to are to be found in this Johannite sect. That is, the origin of the Mandaean cultus goes back farther than most people care to go. The name John, as we have seen, is a much older name, and is, as we have also seen, connected to EnKi: Enki / Ea / U-An / Oannes / Iannes / Ioannes / John / Jon.

Enki / Ea / Iyahi / Yahyah / John / Jon.
Jon / Jonathan / Dositheos / Dostai / al-Dustan.

Picknett and Prince, in *The Templar Revelation* show how the transmission from the Dositheos cultus to the Mandaean Johannites might have taken place, but the purist academics don't want us to take them seriously. They bring up several valid points, though. We shall get to them later in another part of the work.

The Mandaeans are said to pay special reverence to EnKi on account of the fact that EnKi was regarded by the Babylonians as the Lord of the Waters. Life came from the Waters, they hold, and this would be an embarrassment to all the fundamentalists who labor to teach the Book of Genesis as if it were literal history. All true religious and scientific systems hold this view, that Life came from the Waters. Only the false cults consider it to a heresy, like they once considered the Earth (minus the upper case "e") to be the center of the Universe, and to be flat, and if one went too close to the edge (i.e., got too far away from the authorities) one would just fall off the edge where "there bee dragons."

2. Overview.

In this section of the Work (as a whole) we are presenting data on the Mandaeans. Not only our own views, and conclusions, but data that we have found. FIRST, we shall give the historical background, and labor to establish the context for their inclusion in this work, namely that they are a connection between the Sumerian Traditions of the past, and the Johannite tradition which is the main subject of this Work.

SECOND, we shall present some key elements of the Mythos. At least, enough of it to have an idea of how the transmission of ideas from old to new took place. THIRD, Mandaean ideas in re Chronology

and Eschatology are to be explored, because in them we see some influence from the Ophite Gnosis, and some influence rubbed off on the Isma'ilis and the Babylonian Jews who were responsible for formulating the earliest Kabbalah.

FOURTH, we shall give a delineation of the Mandaean Priesthood and give an account of the Festivals.

FIFTH, we will show the influences the Mandaeans had on the West, and on other cultures which had a greater influence on the west, than even the Mandaeans had.

SIXTH, we present our conclusions and show where this is leading.

SEVENTH, at the end of the article proper we have a section entitled "READINGS."

This section presents the documentary material that we quote at length.

EIGHTH, we present our sources, and also a listing of MANDAEOAN Resources on the Web.

FOOTNOTES

1. We wrote this at a time when we had not yet gotten access to the wealth of information that exists on the Internet. It seems that the Mandaeans, as well as the Isma'ili and Yezidi communities, have a strong presence on the World Wide Web. For proof of this see our special links collection. Also, the research that is available online, written by Mandaean scholars, tends to support our own conclusions, to a point, but not entirely. When we say Mandaean scholars, we are not referring to pioneers like Lady E. S. Drower or Kurt Rudolph, but to actual Mandaeans, who find their culture threatened by trends in Modernization. These brave souls have to get this material out, and make it available, because so many Mandaeans live in the West these days, particularly since their native

homeland seems to be in the area of Iraq hit most savagely by the United States' own Military manoeuvres.

2. We apologize to all Mandaeans who might happen to read this. We understand the disgust true Mandaeans feel towards "outsiders" who write about them, or who try to connect outside cults with the Sabians, Sabaeans, Nazareans, Nazaraeans, whether of Basra, Bosra, Bostra, or Bussora! Our work is not intended to offend you. It is an attempt at understanding what really happened in the past, rather than trying to tie the past to our own low-rent pedigree! We hold that no one sect possesses any direct Duranki lineage, like the Jews, Moslems, and Christians would have us believe. Rather, we hold that it is a characteristic peculiar to certain types of people, whether racial characteristics, genetic characteristics, or by belief pattern association, crossing all racial barriers, all barriers of belief, politics, nationality.

3. After the works of Zecharia Sitchin. Some purists may sneer at us for choosing the works of Z. Sitchin and the series of books by Baigent, Leigh, and Lincoln, or, for that matter, the works of Aleister Crowley. But, then, we can sneer back with as much, or more, contempt at the drivel some people consider to be legitimate. We've not merely accepted this material blindly, we have tested it, as best we can, and we have found that the main reason why these authors are considered to be crackpots is because what they reveal has a great deal more truth value in it than comfortable safe scholars so-called want to admit.

4. And, originally, to Sitchin's *The Wars of Gods and Men*.

5. I.e., in *Readings In The Authentic Tradition - 1: Indian Survivals of the Wise Ones*.

6. The Title of the series of works by Z. Sitchin, encompassing six volumes: *The 12th*

Planet, The Stairway to Heaven , The Wars of Gods and Men , The Lost Realms, When Time Began , and The Cosmic Code.

7. For our research, see the list of sources, to be furnished at the end of this section. At the time this was written we were relying primarily on the articles in Hastings' Encyclopaedia of Religion and Ethics (ERE), in the 11th Edition of Encyclopaedia Britannica (by far the best Edition of the EB for scholars, today's version is a mere joke by comparison.); the Schaff-Herzog Encyclopaedia ; and a few other sources. As we rewrite this, we shall be incorporating the materials we have taken from the Web, and works like Kurt Rudolph's GNOSIS.

8. It is worth mentioning here that in the website Mandaean World, <http://www.geocities.com/mandaeans/Sabians6.html>-the Mandaean author demonstrates a complete hatred for the Sabians of Harran, or Harranians. The fact that the Harranians took the name of Sabians in order to escape persecution is a badge of disgrace, to him. We would probably agree, to some extent, if we were Mandaean, but, it is necessary to recognize, at least to we Westerners, (and hence, "outsiders") that not only do the Mandaeans provide us with a key to how the Authentic Tradition survived during the Dark Ages, but that certain Isma'ili groups, which we shall examine in another section, and the Sabians of Harran, or Harranians, are also to be counted on our list of ancestors as well. This is much more like the conflict between the Hatfields and the McCoys. It is like the conflict between the Jews and the Moslems, too. The Harranians influenced Western Esoterica much more than any of the other groups, it cannot be denied. We cannot condemn them, because to do so would be to admit to ignorance. But, we cannot condemn the other groups either, because they

too provide us with keys to our past, and to the belief systems and practices which we cherish today, and which have had a great influence upon Modern Society.

9. Which is to say, the dreaded book, The Necronomicon . It matters nothing to us that the book could be a put-up job, because the magick in there really works, for one thing, and the lore upon which it is based really does possess an antiquity, hence, a pedigree. Of course, it is the Simon edition we hold to be authentic over the vastly over-rated and highly contrived Turner edition. In this connection, too, it might be worth mentioning that H. P. Lovecraft states in his "History of the Necronomicon" article, that Abdul Alhazred was "a mad poet of Sanaa, in Yemen." It is highly likely, or at least possible, because this is where the Wise Men of Damkar existed, as we shall see later. At any rate, either Lovecraft or E. Hoffman Price are to be credited for initiated research on their part.

10. The Necronomicon , Simon Edition, Part 10, "The Magan Text" Introduction. (Page 153 in the paperback edition.)

11. See below, in another part of this work, (not yet completed). The Nergals had the Magical Book of Kings, the Mandaeans had the Recitations of the Kings, or the Book of John . Similarly, the Mandaeans had the Ginza Rabba while the early Kabbalists had the Raza Rabba, and it is possible that some of these early Magical Books could be related at least partially.

12. Now, there might be disagreement with this, that is to be expected. But, we can trace this development in what materials we possess, and what we have seen.

3. Historical Background.

Please refer also to the Readings section. Tracing a group like the Mandaeans is filled with many traps. We could say that this group goes all the way back to the beginnings of recorded history. We could say that this group goes back to the sects of Baptists like we see in the Transjordan area at the time of John the Baptist. We could say that this group really began in Southern Mesopotamia sometime in the late 2nd to early 3rd Century c.e.

However, like all the groups that make up the Authentic Tradition, there is no one line of continuity, from point a to the end of the survey. Because of this, it is necessary for us to do some postulating. Therefore, we present the following theory.

1. Ancient Sumer comes to an end, is replaced by N. W. Semite dynasties.

2. At some point, some say as far back as the 9th Century b.c.e., the Chaldaeans start migrating north, from Southern Arabia, to their new homeland in Southern Mesopotamia. This is what constituted Old Sumer, in the vicinity of the Shatt al-Arab region, near Eridu, etc.

3. The Chaldaeans constitute a body of priests and scientists, and builders. Eventually they take over the Kingdom from the Assyrians. The Chaldaeans form the last Dynasty of Kings before Foreign Rule takes place (i.e., Persian Domination, Hellenization, etc.).

4. During the Chaldaean Dynasty, the Jewish Captivity takes place. An exchange program occurs between the priests and artisans of the Jews and those of the Chaldaeans.

5. The Persian Empire takes over Mesopotamia, as well as many other former Empires.

6. One group of Babylonian Priests, located

in Opis, in the North, near the Tigris, migrates to Asia Minor. Another group migrates with the Jews, back to Palestine. This is the time of the rebuilding of the Temple.

7. Concurrent with all this is the slow, gradual development of the Nabatean kingdom east of the Jordan River, extending as far north as Damascus, as far south as the Red Sea. All or most of the sects that developed in the Transjordan region developed in Nabatean territory. The Nabateans were known as Arabs, and had kinship with the Sabaeans of southern Arabia, as did the Chaldaeans.

8. During the period after Alexander the Great's rule, the Jews began to experience persecution again. A long series of conflicts took place, which resulted in the Maccabean dynasty of kings. Also, it resulted in the Messianic paradigm. In addition to this, a split took place in the Priesthood at Jerusalem which resulted in the establishment of a school near the Dead Sea. This school has come down to posterity as that of the Essenes. It is likely that this is the group known as the Qadosh Fathers, who, it is said, migrated to Israel around the time of Solomon's Temple, from Egypt, and stayed there until 70 c.e. After they translated the Bible for Ptolemy, they would have incurred the wrath of the hardliners who wanted to keep this material secret.

9. The ferment which created the Gnosis had its birth in four crucial areas: the Transjordan area; Samaria; Asia Minor, and Alexandria.

10. Several scholars attribute the real identity of the Naassenes to the Nasoraeans, and the Essenes. Heresiologists have always regarded the Naassenes (along with Simon Magus) as the progenitors of the Gnosis. From the Naassenes, it is said, sprang the Ophites, the Sethians, and so forth. Simon Magus came from Samaria, was said to be a disciple

of Dositheos, the Samaritan Messiah and prototype for the Seth of the Sethian Gnosis. Both of these figures are said to have been disciples of John the Baptist.

11. According to L. A. Waddell, John the Baptist was not merely a Jewish heretic, he was trained according to the Sumerian tradition. He was a Gibil, or Fire Priest. And the baptism he conveyed had the same magical properties that the Baptisms employed by the Mandaeans are said to possess.

12. The Essene community can be placed at the Dead Sea area from circa 90 bce to circa 68 ce. Of course there are scholars who want to place the existence of the Essenes far into the Common Era.

13. Following the closing of the School at Kirbet al-Qumran, some of its members migrated to its sister school in Egypt. Others went to Pella, and other centres in the Transjordan.

14. It is at this time that a new sect arose. It is that of the Elkesaites. The Elkesaites, also known as the Sampsaeans, came about around the end of the 1st Century c.e. The ruling body in this group was that of the Sampsaeans, and it is written that there was something sacred attached to their bloodline.

15. Several scholars, from Heresiologists to Arabic Scholars, to present day scholars are agreed that The Sabians of the Koran were originally denominated Elkesaites.

16. It is likely that from the migration to Pella and other regions nearby, such as the Hauran region, the city of Bosra, Syria, etc., these groups kept migrating, northward, eventually arriving in Damascus. From there, it is clear that some of them made their way to Palmyra, because some of the Mandaean Aramaic has been influenced by the Palmyrene language. From there, it was a migration south along the Euphrates, to their new

hometown. This had to happen in a relatively short period of time, because it is said that Mani's father was baptised as a Mughtasilah, which means sometime early in the 3rd Century c.e.

17. Another group migrated northwest from the Hauran region, the Nazerini of Pliny, and eventually ended up in Latakia (once known as Laodicea). This group became known as the Nusairi. We shall discuss the Nusairis later in our survey.

18. Somehow, the Mughtasilahs / Nasoraean / Elkesaites / Sabians developed a theology that while very similar in many ways with what came before it, is very different. Indeed, we are told by Rudolph that the Mandaeans should be regarded as an extreme fringe sect of Jewish Heretics. It is no secret that the Gnosis developed a strong antipathy to anything Jewish, and to most Christian beliefs, for the most part because of the track record these groups demonstrated.

19. By the time the Mandaeans come into being, the old traditions are rekindled, the Wise Men of John being none other than the Wise Men of Enki. Rather than being Pagans and "Idolaters" like their rivals, the Sabians of Harran, who do possess legitimacy in the family tree, by the way, the Mandaeans retained their monotheistic views, which wasn't really what the Gnostics practiced, but was part of the transmission process. The Gnostics were really Pantheistic, and held the belief that all of manifested creation contained sparks of Divinity. The Mandaeans, like the Jews, the Moslems, even, and the early Christians, were (and are) harsh monotheists. This might be due to the influence from the Persian religion.

20. It is worth mentioning that a lot of the dualistic good-evil material came into vogue as a result of influence from Persia. Before

that, sure, demons were everywhere, and so were gods, but it wasn't something to worry one's soul over. It was more like something to have to deal with, like when we have to deal with this computer today.

21. After 350 c.e., when Pachomius died, the School at the Thebaid was broken up, and its members fled. Some of the sects (whether associated with the School or not) found themselves migrating north to Syria and Asia Minor. These were Sethians, who by Epiphanius' time had received the derogatory name of Borborites, or "Filthy Ones"...

22. Over several centuries from c. 350 c.e., to the 8th century c.e., the "Borborites" gradually found their way to the same place the Mandaeans were, Mesopotamia. And, they took essentially the same route to get there.

23. The Borborites were the Tantriks of the bunch, and they were looked on with disdain by the Christians, by the Jews, by the Mandaeans, and so on.

24. Be that as it may, it is clear to us, that by the time of the formation of the Isma'ilis, the Brethren of Purity, the Batinis, and so on, that these groups may have derived some influence from the Manichaeans, from the Magi cultus, from the Mandaeans even, but they really derived a great deal from the Gnostics. In particular, from the Barbelo-Gnostics, which is to say, the Borborites.

25. By the time of the Crusades, which groups were in Syria? The Batinis, which had managed to survive, (and it is said there are Batinis today), the Isma'ili, of which we shall treat later, the Ikhwan as Safa, or Brethren of Purity, who compiled the first Encyclopaedia of Wisdom, and had a school at Bosra, Syria. This is usually misread as Basra, Iraq. And the Isma'ili influenced the Alawites, the Ansari, also known as the Nusairi. It is interesting to note that while we have these terms like Nazarenes, Nasoreans, Nazaraeans, Na-

soraean, we also have Nazerini, Nusairi, Nosairi, Nusayri. And, we have Nizari, which are the Assassins. And if we remember the name of the Mountain of Salvation, the original Montsalvat, it is Nisir, Mountain of Salvation, Ararat. And, too, the original name for the real Christians who were persecuted by the Orthodoxy, the Nozrei-haberith, or Keepers of the Covenant.

26. Three centuries later, the person known to posterity as Christian Rozenkreuz, went to Damascus in search of the Wise Men of Damcar. He was taken to Damcar, which is not the same thing as Damascus. Damcar is Dhamar, in southern Arabia, near Sa'na, in what we call Yemen. Sabaeen territory. We have it on a map produced by Abraham Ortelius in the 16th Century c.e., long before the Rosicrucian romances were penned. He returned and established the Brotherhood of the Rosy Cross, after three years training in Damcar, and a layover in Fez, Morocco.

27. Also, we are told that the Mandaeans and the Isma'ilis both influenced the early development of the Kabbalah, from the Sepher Yetzirah to the Sepher ha Bahir, and other texts. We know that the Talmud was developed in Babylon, and that the Jewish savants derived a lot from their alleged enemies in religion. This material migrated west, in the 9th century of the common era, in the luggage of Rabbi Abu Aharon ben Samuel ha-Nasi of Baghdad. From there it went to Italy, and from there to the rest of Western Europe, the Languedoc, the Alsace-Lorraine and in Swabia.

28. All these factors developed gradually into what we today refer to as the Western Esoteric Tradition.

29. In the 20th century, c.e., H. P. Lovecraft wrote an alleged history of the Necronomicon, stating that it was written by Abdul Alhazred, the mad poet of Sa'na, in Yemen.

The wanderings between there and Damascus remind one of the difference between Damascus and Damcar, and the text of the Simon edition is suspiciously close to that of the Babylonian Cultus which influenced the Mandaean.

We apologize to those real purists and true religionists that will find this material to be wild conjecture without a foundation to base it on. But, our considerable library and our research on this subject has brought us to these conclusions.

As we stated at the outset, this is our theory, but, is it really theory? And if it is merely theory, or myth, does that make it any less real than what is supposed to constitute cold, hard, facts?

Even though dated by several decades, nearly a century actually, Budge's work is still quotable, and should be cited more often. This work is one of his best. And, we find that the Madaeans were, according to his analysis, the purveyors of the old Sumerian faith.

We find this interesting, since in the works we've had access to, we see the Yezidis and Madaeans confounded with one another, and the Harranians are similarly described in terms which make them appear to be the cult which authored the Necronomicon.

In the quote by Budge, the Madaeans come closest, and they are called 'representatives of the ancient worshippers of EA.' That is, Sons of EnKi. This seems to us that all Sabaeans / Sabians are really related. Viewing it all on a map would clear up a lot of confusion. Even, if they are spread as far apart as Ethiopia, Yemen, Mesopotamia, Syria, Transjordan. The 'Book of Magic' is undoubtedly one of those originals upon which the Necro. was based. For that matter, we might be reading about the kind of book

that inspired the writing of the Raza Rabba. The term, 'Masbutah'. (=Baptism), also identifies the sect known as the Masbotheans land Basmotheans]. In this case, names such as Masbotheans, Mughtasilahs, Haemerobaptists, Nazoreans, Nazaraeans, Nasoraean, Sabaeans, Sabians, Sabeans, Yezidis, Johannites, Assassins, Isma'ili, Batini, Brethren of Purity, Qarmatians, Nusayria, Ansyreh, Nossairi, Nizari, Sufis, Sophis, Sophees, etc., describe this sect, in one form or another. The same can be said regarding the terms Gnostic, Sethian, Ophite, Barbelo-Gnostic, Phibionite, Secundian, Borborite, Coddian, Zachaeuses, Dositheans, Elkesaites, Ebionites, Sampsaeans, Essenes, Naassenes, Nozrei-haberith, Simonians, and so on.

Below, we present some of the more important points we pulled out of the articles we have quoted from in the Readings section, that tie together several millennia of cultic practice.

1. The dress, Crown of Anu in the Necro., North orientation of temples.

2. They claim their first priest to be Pharaoh who through an artifice escaped drowning. Also, they hold that the great earthly Palace of the Light is in the North, represented in the sky by the Pole Star. It is guarded by Abatur, and is in the Mountain of Turquoise. It is the Abode of the Blessed, and it is home to the Egyptians and their loved ones, who drowned in the Red Sea. As we know, The Mountain of Turquoise would pertain to Hathor, who was the goddess of the Turquoise mines, as well as of the Copper mines. See elsewhere in the Qadosh essay for the significance of Hathor, as well as in other articles to be found at this site, namely, "Is THIS the Holy Mountain?"

3. They claim their ancestry, not from Mesopotamia, or Palestine, but from Egypt,

migrating Northeast, via Damascus, where their High Priest resided.

4. They are categorized as Ophite Gnostics, or a survival of them.

5. They reverence the ARBA, or Sacred Four: Ea-Bel-Anu, plus Damkina, EnKi's spouse' and of these, EnKi is the Supreme Lord.

6. The mention of their use of Inanna's descent into the underworld bears a close relation to the Sleep of Ishtar in the Magan Text. There are seven vestibules of Hell, each with a gatekeeper and a password required. In the Mandaean version, the hero was required to give something at each step of the way, at each gate, much like Inanna was required to give Ereshkigal's gatekeepers a piece of her clothing at each gate. In the Mandaean version, the hero is going to see Ruha. In the Sumerian and Babylonian versions, it is Ereshkigal.

7. They are said to possess Magical Books. In fact, in the bibliography to the Introduction of the Simon Edition of the Necro., Lady Drower's Book of the Zodiac, is listed. Drower worked exclusively on Mandaean text translations.

8. Abathur is the same Ab-Adar, or Abadur of Jennings in the quote from Ophiolatrea, which is presented in another section of the work. He is regarded as being positioned on the Borderlands between Life and the After-Life. See Number 2 in this section.

If Madame Blavatsky's rendering of the Nazaraeans is accurate, and external evidence demonstrates that it is, then it is more than likely that this is the same sect, and that an offshoot sect is the Yezidis of Kurdistan. In fact, it is quite possible that when the Mandaeans were still in the region between Haran and Nisibis, which is well known as Yezidi territory, some of their number stayed behind, when the remainder of the group

migrated to Babylonia. This would suggest to us that the Yezidis are in some manner descended from the Mandaeans, or the same root group which the Mandaeans came from. True, the Yezidis don't practice the baptismal rite, but they do pay reverence to the Well of Zem Zem.

Since these people originated in the Transjordan, in Ghassanid times, we might have a connection with the Nusairi.

Also, the root group can claim some descent from the Sabaeans, at some time in their early history.

If we have a connection with early Egyptian ancestry, one exists with the original Qadosh Fathers / Solis Serpentis Priests / Wise Men of EnKi. We see here the Syrian branch of the first split in the community of Qadosh Fathers, and these developed into a group of Ophites. These are likely to be the Haemero-baptists, and they were headed for a time by Dositheos.

This is clearly the parent, and longest surviving branch, of the Gnosis from which all sects sprang (Christian, Simonian, Essenian, Ebionite, Ophite, etc.), and in Southern Syria, a branch of these existed in the area of Bosra, at the time of the Crusades.

Later, a migration to Latakia occurred, which resulted in the Nusayriyya, Alawites, etc. The Druzes, too, are a branch on this same family tree.

The glaring omission is this: Where do the Christians fit into the picture? The forbidden answer? They don't, at least in the form we are supposed to regard as authentic today. The exceptions are the heretical forms of Christianity which go to form a part of the survey as a whole. And, too, the form developed by some individuals within the walls of the orthodoxy. These would be people like St. Pachomius, and other Desert Fathers, whose works are very hard to come by. Also, impor-

tant figures, such as Hildegard von Bingen, Ramon Lull, Joachim of Floris, Fra Dolcino, Meister Eckhart, Johannes Tauler, and others who would be branded as heretics, Luciferians, Devil Worshipers, and so forth, simply because they labored to make Christianity a real practice, not merely a belief system used to prop up a massive pyramid scam.

We may now perhaps scan over Nesta Webster's account of the Mandaeans, and we can see in her account, as in the material presented in the Readings section, that we have perhaps the only ancient sect in the Middle East to have made it to the present day, from the sands of antiquity... and, we can state, the Mandaeans, as we have noticed in this part of the work, are the faithful successors of the parent Sect, like the Dynastic family in a human genealogy, which goes back across time to the Wise Men, established by EnKi himself.

A great deal of Gnosticism owe its origin to the Haemerobaptists. In these will be found the Qadosh Fathers / Solis Serpentis Priests which migrated throughout the known world of the eleventh through the tenth centuries BCE. Blavatsky herself regards the Sumerians as the pre-Vedic Brahmans (Pitris). There is much more than Madame's word to back it up. We have good reason to suspect, that in addition to India, these Sumerians colonized Africa and Southern Arabia, and from thence migrated to Egypt. From there, to Palestine and Greece. Also, as we will see, in another place, in our treatment of the Ophites, a branch of them migrated from Mesopotamia.

The Priests of our Cultus are all descended from EnKi, or EnKi's sons (regardless of gender). Nergals, Marduks, Gibils, and so on. Our work here, then, brings light to the story that we quoted earlier about "John the Baptist:

The Aryan Sun-Fire Priest." Or John the Gibil Priest. In fact, the name John, as we have mentioned repeatedly, has its origins in the name EnKi.

So, when we find Webster referring to the Mandaeans as "Mandai Iyahi", or "Wise Men of John", we see a reference to the very same cultus which Sitchin, seventy years later, termed the "Wise Men of EnKi". And, the reverence paid to the Mystic Trimurti, AUM, has been reported by Waddell, to be an appellation of none other than EnKi. Furthermore, EnKi is attributed by the editors of the *Necro.*, to the Sphere of the Zodiac, or Wisdom!

We are getting ahead of ourselves. We quote pages 70 to 72, below, from *Secret Societies and Subversive Movements*: [She begins by discussing the authenticity of the manuscripts that form the *Levitikon* of Fabre - Palaprat, which we noticed above in *The Johannite Legend of the Templars...*]

"The Antiquity of the manuscript containing the history of the Templars thus remains an open question on which no one can pronounce an opinion without having seen the original. In order, then, to judge of the probability of the story that this manuscript contained ⁽¹⁾ it is necessary to consult the facts of history and to discover what proof can be found that any such sect as the Johannites existed at the time of the Crusades or earlier. Certainly none is known to have been called by this name or by one resembling it before 1622, when some Portuguese monks reported the existence of a sect whom they described as 'Christians of St. John' inhabiting the banks of the Euphrates. The appellation appears, however, to have been wrongly applied by the monks, for the sectarians in question, variously known as the Mandaeans, Mandaites, Sabians, Nazoreans, etc., called themselves Mandai Iyahi, that is to

say, the disciples, or rather the Wise Men of John, the word Mandai being derived from the Chaldean word Manda;⁽²⁾ corresponding to the greek word, or Wisdom.⁽³⁾ The multiplicity of names given to the Mandaeans arises apparently from the fact that in their dealings with other communities they took the name of Sabians, whilst they called the Wise and Learned amongst themselves Nazoreans. The sect formerly inhabited the banks of the Jordan, but was driven out by the Moslems, who forced them to retire to Mesopotamia and Babylonia, where they particularly effected the neighbourhood of rivers in order to be able to carry out their peculiar baptismal rites.

"There can be no doubt that the doctrines of the Mandaeans do resemble the description of the Johannite heresy as given by Eliphaz Levi, though not by the *Ordre du Temple*, in that the Mandaeans professed to be the disciples of St. John the Baptist, however, not the Apostle - but were at the same time the enemies of Jesus Christ. According to the Mandaeans' Book of John (*Sidra d'Yahya*), Yahya, that is to say, St. John, baptized myriads of men during forty years in the Jordan. By a mistake - or in response to a written mandate from Heaven saying, 'Yahya, baptize the liar in the Jordan' - he baptized the false prophet Yishu Meshiha (the Messiah Jesus), son of the devil Ruha Kadishta. The same idea is found in another book of the sect, called the 'Book of Adam', which represents Jesus as the perverter of St. John's doctrine and the disseminator of iniquity and perfidy throughout the world. The resemblance between all this and the legends of the Talmud, the Cabala, and the Toledot Yeshu is at once apparent;⁽⁴⁾ moreover, the Mandaeans claim for the Book of Adam the same origin as the Jews claimed for the Cabala, namely, that it was delivered to Adam

by God through the hands of the angel Razael. This book known to scholars as the *Codex Nasaraeus*, is described by Munter as 'a sort of mosaic without order, without method, where one finds mentioned Noah, Abraham, Moses, Solomon, the Temple of Jerusalem, St. John the Baptist, Jesus Christ, the Christians, and Mohammed.' M. Matter, whilst denying any proof of the Templar succession from the Mandaeans, nevertheless gives good reason for believing that the sect itself existed from the first centuries of the Christian era and that its books dated from the eighth century,⁽⁵⁾ further that these Mandaeans or Nazoreans - not to be confounded with the pre-Christian Nazarites or Christian Nazarenes - were Jews who revered St. John the Baptist as the prophet of ancient Mosaism, but regarded Jesus Christ as a false Messiah sent by the powers of Darkness. Modern Jewish opinion confirms this affirmation of Judaic inspiration and agrees with Matter in describing the Mandaeans as Gnostics: Their sacred books are in an Aramaic dialect, which has close affinities with that of the Talmud of Babylon.' The Jewish influence is distinctly visible in the Mandaean religion. 'It is essentially of the type of ancient Gnosticism, traces of which are found in the Talmud, the Midrash, and in a modified form, the later Cabala.' (*Jewish Encyclopaedia*, art., Mandaeans.)⁽⁸⁾

"It may then be regarded as certain that a sect existed long before the time of the Crusades corresponding to the description of the Johannites given by Eliphaz Levi in that it was Cabalistic, anti-Christian, yet professedly founded on the doctrines of one of the St. Johns.⁽⁹⁾ Whether it was by this sect that the Templars were indoctrinated must remain an open question. M. Matter objects that the evidence lacking to such a conclusion lies in the fact that the Templars expressed no par-

ticular reverence for St. John; but Loiseleur asserts the Templars did prefer the Gospel of St. John to that of the other evangelists, and that modern Masonic Lodges claiming descent from the Templars possess a special version of this gospel said to have been copied from the original on Mount Athos. It is also said that 'Baphomets' were preserved in the Masonic Lodges of Hungary, where a debased form of Johannite Masonry, known as Johannite Masonry, exists to this day.⁽¹⁰⁾ If the Templar Heresy was that of the Johannites, the head in question might be that of John the Baptist, which would accord with the theory that the word Baphomet was derived from Greek words signifying Baptism of Wisdom. This would, moreover, not be incompatible with Loiseleur's theory of an affinity between the Templars and the Bogomils, for the Bogomils also possessed their own version of the Gospel of St. John, which they placed on the heads of their Neophytes during the ceremony of initiation, giving as the reason for the peculiar veneration they professed for its author that they regarded St. John as the servant of the Jewish God Satan-ael."

The Mandaeans have three degrees in their Priesthood, the Templars had nine degrees, the Druzes five. SION allegedly has/had nine degrees, as did the old RC, and the Isma'ili also had nine.⁽¹¹⁾ The Essenes, we have seen, had nine degrees. And, too, we have a nine level system in the Necro. Of course the highest degree of the local outfit form but the lowest probationary degrees - the nursery, as it were, of the International Order.

It is interesting that Webster makes a notice of Mt. Athos, since Blavatsky also mentions a special monastery there. In *ISIS UNVEILED*, 11-52 note (**), it is said of the monks of a 'certain oriental church' that they possessed heaps of very ancient manuscripts.

These monks "did not know what the manuscripts contained, nor 'did they care,' they said. But the 'heap of writing,' they added, was transmitted to them from one generation to another, and there was a tradition among them that these papers would one day become the means of crushing the 'Great Beast of the Apocalypse,' their hereditary enemy, the Church of Rome. They were constantly quarrelling and fighting with the Catholic monks, and among the whole 'heap' they KNEW that there was a 'holy' relic which protected them. They did not know WHICH, and so in their doubt, abstained."

There may be plenty of old and moldy manuscripts, and ancient traditions which we take for granted today, even, that will crush to the ground the Great Beast of the Apocalypse, the Christian Church itself.

It is worth adding, too, that some of the old and moldy manuscripts at Mount Athos are from Pachomius' monastery in the Thebaid, according to articles in the *New Catholic Encyclopedia*.

The Covenant is with EnKi, even with EnLil, and the Great Architect of the Universe, not with Jehovah of the Jews, or the Pope, or Peter, or even the Jesus of the Church that bears, but does not deserve, his name. And sooner or later, the whole edifice will have to be effaced from its existence, once and for all. It has survived by condemning, then stealing wholesale the practices, doctrines, beliefs, and inherited traditions of its most hated enemies, with the exception of the Johannite Story, which is perhaps the most hated heresy of them all. This being the case, probably the most truthful heresy of them all, since that which is most hated and feared by the Church and its cousins, is that which will unmask it and shake it down to its foundations, which are but 20-weight cards.

Space forbids us from quoting at length the article from Hastings ERE. We might comment that both EB and Schaff-Herzog articles are by Kessler. The Hastings article is by Brandt. They were authorities on their subject. Brandt's thesis differentiates the Mandaeans from the Elkesaites, as well as any Jewish influence. The uniform opinion is that the Mandaean Priesthood is a survival of the Babylonian religion, modified by Persian dualism, and, perhaps the Gnosticism of the Ophites, and the Manichaeans. This being the case, the root group would have been established no later than Sassanian times. Possibly even as early as the conquest of Babylon by the Persians. Brandt states that the sources of Mandaean language and religion stem from the Lake Urmia district in Kurdistan. It is possible that this sect came from the south, too. Other reports place their ancestry in the Transjordan.

We remain with our thesis, that while the Kurdish, Babylonian and Persian influences are important elements, very important elements, even, this group originated in the West. That is, in the Transjordan region. It received its first infusion of Babylonian and Persian culture early, before it arrived in Nabatean territory. Later, it moved on. First, to the Hauran region. When the Nabatean kingdom evaporated along with its water supply, it removed to Damascus and to North-eastern Syria. From there it made its way down the Euphrates to the marshes. Always, too, leaving remnants behind in every village and town, until it reached the marshlands of the Shat-al - Arab, where Mani's father is said to have been initiated into it, along with Mani himself. By the time the Moslems came to power, it was an old sect, and by the time of the Crusaders, an ancient one, old enough to be a serious rival not only to Islam, but to Judaism and orthodox Christian-

ity, which it considers its mortal enemy.

Perhaps some of the origins of the Mandaeans can be seen in the surviving Chaldean priesthood, like the one that migrated from Opis near the Tigris River, to Pergamon. Perhaps.

It is possible that the Mandaeans are not the Johannites of the Levitikon text. We have narrowed the choices to three distinct groups which we shall list at the end of the Sabians Section. This is for many reasons. One, the hierarchy of Initiation is not the same. We need a nine degree system, and we find that in the Sufis, in the various branches of the Isma'ili, but not in the Mandaeans, or in the Yezidis, or in the Harranians. Most likely, we are looking at a hitherto unknown survival of the Gnosis, whose name escapes us altogether. The author(s) of the Coptic Hermetica, who may be associated with Saint Pachomius, for reasons we elaborate elsewhere, from Nag Hammadi, Codex VI, suggest a nine-levelled system (The Eighth Reveals the Ninth). Where this would have been found in the second decade of the twelfth century c.e., still baffles us. However, the Mandaeans are DEFINITELY connected to the Authentic Tradition, by being related to a) the Sumerian tradition; b) the Ophites; c) the Haemero-baptists and Mughtasilahs; d) the Peratae; and connections do exist between the Manichaeans and the Mandaeans, and between the Mandaeans and the Dositheans. For example, Theodore bar Khoni claims that one of the names for the Mandaeans was Dostai. This was an early name for the Dositheans, going back to the Samaritan exchange period (8th to 7th centuries bce)... We shall treat further of this.

Footnotes

1. One might consider that this work could have had help from Gerard de Nerval who wrote many things concerning secret sects and practices in the Near East.

2. Also, Mandal, which is the term applied to the Magical Circle in Babylonian Magical texts. Hence, the word Mandala.

3. Actually, GNOSIS = Knowledge. Sophia is Wisdom.

4. And, we might add, the conflict between the Essene Teacher of Righteousness and the Wicked Priest.

5. And, as all Necronomicon Scholars know, the 8th Century c.e., is when that famous book was penned by the Mad Arab in Damascus. And, too, it is at this time that Scholem claims Magic books of this type existed in Damascus.

6. Why not? It is not so unlikely after all...

7. Here she goes. Anything repugnant to God-fearing Christians was inspired by Jews, according to Nesta Webster. Hell, even Islam is part of a Jewish plot according to her twisted logic. Of course, as Rudolph states, it is likely that the Mandaeans were a brand of Jewish Heretics that moved east from the Transjordan region.

8. But... see later, when we discuss Mandaean influences on the Western Tradition. We shall show that it is much more likely that it was the other way around, that the Mandaeans weren't influenced by the Jews, but that certain Jewish schools in Babylonia were influenced by the Mandaeans.

9. It is much more likely that the sect in question was one of the Isma'ili derivatives, like the Nusairi.

10. We have yet to find any reference to this type of Masonry in Hungary, in any of the Masonic works we possess.

11. The Nusairi had 3 degrees, reduced from the Nine.

4. The Mythos

Please refer to the charts,

"Mandaean Cosmology: 1, 2, and 3."

"The ground and origin of all things is PIRA, or more correctly, PERA RABBA ('the great abyss,'...), associated with whom, and forming a triad with him, are the primal aeons AYAR ZIVA RABBA, 'the Great Shining Aether,' and MANA RABBA D'EKARA, 'the great spirit of glory,' usually called simply MANA RABBA. The last-named, the most prominent of the three, is the King of Light properly so-called, from whom the development of all things begins.

"From him emanates YARDENA RABBA, 'the Great Jordan,' (1) which, as the higher-world soul, permeates the whole aether; the domain of Ayar. Alongside of MANA RABBA frequent mention is made of D'MUTHA, his "IMAGE", as a female power; the name 'image of the Father' arises out of the same conception as that which gives rise to the

In some comparisons we see:

PERA RABBA= ANU

AYAR ZIVA RABBA= ENLIL

MANA RABBA=ENKI

D'MUTHA MANA= NIN HARSAG

=The B' ARBA-Elo, or Sacred Four

MANDAEAN COSMOLOGY I

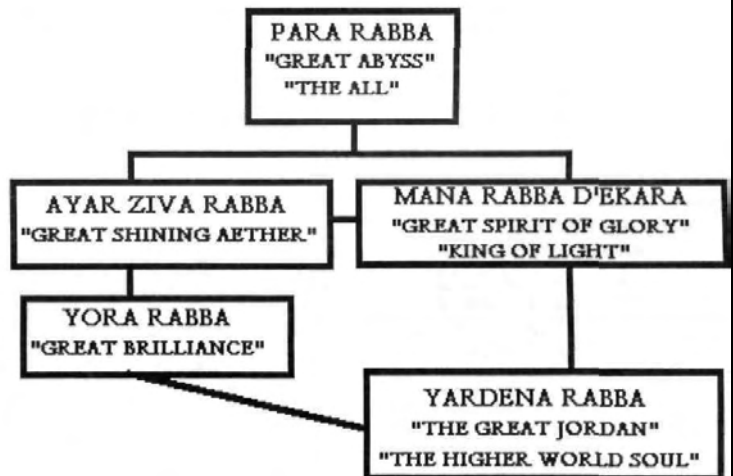

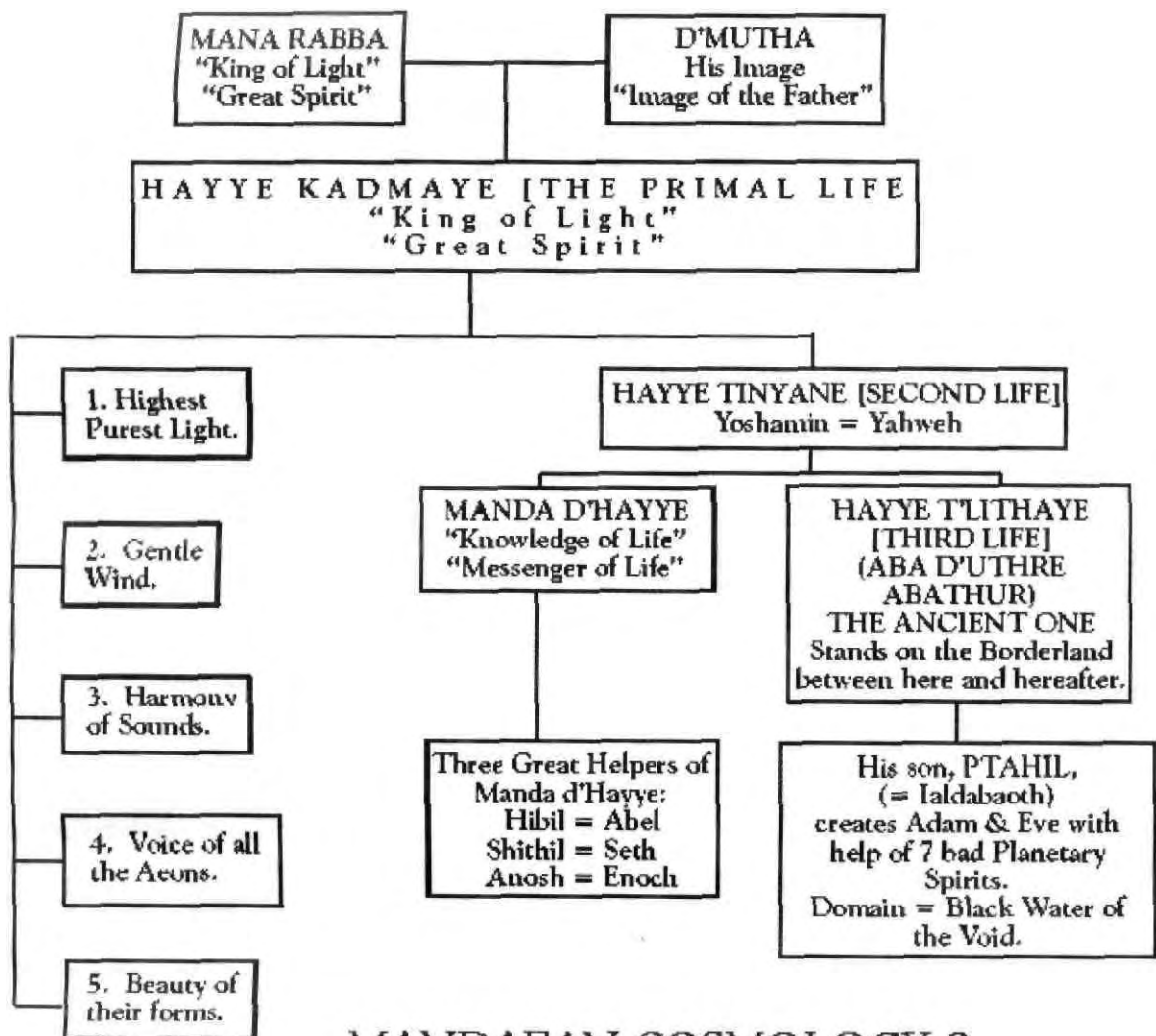

MANDAEAN COSMOLOGY 2

name of Ennoia among the Greek Gnostics.

"MANA RABBA called into being the highest of the aeons properly so-called, HAYYE KADMAYE, 'Primal Life', and then withdrew into deepest secrecy, visible indeed to the highest but not to the lowest aeons (cf. Sofia and Propator), yet manifesting himself also to the souls of the more pious of the Mandaean after their separation from the body. Primal Life, who is properly speaking the Mandaean God, has the same predicates as the primal spirit, and every prayer, as well as every section of the sacred books, begins by invoking him.

"The extremely fantastic delineation of the world of light by which HAYYE KADMAYE is surrounded corresponds very closely with the Manichaeon description of the abode of the 'King of the Paradise of Light.' The King of light 'sits in the far north in might and glory.'

"The Primal Light unfolds himself by five great branches, viz., 'the highest purest light, the gentle wind, the harmony of sounds, the voice of all the aeons, and the beauty of their forms,' all these being treated as abstractions and personified. Out of the further development and combination of these primary manifestations arise numerous aeons ('Uthre, 'splendours', from rt, ('is rich'), of which the number is often stated to be three hundred and sixty. They are divided into a number of classes (Kings, Hypostases, forms, etc.); the proper names by which they are invoked are many, and for the most part obscure, borrowed doubtless, to some extent, from the Parsee angelology.

"From the FIRST LIFE proceeds as a principal emanation the SECOND LIFE. 'HAYYE TINYANE, generally called YOSHAMIN. This last name is evidently meant to be Hebrew, 'YAHWEH of the Heavens,' the God of the Jews being of a secondary rank in the usual Gnostic style.

"The next emanation after YOSHAMIN is 'the Messenger of Life' (MANDA D'HAYYE, literally gnwsii thjzohj), the most important figure in the entire system, the mediator and redeemer, the logoj and the Christ of the Mandaeans, from whom, as already stated, they take their name. He belongs to the heathen Gnosis, and is in his essence the same as the Babylonian MARDUK. Yoshamin desired to raise himself above the Primal Light, but failed in the attempt, and was punished by removal out of the pure aetherial world into that of inferior light. Manda, on the other hand, continues with the First Life and MANA RABBA, and is called his 'beloved son' the 'first born', 'high priest,' and 'word of life'. The 'Life' calls into existence in the visible world a series of three great Helpers, HIBIL, SHITHIL, and ANOSH (late Judaeo-Babylonian transformations of the well-known names of the book of Genesis), the guardians of souls. (2)

"The last son of the SECOND LIFE is HAYYE T'LITHAYE, the 'THIRD LIFE', usually called Father of the Uthre (ABA D'UTHRE, ABATHUR). His usual epithet is The ANCIENT', ('ATIQA), and he is also called 'the deeply hidden and guarded.' He stands on the BORDERLAND between the here and the hereafter, like the mysterious presbutj tritoj or senex tertius of Mani, whose becoming visible will betoken the end of the world. Abathur sits on the far-

these verge of the world of light that lies towards the lower regions, and weighs in his balance the deeds of the departed spirits who ascend to him. Beneath him was originally nothing but a huge void with muddy black water at the bottom, in which his image was reflected, becoming ultimately solidified into P'TAHIL, his son, who now partakes of the nature of matter.

"The demiurge of the Mandaeans, and corresponding to the IALDABAOOTH of the Ophites, he at the instance of his father frames the earth and men - according to some passages in conjunction with the seven bad planetary spirits. He created Adam and Eve, but was unable to make them stand upright, whereupon HIBIL, SHITHIL, and ANOSH were sent by the First Life to infuse into their forms spirit from MANA RABBA himself. HIBIL, at the instance of the Supreme God, also taught men about the World of Light and the aeons, and especially gave them to know that not P'Tahil but another was their creator and supreme God, who as 'the great King of Light, without number, without limit,' stands far above him. At the same time he enjoined the pair to marry and people the world. P'tahil had now lost his power over men, and was driven by his father out of the world of light into a place beneath it, whence he shall at the day of Judgement be raised, and after receiving baptism be made King of the 'UTHRE with divine honours.

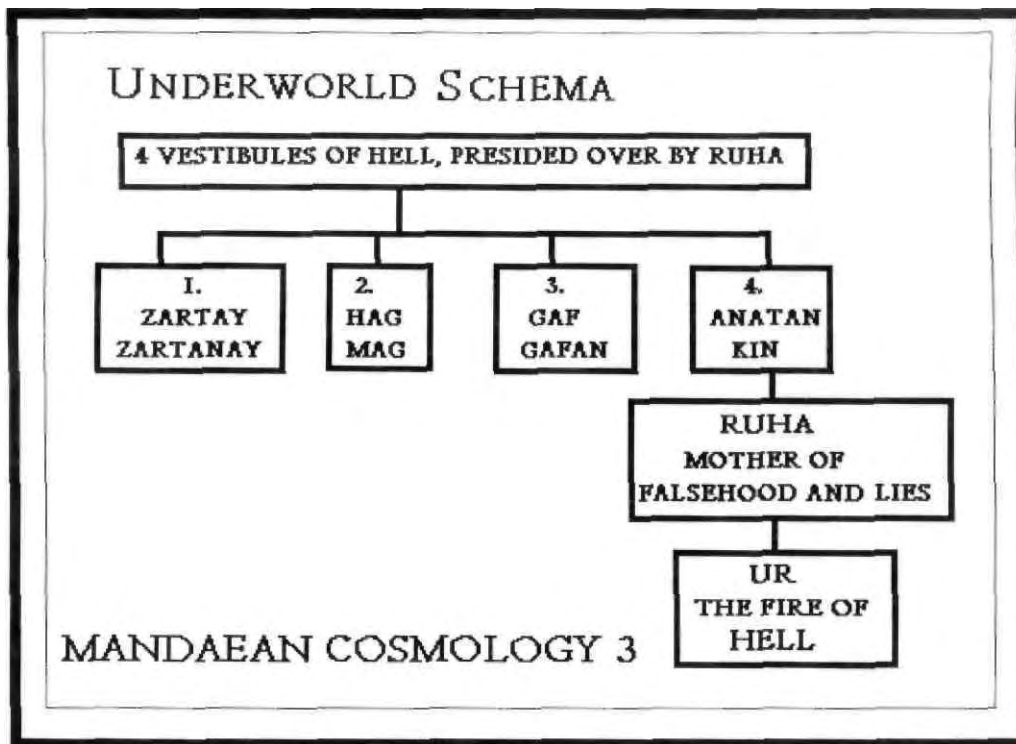

"The underworld is made up of four vestibules and three hells properly so-called. The vestibules have each two rulers, ZARTAY and ZARTANAY, HAG and MAG, GAF and GAFAN, ANATAN and KIN. In the highest hell rules along the grisly king SH'DUM, 'the warrior', (3) in the storey immediately beneath is GIV, 'the great'; and in the lowest is KRUN or KARKUM, the oldest and most powerful of all, commonly called 'the great mountain of flesh' (Tura Rabba d'besra), but also 'the first-born of darkness'.

"In the vestibules dirty water is still to be met with, but the hells are full of scorching, consuming fire, except KRUN's domain, where is nought but dust, ashes and vacancy. Into these regions descended HIBIL the brilliant, in the power of MANA RABBA, just as in the Manichaean mythology of the 'primal man' armed with the elements of the King of Light, descends to a contest with the primal devil. (4) HIBIL lingers, gradually unfolding his power, in each of the vestibules, and finally passing from hell to hell reaches Karkum. Hibil allows himself to be half swallowed by the monster, but is unhurt, and compels his antagonist to recognize the superiority of MANA RABBA, the God of light, and to divulge his profoundest secret, the HIDDEN NAME OF DARKNESS. ARMED WITH THIS HE RETURNS THROUGH THE SUCCESSIVE HELLS, COMPELLING THE DISCLOSURE OF EVERY SECRET, DEPRIVING THE RULERS OF THEIR POWER, AND BARRING THE DOORS OF THE SEVERAL REGIONS.

"From the fourth vestibule he brought the female devil RUHA, daughter of KIN, and set her over the whole four. This RUHA, the mother of falsehood and lies, of poisoning and fornication, is an anti-Christian parody of the RUHA D'QUDDSHA (Holy Spirit) of the Syriac Church. She is the Mother of UR, the personified fire of Hell, who in anger and pride made a violent onset on the world of Light (compare the similar occurrence in the Manichaean mythology), but was mastered by HIBIL and thrown in chains, down to the 'black water', and imprisoned within seven iron and seven golden walls.

"By UR, RUHA, while P'TAHIL was engaged in his work of creation, became mother of three sets of seven, twelve, and five sons respectively; all were translated by P'Tahil to the heavenly firmament (like the Archons of Mani), the First group forming the planets and the next the signs of the Zodiac, while the third is as yet undetermined.

"Of the names of the planets ESTERA (Ishtar, Venus), also called RUHA D'QUDDSHA, 'holy spirit'), ENBA (Nebo, Mercury), SIN (Moon), KEWAN (Saturn), BIL (Jupiter), and NIRIG (Nergal, Mars) reveal their Babylonian origin; IL or ILIL, the sun, is also known as KADUSH and ADUNAY (the Adonai of the Old Testament); as lord of the planetary spirits his place is in the midst of them; they are the source of all temptation and evil amongst men. The houses of the planets, as well as the earth and A SECOND WORLD IMMEDIATELY TO THE NORTH OF IT, REST UPON ANVILS laid by Hibil on the belly of UR.

"In the Mandaean representation the sky is an ocean of water, pure and clear; but of more than adamantine solidity, upon which the stars and planets sail. Its transparency allows us to see even to the pole star, who is the central sun around whom all the heavenly bodies move. Wearing a jewelled crown, he stands before ABATHUR's door at the gate of the World of Light; the Madaeans accordingly invariably pray with their faces turned northward. The earth is conceived of as a round disk, slightly sloping towards the south, surrounded on three sides by the sea, but on the north by a high mountain of turquoises; (5) behind this is the abode of the blest, a sort of inferior paradise, inhabited by the Egyptians who were saved from drowning with the Pharaoh in the Red Sea, and whom the Madaeans look upon as their ancestors, Pharaoh himself having been their first high priest and king."

FOOTNOTES.

1. According to Kessler's article in the Schaff-Herzog, Vol. 7, p. 146, Yardena Rabba emanates from Yora Rabba (Great Brilliance), an emanation of AYAR ZIWA RABBA. Evidently this was left out of his article in the E. B. Is there any possibility of an etymological connection between ZIVA or ZIWA and SIVA or SHIVA? The purists will probably say that there is not, but who knows?
2. Hibil is Abel; Shithil is Seth; and Anosh (sometimes spelled ANUS) or Anosh Uthra, is Enoch. We are told in another place that Anosh is pronounced like Oannes.
3. Any comparison with Saddam? Perhaps...
4. Cf. Inanna's descent into the underworld.
5. Along with Copper, Turquoise is sacred to Hathor.

5. Chronology and Eschatology.

(Taken from Schaff-Herzog, 7:148. Article also by Kessler.)

"The period of duration of the earth is fixed at 480,000 years, divided into seven epochs, each of which is governed by a planet. According to the Ginza, the human race has been three times destroyed by water, fire, sword, and pestilence, only one couple remaining alive after each time.

"At the time of Noah, the world was 466,000 years old. (1) After him rose many false prophets. The first prophet was Abraham, who came 6,000 years after Noah, (2) when the Sun ruled the world. Then came Moses, in whose time the Egyptians had the true religion. After him came Solomon, to whom the demons yielded obedience. The third false prophet was Yishu Mesiha (i.e., Jesus the Messiah), the planet Mercury, a Sorcerer.

"Forty-two years before him lived, under King Pontius Pilate, the only true prophet. Yahya, or Yuhana bar Zakariya (i.e., John, son of Zacharias; Luke 1:13), whose mother was Enishbai (Elizabeth); Yahya, being deceived by the Messiah, baptized him. He is an incarnation of Hibil, who had preached repentance in the time of Noah. (3) "As a contemporary of the Messiah and John the Baptist lived AnosUthra, a younger brother of Hibil, who had descended from Heaven, was baptized by John, wrought miracles, healed the sick, raised the dead, was the cause of the crucifixion of the false Messiah, proclaimed the true religion, and, before his return to the world of lights, sent 360 prophets into the world to proclaim his teaching. Jerusalem, which was once built at the command of Adunay, (Adonai), was destroyed by Anos, while the Jews were dispersed into all the world, having killed John the Baptist.

"Two hundred and forty years after the ap-

pearance of the Messiah, 60,000 Mandaean came out of the world of Pharaoh. THEIR HIGH PRIEST SETTLED IN DAMASCUS, AND THEIR SACRED WRITINGS ARE CONCEALED THERE IN THE CUPOLA OF THE MOSQUE OF THE OMMA-YADE."

"Their last false prophet was M'HAMMAD or AHMAT bar BISBAT (Mahomet), but Anosh, who remained close beside him and his immediate successors, prevented hostilities against the true believers, who claim to have had in Babylonia, under the Abbasids, four hundred places of worship. Subsequent persecutions compelled their withdrawal to Ammara in the neighborhood of Wasit, and ultimately to Khuzistan." - EB (11th edition) vol. 17:556d.

"After 4000 or 5000 years mankind will again be destroyed by a terrific storm, but the earth will be again repopled by a man and a woman from the upper world, whose descendants will dwell on earth for 50,000 years in piety and virtue. Then will UR destroy the earth and the other middle worlds, after which, bursting asunder, he will fall into the abyss of darkness, to be annihilated there with all worlds and powers of darkness. Then the universe will become a realm of light, enduring forever." - Schaff-Herzog, 7:148.

What is most interesting to see in all this is that it is a corrupted version of earlier myths. When we say corrupted version, don't get us wrong. We don't mean that the Mandaean themselves are corrupted, only that time changes things. In these myths we see the original Sumerian stories, blended with early Egyptian copies, and tempered with the Gnostic mythos. Add to this the Jewish varnish, and we see how the Madaeans devel-

oped. It is most likely that the Mandaeans got a lot of their material from the locale they found themselves in. Also, it is likely that the Essenes, transforming into the Elkesaites, and Ebionites, brought with them some of the Zoroastrian-inspired Jewish teachings, as well as the legends pertaining to the famous Old Testament characters. Now, it is more than likely, too, that by this time these Jews would be very upset with their forefathers, because, after so many centuries, the promise had yet to be fulfilled, and since Jerusalem was destroyed and they were cast out of what they claimed was their homeland even though it never was, nor is it now, nor will it ever be, they turned on the stories they had been fed all their lives and sided with and/or created the Gnosis, and this Gnosis eventually made its way east, where it settled in the Marshlands. Here, the Mandaeans developed.

6. Festivals and Priesthood.

A. Mandaean Festivals.

New Year's Day, called Nauruz Rabba, first day of the first winter month, lasting seven days. Forecast of futurity for the coming year. In this, we can see an analogy with the Akitu festival, of Sumer and Babylon, described in the paper, "Akitu."

Feast of Ascension of Hibil Ziwa, 18th - 22nd of the 4th Month. Celebration of the Ascension of Hibil from the regions of darkness. Commemoration of Egyptians who perished in the Red Sea, 1st day of 5th Month. Festival of Baptism, 5 intercalary days between the 8th and 9th months. Mandaeans bathe 3 times daily, before meals, and wear white.

Feast of the 360 Uthras, 1st day of the 11th Month.

Preparation for New Year, last day of the year.

B. Calendar.

Mandaean year is solar, 12 months of 30 days each, plus 5 intercalary days, as mentioned above, between the 8th and 9th Months.

Seasons, 3 months each, beginning with winter.

Weeks, of 7 days, named after the planets.

C. Rites.

Rites include baptism, communion, consecrations.

D. Priesthood.

In Three Grades:

1. Shkanda, Deacon.

Preliminary training of 12 years, picked at age 7.

At age 19 is ordained as an assistant. After one year (at age 20), is admitted to:

2. Tarmida, Priest.

Ordained by a Bishop and 2 Priests, or 4 Priests empowered by the Bishop. Probation is 62 days or longer.

3. Ganzivra, Treasurer or Bishop.

Must be able to interpret difficult passages of scripture.

4. Rish Amma, "Head of the People," corresponds to Pope or High Lama.

Has only been filled twice. (As per Hastings' ERE and EB.)

E. Dress.

Priestly dress is all white; consists of drawers (Rasta); an upper garment, and a girdle with the TAGA (Crown);⁽⁴⁾ in all ceremonies the celebrants must be barefoot.

FOOTNOTES.

1. That means, dear robot of the future, who will survive us, the world will end in the ripe year of 3027 c.e.