

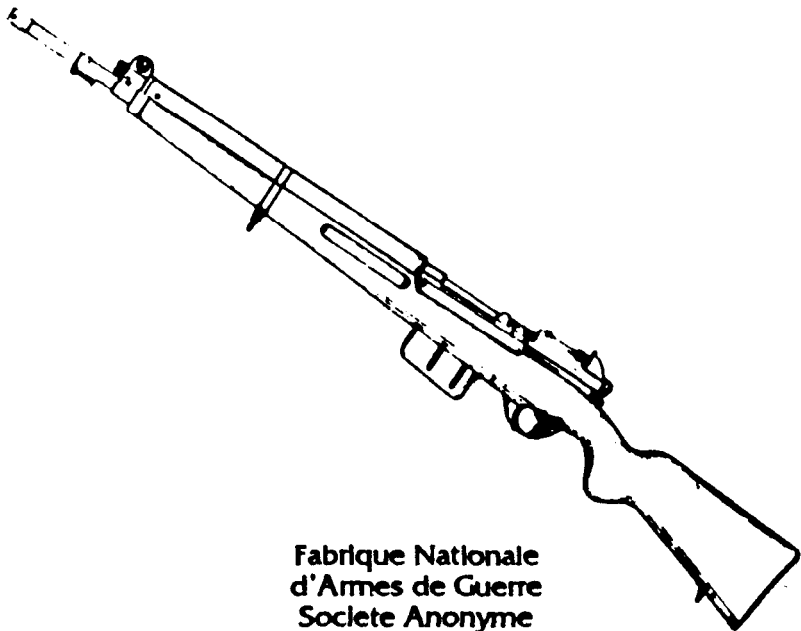

F.N. MODEL 49
SELF - LOADING
RIFLE
USER'S MANUAL



Fabrique Nationale
d'Armes de Guerre
Societe Anonyme
HERSTAL- LEZ - LIEGE
(BELGIUM)



Plate I.

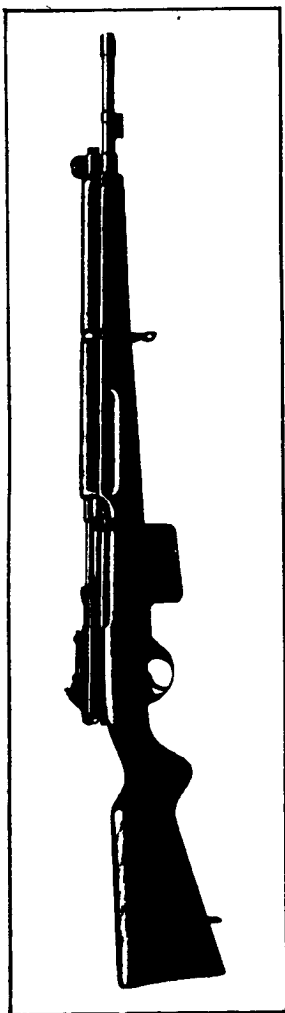

F. N. Self-loading rifle (right side view).



Plate II.

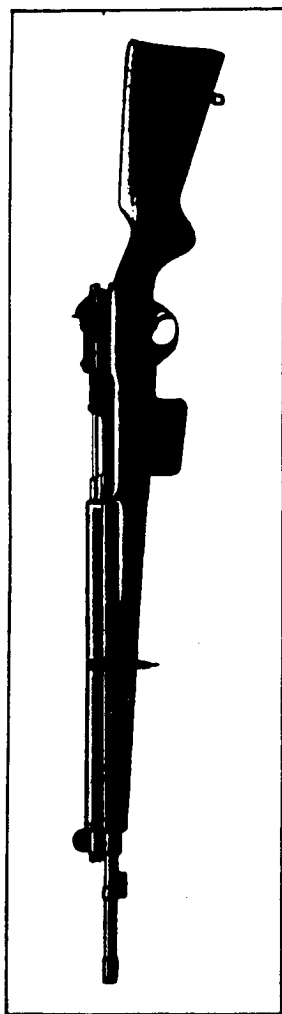

F. N. Self-loading rifle (left side view).



GENERAL CHARACTERISTICS

The F.N. Self-loading Rifle is a **shoulder weapon** which has been developed to use the infantry cartridges i.e. rimless cartridges of a calibre of about 8 mm (7 mm, 7,5 mm, 7,65 mm, 7,9 mm, .30) developing a muzzle energy of approximately 350 kgm. This rifle can be manufactured for all above mentioned ammunitions and calibers.

Method of operation. — It is a self-loading rifle, i.e. that the following operations are automatically performed without interference of the shooter :

Unlocking the mechanism,
Extraction and ejection of the fired case,
Cocking the hammer,
Feeding a cartridge into the chamber,
Locking the mechanism.

The Standard type of the F. N. Self-loading Rifle is designed as to deliver single shot fire only.

On special request, however, this rifle may be designed as to be able to deliver either : single shot or full automatic fire.

Locked weapon. — The rifle is locked and the opening of the mechanism can only occur when there is practically no more pressure in the chamber. This makes the extraction of the fired case more easy and ensures a more regular functioning as it is less sensible to unavoidable variations of ammunitions.

The bolt of the F. N. Self-loading Rifle is in one piece, it is locked downwards at the rear of the magazine.

Gas operation. — The F. N. Self-loading Rifle is a gas operated weapon. The gas port is located sufficiently near the muzzle as to allow the pressure in the chamber to drop before the mechanism is unlocked : the gas intake system permits to take into the mechanism exactly sufficient gas to operate the weapon. This gas regulation enables to suit to atmospheric conditions as well as to variations in ammunition.

As a consequence of the fact that only the required quantity of gas is allowed to pass into the gas cylinder, the fouling of the parts submitted to the action of gas is reduced to a minimum. On the other hand, the escape of the excess



of gas outside of the weapon sweeps continuously into the air the residues of powder combustion, this also reduces the possibility of fouling.

Closed bolt. — In opposition to the automatic machine rifles which generally fire from an open bolt, the self-loading rifles fire with closed bolt i.e. that the bolt is in its forward position and locked when the trigger is depressed. Consequently the bolt of the F. N. Self-loading Rifle is not held at the rear after each shot. The bolt, after performing automatically all its functions, returns to the forward position. This feature enables to obtain a high standard of accuracy.

Capacity. — Owing to the capacity of the magazine (10 cartridges), located in the lower part of the stock, the efficiency of the weapon is greatly increased. Moreover it is possible to reload the magazine while partially empty.

Stability. — The weapon is so designed that the center of gravity is practically in line with the point where the stock rests against the shoulder of the shooter. The upward swing of the muzzle is consequently greatly reduced and there is practically no jumping of the gun when fired. This also gives in a high standard of accuracy.

Light weight. — Notwithstanding the fact that it is an automatic weapon, owing to a thorough study of the functions and the resistance of the components, the weight of the F. N. Self-loading Rifle has been kept very low.

Weather proofness. --- There are no openings allowing dust or mud into the mechanism.

Safety. — The weapon is absolutely safe, the very principle of the relative motions of the working parts prevents the firing as long as the locking of the mechanism is not complete. Further, the firing pin stop prevents the forward motion of the firing pin in any position of the bolt except when it is locked. Accidental firing is consequently materially impossible.

Accessibility. — By the fact that the complete dismounting of the working parts may be performed immediately without using any tool, all the components of the mechanism are



easily accessible. This makes the maintenance of the components very easy and permits to clear immediately an accidental stoppage.

Simplicity. — The weapon is very simple. It consists only in a few groups of components. The instruction of the soldier is consequently very easy.

Bolt and Bolt-carrier catches. — The bolt catch holds the bolt open when the magazine is empty. When the rifle has been completely or partially reloaded, pulling slightly back the cocking handle and releasing it, will release the mechanism forward pushing a cartridge ahead of it into the chamber. A hand operated bolt-carrier catch permits to hold the mechanism in the open position with a loaded magazine.

Loading the gun. — In opposition to other weapons of similar type, the F. N. Self-loading rifle does not require a special clip to load the magazine. The loading can be performed by single cartridges or by means of ordinary clips holding 5 rounds. Owing to the hand operated bolt-carrier catch, it is possible to reload a magazine partially unloaded.

Safety and cocking indicator. — In addition to a high efficient safety which locks the trigger mechanism and is easy to control in the dark, the rifle is provided with a cocking indicator, which extending below the trigger guard when the hammer is cocked, is easily felt. When the cocking indicator protrudes the shooter is aware that he has to set the gun at safe if he does not intend to use it immediately.

Ejection. — Occurs to the right and forward to prevent disturbing neighbouring shooters.

Grenade launching. — A plug fitting the head of the gas cylinder permits to cut inlet of gas from the barrel to the gas cylinder. In this case the mechanism does not work automatically and must be operated directly by hand. This device is specially provided for the launching of grenades.

Accessories. — On special request the rifle is supplied with :

- a bayonet
- a blank firing attachment
- a muzzle brake.



DESCRIPTION

The main components of the F. N. Self-loading Rifle are :

1. Receiver, Barrel and Gas cylinder Assembly.
2. Bolt and Bolt-Carrier Assembly.
3. Receiver Cover with Rear Sight.
4. Trigger Guard with Trigger Mechanism.
5. Stock and Forearm.
6. Magazine with Magazine Platform and Platform Spring.



1. RECEIVER - BARREL - GAS CYLINDER ASSEMBLY

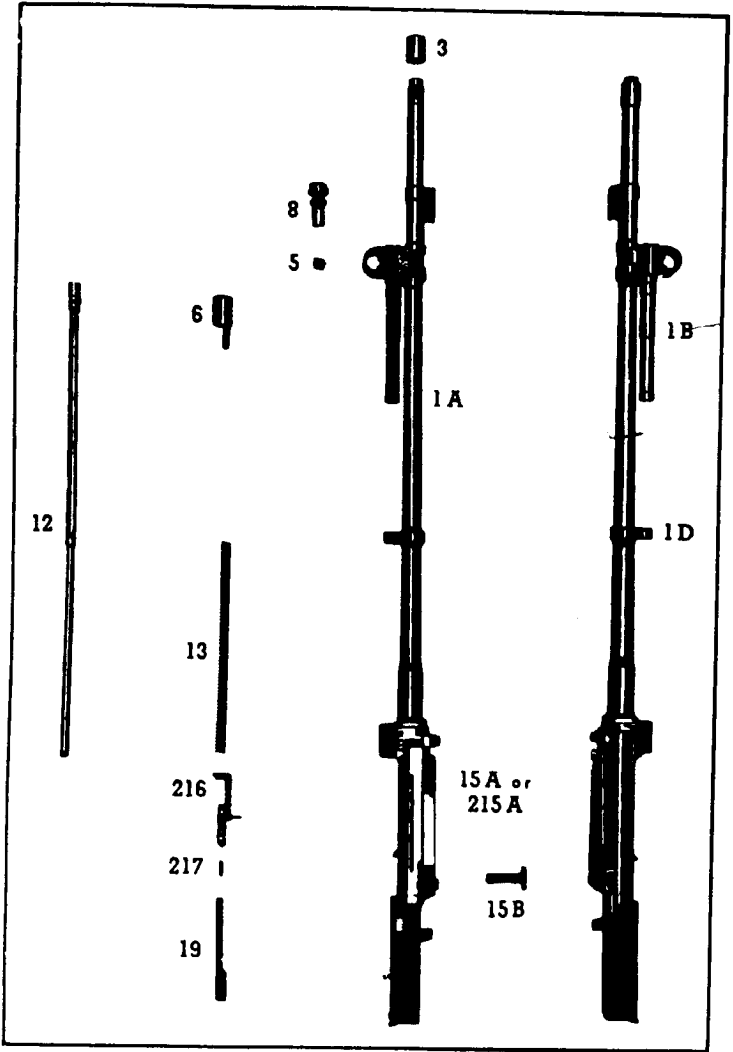

Fig. III



Components

- 1 Barrel Assembly.
- 1A Barrel.
- 1B Gas Cylinder.
- 1C Gas Cylinder Securing Pin.
- 1D Piston Guide.
- 1E Piston Guide Securing Pin.
- 3 Muzzle Cap.
- 5 Front Sight.
- 6 Gas Adjusting Sleeve.
- 8 Gas Cylinder Plug.
- 12 Piston.
- 13 Piston Return Spring.
- 15 Receiver
- 15A)
- or) Receiver Body.
- 215A)
- 15B Locking Shoulder.
- 216 Safety Sear.
- 217 Safety Sear Spring.
- 19 Cover Plate.

The front end of the **barrel** is threaded in order to take muzzle cap. The barrel is breeched to the receiver and is fitted with the gas cylinder, which is one piece with the front sight base, the front sight protecting wings and the bayonet stud. The barrel is also fitted with the piston guide, secured to the barrel by means of a pin.

The **gas cylinder** is pressed on to the barrel and is localized by means of a shoulder and secured by means of its securing pin.

The gas cylinder plug, with its plunger and plunger spring, fits the front end of the gas cylinder. The gas cylinder is also fitted with the gas adjusting sleeve. An aperture cut in the front of the receiver serves as a guide for the rear end of the piston. The front end of the receiver serves as a stop for rear end of the piston return spring. Further, the piston is controlled, in its middle part, by the piston guide.

The top of the **receiver**, which houses the mechanism, is completely cut open, while its underside has two openings; one for the hammer at the rear, and one forward for the cartridges.

• Components used for rifles allowing single shot and full automatic fire.



At the front of the receiver is the lead for the cartridges into the chamber. At the rear of the receiver are: the locking shoulder (which being pressed into the receiver, is a separate part so that the correct head space can be obtained) and the housings for the holding open device and for the ejector. On the side, the receiver is fitted with flanges in order to lead the bolt carrier.

If the rifle is designed to deliver single shot and full automatic fire, a safety sear and its spring, which forces the sear back after the hammer has been liberated, are attached to the receiver.

The upper part of the receiver is fitted to secure the receiver cover.

The underside of the receiver has three threaded holes for the screws assembling the receiver to the stock and to the trigger guard.



2. MECHANISM

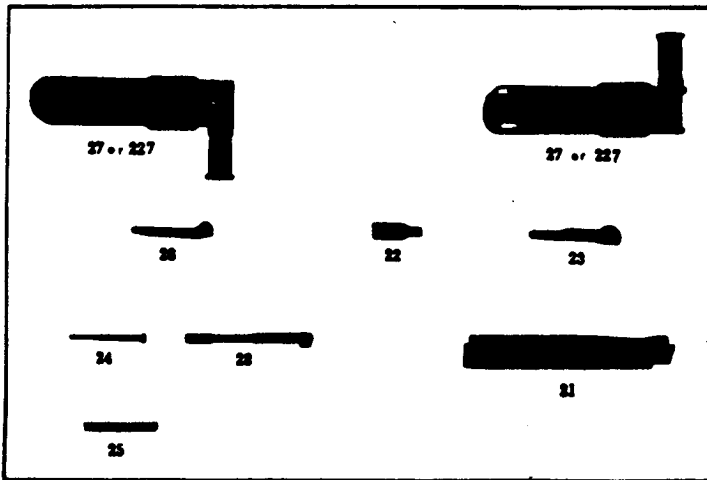

Plate IV.

Components

- 21 Bolt.
- 22 Extractor.
- 23 Extractor Spring.
- 24 Firing Pin - Front End.
- 25 Firing Pin Spring.
- 26 Firing Pin Safety Stop.
- 27 }
or } Bolt Carrier.
- 227 }
- 28 Firing Pin - Rear End.

The bolt houses the extractor and its spring, the firing pin and its spring and firing pin safety stop. It has one lug at the front and two lugs at the rear. These two lugs cammed by the

* Component used for rifles allowing single shot and full automatic fire.



slopes cut in the bolt carrier, perform the locking and the unlocking of the bolt.

The bolt is recessed on its upper side to take the front lug of the bolt carrier, this allows the bolt carrier to carry the bolt rearwards when recoiling.

At the rear the bolt has a flat surface which bears against the locking shoulder located in the receiver, in order to lock the mechanism.

The firing pin and its spring are kept in position by the extractor spring stud engaging in the slot cut in firing pin rear end.

The firing pin safety stop prevents the protrusion of the firing pin until the bolt is properly locked.

The bolt carrier, against which strikes the rear end of the piston rod, is fitted at its fore end with a lug which carries the bolt rearward as soon as the slopes have performed the unlocking.

Externally, the bolt carrier is fitted with two guiding ribs and with the operating handle. In the top of the bolt carrier is the return springs housing.

3. RECEIVER COVER AND SIGHT COMPONENTS

(Plate V)

Components

- 65 Receiver Cover.
- 66 Return Springs Guide and Cover Locking Key.
- 67A Inner Return Spring.
- 67C Inner Return Spring Guide.
- 67D Outer Return Spring.
- 70 Bolt Carrier Catch.
- 71 Bolt Carrier Catch Stop.
- 72 Bolt Carrier Catch Spring.
- 73 Sight Leaf.
- 74 Rear Sight Aperture.
- 75 Rear Sight Aperture Adjusting Screw.
- 76 Rear Sight Leaf Spring.
- 77 Rear Sight Slide.
- 78 Rear Sight Slide Lock.
- 79 Rear Sight Slide Lock Spring.



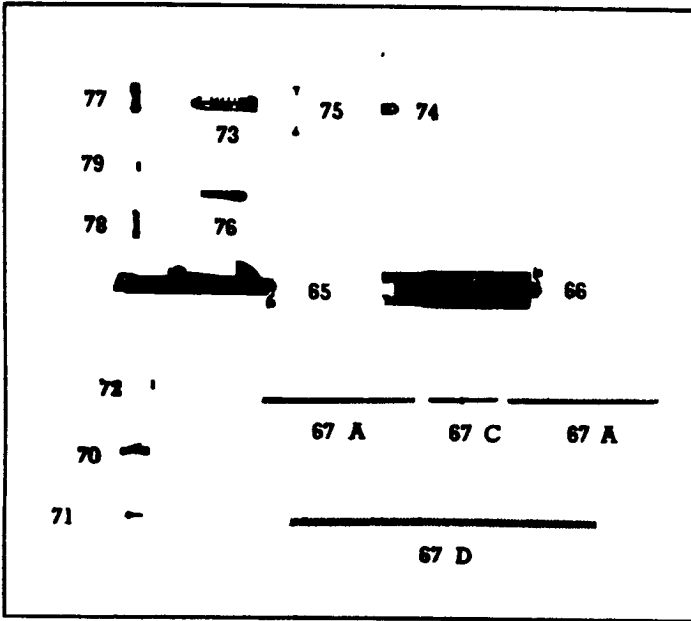

Plate V.

The **Receiver cover** houses the return springs and their guide, the receiver cover locking key and the bolt carrier catch. On the top of the cover is the rear sight base which supports the sight leaf, with the rear sight slide and the rear sight aperture. The fore end of the receiver cover is recessed to take the clip when the cartridges are introduced in the magazine.



4. TRIGGER GUARD AND TRIGGER MECHANISM

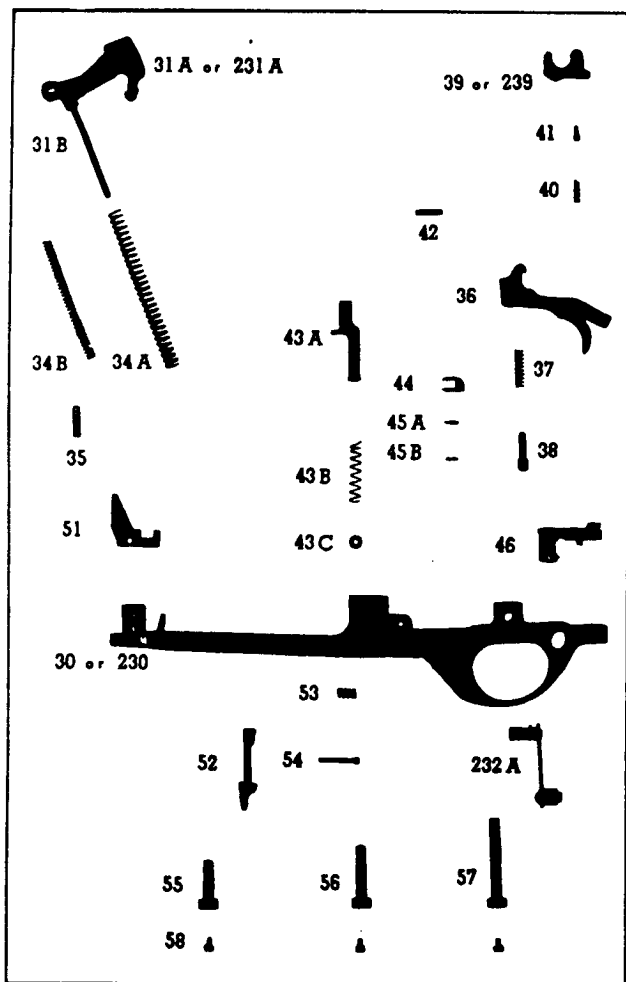

Plate VI.



Components

- 30 }
or } Trigger Guard.
- 230 }
31 } Hammer, complete.
- 31A }
or } Hammer body.
- 231A }
31B } Hammer Spring Guide.
- 31C } Hammer Spring Guide Axis Pin.
- 34 } Hammer Spring.
- 34A } Hammer outer Spring.
- 34B } Hammer inner Spring.
- 35 } Hammer Axis Pin.
- 36 } Trigger.
- 37 } Trigger Spring.
- 38 } Trigger Spring Plunger.
- 39 }
or } Auxiliary Sear.
- 239 }
40 } Auxiliary Sear Spring.
- 41 } Auxiliary Sear Spring Plunger.
- 42 } Trigger Axis Pin.
- 43 } Bolt Stop, complete (Holding Open Device).
- 43A } Bolt Stop Body.
- 43B } Bolt Stop Spring.
- 43C } Bolt Stop Washer.
- 44 } Bolt Stop Retainer.
- 45A } Bolt Stop Retainer Plunger.
- 45B } Bolt Stop Retainer Plunger Spring.
- 46 } Safety, complete.
- 51 } Ejector.
- 52 } Magazine Catch.
- 53 } Magazine Catch Spring.
- 54 } Magazine Catch Axis Pin.
- 55 } Trigger Guard Front Screw.
- 56 } Trigger Guard Center Screw.
- 57 } Trigger-Guard Rear Screw.
- 58 } Trigger Guard Screw Stop Screw.
- 232A } Automatic Fire Lever Body.
- 232B } Automatic Fire Lever Arm.
- 232C } Automatic Fire Lever Arm Plunger.

* Components used for rifles allowing single shot and full automatic fire.



- * 232D Automatic Fire Lever Arm Stop.
- * 232E Automatic Fire Lever Stud.
- * 232F Automatic Fire Lever Locking Screw.

The **Trigger guard** is fixed to the receiver by means of three screws and stop screws.

The trigger guard holds the hammer and its springs, the hammer spring guide (which also acts as a cocking indicator), the trigger, the trigger spring and the trigger spring plunger. The trigger guard also holds the auxiliary sear, its spring and its spring plunger and the safety. In the case of rifles designed to fire automatically the trigger guard also holds the automatic fire lever.

In the front of the trigger guard is the magazine housing. In its middle part the trigger guard holds the magazine catch, its spring, the bolt stop and its spring and the ejector.

5. STOCK - HANDGUARD

(Plate VII)

Components

85A		Stock.
or		
* 285A		
85B		Trigger Guard Rear Screw Bushing.
85E		Recoil Lug.
85F		Recoil Lug Nut.
86A		Handguard Body (2 parts).
86B		Handguard Front Cap.
86C		Handguard Front Cap Rivet.
86D		Handguard Rear Cap.
86E		Handguard Rear Cap Rivet.
87		Stock End Cap.
88		Stock End Cap Screw.
89		Lower Band assembly.
89A		Lower Band Body.
89B		Lower Band Screw.
89C		Lower Band Screw Retaining Collar.
90		Swivel, complete.
STA.18		Swivel Plate and Butt Plate Screw.
STA.19		Swivel Plate Pin.

* Components used for rifles allowing single shot and full automatic fire.



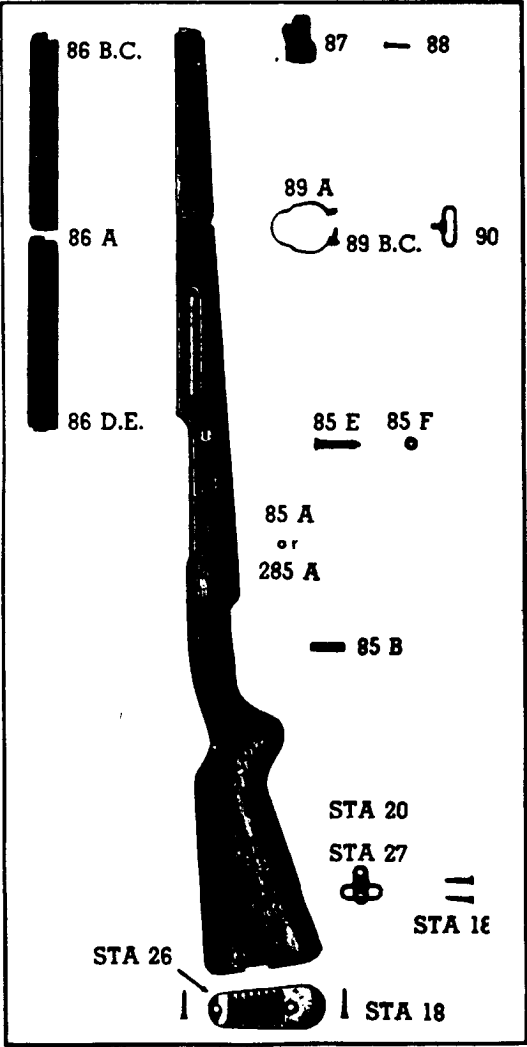

Plate VII.



- STA.20 Swivel Plate.
 STA.27 Swivel.
 ** STA.26 Butt Plate, Standard Type.

** For steel butt plate with trap and brass butt plate with trap see Plates VIII and IX.

STEEL BUTT PLATE WITH TRAP

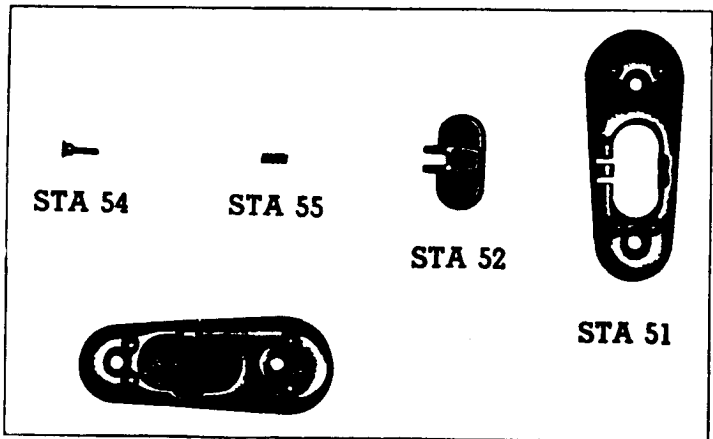

Plate VIII

Components

- STA.51 Butt Plate with Trap.
 STA.52 Butt Plate Trap.
 STA.54 Butt Plate Trap Plunger.
 STA.55 Butt Plate Trap Spring.



BRASS BUTT PLATE WITH TRAP

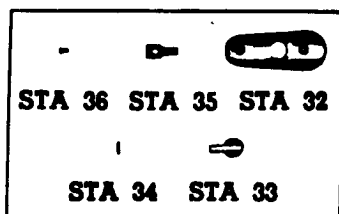

Plate IX.

Components

- STA.32 Butt Plate.
- STA.33 Butt Plate Trap.
- STA.34 Butt Plate Trap Pivot.
- STA.35 Butt Plate Trap Spring.
- STA.36 Butt Plate Trap Spring Screw.

The **stock**, in one piece, is made of walnut and consists of the fore-end and the butt.

The fore-end is fitted at the front to hold the cap, and recessed further back for the lower band. Underneath, the butt is fitted with the butt plate, which is secured by means of two screws.

The stock is grooved to take the barrel, the receiver, the trigger guard, the magazine and the recoil lug. The housing of the rear screw of the trigger guard holds a bushing.

The top of the barrel is covered with a handguard fitted with a front cap and a rear cap. The rear cap is seated in a recess provided in the front end of the receiver. The handguard, in two pieces, is secured at its front end by the front end cap, in the middle by the lower band and at the rear by the receiver.

For rifles used by snipers the stock can be fitted with a cheek piece which is secured to the stock by means of screws.



6. MAGAZINE WITH MAGAZINE FOLLOWER AND FOLLOWER SPRING

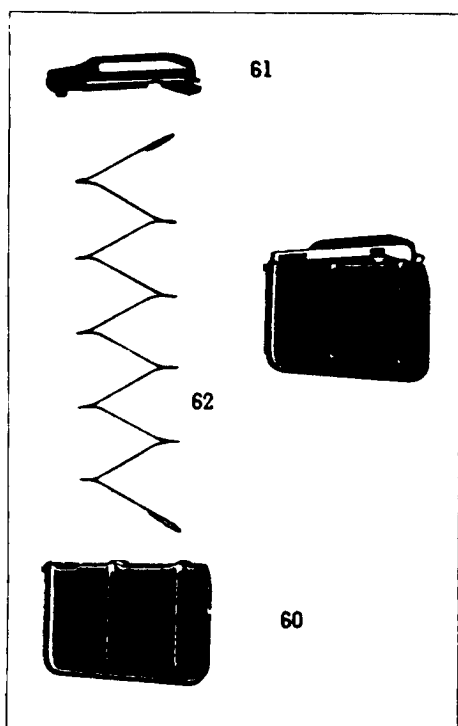

Plate X.

Components

- 60 Magazine Assembly.
- 61 Magazine Follower.
- 62 Magazine Follower Spring.

The **Magazine** holds 10 cartridges and can be removed from the rifle. In front it is held in position in the trigger guard by means of a hook, and at the rear by the magazine catch.

The follower spring raises the cartridges, through the magazine follower.



7. ACCESSORIES SUPPLIED ON SPECIAL REQUEST

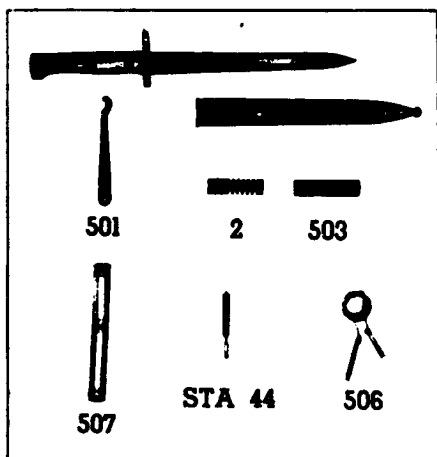

Plate XI.

List of Accessories

- Bayonet.
- Scabbard.
- 2 Muzzle Brake.
- 503 Blank Firing Attachment.
- 506 Barrel Cleaner.
- STA. 44 Barrel Cleaning Brush.
- STA. 45 Chamber Cleaning Brush.
- 507 Cleaner Case.
- 93 Sling.

N. B. — The key 501 is supplied with each rifle, it is used for adjustment of the gas.



HOW THE F. N. SELF-LOADING RIFLE WORKS

The gun being ready for firing the action on the trigger releases the hammer. Under the tension of its springs, the hammer strikes the firing pin, which in turn strikes the primer of the cartridge and ignites the powder charge.

1st. phase. — **The bolt opens under the action of the gas.**

A small amount of gas escapes through a port bored in the barrel and passes in the gas cylinder where it kicks the piston back. The piston drives the bolt carrier back. The bolt carrier unlocks the bolt and pulls it upwards to the rear. The extractor, which fits to the bolt, draws the empty shell out of the chamber. When the empty case is completely disengaged from the chamber its bottom strikes the ejector which ejects it to the right out of the gun. In its backward motion the bolt carrier cocks the hammer and compresses the recoil springs.

2d. phase — **The bolt is closed under the tension of recoil springs.**

As for any weapon firing with closed bolt, as soon as the bolt carrier has completed its backward motion, the recoil springs drive it forward. The bolt carrier itself forces the bolt forward. The bolt drives a cartridge ahead out of the magazine and pushes it into the chamber. The bolt is then locked downwards in the receiver by the action of the bolt carrier.

DETAILS OF OPERATION

1. THE ENGINE

In addition to the barrel (1A), the components of the engine are: the gas cylinder (1B), the piston (12) and its spring (13), the gas cylinder plug (8) and the gas adjusting sleeve (6).

Single shot and full automatic fire

In the F. N. Self-Loading Rifle, the utilization of gas presents several outstanding features:



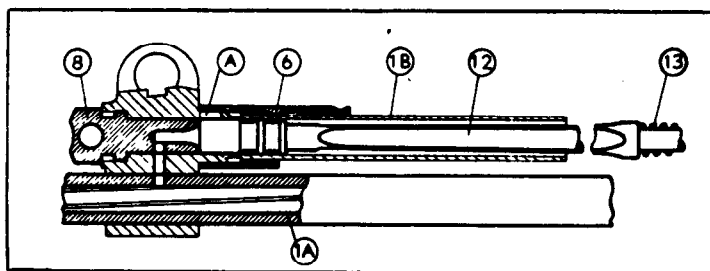

Fig. 1.

a) **Short gas cylinder.** — The gas cylinder (1B) is a very short tubular element, easily cleaned, after the gas cylinder plug and the piston have been removed. As experience has shown that the gas acted on the piston in the way of a hammer blow, without any expanding, the long cylinders which were generally used in gas operated rifles, have consequently become useless.

b) **Gas escape.** — After they have acted in the way of a blow on the piston, the gas escape outside through a slot (A) located on top of the front end of the gas cylinder.

The handicap of the gas operated weapons being the fouling, the advantage of this gas escape system is the permanent sweeping outwards of the combustion residues.

c) **Gas regulation.** — The size of the slot for the escape of gas and its location are such, that when it is completely open the pressure exerted by the gas on the piston is insufficient to operate the mechanism. That is the point where the regulator intervenes. The regulator is built from a simple threaded sleeve (6), screwed around the gas cylinder. When the sleeve is screwed in, the opening for gas escape decreases and consequently the thrust of the gas on the piston is growing, a good functioning of the rifle, without undue fatigue for the mechanism, is thus ensured. The gas regulation is carried out by the manufacturer, when the rifle is assembled. It may not be changed by the soldier. The regulator has therefore been intentionally located under the handguard. On the other hand, it is a very easy task for the armorer to refix the gas regulation if, eventually, another regulation has to be adopted, either in order to use a lot of special ammunition, or to use the rifle in a country in which the atmospheric conditions are completely different.



d) **Independence of the piston.** — The piston (12) and the bolt carrier (27) are located in a straight line, without any connection. The return of the piston is performed instantly under the action of its own spring (13) without the interference of the return springs. It is owing to this original feature that it is possible to load the gun the same way as a repeating rifle.

Repeating fire

Turning 180° the gas cylinder plug (8A), cuts the inlet of the gas. The piston does not transmit any thrust on the bolt carrier. The rifle can then be used like a repeater by pulling the bolt carrier by hand.

2. HOW THE OPENING AND THE CLOSING OF THE MECHANISM IS OPERATED

The components acting in this phase are : the receiver (15A) or (215A) the bolt (21), the bolt carrier (27) or (227), the return spring (67A - 2 pieces - and D), the cover (65).

The bolt carrier (27) or (227) moves along the receiver (15A) or (215A). It is pushed rearwards by the piston (12) and is forced forwards by the 2-piece return spring (67A). The bolt is in one piece and its positive locking is performed when its flat surface at the rear is in line with the locking shoulder made in treated steel and pressed in the receiver at the rear of the magazine. The respective motions of the bolt and of the bolt carrier are controlled as follows :

When the cartridge is fired (position 1), the bolt is in its locking position A and is located in this position by the contact of surface B of the bolt carrier.

The opening operation may be schemed in three phases :



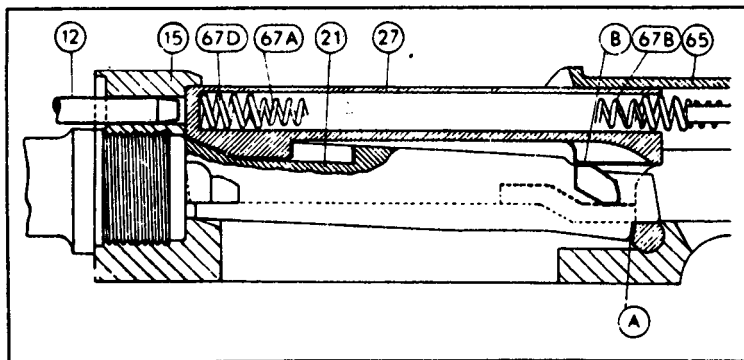

Fig. 2.

First Phase (position 1 to position 2): Break of contact of the surface at B. The bolt is still locked (A) while the pressure in barrel is dropping.

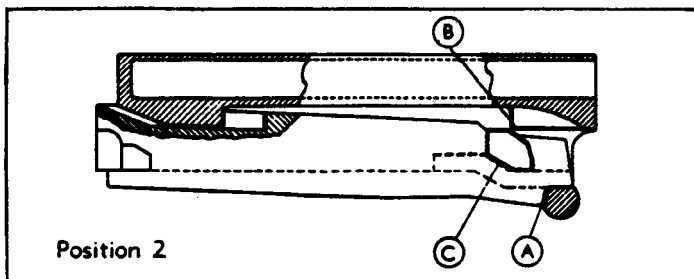

Fig. 3.

Second Phase (position 2 to position 3): Unlocking of the mechanism. The contact between surfaces C forces the bolt up.



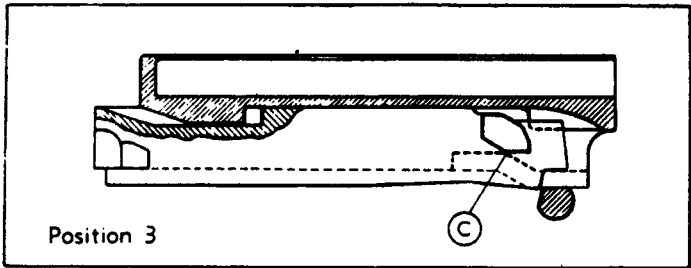

Fig. 4.

Third Phase (position 3 to position 4): Direct opening. The bolt and the bolt carrier are travelling together rearwards owing to the contact of surfaces F.

When the parts are stopped at the rear, they are in position 4, the double return spring is compressed.

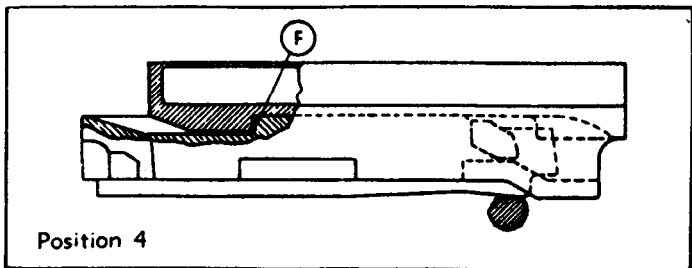

Fig. 5.

The closing of the mechanism may be schemed as below in 3 phases :

Fourth phase (position 4 to position 5): Closing of the mechanism. The bolt carrier pushes the bolt forwards owing to the contact of surfaces G till the bolt is stopped by rear end of the barrel.



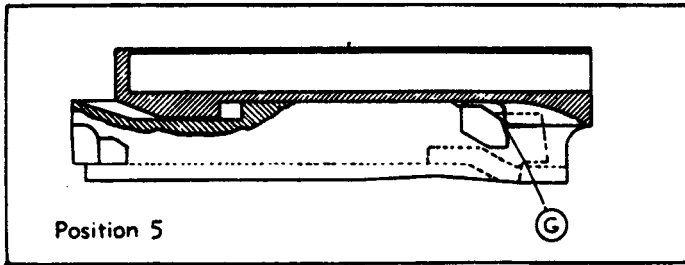

Fig. 6.

Fifth Phase (position 5 to position 6): Locking of the mechanism. At this moment the slope H forces the rear part of the bolt downwards, in the locking position.

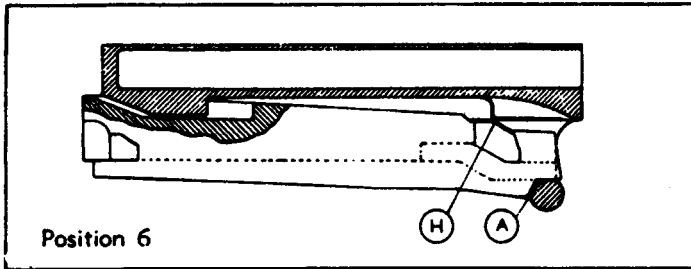

Fig. 7.

Sixth Phase (position 6 to position 1). Confirmation of the locking. The bolt carrier continues its movement forward and the bolt is maintained in the locking position by the surfaces B.

Functioning by hand

The repeating cycle is identical with the automatic cycle. Instead to receive the thrust of the piston, the bolt carrier is operated by hand.



3. FEEDING — EXTRACTION — EJECTION

The additional parts acting in this phase are: the extractor (22) and the ejector (51).

a) **Extraction of the case.** — The extractor which is fitted on the right side of the bolt performs this operation by direct extraction for the withdrawal of the case (see above: 3d phase - position 3 to position 4).

b) **Ejection.** — The ejector is of the fixed type and is fitted in the trigger guard at the rear of the magazine. It protrudes in a groove cut at the left and in the underside of the bolt. At the end of the rearward motion (3d phase), the case strikes against the ejector and being compelled to pivot around the extractor is ejected rightwards.

There exist other types of ejectors but the type chosen for the F. N. rifle has the great advantage to help the shooter to know how his rifle is working, as the ejection occurs nearly at the end of the travel of the bolt to the rear at the moment when it is at the point to be stopped against the rear wall of the receiver.

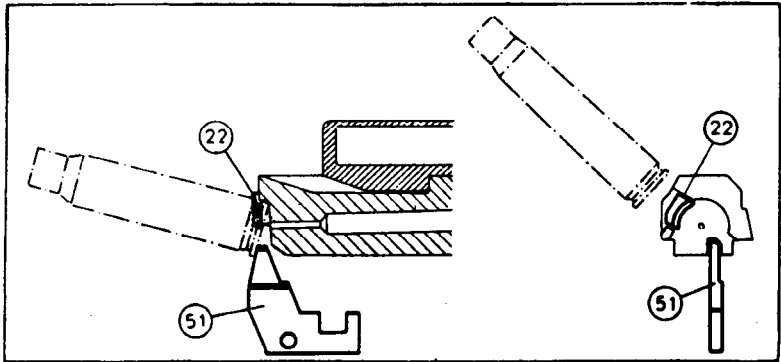

Fig. 8.

A violent ejection shows that the recoil motion develops at a too great velocity and with a needless violence to perform the functioning, with the consequence that the wear and tear of the mechanism is amplified. Thanks to the regulator, it is then



very easy to ensure, with a thorough knowledge of the whereabouts of a perfect functioning of the rifle.

With ejectors which are fitted elastically on the receiver this cannot be reached.

c) **Introduction of a cartridge.** — The bolt has two ribs on its lower side, these ribs, when the bolt is closing (see above 4th phase, — position 4 to position 5) push alternatively the left or the right side cartridge directly into the chamber.

As soon as the cartridge leaves the lips of the magazine, it is caught by the extractor and moves with the bolt. This characteristic, taken from the best repeaters, presents several advantages :

1. The double feeding is impossible ;
2. The extractor is spared, because it has not to go over the rim of the cartridge as it is the case when the cartridge is first introduced into the chamber.
3. The closing is smoother. It ought to be mentioned that the closing is only due to the energy stored during the recoil in the springs and not to a positive mechanical action.

4. HOW THE FIRING ACTION WORKS

For rifles firing only single shot, the firing action is fitted in the trigger guard (30) and consists of :

- The hammer (31A) with its springs (34A-B) and its guide (31B) which serves also as a cocking indicator.
- The trigger (36) which serves as the principal sear.
- The rear hook acting as the auxiliary sear (39).
- The safety (46).

The firing of the cartridge occurs by means of a firing pin (in two parts) (24-28) housed in the bolt.

The characteristics of the mechanism are as follows :



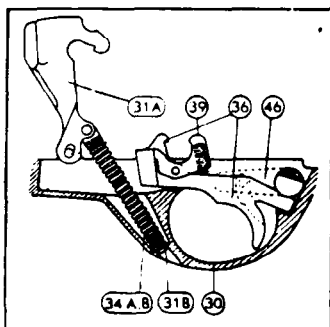

Fig. 9.

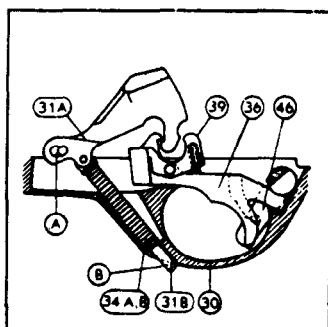

Fig. 10.

Action of rifle firing only single shot fire.

a) **Separation of the shots in single shot fire.** — The device which allows to fire exclusively shot by shot, has been taken over from an outstanding weapon (The Browning automatic shotgun). Since more than 50 years it ensures a perfect functioning to this popular gun.

The hammer (31A) is forced backwards by the recoil of the bolt and bolt carrier and it is in any case caught by the double hook, which is made up by the front end of the trigger acting as the main sear (36) and by the linked hook acting as the auxiliary sear (39).

Indeed if, per chance, owing to the effect of the recoil the finger of the shooter has left the trigger at the moment the hammer is sent backwards, the hammer is directly caught by the main sear (36). If on the contrary, which is generally the case, the trigger is still depressed by the finger, the hammer is caught by the auxiliary sear (39) which has been put on its way by the motion of the trigger. The hammer is caught in this position as long as the trigger is depressed. In order to fire the next shot one has first to release the trigger. — The hammer is then released by the auxiliary sear (39) but is at once and unavoidably caught by the main sear (36). To fire again one has to depress the trigger once more.



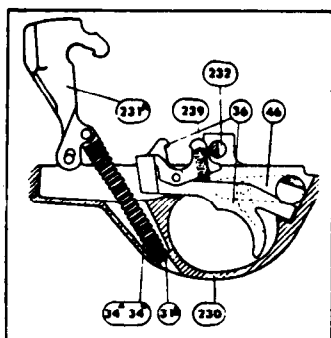

Fig. 11

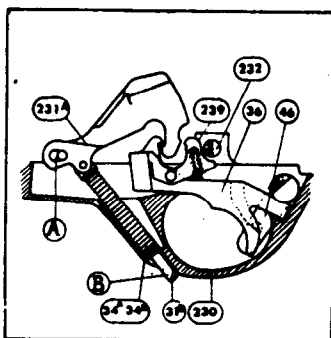

Fig. 12.

Action of rifle firing single shot and full automatic fire

For rifles able to shoot either single shot or full automatic fire, the following parts are designed as to deliver this kind of firing, their item number are then as follows:

- Auxiliary sear (39) superseded by auxiliary sear (239);
- Hammer (31 A) superseded by hammer (231 A);
- Receiver body (15A) superseded by receiver body (215A);
- Bolt carrier (27) superseded by bolt carrier (227);
- Trigger guard (30) superseded by trigger guard (230);
- Stock (85A) superseded by stock (285A).

Further on the following parts are used:

- Safety sear (216A);
- Safety sear spring (217);
- Automatic fire lever (232).

See these components on fig. 11 and 12 as well as the sectional view of weapon at the end of this pamphlet.

It ought furthermore to be noticed that:

1° The weapon being on safety, with the trigger locked, the cocking of the rifle by hand is possible owing to the oval slot (A) of the hammer, which is consequently able to move longitudinally.

2° If the finger depresses the trigger at the moment the hammer returns backwards any shock to the finger is prevented owing to the elasticity of the linkage of the auxiliary sear.

b) **Double pull.** — This is the result of the action of the auxiliary sear spring which resting against the trigger cooperates with the trigger spring and gives the shooter the feeling of a « double pull » motion.



c) **Cocking indicator.** — As the hammer is completely concealed in the weapon, it is desirable that there should be a way to make sure externally, if the rifle is ready or not for action. To this end, the guide (31B) of the hammer spring protrudes beneath the trigger guard when the hammer is cocked. It is thus easy, even in the dark, to make sure by mere feeling if the hammer is cocked or not.

d) **Safety.** — The safety (46) is located on the side of the trigger guard, it is consequently very easily accessible and is easily actuated without removing the hand from the butt.

As the angle between the positions « Fire » and « Safety » is important, the safety is easily felt in the dark and even visible from a certain distance.

The arm of the safety is fitted, inwardly, with a spring plunger which fixes it in the selected position. In the « safety » position, the safety works like a skid against the trigger in such a way that the more the action on the trigger is sharp, the more the safety is confirmed.

Full automatic fire.

In a rifle equipped for full automatic fire, the working of the action is different from that of the single shot fire in the following points :

As the automatic fire-lever (232) is located in the position « A »; the cylindrical part of the lever body is in contact with the tang of the auxiliary sear (239) and prevents the sear to pivot forward when the trigger is depressed. The engagement of the hammer (231A) by the auxiliary sear is consequently impossible when the trigger is depressed. In other words, the auxiliary sear (239) is switched out and does not interfere any more in the action.

On the other hand, as long as the trigger is depressed, the main sear being no more in the way of the hammer (231); this is not caught after each shot. The main sear is however superseded by the safety sear (216) whose rear end penetrates a groove in the hammer and keeps it at the rear until the bolt-carrier comes back to its forward position. The safety sear is then pushed forwards by the bolt-carrier and its spring (217) compressed. The hammer is then free to be flung forward under the action of its springs (34-A-B).

When the trigger is released, the main sear, which is one piece with the trigger, is again in the way of the hammer and catches the hammer rearwards, stopping consequently the firing.

5. LOADING

The reloading of the rifle as it is designed with its piston on top of the barrel, is possible owing to :

1° The independence of the piston and of the bolt carrier, which enables the piston to move back to its location under the



action of its own spring as soon as it has thrown the bolt carrier rearwards.

2° The action of the holding open device which holds the bolt and bolt carrier to the rear.

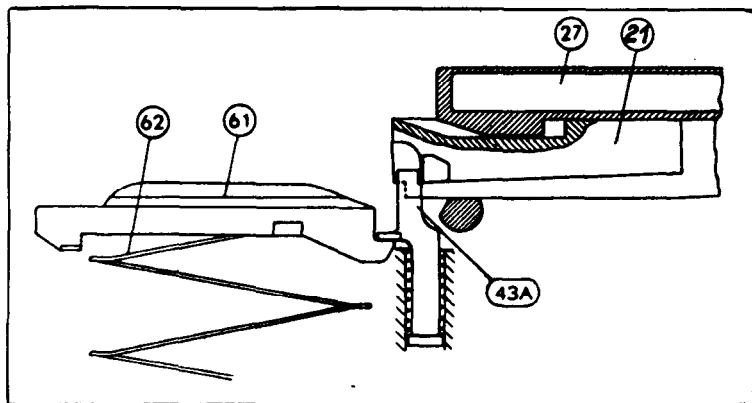

Fig. 13.

This device (43A) consists of a plunger located vertically at the rear of the magazine and in front of the bolt when the bolt is in its full rearward position. The spring of this plunger, keeps the plunger downward, in its housing in the trigger guard, and consequently out of the functioning of the weapon as long as there are cartridges in the magazine. When the last cartridge has been fired and the bolt has travelled to the rear, the magazine platform rear end engages the front end of the bolt stop, lifting the stop in front of the bolt and preventing it to return in the closing position. The shooter is consequently warned that the magazine of his rifle is empty.

As the piston has returned to its forward position and as the bolt is held to the rear, the magazine is open to be refilled. It is only necessary to insert two clips, with 5 rounds each, one after each other in the grooves out in the receiver and to press, with the thumb of the right hand, on the upper cartridge of each clip in order to introduce the 2 bundles of 5 cartridges into the magazine.

After the cartridges have been introduced into the magazine,



closing the rifle only requires a short pull on the operating handle, so introducing a cartridge into the chamber. Pulling of the operating handle compels indeed the bolt to withdraw releasing the holding open device which withdraws in its housing under the action of its spring.

Partial refilling of the magazine

If it is desired to refill the magazine before it is empty in order to give the rifle its full potentiality of fire, the bolt carrier stop is to be used.

This stop is fitted on the left side of the cover and is perfectly accessible to the thumb of the right hand after pulling operating handle, and consequently the bolt, to the rear.

The retracting of this stop is the same as that of the automatic holding open device.

6. SAFEGUARDS

The functioning of the hand safety, which locks the trigger, has been described before.

Further, as detailed below, the rifle may be carried with 10 cartridges in the magazine, without cartridge in the chamber. In order to be ready for firing, only pull operating handle fully rearwards and release it.

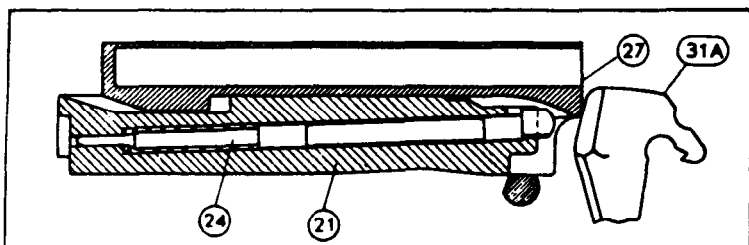

Fig. 14.

There are two internal safeguards which make the firing impossible so long as the rifle is not duly locked.

1° The first of these safeguards is performed without the addition of any part, it results only from the relative motions of the bolt



and of the bolt carrier. In fact, the hammer can only reach the firing pin when the bolt is locked and positively confirmed in this position by the complementary motion of the bolt-carrier.

2° The second safeguard is performed by means of a firing pin stop (26) which prevents the striker to protrude in the face of the bolt so long as the locking of the rifle is not performed, as the bolt carrier prevents any motion of the firing pin stop upwards (see fig. 15). On the contrary, when the rifle is locked, the firing pin stop is allowed to raise and does no more prevent the motions of the firing pin (see fig. 16).

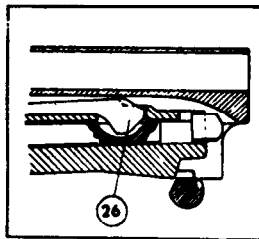

Fig. 15.

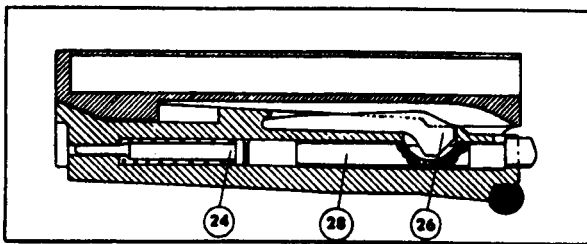

Fig. 16.



HOW TO HANDLE THE RIFLE

TO MAKE THE GUN SAFE

With thumb of right hand, rotate safety lever downwards. In this position of safety lever, trigger is positively locked. Moreover safety lever prevents the finger of the shooter to reach the trigger. It is so very easy, even in the dark, to make sure that the gun is safe.

To release safety, reverse the movement of safety lever upwards, with index finger of right hand.

TO OPEN AND TO CLOSE THE BOLT

To open the bolt, grasp with right hand operating handle and draw it fully back. If there are no cartridges in magazine, bolt will be held in the open position by bolt catch which, under the action of magazine platform, protrudes before the bolt.

To close the bolt, push down magazine platform with thumb of left hand, at the same time draw bolt carrier slightly back with right hand. Under the tension of its spring, bolt catch is forced down and does no more protrude in the path of bolt. Release gently mechanism forward, withdraw left thumb when bolt is above magazine platform.

LOADING THE RIFLE

With right hand, grasp operating handle and pull mechanism to the rear. The mechanism will be held open by the bolt catch.

Loading the gun may be carried out either by inserting single cartridges into magazine, or by means of 5 rounds clips. When the loading is completed, draw slightly back slide handle and let it go, mechanism will close forward under the tension of recoil springs, pushing a cartridge into the chamber.

The magazine holds 10 cartridges but it is not necessary to fill it, the mechanism will close in the same way whatever the number of cartridges in magazine may be.

It is possible to close the mechanism without introducing a cartridge into the chamber with the magazine loaded with 10 rounds: with right hand, grasp operating handle and pull it slightly back, with thumb of left hand push down cartridges of magazine and release gently the mechanism, retaining it with right hand. The mechanism will so close above the top of the cartridges in the magazine and there will be no round in the chamber. This is an original way to transport safely the loaded



gun. To make the weapon ready for firing, one has just to cock the mechanism to introduce a cartridge into the chamber.

If the weapon is partially unloaded, it is possible to complete the loading of the magazine: grasp operating handle with right hand, pull mechanism fully rearwards. With thumb or right hand depress bolt carrier catch and release operating handle, the bolt carrier will be held in the rear position by bolt carrier catch.

Complete the loading of magazine, pull slightly back operating handle, bolt carrier catch will release the bolt carrier. Release operating handle, mechanism will close pushing a round into the chamber.

The possibility to load the gun either with single rounds or standard clips, and the possibility to complete the loading of magazine are original features of the F. N. self loading rifle, in comparison to similar weapons.

Unloading the gun may be carried out in two ways:

The first method is to cock the gun, without firing, with the safety on, as many times as there are cartridges in the magazine. When the magazine is unloaded, the mechanism will be held in the rear position by bolt catch. In order to close the mechanism, with left hand, push down magazine platform, while right hand pulls operating handle slightly backwards, release gently mechanism.

The second method is as follows: release magazine by pressing with nose of cartridge on magazine catch, while other hand gathers magazine and cartridges, cock the gun in order to eject cartridge inserted in chamber. Replace magazine.

All operations necessary for loading or unloading may be performed with gun on safety. The safety does not prevent the motion of mechanism either forwards or rearwards.

FIRING THE RIFLE

To fire, put safety off, sight the rifle and depress the trigger.

With a rifle fitted for the full automatic shooting; to shoot:

Single shot fire. — Put fire lever in position « S. A. », put safety in the « off » position. Sight the rifle and depress the trigger. Each time the trigger is depressed a shot will be fired.

Full automatic fire. — With the fire lever put in position « A. », put safety « off » by turning safety lever. Sight the rifle and depress the trigger. The firing will be automatically performed as long as the trigger is depressed and as long there are cartridges in the magazine. The firing stops as soon as the trigger is released.



STRIPPING AND ASSEMBLING

I. FIELD STRIPPING AND ASSEMBLING

STRIPPING THE MECHANISM

Turn receiver cover locking key 180° upwards, grasp receiver cover and slide it forward against action of recoil springs, raise slightly rear end of receiver cover in order to disengage cover from guides in receiver. Release cover rearward. Cover and recoil springs will so be removed from receiver. Grasp operating handle and pull back bolt carrier and bolt assembly until guides of bolt carrier are in line with clearance cut in guides of receiver. Lift front-end of bolt carrier and bolt assembly and remove bolt carrier and bolt assembly from receiver. Remove bolt from bolt carrier.

STRIPPING THE BOLT

First remove firing pin stop. Using nose of cartridge, lift extractor spring out of spring housing cut in bolt and rotate extractor spring 90°. Remove extractor. Grasp bolt at both ends between thumb and index finger. Push firing pin in bolt. Remove extractor spring, firing pin and firing pin spring. Take firing pin spring off firing pin.

REMOVING THE PISTON

Using nose of cartridge depress gas cylinder plug catch and rotate plug 90°. Remove gas cylinder plug. Tilt rifle forward, piston and piston spring will slide out of gas cylinder. Remove piston spring from piston.

STRIPPING THE MAGAZINE

Using nose of cartridge, lift magazine catch and remove magazine from trigger guard. Remove magazine platform and platform spring. Disengage magazine spring from magazine platform.

The weapon is so disassembled for complete cleaning.

ASSEMBLING THE BOLT

Replace firing pin spring on firing pin. Replace firing pin and firing pin spring in bolt. Depress firing pin in bolt and replace



extractor spring head in bolt (extractor spring being at an angle of 90° with the bolt). Release firing pin which, under the tension of firing pin spring will hold extractor spring. Replace extractor in its seat. Rotate extractor spring 90° in order to insert it in extractor seat. Replace firing pin stop.

ASSEMBLING THE MECHANISM

Replace bolt in bolt carrier. Seize bolt and bolt carrier assembly at both ends between thumb and index and replace bolt and bolt carrier assembly in receiver to enable guides of bolt to pass through clearance cut in guides of receiver. When bolt and bolt carrier assembly is home push it forwards. Grasp receiver cover, turn upwards cover locking key, insert recoil springs in hole of bolt-carrier. Compress recoil springs pushing cover forward.

Replace cover downwards in receiver, front end first, and release cover as to allow it to drop backwards fully home in its guides. Turn cover locking key downwards. Test motions of mechanism a few times by hand in order to make sure assembly is correct.

ASSEMBLING THE PISTON

Replace piston spring on piston, replace piston and piston spring in gas cylinder (head of piston turned to the muzzle). Replace gas cylinder plug, depressing plug catch, and turn plug in such a way that letter A is turned outside. Release gas cylinder plug catch.

ASSEMBLING THE MAGAZINE

Insert magazine platform spring in magazine platform. Replace magazine platform and spring in magazine, take care to replace them in correct position. Seize magazine and introduce magazine in trigger guard, engaging first front stud of magazine in recess in trigger guard. Press on magazine bottom until magazine is caught by magazine catch.

II. COMPLETE STRIPPING AND ASSEMBLY

The rifle ought first to be stripped as described for the field stripping.



COMPLETE STRIPPING OF THE RECEIVER COVER

Remove the return springs by disengaging, with the help of a screw-driver, the first coil of the inner spring from the end of its rod. Separate the outer spring from the inner springs and the inner springs from their guide.

To strip the backsight: depress tail of sight leave in order to compress the sight spring and to disengage the leave studs from the shoulders. Draw back the sight leave and remove it from the cover. Remove the leaf spring from its housing, using the hole cut in the spring. Grasp rear of leaf in right hand, with the left hand grasp the sight slide and slide lock, depress slide lock, and remove slide and slide lock from the leaf. Remove slide lock and its spring from the sight slide.

Unscrew the two lateral adjusting screws and remove rear sight aperture.

In order to strip the bolt carrier catch: with the help of the point of a bullet depress the bolt carrier catch spring, this will allow to turn the bolt carrier catch body outwards. Remove the spring, remove the catch by raising it, remove bolt carrier catch stop.

STRIPPING OF THE HANDGUARD

Unscrew front end cap screw. Remove front end cap from the front. Remove front part of handguard swinging its front end upwards.

Unscrew lower band screw which will free swivel; lower band is so able to open. Remove lower band from the front.

Remove rear part of handguard, swinging its front end upwards.

STRIPPING THE GAS REGULATOR SLEEVE

With the handguard removed, it is only necessary to unscrew gas regulator sleeve using, if necessary, gas regulator key. Remove gas regulator sleeve.

STRIPPING THE BARREL-RECEIVER ASSEMBLY

Unscrew trigger guard stop screws, unscrew and remove trigger guard screws, the barrel-receiver assembly may thus be removed from the stock.



To remove cover plate, raise its front end in order to disengage it from its groove and swing the cover 90°.

In the case of rifles fitted for the full automatic firing, with the barrel-receiver assembly removed from the stock it is possible to remove the safety sear from the receiver. Depress safety sear forwards and at the same time disengage safety sear from its housing by raising it. The safety sear and its spring are thus free.

STRIPPING OF THE TRIGGER-GUARD

With the trigger guard screws and their stop screws removed, it is possible to remove the trigger guard assembly from the stock.

In order to remove the bolt stop, depress the bolt stop retainer plunger, remove bolt stop retainer, bolt stop retainer plunger and its spring. Remove bolt stop.

In order to dismount the ejector and the magazine catch and its spring, remove, from left to right the magazine catch axis pin.

In order to dismount the action, let the hammer gently down, if it is cocked, remove trigger axis pin, remove auxiliary sear, its spring and its plunger, remove the trigger, its spring and its plunger.

In the case of rifle fitted for the full automatic firing, remove the automatic fire lever, to this end, swing it backwards vertically with the trigger guard, remove automatic fire lever from the trigger guard.

In order to remove the safety — after the action has been stripped — swing the safety lever in the intermediate position between the safety position and the fire position, remove then safety from the trigger guard.

STRIPPING THE STOCK

To remove the various components : take out their screws.

ASSEMBLING THE STOCK

Replace the components of stock and fix them by means of their screws.

ASSEMBLING THE TRIGGER-GUARD

To replace the safety : replace safety axis in the trigger-guard, introducing it from the right and locating the safety lever in the



intermediate position between « Safe » and « Off ». Depress safety spring plunger, press safety fully home.

To assemble the action ; replace trigger spring and plunger in their housing, replace the trigger in the trigger guard from the top, taking care that the stud fitted on the safety lever is engaged in the groove cut in the trigger, replace auxiliary sear spring and plunger in their housing in the auxiliary sear, replace auxiliary sear assembly into the trigger guard, the hooks of trigger and of auxiliary sear facing each other and axis holes being in line, replace trigger axis pin.

In the rifles fitted for the full automatic fire, replace the automatic fire lever in the trigger guard, swing it in position « S. A. ».

To replace the ejector and the magazine catch : replace in its housing the magazine catch spring, replace in trigger guard magazine catch and ejector putting their pin holes in line. Replace magazine catch axis pin from right to left.

To replace the bolt stop, replace bolt stop in its housing in the trigger guard, replace bolt stop retainer plunger and spring, replace bolt stop retainer as to engage head of bolt stop retainer plunger into its housing cut in the bolt stop retainer.

ASSEMBLING · RECEIVER · BARREL GROUP

For the rifles which are fitted for the full automatic fire : replace the safety sear spring (with the small coil downwards) on the safety sear. Replace safety sear group in the receiver reversing operation of stripping, taking care that sear spring is placed in its housing.

Put the protective cover into position from the right, vertically, and give it a quarter turn clockwise.

Replace receiver and barrel in position on the stock. Replace and screw fully in trigger guard screws and stop screws.

ASSEMBLING GAS REGULATOR SLEEVE

Screw regulator sleeve on gas cylinder, with the retaining spring to the rear. Use key if necessary.

ASSEMBLING HANDGUARD

Replace handguard rear part, inserting first its rear end into the groove cut in the receiver, replace lower band and swivel,



screw in lower band screw. Replace handguard front part, inserting first its rear end under lower band. Replace front end cap as to fix front end of handguard and screw in front end cap screw.

ASSEMBLING THE COVER

Replace bolt carrier stop : replace bolt carrier catch stop and bolt carrier catch spring in their housing in the bolt carrier stop. Place bolt carrier catch axis in its housing in the cover, at an angle of about 60°, depress bolt carrier catch stop and turn bolt carrier stop home.

To assemble the rear sight : replace sight aperture. Replace rearsight slide lock spring in sight slide, replace slide lock in sight slide taking care that the crosspieces are opposite. Depress slide lock and replace slide assembly on sear leaf taking care that the figures of the sight are turned the same side as the slide cross piece. Make sure that sliding the slide along the leaf is easy, and, on the other hand, that the claw of the slide lock engages well in the notches of sight leaf when slide lock is released. Replace rear leaf spring in its housing. Replace sight leaf on the receiver (figures of leaf being turned upwards) to this end depress leaf spring and slide the studs of the leaf beneath the shoulders in rear sight base. Replace and screw in sight aperture screws.

Replace return springs : to this end place inner springs and inner spring guide in outer spring, replace the return springs assembly on the rod of cover.

GENERAL ASSEMBLY OF RIFLE

See assembly after « Field Stripping », page 40.



RECOMMENDATIONS

1. The rifle must always be on safe during transport.
2. Working parts ought to be slightly oiled. It is however important not to overlubricate when the rifle is used in a sandy country. It is then better to keep the gun nearly dry.
3. Make sure before firing that barrel is clean.
4. Make sure that magazine is clean and dry.
5. Make sure that magazine is fully home in trigger guard and well engaged by magazine catch.
6. Do not introduce by hand a cartridge in a hot barrel.
7. In case of misfire, wait a few seconds before opening the mechanism.
8. Adjustement of gas if necessary is periodically carried out by field armourer, the soldier has not to trouble about it.
9. In case of stoppage, open mechanism and hold it open by means of bolt carrier catch.
10. After daily firing, remove gas cylinder and clean it as well as piston. Make sure that piston is well free in gas cylinder.
11. In order to be ready for immediate firing, the rifle may be transported with magazine loaded with 10 rounds but with the bolt closed on empty chamber. To open fire, it is just necessary to cock the mechanism.
12. When the weapon is not firing, protective cover on right side of receiver ought to be pushed forward in order to avoid sand and dust to get into the mechanism.



NUMERICAL DATA

Weight of rifle	4,300 kg
Weight of single barrel	0,920 kg
Weight of barrel assembly	1,120 kg
Length of rifle	1,110 m
Length of barrel	590 mm
Weight of bayonet (230 mm long)	0,320 kg
Weight of bayonet with scabbard	0,550 kg
Weight of bayonet (385 mm long)	0,450 kg
Weight of long bayonet with scabbard	0,700 kg



COMPONENT PARTS

N. B. — * Components used for rifles allowing automatic firing.

Number of part.	NAME	Quant. per Gun.
1	Barrel Assembly	—
1A	Barrel	1
1B	Gas Cylinder	1
1C	Gas Cylinder Securing Pin	1
1D	Piston Guide	1
1E	Piston Guide Securing Pin	1
3	Muzzle Cap	1
5	Front Sight	1
6	Gas adjusting Sleeve	1
8	Gas Cylinder Plug, complete	—
8A	Gas Cylinder Plug	1
8B	Gas Cylinder Plug Plunger	1
8C	Gas Cylinder Plug Plunger Spring	1
8D	Gas Cylinder Plug Plunger Washer	1
12	Piston	1
13	Piston return Spring	1
15	Receiver	—
15A - *215A	Receiver Body	1
15B	Locking Shoulder	1
• 216A	Safety Sear (for automatic firing)	1
• 216B	Safety Sear Spring Rest	1
• 216C	Spring Rest Axis Pin	1
• 217	Safety Sear Spring	1
19	Cover Plate, complete	—
19A	Cover Plate Body	1
19B	Cover Plate Stud	1
21	Bolt	1
22	Extractor	1
23	Extractor Spring	1
24	Firing Pin - Rear End	1
25	Firing Pin Spring	1
26	Firing Pin Safety Stop	1
27 - *227	Bolt Carrier	1
28	Firing Pin - Front End	1
30 - *230	Trigger Guard	1
31	Hammer, complete	—
31A - *231A	Hammer Body	1
31B	Hammer Spring Guide	1
31C	Hammer Spring Guide Axis Pin	1



Number of part.	NAME	Quant. per Gun.
* 232	Automatic Fire Lever	1
* 232A	Automatic Fire Lever Body	1
* 232B	Automatic Fire Lever Arm	1
" 232C	Automatic Fire Lever Arm Plunger	1
* 232D	Automatic Fire Lever Arm Stop	1
" 232E	Automatic Fire Lever Stud	1
" 232F	Automatic Fire Lever Locking Screw	1
34	Hammer Spring	—
34A	Hammer outer Spring	1
34B	Hammer inner Spring	1
35	Hammer Axis Pin	1
36	Trigger	1
37	Trigger Spring	1
38	Trigger Spring Plunger	1
39 - *239	Auxiliary Sear	1
40	Auxiliary Sear Spring	1
41	Auxiliary Sear Spring Plunger	1
42	Trigger Axis Pin	1
43	Bolt Stop, complete (Holding Open Device)	—
43A	Bolt Stop Body	1
43B	Bolt Stop Spring	1
43C	Bolt Stop Washer	1
44	Bolt Stop Retainer	1
45A	Bolt Stop Retainer Plunger	1
45B	Bolt Stop Retainer Plunger Spring	1
46	Safety, complete	—
46A	Safety Body	1
46B	Safety Lever	1
46C	Safety Spring Plunger	1
46D	Safety Spring	1
46E	Safety Lever Plug	1
46F	Safety Lever Plug Pin	1
46G	Safety Stud	1
51	Ejector	1
52	Magazine Catch	1
53	Magazine Catch Spring	1
54	Magazine Catch Axis Pin	1
55	Trigger Guard Front Screw	1
56	Trigger Guard Center Screw	1
57	Trigger Guard Rear Screw	1
58	Trigger Guard Stop Screw	3
60	Magazine, complete	—
60A	Magazine Case	1
60B	Magazine Case Rear Wall	1



Number of part.	NAME	Quant. per Gun.
60C	Magazine Case Lug	1
60D	Cartridge Front Guide	1
60E	Magazine Catch Hook	1
60F	Magazine Rivet, long	1
60G	Magazine Rivet, short	2
60H	Magazine Catch Hook Rivet	2
61	Magazine Platform	1
62	Magazine Platform Spring	1
65	Receiver Cover	1
66	Return Spring Guide and Cover Locking Key, complete	—
66A	Return Spring Guide	1
66B	Cover Locking Key	1
66D	Cover Locking Key Plunger	1
66E	Cover Locking Key Plunger Washer	1
66F	Cover Locking Key Cap	1
66G	Cover Locking Key Cap Washer	1
67	Return Springs, complete with Guide	—
67A	Inner Return Spring	2
67C	Inner Return Springs Guide	1
67D	Outer Return Spring	1
70	Bolt Carrier Catch, complete	—
70A	Bolt Carrier Catch Body	1
70B	Bolt Carrier Catch Head	1
70C	Bolt Carrier Catch Washer	1
71	Bolt Carrier Catch Stop	1
72	Bolt Carrier Catch Spring	1
73	Rear Sight Leaf	1
74	Rear Sight Aperture	1
75	Rear Sight Aperture Adjusting Screw	2
76	Rear Sight Leaf Spring	1
77	Rear Sight Slide	1
78	Rear Sight Slide Lock	1
79	Rear Sight Slide Lock Spring	1
85	Stock	—
85A - *285A	Stock Body	1
85B	Trigger Guard Rear Screw Bushing	1
85E	Recoil Lug	1
85F	Recoil Lug Nut	1
86	Handguard, complete	—
86A	Handguard Body (2 pieces)	1
86B	Handguard Front Cap	1
86C	Handguard Front Cap Rivet	2
86D	Handguard Rear Cap	1



Number of part.	NAME,	Quant. per Gun.
86E	Handguard Rear Cap Rivet	2
87	Front End Cap - assembly	—
87A	Front End Cap Body	1
87B	Front End Cap Bushing	1
88	Front End Cap Screw	1
89	Lower Band assembly	—
89A	Lower Band Body	1
89B	Lower Band Screw	1
89C	Lower Band Screw Retaining Screw	1
90	Swivel, complete	—
90A	Swivel Support	1
STA.27	Swivel	2
90C	Swivel Pin	1
STA.18	Swivel Base and Butt Plate Screw	4
STA.19	Swivel Base Pin	1
STA.20	Swivel Base	1
STA.26	Butt Plate, Standard Type	1
93	Sling, complete	—
93A	Sling Leather	1
93B	Sling Buckle	1
STA.40	Sling Button	1
501	Gas Regulator Key	1

BAYONET

61	Blade	1
62	Handle	1
63	Cross Guard	1
64	Plunger Catch	1
65	Stock	2
66	Scabbard	1
66a	Scabbard Spring	1
66b	Scabbard Spring Screw	1
66c	Scabbard Hook	1
66d	Scabbard Collar	1
66e	Scabbard Button	1
67	Plunger Catch Nut	1
68	Stock Screw	2
69a	Washer	2
70	Handle Pin	2
71	Cross Guard Pin	2
72	Plunger Catch Spring	1



Number of part.

NAME

Quant. per Gun.

BRASS BUTT PLATE WITH TRAP

STA.32	Butt Plate	1
STA.33	Butt Plate Trap	1
STA.34	Butt Plate Trap Pivot	1
STA.35	Butt Plate Trap Spring	1
STA.36	Butt Plate Trap Spring Screw	1

STEEL BUTT PLATE WITH TRAP

STA.51	Butt Plate	1
STA.52	Butt Plate Trap	1
STA.53	Butt Plate Trap Pivot	1
STA.54	Butt Plate Trap Plunger	1
STA.55	Butt Plate Trap Spring	1

ACCESSORIES TO BE SUPPLIED ON SPECIAL REQUEST

2	Muzzle Brake
503	Blank Firing Attachment
506	Barrel Cleaner
507	Cleaner Case
STA.44	Barrel Cleaning Brush
STA.45	Chamber Cleaning Brush



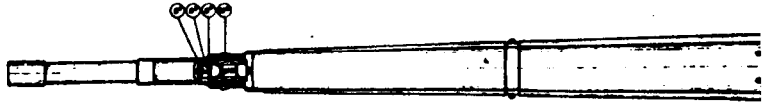
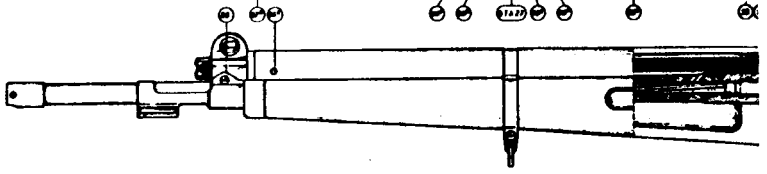
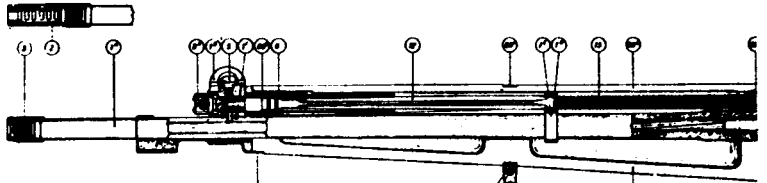
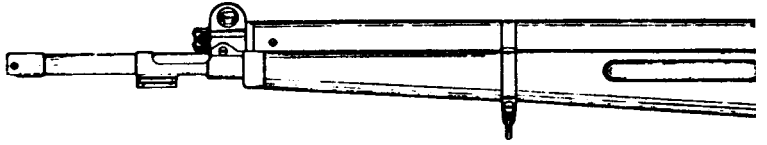

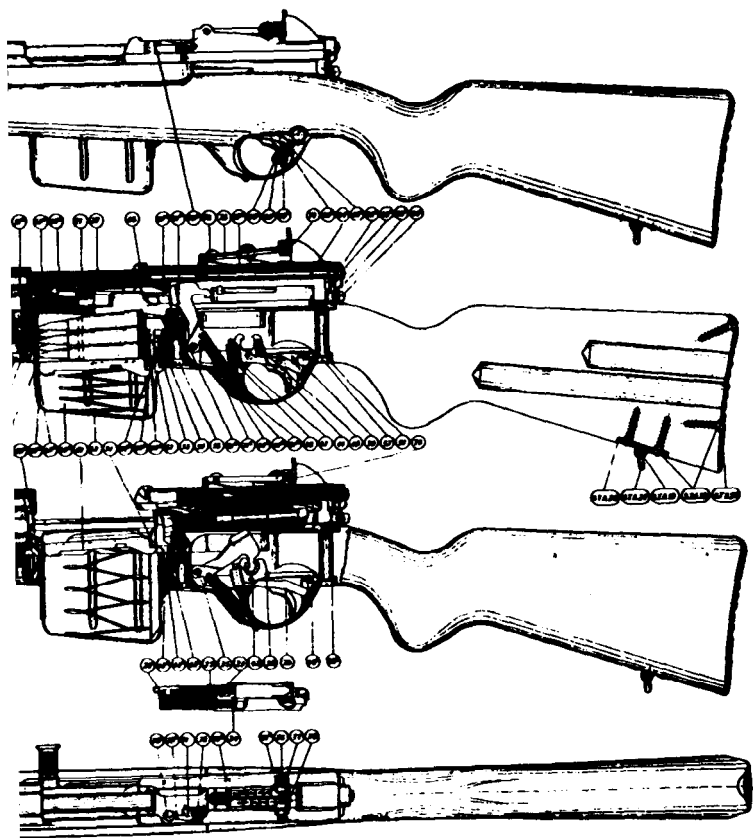



F.N. MODEL 49 SELF - LOADING RIFLE USER'S MANUAL

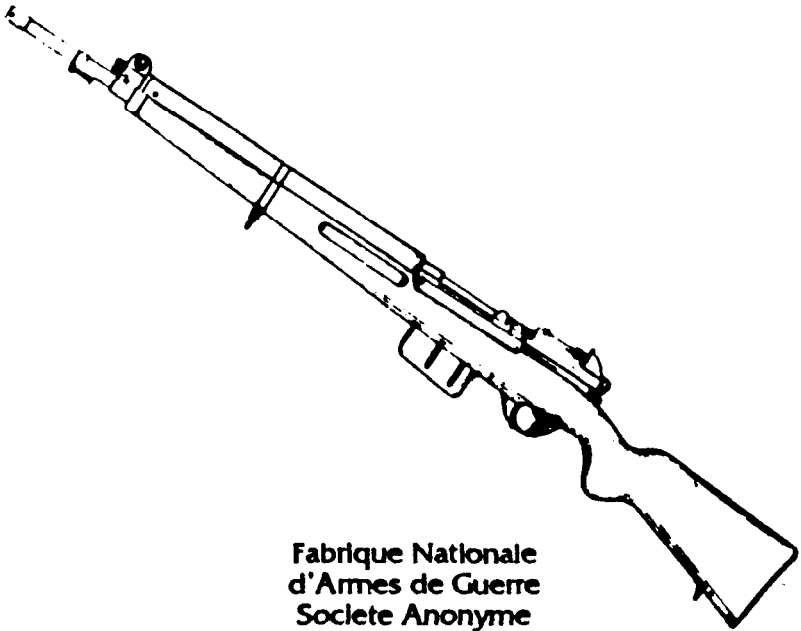

Fabrique Nationale
d'Armes de Guerre
Societe Anonyme
HERSTAL- LEZ - LIEGE
(BELGIUM)

