



PERFECTION



ARMORER'S MANUAL

GLOCK "SAFE ACTION" PISTOLS

THIS ARMORER'S MANUAL WILL BE SUPPLEMENTED BY TECHNICAL BULLETINS

- Information and specifications contained within this manual may change without notification.
- This manual provides basic service and backup information for certified GLOCK armorers, and is not intended for use otherwise.
- Certification can only be granted by GLOCK after attending a GLOCK armorer's school.
- GLOCK cannot be held responsible for any misinterpretation of the instructions in this manual that can lead to improper functioning of the pistol.
- For additional information and service guidelines, contact GLOCK for your nearest certified field representative.

TABLE OF CONTENTS

I.	INTRODUCTION	4
	Technical Specifications	5
	Ammunition Velocities	7
	Exploded Drawing	8
II.	SAFETY	9
	Basic Firearms Safety Rules	9
	Safe Action System	10
III.	FIELD STRIPPING	11
	Magazine Removal	12
	Slide Removal	13
	Barrel Removal	14
IV.	PREVENTIVE MAINTENANCE	15
	Cleaning	15
	Lubrication	16
	Function Testing of Trigger Safety and Firing Pin Safety	17
V.	FURTHER DISASSEMBLY	18
	Slide Disassembly	18
	Firing Pin Assembly	22
	Receiver Disassembly	23
	Trigger Assembly	27
	Magazine Disassembly	32
VI.	REASSEMBLY PROCEDURES	33
VII.	SIGHT REMOVAL AND INSTALLATION	36
	Rear Sight	36
	Front Sight	38
VIII.	SERVICE PROCEDURES AND DIAGNOSTICS	40

I.

INTRODUCTION

All GLOCK pistols are the product of advanced technology, incorporating numerous innovative design features which result in ease of operation, extreme reliability, simple function, minimal maintenance, durability and light weight. GLOCK was the first company to successfully produce a polymer handgun receiver and marry it to a strong steel slide and barrel. In addition to new materials and manufacturing methods, the GLOCK pistol incorporates the "Safe Action" system, a system which works similar to a constant double action and features three safeties.

The GLOCK "Safe Action" Trigger System offers three special advantages over conventional double action pistols. The trigger is the one and only operative control on the gun. GLOCK handguns do not need external levers to render them hot or cold. They are never fully cocked until the trigger is pulled completely to the rear. Every GLOCK has three automatic safeties, and they work sequentially off the trigger. The first safety is built into the trigger itself. If the trigger is pulled and the safety disengaged, the firing pin block safety is still working. If the trigger is pulled far enough to disengage the firing pin safety, the drop safety continues to be engaged until the trigger is pulled fully to the rear. Once the trigger is released, each safety is back in operation. GLOCK pistols combine the safety and simplicity of revolver-like operation with a constant double action trigger pull, high magazine capacity, rapid recovery and

the reduced recoil of a modern, semiautomatic pistol.

The metal parts of GLOCK handguns are treated with GLOCK's hardening and special surface process that makes them as hard as a diamond and seals out moisture and corrosion. This special surface hardening process penetrates the slide, the barrel and certain internal parts. The black matte finish is a final process applied to the surface making the pistol extremely resistant to abrasions and scratches. Should this black finish wear off after heavy and extensive use, the surface will still retain its corrosion protection and durability.

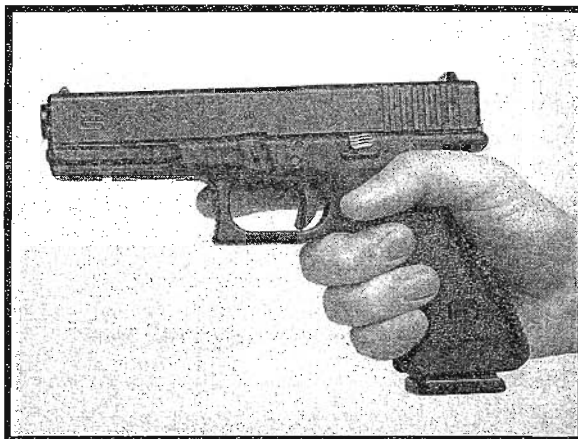

This manual provides maintenance and technical information for certified GLOCK armorers. It contains numerous pictures, each showing exactly how a specific procedure is to be carried out. This makes maintenance extremely simple and straightforward. A unique feature of the GLOCK pistol is that all parts are generally interchangeable within the same model—no hand fitting, filing or polishing is required or advised.

On pages 9 and 10 of this manual is a section devoted to safety as it relates to the GLOCK pistol. Please read and be familiar with this information prior to performing any maintenance on the pistol. Always wear safety glasses while performing maintenance.

NOTE: The terms right and left, front (muzzle) and rear, top and bottom, up and down and forward and backward, as used in this manual, refer to the pistol when being held in shooting position as seen by the operator.

GLOCK CURRENTLY OFFERS:

GLOCK 17/17C	(9x19)	GLOCK 26	(9x19)
GLOCK 17L	(9x19 competition model)	GLOCK 27	(.40)
GLOCK 17T	(9 mm Fx® training pistol)	GLOCK 28*	(.380 Auto)
GLOCK 17T	(7.8x21 AC training pistol)	GLOCK 29	(10 mm Auto)
GLOCK 19/19C	(9x19)	GLOCK 30	(.45 Auto)
GLOCK 20/20C	(10 mm Auto)	GLOCK 31/31C	(.357)
GLOCK 21/21C	(.45 Auto)	GLOCK 32/32C	(.357)
GLOCK 22/22C	(.40)	GLOCK 33	(.357)
GLOCK 22P	(.40)	GLOCK 34	(9x19 competition model)
GLOCK 23/23C	(.40)	GLOCK 35	(.40 competition model)
GLOCK 24/24C	(.40 competition model)	GLOCK 36	(.45 Auto)
GLOCK 25*	(.380 Auto)		

*Available in certain markets only. Not available in the U.S.A.

TECHNICAL SPECIFICATIONS

	G17/G17C		G17L		G19/G19C	
	U.S.	Metric	U.S.	Metric	U.S.	Metric
Action	Safe Action (constant double action mode)		Safe Action (constant double action mode)		Safe Action (constant double action mode)	
Caliber	9x19		9x19		9x19	
Overall length (slide)	7.32in.	186mm	8.85in.	225mm	6.85in.	174mm
Height incl. magazine	5.43in.	138mm	5.43in.	138mm	5.00in.	127mm
Width	1.18in.	30mm	1.18in.	30mm	1.18in.	30mm
Length between sights	6.49in./6.73in.	165mm/171mm	8.07in.	205mm	6.02in./6.26in.	153mm/159mm
Barrel length	4.49in.	114mm	6.02in.	153mm	4.02in.	102mm
Barrel rifling	Hexagonal profile with right hand twist		Hexagonal profile with right hand twist		Hexagonal profile with right hand twist	
Length of twist	9.84in.	250mm	9.84in.	250mm	9.84in.	250mm
Magazine capacity	17		17		15	
Mass (weight):						
Empty without magazine	22.04oz.	625g.	23.63oz.	670g.	20.99oz./20.67oz.	595g./586g.
Empty magazine	2.75oz.	78g.	2.75oz.	78g.	2.46oz.	70g.
Full magazine	79.87oz.	280g.	79.87oz.	280g.	78.99oz.	255g.
Trigger pull (standard)	5.5lbs.	2.5kg.	4.5lbs.	2.0kg.	5.5lbs.	2.5kg.
Trigger travel for discharge	0.5in.	12.5mm	0.5in.	12.5mm	0.5in.	12.5mm
Number of safeties	3		3		3	
	G20/G20C		G21/G21C		G22/G22C	
Action	Safe Action (constant double action mode)		Safe Action (constant double action mode)		Safe Action (constant double action mode)	
Caliber	10 mm Auto		.45 Auto		.40	
Overall length (slide)	7.59in.	193mm	7.59in.	193mm	7.32in.	186mm
Height incl. magazine	5.47in.	139mm	5.47in.	139mm	5.43in.	138mm
Width	1.27in.	32.5mm	1.27in.	32.5mm	1.18in.	30mm
Length between sights	6.77in./7.00in.	172mm/178mm	6.77in./7.00in.	172mm/178mm	6.49in./6.73in.	165mm/171mm
Barrel length	4.60in.	117mm	4.60in.	117mm	4.49in.	114mm
Barrel rifling	Hexagonal profile with right hand twist		Octagonal profile with right hand twist		Hexagonal profile with right hand twist	
Length of twist	9.84in.	250mm	15.75in.	400mm	9.84in.	250mm
Magazine capacity	15		13		15	
Mass (weight):						
Empty without magazine	27.68/27.34oz.	785/775g.	26.28/25.93oz.	745/735g.	22.92oz./22.54oz.	650g./639g.
Empty magazine	2.64oz.	75g.	3.1oz.	88g.	2.75oz.	78g.
Full magazine	71.46oz.	325g.	72.0oz.	340g.	71.46oz.	325g.
Trigger pull (standard)	5.5lbs.	2.5kg.	5.5lbs.	2.5kg.	5.5lbs.	2.5kg.
Trigger travel for discharge	0.5in.	12.5mm	0.5in.	12.5mm	0.5in.	12.5mm
Number of safeties	3		3		3	
	G23/G23C		G24/G24C		G25	
Action	Safe Action (constant double action mode)		Safe Action (constant double action mode)		Safe Action (constant double action mode)	
Caliber	.40		.40		.380 Auto	
Overall length (slide)	6.85in.	174mm	8.85in.	225mm	6.85in.	174mm
Height incl. magazine	5.00in.	127mm	5.43in.	138mm	5.00in.	127mm
Width	1.18in.	30mm	1.18in.	30mm	1.18in.	30mm
Length between sights	6.02in./6.26in.	153mm/159mm	8.07in.	205mm	6.02in.	153mm
Barrel length	4.02in.	102mm	6.02in.	153mm	4.02in.	102mm
Barrel rifling	Hexagonal profile with right hand twist		Hexagonal profile with right hand twist		Hexagonal profile with right hand twist	
Length of twist	9.84in.	250mm	9.84in.	250mm	9.84in.	250mm
Magazine capacity	13		15		15	
Mass (weight):						
Empty without magazine	21.16oz./20.92oz.	600g./593g.	26.70oz.	757g.	20.11oz.	570g.
Empty magazine	2.46oz.	70g.	2.75oz.	78g.	2.40oz.	68g.
Full magazine	79.87oz.	280g.	71.46oz.	325g.	72.0oz.	204g.
Trigger pull (standard)	5.5lbs.	2.5kg.	4.5lbs.	2.0kg.	5.5lbs.	2.5kg.
Trigger travel for discharge	0.5in.	12.5mm	0.5in.	12.5mm	0.5in.	12.5mm
Number of safeties	3		3		3	

TECHNICAL SPECIFICATIONS

	G26		G27		G28	
	U.S.	Metric	U.S.	Metric	U.S.	Metric
Action	Safe Action (constant double action mode)		Safe Action (constant double action mode)		Safe Action (constant double action mode)	
Caliber	9x19		.40		.380 Auto	
Overall length (slide)	6.29in.	160mm	6.29in.	160mm	6.29in.	160mm
Height incl. magazine	4.17in.	106mm	4.17in.	106mm	4.17in.	106mm
Width	1.18in.	30mm	1.18in.	30mm	1.18in.	30mm
Length between sights	5.67in.	144mm	5.67in.	144mm	5.67in.	144mm
Barrel length	3.46in.	88mm	3.46in.	88mm	3.46in.	88mm
Barrel rifling	Hexagonal profile with right hand twist		Hexagonal profile with right hand twist		Hexagonal profile with right hand twist	
Length of twist	9.84in.	250mm	9.84in.	250mm	9.84in.	250mm
Magazine capacity	10		9		10	
Mass (weight):						
Empty without magazine	19.75oz.	560g.	19.75oz.	560g.	18.66oz.	529g.
Empty magazine	1.98oz.	56g.	2.12oz.	60g.	1.98oz.	56g.
Full magazine	7.35oz.	180g.	7.23oz.	205g.	5.11oz.	145g.
Trigger pull (standard)	5.5lbs.	2.5kg.	5.5lbs.	2.5kg.	~ 5.5lbs.	2.5kg.
Trigger travel for discharge	0.5in.	12.5mm	0.5in.	12.5mm	0.5in.	12.5mm
Number of safeties	3		3		3	
	G29		G30		G31/G31C	
Action	Safe Action (constant double action mode)		Safe Action (constant double action mode)		Safe Action (constant double action mode)	
Caliber	10 mm Auto		.45 Auto		.357	
Overall length (slide)	6.77in.	172mm	6.77in.	172mm	7.32in.	186mm
Height incl. magazine	4.45in.	113mm	4.76in.	121mm	5.43in.	138mm
Width	1.27in.	32.5mm	1.27in.	32.5mm	1.18in.	30mm
Length between sights	5.95in.	151mm	5.95in.	151mm	6.49in./6.73	165mm/171mm
Barrel length	3.78in.	96mm	3.78in.	96mm	4.49in.	114mm
Barrel rifling	Hexagonal profile with right hand twist		Octagonal profile with right hand twist		Hexagonal profile with right hand twist	
Length of twist	9.84in.	250mm	15.75in.	400mm	15.98in.	406mm
Magazine capacity	10		10		15	
Mass (weight):						
Empty without magazine	24.69oz.	700g.	23.99oz.	680g.	23.28oz./23.10oz.	660g./655g.
Empty magazine	2.40oz.	68g.	2.50oz.	71g.	2.75oz.	78g.
Full magazine	8.29oz.	235g.	9.87oz.	280g.	9.87oz.	280g.
Trigger pull (standard)	~ 5.5lbs.	2.5kg.	~ 5.5lbs.	2.5kg.	5.5lbs.	2.5kg.
Trigger travel for discharge	0.5in.	12.5mm	0.5in.	12.5mm	0.5in.	12.5mm
Number of safeties	3		3		3	
	G32/G32C		G33		G34	
Action	Safe Action (constant double action mode)		Safe Action (constant double action mode)		Safe Action (constant double action mode)	
Caliber	.357		.357		9x19	
Overall length (slide)	6.85in.	174mm	6.29in.	160mm	8.15in.	207mm
Height incl. magazine	5.00in.	127mm	4.17in.	106mm	5.43in.	138mm
Width	1.18in.	30mm	1.18in.	30mm	1.18in.	30mm
Length between sights	6.02in./6.26in.	153mm/159mm	5.67in.	144mm	7.56in.	192mm
Barrel length	4.02in.	102mm	3.46in.	88mm	5.32in.	135mm
Barrel rifling	Hexagonal profile with right hand twist		Hexagonal profile with right hand twist		Hexagonal profile with right hand twist	
Length of twist	15.98in.	406mm	15.98in.	406mm	9.84in.	250mm
Magazine capacity	13		9		17	
Mass (weight):						
Empty without magazine	21.52oz./21.34oz.	610g./605g.	19.75oz.	560g.	22.92oz.	650g.
Empty magazine	2.46oz.	70g.	2.12oz.	60g.	2.75oz.	78g.
Full magazine	8.64oz.	245g.	7.88oz.	195g.	9.87oz.	280g.
Trigger pull (standard)	5.5lbs.	2.5kg.	5.5lbs.	2.5kg.	4.5lbs.	2.0kg.
Trigger travel for discharge	0.5in.	12.5mm	0.5in.	12.5mm	0.5in.	12.5mm
Number of safeties	3		3		3	

TECHNICAL SPECIFICATIONS

	G35		G36	
	U.S.	Metric	U.S.	Metric
Action	Safe Action (constant double action mode)		Safe Action (constant double action mode)	
Caliber	.40		.45 Auto	
Overall length (slide)	8.15in.	207mm	6.77in.	172mm
Height incl. magazine	5.43in.	138mm	4.76in.	121mm
Width	1.18in.	30mm	1.13in.	28.5mm
Length between sights	7.56in.	192mm	6.18in.	157mm
Barrel length	5.32in.	135mm	3.78in.	96mm
Barrel rifling	Hexagonal profile with right hand twist		Octagonal profile with right hand twist	
Length of twist	9.84in.	250mm	15.75in.	400mm
Magazine capacity	15		6	
Mass (weight):				
Empty without magazine	24.52oz.	695g.	20.11oz.	570g.
Empty magazine	2.75oz.	78g.	2.40oz.	68g.
Full magazine	11.46oz.	325g.	6.88oz.	195g.
Trigger pull (standard)	4.5lbs.	2.0kg.	5.5lbs.	2.5kg.
Trigger travel for discharge	0.5in.	12.5mm	0.5in.	12.5mm
Number of safeties	3		3	

NOTE: Magazine capacities of greater than ten rounds are intended for Law Enforcement and Military use only. Since September 1994, U.S. Federal Law only allows a ten round maximum capacity for all others.

COMPONENT PARTS OF GLOCK PISTOLS

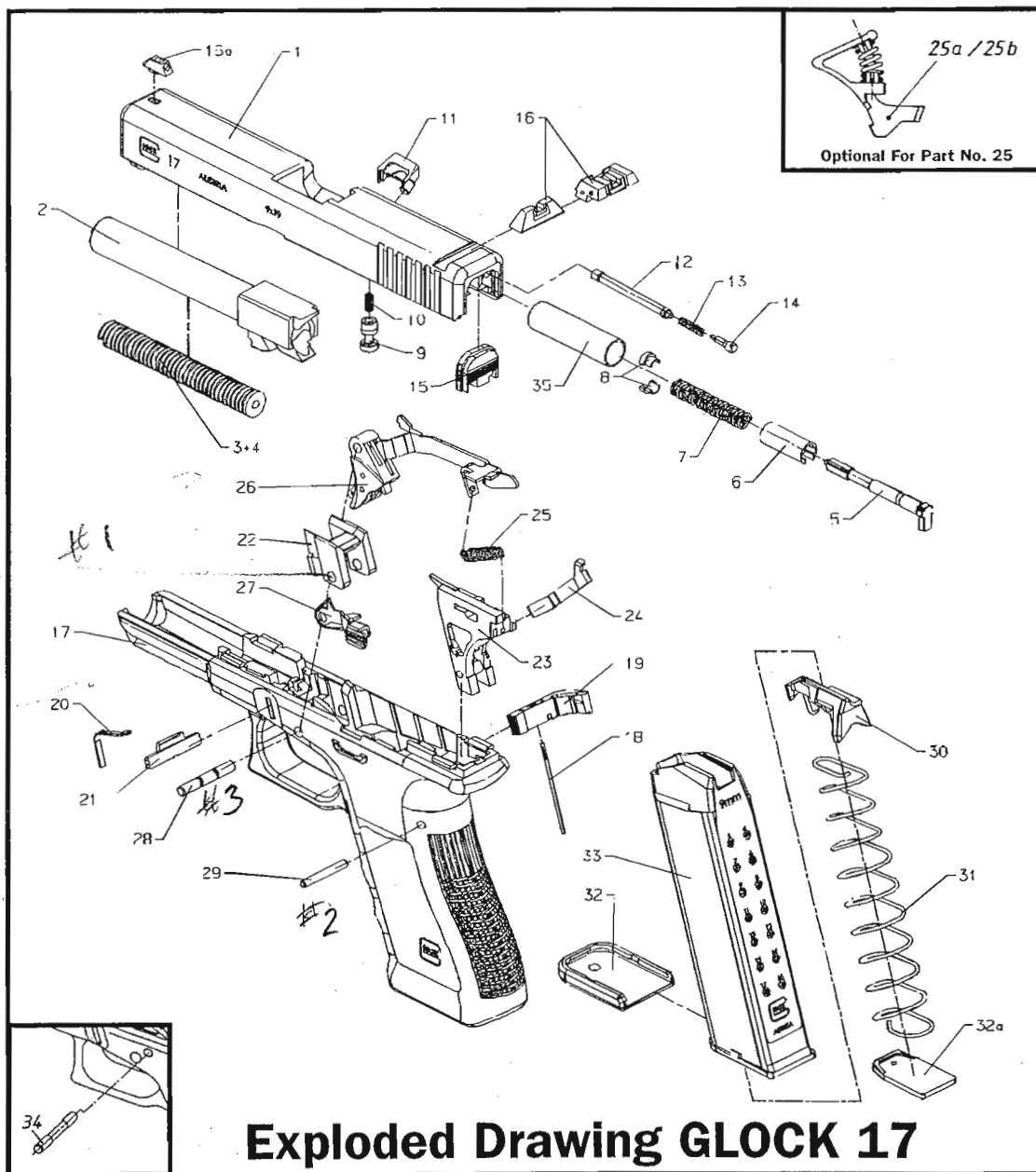

Exploded Drawing GLOCK 17

- | | | |
|--|--|--------------------------------|
| 1. Slide | 14. Spring-loaded bearing | 25a. New York Trigger Spring 1 |
| 2. Barrel | 15. Slide cover plate | 25b. New York Trigger Spring 2 |
| 3. Recoil spring assembly | 16. Rear sight | 26. Trigger with trigger bar |
| 4. Recoil spring assembly | 16a. Front sight | 27. Slide stop lever |
| 5. Firing pin | 17. Receiver | 28. Trigger pin |
| 6. Spacer sleeve | 18. Magazine catch spring | 29. Trigger housing pin |
| 7. Firing pin spring | 19. Magazine catch | 30. Follower |
| 8. Spring cups | 20. Slide lock spring | 31. Magazine spring |
| 9. Firing pin safety | 21. Slide lock | 32. Magazine floor plate |
| 10. Firing pin safety spring | 22. Locking block | 32a. Magazine insert |
| 11. Extractor | 23. Trigger mechanism housing with ejector | 33. Magazine tube |
| 12. Extractor depressor plunger | 24. Connector | 34. Locking block pin |
| 13. Extractor depressor plunger spring | 25. Trigger spring | 35. Channel liner |

II.

SAFETY

BASIC FIREARM SAFETY RULES

- #1 Handle all firearms as if they were loaded.
- #2 The trigger finger stays out of the trigger guard until the firearm is on target and the decision to fire has been made.
- #3 Always keep the firearm pointed in a safe direction.
- #4 Make sure the firearm is in good working order and the barrel clear of obstructions.
- #5 Always check your target, backstop and the surrounding area before firing.
- #6 Quality ear and eye protection should always be worn when shooting or observing.
- #7 When storing a firearm, the firearm should be unloaded, secured in a safe storage case, and out of the reach of children and untrained adults.
- #8 Only use ammunition recommended by the firearm manufacturer and always check caliber and condition of ammunition before loading the firearm.
- #9 Firearm transportation is regulated by Federal, state and local laws. Always transport your firearm in a safe, unloaded condition and in accordance with applicable laws.
- #10 Certain medications, alcohol and firearms do not mix. Never allow anyone to use firearms when under the influence of drugs or alcohol.
- #11 The safe and rational use of a firearm relies on common sense and proper training of the user. Follow safety rules and think before using a firearm.
- #12 Thoroughly read and understand the users manual that is supplied with your firearm. Never use any firearm unless you completely understand its operation and safety features.

SPECIAL WARNINGS:

In case the trigger safety proves to be ineffective for any reason, DANGER of an unintentional discharge exists. THE WEAPON IS THEN TO BE IMMEDIATELY UNLOADED AND RESTRICTED FROM FURTHER USE. MAKE SURE THAT YOUR WEAPON IS PROPERLY REPAIRED AND CHECKED BY GLOCK OR A GLOCK CERTIFIED ARMORER BEFORE USING IT AGAIN!



NOTES: _____

SAFETY DEVICES

GLOCK pistols do not feature a conventional manual safety lever; however, they are equipped with the revolutionary fully automatic safety system consisting of 3 independent, mechanical safety devices.

1. TRIGGER SAFETY

The trigger safety is incorporated into the trigger in the form of a lever and in the untouched state blocks the trigger from moving rearward. To fire the pistol the trigger safety, as well as the trigger itself, must be deliberately depressed, at the same time. If the trigger safety is not depressed, the trigger will not move to the rear and the pistol will not fire. The trigger safety is designed to prevent accidental firing when the pistol is dropped or subjected to an off-center lateral pressure or similar force.

2. FIRING PIN SAFETY

The spring-loaded firing pin safety projects into the firing pin cutout and mechanically blocks the firing pin in the ready and/or loaded condition. When pulling the trigger to the rear, an extension of the trigger bar pushes the firing pin safety upwards, clearing the firing pin channel. During the cycling process the firing pin safety automatically engages with the help of the firing pin safety spring. The firing pin safety is mainly designed to avoid accidental firing should extreme forces allow a separation of slide and receiver assembly.

3. DROP SAFETY

The following denotes the safety function of the trigger mechanism housing. The rear part of the trigger bar, which has a cruciform shape, rests with its wings in the loaded/ready position on a safety ramp located in the trigger mechanism housing. When pulling the trigger to the rear to the pressure point and beyond, the trigger bar starts to leave the safety ramp being lead downwards and further backwards by the connector and finally separating from the firing pin. During the cycling process of the pistol, the connector is pushed inward by a ramp in the slide releasing the trigger bar, which is lifted with the help of the trigger spring and caught by the firing pin. This pushes the trigger bar forward and onto the safety ramp again.

The "SAFE ACTION" System:

3 automatic independently operating mechanical safeties sequentially disengage while pulling trigger and automatically reengage when releasing trigger.

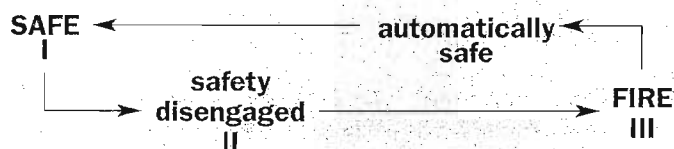

1. TRIGGER SAFETY



2. FIRING PIN SAFETY

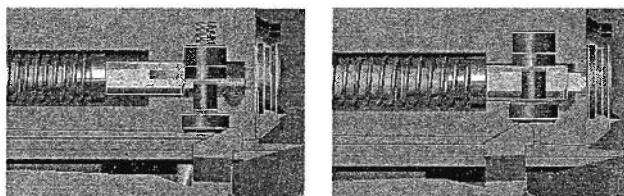

3. DROP SAFETY

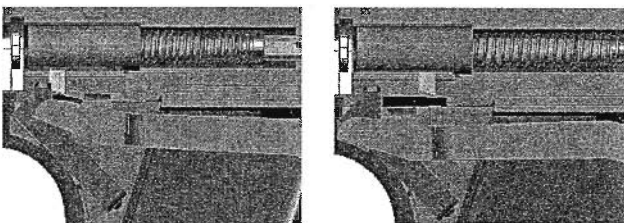

III.

FIELD STRIPPING

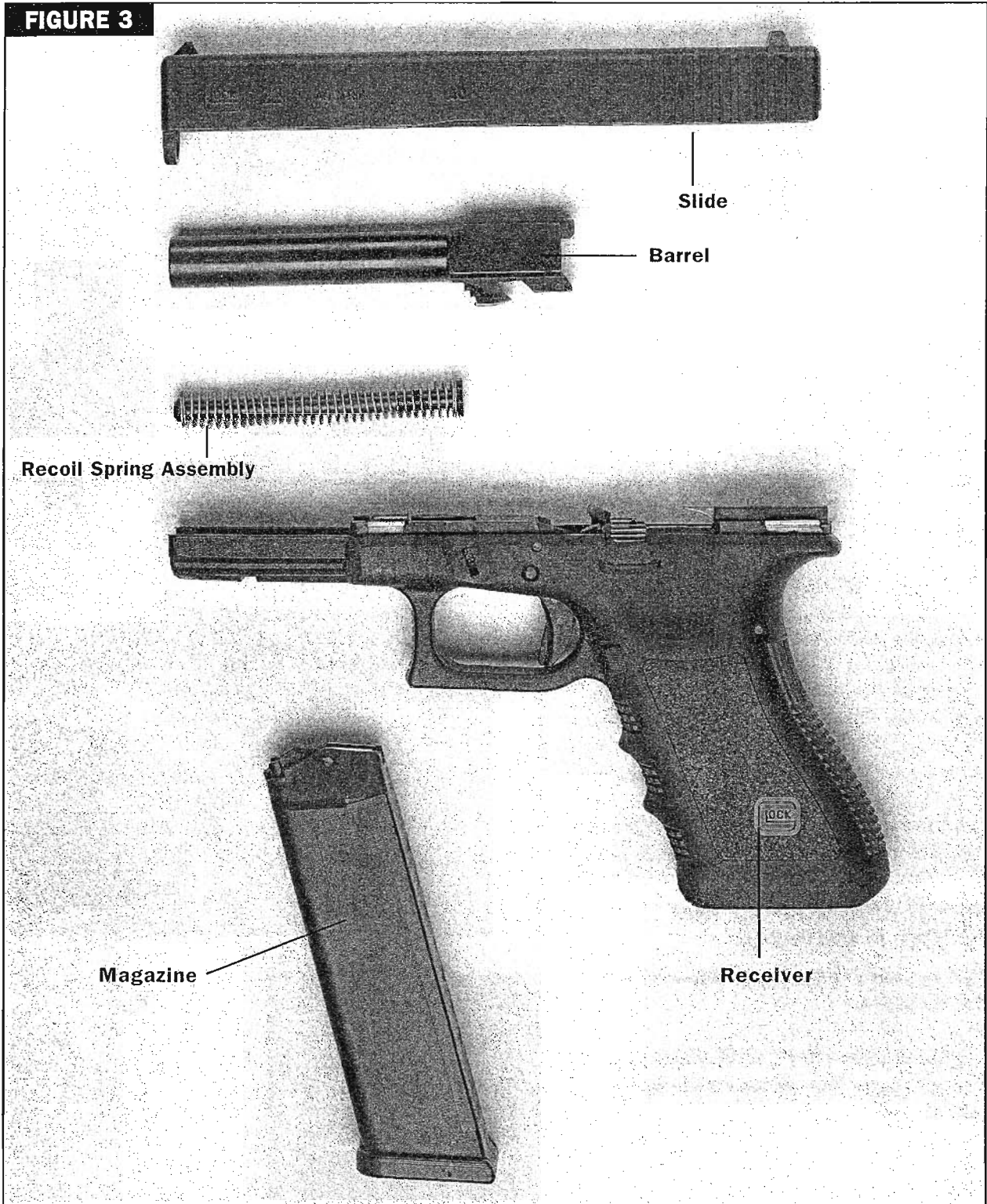

NOTE: Eye Protection should be worn when disassembling and cleaning firearms.

**PRIOR TO FIELD STRIPPING,
FOLLOW PROCEDURES BELOW:
(see page 11)**

MAGAZINE REMOVAL

- Point the pistol in a safe direction (a safe direction is where no one can possibly be injured in the event of an unintentional discharge) - Keep finger OFF the trigger and OUT of the trigger guard.
- Depress the magazine catch (Fig. 4).

NOTE: The GLOCK pistol is designed so that the magazine catch cannot easily be pressed unintentionally when the pistol is held with a proper shooting grip. For this reason you will have to rotate the hand a few degrees to be able to press the catch and release the magazine (Fig. 4).

- Remove the magazine.

SAFETY CAUTION: Prior to further disassembly, with your finger off the trigger and outside of the trigger guard, point the pistol in a safe direction, lock the slide open by pushing up on the slide-stop lever, while pulling the slide to the rear with the other hand (Fig. 5). Once the slide is locked to the rear, both visually and physically (with your little finger) inspect the chamber of the pistol to be sure that the chamber is empty (Fig. 6). Also, check the magazine well. Once you are sure that the pistol is unloaded, continue with disassembly.

ONCE YOU HAVE VERIFIED THAT THE PISTOL IS UNLOADED:

- Pull back slide to release slide stop lever and close the action.
- Point the pistol in a SAFE DIRECTION, then PULL the trigger. You will hear the firing pin move forward.

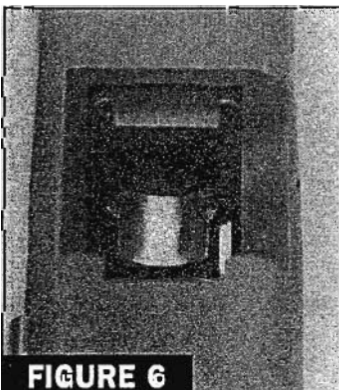
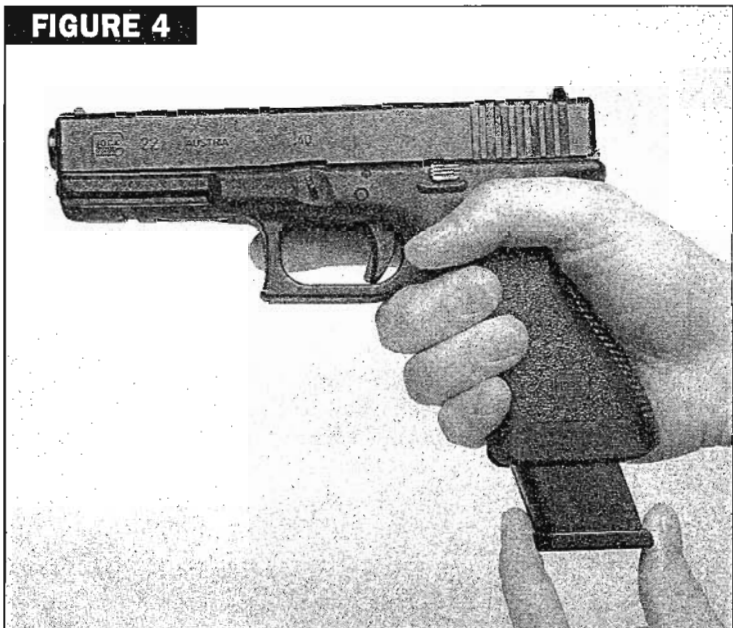

SLIDE REMOVAL

- Hold the pistol in either hand so that four fingers grasp the top of the slide as shown (Fig. 7). With these four fingers, pull and hold the slide back approximately 1/10 inch (2.5mm).

NOTE: The trigger has to be in the rear position to be able to disassemble the slide from the receiver.

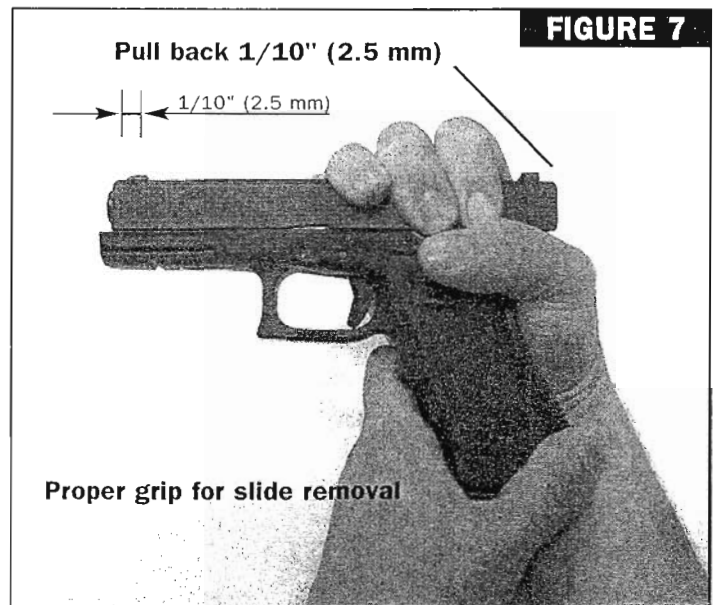

- Simultaneously, pull down the slide lock (part no. 21) and hold both sides of it using the thumb and index finger of your free hand (Fig. 8).

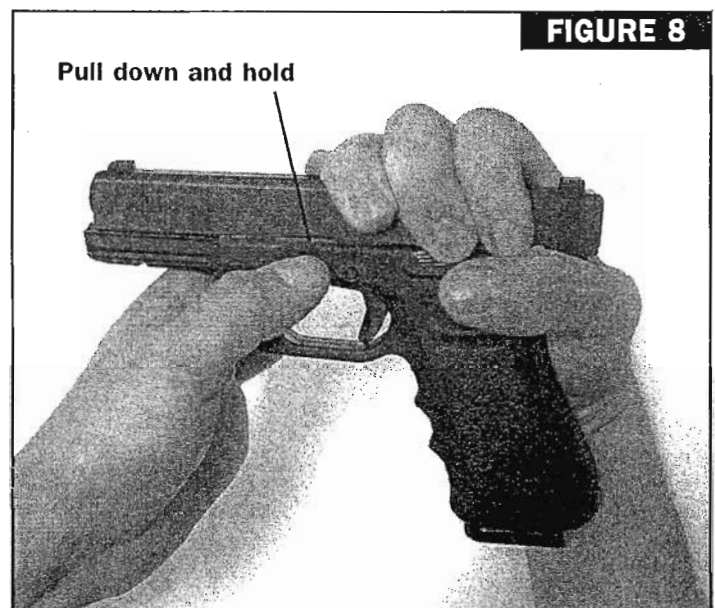

- Push the slide forward until it is fully separated from the receiver (Fig. 9).

NOTE: If the pistol is equipped with a “NY” trigger spring, the trigger may have to be pulled a second time to remove the slide.

- Push the slide forward until it is fully separated from the receiver (Fig. 9).

NOTE: With the slide and receiver separated, the operation of the trigger safety can be checked. See section IV, Function Testing the Trigger Safety (page 17), prior to operating the trigger with slide removed.

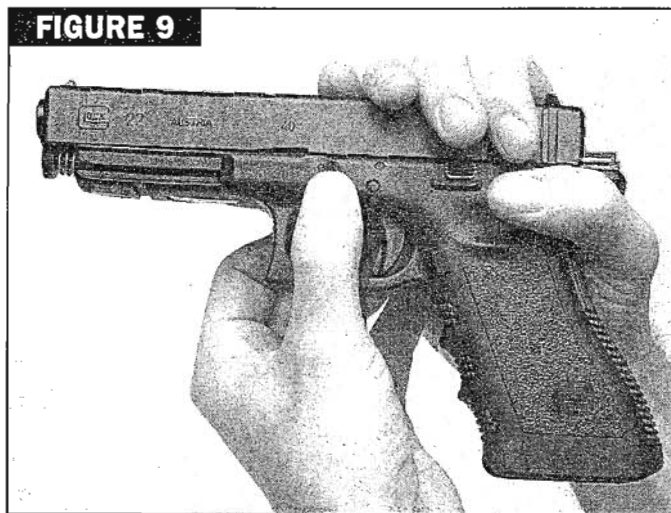

FIGURE 9

BARREL REMOVAL

- Push the recoil spring tube slightly forward while lifting it away from the barrel (Fig. 10).
- Remove the recoil spring assembly (Fig. 11).
- Grasp the barrel lug. While raising the chamber end, move the barrel slightly forward (Fig. 12). Then, lift the barrel from the slide.

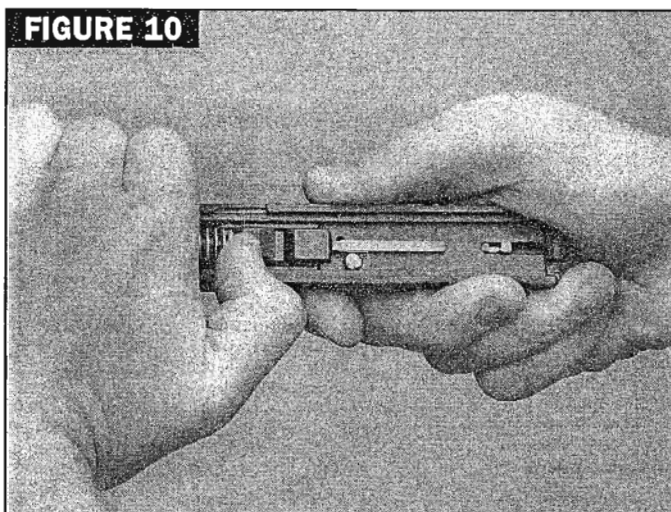

FIGURE 10

SAFETY CAUTION: The recoil spring is under tension. During removal, use care to control the recoil spring assembly but take special care in case an old system with separated recoil spring and recoil spring tube is in use.

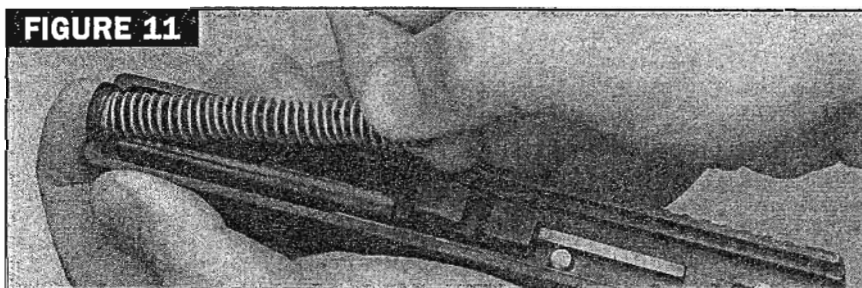

FIGURE 11

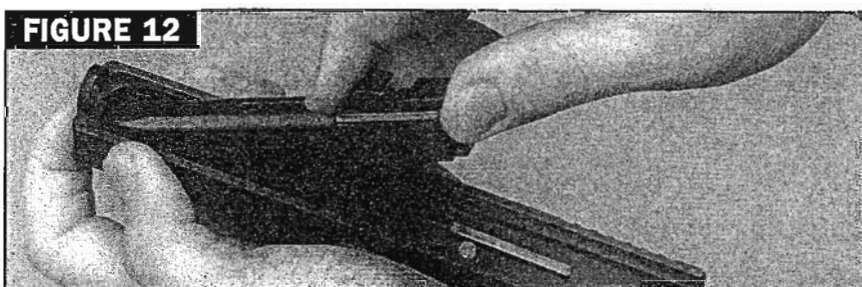

FIGURE 12

IV.

PREVENTIVE MAINTENANCE

The pistol is now field stripped. Further disassembly is not required for normal cleaning and maintenance.

NOTE: Refer to page 11-14 for proper method of field stripping the pistol.

CLEANING THE FIELD STRIPPED FIREARM

GLOCK pistols should be cleaned and lubricated after firing, and periodically to ensure safe and proper functioning. Once field stripped, the barrel and chamber are easily cleaned from the chamber end. The inside of the slide and receiver should be wiped clean. Standard firearm solvents can be used on the pistol. **Solvent manufacturers' warning labels should be followed.** This will ensure proper functioning of a GLOCK pistol.

As with any semiautomatic pistol, GLOCK pistols should not be cleaned by merely locking the slide to the rear and inserting the cleaning rod from the muzzle end. This can cause excessive amounts of solvents to build up in both the receiver and slide and possibly contribute to malfunctions of the pistol. The pistol should be field stripped every time it is cleaned.

CAUTION: When cleaning the slide, the muzzle end should be pointed down so as to prevent debris and solvents from entering the firing pin channel.

The inside of both the chamber and barrel should be wiped completely dry once they have been thoroughly cleaned. The breech face and the area under the extractor claw should both be absolutely dry and free of any debris after cleaning.

The slide rail cuts should be cleaned thoroughly.

All other areas of the slide and receiver should be checked for cleanliness. Most parts in the receiver may be wiped with a clean, soft cloth that has been slightly dampened with a quality firearm cleaning solvent. **Again, follow solvent manufacturer's warning labels.**

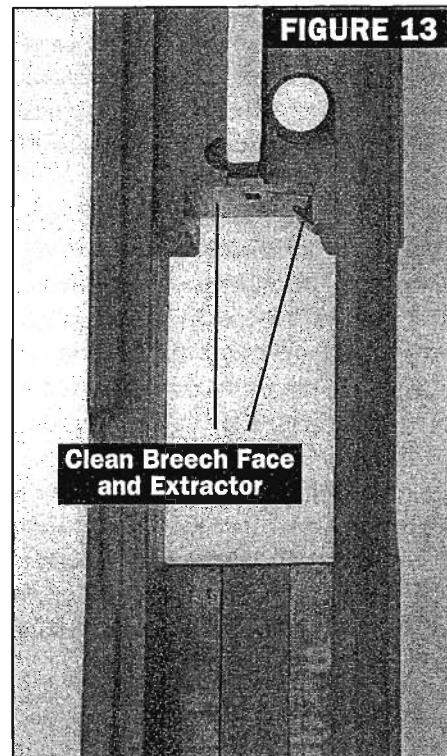

LUBRICATING THE FIELD STRIPPED FIREARM

NOTE: The copper colored substance on the interior of the pistol is a high-temperature, factory-applied lubricant for new guns. The copper colored lubricant should remain, as it will assure long-term lubrication of the slide.

To properly lubricate your GLOCK pistol after it has been thoroughly cleaned and dried, the following lubrication procedures should be followed: Using a quality gun oil, lubricate the barrel, the barrel hood, the barrel lug, and the inside of the slide where the barrel hood rubs against the slide. Take **ONLY** one drop of oil on your finger and rub each slide rail, or put one drop of oil in each slide rail cut. Once the slide is replaced on the receiver after reassembly, the oil drop will be distributed equally along the slide rails. **Most important is the drop of oil (Fig. 14) where connector and trigger bar meet.**

If not properly lubricated, the connector and/or trigger bar may be damaged and produce a hard trigger pull, resulting in their needing to be replaced.

This will assure proper lubrication of your GLOCK pistol without over-lubricating. GLOCK pistols are designed to operate properly with only small amounts of lubrication.

CAUTION: Do not over-lubricate your GLOCK pistol. Large quantities of oil or grease will collect unburned powder and other residue, which could interfere with proper functioning of your GLOCK pistol.

GLOCK pistols may be dry-fired without expectation of damage to the firearm.

CAUTION: Do not put oil inside firing pin channel or magazine tube. Firing pin channel, magazine tube, and breech face should be wiped dry before reassembly. Leaving solvent or lubricant in these areas could cause contamination of primers and failure to fire.

FIGURE 14

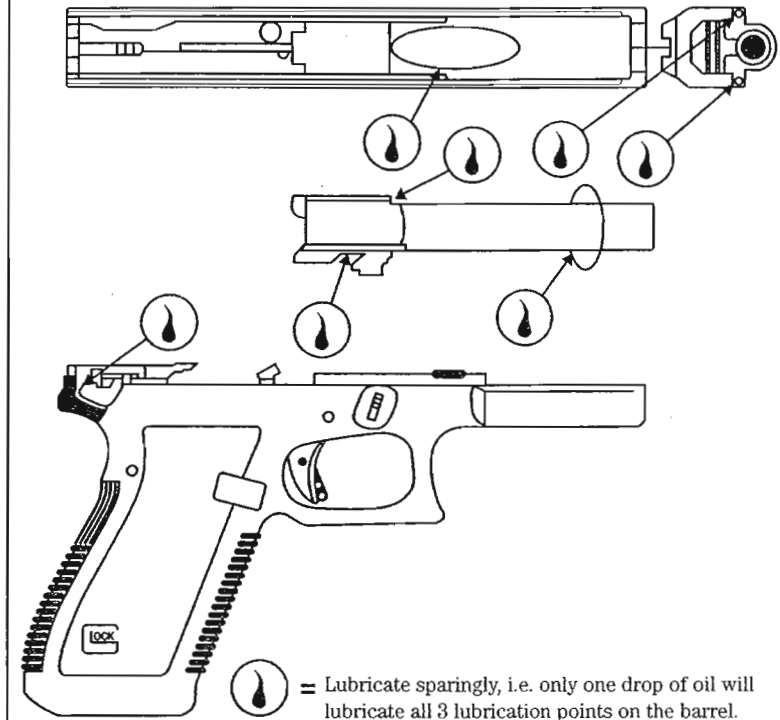

FUNCTION TESTING (SAFETIES)

THE TRIGGER SAFETY

Once the slide is removed from the receiver, the trigger safety can be function-tested in the following manner. Push forward on the vertical extension of the trigger bar as shown (Fig. 15). The trigger will move forward and the trigger safety should engage, holding the trigger in a semi-forward position even if you release pressure on the trigger bar. This verifies the proper engagement of the trigger safety.

CAUTION: Do not pull the trigger after the slide is removed, as the trigger safety is resting against the receiver at the rear of the trigger guard and the trigger safety may be damaged by doing so. Also, do not pull the trigger when the slide is locked to the rear of the pistol, as this could also damage the trigger safety.

Exert and maintain additional forward pressure on the vertical extension of the trigger bar until the trigger moves to its most forward position. Then press the trigger (the trigger safety should disengage) while maintaining, but gradually releasing, the forward pressure on the trigger bar. As you do, the trigger should return to its rearward position.

This verifies the proper disengagement of the trigger safety.

THE FIRING PIN SAFETY

Hold the slide in a muzzle-down position and depress the firing pin safety. The firing pin should move forward and the tip should be visible protruding from the firing pin hole.

A second method of checking the proper movement of the firing pin is to depress the firing pin safety and shake the slide back and forth. When the firing pin safety is depressed, the firing pin should be heard moving freely. If the firing pin is not heard, cleaning is necessary.

Next, to make sure that the firing pin safety is properly engaged, hold the slide as shown (Fig. 16) and push forward on the rear end of the firing pin with your thumb. The firing pin should not protrude from the firing pin hole. If it does, the firing pin or safety that is worn should be replaced. Do not pull back lug of firing pin and let snap forward when slide is removed from frame, as damage to the firing pin and firing pin safety could result.

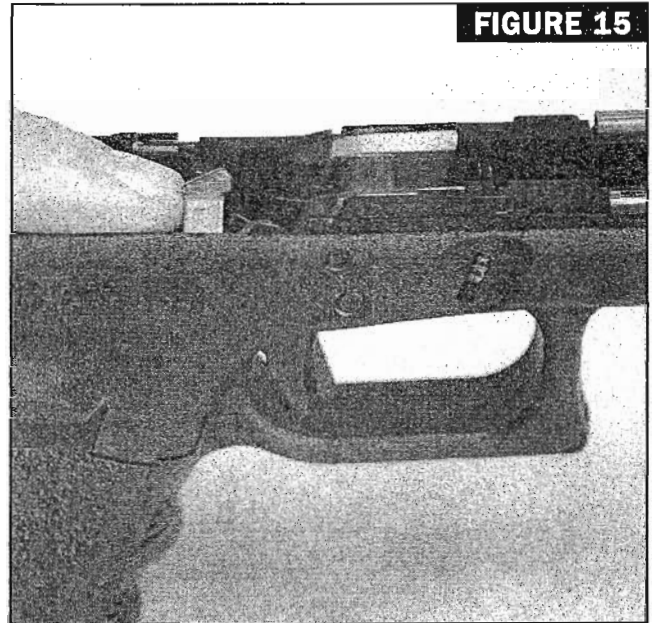

FIGURE 15

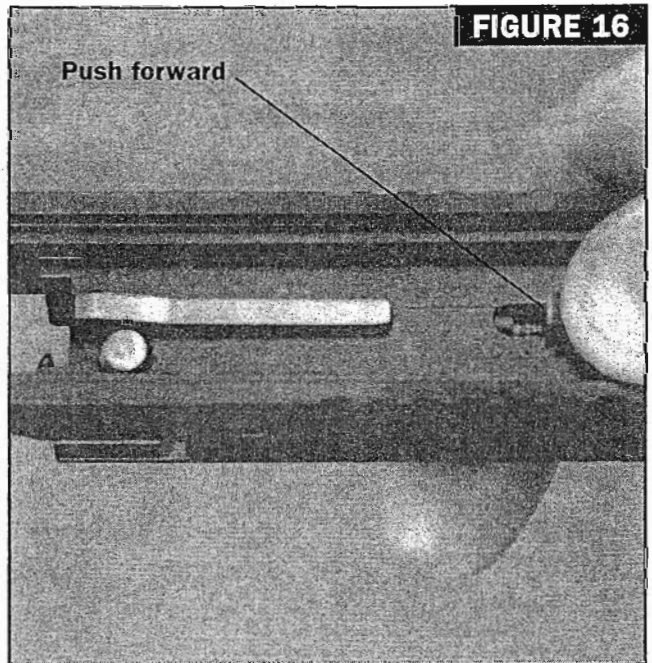

FIGURE 16

V.

FURTHER DISASSEMBLY

Only three tools are required for maintenance of the GLOCK pistol:

1. A Pin Punch 3/32" (2.5mm)
2. A Screwdriver 1/8" Blade (3mm)
3. Long Nose or Needle Nose Pliers (Any common type)

SLIDE DISASSEMBLY

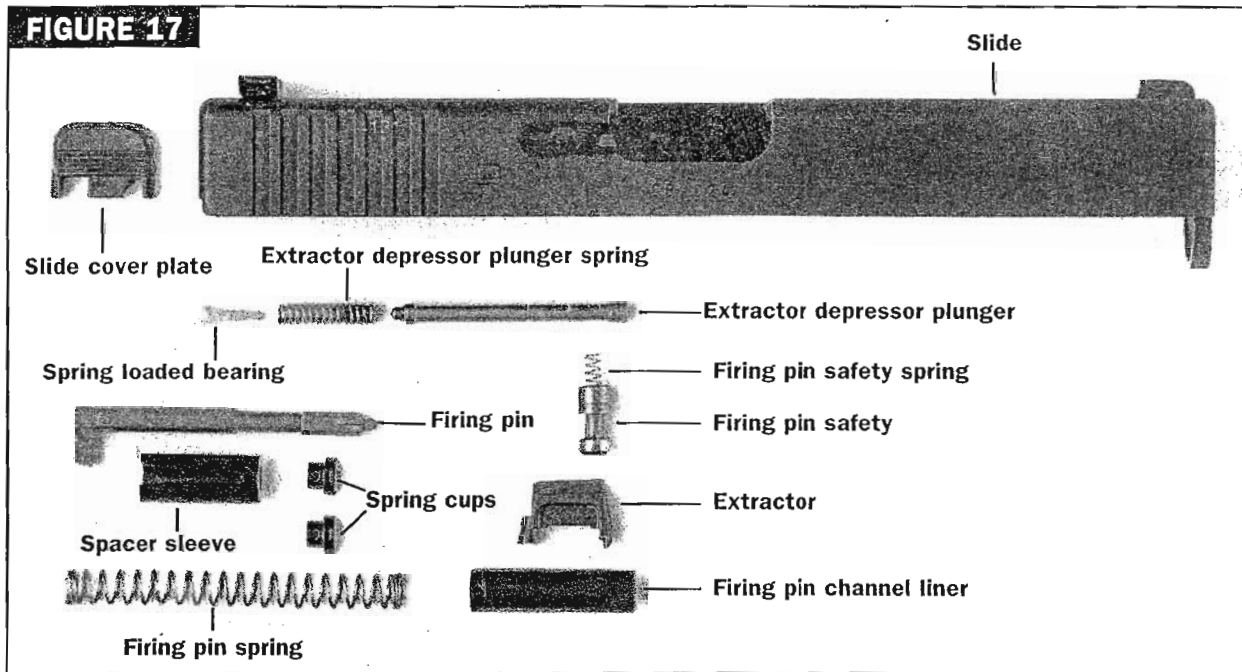

REMOVAL OF FIRING PIN ASSEMBLY AND EXTRACTOR DEPRESSOR PLUNGER ASSEMBLY

- To aid in the removal of the slide cover plate, place the muzzle end of the slide on a smooth, flat surface such as a table. Keep the slide in an upright position while applying firm downward pressure on the slide. With your free hand, use a pin punch to push the spacer sleeve towards the muzzle (Figs. 18 & 19).
- Simultaneously, slide the cover plate down and off.

SAFETY WARNING: The firing pin assembly and extractor depressor plunger are under compression. While removing the slide cover plate, place your thumb over the firing pin assembly and extractor depressor plunger to prevent these parts from ejecting.

It is possible that the slide cover plate will require some additional downward force during disassembly of a new pistol. A thin-bladed screw driver may be used to start removal.

- Remove the firing pin assembly (Fig. 20).
- Remove the extractor depressor plunger assembly (Fig. 21).
- The extractor depressor plunger assembly is made up of three parts: the extractor depressor plunger (part #12), the extractor depressor plunger spring and the spring loaded bearing (part #14).
- There are three color-coded spring loaded bearings: Black – 9x19, White – .40, .357, and Green – 10mm Auto, .45 Auto.
- The firing pin channel liner is located inside the firing pin channel and normally should remain in the channel. Should it separate during cleaning, simply insert with beveled edge toward breech.

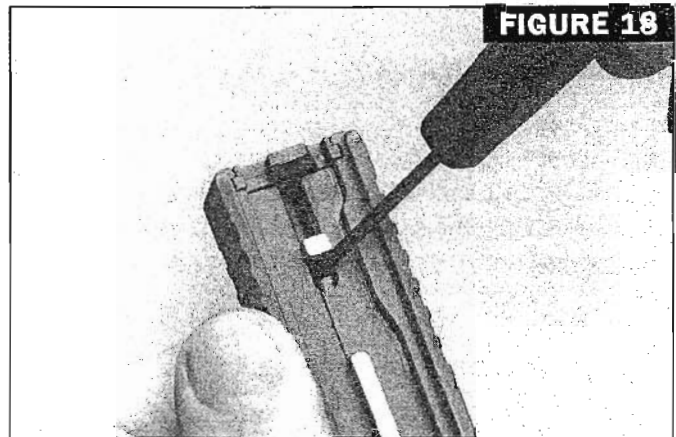

FIGURE 18

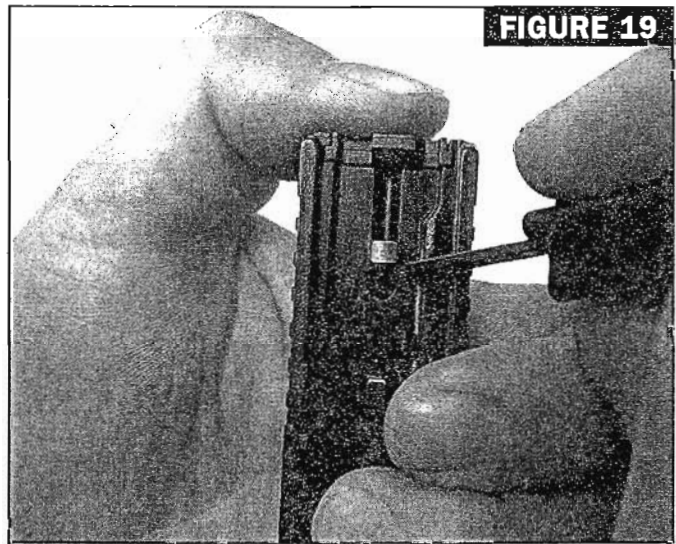

FIGURE 19

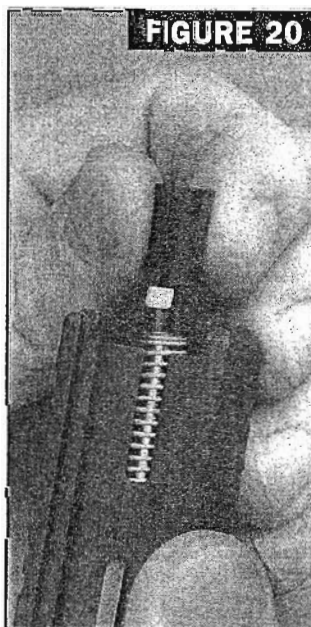

FIGURE 20

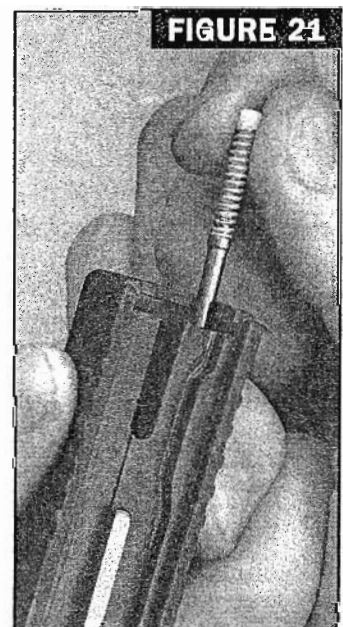

FIGURE 21

FURTHER DISASSEMBLY OF THE FIRING PIN ASSEMBLY AND THE EXTRACTOR DEPRESSOR PLUNGER ASSEMBLY

NOTE: The slide is used for disassembly and reassembly (as shown in Fig. 26).

- Wipe the firing pin spring with a clean dry cloth to remove any lubrication or solvent, including inadvertent lubrication. Pull down on the firing pin spring with thumb and forefinger as far as possible to allow clearance for removal of the firing pin spring cups.

WARNING: Be sure to keep a firm grasp on the firing pin spring so that it does not fly off the firing pin causing possible injury or loss of spring cups.

- Simultaneously, remove the two spring cups. Then, gradually release tension on the firing pin spring and remove it (Fig. 26).
- Take the spacer sleeve off the firing pin.
- When reassembling spring cups, make sure the small end is inside the firing pin spring.
- Remove the extractor depressor plunger spring from the extractor depressor plunger by twisting the spring.

NOTES:

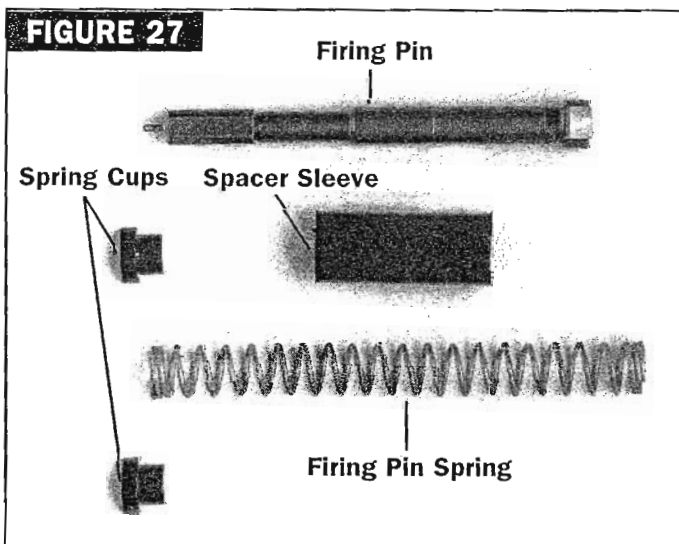
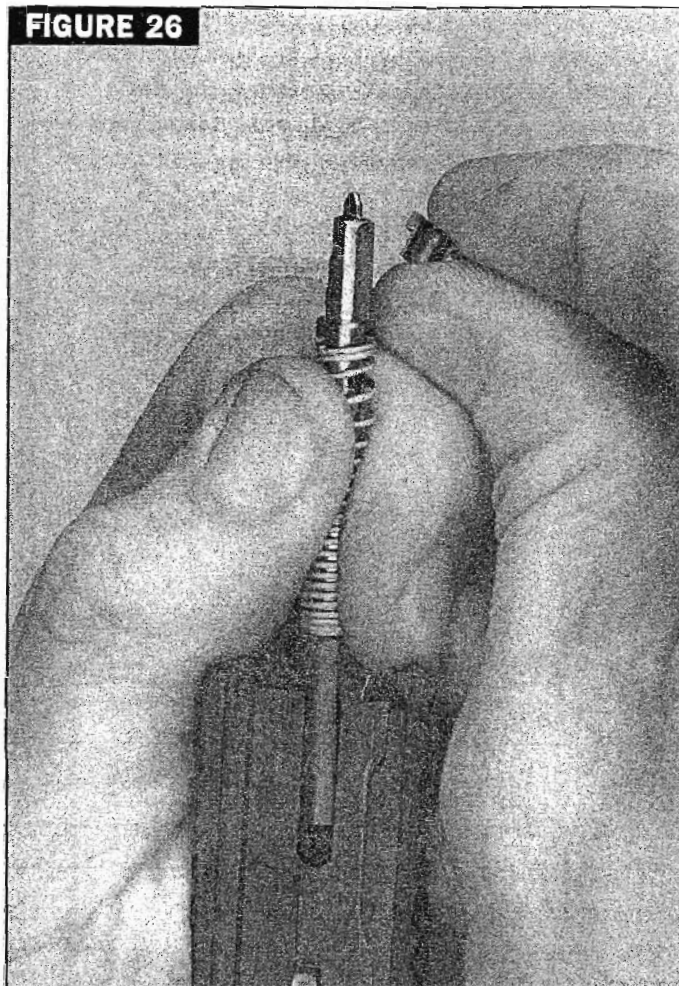

RECEIVER DISASSEMBLY

FIGURE 28

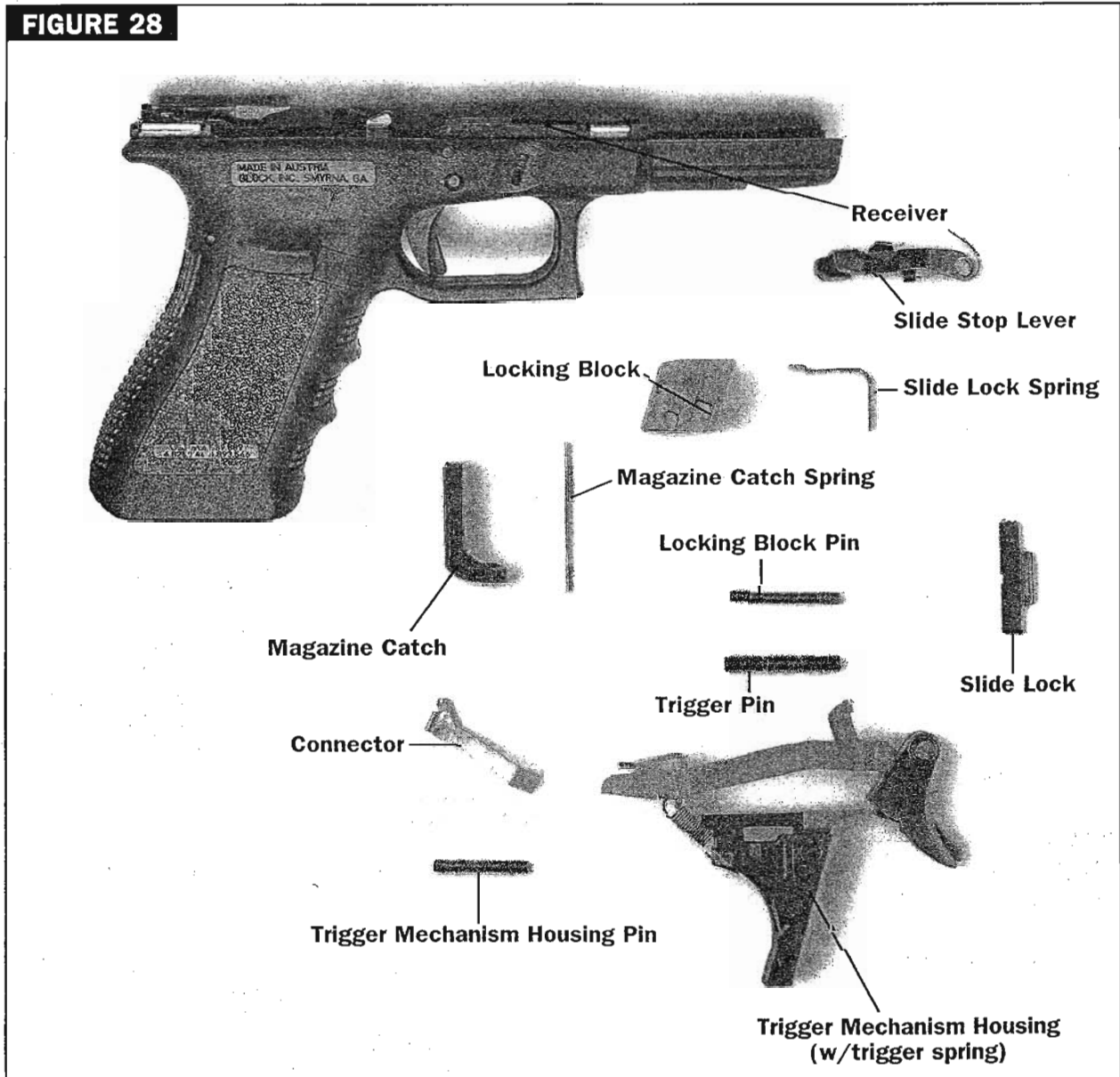

SPARE PARTS OPTIONS

Slide stop lever:

- standard
- extended

Magazine catch:

- standard
- extended (standard for models 17L, 20, 21, 24, 24C, 29, 30, 34, 35)

Connector (approximate weights):

- ~3.5 lb. trigger pull (marked with "-")
- ~5 lb. trigger pull (unmarked)
- ~8 lb. trigger pull (marked with "+")

New York Trigger Spring: please see page 27.

LOCKING BLOCK PIN REMOVAL

Pistol models featuring a locking block pin:
GLOCK 20, 20C, 21, 21C, 22, 22C, 23, 23C, 24, 24C, 26,
27, 28, 29, 30, 31, 32, 33, 35.

THE LOCKING BLOCK PIN SHOULD BE THE FIRST PIN REMOVED (FIG. 29), AND MUST BE THE FIRST PIN PUT IN OVER THE TRIGGER DURING REASSEMBLY.

TRIGGER PIN REMOVAL

- Use a pin punch to push the trigger pin from left to right (Fig. 30).

NOTE: To facilitate trigger pin removal, the slide stop lever should be moved forward/backward while applying pressure on the trigger pin. (Do not use excessive force, i.e. hammering, to remove the trigger pin.) This will unhook the slide stop lever spring, it is the slide stop lever which has to be moved out of the groove (Fig. 31). Always remove the trigger pin from left to right.

- If you failed your first trial to push the pin through, you should stop. If you try to move the lever now (radially i.e. forward and backward, not only up and down) you will see that it is not possible because it is jammed. For this reason you have to take your pin punch to the other end of the trigger pin and press gently against it until you are able to perform the above mentioned movement (forward and backward). Then start procedure again.

- Remove the trigger pin.



FIGURE 29

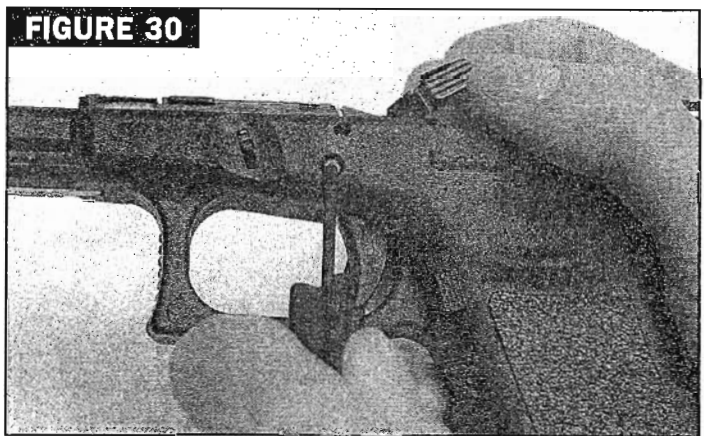

FIGURE 30

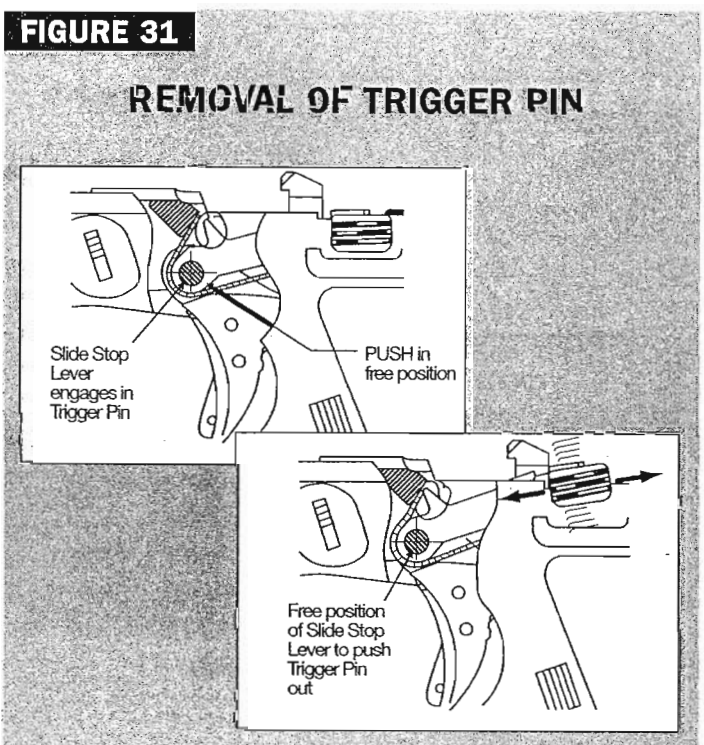
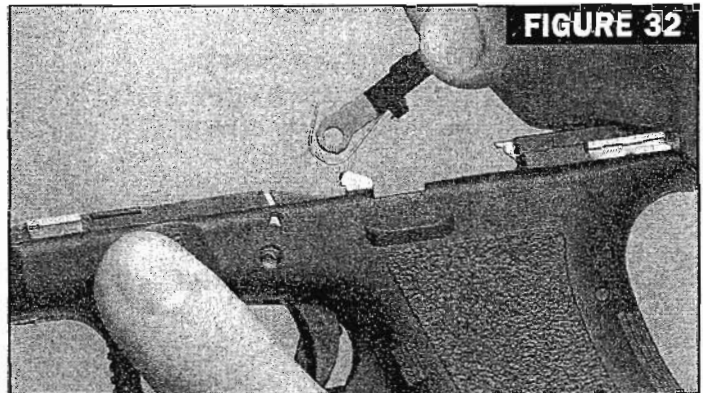

FIGURE 31

SLIDE STOP LEVER REMOVAL

- With the trigger pin removed, simply withdraw the slide stop lever by pulling it back (Fig. 32).



LOCKING BLOCK REMOVAL

- Use a pin punch or a screwdriver to raise the locking block (Fig. 33).
- Pry up from left side to prevent damage to trigger bar. Remove the locking block by hand (Fig. 34).

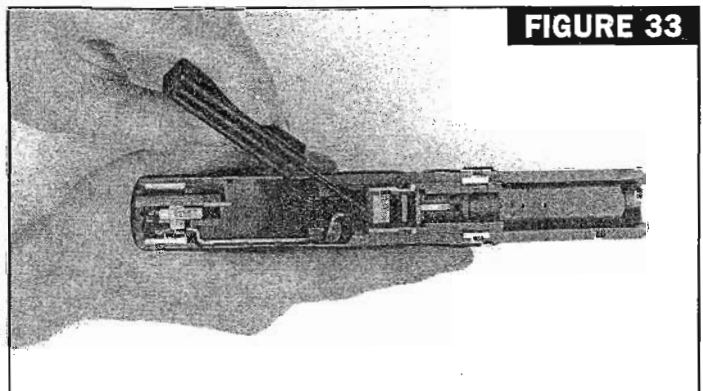

TRIGGER MECHANISM HOUSING PIN REMOVAL

- Use a pin punch to push the trigger mechanism housing pin out of the receiver (Fig. 35).
- Remove the trigger mechanism housing pin. (Remove from either side.)

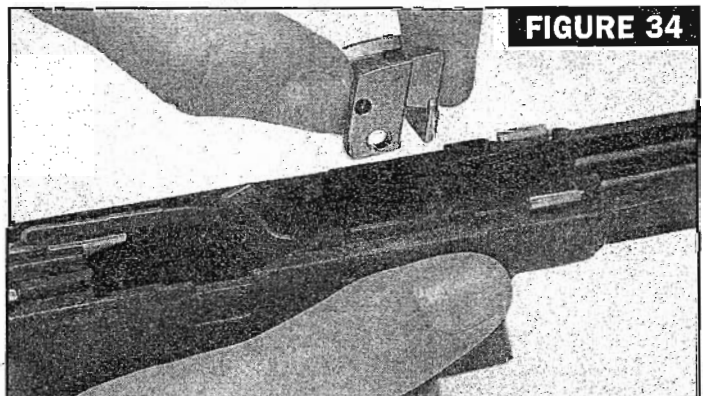

TRIGGER ASSEMBLY REMOVAL

- Using a pin punch, apply upward pressure under the ejector to raise the complete trigger assembly from the receiver as shown (Fig. 36).

Then, raise the rearmost portion of the trigger assembly above the receiver and withdraw the complete assembly (Fig. 37).

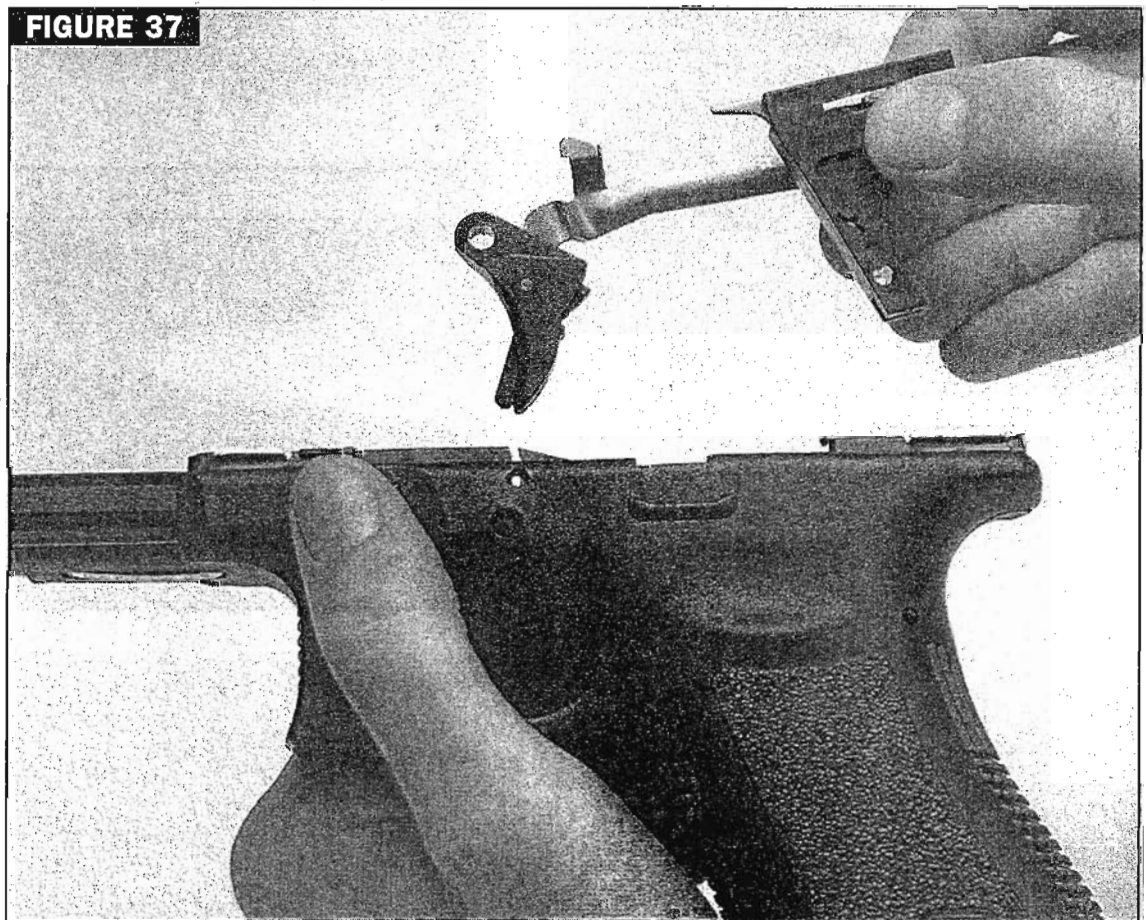
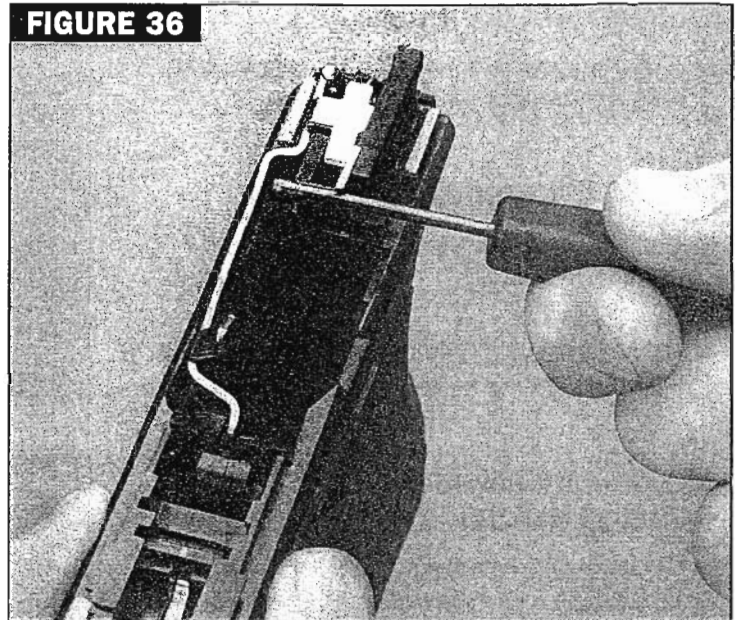

DISASSEMBLY OF TRIGGER ASSEMBLY

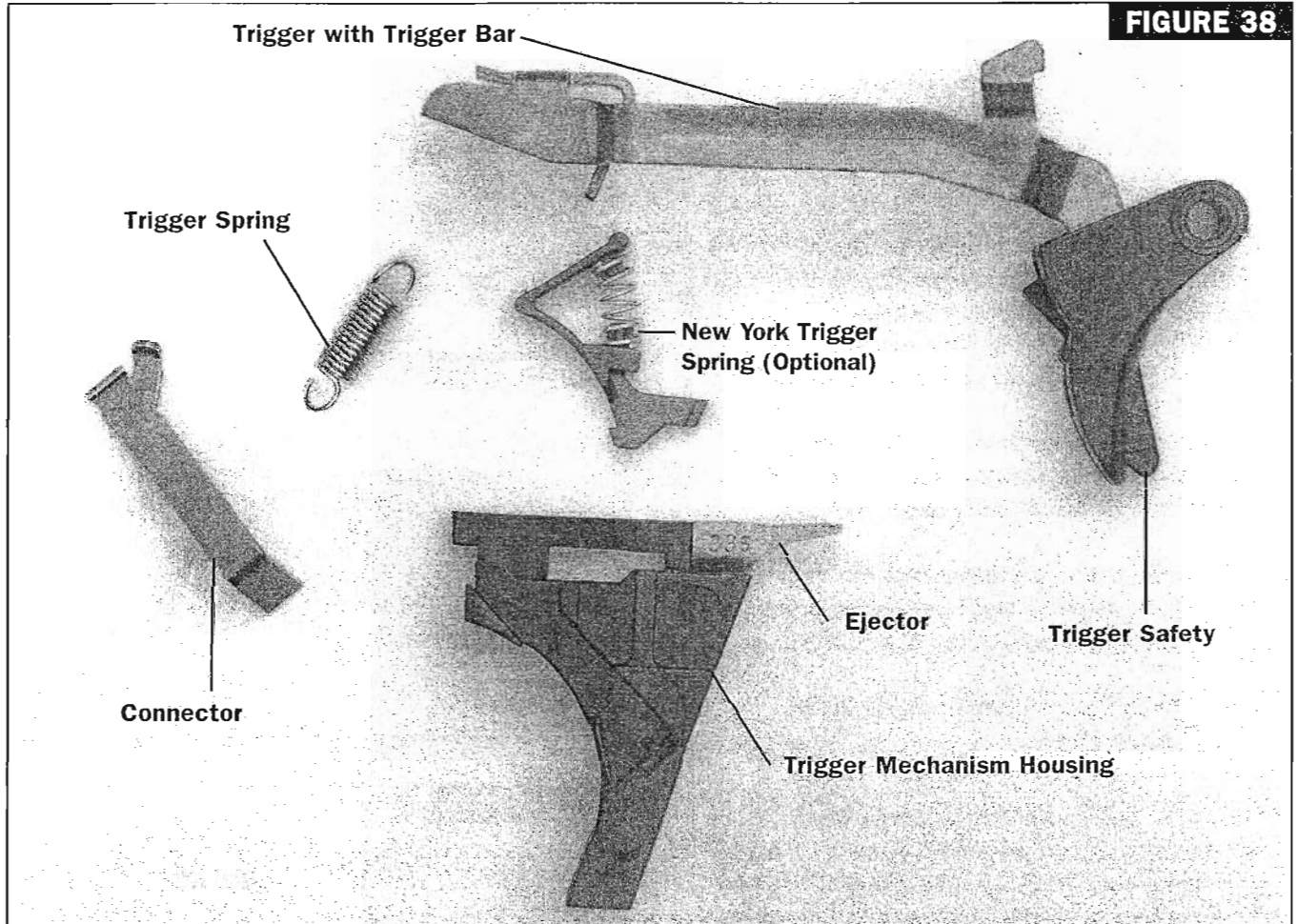

FIGURE 38

NEW YORK TRIGGER SPRING

The NY Trigger Spring is an alternative to standard coil trigger spring for revolver-like trigger characteristics. The New York Trigger Spring is produced in two colors with 2 differently colored springs for two different trigger pulls. **Either spring should be installed only with the 5 lb. connector, neither should be installed with the 8 lb. connector.**

The standard New York Trigger Spring (olive/silver) will increase the 5 lb. connector to an approximate 8 lb. trigger pull. The second and stronger version of the New York Trigger pull (called New York Trigger "2," orange/black) will increase the 5 lb. connector to an approximate 12 lb. trigger pull.

Before installing a New York Trigger Spring in older Model GLOCK 17 and 19 pistols, be sure that the connector fits tightly in the trigger mechanism housing. If the connector does not fit tightly in the trigger mechanism housing, replace with new parts to ensure a tight fit of the connector in the trigger mechanism housing.

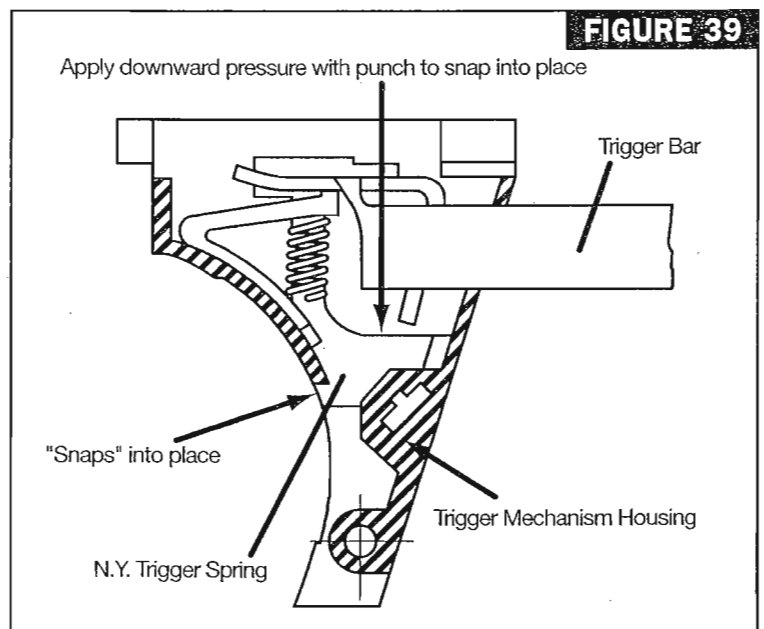

FIGURE 39

- Hold the trigger assembly as shown (Fig. 40).

Pull forward on the trigger with trigger bar while rotating the trigger bar counter clockwise (Fig. 41). The trigger with trigger bar can be lifted from the trigger mechanism housing.

NOTE: After the trigger with trigger bar has been lifted from the trigger mechanism housing, you will see that the coil trigger spring has an “s” configuration when viewed from the right (Fig. 42). Make sure that this same spring orientation is present during reassembly.

- Separate the trigger with trigger bar from the coiled trigger spring by working the hooked end of the trigger spring off the trigger bar.
- Separate the trigger mechanism housing from the trigger spring by removing the spring over the rear of the trigger mechanism housing.
- Using a flat-head screwdriver, remove the connector (Fig. 43).

CAUTION: Any lever you use to move the connector out should be inserted along the axis of the connector (i.e. the point where the lever forces against the connector should be located near the area where it is bent). Otherwise, you are liable to damage the part.

NOTE: On newer pistols the connector can be pushed out from the left side of the trigger mechanism housing using the pin punch.

FURTHER ASSEMBLY NOTE: When inserting the connector you have to make sure that it is completely in place! Press your pin punch (or your screwdriver) against the connector to push it in. While doing this operation, be careful to locate your tool as near as possible to where the connector is inserted in the trigger mechanism housing; otherwise, you could damage the connector.

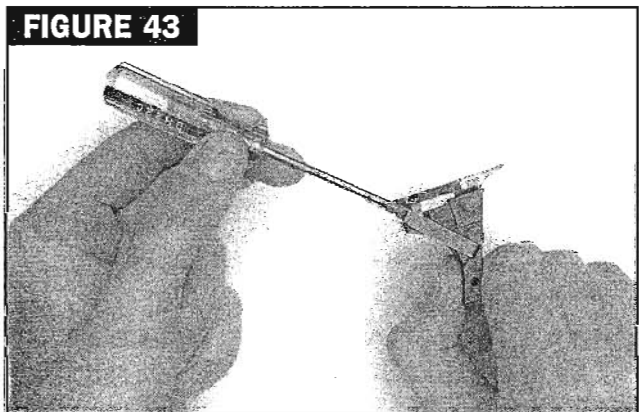
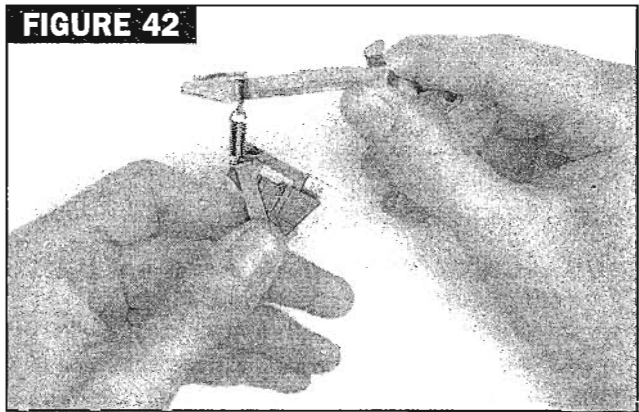
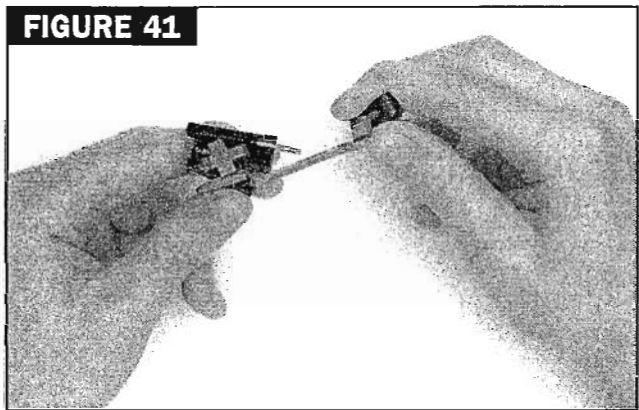
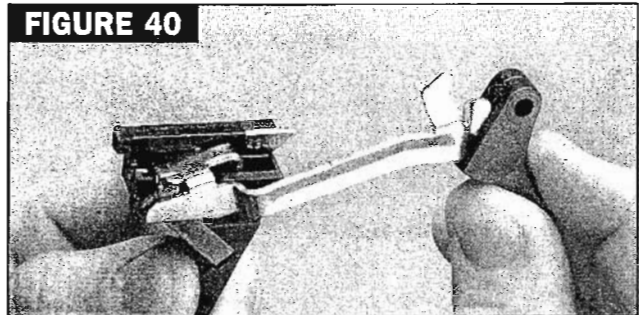

TRIGGER OPTIONS

TRIGGER SPRINGS

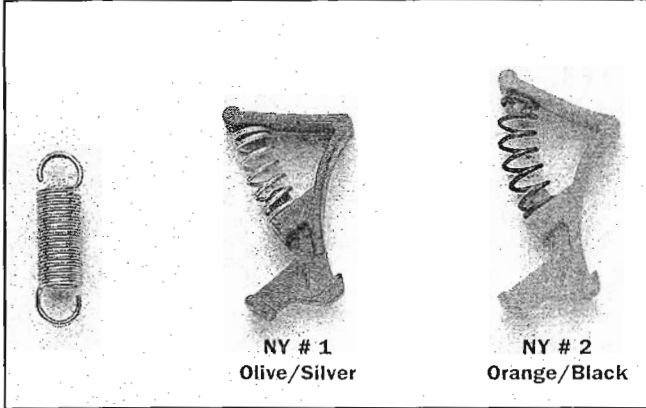

CONNECTORS

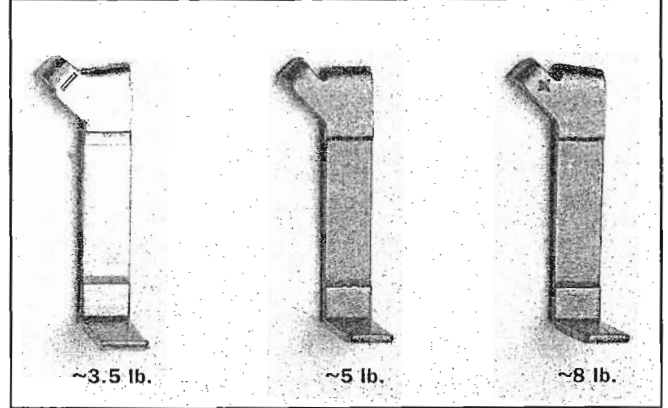

PARTS IDENTIFICATION

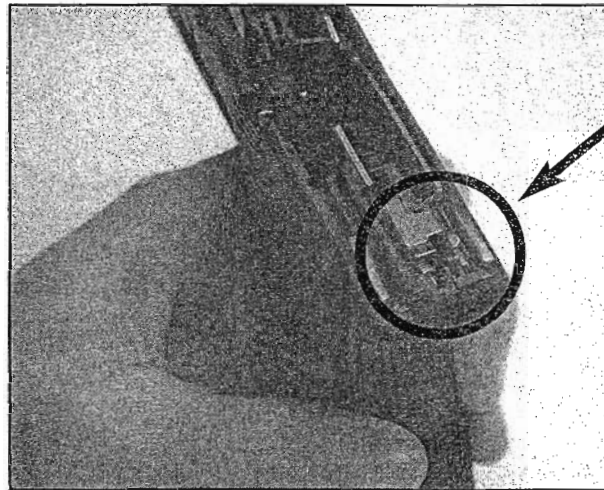

CONNECTOR

MARKED (-), (+)
OR NOTHING

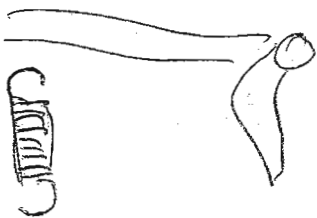

SLIDE LOCK REMOVAL

- While pressing the slide lock spring down as far as possible, as shown (Fig. 44), remove the slide lock (Fig. 45). To facilitate removal of the slide lock, hold the frame of the pistol on its side while depressing the slide lock spring.

SLIDE LOCK SPRING REMOVAL

- Remove the slide lock spring by raising it from the receiver with a pair of needle nose pliers or pin punch of 1/16" diameter or less as shown (in Fig. 46) or with the magazine catch spring (for using the magazine catch spring please follow instructions for magazine catch spring removal on page 31).

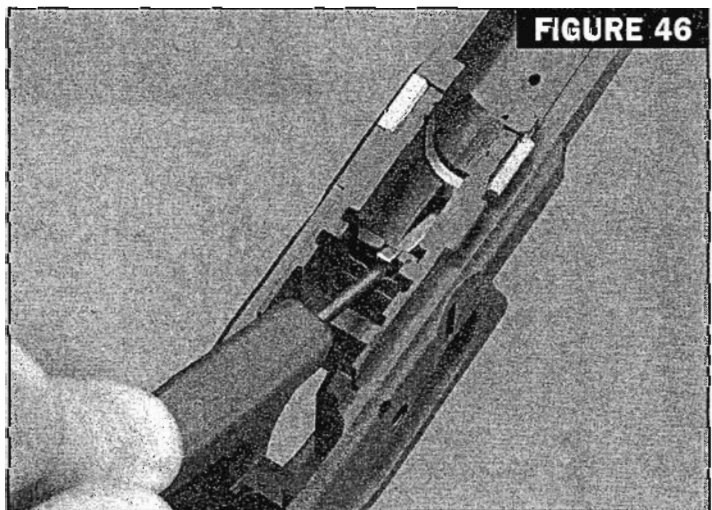
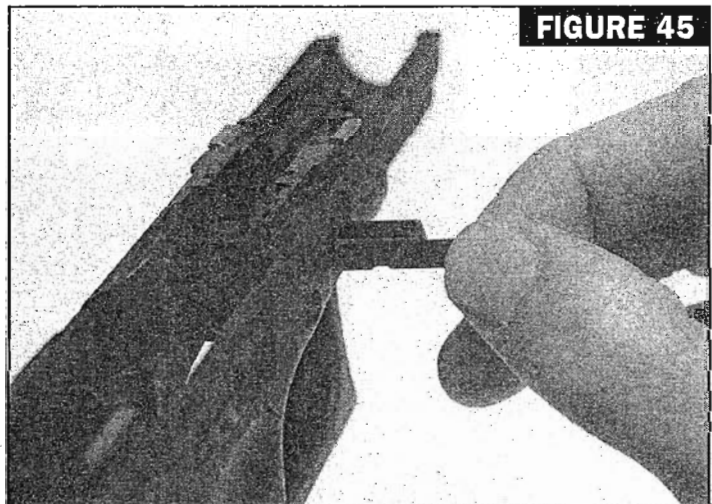
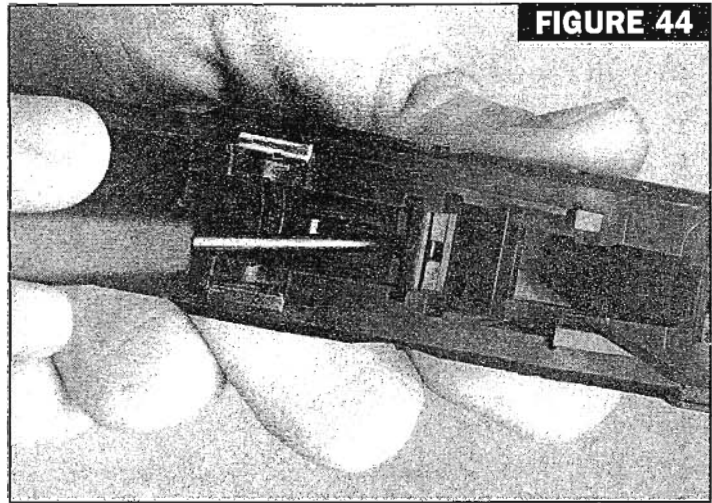

MAGAZINE CATCH REMOVAL

- Use a screwdriver to push the magazine catch spring out of the magazine catch groove (Fig. 47) as follows:

Be sure to press the right side of the magazine catch with a finger to prevent the magazine catch from moving when starting to push the magazine catch spring out of the groove.

Start with the screwdriver to the left of the magazine catch spring (Fig. 47). Push the spring to the right and then pry it out of the groove located on the bottom of the magazine catch.

- Remove the magazine catch from the right side of the receiver (Fig. 48).

MAGAZINE CATCH SPRING REMOVAL

- Using a pair of needle nose pliers, pull the magazine catch spring straight up and remove it.

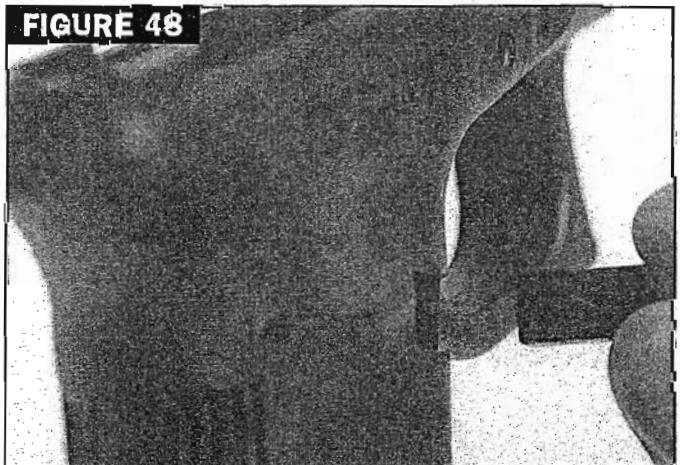
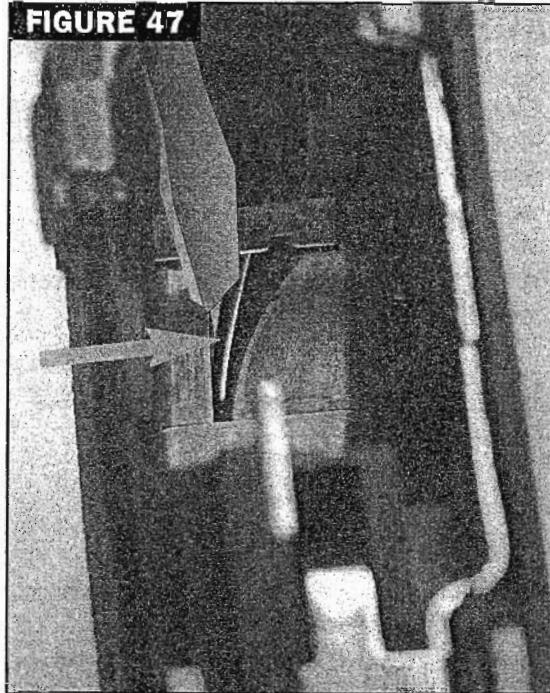

MAGAZINE DISASSEMBLY

For all magazines with the standard magazine floorplate and magazine insert, insert punch fully into the opening in the floor plate (Fig. 50). Push the magazine insert down into the magazine tube, and with the punch still in place, pull the floor plate forward with the punch while holding firmly on the sides of the magazine near its base. Remove the floor plate (Fig. 51), the magazine insert, the magazine spring and the follower.

WARNING: The magazine spring is under compression. Be sure to maintain downward pressure on magazine spring with your thumb while disassembling. Failure to do so could result in injury.

For older magazines without the magazine insert, press inward with thumb and first finger as you push the magazine floor plate forward or use a hard surface (Fig. 52). As soon as the floor plate starts to move, reposition hand so thumb retains magazine spring. Remove the floor plate, magazine spring and follower.

FIGURE 49

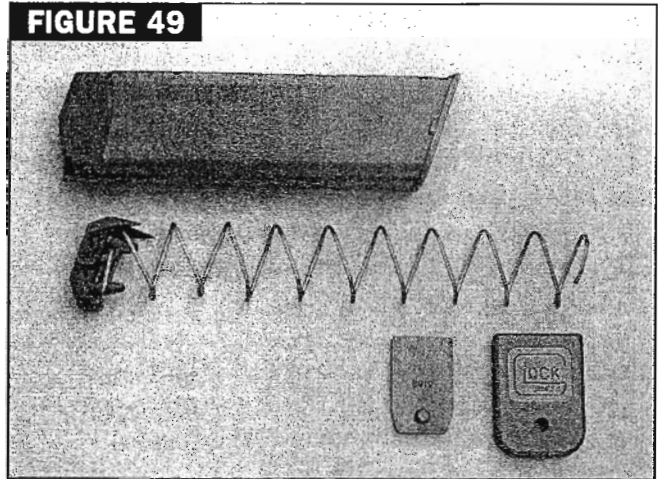

FIGURE 50

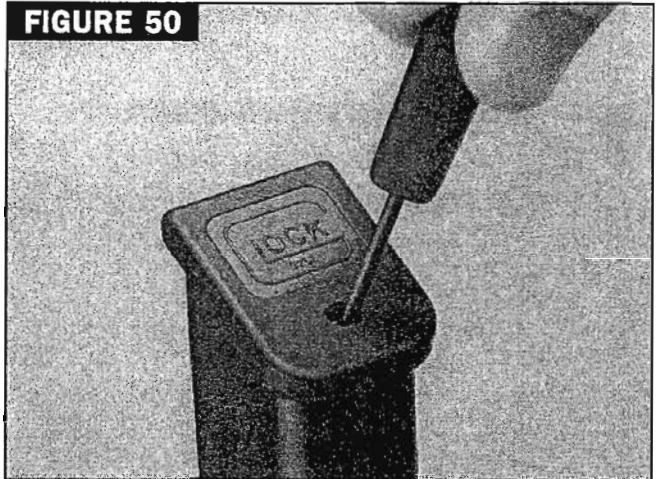

FIGURE 51

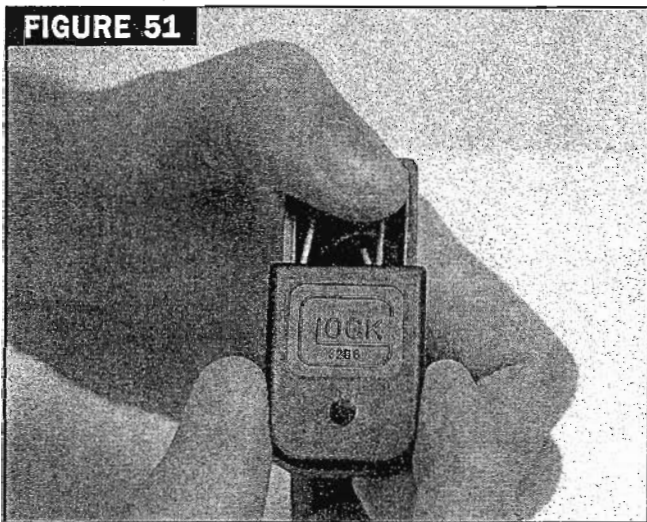
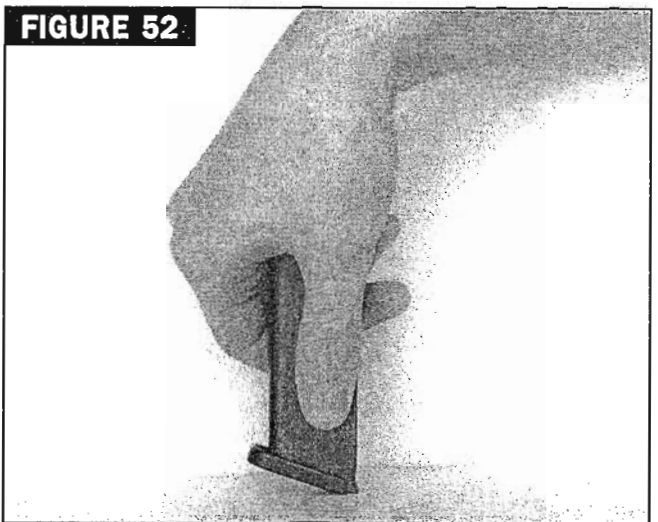

FIGURE 52



VI.

REASSEMBLY PROCEDURES

As with most firearms, reassembly is generally carried out in the reverse order of disassembly. Several specific suggestions are provided below to facilitate reassembly.

The **slide lock spring** has one end which is straight and the other end has a hump on it. The straight end is installed vertically into the receiver, with the hump going toward the rear.

The **slide lock spring** has a long and a short end. The short end is installed vertically into the receiver (Fig. 53).

When installing the **slide lock lever** always take care that the groove of the slide lock lever faces up and to the rear; otherwise a malfunction (e.g. failure of trigger system) of your gun could happen.

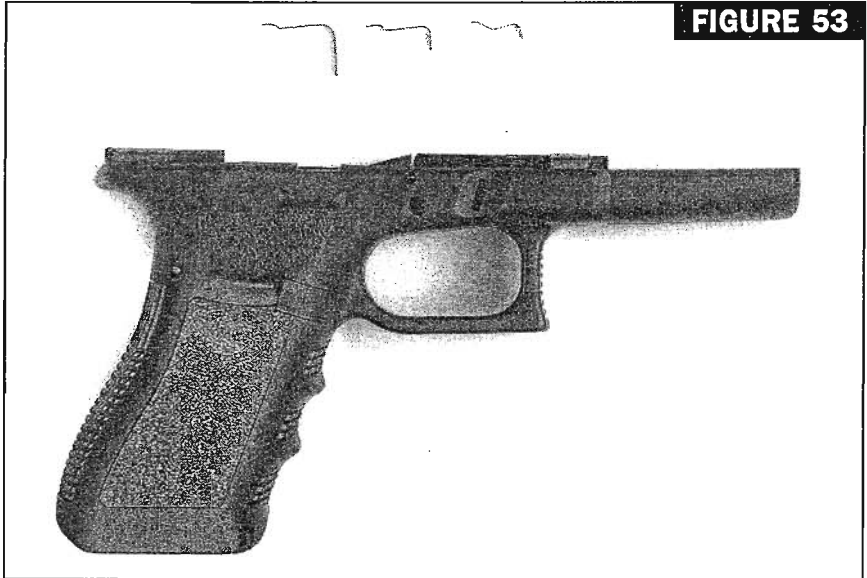

FIGURE 53

When assembling the **firing pin assembly**, use the slide to hold the firing pin and other components (Fig. 54).

To facilitate trigger pin installation, the **slide stop lever** should be moved slightly up/down and forward/backward while applying pressure on the trigger pin. Always insert the trigger pin from right to left.

The locking block pin is the first pin out during disassembly and the first pin in during reassembly.

CAUTION: If you install the locking block pin after inserting the slide stop lever, you will bend and damage the slide stop lever spring.

NOTE: When reinstalling the **extractor depressor plunger**, make sure you have steel to steel and polymer to polymer.

When reinstalling the **slide stop lever** in the pistol, be sure it locks into the groove in the trigger pin. To function check the slide stop lever, lift it from its rest position and release it.

If the **slide stop lever** is properly installed and has engaged the groove in the trigger pin, the slide stop lever will snap back down into the rest position after being lifted and released. Re-check that it is possible to move the slide stop lever forward and backward.

When installing the captive or older style **recoil spring** assembly (Fig. 55), be sure that the back end of the recoil spring tube rests in the half-moon cut in the bottom of the front barrel lug.

When replacing the slide cover plate, use the punch to depress the firing pin assembly as the plate is pushed inward (Fig. 56).

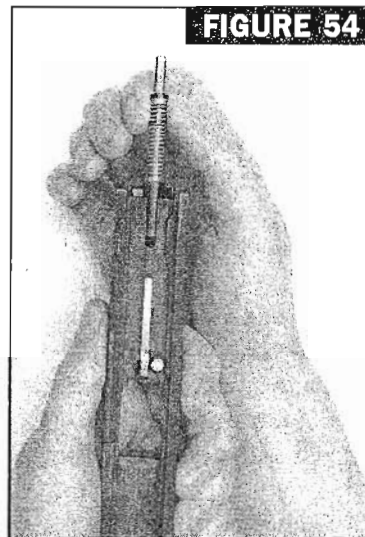

FIGURE 54

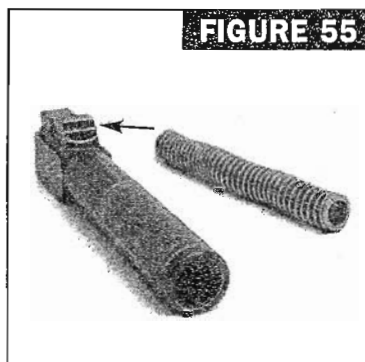

FIGURE 55

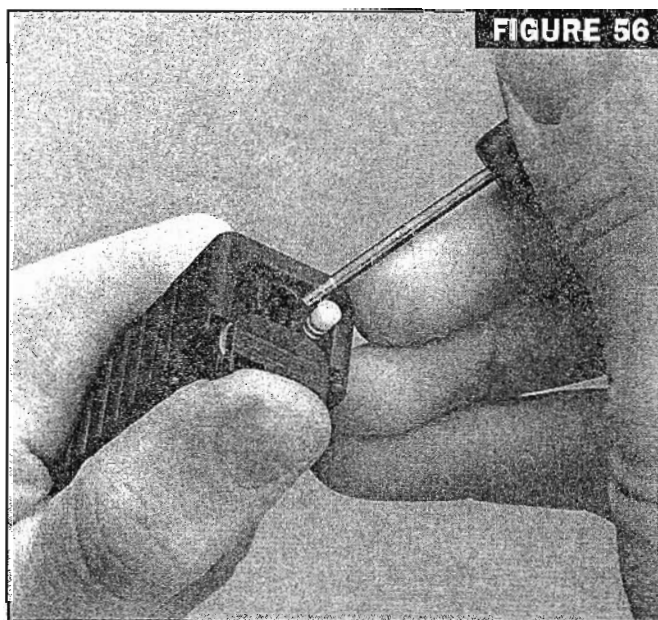

FIGURE 56

Then, use the tip of the pin punch to depress the spring loaded bearing, compressing the extractor depressor plunger spring while pushing the cover plate into its fully locked position (Fig. 57).

CHECK ROUTINES AFTER REASSEMBLY:

- Check that all pins are inserted, and centered in the receiver.
- Pull trigger – hold your finger outside trigger guard – cycle slide quickly again – check if trigger is in forward position.
- Pull trigger – then apply pressure to it – cycle slide quickly – release trigger slowly and check trigger safety – it should engage correctly. If pulling the trigger without actuating the trigger safety, the trigger safety should not release the trigger.
- Shake gun forward and backward with trigger pulled and apply pressure to the trigger – listen to see if firing pin moves freely.
- Check engagement of firing pin with trigger bar: On slide, replace standard slide cover plate with orange slide cover plate (special slide cover plate with lower part cut off; a slide cover plate on which you cut off the lower part beneath the lined area will do as well). You are now able to observe the engagement of the firing pin with the trigger bar. Cycling the slide should result in an engagement of at least $\frac{2}{3}$ of the thickness of the trigger bar. If engagement is okay, remove orange slide cover plate and put on standard one. If engagement is less than $\frac{2}{3}$, replace the trigger bar and repeat check.

NOTE: If your gun does not fulfill test routines, then check your assembly carefully!

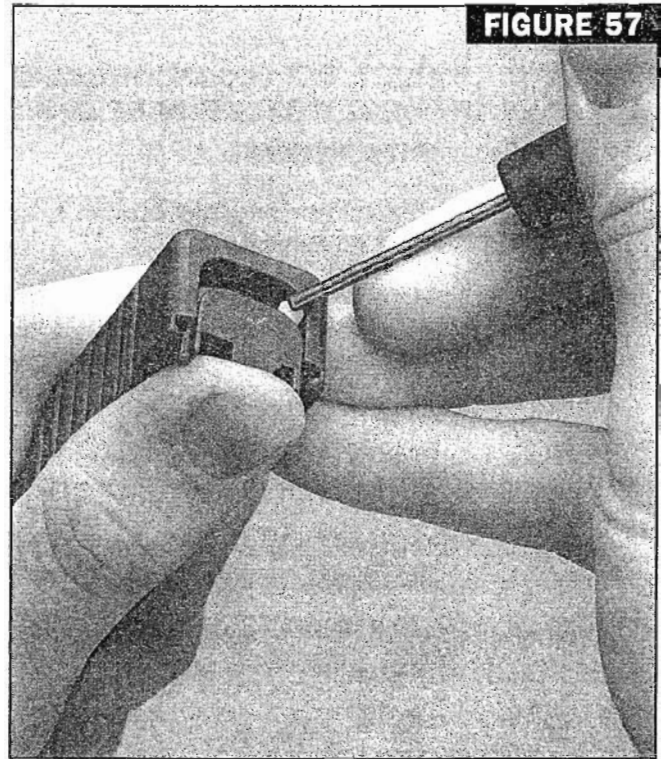

FIGURE 57

VII.

SIGHT REMOVAL AND INSTALLATION

REAR SIGHT

HOW TO OPERATE THE GLOCK INSTALLATION AND ADJUSTMENT DEVICE FOR REAR SIGHTS

For use with ALL GLOCK MODELS

NOTE: There are two different sight installation devices available. One for use with 9x19, .40 and .357, the other for use with 10 mm Auto and .45 Auto pistols.

WARNING: Before installing or adjusting rear sights, BE SURE that your pistol is UNLOADED, with the MAGAZINE REMOVED. Strictly obey the following INSTALLATION SAFETY PRECAUTIONS:

Remove magazine while pointing pistol in a safe direction (with finger off the trigger). Lock the slide to the rear by pushing up on the slide stop lever while pushing the slide to the rear.

Once the slide is locked to the rear, then both visually and physically inspect the chamber to verify that the chamber is empty. The sight installation device can be used with the slide locked to the rear or when the pistol is field stripped.

GLOCK INSTALLATION AND ADJUSTMENT DEVICE FOR REAR SIGHTS ALLOWS:

- removal of rear sight
- mounting of new rear sight
- adjustment (lateral)

NOTE: If you wish to shift the point of impact on your target to the left, you have to move the rear sight to the left and vice versa (left and right in muzzle direction).

Point of impact	Direction in which to move rear sight
left of center	right
right of center	left
low	insert higher rear sight
high	insert lower rear sight

NOTE: Following sizes of original GLOCK rear sights are available:

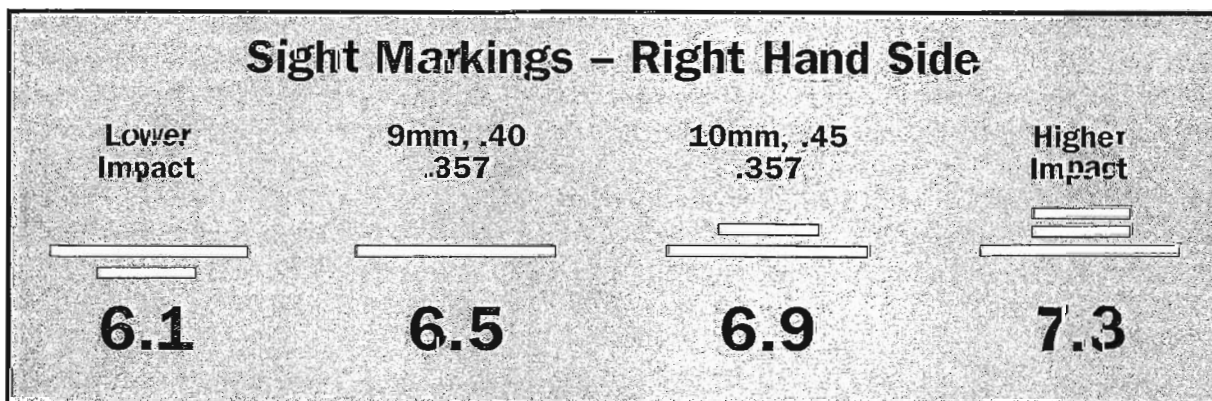

Each size change represents a 3 inch difference in bullet impact at 25 yards.
Always move the rear sight in the direction you want the bullet to move on the target.

NOTE: For proper operation of the GLOCK sight installation device, a drop of quality lubricating oil should be applied between the end play nuts (E). A drop of quality lubricating oil should be applied to the drive screw (D) and the drive screw run back and forth, allowing the oil to penetrate the internal threads of the sight carrier (B).

SIGHT INSTALLATION DEVICE

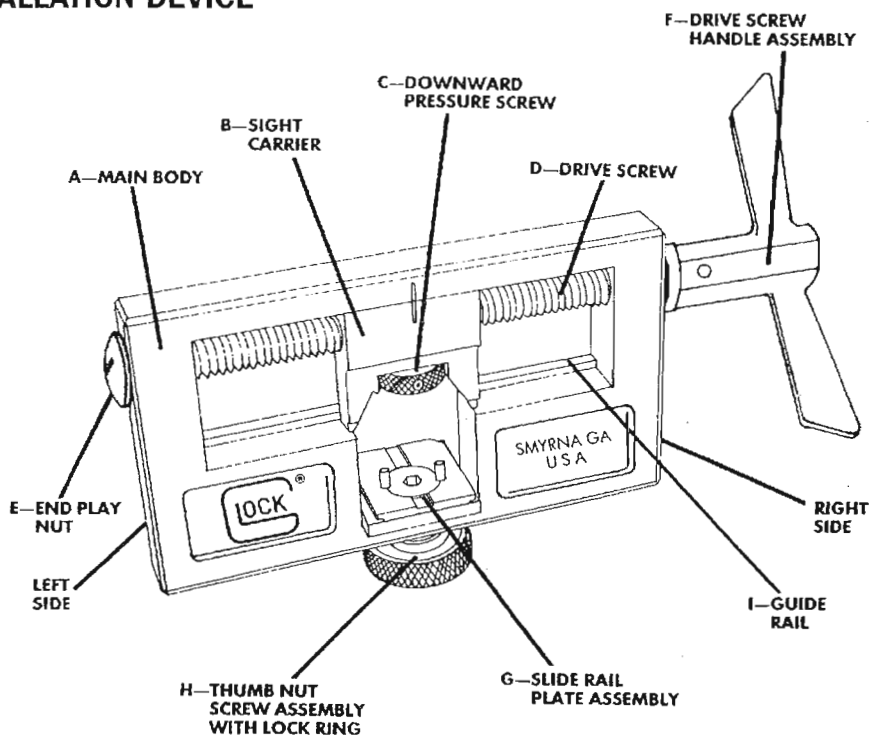

*SIGHT TOOL COMES IN SMALL (9X19, .40 AND .357) AND LARGE (.45 AUTO, 10mm AUTO)

TO ADJUST REAR SIGHT FOR WINDAGE

After loosening the slide rail plate assembly (G) with the thumb nut (H), center sight carrier so that marks on body (A) and sight carrier (B) align. Place slide in slide rail plate assembly (G) by aligning the slide rail cuts with the slide rail plate assembly. Push the slide to the rear until the camming cut in the slide contacts the pin protruding from the right side of the slide rail plate assembly (G), tighten thumb nut (H). Turning handle (F) clockwise will move rear sight to the right and vice versa.

TO REPLACE POLYMER OR REAR NIGHT SIGHT

Turn handle (F) counter clockwise to move carrier to left center of window. Insert slide rail cuts in slide rail plate (G), tighten thumb nut (H). Insert new GLOCK sight in carrier, making sure to seat new sight back against guide rail (I). Turn downward pressure screw (C) to apply slight pressure to the top of new sight, making sure white outline is facing toward the rear. Turn handle (F) clockwise removing old sight, and installing new one simultaneously.

NOTE:

When replacing broken night sight with new one you must center sight carrier (B), install slide in slide rail plate (G), tighten thumb nut (H), push old metal sight out, place new night sight in carrier and install in normal manner. Never push metal sights with outside edge of carrier.

REAR NIGHT SIGHT INSTALLATION

Same procedure as with polymer rear sight, except no downward pressure is required. Be sure the luminous vials face to the rear.

FRONT SIGHT REMOVAL AND INSTALLATION

FRONT SIGHT REMOVAL

- To remove the polymer front sight from the slide, position the front of the slide in an upside down position over the edge of a table or workbench. While firmly holding the slide on the workbench, tap the front sight from the slide with a pin punch and small hammer (the slide may be held in a vice to perform this procedure. If a vice is used, be sure that protective jaw covers are used so as not to damage the slide).

FRONT SIGHT INSTALLATION

- Insert a new front sight into the front sight slot and press it flush with the top surface of the slide.
- The new front sight should be placed on a smooth wood or plastic surface after it has been inserted into the slide to be sure it is not pushed out of the slide when inserting the fixing pin.
- Insert a fixing pin in the slot in the base of the front sight, by hand or with the aid of long nose pliers.
- With a flat screwdriver push the fixing pin into the base of the front sight (Fig. 58).
- Make sure that the fixing pin is just below the edge of the sight.

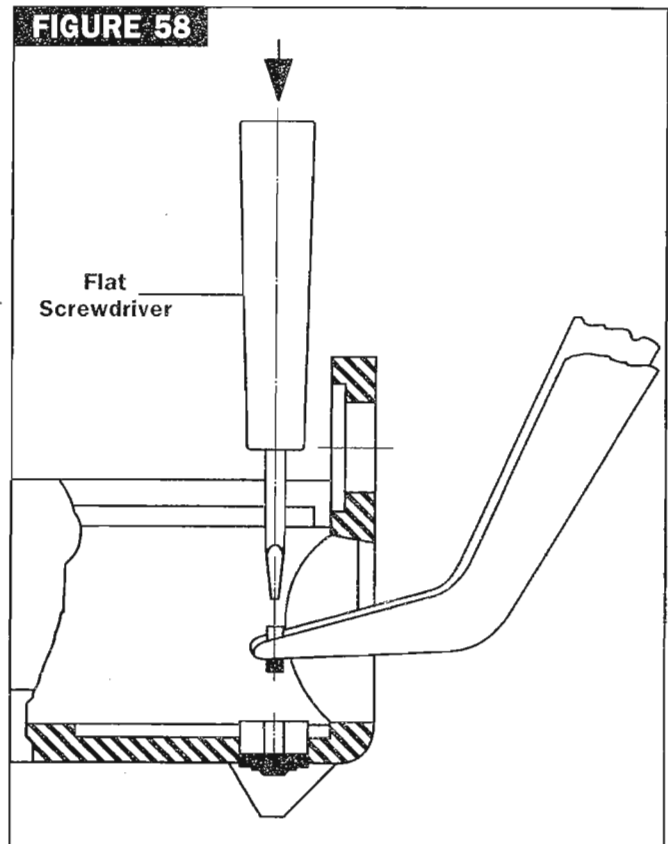

FRONT NIGHT SIGHT INSTALLATION

Position front sight in slot, apply thread adhesive to thread, tighten screw snug. Do not over tighten or screw will snap or break.

FRONT NIGHT SIGHT INSTALLATION TOOL — 3/16" nut driver

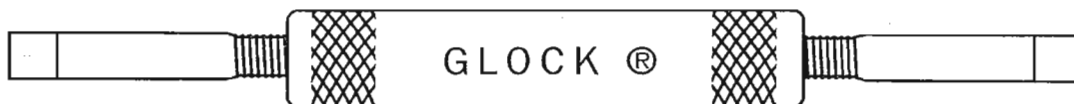

FRONT SIGHT REMOVAL AND INSTALLATION FOR GLOCK® NIGHT SIGHTS

- Put adhesive around the front sight pin.
Adhesive: e.g., Loctite 648 or similar.

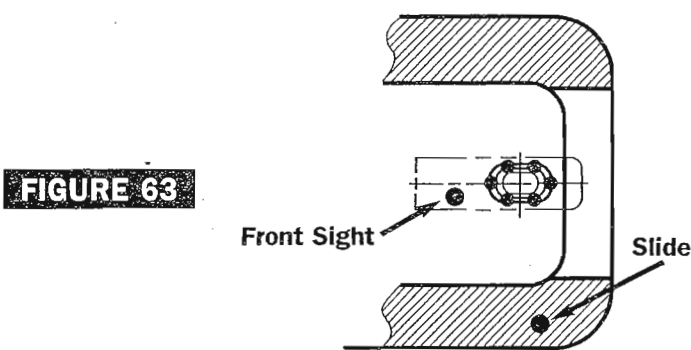
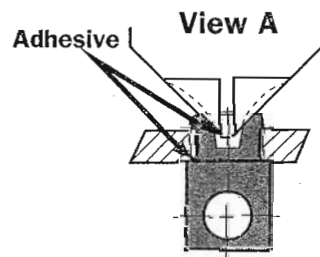
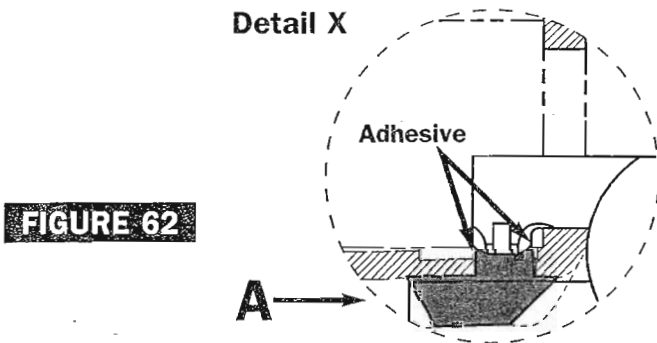
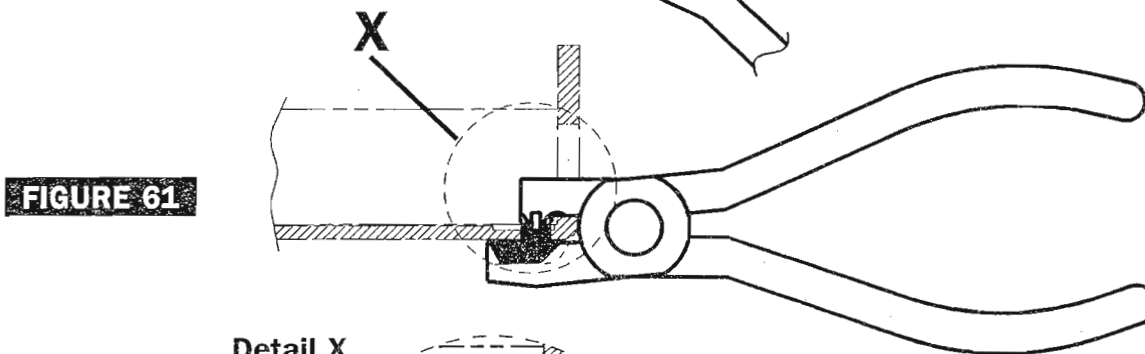
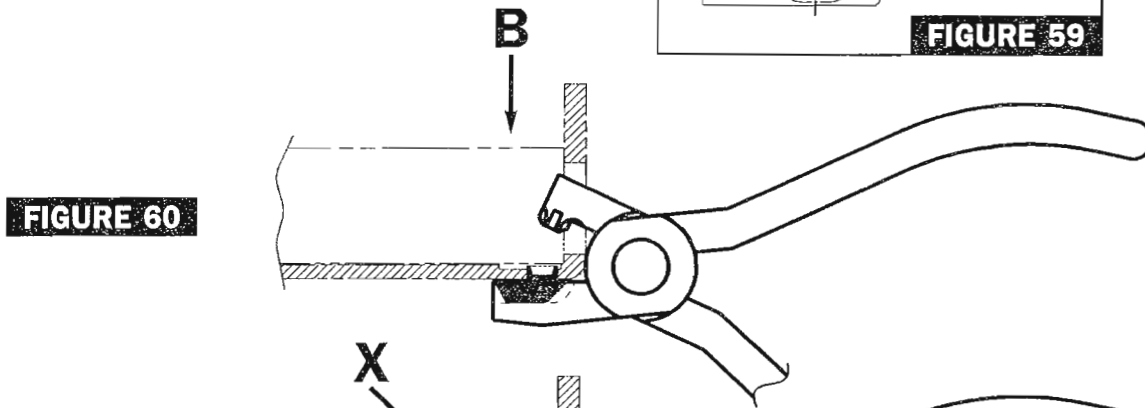
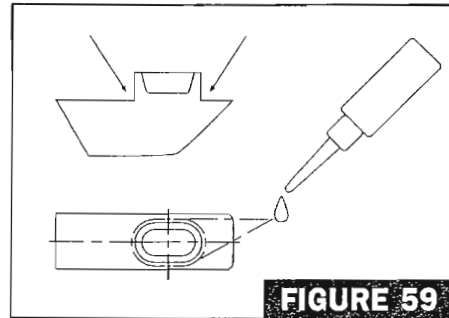

View B
Staked w/Adhesive

VIII.

SERVICE PROCEDURES AND DIAGNOSTICS *

OBSERVED PROBLEM	PROBABLE CAUSES	CORRECTION
FAILURE TO EXTRACT	Extractor worn/broken/missing Overpowered or under-powered defective ammunition Dirt under extraction claw Dirty chamber Shooting with an unlocked wrist	Replace Change ammunition Clean extractor and check function Clean chamber Lock shooting hand wrist
	FAILURE TO EJECT OR ERRATIC EJECTION (INCLUDING STOVE PIPES)	Broken or damaged ejector Underpowered ammunition Dirty chamber Shooting with an unlocked wrist Lack of lubrication Dirty gun
FAILURE TO FEED	Magazine not properly inserted Underpowered ammunition Dirty magazine Weak magazine spring Dirty chamber Tight extractor Shooting with an unlocked wrist Deformed magazine Weak recoil spring	Reinsert magazine Change ammunition Clean and inspect magazine Replace if necessary Clean chamber Replace or clean as needed Lock wrist Magazine sides or lips deformed—replace magazine Replace
	SLIDE FAILS TO LOCK OPEN ON LAST ROUND	Magazine follower broken Dirty magazine Weak magazine spring Worn slide stop lever notch Dirty gun Needs lubrication Deformed magazine Trigger pin inserted too far Improper grip Slide stop lever worn Slide stop lever damaged Underpowered ammunition Shooting with an unlocked wrist

*The above listed are intended as aids in diagnosing the cause and correction of problems observed when shooting. They are not intended to be exclusive or "catch-all" remedies. The actual remedy may consist of one or more of the above listed factors.

SERVICE PROCEDURES AND DIAGNOSTICS * (CONT'D)

OBSERVED PROBLEM	PROBABLE CAUSES	CORRECTION
FAILURE TO FIRE	Slide out of battery (DO NOT FORCE INTO BATTERY) due to: Deformed/defective round Under-powered ammunition Damaged/weak recoil spring Damaged recoil spring tube Mating surfaces of barrel, slide and receiver excessively dirty. Gun dirty/obstructed chamber Shooting with an unlocked wrist	Inspect and replace round Change ammunition Replace recoil spring Replace recoil spring tube Field strip and clean Clean chamber Lock shooting hand wrist
NO PRIMER STRIKE	Worn or broken firing pin tip Obstructed channel Spring cups inverted	Replace Clear Change
LIGHT, CENTERED STRIKE	Hard primer (SMG ammunition) Obstructed firing pin channel	Change ammunition Remove, inspect and clean firing pin and firing pin spring. Clean firing pin channel.
LIGHT OFF-CENTER STRIKE	Tight extractor Dirty gun Slide lock reversed or not beveled	Change Clean Replace
INCONSISTENT TRIGGER PULL OR WILL NOT RELEASE	Connector loose in housing Pistol is excessively dirty Wrong trigger bar Connector needs lubrication Trigger bar is bent/damaged	Replace housing Field strip and clean Replace Lubricate Replace trigger bar
TRIGGER SAFETY FAILS TO RETURN TO ENGAGED (FORWARD) POSITION	Improperly stored in original box with trigger in full forward position (trigger safety fully depressed)	Replace trigger bar. When stored in original box, pistol must be unloaded, trigger in back position.
FIRING PIN SAFETY FAILS DESCRIBED IN THE MANUAL	Damaged, worn or defective firing pin spring	Replace only damaged part
LOCKS OPEN EARLY	Improper hand position Reverse tension on slide stop lever spring Damaged slide stop lever	Change grip Replace Replace

*The above listed are intended as aids in diagnosing the cause and correction of problems observed when shooting. They are not intended to be exclusive or "catch-all" remedies. The actual remedy may consist of one or more of the above listed factors.

NOTES

GLOCK CERTIFIED ARMORER POLICY ON PROFESSIONALISM

GLOCK Certified Armorers have long been known for their professionalism and expertise. The purpose of certification of GLOCK Armorers is to facilitate the professional handling of required maintenance of GLOCK pistols. More specifically, it is our intention that only GLOCK certified Armorers work on GLOCK pistols. It is the belief of GLOCK, Inc. that this policy best ensures the safety of GLOCK customers and the integrity of GLOCK pistols.

In furtherance of this policy:

1. GLOCK, Inc. encourages you to use the GLOCK logo and "GLOCK Certified Armorer" on business cards for yourself or your business. However, further use of the GLOCK trademark and GLOCK logo is not permitted without written authorization from GLOCK, Inc.
2. GLOCK factory parts offered to GLOCK Certified Armorers are to be used for customer requested maintenance only. GLOCK factory parts are not for re-sale.

GLOCK Certified Armorers who deviate from these standards of professionalism will not be invited to renew their certification. Any and all licenses previously granted for use of the trademark and logo will be immediately rescinded upon deviation from this policy.

COURSE FORMS

GLOCK Pistol Inspection Form

WARNING: NO LIVE AMMUNITION IN INSPECTION AREA; CHECK THAT PISTOLS AND MAGAZINES ARE UNLOADED AND CLEAR.

Name: _____ Model: _____ Serial Number _____ Date: _____

INSPECTION OF ASSEMBLED PISTOL (Mark pass/fail)

- | | |
|---------------------------------------|--|
| 1. External visual inspection _____ | 5. Trigger reset check _____ |
| 2. Trigger safety check _____ | 6. Does empty magazine lock slide back _____ |
| 3. Trigger pull _____ | 7. Are component parts correct _____ |
| 4. "Locking up" and "unlocking" _____ | 8. Engagement _____ |

INSPECTION OF FIELD STRIPPED AND DETAILED STRIPPED PISTOL

Component	Pass	Fail	Component	Pass	Fail
I. FIELD STRIPPED EXAM			5. Firing pin spring		
A. Barrel			6. Spacer sleeve		
1. Barrel bulged			7. Firing pin channel liner		
2. Cracks at muzzle or chamber			C. Extractor depressor plunger assembly		
3. Longitudinal cracks			1. Installed properly		
4. Condition of lugs			2. Spring straight and undamaged		
B. Slide			3. Correct spring loaded bearing		
1. Sights/Night Sights (inspection)			D. Extractor		
2. Front Sight pin/screw present			1. Upgrade present		
3. Grooves (condition of)			2. Condition of extractor		
4. Guide ring			E. Firing pin safety		
5. Cracks, especially under ejection port			1. Upgrade present		
6. Slide "stop" lever notch			2. Firing pin safety spring in place		
7. Brass deposits (excessive?)			3. Firing pin safety test		
8. Extractor clearance (clean?)			D. Locking block pin — upgrade		
C. Receiver			E. Trigger pin		
1. Magazine catch			F. Locking block		
2. Receiver cracks			G. Trigger spring — installed correctly		
3. Slide stop lever tension			1. With proper connector		
4. Correct ejector			H. Trigger with trigger bar		
5. Condition of rails			1. Correct for the pistol		
6. Slide lock (up & to the rear)			2. Unusual wear		
D. Recoil spring assembly			I. Trigger mechanism housing		
II. DETAIL STRIPPED EXAM			1. Ejector condition		
A. Slide cover plate			2. Connector tight		
B. Firing pin assembly			J. Magazine		
1. Upgrade present			1. Tube-lips damaged		
2. Correct firing pin			2. Spring-correct, undamaged		
3. Nose chipped or broken?			3. Follower, cracked, broken		
4. Firing pin spring cups			4. Correct for pistol		

Remarks: _____

Reassembly—After the component parts of the "detailed stripped" pistol have been found to be acceptable (or have been corrected), and they have been cleaned, the pistol will be reassembled. The reassembled pistol will then be reinspected to ensure functionality.

Inspected By: _____

TECHNICAL BULLETIN

PARTS ORDERS

As GLOCK, Inc. strives to upgrade its pistols, there are some minor changes to the different models. Therefore, when ordering parts, please have the following information available to ensure that you are shipped the correct parts.

MAGAZINE PARTS

When ordering magazine parts, we must know: 1) the model of the pistol; 2) if it is a 10-round magazine or a high-capacity magazine and, 3) if the magazine is the old style — non-fully lined, or the new style — fully metal lined (see attached drawing).

PISTOL PARTS

When ordering pistol parts, we must know: 1) the pistol model number and, 2) the serial number.

If the pistol has a serial number within the below listed numbers and has not been upgraded, it may be returned to:

GLOCK, Inc.
6000 Highlands Parkway
Smyrna, GA 30082

Older style parts are no longer available. All pistols in the following serial number ranges fall subject to the product upgrade:

GLOCK 17 Pistols — Alphabetical Prefix up to and including XG
GLOCK 19 Pistols — Alphabetical Prefix up to and including XK
GLOCK 20 Pistols — Alphabetical Prefix up to and including WX
GLOCK 21 Pistols — Alphabetical Prefix up to and including XM
GLOCK 22 Pistols — Alphabetical Prefix up to and including YB
GLOCK 23 Pistols — Alphabetical Prefix up to and including SL

All pistols with a three letter prefix already have the upgraded part system.

G21 .45 Automatic

All pistols prior to serial number ALD are subject to the slide modifications, i.e. the pickup rail is reduced and the right rear edge of the ejection port is angled.

A B C D E F G H I J K L M N O P Q R S T U V W X Y Z

TECHNICAL BULLETIN

THE NEW NEW YORK TRIGGER SPRINGS will have a coil spring that replaces the leaf spring type.

The New York #1 trigger spring, part #SP 07405, is olive in color and will be used in place of the standard New York trigger spring, part #SP 03661 which has been discontinued.

The New York #2 trigger spring, part #SP 07412 is orange in color and is used in place of the New York Plus trigger spring, part #SP 05418 which has been discontinued.

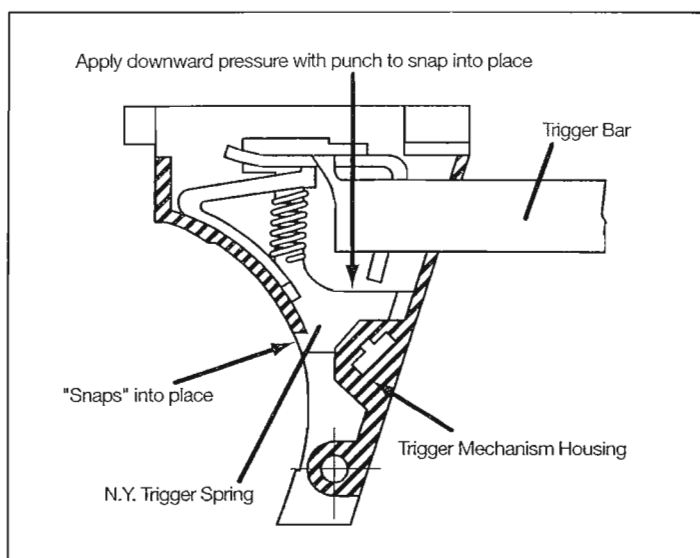

1. Detail strip the pistol frame (trigger assembly)
2. Remove trigger bar
3. Remove coil trigger spring
4. Insert New York trigger spring
5. Re-insert trigger bar over New York trigger spring
6. Reassemble frame and slide

NOTE: This operation should only be performed by a certified GLOCK Armorer. As always, a function test firing should follow with each firearm to assure proper functioning.

REPLACEMENT OF PARTS IN GLOCK PISTOLS

Each time a GLOCK pistol is detail stripped or internal parts are replaced, GLOCK, Inc. recommends that the pistol be function tested and test-fired before the pistol is returned to service or issued for use.

GLOCK, Inc. strives to make sure that all parts shipped meet GLOCK specifications. The final inspection of the part should be made by the GLOCK Armorer prior to installation.

THE GLOCK FLASHLIGHT ADAPTER is designed to fit the new style GLOCK fully metal-lined magazine. It will not fit the old style magazine that is not fully metal-lined due to the fact that the new style magazine has a thicker flange than the old style magazine.

TECHNICAL BULLETIN

EXTRACTORS

When ordering extractors, the serial number of the pistol for which the extractor is ordered should be checked to determine if the extractor with the 90° or 15° angle should be shipped.

All GLOCK pistols, beginning with the below listed serial number prefixes, have a 15° breech face cut and require a 15° extractor to complement it. 9x19 and 10 mm GLOCK pistols have a parallel hook. All .40 caliber and .45 caliber GLOCK pistols have a 5° hook. All .40 caliber pistols should have the new style 14.7 mm ejectors, part # SP 01882.

MODEL	SERIAL NO. PREFIX	IMPORT DATE
G17	BKK	05-95
G17L	BMD	07-95
G19	BKP	05-95
G20	BKU	06-95
G21	ALD	05-93
G22	BKD	05-95
G23	BKH	05-95
G24/24C	BMD	06-95
G26	BMX	07-95
G27	BMY	07-95

9x19 — G17/17L/19/26

For all 9x19 pistols, use trigger housing with ejector part #SP 00322 and ejector part #SP 00336.

90° Breech Face - Extractor #SP 00098 - 90°/Parallel Hook

15° Breech Face - Extractor #SP 01889 - 15°/Parallel Hook

.40 — G22, G23, G24, G24p, G27

For all .40 pistols, use trigger housing with ejector part #SP 01896 and ejector part #SP 01882 (new style).

90° Breech Face - Extractor #SP 06908 - 90°/5°

15° Breech Face - Extractor #SP 06740 - 15°/5°

10 mm Auto — G20

For all 10 mm Auto pistols, use trigger housing with ejector part #SP04431 and ejector part #SP 04340.

90° Breech Face - Extractor #SP 05509 - 90°/5°

15° Breech Face - Extractor #SP 06061 - 15°/5°

.45 Auto — G21

For all .45 Auto pistols, use trigger housing with ejector part #SP 04431 and ejector part #SP 04340.

90° Breech Face - Ship to GLOCK Smyrna to be cut to 15°

15° Breech Face - Extractor #SP 05516 - 15°/5°

Modified Disassembly Tool — ST 03374 — Use to remove the ejector from the trigger mechanism housing.

TECHNICAL BULLETIN

MAGAZINES

When the following magazine parts are ordered and a specific part number is not specified, the customer must be contacted to find out what type of magazine is involved. Following is a list of information needed to determine exactly what parts are required.

9x19 — All

Non Fully Metal-Lined

Floor Plate - SP 00455
Magazine Insert - SP 05572
Orange Floor Plate - SP 02373

Fully Metal Lined

Floor Plate - SP 03206
Magazine Insert - SP 01693
Orange Floor Plate - SP 01294

.40 — All

Non Fully Metal-Lined

Floor Plate - SP 00455
Magazine Insert - SP 05166
Orange Floor Plate - SP 02373

Fully Metal Lined

Floor Plate - SP 03206
Magazine Insert - SP 05166
Orange Floor Plate - SP 01294

10 mm Auto — All

Non Fully Metal-Lined

Floor Plate - SP 03941
Magazine Insert - SP 06055
Orange Floor Plate - SP 02681

Fully Metal Lined

Floor Plate - SP 03941
Magazine Insert - SP 06055
Orange Floor Plate - SP 02681

.45 Auto — G21

Non Fully Metal-Lined

Floor Plate - SP 03941
Magazine Insert - SP 05397
Orange Floor Plate - SP 02681

Fully Metal Lined

Floor Plate - SP 03941
Magazine Insert - SP 05397
Orange Floor Plate - SP 02681

.45 Auto — G30

Non Fully Metal-Lined

N/A

Fully Metal Lined

Floor Plate - SP 03941 - 9 round
Floor Plate - SP 08189 - 10 round
Magazine Insert - SP 06901 - 9 round
Magazine Insert - SP 06901 - 10 round

TECHNICAL BULLETIN

MAGAZINE SPRINGS

When ordering magazine springs, we must be provided with the following information: 1) what model the magazine springs will be used for 2) whether they are high capacity or 10 round magazines. Below is a list of part numbers for magazine springs:

9 ROUND

G30 - SP 02429

10 ROUND

G17 - SP 02309
 G17L - SP 02309
 G19 - SP 02316
 G20 - SP 02323
 G21 - SP 02429
 G22 - SP 02323
 G23 - SP 02429
 G24 - SP 02323
 G26 - SP 02429
 G27 - SP 02429
 G29 - SP 02429
 G30 - SP 02429

HIGH CAPACITY

G17 - SP 00448
 G17L - SP 00448
 G19 - SP 02429
 G20 - SP 00448
 G21 - SP 00448
 G22 - SP 00448
 G23 - SP 02429
 G24 - SP 00448

FOLLOWERS

MODEL	TYPE	PART #	FOLLOWERS MARKED WITH
G17	High Capacity	SP 01812	MM1
G17	10 Round	SP 02183	MM1
G19	High Capacity	SP 01812	MM1
G19	10 Round	SP 02183	MM1
G20	High Capacity	SP 03948	
G20	10 Round	SP 03948	
G21	High Capacity	SP 03955	
G21	10 Round	SP 03955	
G22	High Capacity	SP 01028	5
G22	10 Round	SP 01028	5
G23	High Capacity	SP 01028	5
G23	10 Round	SP 01028	5
G26	All Magazines	SP 01812	MM1
G27	All Magazines	SP 01028	5
G29	All Magazines	SP 03948	
G30	9 Round	SP 03955	
G30	10 Round	SP 03955	

TECHNICAL BULLETINS

THREE GENERATIONS OF GLOCK MAGS

NON-FULL
METAL LINED

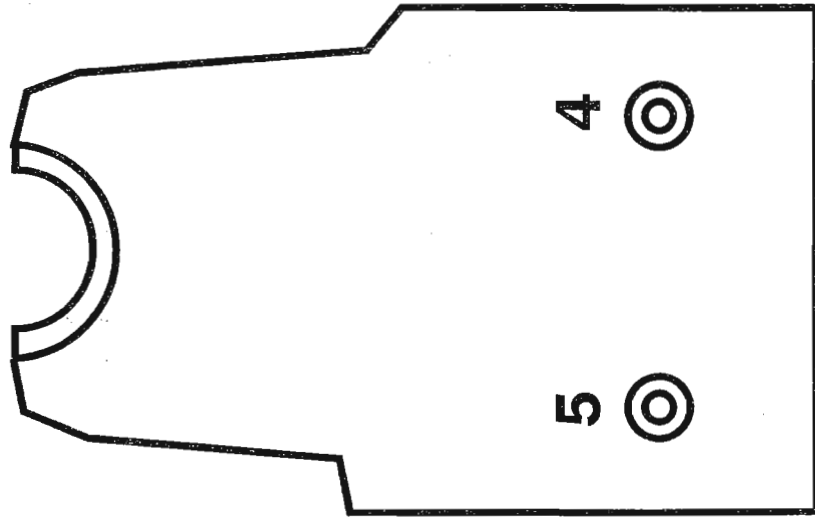

FULL METAL
LINED

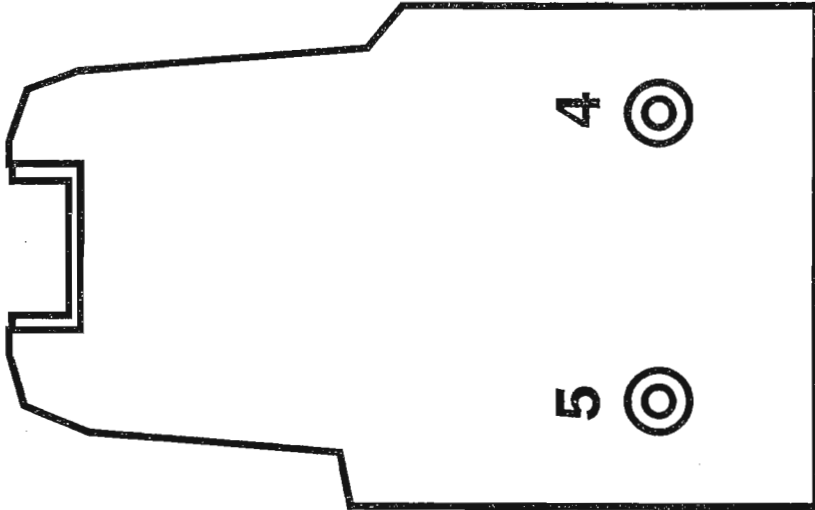

FULL METAL
LINED

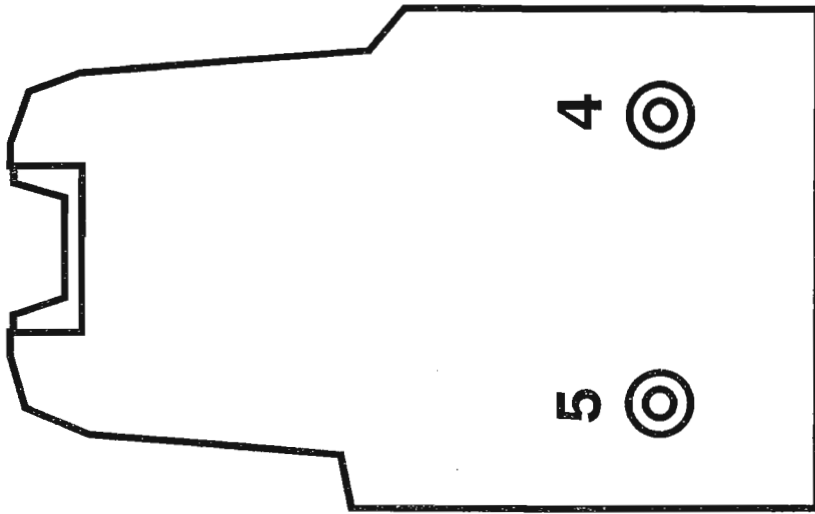

TOP VIEW OF GLOCK SLIDES

90° Breach Face

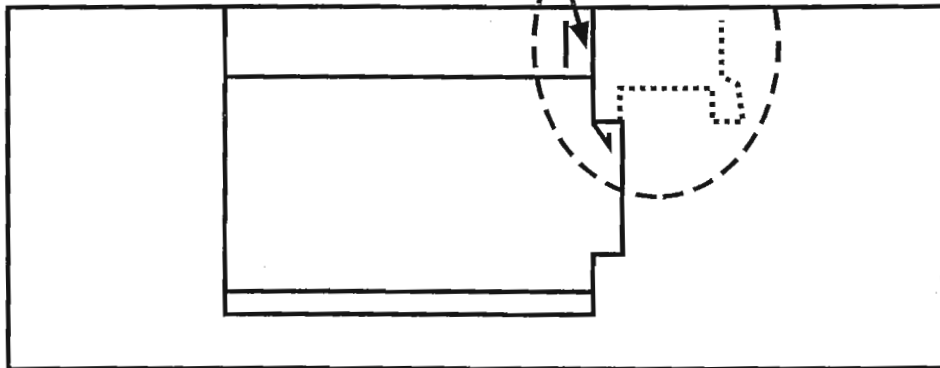

15° Breach Face

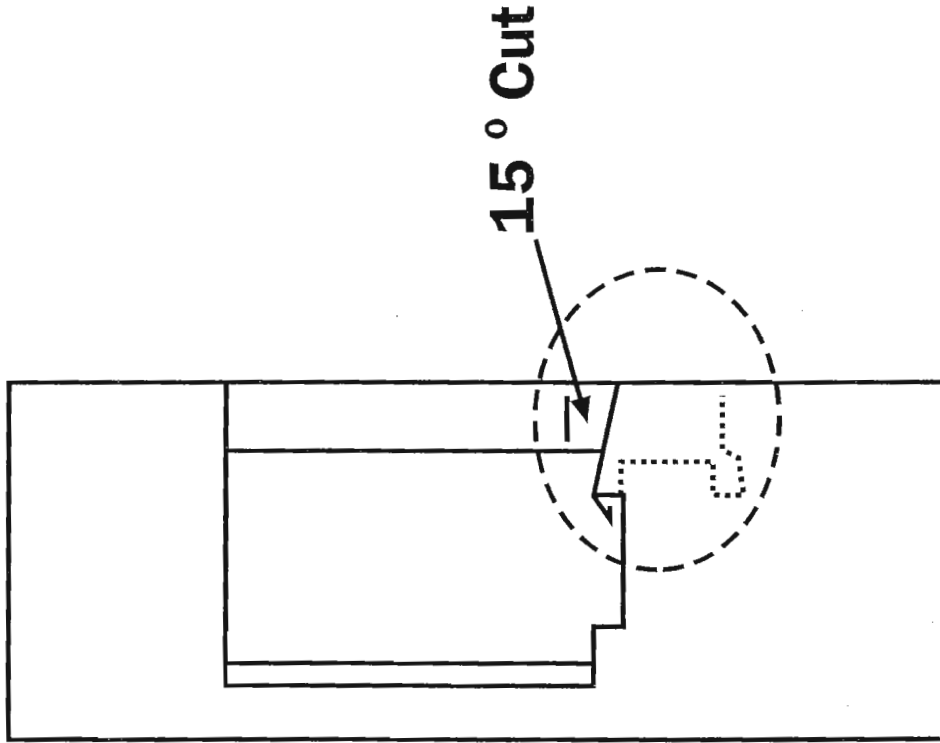

OLD VERSUS UPGRADE PARTS

Old Firing Pin



Upgrade Firing Pin



Old Extractor

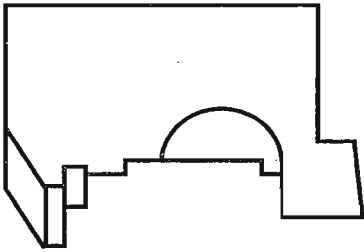

Upgrade Extractor With Debris Channel

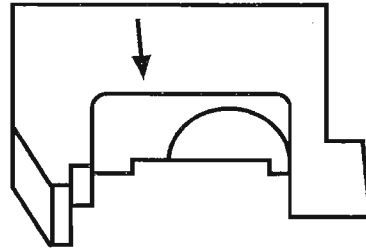

Old Firing Pin Safety

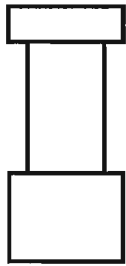

Upgrade Firing Pin Safety

(New Stronger F.P. Safety Spring is included and must also be changed)



Old Spring Loaded Bearing



Upgrade Spring Loaded Bearing

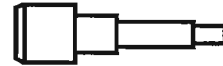

Old Trigger Bar Upright

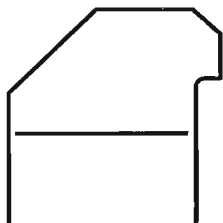

Upgrade Trigger Bar Upright

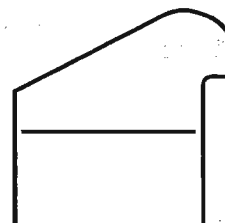

90° \ Parallel Hook

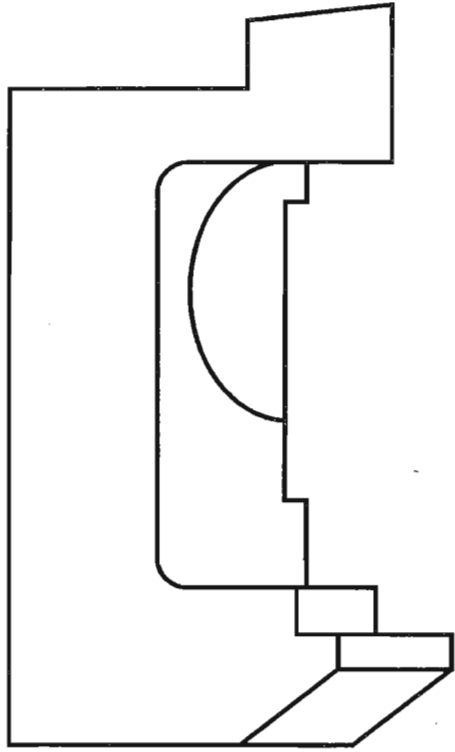

90° \ 5°

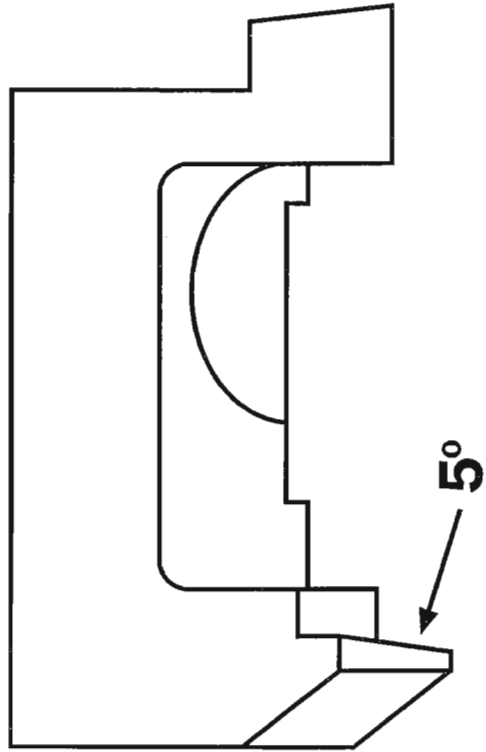

15° \ Parallel Hook
9 x 19

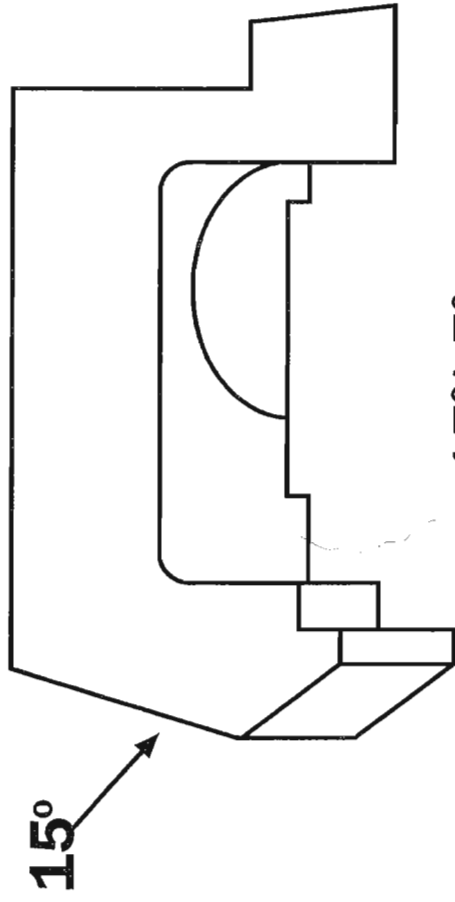

15° \ 5°

.357 / .40 / .45 Auto / 10 mm Auto

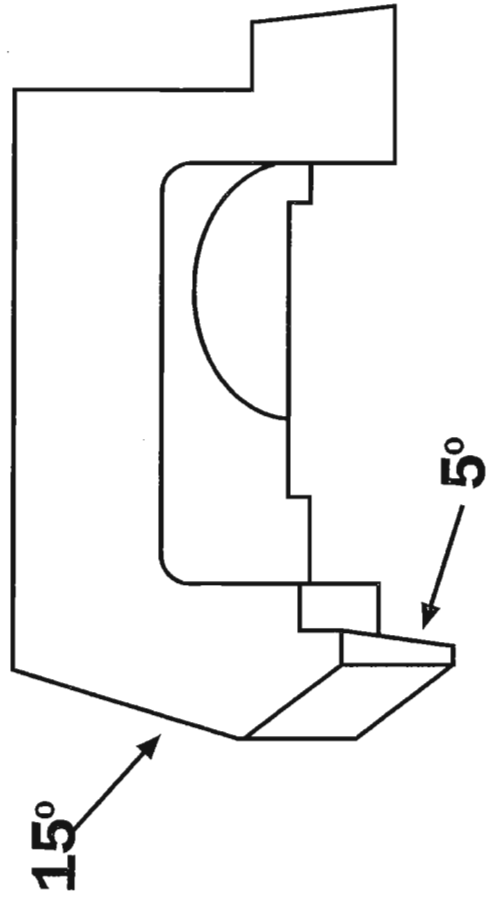

GLOCK 2002 Parts List for Certified Armorers

Item #	Description (New)	Price US\$
SP03570	Barrel G17 US	95.00
SP01747	Barrel G17C US	110.00
SP03633	Barrel G17L US	125.00
SP03577	Barrel G19 US	95.00
SP01768	Barrel G19C US	110.00
SP05355	Barrel G20 US	105.00
SP07557	Barrel G20 US (6")	135.00
SP02062	Barrel G20C US	120.00
SP05362	Barrel G21 US	105.00
SP02083	Barrel G21C US	120.00
SP04452	Barrel G22 US	95.00
SP01789	Barrel G22C US	110.00
SP04456	Barrel G23 US	95.00
SP01803	Barrel G23C US	110.00
SP01917	Barrel G24 US	125.00
SP01924	Barrel G24C US	145.00
SP06012	Barrel G26 US	95.00
SP06026	Barrel G27 US	95.00
SP08623	Barrel G29 US	105.00
SP08637	Barrel G30 US	105.00
SP08651	Barrel G31 US	95.00
SP07659	Barrel G31C US	110.00
SP08665	Barrel G32 US	95.00
SP07673	Barrel G32C US	110.00
SP08659	Barrel G33 US	95.00
SP07186	Barrel G34 US	125.00
SP07200	Barrel G35 US	125.00
SP01872	Barrel G36 US	105.00
SP00497	Bore Brush (Nylon)	3.00
CL00001	Cable Lock	5.00
SP00490	Cleaning Rod	2.00
SP01565	Cleaning Rod (TRAINING Pistols)	5.00
SP00343	Connector 5lb	2.00
SP00735	Connector 8lb	2.00
SP05243	Extr.Dep.Plunger 10mm, .45	2.00

GLOCK 2002 Parts List for Certified Armorers

Item #	Description (New)	Price US\$
SP00112	Extr.Dep.Plunger 9mm, .40, .380, .357	2.00
SP00119	Extr.Dep.Plunger Spring	1.00
SP06908	Extractor .40 (90/5°) Old Style	10.00
SP06740	Extractor .40, .357 (15/5°)	10.00
SP05516	Extractor .45 (15/5°)	10.00
SP01711	Extractor .45 (15/5° Slim) G36	10.00
SP06061	Extractor 10mm (15/5°)	10.00
SP05509	Extractor 10mm (90/5°) Old Style	10.00
SP00098	Extractor 9mm (90/0°) Old Style	10.00
SP01889	Extractor 9mm, .380 (15/5°)	10.00
SP01895	Extractor 9mm/.380 w/Loaded Chamber Indicator	10.00
SP01899	Extractor .40/.357 w/Loaded Chamber Indicator	10.00
SP01909	Extractor 10mm w/Loaded Chamber Indicator	10.00
SP01902	Extractor .45 w/Loaded Chamber Indicator	10.00
SP01906	Extractor G36 Only w/Loaded Chamber Indicator	10.00
SP04270	Firing Pin .40, .357	25.00
SP04557	Firing Pin 10mm, .45	30.00
SP00049	Firing Pin 9mm, .380	25.00
SP01148	Firing Pin Channel Liner	1.00
SP04536	Firing Pin Safety .45	1.00
SP00084	Firing Pin Safety 9mm, .40, .357, 10mm	1.00
SP00091	Firing Pin Safety Spring	1.00
SP00056	Firing Pin Spacer Sleeve	1.00
SP00063	Firing Pin Spring 24N (Silver)	1.00
BL10000	GLOCK Box Lid	2.50
BB10000	GLOCK Box Bottom	2.50
SP04228	GLOCK Box (17L, 24, 24C)	5.00
GT03374	GLOCK Disassembly Tool	4.00
SP00308	Locking Block G17/G17L/G34 (2 Pin Models)	15.00
SP01447	Locking Block G17 (New 3 Pin Models)	15.00
SP02918	Locking Block G17T	15.00
SP02471	Locking Block G19	15.00
SP05264	Locking Block G20/G21	15.00
SP04354	Locking Block G22/G24/G31/G35	15.00
SP04361	Locking Block G23/G32	15.00

GLOCK 2002 Parts List for Certified Armorers

Item #	Description (New)	Price US\$
SP06355	Locking Block G26/G27/G33	15.00
SP07552	Locking Block G29/G30	15.00
SP07552	Locking Block G36	15.00
SP04368	Locking Block Pin	1.00
SP01781	Locking Block Pin G36	1.00
SP03206	Mag Floor Plate 9mm/.40/.380/.357	1.00
SP00455	Mag Floor Plate 9mm/.40/.357 Old Style	1.00
SP01294	Mag Floor Plate 9mm/.40/.357 Orange Training	1.00
SP03941	Mag Floor Plate G20/G21/G29	1.00
SP08189	Mag Floor Plate G30	1.00
SP02681	Mag Floor Plate 10mm/.45 Orange Training	1.00
SP01718	Mag Floor Plate G36	1.00
SP01981	Magazine Catch 10mm/.45	1.00
SP00287	Magazine Catch 9mm/.40/.380/.357	1.00
SP01981	Magazine Catch Extended 9mm/.40	1.00
SP01739	Magazine Catch G36	1.00
SP00280	Magazine Catch Spring	1.00
SP01593	Magazine Follower .357	1.00
SP01009	Magazine Follower .357 (10rd)	1.00
SP01672	Magazine Follower .380	1.00
SP01028	Magazine Follower .40	1.00
SP03955	Magazine Follower .45 (G30, 10rd Mags, Preban)	1.00
SP01304	Magazine Follower .45 New Style High Point (LE Mags Only)	1.00
SP03948	Magazine Follower 10mm	1.00
SP01812	Magazine Follower 9mm	1.00
SP02183	Magazine Follower 9mm (10rd)	1.00
SP01767	Magazine Follower G36	1.00
SP05166	Magazine Insert .40/.357	1.00
SP06831	Magazine Insert 10mm	1.00
SP05572	Magazine Insert 9mm (Old Style)	1.00
SP01693	Magazine Insert 9mm	1.00
SP05397	Magazine Insert G21 New Style Insert (Flat Insert)	1.00
SP06901	Magazine Insert G21 (10rd)/G30	1.00
SP01753	Magazine Insert G36	1.00
ML04832	Magazine Speed Loader	5.00

GLOCK 2002 Parts List for Certified Armorers

Item #	Description (New)	Price US\$
ML05173	Magazine Speed Loader 10mm/.45	5.00
SP03262	Magazine Spring 9mm 33rd	4.00
SP00448	Magazine Spring G17	3.00
SP02309	Magazine Spring G17 (10rd)	3.00
SP02316	Magazine Spring G19 (10rd)	3.00
SP02429	Magazine Spring G19/G23	3.00
SP02323	Magazine Spring G20/G22 (10rd)	3.00
SP02551	Magazine Spring G22 (11 Coil)	3.00
SP01300	Magazine Spring G21 Unique 10 Coil, Wide Base	3.00
SP01071	Magazine Spring G36	3.00
NF17G21	Night Sight – GLOCK Front (Crimp On)	25.00
NR17G25	Night Sight – GLOCK 6.1 Rear	32.00
NR17G24	Night Sight – GLOCK 6.5 Rear	32.00
NR17G26	Night Sight – GLOCK 6.9 Rear	32.00
NF17M20	Night Sight – Meprolight Front (Screw On)	30.00
NR17M25	Night Sight – Meprolight 6.1 Rear	30.00
NR17M20	Night Sight – Meprolight 6.5 Rear	30.00
NR17M26	Night Sight – Meprolight 6.9 Rear	30.00
NF17A24	Night Sight – Trijicon Front (Screw On)	36.00
NF17A25	Night Sight – Trijicon 6.1 Rear	36.00
NF17A24	Night Sight – Trijicon 6.5 Rear	36.00
NF17A26	Night Sight – Trijicon 6.9 Rear	36.00
SP01533	Recoil Spring G17/G22/G24/G31/G34/G35 Assy	3.00
SP02457	Recoil Spring G19/G23/G32	3.00
SP05586	Recoil Spring G20/G21 Assy	3.00
SP02211	Recoil Spring G26/G27/G33 Assy	10.00
SP08063	Recoil Spring G29/G30/G36 Assy	10.00
SP00224	Sight Front	1.00
ST17A24	Sight Tool – Front (3/16" Hex/Screw On)	20.00
SP01053	Sight Tool – GLOCK Front Night Sight Staking	45.00
SP00154	Sight Rear 6.1	2.00
SP00182	Sight Rear 6.5	2.00
SP00196	Sight Rear 6.9	2.00
SP00210	Sight Rear 7.3	2.00
SP05977	Sight Rear Adjustable (2)	15.00

GLOCK 2002 Parts List for Certified Armorers

Item #	Description (New)	Price US\$
ST06635	Sight Rear Adjustable Screwdriver	1.00
ST21025	Sight Tool Rear 10mm/.45	87.00
ST17025	Sight Tool Rear 9mm/.40/.357	87.00
SP00133	Slide Cover Plate	2.00
SP05865	Slide Cover Plate Half Orange for Inspection	2.00
SP00301	Slide Lock	2.00
SP01788	Slide Lock G36	2.00
SP05446	Slide Lock Spring G17/G20/G21/G22/G31/G34/G35	1.00
SP02317	Slide Lock Spring G19/G23/G32	1.00
SP05837	Slide Lock Spring G26/G27/G29/G30/G33/G36	1.00
SP00399	Slide Stop Lever G17/G34 w/Spring	4.00
SP07489	Slide Stop Lever G17/G34 w/Spring (Extended)	8.00
SP01802	Slide Stop Lever G36 w/Spring	4.00
SP02919	Slide Stop Lever w/Spring	4.00
SP07496	Slide Stop Lever w/Spring (Extended)	8.00
SP00070	Spring Cup (2 Parts = 1 Cup)	1.00
SP01197	Spring Loaded Bearing .40/.357 (White)	1.00
SP01204	Spring Loaded Bearing 10mm/.45 (Olive)	1.00
SP01176	Spring Loaded Bearing 9mm/.380 (Black)	1.00
SP00427	Trigger Housing Pin	1.00
SP01774	Trigger Housing Pin G36	1.00
SP01896	Trigger Mech Housing w/Ejector .40/.357	3.00
SP08203	Trigger Mech Housing w/Ejector 10mm/.45	3.00
SP00322	Trigger Mech Housing w/Ejector 9mm/.380	3.00
SP00420	Trigger Pin	1.00
SP01697	Trigger Pin G36	1.00
SP00350	Trigger Spring	1.00
SP07405	Trigger Spring NY 1 (Olive)	1.00
SP07412	Trigger Spring NY 2 (Orange)	1.00
SP00357	Trigger w/Trigger Bar G17/G22/G31/G34/G35	7.00
SP02303	Trigger w/Trigger Bar G19/G23/G26/G27/G32/G33	7.00
SP04417	Trigger w/Trigger Bar G20/G21	7.00
SP01194	Trigger w/Trigger Bar G29/G30	7.00
SP02096	Trigger w/Trigger Bar G36	7.00

*GLOCK, Inc. does not sell 3.5# connectors.

**Magazines can not be ordered as parts.

***GLOCK publications and Owners Manuals are available upon request.

NOTES

NOTES



PERFECTION

**For Europe, Africa,
Middle East**

GLOCK Ges.m.b.H.
Nelkengasse 3
A-2232 Deutsch-Wagram, Austria
Tel. (43) 2247 90 300
Fax. (43) 2247 90 300 312

For USA, Canada

GLOCK, Inc.
6000 Highlands Parkway
Smyrna, GA 30082 USA
Tel. (770) 432-1202
Fax. (770) 433-8719

For Asia, Australia

GLOCK (H.K.) Ltd.
Unit 3102, China Merchants Tower,
Shun Tak Centre
168-200 Connaught Road Central
Hong Kong
Tel. (852) 2375-3858
Fax. (852) 2654-7089

**For Latin America,
Central America,
Caribbean**

GLOCK America N.V.
Plaza Independencia 831, Office 802
CP 11100 Montevideo
Uruguay
Tel. (598-2) 902 22 27, 902 22 28, 902 22 29
Fax. (598-2) 902 22 30

www.GLOCK.com



GLOCK and the GLOCK "G" and the Pistol
Appearance are Trademarks Registered
in the U.S. Patent and Trademark Office.

For further information on GLOCK products please contact your local dealer or the GLOCK office that serves your area.