

Owner's Manual

The Steyr Universal Sporting Rifle



***READ THE INSTRUCTIONS IN THIS
MANUAL CAREFULLY BEFORE
USING THIS FIREARM***

STEYR USR

Owner's Manual

Steyr Universal Sporting Rifle

This manual and the warnings contained herein must be read and understood before using your rifle. This manual familiarizes the user with the function and the handling of the rifle and warns of the potential dangers of misuse that may lead to accidents or injuries. This manual should always accompany this firearm and be transferred with it upon change of ownership, or when the firearm is loaned or presented to another person. THIS MANUAL IS NOT A SUBSTITUTE FOR A HUNTING SAFETY COURSE OR A FIREARMS SAFETY COURSE!



Steyr Mannlicher AG & Co KG
P.O. Box 1000, A-4400 Steyr, Austria

WARNING! TREAT EVERY FIREARM AS IF IT WERE LOADED AT ALL TIMES! REMEMBER, NO SAFETY IS FOOLPROOF! FIREARMS SAFETY IS THE RESPONSIBILITY OF THE PERSON WHO HANDLES FIREARMS AND AMMUNITION!

Dear Customer!

With your purchase of the new USR rifle, manufactured by Steyr Mannlicher AG & Co KG, you have acquired a sporting rifle that meets the highest quality standards. This rifle has been conceived to the state-of-the-art requirements of today's sportsman. Unsurpassed performance, superb quality, optimum user comfort, and long service life were the design goals for the new USR.

Steyr Mannlicher AG & Co KG has been certified according to ISO 9001 since 1994. As a result of our thorough quality assurance system, you can be certain that you have purchased an exclusive product of truly outstanding quality.

Please read this manual and the warnings contained herein carefully to familiarize yourself with the function and operation of this firearm.

THE WARNINGS AND ADVICE GIVEN IN THIS MANUAL ARE FOR YOUR PROTECTION AS WELL AS THE SAFETY OF OTHERS. DISREGARDING INFORMATION IN THIS MANUAL MAY RESULT IN SERIOUS INJURY OR DEATH.

Before you attempt to use or shoot your new USR rifle, learn and understand the following basic rules. Your safety and the safety of others depends upon safe and careful handling of your new rifle.

Any firearm must be considered a potentially dangerous object requiring particular caution in storage, handling and use.

Make sure to always handle and treat every rifle as if it were loaded.

NEVER place your finger on the trigger unless you want to fire a shot. **ALWAYS** load your rifle so as to avoid any danger for by-standers. Adequate rifle safety can only be ensured with the rifle in clean and mechanically sound condition.

Inexpert handling as well as improper or negligent care may impair function and safety of the rifle. Unauthorized alterations, modifications or adjustments to the rifles as well as damage to the rifle through carelessness will void any claims under the manufacturer's service agreement.

Any work on the rifle must be done by qualified and authorized gunsmiths, armorers, or factory authorized service facilities.

Rifles must always be stored out of the reach of persons not familiar with firearms, particularly children.

NEVER store ammunition with a firearm.

In order to avoid damage during transport, the rifle should always be transported in the original packing carton or in a commercially available carrying case.

ALWAYS keep the muzzle of your rifle pointed in a safe direction. **NEVER** point any firearm at anything you do not intend to shoot. Stay alert and be aware of all persons and property within shooting range.

NEVER give a loaded firearm to another person. Always open the action and inspect the chamber for ammunition, and unload any firearm before giving the firearm to another person for inspection. Always unload firearms after use to prevent the occurrence of an accidental discharge.

KEEP the barrel, chamber and bore free of all obstructions. Firing a firearm with a barrel, chamber or bore obstruction can cause damage and injury to both the firearm and the shooter, and could result in death. Keep the barrel, chamber and bore free and clean of mud, snow, cleaning patches, or any other materials which may clog the barrel.

NEVER drink alcohol or take medications while handling a firearm. Responsible firearm handling requires a state of mental alertness.

ALWAYS seek a doctor's advice if you are taking medication to be sure you are fit to shoot and handle a firearm safely.

DO NOT totally and blindly rely on the mechanical safety devices on any firearm.

The mechanical safety's function is to block sear engagement to prevent accidental discharge of the firearm. However, should this device fail, it is possible to fire a rifle even when the safety is in the non-firing position. **NEVER** place your finger on the trigger when you do not intend to shoot. **NEVER** place your finger on the trigger or test any safety device when the muzzle of a rifle is pointed in an unsafe direction.

NEVER transport a loaded rifle.

ALWAYS wear and encourage others to wear protective shooting glasses. Flying particles could damage eyes and cause blindness; but protective shooting glasses could prevent such injury.

ALWAYS wear and encourage others to wear ear protection when shooting, especially on a range. Without ear protection, the noise of even one shot from a firearm, or other firearms close to you, could leave a ringing in your ears for some time after firing while the cumulative long term effect could be permanent hearing loss.

ALWAYS use only clean, dry, original high quality commercially manufactured ammunition in good condition loaded in accordance with factory standards. Do not use ammunition that has been exposed to prolonged periods of dampness or moisture. Gun and ammunition manufacturers design their products within exacting engineering safety limits. Handloads and remanufactured ammunition are sometimes outside those limits and can be so unsafe as to blow up or otherwise damage a firearm, and cause injury, death or damage to property.

If there are any questions concerning the proper caliber for your sporting rifle, call or contact GSI, Inc., 108 Morrow Avenue, P.O. Box 129, Trussville, Alabama 35173, Tel. (205)-655-8299. STEYR MANNLICHER AG & Co KG specifically disclaims any responsibility for damage or injury whatsoever occurring in connection with, or as a result of, the use of faulty, or non-standard, or "remanufactured" or handloaded (re-loaded) ammunition.

DO NOT put your finger on the trigger while unloading, loading or any other time before you are ready to shoot. Do not dry fire on an empty chamber - the chamber may not be empty even if you think it is not loaded! **TREAT EVERY FIREARM AS IF IT WERE LOADED!**

KNOW your target and backdrop area. Be sure it is safe to fire at your target. Think! What will you **HIT** if you **MISS** your intended target? Know the potential range of your rifle and ammunition, and consider this danger for persons and property within that range. **NEVER** fire a rifle in the direction of people, non-game animals or property that could be injured or destroyed.

MAKE SURE your firearm is unloaded before crossing fences, climbing trees, jumping over ditches, or passing through or across other obstacles. **DO NOT** place or lean a loaded firearm on or against a tree, fence, automobile, or similar objects.

FAILURE TO FIRE: If your rifle fails to fire when you pull the trigger, keep the rifle pointed toward the target or a safe open area and wait for at least 30 seconds. If hangfire (slow ignition) has occurred, the round will probably fire within 30 seconds.

If the round does not fire, open the breech of the rifle and remove the cartridge. If the primer of the cartridge is indented, discard the cartridge in a safe manner. If the primer of the cartridge is not indented, or is lightly indented, or off-center, have the rifle examined by a competent gunsmith before the rifle is fired again.

USE caution to avoid dropping a loaded gun. Dropping the rifle may cause an accidental discharge even if the safety is in the on-safe position. Be extremely careful while hunting or during any other activity to avoid dropping any firearm. An accidental discharge could result in serious injury, or death.

TAKE EVERY PRECAUTION to prevent unsafe gun handling practices around yourself and others. If you witness any unsafe gun handling practices by other shooters, politely suggest safe procedures for future use.

NEVER DISCHARGE a firearm near flammable material. Flame and sparks erupt from the firearm when discharged. They could start a fire or cause flammable liquids and gases to explode.

NEVER SHOOT at a hard surface as a rock, or a liquid surface such as water. A bullet may ricochet and travel in any direction to strike you, or an object you cannot see, causing injury, death or damage to property.

NEVER WALK, CLIMB OR FOLLOW a companion with your rifle loaded and a cartridge chambered. When walking, climbing or following a companion, **MAKE SURE** the chamber of the rifle is empty, and the safe is in the "safe" position.

ALWAYS instruct children to respect firearms. If you teach your children to shoot, teach them or get them trained by a qualified instructor to treat and use firearms properly, and always supervise them closely.

NEVER abuse your rifle by using it for any purpose other than shooting.

NEVER fire your firearm near an animal unless it is trained to accept the noise. An animal's startled reaction could injure it or cause an accident.

READ, UNDERSTAND, AND PRACTICE all safety procedures and warnings in this manual. **READ, UNDERSTAND, AND PRACTICE** all safety procedures and warnings on commercial ammunition cartons and containers. It is **YOUR RESPONSIBILITY** to collect, understand and practice the most up-to-date safe handling procedures for your STEYR USR rifle. NEITHER STEYR MANNLICHER AG & Co KG NOR GSI, INC. are responsible for injury, death or damage to property resulting from either intentional or accidental discharge of this firearm, or from its function when used for purposes or subjected to treatment for which it was not designed.

KEEP this instruction manual on hand for future reference. Please include this manual with the firearm in the event you lend, give or sell this firearm to any other person.

BEFORE SHOOTING YOUR NEW STEYR

Usually, your Steyr franchised dealer will furnish your rifle in completely assembled condition. You need only clean the barrel bore of oil and wipe the bore dry before shooting.

BORE OBSTRUCTION WARNING!

ANY OBSTRUCTION IN THE BORE OF THE RIFLE MAY RESULT IN DAMAGE TO THE RIFLE OR INJURY OR DEATH TO THE SHOOTER AND OR OTHER PERSONS NEARBY. BEFORE LOADING THE RIFLE, MAKE CERTAIN THE BORE IS CLEAR AND UNOBSTRUCTED.

If you suspect the rifle may have a bore obstruction resulting from excess oil, grease or cosmoline, or from condensation or rain or snow in the barrel, or from any other source whatsoever, inspect the bore to be sure it is clear and unobstructed.

WHENEVER YOU INSPECT THE BORE, MAKE CERTAIN THE RIFLE IS NOT LOADED, AND THAT THE CHAMBER AND MAGAZINE ARE EMPTY! THE BORE MAY BE INSPECTED BY REMOVING THE BOLT AS DESCRIBED ELSEWHERE IN THIS MANUAL AND VISUALLY INSPECTING THE BARREL FROM THE RECEIVER END, NOT THE MUZZLE! REMEMBER, NEVER LOOK DOWN THE MUZZLE OF THE RIFLE!

Also, remember that a lodged bullet is a common form of bore obstruction. Bullets may become lodged in

the bore if (assuming the trigger has been pulled with a live cartridge in the chamber) the cartridge contains no powder, or the powder fails to ignite, and only the primer charge ignites, resulting in insufficient force to propel the bullet out of the bore. Whenever an obstruction occurs, keep the rifle pointing in a safe direction and proceed as follows:

- * Any cartridges in the magazine should be removed.
- * Insert a proper size cleaning rod (without a tip or brush) into the bore from muzzle and remove the bullet. If the bullet does not readily dislodge, it may be necessary to lightly tap the handle end of the cleaning rod. Do not attempt to remove a lodged bullet using a blank cartridge from which the bullet has been removed, or by any other means other than the use of a cleaning rod. Be certain all loose powder has been removed from the bore and action before inserting the rod. If you are unable to remove the obstruction, take the rifle to the nearest repair facility, or call GSI Inc., 108 Morrow Avenue, P.O.Box 129, Trussville, Alabama 35173, Tel. (205) 655-8299.
- * After removing the obstruction, reinspect the bore to be certain it is free of powder particles or other debris. Clean the mechanism of unburned powder grains.

REMEMBER! ALWAYS CHECK THE BORE FOR AN OBSTRUCTION IF YOU EXPERIENCE DIFFICULTY IN CHAMBERING A CARTRIDGE, EXPERIENCE A FAILURE TO EXTRACT, HAVE A MISFIRE, OR THE RIFLE DOES NOT MAKE A NORMAL LOUD REPORT ON FIRING. A MISFIRE OR UNUSUAL REPORT IS ALWAYS A SIGNAL TO CEASE FIRING. FOLLOWING A MISFIRE OR AN UNUSUAL REPORT, KEEP THE RIFLE POINTED IN A SAFE DIRECTION AND WAIT TWO MINUTES BEFORE UNLOADING THE CHAMBER AND EXAMINING THE BORE OF THE FIREARM.

WARNING! IF A CARTRIDGE IS LODGED IN THE CHAMBER, DO NOT ATTEMPT TO REMOVE A LODGED CARTRIDGE BY USING A CLEANING ROD. TAKE THE RIFLE TO THE NEAREST REPAIR FACILITY, OR CALL GSI, Inc., 108 Morrow Avenue, P.O. Box 129, Trussville, Alabama 35173.
Tel. (205) 655-8299.

Table of contents

1. GENERAL	13
2. TECHNICAL DATA	14
3. DESCRIPTION	15
4. ACCESSORIES	16
5. HOW TO USE THE RIFLE	17
6. DISASSEMBLY AND ASSEMBLY	22
7. IMMEDIATE CLEARING OF JAMS AND MALFUNCTIONS	35
8. TROUBLESHOOTING	36
9. CLEANING AND MAINTENANCE	38
10. PARTS AND DIAGRAMS	39

STEYR UNIVERSAL SPORTING RIFLE

USR

Caliber .223 Rem.



1. GENERAL

- Universal Sporting Rifle (USR)
- Ammunition: Cartridge cal. .223 Rem.
- Interchangeable Barrel
- Sights: optical sight
open sights
- Feeding: Magazine of synthetic material for a maximum capacity of 10 rounds



2. TECHNICAL DATA

Caliber: 5.56x45 mm (.223 Rem.)

Length of barrel: 508 mm (20")

Length of twist: 228 mm (9" right)

Chamber and barrel bore Chrome plated

Overall length: 765 mm (30")

Height: 231 mm (9")

Weight of weapon
with empty magazine: 3980 g (8.8 lbs)

Weight of weapon
with filled magazine: 4100g (9.0 lbs)

Weight of empty magazine 80 g (0.17 lbs)

Magazine capacity 10 rounds



Fig.1 Steyr USR, with special Picatinny style mounting rail, total view, left side

3. DESCRIPTION

The USR is comprised of 6 main groups:

- 1 Barrel - group
- 2 Receiver - group
- 3 Hammer - group
- 4 Bolt - group
- 5 Magazine - group
- 6 Stock - group

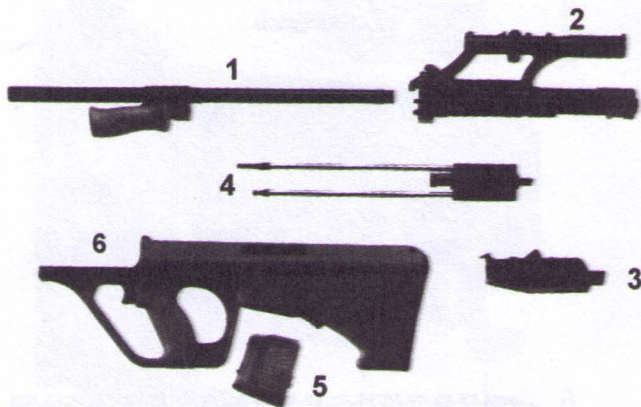
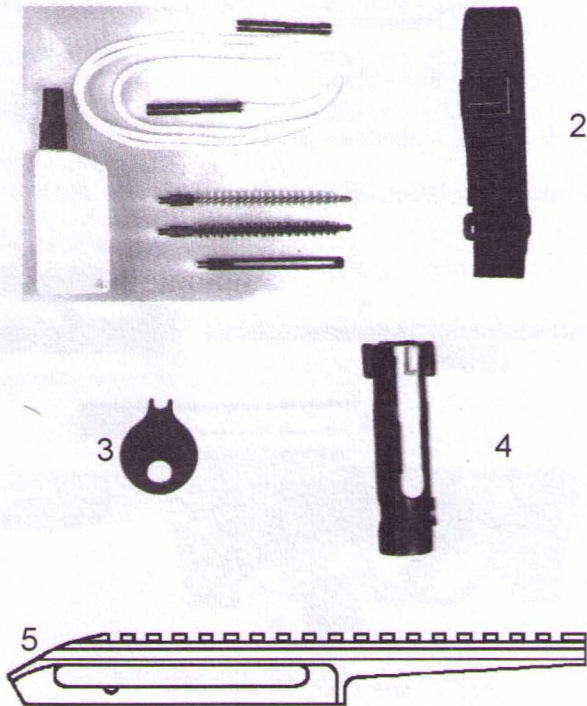

Fig. 2 Steyr USR, main groups

4. ACCESSORIES

- 1 Cleaning kit (not included)
- 2 Carrying sling (black)
- 3 Sight adjusting tool (not included)
- 4 Bolt left ejection (not included)
- 5 Special Picatinny style mounting rail (not included)

Fig. 3 Accessories



5. HOW TO USE THE RIFLE

Before shooting, check position of the gas plug.

For normal shooting the gas plug plunger should be aligned with the small circle symbol stamped on the gas cylinder (Fig.4). The serrated "ears" of the plug will then be positioned approximately horizontally.

With some ammunition, or a very dirty rifle, gas pressure may be insufficient for reliable functioning. In such a case the gas plug plunger may be aligned with the large circle symbol to increase gas flow.

Fig. 4 Gas plug, position for normal shooting

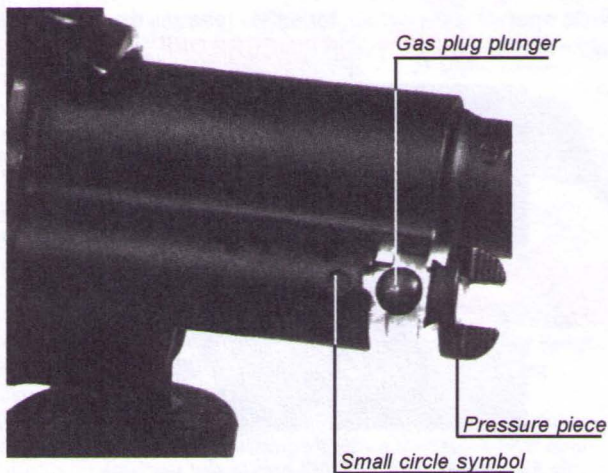

WARNING:

Make sure that the ejection port cover is mounted on the same side as the shooter's cheek rests, and that the correct (right or left-handed) bolt is installed.

Locking and releasing:

WARNING:

Keep the muzzle pointed in a safe direction.

To place safety "ON" (white dot visible), push the square safety button through the stock from left to right. A white indicator dot on the button will be fully exposed when the safety is "ON" (white dot visible) (Fig.5).

To take the safety "OFF" (red dot visible), push the button in the opposite direction to expose a red indicator dot.

NOTE:

While operating the safety, for safety reasons the trigger must not be touched (**KEEP YOUR FINGERS OFF THE TRIGGER!**)

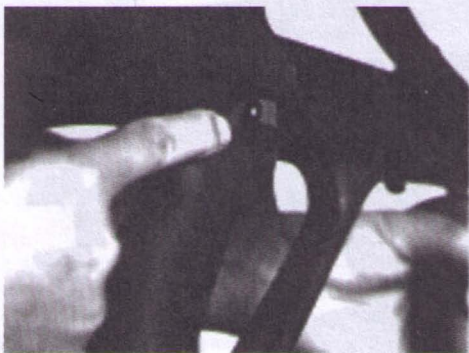

Fig.5 position safety "ON" (white dot visible)

Loading and Firing:

WARNING: Keep the muzzle pointed in a safe direction.

Loading:

Place the safety in the "ON" position (white dot visible). Load 10 rounds in the magazine (Fig. 6) and insert in the magazine well firmly until the magazine catch, clicks audibly (Fig.7). Retract the charging handle with left hand and turn it inwards. Take hand off the charging handle and press the charging handle (with the thumb only) outwards (Fig.8). Bolt moves freely forward and feeds a round into the chamber. The rifle is loaded and on "safe".

Firing:

WARNING: Make sure that the bolt is fully closed.

If not, retract the charging handle back approx. 1" and turn it inwards. This will lock the charging handle to the end of the slide rod guide and function as a forward assist mechanism. Fold down the barrel grip. Shoulder the rifle, point in a safe direction, move safety catch to left "FIRE" position (red dot visible). After firing, immediately place safety catch in "SAFE" position (white dot visible).

NOTE: The charging handle stays in the forward position during firing. The SteyrUSR is equipped with a magazine hold open catch that keeps gun locked to rear after last round is fired.



Fig. 6 Loading magazine



Fig. 7 Inserting magazine



Fig. 8 press charging handle outside with thumb

Unloading:

WARNING:

Keep the muzzle pointed in a safe direction.

- Push safety "ON" (white dot visible)
- Take out the magazine. Grab the magazine with one hand . With the other hand press the magazine catch to release the magazine (Fig. 9).
- Place four fingers of right hand under the magazine well, with the right thumb cover the ejection port.
- Retract the charging handle and secure in the rear position. The cartridge will be extracted and fall through the magazine well into your right hand. **Visually make certain the chamber is empty.**
- Press charging handle outwards with thumb only and allow the bolt to move freely forward.

-CAUTION: DO NOT ATTEMPT TO UNCOCK A LOADED RIFLE.

- Make sure the muzzle is pointed in a safe direction - Push safety "OFF" (red dot visible), pull the trigger - push safety "ON" (white dot visible).

Now the rifle is on "safe", unloaded and uncocked.

Fig. 9 Removing magazine



Adjusting the optical sight:

The optical tube is mounted in the optic housing.

The special screws for elevating and lateral adjustment and the fixing screw are adjusted at the factory prior to shipment and no further adjustment is recommended (Fig.10).

Elevation is adjusted by turning the inner disc on the elevating adjustment screw. Turning the elevation adjustment disc in direction of "U" raises the point of impact.

Turning the elevation adjustment disc in direction of "D" lowers the point of impact.

Windage is adjusted by turning the inner disc on the lateral adjustment screw. Turning the lateral adjustment in direction of arrow "R" (for right) moves the point of impact to the right; turning the lateral adjustment disc in direction of arrow "L" (for left) moves the point of impact to the left.

To turn the inner discs, use the adjusting tool (#3 on the accessories list) or the point of a bullet (Fig.11).

Lateral adjustment screw

Fixing screw

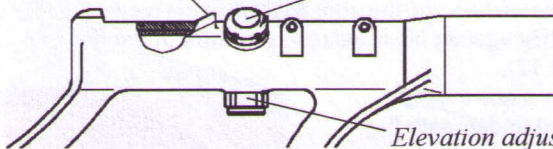
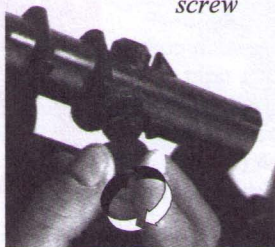

Fig. 10 Optical sight

Elevation adjustment screw

Fig. 11 Using the sight adjusting tool



6. DISASSEMBLY AND ASSEMBLY

The Steyr-USR can be assembled and disassembled without the use of special tools.

Complete stripping of the rifle should be done only by an authorized gunsmith.

WARNING:

BEFORE DISMANTLING MAKE SURE RIFLE IS UNLOADED!

Keep the muzzle pointed in a safe direction and be sure the rifle is unloaded.

DISASSEMBLY:

Before disassembling the rifle, place the safety "ON" (white dot visible). Remove the magazine, eject any cartridge and visually inspect to make certain the chamber is empty.

SUMMARY OF DISASSEMBLY

Removing receiver and bolt:

- With left thumb release the charging handle to its foremost position.
- With the right hand grasp the pistol grip, rest the USR with the butt plate on your right hip.
- Place left hand on the front position of the receiver and press slightly against hip to release pressure of the housing lock (Fig.12).
- Now place the right hand underneath the butt so, that the third finger is able to press the housing latch completely to the right. Point the weapon down and remove receiver with barrel and bolt (Fig.13).
- Separate bolt from receiver (Fig.14).

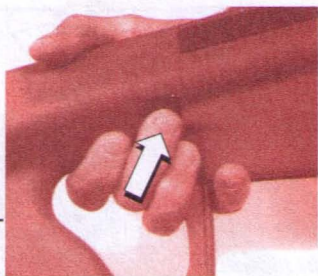

Fig. 12



Fig. 13

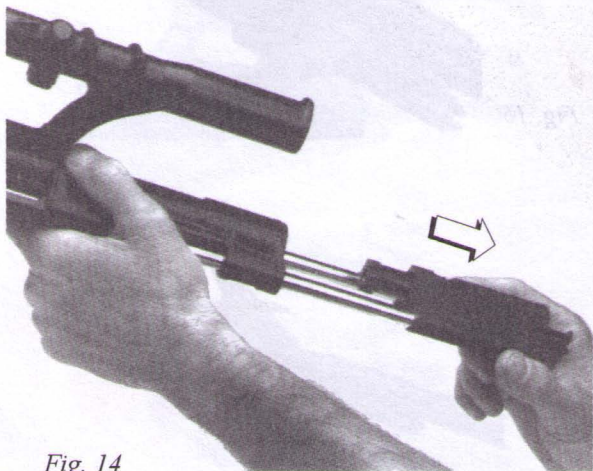

Fig. 14

Removing the barrel:

Put the receiver on a table or on a workbench.

Press down the barrel locking catch with a screwdriver or other suitable tool (Fig.15).

At the same time turn the barrel grip upwards and remove the barrel from the receiver (Fig.16).



Fig. 15



Fig. 16

Removing the optic housing:

Place the receiver on a table or on a workbench.

Press down the release button with a screwdriver or with a cartridge (Fig. 17). At the same time pull back the optic housing and remove it (Fig. 18).

Take the Picatinny style mounting rail, place it on the receiver and slide it forward until it audibly engages.

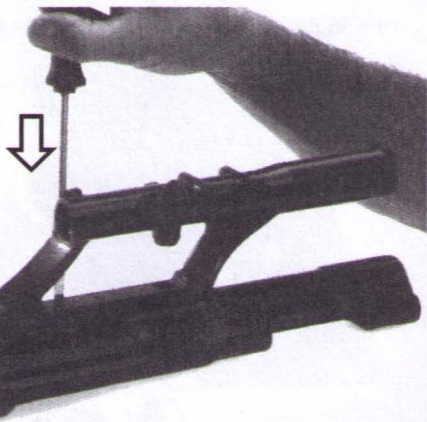

Fig. 17

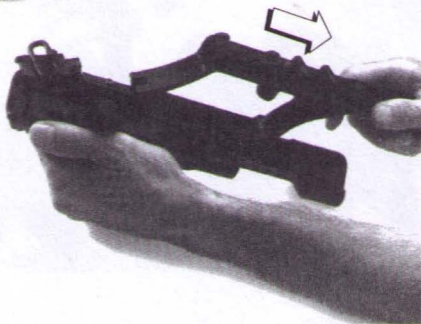

Fig. 18

Removing the butt plate:

- Secure the front of the stock.
- With the right thumb press the marked position on the butt plate (Fig.19).
- At the same time press in the retaining bolt (rear sling swivel) (Fig.19).
- Take off the butt plate (Fig.20).

Fig. 19

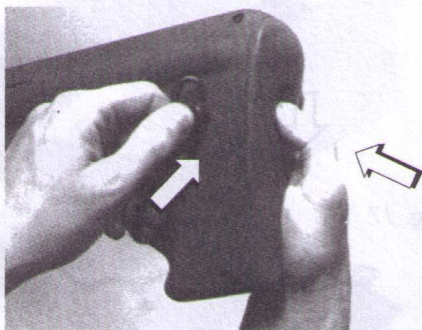
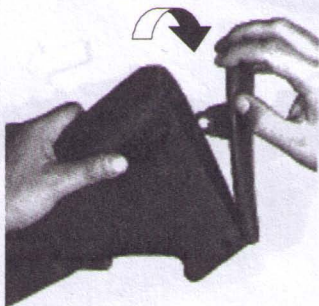

Fig. 20



Removing the hammer group:

(To remove the hammer group it is necessary to remove the butt plate first.)

- Press in the spring support and pull the rear sling swivel (retaining bolt) out completely (Fig.21).
- Grasp the tab on the rear of the hammer group and pull the hammer group out of the stock (Fig.22).
- Now you have stripped the rifle into its main groups.



Fig. 21



Fig. 22

Disassembly of the gas mechanism:

- Press down the serrated "ears" on the gas plug and turn clockwise until the slot on the plug is lined up with the gas cylinder (Fig.23). The gas plug is now free to be removed.
- Remove the piston and spring with the right thrust piece of bolt group or other suitable tool (Fig.24).

DO NOT ADJUST WHILE BARREL IS HOT.



Fig. 23

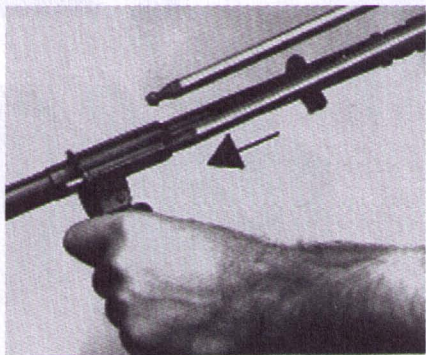

Fig. 24

Dissassembly of the bolt group:

- Hold bolt group in left hand (operating rods pointing left).
- With the right hand rotate the firing pin 90 degrees counterclockwise and remove it from the bolt (Fig.25).
- While keeping the bolt from moving forward with the left index finger, use the right index finger to push down the control bolt in the bolt carrier's cam slot (Fig.26).
- The bolt, adaptor sleeve, bolt spring, and bolt spring sleeve will now come out as a unit. Remove the cocking piece from the slide piece body (Fig.27).

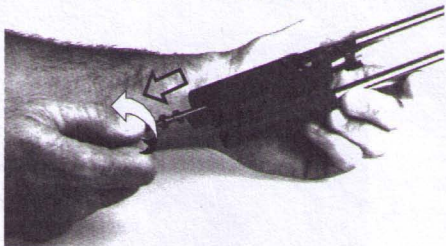

Fig. 25 Rotate firing pin

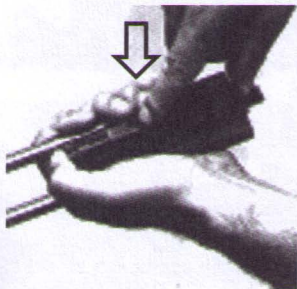

Fig. 26 Push down the control bolt



Fig. 27

Disassembly of the ejection lids, inner and outer:

(Only for converting from right hand to left hand ejection. **Note:** also requires new bolt assembly.)

Carefully lift the edge of the outer ejection lid using a screwdriver, pocket knife or similar tool pushing it forward simultaneously (Fig.28). Now the outer ejection lid may be removed, while the inner ejection lid drops downward into the stock and may be removed either through the magazine well or through the ejection port.

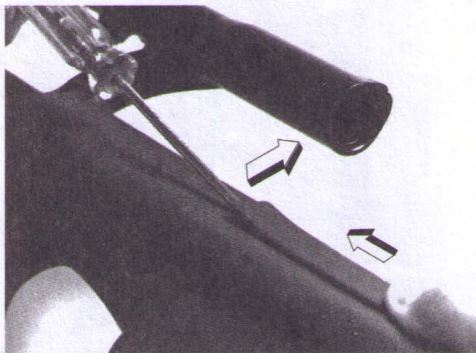

Fig. 28

Assembly of ejection lids:

Place inner ejection lid inside the ejection port and slide on outer ejection lid until it engages (Fig.29).

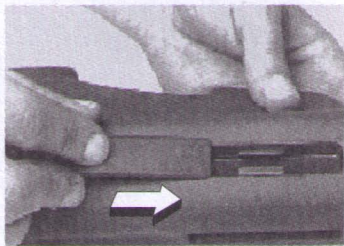

Fig. 29

Inserting the hammer group:

Insert hammer group in stock (Fig.30). Press in the hammer group tab until the holes in the tab, the hammer group and the stock are all aligned. Insert the retaining bolt (rear sling swivel) and push it all the way in. DO NOT FORCE (Fig.31). It will assemble easily when correctly aligned.

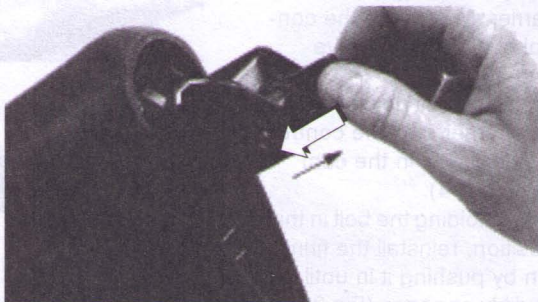

Fig. 30 Inserting hammer group

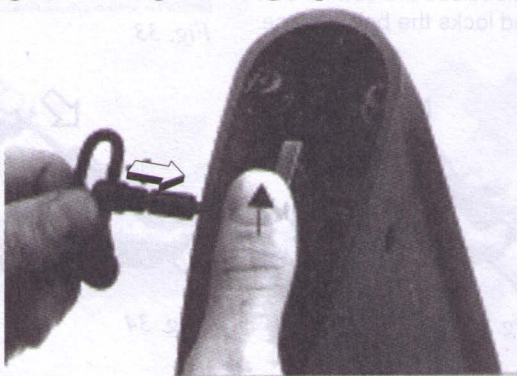

Fig. 31 Pushing in sling swivel

Reassembling of bolt:

- Insert cocking piece in the slide piece body (Fig.32).
- Insert the bolt (with adaptor sleeve, bolt spring, and bolt spring sleeve correctly attached) into the bolt carrier. Make sure the control bolt is free to move (Fig.33).
- Press the bolt down into the bolt carrier until the control bolt is visible in the cam slot (Fig.34).
- While holding the bolt in this position, reinstall the firing pin by pushing it in until it audibly engages (Fig.35). This raises the control bolt and locks the bolt in place.

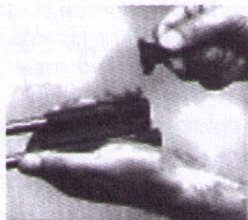

Fig. 32

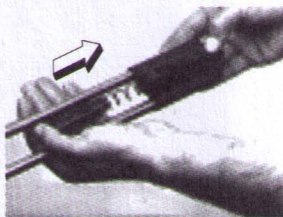

Fig. 33

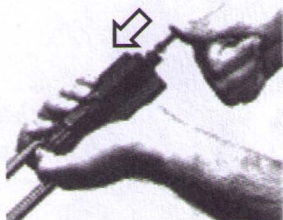

Fig. 35

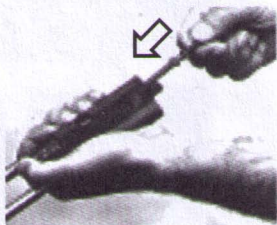

Fig. 34

Installing the butt plate:

Insert butt plate (bottom end first, as shown) (Fig.35).

DO NOT FORCE. It will seat easily if the sling swivel is pushed in fully. When the butt plate is seated, pull out the sling swivel about 1/4" to lock it in place (audible click).

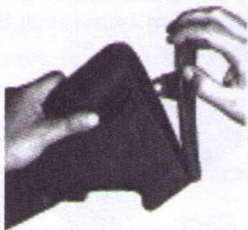

Fig. 35

Inserting the receiver in the stock:

Put the bolt carrier into the receiver (Fig.36). Press receiver with bolt carrier completely into the stock (Fig.37). Push in the housing lock (Fig.38). The system is now locked.

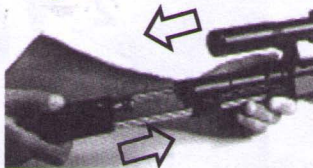

Fig. 36

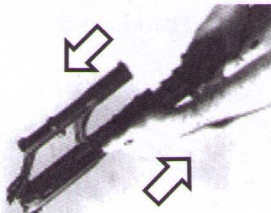

Fig. 37



Fig. 38

Inserting the barrel:

Grasp barrel at the barrel grip, insert barrel completely into the receiver. Turn barrel until the barrel retaining pin is locked automatically (Fig.39).

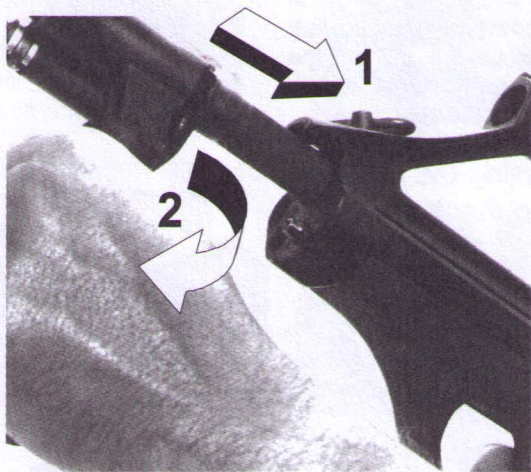

Fig. 39

7. IMMEDIATE CLEARING OF JAMS AND MALFUNCTIONS:

If the rifle is kept clean and given proper care, it will function very reliably. However, if a jam occurs, follow these procedures:

- Keep the muzzle pointed in a safe direction.
- Put the rifle on safe and remove the magazine.
- Pull back charging handle entirely, in order to eject jammed cartridge.

WARNING:

Be sure there is no obstruction in the barrel before attempting to chamber another cartridge.

- Release charging handle allowing the bolt to glide freely forward. Insert magazine again; load again.
- Continue firing.
- If the jam recurs, unload the rifle and have it checked by a qualified gunsmith.

8. TROUBLESHOOTING:

INCORRECT FEEDING AND LOADING

CAUSE

magazine is inserted incorrectly

damaged magazine

incomplete cycling
(low gas pressure)

* NOT RECOMMENDED UNDER NORMAL CONDITIONS

dirty chamber

defective or dirty cartridge

REMEDIAL ACTION

remove magazine and any loose cartridges, reinsert magazine until magazine release button locks audibly

inspect magazine and change it, if necessary

align gas plug with the large circle symbol to increase gas flow*, clean gun.

clean the chamber

discard cartridge (clean the chamber)

BOLT DOES NOT LOCK

CAUSE

dirty chamber or dirty bolt

defective cartridge

extractor jams

REMEDIAL ACTION

clean

change

clean and oil

MISFIRE

CAUSE

defective cartridge
(primer is struck, fail to fire)

defective or broken firing pin
(primer is not or insufficiently struck)

dirty bolt

defective hammer mechanism

REMEDIAL ACTION

wait 30 sec.in firing position, unload

wait 30 sec.in firing position, unload and return the rifle to be serviced.

clean

change hammer mechanism

INCORRECT EXTRACTING

CAUSE

extractor jams

defective extractor

weak spring

REMEDIAL ACTION

clean and oil the extractor

change the extractor

change

INCORRECT EJECTING

(cartidge or empty brass are extracted but not ejected)

CAUSE

ejector defective

REMEDIAL ACTION

change the ejector or ejector spring

9. CLEANING AND MAINTENANCE:

NEVER CLEAN LOADED FIREARMS! REMOVE AMMUNITION FROM CHAMBER AND MAGAZINE BEFORE CLEANING YOUR RIFLE!

Cleaning by user:

Be aware of the fact that proper handling and maintenance is necessary to guarantee it's perfect functional performance.

Clean the rifle after each usage.

Only proper cleaning devices and gun-oil are to be used for this purpose. The wire and bustle brushes are meant only for interior of the barrel.

Maintenance of the barrel:

The barrel must be free of oil prior to each firing.

Maintenance of rifle surface and other metal parts:

The rifle surface should be cleaned with a rag.

The following parts from the bolt group are to be oiled:

operating rods: 2 drops each

cam slot for control bolt: 1 drop

The gas plug and the gas piston are hard-chrome plated and it is not necessary to oil them.

Maintenance of optic:

Clean the lens with a dry clean rag or plain water only. No additional maintenance is required.

10. PARTS AND DIAGRAMS

(subject to technical change without notice)

Barrel group

Fig. No.	Part number	Description
1	1 1245010401	Barrel, 20"
2	1 1245010410	Barrel grip, complete, folding, grey
3	1 1200010072	Barrel grip lid, black
4	1 1200010077	Spring, for barrel grip
5	1 1200010078	Pin, for barrel grip
6	1 1200010050	Gas piston
7	1 1200010051	Ring, Gas piston (3 required)
8	1 1200010052	Spring, Gas piston
9	1 1200010061	Head, Gas plug (Service only)
10	1 1200010460	Gas Plug Assembly, Complete*
11	1 1200010063	Pressure bolt, Gas plug
12	1 1200010064	Spring, Gas plug
13	1 1200010062	Slide, Gas Regulator
14	1 1245010501	Barrel Assy. (Figs. 1-13)

**includes assembled parts 9, 11, 12, 13*

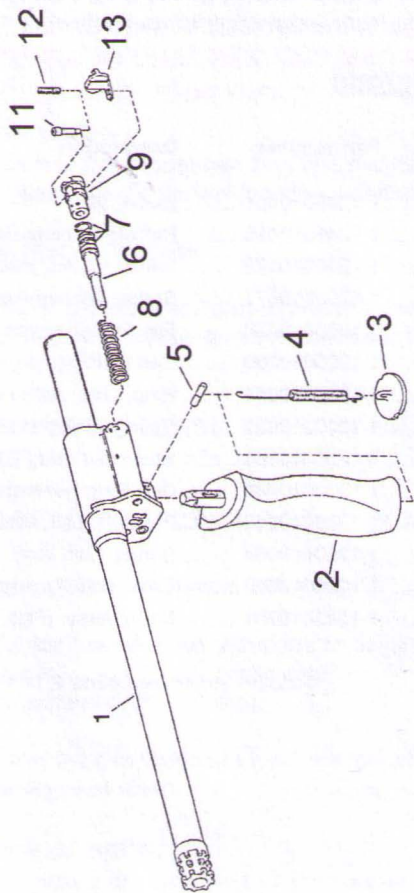

Receiver group

Fig. No.	Part number	Description
1	1 1245020401	Receiver, Only
2	1 1200020026	Pin, barrel lock
3	1 1200020027	Spring, barrel lock pin
4	1 1245020003	Pressure pin, complete
5	1 1200020023	Grub screw, barrel lock
6	1 1240020010	Charging handle, black
7	1 1200020096	Guides, Charging handle
8	1 1200020048	Spring, Charging handle guide
9	190003990099	Pin, Charging handle guide
10	190003909600	Pin, Charging handle retaining
11	1 1200020098	Pin, coupling
12	1 1200020087	Link, folding grip
13	1 1200020083	Spring, coupling pin
14	1 1200020462	Sling ring, complete front
15	190003909606	Pin, retaining sling front
16	1 1200020089	Spring, link piece
17	1 1200020091	Cylindrical pin
18	1 1200020062	Optic/circle, CH/CH
19	1 1200020558	Fixing screw, Optic housing
20	1 1245020002	Optic housing only
21	1 1240020011	Release button
22	1 1200010064	Spring, Release button
23	1 1200020568	Screw, Elevation & Lat. Adj
24	190003900059	Grub screw, Optic Housing
25	1 1245020501	Receiver Assy. (Figs. 1-17, 21, 22)
26	1 1245020502	Optic Housing Assy. (Figs. 19, 20, 23,24)

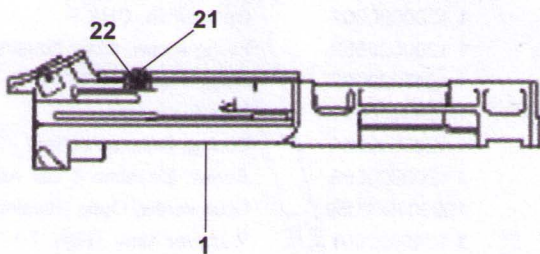
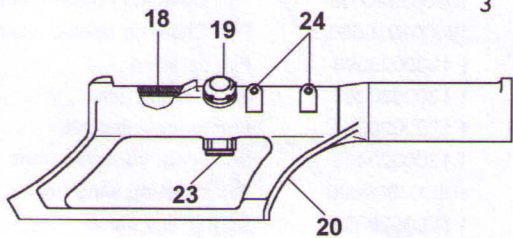
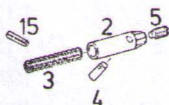
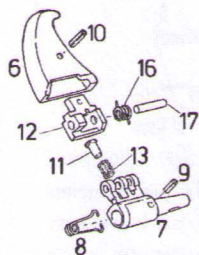

Hammer group

Fig. No.	Part number	Description
1	1 1200030005	Body, for hammer mechanism
2	1 1245030015	Catch, hold open
3	1 1200030016	Spring, lock bolt catch
4	190003903698	Bolt, 3H11 X 10 DIN1434
6	1 1200030050	Trigger lever
7	1 1200030046	Spring right, for trigger lever
8	1 1200030047	Spring left, for trigger lever
9	1 1200030033	Slide
10	1 1200030030	Hinge pin
11	1 1200030045	Disconnecter lever
12	1 1200030036	Pin, for disconnecter lever
13	1 1200030022	Retaining bolt lock
14	1 1212030015	Trigger spring
15	1 1200030460	Retaining bolt, complete, rear sling swivel
16	1 1200030031	Hinge pin, for hammer
17	1 1200030454	Drop safety
18	1 1245030502	Hammer group complete*

***Note:** parts listed above (1-17) are shown for identification only. Hammer group is available ONLY as a complete assembly.

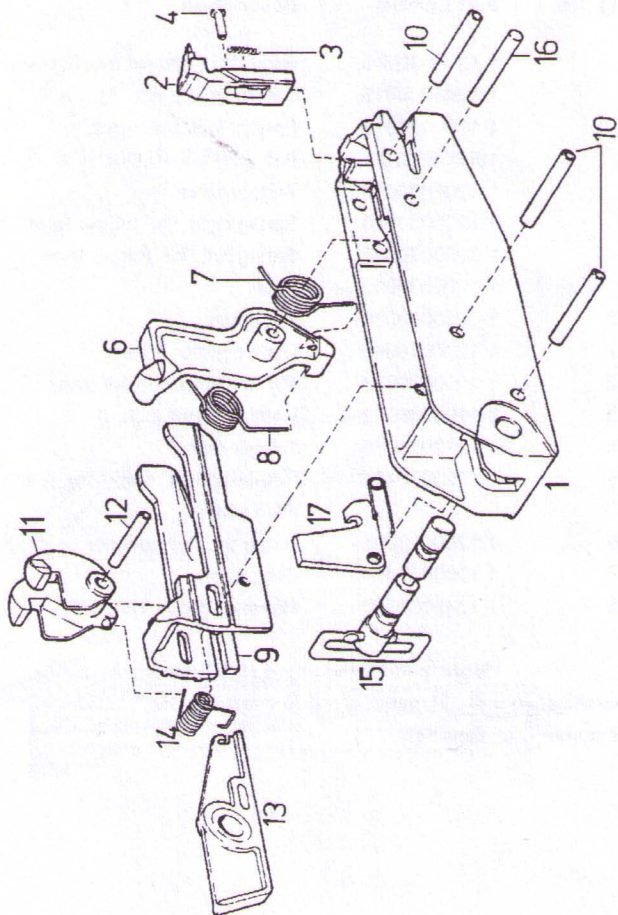

Bolt group

Fig. No.	Part number	Description
1	1 1200040412	Bolt Carrier
2	1 1200040025	Spring loaded bolt
3	1 1200040026	Lock spring, long, for recoil
4	1 1200040091	Spring, firing pin
6	1 1200040029	Thrust piece, left
7	1 1200040030	Thrust piece, right
8	1 1200040070	Bolt body (RH ejection)
10	1 1200040042	Extractor
11	1 1200040037	Pin, for extractor
12	1 1200040438	Spring, for extractor
13	1 1200040045	Ejector
14	1 1200040046	Spring, for ejector
15	190003909598	Adaptor sleeve
16	1 1200040063	Locking piece, bolt
17	1 1200040061	Control bolt
18	1 1200040093	Spring, bolt
19	1 1200040090	Firing pin
20	1 1200040092	Sleeve, Firing pin lock
21	1 1200040075	Cocking piece
22	190003909685	Adaptor sleeve
23	1 1200040005	Roller, Slide
24	190003900000	Pin, Slide roller

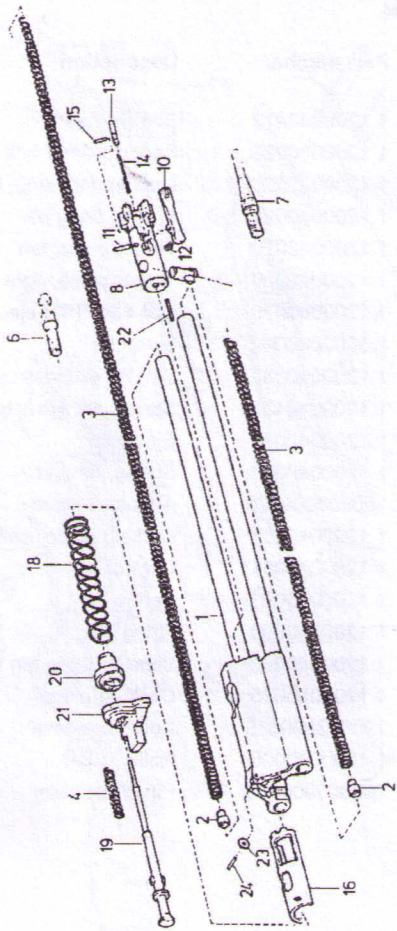

Magazine*

Fig. No.	Part number	Description
1	1 1245050501	Magazine, complete, 10 round

*Individual component parts not available. Sold as a complete unit only!



Stock group

Fig. No.	Part number	Description
1	1 1245060401	Stock, grey (Figs. 2, 3, & 4)
2	1 1200060046	Buffer plate
3	1 1200060051	Guide rod
4	1 1200060052	Buffer
5	190003862112	Screw, Trigger-sear lever
6	1 1200060018	Washer
7	1 1200060029	Trigger, black
8	1 1200060017	Nut, for trigger
9	1 1200060035	Sear lever
10	1 1200060019	Spring, for safety catch
11	1 1200060065	Safety catch, black
12	1 1200060028	Housing lock
13	1 1200060021	Spring, for housing lock
14	1 1200060066	Magazine catch, black
15	1 1200060041	Screw, magazine catch
16	1 1200060013	Hexagon nut, stock screw
17	1 1200060077	Spring, for magazine catch
18	1 1200060450	Butt plate, complete, black
19	1 1200060023	Lid, for cleaning kit compartment
20	1 1200060010	Ejection lid, inner
21	1 1200060006	Ejection lid, outer, black
22	1 12450606001	Stock Assembly, grey (parts 1-21 above)

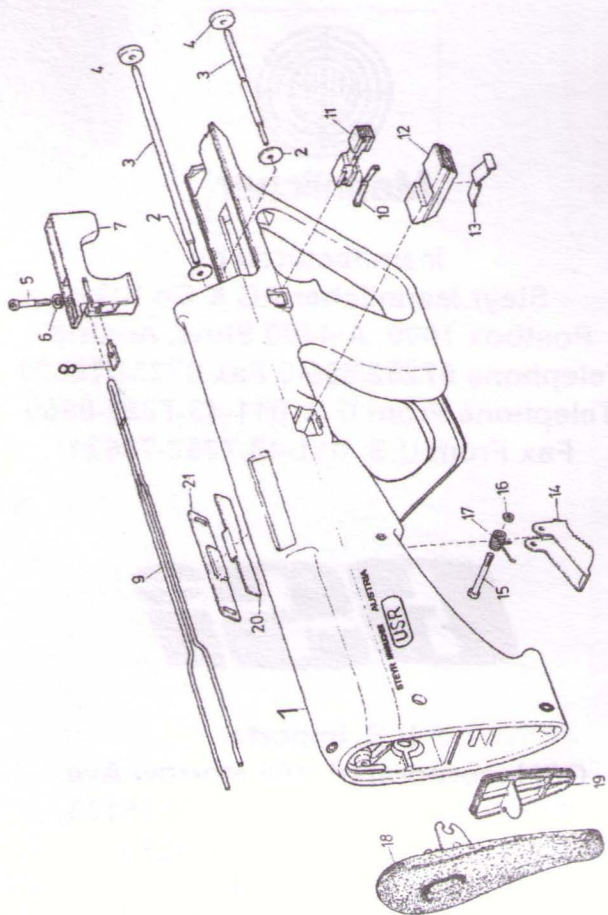



Mannlicher

**Manufactured by
Steyr Mannlicher AG & Co KG
Postbox 1000, A-4400 Steyr, Austria
Telephone 07252/896-0 Fax 07252/78621
Telephone From U.S. 011-43-7252-8960
Fax From U.S. 011-43-7252-78621**



**U.S. Importer
GSI Incorporated, 108 Morrow Ave.,
P.O. Box 129, Trussville, Al 35173.
Telephone (205) 655-8299
Fax (205) 655-7078
E-Mail SteyrSBS@aol.com**