

# Thompson/Center



# Owner's Manual

**⚠ DANGER**

The material in this booklet must be read and understood before attempting to use your Thompson/Center firearm. If pertinent safety information is not read, and the **-⚠WARNING -** statements are not understood and adhered to, death or injury could result.

**READ THIS MANUAL IN ITS ENTIRETY BEFORE  
USING YOUR FIREARM.**



Thompson/Center Arms Co., Inc.  
P.O. Box 5002  
Rochester New Hampshire 03866  
[www.tcarms.com](http://www.tcarms.com)



# Table Of Contents



Subject	Page Number
General Rules for Use and Handling of Muzzleloading Firearms.....	2
Nomenclature .....	8
Assembly & Disassembly of Your Omega™ Muzzleloader .....	10
Takedown Diagram For Your Omega™ Muzzleloader .....	11
Basic Equipment Needs For The Muzzleloading Shooter .....	12
Understanding Black Powder and Pyrodex® .....	13
Ignition in a Muzzleloader .....	18
Black Powder Pressures and Velocities .....	19
Understanding the Omega™ Muzzleloader Trigger & Striker Mechanism.....	21
Charging and Priming the Omega™ Muzzleloader .....	23
Omega™ Muzzleloader Loading Diagram .....	25
Loading Sabots When Using Loose Powder .....	26
Loading Sabots or Conicals When Using Pyrodex® Pellets .....	28
Summary of Charging and Priming.....	32
Pulling a Charge .....	33
Cleaning Your Omega Muzzleloader .....	36
Cleaning Your Omega Muzzleloader From The Muzzle .....	37
Cleaning Your Omega Muzzleloader From The Breech .....	38
Using Cleaning Implements With Your Omega Muzzleloader .....	41
Iron Sight Adjustment.....	42
Scope Mounting .....	43
Statement of Liability .....	43
Limited Warranty .....	44
Bullet Data .....	45
Suggested Load Listings Start for the Omega™ Muzzleloader.....	47
Mag Express™ Sabots .....	48
Shock Wave™ Sabots .....	52
Load Charts Start .....	50
Break-o-Way™ Sabots .....	53
Service Department.....	59

Omega™, T/C Mag Express™, Maxi-Hunter®, Maxi-Ball®, Break-o-Way™ Sabots, Natural Lube 100 Plus Bore Butter™, Mag Express™, Shock Wave™ and PTX™ are Trademarks of Thompson/Center Arms. Copyright 2007 Thompson/Center Arms Co., Inc.

**IMPORTANT NOTE:** *Separate Owner's Manuals for any other models of muzzleloaders which Thompson/Center offers are available free from the factory upon request. Call or write with your specific needs. Or, download the manuals from our web site at [www.tcarms.com](http://www.tcarms.com).*

NOTE: The loading data found in this manual was compiled using Black Powder or Pyrodex as a propellant. With any other approved Black Powder Substitute follow the instructions supplied by the manufacturer and heed all warnings as they apply to loading and usage of that product.



This booklet contains information that is essential to the safe use and maintenance of Thompson/Center's modern-style in-line muzzleloaders with removable breech plugs and fixed barrels. **You must read this material in its entirety and fully understand its significance before you can safely use your muzzleloader.** If a Thompson/Center muzzleloading firearm is loaned or sold (by an individual or a dealer), this booklet must accompany the firearm. Replacement booklets are available at no charge from our factory.

If, after reading this booklet, you still have questions concerning the safe use of your Thompson/Center firearm, write or call our Customer Service Department at:

Thompson/Center Arms Company, Inc.  
P.O. Box 5002  
Rochester, New Hampshire 03866  
Telephone: 1-603-332-2333

**• And Remember •**  
**The Fundamental**  
**National Rifle Association**  
**Rules for Safe Gun Handling Are:**

- 1 - Always keep the gun pointed in a safe direction.**
- 2 - Always keep your finger off the trigger until ready to shoot.**
- 3 - Always keep the gun unloaded until ready to use.**

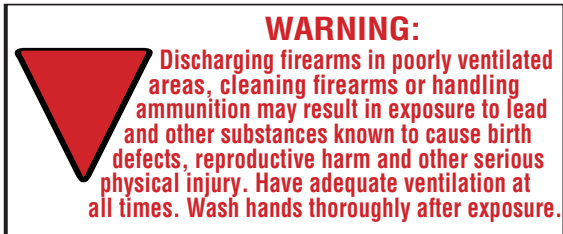

# General Rules for Use and Handling of Thompson/Center Black Powder Muzzleloading Firearms

**1 If you are unfamiliar with muzzleloading firearms seek professional instruction.** Qualified organizations such as local gun clubs, The National Rifle Association, The National Muzzleloading Rifle Association and state Hunter Safety Programs offer approved courses which teach safe gun handling and proper hunting procedure. Those who are unfamiliar with muzzleloading firearms should seek guidance from an instructor who is qualified by one of these organizations.

**2 If you are uncertain of the terminology or meaning of any word used in this booklet, write to Thompson/Center Arms.** Throughout this booklet the term “Prime” or “Primed” applies to the act of placing a percussion cap or a 209 shotshell primer on the nipple of a cap lock rifle or an in-line ignition muzzleloader or the pouring of priming powder into the pan of a flint lock rifle. “Unprime” or “Unprimed” refers to the opposite condition and indicates the percussion cap or primer (cap lock) or priming charge (flint lock) has been removed or is not in place. In addition, the frizzen on the flint lock must be open and the hammer at half-cock to put the firearm in an unprimed condition. “Charge” or “Charged” applies to the presence of a propellant powder charge and projectile in the bore of the rifle. “Uncharge” or “Uncharged” refers to the opposite condition and indicates that the powder charge and projectile have been either fired or removed and that the bore is completely clear.

**3 Know the muzzleloading firearm before attempting to use it.** The overall functioning and safety features of a muzzleloading firearm are different from modern rifles, shotguns, and pistols. Because of these differences the user must exercise caution and skill in the use of a muzzleloading gun. You must read and understand the workings of the muzzleloading firearm as explained in this booklet before attempting to use it.

**4 Use Black Powder or an approved Black Powder Substitute, such as Pyrodex only to load your muzzleloading firearm. WARNING: The use of smokeless powder, or a mixture of smokeless and Black Powder (duplex loads) or the wrong type or granulation of Black Powder or an approved Black Powder Substitute, such as Pyrodex or overloading may cause serious injury and/or death to the shooter or bystanders and damage to property. See section on “Black Powder or an approved Black Powder Substitute, such as Pyrodex,” in this booklet.** Thompson/Center muzzleloaders are designed and intended to be used only with a commercially manufactured Black Powder or an approved Black Powder Substitute, such as Pyrodex propellant of the specific granulation or type called for in this booklet. By Black Powder we mean a powder which is manufactured specifically for use

in muzzleloading firearms as opposed to smokeless powder which is manufactured for use in metallic cartridges or shotshells. NO smokeless powder, even those which appear black in color, should ever be used in a muzzleloading firearm. Be sure you know what type and granulation of powder you are loading. Never buy or use powder unless you have seen it poured from the original manufacturer's container which is clearly identified on the label. Use Black Powder or an approved Black Powder Substitute, such as Pyrodex, only of the type and granulation specified in this booklet and never load charges heavier than those listed.

**5 Always point the muzzle of your Black Powder Gun downrange.** The possibility of accidental discharge is a constant danger when using a firearm. If the muzzle is pointed downrange, away from yourself, other people, domestic animals or property, then injury and/or death and damage to property from an accidental discharge is less likely to occur.

**6 Be sure of your target.** Never fire a muzzleloading firearm unless there is a backstop behind your target. Never fire your muzzleloader in the field unless you have a clear view of your target. Never fire at noise or movement in the brush. If hunting with companions or in an area where there are other hunters, know where members of your party and/or hunters are located. Never fire your muzzleloader if there is a possibility that other hunters are downrange. Never shoot at flat, hard surfaces such as rocks or water. **WARNING: A projectile may ricochet off these surfaces and may cause serious injury and/or death to the shooter or bystanders and damage to property.**

**7 Never prime your muzzleloading gun until you are ready to fire it.** Your muzzleloader should remain unprimed until the instant before firing. After you prime the firearm, your full concentration should be on the target and the act of firing. **WARNING: Failure to follow this rule can result in an accidental discharge which may cause serious injury and/or death to the shooter or bystanders and damage to property. Uncharge the firearm by firing it into a suitable backstop before returning to the road or vehicle.**

**8 Never transport or carry a charged muzzleloading firearm in a vehicle.** **WARNING: Uncharge the firearm by firing it into a suitable backstop before returning to the road or vehicle. Failure to follow this rule may cause serious injury and/or death to the shooter or bystanders and damage to property.** Due to the large number of firearms accidents which occur in or near vehicles, this is a most important rule. The game laws in most states prohibit the taking of game from a road or vehicle. The rules of sportsmanship and common sense dictate that the firearm should not be charged until you are a safe distance away from the vehicle, road and companions. Never prime the firearm until you are actually ready to fire.

**9 The T/C Omega has no half-cock notch.** There are three hammer positions for the T/C Omega, "at rest", full cock and "fired" (hammer in the full downward position).

In the “at rest” position, the hammer is held off the firing pin by the automatic hammer block, preventing the hammer from contacting the firing pin. **WARNING: The T/C Omega should be carried with the hammer in the at rest position, with no 209 shotshell primer installed in the breech plug. The primer should be installed and the hammer cocked only when you are ready to fire. Failure to follow this rule may cause serious injury and/or death to the shooter or bystanders and damage to property.**

→ **⚠ WARNING** ←

**A sharp or heavy blow to the external hammer can fracture parts and cause a malfunction or discharge of the firearm. AN ACCIDENTAL DISCHARGE MAY RESULT IN INJURY AND/OR DEATH TO THE SHOOTER OR BYSTANDERS AND DAMAGE TO PROPERTY.**

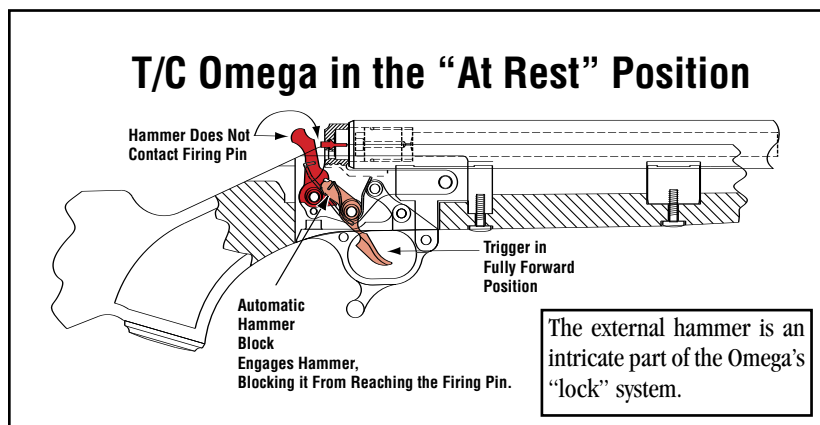

**10 Never hand a charged muzzleloading firearm to another person.** Once charged, a muzzleloading firearm requires your complete attention. Never charge the firearm and then hand it to another shooter. Equally you should never shoot a muzzleloading firearm that has been charged by someone else. Only the person doing the loading knows whether the firearm has been charged properly. **WARNING: Overloads and/or improper loading may cause serious injury and/or death to the shooter or bystanders and damage to property.**

**11 Never lean a charged and primed rifle against a tree, wall or any surface.** Once the rifle has been charged it is your responsibility to guard it against accidental bumps.

**12 Never store a charged muzzleloading firearm in a home, camp, vehicle or building.** **WARNING: After use, a muzzleloading firearm should be discharged (fired) into a suitable backstop before returning to the home or camp. Failure**

**to follow this rule may cause serious injury and/or death to the shooter or bystanders and damage to property.**

**13 Never attempt to clean a charged or primed muzzleloading firearm.**

**14 Wear protective gear when firing your muzzleloading firearm.** Always wear shooting glasses to protect your eyesight from air borne particles and ear protectors to guard against hearing loss due to loud noise when firing your muzzleloader. Protect your arms from flying particles of percussion caps or priming powder by wearing a heavy shirt or jacket with long sleeves. **WARNING: When firing, stand well forward of all bystanders to ensure that they are not struck by particles of powder or caps. Failure to follow this rule may cause serious injury and/or death to the shooter or bystanders and damage to property. Those wearing long hair or beards should use extra caution when firing a flint lock. A flint lock can torch hair.**

**15 Do not load or prime your muzzleloading firearm directly from a can, horn or flask.** A spark from a previous firing may ignite the stream of powder being poured into the gun and cause the container to explode. **WARNING: The explosion of powder can, horn or flask may cause serious injury and/or death to the shooter or bystanders and damage to property. Use a separate pre-calibrated measuring device containing small quantities of powder to load and prime your gun and keep your face, hands and body well away from the muzzle when loading and the pan when priming.**

**16 Do not smoke while using your muzzleloader.** The spark from a lighted cigarette, cigar or pipe can ignite Black Powder or a Black Powder Substitute such as Pyrodex, Percussion Caps or Primers. **WARNING: Smoking around a charged and/or primed muzzleloader, percussion caps, priming powder or supply of powder may cause premature firing of the gun or an explosion of the powder can, horn or flask causing serious injury and/or death to the shooter or bystanders and damage to property.**

**17 Keep powder, percussion caps, or primers well away from a firing position or shooting bench.** A powder horn, flask, can of powder, box of percussion caps or primers can ignite with deadly force if exposed to sparks or intense heat. Follow the manufacturer's instructions for safe handling and storage of powder or caps. **WARNING: Keep unused caps, primers and powder well away from firearms that are being discharged. Sparks from the discharge of a muzzleloading firearm may cause an unused supply of powder, caps or primers to ignite causing serious injury and/or death to the shooter or bystanders and damage to property.**

**18 Give the firearm your complete concentration.** Never cross a fence, jump a ditch or engage in any activity which distracts your attention while holding or carrying a charged and primed muzzleloading firearm.

**19 Know the condition of your muzzleloading firearm before charging, priming or firing.** Function the hammer and trigger of your gun to be sure that the parts are working properly before loading a charge. Be sure the muzzleloading firearm is properly loaded. Use **recommended loads of BLACK POWDER OR AN APPROVED BLACK POWDER SUBSTITUTE, SUCH AS PYRODEX ONLY for your specific model and caliber.** Mark your ramrod as explained in this booklet and always be certain that the ball, bullet or shot charge is seated properly on the powder charge. Be sure the barrel is clear of obstructions (including excess oil, mud, dirt, snow or any foreign material). **WARNING: Failure to observe any of these rules may cause serious injury and/or death to the shooter or bystanders and damage to property.**

**20 Be physically fit and mentally alert when using your muzzleloading firearm.** The use of your muzzleloader involves forceful physical actions which require strength and concentration. Never use alcoholic beverages or drugs before or when shooting or handling your muzzleloader. Never use your muzzleloading firearm when you are overly tired. If you use medication or have medical implants, consult your physician before using your muzzleloading firearm.

**21 At their very best, tree stands are potentially hazardous.** Even with good equipment, safety depends upon the age, health, dexterity and sound judgement of the user. If you feel that you must use a tree stand, purchase a top quality brand only and follow the manufacturer's instructions to the letter. **WARNING: Never climb to or descend from a tree stand with a primed muzzleloading firearm. Never raise or lower a primed muzzleloading firearm to or from a tree stand. Failure to follow this rule may cause serious injury and/or death to the shooter or bystanders and damage to property.**

**22 Respect the muzzleloading firearm.** Used properly your muzzleloader will give you years of pleasure. Used improperly, carelessly or abused, your muzzleloading firearm is a dangerous instrument and is capable of causing serious injury, death or property damage. Always treat your muzzleloader as if it were loaded. Do not drop your muzzleloader or allow it to be struck a blow. Dropping or striking it may cause movement and/or damage to internal parts in such a manner as to cause an accidental discharge. If the gun is dropped it should be examined. **WITH THE FIREARM UNPRIMED** slide your ramrod into the bore to ensure that the barrel is not obstructed. Check your ramrod mark to be certain that the projectile is seated firmly on the powder charge. Check the firearm for external damage. Check the firing mechanism to be sure that hammer and trigger are functioning properly.

**23 Use extreme care in the selection and/or use of accessories, implements or components.** Thompson/Center muzzleloaders are manufactured to a controlled tolerance and are intended for use with accessories and implements of Thompson/Center brand only. For example, Thompson/Center mold dimensions are carefully calculated to produce cast (pure lead) round balls, Maxi-Balls® or Maxi-Hunters® of a proper size and



hardness which are consistent with the specific caliber requirements of our product line. Patch material bearing the T/C brand is of the proper size and thickness for the caliber and round balls specified in this booklet and in our catalog. The reader is warned against the use of any unauthorized accessories, implements or components which are not of our manufacture and over which we have no control. Before purchasing or using accessories, implements or components, the reader must assure himself that such items are safe to use with Thompson/Center firearms. Responsibility for the safe use of such items rests totally with their manufacturer and/or dealer selling these products. If you are unsure as to the safety or compatibility of accessory items to use with our firearms, write to us at the address shown on page 8.

**24 The reader is warned against custom alterations and conversions. Thompson/Center does not endorse or recommend any type of alteration other than those performed by the Thompson/Center Custom Shop.** Replacement nipples, replacement barrels, priming devices or any other unit not of Thompson/Center manufacture and used as a replacement part or attachment to a Thompson/Center firearm is potentially dangerous. Responsibility for such devices rests totally with the manufacturer of the device and/or with the dealer selling the device or the person or persons installing it.

**25 Use Thompson/Center scope mounts only.** The Thompson/Center Catalog lists a series of scopes and mounts which are designed specifically for use with our firearms. These mounts make use of existing screw holes. Those who desire a scope sight should make use of Thompson/Center mounts. **WARNING: Do not drill additional holes in the barrel as this could weaken the barrel structure leading to a rupture. A ruptured barrel can cause serious injury and/or death to the shooter or bystanders and damage to property.**

The foregoing general rules and cautions are printed to contribute to your safety when using Thompson/Center muzzleloading firearms. These rules must be read, understood and adhered to. The remainder of this book is equally important. It contains information which is essential to the proper use and care of your muzzleloading firearm. **Do not attempt to load or fire your muzzleloading firearm until you have read this booklet in its entirety.** If, after reading this booklet, you still have questions concerning the safe use of your Thompson/Center firearm, write or call our Customer Service Department at:

**Thompson/Center Arms Co., Inc.  
P.O. Box 5002  
Rochester, New Hampshire 03866  
Telephone: 1-603-332-2333**

Know your T/C Omega muzzleloading firearm before attempting to use it. This booklet will help you to become familiar with the various terms associated specifically with this type of firearm. The diagram on this page points out the more commonly mentioned parts associated with the T/C Omega muzzleloader.

# T/C Omega Nomenclature

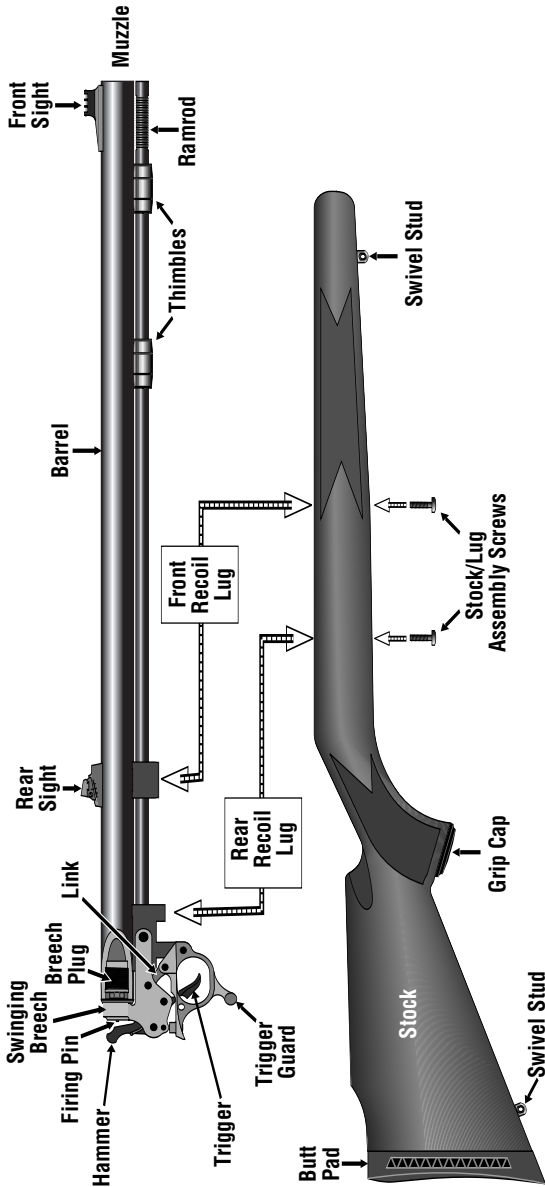

# Detail of Breech/Trigger Mechanism

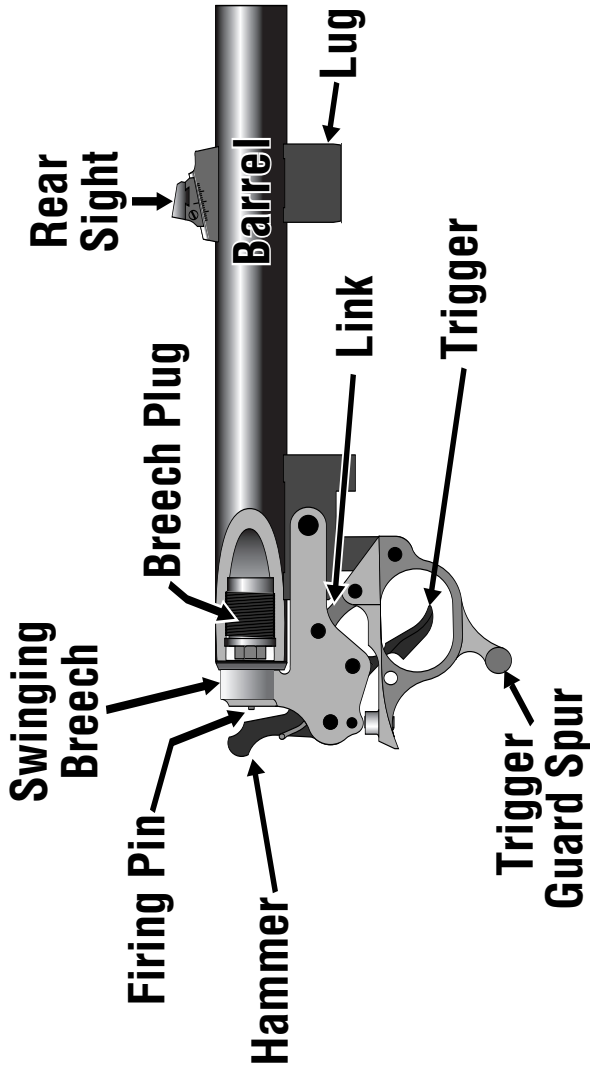

# Assembly & Disassembly Of The T/C Omega Muzzleloader

This T/C Omega Muzzleloader has two (2) basic parts groups:

**1. The Barrel and Action Assembly.** This assembly is held in the stock by two stock screws; one is located about 1" in front of the trigger guard, and the other is approximately 4" ahead of the first.

**2. The Stock Assembly** – molded composite material or wood.

**Note:** The barrel and action assembly can be broken down further by removal of the trigger/action assembly. This is recommended for a thorough cleaning of the rifle if it has undergone use in pouring rain or snow, or at seasons end, but it is not necessary for normal or routine maintenance.

**1st step** - Make sure that the gun is unprimed and uncharged. To ensure that the gun is unprimed and uncharged, lower the swinging breech block to open the action by pivoting the trigger guard forward. This will expose the primer pocket in the breech plug. Make sure there is no primer seated. Next, holding the muzzle up to the light, look through the ignition fire channel to make sure you can see through it. If you can not see through it, it is charged or the channel is obstructed and it will be necessary for you to remove the breech plug. (This is covered later in the text) If you can see light, proceed as follows.

**2nd Step** - Remove the ramrod from the thimbles.

**3rd Step** - Close the swinging breech and remove both the front and rear stock/lug assembly screws by turning them counter clockwise. (As viewed from the bottom of the gun)

**4th Step** - The barrel/action assembly may now be lifted out of the stock.

**5th Step** - Open the breech, and insert the in-line muzzleloader breech plug wrench onto the breech plug. Turn counter clockwise to unscrew the breech plug. You may have to exert some initial force in order to "break" the gas seal, which formed when the breech plug was originally "snugged" to the barrel during installation. There will be initial resistance to overcome.

To reassemble, reverse the above procedure, making sure that you check the functioning of the hammer/trigger mechanism after assembled, and prior to loading and firing. (See page 26).

**If other service is required, contact the factory at (603) 332-2333.**

# T/C Omega Muzzleloader Takedown Procedure

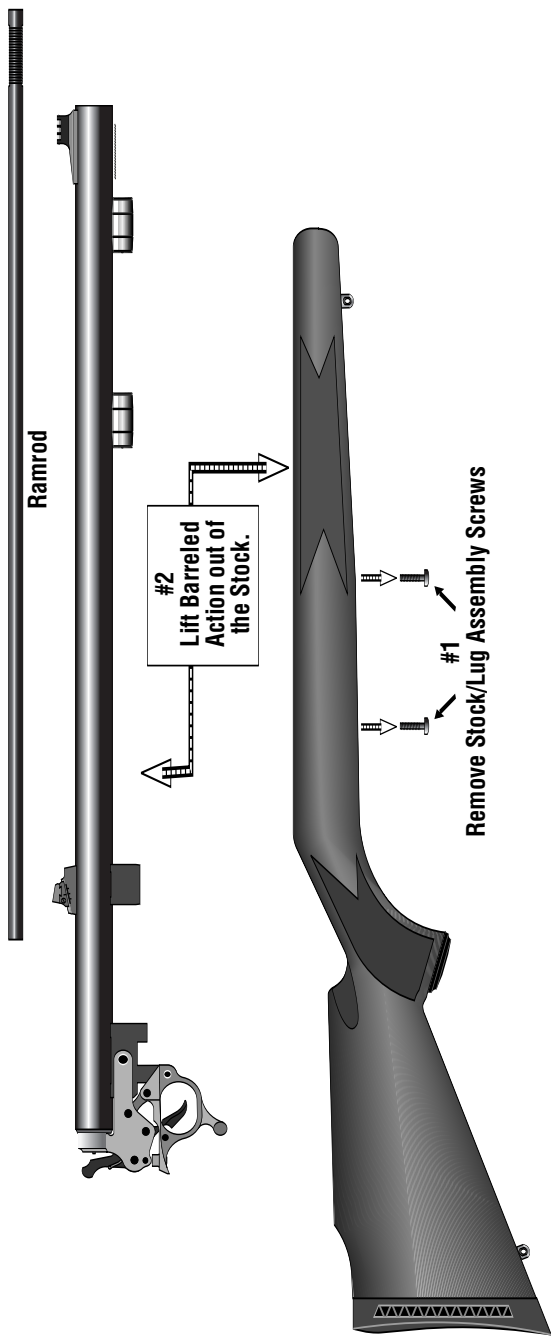

# Basic Equipment For Shooting Your Thompson/Center Omega Muzzleloader

In order to shoot your T/C Omega muzzleloader, a minimum of accessories or equipment will be necessary, these items include the following:

## → **⚠ WARNING** ←

**Do Not attempt to shoot your muzzleloading firearm until you have read this manual in its entirety and understood it fully. FAILURE TO READ AND FOLLOW THESE INSTRUCTIONS COULD RESULT IN AN ACCIDENTAL DISCHARGE, CAUSING INJURY AND/OR DEATH TO THE SHOOTER OR BYSTANDERS AND DAMAGE TO PROPERTY. If you are unable to understand any or all of this material, call the Customer Service Department at Thompson/Center Arms at (603) 332-2333.**

1. Proper eye protection
2. Proper ear protection
3. Black Powder or an approved Black Powder Substitute, such as Pyrodex only, in the appropriate granulation for your particular firearm.
4. Powder Measure.
5. Projectiles: Appropriate for your firearm.
6. 209 Shotshell Primers.
7. Patch worm for retrieving lost cleaning patches.
8. Cleaning patches
9. Jag for cleaning patches (One comes with each new Thompson/Center muzzleloader)
10. An appropriate bore cleaner and lubricant.
11. Breech Plug Wrench.

# Understanding Black Powder or an approved Black Powder Substitute, Such As Pyrodex™

**Make no mistake about it, Black Powder or an approved Black Powder substitute, such as Pyrodex®, are the only propellant powders that are safe to use in a muzzleloading firearm.** Oh, you will hear, or possibly read, advice to the contrary but don't follow it for you will never hear such advice from a competent source.

The reason for using a low yield powder such as Black Powder or an approved Black Powder substitute, such as Pyrodex is quite basic and it is related to firearm design. When used as a propellant, Black Powder or an approved Black Powder substitute, such as Pyrodex generates a relatively low breech pressure. Muzzleloading firearms, even those with modern steel barrels, are not designed to withstand the high pressures produced by a Smokeless Powder charge. Think about it for a minute and you will understand why. The ignition hole in a muzzleloading firearm is a direct port into the combustion chamber. This port is sealed only by the thin foil of a cap and weight of the hammer in the cap lock model. In the flint lock design this port is not sealed at all. The high pressure of a Smokeless Powder charge would destroy this ignition system and the gun itself.

To avoid any misunderstanding on the part of the reader let us explain further why Smokeless Powder cannot be used in a muzzleloader in any quantity. People who become interested in muzzleloading tend to research and to seek out some of the early journals which describe loading implements, components and powders of yesterday. **Reading these old books can be pleasurable. Never assume, however, that obsolete printed material has a safe application in today's world.**

In the early days of the breech loader there were powders manufactured which were called "Bulk Smokeless". These powders were measured by the volume and used interchangeably with Black Powder in early cartridge firearms. Even in their time these powders were never used in muzzleloading firearms.

Early "Bulk Smokeless" powders are not available today and, even if they were, their erratic performance (extreme variations in pressure) would not meet current industry standards. By modern standards, such early bulk powders were unsafe, even in the days of their use. The same type of misinformation exists concerning "duplex loads" or the mixing of Smokeless Powder with quantities of Black Powder. This practice was popular in the days of the early breech loaders. It was dangerous then and it is even more dangerous now for modern Smokeless Powders are far more complex in their composition.

**All presently available Smokeless Powders are designed for use with metallic cartridges and shotshells in strong modern breech loading firearms.**

**They should never be used in a muzzleloading firearm of any type.** Some of these powders are “Black” in color making proper identification extremely important. It is the characteristic of Smokeless Powders to burn in a controlled manner within a given pressure range. Control of this pressure range requires the proper application of the powder to the specific purpose and in the quantities for which it was designed to be used.

→ **⚠ WARNING** ←

---

**Never use smokeless powder of any type or in any quantity in a muzzleloading firearm, and never mix powders. The use of any smokeless powder could result in a detonation or explosion WHICH COULD CAUSE INJURY AND/OR DEATH TO THE SHOOTER OR BYSTANDERS AND DAMAGE TO PROPERTY.**

---

Confine your use to Black Powder or an approved Black Powder substitute, such as Pyrodex, and learn how to identify these powders and to use them correctly in your muzzleloading firearm. Here we will deal first with Black Powder for certainly it is the oldest of our propellant powders.

Black Powder is manufactured in four specific types or granulations for use in firearms. Generally speaking, it is the granule size which determines the appropriate use of Black Powder. Coarsest granulations are naturally the slowest burning and, therefore, work best in large caliber rifles and shotguns. Pistols or small caliber rifles require a finer or faster burning powder. The priming powder used in the pan of a flint lock is extremely fine and fast burning. The accompanying chart will help you to recognize the various granulations of Black Powder and to relate them to their proper use.

	<p><b>WARNING:</b> Discharging firearms in poorly ventilated areas, cleaning firearms or handling ammunition may result in exposure to lead and other substances known to cause birth defects, reproductive harm and other serious physical injury. Have adequate ventilation at all times. Wash hands thoroughly after exposure.</p>
---	---



# Black Powder Chart

## Showing The Appropriate Use Of The Various Granulations



### **FG** (commonly called Single "F")

The muzzleloading enthusiast finds little use for this very coarse black powder. It's use is restricted to the large bore (10, 8, 4 gauge) shotguns of yesterday.



### **FFG** (commonly called Double "F")

This is a very popular powder for the larger (.45 to .58 cal) rifles. It is also used for 12, 16, and 20 gauge muzzleloading shotguns. While it is not considered a pistol powder, it is sometimes used in very large caliber single shot pistols. It is recommended for use in the T/C Omega muzzleloaders.



### **FFFG** (commonly called Triple "F")

Due to its wide range of uses, Triple "F" is the black powder that is most commonly found on a dealer's shelf. It is used in all percussion revolvers, most single shot pistols, and most of the smaller (under .45 caliber) rifles. In a pinch, it can also be used to prime a flint lock.



### **FFFG** (commonly called Four "F")

The finest of all currently available black powders, Four "F" is best used for priming flint locks. Due to its limited use, it is sometimes difficult to obtain.

When purchasing Black Powder be certain that it is in the original manufacturer's container and that its granulation or type is clearly marked on the label. Follow the storage and handling precautions which are on the label. If you have any questions concerning the safe handling or storage of Black Powder, write to the manufacturer of the powder. Additional information on powder storage is available from the National Fire Protection Association, P.O. Box 9146, Quincy, Mass. 02269. Or call 1-800-344-3555. Ask for pamphlet #495.

This instructional booklet lists a range of Black Powder loads which are proper for your Thompson/Center firearm. Use only the granulation of Black Powder that is listed for your specific caliber and model. You will note that a series of charges are shown in each instance. The lightest charge shown for your firearm is the **starting load**. The heaviest charge listed is the maximum load. Start with the lightest load and work upwards gradually until you reach your best performing load. **You will find that the best shooting load is well below the maximum charge listed.**

## → **⚠ WARNING** ←

---

**Never exceed the maximum load listed for your particular firearm. OVERLOADS MAY CAUSE DAMAGE TO THE FIREARM AND INJURY AND/OR DEATH TO THE SHOOTER OR BYSTANDERS AND DAMAGE TO PROPERTY.**

---

Pyrodex is a propellant powder designed for use in muzzleloading cap lock rifles, pistols and shotguns. Pyrodex is not a Black Powder. In accordance with the manufacturer's instructions, Pyrodex relates closely to Black Powder on a **volume to volume basis (not weight of charge)**. In other words, a black powder measure set to dispense 70 grains of black powder will, in fact, dispense approximately 52 grains of Pyrodex (by weight). **However, this lighter charge of Pyrodex will provide a charge which is ballistically similar to 70 grains of Black Powder. For all practical purposes, knowing the actual weight of a charge of Pyrodex may be informative, but not necessary. Your black powder measure will dictate the proper amount by its graduations according to volume.** If you want to know the actual comparative weight of a Pyrodex charge, contact the manufacturer, Hodgdon Powder Co. Inc., Shawnee Mission, KS. 66201.

Pyrodex does not ignite as easily as Black Powder and, consequently, it is not recommended for use in flint lock firearms. Flint locks require strong, positive ignition and should be charged and primed with Black Powder of the appropriate granulation only.

# PYRODEX™ Chart

## Showing Appropriate Use Of The Various Grades



**PYRODEX® CTG** - FOR BLACK POWDER CARTRIDGES. This powder was designed to be used in early model breech loading cartridge firearms (rifles, pistols & shotguns) which were intended for use with Black Powder only. It has no application in Thompson/Center muzzleloading firearms. It is listed here simply for identification purposes.



**PYRODEX® RS** (or PYRODEX SELECT "RS") RIFLE & SHOTGUN POWDER. Designed for use in all calibers of percussion muzzleloading rifles and shotguns, this powder has a wide application. It may be used with all Thompson/Center cap lock rifles and shotguns including the T/C Omega muzzleloader. Pyrodex Select (RS) may also be used in this application.



**PYRODEX® P** - PISTOL POWDER. Designed for use in some percussion muzzleloading pistols and cap and ball revolvers, this powder has application in the Thompson/Center Patriot™ Pistol.

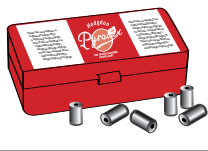

**PYRODEX® PELLETS** - Designed for use in the T/C Omega Muzzleloaders. Use the appropriate caliber pellet for your rifle.

### → **⚠ WARNING** ←

The reader should bear in mind that Thompson/Center does not manufacture or sell powder of any type. If there is ever a question as to the proper application of a particular powder or the safety of a given charge, write to the manufacturer of the powder. Adhere to the safe handling and storage precautions printed on the manufacturer's container and never purchase or use powders which have been removed from their original container. **USE OF THE WRONG PROPELLANT MAY CAUSE INJURY AND/OR DEATH TO THE SHOOTER OR BY-STANDERS AND DAMAGE TO PROPERTY.** For information on Pyrodex write to Hodgdon Powder Co., Inc., Shawnee Mission, Kansas 66202.

## Ignition in a Muzzleloader

Considering that Black Powder ignites easily and burns almost instantaneously, it would not seem that ignition could create problems for the muzzleloading enthusiast. Yet, it was in the age of Black Powder that such terms as misfire, hangfire and flash in the pan found their origins. The problem, of course, is that the muzzleloader requires a great deal more care in its cleaning and handling than does a modern cartridge firearm (see section on “Cleaning Your Muzzleloading Firearm.”)

The propellant Black Powder charge may not ignite if the nipple port is blocked by fouling, if the charge is dampened by oil or water or if the powder and/or caps have been allowed to deteriorate by improper storage (exposure to extreme temperature changes and/or dampness). Maintain the high quality of your Thompson/Center muzzleloader by meticulous cleaning. Make certain that the chamber, nipple port, pan and flashhole are free from oil, water or powder fouling. An appropriate nipple pick is a handy tool for cleaning nipple ports and flashholes. Thompson/Center cap lock rifles, shotguns and pistols use a No.11 percussion cap or in some instances, a musket cap or #209 shotgun primer and it is important that the caps or primers fit properly on their respective nipples. Use only high quality caps or primers and make certain that the cap is pushed securely onto the nipple, or the primer securely into the primer pocket of the breech plug.

### → **⚠ WARNING** ←

---

**Pyrodex, while cleaner burning, is somewhat harder to ignite than Black Powder. If while shooting, you should experience a misfire, hold the firearm downrange and treat the firearm as if it could go off at any minute - it might. After waiting at least one minute, clean out the nipple port or flashhole using your nipple pick. Replace the priming charge (flint lock) or percussion cap (or primer) and try firing the rifle again. Continue to point the firearm downrange while clearing ignition ports and repriming to prevent injury in the event of a discharge. If, after several tries, the firearm still refuses to fire, then the charge must be deactivated and pulled (See section on “Pulling a Charge”). FAILURE TO FOLLOW THESE INSTRUCTIONS MAY CAUSE DAMAGE TO THE FIREARM AND INJURY AND/OR DEATH TO THE SHOOTER OR BYSTANDERS AND DAMAGE TO PROPERTY.**

---

# Black Powder Pressures And Velocities

It is not the purpose of this manual to delve deeply into the complex subject of chamber pressure or how it relates to all firearms. There are, however, some basic differences between a muzzleloader and a modern cartridge firearm. The reader must understand and respect these differences if he or she is to use their T/C muzzleloader in a safe manner.

## → **⚠ WARNING** ←

---

**Shooting muzzleloading firearms requires rethinking all that you have learned about firearms. It requires discipline to cope with the requirements of being a reloader and rifleman at the same time. It requires strict adherence to the instructions set forth in this booklet. FAILURE TO FOLLOW THESE INSTRUCTIONS MAY CAUSE DAMAGE TO THE FIREARM AND INJURY AND/OR DEATH TO THE SHOOTER OR BYSTANDERS AND DAMAGE TO PROPERTY.**

---

Odd as it sounds, your safe introduction to muzzleloading firearms requires a good deal of reverse thought. Our forefathers, trained in the use of muzzleloaders, had little difficulty using the products of their day or adapting to improved concepts as each new idea presented itself in a normal progression. The transition from flint lock to cap lock to breech loader each represented a step forward toward a more technically sophisticated era. Users of firearms had hundreds of years to adapt to these changes. In a single lifetime, no one was exposed to drastic change.

The muzzleloading enthusiast of today, however, has been trained in the use of cartridge firearms. To safely use a muzzleloader he must adjust his thinking backward - bridging hundreds of years of product development - in one giant step! Those reading this booklet must face the realization that the design of a muzzleloading firearm is rooted in tradition. In other words, a manufacturer of muzzleloading firearms, while he does have the benefit of using modern steel, proper heat treating and other technical advances, does not have the option of drastically altering a design which is centuries old. To use a muzzleloader safely requires considerable mental adjustment on the part of today's shooter.

Modern cartridge firearms depend heavily upon the strength of a brass cartridge case to seal the chamber and to safely confine expanding gas. Equally it is the cartridge case which holds the bullet in a fixed position, confines the powder charge to a given volume and controls headspace. Modern cartridge firearms are designed to withstand high working pressures since these same pressures make possible the high velocities, flat trajectories and increased range of modern ammunition. Yet, the modern firearm is no stronger than the cartridge case that is used in its chamber. If the case ruptures, the primer punctures or if the headspace is altered, hot powder gases under extreme pres-

sure will flow back through every seam in the action possibly destroying the firearm and causing injury to the shooter

The propellant charge in a muzzleloader is poured directly into the barrel of the firearm and then compressed by the projectile in the chamber area. Think about this for a minute! Lacking the restraints and protection supplied by a modern cartridge case, the muzzleloading charge rests directly against the steel chamber walls and the face of the breech plug. The ignition channel is a simple hole leading directly into the chamber. Certain surfaces of the breech plug are directly exposed to chamber pressure. Judged by the design standards set for modern firearms, the muzzleloader is extremely primitive. Its design will not tolerate high pressure.

The following text applies to the use of your Thompson/Center muzzleloader with Black Powder or Pyrodex charges properly restricted to the loading information shown in this booklet. It deals with those conditions which singularly or cumulatively can affect muzzleloading pressures.

For years it has been assumed that it is impossible to overload a firearm using Black Powder. The theory was that only a certain portion of a heavy Black Powder charge will burn and that the remaining powder is blown out of the bore in unburned condition. This thinking led to the belief the pressures created by a Black Powder charge would reach a certain (undetermined) range and climb no higher. **Our testing indicates that this theory is completely unfounded.** As heavier and heavier charges were loaded our pressure readings climbed accordingly. At no time was there any indication of a leveling off of pressure. **Unreasonably heavy charges of Black Powder or an approved Black Powder substitute, such as Pyrodex, can be dangerous. Restrict yourself to the loads listed in this booklet and start with the lightest load shown for your particular model and caliber. Bear in mind that the following conditions can be cumulative. If you load the heaviest charge listed without following instructions (working slowly upward) then other conditions such as powder fouling, hard projectiles and improper loading, can carry you well beyond the maximum safe pressure range of muzzleloading firearms.** All propellant powders (depending upon their design and composition) will function most efficiently within a given pressure range. Our testing indicates that the Black Powder used in our testing operated most efficiently at or near the midway point in our loading charts, and recorded the highest velocity in relation to the lowest pressure. **Heavier loading showed marked increases in pressure and substantially more recoil for only minor gains in velocity.**

Fouling in the bore of a muzzleloader will increase pressure. When shooting a muzzleloader, consecutive shots without cleaning will display rapid shot-to-shot increases in pressure, a variation in velocity and a resultant decrease in accuracy. As Black Powder or an approved Black Powder substitute, such as Pyrodex®, fouling builds in the bore of your muzzleloader, loading will become more difficult until it reaches the point where it be-

comes impossible to properly seat the projectile.

This is especially true when firing modern plastic sabots. For optimum accuracy in a range situation, the bore should be swabbed after each shot. Pressures will then be more consistent, and better accuracy will result.

In a hunting situation, this will be impractical, and 1, 2, or even 3 shots may have to be taken without swabbing the bore. Keep in mind however that when loading becomes increasingly more difficult, it is because of fouling building up and accuracy will suffer.

Any increase in bullet weight with a given powder charge will increase pressure. If a shooter has been loading a 240 grain bullet and sabot combination and then decides to use the heavier 300 grain bullet/sabot combination, he must go back to the starting charge and work up slowly to the best performing load.

Improper loading can lead to a serious and dangerous pressure condition. To function properly the muzzleloading projectile must be seated tightly against the powder charge. **Never fire a muzzleloading firearm if the projectile is only part way down the barrel.** Mark your ramrod, as explained in the "Loading Section", and follow instructions carefully.

Variations in patch lubricants and bullet lubricants will effect velocity and accuracy, as well as having an effect on the amount of fouling which develops. Use of T/C's Natural Lube 1000 Plus Bore Butter, an all natural lubricant, developed far less fouling, and permitted extended reloading between shots without the necessity to clean between these shots when used with our all-lead conical bullets. Velocity and accuracy improved over other lubricants used. However, when using jacketed bullets in plastic sabots, lubricating the barrel is not recommended, as accuracy is sure to suffer as a result. Sabots should be loaded without being lubed and any lube in the bore should be removed prior to loading a sabot.

## Understanding The Hammer/Trigger Mechanism of the T/C Omega Muzzleloader

The T/C Omega represents an all-new concept in muzzleloading firearms. The T/C Omega has several design features which are different than traditional muzzleloading firearms, and must be understood before you attempt to use and fire your T/C Omega.

The Omega's entire action has only 4 moving parts, 2 of which are the patented trigger mechanism (Pat #4,854,065) consisting of the trigger and the hammer. The design makes it possible for the hammer to strike the firing pin only when the trigger has been

pulled fully rearward. (See diagrams below) When the shooter pulls the hammer back only part of the way, without pulling the trigger, you will notice that the hammer block, which is an integral part of the trigger, is automatically in a “blocking position”, preventing the hammer from going forward and making contact with the firing pin. Only when the trigger is pulled fully rearward will the hammer block be pivoted out of the way, allowing the hammer to come fully forward and make contact with the firing pin.

There are other design features, which also act to increase safety when using the OMEGA. When the breech block has been lowered by opening the action, you will not be able to cock the hammer; conversely, when the hammer is cocked, you will not be able to lower the breech block and open the action.

## → **⚠ WARNING** ←

**If the trigger does not move forward after being released by the trigger finger, the gun must be returned to the factory for inspection and repair. Failure to follow this rule can result in accidental discharge which can cause injury and/or death to the shooter or bystanders and damage to property**

### T/C Omega in the “At Rest” Position

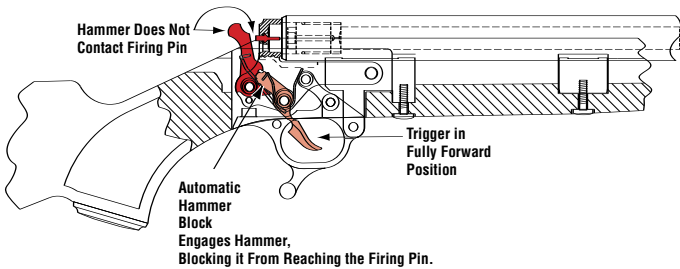

### T/C Omega in the “Cocked” Position

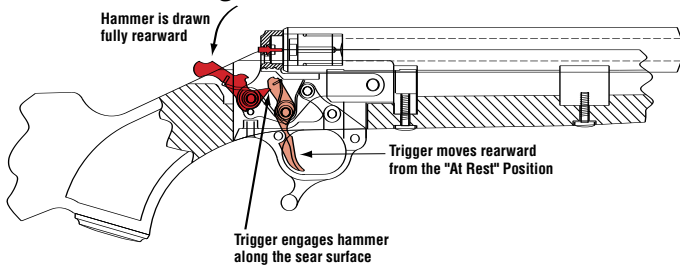



## T/C Omega in the “Fired” Position

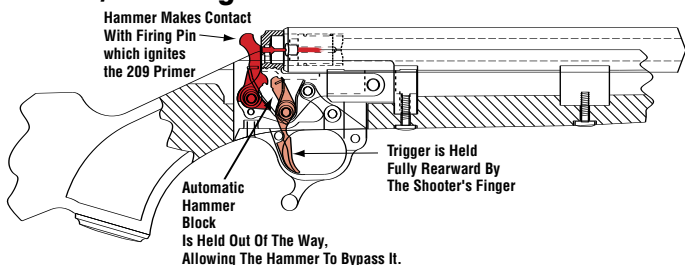

## T/C Omega in the “At Rest” Position

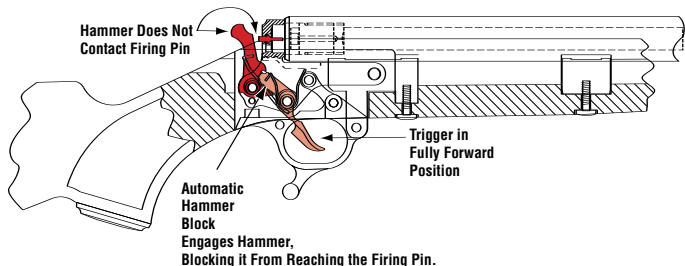

### → **⚠ WARNING** ←

Never prime your Omega muzzleloader until you are ready to fire it. Your T/C Omega should remain unprimed until the instant before firing. After you prime your T/C Omega muzzleloader, your full concentration should be on the target and the act of firing. **FAILURE TO FOLLOW THIS RULE CAN RESULT IN ACCIDENTAL DISCHARGE WHICH CAN CAUSE INJURY AND/OR DEATH TO THE SHOOTER OR BYSTANDERS AND DAMAGE TO PROPERTY**

## Charging & Priming The Omega

### → **⚠ WARNING** ←

If you have not read this manual in its entirety, do so before attempting to load your firearm. **IMPROPER LOADING AND USE OF YOUR FIREARM CAN CAUSE INJURY AND/OR DEATH TO THE SHOOTER OR BYSTANDERS AND DAMAGE TO PROPERTY.**

The photo on page 25 shows a shooter in the process of loading a Omega muzzle-loader. Study this photo carefully and read all the captions before you proceed to charge your Omega muzzleloader rifle.

Before charging your Omega, open the action (swing the breech block down) by pivoting the trigger guard forward. Look into the breech plug primer pocket and check to make sure there is no primer in the pocket. Hold the muzzle up to the light and look through the ignition channel to ensure that there is no charge present. Insert the ramrod into the muzzle and tap it up and down several times. You will hear the metal cap of the ramrod “clink” as it contacts the steel face of the breech plug.

Note exactly how far the ramrod goes into the barrel when the gun is not charged. Commit this exercise to memory and practice it every time that you handle the Omega, or any other muzzleloader. Before you attempt to load it - before you store it away - before you hand it to a friend or leave it unattended, always check to ensure that the firearm is unprimed and uncharged.

The next precharging exercise is to wipe the bore free of all oil. **Be meticulous with your cleaning for the presence of any amount of oil in the barrel or chamber can dampen the powder charge and cause the rifle to misfire or hangfire (see section on “Cleaning”).** Point the muzzle in a safe direction and snap several 209 shotshell primers in the breech plug before charging. This will ensure ignition and clear away any oil that may have accumulated in the ignition channel.

Adjust the powder measure to the desired charge and fill it with Black Powder or an approved Black Powder substitute, such as Pyrodex. To achieve accuracy, consistency in the powder charge is required. Fill the measure exactly the same each time. Set the rifle on its butt with the action open and **hold the muzzle away from your face and body as pictured on page 25.** Pour the measured charge down the barrel and strike the side of the barrel several sharp raps with the heel of your hand. This will settle the powder into the chamber area of the barrel. If you are using Pyrodex Pellets - remember to insert the black end into the muzzle first. The black end contains Black Powder to aid in positive ignition. Seat the projectile firmly on top of the pellet or pellets. Do Not pound on the ramrod or beat the projectile with excessive force, so as to crush the pellet(s).

The loading data found in this manual was compiled using Black Powder or Pyrodex as a propellant. With any other approved Black Powder substitute follow the instructions supplied by the manufacturer and heed all warnings as they apply to loading and usage of that product.

# T/C Omega Loading Diagram

## → **⚠ WARNING** ←

**IMPROPERLY CHARGING YOUR T/C OMEGA MUZZLE-LOADING RIFLE CAN BE DANGEROUS. STUDY THIS PHOTO CAREFULLY BEFORE PROCEEDING.**

**Stay mentally alert. This task requires your complete attention.**

**Eyes, ears & arms protected.**

**Do Not Smoke while loading any muzzleloader.**

**Keep components & reserve powder well away from the firearm.**

**Butt resting firmly on the ground & supported by the side of the shooter's foot to prevent slipping.**

**Barrel held securely with muzzle upwards - directed away from your body.**

**Use Black Powder or an approved Black Powder substitute, such as Pyrodex® ONLY!  
Use a T/C graduated powder measure only and do not overcharge. NEVER charge directly from a powder flask, can or powder horn.**

**Rifle unprimed with the action open.**

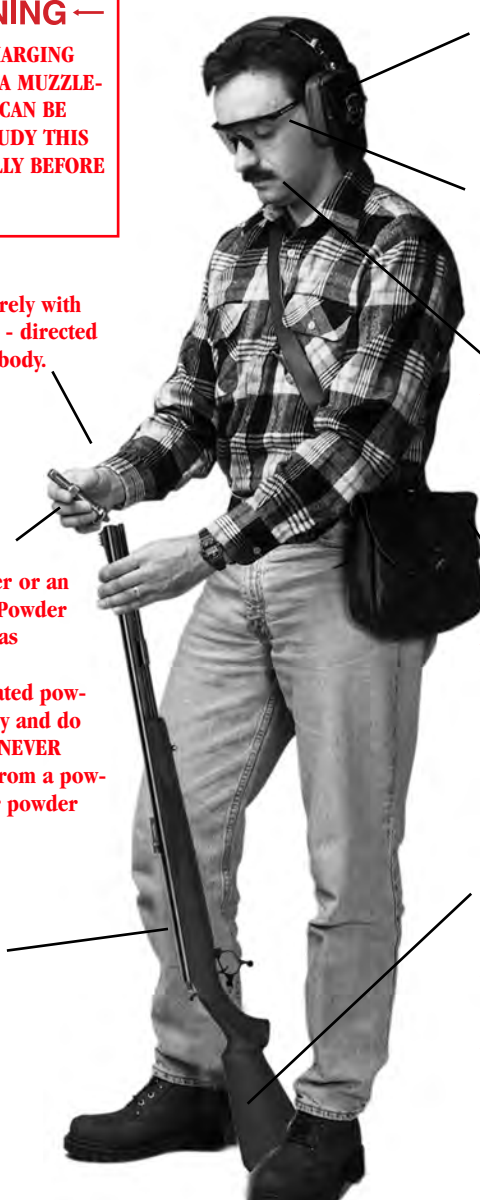

## **Loading And Use of a T/C Omega Muzzleloader**

## Loading Sabots When Using Loose Black Powder or Granular Pyrodex®

The procedures for loading sabots or conical bullets when using loose Black Powder or Pyrodex are basically the same as when using Pyrodex Pellets; the only difference being that instead of dropping Pyrodex pellets down the bore, you will be pouring **premeasured** charges of Black Powder (FFG) or Pyrodex (RS) powder. As with pellets, care should be taken to seat the sabot firmly against the powder. Do not pound it. Again, mark your ramrod at the muzzle, ensuring that each time you load; the projectile will be seated at the same depth.

If you are loading an all-lead conical like T/C's Maxi-Ball or Maxi-Hunter, proceed as follows; do not use a cloth patch with these projectiles. They should be lubed, and are designed to be shot as cast (not sized). T/C Maxi-Balls and Maxi-Hunters now come from the factory prelubed. However, if you find some unlubed bullets, we recommend that you lube these bullets with an all-natural lubricant, free of petroleum, like T/C Natural Lube 1000 Plus Bore Butter. Maxi-Balls and Maxi-Hunters do not have to be sized. Sizing will alter the diameter of the forward bearing band, and this will destroy the accuracy of the projectile and dangerously decrease its diameter (a loose fitting projectile can move off the powder charge). When loading a Maxi-Ball or Maxi-Hunter bullet, you will note how only the forward most bearing band grooves to the rifling when loading. The base of the bullet upsets (increases in diameter) on firing, causing it to fill the grooves, thus stabilizing the projectile.

When loading sabots, do not lubricate them. They are intended to be loaded into the muzzleloader just as they come from the package. In fact, for best results, it is recommended that all evidence of oil or lubricant be removed from the bore before loading a sabot - the drier the bore the better for optimal accuracy.

Hold the rifle as pictured on page 25 and pour your measured powder charge into the barrel. Start the lubricated bullet or sabot into the bore with your fingers. The base of the projectile will enter the bore easily with finger pressure. Drive the projectile down about four inches into the barrel with the rod end of the starter. Using short strokes with the ramrod, push the projectile the remainder of the way down the barrel until it contacts the powder charge. **The sabot or conical bullet must be seated firmly against the powder charge.** Seat the projectile with exactly the same pressure shot after shot. Study Photo "A". **Remove the ramrod before you prime the firearm.**

### PHOTO A

Using short strokes with the ramrod, push the projectile down the barrel and to seat it against the powder charge.

**PROJECTILES MUST ALWAYS BE SEATED FIRMLY AGAINST THE POWDER CHARGE.**



After the projectile is seated tightly against the charge, mark your ramrod to indicate the correct loaded depth of the powder plus the projectile (as shown below)

### PHOTO B

Mark the ramrod at the muzzle. Use a pencil to mark the ramrod. This will allow you to ensure that each projectile is seated to the same depth. Erase and remark each time you adjust the charge or change projectiles. When you arrive at the desired charge, cut a clean notch in the ramrod so you will have a permanent reference mark. This reference mark will serve as an indicator only with the charge and projectile used when it was marked. When the charge and/or projectile change, the reference mark will also change.



## → **WARNING** ←

**Never fire a muzzleloader unless you are sure the projectile is firmly seated on the powder charge and the ramrod has been removed from the bore. Shooters should bear in mind that the muzzleloading projectile is not crimped into position as is the fixed cartridge projectile. If a projectile does not fit tightly then jarring or movement of the firearm can cause it to move forward. If the firearm is fired when a projectile is forward or off the powder charge, or the ramrod is still in the bore, then the projectile or ramrod may act as a bore obstruction. This can cause a ruptured or burst barrel. A RUPTURED OR BURST BARREL MAY CAUSE INJURY AND/OR DEATH TO THE SHOOTER OR BYSTANDERS AND DAMAGE TO PROPERTY. If, due to fouling, a bullet or ball becomes lodged part way down the barrel, the firearm must be disassembled and the charge removed. See section on "Cleaning". Also see section on "Pulling a Charge".**

## Loading Sabots or Conical Bullets with Pyrodex® Pellets

If you are loading sabots like T/C's Mag Express Sabots, make sure that the bore has been swabbed and that all of the oil or lube has been removed. The drier the bore, the better, as this will improve accuracy.

Start by loading two 50 grain Pyrodex pellets, dropping each pellet down the bore with the black end going in first. The black end actually contains black powder, which acts as the igniter. Because black powder ignites at a lower temperature than Pyrodex, this will increase reliable ignition significantly.

Insert your sabot (with bullet installed) or conical bullet into the muzzle using your fingers. Push the projectile into the barrel as far as you can, until it stops. This portion of the muzzle is the recessed portion of T/C's QLA Muzzle System. Your projectile is now perfectly aligned to the center axis of the bore, surrounded by 360° of barrel.

### Photo A

Projectile inserted in the Quick Load Accurizer (QLA) Muzzle, perfectly aligned.



Choking up on your ramrod, or with a short starter, drive the projectile into the bore. There will be a minimal amount of resistance to overcome initially. (See Photo B)

### Photo B

Drive the projectile into the barrel with firm pressure or a short rap.



Once the projectile is in the bore, using short strokes with your ramrod, push the projectile the remainder of the way down the bore, until it makes contact with the Pyrodex pellets. Seat firmly, but do not pound on it, as this will likely crush the Pyrodex pellets, which will affect accuracy and the reliability of ignition. It could also deform the bullet. (See Photo C)

**Photo C**

Use the ramrod to push the projectile down the barrel and seat it against the Pyrodex pellets.



With successive shots, fouling in the bore may build up in sufficient quantity to make loading of subsequent shots more difficult, or even impossible. This is especially true when shooting sabots out of a dry bore. The more fouling present, the more difficult it will be to seat your sabots at the same depth. This will cause differences in pressure, which will affect your accuracy. For maximum accuracy, you should swab your bore (with a powder solvent like T/C's Number 13) after each shot, and while on the range, this will be possible. In the field, you can expect that you will be able to go two to three shots before swabbing may become necessary, especially if you are using magnum charges of 150 grains (three 50 grain Pyrodex pellets). The more powder you use, the more fouling you will build up. When you experience progressively more difficult loading due to build up of fouling, you must clean the bore or safe loading will become impossible. See the sections on "Cleaning" and on " Pulling a Charge".

**Photo D**

Once the sabot has been loaded, it is necessary to carefully mark your ramrod.



**Priming Your Charged T/C Omega muzzleloader.** If you have followed the preceding instructions your firearm will now be charged with Black Powder or Pyrodex and a projectile will be firmly seated against the powder charge. **Your ramrod will be marked to the exact seating depth allowing you to ensure that each future projectile is seated in the same careful manner.**

→ **⚠ WARNING** ←

**Do not prime the firearm until you are actually ready to fire and you have double checked to ensure that the ramrod has been removed from the bore. Thompson/Center does not recommend priming the firearm until the instant before actual firing. Carrying a charged, primed T/C Omega can be dangerous. Accidental discharge is a constant hazard which, if it occurs, can cause injury and/or death to the shooter or bystanders and damage to property. The only safe way to guard against an accidental discharge is to carry your T/C Omega unprimed, with the hammer in the "at rest" position and the muzzle pointed downrange away from yourself, bystanders or property.**

**WHEN YOU ARE READY TO FIRE YOUR T/C OMEGA, PRIME IT AS SHOWN IN PHOTO "G".**

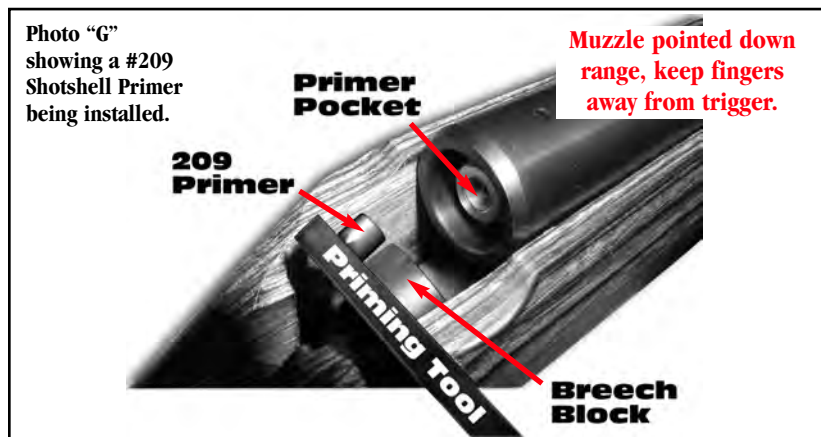

Hold the T/C Omega firmly with the muzzle pointed in a safe direction and open the action by pivoting the swinging breech down - using the trigger guard as the lever - then press a 209 shotgun primer down tightly into the breech plug. Close the breech and the rifle is ready to fire. **COCK THE HAMMER RAISE THE T/C OMEGA AND FIRE THE SHOT!**

Using the 209 shotgun primer as the source of ignition, it will be necessary to insert the 209 primer in the breech plug primer pocket. Insert the 209 shotgun primer



using your fingers - or use the 209 primer/depriming tool provided with your rifle, or sold as an accessory. Slide a 209 primer into the slot as shown in the diagram. Place the protruding part of the primer into the hole in the breech plug. Once the primer has been inserted, pull the tool away from the gun while leaving the 209 primer in the breech plug's primer pocket. To remove a spent 209 primer, or a live 209 primer, use the forked end of the tool. Push this forked end under the rim of the primer. As you push, the primer will lift out of its hole which will help you grasp the primer with your fingers and remove it from the gun.

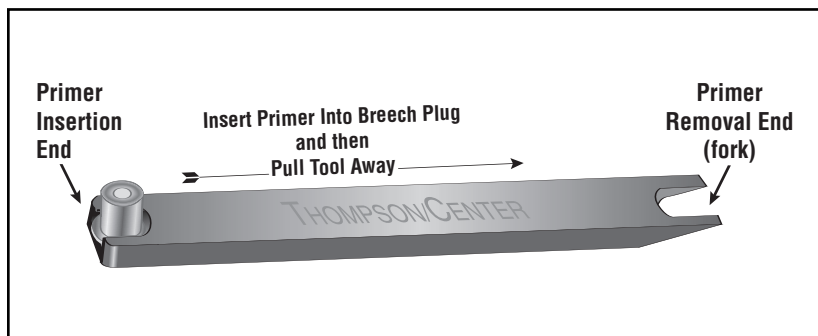

## → **⚠ WARNING** ←

**When firing the T/C Omega, hold it tightly against the shoulder, allowing your body weight to absorb and buffer the force of the recoil. An improperly held firearm can "kick" upwards causing facial injury and/or bruising.**

If you decide not to fire; you must manually (and carefully) lower the hammer from the "Cocked" position to the "At Rest" position. First, make sure the gun is pointed in a safe direction. Then, hold your thumb on the hammer so it cannot drop freely - and hold the trigger back only long enough to disengage the hammer from the hammer sear. Allow the hammer to move forward slowly - with your finger away from the trigger - until it resides in the "At Rest" position. Pivot the swinging breech block down - using the trigger guard lever - and remove the 209 shotshell primer.

## → **⚠ WARNING** ←

**If the firearm is no longer going to be used, uncharge it by firing it into a suitable backstop or pull the charge before returning it to your vehicle, camp or home (see section on "Pulling a Charge"). AN ACCIDENTAL DISCHARGE CAN CAUSE INJURY AND/OR DEATH TO THE SHOOTER OR BYSTANDERS AND DAMAGE TO PROPERTY.**

# Summary of Charging & Priming Your Thompson/Center Omega Muzzleloader

1. Check to ensure that the firearm is uncharged.
2. Wipe the bore free of all oil.
3. Pointing the muzzle in a safe direction, snap several #209 shotshell primers in the breech plug, clearing away any oil residue which may be in the rifle's fire channel.
4. Ensure that the action is open.
5. Set firearm on its butt, holding muzzle away from your face and body.
6. Pour pre-measured powder charge down the bore and settle powder by rapping the side of the barrel with your hand. If you are using Pyrodex Pellets - remember to insert the black end into the muzzle first. The black end contains Black Powder to aid in positive ignition.
7. Load a conical bullet or sabot by placing the projectile in muzzle; straight.
8. Drive the projectile into muzzle with an appropriate short starter.
9. Push the projectile the remainder of the way down the bore using short strokes with the ramrod.
10. Firmly seat the projectile on the powder charge.
11. Remove the ramrod and return it to its proper location in the thimbles under the barrel of the rifle.
12. Carefully place a 209 shotshell primer in the breech plug primer pocket prior to closing the swinging breech. Cock the hammer - and fire the shot.

# **Pulling a Charge From Your Thompson/Center Omega Muzzleloader**

## **→ ⚠ WARNING ←**

**Never attempt to pull a charge from your Omega muzzleloader until you are absolutely certain that the firearm is deprimed (209 primer has been removed). While in the process of pulling the charge (removing the breech plug) do not smoke, or be near anyone else smoking; the spark from a lighted cigarette, cigar, or pipe can ignite black powder, Pyrodex, percussion caps or primers. Any external heat source can ignite your charge, causing an explosion, which could result in injury and/or death to the shooter or bystanders and damage to property.**

### **PULLING A CHARGE FROM A MUZZLELOADING RIFLE**

Under normal conditions a muzzleloader is unloaded simply by firing it into a suitable and safe backstop. There are, however, some conditions under which the firearm cannot be fired and the charge must be pulled.

#### **SOME OF THE MOST COMMON CONDITIONS ARE AS FOLLOWS:**

- 1. If the projectile is not seated firmly against the powder charge, stop immediately! Do not attempt to fire the rifle. You must pull the charge and clean the barrel.**
- 2. If the rifle is loaded in a proper manner yet fails to fire after repeated repriming and clearing of the ignition ports (as explained in the "Ignition" section).**
- 3. If you are at a location that is unsuitable for discharging the firearm before transporting it.**

To pull a charge from your T/C Omega muzzleloader it will be necessary to take the following steps:

## **T/C Omega muzzleloader TAKEDOWN PROCEDURE**

**1st Step** – Open the breech; make sure that the gun is unprimed.

**2nd Step** – Remove the barrel/action assembly from the stock. Remove the ramrod

**3rd Step** – Remove the breech plug, making sure that the muzzle is pointing in a safe direction.

**4th Step** – Once the breech plug has been removed, point the muzzle up. Gravity should then cause the Pyrodex pellets to drop out, or the loose powder to pour out. The sabot or bullet can then be poked out with your ramrod, inserting it through the muzzle. It will be necessary to add the extended super jag (which came with your rifle) to your ramrod, or you may use the longer “range rod” if you have access to one.

**5th Step** – If your propellant (Pyrodex pellets or loose powder) doesn't come out as a result of gravity, pour water into the breech to fully saturate the Pyrodex pellets or powder. Then proceed by pushing the entire charge out (propellant and projectiles) from the muzzle by use of your ramrod.

### ***If you can't remove the breech plug.***

If you can't remove the breech plug in order to pull the charge, it will be necessary to submerge the breech section of the barrel in a pail or bucket of water.

Complete Disassembly of the Omega will be necessary.

1. Check to make sure the gun is unprimed by opening the action.
2. Close the action; remove the barrel/trigger guard assembly from the stock. Remove the ramrod.
3. Loosen the pivot pin set screws so that you can push out the trigger guard pivot pin and the breech block pivot pin (see page 9)

**Note:** You do not have to completely remove the setscrews. Loosen them only enough to allow the pivot pins to be pushed out. If you find that the pivot pins won't push out easily, loosen the setscrew a little more. Do not drive out the pivot pins with a hammer and punch. It is unnecessary if the setscrews have been loosened enough. You should be able to poke both pivot pins out with a pencil or pen.

4. Once the trigger guard assembly has been removed, submerge the breech section of the barrel into a pail of water. (Hot if possible). Make certain that at least 8" of the breech section is submerged for at least 1/2 hour.

5. Once the powder has been soaked for 1/2 hour and rendered inert, try pulling the projectile from the bore by using your ramrod (or a range rod) with a bullet puller. Screw the bullet puller onto your rod, insert from the muzzle end, and when you make contact with the projectile, turn the rod clockwise, screwing the bullet puller into the projectile. Once screwed into the projectile, pull the projectile out. If you are using a sabot, make sure that both the projectile and the sabot are pulled out.

6. If for any reason you are unable to remove the charge in the manner recommended, soak the barrel again. Squirt oil into the primer pocket and into the ignition channel in order to render the Pyrodex pellets or powder more inert, (if you were to use water only - it will just dry out over a period of time), and return the barrel to the service department at the address shown below with a letter describing the problem.

**Thompson/Center Arms Company, Inc.,  
Farmington Road,  
Rochester, New Hampshire 03867**

# Cleaning Your Thompson/Center T/C Omega Muzzleloader

## → **⚠ WARNING** ←

---

**Never attempt to clean a charged or primed muzzleloading firearm. AN ACCIDENTAL DISCHARGE CAN CAUSE INJURY AND/OR DEATH TO THE SHOOTER OR BYSTANDERS AND DAMAGE TO PROPERTY.**

---

### General Comments on Cleaning

Black powder and Pyrodex are very corrosive, and the fouling or residue left over in the bore after firing your firearm can be destructive to the steel, causing oxidation, rust, and pitting. Leaving your firearm unclean with this fouling present can lead to a ruined firearm.

Also, the build up of this fouling from shot to shot will produce shot to shot increases in pressure that will greatly affect accuracy. Lubricants, the amount of your powder charge, and your projectile (sabot or all lead conical bullet) will all affect the amount of fouling you will produce with each shot. Eventually, if not cleaned, the muzzleloading firearm will become impossible to load properly. Driven part way down the bore and blocked by powder fouling, the projectile will hang up and refuse to budge further.

## → **⚠ WARNING** ←

---

**A projectile which is seated only part way down the barrel sets up a highly dangerous condition WHICH MAY CAUSE A BURST BARREL AND INJURY AND/OR DEATH TO THE SHOOTER OR BYSTANDER AND DAMAGE TO PROPERTY. The projectile must be seated firmly against the powder charge. If the ball or bullet is not seated against the powder charge the firearm must be disassembled and the charge removed (see section on "Pulling a Charge"). Never fire a muzzleloading firearm unless the projectile is firmly seated on the powder charge.**

---

The use of T/C's Natural Lube 1000 Plus Bore Butter, a non petroleum based lubricant will reduce fouling of black powder or Pyrodex over conventional petroleum based lubes. T/C's Natural Lube actually seasons the bore with repeated use, and is also the lube used in our pre-lubed all lead conical bullets, the Maxi-Ball and Maxi-Hunter. If shooting these conicals, the Natural Lube will eliminate a lot of cleaning and accuracy problems associated with fouling build up.

However, if shooting sabots like T/C's Mag Express Sabots, any lubricant used to protect the bore should be removed prior to actually loading and shooting sabots. The very nature of what a sabot is ie a plastic sleeve encompassing a bullet, calls for as dry a bore as possible for maximum accuracy. Because of that fact, there will be more fouling build up (including plastic), and swabbing the bore will have to be done more frequently. For maximum accuracy at the range, you should swab the bore between **each** shot.

## **Types of Cleaning**

The user of a muzzleloading rifle or pistol has 2 types of cleaning with which to contend. One is "total or complete cleaning" which is done after shooting for the day, or at seasons end, prior to storing the firearm. The other is simply "wiping out the bore" which is done between shots, or as necessary when fouling builds up to the point of making it difficult to load. This is called "field cleaning".

Field cleaning is merely wiping the bore with a damp patch with a bore cleaner like T/C's No.13 All Natural Bore Cleaner, or even water, and running it up and down the bore to remove the fouling. Follow with a dry patch and you are ready to load again.

## **Cleaning from the Muzzle End**

Cleaning the Omega muzzleloader through the muzzle does not entail removal of the breech plug unless your aim is to totally clean the rifle before storage. If you do remove the breech plug, make sure you clean the threads and lube them with an anti-seize lube like T/C's Super Lube prior to re-installation. Also lubricate the threads inside the breech area of the barrel with anti-seize lubricant.

If you do wish to remove the breech plug, it is a good idea to remove the stock and action assembly from the stock. Trying to clean from the muzzle end after removal of the breech plug could result in powder fouling from the bore and bore cleaner dropping down into the action. Without the stock attached it will be easier to avoid this problem.

Although not necessary, you may want to also remove the trigger guard assembly from the barrel as detailed on page 9 and 10.

Once accomplished, you may now proceed to clean by running patches, bore swabs or brushes, (or all 3) up and down the bore on the end of your ramrod. Or, you may even want to submerge the breech end into a bucket or pail of hot soapy water.

Use a jag, or a worm if you don't have a jag, and a patch saturated with a bore cleaner like T/C's No.13 bore cleaner. Run it down from the muzzle end a few times to remove the fouling. (Photo A).

**Photo A**

Use a Jag for field cleaning (a Patchpuller Worm will also work if you don't have a Jag with you).

Number 13 Bore Cleaner is specifically designed for cleaning Black Powder or Pyrodex® fouling.



After removing all the fouling, follow up with a few dry patches to thoroughly dry the bore. If the gun is to be stored for any length of time, follow the dry patches up with a good protectant lubricant like T/C's All Natural Lube Bore Butter.

Remember, when you reinstall the breech plug, make sure the threads are cleaned and lubed with an anti-seize lube like T/C's Super Lube. Also lubricate the threads inside the breech area of the barrel with anti-seize lubricant.

Clean the trigger guard assembly (hammer & trigger) with a good brush and lightly oil it. Reassemble and function the hammer and trigger assembly.

## Cleaning From The Breech End

### → **▲ WARNING** ←

**Never attempt to clean a charged or primed muzzleloading firearm. AN ACCIDENTAL DISCHARGE CAN CAUSE INJURY AND/OR DEATH TO THE SHOOTER OR BYSTANDERS AND DAMAGE TO PROPERTY.**

When you are finished shooting for the day or for the season and plan to store the T/C Omega muzzleloader away, it is recommended that you clean the firearm thoroughly. This includes removal of the breech plug and cleaning the corresponding threads in the barrel. Follow these instructions for thorough cleaning



1. You may disassemble your Omega muzzleloader as detailed on pages 10 and 11 of this manual - or, merely lower the swinging breech to expose the breech plug.

2. Using the in-line muzzleloader breech plug wrench, remove the breech plug by turning it counter-clockwise (as viewed from the nipple end). It will be necessary to overcome the initial resistance caused by the barrel to breech plug seal. The breech plug should now be scrubbed free of fouling and later it should be lubricated with an anti-seize lubricant like T/C's Super Lube, before re-installation. The threads inside the breech end of the barrel must also be well cleaned with a stiff brush and lubed with anti-seize lube.



3. Fill a pan with very hot soapy water. Submerge the muzzle end of the barrel in the water and push a wet patch down the barrel on the end of your ramrod (that has a jag installed on it) A jag comes with every new T/C muzzleloader. Pump the rod and patch up and down in the barrel. This will draw water into the barrel and flush out the fouling. When the barrel is clean, wipe off the excess water and set the barrel aside to dry.

4. Thoroughly wipe any powder residue from the hammer/trigger assembly and swinging breech. Dry the parts thoroughly. After cleaning your T/C Omega muzzleloading rifle, it is recommended that you lightly lube the metal surfaces of the rifle. Do Not use heavy grease or oil, as during cold weather, excessive lube may congeal and slow the hammer fall (or keep it from striking the firing pin altogether) when the trigger is pulled.

5. Now that the barrel is completely dry, lightly lube the bore with a quality lubricant or, in keeping with the all-natural method, T/C's Natural Lube 1000 Plus Bore Butter. Reinstall the breech plug using the in-line muzzleloader breech plug wrench provided with the firearm. Make sure that you have lubed all of the threads with an anti-seize type lubricant like T/C's Super Lube. Be careful not to cross-thread the breech plug or overtighten it. It should be made snug by turning it clockwise with the breech plug wrench. Also, lubricate the threads inside the breech area of the barrel with anti-seize lubricant.

6. Fouling on the stock, receiver and exterior parts should be wiped off with an oily cloth or T/C's Wonder Cloth saturated with Natural Lube 1000 Plus Bore Butter.

7. Your T/C Omega muzzleloader may now be reassembled in the reverse order of the takedown procedure detailed on page 8 and 9.

8. After your T/C Omega muzzleloader has been reassembled, check that there is no excess lubricant on the surface of the mechanism which could impede safe performance. Check for proper functioning of the hammer/trigger mechanism prior to loading and firing.

→ **⚠ WARNING** ←

---

**Make certain that the action is open and that the muzzleloading firearm is unprimed before attempting to clear any lubricant or debris from the mechanism of your T/C Omega muzzleloader. FAILURE TO FOLLOW THIS WARNING MAY RESULT IN INJURY AND/OR DEATH TO THE SHOOTER OR BYSTANDERS AND DAMAGE TO PROPERTY.**

---

# Using Cleaning Implements With Your Thompson/Center Omega Muzzleloader

Thompson/Center muzzleloading rifles and pistols are supplied with a cleaning jag which is the proper size for the particular caliber. For cleaning use commercial cleaning patches (round or square) or pieces of discarded clothing.

When using the cleaning jag, keep in mind that patch size and thickness are important. Start with a patch that is approximately 2 1/2" square (or in diameter). Position it over the jag as pictured in the illustration and try it in the bore of the firearm (wet patches will enter more easily than dry ones). If it seems to be too tight - don't force it. If your trial patch proves to be too tight, use a smaller size patch and/or thinner material.

A patch which is too small or thin will pull free from the jag teeth during the cleaning process. Such "lost patches" can be quickly retrieved by use of the worm (see illustration). Cleaning will go easier, however, if you establish and maintain an optimum patch/jag/bore fit.

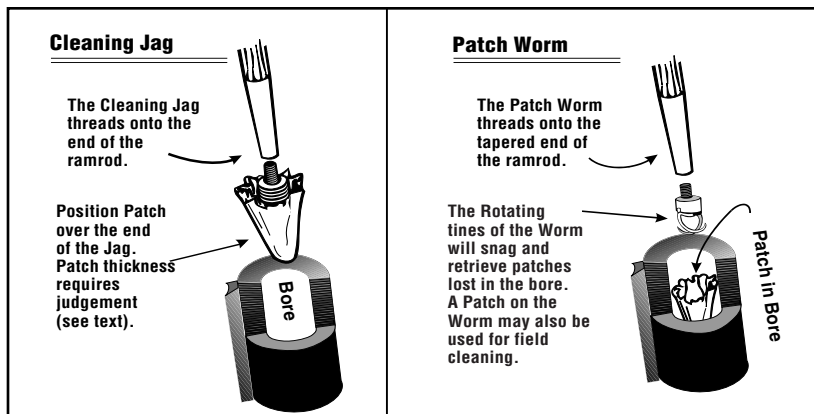

Thompson/Center does not package the worm with each firearm. This is an optional tool and must be purchased separately (one size fits all calibers - see current catalog). The worm is an extremely important muzzleloading tool and every shooter should carry one in his implement bag. While its prime purpose is to retrieve "lost patches", it can also be used for field cleaning. To do so you simply catch the cleaning patch on the tines of the worm and push it into the bore in the conventional manner.

# Iron Sight Adjustment For The T/C Omega Muzzleloader

T/C Omega muzzleloaders are equipped with one of two styles of standard rifle rear sight (See **Illustrations Below**) which are adjustable for elevation and windage.

**For Style 1** To adjust elevation, moving the elevation “blade” up or down changes the point of impact. To do this, turn the Elevation Adjustment Screw clockwise (as viewed from the receiver end) to lower the point of impact, and counter-clockwise, to raise the point of impact.

To adjust the windage it is necessary to move the entire rear sight leaf left or right by using the slotted screw head on the right side of the rear sight (as viewed from the receiver end of the sight). Move the rear sight blade in the direction you want your shots to hit - (Example; Turn the screw clockwise - thereby moving the sight blade to the right, to move your shots to the right and counter-clockwise to move the shots to the left).

**Style 1**  
Some Models Have  
A Rear Sight That  
Looks Like This.



**For Style 2** To adjust elevation, move the elevation slide up or down its ramp to change the point of impact. To do this, turn the Elevation Adjustment Lock Screw counter-clockwise (as viewed from the receiver end) to loosen it - then move the slide down the ramp (using the graduation lines as a guide) to lower the point of impact.

To adjust the windage it is necessary to slide the rear sight blade assembly left or right after loosening the Windage Adjustment Lock Screw. Move the rear sight blade in the direction you want your shots to hit - (Example; moving the sight blade to the right moves your shots to the right and to the left move the shots to the left).

**Style 2**  
Some Models Have  
A Rear Sight That  
Looks Like This.

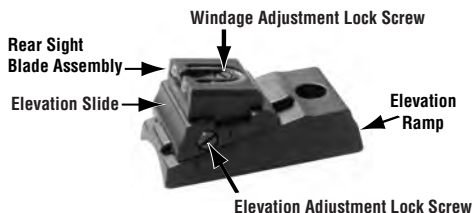

# Mounting A Scope On The T/C Omega Muzzleloader

## → **⚠ WARNING** ←

**Do not drill additional holes in the barrel as this could weaken its structure and contribute to a rupture CAUSING INJURY AND/OR DEATH TO THE SHOOTER OR BYSTANDERS AND DAMAGE TO PROPERTY.**

The barrel is factory drilled and tapped for T/C mounts. The (1-Piece) Weaver-Style Mounts which are appropriate for this rifle are T/C Part No.9899 (Blue) and T/C Part No.9907 (Silver). Follow the instructions that came with your scope mounts for proper mounting of your scope. Questions should be addressed to our Service Department, at Telephone #603-332-2333.

Should your firearm require adjustment, repair or refinishing, we strongly recommend that the firearm be returned to the factory. There is no other way to ensure that the work will be done by a competent staff of trained technicians.

Firearms returned to the factory should be marked to the attention of the service department. A letter of instructions should be enclosed to facilitate handling. Firearms should be uncharged, disassembled and shipped via United Parcel Service (U.P.S.).

Our Service Department will give your firearm a complete inspection and evaluate the problem. If the work required is not covered by our "Lifetime Warranty" you will receive a quotation which must be authorized by you. No actual work will be done without your approval.

## Statement Of Liability From Thompson/Center

This gun is classified as a **FIREARM OR DANGEROUS WEAPON** and is surrendered by us with the express understanding that we assume no liability for its resale or unsafe handling under local laws and regulations. Thompson/Center Arms assumes no responsibility for physical injury or property damage resulting from either intentional or accidental discharge, or for the function of any gun subject to influences beyond our control, and will honor no claim which may result from careless or improper handling, unauthorized adjustments, improper loading, use of improper powder or components, corrosion or neglect.

For your protection, examine your firearm carefully at the time of purchase. Fill out and mail the registration card promptly. Be certain that it bears the firearm's serial number which you will find on the receiver.

→ **⚠ WARNING** ←

---

**Thompson/Center does not approve or recommend any type of custom conversion or alteration other than those performed by the T/C Custom Shop. Muzzleloading firearms subjected to alteration are not covered by our factory warranty. Responsibility for alterations rests totally with the gunsmith or individual performing the work. The consumer is warned that if such work is done improperly or without proper judgement, the firearm can malfunction or rupture CAUSING INJURY AND/OR DEATH TO THE SHOOTER OR BYSTANDERS AND DAMAGE TO PROPERTY.**

---

**Thompson/Center Arms Company, Inc.  
- Limited Warranty -**

**THOMPSON/CENTER ARMS provides a warranty for all factory finished firearms for the LIFETIME OF THE ORIGINAL CONSUMER PURCHASER.** Any firearm or part thereof returned, postage paid, to the factory at Farmington Road, Rochester, New Hampshire 03867, will be repaired or replaced to our commercial standard free of charge, and returned to the consumer purchaser postage prepaid. This warranty is established by return of our authorized warranty card which should be done within (30) days of purchase. **This warranty Does Not cover the finish of the stock or steel components from scratches, dings or rust which may occur through normal usage or improper care, or any damage caused by custom alteration of the firearm other than those performed by the T/C Custom Shop!** Thompson/Center Arms reserves the right to refuse to repair or replace firearms, or parts thereof, damaged by abuse or misuse.

This warranty gives you specific legal rights, and you may also have other rights which vary from State to State. Address all correspondence and inquiries to:

**THOMPSON/CENTER ARMS  
P.O. Box 5002,  
Rochester, New Hampshire 03866**

**PARTS LISTS AVAILABLE ON REQUEST. SPECIFY MODEL, CAL. & SERIAL NUMBER**

# Bullet Data For T/C Omega Muzzleloading Rifle

## Maxi-Balls® For T/C Firearms

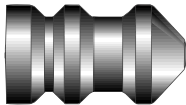

.45 Caliber (240 grs.) For small to medium (deer-sized) game. Now factory lubricated with T/C Natural Lube 1000 Plus Bore Butter.

.50 Caliber (320 grs.) A medium game (deer-sized) bullet for .50 caliber rifles. Factory lubricated with T/C Natural Lube 1000 Plus Bore Butter.

.50 Caliber (370 grs.) A medium and big game bullet for .50 caliber rifles. Factory lubricated with T/C Natural Lube 1000 Plus Bore Butter.

## Maxi-Hunters® For T/C Firearms

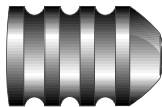

**For Maximum expansion  
on deer-sized game!**

.45 Caliber (255 grs.) A bullet designed specifically for medium (deer-sized) game. Factory lubed with Natural Lube 1000 Plus Bore Butter.

.50 Caliber (275 grs.) A bullet designed for .50 caliber T/C rifles and deer sized game. Lubed with Natural Lube 1000 Plus Bore Butter.

.50 Caliber (350 grs.) A bullet designed for .50 caliber rifles and deer sized game. Factory lubed with Natural Lube 1000 Plus Bore Butter.

## Thompson/Center's Super 45XR Sabots

.45 Caliber (for .400" 155 GR XTP Bullet)

.45 Caliber (for .400" 180 GR XTP Bullet)



## Thompson/Center's Mag Express Sabots

.50 Caliber (for .429" - .430" 180 GR XTP Bullet)

.50 Caliber (for .429" - .430" 240 GR XTP Bullet)

.50 Caliber (for .429" - .430" 300 GR XTP Bullet)



### Thompson/Center's PTX Sabots

.50 Caliber (for .451" 250 GR PTX Bullet)

.50 Caliber (for .451" 300 GR PTX Bullet)



### Thompson/Center's Big Shot Sabots

.50 Caliber (for .475" 325 GR XTP Bullet)

.50 Caliber (for .475" 400 GR XTP Bullet)



### Thompson/Center's Cheap Shot Sabots

.50 Caliber (for .429" - .430" 240 GR

All Lead Hollow Point Bullet)



### Thompson/Center's Break-O-Way Sabots

.50 Caliber (for .429" - .430" 240 GR XTP Bullet)



### Thompson/Center's Shock Wave Bullets in Super Glide Sabots

.50 Caliber (with Standard or Bonded bullets)





**WARNING:** Discharging firearms in poorly ventilated areas, cleaning firearms or handling ammunition may result in exposure to lead and other substances known to cause birth defects, reproductive harm and other serious physical injury. Have adequate ventilation at all times. Wash hands thoroughly after exposure.



# Suggested Loads For The Thompson/Center Omega Muzzleloader

The following charts show recommended charges using Black Powder or Pyrodex as a propellant for Thompson/Center Omega muzzleloading rifles. Charges are listed by caliber, powder charge and type of projectile.

Note that in each instance a series of charges are listed. More than one charge is shown in each category to clearly illustrate the safe loading range for that particular caliber, model and projectile.

## → **⚠ WARNING** ←

---

**Maximum loads are not to be exceeded nor is a substitution of powder or granulations to be attempted! Only use loads that are listed for your particular caliber, model and bullet style. FAILURE TO FOLLOW THESE INSTRUCTIONS MAY RESULT IN INJURY AND/OR DEATH TO THE SHOOTER OR BYSTANDERS AND DAMAGE TO PROPERTY.**

---

The shooter is instructed to start with the lightest charge listed. As you become familiar with the firearm, increase your charges gradually until you reach your best performing load (most accurate). Thompson/Center Arms is not responsible for loading information printed in sources other than this booklet.

NOTE: All loading data contained in this book is the result of testing by Thompson/Center Arms. Testing was done under carefully controlled conditions with the components specified in the text. 28 inch barrels were used to produce the data (unless otherwise specified).

Since Thompson/Center has no control over the components or equipment which may be used with this information, no responsibility is implied or assumed for the results obtained.

The loading data found in this manual was compiled using Black Powder or Pyrodex as a propellant. With any other approved Black Powder substitute follow the instructions supplied by the manufacturer and heed all warnings as they apply to loading and usage of that product.

## Assembly and Loading of T/C Mag Express™ Sabots

T/C Mag Express Sabots come in several variations for .50 caliber muzzleloading applications; some accept 44 caliber (.429" - .430" diameter) bullets and others accept 45 caliber (.451" - .452" diameter) bullets. In either case, insert the correct diameter projectile into the sabot and press firmly, making sure the bullet is fully seated.

### → **⚠ WARNING** ←

**When loading T/C's Mag Express Sabots, make sure that your gun is unprimed, and that your Mag Express Sabot has been properly assembled. Failure to assemble and load your sabot correctly could result in the bullet disengaging from the sabot. This could result in an air space between the components. UNDER SUCH A CONDITION, ONE OR MORE OF THE COMPONENTS MAY ACT AS A BARREL OBSTRUCTION AND FIRING COULD RESULT IN INJURY AND/OR DEATH TO THE SHOOTER OR BYSTANDERS AND DAMAGE TO PROPERTY.**

To properly assemble your T/C Mag Express Sabot, insert the projectile into the sabot and press firmly, making sure the bullet is fully seated. Use only bullets of the correct diameter.

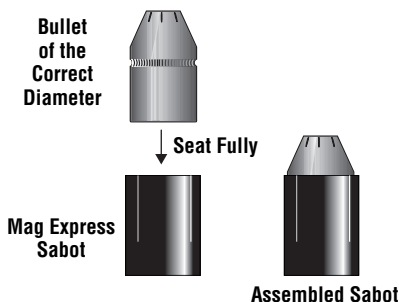

### → **⚠ WARNING** ←

**Use only bullets of the correct diameter that were designed for the sabots you are using. Using bullets of lesser diameter may cause the bullet to separate from the sabot resulting in a barrel obstruction. Using bullets of larger diameter could result in difficult loading, or a condition where the sabot is not seated all the way down on the powder charge, resulting in a barrel obstruction. EITHER CASE CAN RESULT IN A DAMAGED FIREARM AND POSSIBLE INJURY AND/OR DEATH TO THE SHOOTER OR BYSTANDERS AND DAMAGE TO PROPERTY.**

The photo on page 25 pictures a shooter in the process of loading a muzzleloading rifle. Study this photo carefully and read all the captions before you proceed to charge your rifle.

The complete sabot unit should be seated firmly on the powder charge as indicated in the illustration below.

→ **⚠ WARNING** ←

---

**Do not exceed the recommended loading data in this manual when using T/C Mag Express Sabots in Thompson/Center rifles. When using rifles not manufactured by Thompson/Center, do not exceed the recommended loads provided by the manufacturer of your rifle.**

---

**Loaded Mag Express Sabot**

**The Assembled Sabot Must Be Seated Firmly On The Powder Charge.**



# .45 Caliber Omega™ Loading Data

For Use Only With .45 Caliber Thompson/Center Omega Rifle Using Bullet Weights as Shown Below Use a #209 Shotshell Primer.		Super .45 Cal. Using Mag Express® Sabots with Pyrodex® Pellets	
For Use with Bullets Weighing	Powder Charge .45 cal./50 Gr. Pellets	Muzzle Velocity (Feet Per Second)	Muzzle Energy (Foot Pounds)
155 Grain Bullet	2 Pellets	1989 F.P.S.	1362 Ft. Lbs.
	3 Pellets	2657 F.P.S.	2430 Ft. Lbs.
180 Grain Bullet	2 Pellets	1896 F.P.S.	1437 Ft. Lbs.
	3 Pellets	2493 F.P.S.	2485 Ft. Lbs.
Load Shown in Red is Maximum			

For Use Only With .45 Caliber Thompson/Center Omega Rifle Using Bullet Weights as Shown Below Use a #209 Shotshell Primer.		Super .45 Cal. Using Mag Express® Sabots with Black Powder	
For Use with Bullets Weighing	Black Powder Charge (Grains)	Muzzle Velocity (Feet Per Second)	Muzzle Energy (Foot Pounds)
155 Grain Bullet	80 grs. FFG	1883 F.P.S.	1220 Ft. Lbs.
	90 grs. FFG	1945 F.P.S.	1302 Ft. Lbs.
	100 grs. FFG	2053 F.P.S.	1451 Ft. Lbs.
	110 grs. FFG	2125 F.P.S.	1554 Ft. Lbs.
	120 grs. FFG	2176 F.P.S.	1630 Ft. Lbs.
	130 grs. FFG	2223 F.P.S.	1701 Ft. Lbs.
	140 grs. FFG	2281 F.P.S.	1791 Ft. Lbs.
	150 grs. FFG	2326 F.P.S.	1862 Ft. Lbs.
180 Grain Bullet	80 grs. FFG	1711 F.P.S.	1170 Ft. Lbs.
	90 grs. FFG	1786 F.P.S.	1275 Ft. Lbs.
	100 grs. FFG	1843 F.P.S.	1358 Ft. Lbs.
	110 grs. FFG	1902 F.P.S.	1446 Ft. Lbs.
	120 grs. FFG	1948 F.P.S.	1541 Ft. Lbs.
	130 grs. FFG	1999 F.P.S.	1598 Ft. Lbs.
	140 grs. FFG	2084 F.P.S.	1736 Ft. Lbs.
	150 grs. FFG	2131 F.P.S.	1815 Ft. Lbs.
Load Shown in Red is Maximum			

For Use Only With .45 Caliber Thompson/Center Omega Rifle Using Bullet Weights as Shown Below Use a #209 Shotgun Primer.		<b>Super .45 Cal. Rifle</b> Pyrodex Pellets with Shock Wave™ Sabot Loads	
For Use with Bullets Weighing	Powder Charge .45 cal./50 Gr. Pellets	Muzzle Velocity (Feet Per Second)	Muzzle Energy (Foot Pounds)
200 Grain Bullet	2 Pellets	2035 F.P.S.	1840 Ft. Lbs.
	<b>3 Pellets</b>	<b>2398 F.P.S.</b>	<b>2554 Ft. Lbs.</b>
<b>Load Shown in Red is Maximum</b>			

For Use Only With .45 Caliber Thompson/Center Omega Rifle Bullets Lubricated with <i>Bore Butter</i> . Use a #209 Shotgun Primer.		<b>.45 Cal. Rifle</b> Pyrodex Pellets with T/C Maxi-Bullets Loads	
For Use with Bullets Weighing	Powder Charge .45 cal./50 Gr. Pellets	Muzzle Velocity (Feet Per Second)	Muzzle Energy (Foot Pounds)
255 Gr. Maxi-Hunter or 240 Gr. Maxi-Ball	2 Pellets	1878 F.P.S.	1998 Ft. Lbs.
	<b>3 Pellets</b>	<b>2267 F.P.S.</b>	<b>2911 Ft. Lbs.</b>
<b>Load Shown in Red is Maximum</b>			

For Use Only With .45 Caliber Thompson/Center Omega Rifle Bullets Lubricated with <i>Bore Butter</i> . Use a #209 Shotgun Primer.		<b>.45 Cal. Rifle</b> Black Powder with T/C Maxi-Bullets Loads	
For Use with Bullets Weighing	Black Powder Charge (Grains)	Muzzle Velocity (Feet Per Second)	Muzzle Energy (Foot Pounds)
255 Gr. Maxi-Hunter or 240 Gr. Maxi-Ball	80 grs. FFG	1541 F.P.S.	1345 Ft. Lbs.
	90 grs. FFG	1608 F.P.S.	1464 Ft. Lbs.
	100 grs. FFG	1680 F.P.S.	1599 Ft. Lbs.
	110 grs. FFG	1745 F.P.S.	1725 Ft. Lbs.
	120 grs. FFG	1789 F.P.S.	1813 Ft. Lbs.
	130 grs. FFG	1826 F.P.S.	1888 Ft. Lbs.
	140 grs. FFG	1868 F.P.S.	1976 Ft. Lbs.
	<b>150 grs. FFG</b>	<b>1914 F.P.S.</b>	<b>2075 Ft. Lbs.</b>
<b>Load Shown in Red is Maximum</b>			

# .50 Caliber Omega™ Loading Data

## T/C Mag Express™ Sabots

For Use With .50 Caliber T/C Omega Muzzleloader Only Using Bullet Weights Shown Below Use #209 Shotshell Primer		<b>.50 Caliber Rifle</b> Using Pyrodex Pellets & Mag Express™ Sabot Loads	
For Use With Bullet Weights	Powder Charge 50 gr. Pellets	Muzzle Velocity (Feet Per Second)	Muzzle Energy (Foot Pounds)
180 Gr. Bullet	2 Pellets	1937 F.P.S.	1500 Ft. Lbs.
	3 Pellets	2303 F.P.S.	2120 Ft. Lbs.
240 Gr. Bullet	2 Pellets	1889 F.P.S.	1902 Ft. Lbs.
	3 Pellets	2249 F.P.S.	2696 Ft. Lbs.
250 Gr. Bullet	2 Pellets	1863 F.P.S.	1927 Ft. Lbs.
	3 Pellets	2197 F.P.S.	2680 Ft. Lbs.
300 Gr. Bullet	2 Pellets	1729 F.P.S.	1992 Ft. Lbs.
	3 Pellets	2036 F.P.S.	2762 Ft. Lbs.
325 Gr. Bullet	2 Pellets	1624 F.P.S.	1903 Ft. Lbs.
	3 Pellets	1938 F.P.S.	2711 Ft. Lbs.
400 Gr. Bullet	2 Pellets	1512 F.P.S.	2031 Ft. Lbs.
	3 Pellets	1806 F.P.S.	2897 Ft. Lbs.
<b>Load Shown in Red is Maximum</b>			

For Use With .50 Caliber T/C Omega Muzzleloader Only Using Bullet Weights Shown Below Use #209 Shotshell Primer		<b>.50 Caliber Rifle Using Black Powder &amp; Mag Express™ Sabot Loads</b>	
For Use With Bullets Weighing (Grains)	Black Powder Charge (Grains)	Muzzle Velocity (Feet Per Second)	Muzzle Energy (Foot Pounds)
180 Grain Bullet  Like The Thompson/Center XTP™	80 grs. FFG	1609 F.P.S.	1035 Ft. Lbs.
	90 grs. FFG	1685 F.P.S.	1135 Ft. Lbs.
	100 grs. FFG	1737 F.P.S.	1206 Ft. Lbs.
	110 grs. FFG	1766 F.P.S.	1247 Ft. Lbs.
	120 grs. FFG	1852 F.P.S.	1371 Ft. Lbs.
	130 grs. FFG	1907 F.P.S.	1454 Ft. Lbs.
	140 grs. FFG	2004 F.P.S.	1606 Ft. Lbs.
	<b>150 grs. FFG</b>	<b>2043 F.P.S.</b>	<b>1669 Ft. Lbs.</b>
240 Grain Bullet  Like The Thompson/Center XTP™	80 grs. FFG	1511 F.P.S.	1217 Ft. Lbs.
	90 grs. FFG	1629 F.P.S.	1414 Ft. Lbs.
	100 grs. FFG	1672 F.P.S.	1490 Ft. Lbs.
	110 grs. FFG	1710 F.P.S.	1559 Ft. Lbs.
	120 grs. FFG	1761 F.P.S.	1653 Ft. Lbs.
	130 grs. FFG	1794 F.P.S.	1716 Ft. Lbs.
	140 grs. FFG	1846 F.P.S.	1816 Ft. Lbs.
	<b>150 grs. FFG</b>	<b>1879 F.P.S.</b>	<b>1882 Ft. Lbs.</b>
250 Grain Bullet  Like The Thompson/Center PTX™	80 grs. FFG	1472 F.P.S.	1203 Ft. Lbs.
	90 grs. FFG	1601 F.P.S.	1423 Ft. Lbs.
	100 grs. FFG	1642 F.P.S.	1497 Ft. Lbs.
	110 grs. FFG	1696 F.P.S.	1597 Ft. Lbs.
	120 grs. FFG	1724 F.P.S.	1650 Ft. Lbs.
	130 grs. FFG	1775 F.P.S.	1749 Ft. Lbs.
	140 grs. FFG	1828 F.P.S.	1855 Ft. Lbs.
	<b>150 grs. FFG</b>	<b>1853 F.P.S.</b>	<b>1907 Ft. Lbs.</b>
300 Grain Bullet  Like The Thompson/Center XTP™	80 grs. FFG	1452 F.P.S.	1405 Ft. Lbs.
	90 grs. FFG	1535 F.P.S.	1570 Ft. Lbs.
	100 grs. FFG	1601 F.P.S.	1708 Ft. Lbs.
	110 grs. FFG	1646 F.P.S.	1805 Ft. Lbs.
	120 grs. FFG	1667 F.P.S.	1852 Ft. Lbs.
	130 grs. FFG	1693 F.P.S.	1910 Ft. Lbs.
	140 grs. FFG	1714 F.P.S.	1957 Ft. Lbs.
	<b>150 grs. FFG</b>	<b>1758 F.P.S.</b>	<b>2015 Ft. Lbs.</b>

**Load Shown in Red is Maximum - Heavier Bullets continued on next page...**

... continued from previous page.

For Use Only With .50 Caliber  
Thompson/Center Omega Rifle  
Using a Bullet as Listed Below  
Use a #209 Shotshell Primer.

**.50 Caliber Rifle**  
Using Black Powder &  
Mag Express™ Sabot Loads

For Use With Bullets Weighing (Grains)	Black Powder Charge (Grains)	Muzzle Velocity (Feet Per Second)	Muzzle Energy (Foot Pounds)
325 Grain Bullet	100 grs. FFG	1451 F.P.S.	1520 Ft. Lbs.
	120 grs. FFG	1555 F.P.S.	1745 Ft. Lbs.
	150 grs. FFG	1710 F.P.S.	2110 Ft. Lbs.
400 Grain Bullet	100 grs. FFG	1390 F.P.S.	1679 Ft. Lbs.
	120 grs. FFG	1469 F.P.S.	1917 Ft. Lbs.
	150 grs. FFG	1587 F.P.S.	2238 Ft. Lbs.
<b>Load Shown in Red is Maximum</b>			

## T/C Shock Wave™ Sabots

For Use With .50 Caliber  
T/C Omega Muzzleloader Only  
Using Bullet & Sabot Listed Below  
Use #209 Shotshell Primer

**.50 Caliber Rifle**  
Using 50 Gr. Equivalent Pyrodex Pellets &  
Shock Wave™ Bullets with  
T/C Super Glide™ Sabots

For Use With Bullets Weighing (Grains)	Powder Charge 50 Gr. Pellets	Muzzle Velocity (Feet Per Second)	Muzzle Energy (Foot Pounds)
250 Gr. Bullet T/C Shock Wave™ in the T/C Super Glide™ Sabot	2 Pellets	1863 F.P.S.	1927 Ft. Lbs.
	3 Pellets	2197 F.P.S.	2680 Ft. Lbs.
300 Gr. Bullet T/C Shock Wave™ in the T/C Super Glide™ Sabot	2 Pellets	1729 F.P.S.	1992 Ft. Lbs.
	3 Pellets	2036 F.P.S.	2762 Ft. Lbs.
<b>Load Shown in Red is Maximum</b>			



## T/C Shock Wave™ Sabots - Continued

For Use With .50 Caliber T/C Omega Muzzleloader Only Using Bullet & Sabot Listed Below Use #209 Shotshell Primer		<b>.50 Caliber Rifle</b> Using Black Powder & Shock Wave™ Bullets with T/C Super Glide™ Sabots	
For Use With Bullets Weighing (Grains)	Black Powder Charge (Grains)	Muzzle Velocity (Feet Per Second)	Muzzle Energy (Foot Pounds)
<b>250 Gr. Bullet</b> T/C Shock Wave™ in the T/C Super Glide™ Sabot	80 grs. FFG	1472 F.P.S.	1203 Ft. Lbs.
	90 grs. FFG	1601 F.P.S.	1423 Ft. Lbs.
	100 grs. FFG	1642 F.P.S.	1497 Ft. Lbs.
	110 grs. FFG	1696 F.P.S.	1597 Ft. Lbs.
	120 grs. FFG	1724 F.P.S.	1650 Ft. Lbs.
	130 grs. FFG	1775 F.P.S.	1749 Ft. Lbs.
	140 grs. FFG	1828 F.P.S.	1855 Ft. Lbs.
	<b>150 grs. FFG</b>	<b>1853 F.P.S.</b>	<b>1907 Ft. Lbs.</b>
<b>300 Gr. Bullet</b> T/C Shock Wave™ in the T/C Super Glide™ Sabot	80 grs. FFG	1452 F.P.S.	1405 Ft. Lbs.
	90 grs. FFG	1535 F.P.S.	1570 Ft. Lbs.
	100 grs. FFG	1601 F.P.S.	1708 Ft. Lbs.
	110 grs. FFG	1646 F.P.S.	1805 Ft. Lbs.
	120 grs. FFG	1667 F.P.S.	1852 Ft. Lbs.
	130 grs. FFG	1693 F.P.S.	1910 Ft. Lbs.
	140 grs. FFG	1714 F.P.S.	1957 Ft. Lbs.
	<b>150 grs. FFG</b>	<b>1758 F.P.S.</b>	<b>2015 Ft. Lbs.</b>
<b>Load Shown in Red is Maximum</b>			

## Assembly And Loading Of T/C Break-O-Way™ Sabots

### → **⚠ WARNING** ←

When loading T/C's Break-O-Way Sabots, make sure that your gun is unprimed, and that your Break-O-Way Sabot has been properly assembled. Failure to assemble and load your sabot correctly could result in the bullet, sabot halves, or woven wool doughnut separating and disengaging from themselves. This could result in an air space between the components. Under such a condition, one or more of the components may act as a barrel obstruction and firing can result in a damaged firearm and **POSSIBLE INJURY OR DEATH TO THE SHOOTER OR BYSTANDERS AND DAMAGE TO PROPERTY.**

To properly assemble your T/C Break-O-Way Sabot, position 2 sabot halves together forming a complete sabot cup. Press the woven wool "doughnut" firmly on the base, allowing the flange to protrude through the hole. Your sabot is now ready to accept a .429" - .430" diameter .44 cal bullet. Use only bullets of these dimensions.

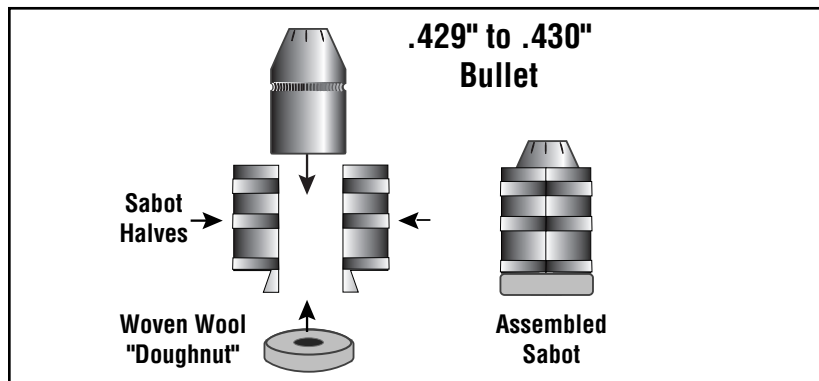

### → **⚠ WARNING** ←

Use only bullets measuring .429" - .430" designed for use in .44 caliber pistols or rifles. Using bullets of lesser diameter may cause the bullet to separate from the sabot resulting in a barrel obstruction. Using bullets of larger diameter could result in difficult loading, or a condition where the sabot is not seated all the way down in the powder charge, resulting in a barrel obstruction. Either case can result in a damaged firearm and **POSSIBLE INJURY AND/OR DEATH TO THE SHOOTER OR BYSTANDERS AND DAMAGE TO PROPERTY.**

The photo on page 25 pictures a shooter in the process of loading a muzzleloading rifle. Study this photo carefully and read all the captions before you proceed to charge your rifle.

The complete sabot unit should be seated firmly on the powder charge as indicated in the illustration below.

→ **⚠ WARNING** ←

---

**Do not exceed the recommended loading data in this manual when using T/C Break-O-Way Sabots in Thompson/Center rifles. When using rifles not manufactured by Thompson/Center, do not exceed the recommended loads provided by the manufacturer of your rifle.**

---

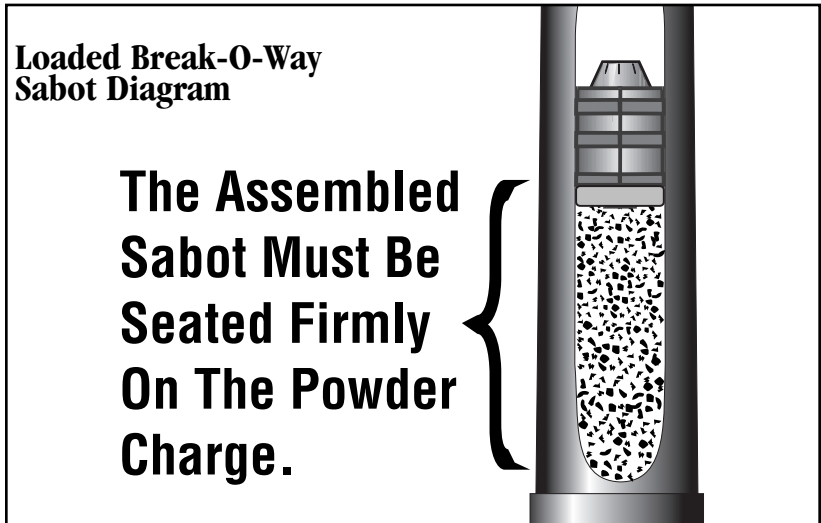

For Use Only With .50 Caliber Thompson/Center Omega Rifle Using a Bullet as Listed Below Use a #209 Shotshell Primer.		<b>.50 Caliber Rifle Using Pyrodex Pellets &amp; Break-O-Way™ Sabot Loads</b>	
For Use With Bullets Weighing (Grains)	Powder Charge .50 cal/50 gr. Pellets	Muzzle Velocity (Feet Per Second)	Muzzle Energy (Foot Pounds)
240 Gr. XTP™ Bullet	<b>2 Pellets</b>	<b>1762 F.P.S.</b>	<b>1655 Ft. Lbs.</b>
<b>Load Shown in Red is Maximum</b>			

For Use Only With .50 Caliber Thompson/Center Omega Rifle Using a Bullet as Listed Below Use a #209 Shotshell Primer.		<b>.50 Caliber Rifle Using Black Powder &amp; Break-O-Way™ Sabot Loads</b>	
For Use With Bullet Weights	Black Powder Charge (Grains)	Muzzle Velocity (Feet Per Second)	Muzzle Energy (Foot Pounds)
240 Grain XTP™ Bullet	80 grs. FFG	1474 F.P.S.	1158 Ft. Lbs.
	90 grs. FFG	1623 F.P.S.	1404 Ft. Lbs.
	<b>100 grs. FFG</b>	<b>1652 F.P.S.</b>	<b>1455 Ft. Lbs.</b>
<b>Load Shown in Red is Maximum</b>			

For Use Only With .50 Caliber Thompson/Center Omega Rifle Bullets Lubricated with <i>Natural Lube</i> <i>1000 Plus Bore Butter</i> . Use a #209 Shotshell Primer.		<b>.50 Caliber Rifle</b> Using Pyrodex® Pellets & Maxi-Balls or Maxi-Hunters	
For Use With .50 Cal. Lead Bullets	Powder Charge .50 cal./50 Gr. Pellets	Muzzle Velocity (Feet Per Second)	Muzzle Energy (Foot Pounds)
275 Gr. Maxi-Hunter & 320 Gr. Maxi-Ball	2 Pellets	1718 F.P.S.	2098 Ft. Lbs.
	<b>3 Pellets</b>	<b>2026 F.P.S.</b>	<b>2917 Ft. Lbs.</b>
350 Gr. Maxi-Hunter & 370 Gr. Maxi-Ball	2 Pellets	1656 F.P.S.	2253 Ft. Lbs.
	<b>3 Pellets</b>	<b>1891 F.P.S.</b>	<b>2939 Ft. Lbs.</b>
<b>Load Shown in Red is Maximum</b>			

For Use Only With .50 Caliber Thompson/Center Omega Rifle Bullets Lubricated with <i>Natural Lube</i> <i>1000 Plus Bore Butter</i> . Use a #209 Shotshell Primer.		<b>.50 Caliber Rifle</b> Using Black Powder & Maxi-Ball or Maxi-Hunter Loads	
For Use With Bullets Weighing (Grains)	Black Powder Charge (Grains)	Muzzle Velocity (Feet Per Second)	Muzzle Energy (Foot Pounds)
275 Grain Maxi Hunter® and 320 Grain Maxi-Ball® Lead Bullet	80 grs. FFG	1408 F.P.S.	1409 Ft. Lbs.
	90 grs. FFG	1462 F.P.S.	1519 Ft. Lbs.
	100 grs. FFG	1511 F.P.S.	1623 Ft. Lbs.
	110 grs. FFG	1588 F.P.S.	1792 Ft. Lbs.
	120 grs. FFG	1632 F.P.S.	1893 Ft. Lbs.
	130 grs. FFG	1675 F.P.S.	1994 Ft. Lbs.
	140 grs. FFG	1697 F.P.S.	2020 Ft. Lbs.
	<b>150 grs. FFG</b>	<b>1742 F.P.S.</b>	<b>2157 Ft. Lbs.</b>
350 Grain Maxi Hunter® and 370 Grain Maxi-Ball® Lead Bullet	80 grs. FFG	1344 F.P.S.	1484 Ft. Lbs.
	90 grs. FFG	1426 F.P.S.	1671 Ft. Lbs.
	100 grs. FFG	1478 F.P.S.	1795 Ft. Lbs.
	110 grs. FFG	1535 F.P.S.	1936 Ft. Lbs.
	120 grs. FFG	1556 F.P.S.	1990 Ft. Lbs.
	130 grs. FFG	1592 F.P.S.	2083 Ft. Lbs.
	140 grs. FFG	1623 F.P.S.	2165 Ft. Lbs.
	<b>150 grs. FFG</b>	<b>1661 F.P.S.</b>	<b>2267 Ft. Lbs.</b>
<b>Load Shown in Red is Maximum</b>			

## Service for Your T/C Muzzleloader

Should your T/C muzzleloading firearm require adjustment, repair or refinishing, we strongly recommend that the rifle be returned to the factory for such work. There is no other way to ensure that the work will be done by a competent staff or trained technicians. Send your rifle back to the factory unloaded with a letter describing the problem.

Any T/C muzzleloader should be sent prepaid (we will not accept collect shipments). Do not include gun case, sling, scopes or other custom accessories and packaging and product literature that you consider to be collectable. These items may be damaged or lost in transit.

The Federal Gun Control Act allows an individual (who is not otherwise barred from purchasing or possessing a firearm) to ship a firearm directly to the manufacturer for purposes of repair. However, before shipping your rifle to us, be certain that your state and local laws permit such shipments and that they will also permit us to return the rifle directly to you. If receiving a rifle is not permitted, then arrangements will have to be made to ship your rifle to a Federally Licensed Firearms Dealer. We will need a signed copy of that dealers Federal Firearms License (F.F.L.).

Muzzleloading firearms that are returned to the factory should be marked for the attention of the service department. A letter of instructions should be enclosed with the gun. Adherence to these suggestions will prevent loss of time and facilitate handling at the factory.

Our service department will give your muzzleloading firearm a complete inspection. They will evaluate the problem or problems specified in your covering letter. If the work required is not covered by our "Lifetime Warranty" you will receive a quotation which must be authorized by you.

Ship complete muzzleloading firearms via U.P.S. or Parcel Post. The shipment should be insured.



# For Your Records



**Important Note:** For fire, theft and insurance purposes, retain this record with your important papers in a safe place.

**My Thompson/Center:** \_\_\_\_\_

**Was Purchased From:** \_\_\_\_\_

**On (date):** \_\_\_\_\_ 20\_\_\_\_\_

**Serial Number:** \_\_\_\_\_ **Caliber:** \_\_\_\_\_

**Accessories:** \_\_\_\_\_

\_\_\_\_\_

**Owner Registration Card Mailed on:** \_\_\_\_\_

**Notes:** \_\_\_\_\_

\_\_\_\_\_

\_\_\_\_\_

\_\_\_\_\_

\_\_\_\_\_

\_\_\_\_\_

\_\_\_\_\_

\_\_\_\_\_

\_\_\_\_\_

\_\_\_\_\_

**This area is provided for your convenience. We suggest that you make a list of important information that pertains to your specific firearm (best performing load, etc.). Keep this booklet with your firearm and review your notes before each hunting season or whenever the firearm has not been used for extended periods of time.**



**Thompson/Center Arms Co., Inc.**  
**P.O. Box 5002**  
**Rochester New Hampshire 03866**

**NOTE: The loading data found in this manual was compiled using Black Powder or Pyrodex as a propellant. With any other approved Black Powder Substitute follow the instructions supplied by the manufacturer and heed all warnings as they apply to loading and usage of that product.**



**02/2007**

**Manual Part Number 00016459**