

CHAPTER 3

SMALL UNIT LIVING

Section 1. GENERAL

3-1. Characteristics of Operations in Cold Weather

Unlimited space and a sparse, widely scattered population are dominant features of most of the colder regions of the world. Such conditions permit unrestricted maneuver for troops properly trained and equipped for cold weather operations. Warfare under such circumstances is characterized by, widely dispersed forces operating at great distances from other units or their parent organization. Units must be highly mobile and have the ability to sustain themselves while carrying out independent operations over extended periods of time.

3-2. Composition of Units

a. Small units (squad, gun crew, tank crew, wire team, etc.) form the basic working group

for cold weather operations. Under normal operating conditions they will work together, cook and eat together, and share the same tent or other shelter. These small units should be formed at the beginning of training and, if possible, kept intact. The standard to be achieved is a unit which can make or break camp quickly, efficiently, and silently under all conditions; one in which each man knows the tasks to be completed and does them without having to be told.

b. Small units operating in cold weather must be thoroughly familiar with the special equipment required and the techniques involved in living away from their parent organization for extended periods of time. Equipment, and the techniques of using it, are discussed in this chapter.

Section II. TENTAGE AND OTHER EQUIPMENT

3-3. General

A considerable quantity of various types of special equipment is required to maintain small units in cold weather. Permanent shelters are usually scarce in northern areas of operations and heated shelters are required. Special tools are necessary for establishing bivouacs, breaking trails, and constructing temporary winter roads and battle positions.

tions depends upon adequate shelter. Tents and stoves, therefore, become a vital part of cold weather equipment.

b. In cold weather, tents should be placed as close as practicable to the scene of activity, whether the activity be combat or administrative. By so placing the tents, rotation of men for warmup is possible and maximum continuity of effort can be maintained.

3-4. Need for Shelter

a. In order to conduct successful military operations in cold weather and maintain a high level of combat efficiency and morale, heated shelter must be provided for all troops. An individual's ability to continue to work, live, move, and fight under extreme climatic condi-

c. Tents vary in size and shape, depending on their purpose. Small units such as a rifle squad, artillery section, or similar type unit are normally equipped with one 10-man arctic tent. During combat, fewer tents will be needed, as part of the personnel are always on guard detail, occupying positions, or performing similar missions. It may become necessary

for the unit, temporarily, to use only one-half or one-fourth of its tentage; i.e., one 10-man tent per platoon, with the men sleeping on a rotation basis. Reduced numbers of tents and stoves will decrease the requirement for logistical support, such as fuel and transportation.

d. Elements smaller than the rifle squad (tank and SP artillery crews), which require less shelter space, are normally equipped with the 5-man tent (FM 31-71).

e. Normally, small reconnaissance patrols are not equipped with tents, as tents tend to hamper the mobility and speed of the patrol. Strong combat patrols and long-range reconnaissance patrols may be equipped with tents and stoves if sufficient transportation is available to move the extra weight. When speed is of the essence, patrols will improvise shelters built from local materials at hand. For semi-permanent base camps, portable type frame shelters may be erected for increased comfort of the troops.

3-5 Description of Tentage

a. *General.* Tentage issued for use in cold weather is designed on the same layer principle as cold weather clothing. It is, however, made of only two layers. The outside layer is made of strong, tightly woven fabric. It is water repellent and impervious to rain and snow. The inner layer is much lighter in weight than the outer layer. The liner is fastened by toggles to the tent and provides an

airspace the same as in clothing. It is designed to provide insulation against the cold. It also prevents frost from forming on the inside of the tent. Heat is provided by stoves (normally the M-1950 Yukon stove).

b. *Tent, Artic, 10-Man* (fig. 3-1). The six-sided, pyramidal tent, supported by a telescopic pole, normally accommodates ten men and their individual clothing and equipment. It will accommodate additional men by leaving individual packs and equipment outside the tent overnight and by lowering the telescopic pole to spread the sidewalls to cover more ground surface. It may also function as a command post, aid station, or as a small storage tent. The tent has two doors; this permits tents to be joined together, with access from one to the other, when additional space is required. A snow cloth is attached to the bottom of the sidewalls for sealing the tent to the ground. This is accomplished by piling and packing snow on the snow cloth. If the tent is used in terrain where there is no snow, sod or other materials may be used to seal the bottom of the tent. Flexible plastic screen doors are provided and may be attached front and rear of the tent for protection against insects. The tent is ventilated by four built-in ventilators on opposite sides and near the peak of the tent. Four lines are provided for drying clothing and equipment. Total weight, to include the pins and tent pole, is 76 pounds. The tent is heated by an M1950 Yukon stove.

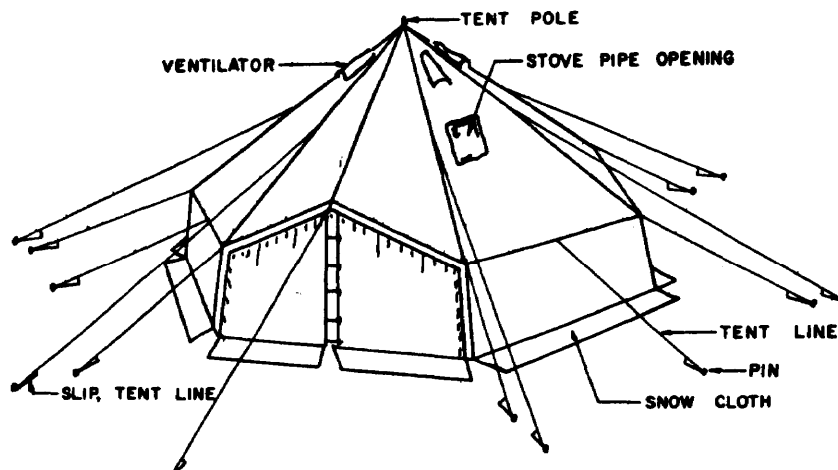

Figure 3-1. Tent, arctic, 10-man.

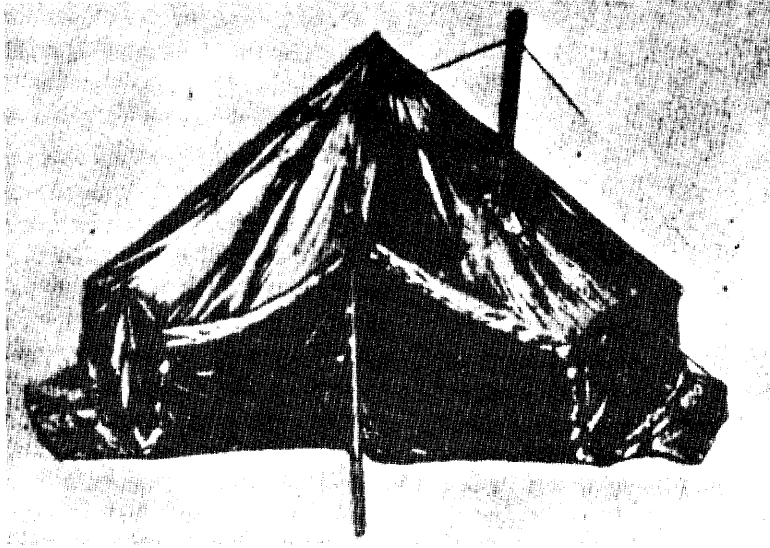

Figure 3-2. Tent, hexagonal, lightweight.

c. Tent, Hexagonal, Lightweight (fig. 3-2). This tent is also six-sided, pyramidal, and supported by a telescopic tent pole. It is designed to accommodate four to five men and their individual clothing and equipment. Under emergency conditions one tent may provide shelter for a rifle squad or other similar unit when rucksacks are placed outside the tent. The tent has one door; ventilation is provided by two built-in ventilators located on opposite sides and near the peak of the tent. Three lines are provided for drying clothing and equipment. Total weight of the tent, including the pins and center poles, is 48 pounds. The tent is heated by an M1950 Yukon stove.

d. Tent, Frame-Type, Sectional (Jamesway). This 16 by 16 frame-type tent (fig. 3-3) is a lightweight unit that offers protection for one squad. It has wooden floor units, a frame, a rounded roof, and comfortable head clearances along the centerline of the shelter. The roof and ends of the tent are fabricated from insulated, coated, fabric blankets. The structure is fastened to the ground with tent pins or snow with improvised devices. An optional vestibule may be erected at one or both ends. Additional floor sections may be added to each other lengthwise for creating larger buildings. Extra end sections may be installed along any rib as interior partitions. It weighs approximately 2,250 pounds and is

heated by one tent stove M1941. The heavier weight of this tent restricts its normal use to permanent or semipermanent base camps. It could be used for forward elements under stabilized conditions.



Figure 3-3. Tent, frame type, sectional.

e. Tent, General purpose, Small (fig. 3-4). This tent is a six-sided pyramidal tent fabricated of cotton duck cloth. A liner is available to insulate the tent during cold weather. The tent is equipped with slide fastener doors, screened doors, screened ventilators, and stove-pipe opening. It has a front and rear entrance, each with a lacing flap arrangement to permit attachment of the vestibule or erection of tents in tandem. The tent is supported by eight ad-



Figure 3-4. Tent, general purpose, small.

justable aluminum poles around the eave line and a standard telescopic magnesium pole at the peak. The tent is used for command posts, fire direction centers, battalion aid stations, or for any general purpose use. Although similar in appearance to the Tent, Arctic, 10-man, the tent has an eave height of 152.40 cm (60") compared to 91.44 cm (36") for the 10-man tent. The complete tent, with liner, pins and poles weighs 186 pounds.

3-6. Pitching and Striking Cold Weather Tents

a. With proper training, small troop units will be able to pitch tents in 15 to 30 minutes. Additional time will be required to complete the camouflage of the tent. Pitching and striking of the tents are performed in a routine drill manner in accordance with instructions contained in FM 20-15.

b. The following must be considered when pitching or striking the tents in snow or on frozen ground:

- (1) Whenever possible snow should be cleared to the ground surface to ob-

tain a lower silhouette and gain advantage of ground temperatures which are generally warmer than air temperatures. Coniferous boughs or similar material should then be placed on the ground for insulation and comfort. When it is impractical to remove snow to ground level, an adequate tent site may be made by packing the snow with skis or snowshoes until a firm base is provided for pitching. In this case, the tent pole is placed on a log or other suitable support to keep the pole from sinking into the snow. Support is also needed for the stove under similar conditions.

- (2) In open terrain, with a strong wind, it may become necessary to build a snow wall on the windward side of the tent to protect it from the wind. The snow wall also makes it easier to heat the tent and less likely that the tent will blow down. The tent is pitched with the entrance 45° down-

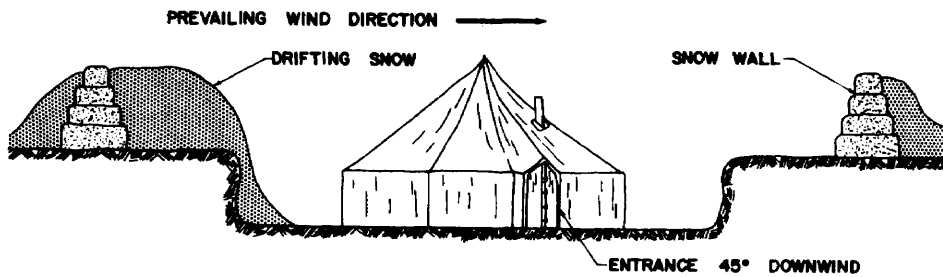
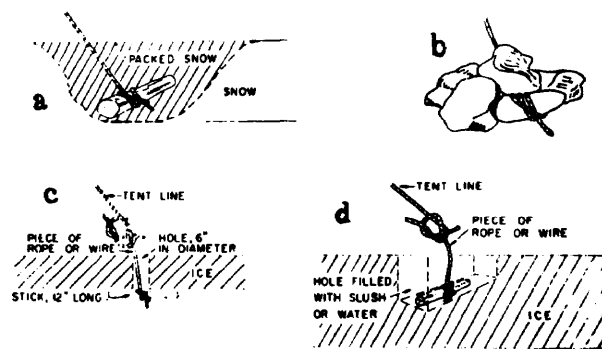

Figure 3-5. A tent dug in with snow wall windbreak.

wind (fig. 3-5). Variable winds may require construction of a windbreak at the entrance. High winds in certain cold areas necessitate anchoring the tent securely. When the tent is set up, the snow cloth should be flat on the ground outside the tent. Stones, logs, or other heavy objects should be placed on the snow cloth in addition to the snow to assist in anchoring the tent. If this is not done, the tent will be drafty and very difficult to keep warm.

- (3) Tents may be pitched rapidly and anchored securely by attaching the tent lines to trees, branches, logs or stumps whenever possible. If these natural anchors are not available, suitable holes are dug into the snow for the purpose of using "deadmen." This is accomplished by digging a hole into the snow large enough to insert a pole or log approximately one meter (3') long with the tent line attached. The hole is then filled with snow, well packed, and in a short period of time the packed snow freezes and the tent will be securely anchored (a, fig. 3-6). Driving metal pins into frozen or rocky ground should be avoided when excessive force is required. On rocky ground, tent lines may be tied around heavy rocks and then weighted down with other stones (b, fig. 3-6).
- (4) Tents are also occasionally pitched on ice. When the thickness of the ice is not excessive, a small hole is chopped

through the ice. A short stick or pole with a piece of rope or wire tied in the middle of it is pushed through and then turned across the hole underneath the ice (c, fig. 3-6). If the ice is very thick a hole 30 to 60 cm (1' to 2') deep is cut in it, the "deadman" inserted and the hole filled with slush or water (d, fig. 3-6). When the slush or water is frozen, an excellent anchor point is provided. When the "deadman" is placed underneath or into the ice, a piece of rope or wire should be fastened to the rope or wire after the "deadman" is secure. This may prevent the tent line from being accidentally cut or damaged when being removed from the ice.



- a. "Deadman" buried in packed snow
- b. Tent line buried under stones
- c. Lowering anchor through ice
- d. "Deadman" placed in thick ice

Figure 3-6. Improvised methods of anchoring tents.

- (5) When striking the tent in winter it normally will be covered with snow and ice which must be removed or the tent may double in weight. Snow and ice can be removed easily by shaking the tent or by beating it with a mitten or a stick. If the snow cloth is frozen to the ground, the snow and ice around it must be carefully removed by chopping or shoveling in order to avoid damage to the material. One method of accomplishing this is to ease the shovel between the cloth and the ground and gently pry the cloth away from the ice.

c. The vestibule attached to the basic frame-type tent (Jamesway) helps reduce heat loss when the door is frequently used. The main door of the tent opens inward, and thus cannot be blocked by drifting snow if the occupants are equipped with a shovel or improvised digging equipment. However, the vestibule door opens outward and can be blocked by drifting snow during a violent storm. A safe practice is to install the vestibule only at one end facing the prevailing wind and to use no vestibule on the more leeward end where drift will probably accumulate. Rapid exit in case of fire or other emergency is then assured. Where severe winds are expected the tent should be sited crosswise to the anticipated wind direction since the curved roof tolerates the wind load better than the flat ends, and buffeting is reduced. A vestibule should not be used on a tent intended for aid station use, since a standard litter cannot negotiate the right angle turn required in the short vestibule.

3-7. Ventilation

a. Tents are pitched to protect occupants from the elements and to provide necessary warmth and comfort. When the bottom of the arctic tent is properly sealed and the doors are zipped shut, moisture will form on the inside of the tent and accumulate on clothing and equipment, thereby causing dampness and hoarfrost. In addition, carbon monoxide, carbon dioxide, and fumes from the stoves may soon accumulate to a dangerous degree. To offset these factors, the built-in ventilators near the peak of the tent must be kept open.

b. To improve ventilation, a draft channel

may be constructed by forming a pipe with green logs (fig. 3-7). The channel is buried in the floor and has an opening under the stove. The draft of the stove draws fresh air from outside the tent into the channel.

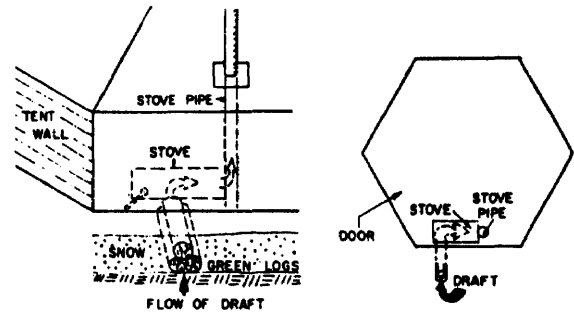
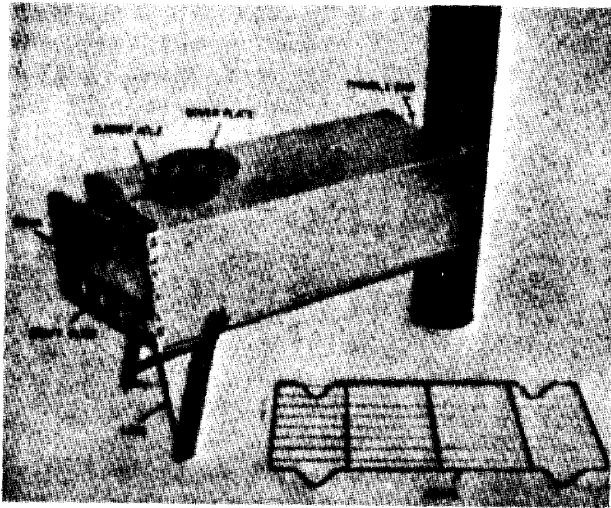

Figure 3-7. Draft channel for stove.

3-8. Heating Tents with Stove, Yukon, M1950, 60,000 BTU

a. *General.* The Yukon stove (1, fig. 3-8) is used to heat the 10-man, 5-man, and GP Small tents. In addition to providing heat, the top surface of the stove and, to a small degree, the area beneath the stove, may be used to cook rations or heat water. The Yukon stove utilizes standard leaded motor fuel as its normal fuel, but may also be operated with white gasoline, kerosene, light fuel oil, naphtha, or JP-4 fuel, without modification (2, fig. 3-8). During low temperatures the stove will burn five gallons of gasoline every 8 to 12 hours. When solid fuels (wood, coal, etc.) are used, the stove must be modified by removing the oil burner from the top of the stove, closing the opening where the burner was installed, and turning over the wire grate so that there is space below the grate for draft and ashes. A piece of plywood slightly larger than the base of the stove should be carried as part of the tent group equipment. The plywood is covered with aluminum foil and is used to provide a firm base for the stove and to prevent it from melting down into the snow.

b. *Operating Procedures.* The compact, lightly constructed, 33-pound Yukon stove permits all accessory parts to be packed within the stove body for convenient portability in a sled or on a packboard. A draft diverter is issued as a component part of the stove. It shields the top of the stovepipe from the wind and pre-



1 Body assembly

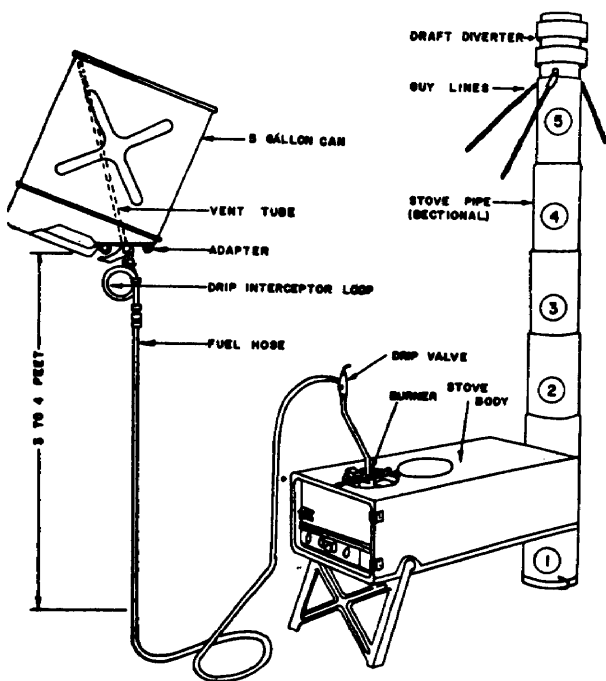

2 Installation setup

Figure 3-8. Stove, Yukon, M1950.

vents a backdraft from forcing smoke or gases into the stove and tent. Three, 4.5 meter (15') guylines tied to the draft diverter serve to anchor the stovepipe in strong winds. These guylines must be anchored to the tent or tent ropes, not to the ground or nearby trees. A simple method of erecting a tripod for the fuel can is to obtain three poles about 2 meters

(6') in length; the poles are tied about two-thirds of the way up using wire from ration cases, string, rope, or emergency thong, and then spread out to form a tripod. The fuel can should be at least one meter (3') higher than the stove. The lowest part of the inverted gasoline can should be a minimum of 30 cm (1') above the level of the needle valve of the Yukon stove. It should not be higher than 1.50 meters (5') if the valve is to operate smoothly. If the fuel can is wobbly or if there is some wind the can must be tied to the tripod for additional protection. Make certain that the can is tilted so that air is trapped in the uppermost corner. The stove is assembled, operated, and maintained in accordance with TM 10-735.

c. *Precautions.* The following precautions must be observed when the Yukon stove is used:

(1) *Burning liquid fuels.*

- (a) All stovepipe connections must be tight and necessary tent shields adjusted properly.
- (b) Stove must be level to insure that the burner assembly will spread an even flame within the stove.
- (c) The fuel hose must be protected so it cannot be pulled loose accidentally. If necessary, a small trench may be dug and the hose imbedded where it crosses the tent floor.
- (d) The fuel line must not be allowed to touch the hot stove.
- (e) When adjusting the fuel flow, the drip valve lever must be turned carefully to prevent damage to the threads.
- (f) Rate of fuel flow must be checked at regular intervals. The rate of flow will change as fuel supply level drops and will require some adjustment. The stove should never be left unattended. Maintaining a hotter fire than necessary may cause the stove body to become overheated and warp.
- (9) If the flame is accidentally extinguished, or if the fuel can is being changed, the drip valve must be closed. When the stove has cooled, any excess fuel inside the stove

must be wiped up and 2 or 3 minutes allowed for gas fumes to escape before relighting the burner. *The burner must be cool before relighting stove. If stove lit before burner is cool, the fuel will vaporize prior to ignition, causing an explosion.*

- (h) All fuel supplies must be kept outside the tent. Spare cans of gasoline or other fuel should never be stored inside the tent. Fuels used in combat areas in the north are normally low temperature fuels which will flow freely.
- (2) *Burning solid fuels.*
 - (a) Fuel should be fed a small amount at a time until the bed of coals is burning brightly.
 - (b) Stove should not be allowed to overheat.
 - (c) Oil or gasoline should not be poured on the fire.
 - (d) Ashes should not be allowed to accumulate below the grate.
 - (e) Clinkers should be removed to prevent grate from becoming blocked.

3-9. Heating of Semipermanent Tents With Tent Stove, M1941

Stoves of this type normally are used to provide heat for the semipermanent, frame-type, sectional tent. The stove may be operated with wood or coal or with various types of oil and gasoline. This stove has the same general characteristics and safety features outlined for the Yukon stove in paragraph 3-8.

3-10. Fuel Economy

The minimum daily fuel consumption per Yukon stove approximates five gallons of gasoline per 8 to 12 hours of operation. The M1941

Tent Stove will burn five gallons in 3 to 4 hours. Prior planning must be accomplished to reduce the number of stoves required, especially for operations that are some distance from a road net. Wood should be used as fuel whenever possible. Cooking and heating are combined and, when extra heat is required to dry clothes, all individuals should dry clothes at the same time, when possible.

3-11. Lighting Tents

Candles will provide light in forward areas. In rear areas, gasoline lanterns or lighting equipment sets may be used.

3-12. Tools

a. Handtools are needed by small units for several purposes such as erection and striking the tent, building ski and weapon racks, building field latrines, chopping firewood, etc. Tools are also needed for trailbreaking, preparation of positions, and similar tasks. Because entrenching tools are lightly constructed, they are of little value for work in heavy timber or frozen ground. The following tools are needed by squad sized units to accomplish routine tasks in cold regions, regardless of the season of the year:

- (1) One axe, chopping.
- (2) One saw (Buck or Swede).
- (3) Two machetes with sheaths.
- (4) One shovel, general purpose.

b. Tools must be kept sharp, clean, oiled and in good condition. Care must be taken to preclude small tools and items of equipment from being left in the snow or thrown aside where they may become buried and lost in the snow. Particular care must be exercised while wearing gloves because ice or frost may form on the gloves and cause the tools to slip from the users hands, resulting in injury to nearby personnel and/or loss of equipment.

Section III. IMPROVISED SHELTERS

3-13. Requirement for Improvised Shelters

a. There are many occasions when tents or other regular shelters are not available. In summer, if the weather is mild, individuals may need protection only from insects. In winter, however, individuals cannot stay in the

open for long periods unless they are moving. The requirement for improvised shelters may arise for several reasons, e.g., vehicles carrying tents may be unable to reach the troops due to difficult terrain or enemy action. In case of emergency, each individual must know how to protect himself from the effects of the weather.

b. If suitable natural shelters such as caves or rock shelves are available, they should be used. If natural shelters are not available, a temporary improvised shelter must be established.

c. The type of improvised shelter to be built depends on the equipment and materials available. By the proper use of materials available, some sort of shelter can be built during any season of the year. In open terrain a shelter can be built using ponchos, canvas, snowblocks, or other materials. Snow caves, snow trenches, or snow holes may be constructed in the winter if the snow is both deep and well-compacted. In the woods, a lean-to is normally preferable to other types of shelter. In northern areas, nature provides the individual with the means to prepare a shelter. His comfort, however, greatly depends on his initiative and skill at improvising.

d. A shelter should always provide adequate protection from the elements, retain heat, have suitable ventilation, and provide drying facilities.

3-14. Poncho Shelters

A poncho is a part of an individual's uniform. It is a multipurpose piece of equipment that may be used as a rain garment, a waterproof bedcover, a ground sheet, or a shelter. The simplest type of shelter can be made by merely pulling the poncho over the sleeping bag. For additional comfort, various types of

shelters and lean-tos may be made by attaching ponchos to trees, tree branches or poles.

a. *One-Man Shelter.* A one-man shelter (fig. 3-9) may be made from one poncho. The poncho is spread, hood side up, on the ground, and the hood opening is tightly closed by adjusting and tying the hood drawstrings. The poncho is raised at the middle of its short dimension to form a ridge, and then staked out at the corners and sides. Side stakes should not be driven through the grommets at the corners or sides, because this may tear the poncho. A short piece of rope is tied to the grommets and, in turn, to the stakes. Snow, sod, or boughs are used to seal two sides and one end of the shelter to provide additional protection from the wind and to retain heat inside the shelter.

b. *Two-Man Shelter.* To construct a two-man shelter (fig. 3-9), ponchos are spread on the ground, hood side up, with the long sides together so that the snap fastener studs of one poncho may be fastened to the snap fastener sockets of the other poncho. Hood openings must be tightly closed by adjusting and tying the hood drawstrings. Ponchos are raised where they are joined to form a ridge; ropes are then attached to grommets at the ends of the ridge and run over forked sticks. The shelter tent is then staked out at the corners and sides, as described in *a* above. A third poncho may be snapped into the other ponchos to form a ground cloth.

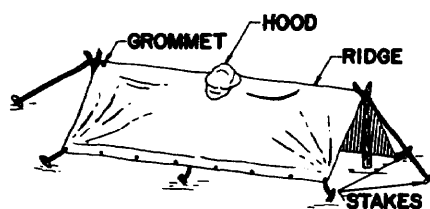

1. ONE-MAN SHELTER

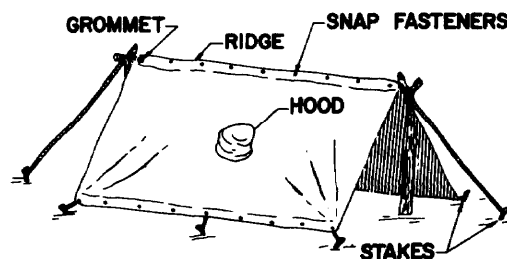

2. TWO-MAN SHELTER

Figure 3-9. Poncho shelters.

3-15. Lean-To

a. *Materials.* The lean-to shelter, used in forested areas, is constructed of trees and tree limbs. String or wire helps in the building, but is not necessary. A poncho, a piece of canvas, tarpaulin, or a parachute, in addition to the boughs, may be used for covering.

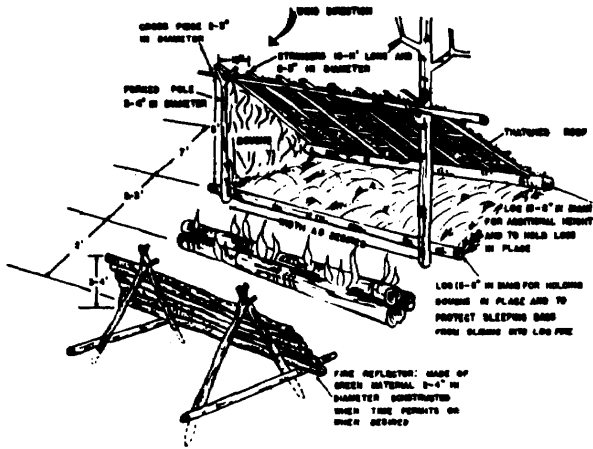

Figure 3-10. Single lean-to.

b. *Size.* The lean-to is made to accommodate a variable number of individuals. It may be built for one man only, teams, gun crews, patrols, or similar small groups. From a practical point of view, a rifle squad is the largest element to be sheltered in one double lean-to.

c. *Types.* Depending on the number of individuals to be sheltered, two types of lean-tos, single and double, are used.

d. *Construction.*

- (1) *Single lean-to* (fig. 3-10). To save time and energy, two trees of appropriate distance apart, and sturdy enough to support the crosspiece approximately 1.50 meters (5') off the ground, are selected when operating in forested areas. It may be necessary to cut two forked poles of desired height, or construct two A-frames to hold the crosspieces, or use a combination of these supports when bivouacking in sparse wooded or semi-open areas. A large log is then placed to the rear of the lean-to for added height. Other methods that may be used are packing the snow down or

using snowblocks instead of a heavy log. Stringers approximately 3 meters (10') long and 5 to 8 centimeters (2" to 3") in diameter are then placed, approximately 46 cm (18") apart, from the crosspiece over the top of the log in the rear of the shelter. Material such as cardboard, canvas or ponchos may be placed over the framework to preclude falling or melting snow, warmed by the fire, from dropping through. One or both sides of the lean-to and the roof are then thatched.

- (2) *Double lean-to* (fig. 3-11). Two single lean-tos are built facing each other and approximately 1.50 to 2 meters (5' to 6') apart. The space between single lean-tos must be sufficient to permit the occupants to move freely around the log fire placed along the centerline of this space and to allow the smoke to get out through the opening instead of gathering under the roofing. If desired, one end of the middle space may be covered by a wall made of boughs or other materials for additional protection from the draft and wind.

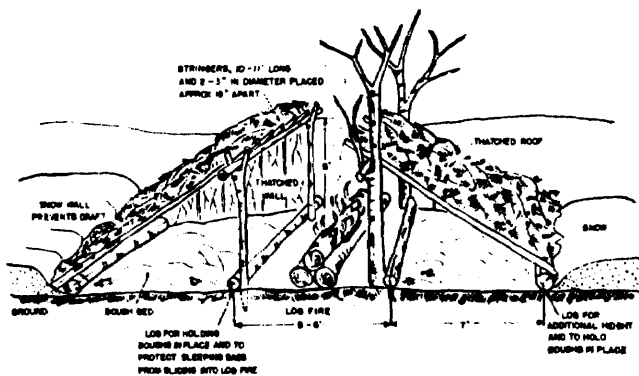

Figure 3-11. Double lean-to.

- e. *Heating.* In heating a lean-to, any kind of oven fire may be used. The best type for large size lean-tos, however, is the log fire, so the heat will be evenly distributed over the entire length of the lean-to, see paragraph 3-21 d. In employing open fires for heating, precautions must be taken to prevent the fire from burning

too hot and burning down the shelter or setting the roof on the with sparks.

3-16. Tree Shelter

a. *Tree-Pit Shelter.* In wooded areas, the deep snow and tree-pit shelter (fig. 3-12) furnishes temporary protection. To construct a tree-pit shelter a large tree is selected with thick lower branches and surrounded with deep snow. The snow is shaken from the lower branches and the natural pit is enlarged around the trunk of the tree. The walls and floor are then lined with branches and the roof thickened. Canvas or other material on hand may be used for the roof.

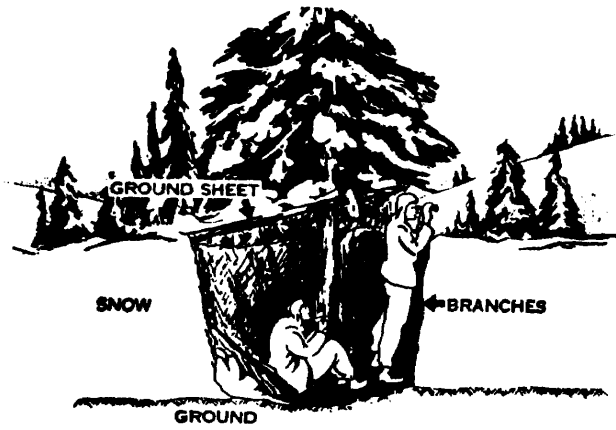

Figure 3-12. Tree-pit shelter.

b. *Fallen Tree Shelter.* An emergency shelter for one man can be constructed by cutting down a coniferous tree at a point about one meter (3') from the ground. The underside is trimmed and the cut material placed on the ground to provide insulation. This shelter will provide some protection from the elements for a man in his sleeping bag. Another way to build this shelter is to tie a pole to a tree and drape a poncho or similar material over the pole.

3-17. Wigwam

A conventional wigwam or tepee can be built in wooded areas by typing a number of poles near the top and spreading them at the bottom to form a large circle. This framework is then covered with available tree boughs, canvas, cardboard, or other suitable material.

3-18. Snow Wall

In open terrain with snow and ice, a snow wall (fig. 3-13) may be constructed for protection from strong winds. Blocks of compact snow or ice are used to form a windbreak.

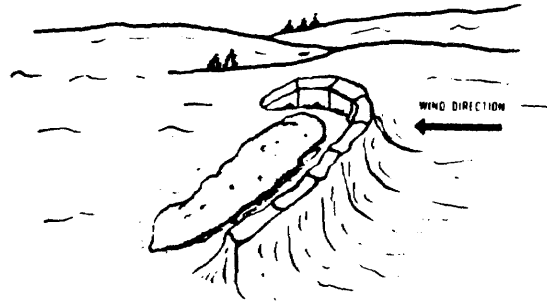
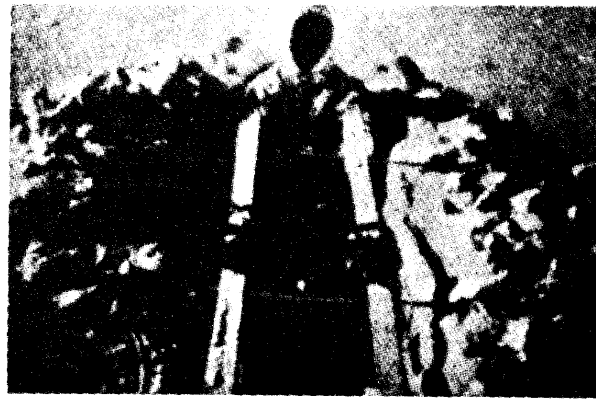

Figure 3-13. Sleeping behind snow wall.

3-19. Snow Hole

A snow hole (fig. 3-14) provides shelter quickly. It is constructed by burrowing into a



1 Snow hole partially constructed.



2 Snow hole completed.

Figure 3-14. Snow hole.

snowdrift or by digging a trench in the snow and making a roof of ponchos and ice or snow-blocks supported by skis, ski poles or snow-shoes. A sled provides excellent insulation for the sleeping bag. Boughs, if available, can be used for covering the roof and for the bed.

3-20. Snow Cave

a. Location. A snow cave (figs. 3-15 and 3-16) can be used as an improvised shelter in the open areas where deep and compacted snow

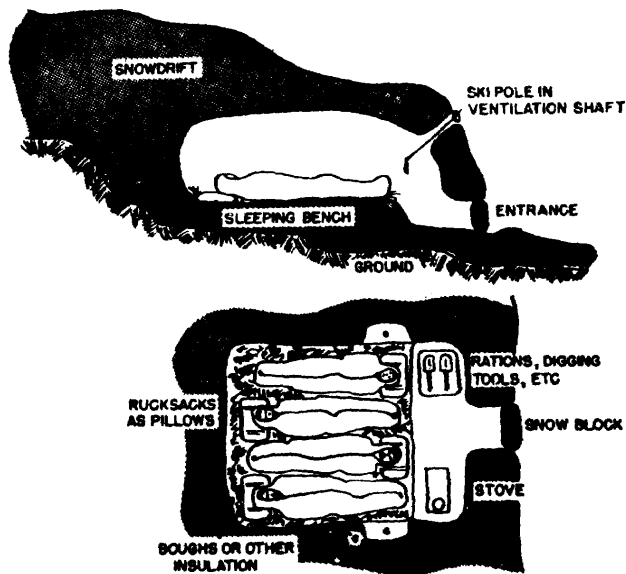
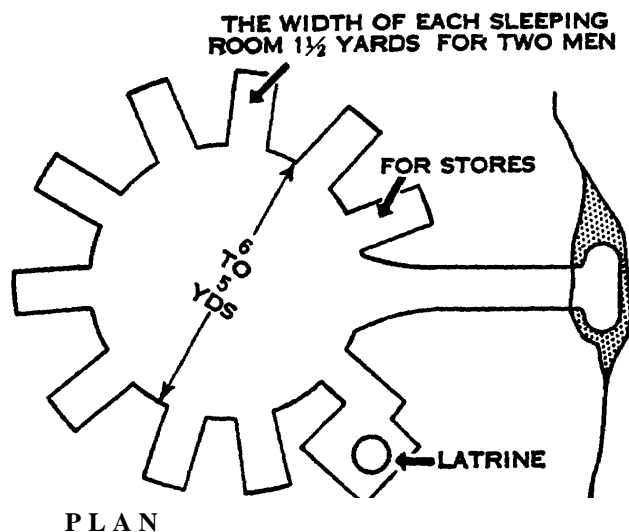

Figure 3-15. Snow cave for four men.



PLAN

Figure 3-16. Snow cave for sixteen men.

is available. Normally, a suitable site is located on the lee side of a steep ridge or riverbank where drifted snow accumulates in unusual depths.

b. Basic Construction Principles. Basic principles for construction of all snow caves are as follows:

- (1) The tunnel entrance must give access to the lowest level of the chamber, which is the bottom of the pit where cooking is done and equipment is stored.
- (2) The snow cave must be high enough to provide comfortable sitting space.
- (3) The sleeping areas must be on a higher level than the highest point of the tunnel entrance so that the rising warm air will permit the men to sleep more comfortably.
- (4) The roof must be arched both for strength and so that drops of water forming on the inside will not fall on the floor, but will follow along the curved sides, glazing over the walls when frozen.
- (5) The roof must be at least 30 cm (1') thick.

c. Size. The size of the snow cave depends upon the number of men expected to occupy it. A large cave is usually warmer and more practical to construct and maintain than several small caves. In good snow conditions a 16- to 20-man cave is the most practical.

d. Shape. The shape of the snow cave can be varied to suit conditions. When the main cave is built, short side tunnels are dug to make one- or two-man sleeping rooms, storage space, latrine and kitchen space.

e. Construction. The following steps should be observed in construction:

- (1) A deep snowdrift at least 243 cm (8') deep is located. Newly fallen, powdery or loose snow should be avoided.
- (2) The depth of a snowdrift may be tested with a sharpened sapling approximately 365 cm (12') in length, or in the absence of trees the shorter ski pole or avalanche probe (The availability of an avalanche probe is discussed in FM 31-72.)

- (3) The entrance is chosen carefully so the wind will not blow into the cave or the entrance become blocked by drifting snow.
- (4) A small tunnel is burrowed directly into the side of the drift for one meter (3'). A chamber is excavated from this tunnel.
- (5) Excavation is done to the right and left so that the length of the chamber is at right angles to the tunnel entrance.
- (6) Due to the fact that the individuals digging will become wet, they should wear the minimum amount of clothing possible to insure that they have a change of dry clothing upon completion of the task.

f. Heating and Safety Measures. The cave can be heated with the one-burner gasoline stove or with candles. The fires should be extinguished when individuals are sleeping, thus reducing the danger of fire and asphyxiation. If the weather is severe and it becomes necessary to keep a fire going while the individuals are asleep, an alert fire guard must be posted in each cave. The ventilation holes must be inspected every 2 or 3 hours to insure that they have not become clogged by snow or by icing.

g. Insulation. To insure that the cave is warm, the entrance should be blocked with a rucksack, piece of canvas, or snowblock when not in use. All available material, such as ponchos, cardboard, brush, boughs, etc., should be used for ground insulation.

h. Other Precautions. Walking on the roof may cause it to collapse. At least two ventilators, one in the door and one in the roof, are used. A ski pole can be stuck through the roof ventilator to clear it from the inside. Extra care must be exercised to keep air in the cave fresh when heating or cooking. The entrance should be marked by placing a pair of skis or other equipment upright on each side of the entry way.

3-21. Campfires

a. Matches and Fire Starters. A supply of matches in a waterproof container, heat tablets, or fire starters must be carried by all individuals operating in cold weather. They

are a necessity, especially where snow and ice add to the problems of securing tinder for starting a fire. In emergencies, matches should be used sparingly and lighted candles used to start fires whenever possible, or if available, a little engine oil will help ignite wet or frozen wood without the flash hazard of the more volatile petroleum fuels. As a safety precaution, it should be remembered that fire starters are extremely inflammable and must be kept away from open flames and heat.

b. Selecting Site. Individuals building a fire in the field should carefully select a site where the fire is protected from the wind. Standing timber or brush makes a good windbreak in wooded areas, but in open country some form of protection must be provided. A row of snowblocks, the shelter of a ridge, or a scooped-out side of a snowdrift will serve as a windbreak on barren terrain.

c. Starting and Maintaining Fire. Before using matches, a supply of tinder must be on hand. The use of heat tablets is recommended for the safe starting of fires. In inclosed areas, gasoline or other high inflammable fire starters will not be used. In the open, and under very strict control, small quantities of gasoline may be used to start fires when other means are not available. Many types of fuel are available for fires. The driest wood is found in dead, standing trees. Fallen timber may often be wet and less suitable. In living trees, branches above snow level are the driest. Green and frozen trees are generally not suitable because they will not burn freely. Splitting green willows or birches into small pieces provides a fairly good method of starting and maintaining a fire, if no deadwood is available. Also, dry grass, birchbark, and splits of spruce bark with pitch tar are excellent fire starters. It is good practice to secure a sufficient amount of firewood to last throughout the night, before retiring.

d. Types of Fire. Any kind of open fire may be used with most of the improvised shelters. In deep snow, a fire base (fig. 3-17) of green wood should be built first to protect the campfire from sinking into the snow. For a single lean-to or snow wall, a fire reflector (fig. 3-10) may be built of green logs or poles to reflect the heat into the shelter and to serve as a

steadily. The most suitable types for single and double lean-tos are the log fires (fig. 3-18).

- (1) Two, preferably three, logs are used for this type of campfire. Dry, hardwood logs, if possible, 20 to 40 cm (approx 1') in diameter and approximately the same length as the lean-to

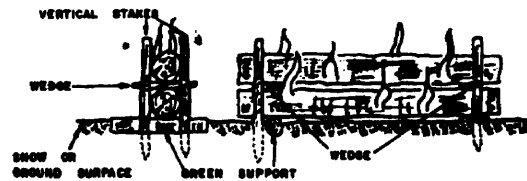

1 Two-log fire

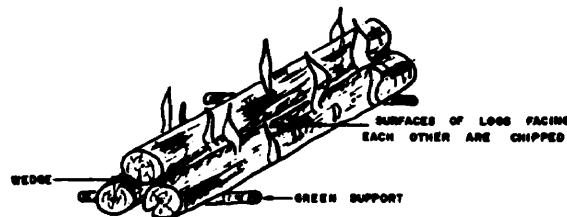

2 Three-log fire

Figure 3-18. Log fires.

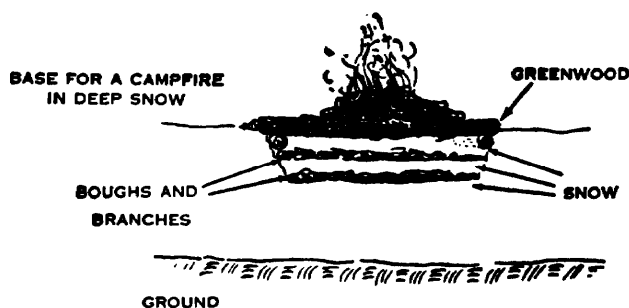

Figure 3-17. Camp fire and fire base on snow.

are selected and brought to the fire site. First, two logs are placed side by side on small green blocks to support them above the snow or ground for a better draft. Then the third log is placed in the middle and on top of the other two logs. For better burning, the surfaces of logs which face each other are chipped. Before lighting the fire, small wedges are placed between the chipped surfaces of the logs for better draft. Fire is then started at several places to help it spread the entire length of the logs. A log fire of this type will burn all night with only minimum care.

- (2) When only two logs are used, four vertical stakes must be driven into the snow to keep one log on top of the other. A disadvantage of this type of log fire is the fact that the vertical stakes tend to give way when the snow starts melting around the fire.

Section IV. FOOD AND WATER

3-22. Principles

a. Importance of Balanced Meals. Army rations are well balanced. The ration for 1 day provides all the essential foods the body requires. However, all the ration must be eaten if

all the caloric value is to be obtained. Some items may, at times, not appeal to the individual sense of taste, but they must be eaten. The tendency to be lazy about preparing and eating satisfactory morning and evening meals

before and after a hard day on the trail must be avoided, since it is exceedingly detrimental to continued good health. After having been without normal supplies for a period of time, it is essential that men be provided with a balanced meal containing the three basic food requirements (fats, protein, and carbohydrates). When possible and especially when troops are involved in rigorous activity, it may be desirable to feed four times daily. A desirable feeding plan would be the normal heavy breakfast meal, a light midmorning meal, a light afternoon meal, with the supper meal being the main meal of the day. The mid-morning and midafternoon meal should consist of foods high in carbohydrates and include a hot liquid. Concentrated foods found in some special and survival rations are suitable for this purpose. Hot soup or tea are most desirable for the liquid. The evening meal should be heavily fortified with protein and eaten just before going to sleep. This heavy protein meal will increase body combustion above basal level, resulting in what is known as specific dynamic heat. This increase in the output of heat within the body also aids in keeping the individual warm while sleeping. If awakened by cold a small snack eaten inside the sleeping bag may increase heat production enough to permit further comfortable sleep.

b. Importance of Liquids. In cold regions, as elsewhere, the body will not operate efficiently without adequate water. Dehydration, with its accompanying loss of efficiency, can be prevented by taking fluids with all meals, and between meals if possible (para 3-34). Hot drinks are preferable to cold drinks in low temperatures since they warm the body in addition to providing needed liquids. Alcoholic beverages should not be consumed during cold weather operations since they can actually produce a more rapid heat loss by the body.

c. Use of Mess Gear. Individual mess gear will be difficult to clean and sterilize, therefore arrangements must be made for return of dirty mess gear to the battalion trains area where it is cleaned under the supervision of the mess stewards. Clean mess gear is sent forward with subsequent meals. During periods of extreme cold, it may be advisable to utilize paper plates and cups instead of mess gear. If utilized,

they should be issued with the rations and sent forward to companies with the meal. When using paper plates and cups, commanders must insure that they are not haphazardly left in the unit area. Controlled disposal must be practiced by burning at squad level or by consolidating at company level and returning them to the battalion trains area. This problem is minimized, and cooling of food is minimized, by the use of individual operational rations which may be consumed directly from their containers.

3-23. Rations

Many types of rations are used for operations in cold weather. The type of ration to be used will be determined by the location, supply situation, mission, and duration of the operation. Rations are normally prepared in the unit kitchens. Insofar as possible two hot meals per day should be served. These generally will be the breakfast and supper meals. In situations where this is not practicable, group rations are utilized and prepared by one member of the small unit. Under certain conditions an individual ration may be issued to each man. When serving meals without shelter, food may become cold or frozen before it can be eaten. Therefore, and whenever possible, shelters should be provided for the preparation and serving of food. Certain packaged rations and food packets are ideal under these circumstances because they are precooked and some components or all of the ration can be eaten without heating. However, one of the components should be heated when possible.

a. Bulk Supplied Rations. Rations of this type are desirable whenever possible. They are characterized by a need for maximum time and effort for preparation, high palatability, a large variety in menus and a high caloric content. These rations are also heavy and bulky.

- (1) "A" Ration. The standard "A" Ration consisting of fresh foods is issued whenever possible. The caloric content of the ration is increased to compensate for the added caloric re-

quirements of cold weather operations.

- (2) *"B" Ration.* The standard "B" Ration is the field ration used for mass feeding in areas where kitchen facilities, with the exception of refrigeration, are available. The ration consists of approximately one hundred nonperishable foods. These are canned and dehydrated. Hot meals furnish approximately 3,900 calories per day with a 15-day cycle of menus. Caloric content may be varied to meet requirements of varying climatic conditions or degree of physical activity.

b. Packaged Operational Rations. Rations found in this category are characterized by a need for minimum time and effort for preparation. They have a high caloric content, limited menus and are lightweight. Maximum advantage is taken of dehydration and concentration. They are for the most part served hot, but certain components may be consumed cold.

- (1) *Ration, individual, trail, frigid.* This ration is designed for trail use under cold weather conditions. While hot meals can and are intended to be prepared from this ration, all components, except the dehydrated soups and beverages may be eaten without preparation. Components of the ration such as, processed cheese, fruitcake bars and candy are especially adaptable to consumption in mobile situations. The inclusion of several condiments enables maximum flexibility in component preparation. The ration supplies a minimum of 4,400 calories. It is intended for use by members of small patrols or trail parties for short periods of time during which resupply is not feasible.
- (2) *Meal, combat, individual.* This ration is designed for and is issued as the tactical situation dictates. It can be used in individual units as a meal or in multiples of three meals as a complete ration. Twelve menus are available. Each meal furnishes approximately one-third of the minimum

nutrient intake prescribed by Army regulations.

- (3) *Food packet, long-range patrol.* The packet was designed for use by forces in remote areas where resupply may be uncertain for as long as 10 days, under tactical situations that require men to eat as individuals, but where normal supply of water is available. There are eight menus, all flexibly packaged. Each furnishes over 1,000 calories, and consists of a precooked, dehydrated, combination item as the main component, with a confection, a cereal, or fruitcake bar, coffee, cream, sugar, toilet paper and matches. Five menus also include cocoa beverage powder. The average volume is 40 cubic inches and the average gross weight is 11 ounces. The principal menu components are packaged in a flexible combination package attached to a chipboard base which gives the package a rigid bottom while the food is being reconstituted in the bag. The main component may be eaten dry with drinking water or reconstituted. If hot water is used the main component will reconstitute in 2 minutes, if cold water is used, in 5 minutes.
- (4) *Survival rations.* Survival rations are designed for use in emergency situations. The food is highly concentrated, lightweight and requires little or no preparation. Per volume it is high in caloric content but contains much less than the minimum required nutrient prescribed by Army regulations. These rations, when available, are especially good to supplement the special rations discussed above.

3-24. Individual or Small Unit Messing

Frequently, while on patrol or during combat conditions, individuals will find it necessary to prepare their own meals or to combine rations with other individuals within the unit.

a. Equipment.

- (1) The one-burner M1950 gasoline cook-

ing stove is a cooking and heating unit for a group of from 2 to 5 men operating in an isolated or forward area where the use of heavier equipment is not practical. The mountain cookset is combined with the stove to make the one-burner cooking outfit.

- (2) Rations may also be heated on the M1950 Yukon stove. The top and to a small degree the area underneath the stove is used for this purpose.
- (3) Any fuel-burning device will give off carbon monoxide, which is poisonous. Adequate ventilation must be provided when using fuel-burning equipment under shelter.

b. Preparation.

- (1) First priority is the procurement of water (para 3-30). If snow or ice must be melted to obtain water, all available stoves are utilized for this purpose. After water is obtained, the stoves are used for food preparation. For convenience in preparation of meals and for conservation of fuel and labor, cooking should be done for as large a group as the situation permits.
- (2) Meals must be prepared efficiently and as quickly as possible. Areas sheltered from the wind should be chosen for stoves or fires. A few blocks of snow or ice or a hole dug in the snow will serve as a windbreak and provide for more efficient use of fires. Heating tablets are not efficient in extremely cold weather accompanied by high winds. Individuals may have to prepare and eat one item at a time, but a hot meal will be worth the effort.
- (3) Instructions for preparing the components of the rations will be found on, or inside, the package. The possibility of combining the various ration components, i.e., mixing meat and vegetables to make stew, should also be considered.
- (4) Canned foods are cooked and require

little heat to make them edible. Overcooking will waste fuel. The juices in canned vegetables are tasty, and contain vitamins and minerals. Drinking them will conserve the water supply. Cans must be punctured or opened before heating by open fires or stoves. Failure to do this may result in an explosion. No puncturing is needed if the can is submerged in water during the heating process.

- (5) Food, including frozen meat, should be thawed before cooking. Partly frozen meats may cook on the outside while the center remains raw. Fresh meats must be cooked thoroughly to kill any germs or parasites that may be present.
- (6) Whenever possible, dried fruit should be soaked overnight in cold water, then simmered slowly in the same water until tender, and sweetened to taste.
- (7) Canned rations, either frozen or thawed, can best be heated by immersion in boiling water. This water can then be used for making tea, coffee, or soups and for washing soiled utensils or personal hygiene.

c. Storage.

- (1) In winter the simplest way to preserve certain perishable foods such as meat products is to allow them to freeze. Rations should be stacked outside the shelter and their location carefully marked. Only as much food as can be thawed and consumed before spoiling should be brought into the shelter.
- (2) Frozen food should not be placed near heat where it may be thawed and later refrozen. Once thawed, certain foods may spoil. Meat thawed and refrozen two or three times is tasteless and watery, and resultant bacterial growth may be sufficient to cause food poisoning.

d. Eating. Meals should be prepared at regular times and as much time as possible allowed

for cooking and eating. Men should be allowed to relax after each meal. There will be times when it may not be possible to prepare a meal. Under such circumstances the meal or components of meals must be distributed to individuals before breaking camp. Any frozen food is thawed before issue to individuals. These items are wrapped in spare clothing and placed in the rucksack or in the pack to prevent them from refreezing. If time permits, halts should be made for the purpose of heating food and drink. To the extent possible, preparation of the following day's food should be done during the night bivouac in order to shorten the time required to break camp in the morning.

e. Suggestions.

- (1) Organize and control cooking.
- (2) Insure that all food is eaten; save any usable leftovers for snacks between meals.
- (3) The squad leader supervises the meals and makes sure that each man is receiving his portion.
- (4) Check continuously to see that each man's mess equipment is kept clean.
- (5) Food is prepared for as large a group as possible.
- (6) Fuel is conserved by prethawing food. This may be done by utilizing heat in the engine compartment of a vehicle or by placing cans of food under and around the tent heating stove.
- (7) Canned rations, either frozen or thawed, can best be heated by immersion in a pot of hot water on the stove. This water can then be used for washing soiled utensils.
- (8) Adequate training of all men in the preparation and cooking of cold weather rations is imperative.
- (9) One-pot meals, such as stews, save preparation time and fuel and can be kept warm more easily than several different food items.

3-25. Small Unit Messing

a. One Man Responsible. One man should be

responsible for the preparation of each meal and this job should be rotated throughout the squad. The squad leader is responsible for supplying any additional assistance needed by the cook.

b. Ingenuity in Cooking. Ingenuity on the part of the man assigned to cook for the small unit will aid immeasurably in the success of field messing in cold weather. Potatoes, onions, or bacon, when available, will increase the palatability of the food and can satisfactorily be added to many foods. The habit of making the morning coffee the night before, or using two stoves to melt snow or ice for the evening's water supply, and of thawing out those rations that are going to be used the next morning, will save time and greatly simplify food preparation at mealtime.

c. Eating Arrangement. When the weather is moderate, the mess line feeding system may be used. During cold weather in a bivouac area the food can be prepared hot and then carried in insulated containers to each tent for consumption in a heated shelter. Food may also be transported in this manner to frontline troops by using track vehicles or other methods of transport.

3-26. Natural Food Resources

a. In some cold regions, animals are abundant at certain seasons of the year. In other areas, very little game can be found during any season of the year. A person without food in these areas must know how to "live off the land" and subsist on what is available. Fish are present in fresh-water lakes and rivers during all seasons of the year, and some salt water near shore will normally yield fish. Fish will form the most readily available and largest portion of available nourishing foods.

b. Small animals and birds are also present in most areas at all times of the year. Large animals, because of migratory habits or other characteristics, are not a reliable source of food in many areas. Game should not be shot unless necessary for survival. Animals to be used for food should be thoroughly bled, internal organs removed, and the carcass chilled as soon as possible. This will prolong the keeping time of the meat. To expedite the

chilling clean snow can be packed in the body cavity. All meat should be cooked thoroughly as a safeguard against harmful micro-organisms and parasites that might be present in the carcass. Only healthy animals should be used; in the absence of a person qualified to determine if the animal is healthy, meat from the animals that appear sick should not be handled or eaten. For additional information, see FM 21-76.

3-27. Animals of Cold Regions

a. *Caribou and Reindeer.*

- (1) These are mainly herd animals found in the high plateaus and mountain slopes as well as in the grassy tundra areas. Their favorite year-round food is the lichens or "reindeer moss." Their summer diet consists of grasses, shrubs, and brush tips. They are very curious animals and will often approach a hunter merely from curiosity, thus presenting a good target. Sight of a human may have no effect on them but the slightest hint of human scent will send them galloping. It is possible to attract them near enough for a shot by waving a cloth and moving slowly toward them on all fours. In shooting, the aim should be for the shoulder or neck rather than the head.
- (2) Reindeer have long been domesticated in Scandinavia and northern Asia for their meat, milk, hide, and as draft animals.
- (3) Both caribou and reindeer should be skinned promptly. Animal heat is the largest factor in meat spoilage. Fast and complete field dressing will eliminate most of this hazard and airing will finish the work. The bones and muscles can hold heat for as long as 48 hours, if the surrounding temperature is not below freezing. Fat should be kept with the carcass, not with the skin. If time does not allow skinning, at least the entrails and genitals should be cleaned out of the animal.

- (4) A poncho may be used for wrapping the meat, whether for packing it out or if it is to be left hanging for the second trip. Meat should be raised off the ground as soon as possible because this will cool it sooner and keep it away from predators. Dirt and contamination should be washed from the meat and the meat then dried, if possible. A carcass should never be washed until it has cooled and is ready to be butchered and stored.

b. *Mountain Sheep and Goats.*

- (1) These animals are available in many northern areas. Although they normally live in the higher elevations, during periods of heavy snow, they may be more readily available than other animals.
- (2) The procedures for skinning and care of caribou and reindeer are also applicable to sheep and goats.

c. *Moose.*

- (1) The moose is the largest known species of the deer family. They are found in most areas of the northern hemisphere. Full grown bulls weigh from 1,000 to 1,200 pounds and may stand two meters (6') high at the shoulder. They require a large amount of forage and usually may be found in areas where food of this type is plentiful, such as burn-offs, swamps, and lake areas.
- (2) The procedures for the skinning and care of caribou and reindeer meat are applicable to moose.

d. *Seals.*

- (1) Seals are widely distributed and generally common. Their flesh is an excellent food. The liver should be avoided since it may contain toxic levels of Vitamin A.
- (2) The seals should be shot as they come to the surface of the water to breathe or as they are basking on rocks. The aim should be for the head. Most of the seals shot through the head will

float, while about half of those shot through the body will not. Seals will also be found in the open leads in the icepack or may be found at their breathing holes in the ice. However, hunting seals through breathing holes requires extreme patience and the holes are difficult to locate without the use of dogs.

- (3) In the spring, mother seals and their pups may sometimes be located under snow hummocks adjacent to and over breathing holes, where they have given birth to their young. In the spring, also, seals lie on the ice and bask in the sun. They must be carefully stalked and the hunter must be close enough at the time he shoots to retrieve the dead seal before it slips into a hole in the ice.
- (4) It takes great skill to stalk a seal. The Eskimo usually tries to imitate noises made by the seal, and he may use a white screen behind which he crawls while the seal sleeps, remaining absolutely still when the seal raises its head to look around. Seals normally sleep only for a few seconds at a time and then look around for their enemies for a few seconds before sleeping again. Seal meat from which the blubber (fat) has not been entirely removed will turn rancid in a short time.

e. Walrus. The meat and blubber (fat) of walrus are edible, as are the clams which may be found in their stomachs.

f. Bears. All bears are edible, although the flesh must be thoroughly cooked to guard against trichinosis. The liver of the polar bear should not be eaten because of toxic Vitamin A concentration. All bears are dangerous and hard to kill. There should be two or more hunters in the party when hunting; soft-nosed bullets should be used. The shoulder shot is best. If the bear stands up, the aim should be at the base and center of the throat for a shot which will sever the vertebrae.

g. Wolves and Foxes. Wolves and foxes are edible. Wolves follow caribou herds. Arctic

foxes follow polar bear and eat their leavings. Foxes will hang around a camp or follow a trail party and try to steal food.

h. Rabbits or Hares. Rabbits or hares can be snared or shot. They should be shot in the head or very little meat will be left. A whistle will probably cause a running one to stop long enough for an aimed shot. When cooking hare or rabbit, fat of some sort, should be added as the meat is very lean. They should not be dressed or cut up with bare hands because of the danger of contracting tularemia (rabbit fever) from contact with the raw flesh. Completely cooked flesh is safe to handle and eat.

i. Marmots. Marmots are woodchuck-like animals that live above the treeline in the mountains. They are excellent food, especially in late summer when they are very fat. The hunter should wait until the marmot moves away from his den before shooting or he may fall into his burrow.

j. Porcupines, Beavers, and Muskrats. These animals are found throughout the colder regions. Porcupines are excellent food, as are both beaver and muskrat. All are easily obtained. The porcupine, beaver, and muskrat when found on land, can be easily killed with sticks.

k. Ground Squirrels. Ground squirrels abound in most cold areas and are easy to catch. They can be easily dug out of their burrows. They are especially common along streams with sandy banks.

3-28. Birds

All birds and their eggs found in cold regions are edible. Certain nonmigratory birds are found in cold regions in wintertime. Several species of grouse, like the ruffed, sharp tail, spruce, and ptarmigan (which turn white in winter) are common. To obtain the greatest food value from birds, they should be plucked rather than skinned.

3-29. Fish

Fish form a large part of the native diet in cold regions and are almost the entire diet of work dogs in these areas. Along the coast, salmon, tomcod, flounder, sculpin, sand sharks,

herring and other fish are found. Inland waters yield salmon, several varieties of whitefish, blackfish, and suckers. All fish and shellfish are edible, with the exception of the black mussel. Mussels from Pacific waters should be avoided entirely. Mussels are easily distinguished from clams and oysters by their orange-pink flesh. Shellfish can be cooked by boiling them in water.

3-30. Water

Water points, operated by Corps of Engineer personnel, offer the best source of water supply for all troop units in any area and in any season. Under normal operating conditions, an Engineer unit with a water point capability will be attached to task forces of brigade size or larger. Engineer water point operations under cold weather conditions are discussed in FM 31-71. This paragraph, together with paragraphs 3-31 and 3-56 offers possible solutions to the problem of water supply that confronts individuals and small detachments operating in isolated areas away from normal support activities.

a. Water is plentiful in most cold regions in one form or another. Potential sources are streams, lakes and ponds, glaciers, fresh-water ice, and last year's sea ice. Freshly frozen sea ice is salty, but year-old sea ice has had the salt leached out. It is well to test freshly frozen ice when looking for water. In some areas, where tidal action and currents are small, there is a layer of fresh water lying on top of the ice; the lower layers still contain salt. In some cases, this layer of fresh water may be 50 to 100 cm (20" to 40") in depth.

b. If possible, water should be obtained from running streams or lakes rather than by melting ice or snow. Melting ice or snow to obtain water is a slow process and consumes large quantities of fuel, 17 cubic inches of uncompacted snow, when melted, yields only 1 cubic inch of water. In winter a hole may be cut through the ice of a stream or lake to get water; the hole is then covered with snow-blocks or a poncho, board, or a ration box placed over it. Loose snow is piled on top to provide insulation and prevent refreezing. In extremely cold weather, the waterhole should

be broken open at frequent intervals. Water-holes should be marked with a stick or other marker which will not be covered by drifting snow. Water is abundant during the summer in lakes, ponds, or rivers. The milky water of a glacial stream is not harmful. It should stand in a container until the coarser sediment settles.

c. In winter or summer, water obtained from ponds, lakes and streams must be purified by chemical treatment, use of iodine tablets or in emergencies by boiling.

d. During chemical, biological, and/or nuclear warfare, precautions should be taken against using contaminated water sources. In general, cold weather conditions tend to prolong or conceal contamination hazards, and unexpected contamination may thus be encountered. When snow or ice is thawed to provide water supplies, detection tests should be conducted during or after the melting operation, since frozen contamination may not be detectable. Radiological contamination which has been covered with snow or ice may or may not show up on radiac instruments, depending upon the thickness of the cover. Boiling or treating with water purification tablets has no effect on radioactive contaminants in water. In emergencies, water suspected of radiological contamination may be filtered through a 15 cm (6") column of loose dirt and then chlorinated or iodinated. Purification of water showing, or suspected of containing, chemical contamination should not be attempted.

e. After the water is obtained, the problem of transporting and storing it arises. Units operating in the field under cold weather conditions may store water in 5-gallon water cans with insulated covers, or other similar type containers for use by small detachments or individuals. Immersion-type heaters may be used to prevent freezing of water supply tanks. Some points to be remembered are-

- (1) Transportation of water by wheeled vehicles in barren, sparsely settled areas under snow and ice conditions is practicable only when there is a road net established. The best way to transport water in cold regions is by the use of track-laying vehicles which are not dependent on roads for ma-

neuverability. If 5-gallon cans are used to carry water, they are filled only three-quarters full to allow agitation of the water and help prevent freezing while in transit. Cans are stored off the floor in heated shelters as soon as they are delivered. Sled-mounted, 250- to 300-gallon water tanks in which immersion-type heaters have been installed have proved satisfactory.

- (2) For small units of two to four men, the 5-gallon insulated food container is satisfactory for water storage. These can be filled at night and will hold enough water for the next day's needs for about four men. The insulation of these containers is sufficient to keep water from freezing for as long as 40 hours at an ambient temperature of -20° F., if the temperature of the water was at boiling point when the container was filled.

3-31. Types of Ice and Snow

a. When water is not available from other sources, it must be obtained by melting snow or ice. To conserve fuel, ice is preferable when available; if snow must be used, the most compact snow in the area should be obtained. Snow should be gathered only from areas that have not been contaminated by animals, humans, or toxic agents.

b. Ice sources are frozen lakes, rivers, ponds, glaciers, icebergs, or old sea ice. Old sea ice is rounded where broken and is likely to be pitted and to have pools on it. Its underwater part has

a bluish appearance. Fresh sea ice has a milky appearance and is angular in shape when broken. Water obtained by melting snow or ice may be purified by use of water purification tablets, providing it has not been contaminated by toxic agents.

c. If chemical, biological, or radiological contamination is detected, procedures as outlined in paragraph 3-30 *d* will be followed.

3-32. Procedures for Melting Snow and Ice

a. Burning the bottom of a pot used for melting snow can be avoided by "priming." Place a small quantity of water in the pot and add snow gradually. If water is not available, the pot should be held near the source of heat and a small quantity of snow melted in the bottom before filling it with snow.

b. The snow should be compacted in the melting pot and stirred occasionally to prevent burning the bottom of the pot.

c. Pots of snow or ice should be left on the stove when not being used for cooking so as to have water available when needed.

d. Snow or ice to be melted should be placed just outside the shelter and brought in as needed.

e. In an emergency, an inflated air mattress can be used to obtain water. The mattress is placed in the sun at a slight inclined angle. The mattress, because of its dark color, will be warmed by the sun. Light, fluffy snow thrown on this warm surface will melt and run down the creases of the mattress where it may be caught in a canteen cup or other suitable container.

Section V. HYGIENE AND FIRST AID

3-33. General

In cold weather, the care of the body requires special emphasis. If men are allowed to go without washing, fail to eat properly, do not get sufficient liquids or salt, efficiency will suffer. Lowered efficiency increases the possibility of casualties, either by cold injury or enemy action.

AGO 8641A

3-34. Dehydration

a. Definition and Principle. Dehydration means to lose or be deprived of water or the elements of water. A growing plant loses (uses) water in the growing process. If this water is not replaced by either natural means (rain) or by watering, the plant will wither and eventually dry up. The same principle applies to the human body which loses water and,

an additional element, salt. A certain amount of this loss is taking place constantly through the normal body processes of elimination; through the normal daily intake of food and liquids, these losses are replaced.

b. Dangers. When individuals are engaged in any strenuous exercises or activities, an excessive amount of water and salt is lost through perspiration. This excessive loss creates what is known as "imbalance of liquids" in the body and it is then that the danger of dehydration arises, unless this loss of liquids and salt is replaced immediately and individuals are allowed sufficient rest before continuing their activities.

c. Training and Discipline. The danger of dehydration for troops operating under cold weather conditions and over ice and deep snow is a problem that does exist and cannot be overemphasized. It is equally important, however, to recognize that the problem can be overcome and will present no great obstacle to well trained, disciplined troops who have been thoroughly oriented in the causes, the symptoms, and the effects of dehydration and who have been properly instructed in preventive measures.

d. Differences. It is important, therefore, to be aware that the danger of dehydration is as prevalent in cold regions as it is in hot, dry areas. The difference is that in *hot weather* the individual is conscious of the fact that the body is losing liquids and salt because he can see and feel the perspiration with its saline taste and "feel" it running down the face, getting in the eyes, and on the lips and tongue, and dripping from the body. In *cold weather*, it is extremely difficult for an individual who is bundled up in many layers of clothing to realize that this condition does exist. Under these conditions, perspiration is rapidly absorbed by the heavy clothing or evaporated by the air and is rarely visible on the skin.

e. Cause, Symptoms, Effects, Preventive Measures, and Treatment.

- (1) Dehydration results from failure to correct the body's "imbalance of liquids" through replacing liquid and salt which has been lost.
- (2) The symptoms of cold weather dehy-

dration are similar to those encountered in heat exhaustion. The mouth, tongue, and throat become parched and dry and swallowing becomes difficult. General nausea is felt and may be accompanied by spells of faintness, extreme dizziness and vomiting. A feeling of general tiredness and weakness sets in and muscle cramps may occur, especially in the legs. It becomes difficult to keep the eyes in focus and fainting or "blacking out" may occur.

- (3) The effect of dehydration on the individual is to incapacitate him for a period of from a few hours to several days. The effectiveness of the individual's unit is likewise reduced by the loss of his contribution to the accomplishment of the unit mission. Small patrols and detachments operating beyond range of immediate help from the parent unit must be extra-cautious to avoid dehydration since they run the risk of a secondary but more dangerous effect of dehydration, that of becoming cold weather casualties while incapacitated.
- (4) Dehydration can be prevented during cold weather operations by following the same general preventive measures applicable to hot, dry areas. Salt and sufficient additional liquids are consumed to offset excessive body losses of these elements. The amount will vary according to the individual and the type of work he is doing, i.e., light, heavy, very strenuous, etc. Rest is equally important as a preventive measure. Each individual must realize that any work that must be done while bundled in several layers of clothing is extremely exhausting. This is especially true of any movement by foot, regardless of how short the distance.
- (5) In treating a person who has become dehydrated, the individual should be kept warm but his clothes loosened sufficiently to allow proper circulation; liquids and salt should be fed to him gradually and, most important

of all, he must have plenty of rest. When salt tablets are not available, common table salt may be used. Approximately one-half of a level mess spoon of salt mixed in one gallon of water makes a palatable solution. The individual should receive prompt attention of trained medical personnel.

3-35. Personal Hygiene

Because of the extremes in temperatures and lack of bathing and sanitary facilities, keeping the body clean in cold weather will not be easy.

a. The entire body should be washed at least weekly. If bathing facilities are not available, the entire body can be washed with the equivalent of two canteen cups of water, using half for soap and washing, and half for rinsing. If circumstances prevent use of water, a rubdown with a dry cloth will help. Care should be taken not to abrade the skin. The feet, crotch, and armpits should be cleaned daily.

b. A temporary steam bath can be built in a large-size tent. Stones are piled up to form a furnace. The furnace is either heated inside the tent (ventilation flaps wide open) or in the open with the tent pitched over the furnace after the stones are heated. Wood is used for fuel. Seats and water buckets are taken into the tent after the stones are nearly red-hot and the fire has died down, so that they do not get sooty. The pouring and washing water is usually heated outside the tent. The water is thrown on the hot stones in small quantities. Thus it does not drop into the ashes and the temperature does not rise too fast. A naked person spends from 15 minutes to 1 hour in this steam bath. After thoroughly perspiring, the body is washed with tepid water.

c. Beards should be shaved or clipped close. Hair should be combed daily and not allowed to grow too long. A beard or long hair adds very little in insulation value and soils clothing with the natural hair oils. In winter, a beard or a mustache is a nuisance since it serves as a base for the buildup of ice from moisture in the breath and will mask the pres-

ence of frostbite. All individuals should shave daily, when possible. Because shaving with a blade and soap removes the protective face oils, the individuals should shave, if possible several hours before exposing his face to the elements. This action will reduce the danger of frostbite. Shaving with an electric razor will not remove the protective oils. Under chemical or biological warfare conditions a beardless face and daily shaving are especially important, since an airtight seal of the protective mask is difficult to obtain with even stubble on the face.

d. Socks should be changed and the feet washed daily. If this is not possible, the boots and socks should be removed, and the feet massaged and dried. By sprinkling the feet liberally with foot powder and then rubbing the powder off, the feet can be efficiently dry-cleaned.

e. Sleeping bags should be kept clean. Subject to operational requirements, the best method is to wear the minimum clothing in the sleeping bag. Never wear damp socks or underwear in the sleeping bag. Dry underwear and socks should be put on before going to sleep and the other set hung up to dry. Perspiration will soil a sleeping bag, and cause it to become damp, therefore, the bag should be aired as frequently as possible. In the morning, the bag should be opened -wide and air pumped in and out to remove the moist air within the bag.

f. Teeth should be cleaned daily. If a toothbrush is not available, a clean piece of gauze or other cloth wrapped around the finger, or end of a twig chewed into a pulp may be used in lieu of a toothbrush.

g. Underwear and shirts should be changed at least twice weekly; however, if it is not possible to wash the clothing this often the clothing should be crumpled, shaken out, and aired for about 2 hours.

3-36. Cold Injury

a. Frostbite. Frostbite is the freezing of some part of the body by exposure to temperatures below freezing. It is a constant hazard in operations performed at freezing temperatures, especially when the wind is strong. Usu-

ally there is an uncomfortable sensation of coldness followed by numbness. There may be a tingling, stinging, or aching sensation, even a cramping pain. The skin initially turns red. Later it becomes pale gray or waxy white. For all practical purposes frostbite may be classified as superficial or deep. Treatment and management are based solely upon this classification.

- (1) It is easier to prevent frostbite, or stop it in its very early stages, than to thaw and take care of badly frozen flesh. Clothing and equipment must be fitted and worn so as to avoid interference with circulation. To prevent severe frostbite—
 - (a) Sufficient clothing must be worn for protection against cold and wind. The face must be protected in high wind, and when exposed to aircraft prop blast.
 - (b) Every effort must be made to keep clothing and body as dry as possible. This includes avoidance of perspiring. For heavy work in the cold, remove outer layers as needed, and replace as soon as work is stopped. Socks should be changed as needed whenever the feet become moist, either from perspiration or other sources.
 - (c) Any interference with the circulation of the blood reduces the amount of heat delivered to the extremities. All clothing and equipment must be properly fitted and worn to avoid interference with the circulation. Tight fitting socks, shoes and hand wear are especially dangerous in very cold climates.
 - (d) Cold metal should not be touched with the bare skin in extreme-low temperatures. To do so could mean loss of skin.
 - (e) Adequate clothing and shelter must be provided during periods of inactivity.
 - (f) The face, fingers, and toes should be exercised from time to time to keep them warm and to detect, any numb or hard areas. The ears

should be massaged from time to time with the hands for the same purpose.

- (g) The buddy system should always be used. Men should pair off and watch each other closely for signs of frostbite and for mutual aid if frostbite occurs. Any small frozen spots should be thawed immediately, using bare hands or other sources of body heat.
- (2) Some cases of frostbite may be superficial, involving the skin. But if freezing extends to a depth below the skin it constitutes a much more serious situation, demanding radically different treatment to avoid or minimize the loss of the part (fingers, toes, hands, feet). If a part of the body becomes frostbitten it appears yellowish or whitish gray. Frequently there is no pain, so keep watching one another's face and hands for signs. The face, hands, and feet are the parts most frequently frostbitten. The problem is to distinguish between superficial and deep frostbite. This can usually be told with respect to the face. The hands and feet are a different matter. A person may be able to judge by remembering how long the part has been without sensation. If the time was very short the frostbite is probably superficial. Otherwise assume the injury to be deep and therefore serious.
 - (3) For treatment of superficial frostbite in the field—
 - (a) Cover the cheeks with warm hands until pain returns;
 - (b) Place uncovered superficially frostbitten fingers under the opposing armpits, next to the skin.
 - (c) Place bared, superficially frostbitten feet under the clothing against the belly of a companion.
 - (d) Do not rewarm by such measures as massage, exposure to open fires, cold water soaks, rubbing with snow.

- (e) Be prepared for pain when thawing occurs.
- (4) In treatment of deep frostbite (freezing injury) the following measures must be taken: If freezing is believed to be deep, do not attempt to treat it in the field. Get to a hospital or aid station by the fastest means possible. *If transportation is available, avoid walking.* Protect the frozen part from additional injury but do not attempt to thaw it out by rubbing, bending, massage. Do not rub with snow; do not place in either cold or warm water; do not expose to hot air or open fires; do not use ointments or poultices. Thawing in the field increases pain and invites infection, greater damage, and gangrene. There is less danger of walking on feet while frozen than after thawing. Thawing may occur spontaneously, however, during transportation to a medical facility. This cannot readily be avoided since the body in general must be kept warm.

b. Trenchfoot. Trenchfoot is the thermal injury sustained as a result of exposure to cold, short of freezing, in a damp or wet environment. Arbitrarily, it is said to occur in the temperature range between 32° F. and 50° F. Partial causes include immobility of the limbs (legs and feet down as in sitting or standing), insufficient clothing, and constriction of parts of the body by boots, socks, and other garments. This type of cold injury is almost identical with gradual frostbite, which might be expected, since the primary causes are the same except for differences in the degree of cold. In the early stages of trenchfoot, feet and toes are pale and feel cold, numb, and stiff. Walking becomes difficult. If preventive action is not taken at this stage, the feet will swell and become painful. In extreme cases of trenchfoot the flesh dies and amputation of the foot or of the leg may be necessary. Because the early stages are not painful, individuals must be constantly alert to prevent the development of trenchfoot. To prevent this condition—

- (1) Feet should be kept dry by wearing waterproof footgear and by keeping the floor of shelters dry.

- (2) Socks and boots should be cleaned and dried at every opportunity, preferably daily.
- (3) The feet should be dried as soon as possible after getting them wet. They may be warmed with the hands. Foot powder should be applied and dry socks put on.
- (4) If it becomes necessary to wear wet boots and socks, the feet should be exercised continually by wriggling the toes and bending the ankles. Tight boots should never be worn.
- (5) In treating trenchfoot, the feet should be handled very gently. They should not be rubbed or massaged. If necessary, they may be cleansed carefully with plain white soap and water, dried, elevated, and allowed to remain exposed. While it is desirable to warm the patient, the feet should always be kept at room temperature. The casualty should be carried and not permitted to walk on damaged feet.

c. Immersion Foot. Immersion foot is a form of injury which follows prolonged immersion of the feet in water not sufficiently cold to cause freezing or frostbite. It has been observed after exposure in subtropical waters also. Clinically and pathologically, it is indistinguishable from trenchfoot which would be expected, since its cause is essentially the same, lowering of the temperature of the part of the body involved. It is usually associated with dependency (legs and feet down as in sitting or standing) and immobility of the lower extremities and with constriction of the limbs by clothing and shoes. Other factors which play more or less important roles are-body cooling, as the result of wind; total immersion; and inadequate clothing (protection), sickness, and starvation. The incidence and severity of immersion foot however, is more directly influenced by the other factors listed. The treatment is the same as that given for trenchfoot.

d. Total immersion. Immersion in near freezing water for but a few minutes, or exposure to severe dry cold while inadequately dressed will cause total body cooling, including

a marked drop in the inner body (core) temperatures. For description and therapy see appendix F.

e. Miscellaneous. The length of time that a casualty may be exposed to the weather without danger of cold injury varies directly with the temperature and wind velocity. The lower the temperature and the stronger the wind, the sooner injury will occur. There is a great variation in individual reactions to cold. To give competent care to the injured in extreme cold, the medical personnel must have heated shelter in which to operate. Battle wounds in the cold are no different from those sustained in more temperate climates, and should be treated in the same manner. Morale is helped by the assurance that the sick and wounded can be rapidly evacuated from the battlefield to hospitals, and that for the nontransportable cases requiring prompt lifesaving surgery, hospitals with highly skilled surgical personnel are available adjacent to division clearing station level.

3-37. Shock

Shock is brought about by a reduction of the circulating blood volume within the body. This can be caused by severe injuries, loss of blood, pain, emotional disturbances, or any of many factors. The normal reaction of the body to severe cold, reduction of the volume of blood circulating to extremities, is very similar to the reaction of the circulatory system to the condition of shock. Shock will usually develop more rapidly and progress more deeply in extreme cold than in normal temperature.

a. Signs of Shock. The signs of shock are apprehension; sweating; pallor; rapid, faint pulse; cold clammy skin; and thirst. If the patient is not given good first aid treatment immediately the condition of shock may progress until the patient passes into unconsciousness and further into death.

b. First Aid for Shock.

- (1) The injured person should be made as comfortable as possible.
- (2) Pain may be relieved by proper positioning, good bandaging and splinting. Aspirin will also help, if it is

available and if there is no known or suspected abdominal injury.

- (3) The litter should be positioned so that the patient is comfortable and not apt to inhale vomitus.
- (4) The patient should be kept warm with blankets and sleeping bags.
- (5) When the patient is conscious he should be given warm soup, chocolate, coffee, or tea if there is no known or suspected abdominal injury.
- (6) The patient should receive medical attention as soon as possible.

3-38. Sunburn

An individual may get sunburned when the temperature of the air is below freezing. On snow, ice, and water, the sun's rays reflect from all angles; in a valley the rays come from every direction. Sunlight reflected upward from the bright surfaces attacks man where the skin is very sensitive—around the lips, nostrils, and eyelids. The exposure time which will result in a burn is reduced in the clear air of high altitudes. Sunburn cream and a chapstick should be carried in the pocket, and applied to those parts of the face that are exposed to direct or reflected light. In mild weather protection of the neck and ears can be improvised by draping a handkerchief over the back of the head which is held in place by the cap in the manner of a desert neckcloth. Soap or shaving lotions with a high alcoholic content should not be used because they remove natural oils that protect the skin from the sun. If blistered, report to an aid station as soon as possible, as the blistered area, especially lips, may become badly infected.

3-39. Snow Blindness

Snow blindness occurs when the sun is shining brightly on an expanse of snow, and is due to the reflection of ultraviolet rays. It is particularly likely to occur after a fall of new snow, even when the rays of the sun are partially obscured by a light mist or fog. The risk is also increased at high altitudes. In most cases, snow blindness is due to negligence or failure on the part of the soldier to use his sunglasses. Waiting for discomfort to develop

before putting on glasses is folly. A deep burn of the eyes may already have occurred by the time any pain is felt. Putting on the glasses then is essential to prevent further injury but the damage has already been done. Symptoms of snow blindness area sensation of grit in the eyes with pain in and over the eyes made worse by eyeball movement, watering, redness, headache, and increased pain on exposure to light. First aid measures consist of blindfolding, which stops the painful eye movement, or covering the eyes with a damp cloth, which accomplishes the same thing. Rest is desirable. If further exposure to light is unavoidable the eyes should be protected with dark bandages or the darkest available glasses. The condition heals in a few days without permanent damage once unprotected exposure to sunlight is stopped.

3-40. Constipation

a. When operating under cold weather conditions there is a general tendency for individuals to allow themselves to become constipated. This condition is brought about by the desire to avoid the inconvenience and discomfort of relieving themselves under adverse conditions. This condition is also caused by changes in eating habits and failure to drink a sufficient amount of liquids.

b. Constipation can usually be prevented by adjusting the normal eating and drinking habits to fit the activities in which engaged, and by not "putting off" the normal, natural, processes of relieving the body of waste matter. Medical personnel should be consulted if constipation persists. Each individual must be educated concerning the consequences of neglecting personal hygiene habits.

3-41. Carbon Monoxide Poisoning

a. Whenever a stove, fire, gasoline heater, or internal combustion engine is used indoors there is danger of carbon monoxide poisoning. A steady supply of fresh air in living and working quarters is vital. Carbon monoxide is a deadly gas, even in low concentration, and is particularly dangerous because it is odorless.

b. Units should appoint a qualified carbon monoxide safety officer. AR 386-55 and TB

Med 269 should be used as references by these safety officers.

c. Generally there are no symptoms. With mild poisoning, however, these signs may be present-headache, dizziness, yawning, weariness, nausea, and ringing in the ears. Later on, the heart begins to flutter or throb. But the gas may hit without any warning whatsoever. A soldier may not know anything is wrong until his knees buckle. When this happens, he may not be able to walk or crawl. Unconsciousness follows; then death. Men may be fatally poisoned as they sleep.

d. In a case of carbon monoxide poisoning, the victim must be moved into the fresh air at once, but must be kept warm. In the winter, fresh air means merely circulating air that is free from gases. Exposure to outdoor cold might cause collapse. If the only fresh air is outdoors, the patient should be put into a sleeping bag for warmth. A carbon monoxide victim should never be exercised, because this will further increase his requirements for oxygen. If a gassed person stops breathing or breathes only in gasps, mouth-to-mouth resuscitation should be started immediately. In the latter case, the operator's movements must be carefully synchronized with the victim's gasps. Breathing pure oxygen removes carbon monoxide from the blood faster than does breathing air and greatly hastens recovery. Carbon monoxide is serious and a victim who survives it must be kept absolutely quiet and warm for at least a day. Hot water bottles and hot pads are helpful in maintaining body temperatures.

3-42. Care of Casualties

If any member of a group is injured, the most important course of action is to get him to competent medical aid as soon as possible. The casualty should be given first aid treatment, protected from the cold and shock effects, and evacuated to an aid station with a minimum of delay. He should be placed in a casualty bag, sleeping bag, or the best available substitute. He should have warm drinking water or other hot drinks, *except in the case of abdominal injury.*

Warning: Once a tourniquet has been applied, the wounded man should be examined by a medical officer as soon as possible.

If possible, the tourniquet should not be loosened by anyone except a medical officer who is prepared to stop the hemorrhage or bleeding by other means and to administer other treatment as necessary. Repeated loosening of the tourniquet by inexperienced personnel is extremely dangerous, can result in considerable loss of blood, and endanger the life of the patient. Halting of circulation to the extremities is an invitation to frostbite. If morphine is to be administered, caution must be exercised to avoid overdosage.

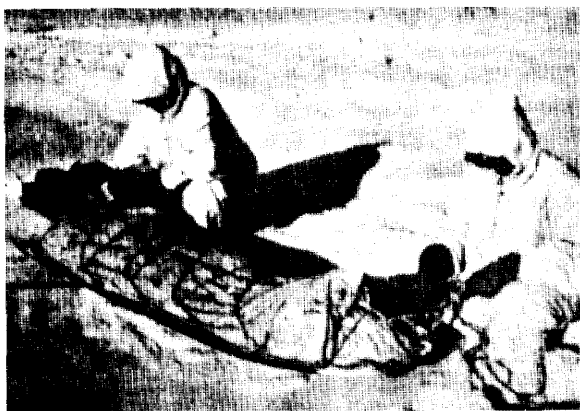

Figure 3-19. Evacuation of wounded on sled.

3-43. Emergency Evacuation

Personnel who have been wounded should be evacuated to the nearest medical facility by

the fastest means of transport available. Sleds can be used if oversnow vehicles or air evacuation facilities cannot be obtained. It may be necessary to use manhauled sleds to move the wounded a safe distance behind the frontlines before they can be transferred to faster means of transport (fig. 3-19). Speed in evacuation is essential because of the combined effects of severe cold and shock on the wounded.

3-44. Body Parasites

a. General. Body parasites are very common in the more populated cold regions because of the crowded living conditions and shortage of bathing and cleaning facilities. When in the midst of a native population, or when occupying shelters which have been used before, individuals must inspect clothing and body each night for parasites.

b. Means of Control. If clothing has become infested with lice, the following methods of removing them are recommended:

- (1) While extreme cold does not kill lice, it paralyzes them. The garments should be hung in the cold; then beaten and brushed. This will help rid the garments of lice, but not of louse eggs.
- (2) An appropriate insecticide powder can be used to free the body and clothing of body parasites.

Section VI. BIVOUAC ROUTINE

3-45. Location of Bivouac Sites

The selection of bivouac sites in northern areas is all-important and requires careful consideration. The problem of selection varies with the tactical situation, weather conditions and terrain. Terrain hazards such as steep rock faces concealed by snow, glaciers, crevasses and avalanches are typical, especially in mountainous areas. Guides familiar with terrain peculiarities must be used to the greatest extent during the troop movement.

a. If possible, the bivouac area should be tactically located in accordance with the principles of security and defense. It should be

located so that it would be advantageous for future operations. If contact with the enemy is imminent, the bivouac should be located on high ground; this, at times, is disregarded in favor of cover and concealment, more suitable ground conditions, etc.

b. Cover and concealment against air and ground observation is essential for the bivouac area. Forested areas pose few problems in comparison to that area north of the treeline. Particular attention must be given in selecting areas in cold regions to insure that local camouflage materials are available.

c. In the winter, protection from the wind is

a prime consideration. This is particularly true in areas of northern operations, where violent local gales frequently occur. In wooded areas the wind has little effect on tentage or individuals.

d. The condition of the ground is important and, if possible, the bivouac should be located on hard, dry ground.

e. Construction materials play an important part in the selection of a bivouac. When making a reconnaissance for the area, such things as the availability of firewood, water, snow for snow shelters, boughs, etc., must be reconsidered.

3-46. Bivouac in Forests

a. Most forests in cold regions provide excellent bivouac sites and should be reutilized whenever possible. Forests provide many natural materials such as boughs for insulation, firewood, and camouflage construction materials. They also provide excellent concealment against enemy air and ground observation. Coniferous (cone-bearing trees) provide better protection from wind and better insulation material and firewood than deciduous forests. Pine and spruce forests, normally found on well drained soil, offer the best hardstand for shelter.

b. Tracks are visible in both summer and winter. On dry ground, however, they normally are not as noticeable as on wet soil. Consideration should be given to building dummy positions for the purpose of misleading the enemy (fig. 3-20). Track discipline must be rigidly enforced in the bivouac area. Once tracks are made, all movement within the areas should be restricted to those tracks.

3-47. Bivouac on Marshy Ground

a. In winter, when the ground is frozen, good bivouac sites may be found in areas which otherwise would not be usable. Some swampy areas may not freeze during the winter, because of warm water springs or gases. They provide poor facilities for the bivouac site. If it becomes necessary to establish the bivouac on swampy ground, flooring for shelters must be constructed. If tree trunks are available, a

“float” may be built under the shelter (fig. 3-21). In the absence of tree trunks, brush matting will serve the same purpose.

b. Areas to be used for extended periods of time require draining, clearing of existing creeks, digging of ditches around the shelter, or preparing a water trench inside the shelter.

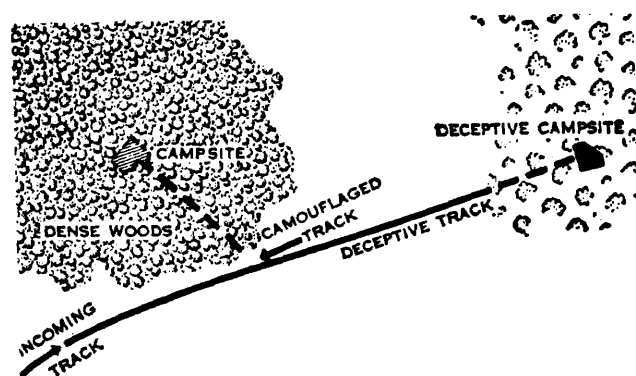

Figure 3-20. Selection of route when entering bivouac in forest.

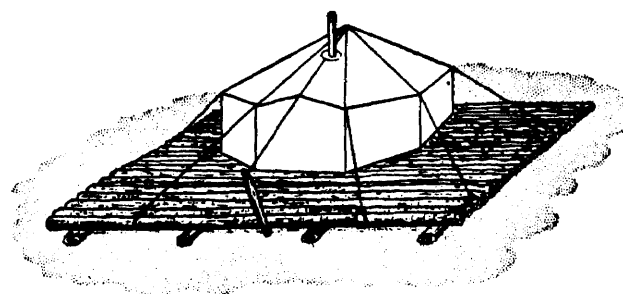

Figure 3-21. “Float” under shelter.

3-48. Bivouac in Open Terrain and on Ice

a. Due to strong winds, drifting snow, and poor concealment, bivouac areas in the barren tundra must be carefully chosen.

b. Tents should be pitched where they can be sheltered by natural windbreaks whenever possible. The windbreak may consist of depressions in the ground or pressure ridges on the ice. A visual inspection will indicate the degree of drifting, direction of the prevailing wind, and more suitable protected areas for locating the shelters. In areas where natural windfalls do not exist, snow walls may be constructed to provide protection from winds and

enemy small arms fire, as well as concealment from ground observation. In open areas with high winds, snow gathers rapidly on the lee side, making it necessary to clear the sides and tops of the tents periodically to prevent the weight of the drifting snow from collapsing the tent. The entrance to the shelter should face downwind from the prevailing wind. This will prevent the snow from blocking the exit and cutting off the ventilation.

c. When the tent is pitched on ice, holes are chopped where the tent pins are normally set. "Deadmen" are inserted in the holes at right angles to the tent. The holes are then packed with snow or filled with water and left to freeze.

3-49. Bivouacs in Mountains

a. Mountainous terrain is characterized by strong turbulent winds, cold and general lack of concealment above the timberline. The wind overhead creates an extensive lee near the mountain. The overhead lee resembles the dry space behind waterfalls caused by water having such speed that it shoots over the edge of the cliff and descends in a curve. An inland wind blowing 50 miles an hour (43 kts) may not strike the ground for several kilometers after passing the edge of a cliff or a very steep slope. While such a lee is an attractive bivouac site from the standpoint of wind protection it should be noted that such a lee area is often an area of maximum snow deposit. The requirement to constantly dig out vehicles, walkways, and weapons positions may offset the windfree advantages of a lee site during snowfall or snowblowing weather.

b. Cold air is heavier and frequently settles in valleys. The point where the temperature starts changing is low in summer and higher and more noticeable in winter. Therefore, in some instances it is better to establish a bivouac up the hillside above the valley floor and below the timberline, where applicable. Avalanche hazard areas must be carefully avoided.

3-50. Establishing Bivouac

a. *General.* Setting up a bivouac is a routine based on SOP which enables the commander to control the bivouac area, have it always

protected, camouflaged, and the personnel ready to fight. Only the minimum amount of time should be devoted to pitching and striking the shelters and to general housekeeping. Bivouacking in a routine manner allows more time for daily movement, establishing an effective security system, and defense of the bivouac site. Finally, it allows more time for rest and to make preparations for the continuation of the operation.

b. *Responsibilities of Unit Leader.* On entering the bivouac site, the unit leader is responsible for—

- (1) Posting a security guard.
- (2) Checking the bivouac site.
- (3) Determining exact tent locations providing the best natural shelter and camouflage.
- (4) Designating an area from which construction material and firewood will be obtained.
- (5) Selection of a water point, or marking off the snow area to be utilized for water.
- (6) Designating latrine and garbage disposal sites.
- (7) Designating a site for weapon and ski racks. Temporary placement for weapons and equipment must be arranged until the bivouac has been established.
- (8) Breaking a minimum number of trails between the tent site and area assigned for firewood and construction material, water point, and latrine.
- (9) Maintaining camouflage and track discipline at all times.
- (10) Organization and assignments for the work details as follows:
 - (a) Clearing and leveling the shelter sites. In winter the snow is dug to the ground level or in an emergency, packed down by trampling with skis, snowshoes, or tracked vehicles.
 - (b) Pitching tents (when used).
 - (c) Cutting, trimming, and hauling

- trees and boughs for construction of improvised shelters and bough beds (when tents are not available).
- (d) Construction of improvised shelters best suited to the area concerned.
 - (e) Construction of windbreaks, if necessary.
 - (f) Building necessary weapon and ski racks. Special care must be given to the protection of the weapons from the elements.
 - (g) Construction of field latrines and garbage disposal sites.
 - (h) Preparing a water point.
 - (i) Gathering and cutting a supply of firewood.
 - (j) During cold weather, situation permitting, starting fires and preparing hot drinks for all individuals.
 - (k) Upon completion of shelter construction, starting a warm meal.
- (11) Maintaining and emphasizing cleanliness, tidiness, and teamwork.
 - (12) Upon completion of the bivouac, arranging equipment within the outside of shelters.
 - (13) Preparing defensive positions and breaking and marking a trail from the shelters to the positions.
 - (14) Maintaining a duty roster for exterior guards, fire guards, and similar assignments.
 - (15) Rotating individuals on all jobs on a daily basis.
 - (16) Assigning specific sleeping areas for all individuals in accordance with the duty roster.
 - (17) Upon establishing the bivouac, removing the exterior guard in case the parent unit has taken over the security of the area.
 - (18) Inspecting the area, examining the security, camouflage, cover, weapons, skis, sleds, vehicles (if applicable), and the conditions of the men and their equipment.

- (19) Outlining and rehearsing the action to be taken in the event of attack.
- (20) Assuring that necessary safety precautions are taken to eliminate or control any hazards that could result in unnecessary accidental loss of men and their equipment.

3-51. Shelter Discipline

a. When a shelter is finished, the first man entering it will arrange all equipment in the proper place. The stove, water can, firewood, tools, and rations are placed in the most convenient place by the door of the tent. In a snow shelter, a special storeroom may be dug for these items.

b. In low temperatures, weapons should be left outside on improvised weapon racks in order to avoid condensation. However, as a word of caution commanders must insure that weapons left outside are properly secured, e.g., providing security guards or securing the weapons in an unheated shelter. When cold weapons are taken into heated shelters, condensation will form as the warm air comes in contact with cold metal. This "sweating" will continue for about one hour. If weapons are brought into a warm shelter they should be placed at floor level away from direct heat to minimize condensation. To avoid freezing of moving parts, moisture must be removed and Lubrication Oil, Weapon (LOW) applied to the weapon before it is taken outside. If the situation requires that weapons be taken inside and later outside before they can be dried, the working parts must be hand operated until the moisture is frozen and there is no danger of parts freezing together.

c. Before entering the shelter, hoarfrost and snow must be brushed off clothing and equipment. This keeps the clothing dry and the shelter clean.

d. To live comfortably in a shelter is not an easy art. Individuals usually are crowded and must keep their equipment orderly and out of the way of other occupants of the shelter. Unnecessary running in and out of the shelter should be avoided whenever possible.

e. The use of fire and lights in the shelter

must be carefully supervised. Security, fuel economy, and the prevention of fire and asphyxiation are essential. When wood is available, it is burned in the stoves in place of gasoline. Lamps must be extinguished before retiring for the night. All lamps and cooking stoves must be filled and lighted outdoors. A stand or bracket should be made for the lamps or candles and they should be placed where they are least likely to be knocked over. Sparks on the tent or lean-to must be extinguished at once. Smoking while in the sleeping bag is not permitted.

f. As many tasks as possible should be accomplished before retiring in order to conserve time in the morning. All eating utensils should be cleaned, snow melted, canteens or thermos bottles filled, and all weapons should be checked.

g. Upon breaking the bivouac in the morning all personal equipment should be rolled, warm drinks and breakfast should be consumed, and last-minute details accomplished prior to resuming the march.

3-52. Heat Discipline and Fire Prevention

Heat discipline presents a paramount problem during periods of extreme cold.

a. Overheating the shelter is very common and can and should be avoided. It causes sweating of individuals and increases the fire hazard.

b. There are many ways to save fuel. Cooking and heating may be combined. The melting of snow and ice uses large amounts of fuel and should be avoided when water from other sources is available. In cooking, liquid fuel is used sparingly. Wood should be burned when available. In extreme cold it may be necessary to keep the fire burning throughout the night in order to keep the men warm, especially when living in temporary shelters which provide little heat. The drying of wet clothing and the providing of hot drinks for combat reliefs are also necessary throughout the night.

c. Fire prevention during both summer and winter seasons is extremely important. The combination of low humidity and the drying

effect of continuously heated shelters is conducive to fire. Shifts in wind and the accumulation of frost or soot in the stovepipe lead to backfiring of flaming fuel into the shelter. The excessive spilling of fuel containers, lamps, and candles create additional hazards. The stamping of feet to shake off snow or frost may cause stoves and small heating units to spill and spread fire. The strict enforcement of all regulations is necessary in order to avoid fire hazards. No set rules can be given for each occasion. Common sense in the handling of all kinds of fires, fuels, and flammable materials is essential; alert, wide-awake fire guards must be on duty in each shelter at all times when men are sleeping and a fire is burning. Applicable technical manuals should be consulted prior to operating tent stoves, cooking stoves or gasoline lanterns.

d. A base made from green logs must be placed under the stove if the snow has not been shoveled away from the tent site. Fire reflectors may be used not only to get more warmth, but also to keep the fire burning evenly and to help avoid sparks.

e. Care must be exercised when lighting the gasoline-type stove; it may flare up and either damage the tent or set it on fire. All stovepipes must be cleaned frequently. When using wood as fuel, cleaning must be done every day in order to maintain a good draft and avoid fires in the stovepipes. Stoves burning petroleum fuels tend to accumulate more soot when operated at low settings because of cooler pipe temperatures. It is better to turn the stove off in mild weather than to run it at low settings. Detailed instructions for operating stoves are covered in TM 10-735 (Yukon stove) and TM 10-725 (Stove M1941). Precautions against forest and ground fires in summertime are extremely important. Coniferous forests are highly inflammable during the summer season. Ground fires can burn for months in muskeg and are extremely hard to put out. A fire ditch is always dug before lighting fire. A base of green wood, gravel, or rocks must be used under the fire; the fire must be made on high ground when the forest is dry. Before leaving the campsite, individuals must always be sure that the fire is completely out.

3-53. Drying Clothes

a. Keeping dry is important in low temperature. At times it is impossible to avoid sweating. The drying of clothes and footgear is therefore a necessity. Every opportunity must be used by each individual to dry his clothing.

b. When drying outside using an open fire, clothes should not be placed downwind from the fire, due to the sparks and smoke. Clothes hung for drying should be frequently checked and not left unattended. Clothing should never be placed too close to the fire or stove in the shelter. Leather items are extremely vulnerable to extreme heat. Clothing being dried in the shelter is placed on drying lines.

c. The use of a "Christmas Tree" (fig. 3-22) for drying in the shelter is handy when operating in a wooded area. Branches are cut off a dry or green tree which is then made to stand up in the shelter next to the center pole so that it is in the air current. This offers an excellent place for drying heavy items such as boots and parkas. The Tent, 10-Man, Arctic, is also equipped with strong hooks at the inside peak for suspending lighter weight clothing for drying.

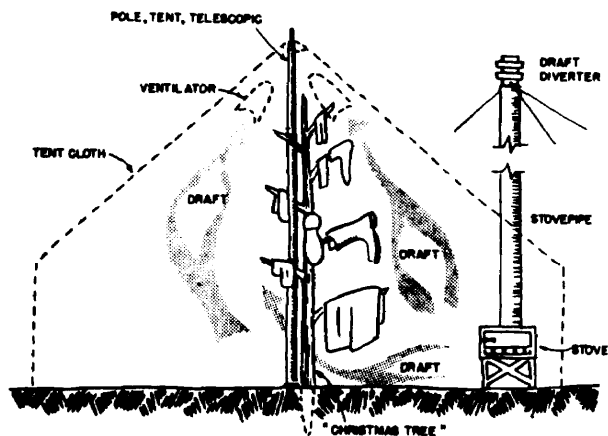

Figure 3-22. "Christmas Tree" for drying clothing.

3-54. Sleeping Arrangements in Bivouac

a. When arranging the sleeping procedures in a tent or improvised shelter, the position of every man, especially the position of reliefs for sentries, is planned. Each man must know

where his relief is sleeping. Therefore, the floorspace is occupied by the individuals in accordance with the duty roster. The number one man sleeps next to the door, number two man towards the rear. In this manner, starting from the door, the relief is easily located without waking up all occupants. The systematic sleeping arrangement will also permit exit from the tent in an organized manner in case of alert.

b. Ground insulation is most important. Often the occupants may have to improvise insulation using all available material. Backboards, snowshoes, man-hauled sleds, and empty cartons may be used. In timbered areas evergreen boughs are especially suitable. On the tundra, dry lichen, grass, or shrubs provide effective insulating material. To make a bough bed, one single bed is constructed for all; the size varies with the number of persons. For improvised shelters, logs approximately 8 cm (3") in diameter are pegged or fitted around the bough or grass bed. This helps to keep the boughs in place. If material and time permit, a 15 to 30 cm (6" to 12") thick shingled bed made from spruce, fir, or balsam boughs (fig. 3-23) gives excellent insulation and provides a soft mattress.

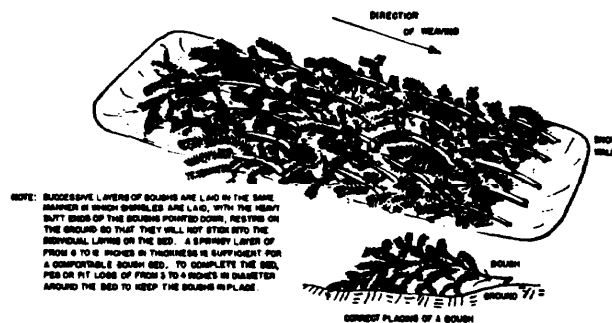

Figure 3-23. Building bough bed.

c. The tactical situation dictates whether or not sleeping bags are used. The amount of clothing to be worn when sleeping on a bough bed or in the sleeping bag can be best judged by experience and will depend on temperature and the tactical situation. As a minimum, outer clothing is usually removed when the sleeping bag is used. The removed clothing is placed beneath the individual for additional

insulation and instant availability. In an emergency it may be necessary to dress in the dark. In the morning all ice and frost is removed and the bag ventilated before rolling it up. Time permitting, it is hung up by the strings and thoroughly dried.

d. When sleeping in a heated tent without a sleeping bag, boots are usually removed, situation permitting. The parka is used like a blanket. The rucksack makes a good pillow. The clothing is always loosened.

3-55. Water Points and Snow Area Locations

During the winter it may be necessary to obtain water by melting snow or ice. When such a source is utilized for drinking purposes, an area should be set aside and restricted to this purpose only. A preferable site is one upwind from the bivouac and isolated from the latrine and garbage disposal areas. If such an area is not available, then snow should be gathered from the branches of trees or lightly skimmed from a carefully isolated area adjacent to the individual shelters. Water obtained in this manner must be boiled for one minute or chemically treated. Chemical sterilization of water under freezing conditions requires a longer period because the disinfecting compounds act with retarded efficiency under such conditions. The time allotted for contact with purification tablets should be two to four times the normal period of one-half hour. Eating ice or snow is unsatisfactory and may result in injury to lips or tongue. Contamination may also be a hazard. If no other water source is available, as in a survival situation, snow can be eaten but it must first be brought to the melting point by holding it in the bare hand. It may then be eaten slowly and in small amounts. This is best done during periods of temporary heat excess, as during marching, or while in the sleeping bag. The risk of frostbite to the hand must be considered and balanced against the need for fluids. Should some water be available in an uninsulated canteen during a survival situation, this should be warmed under the clothing or in the sleeping bag. Then snow may be added to the canteen after each drink to replace the water consumed. Body heat stored in the slightly warmed water will

thus melt the snow with less risk of cold injury to hands or lips. A glass bottle or plastic bag can be used in place of an uninsulated canteen.

3-56. Bough and Firewood Areas

The areas for cutting boughs and firewood should be immediately designated when a bivouac site is selected.

a. *Bough Area.* The area for cutting boughs for bedding as well as for construction of improvised shelters should be common to all individuals of the group. It is selected in a dense area of woods in which springy, unfrozen boughs are available, and should not be too close to the bivouac site. It is advisable to use sleds in hauling material to the shelter site. Due to the camouflage and track discipline, only one well-concealed trail is used. When cutting boughs, the unnecessary felling of trees should be avoided because trees lying on the ground can be easily observed from the air. Instead of felling trees, only the lower branches should be used.

b. *Firewood Area.* It is advisable to have the firewood area nearby the area designated for bough cutting so that the same track can be used. Dry, dead pine trees make the best firewood. If no dead trees are available, green birch trees may be chopped; they possess excellent burning qualities even when frozen. The top parts of dead trees should be burned during the daytime, as they give off lighter colored smoke. The lower part of the trunk has more resin and tar, and burns better, but makes more and much darker smoke.

3-57. Storage

Storage problems in winter are increased by snow, low temperatures, thaws, limited storage space, and the increased problems of transportation. Space in any shelter is limited. Only items which are affected by cold, or which must be immediately available, should be stored inside. All other stores must be concentrated, well marked, covered, and left outside. On the other hand, some perishables which are difficult to preserve in summer may be kept during the winter months in a natural "deepfreeze" over an extended period of time. In areas where permafrost exists, a hole can

be dug or blasted out and then covered with insulating material, such as boughs. A constant low temperature can thus be maintained.

a. Rifle Stand and Hanging of Weapon. In wooded terrain a weapon rack may be built from poles placed in a horizontal position and covered with boughs (fig. 3-24). When boughs are not available, various other materials such

as empty cardboard boxes, tent or sled covers, waterproof bags or ponchos can be utilized to protect the weapons from rain, dust, and falling or drifting snow. When weapons are hung outside on stacked skis, or suspended above the snow in some other manner, they are hung with the muzzle down to keep falling or blowing snow out of the barrel and working parts.

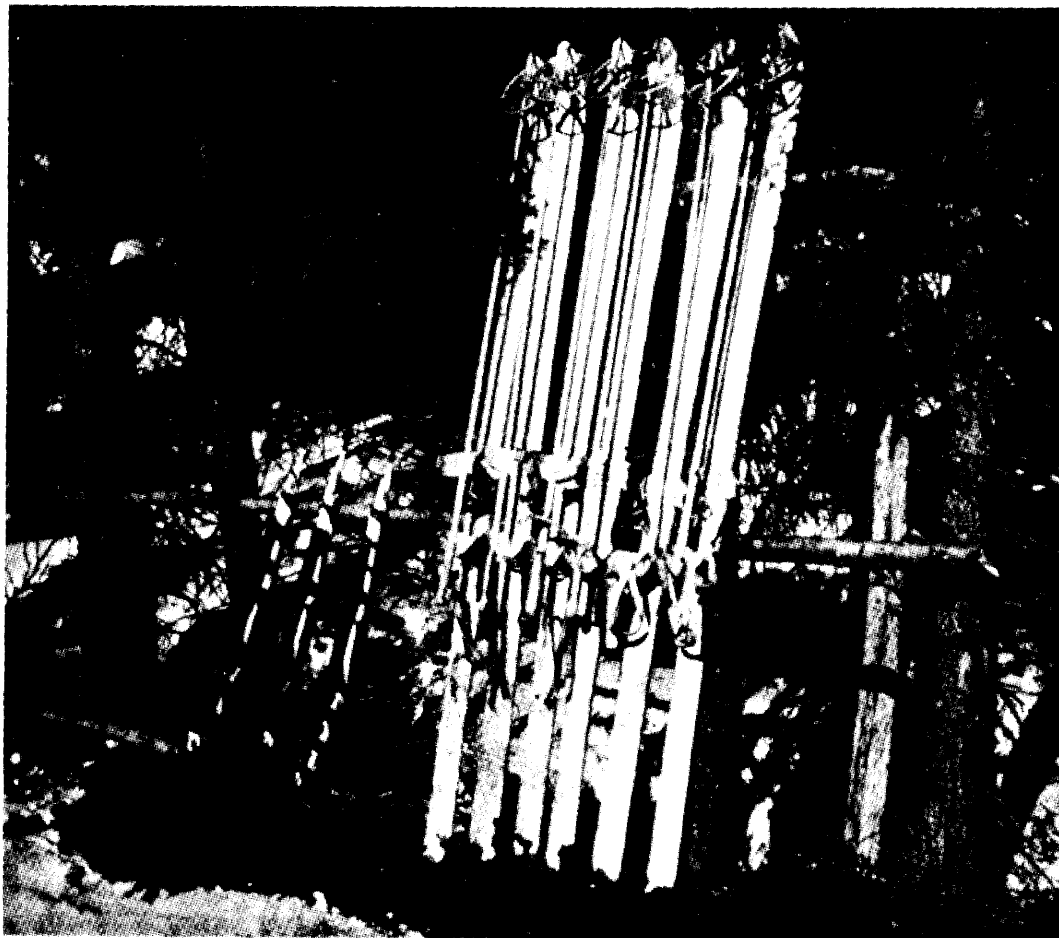

Figure 3-24. Rifle and ski stand.

b. Ski Racks and Stacking of Skis. Care of skis in the field is highly important because unit and individual mobility depends upon them. If left lying on the snow in the bivouac area the bindings and running surfaces will freeze and render the skis unusable for a long period of time, or they may be entirely lost under drifting snow. Therefore, the skis and ski poles are placed on an improvised ski rack made of one or two long poles which have

been secured between two growing trees horizontal position (fig. 3-24). In open areas, skis are simply stuck upright or stacked in the snow as described in appendix C.

c. Sleds. Sleds are placed on their sides or on end outside. If loaded sleds are left on the snow, sticks, poles, or branches are laid under the runners to prevent them from freezing to the snow. Heavy cargo sleds, 1-ton or larger, must be placed on top of heavy poles or logs

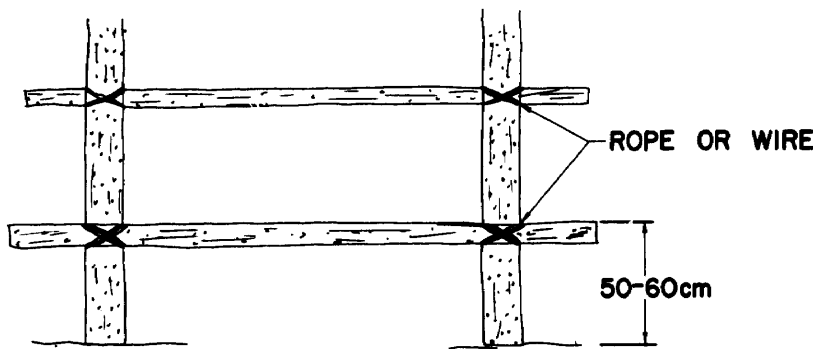

Figure 3-25. Field latrine in the forest.

due to the fact that sled runners remain hot after extensive usage and tend to settle into the snow and become frozen, making movement of the sled difficult the following day.

d. Vehicles. Vehicles are driven under a big tree or in lee of a shelter or snowdrift. Vehicles should be parked so the least amount of snow can get into the engines and parked on brush, logs, dry ground, or other surfaces not liable to thaw from heat of tires and tracks and refreeze.

e. Ammunition and Fuel. Ammunition and fuel are stored separately outside. Ammunition boxes should be stacked off the ground in a dry place and covered with canvas or boughs. In order to locate stacks if snow-covered, a pole should be erected near them. Boughs or poles are placed under fuel containers to prevent them from freezing to the snow.

3-58. Field Sanitation

a. Waste Disposal. Field sanitation in the

colder regions is based on the same principles as in temperate climates. The extremes in climate and weather, however, make the problem more acute. The wastes that present constant and real problems are human excreta, garbage, and trash.

- (1) In bivouac areas, pit or "cross-tree" type latrines are used for the disposal of human waste (fig. 3-25). One latrine will usually serve the needs of individuals occupying 3 to 4 shelters, or a unit of platoon size. The latrine is placed downwind from the bivouac, but not so far from the shelters as to encourage individuals to break sanitary discipline. Ration boxes or similar material should be used to collect waste. A urinal, designated for each shelter, should be located within 4 to 5 meters (4 to 5 yards) of the shelter. A windbreak of boughs, tarpaulins, ponchos, or snow wall should

be constructed to protect the latrine from the wind.

- (2) When breaking bivouac, the human waste that has accumulated in the latrine will be burned or buried. All closed latrine sites, tactical situation permitting, will be clearly marked.

b. Trash and Garbage Disposal.

- (1) In winter the edible portion of food waste may be collected in receptacles and disposed of by burial in the snow at a safe distance from the bivouac. Every effort should be made to burn the bulk of the trash and garbage. During seasons and in locations where bears are found, all edible garbage should be burned to avoid attracting bears to campsites.

- (2) All trash and garbage dumps should be marked with appropriate signs to warn troops who might occupy these disposal sites at a later time.

- (3) Strict camouflage of all trash and garbage is essential. Dark trash on the white snow is easily seen from the air. Glittering tin cans or bottles may be seen by the enemy. Trash and garbage should be placed under any available cover and camouflaged with snow, branches, or other materials.

c. Rats and Mice. Rats and mice will be found in most of the habitable cold regions of the earth. They are a definite menace to health and property and should be kept under strict control. Rat poisons or traps should be used when available.