

# SPRINGFIELD ARMORY® 1911-A1 PISTOLS

## OPERATION AND SAFETY MANUAL

### **Important Safety Information Inside**

Read this manual before handling this firearm.

Keep this manual with your pistol and review it before each use. This manual was designed to fit in your shirt or jacket pocket. Do not allow others to handle or fire your pistol until they have read this manual. Transfer this manual with the firearm upon ownership change.

**Be a responsible gun owner. Use it safely, store it securely, and always transfer a gun responsibly and legally.**



The Oldest Name In American Firearms  
**SPRINGFIELD ARMORY®**

# CONTENTS

Read and Understand this Manual . . . . .	3
Know Your Gun . . . . .	4
<b>Safety Rules</b> . . . . .	5
Loaded Chamber Indicator . . . . .	12
Springfield's Integral Locking System (ILS) . . . . .	13
Loading . . . . .	18
Firing . . . . .	19
Unloading . . . . .	20
Hammer Lowering . . . . .	22
Malfunction Warning . . . . .	23

## **Disassembly and Assembly**

<b>Section 1:</b> Full-Size Models . . . . .	25
<b>Section 2:</b> TRP Operator Models . . . . .	31
<b>Section 3:</b> V-12, V-16, and Long Slide Models . . . . .	35
<b>Section 4:</b> Micro-Compact, Ultra Compact, V-10, Compact, and Champion Models . . . . .	40

Ported Barrel . . . . .	46
-------------------------	----

## **Exploded View & Parts List**

Mil-Spec Models . . . . .	48
"Loaded" Models . . . . .	50
High Capacity Models . . . . .	52
Micro-Compact Models . . . . .	54
Point of Aim . . . . .	56
Care and Cleaning . . . . .	57
<b>Warnings</b> . . . . .	60 & 61



The Oldest Name In American Firearms  
**SPRINGFIELD ARMORY**®

Springfield Inc. • 420 West Main St. • Geneseo, IL 61254  
Toll Free 800-680-6866 • Phone 309-944-5631 • Fax 309-944-3676  
[www.springfieldarmory.com](http://www.springfieldarmory.com)

# BEFORE LOADING AND FIRING THIS PISTOL, READ AND UNDERSTAND THE INFORMATION IN THIS MANUAL.

This is an auto loading pistol. It is immediately loaded and ready to fire again after each shot until all shells loaded in magazine have been fired. The pistol is able to fire both with and without the magazine in place. Removing the magazine does not unload the pistol nor engage the safety. The pistol is not unloaded until the chamber is empty.

## About your owners manual

This is an instruction booklet on how to operate this firearm with some basic safe handling rules. It does not attempt to provide information about using a gun to defend yourself, how to hunt, or for competitive or target shooting. It is important to get instruction from a competent instructor prior to engaging in any of these activities. The National Rifle Association, your local or state authorities, or your gun dealer may provide information regarding available instructors or training courses. If you have a license to carry concealed, never do so without prior instruction from a certified instructor. Using a gun for self defense is a complex subject with dangers and risks for which you must be properly trained. Every safety rule has a reason behind it - read the rules carefully and understand why each is important for safety.

It is recommended that every person receive instructions from a competent firearms instructor before handling this or any other firearm.

Know and obey all gun laws. Do not give a gun to someone who is not allowed to own a gun or who may use it for a criminal purpose.

## Used guns

If you purchased this firearm as a used gun have it inspected and tested by a competent gunsmith before you use it. Guns are sometimes altered and may require repair before they can be used safely.

## Store guns safely in the home

Store guns unloaded, locked and in a secure place. Obey gun storage laws. Store guns and ammunition separately. Because your children may be in other homes where guns are stored, you should show them what to do if they see or find a gun by showing them the *Eddie Eagle* video available from the NRA by calling (703) 267-1000.



# KNOW YOUR GUN

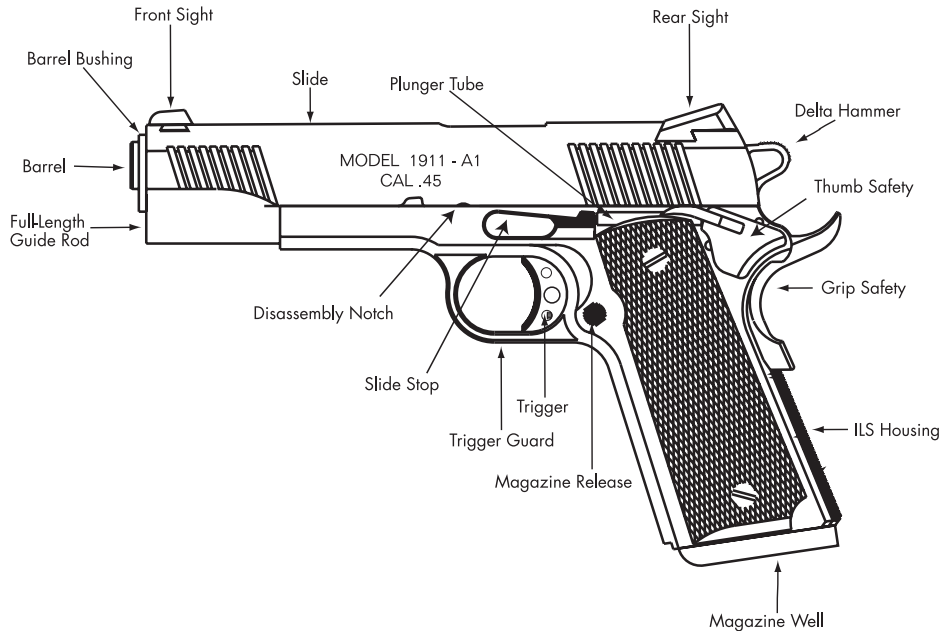

# SAFETY RULES

## READ AND UNDERSTAND THESE SAFETY RULES

### Be A Safe Shooter.

**ACCIDENT** (*ak' si dent*) N. 1. An unintentional or unexpected happening that is undesirable or unfortunate, especially one resulting in injury, damage, harm or loss.

### Don't be the cause of an accident.

A responsible gun owner is safety minded and always handles guns in a safe manner by following the basic rules of safe shooting and by using common sense in the handling of a firearm.

Store firearms unloaded, locked, and in a secure place. Keep keys for locks separate from lock and in secure place away from children. Keep firearms out of reach of children. You are responsible for children's safety.

### Be A Responsible Gun Owner.

- Always keep the muzzle pointed in a safe direction.
- Never point a gun at any person or thing you do not intend to shoot.
- **Do not drop your gun.** If it falls, it may fire even with the safety on. If you do drop it, unload it and examine it to be sure it works correctly. Do not attempt to fire it again until you have completed this safety check.
- Never put your hand over the muzzle of the gun.
- Keep your finger(s) off the trigger and out of the trigger guard until you are actually aiming at your target, ready to shoot.

**TREAT EVERY GUN AS IF IT WAS LOADED...ALL THE TIME.**

# BE A RESPONSIBLE GUN OWNER!

- Never rely on a gun's "safety" to protect you from unsafe gun handling. A safety is only a mechanical device, not a substitute for common sense.
- When the gun is loaded and cocked, always keep the thumb safety on until you are ready to fire.
- Be sure of your target and backstop before you shoot. Ask yourself what your bullet will hit if it misses or goes through the target.
- Before shooting, be sure the barrel is clear of obstructions, including excessive oil and grease.
- If anything does get into the barrel, remove cartridges, and clean bore immediately, before attempting to shoot. Obstructed barrels can burst and injure you or bystanders.
- Never let water, snow, mud or other materials enter the barrel.
- Never pull a gun toward you by the muzzle.
- Do not climb a tree, cross a fence or ditch, or jump over an object with a loaded gun.
- Always hold your gun so you control the direction of its muzzle in case you fall or stumble.



**Model 1911-A1 Pistols are classified firearms and dangerous weapons. Injury or death to you or others may result from unsafe or improper use.**

# BE A SAFE SHOOTER!

- Guns and alcohol or drugs do not mix. Do not take them before or during shooting activities. Your vision, coordination and judgment could be impaired, making gun handling unsafe.
- When taking medication, seek a doctor's advice to be sure you can operate and handle your firearm safely.
- Get instructions from a competent firearms instructor before using any gun.
- Before attempting to shoot, practice operations by dry firing with the chamber empty, without ammunition, or with dummy shells. Become familiar with the safety features, trigger control, and handling of the firearm.
- Always keep and carry your pistol with an empty chamber and with the hammer forward until you intend to shoot, so your pistol cannot be fired unintentionally.
- Firearms should be unloaded when not in use. This means both the chamber and magazine are empty.
- When transferring a gun by hand, always ask the person receiving it to open the action and check that it is unloaded.
- Never take anyone's word that a firearm is unloaded. When receiving a gun, always open the action and check that it is unloaded.

# READ THESE RULES!

- Always load shells from the magazine and keep your finger off the trigger.
- Load gun only when on range preparing to fire. Unload it before leaving range.
- Treat every gun as if it is loaded...**all the time!**
- Load and unload with the gun pointed in a safe direction.
- Be certain gun is unloaded before cleaning.
- Completely unload your gun before storing, travelling, standing it against an object, laying it down, entering a house, car, truck, boat, RV/camper, building, or handing it to someone.
- Never leave a loaded gun unattended.
- Tragedy may result if a child finds your gun and plays with it. Keep every gun secure. Children do not believe guns can kill.
- Store guns and ammunition separately. Both should be placed beyond children's reach.
- Obey all laws regarding the storage and security of guns in the home.
- Know and obey the laws regarding the transportation and carrying of firearms.
- Never carry any handgun in your pocket, purse or tucked in your belt or waistband. Use a pistol case or a proper holster with safety flap or strap.
- New non-defective brass is essential to ensure safe functioning of your gun.
- **Old or reloaded ammunition may be dangerous. Use only clean, dry original, high-quality, commercially manufactured ammunition. Reloaded ammunition will void the warranty.**



# TREAT EVERY GUN AS IF IT IS LOADED...ALL THE

- Many ammunition identifications sound similar. Make sure you use the right size ammunition in your gun.
- If gun fails to fire when the trigger is pulled, keep it pointed at the target for at least 30 seconds before opening the action and removing the cartridge from the chamber. Sometimes slow primer ignition will cause a "hang fire" and the cartridge will go off after a short pause.
- When group firing, always appoint someone to maintain safety control. Obey his/her commands immediately and completely.
- While shooter is loading, firing, and unloading, spectators should be at least 10 feet behind the shooter.
- Always wear protective glasses when shooting.
- Always wear hearing protection when shooting.
- Never shoot at hard flat surfaces or water ...bullets will ricochet.
- Do not alter or modify your gun.
- Have your gun serviced regularly by a qualified gunsmith.
- Discharging firearms in poorly ventilated areas, cleaning firearms, or handling ammunition may result in exposure to lead and other substances known to cause birth defects, reproductive harm, cancer and other serious physical injury. Have adequate ventilation at all times. Wash hands thoroughly after exposure.



Always wear eye and ear protection when using any firearm. Safety and instruction manuals are available from Springfield, Inc.

# BE A SAFE SHOOTER!

- Do not try to change your gun's trigger pull, because alterations of trigger pull usually affect sear engagement and might cause accidental firing.
- Never disassemble the safety, it has been correctly designed, fitted and tested. Any mechanical device can fail, however, so never rely on the safety as an alternative to safe handling.
- Never use a gun that jams or fails to function properly. Should this occur, return to Springfield, Inc. for warranty/repair.
- If your shot sounds weak or underpowered, it could mean a bullet is in the chamber/bore. Gun should be immediately unloaded and the chamber/bore checked for obstructions before refiring.
- Do not "horseplay" with a gun. Your gun cannot think...but you can. Firearm safety depends on you and is the responsibility of the operator.



**WARNING:** When you squeeze the trigger, you must expect the gun to fire. You must take full responsibility for firing it. Your care can avoid accidental discharge and thereby avoid accidental injury and death.

Write or call us concerning any items you do not understand and/or which might relate to your safety and the safe operations of any of our products.

**Springfield, Inc.**  
**Consumer Safety Department**

420 West Main Street  
Geneseo, IL 61254  
(309) 944-5631

**CAUTION!**

*There is no safe way to discharge a pistol in a home or apartment. Bullets will go through walls, floors, furniture, and appliances and still cause serious injury or death to persons in the house, next-door, or outside. Accidental discharges indoors always result in property damage or personal injury.*

# HANDLING

## We want you to be a safe, satisfied shooter.

Before attempting to load this firearm with live ammunition, follow the sequence of operations shown here without ammunition or with dummy shells.

By practicing operations without ammunition (or with dummy shells), you will become familiar with:

- Safety features,
- Trigger control (dry firing),
- and handling of your firearm.

As a result you will be a safer, more confident shooter when aiming at your first target.

**Caution:** Control hammer with your thumb and always point pistol in a safe direction when squeezing the trigger to lower the hammer. This will avoid accidental injury in the unlikely event of pistol discharge. Lowering the hammer in this way should be done only when the chamber is empty.

## Safety Stop on Hammer

The Springfield hammer incorporates redundant physical safety stops. These two surfaces of the hammer (See Figure 11 A & B) ensure that the hammer does not strike the firing pin unless the trigger and grip safety are purposely pressed. The safety stops of the hammer are not manual safeties. Do not carry the pistol with either of the safety stops engaged.

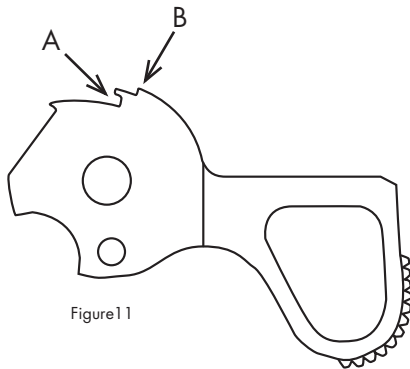

Figure 11

# LOADED CHAMBER INDICATOR

Springfield pistols sold after January, 2001 have a loaded chamber indicator. (See Figure 12.) The barrel slot allows you to observe whether a shell is in the chamber. When a shell is in the chamber the brass case can be seen clearly. GI .45s do not have this feature.

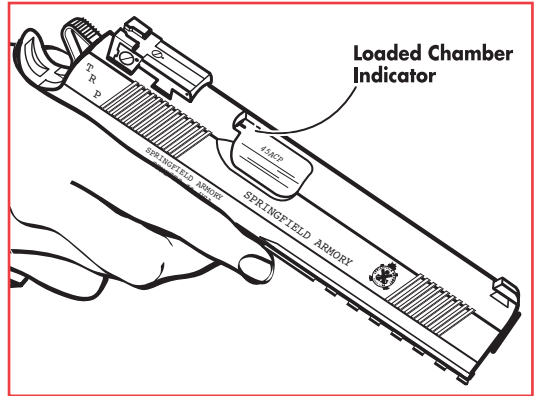

Figure 12



**Caution!** Even though the chamber is empty there may be shells in the magazine. The gun is not completely empty until both the chamber and magazine are empty.

# SPRINGFIELD'S INTEGRAL LOCKING SYSTEM (ILS)

**Warning:** Do not remove the mainspring housing before reading instructions and using eye protection. The ILS has parts under spring pressure. If improperly disassembled, the mainspring cap will be forcefully ejected and could cause injury to you or a bystander.

**Caution:** The ILS is designed to lock the pistol when stored or left unattended. It is not intended to replace any of the existing safety features.

## ILS Operation

Locate the ILS switch on your mainspring housing.  
(See Figure 13)

1. If the holes are vertical (stacked) the gun is not locked. (See Fig. 13-1) To activate the ILS and lock your gun, follow these steps. Point the gun in a safe direction. Unload the gun. (See page 20) Fully lower the hammer (see page 22). Insert the key and turn clockwise until the holes are horizontal (side-by-side). The ILS is now activated and the gun is locked. (See Fig. 13-2)

**Note:** *The ILS requires firm pressure to operate, but do not over-torque.*

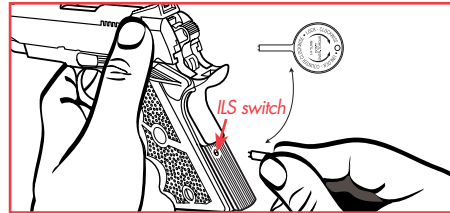

Figure 13

2. If the holes are horizontal (side-by-side) the gun is locked. To unlock, follow these steps.

- Point the gun in a safe direction.
- Insert the key and turn counter-clockwise until the holes are vertical or stacked. (see Fig. 13-3)

Before cocking the gun make sure it is unloaded.

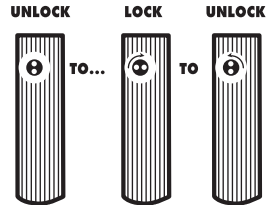

Fig.13-1

Fig.13-2

Fig.13-3

# SPRINGFIELD'S INTEGRAL LOCKING SYSTEM (ILS)

## Removing the Mainspring Housing with ILS

**Caution:** Always be sure the pistol is unloaded before proceeding.

1. With the hammer full down, deactivate the ILS. The holes should be vertical (or stacked). (Fig. 13-1)
2. Wrap a heavy-duty rubber band around the grip safety until it is completely depressed. Doing so will maintain the alignment of the sear spring and negate further disassembly of the pistol. (Fig. 14)
3. Cock the hammer to the full cocked position.
4. Insert takedown pin into takedown hole. (Fig. 14)
5. Slowly lower the hammer to the full-down (fired) position.
6. With a proper punch, drive out the mainspring housing retaining pin.
7. Remove the mainspring housing.

**Caution:** Do not remove the takedown pin until the mainspring housing is reinstalled.

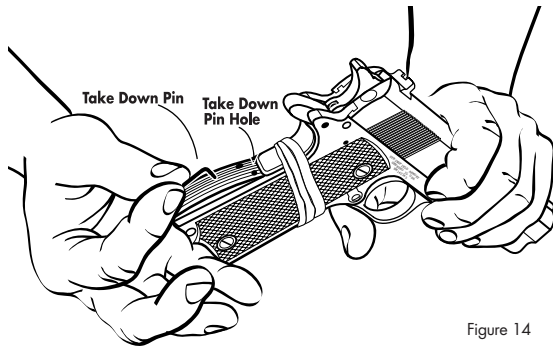

Figure 14

# SPRINGFIELD'S INTEGRAL LOCKING SYSTEM (ILS)

## Disassembly of the Mainspring Housing with ILS

Do not attempt this procedure unless you have considerable experience in firearms disassembly.

1. Place mainspring housing in a vice.
2. With a suitable punch, depress the ILS spring cap and hold it down. (Figure 15-1)
3. While continuing to depress the ILS spring cap, remove the takedown pin. (Fig. 15-2)
4. Slowly and carefully release the pressure on the spring cap allowing it to move out of the mainspring housing. (Fig. 15-3)
5. After the spring cap has been removed, the mainspring and mainspring retainer can be removed.

**Caution:** Do not turn the locking pin when the ILS is disassembled. The system may be reassembled only with the ILS pin deactivated (with the holes vertical or stacked).

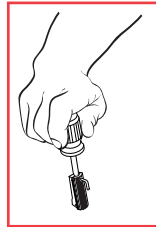

Fig. 15-1

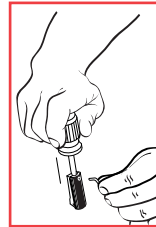

Fig. 15-2

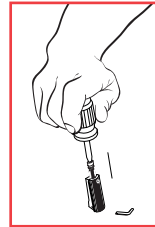

Fig. 15-3



**WARNING**

This procedure requires extreme caution. The ILS spring cap is under extreme pressure and will be ejected if you fail to perform the disassembly properly. Use extreme care and wear eye protection.

# SPRINGFIELD'S INTEGRAL LOCKING SYSTEM (ILS)

## Reassembly of the Mainspring Housing with ILS

1. Assemble the mainspring cap, mainspring, and mainspring retainer then insert into the mainspring housing. (See Figure 16)
2. Carefully depress the cap far enough to allow you to reinstall the takedown pin. (See Fig. 16-1).
3. Carefully and slowly release the pressure on the spring cap until the takedown pin captures it.

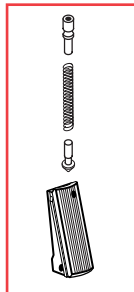

Figure 16

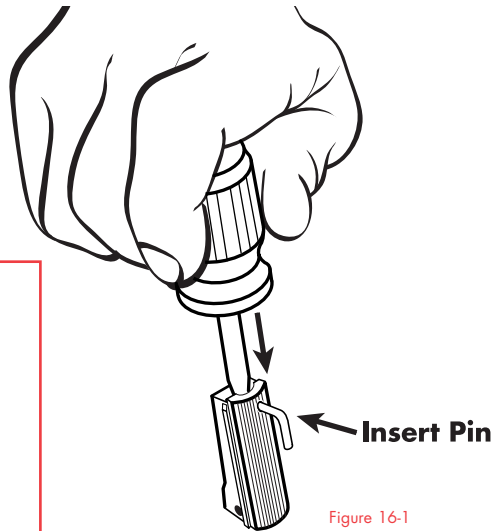

Figure 16-1



# SPRINGFIELD'S INTEGRAL LOCKING SYSTEM (ILS)

## Replacing the Mainspring Housing with ILS

1. Slide the mainspring housing into place and reinsert the mainspring housing retaining pin.
2. Cock the hammer to a full cock position.
3. Remove the takedown pin.
4. Remove the rubberband from the grip safety.
5. Lower the hammer to the full down position.

The mainspring housing with ILS is now installed.

# LOADING

1. Place the EMPTY magazine in the magazine well, located in bottom of pistol grip. Push firmly enough on bottom of magazine to make sure it is properly seated. A distinctive “click” will confirm the magazine has been properly inserted. Pull the slide all the way to the rear, until it locks back.
2. Depress magazine release and remove magazine. Place rim of first cartridge on front of follower. Then push down on the follower and slide cartridge under the lips of the magazine and to the rear. Load successive rounds the same way. Use only clean, dry, original, high-quality, commercially manufactured ammunition.
3. Re-insert magazine into magazine well, located in bottom of pistol grip. Push firmly enough on bottom of magazine to make sure it is properly seated.

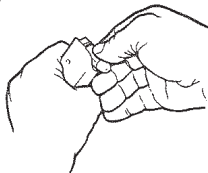

4. Point gun in a safe direction and keep finger off trigger. Pull slide back and release slide smartly to allow slide to move forward and load a shell from the magazine into the chamber.



**Warning:** Improperly loading the 1911 by manually inserting a round in the chamber may cause accidental discharge. Always load the pistol using the magazine. When loading the pistol, always point the muzzle in a safe direction.



Never touch the trigger when loading or unloading the pistol.

# FIRING

If you have never fired a gun before, practice without live ammunition before your first shot. Then load only **one** cartridge into the magazine for your first live ammunition firing.

1. Load shell into chamber from magazine and engage the thumb safety.
2. Grasp grip of pistol firmly. (A loose grip may cause the pistol to malfunction.) The pressure from the hand will disengage grip safety located at top of rear grip area.
3. Move thumb safety down taking gun off safety.  
**Caution:** The gun is now ready to fire. Be prepared for noise and recoil when pistol fires.
4. Aim gun at target by aligning sights.
5. Lightly place finger on trigger, and slowly squeeze trigger. Spent cartridge is expelled up and to the right.

*Point gun in a safe direction at all times.*

6. Pistol will automatically be ready to fire again after each shot until all cartridges loaded in magazine have been fired.
7. When last cartridge has been fired, slide will lock open and remain to rear.



**Warning:** Improperly loading the 1911 by manually inserting a round in the chamber may cause accidental discharge. Always load the pistol using the magazine. When loading the pistol, always point the muzzle in a safe direction.

# UNLOADING

If slide is already in “locked back” position:

1. Point gun in safe direction.
2. Press magazine release button to remove magazine.
3. From top and rear, carefully inspect chamber to make sure it is empty.
4. Hold slide, disengage slide stop, ease slide forward.

**Notice:** *The slide of a 1911-A1 pistol should never be released on an empty chamber; especially one which has had an action job. Releasing the slide on an empty chamber causes damage to the breech face on the barrel and undue stress on all action parts, including the hammer and the sear. This will ruin the action job performed on your pistol.*

5. Carefully lower hammer as described in the **HAMMER LOWERING** section. (Page 22)



**WARNING**

Pistol is not empty or unloaded until the chamber is empty and the magazine removed.

# UNLOADING

If slide is forward and hammer is cocked:

1. Point gun in safe direction.
2. Engage thumb safety.
3. Press magazine release button to remove magazine.
4. Disengage thumb safety.
5. Pull slide fully to rear to eject any cartridge remaining in chamber.
6. While holding slide in rearward (open) position, carefully inspect chamber making sure it is empty.
7. Slowly release slide, allowing it to return to forward position.
8. Carefully lower hammer as described in **HAMMER LOWERING** section. (Page 22)

When magazine has been removed and when chamber is empty, the ILS may be activated or a gun lock can be installed. Pistol can now be safely stored in a secure



Pistol is not empty or unloaded until the chamber is empty and the magazine removed. Never touch the trigger when loading or unloading the pistol.

# HAMMER LOWERING

1. Point gun in safe direction and ensure pistol is unloaded.
2. Firmly hold gun, depressing grip safety.
3. Using non-shooting hand, firmly grasp hammer with thumb and forefinger.
4. Be prepared for hammer movement.  
Squeeze trigger.
5. *Slowly* lower hammer with thumb and forefinger until it is fully forward.
6. Release trigger. (If the trigger is released early the gun may be on the Safety Stop.)

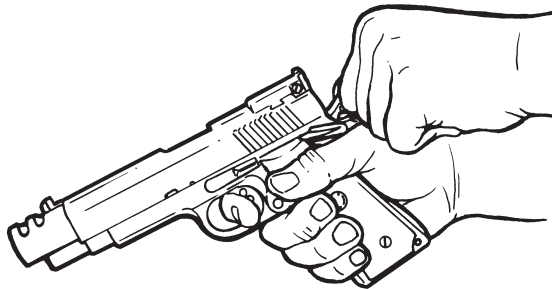

**Note:** Always keep and carry your pistol with an empty chamber and with the hammer forward (down) until you intend to shoot, so your pistol cannot be fired unintentionally.



**Caution:** If pistol is loaded, gun may discharge if the hammer slips from your grip during this procedure.

# MALFUNCTION WARNING!

**If cartridge hangs up, jams or binds when being chambered from magazine into chamber, do not attempt to force it into chamber by pushing or striking slide.**

1. What to do:
  - Point gun in a safe direction.
  - Remove magazine.
  - Pull back on slide and allow cartridge to fall from gun.
  - If cartridge does not fall free, pull slide back and lock it back.
  - Carefully dislodge cartridge.
  - If cartridge cannot be removed, carefully store your gun and take it to a gunsmith.
2. Most failures of cartridge to feed or chamber are the result of a damaged magazine, improper gun handling or defective ammunition.
3. Whatever the cause, a jammed cartridge can be a dangerous situation. Should shell be discharged while out of chamber, cartridge will rupture and fragments will be blown out of pistol with sufficient force to cause injury.

If any information in this manual is not clear, call Springfield's Consumer Safety Department at (309) 944-5631 for assistance.



**Always wear eye and ear protection when using any firearm. Safety and instruction manuals are available from Springfield, Inc.**



**WARNING**

Always have gun pointed in a safe direction.  
Failure to obey safety information may result in injury to you or others.

# TO ELIMINATE MALFUNCTIONS

1. Change type/brand of ammunition and/or magazine.
2. If changing to another type/brand of ammunition and/or magazine does not at once result in smooth feeding of cartridges from magazine to chamber, the following steps should be taken:
  - Make certain chamber and magazine are unloaded. Magazine should be removed first. Check chamber to be sure it and magazine well are clear of cartridges.
  - Thoroughly clean magazine, paying particular attention to removing accumulated grease. Thoroughly clean breech mechanism of pistol. Use a bristle brush and solvent to remove grease and fouling from breech face, extractor, chamber and feed ramp. (See **CARE AND CLEANING** section for detailed instruction.)
  - Check that magazine spring tension is adequate. The spring should hold the follower tightly against the lips of the magazine.
  - Check that magazine lips are free of nicks and burrs and are not deformed.
  - Remove excess oil and solvent from all cleaned components, load magazine and try pistol again.



Proceed slowly and exercise caution to prevent the discharge of a jammed cartridge. The discharge of a jammed cartridge could cause serious injury to you or bystanders.



# SECTION 1: DISASSEMBLY OF FULL-SIZE MODELS



## WARNING

If you decide to disassemble your Springfield pistol, do so properly. Improper disassembly and assembly will create unsafe conditions that could result in injury or death or a gun that simply will not work. Don't take chances. Do not attempt to disassemble this or any other firearm until you have received training and instructions from a competent gunsmith.

# SECTION 1: DISASSEMBLY

## FULL-SIZE MODELS

### Step 1 - Magazine Removal & Chamber Check

*Point gun in a safe direction.*

1. Press magazine catch and remove magazine.
2. Pull slide backwards and check that no cartridge is in the chamber.
3. Release slide allowing it to go to forward position.

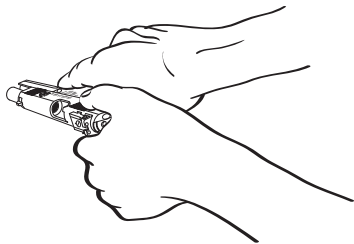

**WARNING:** Point muzzle away from face to prevent injury in the event plug is ejected by spring.

### Step 2 - Recoil Spring Removal

*Point gun in a safe direction.*

1. If your pistol contains a full length guide rod, use a 5/32 Allen wrench or a screwdriver to remove the front portion of guide rod. If your pistol does not contain a full length guide rod, skip to step 3.
2. Grip slide behind the front sight, resting pistol butt on top of your knee.
3. Move slide rearward, approximately 1/2 inch, grasp firmly to hold in place, and depress recoil spring plug with thumb.
4. Point muzzle away from face and rotate barrel bushing clockwise.
5. Do not rotate bushing off of plug unless you have control of plug and spring.

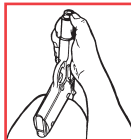

2.



3.

# SECTION 1: DISASSEMBLY

## FULL-SIZE MODELS

### Step 3

Cautiously allow plug and recoil spring to move forward.

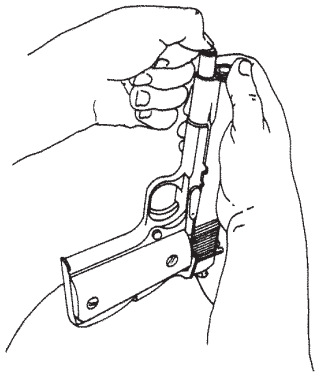

### Step 4 - Slide Stop Removal

1. Align disassembly notch on slide with slide stop.
2. Press slide stop shaft on right side of frame and remove slide stop by pulling it out of left side of frame.

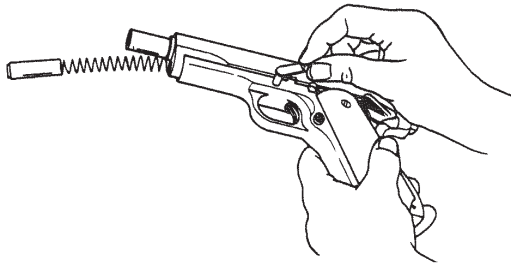

Always wear eye and ear protection when using any firearm. Safety and instruction manuals are available from Springfield, Inc.



**BE SAFE!** Be sure pistol is unloaded before beginning disassembly! Wear eye protection, gun contains spring-loaded parts.

# SECTION 1: DISASSEMBLY

## FULL-SIZE MODELS

### Step 5 - Slide Removal

Pull slide forward in its guides and remove slide. Barrel, barrel bushing, recoil spring plug, recoil spring and guide will come with it.

### Step 6 - Recoil Spring Components Removal

Remove recoil spring and guide through back side.

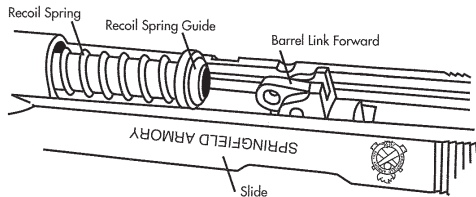

### Step 7 - Barrel Removal

1. Rotate barrel bushing to left of slide and remove it through the front.
2. Tilt barrel link forward and remove barrel from front of slide.

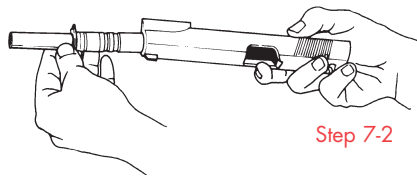
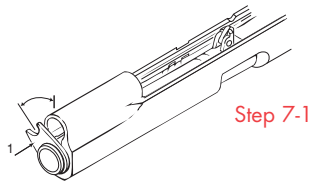

# SECTION 1: DISASSEMBLY

## FULL-SIZE MODELS

**Note:** There are many after-market or accessory items for 1911 style pistols. If you are not the original owner of your pistol or you are unclear on disassembling your pistol, call or write to Springfield Armory.

Call Springfield Consumer Safety Department at  
(309) 944-5631

or write c/o:

Springfield Inc.  
420 West Main Street  
Geneseo, IL 61254



Improper disassembly may damage the firearm.  
Always consult an experienced gunsmith if you  
experience any difficulty or have any questions  
concerning assembly procedure.

# SECTION 1: ASSEMBLY

## FULL-SIZE MODELS

**Assemble by reversing the order of disassembly.**

**Note:** When replacing recoil assembly (*Step 6*), be certain the recoil spring guide and recoil spring are aligned with the barrel before inserting in slide. Be sure to flip barrel link forward before installing slide assembly. Slide stop shaft **must** go through hole in barrel link.



An improperly assembled firearm is dangerous and should not be fired. Always consult an experienced gunsmith if you experience any difficulty or have any questions concerning assembly procedure.

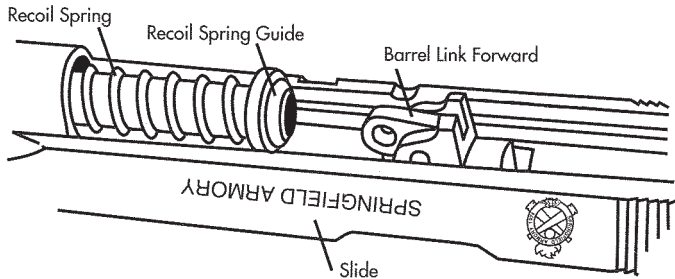

# SECTION 2: DISASSEMBLY OF TRP OPERATOR MODELS



## WARNING

If you decide to disassemble your Springfield pistol, do so properly. Improper disassembly and assembly will create unsafe conditions that could result in injury or death or a gun that simply will not work. Don't take chances. Do not attempt to disassemble this or any other firearm until you have received training and instructions from a competent gunsmith.

# SECTION 2: DISASSEMBLY

## TRP OPERATOR MODELS

### Step 1 - Magazine Removal & Chamber Check

*Point gun in a safe direction.*

1. Press magazine catch and remove magazine.
2. Pull slide backwards and check that no cartridge is in the chamber.



**WARNING**

Improper disassembly may damage the firearm. Always consult an experienced gunsmith if you experience any difficulty or have any questions concerning assembly procedure.

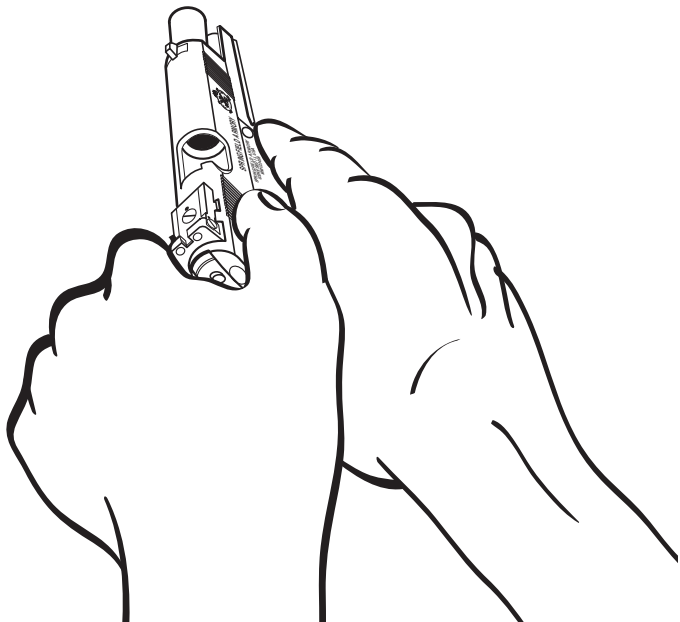



# SECTION 2: DISASSEMBLY

## TRP OPERATOR MODELS

### Step 2 - Slide Stop Removal

1. Align disassembly notch on slide with slide stop.
2. Press slide stop shaft on right side of frame.
3. Remove slide stop from left side.
4. Pull slide assembly forward off frame.

### Step 3 - Recoil Spring Assembly Removal

1. Push recoil spring assembly forward to expose a small, pin-sized hole. (*Fig. 33-1*)
2. Insert the provided pin (or cut a paper clip so that it extends  $1/16''$  on both sides of guide rod) into pin hole.
3. Remove recoil spring housing from the rear of the slide. (*Fig. 33-2*)
4. Remove the barrel from the front of the slide.

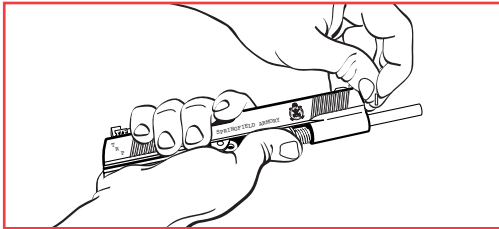

Figure 33-1

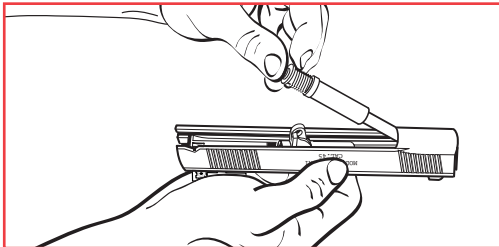

Figure 33-2

# SECTION 2: ASSEMBLY

## TRP OPERATOR MODELS

**Assemble by reversing the order of disassembly.**

**Note:** Be sure to flip barrel link forward before installing barrel into slide.



An improperly assembled firearm is dangerous and should not be fired. Always consult

an experienced gunsmith if you experience any difficulty or have any questions concerning assembly procedure.



**Model 1911-A1 Pistols are classified firearms and dangerous weapons. Injury or death to you or others may result from unsafe or improper use.**

## **SECTION 3: DISASSEMBLY OF V-12, V-16, & LONG SLIDE MODELS**



### **WARNING**

If you decide to disassemble your Springfield pistol, do so properly. Improper disassembly and assembly will create unsafe conditions that could result in injury or death or a gun that simply will not work. Don't take chances. Do not attempt to disassemble this or any other firearm until you have received training and instructions from a competent gunsmith.

# SECTION 3: DISASSEMBLY

## V-12, V-16, & LONG SLIDE MODELS

### Step 1 - Magazine Removal & Chamber Check

*Point gun in a safe direction.*

1. Press magazine catch and remove magazine.
2. Pull slide backwards and check that no cartridge is in the chamber.



**BE SAFE!** Be sure pistol is unloaded before beginning disassembly! Wear eye protection, gun contains spring-loaded parts.

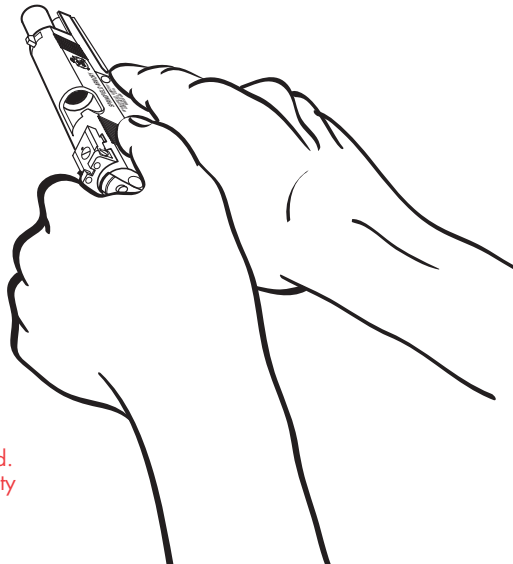

## WARNING

An improperly assembled firearm is dangerous and should not be fired. Always consult an experienced gunsmith if you experience any difficulty or have any questions concerning assembly procedure.

# SECTION 3: DISASSEMBLY

## V-12, V-16, & LONG SLIDE MODELS

### Step 2 - Full Length Guide Rod Removal

V-series and Long Slide Models contain full-length guide rods.

1. Use a 5/32 Allen wrench to remove the front portion of the guide rod.

### Step 3 - Slide Stop Removal

1. Align disassembly notch with slide stop.
2. Press slide stop shaft on right side of slide and remove slide stop by pulling it out of left side of frame.

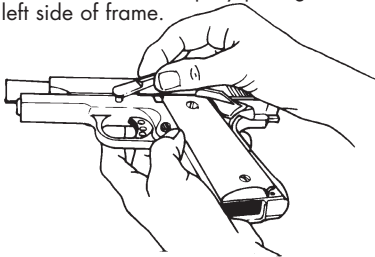

### Step 4 - Slide Removal

Pull slide forward in its guides and remove slide. Barrel, recoil spring plug, recoil spring, and guide will come with it.

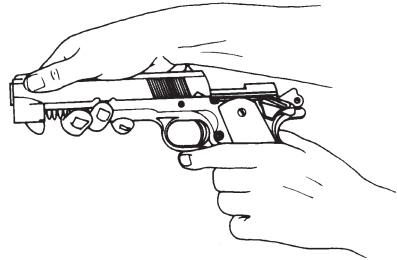

Recoil spring guide could eject out from the side as slide is removed. To keep the recoil spring from ejecting sideways, hold fingers around slide while moving it forward.

# SECTION 3: DISASSEMBLY

## V-12, V-16, & LONG SLIDE MODELS

### Step 4 - Recoil Spring Components Removal

Remove guide, recoil spring, and its plug through back of slide.

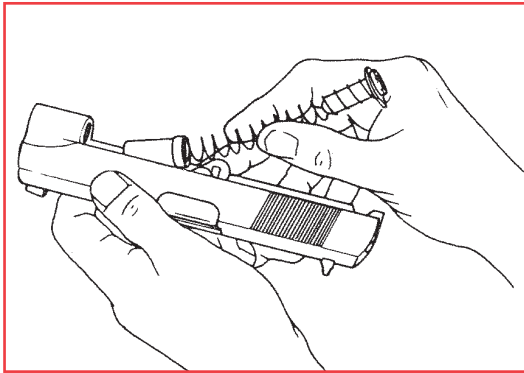

### Step 5 - Barrel Removal

Tilt barrel link forward and remove barrel through front of slide.

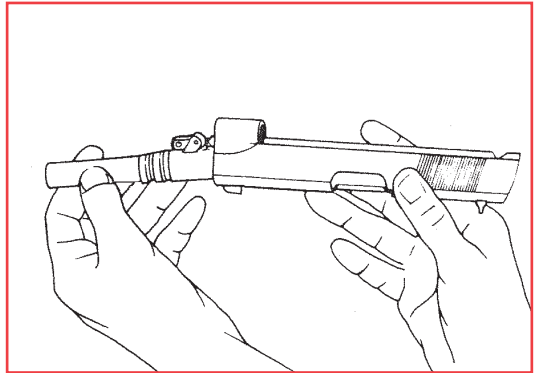

# SECTION 3: ASSEMBLY

## V-12, V-16, & LONG SLIDE MODELS

**Assemble by reversing the order of disassembly.**

**Note:** When replacing recoil assembly (Step 4), be certain barrel clearance cuts on recoil spring guide are aligned before inserting in slide. Be sure to flip barrel link forward before installing slide assembly.

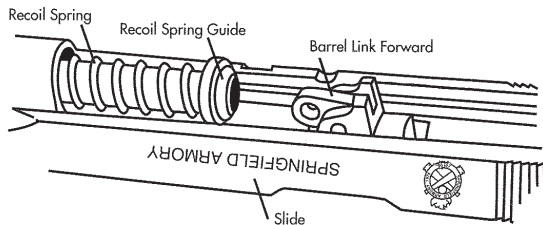

An improperly assembled firearm is dangerous and should not be fired. Always consult an experienced gunsmith if you experience any difficulty or have any questions concerning assembly procedure.

# SECTION 4: DISASSEMBLY of MICRO-COMPACT, ULTRA COMPACT, V-10, COMPACT, & CHAMPION MODELS



## WARNING

If you decide to disassemble your Springfield pistol, do so properly. Improper disassembly and assembly will create unsafe conditions that could result in injury or death or a gun that simply will not work. Don't take chances. Do not attempt to disassemble this or any other firearm until you have received training and instructions from a competent gunsmith.

**Note:** 1911-A1 Ultra-Compact Pistols are designed to use standard pressure ball ammo and self defense loads. +P ammunition is not recommended in pistols shorter than 5 inches. Use only clean, dry, original, high-quality, commercially manufactured ammunition.



# SECTION 4: DISASSEMBLY

## MICRO-COMPACT, ULTRA COMPACT, V-10, COMPACT, & CHAMPION MODELS

### Step 1 - Magazine Removal & Chamber Check

*Point gun in a safe direction.*

1. Press magazine catch and remove magazine.
2. Pull slide backwards and check that no cartridge is in the chamber.
3. Release slide allowing it to go to forward position.

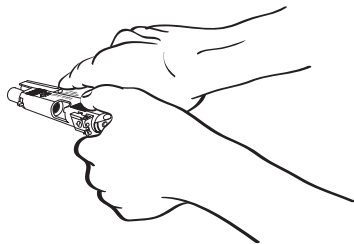

**WARNING:** Point muzzle away from face to prevent injury in the event plug is ejected by spring.

# SECTION 4: DISASSEMBLY

## MICRO-COMPACT, ULTRA COMPACT, V-10, COMPACT, & CHAMPION MODELS

### Step 2 - Recoil Spring Removal

*Point gun in a safe direction.*

1. Lock slide to the rear. (See fig. 57-1)
2. Firmly “snap” the takedown piece over the exposed portion of the guide rod between inner spring plug and guide rod cap. (See fig. 57-2)
3. Grasp slide, release slide lock and slowly allow slide to go forward. Align disassembly notch on slide with stop. Remove the slide stop.
4. Carefully remove the slide assembly from the receiver.
5. The recoil spring system can now be removed from the slide. (See fig. 57-3)
6. The barrel can now be removed from the front of the slide.
7. Disassembly is now complete.

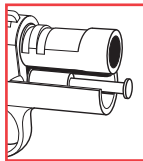

Figure 57-1

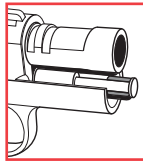

Figure 57-2

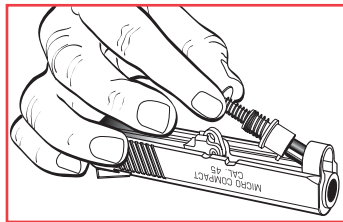

Figure 57-3

## ALTERNATE METHOD FOR DISASSEMBLY

1. Retract slide to the takedown notch.
2. Align disassembly notch on slide with slide stop.
3. Remove slide stop and slowly remove slide from receiver keeping in mind that the slide is under spring pressure until it clears the receiver.
4. With the bottom of the slide facing up, press the guide rod head forward until enough of the rod is exposed and firmly snap the takedown piece over the rod. (See fig. 58-1 and 2)
5. The slide assembly can now be disassembled as previously laid out. (Described in section 4, Step 2).

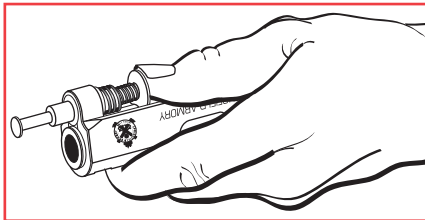

Figure 58-1

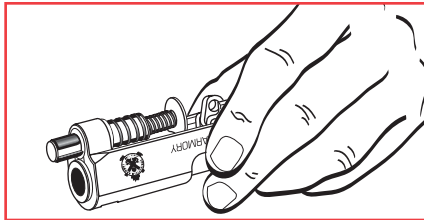

Figure 58-2

# SECTION 4: ASSEMBLY

## MICRO-COMPACT, ULTRA COMPACT, V-10, COMPACT, & CHAMPION MODELS

**Assemble by reversing the order of disassembly.**

**Note:** Be sure to flip barrel link forward before installing barrel into slide.



**WARNING**

An improperly assembled firearm is dangerous and should not be fired. Always consult

an experienced gunsmith if you experience any difficulty or have any questions concerning assembly procedure.



**WARNING**

**Model 1911-A1 Pistols are classified firearms and dangerous weapons. Injury or death to you or others may result from unsafe or improper use.**

# CAUTION

Never leave pistol cocked and ready to fire as the fire condition is extremely dangerous. Pistol could easily be accidentally discharged causing injury, death, or damage to property.

A gun lock is provided with this gun. Follow the instructions for its use. Proper use will prevent the gun from being fired accidentally. No mechanical device is a substitute for safe gun handling. Every household member should be trained in safe gun handling practices. Minor children should be given the Eddie Eagle Safety Program from the NRA. Call 703-267-1000 for the video.



**Always wear eye and ear protection when using any firearm. Safety and instruction manuals are available from Springfield, Inc.**

# PORTED BARREL SAFETY INSTRUCTIONS

## Warnings, Ammunition Restrictions, and Maintenance

Completely read this safety manual before using a ported barrel pistol. Transfer this manual to any subsequent owner or user of the pistol. If you are inexperienced in the handling of firearms, obtain expert instruction before attempting to shoot. Neither this manual nor this product can take the place of proper instruction in the safety aspects of shooting, the use of firearms, and the use of a firearm for self-defense. Severe injury to hands, eyes, face, other persons or property will occur with improper use of a ported pistol.

## Safety Notes

Always use eye and ear protection when shooting or when in close proximity to shooting. A ported barrel pistol, in common with most pistols using muzzle brake devices, produces greater noise than normal pistols and this poses a danger to hearing. Never position any part of the body over or near the exhaust ports. Never cycle the slide with your hands over the exhaust ports. Never point a gun at anything you do not intend to shoot. If the ported pistol is drawn rapidly it must not be discharged in proximity to the holster or the shooter's eyes, legs, arms, clothing or bystanders. Do not shoot a ported barrel pistol from the hip. The blast from the exhaust ports can cause injury or property damage several feet away. Use caution when shooting to avoid overhead objects that may be damaged by the blast from the barrel exhaust ports.



Always point gun in a safe direction.  
Keep your gun unloaded until you are ready to shoot.

# PORTED BARREL SAFETY INSTRUCTIONS

## Ammunition

Use only fresh factory ammunition such as Winchester or Federal. DO NOT use handloads, reloads, or remanufactured ammunition in your Springfield firearm. Only shoot cartridges of the caliber engraved on the barrel. DO NOT use shot cartridges or any ammunition which is loaded with a frangible projectile or any ultra-light weight projectile at elevated velocities, or any wooden or plastic projectile.

## Caution

Fragments of the metal jackets on jacketed bullets may be propelled through the exhaust ports with great force and have the potential to cause injury or property damage at a distance of several feet. The misuse of any of the ammunition described above may result in injury, property damage, or both.

## Maintenance

Accumulated debris in the barrel exhaust ports may result in damage to the pistol or injury to the shooter. With the gun unloaded, regularly inspect the bore and exhaust ports for dirt and debris. Never discharge the firearm when any form of debris is present in the barrel or exhaust ports.



**Always wear eye and ear protection when using any firearm. Safety and instruction manuals are available from Springfield, Inc.**

# EXPLODED VIEW & PARTS LIST

## MIL-SPEC MODELS

- |     |        |                                 |     |        |                               |
|-----|--------|---------------------------------|-----|--------|-------------------------------|
| 1.  | PI9911 | .45 Mil-Spec Frame              | 2.  | PX4546 | .45 Slide                     |
| 1a. | PI0037 | Slide Stop                      | 2a. | PI5350 | 3-Dot Front Sight, .180       |
| 1b. | PI0038 | Thumb Safety                    | 2b. | PI5341 | H.P. Fixed Rear Sight, 3-Dot  |
| 1c. | PI0044 | Slide Stop Plunger              | 2c. | PI0011 | Extra Power Firing Pin Spring |
| 1d. | PI0042 | Thumb Safety/Slide Stop Spring  | 2d. | PI0910 | 9mm Titanium Firing Pin       |
| 1e. | PI0043 | Safety Plunger                  | 2e. | PI4506 | .45 Extractor                 |
| 1f. | PI0041 | Plunger Tube                    | 2f. | PI4511 | .45 Firing Pin Stop           |
| 1g. | PI0017 | Hammer Pin                      | 2g. | PI0032 | Recoil Spring Guide           |
| 1h. | PI0015 | Grip Screw Escutcheon           | 2h. | PI0030 | Recoil Spring (16 lb.)        |
| 1i. | PI0026 | Mainspring Housing Retainer Pin | 2i. | PI0031 | Recoil Spring Plug            |
| 1j. | PI4507 | .45 Ejector, Extended           | 3.  | PI3501 | .45 Barrel (Stainless)        |
| 1k. | PI0005 | Disconnecter                    | 3a. | PI0004 | Barrel Link Pin               |
| 1l. | PI0034 | Sear                            | 3b. | PI0003 | Barrel Link                   |
| 1m. | PI0027 | Magazine Catch                  | 3c. | PI3002 | Barrel Bushing (Stainless)    |
| 1n. | PI0029 | Magazine Catch Spring           | 4.  | PI4523 | .45 7-Round Magazine          |
| 1o. | PI0028 | Magazine Catch Lock             | 5.  | PI0020 | Arched Mainspring Housing     |
| 1p. | PI5006 | Regular Spur Hammer             | 5a. | SL0008 | ILS Locking Bolt              |
| 1q. | PI0019 | Hammer Strut Pin                | 5b. | PI0024 | Mainspring Retainer           |
| 1r. | PI0018 | Hammer Strut                    | 5c. | PI0052 | Mainspring (28 lb.)           |
| 1s. | PI5308 | Mil-Spec Trigger                | 5d. | SL0007 | ILS Mainspring Cap            |
| 1t. | PI0036 | Sear Spring                     | 5e. | SL0009 | ILS Plunger                   |
| 1u. | PH5066 | Grip Safety                     | 5f. | SL0010 | ILS Plunger Spring            |
| 1v. | PI5143 | Black Plastic Grip (L.H.)       |     |        |                               |
| 1w. | PI5144 | Black Plastic Grip (R.H.)       |     |        |                               |
| 1x. | PI0014 | Grip Screw                      |     |        |                               |
| 1y. | PI0035 | Sear Pin                        |     |        |                               |
| 1z. | PI0008 | Ejector Pin                     |     |        |                               |



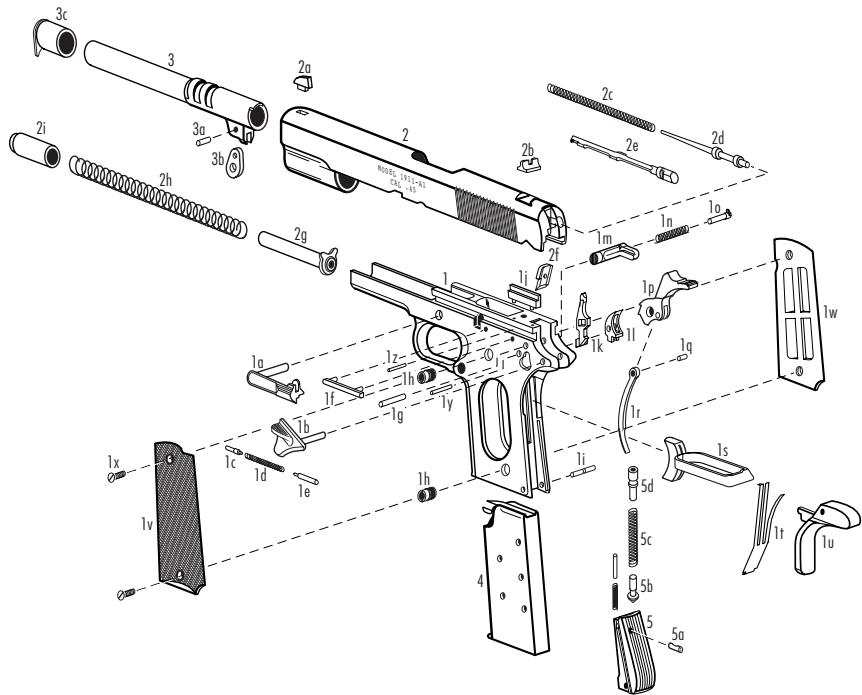

# EXPLODED VIEW & PARTS LIST

## "LOADED" MODELS

- |     |        |  |     |         |  |
|-----|--------|--|-----|---------|--|
| 1.  | PI9911 | .45 "Loaded" Frame                     | 2.  | PX4546  | .45 Slide                                  |
| 1a. | PI0037 | Slide Stop                             | 2a. | PI5017  | Dovetail Front Sight                       |
| 1b. | PH5036 | Extended Thumb Safety                  | 2b. | PI5021m | Fixed Combat Rear Sight                    |
| 1c. | PI0044 | Slide Stop Plunger                     | 2c. | PI0011  | Extra Power Firing Pin Spring              |
| 1d. | PI0042 | Thumb Safety/Slide Stop Spring         | 2d. | PI0910  | 9mm Titanium Firing Pin                    |
| 1e. | PI0043 | Safety Plunger                         | 2e. | PI4506  | .45 Extractor                              |
| 1f. | PI0041 | Plunger Tube                           | 2f. | PI4511  | .45 Firing Pin Stop                        |
| 1g. | PI0017 | Hammer Pin                             | 2g. | PI5192  | National Match 2-piece Recoil Spring Guide |
| 1h. | PI0015 | Grip Screw Escutcheon                  | 2h. | PI0030  | Recoil Spring (16 lb.)                     |
| 1i. | PI0026 | Mainspring Housing Retainer Pin        | 2i. | PI5198  | National Match Guide Plug (Stainless)      |
| 1j. | PI4507 | .45 Ejector, Extended                  |     |         |  |
| 1k. | PI0005 | Disconnecter                           | 3.  | PI3501  | .45 Barrel (Stainless)                     |
| 1l. | PI0034 | Sear                                   | 3a. | PI0004  | Barrel Link Pin                            |
| 1m. | PI0027 | Magazine Catch                         | 3b. | PI0003  | Barrel Link                                |
| 1n. | PI0029 | Magazine Catch Spring                  | 3c. | PI3002  | Barrel Bushing (Stainless)                 |
| 1o. | PI0028 | Magazine Catch Lock                    |     |         |  |
| 1p. | PI5006 | Delta-Style Hammer                     | 4.  | PI4523  | .45 7-Round Magazine                       |
| 1q. | PI0019 | Hammer Strut Pin                       |     |         |  |
| 1r. | PI0018 | Hammer Strut                           | 5.  | SL0005  | ILS Mainspring Housing                     |
| 1s. | PI5308 | National Match Aluminum Trigger        | 5a. | SL0008  | ILS Locking Bolt                           |
| 1t. | PI0036 | Sear Spring                            | 5b. | PI0024  | Mainspring Retainer                        |
| 1u. | PH5066 | Beavertail Grip Safety                 | 5c. | PI0052  | Mainspring (28 lb.)                        |
| 1v. | PI5143 | Cocobolo Checkered Grip w/bevel (L.H.) | 5d. | SL0007  | ILS Mainspring Cap                         |
| 1w. | PI5144 | Cocobolo Checkered Grip w/bevel (R.H.) | 5e. | SL0009  | ILS Plunger                                |
| 1x. | PI0014 | Grip Screw                             | 5f. | SL0010  | ILS Plunger Spring                         |
| 1y. | PI0035 | Sear Pin                               |     |         |  |
| 1z. | PI0008 | Ejector Pin                            |     |         |  |



# EXPLODED VIEW & PARTS LIST

## HIGH CAPACITY MODELS

- |     |        |                                 |     |        |                                     |
|-----|--------|---------------------------------|-----|--------|-------------------------------------|
| 1.  | PH9900 | High-Capacity Frame             | 2.  | PI4546 | .45 Slide                           |
| 1a. | PI0037 | Slide Stop                      | 2a. | PI5350 | 3-Dot Front Sight, .180             |
| 1b. | PH5036 | Extended Thumb Safety           | 2b. | PI5341 | H.P. Fixed Rear Sight (3-Dot)       |
| 1c. | PI0044 | Slide Stop Plunger              | 2c. | PI0011 | Extra Power Firing Pin Spring       |
| 1d. | PI0042 | Thumb Safety/Slide Stop Spring  | 2d. | PI0910 | 9mm Titanium Firing Pin             |
| 1e. | PI0043 | Safety Plunger                  | 2e. | PI4506 | .45 Extractor                       |
| 1f. | PI0017 | Hammer Pin                      | 2f. | PI4511 | Firing Pin Stop                     |
| 1g. | PH0015 | Grip Screw Escutcheon           | 3.  | PI3501 | .45 Barrel (Stainless)              |
| 1h. | PI0026 | Mainspring Housing Retainer Pin | 3a. | PI0004 | Barrel Link Pin                     |
| 1i. | PI4507 | .45 Ejectors, Extended          | 3b. | PI0003 | Barrel Link                         |
| 1j. | PI0005 | Disconnecter                    | 3c. | PI3002 | Barrel Bushing (Stainless)          |
| 1k. | PI0034 | Sear                            | 4.  | PI5445 | .45 High Capacity Standard Magazine |
| 1l. | PH0027 | Magazine Catch                  | 5.  | SL0005 | ILS Mainspring Housing              |
| 1m. | PI0029 | Magazine Catch Spring           | 5a. | SL0008 | ILS Locking Bolt                    |
| 1n. | PI0028 | Magazine Catch Lock             | 5b. | PI0024 | Mainspring Retainer                 |
| 1o. | PI5006 | Delta Style Hammer              | 5c. | PI0052 | Mainspring (28 lb.)                 |
| 1p. | PI0019 | Hammer Strut Pin                | 5d. | SL0007 | ILS Mainspring Cap                  |
| 1q. | PI0018 | Hammer Strut                    | 5e. | SL0009 | ILS Plunger                         |
| 1r. | PH0039 | High-Capacity Trigger           | 5f. | SL0010 | ILS Plunger Spring                  |
| 1s. | PI0036 | Sear Spring                     |     |        |                                     |
| 1t. | PH5066 | Beavertail Grip Safety          |     |        |                                     |
| 1u. | PH0006 | High-Capacity Grip (L.H.)       |     |        |                                     |
| 1v. | PH0007 | High-Capacity Grip (R.H.)       |     |        |                                     |
| 1w. | PH0014 | High-Capacity Grip Screw        |     |        |                                     |
| 1x. | PI0035 | Sear Pin                        |     |        |                                     |
| 1y. | PI0008 | Ejector Pin                     |     |        |                                     |

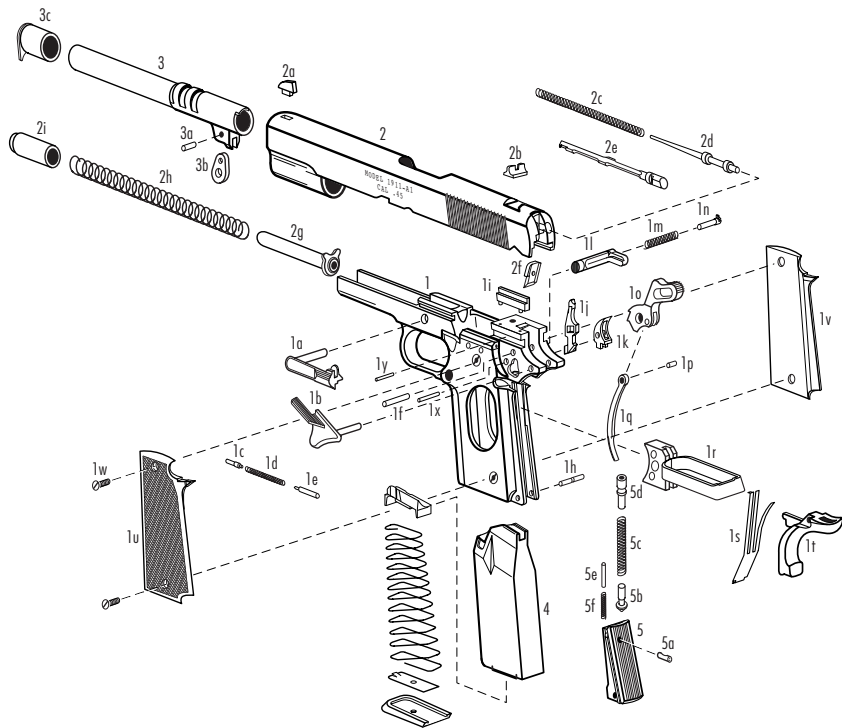

# EXPLODED VIEW & PARTS LIST

## "MICRO-COMPACT" MODELS

- |      |         |  |     |         |  |
|------|---------|--|-----|---------|--|
| 1.   | PI9980  | .45 "Micro-compact" Frame                        | 2.  | PI4845  | .45 Micro-Compact Slide                    |
| 1a.  | PI0037  | Slide Stop                                       | 2a. | PI5016M | Dovetail Front Sight                       |
| 1br. | PH5114  | Extended Ambidextrous Thumb Safety (Right)       | 2b. | PI4600M | Fixed Combat Rear Sight                    |
| 1bl. | PH5113  | Extended Ambidextrous Thumb Safety (Left)        | 2c. | PI0011  | Extra Power Firing Pin Spring              |
| 1c.  | PI0044  | Slide Stop Plunger                               | 2d. | PI0910  | 9mm Titanium Firing Pin                    |
| 1d.  | PI0042  | Thumb Safety/Slide Stop Spring                   | 2e. | PI4506  | .45 Extractor                              |
| 1e.  | PI0043  | Safety Plunger                                   | 2f. | PI0911  | 9MM Firing Pin Stop                        |
| 1f.  | PI0041  | Plunger Tube                                     | 2g. | PI5192  | National Match 2-piece Recoil Spring Guide |
| 1g.  | PI0017  | Hammer Pin                                       | 2h. | PI4834  | Micro-Compact Outer Recoil Spring          |
| 1h.  | PI4815  | Thin Line Grip Screw Escutcheon                  | 2i. | PI4831  | Micro-Compact Reverse Spring Plug          |
| 1i.  | PI0026  | Mainspring Housing Retainer Pin                  | 3.  | PI4801  | .45 Barrel (Stainless)                     |
| 1j.  | PI0907  | Micro-Compact Ejector, Extended                  | 3a. | PI0004  | Barrel Link Pin                            |
| 1k.  | PI0005  | Disconnecter                                     | 3b. | PI0003  | Barrel Link                                |
| 1l.  | PI0034  | Sear   | 4.  | PI4726  | .45 Compact 6 Round Magazine               |
| 1m.  | PI0027  | Magazine Catch                                   | 5.  | SL0005  | ILS Mainspring Housing                     |
| 1n.  | PI0029  | Magazine Catch Spring                            | 5a. | SL0008  | ILS Locking Bolt                           |
| 1o.  | PI0028  | Magazine Catch Lock                              | 5b. | PI4724  | Mainspring Retainer                        |
| 1p.  | PI5006  | Delta-Style Hammer                               | 5c. | SL0014  | Mainspring (23 lb.)                        |
| 1q.  | PI0019  | Hammer Strut Pin                                 | 5d. | SL0007  | ILS Mainspring Cap                         |
| 1r.  | PI0018  | Hammer Strut                                     | 5e. | SL0009  | ILS Plunger                                |
| 1s.  | PI5308  | National Match Aluminum Trigger                  | 5f. | SL0010  | ILS Plunger Spring                         |
| 1t.  | PI0036  | Sear Spring                                      |     |         |  |
| 1u.  | PH5066  | Beavertail Grip Safety                           |     |         |  |
| 1v.  | PI5167L | Cocobolo Checkered Thin Line Grip w/bevel (L.H.) |     |         |  |
| 1w.  | PI5167R | Cocobolo Checkered Thin Line Grip w/bevel (R.H.) |     |         |  |
| 1x.  | PI4814  | Thin Line Grip Screw                             |     |         |  |
| 1y.  | PI0035  | Sear Pin   |     |         |  |
| 1z.  | PI0008  | Ejector Pin                                      |     |         |  |



# POINT OF AIM

## Point of Impact

Shooters may use a “point of aim” sight picture at 25 yards. This means that, at 25 yards the bullet should impact the target at the point visible at the top of the front sight. Shooters may also use a “6 o’clock” sight picture to strike the center of the target. Springfield Armory pistols are designed to use the “6 o’clock” sight picture at 25 yards. However, some pistols may shoot “point of aim” at 25 yards depending on shooter and ammunition.

**Note:** 1911-A1 Ultra-Compact Pistols are designed to use standard pressure ball ammo and self-defense loads. +P ammunition is not recommended in pistols shorter than 5 inches. Use only clean, dry, original, high-quality, commercially manufactured ammunition.

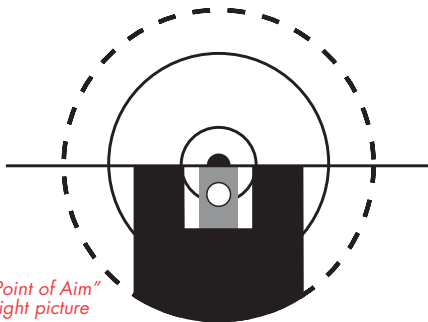

*"Point of Aim"  
sight picture*

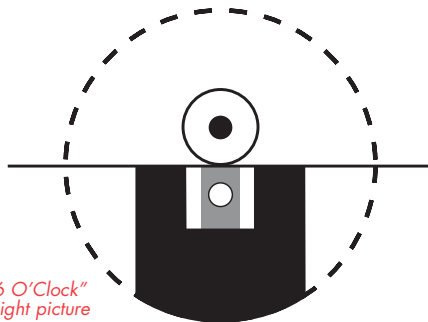

*"6 O'Clock"  
sight picture*



# CARE & CLEANING

## Basic materials needed:

- Cleaning rod of proper size with bristle bore brushes (fiber or brass) and tip into which cleaning patch can be inserted.
- Cloth patches
- Powder solvent
- Lubricating oil
- Small lint-free cloths for wiping and oiling
- Bristle brush for scrubbing dirt off breech face, extractor, magazine lips, follower, etc.

Use proper size bore brushes and patches - if they are too small they won't do the job, and if they are too large they will bind inside bore.

When possible, insert cleaning rod from chamber end of bore and push rod all the way through so it emerges from muzzle.

Do not "reverse" rod direction when patch or brush is in barrel, it might bind.

Do not use patches dripping with solvent or oil. Wet patches or brushes, then squeeze out excess before using.

When using bore brushes or a larger bristle brush on breech face, breech areas, magazines, etc., work carefully to prevent damaging components.

**Note:** *If lower parts of receiver and its mechanism are especially dirty, soak in appropriate solvent, or flush clean with same solvent. Remove grip panels before soaking or flushing, and make certain that all foreign matter is removed after cleaning. Lightly oil after cleaning.*

*Only a very small amount of oil is needed to adequately lubricate moving parts and prevent rust. Stainless Steel pistols require slightly more lubrication than parkerized or blued pistols. Accumulation of oil tends to attract dust and dirt which interferes with the safe and reliable functioning of pistol. Do not apply excess lubricating oil.*



**Wear eye protection when using solvent. Thoroughly wash your hands to remove powder and solvents after cleaning your gun.**



**Always wear eye and ear protection when using any firearm. Safety and instruction manuals are available from Springfield, Inc.**

# CLEANING PISTOL

1. Point gun in safe direction.
2. Remove magazine and empty chamber.
3. Separate cartridges from pistol before cleaning operation.
4. Open slide and visually check that chamber and magazine well are free of cartridges.
5. Disassemble pistol as described in the proper **DISASSEMBLY** Section.
6. Using cleaning rod, run solvent-wetted patch through barrel several times.
7. Attach solvent-wetted bristle brush to rod and run back and forth full length of bore as needed until clean of grease and dirt.
8. Clean barrel with dry patches and examine it. If necessary, repeat barrel scrubbing. Bore fouling can contribute to reduced accuracy, and grease accumulation in the chamber can interfere with proper feeding of cartridges from magazine.
9. Using powder solvent on a clean patch, remove powder residue from all components of mechanism. If grease or dirt cannot be removed by wiping with patch, use solvent-wetted bristle brush.
10. Next, wipe scrubbed areas with solvent wetted patch.
11. After cleaning, run dry patch through barrel, then follow with lightly-oiled patch.
12. Wipe all surfaces clean with cloth, then wipe all surfaces with lightly-oiled patch (or cloth).
13. Reassemble pistol. Remember, an improperly assembled firearm is dangerous and should not be fired. Always consult an experienced gunsmith if you experience any difficulty or have any questions concerning assembly procedure.
14. If pistol is to be stored for an extended period, final oil wiping can be heavier so there will be less tendency for it to evaporate. Stainless steel pistols must be lubricated.

# PERIODIC CLEANING: EXTRACTOR

**Note:** Once the slide is removed, the firing pin removal and cleaning can be done.

## Step 1 - Firing Pin Removal

1. If necessary, remove firing pin by pressing it with pin punch while simultaneously pushing firing pin tail past the firing pin stop, then pull firing pin stop downward from slide.
2. Remove firing pin and its spring.



**Caution:** Point the back end of the slide, where the firing pin exits, away from face to prevent injury in the event the firing pin is ejected by the spring.

## Step 2 - Extractor Removal

1. Using pin punch, pull extractor by groove where firing pin stop runs.

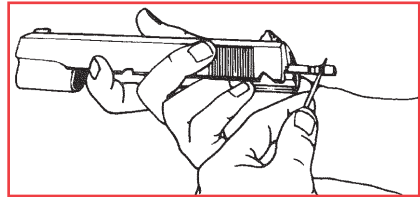

## Used Guns

If you got this firearm as a used gun, **before you use it** you should make sure it is unloaded and check all its functions to be sure it works right. Guns are sometimes altered to work incorrectly, or parts may be removed, lost or replaced with incorrect parts. First, unload it and check it yourself, then take it to a good gunsmith who knows about this model of firearm, and have it checked.

## DANGEROUS: .22 CONVERSION KITS FOR MODEL 1911



The firing pin on some commercial .22 conversion kits protrudes back too far causing the hammer to hit the firing pin when the hammer is in the Safety Stop position. When this occurs the gun could fire and is a potentially dangerous situation. *.22 conversion kits with this condition are dangerous and could cause serious injuries.*

For your safety and the safety of others, these .22 conversion kits should not be used on any Springfield 1911 model pistol.

# NOTICE: DISCLAIMER OF LIABILITY

**SPRINGFIELD, INC. WILL NOT BE RESPONSIBLE FOR THE RESULTS OF CARELESS HANDLING, UNAUTHORIZED REPAIRS AND ADJUSTMENTS, CORROSION, NEGLIGENCE, UNREASONABLE OR UNSAFE USE.**

**SPRINGFIELD, INC. ASSUMES NO RESPONSIBILITY FOR DAMAGE AND/OR INJURY CAUSED IN WHOLE OR IN PART BY HANDLOADED, RELOADED OR DEFECTIVE AMMUNITION. UNDER NO CIRCUMSTANCES SHALL SPRINGFIELD, INC. BE RESPONSIBLE FOR INCIDENTAL OR CONSEQUENTIAL DAMAGES WITH RESPECT TO ECONOMIC LOSS OR INJURY TO PROPERTY ARISING OUT OF USE OF HANDLOADED OR REMANUFACTURED AMMUNITION, NEGLIGENCE, UNSAFE HANDLING, OR UNAUTHORIZED MODIFICATIONS TO THE FIREARM.**

**SOME STATES DO NOT ALLOW THE EXCLUSION OR LIMITATION OF INCIDENTAL OR CONSEQUENTIAL DAMAGES, SO THE ABOVE LIMITATIONS MAY NOT APPLY TO YOU.**

**\*TECHNICAL SPECIFICATIONS MAY BE ALTERED WITHOUT NOTICE.**



**Model 1911-A1 Pistols are classified firearms and dangerous weapons. Injury or death to you or others may result from unsafe or improper use.**







**Always wear eye and ear protection when using any firearm. Safety and instruction manuals are available from Springfield, Inc.**



The Oldest Name In American Firearms  
**SPRINGFIELD ARMORY®**

Springfield Inc. • 420 West Main St. • Geneseo, IL 61254  
Toll Free 800-680-6866 • Phone 309-944-5631 • Fax 309-944-3676  
[www.springfieldarmory.com](http://www.springfieldarmory.com)