



Samuel C. Sugarman

HVAC

FUNDAMENTALS

Second Edition

HVAC Fundamentals

Second Edition

This page intentionally left blank

HVAC Fundamentals

Second Edition

Samuel C. Sugarman



THE FAIRMONT PRESS, INC.



CRC Press
Taylor & Francis Group

Library of Congress Cataloging-in-Publication Data

Sugarman, Samuel C., 1946-

HVAC fundamentals / Samuel C. Sugarman. -- 2nd ed.

p. cm.

Includes index.

ISBN 0-88173-559-0 (print) -- ISBN 0-88173-560-4 (electronic)

1. Heating--Equipment and supplies. 2. Ventilation--Equipment and supplies. 3. Air conditioning--Equipment and supplies. I. Title.

TH7345.S795 2007

697--dc22

2006051481

HVAC fundamentals 2nd ed / by Samuel C. Sugarman

©2007 by The Fairmont Press, Inc. All rights reserved. No part of this publication may be reproduced or transmitted in any form or by any means, electronic or mechanical, including photocopy, recording, or any information storage and retrieval system, without permission in writing from the publisher.

Published by The Fairmont Press, Inc.

700 Indian Trail

Lilburn, GA 30047

tel: 770-925-9388; fax: 770-381-9865

<http://www.fairmontpress.com>

Distributed by Taylor & Francis Ltd.

6000 Broken Sound Parkway NW, Suite 300

Boca Raton, FL 33487, USA

E-mail: orders@crcpress.com

Distributed by Taylor & Francis Ltd.

23-25 Blades Court

Deodar Road

London SW15 2NU, UK

E-mail: uk.tandf@thomsonpublishingservices.co.uk

Printed in the United States of America

10 9 8 7 6 5 4 3 2 1

0-88173-559-0 (The Fairmont Press, Inc.)

1-4200-5245-4 (Taylor & Francis Ltd.)

While every effort is made to provide dependable information, the publisher, authors, and editors cannot be held responsible for any errors or omissions.

Table of Contents

Chapter	1	HVAC Systems.....	1
Chapter	2	Heat Flow.....	15
Chapter	3	Psychrometrics	25
Chapter	4	Heating and Ventilating Systems	47
Chapter	5	Air Conditioning Systems.....	69
Chapter	6	Compressors	95
Chapter	7	Water Chillers.....	105
Chapter	8	Fans	119
Chapter	9	Air Distribution.....	137
Chapter	10	Variable Air Volume.....	163
Chapter	11	Pumps and Water Distribution.....	191
Chapter	12	Control Systems	217
Chapter	13	Control System Components.....	227
Chapter	14	Choosing an HVAC System	241
Chapter	15	Heat Recovery	251
Chapter	16	Energy Conservation Opportunities	263
Chapter	17	Central Plant Water Chiller Optimization.....	281
Chapter	18	Fan Drives.....	293
Chapter	19	Terminology	303
Chapter	20	HVAC Timeline.....	315
Index			321

This page intentionally left blank

Foreword

HVAC Fundamentals covers the full range of HVAC systems used in today's facilities. This is a comprehensive book providing the reader a detailed description of how HVAC systems operate. The HVAC systems are divided into components and controls for air, water, heating, ventilating and air conditioning to clearly illustrate the way in which each system, subsystem, control or component contributes to providing the desired indoor environment. The reader will learn why one component or system may be chosen over another with respect to design, application, energy conservation, indoor air quality and cost. The book also covers heat flow fundamentals and the heat flow calculations used in selecting equipment and determining system operating performance and costs. Fluid flow fundamentals and equations, and fundamentals of system testing and verification of system performance are also covered in this book. This gives the reader a complete picture of systems from conception to operation. The chapters are organized in a way that one builds upon another and systems, components, design and application are revisited as the reader gains knowledge and insight about the workings of HVAC systems.

Sam Sugarman

This page intentionally left blank

Acknowledgments

Writers do not write alone, so I would like to acknowledge just a few of those colleagues, friends and family who shared their support, ideas and guidance for this second edition. I would especially like to thank Bill Payne, my acquisitions editor, for his intellectual support and stimulating ideas, Bahman Rafii, professional engineer, who reviewed the psychometric chapter and Margaret Monger for helping with the proof reading. Thanks also to the rest of my family and loved ones who watched me stare at my computer for hours on end, for bringing me sustenance, their critiques and then leaving me in relative solitude—almost alone. As always, the most special thanks to Westley Jane down by the sea, to whom this book is dedicated.

This page intentionally left blank

Chapter 1

HVAC Systems

The objectives of HVAC systems are to provide an acceptable level of occupancy comfort and process function, to maintain good indoor air quality (IAQ), and to keep system costs and energy requirements to a minimum.

HEATING, VENTILATING, AND AIR CONDITIONING SYSTEMS

Commercial heating, ventilating, and air conditioning (HVAC) systems provide the people working inside buildings with “conditioned air” so that they will have a comfortable and safe work environment. People respond to their work environment in many ways and many factors affect their health, attitude and productivity. “Air quality” and the “condition of the air” are two very important factors. By “conditioned air” and “good air quality,” we mean that air should be clean and odor-free and the temperature, humidity, and movement of the air will be within certain acceptable comfort ranges. ASHRAE, the American Society of Heating, Refrigerating and Air Conditioning Engineers, has established standards which outline indoor comfort conditions that are thermally acceptable to 80% or more of a commercial building’s occupants. Generally, these comfort conditions, sometimes called the “comfort zone,” are between 68°F and 75°F for winter and 73°F to 78°F during the summer. Both these ranges are for room air at approximately 50% relative humidity and moving at a slow speed (velocity) of 30 feet per minute or less.

An HVAC system is simply a group of components working together to move heat to where it is wanted (the conditioned

space), or remove heat from where it is not wanted (the conditioned space), and put it where it is unobjectionable (the outside air).

The components in a typical roof-mounted package HVAC system (Figure 1-1) are:

1. An indoor fan (blower) to circulate the supply and return air.
2. Supply air ductwork in which the air flows from the fan to the room.
3. Air devices such as supply air outlets and return air inlets.
4. Return air ductwork in which the air flows back from the room to the mixed air chamber (plenum).
5. A mixed air chamber to receive the return air and mix it with outside air.
6. An outside air device such as a louver, opening or duct to allow for the entrance of outside air into the mixed air plenum.

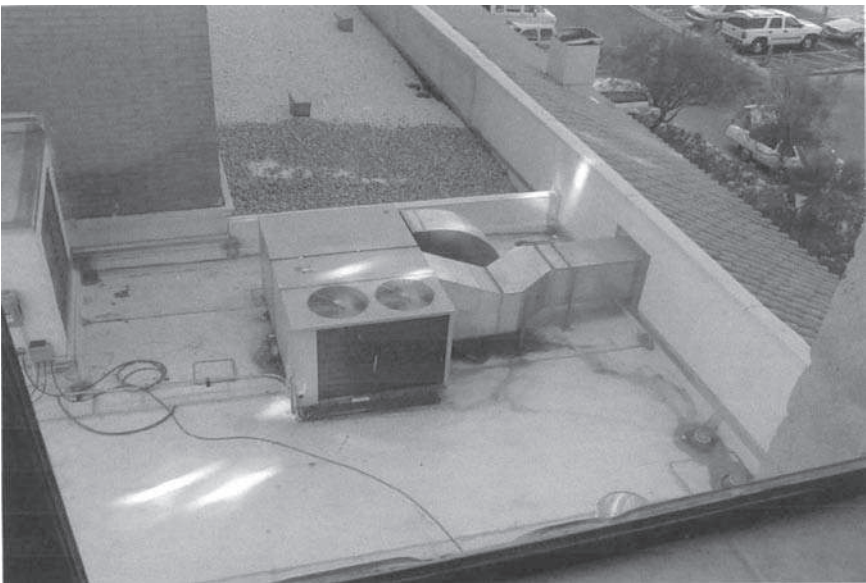

Figure 1-1. Roof-mounted Package Air Conditioning Unit

7. A filter section to remove dirt and dust particles from the air.
8. Heat exchangers such as a refrigerant evaporator and condenser coil for cooling, and a furnace for heating.
9. A compressor to compress the refrigerant vapor and pump the refrigerant around the refrigeration system.
10. An outdoor fan (blower) to circulate outside air across the condenser coil.
11. Controls to start, stop or regulate the flow of air, refrigerant, and electricity.

HVAC COMPONENTS

H is for Heating

Boilers (Figure 1-2)

- Types of Boilers
 - Steam
 - Water
- Boiler Pressures
 - Low
 - High
- Boiler Fuels
 - Natural Gas
 - Oil
 - Coal
 - Electricity
- Boiler Configurations
 - Fire Tube
 - Water Tube

Furnaces (Figure 1-3)

- Furnace Fuels
 - Natural Gas
 - Oil
 - Coal
 - LPG (Liquid Petroleum Gas)
 - Electricity

Heating Coils (Figure 1-4)

- Types of Heating Coils
 - Steam
 - Water
 - Electrical

V is for Ventilation for each of the following:

- 1) Approximately 20 cfm (cubic feet per minute) of air volume per person of outside air (OA) for ventilation for non-smoking areas.
- 2) Make-up air (MUA) for exhaust systems such as:
 - Kitchen hoods
 - Fume hoods
 - Toilets
- 3) Room (conditioned space) pressurization
 - +0.03 to +0.05 inches of water gage for commercial buildings.

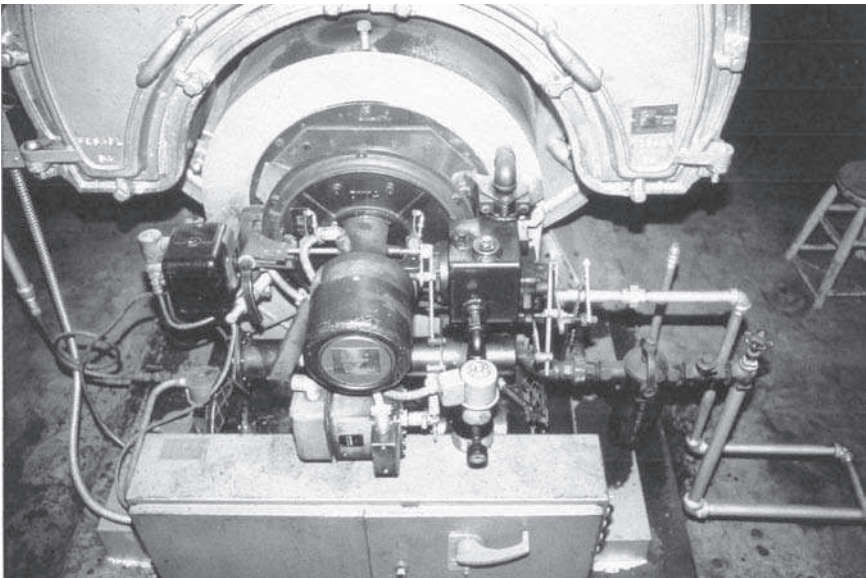

Figure 1-2. Fire Tube Boiler

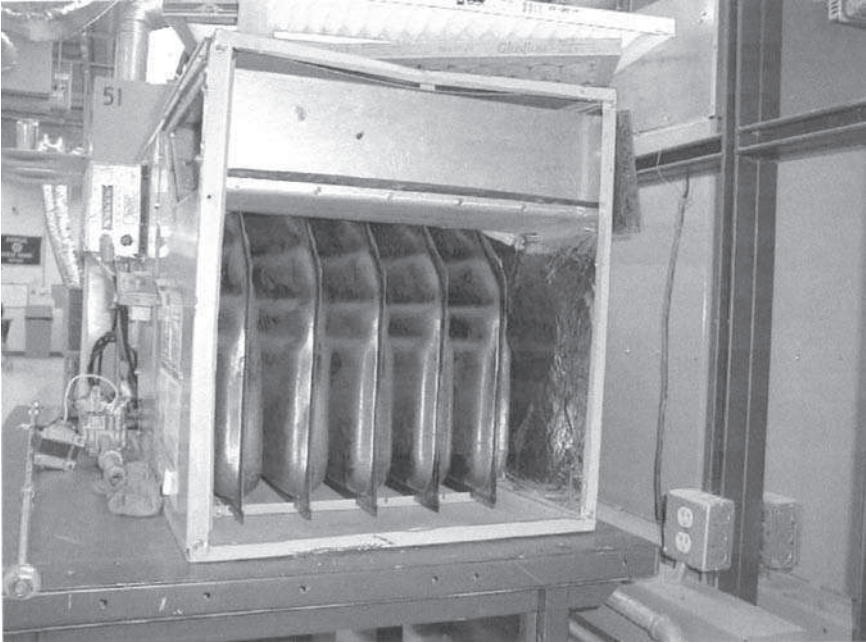

Figure 1-3. Natural Gas Furnace

AC is for Air Conditioning

For most of us, air conditioning means comfort cooling with either chilled water systems or refrigerant systems. Both of these systems include cooling coils to remove heat from the air.

- Chilled Water Systems
 - Vapor-compression system
 - Absorption system
- Refrigeration (DX) Systems
 - Vapor-compression system
- Cooling Coils
 - Water coil
 - Refrigerant (DX) coil



Figure 1-4. Hot Water Heating Coil

Cooling and heating coils (Figure 1-4) are heat transfer devices or heat exchangers. They come in a variety of types and sizes and are designed for various fluid combinations: water, refrigerant or steam. Water coils are used for heating, cooling or dehumidifying air and are most often made of copper headers and tubes with aluminum or copper fins and galvanized steel frames.

AC (Air Conditioning) also means conditioning the air in the following ways:

- Temperature (tempering the air)
 - Cooling (removing heat)
 - Heating (adding heat)
- Humidity control
 - Dehumidifying (removing moisture)
 - Humidifying (adding moisture)
- Volume of airflow
 - cfm (cubic feet per minute)
- Velocity (speed) of airflow
 - fpm (feet per minute)
- Cleaning
 - Filtering
- Pattern of airflow
 - Direction
 - horizontal
 - vertical

CENTRAL HVAC SYSTEM COMPONENTS (Figure 1-5)

Components

Cooling Tower, CT

Condenser Water Pump, CWP

Condenser Water Supply, CWS

Condenser Water Return, CWR

Condenser, Cond

Evaporator (Water Chiller, Water Cooler), Evap

Compressor, Comp

The condenser, evaporator and compressor together are typically called the Chiller, CH

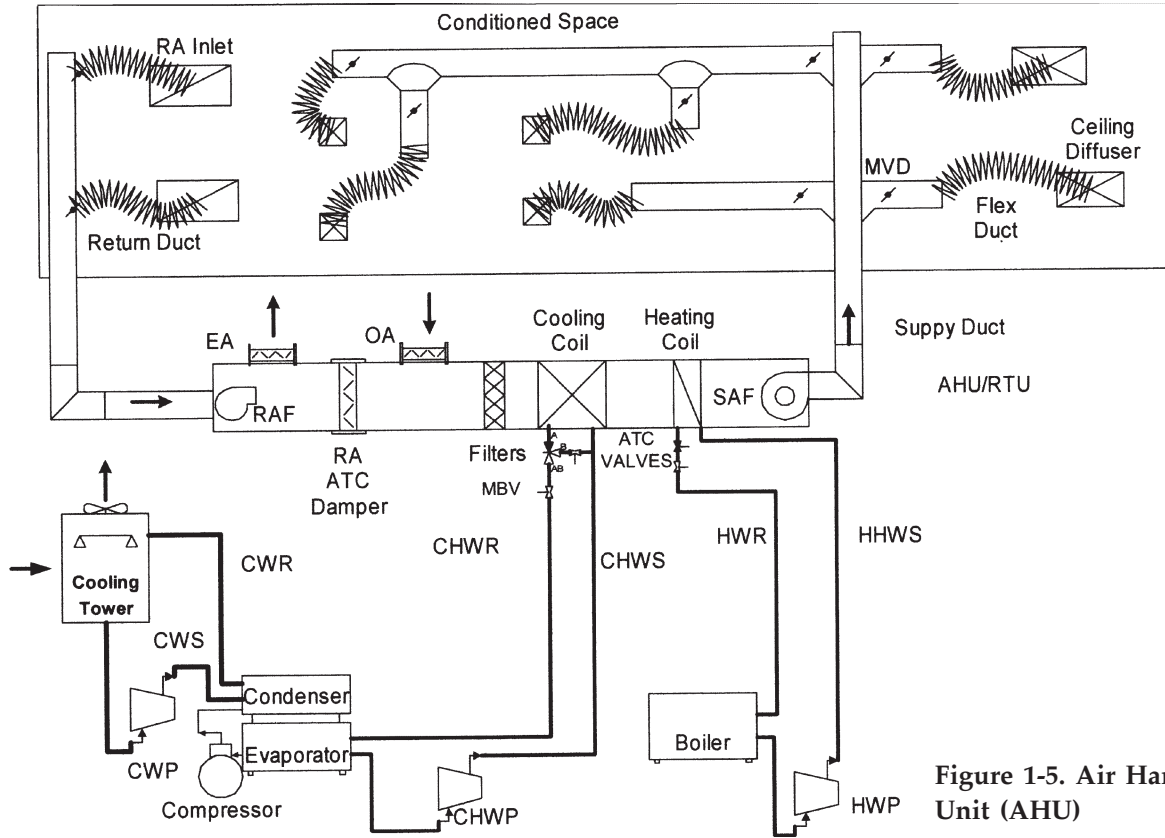

Figure 1-5. Air Handling Unit (AHU)

Chilled Water Pump, CHWP
Chilled Water Supply, CHWS
Chilled Water Return, CHWR
Chilled Water Coil (Cooling Coil), CC
Heating Water Coil (Hot Water Coil, Heating Coil), HC
Heating Water Supply, HWS or HHWS
Heating Water Return, HWR or HHWR
Heating Water Pump, HWP
Boiler, B
Supply Air Fan, SAF, SF
Supply Air Duct, SA
Manual Volume Damper, MVD
Flex Duct, Flex
Ceiling Diffuser, CD
Return Air Inlet, RA
Return Air Duct, RA
Return Air Fan, RAF
Return Air Dampers, RA, ATC Damper (Automatic Temperature Control Damper)
Exhaust Air (Dampers), EA, ATCD
Outside Air (Dampers) OA, ATCD
Filters, F
Water Valves, 3-way or 2-way ATC Valve(Automatic Temperature Control Valve). MBV (Manual Balancing Valve) or Self-regulating Balancing Valve

This AHU is located on the roof and is therefore designated as a “roof top unit” (RTU).

HOW AN HVAC SYSTEM WORKS

An HVAC system is designed to provide conditioned air to the occupied space, also called the “conditioned” space, to maintain the desired level of comfort. To begin to explain how an HVAC system works let’s set some design conditions. First, we

will need to determine the ventilation requirements. We know that in the respiratory process the contaminate carbon dioxide is exhaled. In buildings with a large number of people, carbon dioxide and other contaminants such as smoke from cigarettes and odors from machinery must be continuously removed or unhealthy conditions will result. The process of supplying “fresh” air (now most often called outside air) to buildings in the proper amount to offset the contaminants produced by people and equipment is known as “ventilation.” Not only does the outside air that is introduced into the conditioned space offset the contaminants in the air but because of its larger ion content, outside air has a “fresh air” smell in contrast to the “stale” or “dead air” smell noticed in overcrowded rooms that do not have proper ventilation. In many instances, local building codes stipulate the amount of ventilation required for buildings and work environments.

Let’s say that an HVAC system supplies air to a suite in an office complex and the code requirement is for 20 cubic feet per minute (abbreviated cfm) of outside air for each building occupant. If the suite is designed for 10 people then the total outside air requirement for the people in the suite is 200 cfm. An additional amount of outside ventilation air may be required if there are exhaust hoods such as laboratory fume hoods, kitchen hoods, and spray hoods or there are other areas where the air needs to be exhausted or vented to the outside such as bathrooms and restrooms. This ventilation air is called make-up air.

If more air is brought into a room (conditioned space) than is taken out of a room the room becomes positively pressurized. If more air is taken out of a room than is brought into a room the room becomes negatively pressurized. These air pressures, whether positive or negative are measured in inches of water gage (in wg) or inches of water column (in wc).

Commercial office buildings are typically positively pressurized to about 0.03 inches of water pressure. This is done to keep outside air from “infiltrating” into the conditioned space through openings in or around doorways, windows, etc. Other areas that need positive pressurization are hospital operating rooms and

clean rooms. Examples of negative rooms are commercial kitchens, hospital intensive care units (ICU) and fume hood laboratories.

Air Volume

Using the roof top air handling unit (Figure 1-5) as an example, the volume of air required to heat, ventilate, cool and provide good indoor air quality is calculated based on the heating, cooling and ventilation loads. The air volumes are in units of cubic feet per minute (cfm). The total volume of air for this roof top unit (RTU) is calculated to be 5250 cfm. Constant volume supply air and return air fans (SAF and RAF) circulate the conditioned air to and from the occupied conditioned space.

The total volume of return air back to the air handling unit is 4200 cfm. The difference between the amount of supply air (5250 cfm) and the return air (4200 cfm) is 1050 cfm. This is the ventilation air. It is used in the conditioned space for make-up air (MUA) for toilet exhaust and other exhaust systems. Ventilation air is also used for positive pressurization of the conditioned space, and for “fresh” outside air to maintain good indoor air quality for the occupants. The return air, 4200 cfm, goes into the mixed air chamber (plenum). The return air is then mixed with 1050 cfm, which is brought in through the outside air (OA) dampers into the mixed air plenum. This 1050 cfm of outside air is the minimum outside air required for this system. It is 20% of the supply air (1050/5250). It mixes with the 4200 cfm of return air (80%, 4200/5250) to give mixed air (MA, 100%). Next, the 5250 cfm of mixed air then travels through the filters and into the coil sections. If more outside air than the minimum is brought into the system, perhaps for air-side economizer operation, any excess air is exhausted through exhaust air dampers (EA) to maintain the proper space pressurization. For example, if 2050 cfm is brought into the system through the OA dampers and 4200 cfm comes back through the return duct into the unit then 1000 cfm is exhausted through the exhaust air dampers (EA). This maintains the total supply cfm (5250) into the space and maintains the proper space pressurization.

The airflow diagram looks like this:



RA (return air)
 EA (exhaust air)
 MA (mixed air)
 OA (outside air)
 SA (supply air)

Heating

The heating load requirement is based on design indoor and outdoor winter conditions. The design conditioned space heating load for this air handling unit (AHU) is 198,450 Btu/hr. This is the amount of heat lost in the winter (mainly by conduction) through the walls, windows, doors, roofs, etc. An additional amount of heat is required to heat the outside ventilation air based on design conditions. This additional amount of heat is 45,360 Btuh (Btu/hr). To maintain the temperature and humidity in the comfort zone for the conditioned space the heating cycle is this: The supply air leaves the heating coil carrying 198,450 Btuh of heat. The air goes through the supply air fan (SAF), down the insulated supply duct, past the manual volume dampers (MVD) which have been set for the correct amount of air for each diffuser, and into the conditioned space. The supply air gives up all its 198,450 Btuh of heat to the conditioned space to replace the 198,450 Btuh that is leaving the space through the walls, doors, windows, ceiling, roof, etc. As the air gives up its heat it makes its way through the room and into the return air (RA) inlets, then into the return air duct and back to the air handling unit.

The return air goes through the return air fan (RAF), through the return air automatic temperature control (ATC) dampers into the mixed air chamber and mixes with the outside air (OA). The mixed air flows through the filters, through the cooling coil (which is off), and into the heating coil. The mixed air travels

through the heating coil where it picks up heat via conduction through the hot water tubes in the coil. In addition to the tubes, the heating coil also has fins attached to the tubes to facilitate the heat transfer. 243,810 Btuh of heat is transferred from the coil into the air. Of this amount of heat, 45,360 Btuh heats the outside air to bring it up to the design room air temperature. The remainder, 198,450 Btuh of heat, leaves the heating coil in the supply air and goes into the space and the air cycle repeats. The heating water, after giving up heat to the air, leaves the coil and goes back to the oil-fired boiler through the heating water return (HWR) pipe and into the boiler where it picks up the same amount of heat that it has just given up in the coil. The water leaves the boiler, flows through the heating water pump (HWP) and is pumped through the heating water supply (HWS) or heating hot water supply (HHWS) piping into the heating coil to give up its heat into the mixed air and the water cycle repeats.

Ventilating

The ventilation requirement is 1050 cfm. 1050 cfm of outside air is brought in through the outside air (OA) dampers into the mixed air plenum. This 1050 cfm of outside air mixes with the 4200 cfm of return air to form 5250 cfm of mixed air, which goes through the coil(s) and becomes supply air.

Cooling

For this system, the total heat given off by the people, lights and equipment in the conditioned space plus the heat entering the space through the outside walls, windows, doors, roof, etc., and the heat contained in the outside ventilation air will be approximately 154,000 Btu/hr. A ton of refrigeration (TR) is equivalent to 12,000 Btu/hr of heat. Therefore, this HVAC system requires a chiller that can provide approximately 13 tons of cooling ($154,000 \text{ Btu/hr} \div 12000 \text{ Btu/hr/ton} = 12.83 \text{ TR}$)

To maintain the proper temperature and humidity in the conditioned space the cooling cycle is this: The supply air (which is 20°F cooler than the air in the conditioned space) leaves the cool-

ing coil and goes through the heating coil (which is off), through the supply air fan, down the duct and into the conditioned space. The cool supply air picks up heat in the conditioned space. The warmed air makes its way into the return air inlets, then into the return air duct and back to the air handling unit. The return air goes through the return air fan into the mixed air chamber and mixes with the outside air. The mixed air goes through the filters and into the cooling coil. The mixed air flows through the cooling coil where it gives up its heat into the chilled water tubes in the coil. This coil also has fins attached to the tubes to facilitate heat transfer. The cooled supply air leaves the cooling coil and the air cycle repeats. The water, after picking up heat from the mixed air, leaves the cooling coil and goes through the chilled water return (CHWR) pipe to the water chiller's evaporator. The "warmed" water flows into the chiller's evaporator—sometimes called the water cooler—where it gives up the heat from the mixed air into the refrigeration system. The newly "chilled" water leaves the evaporator, goes through the chilled water pump (CHWP) and is pumped through the chilled water supply (CHWS) piping into the cooling coil to pick up heat from the mixed air and the water cycle repeats. The evaporator is a heat exchanger that allows heat from the chilled water return (CHWR) to flow by conduction into the refrigerant tubes. The liquid refrigerant in the tubes "boils off" to a vapor removing heat from the water and conveying the heat to the compressor and then to the condenser. The heat from the condenser is conveyed to the cooling tower through the condenser water in the condenser return (CWR) pipe. As the condenser water cascades down the tower, outside air is drawn across the cooling tower removing heat from the water through the process of evaporation. The "cooled" condenser water falls to the bottom of the tower basin and is pumped from the tower through the condenser water pump (CWP) and back to the condenser in the condenser water supply piping (CWS) and the cycle repeats.

Chapter 2

Heat Flow

Heat is energy in the form of molecules in motion. Heat flows from a warmer substance to a cooler substance. Heat energy flows downhill! Heat does not rise, **heated air rises!**

Temperature is the level of heat (energy).

The lowest temperature is minus 460°F.

The sun's temperature is approximately 27,000,000°F.

The temperatures associated with most HVAC systems range from 0°F to 250°F.

Most people feel comfortable if the indoor air temperature is between 68°F and 78°F.

HEAT AND TEMPERATURE

Heat is energy in the form of molecules in motion. As a substance becomes warmer, its molecular motion and energy level (temperature) increases. Temperature describes the level of heat (energy) with reference to no heat. Heat is a positive value relative to no heat. Because all heat is a positive value in relation to no heat, cold is not a true value. It is really an expression of comparison. Cold has no number value and is used by most people as a basis of comparison only. Therefore, warm and hot are comparative terms used to describe higher temperature levels. Cool and cold are comparative terms used to describe lower temperature levels. The Fahrenheit scale is the standard system of temperature measurement used in the United States. However, the U.S. is one of the few countries in the world still using this system. Most countries use the metric temperature measurement

system, which is the Celsius scale. The Fahrenheit and Celsius scales are currently used interchangeably in the U.S. to describe equipment and fundamentals in the heating, ventilating and air conditioning industry.

STANDARD TEMPERATURES ON THE FAHRENHEIT AND CELSIUS SCALES

Freezing point of (pure) water is:

32 degrees Fahrenheit (32°F) and zero degrees Celsius (0°C).

Boiling point of (pure) water is:

212 degrees Fahrenheit (212°F) and 100 degrees Celsius (100°C).

Temperature Conversions for Fahrenheit and Celsius

$$^{\circ}\text{C} = (^{\circ}\text{F} - 32) \div 1.8$$

$$^{\circ}\text{F} = 1.8 (^{\circ}\text{C}) + 32$$

The following is a quick reference for estimating and converting everyday temperatures from Celsius to Fahrenheit:

0°C is 32°F

16°C is approximately 61°F

28°C is approximately 82°F

37°C is 98.6°F

100°C is 212°F

Absolute Temperatures

The Fahrenheit absolute scale is the Rankine (°R) scale.

The Celsius absolute scale is the Kelvin (°K) scale.

Absolute zero is minus 460°F and 0°R, or minus 273°C and 0°K.

The Fahrenheit/Celsius and the Rankine/Kelvin scales are used interchangeably to describe equipment and fundamentals of the heating and air conditioning industry.

HEAT TRANSFER

Heat naturally flows from a higher energy level to a lower energy level. In other words, heat travels from a warmer substance to a cooler substance. When there is a temperature difference between two substances, heat transfer will occur. In fact, temperature difference is the driving force behind heat transfer. The greater the temperature difference, the greater the heat transfer.

TYPES OF HEAT TRANSFER

The three types of heat transfer are conduction, convection and radiation.

Conduction

Conduction heat transfer is heat energy traveling from one molecule to another. A heat exchanger in an HVAC system or home furnace uses conduction to transfer heat. Your hand touching a cold wall is an example of heat transfer by conduction from your hand to the wall. However, heat does not conduct at the same rate in all materials. For example, all HVAC copper conducts at a different rate than iron or aluminum, etc.

Convection

Heat transfer by convection is when some substance that is readily movable such as air, water, steam, or refrigerant moves heat from one location to another. Compare the words “convection” (the action of conveying) and “convey” (to take or carry from one place to another). An HVAC system uses convection in the form of air, water, steam and refrigerants in ducts and piping to convey heat energy to various parts of the system. When air is heated, it rises; this is heat transfer by “natural” convection. “Forced” convection is when a fan or pump is used to convey heat in fluids such as air and water. For example, many large

buildings have a central heating plant where water is heated and pumped throughout the building to the final heated space. Fans then move heated air into the conditioned space.

Radiation

Heat transferred by radiation travels through space without heating the space. Radiation or radiant heat does not transfer the actual temperature value. The first solid object that the heat rays encounter absorbs the radiant heat. A portable electric space heater that glows red-hot is an example of heat transfer by radiation. As the electric heater coil glows red-hot it radiates heat into the room. The space heater does not heat the air (the space)—instead it heats the solid objects that come into contact with the heat rays. Any heater that glows has the same effect. However, radiant heat diminishes by the square of the distance traveled; therefore, space heaters must be placed accordingly. Another good example of radiant heat is the sun; the sun heats the earth, but not the air around the earth. The sun is also a good example of diminishing heat. The earth does not experience the total heat of the sun because the sun is some 93 million miles from the earth.

UNITS OF HEAT ENERGY AND HEAT POWER

A British thermal unit (Btu) is used to describe the quantity of heat contained in a given substance. Because the Fahrenheit scale is the standard system of temperature measurement used in the United States, a Btu is defined as the amount of heat required to raise the temperature of 1 pound (lb) of water 1 degree Fahrenheit (°F). A Btu is a unit of heat energy.

The rate of heat consumption, called power, can be determined with a unit of heat energy and a unit of time. For example, Btu per minute or Btu per hour, written: Btu/m or Btum and Btu/hr or Btuh are common units of power used in HVAC work. Btu/hr is a unit of heat power.

Other expressions of heat power are:

1000 Btuh (can be expressed as MBh).

1,000,000 Btuh (can be expressed as MMBh).

(Roman numeral "M" = 1000, Roman numeral "MM" = 1,000,000).

UNITS OF ELECTRICAL ENERGY AND ELECTRICAL POWER

Watt-hours (Wh) or kilowatt-hours (kWh,) are units of electrical energy. A kilowatt-hour is equivalent to 1000 Watt-hours.

Watts (W) and kilowatts (kW) are units of electrical power. A kilowatt is equivalent to 1000 Watts (kilo (k) = 1000).

POWER EQUALS ENERGY TIMES TIME, $P = E \times t$.

Btu/hr (a unit of power) = Btu (a unit of energy) \times hr (a unit of time).

kW (a unit of power) = kWh (a unit of energy) \times hr (a unit of time).

Mathematically, kWh is also expressed kW/hr.

ELECTRICAL POWER AND HEAT POWER EQUIVALENTS

$$1 \text{ W} = 3.413 \text{ Btuh}$$

$$1 \text{ kW} = 3413 \text{ Btuh}$$

MOTOR HORSEPOWER AND HEAT POWER EQUIVALENTS

$$1 \text{ hp (horsepower)} = 2545 \text{ Btuh}$$

MOTOR HORSEPOWER AND ELECTRICAL POWER EQUIVALENTS

$$1 \text{ hp} = 746 \text{ W}$$

$$1 \text{ hp} = 0.746 \text{ kW}$$

BOILER HORSEPOWER AND HEAT POWER EQUIVALENTS

$$1 \text{ boiler horsepower} = 33,475 \text{ Btuh}$$

HEAT CONTENT AND SPECIFIC HEAT

The heat content of a substance is called enthalpy. The symbol is h . The units of enthalpy are Btu/lb or Btu/lb°F. Specific heat (Fahrenheit scale) is the amount of heat necessary to raise the temperature of 1 lb of a substance 1°F. Every substance has a different specific heat. Some examples of specific heat values for HVAC substances are: The specific heat of water is 1.0 Btu/lb°F. The specific heat of air is 0.24 Btu/lb°F and the specific heat of steam or ice is approximately 0.5 Btu/lb°F.

HEAT MEASURED IN HVAC SYSTEMS

Sensible Heat

People, lights, motors, heating equipment and outdoor air are examples of substances that give off sensible heat. A seated person in an office, for instance, gives off approximately 225 Btuh of sensible heat into the conditioned space. Enthalpy units of sensible heat are in Btu/lb°F. The change in the sensible heat level as measured with an ordinary thermometer is sensible temperature. Sensible temperature is measured in degrees Fahrenheit (°F) and it is indicated as dry bulb (db) temperature. Sensible temperatures are written °Fdb. For example, 55°Fdb.

Latent Heat

The definition of latent or hidden heat is: heat that is known to be added to or removed from a substance but no temperature change is recorded." The heat released by boiling water is an example of latent heat. Once water is brought to the boiling point, adding more heat only makes it boil faster; it does not raise the temperature of the water. The level of latent heat is measured in degrees Fahrenheit (°F) and it is indicated as dew point (dp) temperature (for example, 60°Fdp). Enthalpy is in Btu/lb°F. People, water equipment, and outdoor air are examples of substances that give off latent heat. A seated person in an office gives off approximately 225 Btuh of latent heat into the conditioned space.

Total Heat

Total heat is the sum of sensible heat and latent heat. It is measured in degrees Fahrenheit (°F) and it is indicated as wet bulb (wb) temperature. For example, 54°Fwb. Total heat level is measured with an ordinary thermometer; however, the thermometer tip is covered with a sock made from a water-absorbing material. The sock is wetted with distilled water and the thermometer is placed in the air stream in the air handling unit or duct. As air moves across the wet sock, some of the water is evaporated. Evaporation cools the remaining water in the sock and cools the thermometer. The decrease in the temperature of the wet bulb thermometer is called "wet bulb depression." For room wet bulb temperature the wet bulb thermometer is typically in an instrument such as a sling- or power-psychrometer along with a dry bulb thermometer. Enthalpy is in Btu/lb°F. A seated person gives off approximately 450 Btuh of total heat (225 Btuh sensible heat plus 225 Btuh latent heat).

HEAT TRANSFER EQUATIONS

AIR SYSTEMS - SENSIBLE HEAT TRANSFER EQUATION

$$\text{Btuh} = \text{cfm} \times 1.08 \times \text{TD}$$

Where:

Btuh = Btu per hour (sensible heat) also written Btuhs

cfm = volume of airflow, cubic feet per minute

1.08 = constant:

$60 \text{ min/hr} \times 0.075 \text{ lb/cf}$ (density of air) $\times 0.24 \text{ Btu/lb}^\circ\text{F}$
(specific heat of air)

TD = dry bulb temperature difference of the air entering and leaving a coil EAT – LAT or LAT – EAT (Entering Air Temperature and Leaving Air Temperature). TD (temperature difference) is often written as delta T or ΔT . In applications where cfm to the conditioned space needs to be calculated, the TD is the difference between the supply air temperature dry bulb and the room temperature dry bulb.

To find volume: $\text{cfm} = \text{Btuh} \div (1.08 \times \text{TD})$

To find temperature difference: $\text{TD} = \text{Btuh} \div (1.08 \times \text{cfm})$

AIR SYSTEMS - TOTAL HEAT TRANSFER EQUATION

$$\text{Btuh} = \text{cfm} \times 4.5 \times \Delta h$$

Where:

Btuh = Btu per hour (total heat) also written Btuht

cfm = volume of airflow, cubic feet per minute

4.5 = constant: $60 \text{ min/hr} \times 0.075 \text{ lb/cf}$

Δh = Btu/lb change in total heat content (enthalpy) of the air

The total heat content of the air is determined from a wet bulb and dry bulb temperature, and a psychrometric chart. For example, the air temperature leaving a typical commercial cooling coil might be 55°Fdb and 54°Fwb . Plotting these temperatures on a psychrometric chart gives an enthalpy (total heat content) of the air at 22.627 Btu/lb.

To find volume: $\text{cfm} = \text{Btuh} \div (4.5 \times \Delta h)$

To find enthalpy difference: $\Delta h = \text{Btuh} \div (4.5 \times \text{cfm})$

 WATER SYSTEMS-HEAT TRANSFER EQUATION

$$\mathbf{Btuh = gpm \times 500 \times TD}$$

Where:

Btuh = Btu per hour

gpm = volume of water flow, gallons per minute

500 = constant:

60 min/hr \times 8.33 lb/gal (weight of water) \times 1 Btu/lb°F
(specific heat of water).

TD = temperature difference of the water entering and leaving a coil EWT – LWT or LWT – EWT (Entering Water Temperature and Leaving Water Temperature). TD can also be expressed as ΔT .

To find volume: $gpm = Btuh \div (500 \times TD)$

To find temperature difference: $TD = Btuh \div (500 \times gpm)$

 WATER SYSTEMS —
 PRESSURES AND BOILING TEMPERATURES

The boiling point or boiling temperature of water can be changed by changing the pressure on the water. In the case of water in a heating system if the pressure is to be changed, the water must be in a boiler and then the water can be boiled at a temperature of 212°F or 250°F or any other temperature. The only requirement is that the pressure in the boiler is changed to the one corresponding to the desired boiling point. If the pressure is 14.7 psia the boiling temperature is 212°F. A common low pressure HVAC steam heating system, for instance, operates at 15 pounds per square inch gage pressure (psig), which is an absolute pressure of 30 psia and a temperature of 250°F.

Sea Level Barometric Pressure is 14.7 pounds per square inch absolute (psia)

Sea Level Barometric Pressure is 0 pounds per square inch gage (psig)

$$\text{psia} = \text{psig} + 14.7$$

pounds per square inch absolute = pounds per square inch gage + 14.7

As a hint for calculations psia can stand for “**psi add 14.7**” to gage pressure.

Sea Level Barometric Pressure is 29.92 inches of mercury (“Hg)

Sometimes sea level barometric pressure, for estimation purposes only, is rounded off to 15 psia and 30 inches of mercury.

1 psi equals 2.04” Hg

(sometimes, for estimation purposes only, rounded to
1 psi = 2” Hg)

1” Hg equals 0.49 psi

(sometimes, for estimation purposes only, rounded to
1” Hg = 0.5 psi)

Chapter 3

Psychrometrics

Pychrometrics is from the Greek words, “psychro” meaning “cold” and “metrics” meaning “measure of.” However, psychrometrics is more than just the measure of cold (a comparative term discussed in Chapter 2); it is the science of moist air thermodynamics applied to HVAC systems. With an understanding of psychrometrics, one can use psychrometric charts or “psych” charts to illustrate the changes that occur to air as it goes through the air conditioning processes of heating, cooling, humidifying, and dehumidifying with a minimum of time and effort.

This chapter introduces psychrometric charts and describes their use in analyzing HVAC systems. The psychrometric chart is a valuable tool for HVAC engineers and technicians alike.

PSYCHROMETRIC CHART

Psychrometric charts are for sea level pressures (the standard chart) but psych charts for other elevations are available. Printed psychrometric charts provide most or all the following information:

Temperatures, Dry Bulb, Wet Bulb and Dew Point

- Degrees Fahrenheit (°F)

Specific Volume

- Cubic feet per pound (cf/lb)
- Density in pounds per cubic foot (lb/cf) is not shown directly on the psychrometric chart but can be calculated from specific volume

Enthalpy

- Btu per pound of dry air

Sensible Heat Ratio

- Btuh sensible heat divided by Btuh total heat

Moisture Content (Specific Humidity)

- Grains of moisture per pound of dry air or pounds of moisture per pound of dry air

Relative Humidity

- Percentage

Vapor Pressure

- Inches of Mercury (in. Hg)

Standard Air Dot**Temperatures***Dry Bulb (DB) Temperature*

Dry bulb temperature is the temperature of the air read on a standard thermometer. On the psychrometric chart, the straight vertical lines are dry bulb temperatures (example: 60°FDB shown as #1 in Figure 3-1). The dry bulb temperature scale in degrees Fahrenheit (°F) is along the bottom of the chart (scale shown from 40°FDB to 110°FDB). Follow the 60°F dry bulb line down to intersect the scale at 60°F. Psychrometric charts are available in the following approximate dry bulb temperature ranges: low temperatures: -20°FDB to 50°FDB, normal temperatures: 20°FDB to 100°FDB, and high temperatures from 60°FDB to 250°FDB. All charts used in this text are normal temperatures.

Wet Bulb (WB) Temperature

To get wet bulb temperatures above 32°F use a standard thermometer. Cover the sensing bulb with a wet (distilled water) wick. Expose the thermometer wick to air moving at a velocity greater than 900 feet per minute. To obtain wet bulb temperatures below 32° Fahrenheit use a standard thermometer with a wick on the sensing bulb. The distilled water on the wick is frozen. The wet bulb temperature scale on the psychrometric chart is along the 100 percent saturation line on the chart (the curved left line

indicated by #3, wet bulb temperatures indicated from 40°F to 85°F). The wet bulb lines run at about a 30 degree angle across the chart as shown by #2 in Figure 3-1 (40°FWB).

Dew Point (DP) Temperature

Dewpoint temperature is the temperature at which moisture will start to condense from the air. The scale (shown from 0°F to 85°F) for dew point temperatures is along the right side of the chart (#7, Figure 3-1). The dewpoint temperature lines run horizontally, at right angles to the dry bulb temperature lines (#4 in Figure 3-1); in fact, they are the same lines as the specific humidity (also called the humidity ratio) lines (#6, Figure 3-1). For some charts, dew point temperature is along the curved line on the left side of the chart (#8, Figure 3-1). This curved line is the 100 percent saturation line. The dew point is where the humidity ratio line intersects the 100 percent saturation curve.

Specific Volume and Density

Specific volume is the volume of a substance per unit weight. For air, the units of specific volume are cubic feet per pound. Specific volume lines run across the chart at about a 70 degree angle (#10, Figure 3-1).

Density and specific volume are reciprocals. Once specific volume is found on the psych chart, density is calculated using the equation: $\text{density} = 1/\text{specific volume}$. For example, if the specific volume is 13.33 cubic feet per pound then the density is 0.075 pounds per cubic foot ($0.075 = 1/13.33$).

Enthalpy

Enthalpy (h) is a thermodynamic property, which serves as a measure of heat energy. Chapter 2 discussed heat in terms of temperature and Btu. To review: temperature is an indication of heat intensity and Btu is the quantity of heat in a substance. Enthalpy is the measurement of the heat content of a substance used in psychrometrics to find the amount of heat necessary for various processes. On the psych chart, enthalpy represents the energy in

one pound of dry air and the grains of moisture associated with it at a given condition. Enthalpy is used in HVAC calculations to find the total heat (typically in Btu per hour) of the air at a given condition. For example, the total heat of the air entering a cooling coil less the total heat of the air leaving the cooling coil would give the total heat removed by the cooling coil. The difference is the change in enthalpy and is an indication of how efficient or effective the coil is operating. The enthalpy scale is on the far left side of the psych chart (represented as #9 in Figure 3-1). To find enthalpy on some psych charts extend the wet bulb line from the condition point past the 100 percent saturation line to the enthalpy scale. On other charts (such as represented in Figure 3-1) use a straight edge and draw a line from the left hand enthalpy scale to another enthalpy scale at the bottom or right side of the chart (also shown as #9). The enthalpy line pivots on the condition point. The enthalpy is correct when the line passes through condition point and the enthalpy is the same on the left hand scale and the right or bottom scale. The units of enthalpy are Btu per pound of dry air.

Sensible Heat Ratio

The sensible heat ratio (SHR), also called sensible heat factor (SHF), is the ratio of sensible heat to total heat (Q_s/Q_t , where Q is quantity). It is also expressed as Btu_h/Btu_t , Btu per hour sensible heat divided by Btu per hour total heat. The sensible heat ratio scale is shown on the right side of the chart (#11, Figure 3-1), and is used in conjunction with the SHR reference dot near the center of the chart (#12, Figure 3-1). The SHR reference dot is located at 50%RH and 78°FDB on some charts and at 50%RH and 80°FDB on other charts. The sensible heat ratio line is drawn from the SHR dot and extended through the SHR scale.

Moisture Content (Specific Humidity)

Moisture content (W) is the weight of water vapor in each pound of dry air. Moisture content is also called humidity ratio or specific humidity. The moisture content scale is on the right side

of the chart from 0 to 200 grains of moisture per pound of dry air (#5, Figure 3-1). Some psychrometric charts also have a scale that gives the moisture content in pounds of moisture (water) per pound of dry air from 0.0 to 0.026 pounds. Specific humidity (as compared to relative humidity) is the actual amount of moisture in a pound of air. On the psych chart, the specific humidity lines (#6, Figure 3-1) run horizontally at right angles to the dry bulb lines. The units of specific humidity are grains of moisture per pound of dry air or pounds of moisture per pound of dry air. 7000 grains of moisture equals one pound of moisture.

Relative Humidity

Relative humidity (RH) is the ratio of the amount of moisture (water vapor) present in the air to the total amount of moisture that the air can hold at a given temperature. Relative humidity is expressed as a percentage. The percent relative humidity lines are the curved lines that start on the left side of the chart at the 100 percent saturation line and decrease going to the right side of the chart. On most psych charts, the designated RH lines are in 10% increments starting at the saturation line. The next line to the right of the saturation line is 90%, then 80%, 70%, etc., with the last line at 10%RH. In Figure 3-1: #8, indicates relative humidity lines shown at 100%RH, 50%RH and 10%RH.

Table 3-1 shows the changes in relative humidity as air temperature changes with a constant amount of moisture content (specific humidity) in the air.

Vapor Pressure

Vapor pressure (P_w) is the pressure exerted by water vapor in the air (#13, Figure 3-1). The units of vapor pressure are inches of mercury (in Hg).

Standard Air Dot

Some psych charts have a dot indicating standard air (#14, Figure 3-1).

Standard air is dry air with the following properties:

Table 3-1

<i>Specific Humidity</i>	<i>Air Temperature</i>	<i>Relative Humidity</i>
60 gr/lb	100°F	21%
60 gr/lb	70°F	54%
60 gr/lb	55°F	94%

Temperature \approx 70°F.

Pressure = 29.92 inches mercury or 14.7 pounds per square inch

Volume (specific volume) = 13.33 cubic feet per pound

Weight (density) = 0.075 pounds per cubic foot

HVAC PROCESSES ON THE PSYCHROMETRIC CHART

Sensible Heating

Sensible heating is heat added to the air, which causes the air temperature to increase. Sensible heat is measured using a standard thermometer. A horizontal line on the psych chart represents any heating process... such as a typical residential or commercial office heating process... that adds sensible heat only. Figure 3-2: Air enters the heating coil at 50°FDB and 40°FWB (condition point A) and leaves the heating coil at 100°FDB and 62.5°FWB (condition point B). As the air is heated, the dry bulb and wet bulb temperatures increase but the dew point temperature and the moisture content (specific humidity) remain constant. The relative humidity also changes from 40% to less than 10%. This change in relative humidity is because as the air gets warmer, the air can hold more moisture (per pound of air), but because the amount of moisture is the same, about 22 grains, the relative humidity goes down (see Table 3-1 above).

Sensible Cooling

Opposite of sensible heating only would be sensible cooling only. This is not common but is used in some applications. Chemical dehumidification is one example. Sensible cooling is heat removed from the air, which causes the air temperature to decrease as sensed by a thermometer. A horizontal line on the psych chart also represents any cooling process that removes sensible heat only. Figure 3-2: Air enters the cooling coil at 100°FDB and 62.5°FWB (B) and leaves the cooling coil at 50°FDB and 40°FWB (A). As the air is cooled (heat removed), the dry bulb and wet bulb temperatures decrease but the dew point temperature (27°FDP) and the moisture content (22 grains) remain constant. The relative humidity also changes from approximately 8% to 40%. This change in relative humidity is because as the air gets cooler, the air's ability to hold moisture (per pound of air) lessens, but because the amount of moisture is the same, the relative humidity goes up (see Table 3-1 above).

Humidification

Humidification occurs when air absorbs moisture as it passes through a water spray or through water on a wetted pad. To illustrate the concept of humidification see Figure 3-3 where air at 70°FDB and 10%RH enters a water spray at condition point A. The air leaves the spray at 70°FDB and 50%RH (B). In this example, the dry bulb temperature remains constant while the wet bulb temperature, dew point temperature, relative humidity and specific humidity increase. In normal psychrometric processes what actually occurs is either heating and humidification or cooling and humidification.

Dehumidification

The opposite of humidification is dehumidification. Dehumidification occurs when air passing through a chilled water coil, a refrigerant coil or a chemical dehumidifier releases moisture and is dehumidified. Figure 3-3 illustrates this concept: Air enters a dehumidifier at 70°FDB and 50%RH (condition point

B). The air leaves the dehumidifier at condition point A (70°FDB and 10%RH). In this example, the dry bulb temperature remains constant while the wet bulb temperature, dew point temperature, relative humidity and specific humidity decrease. In a typical commercial and industrial cooling coil HVAC system, using either a chilled water coil or a refrigerant coil, the psychrometric process is both cooling and dehumidification simultaneously (see below). When using a chemical dehumidifier, the process is heating and dehumidifying (see below).

Heating and Humidification

Both heating and humidification occurs when air passes through a warm water spray or steam. The air absorbs moisture and is humidified and heated simultaneously. Figure 3-3: Air at 70°FDB and 10%RH enters a warm water spray at condition point A. The air leaves the spray at 80°FDB and 50%RH (condition C). The dry bulb temperature, wet bulb temperature, dew point temperature, relative humidity and specific humidity increase.

Cooling and Humidification

When air passes through cold water, either a spray or a wetted pad, it absorbs moisture and is humidified and cooled simultaneously. This is “evaporative cooling” and is effective in dry (arid) areas with low relative humidity. Figure 3-4: Air at 100°FDB, 70°FWB and 20%RH enters a cold water spray at point A. The air leaves the spray at 80°FDB, 70°FWB and 61%RH (B). The wet bulb temperature remains constant while the dry bulb temperature decreases. The dew point temperature, relative humidity and specific humidity increase.

Heating and Dehumidification

When air passes through a chemical dehumidifier the psychrometric process is heating and dehumidifying following along a constant wet bulb line. Figure 3-4: Air enters a chemical dehumidifier at 72°FDB, 60°FWB and 50%RH (condition point C). The air leaves the dehumidifier at condition point D (80°FDB, 60°FWB

and 30%RH). The wet bulb temperature remains constant while the dry bulb temperature increases. The dew point temperature, relative humidity and specific humidity decrease.

Cooling and Dehumidification

Air is dehumidified and cooled simultaneously by passing it through sprays of cold water or over a cold surface such as an energized refrigerant coil or chilled water coil. The most common type of HVAC cooling is “mechanical cooling” using a cold surface. Figure 3-5: Air at 80°FDB and 50%RH enters a cooling coil (A). The air leaves the cooling coil at 55°FDB, 53°FWB and 90%RH (B). A line drawn between the two points illustrates the changes in the air as it goes through the cooling and dehumidifying process. This line is the “process line.” The dry bulb temperature, wet bulb temperature, dew point temperature and specific humidity decrease. Relative humidity has increased.

HVAC CALCULATIONS AND THE PSYCHROMETRIC CHART

A condition point is the condition of the air at a given point in the HVAC system such as the supply air, room air/return air, outside air, mixed air, entering or leaving a heating or cooling coil, etc. To plot a condition point on the psych chart two properties of the air must be known. Typically, they are dry bulb temperature and wet bulb temperature or dry bulb temperature and relative humidity. Once the condition point is plotted most or all of the following properties of the air can be found on a psych chart: dry bulb temperature, wet bulb temperature, dew point temperature, relative humidity, moisture content, enthalpy, specific volume (density is calculated), and vapor pressure.

Determining Air Properties from the Psychrometric Chart

Exercise:

The return air from a conditioned space has these two prop-

erties: 75°FDB and 50%RH. Using a psychrometric chart, the other return air properties are (see Figure 3-6):

Wet bulb: 62.5°FWB

Enthalpy: 28.1 Btu/lb of dry air

Dew point: 55°FDP

Specific humidity (moisture content): 66 grains of moisture per pound of dry air

Vapor pressure: 0.44 inches of mercury

Specific volume: 13.7 cubic feet per pound of dry air

Density: 0.073 pounds per cubic feet (calculated)

Using the Psychrometric Chart

Exercise:

An HVAC engineer has determined that the optimum indoor temperature for a conditioned space in Wichita, Kansas is 75°FDB at 63°FWB. The design outside air is 98°FDB, 73°FWB. The conditioned space design sensible cooling load is 194,400 Btuhs and the total load is 228,700 Btuht. The design relative humidity leaving the cooling coil is 90%. Using a psychrometric chart plot and calculate the design conditions for air conditioning system AC-1 to provide the room requirements.

Plotting the Return Air Condition for Air Conditioning System AC-1

The return air condition is the space condition.

Figure 3-7: Point A, return air condition: 75°FDB, 63°FWB, 52%RH.

Calculating Conditioned Space Sensible Heat Ratio for Air Conditioning System AC-1

To calculate sensible heat ratio use:

$$\text{SHR} = \text{Btuhs} \div \text{Btuht}$$

Where:

SHR = sensible heat ratio

Btuhs = sensible heat in Btu per hour in the conditioned space

Btuht = total heat in Btu per hour in the conditioned space

Then:

$$\text{SHR} = 194,400 \text{ Btuhs} \div 228,700 \text{ Btuht}$$

Answer:

$$\text{SHR} = 0.85$$

Plotting Sensible Heat Ratio Line for Air Conditioning System AC-1

Figure 3-7: Draw a line from the SHR reference dot (#12) to 0.85 on the SHR scale on the right side of the psych chart.

Plotting the Supply Air Condition for Air Conditioning System AC-1

Figure 3-7: Using drawing instruments, draw a line parallel to the SHR line through the return air condition point (A) to the 90% RH line. This is condition point D, the supply air condition: 57°FDB, 55°FWB, 90%RH.

Calculating Supply Air Flow for Air Conditioning System AC-1

To calculate supply air cubic feet per minute use:

$$\text{cfm} = \text{Btuhs} \div (1.08 \times \text{TD})$$

Where:

cfm = cubic feet per minute (supply air flow)

Btuhs = sensible heat in Btu per hour in the conditioned space

1.08 = constant, 0.24 Btu/lb-°F (specific heat of air) × 60 min/hr × 0.075 lb/cf (weight of standard air)

TD = temperature difference between return air temperature (75°F) and supply air temperature (57°F)

Then:

$$\text{cfm} = 194,400 \text{ Btuhs} \div (1.08 \times 18^\circ\text{F})$$

Answer:

$$\text{cfm} = 10,000$$

Plotting the Outside Air Condition for Air Conditioning System AC-1

Figure 3-8, condition point B, outside air: 98°FDB, 73°FWB, 31%RH.

Calculating Mixed Air Condition for Air Conditioning System AC-1

The total supply air for this system is 10,000 cubic feet per minute (cfm). The outside and return air requirements are 1500 cfm outside air (15%) and 8500 cfm return air (85%). The outside air and return air must add up to the total supply air (100%).

To calculate mixed air temperature use:

$$\text{MAT} = (\% \text{OA} \times \text{OAT}) + (\% \text{RA} \times \text{RAT})$$

Where:

- MAT = mixed air temperature, dry bulb
- OAT = outside air temperature, dry bulb
- RAT = return air temperature, dry bulb

Then:

$$\begin{aligned} \text{MAT} &= (15\% \times 98 \text{ }^\circ\text{F}) + (85\% \times 75 \text{ }^\circ\text{F}) \\ \text{MAT} &= (14.7) + (63.8) \end{aligned}$$

Answer:

$$\text{MAT} = 78.5^\circ\text{F}$$

Plotting the Mixed Air Condition for Air Conditioning System AC-1

Figure 3-8, condition point C: Draw a line between the return air condition (point A) and the outside air condition (point B). Plot the calculated mixed air temperature (MAT) on line A-B. This is mixed air condition point C. Read the properties at point C: 78.5°FDB, 64.5°FWB, 48%RH.

Cooling Process Line for Air Conditioning System AC-1

The cooling process line illustrates the changes in the air as it goes through the cooling coil. Figure 3-8: Draw the process

line between the mixed air condition, point C and the supply air condition, point D (see Figure 3-7). The process line (C-D) shows a cooling and dehumidifying process. The air is cooled 21.5°FDB (78.5°FDB - 57°FDB) and dehumidified by removing 2 grains of moisture (70 grains - 68 grains) per pound of air.

Calculating Moisture Removed for Air Conditioning System AC-1

To calculate moisture removed in grains per hour use:

$$\text{gr/hr} = \text{cfm} \times 4.5 \times \Delta\text{gr/lb}$$

Where:

gr/hr = grains of moisture per hour

cfm = cubic feet per minute (supply air flow)

4.5 = constant, 60 minutes per hour \times 0.075 lb/cf
(weight of standard air)

$\Delta\text{gr/lb}$ = moisture removed from the air as the
air passes through the cooling coil

Then:

$$\text{gr/hr} = 10,000 \text{ cfm} \times 4.5 \times 2 \text{ gr/lb}$$

Answer:

$$\text{gr/hr} = 90,000$$

To calculate moisture removed in pounds per hour use:

$$\text{lb/hr} = \text{gr/hr} \div 7,000 \text{ gr/lb (constant, 7000 grains in one pound)}$$

Answer:

$$90,000 \text{ gr/hr} \div 7,000 \text{ gr/lb} = 12.86 \text{ lb/hr moisture removed}$$

To calculate moisture removed in gallons per hour use:

$$\text{gal/hr} = \text{lb/hr} \div 8.33 \text{ lb/gal (constant, weight of water)}$$

Answer:

$$12.86 \text{ lb/hr} \div 8.33 \text{ lb/gal} = 1.54 \text{ gal/hr water removed}$$

Figure 3-1. Representation of a Psychrometric Chart—Not to Scale

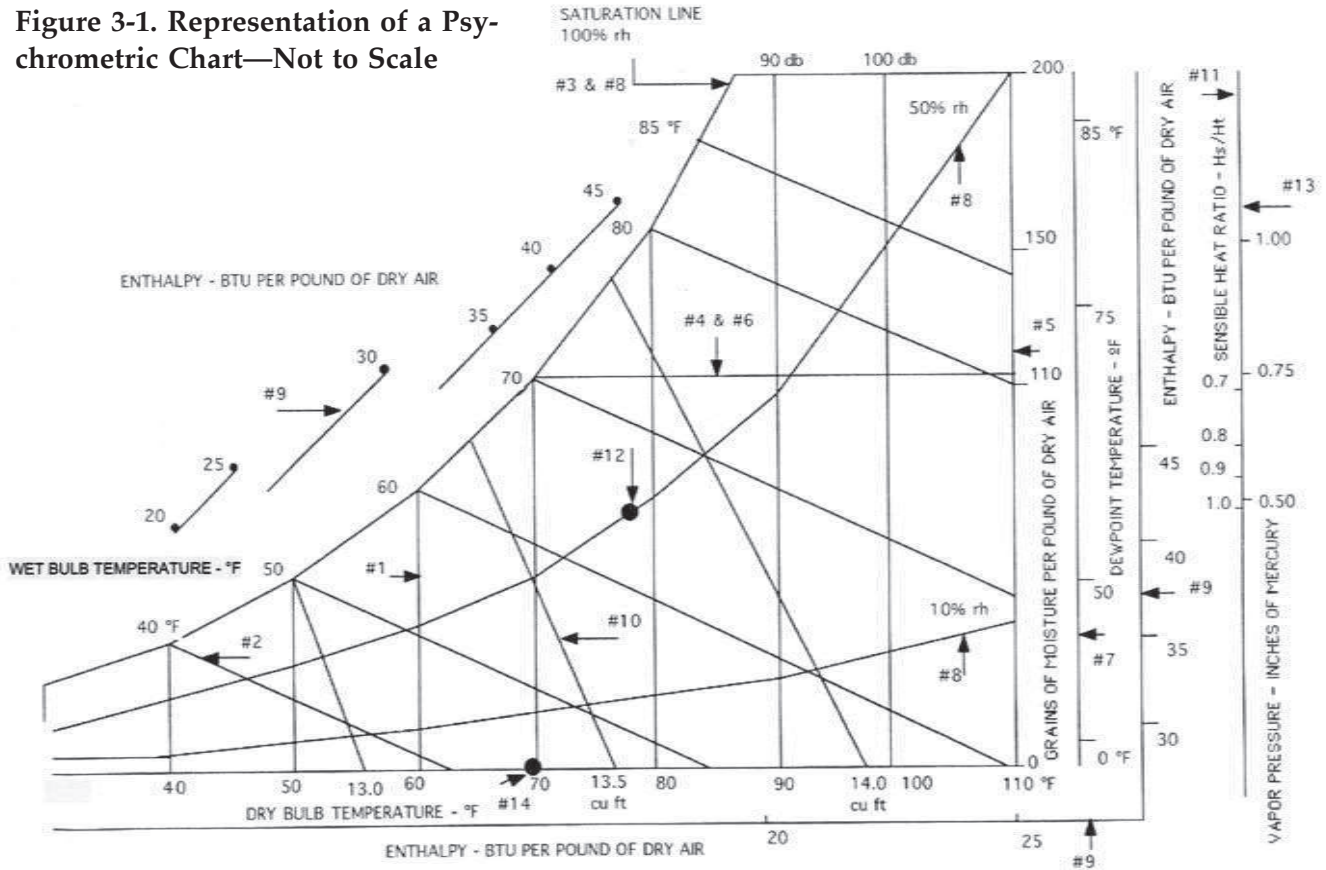

Figure 3-2. Representation of a Psychrometric Chart—Not to Scale

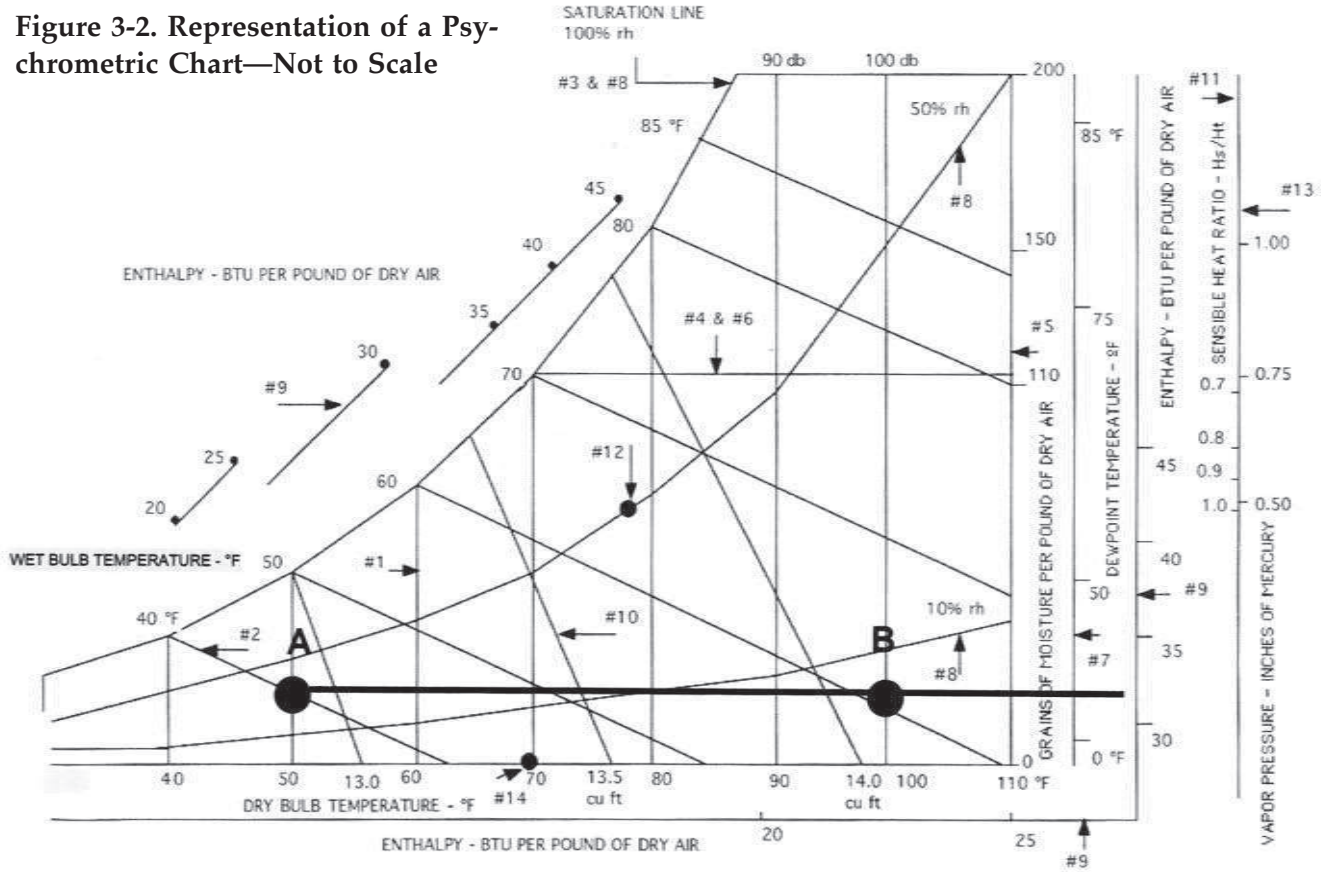

Figure 3-3. Representation of a Psychrometric Chart—Not to Scale

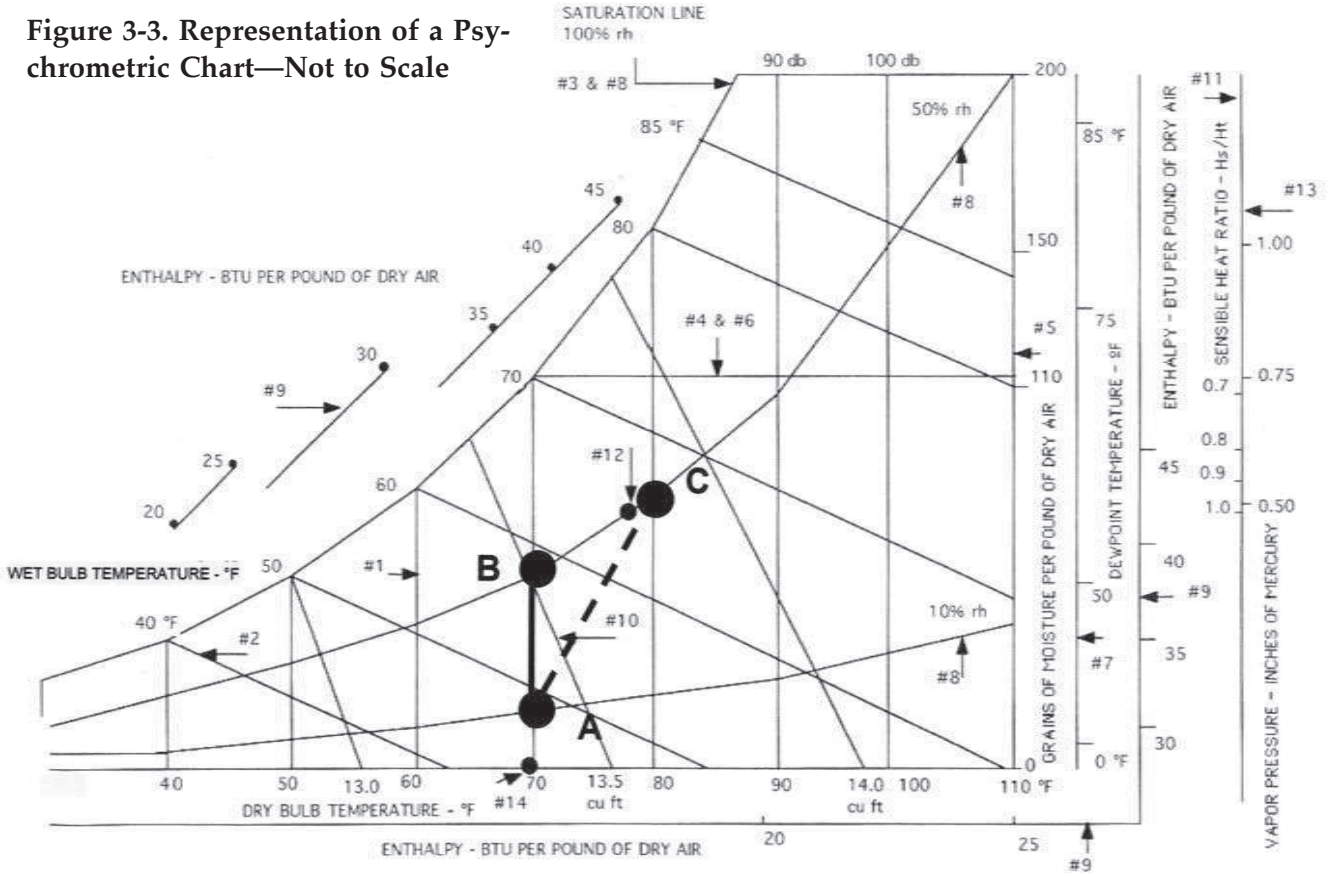

Figure 3-4. Representation of a Psychrometric Chart—Not to Scale

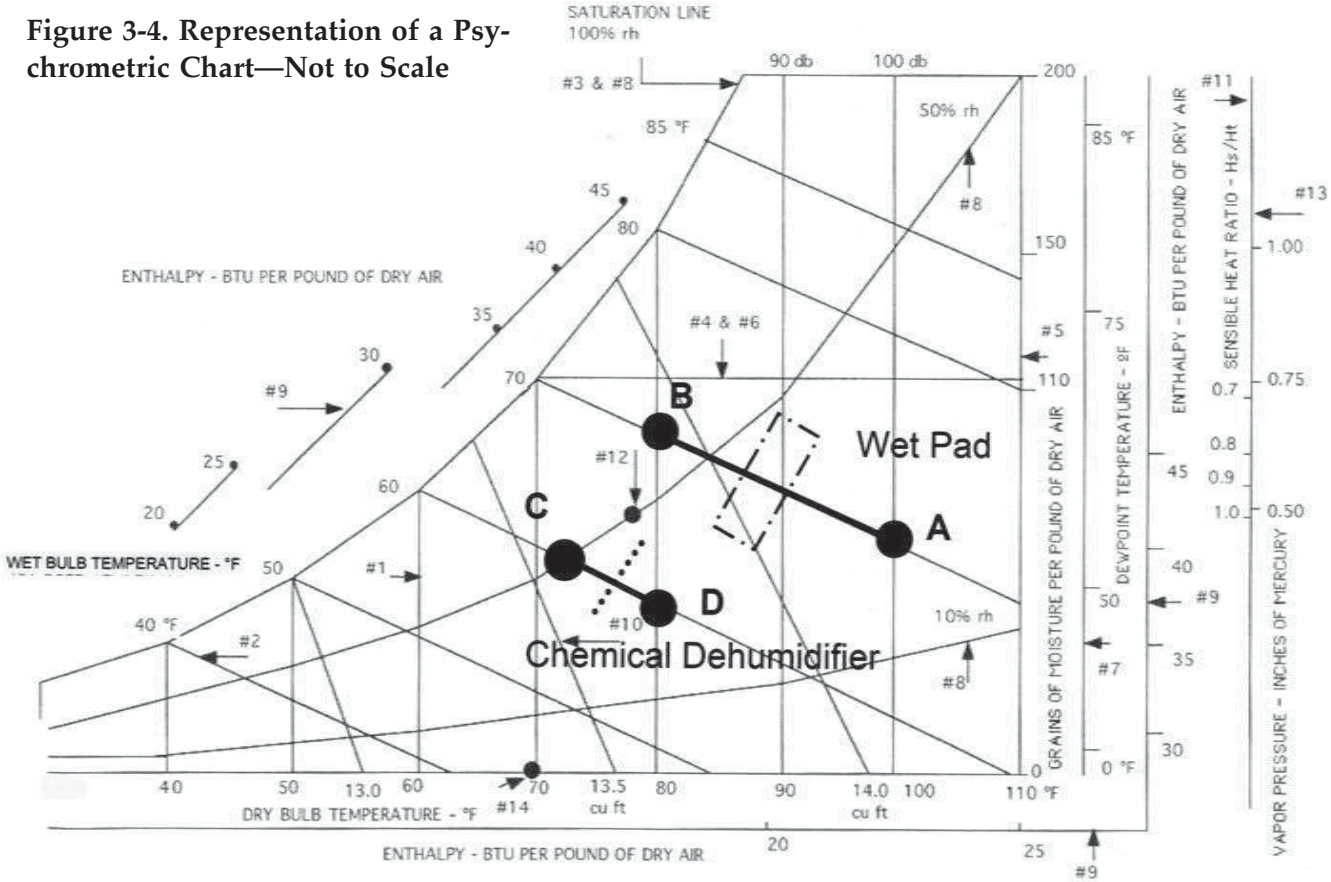

Figure 3-5. Representation of a Psychrometric Chart—Not to Scale

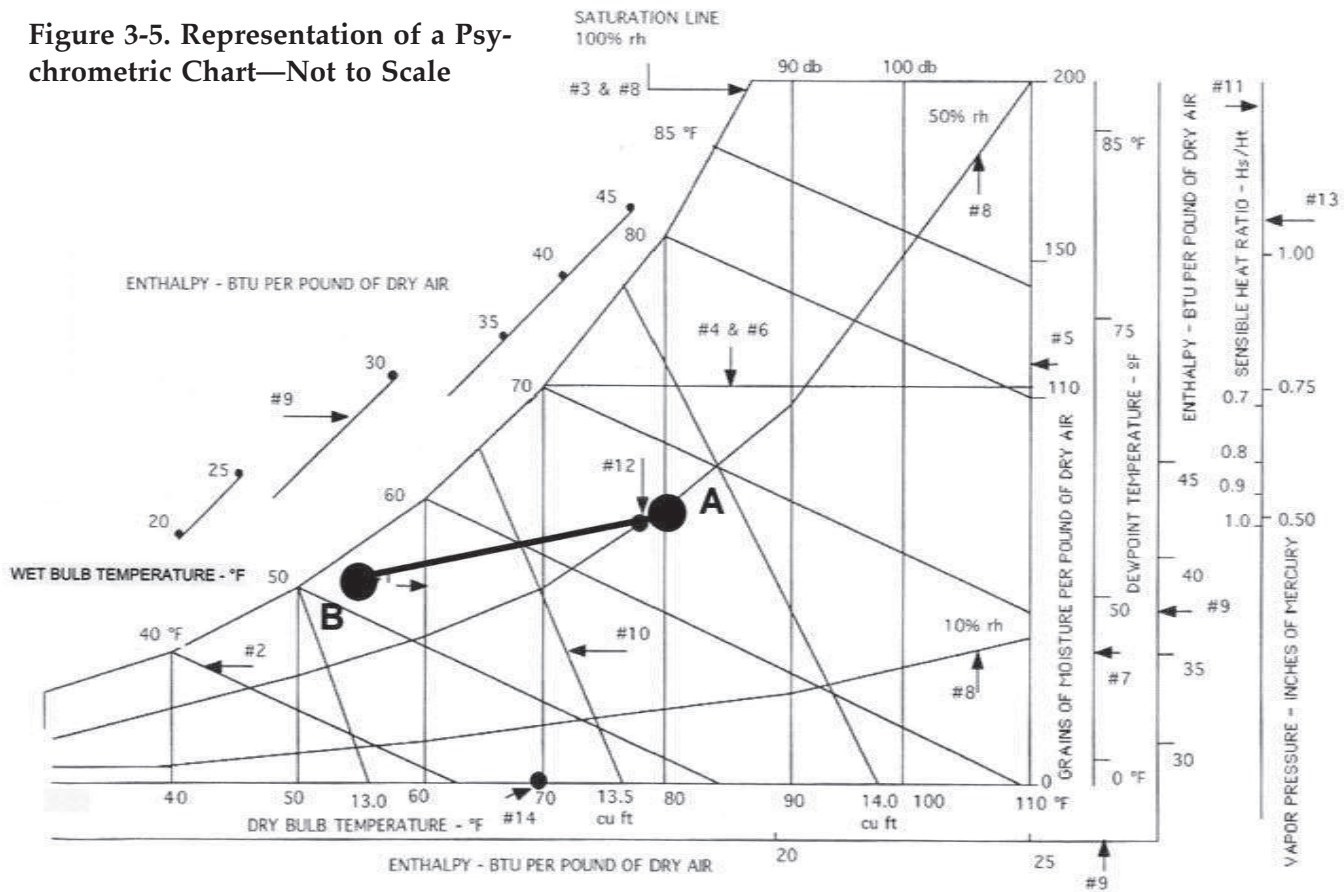

Figure 3-6. Representation of a Psychrometric Chart—Not to Scale

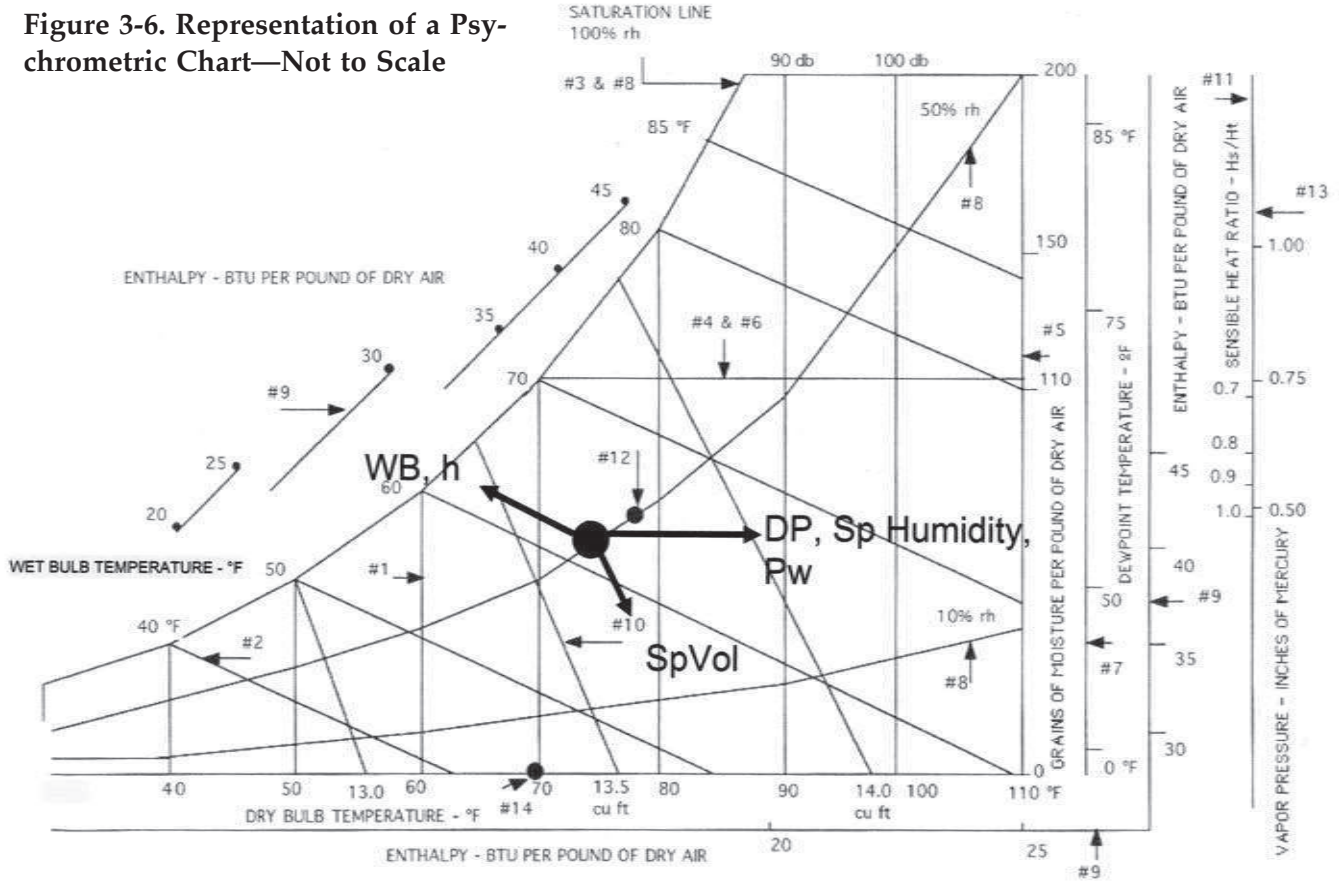

Figure 3-7. Representation of a Psychrometric Chart—Not to Scale

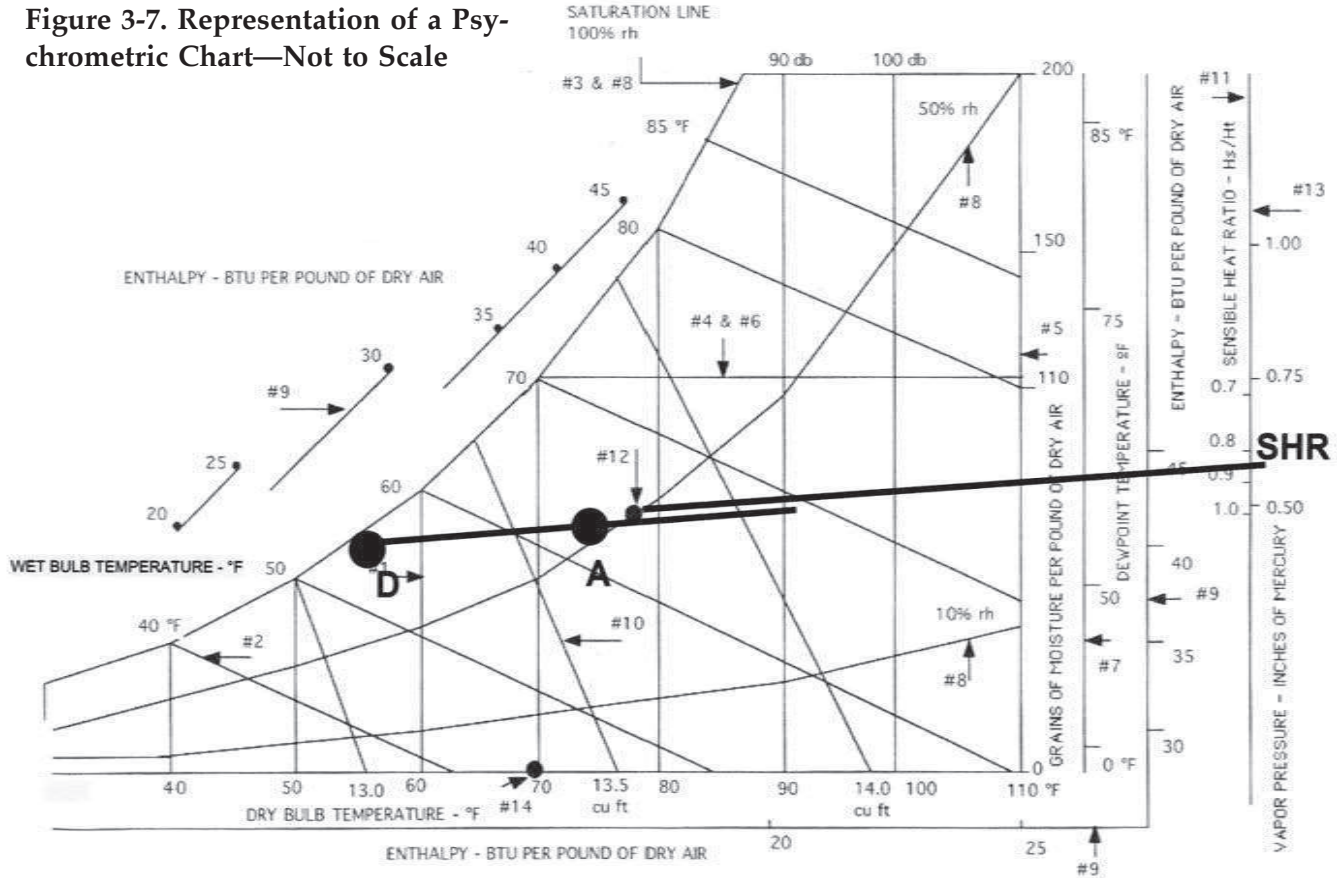
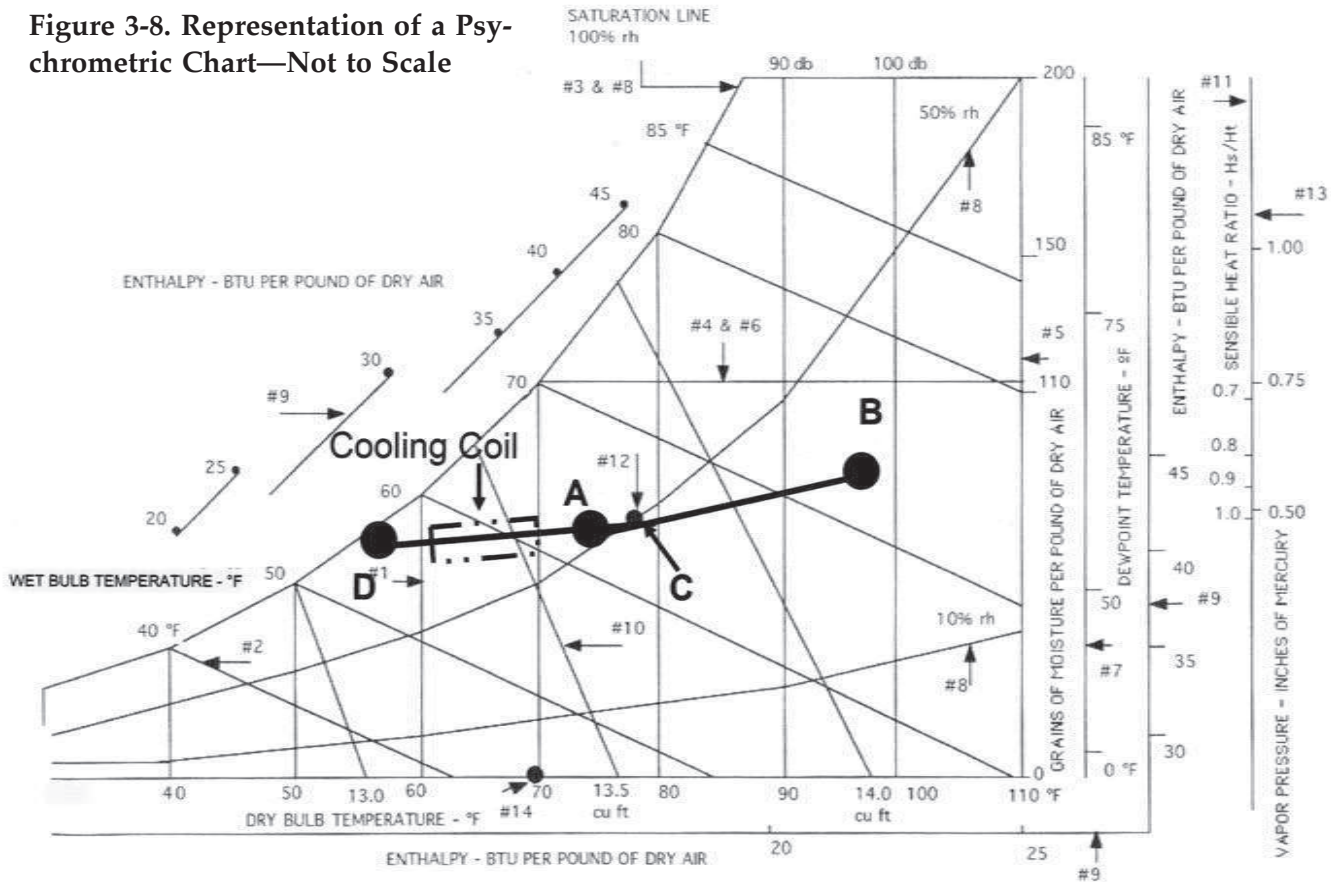

Figure 3-8. Representation of a Psychrometric Chart—Not to Scale



This page intentionally left blank

Chapter 4

Heating and Ventilating Systems

Entering a steam or hot water boiler are the following:

- Electrical Power
- Fuel (oil, gas, or coal)
- Combustion Air
- Chemical Treatment

Leaving a steam or hot water boiler are the following:

- Flue Gases
- Radiation Losses
- Blowdown
- Heating Medium — Steam or Hot Water

Typical Heating Medium Operating Temperatures

Steam	Hot Water
250°F	170°F-200°F

HEATING SYSTEMS

For over 10,000 years, man has used fire to warm himself. In the beginning, interior heating was just an open fire, but comfort and health was greatly improved by finding a cave with a hole at the top. Later, fires were contained in hearths or sunken beneath the floor. Eventually, chimneys were added which made for better heating, comfort, health, and safety and also allowed individuals to have private rooms. Next, came stoves usually made of brick,

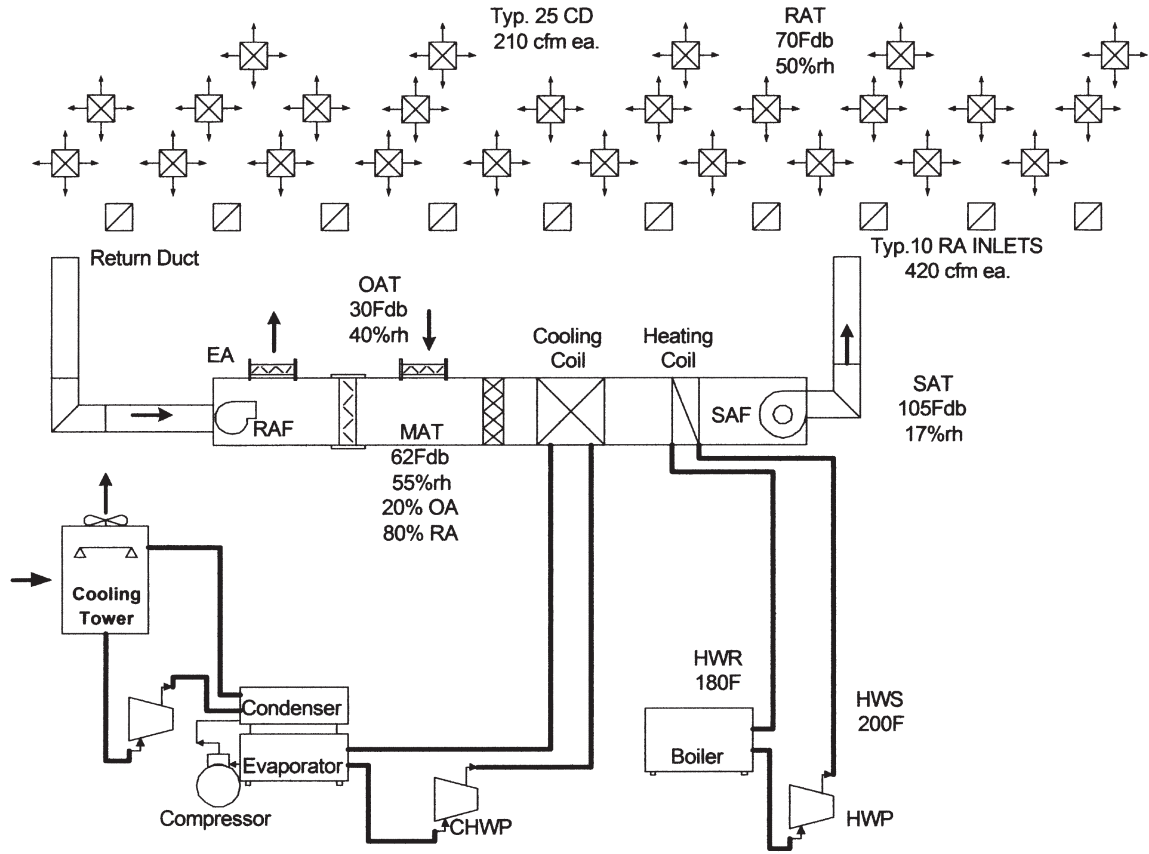

Figure 4-1. Central HVAC System "Hot Water Heating"

earthenware, or tile. In the 1700s, Benjamin Franklin improved the stove, the first steam heating system was developed, and a furnace for warm-air heating used a system of pipes and flues and heated the spaces by gravity flow. In the 1800s, high speed centrifugal fans and axial flow fans with small, alternating current electric motors became available and high-pressure steam heating systems were first used. The 1900s brought the Scotch marine boiler and positive-pressure hydronic circulating pumps that forced hot water through the heating system. The heating terminals were hot water radiators, which were long, low, and narrow, as compared to steam radiators, and allowed for inconspicuous heating. Centrifugal fans were added to furnaces in the 1900s to make forced-air heating systems.

COMBUSTION

Combustion is defined as a chemical reaction between a fossil fuel such as coal, natural gas, liquid petroleum gas, or fuel oil, and oxygen. Fossil fuels consist mainly of hydrogen and carbon molecules. These fuels also contain minute quantities of other substances (such as sulfur) which are considered impurities. When combustion takes place, the hydrogen and the carbon in the fuel combine with the oxygen in the air to form water vapor and carbon dioxide.

If the conditions are ideal, the fuel-to-air ratio is controlled at an optimum level, and the heat energy released is captured and used to the greatest practical extent. Complete combustion (a condition in which all the carbon and hydrogen in the fuel would be combined with all the oxygen in the air) is a theoretical concept and cannot be attained in HVAC equipment. Therefore, what is attainable is called incomplete combustion. The products of incomplete combustion may include unburned carbon in the form of smoke and soot, carbon monoxide (a poisonous gas), as well as carbon dioxide and water.

BOILER HEATING SYSTEMS

Heating systems provide heat to designated areas by transporting heat energy generated in the boiler. The two types of boiler heating systems are steam heating and hot water heating. The difference in the two heating systems is the medium used to transport heat energy from the boiler to the area to be heated. Steam is used to transport heat energy in the steam heating system, and water is used to transport heat energy in the hot water heating system.

STEAM HEATING SYSTEMS

Steam has some design and operating advantages over hot water heating systems. For instance, one pound of steam at 212°F when condensed (latent heat of condensation) into one pound of hot water gives up approximately 1000 Btu per pound of steam. On the other hand, a hot water heating system with supply water temperatures at 200°F and return water temperatures at 180°F only gives up 20 Btu per pound of water (1 Btu/lb/°F). Another advantage is that steam, based on its operating pressure, flows throughout the system on its own while a pump and motor is needed to circulate hot water.

In an open vessel, at standard atmospheric pressure (sea level), water vaporizes or boils into steam at a temperature of 212°F. But the boiling temperature of water, or any liquid, is not constant. The boiling temperature can be changed by changing the pressure on the liquid. If the pressure is to be changed, the liquid must be in a closed vessel. In the case of water in a heating system, the vessel is the boiler. Once the water is in the boiler it can be boiled at a temperature of 100°F or 250°F or 300°F as easily as at 212°F. The only requirement is that the pressure in the boiler be changed to the one corresponding to the desired boiling point. For instance, if the pressure in the boiler is 0.95 pounds per square inch absolute (psia), the boiling temperature of the water will be 100°F. If the pressure is raised to 14.7 psia,



Figure 4-2. Steam Boiler

the boiling temperature is raised to 212°F. If the pressure is raised again to 67 psia, the temperature is correspondingly raised to 300°F. A common low pressure HVAC steam heating system will operate at 15 pounds per square inch gage pressure (psig), which is a pressure of 30 psia and a temperature of 250°F.

The amount of heat required to bring the water to its boiling temperature is its sensible heat. Additional heat is then required for the change of state from water to steam. This addition of heat is steam's latent heat content or "latent heat of vaporization." To vaporize one pound of water at 212°F to one pound of steam at 212°F requires 970 Btu. The amount of heat required to bring wa-

ter from any temperature to steam is called “total heat.” It is the sum of the sensible heat and latent heat. The total heat required to convert one pound of water at 32°F to one pound of steam at 212°F is 1150 Btu. The calculation is as follows: the heat required to raise one pound of water at 32°F to water at 212°F is 180 Btu of sensible heat. 970 Btu of latent heat is added to one pound of water at 212°F to convert it to one pound of 212°F steam. Notice that the latent heat is over 5 times greater than sensible heat ($180 \text{ Btu} \times 5.39 = 970 \text{ Btu}$). The total heat is 1150 Btu ($180 + 970$). See Figure 4-3.

Point 1 — One pound of ice (a solid) at 0°F.

Point 1 to Point 2 — 16 Btu of sensible heat added to raise the temperature of the ice from 0°F to 32°F. Specific heat of ice is 0.5 Btu/lb/°F.

Point 2 to Point 3 — Ice changing to water (a liquid) at 32°F. It takes 144 Btu of latent heat to change one pound of ice to one pound of water.

Point 3 to Point 4 — 180 Btu of sensible heat added to raise the temperature of the water from 32°F to 212°F. Specific heat of water is 1.0 Btu/lb/°F.

Point 4 to Point 5 — Water changing to steam (a vapor) at 212°F. It takes 970 Btu of latent heat to change one pound of water to one pound of steam.

Point 5 to Point X — X amount of Btu of sensible heat added to raise the temperature of the steam from 212°F to X°F. This is called superheating the steam and the result is “superheated steam.” For example, if the final temperature of the superheated steam is 250°F then 19 Btu of sensible heat would have to be added ($250^\circ\text{F} - 212^\circ\text{F} = 38^\circ\text{F}$. $38^\circ\text{F} \times 0.5 \text{ Btu/lb/}^\circ\text{F}$ specific heat for steam $\times 1 \text{ lb of steam} = 19 \text{ Btu}$).

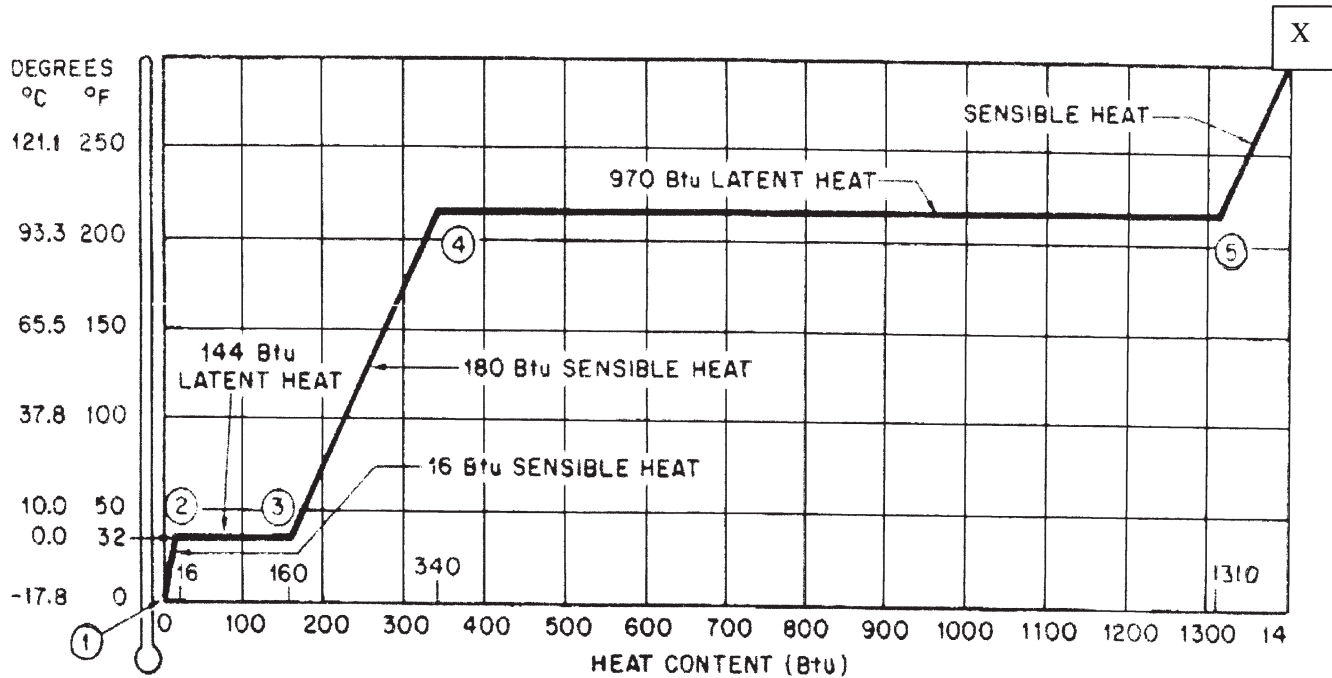

Figure 4-3. Btu change in One Pound of Ice to Water to Steam to Superheated Steam

PRESSURE CLASSES OF STEAM HEATING SYSTEMS

Steam systems may be classified as low pressure (15 psig/30 psia or less) or high pressure (greater than 15 psig/30 psia). It is important to recognize that low pressure steam contains more latent heat per pound than high pressure steam. For example, low pressure steam at 250°F and 30 psia has 946 Btu per pound of latent heat while high pressure steam at 700°F and 3,094 psia has only 172 Btu per pound of latent heat. This indicates that while high pressure steam may be required to provide very high temperatures and pressures for process functions, low pressure steam provides more economical operation.

STEAM TRAPS

Steam traps are installed in locations where condensate is formed and collects, such as all low points, below heat exchangers and coils, at risers and expansion loops, at intervals along horizontal pipe runs, ahead of valves, at ends of mains, before pumps, etc. The purpose of a steam trap is to separate the steam (vapor) side of the heating system from the condensate (water) side. A steam trap collects condensate and allows the trapped condensate to be drained from the system, while still limiting the escape of steam. The condensate may be returned to the boiler by a gravity return system, a mechanical return system using a vacuum pump (closed system), or condensate pump (open system).

Condensate must be trapped and then drained immediately from the system. If it isn't, the operating efficiency of the system is reduced because the heat transfer rate is slowed. In addition, the build up of condensate can cause physical damage to the system from "water hammer." Water hammer can occur in a steam distribution system when the condensate is allowed to accumulate on the bottom of horizontal pipes and is pushed along by the velocity of the steam passing over it. As the velocity increases, the condensate can form into a non-compressible

slug of water. If this slug of water is suddenly stopped by a pipe fitting, bend, or valve the result is a shock wave which can, and often does, cause damage to the system (such as blowing strainers and valves apart).

Steam traps also allow air to escape. This prevents the build up of air in the system which reduces the heat transfer efficiency of the system and may cause air binding in the heat exchanger. In a steam heating system, water enters a heat conversion unit (a heat exchanger, the boiler, etc.) and is changed into steam. When the water is boiled, some air in the water is also released into the steam and is moved along with the steam to the heat exchanger. As the heat is released at the heat exchangers (and through pipe radiation losses), the steam is changed into condensate water. Some of the air in the piping system is absorbed back into the water. However, much of the air collects in the heat exchanger and must be vented.

Steam traps are classified as thermostatic, mechanical or thermodynamic. Thermostatic traps sense the temperature difference between the steam and the condensate using an expanding bellows or bimetal strip to operate a valve mechanism. Mechanical traps use a float to determine the condensate level in the trap and then operate a discharge valve to release the accumulated condensate. Some thermodynamic traps use a disc which closes to the high velocity steam and opens to the low velocity condensate. Other types will use an orifice which flashes the hot condensate into steam as the condensate passes through the orifice.

HOT WATER HEATING SYSTEMS

Hot water heating systems (Figure 4-4) transport heat by circulating heated water to a designated area. Heat is released from the water as it flows through the heating unit (coil, terminal). After heat is released, the water returns to the boiler to be reheated and recirculated. Low temperature hot water boilers are $\leq 250^{\circ}\text{F}$. High temperature hot water boilers are $>250^{\circ}\text{F}$.

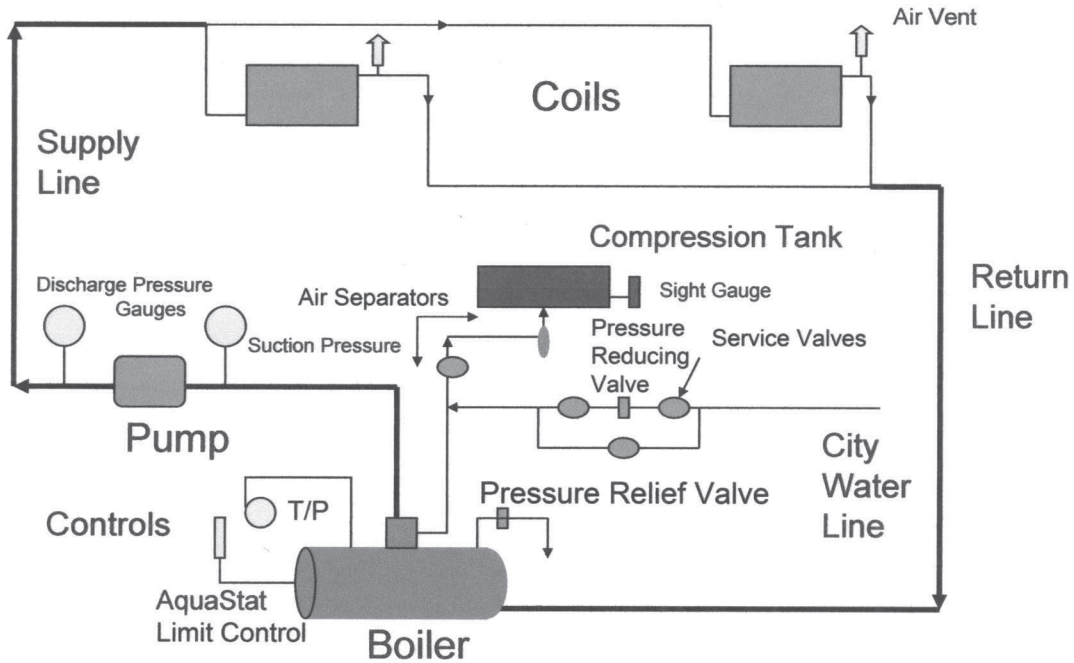

Figure 4-4. Hot Water Heating System

ADVANTAGES OF HOT WATER HEATING OVER STEAM HEATING

Hot water heating systems produce heat more consistently than steam heating systems. The water in a hot water heating system remains in the lines at all times. The water in the heating unit lines heats and cools slowly, resulting in an even rate of heat production. When pressure is lost in the steam heating system, steam leaves the heating units resulting in a more rapid loss of heat than in a hot water heating system. In addition, the steam heating system has a longer recovery time in producing heat after the boiler is shut down.

BOILERS

Boilers are used in both hot water heating systems and steam heating systems. The hot water heating systems most often encountered in HVAC work will be low temperature systems with boiler water temperatures generally in the range of 170-200 degrees Fahrenheit. Most of the steam heating systems will use low pressure steam, operating at 15 psig (30 psia, and 250°F). There are a great many types and classifications of boilers. Boilers can be classified by size, construction, appearance, original usage, and fuel used. Fossil-fuel boilers will be either natural gas-fired, liquid petroleum (LP) gas-fired, or oil-fired (Figure 4-5). Some boilers are set up so that the operating fuel can be switched to natural gas, LP gas or oil, depending on the fuel price and availability. The construction of boilers remains basically the same whether they're water boilers or steam boilers. However, water or steam boilers are divided by their internal construction into fire tube or water tube boilers.

FIRE TUBE BOILERS

A fire tube boiler, as the name suggests, has the hot flue gases from the combustion chamber (Figure 4-6), the chamber

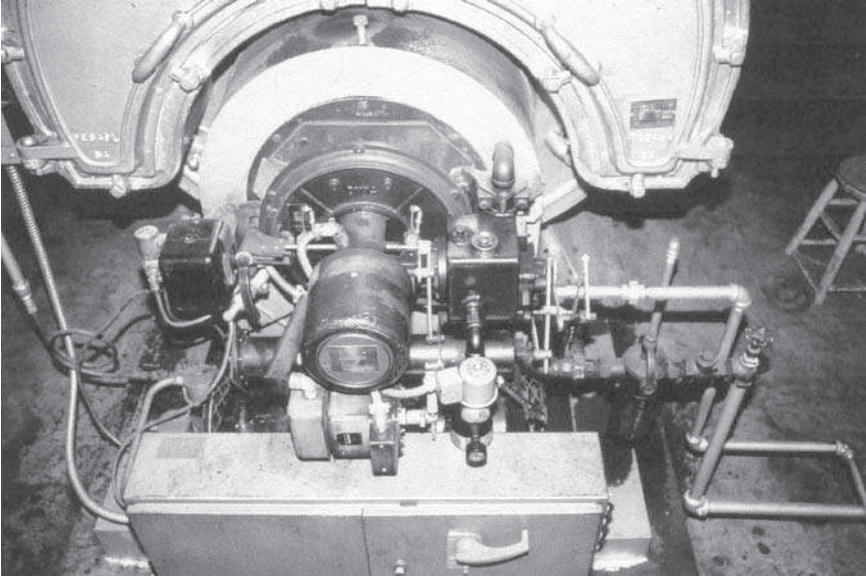

Figure 4-5. Oil-fired Boiler

in which combustion takes place, passing through tubes and out the boiler stack. These tubes are surrounded by water. The heat from the hot gases transfers through the walls of the tubes and heats the water. Fire tube boilers may be further classified as externally fired, meaning that the fire is entirely external to the boiler or they may be classified as internally fired, in which case, the fire is enclosed entirely within the steel shell of the boiler. Two other classifications of fire tube boilers are wet-back or dry-back. This refers to the compartment at the end of the combustion chamber. This compartment is used as an insulating plenum so that the heat from the combustion chamber, which can be several thousand degrees, does not reach the boiler's steel jacket. If the compartment is filled with water it is known as a wet-back boiler and conversely, if the compartment contains only air is called a dry-back boiler.

Still another grouping of fire tube boilers is by appearance or usage. The two common types used today in HVAC heating systems are the marine or Scotch marine boiler and the firebox



Figure 4-6. Combustion Chamber and Fire Tubes. Two-pass Boiler

boiler. The marine boiler was originally used on steam ships and is long and cylindrical in shape. The firebox boiler has a rectangular shape, almost to the point of being square. A Scotch marine fire tube boiler has the flame in the furnace and the combustion gases inside the tubes. The furnace and tubes are within a larger vessel, which contains the water and steam. Fire tube boilers are also identified by the number of passes that the flue gases take through the tubes. Boilers are classified as two-, three- or four-pass. The combustion chamber is considered the first pass. Therefore, a two-pass boiler would have one-pass down the combustion chamber looping around and the second pass coming back to the front of the boiler and out the stack. A three-pass boiler would have an additional row of tubes for the gas to pass through going to the back of the boiler and out the stack. A four-pass boiler would have yet another additional row of tubes for the gas to pass through going to the front of the boiler and out the stack. An easy way to recognize a two-, three- or four-pass boiler is by the location of the stack. A two- or four-pass boiler

will have the stack at the front, while a three-pass boiler will have the stack at the back.

Fire tube boilers are available for low and high pressure steam, or hot water applications. The size range is from 15 to 1500 boiler horsepower (a boiler horsepower is 33,475 Btuh). HVAC fire tube boilers are typically used for low pressure applications.

WATER TUBE BOILERS

In a water tube boiler, the water is in the tubes while the fire is under the tubes. The hot flue gases pass around and between the tubes, heating the water and then out the boiler stack. Most of the water tube boilers used in heating systems today are rectangular in shape with the stack coming off the top, in the middle of the shell. Water tube boilers produce steam or hot water for industrial processes, commercial applications, or other modest-size applications. They are used less frequently for comfort heating applications. Water tube boilers typically range from 25 boiler horsepower (836,875 Btuh or 836.88 MBh) to 250 boiler horsepower (8,368,750 Btuh, or 8368.75 MBh or 8.37 MMBh).

BOILER OPERATION

For a better understanding of boiler construction and operation, let's examine a four-pass, internally fired, fire tube, natural gas-fired, forced-draft, marine, wet-back boiler. The boiler consists of a cylindrical steel shell which is called the pressure vessel. It is covered with several inches of insulation to reduce heat loss. The insulation is then covered with an outer metal jacket to prevent damage to the insulation. Some of the other components are a burner, a forced-draft fan and various controls. When the boiler is started it will go through a purge cycle in which the draft fan at the front of the boiler will force air through the combustion

chamber and out the stack at the front of the boiler. This purges any combustibles that might be in combustion chamber. An electrical signal from control circuit will open the pilot valve allowing natural gas to flow to the burner pilot light. A flame detector will verify that the pilot is lit and gas will then be supplied to the main burner. The draft fan forces air into the combustion chamber and combustion takes place. The hot combustion gases flow down the chamber and into the tubes for the second pass back to the front of the boiler. As the gases pass through the tubes they are giving up heat into the water. The gases enter into the front chamber of the boiler, called the header, and make another loop to the back of the boiler for the third pass. The fourth pass brings the hot gases back to the front of the boiler and out the stack. The temperature in the combustion chamber is several thousand degrees while the temperature of the gases exiting the stack should be about 320 degrees (or 150 degrees above the medium temperature).

BURNERS

The function of the burner is to deliver, ignite and burn the proper mixture of air and fuel. The types of burners are varied and selection depends on the design of the boiler. For instance, gas burners are classified as atmospheric or mechanical-draft burners. Atmospheric burners are sub-classified as natural-draft or Venturi burners. Mechanical-draft burners are either forced- or induced-draft burners. A typical gas burner used on large industrial and commercial boilers is a burner with a fan or blower at the inlet. This type of burner, which is a forced-draft burner, is called a power burner (Figure 4-7). It uses the blower to provide combustion air to the burner and the combustion chamber under pressure and in the proper mixture with the gas over the full range of firing from minimum to maximum. Another type of gas burner uses a blower at the outlet of the combustion chamber to create a slight partial vacuum within the chamber. This causes a suction which draws air into the chamber. This type of burner is

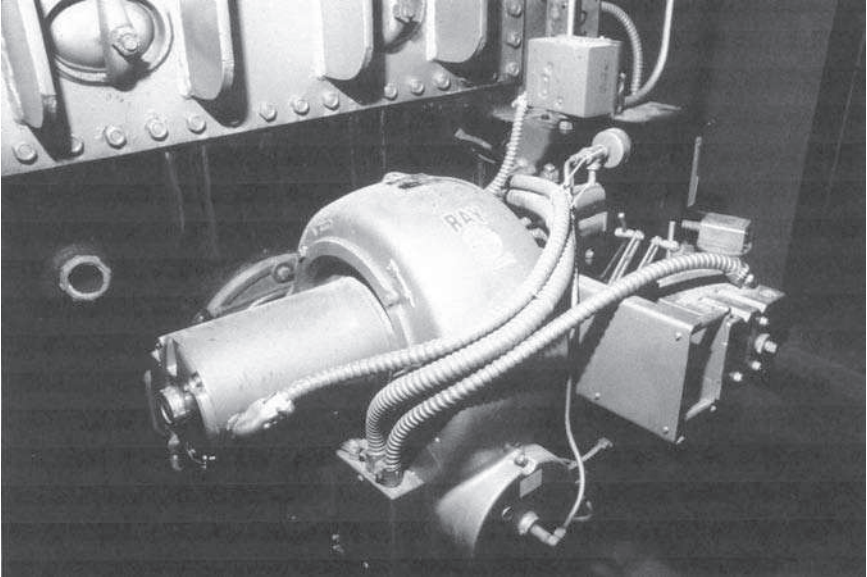

Figure 4-7. Gas Power Burner

called an induced-draft burner.

Oil burners (Figure 4-8), except for small domestic types, deliver the fuel to the burner under pressure provided by the oil pump. The heavier oils, numbers 4, 5, and 6, generally require preheating to lower their viscosity so that they can be pumped to the burner. In addition, all oils must be converted to a vapor before they can be burned. Large commercial and industrial burners use two steps to prepare the oil for burning. The first step is called atomization which is the reduction of the oil into very small droplets. The second step is vaporization which is accomplished by heating the droplets. Oil burners are classified by how they prepare the oil for burning such as vaporizing, atomizing or rotary. Oil burners use the same methods of delivering air to the combustion chamber as do gas burners. They are either natural-, forced- or induced-draft. Regardless of what type of burner is used, proper combustion depends on the correct ratio of fuel-to-air.

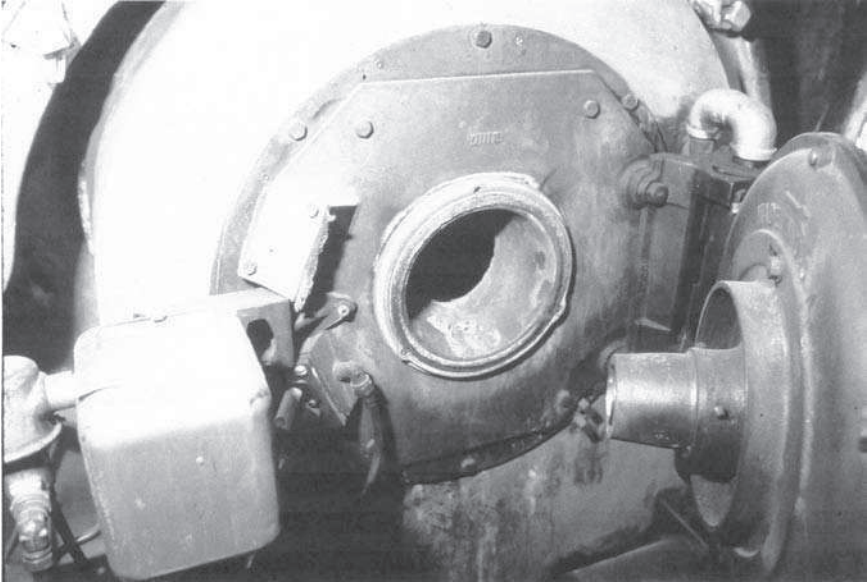

Figure 4-8. Oil Burner

FUEL-TO-AIR RATIOS

A high fuel-to-air ratio causes sooting and lowers boiler efficiency. In certain conditions, it may also be dangerous if there's not enough air for complete combustion and dilution of the fuel. An improperly adjusted burner, a blocked exhaust stack, the blower or dampers set incorrectly, or any condition which results in a negative pressure in the boiler room, can cause a high fuel-to-air condition. A negative pressure in the boiler room can be the result of one or a combination of conditions such as an exhaust fan creating a negative pressure in the boiler room, a restricted combustion air louver into the boiler room, or even adverse wind conditions.

High air-to-fuel ratios also reduce boiler efficiency. If too much air is brought in (excess air), the hot gases are diluted too much and move too fast through the tubes before proper heat transfer can occur. High air volumes are typically caused by improper blower or damper settings.

ELECTRIC BOILERS

Electric boilers produce heat by electricity and operate at up to 16,000 volts. Electric boilers are typically compact, clean and quiet. They have replaceable heating elements, either electrode or resistance-coil. With the electrode type boiler, the heat is generated by electric current flowing from one electrode to another electrode through the boiler water. Resistance-coil electric boilers have the electricity flowing through a coiled conductor similar to an electric space heater. Resistance created by the coiled conductor generates heat. Resistance-coil electric boilers are not as common as electrode electric boilers.

Electric boilers are an alternative to oil or gas boilers where these boilers are restricted by emission regulation and in areas where the cost of electric power is minimal. Electric boilers can be fire tube or water tube and supply low or high pressure steam or hot water. Sizes range from 9 kW to 3,375 kW output, which is 30,717 Btuh to 11,518,875 Btuh (1 kW = 3413 Btuh).

HEAT AND FLUID FLOW CALCULATIONS FOR HEATING SYSTEM

Looking at the heating system, Figure 4-9, calculate gpm of water flow if the heating coil load is 243,810 Btuh and TD is 20°F (200°F EWT - 180°F LWT).

$$\text{Btuh} = \text{gpm} \times 500 \times \text{TD}$$

Where:

Btuh = Btu per hour

gpm = volume of water flow, gallons per minute

500 = constant

$60 \text{ min/hr} \times 8.33 \text{ lb/gal} \times 1 \text{ Btu/lb/}^\circ\text{F}$

TD = temperature difference of the water entering (EWT) and leaving (LWT) the coil. ΔT may be used substituted for TD.

Then:

$$\text{gpm} = \text{Btuh} \div (500 \times \text{TD})$$

$$\text{gpm} = 243,810 \div (500 \times 20)$$

Answer:

24.4 gpm of water flows through the heating coil.

Now calculate the air TD across the heating coil if:

198,450 Btuh is the Sensible Room Heating Load.

The math is: $198,450 = 5250 \text{ cfm} \times 1.08 \times 35 \text{ TD} (105-70)$

243,810 Btuh is the Sensible Coil Heating Load.

The difference of 45,360 Btuh (243,810–198,450) is the additional heat required for the outside air.

The math is: $45,360 = 1050 \text{ cfm} \times 1.08 \times 40 \text{ TD} (70-30)$

LAT - leaving air temperature (coil). (Also called SAT, supply air temperature) (105°F)

EAT - entering air temperature (coil), (also called RAT, room air temperature) (70°F)

OAT - outside air temperature (30°F)

Then:

$$\text{TD} = \text{Btuh} \div (1.08 \times \text{cfm})$$

$$\text{TD} = 243,810 \div (1.08 \times 5250)$$

Answer:

43°F TD (62 EAT + 43 TD = 105 LAT)

243,810 Btuh is the Sensible Coil Heating Load.

The math is: $243,810 = 5250 \text{ cfm} \times 1.08 \times 43 \text{ TD} (105-62)$

The mixed air temperature (MAT also called EAT) was calculated using this equation:

$$\text{MAT} = (\% \text{OA} \times \text{OAT}) + (\% \text{RA} \times \text{RAT})$$

Where:

MAT = mixed air temperature

OAT = outside air temperature
 RAT = return air temperature, also called room air temperature

Then:

$$\text{MAT} = (20\% \times 30^\circ\text{F}) + (80\% \times 70^\circ\text{F})$$

$$\text{MAT} = (6) + (56)$$

Answer:

$$\text{MAT} = 62^\circ\text{F}$$

VENTILATING SYSTEMS

In occupied buildings, carbon dioxide, human odors and other contaminants such as volatile organic compounds (VOC) or odors and particles from machinery and the process function

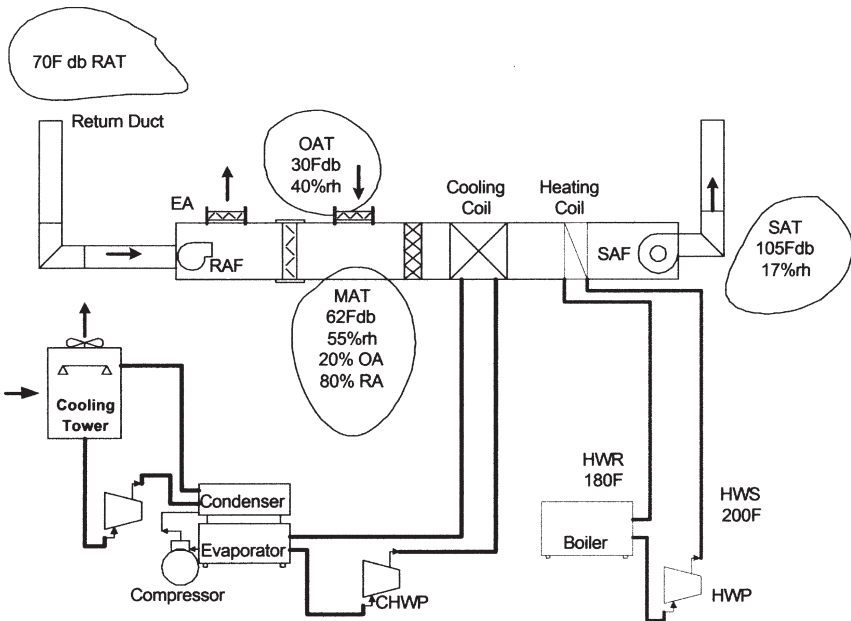

Figure 4-9. Heating System

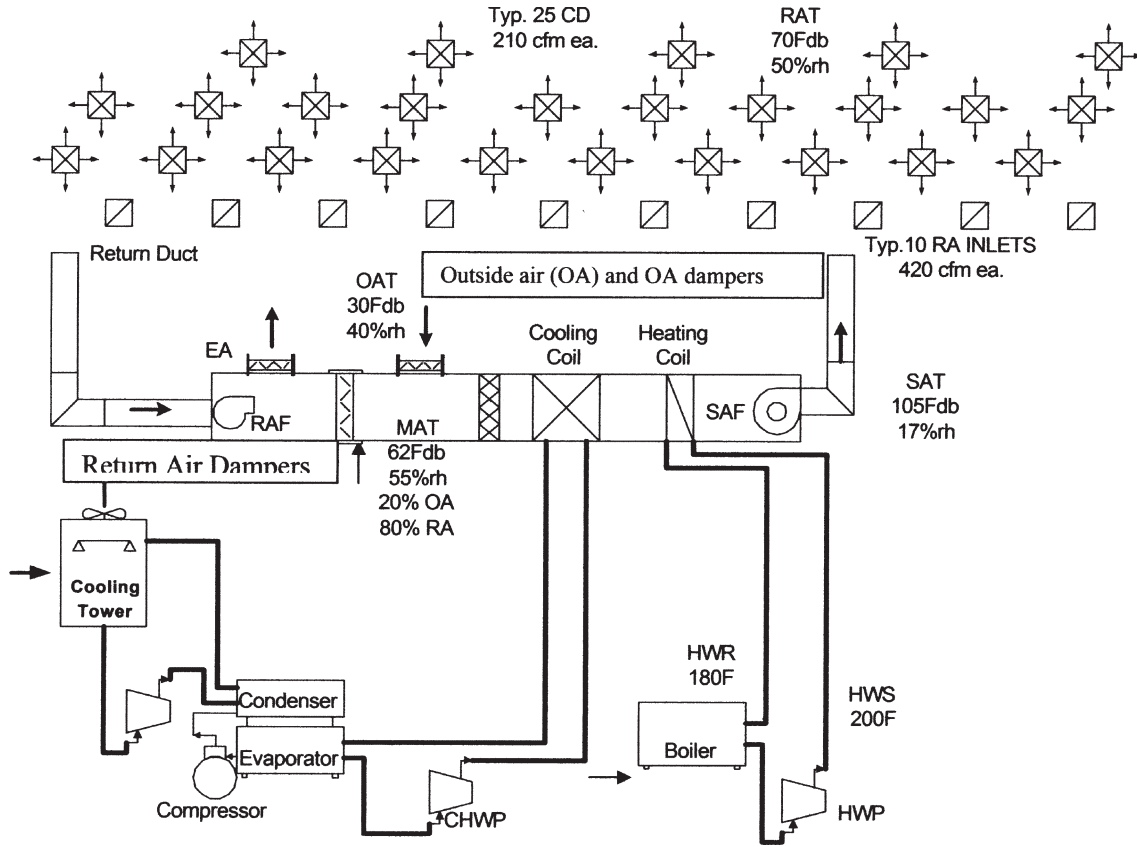

Figure 4-10. Central HVAC System "Ventilating"

need to be continuously removed or unhealthy conditions will result. Ventilation is the process of supplying “fresh” outside air to occupied buildings in the proper amount to offset the contaminants produced by people and equipment.

In many instances, local building codes, association guidelines, or government or company protocols stipulate the amount of ventilation required for buildings and work environments. Ventilation systems have been around for a long time. In 1490, Leonardo da Vinci designed a water driven fan to ventilate a suite of rooms. In 1660, a gravity exhaust ventilating system was used in the British House of Parliament. Then, almost two hundred years later, in 1836, the supply air and exhaust air ventilation system in the British House of Parliament used fans driven by steam engines.

Today, ventilation guidelines are approximately 15 to 25 cfm (cubic feet per minute) of air volume per person of outside air (OA) for non-smoking areas, 50 cfm for smoking areas. Ventilation air may also be required as additional or “make-up” air (MUA) for kitchen exhausts, fume hood exhaust systems, and restroom and other exhaust systems. Maintaining room or conditioned space pressurization (typically +0.03 to +0.05 inches of water gage) in commercial and institutional buildings is part of proper ventilation.

Figure 4-10 shows 20% of the total supply air is ventilation outside air (OA) and 80% is return air (RA). The outside air is brought (or forced) into the mixed air plenum by the action of the supply air fan. The outside air coming through the outside damper is mixed with the return air from the conditioned space. The return air dampers control the amount of return air. If the room pressure is too high, the exhaust air (EA) dampers open to let some of the return air escape to the outside, which relieves some of the pressure in the conditioned space. Exhaust air dampers are also called relief air dampers.

Chapter 5

Air Conditioning Systems

Standard Air Conditions (sea level):

Temperature: 70°F

Density: 0.075 lb/cf

Specific Volume: 13.34 cf/lb

Specific Heat: 0.24 Btu/lb°F

Density and Specific Volume are reciprocals.

$$D = 1/SpV \quad 1 \div SpV (1 \div 13.34 = 0.075)$$

$$SpV = 1/D \quad 1 \div D (1 \div 0.075 = 13.34)$$

Barometric Pressure: 29.92" Hg (inches of mercury) (rounded to 30)
14.7 psia (pounds per square inch absolute)
(rounded to 15)
1 psi = 2.035" Hg (rounded to 2.0)
1" Hg = 0.491 psi (rounded to 0.5)

Barometric Pressure Rule of Thumb:

Barometric pressure drops 1" for every 1000' increase in altitude or 0.1" for every 100' increase in altitude.

Example: 5000' altitude is approximately 25" Hg (30" - 5" = 25")

Actual barometric pressure is 24.89" Hg. (at 70°F)

Specific Humidity is the amount of moisture (measured in grains or pounds) in a pound of air. Example: 60 grains of moisture per pound of air (60 gr/lb).

Relative Humidity (RH) is the ratio of the amount of moisture (water vapor) present in the air to the total amount of moisture that

the air can hold at a given temperature. Relative humidity is expressed as a percentage. Human comfort range is approximately 40% to 60% RH.

Example of the relationship between specific humidity, temperature and relative humidity:

<i>Specific Humidity</i>	<i>Temperature</i>	<i>Relative Humidity</i>
60 gr/lb	100°F	21%
60 gr/lb	70°F	54%
60 gr/lb	55°F	94%

AIR CONDITIONING SYSTEMS

Brooklyn, New York, was the place, and 1902 was the year the first truly successful air conditioning system for room temperature and humidity control was placed into operation. But first it took the engineering innovations of Willis Carrier to advance the basic principles of cooling and humidity control and design the system. Cooling air had already been done successfully but it was only part of the air conditioning problem. The other part was how to regulate space humidity. Carrier recognized that drying the air could be accomplished by saturating it with chilled water to induce condensation. In 1902, Carrier built the first air conditioner to combat both temperature and humidity. The air conditioning unit was installed in a printing company and chilled coils were used in the machine to cool the air and lower the relative humidity to 55%. Four years later, in 1906, Carrier was granted a patent for his air conditioner the "Apparatus for Treating Air." However, Willis Carrier did not invent the very first system to cool an interior structure nor interestingly, did he come up with the term "air conditioning." It was Stuart Cramer, a textile engineer, who coined the term "air conditioning." Mr. Cramer used "air conditioning" in a 1906 patent for a device that added water vapor to the air.

In 1911, Mr. Carrier, who is called the "father of air con-

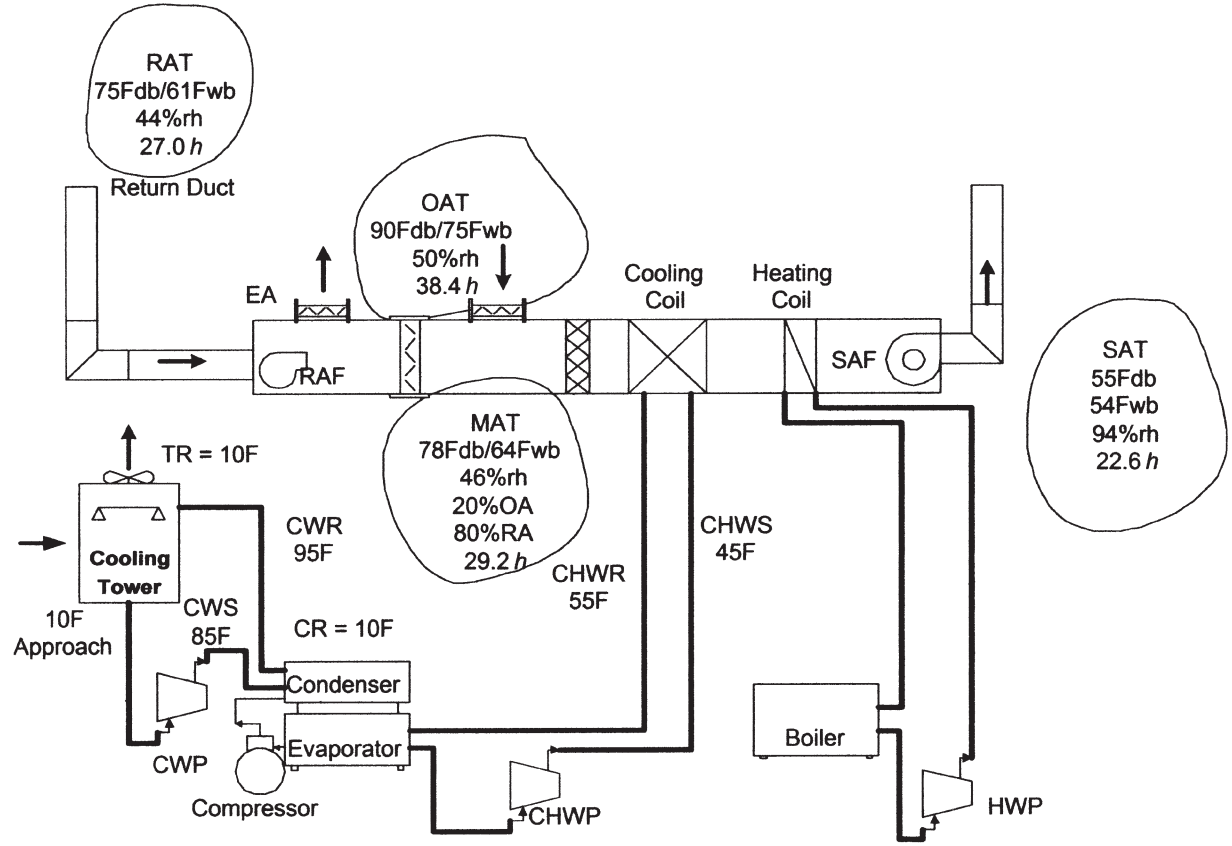

Figure 5-1. Central HVAC System "Air Conditioning"

ditioning,” presented his “Rational Psychrometric Formulae” to the American Society of Mechanical Engineers. Today, the formula is the basis in all fundamental psychrometric calculations for the air conditioning industry. Though Willis Carrier did not invent the first air conditioning system, his cooling and humidity control system and psychrometric calculations started the science of modern psychrometrics and air conditioning. As already mentioned, air “cooling” was only part of the answer. The big problem was how to regulate indoor humidity. Carrier’s air conditioning invention addressed both issues and has made many of today’s products and technologies possible. In the 1900s, many industries began to flourish with the new ability to control the indoor environmental temperature and humidity levels in both occupied and manufacturing areas. Today, air conditioning is required in most industries and especially in ones that need highly controllable environments, such as clean environment rooms (CER) for medical or scientific research, product testing, and sophisticated computer and electronic component manufacturing.

HEAT AND FLUID FLOW CALCULATIONS FOR AIR CONDITIONING SYSTEMS

Looking at the air conditioning system in Figure 5-1, calculate mixed air temperature. $MAT = (\%OA \times OAT) + (\%RA \times RAT)$

Where:

MAT = mixed air temperature

OAT = outside air temperature

RAT = return air temperature

Then:

$$MAT = (20\% \times 90^\circ\text{F}) + (80\% \times 75^\circ\text{F})$$

$$MAT = (18) + (60)$$

Answer:

$$\text{MAT} = 78^{\circ}\text{F}$$

Calculate cfm if the Room Cooling Load is 113,400 Btuh (Sensible Heat). There is a 20 TD difference between the air leaving the coil at 55°F and room design temperature set at 75°F.

Using:

$$\text{Btuh} = \text{cfm} \times 1.08 \times \text{TD}$$

Then:

$$\text{cfm} = \text{Btuh} \div (1.08 \times \text{TD})$$

$$\text{cfm} = 113,400 \div (1.08 \times 20)$$

Answer:

$$\text{cfm} = 5250$$

Now calculate total heat removed by the cooling coil using this equation:

$$\text{Btuht} = \text{cfm} \times 4.5 \times \Delta h$$

Where:

Btuht = Btu per hour total heat (wet cooling coil)

cfm = volume of airflow

4.5 = constant, 60 min/hr \times 0.075 lb/cf

Δh = Btu/lb change in total heat content of the supply air (from wet bulb and dry bulb temperatures and a psychrometric chart)

The enthalpies (in Btu/lb from the psychrometric chart) are:

$$78^{\circ}\text{Fdb}/64^{\circ}\text{Fwb} = 29.156 \text{ Btu/lb}$$

$$55^{\circ}\text{Fdb}/54^{\circ}\text{Fwb} = 22.627 \text{ Btu/lb}$$

$$\Delta h = 6.529 \text{ Btu/lb}$$

Then:

$$\text{Btuht} = \text{cfm} \times 4.5 \times \Delta h$$

$$\text{Btuht} = 5250 \times 4.5 \times 6.529$$

Answer:

$$\text{Btuht} = 154,248 \text{ (Coil Load)}$$

And since:

12,000 Btuh equals 1 ton of refrigeration (TR)

154,248 Btuh \div 12,000 Btuh per ton is 12.854 TR (\approx 13 TR)

Now calculate the water flow through the coil using:

$$\text{Btuh} = \text{gpm} \times 500 \times \text{TD}$$

Then:

$$\text{gpm} = \text{Btuh} \div (500 \times \text{TD})$$

$$\text{gpm} = 154,248 \div (500 \times 10) \text{ (TD} = 55^\circ\text{F} - 45^\circ\text{F)}$$

Answer:

$$\text{gpm} = 30.8 \text{ (water flow through the cooling coil)}$$

THE AC REFRIGERATION CYCLE

Let's go through the air conditioning system when it is in the cooling mode. Let's say that it is a summer day and the outside air is 90 degrees. The outside air damper is open to allow 200 cfm of outside air to mix with 1000 cfm of return air. The return air temperature is 75°F. The temperature of the mixed air is 78°F. The mixed air comes through the filter section where it is cleaned and enters the coil to be cooled. The coil in this example is a refrigerant evaporator coil (Figure 5-2). The other type of coil used in HVAC systems uses cooled water to bring the temperature of the mixed air down. This coil is called a chilled water coil. Both types of coils are also termed "heat exchangers" and they can be located on either side of the fan. Let's take a look at a simple mechanical refrigeration cycle and see what happens to enable the mixed air to be cooled down to 55°F. This 55°F air leaving the evaporator coil is now called the supply air. The volume of supply air is 1200 cfm.

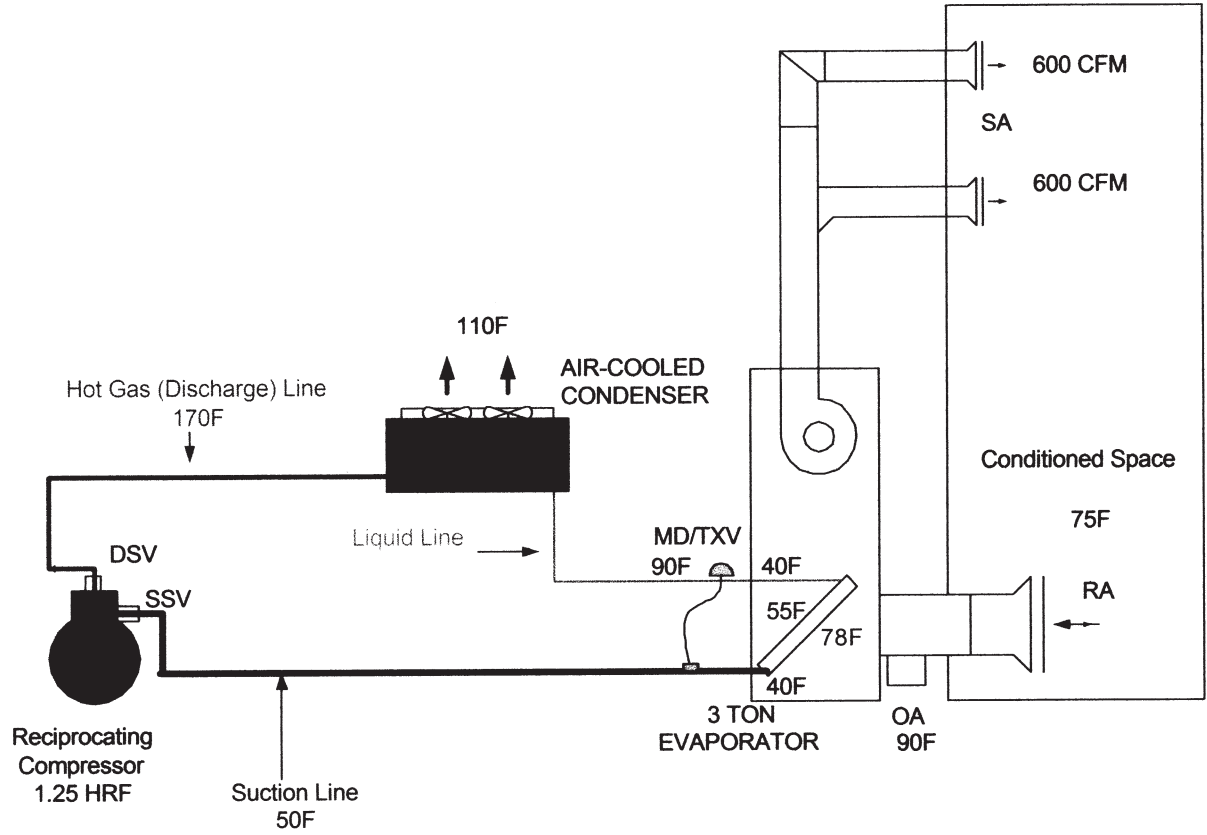

Figure 5-2 Air Conditioning System Example

The purpose of the refrigeration cycle is to remove unwanted heat from one place and discharge it into another place. In our HVAC system the unwanted heat is in the conditioned space. This heat in the conditioned space is picked up by the supply air and brought back through the duct system to the evaporator coil. Now let's start our refrigeration cycle. To begin, a mechanical refrigeration cycle is a completely closed system consisting of four different stages: expansion, evaporation, compression, and condensation. Contained in this closed system is a chemical compound called a refrigerant. The system is closed so that the refrigerant can be used over and over again, for each time it passes through the cycle it removes some heat from the supply air and discharges this heat into the outside air. The closed cycle also keeps the refrigerant from becoming contaminated, as well as, controlling its flow.

The expansion stage is a good place to start our trip through the refrigeration cycle. This stage consists of a pressure reducing device (also called a metering device, MD) such as an expansion valve, capillary tube or other device to control the flow of refrigerant into the evaporator coil. Our system has a thermal expansion valve abbreviated TXV. The refrigerant enters the expansion stage as a high-pressure, high-temperature liquid at 90°F. It goes through the metering device and leaves the expansion stage as a low-pressure, low-temperature liquid. This low-temperature liquid refrigerant, let's say that it is 40°F (its boiling temperature at this pressure), enters the evaporator coil. This begins the evaporation stage of the cycle. At same time that the 40°F liquid refrigerant is passing through the tubing of the evaporator coil the 78°F mixed air is passing over the same tubes. In order for heat to flow there must be a difference in temperature. Heat always flows from a higher level or temperature to a lower level or temperature. The air passing over the evaporator coil is warmer than the liquid refrigerant in the tubes. Therefore, heat will be picked up by (or transferred to) the refrigerant. In other words, the air is cooled and the refrigerant is heated. This heating of the refrigerant causes it to boil off and change state from a liquid to a vapor just as adding

heat to water will cause it to boil off and change state to steam.

The difference between the refrigerant in our system and water, which incidentally is also a refrigerant (refrigerant-718), is that the boiling point of our refrigerant is minus forty degrees below zero (-40), while the boiling point of water is 212 degrees above zero. Both these boiling points occur at sea level. It is important to understand that the boiling point of a liquid will change in the same direction as the pressure to which the liquid is subjected. For example, water at sea level, 14.7 pounds per square inch, boils at 212°F, while water subjected to 25 pounds per square inch of pressure boils at approximately 240°F. Since our closed refrigeration system is under pressure, in other words greater than atmospheric, we have elevated the boiling point of the refrigerant to approximately 40°F above zero. As the refrigerant passes through the evaporator tubes the boiling process continues. As long as the refrigerant is changing state from a liquid to a vapor the temperature remains at 40°F. However, once all the liquid has been changed to a vapor, and this occurs near the end of the evaporator, the vapor can now absorb additional heat. This process is called superheating the vapor, or simply, superheat.

Our system will pick up about 10 degrees of superheat and the refrigerant, which is now a low-pressure, low-temperature vapor, will flow through the suction line and enter the compression stage at 50°F. The compression stage consists of an electrically driven mechanical compressor. The compressor has two main functions within the refrigeration cycle. One function is to pump the refrigerant vapor from the evaporator so that the desired temperature and pressure can be maintained in the evaporator. The second function is to increase the pressure of the refrigerant vapor through the process of compression, and simultaneously increase the temperature of the vapor. This change in pressures also causes the refrigerant to flow through the system. Let's say that our compressor increases the pressure of the vapor so that the corresponding temperature of the vapor will be 120°F. This is the condensing temperature, that is, the temperature in the condenser. This high-pressure, high-temperature vapor leaves the

compressor and enters the condensation stage. In our example, the actual temperature of the refrigerant in the hot gas or discharge line is 170°F. The temperature of the refrigerant will cool down from 170°F to 120°F as it goes through the hot gas line and in the condenser. This loss of heat, in this case 50°F of sensible heat, is called “desuperheating.”

The condensation stage in our refrigeration system consists of an air-cooled condenser coil and a fan. Some systems however, use a pump and a water-cooled condenser. Our air-cooled condenser has a fan or blower, sometimes called the outdoor fan, which draws outside air across the condenser coil. The temperature of the refrigerant vapor flowing through the condenser tubes is 120°F. At the same time, the 90°F outside air is passing over the condenser tubes. As before, heat travels from a higher temperature to a lower temperature. Since the air passing over the condenser coil is cooler than the refrigerant in the tubes, heat will be picked up by the outside air. In other words, the refrigerant is cooled and the air is heated. The condenser is said to be discharging or rejecting its heat into the atmosphere.

Let’s back up for a minute. Where did we get this heat that is in the condenser? Well, about 75% of it is the unwanted heat from the conditioned space. The other 25% is heat from the compression stage. So now we have taken the unwanted heat from one place, the conditioned space, and discharged it to another place, the outside.

In order for the refrigerant to be able to pick up more heat from the supply air it must once again become a low-temperature liquid. The cooling of the vapor in the condenser causes the refrigerant to change state from a vapor to a liquid. This process is called condensation. As the refrigerant vapor passes through the tubes the condensation process continues. As long as the refrigerant is changing state from a vapor to a liquid the temperature remains at 120°F.

However, once the entire vapor has been changed to liquid, the liquid can reject additional heat. As the refrigerant, which is now a high-pressure, high temperature liquid (120°F @ 260 psig)

flows through the liquid line to the pressure reducing device it continues to give up heat. This is called “subcooling.” The liquid refrigerant will enter the expansion stage’s pressure reducing device (metering device) at approximately 90°F. The liquid was subcooled 30°F. Only liquids can be subcooled and only vapors can be superheated or desuperheated. When the liquid refrigerant goes through the metering device the pressure on the refrigerant is reduced to 70 psig. This reduction in pressure (from 260 psig to 70 psig) reduces the boiling point of the liquid refrigerant to 40°F. However, the temperature of the liquid refrigerant at 90°F is above the new boiling point (40°F). Because the liquid refrigerant is hotter than its boiling point a part of the liquid refrigerant begins to boil off. This boiling off of the liquid refrigerant is called flashing. The liquid refrigerant which is boiled off or flashed, changes state to a vapor or gas. This vapor is called “flash gas.” When a part of the liquid refrigerant is flashed, it removes heat from the remaining liquid. This flashing continues until the remaining liquid refrigerant is cooled down to the boiling point which corresponds to the pressure on the liquid (40°F @ 70 psig). About 18% of the liquid is flashed off to a vapor and is not available to pick up heat (i.e., latent heat of vaporization) but can pick up sensible heat in the evaporator stage. The vapor and the remaining liquid (82%) enters the evaporation stage and the cycle starts over. The AHU has taken 1200 cfm of mixed air at 78°F and cooled it down to 55°F supply air.

AIRFLOW

Supply air moves through ductwork because of a difference in pressures. Just as heat moves from a higher level to a lower level, so do fluids. Fluids move from a higher pressure to a lower pressure. Air is a vapor and as such is a compressible fluid.

Remember, we said that the refrigerant vapor moved through the system because the pressure on one side of the compressor was higher than on the other side. The same is true

for the air. The fan produces a pressure at the discharge of the fan that is higher than the pressure in the conditioned space. For example, the pressure in the conditioned space is atmospheric pressure while the pressure at the fan discharge is greater than atmospheric pressure.

To continue, the air moves through the ductwork until it reaches the supply air outlets in the conditioned space. As the 55°F supply air is discharged it mixes with the warmer room air. Also as the supply air comes in contact with the greater mass of room air the velocity of the air slows down. After circulating through the room the air exits the room by way of the return air inlet. This amount of air, the 1200 cfm of supply air continuously flowing through the room, will result in about 7.5 complete air changes per hour. Once again, the air flows through the ductwork because of a difference in pressures. In this case, the room air is at atmospheric pressure, or slightly above, because of room pressurization and the inlet to the fan is less than atmospheric pressure so the air flows towards the fan. The return air carrying the heat removed from the conditioned space mixes with the outside air, which also contains some heat. This mixture goes through the filter section and into the cooling coil and our cooling cycle starts over again.

FOUR TYPES OF AIR CONDITIONING COOLING SYSTEMS

Water	to	Water
Air	to	Air
Air	to	Water
Water	to	Air

AC COOLING SYSTEM #1

Heat Rejection Side		Heat Pickup Side
Water	to	Water

A water-to-water cooling system (Figure 5-3) has a water-cooled condenser and cooling tower on the heat rejection side. Chilled water coil(s) in the air handling unit(s) (AHU) or fan-coil unit(s) (FCU) are on the heat pickup side.

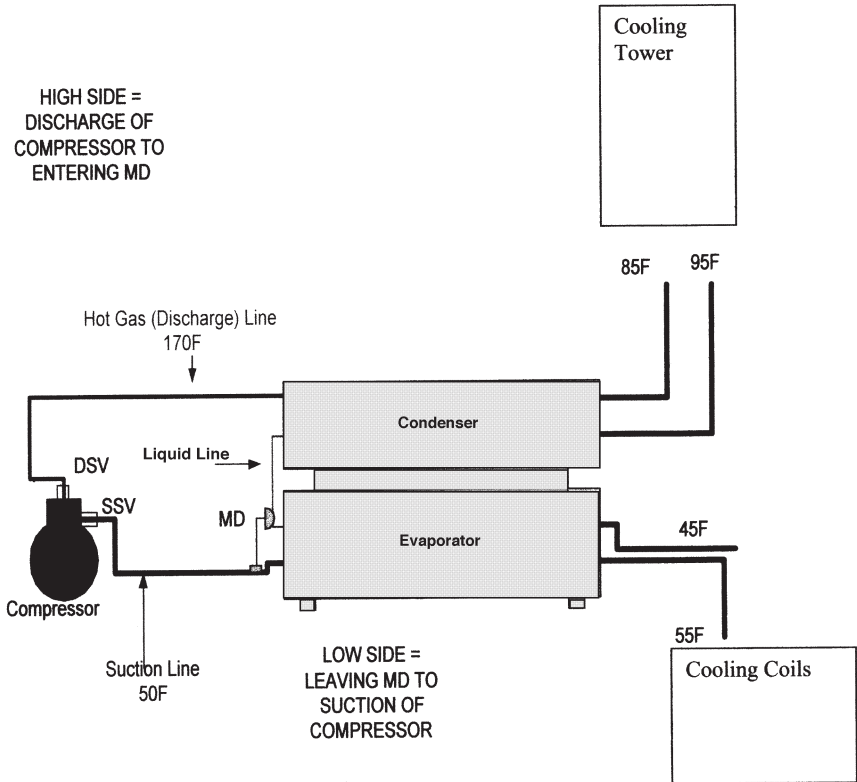

HIGH SIDE =
DISCHARGE OF
COMPRESSOR TO
ENTERING MD

LOW SIDE =
LEAVING MD TO
SUCTION OF
COMPRESSOR

Metering Device
Thermal Expansion Valve
90F Entering Liquid Temp
100% Liquid
40F Leaving Temp
82% Liquid
18% Vapor
(Flash Gas)
50F Sensing Bulb
10F Superheat

SSV(EVAPORATOR)
40F
70 PSIG

DSV(CONDENSER)
120F
260 PSIG

LIQUID LINE
30F SUBCOOLING

DISCHARGE LINE
50F Desuperheating

Figure 5-3. Water-to-Water AC System

AC COOLING SYSTEM #2

Heat Rejection Side Heat Pickup Side
Air **to** **Water**

An air-to-water cooling system (Figure 5-4) has an air-cooled condenser on the heat rejection side. Notice that while the condenser is rated for 3.75 tons or 45,000 Btuh (3.75 ton × 12,000 Btuh/ton) the evaporator is rated for 3 tons or 36,000 Btuh. Why is the condenser rated for more Btuh than the evaporator? Because of the additional heat from the compressor, 25% more Btuh from “heat of compression.” If a condenser rated at 36,000 Btuh was installed the system would not work. Chilled water coil(s) in the air handling units (AHU) or fan-coil units (FCU) are on the heat pickup side.

AC COOLING SYSTEM #3

Heat Rejection Side Heat Pickup Side
Air **to** **Air**

An air-to-air cooling system (Figure 5-5) has an air-cooled condenser on the heat rejection side. On the heat pickup side there is an evaporator (refrigerant DX) coil in the air handling units (AHU) or fan-coil units (FCU). In this system the condenser is rated for 3 tons for a 3 ton evaporator. This is because the condenser is rated at 15,000 Btuh per ton (12,000 × 1.25HRF). When we say a 3 ton or X ton system, we are talking about the evaporator or heat pickup side of the system. The heat rejection side will always be more tonnage.

AC COOLING SYSTEM #4

Heat Rejection Side Heat Pickup Side
Water **to** **Air**

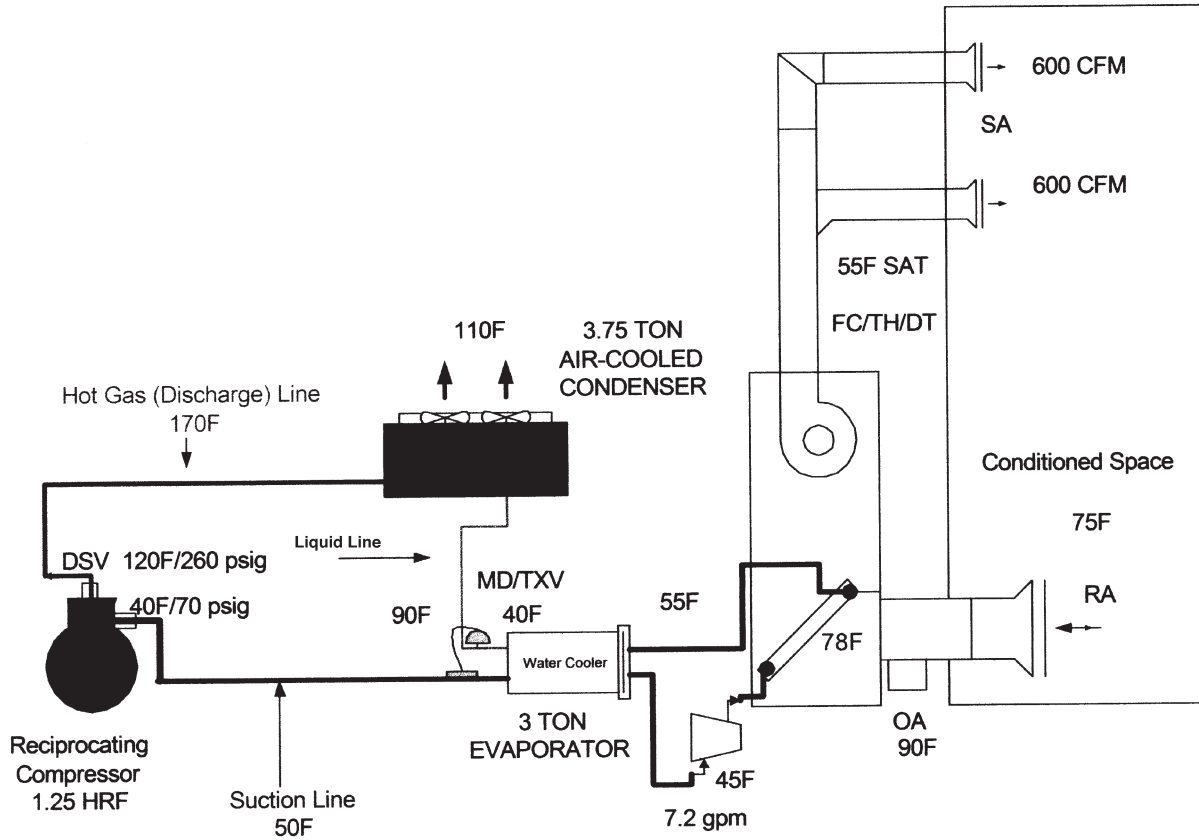

Figure 5-4. Air-to-Water AC System

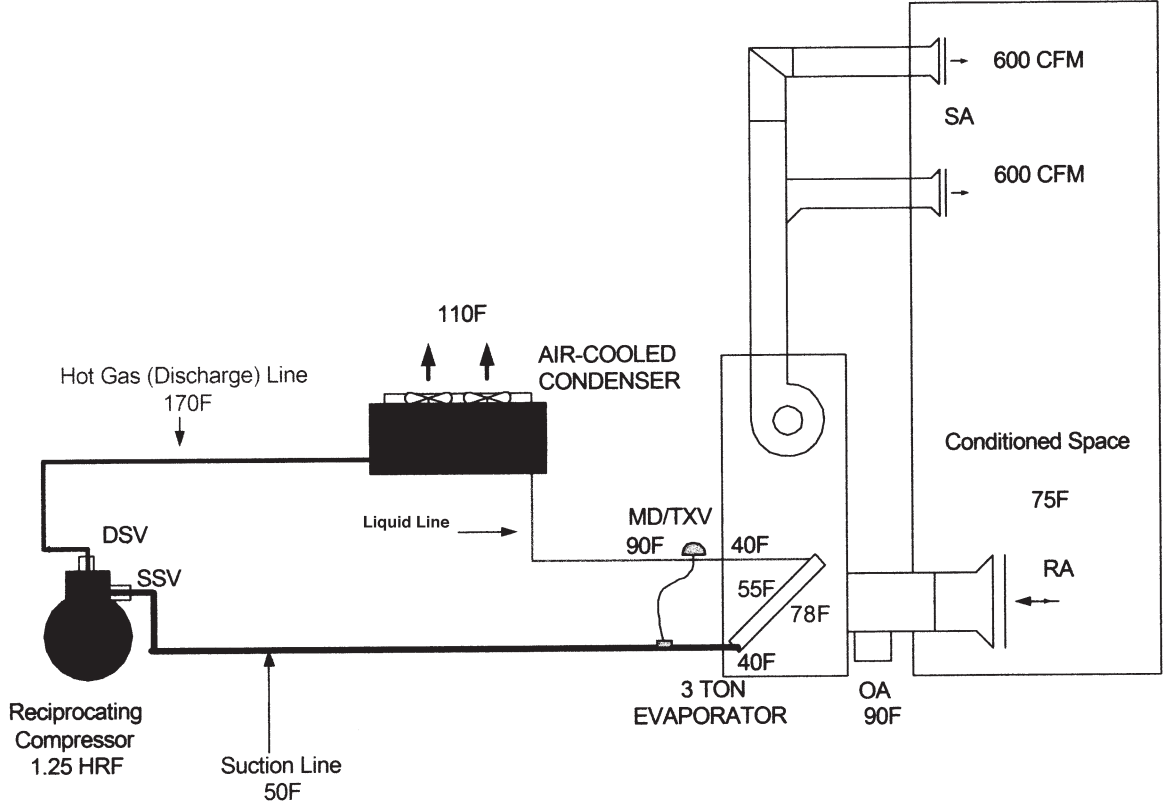

Figure 5-5. Air-to-Air AC System

A water-to-air cooling system (Figure 5-6) has a water-cooled condenser and cooling tower on the heat rejection side. On the heat pickup side there is an evaporator (refrigerant DX) coil in the air handling units (AHU) or fan-coil units (FCU).

PROBLEM

Calculate heat removed by the cooling tower in Figure 5-7.

$$\text{Btuh} = \text{gpm} \times 500 \times \text{TD}$$

$$\text{gpm} = \text{Btuh} \div (500 \times \text{TD})$$

$$\text{gpm} = 192,810^* \div (500 \times 10)$$

$$(\text{TD} = 95^\circ\text{F} - 85^\circ\text{F})(\text{This TD is the tower range, TR})$$

$$\text{gpm} = 38.6$$

*Includes heat of compression from the compressor

$$\text{HRF (Heat Rejection Factor)} = 1.25$$

$$(1.25 \times 154,248 \text{ Btuh coil load} = 192,810 \text{ Btuh tower load})$$

AIR CONDITIONING COMPONENTS VAPOR-COMPRESSION SYSTEM

Evaporators (heat picked up from the conditioned space)

Direct or Dry Expansion (DX)

Flooded

Condensers (heat rejected to the outside air)

Air-cooled

Water-cooled

Evaporative (combination of air and water cooled)

Compressors (pump)

Reciprocating (up to 200 tons of refrigeration, TR)

Constant volume

Centrifugal (80 to 10,000 TR)

Variable volume

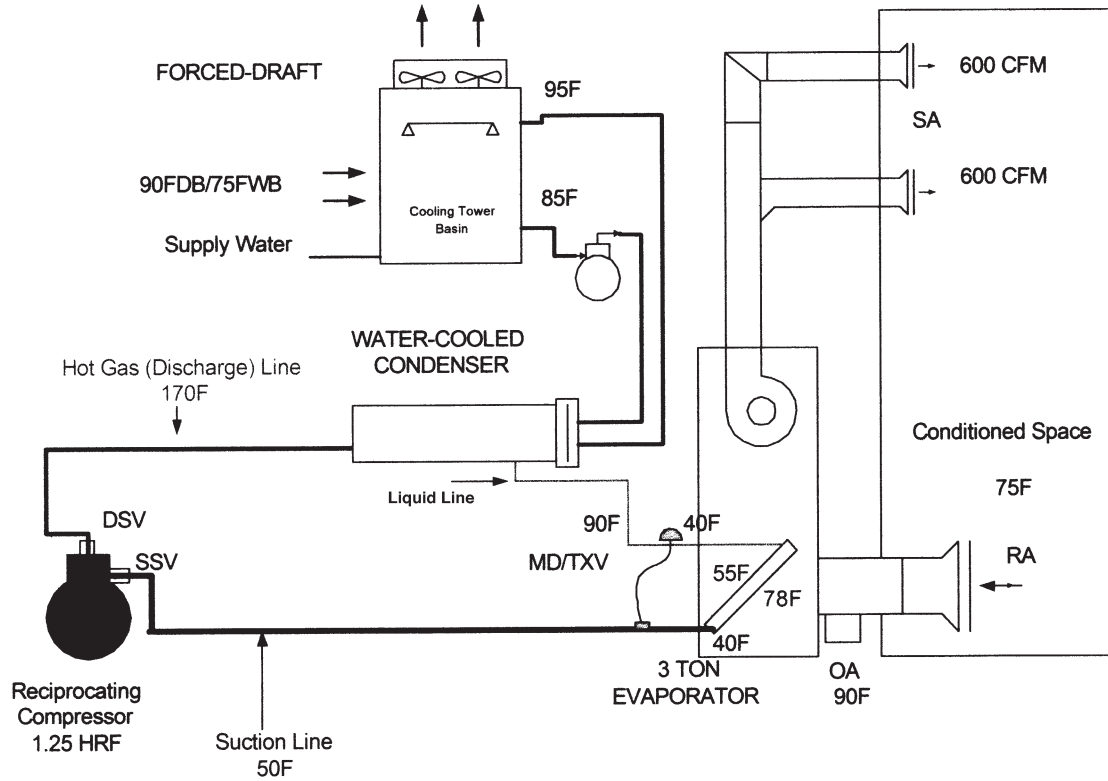

Figure 5-6. Water-to Air AC System

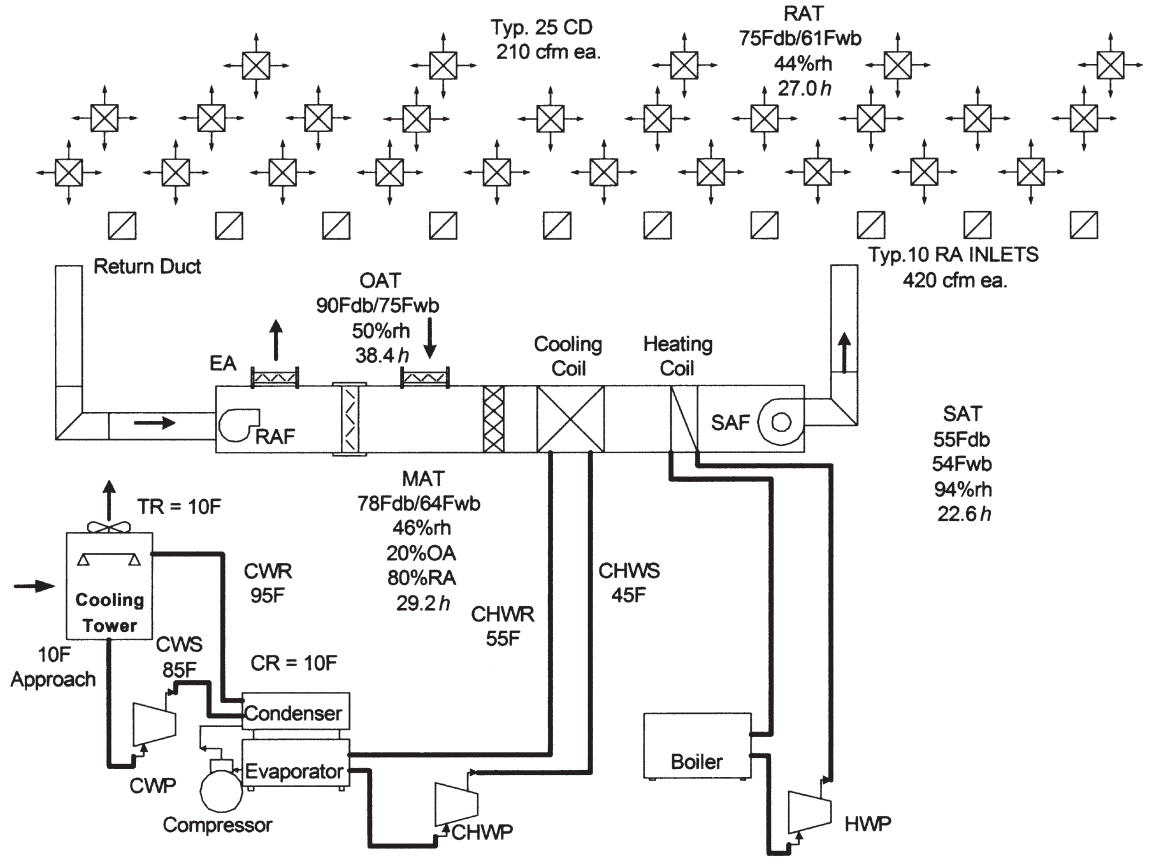

Figure 5-7. Cooling tower. TR is tower range (95°F - 85°F), CR is condenser rise (85°F to 95°F).

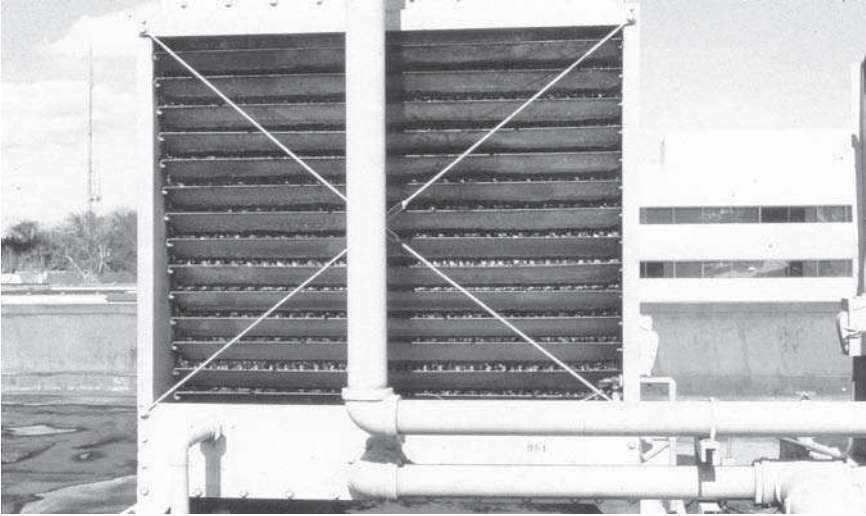

Figure 5-8. Forced Air Cooling Tower

Metering Devices (flow control)

Thermal Expansion Valve (TXV) (TEV)

Automatic Expansion Valve (AXV) (AEV)

Float Valve

(High Side or Low Side, Flooded Systems)

Capillary Tube

Hand Valve

EVAPORATORS

HVAC evaporator temperatures are usually between 34 and 45 degrees Fahrenheit. This is true whether the air conditioning unit's cooling coil is a direct expansion refrigerant coil supplying cold air to the conditioned space or a water cooler supplying chilled water to the cooling coils. Operating at less than 34°F increases the likelihood of frosting up the direct expansion refrigerant coil or freezing the water in the water cooler and water coil. However, operating at higher evaporator temperatures reduces the horsepower-per-ton ratio of the compressor (Table 5-1).

CONDENSERS

Condensers may be either air-cooled or water-cooled. The compressor's discharge pressure depends on how rapidly the condenser cooling medium, that is, the air or the water, will carry away the heat of the refrigerant vapor. This heat transfer rate depends on both the temperature of the condenser cooling medium and the volume of flow of the medium across or around the heat transfer surfaces of the condenser. The importance of lower condenser temperatures is that the lower the refrigerant temperature that can be maintained in the condenser, the lower the condenser pressure will be and the smaller the horsepower-per-ton ratio of the compressor (Table 5-1).

When the coils become dirty the dirt acts as an insulator reducing heat transfer. If this occurs on the evaporator the evaporator temperature is lowered. If the condenser coil is dirty the temperature inside the condenser is increased. Service technicians can help maintain good system performance by being aware of the evaporator and condenser temperatures. Efficiency is increased by increasing evaporator temperature and decreasing condenser temperature. One way this can be done is by improv-

Table 5-1. Reduction in system efficiency when condensers and evaporators are not maintained.

<i>Operating Condition</i>	<i>Evaporating Temperature</i>	<i>Condensing Temperature</i>	<i>Tons Ref.</i>	<i>Brake HP</i>	<i>BHP per ton</i>	<i>Increased BHP per ton</i>
Normal Operation	45°F	105°F	17.0	15.9	0.93	
Dirty Condenser	45°F	115°F	15.6	17.5	1.12	20%
Dirty Evaporator	35°F	105°F	13.8	15.3	1.10	18%
Dirty Cond. & Evap.	35°F	115°F	12.7	16.4	1.29	39%

ing heat transfer by keeping the evaporator coil and condenser coil clean (Table 5-1).

COMPRESSORS

The function of the compressor in the refrigeration system is to pump refrigerant vapor around the system and compress the low pressure refrigerant vapor to a higher pressure. The compressor must be capable of pumping the refrigerant vapor from the evaporator as fast as it vaporizes. If it doesn't, the accumulated refrigerant vapor will increase the pressure inside the evaporator. If this happens, the boiling point of the liquid refrigerant will be raised and the cooling process will stop. The second function of the compressor is to compress the refrigerant vapor changing it from a low pressure vapor to a higher pressure vapor. This process of compression adds heat to the vapor changing it from a low temperature vapor to a higher temperature vapor... a temperature higher than the condensing medium, water or air. This is important so the heat from the refrigerant can be rejected into the lower temperature condensing medium. The higher pressure supports the higher temperature. For example, in Figure 5-3, 70 psig supports a temperature of 40°F, while 260 psig supports a temperature of 120°F.

METERING DEVICES

The main types of metering devices are thermal expansion valve (abbreviated TXV or TEV), automatic expansion valve (AXV or AEV), float valve (on the high side or low side of flooded systems), and capillary tube (cap tube). A metering device is a pressure-reducing device; it reduces the pressure in the system from high to low. It is also a flow-control device. It controls the flow of refrigerant into the evaporator coil so that if the refrigerant is boiling off too soon in the evaporator, the metering device

will open up to allow more refrigerant in. If the refrigerant is boiling off too late in the evaporator, the metering device will close to allow less refrigerant into the evaporator. In the systems illustrated in this chapter, the metering devices are TXVs. A sensing bulb from the TXV is attached to the suction line as it leaves the evaporator. The suction line is insulated and the sensing bulb is underneath the insulation and is in direct contact with the suction line pipe. The superheat, 10 degrees in the examples, is set on the TXV. If the entire refrigerant boils off too soon there is more evaporator for the refrigeration gas to flow through and pick up additional sensible heat adding to the superheat. When the sensing bulb senses the superheat is greater than 10 degrees the metering device will open up to allow more refrigerant into the evaporator. On the other hand, if the entire refrigerant boils off too late there is less evaporator for the refrigeration gas to flow through and pick up sensible heat, reducing the required superheat. When the sensing bulb senses the superheat is less than 10 degrees, the metering device will close to allow less refrigerant into the evaporator. The entire refrigerant will then boil off sooner and pick up the required sensible heat to have 10 degrees superheat at the sensing bulb.

UNITARY SYSTEMS

Unitary systems are also called packaged units.

Heat Pump (Air-Air)

A unitary heat pump is factory-assembled and contains an evaporator, compressor, condenser, and a reversing valve. Types include:

Through-the-wall

Window-mounted

PTHP (Package Terminal Heat Pump)

Air Conditioner

A unitary air conditioner is factory assembled and contains an evaporator or cooling coil, compressor and a condenser. It may also include a heating function. Types include:

Through-the-wall

Window-mounted

Rooftop

PTAC (Package Terminal Air Conditioner)



Figure 5-9. Unitary air conditioning system. Typical small commercial package unit.

Table 5-2. Refrigeration Troubleshooting Chart

Pressures		Temperatures		Amperage	System
Discharge	Suction	Superheat	Subcooling	Reading	Problem
Low	Low	High	High	Low	TXV Sensing Bulb Lost Charge or
Low	Low	High	High	Low	Low Outside Ambient Air Temperature or
Low	High	High	High	Low	Inefficient Compressor
High	High	Low	High	High	Refrigerant Overcharge
Low	Low	High	Low	Low	Refrigerant Undercharge
Low	Low	Low	High	Low	Insulated Evaporator
Low	Low	High	High	Low	Restricted Liquid Line
High	High	Low	Low	High	Insulated Condenser or
High	High	Low	Low	High	TXV Sensing Bulb Mounted Loose or
High	High	Low	Low	High	TXV Sensing Bulb Poorly Insulated

This page intentionally left blank

Chapter 6

Compressors

T*he mechanical compressor is the heart of the vapor-compression air conditioning cooling system. It pumps refrigerant around the system and compresses the vapor from a low pressure to a higher pressure.*

TYPES OF AIR CONDITIONING COMPRESSORS

Three types of mechanical compressors are commonly used for HVAC air conditioning cooling duty. They are reciprocating, rotary and centrifugal. The reciprocating and rotary type compressors are positive displacement machines. In positive displacement reciprocating compressors, compression of the refrigerant vapor is done by a reciprocating piston (Figure 6-1). A rotating piston, rotating vane, or rotor is used in rotary compressors. Compression in a centrifugal compressor is done primarily by the centrifugal force produced as a high-speed impeller rotates the vapor. Each of the compressor types has certain advantages and disadvantages. The type of compressor used for a certain application depends on the size and requirements of the application.

RECIPROCATING COMPRESSORS

Reciprocating compressors are positive displacement machines and are among the most widely used compressors because of their range of sizes and designs. Reciprocating compressors range from fractional tonnage units to hundreds of tons of refrigeration capacity in a single unit. Reciprocating compressors are

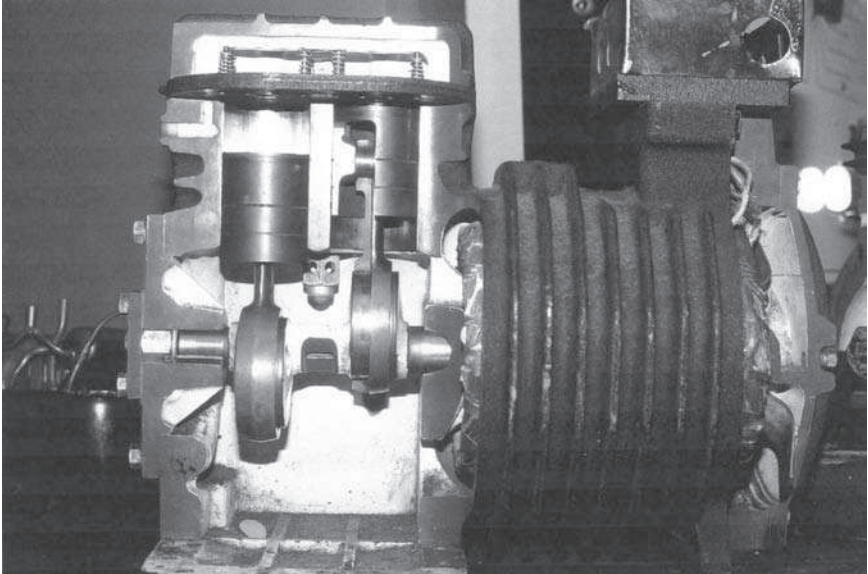

Figure 6-1. Cutaway of a reciprocating compressor showing pistons in the cylinders.

generally classified according to type of drive, motor accessibility, type of piston, number and arrangement of cylinders, valve construction, method of lubrication, and capacity control.

Type of Drive

When a reciprocating compressor has an external motor it is called an open compressor. An open compressor may be belt driven or directly coupled. When the motor is directly coupled to the compressor, it is called a direct drive system. A reciprocating compressor, driven by a direct drive motor sealed inside the compressor housing, is called a hermetic compressor.

Motor Accessibility—Open Compressors

One advantage of the open compressor is that it is accessible for repairs. In the event of a motor burnout, the open compressor is much easier to service than a hermetic compressor. Another advantage is that if the open compressor is belt driven, the V-belt

drive allows the speed ratio between the motor and the compressor to be easily changed. This means that a single compressor can be used on several different units by merely changing the size of the motor sheave and compressor valve clearance. The disadvantage of the open compressor is that the crankshaft must emerge from the crankcase for installation of the driven sheaves. This means that the shaft must be sealed to separate the refrigerant from the atmosphere to prevent loss of refrigerant vapor. Mechanical seals, similar to the ones in water pumps, are generally used. One part of the mechanical seal is attached to the compressor housing and the other part is attached to the rotating crankshaft. A spring exerts pressure on the assembly to hold parts together. The assembly is flooded with oil from the lubrication system which forms a vapor-tight seal between the refrigerant and the atmosphere. Leaking shaft seals are a common source of compressor problems. In open systems, the compressor motor is cooled by the flow of ambient air across the motor housing.

Motor Accessibility—Hermetic Compressors

Generally, hermetic units range from fractional horsepower sizes to about 10 tons in a single unit. If more tonnage is needed, several compressors may be installed in the same air conditioning unit. Above 10 tons, the construction is often the open type or the semi-hermetic type. Semi-hermetic compressors are almost completely accessible. Semi-hermetics range in capacity from 2 tons to about 150 tons and offer the advantage of direct drive and hermetic sealing plus serviceability. The hermetic compressor is also called a welded hermetic and the semi-hermetic compressor is called a bolted hermetic.

One advantage of the hermetic compressor is that it's smaller, more compact and has less vibration than the open compressor. However, the main advantage of the hermetic compressor is that it has no external shaft. This eliminates mechanical problems with shafts, belts, and sheaves, and concern for refrigerant leakage. In a hermetic unit, the motor is located within the refrigerant atmosphere. Therefore, another advantage is that the motor

is continuously cooled by the refrigerant vapor flowing to the compressor suction valves. Lubrication is also simplified since both the motor and the compressor operate in the same closed space with the oil.

The disadvantages of hermetic compressors are that they're limited on capacity, and limited on speed because the compressor has to run at the motor speed (direct drive). A third disadvantage is that it's not field serviceable. Therefore, if a motor burns out in a hermetic compressor, or any other internal problem occurs, the maintenance trend is for a complete replacement of the compressor. Otherwise, the entire unit must be returned to the shop or factory to be dismantled and reconditioned.

Type of Piston

The reciprocating compressor is comprised of a group of pistons operated by a rotating crankshaft. The pistons are either the automotive type or a double-trunk piston. Double-trunk pistons are used in medium and large compressor applications. Reciprocating compressors may also be classified as either single-acting or double-acting. The double-acting type compresses the refrigerant vapor alternately on both sides of the piston so that the compression occurs twice during each revolution of the crankshaft. This type of compressor isn't practical for small sizes and is limited to large industrial applications. Therefore, most reciprocating compressors for HVAC systems are the single-acting type with the automotive type pistons (Figure 6-1).

Single-acting compressors compress the vapor on the upstroke of the piston only once, during each revolution. The cycle of operation is this: when the piston moves down refrigerant vapor is drawn into the cylinder from the evaporator. As the piston moves up, it begins to compress the vapor. The volume of the refrigerant vapor is reduced and the pressure of the vapor is increased. At the top of the piston stroke, the vapor exits through the discharge valve and enters the discharge line to the condenser. The piston starts its downward stroke and the cycle is repeated.

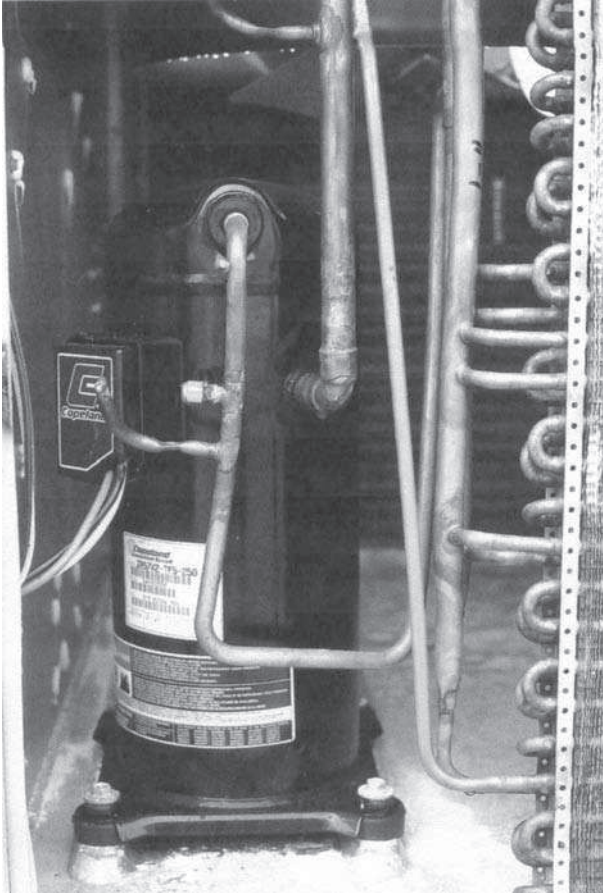

Figure 6-2. Hermetic compressor

Number and Arrangement of Cylinders

Reciprocating compressors come with one to sixteen cylinders. In multi-cylinder compressors, the cylinder arrangement may be in-line, radial, or at an angle to each other in the shape of a V, VV or W pattern. For two and three cylinder units, the cylinders are generally arranged in-line. Compressors with four or more cylinders use the radial or the V or W patterns.

Valve Construction

Three basic types of valves are used in compressors: a non-flexing ring plate, a flexing reed, and poppet. In high-speed HVAC compressors, the ring plate or flexing valve is used. The poppet valve is limited to slow speed compressors. Valves are further classified according to mechanical function. The classifications are suction valves and discharge valves. Valves operate because of the difference in the pressure between the inside of the cylinder and the suction and discharge lines. For instance, the suction valve opens on the downstroke of the piston when the pressure inside the cylinder becomes less than the pressure in the suction line from the evaporator. On the upstroke of the piston, the pressure inside the cylinder is increased. This closes the suction valve. As the piston continues upward, the cylinder pressure continues to increase. The discharge valve opens because the pressure inside the cylinder is greater than the pressure in the discharge line. This allows the compressed vapor to flow into the discharge line.

Method of Lubrication

The compressor requires lubrication for the bearings, cylinders, pistons and gears. Lubricating oil is mixed in, and travels with, the refrigerant. Special care is taken in the design and operation of the refrigerating system to assure that the oil returns to the compressor from the evaporator and refrigerant lines. The oil also acts as a sealant in the space between the piston and the walls of the cylinder so all the refrigerant vapor is forced out the discharge valve and into the discharge line. If the oil doesn't seal the space, the vapor leaks back to the crankcase and results in a loss of efficiency. Lubrication is accomplished either by simple splash feed systems or by forced feed systems. Small, open compressors generally use splash feed systems. In this arrangement, the crankcase acts as an oil sump and is filled with oil to a level about even with the bottom of the main bearings. As the crankshaft rotates, it dips into the oil in the crankcase. The oil is splashed around within the crankcase, lubricating the bearings, cylinder walls and other rubbing surfaces as the crankshaft

rotates. In larger compressors, a positive or forced feed system is needed. In this type of system, the crankshaft drives a positive displacement oil pump, which supplies oil to the crankshaft, bearings, cylinder walls and the other moving parts.

Capacity Control

Many large HVAC reciprocating compressors are equipped with controls to provide variable capacity although the compressor operates at a constant speed. These capacity controllers are called cylinder unloaders. Cylinder unloaders may be electrically, mechanically, or hydraulically operated. A typical hydraulic cylinder unloader is operated by a capacity control actuator. The function of the capacity control actuator is to control the oil pressure in a hydraulic valve mechanism. The controls work like this: The capacity control actuator is mounted inside the crankcase. It operates on a difference in pressure between the refrigerant suction pressure and the atmospheric pressure. If the demand for refrigerant in the evaporator decreases, for instance, because the conditioned space cools off, the suction pressure in the evaporator drops and the capacity control actuator, sensing this drop in pressure reduces the oil pressure to the valving mechanism. This opens the suction valve. The suction valve stays open on the upstroke of the piston and there's no increase in pressure inside the cylinder because the refrigerant vapor is forced back out the suction opening. Since there's no increase in pressure to overcome the pressure in the discharge line, the discharge valve stays closed and, therefore, no compression occurs. If the suction pressure continues to decrease, the capacity control actuator, valving mechanism and unloader assembly all function to unload another cylinder. This process continues until the operating cylinders are matched with the cooling load from the conditioned space. Therefore, at partial load, which is generally the case, not all the cylinders are pumping refrigerant, they're merely idling, needing only enough power to overcome friction. This means that the horsepower requirement is reduced. When the conditioned space becomes too warm the space thermostat will send out a call

for cooling. More refrigerant will be allowed into the evaporator increasing the suction pressure. This increased pressure is sensed by the capacity control actuators. They in turn increase the hydraulic oil pressure to the cylinder unloaders. The unloaders are filled with oil and close the suction valve for normal operation. As the piston goes down the suction valve is opened, allowing in refrigerant vapor until the suction pressure and the pressure in the cylinder equalize. When this happens the suction valve closes and the piston starts upward compressing the refrigerant.

Another type of capacity control is called hot gas bypass. With this type of control a part of the compressed discharge vapor goes to the condenser and a part is bypassed back to the compressor suction chamber. The type and staging of capacity controls depends on the size of the compressor and the application. However, the unloader type of capacity control is more energy efficient than the hot gas bypass since no pumping work is done on the unloaded cylinders.

ROTARY COMPRESSORS

Rotary compressors are also positive displacement machines but because of the rotary motion of their compressing mechanism, they operate smoother than reciprocating compressors. The three general designs of rotary compression mechanisms in common use today are the rolling piston, the rotating vane, and the screw type. In the rolling piston machine, a cylindrical steel roller or piston rolls around the cylinder wall in the direction of crankshaft rotation. Refrigerant vapor is drawn into a space between the roller and the cylinder through a suction port from the evaporator suction line. As the roller continues to roll around the cylinder, the space ahead of the roller gets smaller. The vapor trapped ahead of the roller is compressed and forced out the discharge line. The roller continues on and a new space is made for the next cycle of refrigerant. The rotating vane operates in a similar manner to the rolling piston. Vanes are attached to a rotor and move back and forth in slots in

the rotor as the rotor turns inside the cylinder wall. This maintains a positive seal against the walls. As the rotor turns, the space in the cylinder is reduced and the vapor is compressed.

SCREW COMPRESSORS

The other type of rotary compressor is the screw compressor, which is generally used on systems 50 tons or larger. This type of compressor uses two helically grooved rotors to compress the refrigerant vapor. The rotors intermesh to progressively reduce the space inside the cylinder and reduce the volume of refrigerant vapor and increase its pressure. As the rotors turn, vapor from an inlet port at the suction end of the screw cylinder enters the space between the rotors. The rotors continue to turn and close off the suction port. The screw action then forces the vapor to the discharge end and compresses it against a discharge plate. At a given point, the rotating screws uncover discharge ports in the discharge plate and the compressed vapor is forced out into the discharge line. Capacity control on the screw compressor is done by a slide valve in the housing wall underneath the rotors. The slide valve is hydraulically operated. When the system calls for a slowing of the refrigeration process the valve is opened allowing some vapor to recirculate in the cylinder without being compressed.

CENTRIFUGAL COMPRESSORS

Centrifugal compressors are high capacity machines moving large volumes of vapor and can't be economically built for small capacity systems. A positive displacement compressor is usually more economical below 100 tons. The centrifugal compressors used in HVAC refrigeration start about 80 tons and go to several thousand tons. The larger the capacity the more advantageous the centrifugal compressor becomes. Centrifugal compressors, centrifugal fans and centrifugal pumps are all members of the same family of machines where the pumping force is based on impeller

size (wheel size for fans) and rotating speed. The operating principles are also similar. In a centrifugal compressor, low pressure, low temperature and low velocity refrigerant vapor is drawn into the impeller housing near the center of the compressor, and then enters the inlet of the impeller. As the impeller spins, the vapor is discharged at high velocities and higher temperature and pressure to the outside of the housing. To maintain the centrifugal force, the impeller rotates at very high speeds (much higher than centrifugal fans or pumps). Speeds to 25,000 rpm are common. However, centrifugal compressors don't build up as much pressure as do positive displacement compressors. Therefore, several impellers are put in series to increase the pressure of the vapor. Commonly, centrifugal compressors will have two, three or four impellers. Each impeller is a stage of compression. After the vapor leaves an impeller, it's directed into another impeller or into the discharge line. The capacity of the compressor, number of stages, and speed all depend on the application.

Centrifugal compressors may be either open or hermetic. And, since they have no cylinders, valves or pistons there are fewer parts needing lubrication. In the hermetic compressor, the only points needing lubrication are the main bearings supporting the drive shaft and the motor bearings. Open compressors require lubrication to the shaft seal as well. Centrifugals use a pressurized, forced-feed lubrication system. Sometimes, the oil pump is driven by the compressor shaft. In other units, the oil pump is driven by a separate motor. This pump brings the oil pressure up before the compressor starts. Capacity control of centrifugals is usually done by varying the speed of the compressor or by variable inlet guide vanes. Both reducing impeller speed and closing inlet vanes reduces vapor flow and, therefore, reduces refrigeration capacity. Variable inlet guide vanes or pre-rotation vanes (similar to vortex dampers or inlet guide vanes in centrifugal fans) are located directly ahead of the impeller inlet. These vanes change the direction, or rotation, of flow of the refrigerant vapor immediately before it enters the impeller. This change in direction results in a reduction in total flow.

Chapter 7

Water Chillers

Types of air conditioning cooling systems using refrigeration (DX) systems:

<i>Heat Rejection Side</i>		<i>Heat Pickup Side</i>
<i>Air</i>	<i>to</i>	<i>Air</i>
<i>Water</i>	<i>to</i>	<i>Air</i>

Types of air conditioning cooling systems using water chillers:

<i>Water</i>	<i>to</i>	<i>Water</i>
<i>Air</i>	<i>to</i>	<i>Water</i>

WATER CHILLERS

The two categories of water chillers used in HVAC systems are mechanical and absorption. The mechanical chiller system is most often used. This type of system uses a reciprocating, screw, or centrifugal compressor. The other components in the mechanical system are a condenser, an evaporator, and various control devices. The other type of chiller system is the absorption chiller which does not have a mechanical compressor, but instead uses a generator (also called a concentrator), plus an absorber, along with a condenser, an evaporator and control devices to chill water. This chapter discusses the operation, maintenance, and optimization of mechanical water chillers (Figure 7-1).

CENTRIFUGAL WATER CHILLERS

Willis Carrier, the “Father of Air Conditioning,” patented the “centrifugal chiller” in 1921. The centrifugal refrigeration

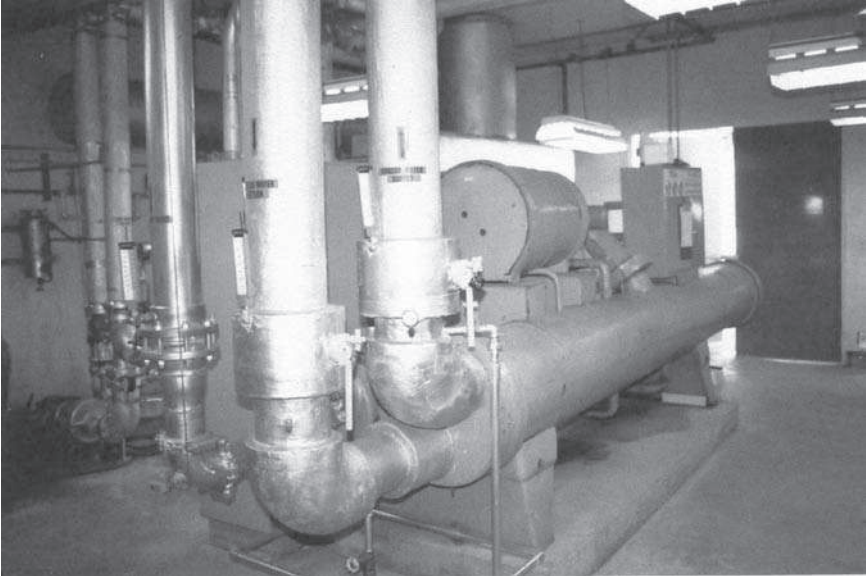

Figure 7-1. Centrifugal Mechanical Chiller

machine was the first practical method of air conditioning large spaces. Before this, refrigeration machines used reciprocating compressors to move refrigerant through the system. The heart of a centrifugal water chiller is the centrifugal compressor. Carrier's design for a centrifugal compressor was similar to the centrifugal blades in a water pump.

CENTRIFUGAL WATER CHILLER OPERATION

Let's start the explanation of how a centrifugal water chiller works at the evaporator. Refrigerant vapor (gas) from the evaporator flows into the center (eye) of the centrifugal compressor impeller. Vanes in the eye of the impeller draw the gas into radial passages. As the impeller rotates, it increases the velocity of the gas, which then goes through diffuser passages, and into a space in the perimeter of the compressor housing where the gas is stored. Inlet vanes installed ahead of the impeller stabilize the

performance of the compressor over a range of load conditions. The inlet vanes adjust the gas quantity (gas flow rate) as well as the angle of the vapor as it enters the impeller, which creates a new compressor performance characteristic for each vane position. The vapor goes through several stages of compression and then is discharged into the condenser.

The hot vapor enters the condenser. The vapor is cooled by water from the cooling tower circulating through the condenser. As the water passes through tubes in the condenser it picks up heat from the vapor. The water then goes back to the cooling tower to release into the outside air the heat that it has picked up in the condenser. The condenser pump moves the water around this circuit. Once the entire vapor refrigerant is condensed to a hot liquid, the refrigerant leaves the condenser through the liquid line.

The hot liquid refrigerant from the condenser is metered through an orifice system into a pressure chamber, which is called an economizer. The purpose of the economizer is to pre-flash the liquid refrigerant. When the liquid refrigerant enters the economizer the pressure on the refrigerant is reduced. This reduction in pressure reduces the boiling point of the liquid refrigerant. However, the temperature of the liquid refrigerant is still above the new boiling point. Because the liquid refrigerant is hotter than its boiling point a part of the liquid refrigerant begins to boil off. This boiling off of the liquid refrigerant is called flashing. The liquid refrigerant which is boiled off, or flashed, changes state to a vapor or gas. This gas is called flash gas. When a part of the liquid refrigerant is flashed, it removes heat. This flashing continues until the remaining liquid refrigerant is cooled down below the boiling point which corresponds to the pressure on the liquid. This is the same process that is used in metering devices to cool the liquid refrigerant down to the required evaporator temperature.

Pre-flashing in the economizer reduces the volume of flash gas required to cool the refrigerant flowing through the metering device into the evaporator. This reduction in the volume of flash gas in the metering device means that more of the liquid refrigerant

is available for use in the evaporator. This makes the chiller system more efficient. Also, there is less of a load on the first stage of the compressor and, therefore, a reduction in the power requirements on the compressor. The pre-flashed gas from the economizer is sent back to the compressor to be compressed. The liquid refrigerant in the economizer, which is now at an intermediate pressure, that is, a pressure somewhere between the higher pressure of the compressor and the lower pressure of the evaporator, continues through the liquid line into the metering device.

The condensed liquid refrigerant from the economizer is metered into the evaporator through the metering device. The metering device is a system of orifices in the liquid line. The purpose of the metering system is to maintain the required refrigerant flow for each load condition. As the liquid refrigerant flows through the various orifices, its pressure and temperature is reduced. This causes a part of the liquid refrigerant to flash, reducing the temperature of the remaining liquid to the required evaporator temperature. This cooler, lower pressure liquid-vapor mixture now enters into the evaporator through the liquid line. As the refrigerant liquid-vapor mixture leaves the liquid line it goes into a liquid distributor which runs the length of the evaporator. The distributor helps to promote a more uniform heat transfer throughout the entire length of the evaporator. The temperature of the refrigerant liquid-vapor mixture is about 40°F. The temperature of the water from the air handling units is about 55°F. As the water travels through tubes in the evaporator it is cooled down about 10 degrees to approximately 45°F.

CHILLED WATER TEMPERATURE CONTROL SYSTEM

One of the functions of the chilled water temperature control system is to modulate the centrifugal compressor's inlet vane position. By varying inlet vanes or compressor speed, the capacity of the compressor is modulated according to the system load. A typical sequence of operation would be that a rising return chilled

water temperature would cause a sensor to send an increasing signal to a controller. A rising return water temperature indicates that the conditioned space is becoming warmer and the system load is increasing. The controller sends a signal to start the compressor motor. The signal also goes to a variable speed drive or to the compressor inlet vanes. The compressor inlet vanes are set normally closed (NC). As the pressure increases, the vanes start to open, allowing more refrigerant vapor into the compressor. A load limiting relay (LLR), allows the control signal to pass on to the inlet vane operator as long as the compressor motor current is less than 98% of maximum. If the motor current exceeds 98% the LLR allows the control signal to decrease which closes the inlet vanes, and the refrigerant vapor flow to the compressor is reduced which reduces the load on the motor. The load limiting relay remains in control until the load on the compressor is reduced below the setting on the relay. At this point, the LLR once again allows the control signal to pass on to the vane operator and control of the chiller is returned to the chilled water temperature control system. In addition to the automatic load limiting relay, a manual demand limiter device is installed in the control panel to set the limits of chiller operation. By setting the demand limiter the load on the compressor can be limited to 40, 60, 80 or 100% of full load.

COMPRESSOR LUBRICATION

Centrifugal compressors use a pressurized, forced-feed lubrication system. The pressurized oil is fed to the compressor bearings by an oil pump submerged in the oil sump. The pump brings the oil pressure up to requirements before starting the compressor. The oil pressure is regulated by a valve in the pump discharge. An oil pressure control senses the differential pressure across the bearings and prevents the compressor from operating should the oil pressure fall below the minimum limits. The temperature of the oil in the sump is maintained at about 130 degrees Fahrenheit through the use of an electrical heater. The

oil is heated to prevent refrigerant from condensing in the sump and diluting the oil. When the oil leaves the sump, an oil cooler cools the oil down to the required bearing lubrication temperature, approximately 100 degrees.

MOTOR COOLING

Depending on the size and manufacturer of the chiller, the compressor motor may be cooled by the liquid refrigerant or by chilled water. A jacket surrounds the motor windings. On some systems liquid refrigerant flows by gravity from the economizer into the jacket. The heat from the motor causes the refrigerant to boil. This cools the motor. The refrigerant vapor is returned to the economizer where it is drawn off into the compressor. On other systems, chilled water is circulated through the jacket.

CHILLER START-UP AND SHUTDOWN

The following chiller start-up and shutdown procedure is a generalized procedure. Caution: Before operating any piece of equipment be sure to get the manufacturer's specification on operation and maintenance. Lubricating oil should be visible in the oil level sight glass in the oil sump. And, the purge heater should have been on for about 30 minutes before start-up. The start-up begins by turning on the chilled water and condenser water pumps. Set the demand limiter switch to the percent of capacity required for the seasonal and building load conditions. This setting can be determined by monitoring the chiller system and the load requirements. To avoid a high demand charge from the utility company, the demand limiter should not be set higher than needed. After the chilled and condenser water pumps are operating, place the purge compressor switch in the auto position and turn the oil pump switch on. This starts both the centrifugal compressor and the purge compressor. The chiller will now operate automatically. Wait a few minutes to let the system stabilize and read the operating temperatures and pressures on

the gauges in the control panel. For correct operating pressures, check the manufacturer's submittals. To shutdown the system turn the oil pump switch off. The chiller's operating pressures and temperatures should be taken daily and kept in a log book. This information will provide a means to detect variations in the system's performance. Any major variation in the recorded pressures or temperatures should be investigated. Take the time to investigate, analyze and correct any problem.

CONDENSING PRESSURE AND TEMPERATURE

The pressure and temperature in the condenser is a function of condenser water temperature, condenser water flow rate, the amount of non-condensable gases in the condenser and the cleanliness of the condenser tubes. Air is an example of a non-condensable gas, i.e., a gas that will not condense at the pressures and temperatures in this system. Condenser water temperature is normally about 95°F leaving the condenser and going to the cooling tower and about 85 degrees coming back from the tower into the condenser. The condenser flow rate, in gallons per minute, gpm, will vary depending upon the size of the system. The water flow should be balanced between plus or minus 10% of full flow. The condenser tubes must be clean and free of scale. To check the efficiency of the condenser, place a thermometer in the liquid line temperature well. Next, at the temperature well, take a temperature of the water leaving the condenser. If the difference between these two reading has increased from those previously recorded, it means that the heat transfer efficiency of the condenser is declining. If this is the case, open the vents on the condenser to relieve any accumulated air that may be trapped in the condenser water tubes. If this fails to correct the problem, check the manufacturer's submittals and the water balance report for the pressure drop through the condenser. If the pressure drop has increased, while the gpm has remained constant, the tubes of the condenser are becoming scaled or dirty and cleaning is

required. If, on the other hand, the gpm is low and the pressure drop has decreased, investigate the water pipe. The strainer is probably clogged or one of the valves has been partially closed.

If there are still problems, check the purge unit to make sure that it is operating properly. Operate it continuously for several hours or until the relief valve stops purging non-condensable gases into the atmosphere. When checking the condenser efficiency the temperature difference between the condenser water and the refrigerant may have decreased. In other words, the condenser efficiency has increased, while the condensing pressure and temperature has been reduced. This may be because the weather is cool and the temperature of the water from the cooling tower is lower. Also, the cooler weather means that the conditioned space cooling load is less. However, it may also indicate that the water flow has been increased. Measure and then compare the water flow to the quantities in the water balance report or commissioning report.

EVAPORATOR PRESSURE AND TEMPERATURE

To check the efficiency of the evaporator, measure and compare the temperatures and pressures with those previously recorded. If the temperature difference is lower while the pressure drop is higher the system is overpumping. If the flow rate has increased correct this condition by closing the discharge valve on the chilled water pump or changing the size of the pump impeller. If however, the temperature difference is higher, while the pressure is lower, the system is probably low on water. Check the piping for improperly adjusted flow control, bypass, or shutoff valves.

OIL PRESSURE

A reduction in the oil pressure reading from those previously recorded is usually caused by a clogged oil filter, a need for a readjustment of the oil pressure regulating valve or liquid refrigerant

erant in the oil sump. If there is refrigerant in the oil, it forms bubbles in the oil line which restrict flow. Check the oil filter and change as needed. Next, look at the oil sump sight glass. If foam appears, shut down the system and check the oil sump heater. If the heater is working properly call the chiller service representative to check the system before restarting.

SAFETY CONTROLS

Chillers have certain safety controls such as low temperature, high pressure and motor temperature displayed on the control panel. Once a safety control is tripped, the system is automatically shutdown and condition light or message is displayed. The pilot light or message will remain on until the condition that caused the control to trip is corrected and the system is started by the "reset switch." The low temperature safety senses the temperature of the refrigerant in the evaporator. Some causes of the low temperature control tripping are: loss of refrigerant, inlet vane operator out of adjustment, or chiller water temperature controller set too low. The high pressure control senses the pressure in the condenser. Some causes of the high pressure control tripping are: dirty or scaled condenser tubes, air in the condensing water, non-condensables in the condenser. The motor temperature control senses the temperature of the motor. If the temperature of the motor exceeds the limit of the safety, the system is shutdown. Some causes of the motor temperature control tripping are: loss of refrigerant to motors that are refrigerant cooled, the coolant supply line to the motor is damaged, the water flow valve is not working, or the motor jacket has scale.

CENTRAL CHILLER OPTIMIZATION

The HVAC system and the lighting system are two of the most energy intensive building systems in commercial, institu-

tional, and industrial facilities. While retrofitting each system separately can certainly boost energy efficiency and lower energy consumption, what many end-users may not realize is that retrofitting lights and other building systems prior to a chiller upgrade may produce much better results, i.e., if the building cooling loads are reduced enough perhaps the chillers can be downsized.

CENTRAL CHILLER PLANTS

Many central chiller plants consist of a vapor-compression liquid chiller, cooling tower, water pumps, distribution piping, and controls. The chiller includes an evaporator or liquid cooler, a condenser (water- or air-cooled), and a compressor (reciprocating, screw, or centrifugal). Therefore, the main energy-using components of this type of chiller plant are the motors that drive the compressors, chilled water pumps, condenser water pumps, air-cooled condenser fans, and cooling tower fans. These driving components use substantial amounts of energy. The amount of energy used by the air conditioning system is dependent upon, among other things, proper design, installation, operation, and maintenance of the mechanical and electrical components. Unfortunately, engineering studies and energy audits have shown that in many buildings the cooling systems often have extensive inefficiencies due to neglect in the aforementioned areas. Adjusting, modifying, or retrofitting the cooling system often can correct inefficiencies and bring the systems back to proper operating conditions while generating substantial energy savings.

SYSTEM DESIGN

Because there is a narrow range of water temperatures low enough to provide adequate dehumidification and high enough to avoid chiller freeze-up, system designers have limited choice

in selecting supply water temperatures for cooling applications. Likewise, water chillers have a critical range of flow rates in which they will safely operate. If the designer chooses to vary the flow through the chiller to save on pumping energy at any condition less than full load, the control system must be properly designed to operate safely. Because of these design limitations and safety concerns, chillers are usually designed for constant water flow. However, there is an energy-saving opportunity if the chiller pump is variable flow.

Cooling equipment is normally designed for a 10°F temperature difference or delta T (ΔT). For example, chillers and cooling coils might be designed to operate with a supply water temperature of 45°F and a return temperature of 55°F, while the cooling tower (tower range) and water-cooled condenser (condenser rise) operate between 85°F and 95°F.

PLANT MAINTENANCE AND OPERATION

Good maintenance and the proper operation of plant equipment cannot be overemphasized. Proper maintenance helps ensure efficient operation of equipment and systems (thereby reducing energy usage) and helps prolong equipment life. The following maintenance procedures can help in the optimization of chiller plant equipment and determine the cause of any abnormalities and correct them as needed.

Compressors and Motors

Follow manufacturer's guidelines for compressor and motor maintenance and observe compressor operation. Frequent stopping and starting or continuous running may indicate inefficient operation. It is also important to listen to the compressor. A high noise level may be a sign of a loose drive coupling or excessive vibration. Next, inspect the compressor for oil leaks and use a leak detector to check for refrigerant leaks. Establish normal operating pressures and temperatures for the system. Routinely

record operating temperatures and oil pressures in a log. Be sure to compare readings with manufacturer's specifications to ensure normal operation.

Pumps and Motors

Follow manufacturer's guidelines for pump and motor maintenance. Observe and listen to the pump operation. Keep the pump and motor properly lubricated; lubricate motor bearings and all moving parts according to manufacturer's recommendations. Keep pump and motor properly aligned. Water balance pumps for proper flow quantity; change impellers as needed.

Fans and Motors

Follow manufacturer's guidelines for fan and motor maintenance. Lubricate motor and fan bearings and all moving parts according to manufacturer's recommendations. Keep fan and motor drives properly aligned. Inspect condition of belt(s) and check belt tension. Observe and listen for any unusual noise or vibration.

Condensers and Cooling Towers

Clean tubes on water-cooled condensers and keep condenser coil faces clean on air-cooled condensers. Perform chemical treatment to determine if desolved solids concentrations are being maintained at acceptable levels on evaporative condensers and cooling towers. Monitor effectiveness of water treatment program. Keep the tower clean to minimize drops in air and water pressure. Check overflow pipe clearance for proper operating water level. Clean intake strainer. Determine if there is air recirculation from tower outlet back to tower inlet. Inspect towers for proper nozzle performance.

Plant Retrofit

The biggest energy users in chilled-water plants are the motors driving the chiller compressors, pumps, and fans. Therefore, significant energy savings can be achieved by:

-
- Reducing system loads
 - Reducing losses in the distribution system
 - Increasing the refrigerant system COP (coefficient of performance)
 - Reducing water flow rates
 - Trimming impellers
 - Downsizing pumps
 - Installing variable-speed drives

This page intentionally left blank

Chapter 8

Fans

Fan and duct air pressures are measured in inches of water gage (in wg) or water column (in wc)

Fan Pressure Equation

- $TSP = SP_{outlet} + SP_{inlet}$
- $TSP = \text{Total Static Pressure}$
- $SP_{outlet} = \text{Static Pressure at the fan discharge}$
- $SP_{inlet} = \text{Static Pressure at the fan suction}$

Duct Pressure Equation

$$TP = SP + VP$$

- $TP = \text{Total Pressure}$
- $SP = \text{Static Pressure}$
- $VP = \text{Velocity Pressure}$

Axial Fan Types

Propeller

Tubeaxial

Vaneaxial

Centrifugal Fan Types

- *Single Wide (SW)*
— *Single Inlet Single Wide (SISW)*
- *Double Wide (DW)*
— *Double Inlet Double Wide (DIDW)*

Forward Curved (FC)

Backward Inclined/Curved (BI/BC)

Airfoil (AF)

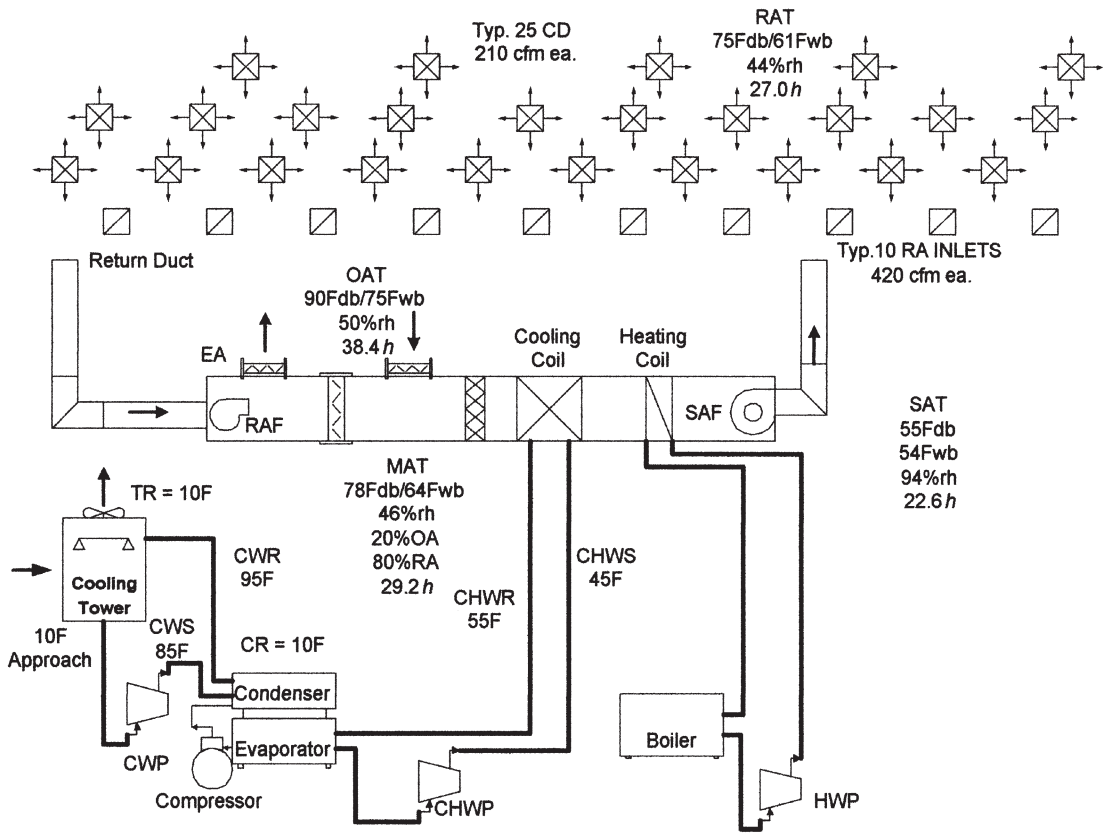

Figure 8-1. Central HVAC System "Fan"

FAN AND DUCT PRESSURES

The duct pressure generated by a fan has two components—velocity pressure (VP) and static pressure (SP). The velocity pressure is due to the air movement within the duct while the static pressure is due to the outward “push” of the air against the walls on the supply side of the fan and inward “pull” of the air against the walls on the return side. The sum of the two pressures is total pressure (TP). $TP = SP + VP$

FAN CURVES

A fan curve shows the performance of a fan at various static pressures and volumes of airflow. It is a graphic representation of the performance of a fan from free delivery to no delivery. Airflow versus static pressure is plotted on a chart with the static pressure on the left vertical axis and the cfm airflow on the bottom horizontal axis. At the top left of the curve is the block tight static pressure condition (BTSP) at maximum static pressure and zero airflow. The curve will then flow and fall to the lower right of the chart to a point of wide-open cfm (WOCFM) at the maximum airflow and zero static pressure.

Fan performance curves are developed from actual tests. Depending on the testing, the following fan characteristics may be plotted against cfm: static pressure (SP), static efficiency (SE), total pressure (TP), total efficiency (TE) which is also known as mechanical efficiency (ME), and brake horsepower (BHP). The Air Movement and Control Association (AMCA), and fan manufacturers have established procedures and standards for the testing and rating of fans. The procedure requires the testing of the entire range of the fan’s performance from free delivery to no delivery. Both the discharge pressure and the inlet pressures are measured. A dynamometer drives the test fan. Torque is measured at each of the operating points while readings of fan speed are simultaneously taken. This allows calculation of horsepower

input for each of the settings. Readings are also taken of dry and wet bulb temperature and barometric pressure so the air density can be calculated. These measured and calculated values are then plotted to develop the fan performance curve. Testing continues and performance curves are established for other fan speeds. This defines the fan airflow delivery capability at various speeds and static pressures. If the curve is developed for one fan speed only, the air density, wheel size and fan speed are usually stated on the curve and are constant for the entire curve.

Although performance curves can be useful in troubleshooting fans, you should be aware that because of installation conditions which almost never duplicate the ideal conditions under which fans are tested, fan performance as determined by field tests is usually less than shown by manufacturers' tests.

FAN CLASSES

Most manufacturers offer fans in different classes. Classes are designated by number as Class I, II, III, or IV. The classifications are based on: fan construction and materials used, type of duty, static pressure developed, fan speed and outlet velocity. Each higher number represents higher speed and air performance capabilities of the fan.

SURGE

Surge occurs as the fan's operation moves too close to block tight static pressure and is an unstable operating condition. Surge is when the airflow out of the fan falls below that needed to maintain the required static pressure difference between the inlet and outlet of the fan. When the static pressure difference falls below requirement air will "surge" back into the fan reducing duct static pressure. This reduction in duct static pressure allows the fan to regain its differential static pressure and airflow and the system monetarily comes back to normal until the duct static pressure

increases which causes the airflow to drop and the process starts all over again. The resulting fluctuations in fan and duct static pressures and air flows cause turbulence, vibration and noise in the fan and ductwork and reduces the efficiency of the fan. A surge line is plotted on the left side of the fan curve chart to indicate the performance area where surge can occur and the fan becomes unstable. Fans are never selected nor should be allowed to operate to the left of the surge line. Fans selected to the right of the surge line operate in a stable condition.

FAN PERFORMANCE TABLE

To make fan selection and comparisons as simple as possible most fan manufacturers publish fan multi-rating tables called a fan performance table or fan rating table. The fan manufacturers provide the fan curve information in tabular form. These tables normally show the cubic feet per minute (cfm), static pressure (SP), revolutions per minute (rpm), outlet velocity (ov), brake horsepower (bhp), blade configuration, wheel configuration, fan wheel diameter, outlet area, tip speed equation, maximum brake horsepower equation, and pressure class limits for each class of fan.

The tables can also be used to help determine how the fan is operating under field conditions by measuring the fan speed and the fan static pressure and entering this information on the table. If the measured conditions are within the scope of the table the approximate cfm and brake horsepower can be determined.

Fans that have high rotating speeds and operate at high pressures are built to withstand the stresses of centrifugal force. However, if the fan is rotating too fast, the wheel could fly apart or the fan shaft could whip. Therefore, for safety reasons, the performance tables list the maximum rpm for each class of fan. Maximum allowable fan speed should be checked before increasing the fan rpm to ensure that the new operating conditions don't require a different class fan.

FAN TYPES

Heating, ventilating and air conditioning fans are divided into two general categories. One category is axial fans. The air flow within the fan wheel is parallel to the fan shaft in these fans. The second category is centrifugal fans. The airflow within the fan wheel is radial or circular to the fan shaft in these fans. Sometimes a third category of fans is used called special design fans (Figure 8-2). These are fans such as centrifugal power roof ventilators and axial power roof ventilators.

AXIAL FANS

The general classifications of axial fans are: propeller, tube axial and vane axial. Propeller fans, such as ones used in residences, produce large volumes of air at low pressures. A typical commercial application of propeller fans would be general room air circulation or exhaust ventilation. Very large propeller fans are sometimes used in cooling towers. The housing for a typical propeller fan is normally a simple ring enclosure and the fan wheels usually have two or more single thickness blades. Propeller fans are generally not very efficient. A characteristic of propeller fans is that the operating horsepower, which is called brake horsepower, is lowest at maximum airflow and highest at minimum air flow. An example of this characteristic is the typical box-type home fan. If you look at this type of fan, you'll notice that the first position on the air volume switch is "off." The next position is "high," then "medium," and last is "low." This means that when the fan is turned on the electrical current draw and the horsepower will be at its lowest. In the last position, or the "low" position, the current and horsepower are the highest.

Another type of propeller fan is the tube axial fan. Tube axial fans are heavy-duty propeller fans used in such HVAC applications as fume hood exhaust systems, paint spray booths and drying ovens. The fan wheel of the tube axial fan is enclosed in



Figure 8-2. Power roof ventilator

a cylindrical tube and is similar to the propeller type except that it usually has more blades, 4 to 8, and they're a heavier design. The tube axial fan is the more efficient than the propeller fan. Like the propeller fan, the tube axial fan's operating horsepower is lowest at maximum airflow and highest at minimum airflow.

The third category of axial fans is the vane axial fan. Vane axial fans are tube axial fans with straightening vanes. They're used in HVAC ducted systems in office buildings or other commercial applications to provide airflow to the conditioned space. The housing is a cylindrical tube similar to the tube axial fan with the addition of air straightening vanes. The straightening vanes straighten out the spiral motion of the air and improve the efficiency of the fan. The vane-axial fan has the highest efficiency of all the axial type fans. The wheel of the vane axial fans has shorter blades and a larger hub than the tube axial and like the propeller fan and the tube axial fan, the operating horsepower is lowest at maximum airflow and highest at minimum airflow.

Propeller Fan

A propeller fan wheel has two or more single-thickness blades in a simple ring enclosure. Fan efficiencies are generally low and use is limited to low pressure, high volume air moving applications such as air circulation within a space or ventilation through a wall without attached duct work. Air delivery decreases with increase in air resistance. Fan speeds range from 900 to 1800 rpm and blade rotation is perpendicular to direction of air flow.

Tube Axial Fan

The tube axial fan wheel is similar to the propeller type except it usually has more blades of a heavier design. The wheel is enclosed in a drum or tube to increase efficiency and pressure capability. The tube axial fan is used in ducted HVAC applications where air distribution on the downstream side is not critical. Industrial applications include drying ovens, paint spray booths and fume exhaust systems. It is more efficient than propeller fans at high air volumes. Fan speeds range from 2000 to 3000 rpm. The tube axial fan tends to be noisy and may require sound attenuators in the duct.

Vane Axial Fan

The vane axial (VA) fan is the most efficient axial type fan (Figure 8-3). A propeller fan produces a spiral air stream. The VA fan uses straightening vanes on the leaving air side of the fan to straighten the spiral to a smooth air stream. This reduces turbulence and improves efficiency and pressure capability. It also reduces noise levels. The static efficiencies of the VA fan are comparable to the backward inclined (BI) and airfoil (AF) centrifugal fans. Static efficiencies of the VA fan are typically 70 to 72 percent. The operating or application range of the VA fan is about 60 to 90 percent of full flow cfm.

The fan blades often have airfoil shapes and may be available with adjustable pitch. The variable pitch vane axial fan (VPVA) is similar in construction to the fixed pitch vane axial

fan (FPVA). The main difference in the two fans is that the VPVA is non-adjustable speed with variable pitch blades where as the fixed pitch vane axial fan is adjustable speed with non-adjustable blades.

The pressure capabilities of VA fans are in the medium to high range (low pressure is up to 2" water column and high pressure is over 6" water column). The vane axial fan is used with HVAC systems where straight-through flow and compactness is required. It has good down-stream air distribution and is used in many commercial and industrial applications. The VA is "non-overloading." The operating horsepower of this type of fan increases with an increase in airflow but only to a point, and then gradually decreases. Because of this characteristic, vane axial fans are "non-overloading" fans. In other words, the fan motor will not draw more electrical current than its name-plate rated current.

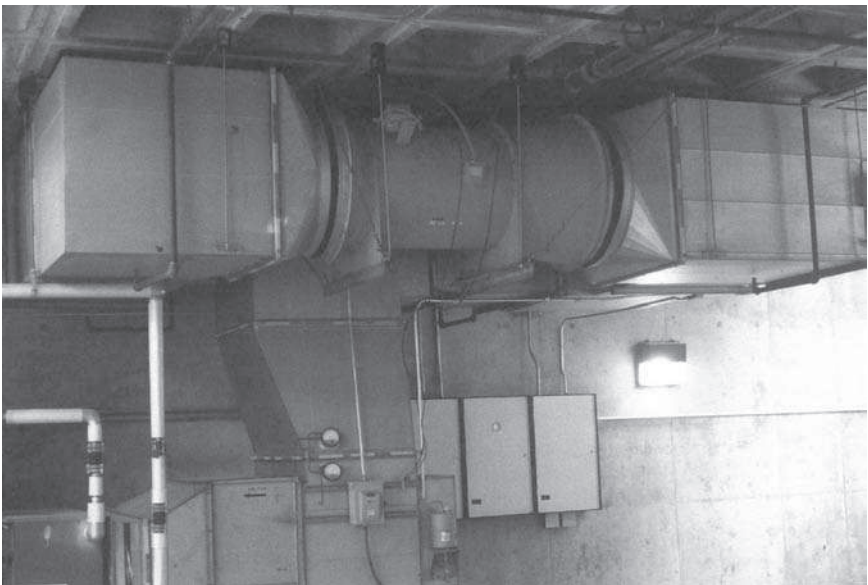

Figure 8-3. Vane Axial Fan

CENTRIFUGAL FANS

Centrifugal fans are divided into several general categories as distinguished by the type of fan wheel used and the orientation or shape of the fan blades. The categories are: forward curved (FC), radial (R), backward curved (BC), backward inclined (BI) and airfoil (AF). This chapter will discuss FC, BI and AF fans.

Forward Curved Fan

The forward curved fan (Figure 8-4), also called a squirrel cage fan, is used primarily for low pressure heating, ventilating and air conditioning in residences and small commercial and industrial applications. The fan housing is of lightweight construction. The fan wheel has 24 to 64 shallow blades with the blades curving toward the direction of rotation. The wheel is usually 24 inches in diameter or smaller. There may also be multiple wheels on a common shaft. A characteristic of this type of fan is that the operating horsepower is low when the fan's air output is also low but continues to increase as the airflow increases. This fan is "overloading" in that the motor horsepower increases as the static pressure in the duct decreases (and airflow increases). The FC fan runs at a relatively slow speed. This fan type moves a given amount of air within its static pressure and cfm range at lower speeds than other centrifugal fans. The forward curved fan is less expensive than BI or AF fans.

The light construction of the forward curved blades does not allow this fan wheel to be operated at speeds needed to generate high static pressures. Therefore, a FC fan is a low to medium pressure fan generating up to 5" static pressure at 400-1200 rpm. The maximum static efficiency of the forward curved fan is in the range of 60 to 70 percent which occurs to the right of maximum static pressure.

The curved shape of the forward curved fan blade gives a forward thrust to the air as it leaves the blade tip. This forward motion of the air and the tip speed of the blade cause the air to leave the fan at a relative high velocity. Pressures produced by a fan (or

any centrifugal machines such as HVAC pumps) are a function of the forward motion of the air (a compressible fluid, or water in a pump, which is a non-compressible fluid) at the blade tip.

The FC fan operates efficiently between 40 and 80 percent of wide open air volume. If this type of fan is operated below 40% it may become unstable. If, on the other hand, a FC fan is operated above 80% of wide open cfm it typically produces noise and inefficiency. As with all fans, the FC fan can become unstable. This unstable condition is called surge or surging. The fan curve indicates pressures on the left hand side and airflow along the bottom of the fan performance curve. There is also a surge line drawn on the fan curve. The line is indicated as “do not select to the left of the surge line.”

Backward Inclined Fan

The next category of fans is the backward inclined fan. The wheel of the backward incline fan has 10 to 16 blades with the blades leaning away from the direction of rotation. The operating horsepower of this type of fan increases with an increase in

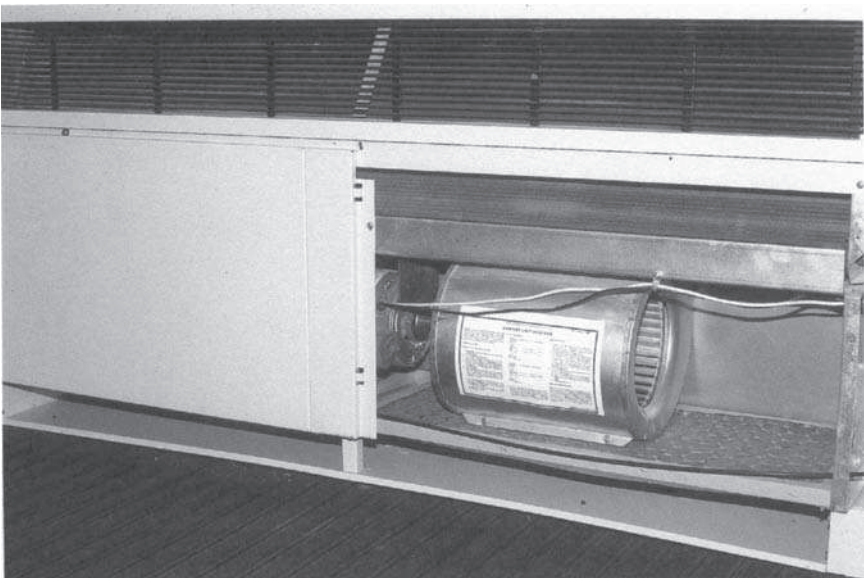

Figure 8-4. Forward Curved fan

airflow but only to a point and then gradually decreases. Because of this characteristic, the backward inclined fan is a “non-overloading” fan. In other words, the fan motor, if selected properly, will not draw more electrical current than its nameplate rated current. The backward fans are more efficient than the forward curved fans but less efficient than the airfoil fans. This fan runs at a relatively high speed... 1200-2400 rpm, about double the speed of FC for similar air quantities. The BI fan’s performance is characterized by high efficiency at high cfm flow. The fan is built stronger than the FC fan, which makes it suitable for higher static pressure applications. The BI fan is used in general heating, ventilating and air conditioning systems and in many industrial applications where the blades might be subjected to erosion from light dust. The best efficiency is at medium pressures, 3.5” to 5” static pressure. The BI fan’s maximum static efficiency is about 75 to 80 percent and occurs at approximately 50 percent of wide open cfm.

The angle of the blade causes the air leaving the fan blade to be bent back against the direction of rotation. The blade “slaps” the air around. The forward movement of the blade gives the air a forward velocity. However, compared to a FC fan the BI fan’s air velocity is substantially less for a given fan speed. Therefore, when a BI fan is selected for a given air quantity it must rotate at approximately twice the speed of a comparable FC fan. But, the horsepower requirement for the BI fan is less than that of the comparable FC fan, making the BI fan more efficient.

The BI fan’s application range is typically 40 to 85 percent of full flow cfm. As with the FC fan, operating the BI fan at less than 40% open may put the fan in a surge condition. Running the BI fan above 85% may cause it to operate inefficiently and be noisy.

Airfoil Fan

The airfoil fan (AF) is an important refinement of the backward inclined wheel design. In the AF fan (Figures 8-5 and 8-6) the flat blade of the BI fan has been changed to an airfoil (looks

like an airplane wing). Like an airplane wing, the airfoil blade induces a smooth air flow across the entire blade surface. This reduces air currents which produce turbulence in the fan wheel and results in increased static efficiencies and decreased noise levels. The AF fan's maximum static efficiency is about 86 percent. In general, the flow and pressure characteristics of the AF fan are essentially the same as the BI fan. The application range of the AF fan is between 50 and 85 percent of full open cfm. This a little narrower operating range than the FC or BI fan (FC is 40 to 80 percent; BI is 40 to 85 percent). The reason is that because the AF fan surges at a higher percentage (85%) of full open cfm thus moving the surge line further to the right on the fan curve and this reduces the application area of the fan.

The AF fan has the highest efficiency and runs at a slightly higher speed than the standard flat blade BI fan to move a given amount of air. It is the most efficient of all centrifugals and is usually used in both larger HVAC systems and clean-air industrial applications where the energy savings are significant. It is

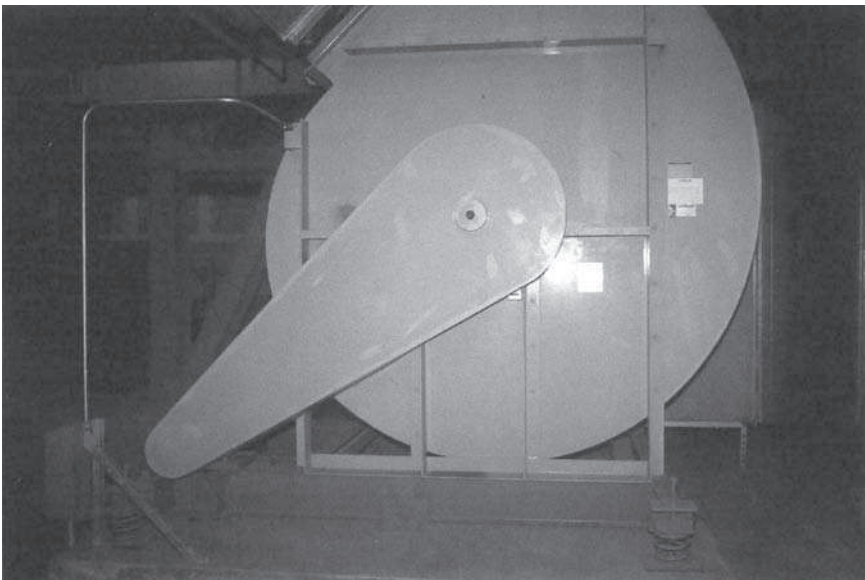

Figure 8-5. Centrifugal Airfoil Fan

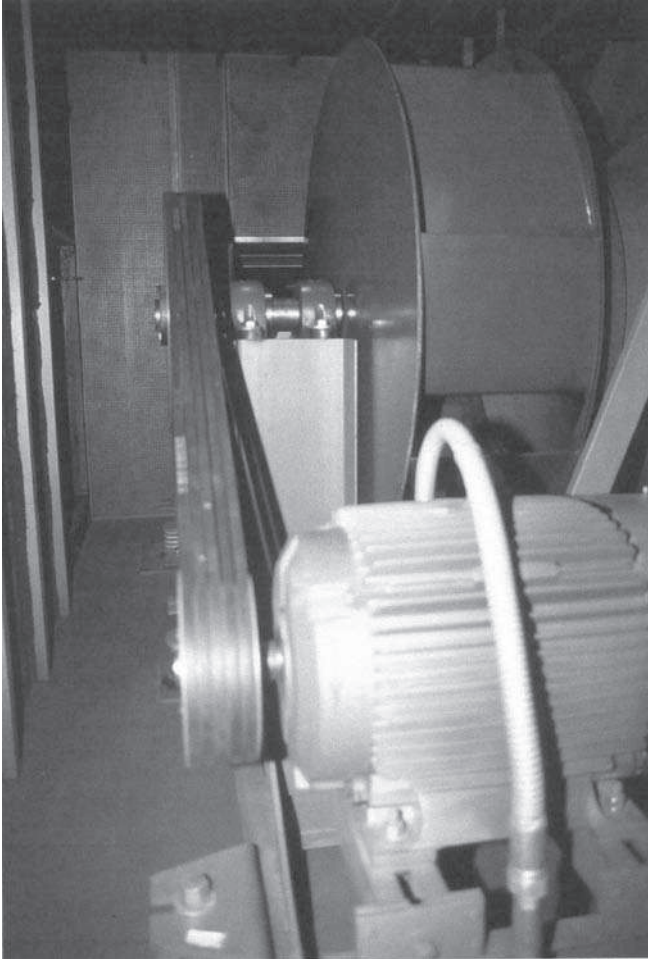

Figure 8-6. Centrifugal airfoil plug fan with a fixed pitch motor sheave.

non-overloading, i.e., the horsepower (HP) increases as static pressure (SP) decreases to a maximum point. The best efficiency is in high capacity and high pressure applications. The AF fan is the most expensive of the centrifugals. The fan operates between 1200-2800 rpm, or about double the speed of FC fans for similar air quantity.

FAN SELECTION

The selection of the type of fan to be applied in a particular constant volume system is based on system size and space availability. The FC fan is used in smaller systems requiring air volumes to 20,000 cfm or less and static pressures to 5 inches. The FC fan is the least costly. The more efficient BI or AF fans are typically selected for systems requiring air volumes in excess of 20,000 cfm and 3 inches of static pressure. The larger fan sizes for greater air volume and static pressures require larger motors. However, the higher fan efficiencies of the BI/AF fans result in significant brake horsepower savings.

An inline VA fan may be selected when space is a major consideration. The straight-through airflow design permits VA fans to be installed in limited space and the fan can be mounted off the deck in the ceiling space. The VPVA fan is generally applied in large systems, which require flow quantities and pressures in excess of 50,000 cfm and 3 inches of water pressure.

VARIABLE AIR VOLUME FANS

The basic variable air volume system (VAV) is variable volume and constant temperature. A modulating device, either a damper or air valve, positioned by a room or zone thermostat controls the air volume supplied to each conditioned space. As the heating load changes in the conditioned space, the modulating device adjusts the airflow into the space accordingly so that only the air quantity that is required to balance the load is supplied. This can produce significant energy savings. This modulation requires the VAV fan to operate over a range of points on its performance curve rather than a single point as with a constant volume fan.

There are various ways to control the volume out of the VAV fan. The simplest form of fan control is "riding the fan curve." As the modulating devices are closing, the system resis-

tance increases in the duct creating a new operating point on the fan performance curve. This point is up, or “rides up” on the fan curve, closer to no delivery. This increase in static pressure reduces fan cfm output. As the space heat load increases, the modulating devices open, reducing system resistance and again creating a new operating point on the fan performance curve. This point is down, or “rides down” on the fan curve, closer to free delivery (WOCFM). This decrease in static pressure increases fan cfm output. This type of modulation control works best with forward curved fans.

Another way to control fan volume is with discharge dampers. Discharge dampers, also called static pressure dampers, are a set of automatic dampers in the ductwork at the discharge (outlet) of the fan. As with “riding the curve,” discharge dampers work best with forward curved fans. The discharge dampers modulate the air volume out of the fan by opening or closing, and controlling static pressure at the fan outlet. The dampers are controlled by a pressure-sensing controller located in the duct beyond the turbulent area of the dampers. As the air valves or VAV dampers in the terminal boxes are closing throughout the air distribution system the static pressure starts to build up in the main duct. The static pressure sensor for the discharge dampers picks up the rising pressure and sends a signal to the discharge dampers to close enough to compensate for the rising duct pressure. This reduces air volume of the fan to meet the requirement of the decreasing load. As thermostats in the conditioned spaces sense there is a need for cooling, a signal is sent to the air valves or VAV dampers to open. As the VAV dampers open, the static pressure in the main duct falls. The static pressure sensor for the discharge dampers picks up the falling pressure and sends a signal to the discharge dampers to open enough to compensate for the falling duct pressure. This increases the air volume of the fan to meet the requirements of the increasing load.

Inlet vanes, also called inlet guide vanes (IGV) or vortex dampers, are used to modulate the volume of centrifugal and axial fans. Inlet vanes actually alter the performance of the fan

as they close by imparting a spin to the air in the direction of fan rotation (pre-rotational spin). Pre-spinning the air reduces the ability of the fan blades to cut the air. This lessens the volume of the air through the fan and reduces static pressure and horsepower. As the inlet vanes modulate, they create a new fan performance curve and fan motor horsepower curve with each vane position.

A static pressure-sensing controller located in the ductwork controls the inlet vanes. As the distribution VAV dampers or air valves open, the static pressure in the main duct falls. The static pressure sensor for the vortex dampers picks up the falling pressure and sends a signal to the vortex dampers to open enough to compensate for the falling duct pressure. This increases air volume of the fan to meet the requirement of the increasing load. As thermostats in the conditioned spaces sense there is a need for heating, a signal is sent to the air valves or VAV dampers to close. When the air valves or VAV dampers in the terminal boxes are closing throughout the air distribution system the static pressure starts to build up in the main duct. The static pressure sensor for the inlet guide vanes picks up the rising pressure and sends a signal to the IGV to close sufficiently to compensate for the rising duct pressure. This reduces the air volume of the fan to meet the requirements of the decreasing load.

Fan speed adjustment (adjustable speed drive) is another way to control fan capacity. As with other types of fan controllers previously discussed, fan speed adjustment uses a static pressure sensor-controller to sense duct static pressure variations. The static pressure sensor sends a signal to a fan speed control device to increase or decrease fan speed. Changing fan speed changes air volume and static pressure out of the fan. Brake horsepower also changes approximately by the square of the change in rpm when used with a variable frequency drive (VFD) speed controller. Air volume changes directly as the rpm changes.

There are two basic categories of adjustable speed drives. They are mechanical and electrical. The drive can be used on centrifugal or axial fans. One type of mechanical system used on

centrifugal fans has an automatically adjusting motor sheave. The signal from the static pressure controller converts to a mechanical action, which in turn adjusts the motor sheave diameter either larger or smaller to increase or decrease the fan speed to stabilize the duct static pressure. Another type of mechanical speed drive is used with vane axial fans. This system uses a variable pitch control for varying air volume. The static pressure controller signals the axial wheel's blades, to change pitch to either increase or decrease air volume and static pressure to meet demands and stabilize duct static pressure.

There are also several types of electrical drives including eddy current, direct current, and variable frequency drive (VFD). The electrical drive most often used is the variable frequency drive. The VFD control scheme uses a static pressure signal to vary this voltage and frequency of an alternating current (AC). Changing voltage and frequency adjusts the motor speed and in turn, directly changes fan speed to meet airflow and static pressure requirements.

IMPROVING THE EFFICIENCY OF FANS

1. Check that the fan wheel is installed correctly and rotating in the correct direction.
2. Avoid installing restrictive ductwork on the inlets and discharges of fans.
3. Complete an air balance of the system.
4. Clean the fan blades.
5. Clean the filters and coils.
6. Repair leaks in the duct system.
7. When reducing airflow on a constant volume fan, consider changing fan speed instead of closing dampers.

Chapter 9

Air Distribution

A*ir volume in ducts*

$$Q = AV$$

- Q = volume of air (cfm)
- A = cross sectional area of the duct (sf)
- V = velocity (fpm)

$$V = 4005 \times (VP)^{1/2}$$

$$VP = (V \div 4005)^2$$

- V = velocity, fpm—feet per minute
- VP = velocity pressure (in wg)
- 4005 = constant, @ standard conditions (SCFM)

DUCTS (DUCTWORK)

Air moves through the ductwork because of a difference in pressures. Just as heat moves from a higher level to a lower level, so do fluids. Fluids move from a higher pressure to a lower pressure. Air is a vapor and as such is a compressible fluid. Air moves through the duct system because the pressure on one side (discharge) of the fan is higher than on the inlet or suction side of the fan. The fan produces a pressure at the discharge of the fan that is higher than the pressure in the conditioned space, i.e., the pressure in the conditioned space is atmospheric pressure while the pressure at the fan discharge is greater than atmospheric pressure.

Air moves through the ductwork (Figure 9-1) until it reaches

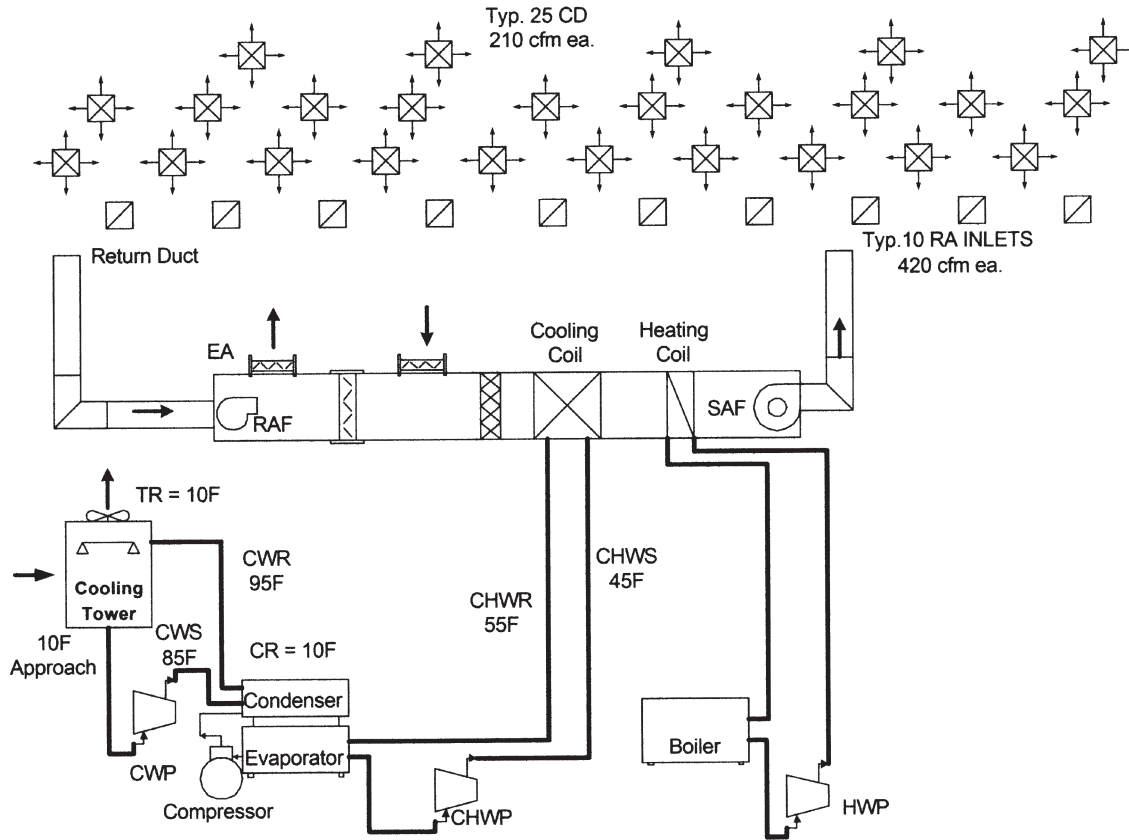

Figure 9-1. Central HVAC System "Air Distribution"

the supply air outlets in the conditioned space. As supply air is discharged it mixes with the room air. As the supply air comes in contact with the mass of room air, the velocity of the supply air slows down. After circulating through the room, the air exits the room by way of the return air inlet and goes back to the air handling unit. As long as the fan is on, the supply air continuously flows through the room, resulting in about 5 to 10 complete air changes per hour, for office areas.

When the system is in the cooling mode, the return air carries the heat removed from the conditioned space. The return air mixes with the outside air, which also contains some heat. This mixture then goes through the filter section and into the cooling coil and the cooling cycle starts over again. When the system is in the heating mode (wintertime condition) the return air is cooler than the supply air. Heat from the supply air has been released into the conditioned space. The "cool" return air mixes with the outside air, which is cool to cold. This mixture then goes through the filter section and into the heating coil and the heating cycle starts over again.

Ductwork may be round (Figure 9-2), rectangular (Figure 9-3), or a combination of rectangular and round called flat-oval. Most ducts are made from galvanized sheet metal. Ducts may be insulated, either lined or wrapped, to provide a thermal barrier to keep the supply air from losing heat when in the heating mode or gaining heat when in the cooling mode. Vapor-barrier insulation is used to wrap cooling duct to keep it from "sweating." Condensation will form on the duct if it is not insulated when there is 10 degree or more temperature difference between the cool air inside the duct and the warm, ambient air. Another reason for insulating duct is sound attenuation.

TERMINAL BOXES

Medium to high pressure duct systems will typically have pressure reducing, sound attenuation, constant air volume or

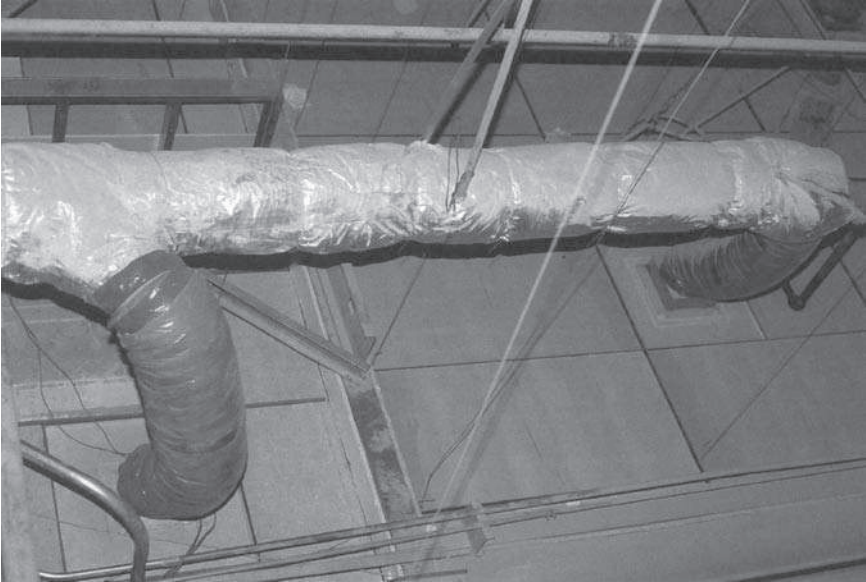

Figure 9-2. Round duct wrapped with vapor-barrier insulation.

variable air volume terminal boxes. The terminal boxes may be single or dual inlet. The inlet duct to the terminal box is medium pressure (2" - 6") or high pressure (over 6"). The duct from the terminal box into the conditioned space is low pressure (up to 2"). A terminal box is a device or unit which regulates supply airflow, temperature and humidity to the conditioned space. Terminal boxes are classified as single duct, dual duct, constant volume, variable volume, medium pressure, high pressure, pressure dependent, pressure independent, system powered, fan powered, induction, terminal reheat and bypass. They may also contain a combination of heating or cooling coils, dampers and sound attenuation. The airflow through the box is normally set at the factory but can also be adjusted in the field. Terminal boxes also reduce the inlet pressures to a level consistent with the low pressure, low velocity duct connected to the discharge of the box. Any noise that's generated within the box in the reduction of the pressure is attenuated. Baffles or other devices are installed which reflect the sound back into the box where

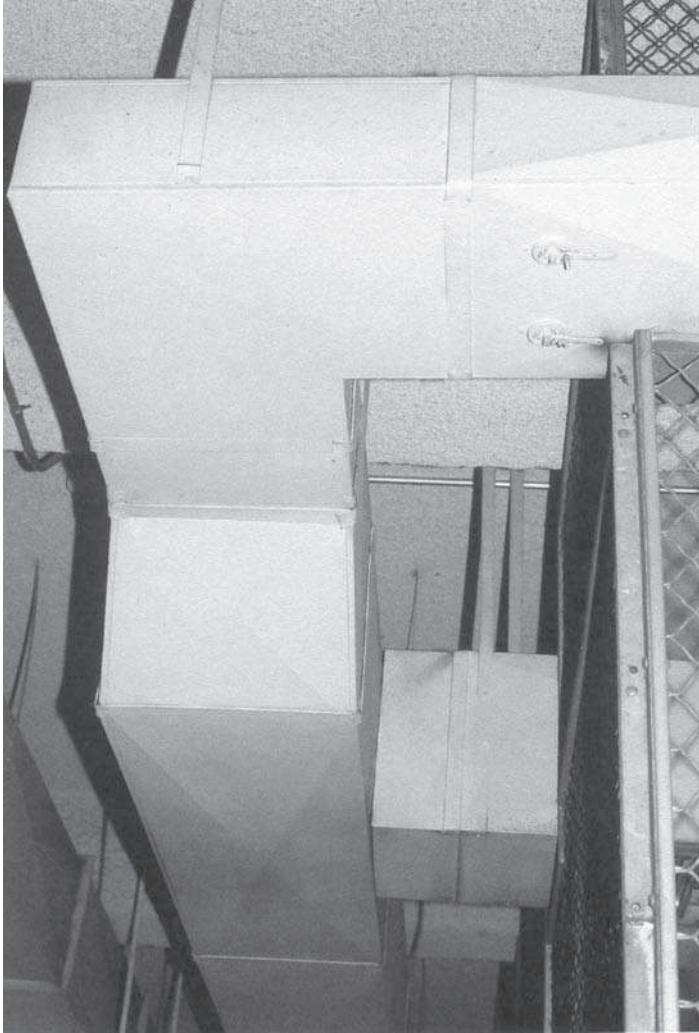

Figure 9-3. Rectangular exhaust duct, uninsulated.

it can be absorbed by the box lining. The boxes are lined with fiberglass which also provides thermal insulation so the conditioned air within the box won't be heated or cooled by the air in the spaces surrounding the box. Terminal boxes work off static pressure in the duct system. Each box has a minimum inlet static pressure requirement (typically 0.75" to 1") to

overcome the pressure losses through the box plus any losses through the discharge duct, volume dampers, and outlets.

Constant Volume Single Duct Terminal Box

A constant volume single duct terminal box (Figure 9-4) is a single inlet box supplied with air at a constant volume and temperature (typically cool air). Air flowing through the box is controlled by a manually operated damper or a mechanical constant volume regulator. The mechanical volume regulator uses springs and perforated plates or damper blades which decrease or increase the available flow area as the pressure at the inlet to the box increases or decreases. A reheat coil (water, steam, or electric) may be installed in the box or immediately downstream from it. A room thermostat controls the coil.

Constant Volume Dual Duct Terminal Box

Constant volume dual duct terminal boxes (Figure 9-5) are supplied by separate hot and cold ducts through two inlets. The boxes mix warm or cool air as needed to properly condition the space and maintain a constant volume of discharge air. Dual duct boxes may use a mechanical constant volume regulator with a single damper motor to control the supply air. The mixing damper is positioned by the motor in response to the room thermostat. As the box inlet pressure increases, the regulator closes down to maintain a constant flow rate through the box. Another type of constant flow regulation uses two motors, two mixing dampers and a pressure sensor to control flow and temperature of the supply air. The motor connected to the hot duct inlet responds to the room thermostat and opens or closes to maintain room temperature. The motor on the cold duct inlet is also connected to the room thermostat but through a relay which senses the pressure difference across the sensor. The motor opens or closes the damper on the cold duct inlet to (1) maintain room temperature and (2) maintain a constant pressure across the sensor and therefore, a constant volume through the box.

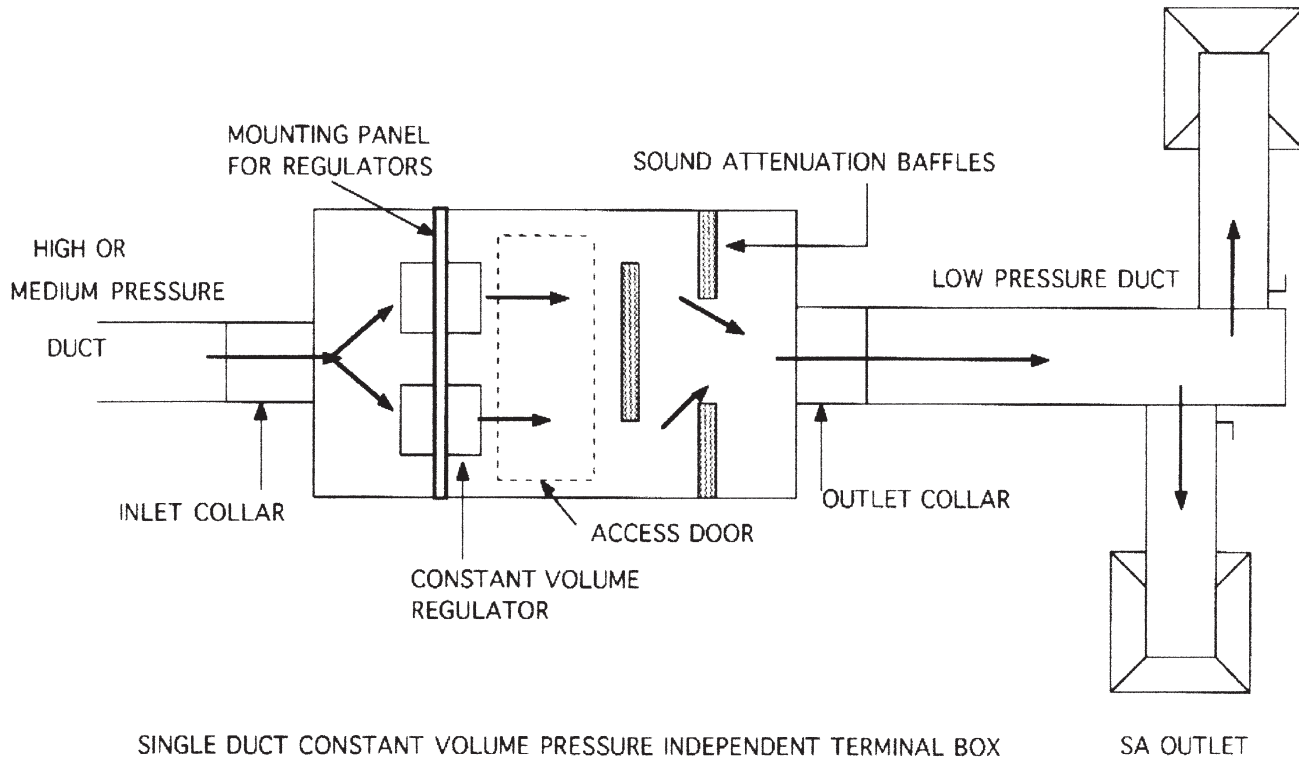

SINGLE DUCT CONSTANT VOLUME PRESSURE INDEPENDENT TERMINAL BOX

Figure 9-4. Constant Volume Single Duct Terminal Box

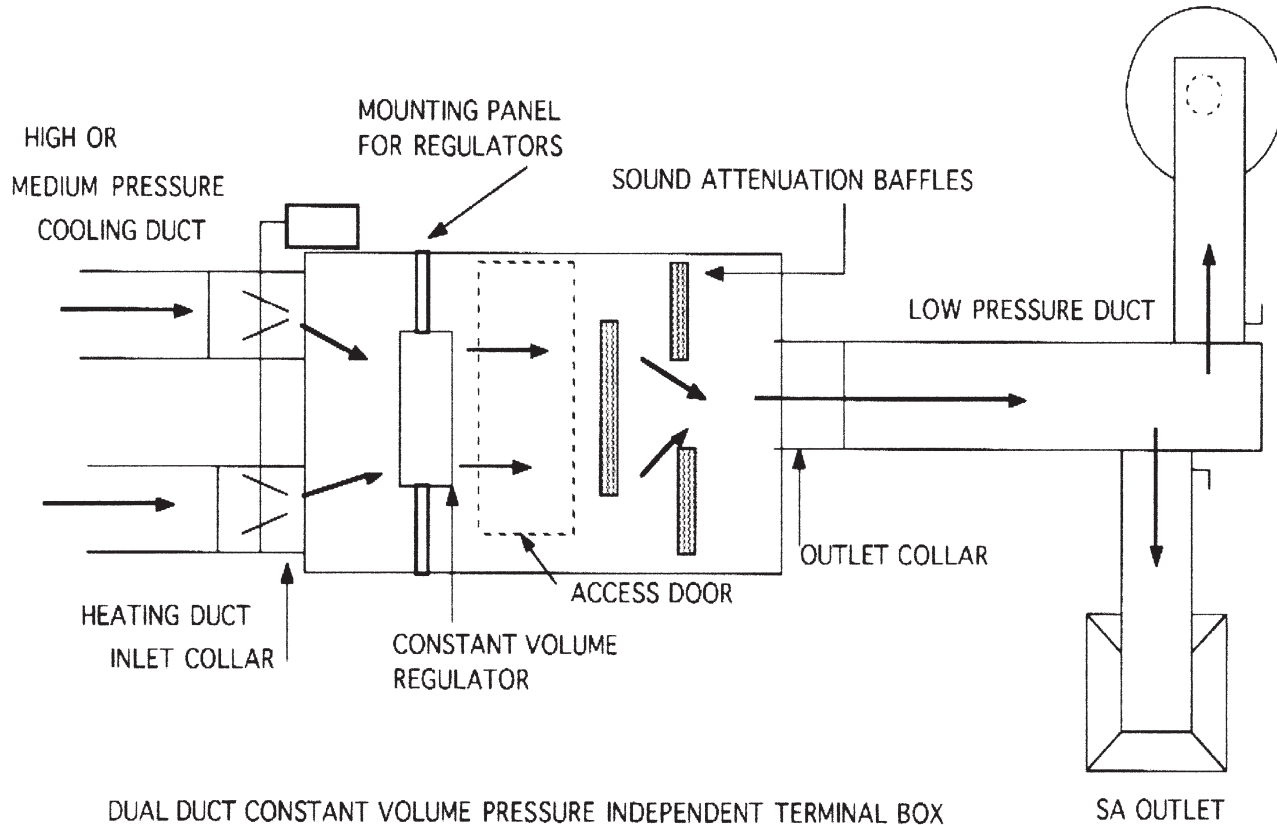

DUAL DUCT CONSTANT VOLUME PRESSURE INDEPENDENT TERMINAL BOX

Figure 9-5. Constant Volume Double Duct Terminal Box

Variable Air Volume (VAV) Terminal Box

VAV boxes are available in many combinations that include: pressure dependent, pressure independent, single duct, dual duct, cooling only, cooling with reheat, induction, bypass, system and fan powered. VAV boxes can also be classified by (1) volume control: throttling, bypass, or fan powered, (2) intake controls and sensors: pneumatic, electric, electronic (direct digital control, DDC), or system powered, (3) thermostat action: direct acting or reverse acting and (4) the condition of the box at rest: normally open or normally closed. The basic VAV box has a single inlet duct. The quantity of air through the box is controlled by throttling an internal damper or air valve. If the box is pressure dependent, the damper will be controlled just by a room thermostat, whereas, the pressure independent version will also have a regulator to limit the air volume between a preset maximum and minimum. Inside the pressure independent box is a sensor. Mounted on the outside is a controller with connections to the sensor, volume damper and room thermostat. The quantity of air will vary from a design maximum cfm down to a minimum cfm which is generally around 50% to 25% of maximum. The main feature of the VAV box is its ability to vary the air delivered to the conditioned space as the heat load varies. Then, as the total required volume of air is reduced throughout the system, the supply fan will reduce its cfm output. This means a savings of energy and cost to operate the fan. The exception to this is the VAV bypass box.

VAV Single Duct Pressure Independent Terminal Box

Pressure independent VAV boxes can maintain airflow at any point between maximum and minimum, regardless of box inlet static pressure, as long as the pressure is within the design operating range. Flow sensing devices regulate the flow rate through the box in response to the room thermostat's call for cooling or heating. A variable air volume single duct terminal box (Figure 9-6) is a single inlet box supplied with air at a varying volume and constant temperature (typically cool air 55°F to 60°F). To

maintain the correct airflow in a pressure independent box over the entire potential range of varying inlet static pressure, a sensor reads the differential pressure at the inlet of the box and transmits it to the controller. The room thermostat responding to the load conditions in the space also sends a signal to the controller. The controller responds by actuating the volume damper and regulating the airflow within the preset maximum and minimum range. For example, as the temperature rises in the space, the damper opens for more cooling. As the temperature in the space drops, the damper closes. If the box also has a reheat coil, the volume damper, on a call for heating, would close to its minimum position—but usually not less than 50%—and the reheat coil would be activated. Because of the pressure independence, the airflow through the boxes is unaffected as other VAV boxes in the system modulate and change the inlet pressures throughout the system.

VAV Dual Duct Pressure Independent Terminal Box

Variable volume dual duct terminal boxes (Figure 9-7) are supplied by separate hot and cold ducts through two inlets. There is a controller and damper for each inlet (Figure 9-8). The boxes mix warm or cool air as needed to properly condition the space. To maintain the correct airflow in a pressure independent box over the entire potential range of varying inlet static pressure, a sensor reads the differential pressure at the outlet of the box and transmits it to the controller. The room thermostat responding to the load conditions in the space also sends a signal to the controllers. The controllers respond by actuating the appropriate volume damper and regulating the airflow within the preset maximum and minimum range. For example, as the temperature rises in the space, the cold duct damper opens for more cooling and the hot duct damper closes. As the temperature in the space drops, the dampers reverse their positions. Because of the pressure independence, the airflow through the boxes is unaffected as other VAV boxes in the system modulate and change the inlet pressures throughout the system.

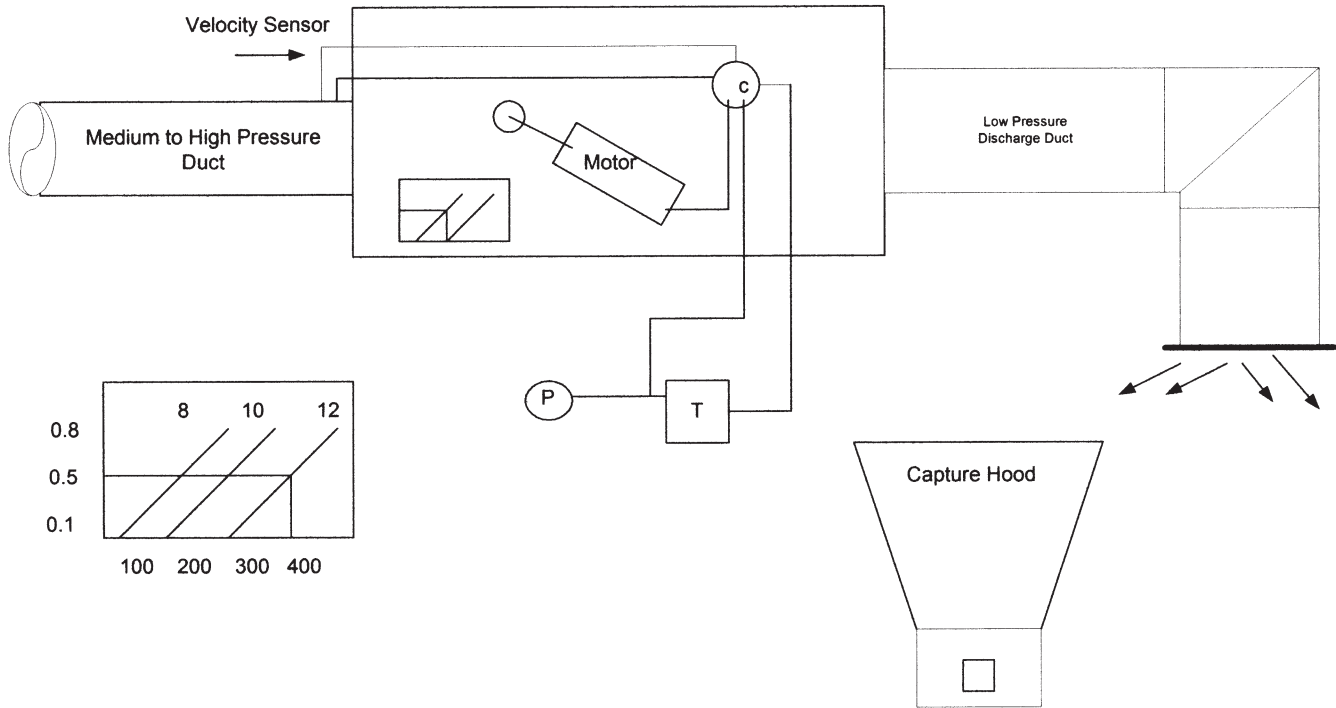

Figure 9-6. VAV Single Duct Pressure Independent Terminal Box

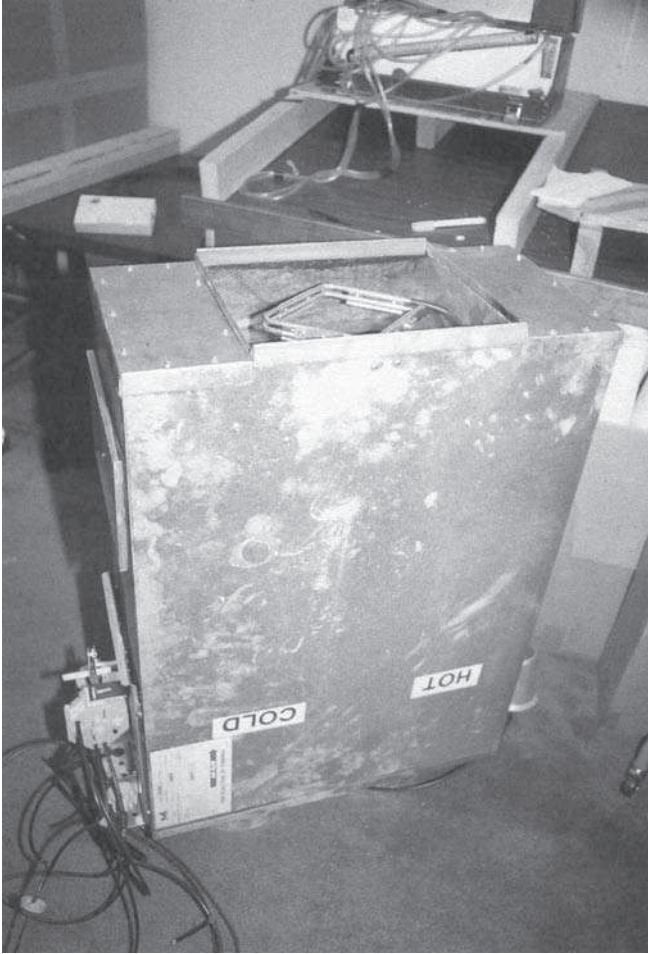

Figure 9-7. VAV dual duct pressure independent terminal box with velocity sensor at the discharge of the box.

VAV Series or Parallel Fan Powered Terminal Box

A VAV fan powered box (Figure 9-9) has the advantage of the energy savings of a conventional, single duct VAV system with the addition of several methods of heating and a constant airflow to the conditioned space. The box contains a fan and a return air opening from the ceiling space. When the room thermostat is calling for cooling the box operates as would the stan-

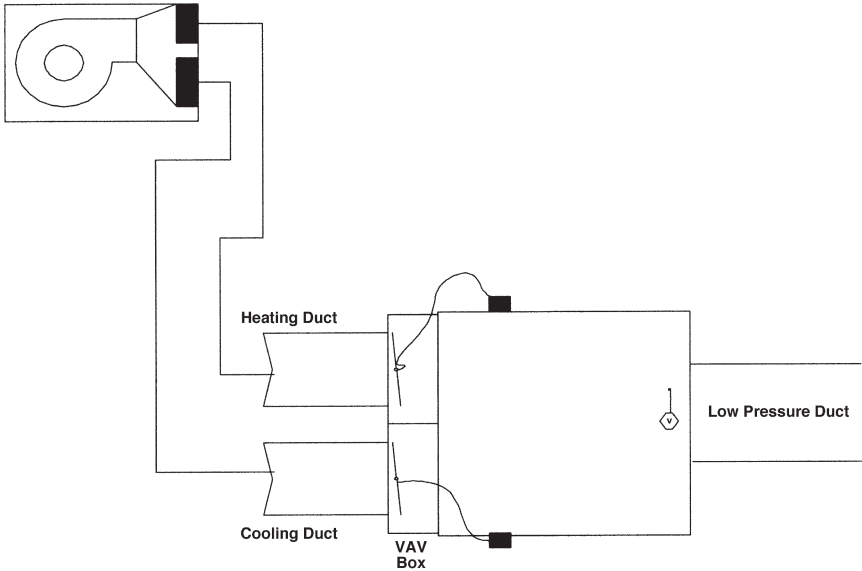

Figure 9-8. VAV Dual Duct Pressure Independent Terminal Box

standard VAV box. However, on a call for heat the fan draws warm (secondary) air from the ceiling plenum and recirculates it into the rooms. Varying amounts of cool (primary) air from the main system are introduced into the box on either the inlet or discharge side of the fan and mix with the secondary air. A system of dampers, backdraft or motorized, control the airflow and mixing of the air streams. As the room thermostat continues to call for heat, the primary air damper closes off and more secondary air is drawn into the box and it alone is recirculated. Therefore, the airflow to the conditioned space stays constant. If more heat is needed, reheat coils may be installed in the boxes. The fan may operate continuously or it may shut off. A common application of fan powered boxes is around the perimeter or other areas of a building where: (1) air stagnation is a problem when the primary air throttles back, (2) zones have seasonal heating and cooling requirements, (3) heat is needed during unoccupied hours when the primary fan is off, (4) the heating load requirement can be offset mainly with recirculated return air.

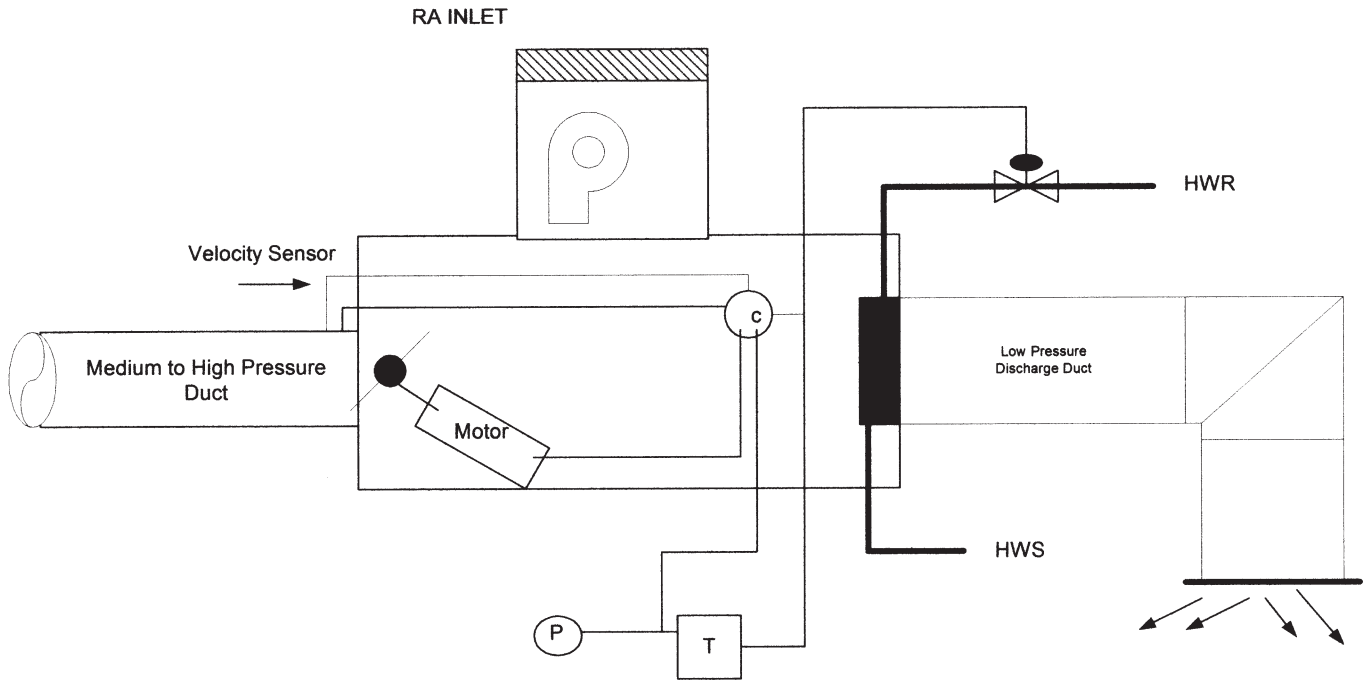

Figure 9-9. VAV Parallel or "Side Pocket" Fan Powered Terminal Box

VAV Pressure Dependent Terminal Box

A pressure dependent VAV box (Figure 9-10) is essentially a pressure reducing and sound attenuation box with a motorized damper that's controlled by a room thermostat. There is no differential pressure velocity sensor at the inlet of the box. These boxes don't regulate the airflow, but simply position the damper in response to the signal from the thermostat. Because the airflow to these boxes is in direct relation to the box inlet static pressure, it's possible for the boxes closest to the supply fan, where the static pressure is the greatest, to get more air than is needed, so the boxes farther down the line will be getting little or no air. Therefore, pressure dependent boxes should only be installed in systems where there's no need for limit control and the system static pressure is stable enough not to require pressure independence. Pressure dependent maximum regulated volume boxes may be used where pressure independence is required only at maximum volume and the system static pressure variations are only minor. These boxes regulate the maximum volume but the flow rate at any point below maximum varies with the inlet static pressure. This may cause "hunting," or pulsating as the dampers move back and forth to maintain desired airflow.

AIR DISTRIBUTION DEVICES

Diffuser

A diffuser (Figure 9-11) is a supply air outlet generally found in the ceiling with various deflectors arranged to promote mixing of primary air with secondary air. Types of diffusers are: round, square, rectangular, linear and light troffers. Some diffusers have a fixed air flow pattern while others have field-adjusted patterns.

Ceiling Diffuser

A ceiling diffuser (CD) is a diffuser which typically provides a horizontal flow pattern that tends to flow along the ceiling producing a high degree of surface effect. Round ceiling diffusers deliver air in all directions.

Single Duct Variable Air Volume Pressure Dependent Box

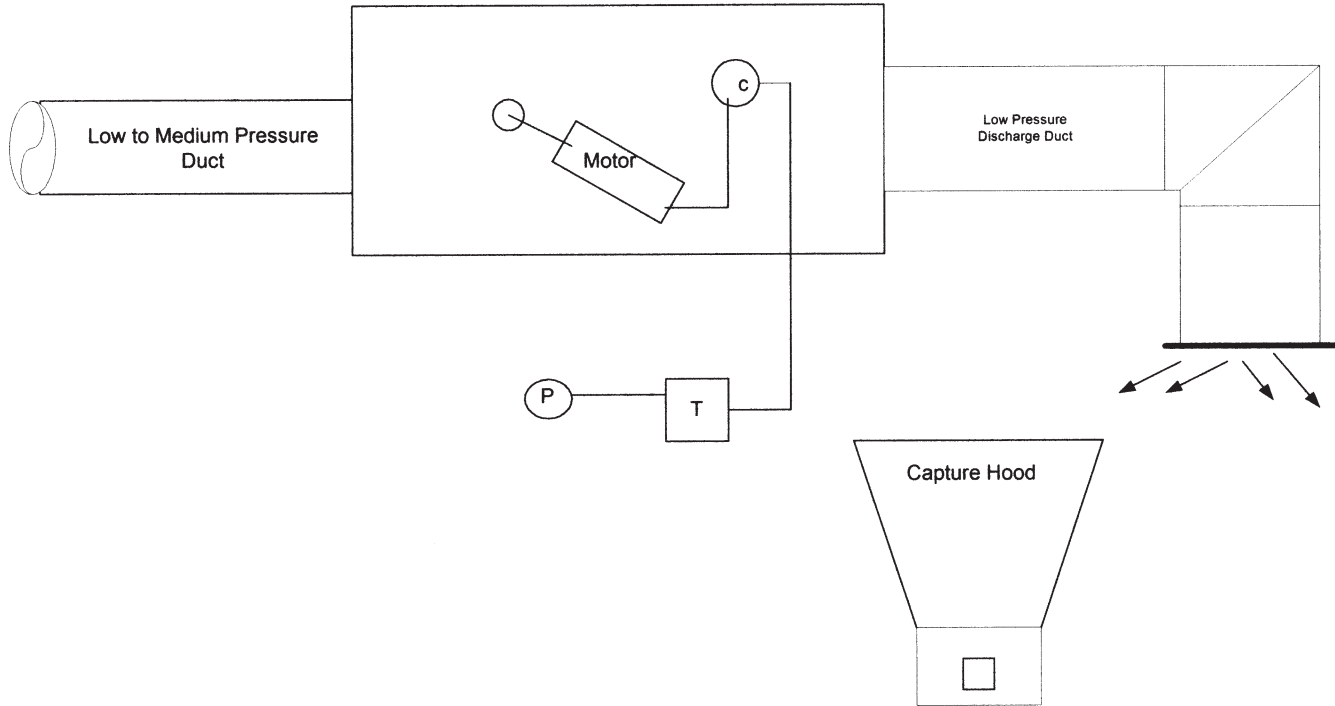

Figure 9-10. VAV Pressure Dependent Terminal Box

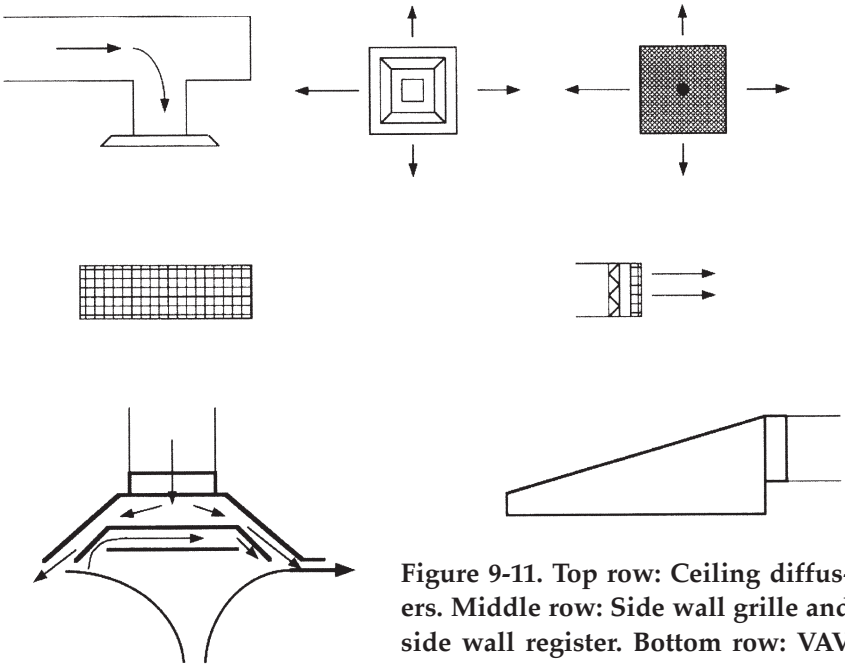

Figure 9-11. Top row: Ceiling diffusers. Middle row: Side wall grille and side wall register. Bottom row: VAV diffusers

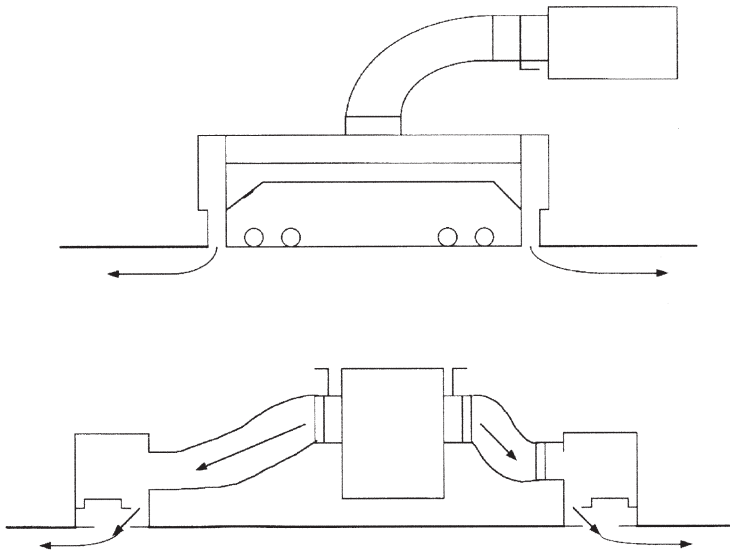

Figure 9-12. Top: Fluorescent light troffer. Bottom: Linear slot diffuser

Typical square or rectangular ceiling diffusers supply air in a one-, two-, three- or four-way pattern. CD with a four-way throw pattern.

Perforated Face Diffuser

Perforated face diffusers are used with lay-in ceilings and are similar in construction to the standard square ceiling diffuser with an added perforated face plate. They're generally equipped with adjustable vanes to change the flow pattern to a one-, two-, three-, or four-way throw.

Grille

A grille is a wall-, ceiling- or floor-mounted louvered or perforated covering for an air opening. To control airflow pattern, some grilles have a removable louver. Reversing or rotating the louver changes the air direction. Grilles are also available with adjustable horizontal or vertical bars so the direction, throw, and spread of the supply air stream can be controlled.

Register

A register is a grille with a built-in or attached damper assembly.

VAV Diffusers

VAV diffusers work off a room or internal thermostat to open or close. They reduce airflow but maintain adequate air velocity so that at the lower volume air does not drop out of the diffuser (dumping) but hugs the ceiling until it reaches terminal velocity as is the normal pattern for a ceiling diffuser. There are no VAV terminal boxes in this type of system.

Light Troffers

A light troffer (Figure 9-12) is a type of ceiling diffuser which fits over a fluorescent lamp fixture and delivers air through a slot along the edge of the fixture. They're available in several types. One type supplies air on both sides of the lamp fixture and another type provides air to only one side of the fixture.

Linear Slot Diffuser

This type of diffuser is manufactured in various lengths and numbers of slots and may be set for different throw patterns.

Damper

A damper is a device used to regulate airflow.

Manual Volume Dampers (MVD)

Manual dampers are used to control the quantity of airflow in the system by introducing a resistance to flow. If not properly selected, located, installed and adjusted, they (1) don't control the air as intended, (2) they add unnecessary resistance to the system and (3) they can create noise problems. The resistance a volume damper creates in a duct system is determined by how complicated the system is. For instance, if the system is very simple and the damper is a large part of that resistance, then any movement of the damper will change the resistance of the entire system and good control of the airflow will result. If, however, the damper resistance is very small in relation to the entire system, poor control will be the case. For instance, partial closing of a damper will increase its resistance to airflow, but depending on the resistance of the damper to the overall system resistance, the reduction in airflow may or may not be in proportion to closure. In other words, closing a damper 50% doesn't necessarily mean that the airflow will be reduced to 50%. For example, a damper when open might be 10% of the total system resistance. When this damper is half closed the airflow will be reduced to 80% of maximum flow. However, a similarly built damper in another duct system is 30% of the total system resistance when open. When this damper is half closed the airflow is reduced to 55% of maximum. The relationship between the position of a damper and its percent of airflow is termed its "flow characteristic." Opposed blade dampers are generally recommended for large duct systems because they introduce more resistance to airflow for most closed positions, and therefore, have a better flow characteristic than parallel blade dampers. However, flow characteristics

of dampers aren't consistent and may vary from one system to another. The actual effect of closing a damper can only be determined in the field by measurement.

Proper location of balancing dampers not only permits maximum air distribution but also equalizes the pressure drops in the different airflow paths within the system. Manual dampers should be provided in each duct takeoff to control the air to grilles and diffusers. They should also be in (1) the main, (2) each submain, (3) each branch and (4) each sub-branch duct. Manually operated opposed blade or single blade quadrant type volume dampers should also be installed in every zone duct of a multizone system.

Single blade or opposed blade volume dampers immediately behind diffusers and grilles shouldn't be used for balancing because when throttled they (1) create noise at the outlet and (2) change the effective area of the outlet so the flow (A_k) factor is no longer valid. Proper installation and location of balancing dampers in the takeoffs eliminates the need for volume controls at grilles and diffusers.

Manual volume dampers may need to be installed in the outside, exhaust (relief) and return air connections to the mixed air plenum in addition to any automatic dampers. These volume control dampers balance the pressure drops in the various flow paths so the pressure drop in the entire system stays constant as the proportions of return air and outside air vary to satisfy the temperature requirements.

Manual volume dampers and handles should have enough strength and rigidity for the operating pressures of the duct system in which they will be installed. For small duct, a single blade damper is satisfactory. For large duct, dampers should be multi-blade. Each damper should have a locking handle, quadrant, or regulator.

Opposed Blade Damper (OBD)

An opposed blade damper (Figure 9-13) is a multiple bladed damper with a linkage which rotates the adjacent blades in op-

posite directions resulting in a series of openings that become increasingly narrow as the damper closes. This type of blade action results in a straight, uniform flow pattern sometimes called “non-diverting.” Opposed blade dampers are used in a volume control and mixing applications. They may be manual or automatic. Automatic dampers are also called automatic temperature control dampers, ATCD. Dampers should have enough strength and rigidity for the operating pressures of the duct system in which they will be installed.

Parallel Blade Damper

A parallel blade damper (Figure 9-14) is a multiple bladed damper. Generally, parallel blade dampers are used in mixing applications. Because the blades rotate parallel to each other, a parallel blade damper produces a “diverting” type of air pattern and when in a partially closed position, the damper blades throw the air to the side, top or bottom of the duct. This flow pattern may adversely affect coil or fan performance or the airflow into branch ducts if the damper is located too close upstream. Dampers should have enough strength and rigidity for the operating pressures of the duct system in which they will be installed. Parallel blade dampers may be manual or automatic.

AIR SIDE ECONOMIZERS

Occupied commercial and industrial buildings require a specified quantity of outside air for ventilation. Depending on the usage of the building, the outside air quantity will be approximately 15 to 25 cubic feet per minute (cfm) per person. In some buildings, the HVAC system is supplied with 100% outside air. Most systems are designed to combine outside ventilation air with the return air. This conserves the energy needed to condition the air entering the heating and cooling coil. The combination of the return and outside air is called mixed air (MA). Any return air not used in the mixed air is exhausted to the outside and is



Figure 9-13. Opposed blade dampers in mixed air plenum. Notice blade action for opposed blade and parallel blade dampers.



Figure 9-14. Parallel blade dampers in mixed air plenum. Notice blade action for opposed blade and parallel blade dampers.

called exhaust air (EA). The control of the return air, outside air, exhaust air and mixed air is called the “mixed air control” or “the economizer control.” A mixed air, low limit thermostat modulates the outside air, return air and exhaust air dampers to maintain the desired mixed air temperature. Other controls, an outside air high limit and a morning warm up low limit, are added to make the mixed air economizer system function economically with better temperature control.

When properly controlled, the outside ventilation air can aid the heating, cooling and humidifying of the building spaces. It can also provide a positive static pressure in the conditioned spaces. This positive pressure reduces the amount of air infiltration. Commercial buildings will generally be pressurized at about 0.03 to 0.05 inches of water column static pressure. Automatic

dampers are used to control the amount of outside ventilation air entering the building as well as the return air and exhaust air dampers.

An air side economizer is used when it is advantageous to use outside air instead of mechanical refrigeration to cool the space. Figure 9-15, shows the basic dry bulb economizer cycle. The outside air (OA) normally closed (NC), return air (RA) normally open (NO), and exhaust air (EA) normally closed (NC) dampers are controlled by the mixed air low limit (MA-LL) controller. This controller is direct-acting (D/A) and set for 55°F. The second control for this economizer is a reverse-acting (R/A) outside air high limit (OA-HL) controller set for 72°F. When the air temperature in the mixed air plenum rises above the MA-LL set point (55°F, in this example), the controller will send an increasing branch signal to the OA, RA and EA dampers, moving

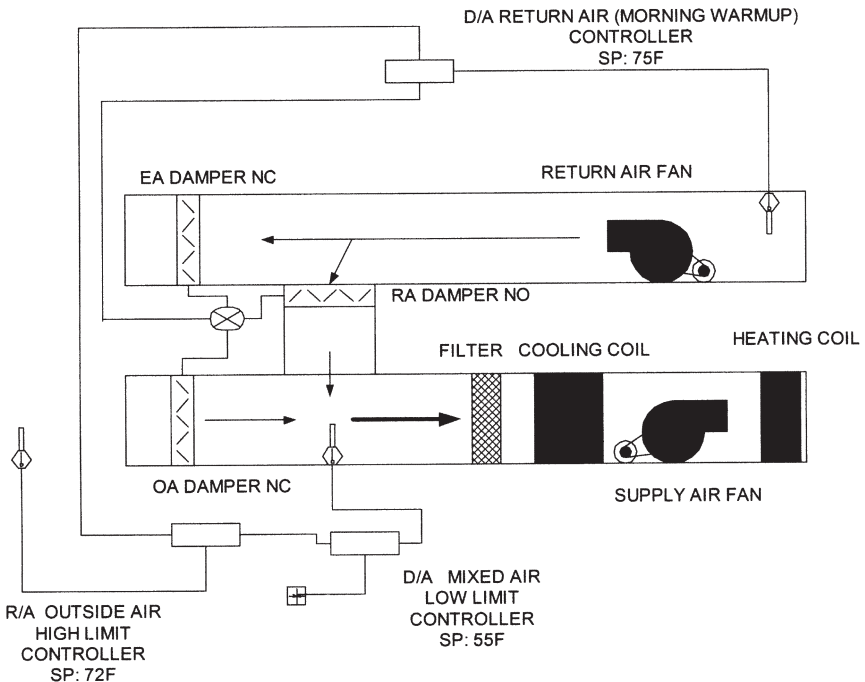

Figure 9-15. Air Side Economizer

them away from their normal positions. The OA and EA damper will go open and the RA damper will go closed. This sequence will continue as long as the mixed air temperature is above set point and the outside air temperature is below setpoint (72°F). When the outside air reaches set point, the OA-HL will reverse the branch signal going to the dampers. The dampers will see a decreasing pressure which will cause them return to their normal positions. A return air low-limit (RA-LL) controller modulates the outside, return and exhaust dampers to maintain space temperature. This direct-acting (D/A) controller overrides both the mixed air and outside air controllers. The RA-LL is set for 75°F. If the temperature in the return duct is below the set point, the RA-LL will send a signal for the OA, EA and RA dampers to go to their normal positions, i. e., OA and EA closed, RA open. The dampers would remain at this condition until the air temperature in the return duct is above 75°F. At this time, the mixed air controller and outside air controller would take over and modulate the dampers according to mixed air and outside air temperatures.

This page intentionally left blank

Chapter 10

Variable Air Volume

Ways to vary the air volume and static pressure in a VAV system.

Riding the Curve

Static Pressure Damper in the Duct, Closing Box Dampers

Inlet Guide Vanes (Vortex Dampers)

Variable Frequency Drive

Adjustable Pitch Motor (Drive) Sheave (Centrifugal)

Variable Pitch Blades (Axial)

Eddy Current Drive

Shroud

Bypass (no energy savings)

VAV Diversity

It will not be possible to have full flow through all the VAV boxes simultaneously.

The total of the boxes or outlets is greater than the capacity of the fan.

Types of VAV Terminal Boxes

Pressure Dependent

Pressure Independent

Single Inlet

Dual Inlet

Series Fan Powered

Parallel Fan Powered

Ceiling Induction

Bypass (Constant Volume Fan)

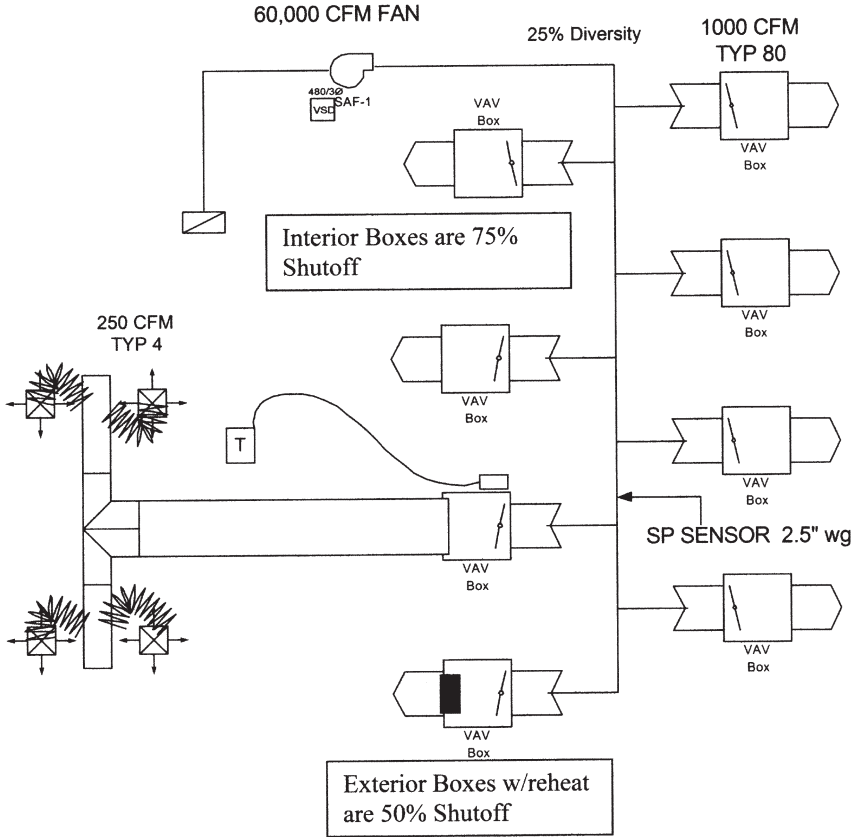

Figure 10-1. VAV System. Pressure Independent (PI) with Reheat

VARIABLE AIR VOLUME SYSTEM

The basic pressure independent variable air volume system is constant temperature and variable volume. The VAV system in Figure 10-1 has a constant supply air temperature of 55 degrees Fahrenheit off the coil and into the space. The total of all the terminal boxes or all the diffusers is 80,000 cfm. However, the fan has a maximum output of 60,000 cfm. This system has a 25% diversity, or difference between the total output of the fan and the total of the diffusers (60,000/80,000). Therefore, if all the space thermostats called for full cooling and the boxes opened to

maximum simultaneously then the fan would not have enough air output to meet the demand. The boxes closest to the fan would get their required air while the boxes further downstream “starve” for air. In Figure 10-1 all the boxes are set for a maximum flow of 1000 cfm. The interior boxes have maximum shutoff at 75%. The minimum flow then is 250 cfm. The exterior boxes with reheat coils have maximum shutoff at 50%. In other words, the minimum flow is 500 cfm. If the airflow through these reheat boxes falls below 50% the heat transfer may diminish, i.e., the required heat from the steam, hot water or electricity may not be picked up by the air if the airflow is too slow. Safety and fire may be a concern, especially with electric reheats if not enough air is moving across the electric resistance coil to remove the heat.

MAXIMIZING VAV PERFORMANCE

How do you maximize the performance of VAV systems? Well, that probably depends on what stage of the system you’re working on. If your system is already installed and it’s not working properly you’ll probably want to look at maintenance and an understanding of the system by the operating staff. The next step might be to do a verification of system performance (VOSP) to find out what the system is doing or check the air balance of the system. While you’re doing the VOSP or having the system air balanced, the next step may be to look at the installation. Finally, is the system properly designed? You may have a commissioning report, which should provide information on installation and design. Let’s start with the first step: the understanding and maintenance of the system. The operations and maintenance staff will need to have training on the systems and their components. In addition, as with any other HVAC system, regularly scheduled inspections and maintenance should be conducted.

VAV Operation

Most VAV systems use a single duct, which supplies a con-

stant air temperature, generally between 55°F and 60°F, to the VAV terminal box. There are also some dual duct systems that use two single duct supplies to the boxes. The air volume through the terminal box and into the space is varied to maintain the space temperature. The sensible heat transfer equation ($\text{Btuhs} = \text{cfm} \times 1.08 \times \text{TD}$) illustrates this.

As the heat load (Btuhs) goes up in the conditioned space the cfm into the space increases. In other words, as the temperature rises in the space (as sensed by the space thermostat) more air at 55°F comes into the space. For example, as the temperature rises from 75°F to 77°F (heat load is increasing) the cfm into the space increases from 500 cfm to 750 cfm. The sensible heat transfer equation, $\text{Btuhs} = \text{cfm} \times 1.08 \times \text{TD}$ (1.08 is a constant value), states that as the heat load varies, Btuhs increases or decreases, and we have a choice to increase or decrease either the cfm (air-flow volume) or the temperature of the air into the space. That is, if the Btuhs (heat load) increases, we can increase the cfm into the space and the temperature of the air into the space remains constant. This will cool the space. Likewise, if the Btuhs (heat load) decreases we can decrease the cfm into the space while the temperature of the air remains constant. This will allow the space to warm up (from the heat generated by the people, lights and equipment in the space). This is a variable air volume system.

However, we may elect to design the system so that the air temperature varies with the changes in heat load. Now, if the Btuhs (heat load) increases, we can decrease the temperature of the air into the space and the cfm remains constant. This will cool the space. Likewise, if the Btuhs (heat load) decreases, we can increase the temperature of the air while the cfm into the space remains constant. We vary the temperature of the supply air to maintain the space temperature. This is a constant air volume system.

VAV Terminal Box Operation

As the VAV terminal box dampers throttle back to allow less airflow into the space (heat load is reducing and the space

thermostat is calling for less cfm), static pressure builds up in the supply duct. A static pressure sensor (Figure 10-1), generally installed about two-thirds to three-quarters of the way from the fan to the end of the duct system, senses the increase in duct static pressure and sends a signal back to a control device. The control device, a controller, controls the supply air volume (cfm). The sensor and the volume controller react to maintain a constant static pressure (2.5 inches water gage in this example) at the sensor location as the system's air volume fluctuates. If on the other hand, the heat load is increasing, and the space thermostat is calling for more cfm, the terminal box dampers or air valves start opening to allow more airflow into the space. The static pressure in the supply duct decreases. The static pressure sensor senses the decrease in duct static pressure and sends a signal back to the control device to increase the supply air volume to the boxes.

Sensor Location

The location of the sensor is a compromise between energy efficiency and control of the system. For the maximum energy efficiency, the sensor would be installed before the terminal box "farthest" (from a static pressure standpoint) from the fan and the static pressure set only high enough to operate that box and its associated low-pressure system. However, because the entire system may be continuously changing, i.e., some boxes are closing while others are opening; the "farthest" box may also be constantly changing. This means that at any given time any terminal box may be the "farthest" box and may need more static pressure than was required at the original box. Therefore, the sensor is located closer to the fan and set at a higher static pressure to accommodate any additional pressure losses. This gives control to the system but also increases the pressure that the fan must produce, and some energy savings is lost.

VAV Controller and Controlled Device

A volume and static pressure control device (controller) receives the signal from the sensor. The controller sends a signal to

a controlled device. The controlled device may be an electronic variable frequency drive (VFD), which varies the speed of the motor and varies fan speed. Another controlled device is a variable pitch fan. Other controlled devices include a mechanical variable position drive (adjustable motor drive or adjustable speed drive), which changes the pitch of the motor sheave, varying fan speed; inlet or vortex dampers at inlet of the fan, varying the spin of the air and reducing open area into the fan; and static pressure dampers at the fan discharge, reducing air volume. All these methods save energy. Additional methods are listed at the beginning of this chapter. Table 10-1 compares the most common.

The exception to the above energy-saving static pressure control schemes is a bypass type of system, which uses relief dampers to bypass the air to the fan inlet as the terminal boxes close. This type of VAV (into the conditioned space) system has no energy savings since the primary fan is constant air volume.

Pressure Dependent and Pressure Independent VAV Systems

Variable air volume systems can be pressure independent or pressure dependent (Figure 10-2). The pressure independent systems can be single duct, double duct, induction, fan powered, or system powered. Pressure dependent systems can be single duct, fan powered, or bypass. They may or may not have diversity. Pressure independent boxes are independent of what is happening in the system duct or at any other box, where as pressure dependent boxes can vary depending on what is happening in the system duct and at adjacent boxes.

Pressure dependent (PD) terminal boxes do not have an automatic volume controller to regulate airflow as the inlet static pressure changes as do pressure independent boxes. What they do have is an automatic inlet volume damper controlled by the space thermostat. These volume dampers may or may not have a minimum position limiter. The airflow delivered by the box is solely dependent on the inlet static pressure and, therefore, changes as the inlet static changes. This type of system will also usually have a manual balancing damper at the inlet of the

Table 9.1 Airflow verses Power

<i>VAV Fan Output Modulation: Airflow vs. Approximate Horsepower Requirement</i>						
<i>Percent of Airflow</i>	<i>80%</i>	<i>70%</i>	<i>60%</i>	<i>50%</i>	<i>40%</i>	<i>30%</i>
<i>System Type</i>	<i>% Horsepower Required</i>					
BI Static Dampers	90%	85%	80%	75%	70%	60%
FC Static Dampers	80%	65%	52%	42%	35%	28%
AF Inlet Guide Vanes	75%	68%	55%	50%	45%	35%
FC, BI, AF ASD	70%	60%	50%	40%	30%	25%
FC Inlet Guide Vanes	68%	55%	42%	32%	25%	22%
FC, BI, AF VFD	60%	50%	40%	28%	20%	17%

FC - forward curved fan

BI - backward inclined fan

AF - airfoil fan

ASD - adjustable speed drive

VFD - variable frequency drive

box and balancing dampers in the branch lines. With pressure dependent systems, whether the system is being balanced or is in normal operation, every change in damper setting at one box affects adjacent boxes.

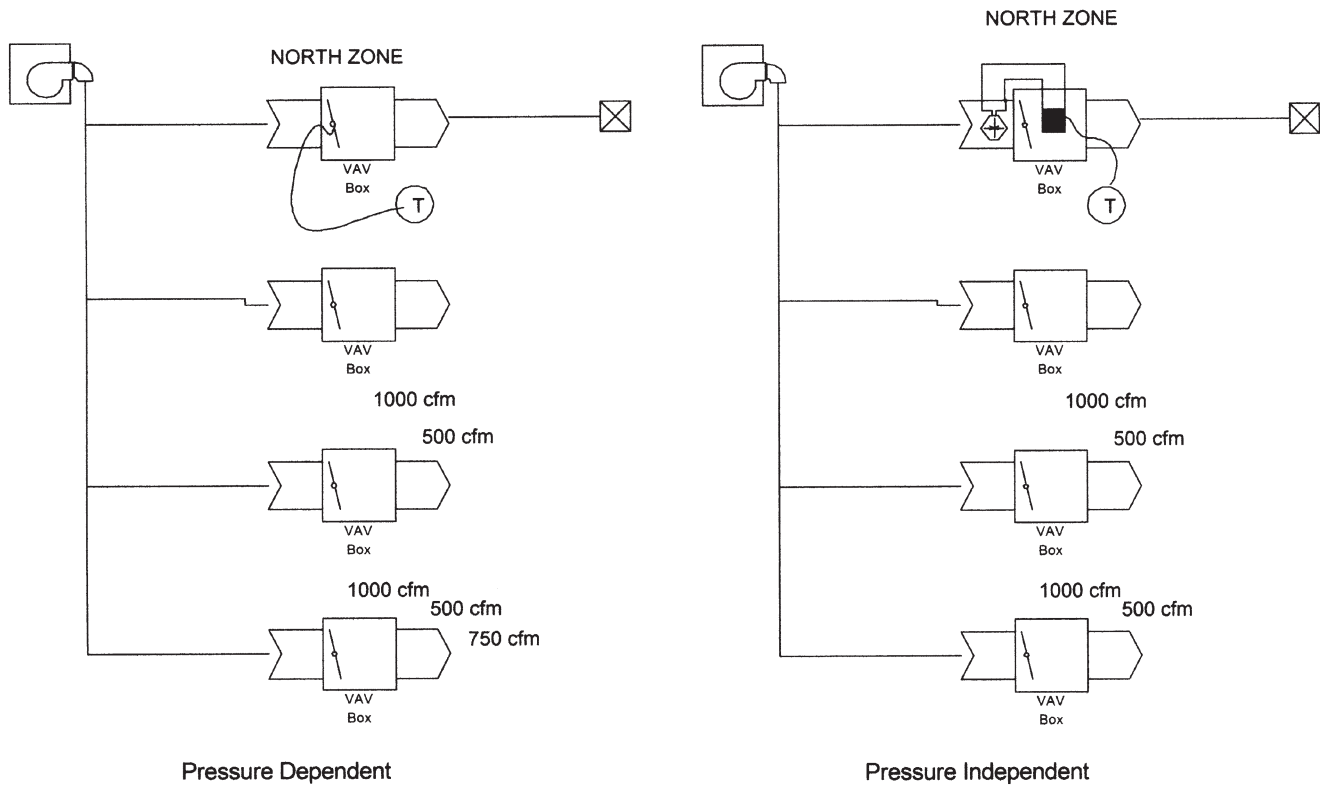

Figure 10-2. Pressure Dependent VAV System vs. Pressure Independent VAV System

Pressure independent (PI) systems have terminal boxes (Figure 10-3), which work off the space thermostat signal as the master control. This signal operates a damper motor, which in turn opens and closes the box's volume damper or air valve. A velocity (volume) controller is used as a submaster control to maintain the maximum and minimum air volume to the space. The maximum to minimum airflow will be maintained when the static pressure at the inlet of the box is in compliance with the box manufacturer's published operational data.

The terminal box in Figure 10-3 is single duct, pressure independent. The inlet duct conveys medium to high pressure air (typically 2" to 6" wg). A velocity sensor for volume control is at the inlet of the box. Control pressure (P), either pneumatic compressed air or electricity, goes to the thermostat (T) and to the controller (C). A signal from the velocity sensor and the thermostat also go to the controller. A signal from the controller goes to the damper motor. This is the control sequence: When the thermostat senses a space temperature above or below set point a signal is sent to the controller. The controller sends a signal to the damper motor to open or close the volume damper. If the velocity sensor senses that the air velocity and calculated air volume is incorrect it will send a signal to the controller to readjust the damper.

On the side of the box is a chart that has pressure along the vertical axis and cfm along the horizontal axis. The diagonal lines are the possible inlet duct sizes for this box. Leaving the box is the low pressure discharge duct going to diffusers in the conditioned space. A capture hood can be used to measure airflow volume at the diffusers.

For a simple explanation of how the two systems work look at Figure 10-2. The PD system on the left has four VAV terminal boxes serving the North Zone. Typically, there will be at least five zones served by any VAV system... north, south, east, west, and center or core zone. Boxes 3 and 4 (numbering from top to bottom) at the end of the line are the same, 1000 cfm maximum. In the conditioned space served by Box 3 some people leave the space and some lights are turned off. The heat load drops. The

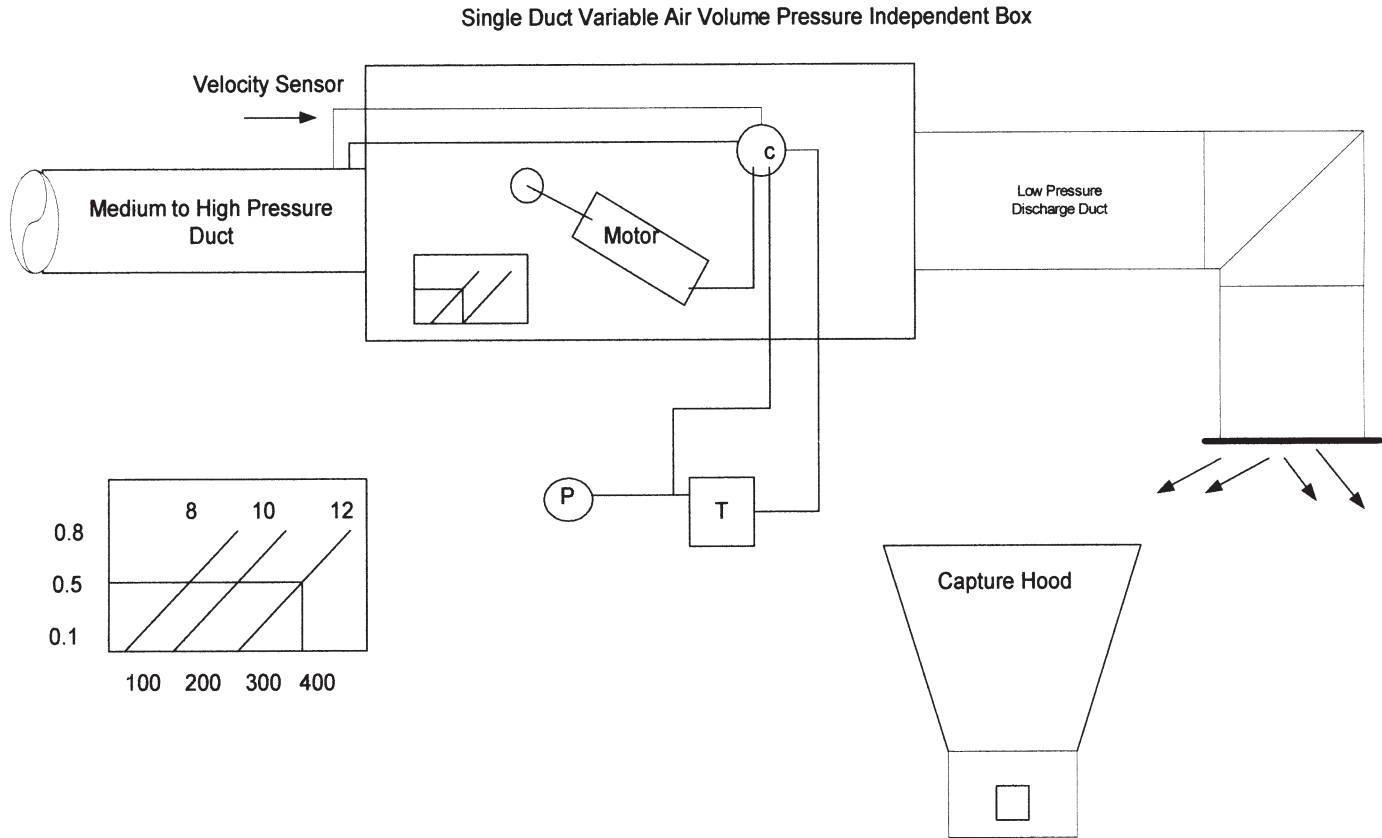

Figure 10-3. Pressure Independent Terminal Box

thermostat senses that there is a drop in temperature below set point. The room is being over-cooled. The thermostat sends a signal to reduce the cfm into the space from 1000 cfm to 500 cfm and allow the room to warm back to set point. The other 500 cfm (1000 – 500) “backs-up in the branch duct with most of it going down to Box 4. At about the same time that Box 3 is closing down some people leave the space served by Box 4 and some lights are turned off. The heat load drops. The thermostat senses that there is a drop in temperature below set point. The room is being over-cooled. The thermostat sends a signal to reduce the cfm into the space from 1000 cfm to 500 cfm and allow the room to warm back to set point. This happens at Box 4 but the air from Box 3 is now coming into Box 4 and then into its conditioned space. Instead of getting 500 cfm as the thermostat called for it is getting 750 cfm. The room is still being over-cooled. The room will continue to be over-cooled until the thermostat senses that it is still below set point and sends a signal to close the damper more, to 500 cfm in this example. This time lag can make the space uncomfortable.

The PI system on the right has four VAV terminal boxes serving the North Zone. Boxes 3 and 4 (numbering from top to bottom) at the end of the line are the same, 1000 cfm maximum. In the conditioned space served by Box 3 some people leave the space and some lights are turned off. The heat load drops. The thermostat senses that there is a drop in temperature below set point. The room is being over-cooled. The thermostat sends a signal to reduce the cfm into the space from 1000 cfm to 500 cfm and allow the room to warm back to set point. The other 500 cfm “backs-up” in the branch duct with much of it going down to Box 4. At about the same time that Box 3 is closing down, some people leave the space served by Box 4 and some lights are turned off. The heat load drops. The thermostat senses that there is a drop in temperature below set point. The room is being over-cooled. The thermostat sends a signal to reduce the cfm into the space from 1000 cfm to 500 cfm and allow the room to warm back to set point. This happens at Box 4 but the

air from Box 3 is now coming into Box 4. At the inlet of Box 4 is a velocity sensor (shown at Box 1) which senses that more than 500 cfm is coming into the box. The sensor sends a signal to the controller to close the damper and reduce the cfm to 500. So the damper is repositioned by a signal at the box instead of the room thermostat resulting in minimal lag time. Also, as the boxes close, the static pressure sensor in the main duct will detect when the static pressure goes above set point. When it does, a signal is sent to the controller to reduce airflow and static pressure out to the system, which reduces the tendency for the air from one box to flow into another box.

VAV Volume and Static Pressure Controls

Figure 10-4 shows an air handling unit (AHU) with an air side economizer with automatic temperature control dampers (ATCD) at the return air (RA), exhaust air (EA) and outside air (OA). This unit has filters, a cooling coil and a “draw-thru” (the fan is after the coil, if the fan is before the coil it is a “blow-thru”) forward curved centrifugal supply fan. In the discharge duct is a set of static pressure dampers (SPD) for system volume and static pressure control. A static pressure sensor (SP) is located in the supply duct two-thirds to three-quarters of the way down the length of the duct from the fan. The static pressure sensor is set for a static pressure to operate all the boxes that need to be served at any given time. If the static pressure sensed in the duct is above or below set point, a signal is sent to the receiver-controller (RC). The RC then sends a signal to the damper motor (DM) to reposition the damper to bring the static pressure in the duct back to set point.

Figure 10-4 also shows a system with inlet guide vanes (IGV), also called vortex dampers (Figure 10-5). The signal from the RC goes to both the damper motors on the supply fan and the return fan. IGV are installed on variable air volume fan systems to control discharge pressure and air volume. The IGV give the air a spinning motion as it enters the fan and allow for reduced fan performance at reduced loads. They are a restriction to airflow

and even with the vanes (blades) wide open; they reduce the fan volume output by approximately 5%. In this system both the supply air volume and the return air volume is controlled by the supply duct static pressure sensor. If this system is not working properly, for example the return fan sometimes leads or lags the supply fan too much (the fans are pulsating or “hunting”), it may be necessary to put in another static pressure sensor and controller in the mixed air plenum to control the return fan separately.

Figure 10-6 shows the same AHU with both return and supply fans controlled by a single supply duct sensor. The adjustable motor drive (AMD) or adjustable speed drive (ASD) unit uses the signal from the supply sensor to automatically adjust the pitch diameter of the motor sheaves on the supply and return fans. As the motor sheave pitch diameter goes, so goes the speed of the fan, i.e., larger pitch diameter, faster speed, etc. The AHU with the variable frequency drive (VFD), also known as a variable speed drive (VSD), has the same control scheme. As an example of how the unit controls volume and static pressure out of the fans let's say that a number of terminals in the system close down to minimum cfm. The dampers or air valves in the terminal boxes are closing on a signal from their respective space thermostats indicating that the temperature in the space is below set point. As the boxes close to reduce airflow into the space, static pressure begins to build up in the main supply duct. When the static pressure sensor in the main duct senses that the static pressure is above set point it sends a signal to the VFD (AMD, IGV or SPD). The VFD varies the frequency of the motor, which in turn varies the motor speed; in this case, to slow the motor down and slow the fan down. Slowing the fan reduces the air volume and static pressure out to the system.

Some time later a number of terminals in the system open to maximum cfm. The dampers or air valves in the terminal boxes are opening on a signal from their respective space thermostats indicating that the temperature in the space is above set point. As the boxes open to increase airflow into the space static pressure begins to fall in the main supply duct. When the static pressure

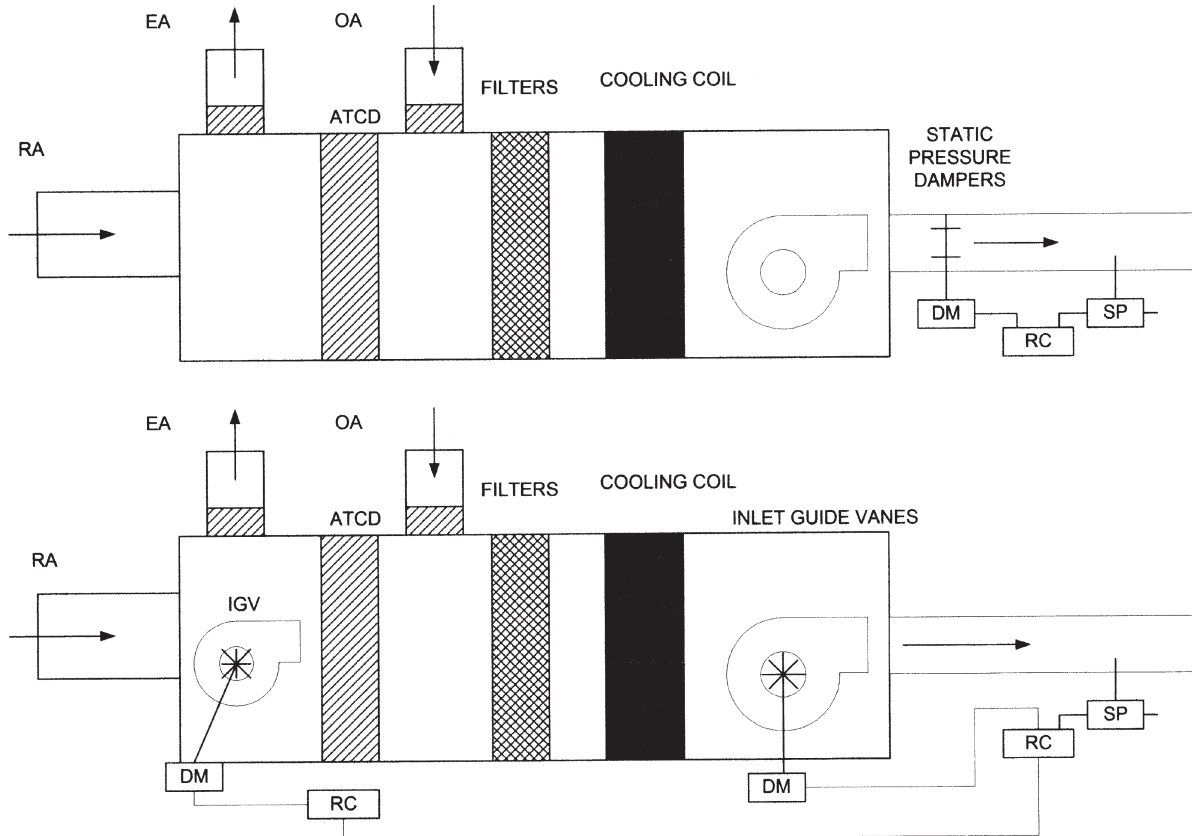

Figure 10-4. VAV Volume and Static Pressure Controls: Static Pressure Dampers and Inlet Guide Vanes (Vortex Dampers)

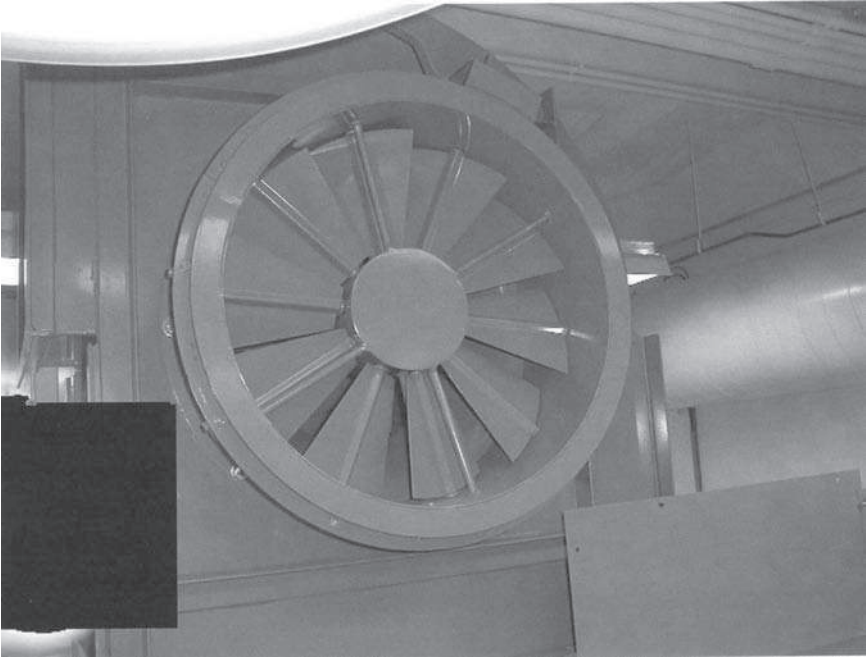

Figure 10-5. Inlet Guide Vanes (IGV) or Vortex Dampers

sensor in the main duct senses that the static pressure is below set point it sends a signal to the VFD to increase the motor and fan speed. Speeding up the fan increases the air volume and static pressure out to the system.

VAV Fan Powered Terminal Boxes

Figure 10-7 shows a single duct pressure independent series fan powered VAV box. The primary fan in the AHU is variable volume and the secondary fan in the box is constant volume. The secondary fan is energized along with the primary fan, and operates continuously. Here is an example of how this box operates. This box operates at 1000 cfm. On a call for cooling, the thermostat sends a signal to open the VAV damper. 1000 cfm (at 55°F) from the primary fan comes into the box. The secondary fan is set up to move 1000 cfm. It picks up the air after the damper and blows it into the conditioned space.

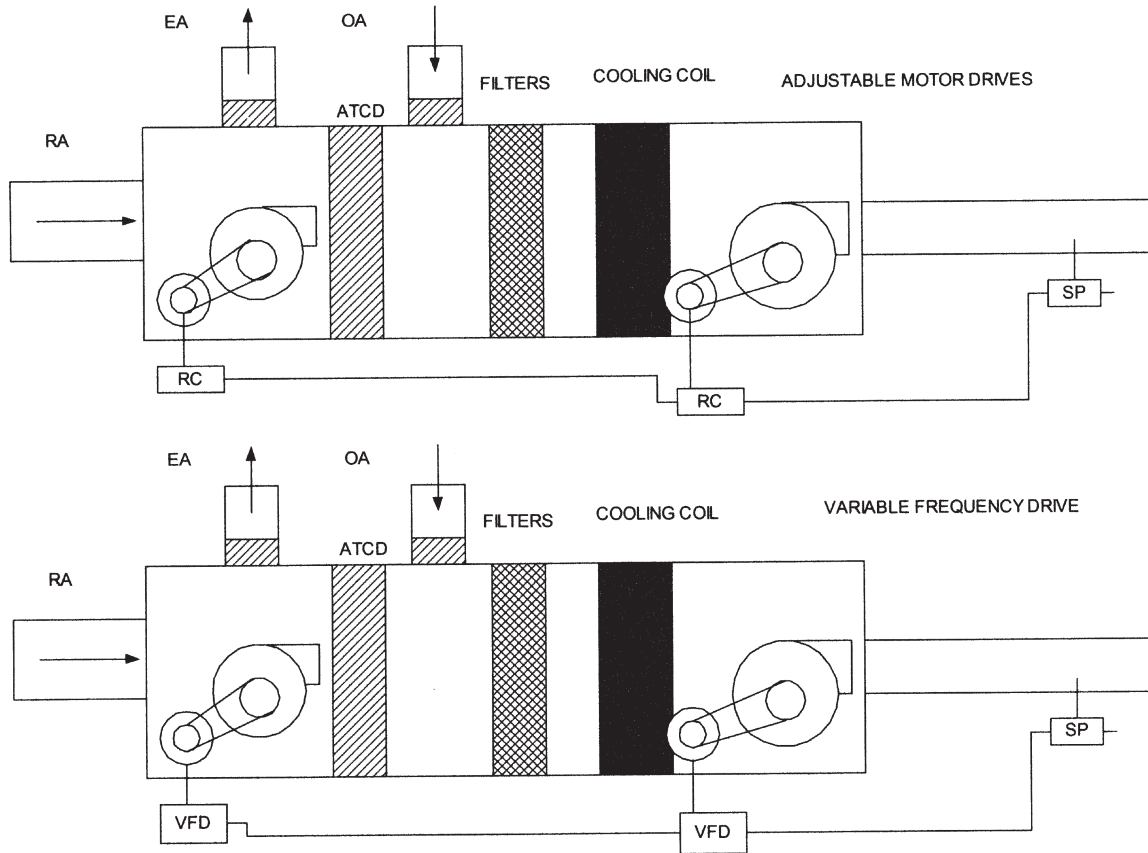

Figure 10-6. VAV Volume and Static Pressure Controls: Adjustable Motor Drive and Variable Frequency Drive

If the space over-cools the thermostat sends a signal to close the damper. In this example, the damper closes to allow only 500 cfm of 55°F into the box. However, the secondary fan is set up to move 1000 cfm. At this condition, the dampers in the RA (return air) inlet open and the secondary fan pulls 500 cfm from the return air ceiling plenum. The temperature of the air in the ceiling plenum is 75°F. Therefore, the secondary fan will blow 1000 cfm of air at 65°F into the conditioned space. The calculation is: 500 cfm @ 55°F + 500 cfm @ 75°F = 1000 cfm @ 65°F. This fan powered box maintains a constant volume into the space at a varying temperature. This box also has a hot water reheat coil. If the box closes to minimum and the thermostat is still calling for heat, the reheat coil's two-way valve will open and hot water will heat the coil. Now, 1000 cfm will be blown across the coil picking up heat and go into the space.

Figure 10-8 shows two types of single duct pressure independent parallel fan powered VAV boxes. Each type of box contains a fan and a return air opening from the ceiling space. When the room thermostat is calling for cooling, the box operates as would the standard cooling VAV box. However, on a call for heat the fan draws warm (secondary) air from the ceiling plenum. Unlike the secondary fan in the series box, this secondary fan is intermittent, that is, it only comes on when there is a call for heat or low volume of primary air. Varying amounts of cool primary air from the main system are introduced into the box at the inlet (parallel fan) or discharge (side pocket perpendicular fan) of the secondary fan and mixes with the secondary air. A system of dampers, backdraft or motorized, controls the airflow and mixing of the air streams. As the room thermostat continues to call for heat, the primary air damper closes down and more secondary air is drawn into the box. If more heat is needed, reheat coils may be installed in the boxes.

VAV Bypass Terminal Box

A bypass box (Figure 10-9) uses a constant volume supply fan but provides variable air volume to the conditioned space.

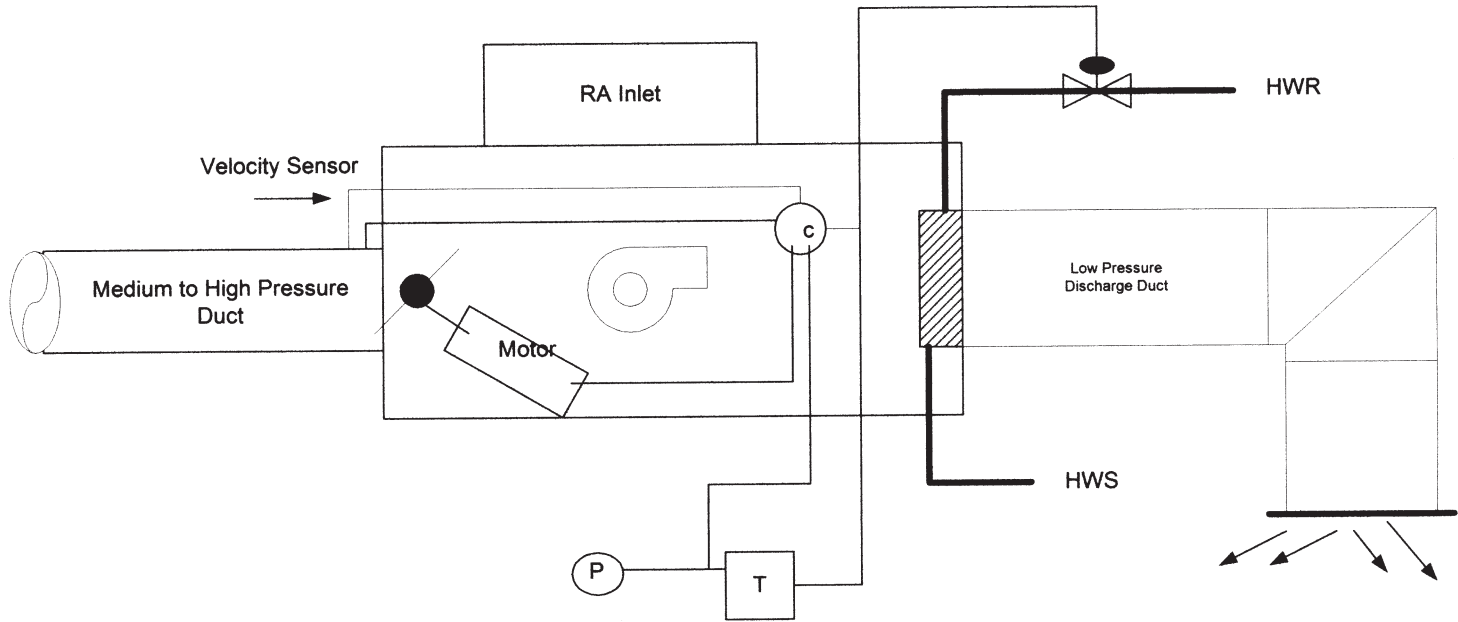

Single Duct Pressure Independent Series Fan Powered VAV Box

Figure 10-7. Pressure Independent Series Fan Powered Terminal Box

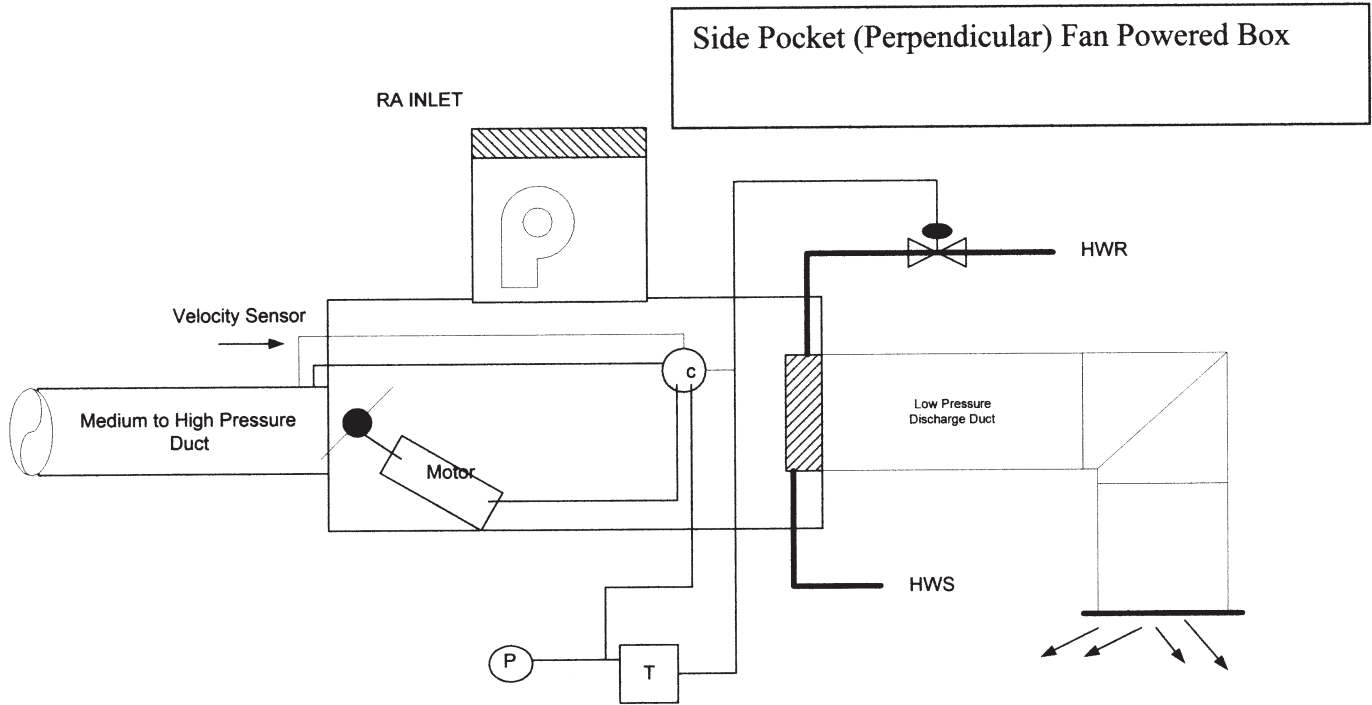

Figure 10-8. Pressure Independent Parallel or "Side Pocket" Fan Powered Terminal Box (Continued)

Single Duct Pressure Independent Parallel Fan Powered VAV Box

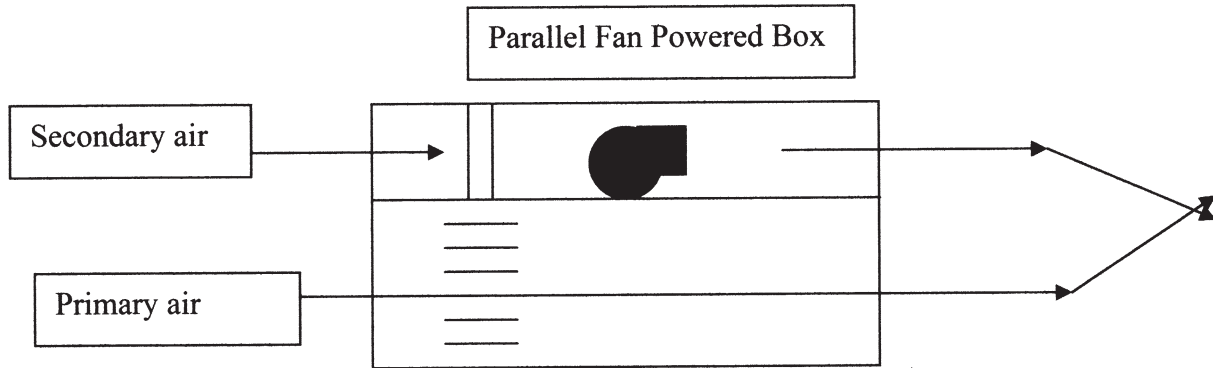

Figure 10-8 (Continued). Pressure Independent Parallel or "Side Pocket" Fan Powered Terminal Box

The supply air comes into the box and can exit into the conditioned space through the discharge ductwork and ceiling diffuser or go back to the return system through a bypass damper. The conditioned space receives either all the supply air or only a part of it depending on what the room thermostat is calling for. Since there's no reduction in the main supply air volume feeding the box, this type of system has no savings of fan energy.

Air Balancing the VAV System

After you and your staff have a thorough understanding of the system and its components, you'll need do a VOSP and balance the system or have an air balancing company do that for you. Since there are so many types of control schemes on the various VAV boxes, no one procedure will cover all systems. The following presents only a basic procedure for balancing pressure independent single duct systems:

- Do the preliminary field inspection.
- Inspect the job site.
- Inspect the distribution system.
- Find out if the duct system has been leak tested.
- Set all dampers at the full open position except the outside air.
- If applicable, set the fan inlet (vortex) dampers or VFD at minimum position.
- Check fan rotation.
- Set the system for full cooling.
- Start the fan and take electrical measurements with the volume control set for minimum airflow.

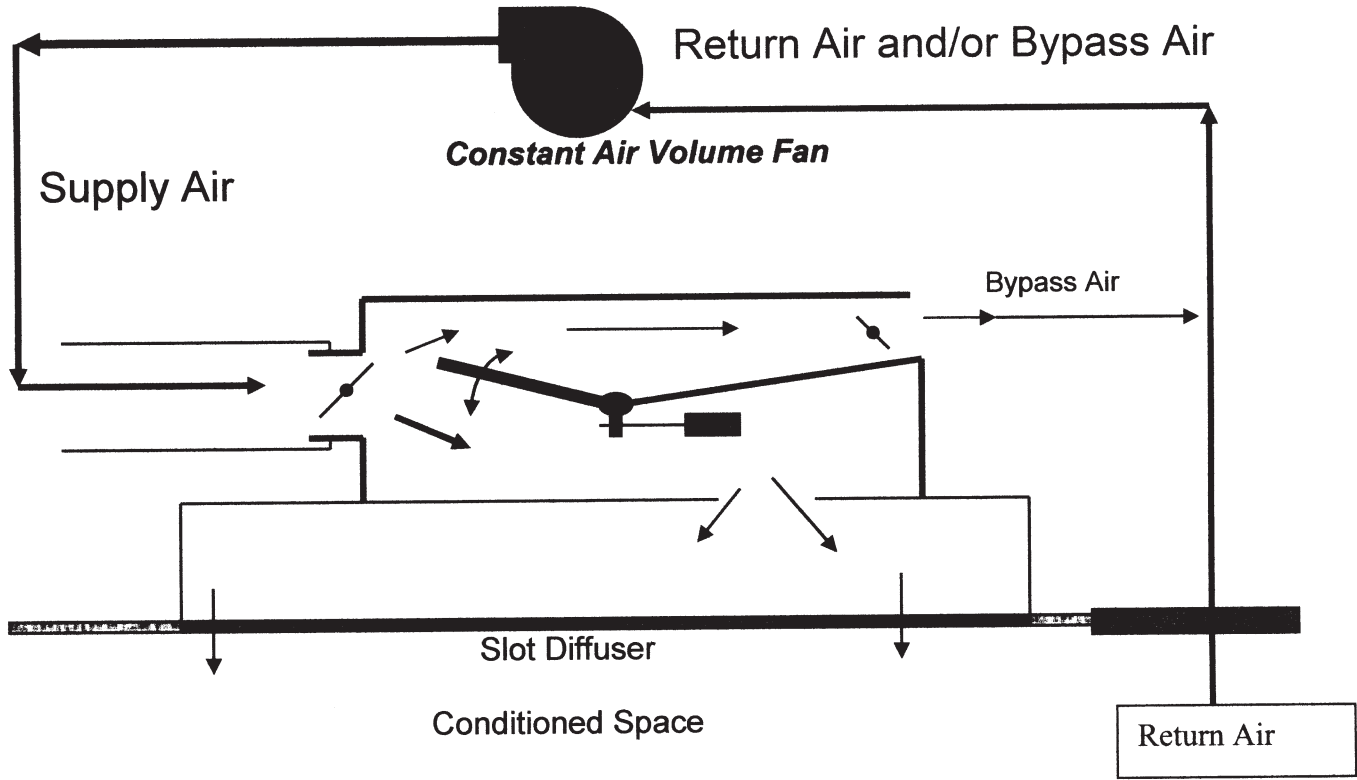

Figure 10-9. Bypass Terminal Box

-
- Gradually increase the flow to maximum.
 - Take electrical measurements and observe the system for any adverse effects caused by the higher pressure.
 - Operate all fans (supply, return and exhaust) at or near design speeds.
 - Take static pressure measurements at the unit.
 - Take measurements at several boxes at the end of the system to determine if the inlet static pressure is at or above the minimum required by the manufacturer for VAV box operation.
 - Increase or decrease fan speed as needed.
 - Take total air measurements.

If the system has diversity, determine the diversity ratio. Now, determine the number of terminal boxes to be placed in a maximum flow condition (typically, by setting the space thermostats to the lowest temperature). The remaining boxes will be set to minimum flow (heating). The sum of the cfm from the maximum flow boxes plus the minimum flow boxes should approximate the total design cfm output of the fan. The pattern of setting the boxes to maximum and minimum flow for testing and balancing should approximate normal operating conditions.

Balance and adjust the distribution system

Consider each terminal box and associated downstream low pressure ductwork as a separate, independent system. Verify the action of the thermostat (direct acting or reverse acting) and the volume damper position (normally closed or normally open). Verify the range of the damper motor as it responds to

the velocity controller. Consult the box manufacturer's data for the required pressure drop range across the box. Then add the pressure losses needed for the low pressure distribution system downstream of the box—approximately 0.1 inch wg per 100 feet of duct (equivalent length) and 0.05 to 0.1 inch wg for the outlet. This is the total required inlet static pressure. Verify that the box is at maximum flow. Take the static pressure drop across the box and the inlet static pressure. They should be within the required range.

Connect a differential pressure gage, such as a manometer or other differential air pressure gage (pneumatic system), or electric meter or computer (electric DDC system), to the controller's test points and read the output. Use the manufacturer's published data to convert the readings to cfm. Field conditions may be such that the inlet duct configuration to the box may give an erroneous reading at the sensor. To verify the readings at the box take a Pitot tube traverse of the low pressure duct off the boxes. Then use a capture hood to read the outlets. Total the outlet readings to confirm the box setting and the Pitot tube traverse. The readings will provide the actual cfm delivered by the box and help to determine the amount and location of any low pressure duct leakage.

Balance the Outlets

Set the box controller for maximum and minimum cfm according to manufacturer's recommendations. Proportionally balance the system at maximum flow. Read and record the cfm of the individual outlets at maximum flow. Next, set the box to minimum flow. Read and record the minimum cfm of the individual outlets. They should remain in proportion. However, it's usual for some outlets to be out of balance in the minimum setting. Do not rebalance. Leave the system balanced for maximum flow. After the system has been proportionally balanced and the static pressure set at the sensor, be sure to thoroughly check the sensor and associated controller for proper operation and location.

TROUBLESHOOTING VAV SYSTEMS

The following is a troubleshooting guide for VAV systems.

Diffuser Dumps Cold Air.

- Airflow too low (velocity too slow).
- Check to determine if box is reducing too far. Evaluate box minimum setting.
- Diffuser is too large, check installation.

Conditioned Space is Too Cold.

- Supply air temperature is too cold.
- There is too much supply air.
- Diffuser pattern or throw is incorrect causing drafts.
- Temperature sensor is located incorrectly or needs calibration.

Conditioned Space is Too Warm.

- Supply air temperature setting is too warm.
- Not enough supply air.
- Refrigeration system not operating properly.
- Fan-coil evaporator is iced over because of low airflow.
- Temperature sensor is located incorrectly or needs calibration.
- Low pressure duct leaking.
- Low pressure duct not insulated.
- Cold air from diffuser isn't mixing properly with room air.
- Increase air volume or velocity, change into space; or retrofit diffuser as needed.

Noise.

- Too much air in low pressure duct; check box maximum setting.
- Static pressure in the system is too high.
- Diffuser is too small.
- Diffuser is dampered at face (always damper at takeoff).
- Pattern controllers loose; tighten or remove.

Not Enough Air.

- Box not operating properly; check minimum setting, reset as necessary.
- Not enough static pressure at box inlet for proper operation.
- Damper in VAV box is closed; may be loose on shaft or frozen.
- Low pressure damper closed.
- Restrictions in low pressure duct.
- Remove pattern controllers in diffusers.
- Low pressure duct is leaking, disconnected or twisted.
- Install fan powered boxes.

Box Not Operating Properly.

- Not enough static pressure at the box inlet.
- Too much static pressure at the box inlet.
- Static pressure sensor is defective, clogged, or located incorrectly.
- Static pressure setting on controller is incorrect.
- Static pressure controller needs calibrating.
- Fan speed is not correct.
- Inlet duct leaking or disconnected.
- Box is leaking. Leak test.
- Main ductwork improperly designed.
- Not enough straight duct at the inlet of the box.
- Diversity is incorrect.
- Box is wrong size or wrong nameplate.
- Damper is loose on shaft.
- Linkage from actuator to damper is incorrect or binding.
- Actuator is defective.
- Controls are defective, need calibration or are set incorrectly.
- Volume controller not set properly
- Controls are incorrectly set for normally open or normally closed operation.
- Damper linked incorrectly, NO for NC operation or vice

versa.

- Pneumatic tubing to controller is piped incorrectly, leaking, or pinched.
- Restrictor in pneumatic tubing is missing, broken, or the wrong size
- Restrictor in pneumatic tubing placed incorrectly or clogged.
- Oil or water is in pneumatic lines.
- There is no pneumatic or electric power to the controls.
- The controls are wired incorrectly.
- The PC board is defective.

Fan Not Operating Properly.

- Inlet vanes on centrifugal fans not operating properly.
- Pitch on vane axial fans not adjusted correctly.
- VFD not operating or not set correctly.
- Fan speed is not correct, check drives and rpm.
- Fan rotating backwards.
- Return air fan not tracking with supply fan.
- Fan allowing recirculation, check cutoff plate.
- Parallel fans not getting required cfm at inlet or backdraft damper not correct.
- Wheel installed backwards.
- Wheel needs balancing or is dirty.
- Check static pressure sensors, move, clean or calibrate.
- Check airflow measuring stations, move, clean or calibrate.

Negative Pressure in the Building.

- Check for stack effect.
- Check for improper return air control.
- Seal building properly.
- Balance return system.
- Install manual balancing dampers needed to control OA, RA and EA at the unit.
- Get return fan to track with supply fan.
- Consider replacing return fan with relief fan.

- Check that static pressure sensors are properly located and working.
- Install pressure controlled return air dampers in return air shafts.
- Supply fan is reducing air volume.
- Not enough outside air for the constant volume exhaust fans and exfiltration.
- Increase minimum outside air by opening manual volume damper.
- Increase outside air duct size.
- Control OA from supply fan. As fan slows, outside air damper opens.
- Control OA damper from flow monitor in OA duct.
- Maintain a constant minimum OA volume.

Chapter 11

Pumps and Water Distribution

Pump operation

When pumps are placed in series:

The total dynamic head (TDH) is added

The horsepower (HP) is added

The gallons per minute (GPM) remains the same

When pumps are placed in parallel:

The gallons per minute (GPM) is added

The horsepower (HP) is added

The total dynamic head (TDH) remains the same

Water coils are typed by:

Construction

fins per inch (FPI)

number of rows

Water flow vs. airflow

Counter Flow

Parallel Flow

HVAC PUMP OPERATION

An HVAC centrifugal pump is a electrical power-driven machine that is used to overcome system resistance and produce required water flow. As the pump impeller (Figure 11-3)

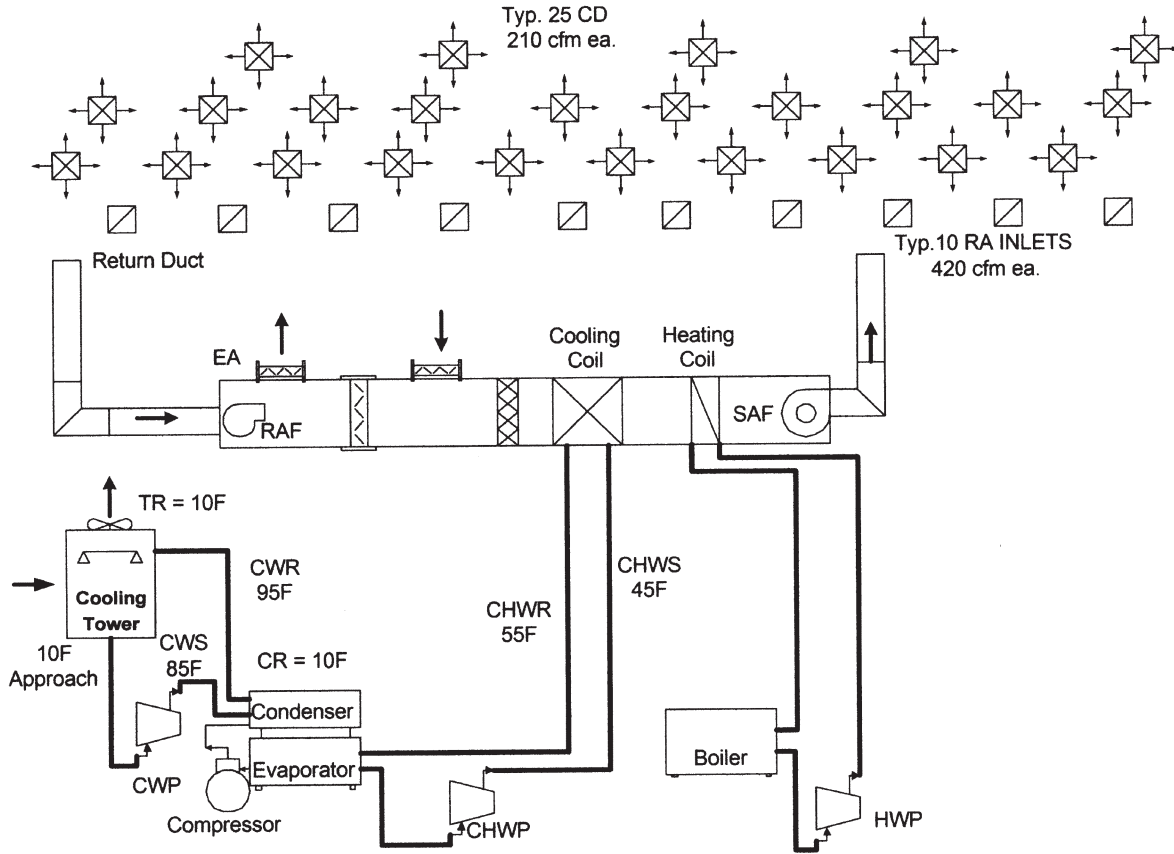

Figure 11-1. Central HVAC System "Pumps"

is rotated, centrifugal force throws the water outward from the impeller. The centrifugal force and other design characteristics reduce the pressure (a partial vacuum is created) at the inlet of the impeller and allow more water to be forced in through the pump suction opening by atmospheric or external pressure. This makes the pump's discharge pressure higher than the pump's suction pressure. After the water enters the pump's suction opening, there's a further reduction of pressure between this opening and the inlet of the impeller. The lowest pressure in the system is at the pump inlet. The water leaves the impeller at a relatively high velocity. Then, in the pump casing, the velocity (velocity pressure) is reduced and converted into static pressure. The size of the pump impeller and its rotational speed determines the static head pressure developed by the pump.

A typical HVAC centrifugal pump will have a volute (spiral) casing with one or more closed backward curved radial flow impellers. If the pump has one impeller, it is a single stage pump. If it has two or more impellers in series on a common shaft it is a multi-stage pump. The inlet to the pump may be on just one side. This is a single inlet pump. If the inlet to the pump is on both sides of the pump it is a double suction inlet pump. The suction pipe may be the same size or larger than the discharge pipe.

Most HVAC water pumps are constant volume machines and are coupled directly (direct drive) to a constant speed motor. Some direct drive pumps are driven by a variable frequency-variable speed motor. Varying the speed of the motor changes the speed of the pump. Varying the pump speed makes the pump variable volume. However, some HVAC pumps are belt driven. These pumps may be either constant speed and volume or variable speed and volume.

FILTRATION

Strainers are water filters. A strainer is used to protect the components in the water system. Inside the strainer body is a

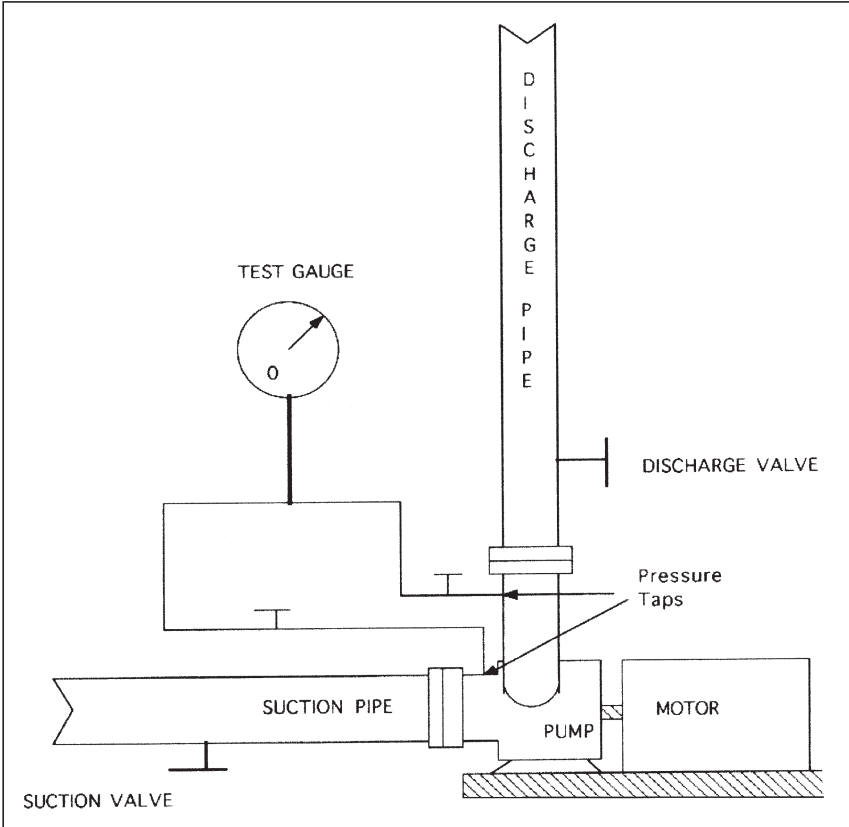

Figure 11-2. Centrifugal HVAC direct-drive water pump with a single inlet (suction pipe) into the impeller and discharge pipe out of the top of the pump.

mesh screen. The screen is in the shape of a sleeve or basket and is designed to catch sediment or other foreign material in the water. If the system is open, the screen must be periodically removed and cleaned. If the system is closed, the screen must be removed and cleaned during startup. If the strainer screen is not properly cleaned a higher than normal pressure drop across the strainer and lower water flow may occur. There may also be a higher than normal pressure drop when the screen has too fine a mesh. If the system is closed and the strainer has a fine mesh screen (construction screen), it is replaced with a larger mesh screen during

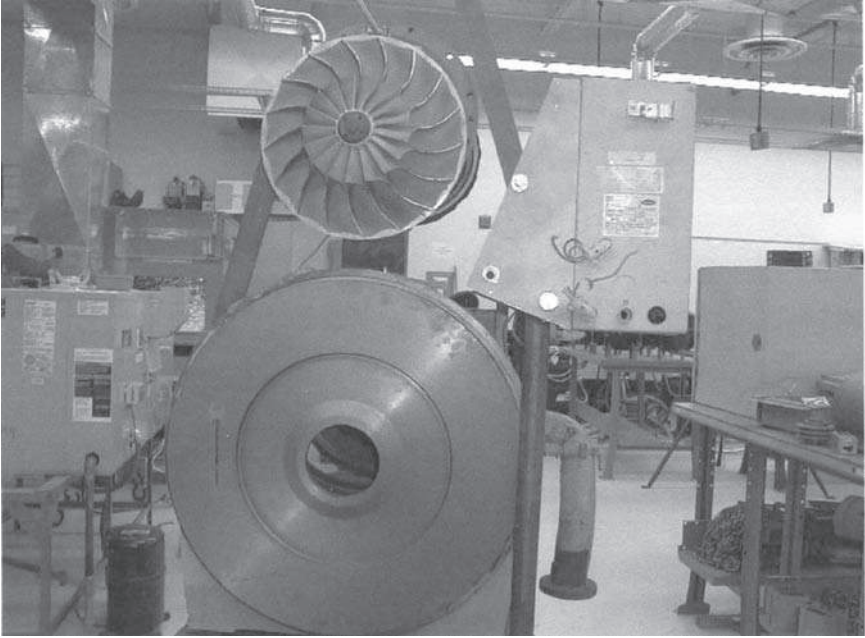

Figure 11-3. Centrifugal pump impeller

startup. To avoid cavitation, strainers placed in the suction side of the pump must be properly sized and kept clean. A possible remedy for cavitating condenser pumps is to remove the pump strainer altogether or move the strainer to the pump discharge. For example, in cooling towers, the strainer in the tower basin may provide adequate protection and a pump strainer may not be needed. In addition to pump strainers, individual fine mesh strainers may also be installed before automatic control valves or spray nozzles (which operate with small clearances and require protection from materials that might pass through the pump strainer).

PUMP CAVITATION

Cavitation is the phenomena occurring in a flowing liquid when the pressure falls below the vapor pressure of the liquid, causing the liquid to vaporize and form bubbles. The bubbles are

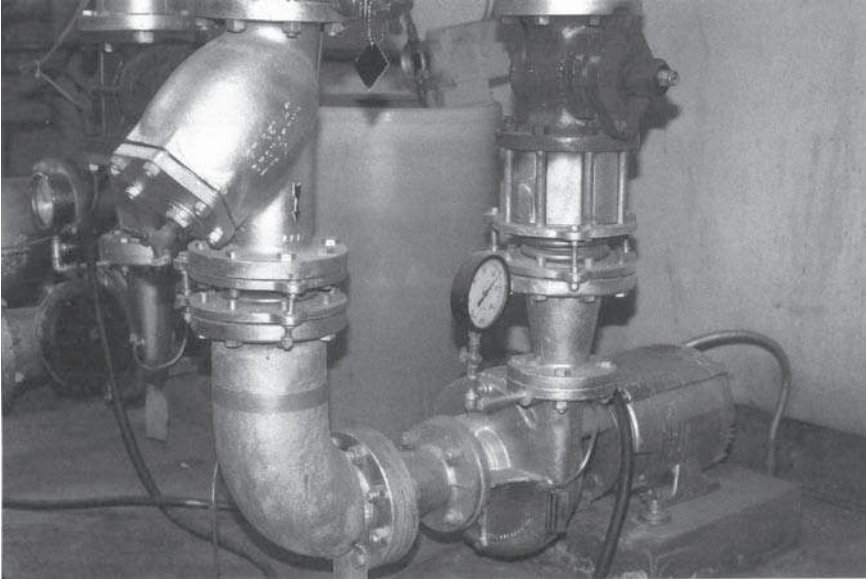

Figure 11-4. Single inlet direct-drive HVAC pump with inlet pipe to the left and discharge pipe out of the top. The strainer in the inlet pipe.

entrained in the flowing liquid and are carried through the pump impeller inlet to a zone of higher pressure where they suddenly collapse or implode with terrific force. The following are symptoms of a cavitating pump: snapping and crackling noises at the pump inlet, severe vibration, a drop in pressure and brake horsepower, and a reduction in flow, or the flow stops completely.

HVAC HYDRONIC PIPING SYSTEMS

Hydronics is the process of heating or cooling with water. Some of the classifications for hydronic piping systems are open, closed, series loop, one-pipe, two-pipe, three-pipe, four-pipe, direct-return, reverse return and combination. Hydronic systems are generally two- or four-pipe heating and cooling circuits. These piping circuits provide heated or chilled water to coils in central

air handling units, fan-coil units, ductwork, and terminal boxes. Hydronic coils also are found in unit heaters, valence units, and in fin-tube radiation.

Open and Closed Piping Systems

An open system has a break in the piping and the water is “open” to the atmosphere. A closed system has no break in the piping and the water is “closed” to the atmosphere. A typical air conditioning chiller gives examples of both the open and closed piping system. The water-cooled condenser and cooling tower loop of the air conditioning system is an open piping system; the loop from the water cooler to the chilled water coil is a closed piping system.

Series Loop and One-pipe Systems

A series loop piping system is a continuous run of pipe, generally limited to residential and small commercial heating applications. Supply water is pumped through each coil in series and then back to the boiler. The advantage of this type of piping arrangement is that it is simple and inexpensive. The disadvan-

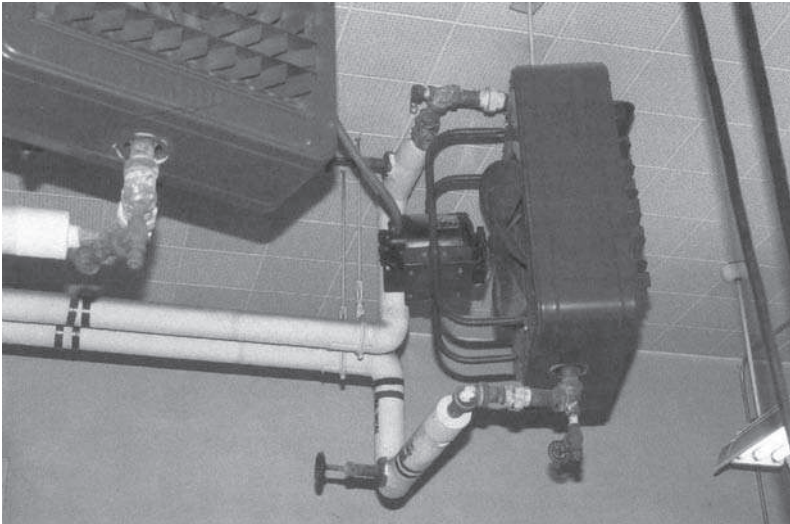

Figure 11-5. Hot Water Unit Heaters

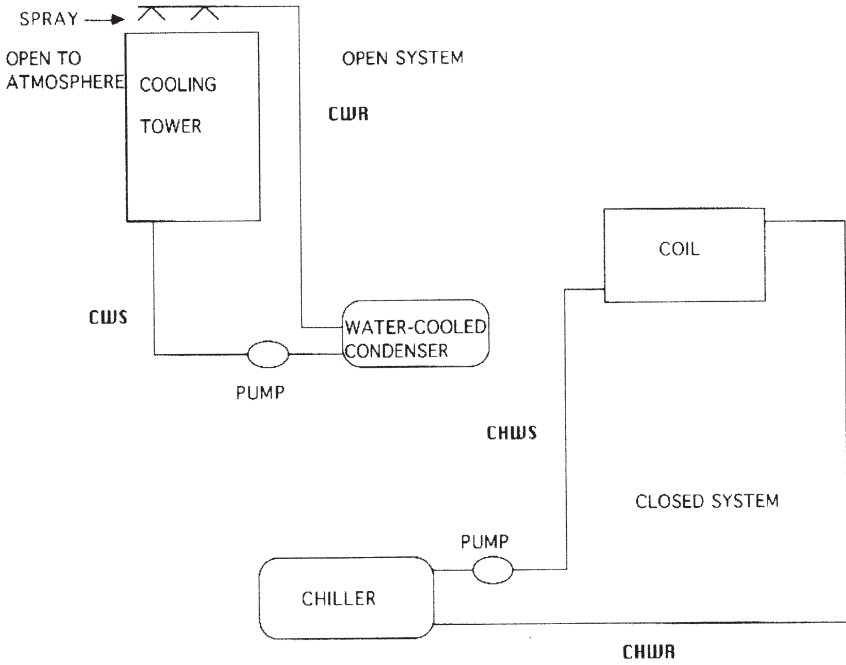

Figure 11-6. Open and Closed Piping Systems

tages are that if repairs are needed on any coil, the whole system must be shut and drained. Additionally, it is impossible to provide a separate capacity control to any individual coil since “valving down” one coil reduces flow to all the down-line coils. These disadvantages can be partly remedied by designing the piping with two or more circuits and installing balancing valves in each circuit to create a “split” series loop.

The one-pipe circuit uses a single main loop and individual space control for residential, small commercial and industrial heating applications. This piping arrangement differs from the series loop system, with each coil connected by an individual supply and return branch pipe to the main loop. The advantage of the one-pipe main over the series loop is that each coil can be separately controlled and serviced by installing valves in the branches. However, if there are too many coils, the water temperature at the coils farthest from the boiler may not be adequate to heat the space.

Two-pipe Systems

Two-pipe systems are used to ensure that the water temperature to each coil is the same as the water temperature leaving the boiler or chiller. This should be the case if there are no water leaks and the piping is properly insulated. Because the supply water temperature is the same at each coil, two-pipe system can be used for any size application. Two-pipe arrangements have two mains, one for supply water and one for return water. Each coil is connected by a supply and return branch to its respective main. This design allows for separate control and servicing of each coil. The return connections from the coils can be made either direct- or reverse-return.

Three-pipe Systems

A three-pipe system has two supply mains and one return main. One supply circulates chilled water from the chiller(s), and the other supply circulates heated water from the boiler(s). The return main carries water from each coil back to either the chiller or boiler. The return connections from the coils can be made either direct- or reverse-return. A three-way valve at the inlet of each coil delivers either cold or hot water to the coil. The supply water streams are not mixed. When both cold and hot water are available, any coil can either heat or cool without regard to the operation of any other coil. Typically during the year (e.g., spring and fall) there are times that the HVAC system is simultaneously heating and cooling, with the return pipe carrying a mixture of both hot and cold water. The result is that both the chiller and the boiler receive warm water and must use more energy in order to supply their proper water temperature. Three-pipe systems use less piping than four-pipe systems and therefore are less expensive on initial cost, but they use more energy, resulting in greater long-term costs.

Four-pipe Systems

A four-pipe system consists of two separate two-pipe arrangements. One two-pipe arrangement is used for chilled water;

the other is used for hot water. No mixing occurs. The return connections from the coils can be made either direct- or reverse-return. The air handling unit usually has two separate water coils, one for heating and one for cooling. The water flow through each coil is controlled by either a two- or three-way modulating automatic temperature control valve.

Direct- and Reverse-return Pipe Systems

A direct-return piping system is routed to bring the water back to the pump by the shortest possible path. The heating or cooling coils are piped so that the first coil supplied is the first returned and the last coil supplied is the last returned. Balancing valves are required for flow adjustments since water will follow the path of least resistance, and the coils closest to the pump will tend to receive too much water while the coils farthest from the pump will be starved. A reverse-return piping system is designed so the length of the circuit to each coil and back to the pump is essentially equal in pressure drop. The coils are piped so that the first coil supplied is the last returned, and the last coil supplied is the first returned. Reverse-return systems generally need more piping than direct-return systems. Reverse-return systems are sometimes considered self-balancing because the intent of the design is to have equal pressure drops throughout the loop. However, because of varying circumstances in design or installation, reverse-return systems are usually not self-balancing, and balancing valves are still required for proper flow adjustments (Figure 11-8).

S - water source (chiller or boiler)

P - pump

C - coil

BV - balancing valve (manual).

Combination Piping Systems

A piping system can contain many of the piping arrangements mentioned. But names for piping systems become meaningless as

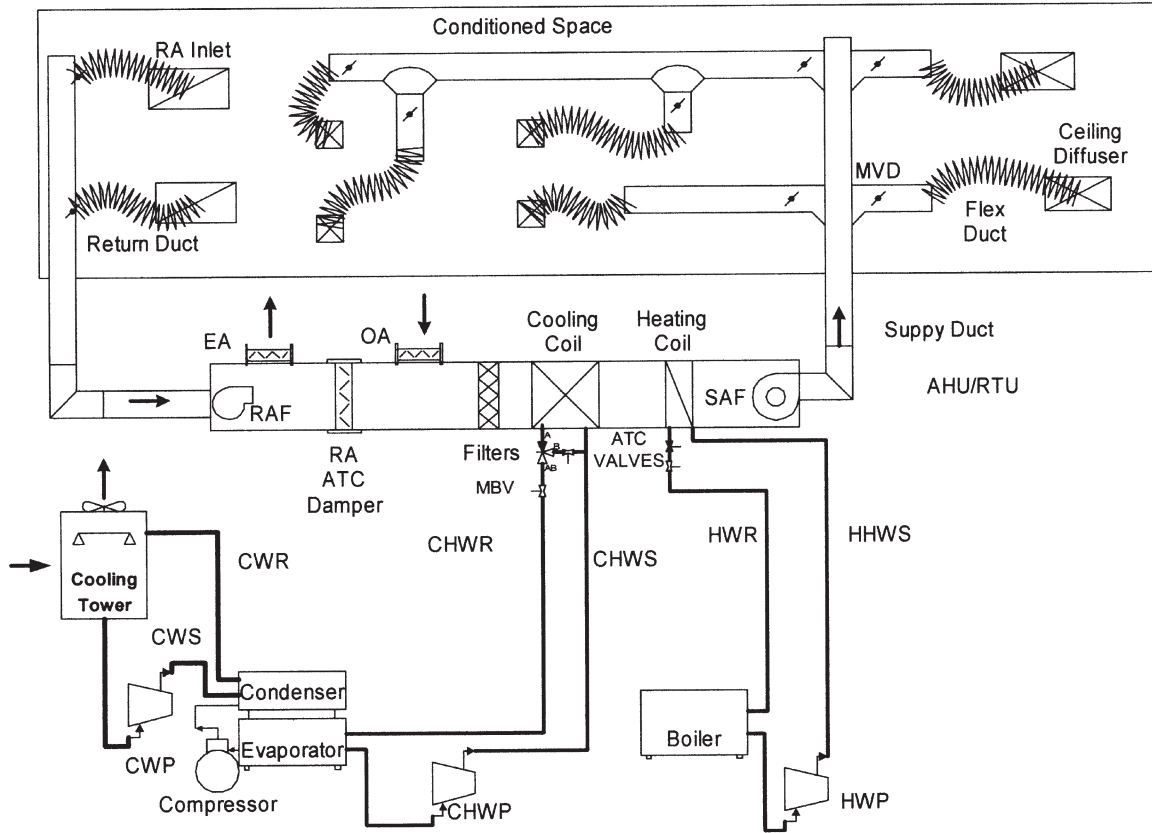

Figure 11-7. Four-pipe system with two-way and three-way automatic temperature control valves.

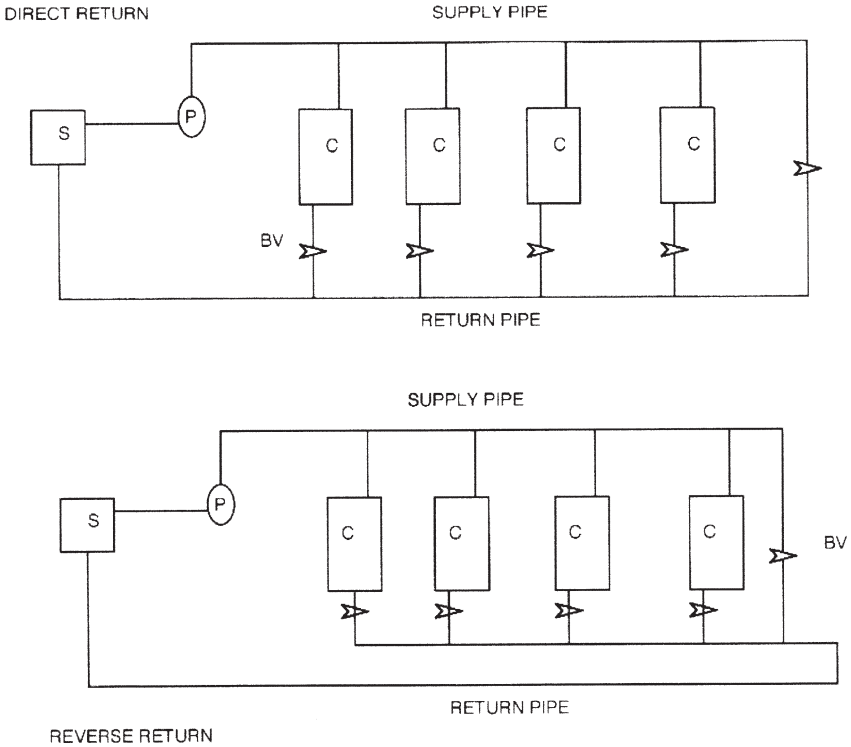

Figure 11-8. Direct- and reverse-return piping systems.

pipe lengths and number or types of coils vary, and piping arrangements are combined. What is important is the system volume of water flow in gallons per minute (gpm), the water head pressure in pounds per square inch (psi), feet of water (ft H₂O) or feet of head (ft hd), and the water temperature (°F). These values must be measured to determine the performance of the hydronic system.

COILS

Coils or terminals are heat transfer devices (heat exchangers). They come in a variety of types and sizes and are designed for various fluid combinations. In HVAC applications coils are

used for heating, cooling or dehumidifying air. Water coils are most often made of copper headers and tubes with aluminum or copper fins and galvanized steel frames.

Coil tubes are usually made of copper but other materials used include carbon steel, stainless steel, brass and for special applications, cupro-nickel. For applications where the air stream may contain corrosives, there are various protective coatings available. The number of tubes varies in both depth and height. Usually one to twelve rows in the direction of airflow (depth) and 4 to 36 tubes per row (height). The more tubes in the coil, the more heat transfer, but also the more resistance to airflow and initial cost of the coil. Tube diameters are usually 5/8". Fins on a coil increase the area of heat transfer surface to improve the efficiency and rate of transfer and are generally spaced from 4 to 14 fins per inch (fpi). As with coil tubes, the more fins, the more heat transfer, but also the more resistance to airflow. Aluminum is usually picked over copper for fin material for reasons of economy. However, when cooling coils are sprayed with water, copper fins are needed to prevent electrolysis between the dissimilar copper tubes and aluminum fins. Coils wetted only by condensation are seldom affected by electrolysis and are usually copper tube, aluminum fin.

WATER VALVES

Water flow is controlled through the use of various types of valves. Automatic and manual flow control valves and manual balancing valves are used to regulate flow rate. Service valves are used to isolate part or all of the system. Check valves are used to limit the direction of flow.

MANUAL VALVES

There are three basic types of manual valves: flow control or balancing valves, service valves, and check valves. Specific types are described in the following sections.

Flow Control (Balancing Valves)

The types of flow control or balancing valves include: ball valves, butterfly valves, globe valves, combination valves, plug valves, and calibrated balancing valves.

Ball Valves and Butterfly Valves

Ball valves have a low pressure drop, good flow characteristics and are often used for water balancing. Butterfly valves have a low pressure drop and are sometimes used as balancing valves. However, they do not have the good throttling characteristics of ball or plug valves.

Globe Valves

Globe valves are normally used in water make-up lines. Although globe valves are sometimes used for throttling flow, they have a high pressure drop and therefore should not be used for balancing.

Combination Valves

Combination valves are also called multipurpose or triple-duty valves. These valves regulate flow and limit direction. They come in a straight or angle pattern and combine a check valve, calibrated balancing valve, and shutoff valve into one casing. The valve acts as a check valve preventing backflow when the pump is off and can be closed for tight shutoff for servicing. Combination valves also have pressure taps for connecting flow gauges and reading pressure drop. A calibration chart is supplied with the valve for conversion of pressure drop to gpm for balancing. The valves generally have a memory stop.

Plug Valves

Plug valves are used primarily to balance water flow, but they are also used for shutoff. Plug valves have a low pressure drop and good throttling characteristics. Some plug valves have adjustable memory stops. The memory stop is set during the final balance. If the valve is closed for any reason it can later be reopened to the original setting.

Calibrated Balancing Valves

Calibrated balancing valves are plug valves with pressure taps in the valve casing at the inlet and outlet. They have also been calibrated by the manufacturer for flow versus pressure drop. A graduated scale or dial on the valve shows the degree that the valve is open. Calibration data which shows flow rate in gallons per minute (gpm) versus measured pressure drop is provided by the manufacturer.

Service Valves (Gate Valves)

Gate valves are service valves used for tight shutoff to service or remove equipment. Gate valves regulate flow only to the extent that they are either fully open or fully closed. Even though gate valves have a low pressure drop, they cannot be used for throttling. The internal construction of the gate valve is such that when the plug is only partly opened, the resulting high velocity water stream will cause erosion of the valve plug and seat. The erosion of the plug and seat will allow water leakage when the valve is used for tight shutoff.

Check Valves

Check valves are installed on the discharge of the pump to prevent backflow. Check valves allow the water to flow in one direction only. The operation of check valves is such that when there is water pressure in the correct direction, the water forces the gate in the valve to open. The gate will close due to gravity (swing check valve) or spring action (spring-loaded check valve) when the system is off or when there is water pressure in the wrong direction.

AUTOMATIC TEMPERATURE CONTROL VALVES

Automatic temperature control valves (ATCV) can be classified according to type of construction: Two-way valves: single seated and double seated; and three-way valves: single-seated mixing valves and double-seated diverting valves.

Installation

Valves must be installed with the direction of flow opposing the closing action of the valve plug. The water pressure pushes the valve plug open. If the valve is installed the opposite way the valve may chatter. Chattering occurs when the valve plug (in an incorrectly installed valve) modulates to the almost full closed position. The velocity of the water around the plug becomes very high because the area through which the water flows has been reduced. This high velocity (and resulting high velocity pressure) overcomes the spring resistance and forces the plug closed. When the plug seats, flow is stopped and the velocity and velocity pressure goes to zero. At this point, the spring force takes over and opens the plug. When the plug is opened (to the almost closed position) the cycle is repeated and chattering is the result.

Two-way Valves

Two-way valves are used to regulate water flow to control heat transfer in water coils (terminals). They close off when heat transfer is not required and open up when heat transfer is needed. Single-seated, two-way control valves are the type most used in HVAC systems. Double-seated, two-way valves may be used when there is a high differential pressure and tight shutoff is not a requirement. The flow-through double-seated valves close one port while opening the other port. This design creates a balanced thrust condition which enables the valve to close off smoothly without water hammer, despite the high differential pressure.

Three-way Valves

Three-way control valves may be either single-seated (mixing valve) or double-seated (diverting valve). The single-seated, mixing valve is the most common. A mixing valve has two inlets and one outlet. A double-seated, diverting valve has one inlet and two outlets. The terms “mixing” or “diverting” do not indicate the valve application, but refer to the internal construction

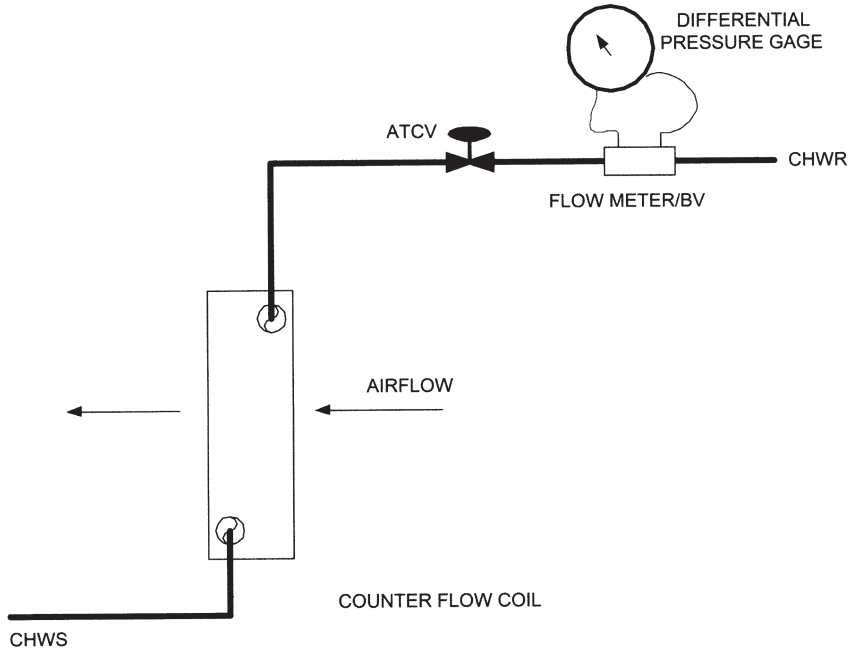

Figure 11-9. Two-way valve controlling water flow through a chilled water coil. The coil is piped counter flow. There is a flow meter and (manual) balancing valve in the return pipe.

of the valve. The determination of which valve to use is based on where the valve will be installed so that the plug will seat against flow. Substituting one type of valve for the other in a system (or installing either design incorrectly) will tend to cause chatter. Depending on its location in the system, either valve may be installed for a temperature control action (mixing application) or flow control action (bypassing application).

FLOW METERS

Flow meters such as annular, orifice plate, venturi, and calibrated balancing valve are permanently installed devices used for flow measurements of pumps, primary heat exchange

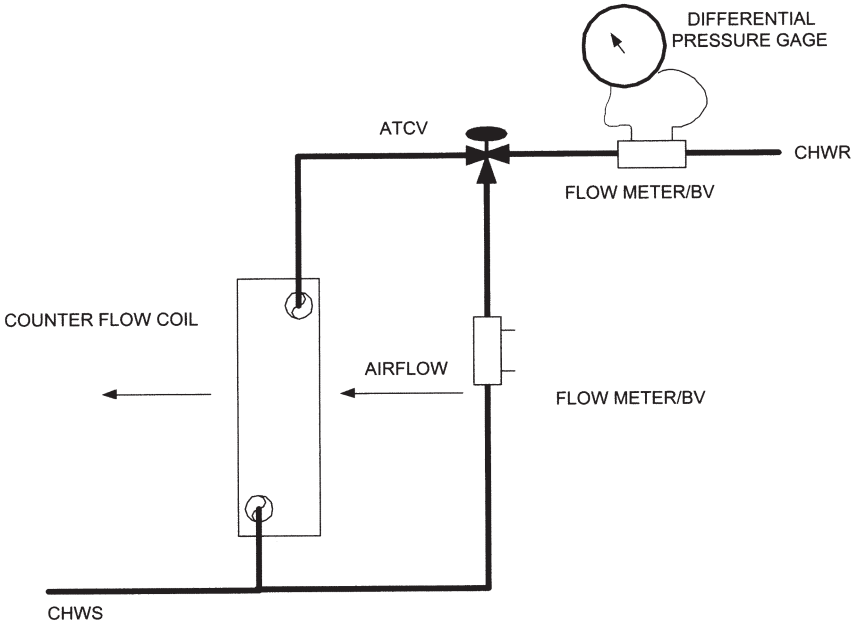

Figure 11-10. Three-way mixing valve in a bypass application. The coil is piped counter flow. There are flow meters and (manual) balancing valves installed in the return pipe and the bypass pipe.

equipment, distribution pipes and terminals. For flow meters to give accurate, reliable readings they should be installed far enough away from any source of flow disturbance to allow the turbulence to subside and the water flow to regain uniformity. The manufacturers of flow meters usually specify the lengths of straight pipe upstream and downstream of the meter needed to get good readings. Straight pipe lengths vary with the type and size of flow meter but typical specifications are between 5 to 25 pipe diameters upstream and 2 to 5 pipe diameters downstream of the flow meter.

Annular Flow Meters

Annular flow meters have a multi-ported flow sensor installed in the pipe. The holes in the sensor are spaced to represent equal annular areas of the pipe. The flow meter is de-

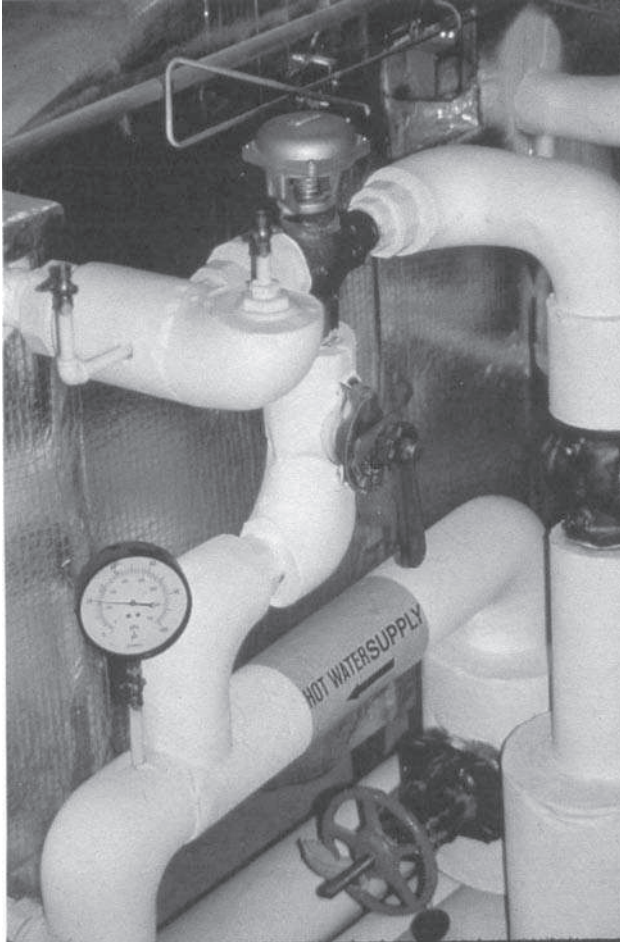

Figure 11-11. Pneumatically controlled three-way mixing valve in a bypass application. Manual air vent at top of the return line. Water is supplied at the bottom of the coil and returned from the top. Bypass piping goes from hot water supply line up to the bottom port on the three-way valve.

signed to sense the velocity of the water as it passes the sensor. The upstream ports sense high pressure and the downstream port senses low pressure. The resulting differential pressure is measured with an appropriate differential pressure gauge.

Calibration data which show flow rate in gallons per minute (gpm) versus measured pressure drop is furnished with the flow meter.

Orifice

Plate Flow Meters

Orifice plates are fixed circular openings in the pipe. The orifice is smaller than the pipe's inside diameter. A measurable "permanent" pressure loss is created as the water passes through the orifice. The abrupt change in velocity due to the smaller opening creates turbulence and friction which results in a pressure drop across the orifice. Calibration data which shows flow rate in gallons per minute (gpm) versus measured pressure drop is furnished with the orifice plate. A differential pressure gauge is connected to the pressure taps and flow is read.

Venturi

Flow Meters

Venturi flow meters operate on the same principle as orifice plate flow meters, but the shape of the venturi allows gradual changes in velocity. The "permanent" pressure loss is less than the loss created by an orifice plate. Calibration data which shows flow rate in gallons per minute (gpm) versus measured pressure drop is furnished with the venturi. The pressure drop is measured with a differential gauge.

Calibrated

Balancing Valves

A balancing valve is needed with the venturi, orifice plate, annular flow meter and other types of flow meters. Calibrated balancing valves, however, are designed to do the duties of both a flow meter and a balancing valve. The manufacturer calibrated the valve by measuring pressure drop through the valve at various positions against known flow quantities. Calibration data which shows flow rate in gallons per minute (gpm) versus measured pressure drop is provided with the valve. Pressure drop is measured with a differential gauge.

PRESSURE CONTROL VALVES

Pressure Reducing Valve

Pressure reducing valves (PRV) are installed in the make-up water pipe to the system. They reduce the pressure of city water down to the pressure needed to completely fill the system. They generally come set at 12 pounds (psig). This is adequate pressure for one or two story buildings. For a three story or higher building the pressure on the PRV is adjusted up.

Pressure Relief Valve

Pressure relief valves are safety devices installed on boilers or other equipment to protect the system and human life. Pressure relief valves come preset to open at a pressure less than the maximum pressure rating of the system.

PRESSURE CONTROL TANKS

After the water system is constructed it is filled with water through the city supply main or other appropriate source. The pressure reducing valve (PRV) is adjusted and the system is tested. Water expands when heated and contracts when cooled. When the boiler is started (fired) the water is heated and begins to expand. If the expanding water has nowhere to go, the increased pressure in the system could break a pipe or damage other equipment. Water expansion tanks are used to keep this from happening. These tanks maintain the proper pressure on the system and accommodate the fluctuations in water expansion and contraction while controlling pressure changes in the system. Expansion tanks are used in open systems. Compression tanks are used in closed systems. However, in most cases compression tanks are called expansion tanks.

Expansion Tank

An expansion tank is simply an open tank used in an open water system to compensate for the normal expansion and con-

traction of the water. As the water temperature increases the water volume in the system increases and the water in the expansion tank rises. Corrosion problems are associated with open expansion tanks as a result of the exposure to the air and evaporation and/or boiling of the water. Because of this, expansion tanks are limited to installations having operating water temperatures of 180°F or less.

Compression Tank

A compression tank is a closed vessel containing water and air or an air bladder. The tank is generally filled with water to about two-thirds full. The air in the compression tank or the bladder acts as a cushion to keep the proper pressure on the system. It accommodates the fluctuations in water volume and controls pressure changes in the system. Pressures in the water system will vary from the minimum pressure required to fill the system to the maximum allowable working pressure created by the boiler. If the air in the compression tank leaks out, water will begin to fill the tank. The condition is called a “waterlogged” tank. Water logging can happen when the air leaks out of the compression tank and the pressure on the system is reduced below the setpoint on the pressure reducing valve. The PRV will then open to allow in more water to fill the tank until the setpoint on the pressure reducing valve is reached. When the tank becomes waterlogged the fluctuations in water volume and the proper system pressures cannot be maintained. A waterlogged tank must be drained and the leaks found and sealed. If the tank remains waterlogged when the water in the system is heated, the water will expand to completely fill the tank. Since there is no longer a cushion, and nowhere else for the water to go, every time the boiler fires, the pressure relief valve on the boiler will open to spill water in order to relieve the pressure in the system. When the pressure relief valve opens and reduces the pressure in the system, the pressure reducing valve opens to bring fresh water into the system. This cycle continues. Every time fresh water comes into the system it also brings in air.

AIR CONTROL DEVICES

To prevent air problems, such as corrosion or air locks in the bends of the piping or coils, water should be introduced into the system at some point either in the air line to the compression tank or at the bottom of the compression tank. In a closed water system that is correctly designed, installed, and operated, air in the system travels through the pipes and is vented out at the high points or collected in the compression tank. In addition to the air that is already in the system, when water is heated, air entrained in the water is released. Air control devices (air separators and air vents) are designed to free the air entrained in water in the system.

Air Separators

There are several types of air separators. One large type is the centrifugal air separator which uses centrifugal force and low

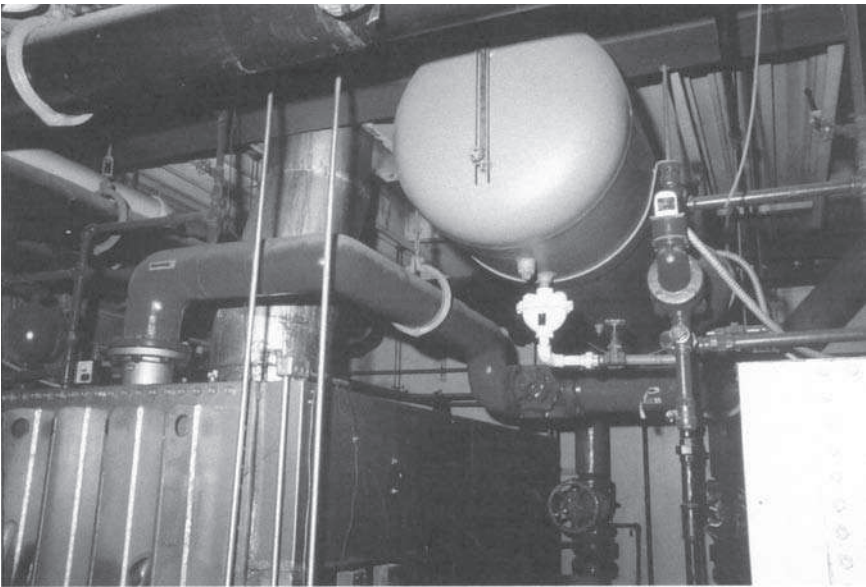

Figure 11-12. Compression tank, usually called expansion tank, with air separator piped into the bottom. Sight glass is shown.

water velocities for air separation. As water circulates through the air separator, centrifugal motion creates a vortex or whirlpool in the center of the tank and sends heavier, air-free water to the outer part of the tank. The lighter air-water mixture moves to a low velocity air separation and collecting screen located in the vortex. The entrained air collects and rises into the compression tank.

Air Vents

Air vents are installed at the high points and bends in the system and may be automatic or manual. One type of automatic air vent is the hydroscopic air vent, which contains a material that expands when wet and holds the vent valve closed. When there is air in the system, the hydroscopic material dries out, causing it to shrink and open the air vent valve. The float type of automatic air vent has a float valve that keeps the air vent closed when there's water in the system and vent. When there is air in the system it rises into the air vent replacing the water. The float drops and opens the air vent valve. Manual air vents are manually opened periodically to allow entrained air to escape.

WATER COIL PIPING

HVAC coils can be piped either counter flow or parallel flow. However, for the greatest heat transfer water coils are piped counter flow. In addition to being piped counter flow, water coils should also be piped so that the inlet is at the bottom and water flow is up through the coil and out the top. This will enable the air entrained in the water that's inside the coil to be pushed ahead of the water and accumulate in the top portion of the system where it can be easily vented. Note: Steam coils are piped supply steam at the top and condensate return at the bottom.

Counter Flow Coil

Counter flow means that the flow of air and water are in

opposite directions to each other. In other words, the supply water enters on the same side of the coil that the air leaves. For cooling coils, this would mean that the coldest water is entering the coil on the same side that the coldest air is leaving the coil (Figure 11-10).

Parallel Flow Coil

A coil that is piped parallel flow means that the flow of air and water are in the same direction to each other, i.e., the water and air enter on the same side. In some applications such as pre-heat coils, coils are intentionally designed for parallel flow. For example, a preheat coil may be used to heat the outside air in cold climates to prevent the freezing of other downstream coils. Therefore, the coil is piped parallel flow so hot water enters the coil on the same side that cold outside air enters. Heat transfer, in this example, is critical, and getting the most heat to the coil as quickly as possible is what is important.

This page intentionally left blank

Chapter 12

Control Systems

Control Systems:
Pneumatic
Electric
Electronic—Direct Digital Control (DDC)

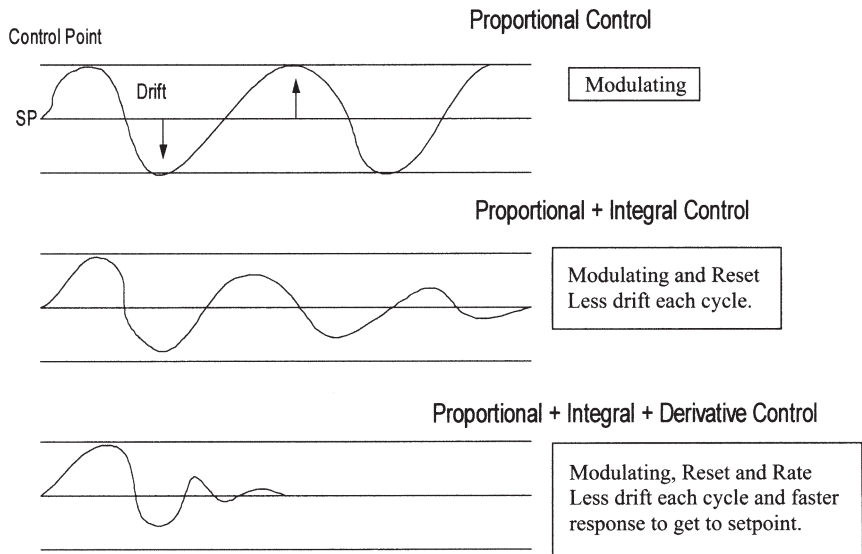

Figure 12-1. Proportional, integral and derivative (PID) control. Control point, setpoint (SP), and drift (offset) from setpoint to control point.

HVAC CONTROL SYSTEMS

The purpose of an HVAC automatic control system is to start, stop or regulate the flow of air, water or steam and to provide stable operation of the system by maintaining the desired temperature, humidity and pressure. The automatic control system is a group of components, each with a definite function designed to interact with the other components so that the system is self-regulating. HVAC control systems are classified according to the source of power used for the operation of the various components. The classifications and power sources are:

Pneumatic Systems: Compressed air.

Electric Systems:

 Low voltage electricity (normally 24 Volts)

 Line voltage electricity (normally 110 to 220 Volts)

Electronic Systems (DDC): Low voltage electricity (normally 5 to 15 Volts).

Electric- or Electronic-to-Pneumatic Systems: Electricity and compressed air.

PNEUMATIC CONTROL SYSTEMS OPERATION

Main Air

The source of the compressed air in a pneumatic system is an electrically driven, reciprocating, positive displacement air compressor generally sized at 25 horsepower or less. Compressors are normally sized so that they do not operate more than one-third of the time. This extends compressor life and allows sufficient time to cool the air in the receiver tank. The receiver tank receives and stores the compressed air from the compressor for use throughout the system. In order for the pneumatic components to function correctly the compressed air used to operate the system must be kept clean, dry and oil-free. Therefore, a number of devices are installed in the system to dry the air and

remove oil, vapors, dirt and other contaminants. The first device is an air filter installed in the compressor's air intake to keep dirt and oil vapors from entering and being passed through the compressor and condensing into droplets in the air lines. As the air goes through the compressor its pressure is increased, generally to 60 to 100 pounds per square inch. Heat is also added to the air during the compression phase. As the air cools, moisture in the air is released. By only allowing the compressor to operate about 1/3 of the time the maximum amount of cooling and condensation of water and oil vapors will take place. Therefore, an automatic or manual drain is installed in the receiver tank to remove any accumulated water, oil, dirt or scale which has settled to the bottom of the tank. To remove any moisture which may have been carried over, a refrigerated air dryer equipped with an automatic drain is placed downstream of the receiver tank. In addition to the refrigerated air dryer, a filter is installed in the main supply to collect any oil vapor or particles of dirt to ensure that the lines are oil and dirt free. Normally, a manual bypass is installed around the refrigerated air dryer and filter so they can be serviced without interrupting the system operation.

A pressure switch is installed on the compressor-tank assembly to start and stop the compressor at predetermined set points. For example, the switch may be set to start the compressor when the pressure in the receiver tank falls to 60 psig and stop the compressor when the pressure in the tank reaches 100 psig. Generally, a pressure reducing valve downstream of the refrigerated air dryer and filter maintains the system pressure at 18 to 20 psig. A high pressure gauge is installed in the main supply line before the pressure reducing valve to indicate the pressure of the air stored in the receiver tank. A low pressure gauge is installed in the main supply line after the pressure reducing valve to show the pressure of the main air.

In addition to the devices installed to start and stop the compressor and to keep the system clean there must also be safety devices to protect the equipment. Generally, there are two safety relief valves installed in the system. A high pressure relief

valve is installed on the receiver tank and a second relief valve is installed in the supply line downstream of the pressure reducing valve. The pressure relief valve at the receiver tank protects the tank from excessive pressures while the relief valve downstream of the pressure reducing valve protects the system if the pressure reducing valve fails. The relief valve in the supply line is normally set for 30 psig since this is the maximum safe operating pressure for most pneumatic devices.

The air lines coming from the compressor receiver tank assembly and going to the controlling devices such as thermostats, humidistats, etc., are called "mains." The air lines leading from controlling devices to the actuator of controlled devices such as dampers or valves are called "branches." Air lines are generally made of either copper (older systems or special systems) or polyethylene (plastic) tubing.

Types of Pneumatic Systems

Pneumatic systems are divided into single pressure and dual pressure systems. A single pressure system requires only one main air pressure. In a dual pressure system there are two different applications, summer/winter or day/night, which require two different main air pressures. The summer/winter system provides for the seasonal requirements of either cooling or heating. In other words, depending on the season, either chilled water or hot water is supplied to the water coil in the air handling unit. The day/night system allows for setting and controlling space temperature at different setpoints for the day and the night.

The configuration of a dual pressure system is the same as the single pressure system described before up to the pressure reducing valve. Since two different pressures are required, two pressure reducing valves are needed. One pressure reducing valve reduces pressures to about 13 to 16 psig and the other one is set for 18 to 25 psig. The higher-pressure reducing valve supplies air to the controlling device only when the device is on the winter or night setting. The lower pressure is supplied to the controller for summer or day operation. Downstream of the pres-

sure reducing valves is a three-way air valve and a two-position manual or automatic switch. The function of this switch is to change the ports on the three-way valve. If the switch is set for summer or day the normally open (NO) port is open, and the normally closed (NC) port is closed. Air from the lower pressure reducing valve is allowed to flow through the NO port into the common (C) port to the controllers. Air from the higher pressure, pressure reducing valve is blocked. When the switch is set for winter or night operation, the NO port closes and the NC port opens. This allows air from the higher pressure, pressure reducing valve to flow through the NC port into the common (C) port to the controllers. Air from the lower pressure, pressure reducing valve is blocked.

DIRECT DIGITAL CONTROL SYSTEMS OPERATION

DDC (direct digital control) is the automated control of a condition or process by a digital computer. A comparison can be made between conventional pneumatic controls and DDC. A typical HVAC pneumatic control system may consist of a pneumatic temperature sensor, pneumatic controller, and a heating or cooling valve. In the pneumatic system the sensor provides a signal to the controller, the controller provides an output to the valve to position it to provide the correct temperature of supply air. A DDC system replaces this local control loop with an electronic temperature sensor and a microprocessor to replace the controller. The output from the microprocessor is converted to a pressure signal to position the same pneumatic heating and cooling valve as in the pneumatic control system. However, the DDC system is not limited to utilizing pneumatic control devices but may also interface with electric or electronic actuators.

Electric or pneumatic devices can be used to provide the control power to the final control elements (the controlled device), but the DDC system provides the signal to that device. In a true DDC system, there is no conventional controller. The controller

has been replaced by the microprocessor. A common application of DDC includes the control of the heating valve, cooling valve, mixed air damper, outside air damper, return air damper, and economizer cycles to maintain the desired supply air temperature. Other systems commonly controlled by DDC include: chilled water temperature, hot water temperature, and variable air volume capacity.

The DDC system uses a combination of software algorithms (mathematical equations) and hardware components to maintain the controlled variable according to the desires of the system operator. The controlled variables may be temperature, pressure, relative humidity, etc. In the past, the maintenance and operations personnel had to calibrate the local loop controller at the controller's location. Now, with a DDC system, the system's operator may tune the control loop by changing the software variables in the computer using the operator's keyboard. So, instead of calibrating the hardware controller the control sequence and setpoint are input to the computer by a software program and modified by a proper password and the appropriate command keyboard entry.

The DDC system monitors the controlled variable and compares its value to the desired value stored in the computer. If the measured value is less than or greater than the desired value, the system output is modified to provide the correct value. Because the microprocessor is a digital device, there must be some feature in the DDC panel to convert the digital signal to an output signal which the controlled device can use. Pneumatic actuators can be used to position the controlled device. If this is the case, there must be a component or translator incorporated to provide a digital-to-pneumatic conversion. This is done with a digital-to-voltage converter and voltage-to-pressure converter (electric-to-pneumatic transducer). It is the development of these transducers and the development of the computer hardware and software that have made DDC systems cost effective. If the measured value is less than or greater than the desired value the computer circuitry outputs a series of digital impulses that are converted

to a modulating signal to the actuator by way of a transducer (electrical-to-pneumatic or electrical-to-electrical). The transducer maintains the computer output signal until readjusted by the computer. Other DDC systems may change the control signal by a series of on-off or open-closed signals to bleed air out of, or put air into the actuator. In all cases there is some interfacing signal device required to isolate the computer output circuitry from the control signal circuitry.

The DDC system can utilize many forms of logic to control the output from a given input. The input signal can be modified considerably by various logic statements as desired, thereby providing a great amount of flexibility in establishing the sequence of operation. With a practical understanding of the HVAC system, the system operator is able to fine tune the control system to provide the most efficient operation possible.

A DDC controller's output signals (in volts direct current) for both direct acting and reverse acting operation are:

Temperature	D/A Output	R/A Output
72° F	6 vdc	9 vdc
75° F	7.5 vdc	7.5 vdc
78° F	9 vdc	6 vdc

ENERGY MANAGEMENT CONTROL SYSTEMS

Most DDC systems, in addition to providing local loop control, provide energy management functions that are usually associated with supervisory type energy management systems. Historically, energy management systems (EMS) were installed separate from, and in addition to, the local loop controls to provide these functions. This resulted in a local pneumatic control system which was interfaced to a computer system to provide the energy management functions. Now a DDC system can provide both these functions in one system. The energy management functions provided by these systems include cooling demand

control, hot and cold deck reset, chilled water reset, dead band, duty cycling, optimized start/stop, etc.

Cooling Demand Control

The DDC system can automatically reduce the fan speed and/or increase the cooling temperature to unload the refrigeration compressor(s). This provides a percentage of load reduction as opposed to the simple on/off function.

Hot and Cold Deck Reset

Because the local loop control is being set by the DDC system, the hot/cold deck temperatures can be controlled directly, which allows the hot and cold valves to be positioned independently of each other. The heating valve can be commanded, for example, to be closed during the cooling season so there is no overlap of the heating and cooling functions.

Chilled Water Reset

By directly controlling the capacity of the chiller, the water temperature can be set at any value desired. This can be a function of outside air temperature, building load, or a combination of both. It assures the most efficient operation of the chiller no matter what the load or outside temperature may be.

Dead Band

By direct control of the setpoints of the various systems, a dead band can be programmed into the control algorithm to provide a separation of the heating and cooling setpoints, i.e., the heating setpoint may be set at 70°F and the cooling set for 75°F. Between these two temperatures, the system commands the heating valve and cooling valve closed.

BENEFITS of DDC

The benefits of DDC include simplicity of operation (with one system providing control and energy management), tighter,

better control, greater reliability, greater flexibility, and substantial energy and cost savings.

Direct Control

Because all the setpoints are now programmed within the microprocessor of the DDC system, the owner, energy manager, or system operator has direct control over the environment within the building by dictating the temperature, pressure and humidity setpoints. This prevents the occupants (KTI's) from constantly adjusting the setpoints up and down to their individual wishes which causes significant energy waste. An environmental control system can now be provided that is more attuned to the needs of the majority of the occupants and not the individual desires of a select few controlling the room thermostats.

Precise Control

The DDC systems provide the ability to control the setpoint much more accurately than traditional pneumatic systems. One of the inherent flaws of a pneumatic system is that it could not provide a precise and repeatable setpoint. Pneumatic systems are modulating control only. There is always an offset from the setpoint under minimum and maximum load conditions. The DDC system, because it can be programmed to provide proportional, integral, and derivative (PID) control (Figure 12-1), can provide absolute control of the setpoint under all load conditions. Therefore, if the setpoint is 72°F, it will maintain that setpoint regardless of the load on the HVAC system. This provides considerable energy savings because the controlled variable (temperature, pressure or relative humidity) can be precisely maintained. The digital computer can be programmed to maintain the control point equal to the setpoint using proportional (modulating) control, and adding integral (reset) control. Derivative (rate) control is added for some control sequences (PID) but PI (proportional, integral) will provide adequate control and energy savings for most HVAC control schemes. A floating point (moving the controlled device only when the con-

trolled variable reaches an upper or lower limit) may be added as well.

Dead Band and Control Sequence

Based on the response time of any particular controlled device a small dead band (above and below the setpoint) can be established to maintain stability. These dead bands, as well as rate of change of the signal to the actuator and minimum length of time between control signal changes, are individually changeable by an authorized operator. The control sequence can be modified by changing the program algorithms, usually without any change in hardware. The ease of making the changes varies with the system design.

Schedule Changes

DDC and energy management systems (EMS) provide easy changing of schedules and therefore can reduce the energy waste by being on the wrong time and HVAC operation schedule. Day-night schedules, monthly schedules, seasonal schedules, winter-summer schedules, yearly schedules, holiday schedules, etc., can all be quickly changed with simple keyboard entries. For example, in a given facility to change the time clocks from Standard Time to Daylight Saving Time or vice versa might previously have literally required days or longer, whereas a knowledgeable operator can change the schedule in a few minutes.

Flexibility

The DDC system provides greater flexibility in determining how the control loop is to function. The owner-operator-manager has access to software programs which change settings as desired. The system operator can now optimize the control system and provide the most economical operation under all conditions. This is especially important in continually changing conditions within the building or conditioned space such as: number of people, schedule changes, work load changes, and environment changes (lighting, computer, and other heat-generating equipment).

Chapter 13

Control

System Components

Controllers

- *Direct acting*

An increase in sensed temperature (pressure or humidity) is an increase in branch pressure (pneumatic or electric)

- *Reverse acting*

An increase in temperature, etc., is a decrease in branch pressure

CONTROL COMPONENTS

Controllers

A controller is a proportioning device designed to control dampers or valves to maintain temperature, humidity, or pressure. Types of controllers are thermostats for temperature, humidistats for humidity, pressurestats for pressure, master controllers to control submaster controllers, and receiver-controllers. A controller may be direct acting (D/A) or reverse acting (R/A). A direct acting controller increases its branch line pressure as the condition it is sensing increases. A reverse acting controller decreases its branch line pressure as the condition it is sensing increases. Some other important terms you'll need to know are throttling range and setpoint. Throttling range is the change in the controlled condition necessary for the controller output to change over a certain range. For example, a 4 degree throttling range (TR) means that the thermostat's branch line output will

vary from 3 to 15 psig over a 4 degree change in temperature. "Setpoint" is the point at which the controller is set and the degree of temperature, or percent relative humidity, or pressure which is to be maintained. An example of a DDC controller's output signals for both direct acting and reverse acting operation for a 6 degree throttling range is that the electrical signal will vary from 6 to 9 vdc over a 6 degree change in temperature. You'll understand these terms better when we describe the various controllers, controlled devices and relays.

Single Pressure Thermostat

A single pressure thermostat may be a one-pipe, bleed-type or a two pipe, relay-type controller. The bleed-type thermostat has only one pipe connection. The main air is introduced through a restrictor into the branch line between the thermostat and the controlled device. The two-pipe thermostat has two connections, branch and main, and receives main air directly. The two-pipe thermostat will provide a greater volume of air to the controlled device which produces a faster response to a change in temperature. Thermostats may be either direct or reverse acting. The standard thermostat has a temperature range of 55°F to 85°F and a 3 to 15 psig output range. Generally, the throttling range may be adjusted between 2 and 12 degrees. As an example, a room has a direct acting thermostat set for 72°F and a 4 degree throttling range is selected (70°F to 74°F). A direct acting thermostat means that a rise in space temperature causes a rise in the branch pressure output of the thermostat. Therefore, when the room temperature is at or below 70°F the thermostat will put out 3 psig branch pressure. When the room is 72°F the output will be 9 psig. At 74 degrees or above the branch output will be 15 psig. Another example would be a room that has a reverse acting thermostat with a 6 degree throttling range and a setpoint of 72°F. The control sequence is: at 75°F, the branch output would be 3 psig (a rise in space temperature is a decrease in pressure output), at 72°F the output pressure would be 9 psig and at 69°F the branch output would be 15 psig.

Dead Band Thermostat

A dead band thermostat is a two-pipe controller that operates in the same manner as a single pressure, single temperature thermostat. It's used for energy conservation when a temperature span or "dead band" is required between the heating and cooling setpoints. The dead band pressure is the output pressure at which neither heating nor cooling takes place. This type of thermostat uses two bimetal strips. One bimetal strip for heating and one for cooling. The heating bimetal modulates the output pressure between zero and the dead band pressure. The cooling bimetal modulates the output pressure between the dead band pressure and branch air pressure. For example, a dead band thermostat allows for heating below 70°F and cooling above 76°F. The dead band pressure is 8 degrees and the temperature span is 6 degrees. Therefore, when the space temperature is 70°F or below the branch output will be between 0 and 7 psig and heating will occur. However, when the space temperature is 76°F or above the output pressure will be between 9 and 15 psig and cooling will occur. There will be no heating or cooling at 8 psig when the space temperature is between 70°F and 76°F. Dead band thermostats are adjustable within the limits depending on the heating and cooling set points selected.

Dual Pressure Thermostat

The summer/winter system provides for the seasonal requirements of either cooling or heating and, depending on the season, either chilled water or hot water is supplied to the water coil in the air handling unit. Since the valve controlling the flow of hot water or chilled water remains the same, either normally open or normally closed, but not both, the system must have a thermostat which can be both direct acting and reverse acting. The bimetal strip in the thermostat is changed from direct acting to reverse acting by a change in the main air pressure. For example, a dual pressure thermostat controls a normally open two-way valve. When the system is in the winter condition the higher main air pressure (18-25 psig) is sent to the thermostat.

This makes the thermostat direct acting. As the space temperature rises an increased branch pressure is sent to the valve causing it to close, allowing less hot water into the coil. With a reduced supply of hot water the space will begin to cool. When the system is switched to summer conditions the lower main air pressure (13-16 psig) is sent to the thermostat, which changes it over to reverse acting. Now on a rise in space temperature, a decreasing pressure is sent to the valve causing it to open, supplying chilled water to the coil and the space will begin to cool.

The day/night dual pressure thermostat lets you set and control space temperature at different points for the day and night or for varying load conditions. A day/night thermostat is essentially the same as a summer/winter thermostat except that the day/night thermostat has two bimetal strips and both are either direct acting or reverse acting. The two bimetal strips have separate setpoints. When the higher main air pressure (18-25 psig) is sent to the thermostat, the night bimetal strip is in control. When the lower pressure (13-16 psig) is sent the day bimetal is in control. For example, a direct acting day/night thermostat controls a two-way, normally open heating valve. During the day the lower main air pressure is sent to the thermostat. The thermostat's day setpoint is 71°F. Any temperature above 71°F will send an increasing branch pressure to the valve causing it to close. At 71°F or below the thermostat will send a decreasing branch pressure to the valve causing it to open allowing more hot water into the coil. At night the main pressure is switched sending the higher main air pressure to the thermostat. The thermostat will now modulate the branch pressure based on the night bimetal strip which is set for 60°F. At 60°F or below the thermostat will send a decreasing branch pressure to the valve causing it to open allowing more hot water into the coil. Any temperature above 60°F will send an increasing branch pressure to the valve causing it to close.

Humidistat

Humidistats are similar in appearance to thermostats; how-

ever, instead of using a bimetal strip as the sensor, humidity is sensed by a hygroscopic, or water absorbing, material such as human hair, nylon, silk, wood or leather. Nylon is generally used. Humidistats may be direct acting or reverse acting. For example, a reverse acting humidistat controls a normally closed two-way steam valve. As the room's relative humidity drops the pressure to the valve is increased, opening the valve and allowing steam to enter the humidifier.

Master/Submaster Controller

A master controller is one which transmits its output signal to another controller. The second controller is called the submaster. The submaster's setpoint will change as the signal from the master controller changes. This is a reset type of control. For example, a space thermostat is the master controller. The branch output signal from the master controller is piped to the reset port on the submaster controller. The branch output from the submaster is piped to a two-way normally open hot water valve. The remote sensing element for the submaster is located in the discharge air duct. Both master and submaster are piped with main air. As the space thermostat (master controller) senses an increase in room temperature, an increased pressure is sent to the submaster controller to reset its set point lower. The submaster then senses discharge temperature and sends a signal to the valve to close down. Another application is to reset the hot water or hot deck discharge air temperature submaster controller from the outside air temperature master controller. For example, a master controller in the outside air is set for 70°F. The submaster controller operates the heating valve in the piping from the boiler. The setpoint on the submaster is 80°F. As the outside air temperature falls, the submaster setpoint is reset upwards and the hot water temperature is increased. The relation between the master and submaster in this example is 1 to 2, i.e., for every one degree the outside air temperature drops, the water temperature is reset upwards by two degrees.

The reset schedule is:

OA	Water	Controller
Temp.	Temp.	Output
70°F	80°F	3 psig
40°F	140°F	9 psig
10°F	200°F	15 psig

Receiver-controller and Transmitter

The receiver-controller and transmitter is the controlling device used most often in present day pneumatic HVAC control systems. The receiver-controller, like the other controllers, receives a signal from a sensor and then varies its branch output pressure to the controlled device. The sensing device for receiver-controllers is the transmitter. Transmitters are one-pipe, direct acting, bleed-type devices which use a restrictor in the supply line to help maintain the proper volume of compressed air between the transmitter and the receiver-controller. The transmitter sends a varying pneumatic signal back to the receiver-controller. Transmitters are used to sense temperature, pressure or humidity. All transmitters have an pressure output span of 12 psig (15 minus 3). However, they come in a variety of transmitter spans such as 0 to 100°F (100 degree span), 25 degrees to 125°F (150 degree span), 30% RH to 80% RH (50% relative humidity span), 0 inches to 7 inches (7 inches water column air pressure span), etc. The transmitter's output span divided by its transmitter span is called the sensitivity of the transmitter. For example, a transmitter that has a 100 degree span would have a sensitivity of 0.12 psig per degree (12 psig divided by 100 degrees).

CONTROLLED DEVICES

A controlled device is a fluid flow control device such as a damper for air control or a valve for water or steam control. It is the final component in the control system. Attached to the controlled device is an actuator. The actuator receives the branch signal from the controller and positions the controlled device.

Actuators are also called motors or operators. Some important terms to understanding the workings of controlled devices are normally open, normally closed and actuator spring range. The terms normally closed (NC) and normally open (NO) refer to the position of a controlled device when the power source, compressed air in a pneumatic system, or electricity in an electrical or DDC system, is removed. A controlled device that moves toward the closed position as the branch line pressure decreases is normally closed. A controlled device that moves toward the open position as the branch line pressure decreases is normally open. The spring range of an actuator restricts the movement of the controlled device within set limits.

Dampers

Automatic dampers used in HVAC systems may be either single blade or multi-blade. Multi-blade dampers are usually parallel blade for mixing applications such as in the return air duct and the outside air duct to the mixing plenum. Opposed blade dampers are used for volume applications. Dampers may be installed either normally open or normally closed.

Damper Actuator

Damper actuators position dampers according to the signal from the controller. The air pressure from the controller may operate the actuator in either a two-position or proportioning manner. Inside the actuator the control air pressure expands the diaphragm around the piston and forces the piston outward against the spring, driving the pushrod out. As air pressure is increased, the pushrod is forced to the maximum of the spring range. As air is removed from the actuator, the spring's tension drives the piston towards its normal position. For example, a damper with a proportioning actuator has a spring range of 3 to 7 psig. The actuator is in its normal position when the air pressure is 3 psig or less. Between 3 and 7 psig the stroke of the pushrod is proportional to the air pressure, for instance, 5 psig would mean that the pushrod is half-way extended. Above 7 psig the maximum stroke is achieved.

Dampers can be sequenced by selecting actuators with different spring ranges. For example, two normally closed dampers operating from the same controller control the air to a conditioned space. The top damper operates from 3 to 7 psig. The bottom damper operates between 8 and 13 psig. Both dampers are closed at 3 psig. At 7 psig the top damper is full open and the bottom damper is closed. At 8 psig the top damper is full open and the bottom damper is starting to open. At 13 psig both dampers are full open. Damper actuators may be directly or remotely connected to the damper. The damper position, normally open or normally closed, is determined by the way the damper is connected to the actuator. In other words, if the damper closes when the actuator is at minimum stroke, the damper is normally closed. If, on the other hand, the damper opens when the actuator is at minimum stroke, the damper will be normally open.

Valves

Control valves are classified according to their flow characteristics, such as quick opening, linear or equal percentage; their control action, such as normally open or normally closed; and the design of the valve body such as two-way, three-way, single seated or double seated.

Flow characteristic refers to the relationship between the length of the valve stem travel expressed as a percent and the flow through the valve expressed as percent of full flow. For example, the quick opening valve has a flat plug, which gives maximum flow as soon as the stem starts up. This type of valve might deliver 90% of the flow when it's open only 10%. Therefore, a typical application for a quick opening valve might be on a stream preheat coil where it is important to have a lot of fluid flow as quickly as possible. By comparison, in a linear valve the percent of stem travel and percent of flow are proportional. For instance, if the stem travel is 50%, the flow is 50%. In the equal percentage valve, each equal increment of stem travel increases the flow by an equal percentage. For example, an equal percentage valve has the following characteristics: for each 10% of stem

travel the flow is increased by 50%.

Stem travel	Flow
30%	8%
40%	12%
50%	18%
60%	27%
70%	40.5%
80%	60.75%
90%	91.125%

Valve Actuator

Generally, normally open valves are used in heating applications and usually have lower spring ranges, 3 to 7 psig, 4 to 8 psig, etc. Cooling applications are valved normally closed with higher spring ranges, 8 to 12 psig, 9 to 13 psig, etc. This will allow sequencing of the valves without simultaneous heating and cooling. For example, an air handling unit has a heating coil piped with a normally open two-way valve, 3 to 7 psig, and a cooling coil piped with a normally closed two-way valve, 9 to 13 psig. The space thermostat is piped to both valves. It is a direct acting thermostat with the setpoint at 73 degrees and a 6 degree throttling range. The space temperature is 70 degrees. Since the space temperature is below the setpoint the branch pressure going to the heating and cooling valve is low, in this case 3 psig. With 3 psig on the valve actuators the heating valve is full open and the cooling valve is full closed. These are their normal positions. As the space temperature rises, the branch output pressure also increases. When the pressure rises to 7 psig both the heating valve and the cooling valve are closed. If the space temperature increases to 73 degrees or above, the output pressure will be 9 psig or greater, opening the cooling valve and keeping the heating valve closed. Should the space temperature start to drop, the pressure will also decrease, closing the cooling valve. The heating valve will remain closed until the output pressure is 7 psig or below. Between the dead band area of 7 psig to 9 psig there is no heating or cooling.

RELAYS

Amplify/Retard Relay

The amplify/retard relay is a device used to change the output start point. It is also called a bias start relay or ratio relay. A typical application is when a heating valve and cooling valve operating from the same controller do not have a dead band and one is required. For example, the normally open heating valve is 3 to 7 psig. The normally closed cooling valve is 7 to 11 psig. A retard relay is installed between the valves. The sequence is for the output pressure from the thermostat to go to the heating valve actuator then to the relay. The relay then sends a signal to the cooling valve actuator. In this example, the thermostat output pressure is 7 psig. The heating valve actuator receives 7 psig as does the input to the relay. This relay is set for a 2 psig retard bias. This means that the input to the relay is 7 psig but the output of the relay to the cooling valve is 5 psig. Therefore, the cooling valve would not start to open until the output from the thermostat was 9 psig which would be 7 psig to the cooling valve.

Averaging Relay

An averaging relay is a device used when the application requires the setting of a controller, or the operation of a controlled device, by the average signal from two or more controllers. For example, two direct acting thermostats each send a signal to the averaging relay. One signal is 3 psig and the other is 7 psig. The output from the relay to the heating valve is the average of the two signals or 5 psig.

Electric-Pneumatic Relay

An electric-pneumatic relay, or E-P switch, is an electrically operated device used to divert control air from one point to another. The E-P switch is a solenoid three-way air valve. It is used in applications when an electric circuit is used to control a pneumatically operated device. An example would be outside air

dampers interlocked with the operation of the fan. When the fan is turned on, the E-P switch, which is wired to the fan, is energized. This allows control air piped to the normally closed port to connect to the common port and go on to the damper actuator, opening the dampers. When the fan is turned off, the plunger blocks the NC port and connects the C port to the normally open port. This allows air in the actuator to bleed off through the NO port, closing the dampers.

Diverting Relay

A diverting relay is a device used to switch air signals. A diverting relay is a three-way air valve used primarily to convert a signal, at a predetermined setpoint, into a signal for a controlled device. For example, a diverting relay can be used as either a high or low limit control in an economizer application. As a high limit control it would be used to control the outside and return air dampers. A typical application would be for the high limit diverting relay to be set at 70 degrees. This allows the mixed air controller to control the outside and return air dampers up to 70 degrees. The sequence is: the output from the mixed air controller is piped into the NO port of the diverting relay. As long as the outside air temperature is below 70 degrees this signal is passed along to the dampers through the common port to the damper actuators. At this point, the outside dampers would be open and the return air dampers closed. When the OA temperature reaches 70 degrees the diverting relay switches and blocks the NO port and connects the common port to the NC exhaust port to allow the air pressure to be exhausted from the damper actuators. This closes the outside air dampers and opens the return air dampers.

Pneumatic-electric Relay

A pneumatic-electric relay, or P-E switch, is an air actuated device used to make or break electrical contacts. Pneumatic-electric relays are used to start or stop fans, pumps or other electrically driven equipment and can be wired either normally open or

normally closed. Note: when using electrical terms normally open means the circuit is de-energized and normally closed means that it is energized.

Positive Positioning Relay

A positive positioning relay is an auxiliary device which is fitted to the damper motor or valve actuator. Positive positioning relays are piped with both branch pressure and main air and are used to position the motor or actuator accurately with respect to signal pressure from the controller regardless of the load on the damper or valve.

Selector Relay

A selector relay is a device used to compare, select and transmit proportional signals. The relay may be either a low select, high select or a hi-lo select. The relay receives two or more signals, compares them, then selects and transmits either the lowest signal, the highest signal or both the lowest and the highest signals. For example, a hi-lo select on a multizone air handling unit receives the input from five direct-acting zone thermostats. The pressures are 6 psig, 7 psig, 9 psig, 8 psig, and 10 psig. The highest pressure, 10 psig, is sent to the cooling valve to allow only enough chilled water into the coil to cool the zone with the greatest cooling requirement. The lowest pressure, 6 psig, is sent to the heating valve to allow only enough hot water into the coil to heat the zone with the greatest heating requirement.

The selector relay is used as an energy management retrofit. If none of the zones in a multizone unit is calling for the coldest temperature air (for example 55°F) or the warmest temperature air (105°F), then the cooling coil and heating coil can be set for lesser conditions. In the example, the zone at 10 psig is receiving 62°F air and the zone at 6 psig is getting 85°F air. The 7, 8, and 9 psig zones are getting some 62°F air and some 85°F air to satisfy the temperature required of their respective zone thermostats. This lowers the load on the chiller(s) and the boiler(s) and reduces energy costs.

Reversing Relay

A reversing relay is a device used to reverse the proportional signal from the controller. The relay's output pressure decreases, or reverses, in direct proportion to an increase in the relay's input pressure from the controller. Reversing relays are used when the application requires reversing a signal from the controller. For example, a direct acting space thermostat is controlling a heating valve and a cooling valve. Both valves are normally open. This is an incorrect installation. The heating valve is correct (normally open), but the cooling valve should be normally closed. In this application, a reversing relay would need to be installed between the heating valve and the cooling valve. In this example, the space is too warm. The thermostat senses the rise in temperature and sends out an increasing branch pressure signal. The sequence would be for the branch pressure from the controller to be piped into the heating valve and then to the reversing relay. The signal from the reversing relay is piped to the cooling valve. As the pressure is increasing to the heating valve, the cooling valve gets a decreasing pressure. This sequence closes the heating valve and opens the cooling valve. If a dead band is required, an amplify relay could also be installed.

Input psig to relay	Output psig to cooling valve
3	7
4	6
5	5
6	4
7	3

This page intentionally left blank

Chapter 14

Choosing an HVAC System

The goals of HVAC systems:

- To provide an acceptable level of occupancy comfort.*
- To provide temperature and humidity control for process function.*
- To maintain good indoor air quality (IAQ).*
- To minimize energy requirements and costs.*

The purpose of an HVAC (heating, ventilating, and air conditioning) system is to provide and maintain environmental conditions within an area called the “conditioned space.” The type of system selected is determined by the mechanical designer’s knowledge of systems and the building owner’s financial and functional goals.

The commercial system selected for a particular application endeavors to provide the optimum environment for employee comfort and productivity, process function, and good indoor air quality with energy efficiency and cost savings. Different systems will satisfy each of these objectives with different degrees of success. It is up to the designer and the owner to make the correct assessments.

In most applications, there are several choices for the type of system to use. The selection of the type of HVAC system by the designer and the building owner is a critical decision. It is the designer’s responsibility to consider the various systems and select the one that will provide the best combination of initial cost, operating cost, performance, and reliability based on his

understanding of the owner's needs and goals. In the selection process all factors must be analyzed, but cost of installation and operation are usually foremost.

Some of the many cost concerns include initial or installation cost, operating and maintenance cost, and equipment replacement costs. Another cost concern that may be overlooked by the designer is the cost associated with equipment failure. For example, how often might a selected system or component be expected to fail and what is the cost in loss of product and production? How long will the system be down? How will the comfort, safety and productivity of the occupants be affected by such a failure and what are these costs?

Depending on the owner's goals, each of these concerns has a different priority. Most owners do not have knowledge or understanding of the advantages and disadvantages of the different types of systems, so it is up to the designer to advise the owner which is best for each application. Likewise, the designer does not usually have a complete understanding of all the owner's financial and functional goals. For these reasons, the best situation is when designer and owner are both involved in the HVAC selection process.

HVAC SELECTION

The first step in the selection process is for the designer to ascertain and document from the owner the desired environmental conditions for the building or conditioned space. The designer must also learn and document the restrictions placed on the system design. For example, what is the required equipment space for a particular system versus what is available? Unfortunately, it is the nature of the business that very few projects allow as much detailed evaluation of all conditions and alternatives as some would like. Therefore, the designer must also rely on common sense and subjective experience to narrow the choice of systems.

Step two in the selection process is determining the building's heating and cooling loads. For example, is the cooling load mostly sensible or latent? Is the load relatively high or low per square foot of conditioned area as compared to other similar buildings? Is the load uniformly distributed throughout the conditioned space? Is it relatively constant or does it vary greatly? How does the load vary with time and operating conditions? Determining the heating and cooling loads establishes the system's capacity requirements. Cooling loads and humidity requirements are used to size air conditioning (comfort and process cooling) systems. In other systems, heating or ventilation may be the critical factors in sizing and selection. For example, a building may require a large air handling unit and duct system to provide huge quantities of outside air for ventilation or as make-up air to replace air exhausted from the building. In other buildings, in colder climates for instance, heating may be the determining factor on equipment size. The physical size of the equipment can be estimated from the heating and cooling load information alone. This information can help to reduce the choice of systems to those that will fit the space available.

There are also choices to be made depending on whether the system is to be installed in a new building or an existing building. In existing buildings, for example, the HVAC system was designed for the loads when the building was built. This means if new systems are to be integrated with existing ones (in order to keep costs down or for other reasons), the new or retrofitted systems must be adaptable to existing equipment, ductwork and piping, and new equipment or systems must fit into existing spaces. If new systems are to perform properly when tied in with existing systems, the old and the new must be looked at carefully and in its entirety. The designer will need to determine how a change to one part of a system will affect another part and how a change in one system will affect another system. The number of choices is narrowed further to those systems that will work well on projects of a given application and size and are compatible with the building architecture.

SYSTEM SELECTION GUIDELINES

Each of the following issues should be taken into consideration each time an HVAC system is selected.

- Financial factors
 - Initial cost
 - Operating costs
 - Maintenance and repair cost
 - Equipment replacement or upgrading cost
 - Equipment failure cost
 - Return on investment (ROI)
 - Energy costs

- Building conditions
 - New or existing building or space
 - Location
 - Orientation
 - Architecture
 - Climate and shading
 - Configuration
 - Construction
 - Codes and standards

- Usage
 - Occupancy
 - Process equipment

- Energy availability
 - Types
 - Reliability

- Control scheme
 - Zone control
 - Individual control

TYPES OF HVAC SYSTEMS

The basic types of HVAC systems used in commercial buildings are all-air, air and water, all-water, and unitary. Water systems are also called hydronic systems. Hydronic is the term used for heating and cooling with liquids.

All-air systems provide heated or cooled air to the conditioned space through a ductwork system. The basic types of all-air duct systems are: single-zone, multizone, dual or double duct, terminal reheat, constant air volume, variable air volume (VAV), and combination systems. In the typical system, cooling and heating is accomplished by the mixed air (a combination of the return and outside air) passing over a refrigerant coil (cooling) or a heat exchanger (heating).

The basic air-water system (also called air-hydronic) is a central system similar to the all-air system with chilled water coils instead of refrigerant coils for cooling (with an air-cooled condenser) and hot water coils for heating. A variation of this system is the water-air (hydronic-air) system with refrigerant coils for cooling and a water-cooled condenser.

All-water (all-hydronic) systems accomplish space cooling by circulating chilled water from a central refrigeration system through cooling coils in air handling units (also called terminal units or fan-coil units). The units are located in the building's conditioned spaces. Heating is accomplished by circulating hot water through the same (cooling/heating) coil or through a separate heating coil. When one coil is used for cooling only, heating only, or heating and cooling at various times, a two-pipe water distribution system is used. When two coils are used, one for heating and one for cooling, a four-pipe water distribution system is used. Heating may also be accomplished using electricity or steam. Straight water heating systems will commonly use convectors, baseboard radiation, fin-tube radiation, standard fan-coil units, and unit heaters.

UNITARY SYSTEMS

A unitary system is an air-conditioning unit that provides all or part of the air-conditioning functions. The components, fan(s), filter(s), controls, and the cooling apparatus (refrigerant coil, refrigerant piping, compressor, and condenser) are all factory-assembled into an integrated package. Components are matched and assembled at the factory to achieve specific performance objectives in accordance with industry-established increments of capacity (such as cfm of air per ton of refrigeration). These performance objectives are set by trade associations that have developed standards by which manufacturers may test and rate their equipment. These performance parameters and standards allow for the manufacture of quality-controlled, factory-tested systems. Types of unitary systems include window-mounted air conditioners and heat pumps, through-the-wall air conditioners and heat pumps, packaged terminal air conditioners and heat pumps, packaged units, and rooftop units.

Unitary systems are used in a wide range of applications and may or may not be used with central systems. Cooling capacity can range from fractional tonnage for window-type units to 100 tons of refrigeration or more for package units. A unitary system that uses the refrigeration system as the primary heating source is a heat pump. Commercial grade unitary systems are called package units. Some package units also have heating apparatus (e.g., natural gas heat exchanger, electric elements, steam or hot water coils) and humidifiers. A package unit designed to be placed on the roof is called a rooftop unit.

PACKAGE UNITS

Package units are used in almost all types of building applications, especially in applications where performance requirements are less demanding, and relatively low initial cost and simplified installation are important. Applications include hotels,

manufacturing plants, medical facilities, motels, multi-occupancy dwellings, nursing homes, office buildings, schools, shopping centers, and other buildings with limited life or limited income potential. However, package units are also used in applications where dedicated, high performance levels are required, such as computer rooms, laboratories and cleanrooms.

WINDOW-MOUNTED AIR CONDITIONERS and HEAT PUMPS

Window-mounted air conditioners and heat pumps cool or heat individual conditioned spaces. They have a low initial cost and are quick and easy to install. They are also used to supplement a central heating or cooling system or to condition selected spaces when the central system shuts down. When used with a central system, the units usually serve only part of the spaces conditioned by the central system. In such applications, both the central system and the window units are sized to cool the particular conditioned space adequately without the other operating. In other applications, where window units are added to supplement an inadequate existing system, they are selected and sized to meet the required capacity when both systems operate. Window units require outside air and cannot be used for interior rooms. Window units are factory-assembled with individual controls. However, when several units are used in a single space, the controls may be interlocked to prevent simultaneous heating and cooling. For energy management in hotels, motels or other hospitality applications, a central on/off control system may be used to de-energize units in unoccupied rooms. Another factor to consider when selecting window unit systems is that window units are built to appliance standards, rather than building equipment standards, so they may have a relatively short life and high energy usage.

THROUGH-THE-WALL MOUNTED AIR CONDITIONERS, HEAT PUMPS, PTACs and PTHPs

Through-the-wall air conditioners, package terminal air conditioners (PTACs), heat pumps, and package terminal heat pumps (PTHPs) incorporate a complete self-contained air-cooled, direct expansion (DX) cooling system, a heating system (gas, electric, hot water, or steam), controls, and fan in an individual package. They are designed to cool or heat individual spaces. Each space is an individual occupant-controlled zone into which cooled or heated air is discharged in response to thermostatic control to meet space requirements. These systems are usually installed in apartments, assisted-living facilities, hospitals, hotels, motels, office buildings, and schools. Units range from appliance grade to heavy-duty commercial grade.

UNITARY SYSTEM SELECTION GUIDELINES

Unitary systems are selected when it is decided that a central HVAC system is too large or too expensive for a particular project, or a combination system (central and unitary) is needed for certain areas or zones to supplement the central system. For example, unitary systems are frequently used for perimeter spaces in combination with a central all-air system that serves interior building spaces. This combination will usually provide greater temperature and humidity control, air quality, and air (conditioned air and ventilation air) distribution patterns, than is possible with central or unitary units alone. As with any HVAC system, both the advantages and the disadvantages of unitary systems should be carefully examined to ensure that the system selected will perform as intended for the particular application.

FACTORS TO CONSIDER WHEN SELECTING UNITARY SYSTEMS

A solid understanding of the various types of commercial HVAC systems and their selection is important because if you are the energy manager or facilities engineer the position often calls for being the owner's representative to work with others to ensure that the owner gets the environmental system that will best fit his needs. The following are some of the advantages and disadvantages to consider when selecting unitary systems.

Unitary systems can provide heating and cooling capability at all times independent of other spaces in the building but basic systems do not provide close humidity control. However, close humidity control is not needed for most applications. Close humidity control, if needed, in computer room applications or the like, can be accomplished by selecting special purpose packaged units. An advantage of unitary systems is only the one unit and one temperature zone is affected if a unit malfunctions. One drawback of unitary units is that the operating sound levels can be high. Another is that appearance can be unappealing. Other disadvantages are that air filtration options may be limited and outdoor air economizers are not always available to provide low cost cooling. Condensate can be a problem if proper removal is not provided.

Control of Temperature and Airflow

Individual room control (on/off and temperature) is simple and inexpensive. However, because temperature control is usually two-position, there can be swings in room temperature. The room occupant has limited adjustment on air distribution but airflow quantity is fixed by design. Ventilation air is provided whenever the conditioner operates. Ventilation air is fixed by design as are the sizes of the cooling and condenser coils.

One Manufacturer is Responsible for the Final Unit

Manufacturer-matched components have certified ratings

and performance data and factory assembly allows improved quality control and reliability. There are a number of manufacturers, so units are readily available, but equipment life may be short (10-15 years) as compared to larger equipment which may have life expectancies of 20-25 years. Manufacturers' instructions and multiple-unit arrangements simplify the installation through repetition of tasks.

Maintenance and Operation

Generally, trained operators are not required and less mechanical and electrical space is required than with central systems. However, maintaining the units is more difficult because of the many pieces of equipment and their location, which is usually in occupied spaces.

Costs and Energy Efficiency

Initial cost is usually low but operating cost may be higher than for central systems. This will be the case when the unitary equipment efficiency is less than that of the central system components. Also, energy use may be greater because fixed unit size increments require over-sizing for some applications. However, for applications such as leased office space, energy use can be metered directly to each tenant. Units can be installed to condition just one space at a time as a building is completed, remodeled, or as individual areas are leased and occupied. Another energy management opportunity with unitary systems is that units serving unoccupied spaces can be turned off locally or from a central point, without affecting occupied spaces.

Chapter 15

Heat Recovery

The objective of heat-recovery systems is to reduce the energy consumption and cost of operating a building by transferring heat between two fluids, such as exhaust air and outside air. In many cases, the proper application of heat-recovery systems can result in reduced energy consumption and lower energy bills, while adding little or no additional cost to building maintenance or operations. However, if it cannot be shown that the benefits of a heat recovery system outweigh the costs, building owners will not be motivated to make a financial investment in such a system.

During the past 40 years, building owners and other commercial energy end-users have had to find ways to cope with increasing uncertainty about the supply and economic volatility of fossil fuels used to generate energy for their facilities. Indeed, weather, politics, and market forces play a significant role in determining the availability of energy and its cost. End-users need only to recall the power shortages in the last few years that plagued sections of the U.S. crimping supplies, and sending energy prices soaring. Those with a greater sense of history are aware of the oil shortages of the mid-1970s. For today's building owners and end-users, the continuing oil crisis is another wake-up call that energy created by fossil fuels will not always be readily accessible. It also serves notice about the need to reduce our reliance on such energy sources to better insulate business from forces beyond our control. Achieving the latter means that designers and facility managers of commercial buildings need to shift their approach away from just maximizing occupant comfort to energy conservation as well. Instead of centralizing and increasing capacity and usage of heating, ventilating, and air conditioning (HVAC) systems, and increasing the illumina-

tion levels of electric lamps, facility managers need to focus on using alternative energy sources and finding energy conservation opportunities for their systems and then implementing energy conservation measures. While many of the conservation measures implemented are voluntary, regulators will also continue to mandate energy-conservation strategies.

One energy conservation measurement worth considering is heat-recovery systems, which capture waste heat, such as exhaust air, and transfer it to a fluid, such as water. In doing so, the system reduces energy consumption by eliminating the need to generate new heat, and in turn lowers building operating costs. Typically, heat-recovery systems work by capturing waste heat from the flue gas of a steam boiler, and then reusing that heat, or energy, to preheat the boiler input water. In doing so, the amount of heat required to generate steam or hot water is reduced. Waste heat from large ovens that operate 24 hours a day can be used for comfort heating. In addition, heat-recovery systems (also known as “heat energy” or “energy” recovery systems) can be used to provide reserve energy capacity.

The reason for having reserve capacity is that many times the implemented energy-conservation measures substantially reduce the capacities of HVAC equipment. Therefore, the installed equipment capacities now closely match the design load and less reserve capacity is available for new projects that may substantially change the building HVAC systems. For example, many installed systems may not have enough reserve capacity to make needed changes to accommodate increased outdoor air requirements in order to satisfy indoor air quality (IAQ) concerns. When more outside air is needed, a heat-recovery system can help to offset the increased energy cost to heat up or cool down the increased volume of outside air.

HEAT RECOVERY SYSTEMS

There are three basic types of heat recovery systems: comfort-to-comfort, process-to-comfort, and process-to-process. The

types of heat exchangers for these systems include rotary wheel, fixed plate, heat pipe, and run-around coil. To obtain a better understanding of how to best make use of heat transfer systems it is important to first understand the components that make up heat recovery. Heat is a form of energy, which can be converted from-or-to other forms of energy such as mechanical energy or electrical energy.

Thermodynamics is the science of heat energy and the study of how heat energy can be changed from one form of energy to another. One of the laws of thermodynamics states that heat energy flows from a higher level to a lower level. When this law is applied to heat recovery systems, it tells us that the waste heat in a fluid such as air, flue gas, steam, refrigerant, brine, or water from a heat-generating process can be captured and transferred to a cooler fluid for use in another process. The intent of heat recovery is to reduce energy costs by supplementing the energy required to fuel the process or comfort system. Conduction, convection, and radiation are the three means of heat transfer. Conduction is the transfer of heat from one substance to another when each substance is in direct physical contact with the other. A simpler way to view conduction is by placing a human hand on a cold pipe. Warmth from the skin is transferred to the pipe. Convection is heat transfer by movement of a fluid over a substance. Convection is demonstrated when heated air flows into a room and warms the occupants. Radiation is heat transfer by waves transmitted from the source of the heat to an object receiving the heat waves without heating the space. Examples are when the sun's rays heat a glass window or when a person is warmed by the heat waves from a fire or infrared heater.

The effectiveness of a heat exchanger (coil, plate heat exchanger, heat wheel, etc.) in a heat recovery system is dependent upon three factors: (1) the temperature difference of the fluids circulated through the exchanger; (2) the thermal conductivity (ability to conduct heat) of the material (copper, aluminum, steel, etc.) in the exchanger; and (3) the flow pattern (e.g., counter flow or parallel flow) of the fluids. Heat transfer is greatest in counter

flow exchangers. Counter flow is when “Fluid A” enters on the same side of the exchanger that “Fluid B” is leaving. Parallel flow is when “Fluid A” enters on the same side of the exchanger that “Fluid B” is entering.

COMFORT-TO-COMFORT HEAT RECOVERY SYSTEMS

Comfort-to-comfort systems are typically used in HVAC applications. These heat recovery systems capture a building’s exhaust air and reuse the energy in that waste heat to precondition the outside air coming into the building. In comfort-to-comfort applications, the energy recovery process is reversible, i.e., the enthalpy (total heat content) of the building supply air is lowered during warm weather and raised during cold weather. Air-to-air heat recovery systems for comfort-to-comfort applications fall into two general categories: sensible heat (dry bulb) systems and total heat (wet bulb, sensible heat plus latent heat) systems. Sensible heat recovery systems transfer sensible heat between exhaust air leaving the building and make-up or supply air entering the building. Rotary wheel heat exchangers are used in typical comfort-to-comfort sensible heat recovery applications. To determine the amount of heat transferred, use the sensible heat transfer equation.

$$\mathbf{Btuhs = cfm \times 1.08 \times \Delta T}$$

Where:

- Btuhs = sensible heat transferred
- cfm = quantity of airflow
- 1.08 = a constant for sensible heat equations
- ΔT = the dry bulb (db) temperature difference between the airstreams.

Example: The average summer outside air (OA) temperature is 90°Fdb and the exhaust air (EA) temperature is 75°Fdb. The heat

recovery system operates at 20,000 cfm at 73 percent efficiency.

The sensible heat transferred from the outside air is 236,520 Btuhs ($20,000 \times 1.08 \times 15 \times 0.73$).

In the winter, the energy recovered from the exhaust air is 709,560 Btuhs because the temperatures are 30°Fdb OA and 75°Fdb EA (45°Fdb ΔT).

For total (enthalpy) heat recovery systems, the equation used is: $Btuht = cfm \times 4.5 \times \Delta h$

Where:

Btuht = total heat transferred

cfm = quantity of airflow

4.5 = a constant for total heat equations, and

Δh = the enthalpy (total heat) difference between the airstreams (from wet bulb and dry temperatures).

Example: The average summer outside air wet bulb (wb) temperature is 70°Fwb (enthalpy 33.8 Btu/lb°F @ 90db and 70wb) and the exhaust air wet-bulb temperature is 60°Fwb (enthalpy 26.3 Btu/lb°F @ 75db and 60wb). The heat recovery system operates at 20,000 cfm at 73 percent efficiency.

The total heat transferred from the outside air is 492,750 Btuhs ($20,000 \times 4.5 \times 7.5 \times 0.73$).

In the winter, the energy recovered from the exhaust air is 1,261,440 Btuhs because the temperatures are 20°Fwb OA (enthalpy 7.1 Btu/lb°F @ 30db and 20wb) and 60°Fwb EA (enthalpy 26.3 Btu/lb°F @ 75db and 60wb).

PROCESS-TO-COMFORT SYSTEMS

Process-to-comfort systems are generally sensible heat recovery only. Therefore, they are used only during the spring, fall, and winter months... there is no heat recovery during the summer months. When considering process-to-comfort heat-recovery systems, the process effluent must be evaluated for harmful ma-

terials such as corrosives, condensibles (moisture or water vapor), contaminants, and noxious or toxic substances.

PROCESS-TO-PROCESS SYSTEMS

Process-to-process systems also perform sensible heat recovery only, usually full recovery, but in some cases, partial recovery can be performed if circumstances dictate. Determining when to use a process-to-process system for partial sensible heat recovery instead of full sensible recovery is based on the circumstances under which the system will operate. For example, when the exhaust stream contains condensibles, such as moisture or water vapor, and possible overcooling of the exhaust air stream could occur with full recovery then a partial recovery system is more appropriate. Keep in mind, that as with process-to-comfort systems, the process effluent must be evaluated for harmful substances such as corrosives, condensibles, contaminants, and noxious or toxic materials.

HEAT EXCHANGERS

A heat exchanger is a device specifically designed to transfer heat between two physically separated fluids. The term heat exchanger can describe any heat transfer device such as a coil or a particular category of devices. Heat exchangers are made in various sizes and types. The basic types of heat exchangers are shell and tube, shell and coil, U-tube, helical, and plate. Typical HVAC heat exchangers are designed for a number of fluid combinations including:

- steam to water (converter, steam coil)
- water to steam (generator, boiler)
- water to water (heat exchanger)
- refrigerant to water (condenser)

- refrigerant to air (condenser)
- water to refrigerant (evaporator, cooler, chiller)
- air to water (water cooling coil)
- air to refrigerant (evaporator, cooling coil)

HEAT RECOVERY HEAT EXCHANGERS

Rotary Wheel

The rotary wheel, or heat wheel, is a sensible heat, air-to-air heat exchanger that has a large-surface revolving cylinder. The cylinder is filled with a gas-permeable material. As the cylinder revolves, each of two air streams flows through approximately half of the wheel in a counter flow pattern. The two air streams (exhaust and outside air, for example) flow axially to the shaft. The heat from the warm air, for example, is absorbed into the



Figure 15-1. HVAC heat exchanger. Air-cooled condenser (refrigerant to air).

porous materials and then released into the cooler airstream as the wheel rotates. Some rotary wheels are treated with a hygroscopic (water absorbing) material to enable them to transfer moisture (latent heat) from one airstream to another. The moist airstream is dehumidified, and the drier airstream is humidified. A hygroscopic heat wheel is an example of a total heat rotary wheel because both sensible and latent heat is transferred simultaneously. Rotary wheel heat exchangers use counter flow and parallel flow patterns with temperature ranges from below zero to over 1000°Fdb.

Fixed Plate Exchangers

Fixed plate exchangers have no moving parts. They have alternate layers of plates that are separated and sealed. Heat is transferred directly from the warm fluid through the separating plates into the cooler fluid. Some plate exchangers, called plate-fin heat exchangers, have alternating layers of separate plates and interconnecting fins. Fixed plate heat exchangers use counter flow, parallel flow, and cross-flow patterns. The temperature range of fixed plate exchangers is from below 32°Fdb to over 1000°Fdb.

Heat Pipe Exchangers

Heat pipe exchangers are similar in appearance to a fin-tube water coil except that the tubes are not interconnected and the exchanger is divided into evaporator and condenser sections by a partition plate. In HVAC systems, the pipe is filled with a suitable refrigerant. On the evaporator side of the exchanger, hot air flows past the evaporator, boiling off the liquid refrigerant. This air is then cooled and the vapor refrigerant goes to the condenser side of the heat pipe. On the other side of the partition, cold air passes over the condenser side. This air is heated. The vapor refrigerant is condensed to a liquid and flows to the evaporator side of the heat pipe. Heat pipes are essentially sensible heat transfer equipment, but condensation of moisture (latent heat) from the hot air on the fins improves recovery performance. This

type of heat exchanger uses a counter flow pattern. Other heat pipe exchangers use parallel flow. The temperature range of heat pipe exchangers is from below zero to over 1000°Fdb.

Run-around System

The coils of a run-around heat recovery system for HVAC comfort-to-comfort applications are fin-tube type connected by counter flow piping. A pump circulates water, glycol, or other liquids through the system. The coils are mounted in different airstreams connected either in series or parallel to provide the greatest heat recovery. This system is seasonally reversible, meaning that the exhaust air coil either preheats or precools the outside air, depending on the season. When the outside air is cooler than the exhaust air, waste heat is recovered to preheat the outside air. When the outside air is warmer than the exhaust air, heat is removed from the outside air and, therefore, it is precooled.

Hot Gas Heat Exchangers

The refrigeration cycle of air conditioners and heat pumps provides an opportunity to capture waste heat for heating domestic water. HVAC compressors concentrate heat by compressing gaseous (vapor) refrigerant. The resultant superheated gas is normally pumped to a condenser for heat rejection. However, a hot gas-to-water heat exchanger may be placed into the refrigerant line between the compressor and the condenser coils to capture a portion of the rejected heat. In this system, water is looped between the water storage tank and the heat exchanger when the HVAC system is on. Heat pumps operating in the heating mode do not have waste heat because the hot gas is used for space heating. The heat pump, however, can still heat water more efficiently compared to electric resistance heating.

Double Bundle Condensers

Double bundle condensers contain two sets of water tubes bundled within the condenser shell. Heat is rejected from the system by releasing superheated gas into the shell and removing

the refrigerant condensers by one of two methods. During the heating season, water pumped through the “winter bundle” absorbs heat where it is used for heating domestic water or heating the perimeter of the building. During the cooling season, water pumped through the “summer bundle” rejects heat to the cooling tower after hot water needs are met.

Heat Jackets

Heat exchangers can be placed in exhausts of reciprocating engines and gas turbines to capture heat for water heating systems or steam generation. Water jackets may also be placed on engines in order to capture heat from the engine exhausts in series.

Hot Flue Gas Heat Exchanger

Hot flue gases from boilers can provide a source of waste heat for a variety of uses. The most common use is pre-heating boiler feed water. Heat exchangers used in flues must be constructed to withstand the highly corrosive nature of cooled flue gases.

Hot Drain Heat Exchangers

Kitchens and laundries offer the greatest opportunities for this type of heat recovery. Steam systems for space heating or kitchen facilities can recover some of the heat contained in hot condensate. Condensate is continuously formed in steam systems when steam loses heat in the distribution lines or when it performs work. A condensate receiver reduces steam to atmospheric pressure to allow reintroduction into the boiler. A heat exchanger located in the condensate return before the receiver can capture condensate heat for heating water.

Heat Pump Water Heater

Rooms containing laundries and food preparation facilities are often extremely hot and uncomfortable. Heat from the air can be captured for heating water by using a dedicated heat pump that mechanically concentrates the heat contained in the air.

Refrigeration Equipment

Commercial refrigerators and freezers can be installed with all the condensing units in one location. This will enhance the economic feasibility of capturing heat from refrigerant gases for heating water.

DETERMINING VALUE

A heat recovery system, as with any other energy-conservation retrofit, must have resultant benefits that exceed the investment costs. The reason for installing, and the effective use of a heat recovery system depends on many factors. A heat recovery system is warranted when all the factors are analyzed and there are (1) annual energy savings, and (2) the payback period is reasonable. In some cases, heat recovery systems are also considered when additional energy is currently unavailable or unattainable.

CONSIDERATIONS FOR SELECTING A HEAT RECOVERY SYSTEM

- Space requirements of the heat recovery system
- Distance between airstreams
- Temperature differences of the airstreams (sensible and latent heat)
- Mass flow rates (pounds per hour) of the airstreams
- Efficiency of the heat recovery system
- Additional operating energy required for the heat recovery system

- Quality of the indoor and outdoor air
- Existing modifications to the HVAC systems
- Mandatory energy conservation regulations and costs
- Mandatory pollution regulations and costs
- Pollution abatement savings
- Construction costs of heat recovery system
- Reduced capital cost of HVAC equipment due to reduced capacity
- Maintenance costs of the heat recovery system
- Reduced maintenance costs for existing equipment
- Revenue from sales of recovered heat or energy
- Increased production
- Reduction in production labor costs
- Availability of fuel
- Forecast for the rising cost of fuel
- Possibility of changeover to other fuels
- Fuel savings

Chapter 16

Energy Conservation Opportunities

The 5 Ts of energy conservation

1. Turn it off
2. Turn it down
3. Tune it up
4. Turn it around
5. Tear it out

In the 1900s, air conditioning systems dramatically changed the way we live in the United States. As HVAC systems became more reliable, efficient and controllable, we were no longer dependent on the weather for work or leisure. We made the environment adapt to our needs. In fact, we started cooling to temperatures lower than the temperatures to which we had previously heated. Now, HVAC climate control has become so reliable and affordable it is a common necessity in industry and our homes alike. Today, almost all commercial buildings have HVAC systems and most U.S. households have air conditioning.

ENERGY SYSTEMS

It's generally assumed that the HVAC systems and lighting systems account for most of a building's energy use. HVAC energy consumption is affected in part by the common practice

of specifying oversized heating and cooling equipment to compensate for the energy inefficiency in a building's design and construction. The following are energy conservation opportunities (ECOs) for HVAC systems and subsystems.

HVAC SYSTEMS

ECOs:

- Compare field measurements (air, water, steam and electrical) with the air or water balance report, commissioning report, and fan, pump, and motor curves to determine if the correct amount of air and water is flowing.
- Use nameplate data to prepare an up-to-date list of motors for fans, compressors, pumps, etc., and list routine maintenance to be performed on each.
- Routinely check time clocks and other control equipment for proper operation, correct time and day, and proper programming of on-off setpoints.
- Reduce or turn off heating and cooling systems during the last hour of occupancy.
- Close interior blinds and shades to reduce night heat loss in the winter or night and solar heat gain in the summer or day. Repair or replace damaged or missing shading devices.
- Inspect room supply air outlets and return and exhaust air inlets, diffusers, grilles and registers.
- Clean ducts. Open access doors to check for possible obstructions, such as loose insulation in lined ducts, loose turning vanes and closed volume or fire dampers. Adjust, repair or replace these items as necessary.

-
- Reduce outdoor air intake quantity to the minimum allowed under codes by adjusting outdoor air dampers. Maintain a rate of 15-25 cubic feet per minute (cfm) of air per person. Maintain outside air dampers.
 - List automatic and gravity dampers, and routinely check that they open and close properly. Adjust linkage or replace dampers if the blades do not close tightly.
 - Replace unsatisfactory automatic dampers with higher quality opposed blade or parallel blade dampers with seals at edges and ends to reduce air leaks. Readjust position indicators as needed to accurately show the position of all dampers.
 - Regularly clean or replace dirty or ineffective filters.
 - Clean coils and other heat exchangers.
 - Ensure that all fans rotate in the proper direction.
 - Check fan, pump, or compressor motor voltage and current.
 - Measure total static pressure across fans and total dynamic head across pumps.
 - Adjust fan speed, inlet guide vanes, or VFD (variable frequency drive) for proper airflow.
 - Maintain correct belt tension on fan-motor drives.
 - Check drive misalignment.
 - Discontinue use of unneeded exhaust fans.
 - Rewire toilet exhaust fans to operate only when lights are on.

- Check pump suction and discharge pressures and plot differential pressure on the pump curve.
- Close the discharge valve if the pump circulation is more than 10 percent greater than required flow.
- Reduce pump impeller size for greater energy savings.
- Adjust pump speed, impeller, or VFD (variable frequency drive) for proper water flow.
- Properly adjust and balance air and water systems.
- Properly adjust controls.
- Install a time clock or automated energy management system that will reduce heating and cooling.
- Close some air conditioning supply and return ducts for HVAC systems operating in lobbies, corridors, vestibules, public areas, unoccupied areas or little-used areas. Disconnect electrical or natural gas heating units to these areas.

HVAC SUBSYSTEMS—BOILERS

Maintaining The Boiler

A daily log of the boiler's operating pressures and temperatures and firing rate will detect variations in the system's performance. Any major variation in the recorded pressures or temperatures may indicate that a problem exists. Taking the time to investigate, analyze, and correct any developing problem will extend the life of the boiler and maintain high operating efficiency. Most commercial package boilers operate at a maximum efficiency of about 80 to 83%. However, this is only true when the burner is functioning properly and the tubes are clean.

Maintaining a high efficiency in the boiler will decrease operating expenses and increase the life of the boiler.

Flue Gas Analysis

In order to determine the combustion efficiency of a boiler a flue gas analysis uses an electronic flue gas analyzer and reads and records firing rate, percent of carbon dioxide (CO₂), percent of excess air, stack temperature, and the net stack temperature. These readings will determine the percent of stack loss and the combustion efficiency. The maximum combustion efficiency attainable for both natural gas- and oil-fired boilers will be about 80% to 83%. To make a test of the boiler's combustion efficiency drill a hole, large enough to accommodate the instrument probe, in the flue stack between the boiler shell and the stack damper. The hole should be a least 6 inches from the damper. Using the thermometer supplied with the instrument, or one that reads to 1000°F, read the boiler stack temperature. Stack temperatures can vary 100 degrees within a few minutes during load changes; therefore, note the firing rate when logging temperatures and pressures. While waiting for the stack temperature reading to stabilize, use another thermometer to take the boiler room temperature. The difference between these readings is called the net stack temperature.

Table 16-1. Flue Gas Analysis

Rating	<i>Percent Carbon Dioxide</i>		
	Gas	#2 Oil'	#6 Oil
Excellent	10.0%	12.8%	13.8%
Good	9.0%	11.5%	13.0%
Fair	8.5%	10.0%	12.5%
Poor	8%>	9%>	12%>

Measurement of carbon dioxide (CO₂), oxygen (O₂), and carbon monoxide (CO) is a good indication of combustion efficiency and burner performance. CO₂ should be good to excellent. O₂ should be a maximum of 1-2% and there should not be any CO. The stack temperature should not be more than 150°F above steam or water temperature.

Stack Temperatures

The boiler stack temperature should be no more than 150°F above the steam or water temperature. If it is, the boiler is not working efficiently. The rule of thumb for stack temperature is that for each 100 degrees that the stack temperature can be lowered there is a 2.5% increase in efficiency. A high stack temperature means that there's poor combustion, the tubes are fouled, or there's too much combustion air being brought into the boiler and it's pushing the gases through the boiler without the proper heat exchange taking place. The stack temperature should be at least 320 degrees. If the stack temperature is too low the water vapor in the flue gas will start to condensate in the stack. This water mixes with the sulfur in the gas and creates sulfuric acid which will corrode the stack and the tubes. A minimum boiler water temperature of 170°F should be maintained. This will mean a stack temperature of about 320°F (150 degree delta T).

Excess Air

The amount of excess air, that is, the air needed for complete combustion plus some extra for a safety factor, should not exceed 10%. To take carbon dioxide and oxygen readings use the same hole in the stack, insert the instrument probe, and take the measurements. The instrument will read out directly in percent of carbon dioxide, oxygen and efficiency. The oxygen level should be at least 1 percent but should not exceed 2 percent. A rule of thumb says that there is approximately 5% excess air for each 1% of oxygen in the flue gas. The amount of carbon dioxide should be as high as possible. For maximum efficiency in natural gas boilers this will be about 10%, while oil-fired boilers should have

about 13 to 14% carbon dioxide.

Carbon Monoxide Test

Test for the presence of carbon monoxide. There should not be any. The existence of carbon monoxide indicates incomplete combustion. Carbon monoxide is a deadly gas. If its presence is found, the boiler should be shut down and the problem corrected. Either there is not enough air being brought into the boiler or there is a problem with the burner.

Smoke Test

In addition to the flue gas test, a smoke test should be made on oil-fired boilers. Excessive smoke is evidence of incomplete combustion of the oil. This means that fuel is being wasted. It also can result in soot being deposited on the heat transfer surfaces which also means lower efficiencies. A one-eighth inch thick soot deposit increases fuel consumption by approximately 10%.

Boiler Scale

Scale acts as an insulator reducing boiler efficiency. But, it can also result in overheating of the firing chamber and tubes (Figure 16-1). This can cause cracking and eventually, leakage problems. Routinely do a visual check of the rear portion of your boiler. This is the area that's the most prone to scale buildup. Use a scraper or a small hammer to get some samples of any scale formation which may be present. Scale formation is the result of improper feedwater treatment or improper blowdown procedures. "Blowdown" is the process of draining off some of the boiler water to reduce the concentrations of minerals in the water. These minerals are brought in by the feedwater (water source from the city, well, river, etc.). When the water is boiled off, concentrations of solids are left in the remaining boiler water. If these concentrations of solids are not reduced they will be deposited on the tube surfaces forming scale.

A buildup of 1/8" thickness of scale will result in a 15% loss of efficiency. When the heating surfaces become scaled, heat

transfer is reduced. Some of the extra heat goes out the stack, but much of it overheats the boiler tubes, causing corrosion, blistering and early tube failure. To combat losses in efficiency, excessive fuel costs and reduced life expectancy resulting from boiler scale, it probably will be necessary to call in a feedwater specialist to give you recommendations on blowdown procedures and frequency of blowdown to reduce the concentrations of scale producing elements. Blowdown is usually a percentage expressing the quantity of blowdown versus the quantity of feedwater. For instance, a 5% blowdown means that 5% of the water fed to the boiler is removed during the blowdown process. Give the scale samples removed from the boiler to the feedwater consultant. The consultant will analyze the water and then make recommendations on the proper chemical treatment to use to prevent scale formation on the boiler's heating surfaces.

Pitting and Sediment Accumulation

Pitting or oxygen corrosion of the tubes is another problem resulting from incorrect water treatment. A deaerating or oxygen-removing feed water heater may also be needed. Check for pitting problems at least once a year. This will require draining the boiler and using a flashlight and a mirror, visually checking the tubes and shell for blisters, pock marks or any other type of erosion of the metal surfaces. Contact a feedwater specialist for help with diagnosing problems. Sometimes the water conditions, or even the chemicals used to treat the water, will cause an accumulation of sediment in the bottom of the boiler. This sediment or "mud" will be found during visual inspection. It must be removed. Use a high pressure hose to wash out the bottom of the boiler and then check by hand to make sure that all the sediment has been removed.

Soot Deposits

Soot deposits act as an insulator, decreasing heat transfer and boiler efficiency. The boiler tubes should be checked frequently for evidence of soot deposits. To reduce the time needed



Figure 16-1. Inspecting firing chamber.

for visual inspection of the tubes, install a thermometer in the exhaust stack and keep a daily log. If the stack gas temperature rises above normal, it means that the tubes are dirty and need cleaning. The length of time between cleaning varies with the type of burner, the type of fuel used and the burner adjustment. However, if there's heavy sooting within a short period of time after cleaning the tubes, it probably means that the fuel-to-air ratio is incorrect. In other words, there is too much fuel and not enough air. If this is the case, the burner needs adjustment.

Linkages, Tube Sheets, Gaskets, Refractory and Stack

Check the burner and air damper linkages for tightness. Watch as the linkage moves back and forth. If there's any jerking motion or slippage this will need to be corrected. Check for white streaks or deposits at the ends of the tube sheets. The white streaks mean that the tube ends are leaking and a re-rolling of the tubes may be needed. Check for any leaking gaskets around doors, handholds, or manholes (Figure 16-2). At least once a year,

wash down and check the refractory surfaces for loose, cracked, broken or missing tiles. Replace or repair as instructed by the boiler manufacturer. Inspect the stack. It should be free of haze. If not, it indicates that a burner adjustment is needed.

Water Level Controls

On steam boilers the low water cutoff and water column should be blown daily to remove the solids. Additionally, the low water cutoff should be checked under operating conditions at least once a week. To do this, turn off the feedwater pump and let the system operate as normal. Watch the gauge glass and mark the glass at the precise level where the low water cutoff shuts off the boiler. This is now a reference point. The cutoff control should shut down the boiler at the same water level each time. If it doesn't, the controls may need to be replaced. On water boilers, check the low water cutoff periodically by manually tripping the control.

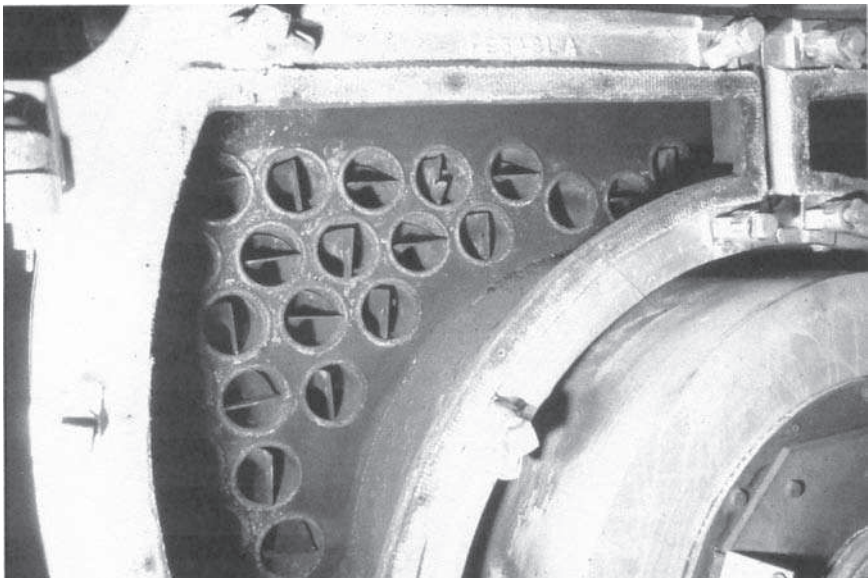

Figure 16-2. Inspecting Tubes and Doors

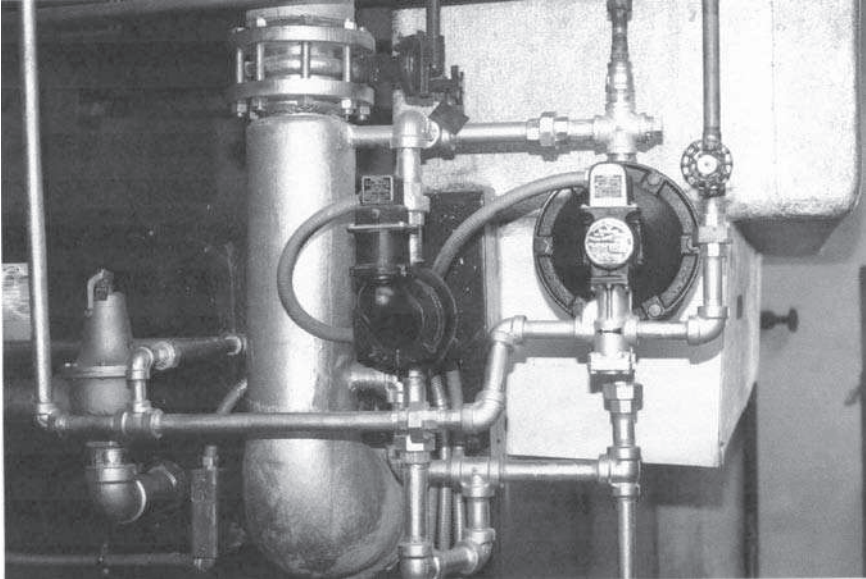

Figure 16-3. Water Level Controls and Pressure Relief Valve

High Fuel-to-air Ratios and High Air-to-fuel Ratios

A high fuel-to-air ratio causes sooting and lowers boiler efficiency. In certain conditions, it may also be dangerous if there's not enough air for complete combustion and dilution of the fuel. A high fuel-to-air condition can be caused by an improperly adjusted burner, a blocked exhaust stack, the blower or dampers set incorrectly or any condition which results in a negative pressure in the boiler room. A negative pressure in the boiler room can be the result of one or a combination of conditions such as an exhaust fan pulling a negative pressure in the boiler room, a restricted combustion air louver into the room, or even adverse wind conditions. High air-to-fuel ratios also reduce boiler efficiency. If too much air is brought in, the hot gases are diluted too much and rapidly swept out of the tubes before proper heat transfer can occur. High air volumes are caused by improper blower or damper settings.

ECOs:

- Ensure the proper amount of air for combustion is available. Check that primary and secondary air can enter the boiler's combustion chamber only in regulated quantities and at the correct place.
- Inspect boiler gaskets, refractory, brickwork and castings for hot spots and air leaks.
- Defective gaskets, cracked brickwork and broken casings allow uncontrolled and varying amounts of air to enter the boiler and prevent accurate fuel-air ratio adjustment.
- Perform a flue-gas analysis. Take stack temperatures and oxygen readings routinely, and inspect the boiler for leaks.
- Repair all defects before resetting the fuel-air ratio. Consider installing an oxygen analyzer with automatic trim for larger boilers. This device continuously analyzes the fuel-air ratio and automatically adjusts it to meet the changing stack draft and load conditions.
- Check that controls are turning off boilers and pumps as outlined in the sequence of operations. Observe the fire when the boiler shuts down. If it does not cut off immediately, check for a faulty solenoid valve, and repair or replace it as needed.
- Adjust controls on multiple systems so a second boiler will not fire until the first boiler can no longer satisfy the demand. Make sure that reset controls work properly to schedule heating water temperature according to the outside air temperature.
- Install automatic blowdown controls. Pipe the blowdown water through a heat exchanger to recover and reuse waste heat.

-
- Experiment with hot water temperature reduction until reaching an acceptable comfort level.
 - Inspect boiler nozzles for wear, dirt or incorrect spray angles. Clean fouled oil nozzles and dirty gas parts.
 - Replace all oversized or undersized nozzles. Adjust nozzles as needed.
 - Verify that fuel oil flows freely and oil pressure is correct.
 - Watch for burner short-cycling.
 - Inspect boiler and pipes for broken or missing insulation, and repair or replace it as needed
 - Clean the fire side, and maintain it free from soot or other deposits.
 - Clean the water side, and maintain it free from scale deposits.
 - Remove scale deposits and accumulation of sediment by scraping or treating chemically, or both. Maintain the correct water treatment.

HVAC SUBSYSTEMS—COOLING

ECOs:

- Adjust controls on multiple staging systems so a second compressor won't energize until the first compressor can no longer satisfy the demand.
- Clean all condenser coils on air-cooled systems. Clean off

scale build-up in water-cooled condensers.

- Defrost evaporator coils if iced. Determine the cause of icing, and correct it (normally low air volume or low refrigerant charge).
- Record normal operating temperatures and pressures, and check gauges frequently to ensure conditions are met.
- Check for proper refrigerant charge, superheat, and operation of the metering device.
- Repair leaking compressor valves.
- Repair leaking liquid line solenoid valves, and clean liquid line strainers.
- Experiment with chilled water supply temperature while maintaining an acceptable comfort level.
- Increase temperatures to reduce energy used by the compressor or decrease temperature to reduce water pump horsepower.

HVAC SUBSYSTEMS—CONTROLS

ECOs:

- Set the locking screws on the stat cover after setting and calibrating thermostats to prevent occupant readjustment. Replace missing locking screws.
- Consider replacing existing covers with tamper-proof covers, moving thermostats to a less accessible area, such as the return air duct, or installing solid-state thermostats if tampering persists.

-
- Change the location of thermostats from areas subject to extreme temperature fluctuations or vibrations, such as next to a heating or cooling unit, window, outside wall or wall with a lot of vibration.
 - Remove moisture, oil and dirt from pneumatic control lines.
 - Clean contacts on electrical controls.
 - Calibrate controllers.
 - Ensure that control valves and dampers are operating properly.
 - Check that three-way and two-way valves are installed correctly.

LIGHTING SYSTEMS

Electrical lighting is a major contributor to internal heat gain, or cooling load. And, because it increases the cooling load, lighting causes an added use of energy to run the air conditioning system, compressor and other components, including air conditioning fans, chilled water pumps, and cooling tower and condenser water pumps and fans.

In addition to reducing overall energy consumption and costs, and to lessen the cooling load or not increase it, consider the following lighting energy conservation opportunities.

ECOs:

- Set up regular inspection and cleaning of lamps and fixtures. The rule of thumb for interior light sources is that as the useful life of the lamp decreases, there is also a drop in light output. Dirt and dust that accumulates on lamps, fixtures and lenses further reduce the quantity of light.

-
- Replace lenses that are yellow or that have become hazy with new acrylic lenses that do not yellow. Replace outdated or damaged fixtures with those that are energy efficient and easy to clean. Update fluorescent lighting systems with energy efficient ballasts, lamps and controls. Replace old standard magnetic ballasts with energy efficient magnetic ballasts, cathode cutout ballasts, or electronic ballasts.
 - Replace 40-watt T12 (1" diameter) lamps with either 34-watt T12 or T10 (7/8" diameter) lamps, or 32-watt T8 (3/4" diameter) lamps. Replacing T12 lamps with T10 or T8 lamps allows room for a reflector to be installed in some fixtures. The combination of the reflector and the smaller lamp allows more light to come from the fixture. Therefore, it's possible to remove two lamps from a four-lamp fixture and maintain appropriate light levels. Retrofitting lighting systems with energy-efficient lamps and ballasts can produce savings of 20 to 40% over standard lamps and ballasts.

DEMAND-SIDE MANAGEMENT

In an effort to influence customers' electricity use, many electric utilities offer demand-side management (DSM) programs that provide incentives for retrofit and replacement projects involving energy-efficient systems, including those for HVAC, lighting, and thermal energy storage (TES).

Utilities are restructuring DSM programs to include the maintenance of HVAC systems that can lead to more efficient energy use. Facilities and maintenance managers have long known that efficient, effective preventive maintenance of certain building systems, such as HVAC and lighting, can cut a building's energy use dramatically. One problem for managers has been finding the time, money and support from facility executives that would let them carry out these procedures properly. Utilities recognizing this opportunity are reshaping their DSM programs to include

incentives for carrying out these preventive and predictive maintenance procedures.

Maintenance departments can use the energy conservation opportunities for HVAC systems outlined previously to get the largest possible benefits for their facilities from participation in a DSM program. The ECOs listed typify maintenance procedures for HVAC systems, HVAC subsystems—boilers, cooling and controls—and lighting systems that fall under incentive programs from many local utilities. It is up to maintenance managers to identify the ECOs for their facilities by doing an on-site verification of system performance including inspections and qualitative and quantitative measurements.

This page intentionally left blank

Chapter 17

Central Plant Water Chiller Optimization

T*o determine if the central plant can be optimized, the first step is to conduct an energy survey and testing of the system's operating performance. The second step is to consider the options. For example, is it more cost effective to decrease chilled water supply temperature creating a higher delta T, reducing pumping horsepower but increasing compressor horsepower, or is it better to increase chiller water supply temperature creating a lower delta T, increasing pumping horsepower but decreasing compressor horsepower? The third step to any proposed retrofit is to consider the consequences of the retrofit before starting the project.*

OPTIMIZATION

The following are some ways to optimize the chiller plant:

Select Proper Air Quantities and Heat Transfer Surfaces for the Cooling Coils

Selecting proper air quantities and heat transfer surfaces for the cooling coils can substantially reduce circulating water quantities. Consider installing coils suited for a higher water temperature rise. For example, a 12°F (2 gpm per ton) rise rather than a 10°F rise (2.4 gpm/ton) reduces circulated water quantity by 17 percent and can reduce pump horsepower by 42 percent. However, a cooling coil with a higher ΔT needs to be larger. There may also be an increase in air pressure drop through the coil that

would slightly increase the fan horsepower. Cost of operation of a motor per year is equal to the horsepower times 0.746 kilowatts per horsepower times the hours of operation per year times the cost per kilowatt-hour divided by the efficiency of the motor. The equation is

$$(\$/\text{yr} = \text{hp} \times 0.746 \text{ kW}/\text{hp} \times \text{hrs}/\text{yr} \times \$/\text{kWh} \div \text{Eff}_m)$$

Raise the Evaporator Temperature

As evaporator temperature and chilled water temperature increase, the COP of the system also increases and the power used by the compressor decreases. The equation for this is: HP/Ton = 4.71 ÷ COP [the horsepower per ton required to run the compressor motor is equal to the constant 4.71 (200 Btu/min/ton ÷ 42.42 Btu/min/hp) divided by the system's COP (Coefficient of Performance)]. One way to increase evaporator temperature is to raise supply air temperature to follow the building's cooling load. Executing this task requires retrofitting the control system to raise supply air temperature when the building cooling load permits and then raise chilled water temperature to meet the lighter cooling load. Raising the chilled water temperature increases the evaporator temperature. To accomplish this control strategy, chilled water control valves are monitored. When chilled water control valves are closed or partially open (indicating that the water flow is reduced to match the light load condition), the chilled water supply temperature setpoint is raised. When one or more of the coil control valves return to the full open position to try to match a heavier load, the flow to the coils is increased and the supply water temperature is lowered.

Lower Condenser Water Temperature

As the condenser temperature decreases, the COP of the compressor increases and the power used decreases (HP/ton = 4.71 ÷ COP). One way to decrease condenser temperature is to decrease the temperature of the water entering the condenser. However, because there practical limits to the lowest acceptable

condensing temperature, it is important to consult with the manufacturer for the recommended lower limit.

To lower condenser water temperature, consider increasing the fan volume in the cooling tower by increasing fan speed or increasing the pitch of the propeller fan blades. Boosting fan volume, however, increases the horsepower of the fan by the cube [$HP_2 = HP_1 (cfm_2 \div cfm_1)^3$]. In addition, if the volume change is great enough, it may require replacing the existing fan motor with a larger size. Therefore, it is important, with this or any other proposed retrofit, to consider the consequences of the retrofit before commencing the project. In this case, the trade-off between increased fan horsepower and decreased compressor horsepower needs to be calculated.

For chiller installations operating at constant condenser water temperature using on-off cycling of cooling tower fans, consider modifying the controls to operate cooling tower fans continuously whenever there is a chiller on-line. Doing so will allow the condenser water temperature to drop until it reaches a predetermined low limit, at which point the cooling tower fans can be cycled on and off to maintain the low limit. Also, consider using low temperature water from a well or other source for condenser water rather than cooling towers. Energy savings in compressor horsepower resulting from lower condenser water temperatures may make it a viable retrofit.

Condensing temperatures increase if the condenser heat exchanger is insulated. Scaling or fouling of the tubes in water-cooled condensers, or restriction of airflow with air-cooled condensers are examples of unintentionally insulated heat exchangers. On water-cooled condensers, consider installing automatic tube cleaners such as a cylindrical brush in each tube that is periodically forced from one end of the condenser tube bundle to the other by a reversal in the direction of water flow. This type of system can be effective in keeping condenser tubes clean by maintaining low fouling factors and reducing condensing temperatures. On air-cooled condensers kept coils clean and unobstructed.

To reduce condensing temperatures on air-cooled condensers consider the following measures:

- Increase the air volume through the condenser by increasing fan speed.
- Add additional air-cooled condensers in parallel to increase coil heat transfer surface area.
- Replace the existing condenser coil with a coil that has a larger surface area or remove restrictions to airflow.

Optimize Chillers in Series

System efficiency (measured by COP) is affected by the piping arrangement of the chillers. Chillers piped in parallel must each produce the coldest water required for the system. However, when chillers are piped in series, the second (or third) chiller in the system operates at a higher suction pressure (higher evaporator temperature) and uses less energy for heavy cooling load conditions. One drawback to series arrangement is that at cooling loads, chilled water is still pumped through the off-line chiller. Hence, the pump must be selected to operate at the higher resistance created by two or more chillers in series.

To optimize this system, a bypass is added around the off-line chiller. Pumping horsepower will be reduced when the series chiller goes off-line. Pump horsepower can also be reduced (by the cube of the change in volume) if the total chilled water volume can be reduced and the pump impeller trimmed. The equation for this change in horsepower is:

$$HP_2 = HP_1 \times (gpm_2 / gpm_1)^3$$

Where:

HP₂ = the final horsepower

HP₁ = the initial horsepower

gpm₂ = the final gallons per minute

gpm₁ = the initial gallons per minute

Increasing chiller and coil temperature differential will reduce the flow rate or gpm required.

Optimize Chillers in Parallel

In some multiple-chiller operations, with chillers piped in parallel, chilled water is always circulated through all the chillers even when only one chiller is operating to meet a light cooling load demand. The result of this process results in wasted pump energy. The situation requires that the on-line chiller operate at a low evaporator temperature to produce chilled water at temperatures to meet the desired supply water temperature and offset the mixing effect of the water being circulated through the off-line chillers. COP is reduced and horsepower rises.

Optimizing a parallel-piped system requires the installation of multiple pumps, one for each chiller. Each pump is selected and balanced for the gpm required and interlocked with its associated chiller. Isolating valves that close when a chiller goes off-line are installed on each chiller. Then, under lighter loads off-line chillers will be isolated. Only on-line chillers and pumps will be operating, thus reducing pumping horsepower. The on-line chillers will operate at evaporator and water temperatures to meet the load. Pumping horsepower will drop by the cube [$HP_2 = HP_1 \times (gpm_2/gpm_1)^3$] if the chilled water volume through the chiller can be reduced and the pump impeller trimmed. Another solution, instead of multiple chilled water pumps, is the installation of a multi-speed or variable drive on the present pump to make it multi- or variable volume.

When greater water volume is required in the system than can be supplied by on-line chillers consider installing variable volume system pumps sized for the critical load and a bypass (uncoupler or common loop) around the chillers. Each chiller has a dedicated constant volume pump. At lighter loads the chillers and the dedicated pumps go off-line and the system pumps draw through the bypass (common or uncoupler loop) and from the on-line chillers to satisfy the load (Figure 17-1, operations 1-5).

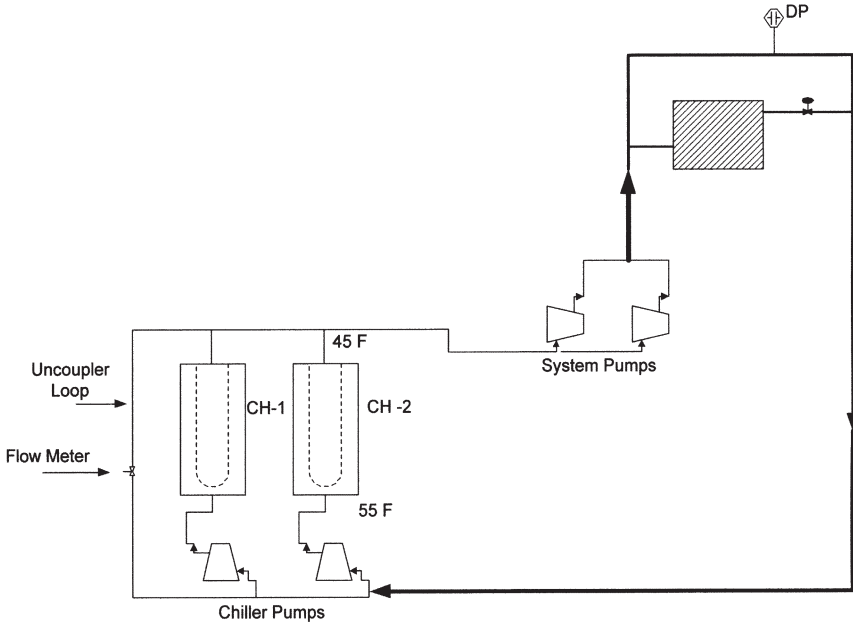

Figure 17-1. Variable flow chilled water system, chillers in parallel.

Figure 17-1 Operation 1—Maximum Flow (2000 gpm)

1. Both chillers and their associated pumps are operating. The pumps are constant speed and volume. Each pump, when on, moves 1000 gpm, a total of 2000 gpm.
2. The thermostats in the system are calling for full flow (full cooling), 2000 gpm.
3. Both system pumps are operating. The pumps are variable speed and volume. At maximum flow each pump is moving 1000 gpm, a total of 2000 gpm.
4. Water leaves the chillers at 45°F, goes through the coils where it picks up heat, and returns to the chillers at 55°F.

Figure 17-1 Operation 2—Reduced Flow (1500 gpm)

1. Both chillers and their associated pumps are operating. The

- pumps are constant speed and volume. Each pump, when on, moves 1000 gpm, a total of 2000 gpm.
2. The thermostats in the system are calling for reduced flow (because of a reduced cooling load), 1500 gpm. The DP (delta P) sensor and controller senses a rise in pressure in the system and sends a signal to slow down the system pumps thus reducing water flow.
 3. Both system pumps are operating. The pumps are variable speed and volume. At this reduced flow each pump is moving 750 gpm, a total of 1500 gpm.
 4. Water leaves the chillers at 45°F, goes through the coils where it picks up heat, and returns to the chillers at 55°F.
 5. Chiller pump for chiller #2 picks up 1000 gpm of water at 55°F. 1000 gpm of water at 55°F goes into the chiller and is cooled down to 45°F.
 6. Chiller pump for chiller #1 picks up 500 gpm of water at 55°F. This is the remainder of the flow from the 1500 gpm back from the coils. Chiller pump for chiller #1 picks up an additional 500 gpm of water at 45°F. This is water from the uncoupler loop. 1000 gpm of water at 50°F $[(50\% \times 55^\circ\text{F}) + (50\% \times 45^\circ\text{F})]$ goes into chiller #1 and is cooled down to 45°F. The chiller is not working to maximum capacity and therefore is using less energy.
 7. 1000 gpm leaves chiller #1. 500 gpm goes to the system pumps and 500 gpm through the uncoupler loop.

Figure 17-1 Operation 3—Reduced Flow (1200 gpm)

1. Both chillers and their associated pumps are operating. The pumps are constant speed and volume. Each pump, when on, moves 1000 gpm, a total of 2000 gpm.

2. The thermostats in the system are calling for reduced flow (reduced cooling load), 1200 gpm. The DP (delta P) sensor and controller senses a rise in pressure in the system and sends a signal to slow down the system pumps thus reducing water flow.
3. Both system pumps are operating. The pumps are variable speed and volume. At this reduced flow each pump is moving 600 gpm, a total of 1200 gpm.
4. Water leaves the chillers at 45°F, goes through the coils where it picks up heat, and returns to the chillers at 55°F.
5. Chiller pump for chiller #2 picks up 1000 gpm of water at 55°F. 1000 gpm of water at 55°F goes into the chiller and is cooled down to 45°F.
6. Chiller pump for chiller #1 picks up 200 gpm of water at 55°F. This is the remainder of the flow from the 1200 gpm back from the coils. Chiller pump for chiller #1 picks up an additional 800 gpm of water at 45°F. This is water from the uncoupler loop. 1000 gpm of water at 47°F $[(20\% \times 55^\circ\text{F}) + (80\% \times 45^\circ\text{F})]$ goes into chiller #1 and is cooled down to 45°F. The chiller is not working to maximum capacity and therefore is using less energy.
7. 1000 gpm leaves chiller #1. 200 gpm goes to the system pumps and 800 gpm through the uncoupler loop.
8. At this gpm (1200), or some lesser amount chiller #1 and its pump shuts down.

Figure 17-1 Operation 4—Reduced Flow (1200 gpm), Chiller Off

1. One chiller (#2) and its associated pump are operating. One chiller (#1) and its associated pump are off.

2. The thermostats in the system are calling for reduced flow (reduced cooling load), 1200 gpm. The DP (delta P) sensor and controller senses a rise in pressure in the system and sends a signal to slow down the system pumps thus reducing water flow.
3. Both system pumps are operating. The pumps are variable speed and volume. At this reduced flow each pump is moving 600 gpm, a total of 1200 gpm.
4. Chiller pump for chiller #2 picks up 1000 gpm of water at 55°F. 1000 gpm of water at 55°F goes into the chiller and is cooled down to 45°F.
5. Chiller pump for chiller #1 is off. 200 gpm of water at 55°F (the remainder of the flow from the 1200 gpm back from the coils) bypasses the chiller pump for chiller #1 and flows up through the uncoupler loop where it mixes with the water from chiller #2. The water going out to the systems pumps is 46.7°F $[(16.7\% \times 55^\circ\text{F}) + (83.3\% \times 45^\circ\text{F})]$.

Figure 17-1 Operation 5—Increased Flow (1300 gpm), Chiller On

1. The thermostats in the system are calling for increased flow (because of increased cooling load), 1300 gpm. The DP (delta P) sensor and controller senses a drop in pressure in the system and sends a signal to speed up the system pumps thus increasing water flow.
2. One chiller (#2) and its associated pump are operating. One chiller (#1) and its associated pump are off.
3. Both system pumps are operating. The pumps are variable speed and volume. At this point each pump is moving 650 gpm, a total of 1300 gpm. At some designated low flow (a total flow less than 1000 gpm) one system pump would stop.

-
4. Chiller pump for chiller #2 picks up 1000 gpm of water at 55°F. 1000 gpm of water at 55°F goes into the chiller and is cooled down to 45°F.
 5. Chiller pump for chiller #1 is off. 300 gpm of water at 55°F (the remainder of the flow from the 1300 gpm back from the coils) bypasses the chiller pump for chiller #1 and flows up through the uncoupler loop mixing with the water from chiller #2.
 6. At this point, the flow meter in the uncoupler loop senses too much water (300 gpm) flowing up and sends a signal to start the chiller pump for chiller #1.
 7. Chiller pump for chiller #1 starts and picks up 700 gpm of water from the uncoupler loop and mixes it with 300 gpm of water back from the coils (the remainder of the flow from the 1300 gpm). 1000 gpm goes into chiller #1 and is cooled down to 45°F.
 8. Both chillers and their associated pumps are operating again.

Install Water-side Economizers

Use a water-side economizer system where and when outside air conditions are favorable. A water-side economizer pumps cool water from the cooling tower to cool the conditioned space supply air temperature without operating the compressor. Two methods are used: the strainer cycle and the plate heat exchanger cycle.

Strainer Cycle

With the strainer cycle, cool water from the tower basin is pumped from the tower by the condenser pump through a strainer and then directly through the cooling coils and back to the tower.

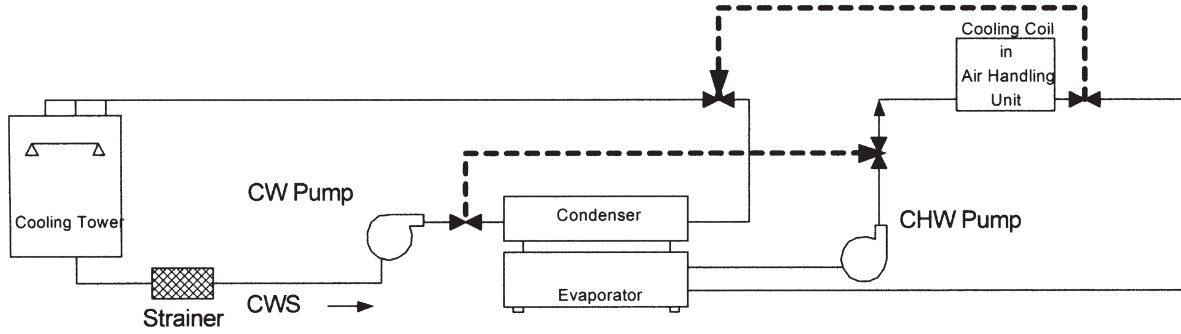

Figure 17-2 A Water-side Economizer—Strainer Cycle

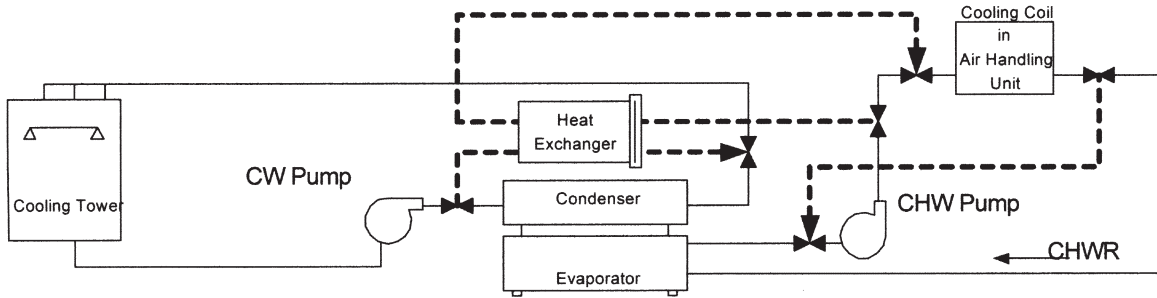

Figure 17-2 B Water-side Economizer—Heat Exchanger Cycle

Heat Exchanger Cycle

In the heat exchanger cycle, cool water from the tower basin is pumped from the tower by the condenser water pump. The cooling tower water goes through a plate heat exchanger and back to the tower. The chilled water pump pumps cooling coil water (system water) around the closed loop system. The path of the system water is through the heat exchanger and the coils. The cooling tower water and the system water do not mix.

Figure 17-2 A Water-side Economizer—Strainer Cycle

Economizer off: Cooling tower water is pumped through the water-cooled condenser and back to the cooling tower.

Economizer on: Cooling tower water is pumped around the water-cooled condenser and directly into the system (chilled water) loop and through the coils and back to the cooling tower.

Figure 17-2 B Water-side Economizer—Heat Exchanger Cycle

Economizer off: Cooling tower water is pumped through the water-cooled condenser and back to the cooling tower.

Economizer on: Cooling tower water is pumped around the water-cooled condenser and directly into the heat exchanger and back to the cooling tower. The system (chilled water) water is pumped through the heat exchanger and back to the coils (system loop).

Chapter 18

Fan Drives

Motor Sheave

3MVP60B74P

- 3 grooves
- Companion sheave
- Variable pitch
- 6.0" to 7.4" pitch range with a "B" belt
- P bushing (P2 - 3/4" to 1-3/4" bore range)

Fan Sheave

3MVB154R

- 3 grooves
- Companion sheave
- Fixed pitch
- 15.4" pitch with a "B" belt
- R bushing (R1 - 1-1/8" to 3-3/4" bore range)

Fan rpm varies directly as motor sheave pitch diameter

Fan rpm varies indirectly as fan sheave pitch diameter

FAN DRIVE COMPONENTS

To take drive component information, first stop the fan and put your own personal padlock on the motor disconnect switch so that, only you have control over starting the fan. Next, remove the belt guard (plug fans do not have belt guards or a housing around the fan wheel) and read and record the information from the motor and fan sheaves and the belts. Also, measure the shaft sizes and the distance between the center of the fan and motor

shafts. This is a good time to also measure and record the slide adjustment on the motor frame. The motor slide is for adjusting belt tension. For instance, if a sheave needs changing and there is space available on the motor frame, you may be able to move the motor forwards or backwards, so that the old belt will fit. If the adjustment space is not adequate, a change in sheave size will mean that you'll have to install a different size belt.

The fan sheave is the driven pulley on the fan shaft (Figure 18-1). The motor sheave is the driver pulley on the motor shaft. The motor sheave may be either a fixed or adjustable groove sheave. Adjustable groove sheaves, or simply, adjustable sheaves are also known as variable speed or variable pitch sheaves. An adjustable sheave means that the belt grooves on the sheave are movable. A fixed sheave means that the belt grooves are non-movable. Fixed sheaves are typically used for fans. And, generally, after fans have been air balanced for the proper airflow, adjustable motor sheaves are replaced with fixed sheaves. The reason is, size for size, fixed sheaves are less expensive than adjustable sheaves, and there's less wear on the belts. Some other terms that we need to define refer to belts. Let's start with V-belts. There are two types of V-belts generally used on HVAC equipment. Light duty, fractional horsepower (FHP) belts, sizes 2L through 5L, and heavier duty industrial belts, sizes "A" through "E." Fractional horsepower belts are generally used on smaller diameter sheaves because they're more flexible than industrial belts for the same equivalent cross-sectional size. For example, a 5L belt and a "B" belt have the same cross-sectional dimension, but because of its greater flexibility, the 5L belt would generally be used on light duty fans that have smaller sheaves. (Note: A 4L belt and an "A" belt have the same cross-sectional dimension.) The general practice in HVAC design is to use belts of smaller cross-sectional size with smaller sheaves instead of large belts and large sheaves for the drive components. Multiple belts are used to avoid excessive belt stress. The term pitch diameter is a measurement that refers to where the middle of the V-belt rides in the sheave groove. A matched set of belts is a set of belts whose

exact lengths and tensions are measured and matched by the belt supplier in order for each belt to carry its proportionate share of the drive load.

FAN DRIVE INFORMATION

Now that we have an understanding of some of the important drive component terms, let's go back and continue to get information from the sheaves and belts. After you have the belt guard off, check the outside of the sheave for a stamped part number. The part number indicates the sheave size. For example, on the motor sheave, you might find 3MVP60B74P. Looking in the manufacturer's catalog (Browning, in this example) you'd find that the numbers and letters indicate that the motor sheave has 3 fixed grooves and can have either a "B" belt with a pitch diameter range from 6.0 to 7.4 inches or an "A" belt with a pitch diameter range from 5.9 to 7.0 inches. The bushing size is P (P2).

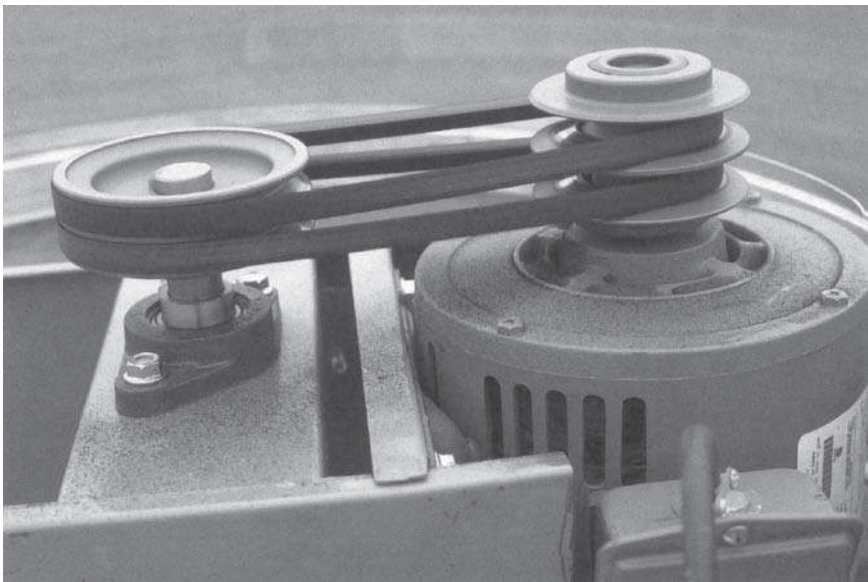

Figure 18-1. Variable pitch motor sheave and fixed pitch fan sheave.

The bushing bore range table for a P2 bushing indicates that you can purchase a bushing to fit shaft sizes from 3/4 to 1-3/4 inches. "M" is the companion sheave designation.

On the fan sheave you might find the word Browning and the numbers and letters 3MVB154R (Tables 18-1 and 18-2). Looking in the Browning catalog you'd find that the numbers and letters indicate that the fan sheave has 3 fixed grooves and can accommodate either a "B" belt with a pitch diameter of 15.4 inches or an "A" belt with a pitch diameter of 15.0 inches. The bushing size is R (R1). The bushing bore range table for an R1 bushing indicates that you can purchase a bushing to fit shaft sizes from 1-1/8 to 3-3/4 inches. "M" is the companion sheave designation.

If there's no part number on the sheave, measure the outside diameter and then refer to the manufacturer's catalog to find the corresponding pitch diameter. Most manufacturers list both pitch diameter and outside diameter in their catalogs. If you can't get the pitch diameter from the catalog use a tape measure or ruler to measure, as close as possible, the approximate pitch diameter. Next, write down the quantity of belts, the name of the belt manufacturer and the belt sizes.

CHECKING FAN ROTATION

Check the rotation of motors to ensure that fans are rotating in the correct direction. Certain centrifugal fans will produce measurable pressures and some fluid flow, sometimes as much as 50% of design, even when the rotation is incorrect. In axial fans, if the motor rotation is incorrect, the airflow will reverse direction. In order to check fan rotation momentarily start and stop the fan motor to "bump" the fan just enough to determine the direction of rotation. There may be an arrow on the fan housing or motor showing correct rotation. However, if there's no arrow, view double inlet centrifugal fans from the drive side and single inlet fans from the side opposite the inlet. This will

Table 18-1. Fan sheave information
NO. 1—SPECIFICATIONS

<i>Diameters</i>		<i>Part Number</i>	
<i>Pitch "A" Belts 3Grooves</i>	<i>Pitch "b" Belts</i>	<i>Sheave</i>	<i>bushing</i>
10.6"	11.0"	3MVB110Q	Q1
12.0"	12.4"	3MVB124Q	Q1
13.2"	13.6"	3MVB136Q	Q1
15.0"	15.4"	3MVB154Q	Q1
15.0"	15.4"	3MVB154R	R1

Table 18-2. Fan sheave information
NO. 2—BUSHING BORES

<i>Bushing No.</i>	<i>Bore Range</i>
P1	1/2" - 1-3/4"
Q1	3/4" - 2-11/16"
Q2	1" - 2-5/8"
R1	1-1/8" - 3-3/4"

let you determine correct rotation and whether the wheel is turning clockwise or counterclockwise. If the rotation is incorrect, it can be changed in the field. To reverse the rotation on a three-phase motor, change any two of the three power leads at the motor control center or disconnect. Sometimes, you may also be able to change rotation in single-phase motors by switching the internal motor leads within the terminal box. Wiring diagrams for single-phase motors are usually found on the motor or inside the motor terminal box.

CHECKING FAN SPEED

Two types of instruments, contact and non-contact tachometers, are used for measuring fan speeds. Two excellent types of contact tachometers are the chronometric, which is a combination of a precision stopwatch and a revolution counter, and the digital type. Generally, included in the kit with contact tachometers are both rubber and metal tips for centering the tachometer on the fan shaft. The fan shaft should be clean to ensure proper contact with the tachometer tip. The tip should be properly centered on the fan shaft and held against the shaft tight enough to avoid slippage but not so tight as to increase drag in the tachometer to the point of causing an incorrect reading. The tachometer should be held parallel to the fan shaft. Readings should be taken until you read two consecutive, repeatable values.

Non-contact tachometers are used for measuring rotational speeds when the shaft isn't accessible. Two types are the strobe light tachometer and the photo tachometer (phototac). A strobe light tachometer has an electronically controlled flashing light which is manually adjusted to equal the frequency of the rotating sheave so the sheave will appear motionless. To read the strobe light, use the fan's nameplate rpm or use the drive equation to determine the approximate rpm of the fan and start at that point. A phototac measures rpm by flashing a light at the moving sheave and counting the reflections. I have found that laser-light phototacs do not work well on HVAC equipment (especially equipment outside the building) because of problems with ambient light.

CALCULATIONS FOR CHANGING FAN SPEED

If you determine that a fan speed change is needed to increase or reduce the air volume output of the fan, use the following drive equation to determine the size of the sheaves needed to get the correct fan speed and airflow. You'll notice that the pitch diameter is used in the calculations. For field calculations you can use the out-

side diameter of a fixed sheave for pitch diameter. For adjustable sheaves, when the belt is riding down in the groove, an approximation of the pitch diameter will be used for calculation purposes. Also, notice that increasing the size of a fixed pitch motor sheave, or adjusting the belts to ride higher in an adjustable motor sheave, will mean an increase in fan speed. Decreasing the size of a fixed pitch motor sheave, or adjusting the belts to ride lower in an adjustable motor sheave, will result a decrease in fan speed. The opposite is true if you're re changing the fan sheave instead of the motor sheave. In other words, increasing the pitch diameter of the fan sheave decreases the fan speed while decreasing the pitch diameter of the fan sheave increases the fan speed.

$$\text{RPM}_m \times \text{Pdm} = \text{RPM}_f \times \text{Pdf}$$

- RPM_m = speed of the motor shaft
- Pdm = pitch diameter of the motor sheave
- RPM_f = speed of the fan shaft
- Pdf = pitch diameter of the fan sheave

- RPM is Revolutions Per Minute
 - Motor sheave is usually changed. Fan sheave is sometimes changed.
 - Fan rpm goes the same way as motor sheave pitch diameter
 - Fan rpm goes the opposite way as fan sheave pitch diameter

CHANGING DRIVES

After calculating new sheave size, the following information will be needed.

1. Motor and fan shaft diameter. To help you in measuring, remember that motor shaft diameters are in increments of $1/8''$ and fan shaft diameters are in increments of $1/16''$.

-
2. Bushing sizes. Sheaves may have a fixed bore in which case they fit the exact size of the shaft, or they may have a larger bore to accept bushings of various bore diameters to fit different shaft sizes.
 3. Number of belt grooves.
 4. If the motor is mounted on an adjustable base (or all-thread), measure the amount of motor movement on the motor slide rail (or all-thread) to allow for adjustment of belt tension.

To change the sheaves, first loosen and slide the motor forward (or up) toward the fan for easier removal of the belts. Never force the belts over the sheaves. For proper removal or mounting of sheaves or adjustment of adjustable sheaves, consult the manufacturer's published data. Caution: Before trying to remove or adjust the pitch diameter of an adjustable sheave be sure to loosen all locking screws. After adjustments are finished be sure to tighten all locking screws.

To prevent unnecessary belt wear or the possibility of a belt jumping off the sheaves, the motor and fan shafts should be parallel to each other and the motor and fan sheaves in alignment. To align the motor and fan sheaves:

1. Place a straightedge from the fan sheave to the motor sheave. The straightedge is on the outside flanges of the sheaves.
2. Move the motor or the sheaves for equal distance from the straightedge to the center of both fan and motor sheaves.

After the sheaves are in place put the proper sized belts on. Belts shouldn't be too tight or too loose. Slack belts will squeal on start-up, and they'll wear out quicker and deliver less power. Belts with excessive tension will also wear faster and can cause excessive wear on shaft bearings and possibly overload the motor and drive. The correct operating tension is the lowest tension at

which the belts will perform without slipping under peak load conditions. A belt tension checker is available from some belt manufacturers. To install belts:

1. Loosen and slide the motor toward the fan.
2. Put the belts on the sheaves and move the motor back to adjust the belts for proper tension.
3. Secure the motor.

After the belts have been installed, check the sheave alignment. After the first day's operation and again a few days later, check the sheaves, belt tension and drive alignment.

This page intentionally left blank

Chapter 19

Terminology

Air Conditioning: Treating or conditioning the temperature, humidity, and cleanliness of the air to meet the requirements of the conditioned space.

Air Conditioning Unit: An assembly of components for air treatment. Also called: air handling unit (AHU) for larger systems or fan-coil unit (FCU) for smaller systems.

Algorithm: A set of rules specifying a sequence of actions

Analog Signal: A type of signal whose level varies smoothly and continuously in amplitude or frequency. Traditionally, analog devices such as pneumatic controllers, transducers, relays and actuators have performed HVAC control.

Apparatus Dew Point: The point at which a line extended from the coil condition intersects the 100 percent saturation line. This point represents the cooling coil temperature. Apparatus dew point, or coil temperature, is used to determine the coil bypass factor.

Automatic Temperature Control Damper: Dampers controlled by temperature requirements of the system. Automatic temperature control dampers are usually opposed or parallel bladed dampers and can be either two-position or modulating. Two-position control means the damper is either open or closed. Modulating control provides for the gradual opening or closing of a damper. Automatic temperature control dampers should have a tight shutoff when closed.

Automatic Temperature Control Valve: Automatic control valves are used to control flow rate or to mix or divert water streams. They're classified as two-way or three-way construction and either modulating or two position.

Btu: A "Btu" is a unit of heat. Btu stands for British Thermal Unit. In scientific terms, a Btu is the amount of heat required to raise one pound of water one degree Fahrenheit. The term Btu/hr is used to quantify heat losses and heat gains in the conditioned space and to identify the heating and cooling capacities of various types of equipment.

Ceiling Diffuser: A diffuser which typically provides a horizontal flow pattern that tends to flow along the ceiling producing a high degree of surface effect. Typical square or rectangular ceiling diffusers deliver air in a one, two, three or four-way pattern. Round ceiling diffusers deliver air in all directions.

Cleanroom: A specially constructed, enclosed area environmentally controlled with respect to airborne particles, temperature, humidity, airflow patterns, air motion, sound, vibration, and lighting. A room in which the concentration of airborne particles is controlled and which contains one or more clean zones. A cleanroom is constructed and used in a manner to minimize the introduction, generation, and retention of particles inside the room. Other relevant parameters, e.g. temperature, humidity, and pressure, are controlled as necessary. Also called Controlled Environment Room.

Cleanroom occupancy states:

As-built: A cleanroom which is complete and operating with all services connected and functioning. It has no production equipment or personnel.

At-rest: A cleanroom which is complete and operating, with all services connected and functioning. It has production equipment but no personnel.

Operating: A cleanroom which is complete and operating with all services connected and functioning. It has production equipment and personnel.

Clean zone: A defined or dedicated space in which the concentration of airborne particles is controlled to meet a specified airborne particulate cleanliness class. A clean zone is constructed and used in a manner to minimize the introduction, generation, and retention of particles inside the zone. Other relevant parameters, e.g. temperature, humidity, and pressure, are controlled as necessary. A clean zone may be open or enclosed and may or may not be located within a cleanroom.

Coil: Coils are heat transfer devices (heat exchangers). They come in a variety of type and sizes and are designed for various fluid combinations. In hydronic applications coils are used for heating, cooling or dehumidifying air. Hydronic coils are most often made of copper headers and tubes with aluminum or copper fins and galvanized steel frames.

Coil Bypass Factor: Coil bypass factors indicate the amount of air that passes through coils without being affected by coil temperature. It is the ratio of the leaving air dry-bulb temperature minus the coil temperature, divided by the entering air dry-bulb temperature minus the coil temperature. Highly efficient coils—those with more fins per inch and/or more rows—have a lower coil bypass factor.

Cold: Cold is a relative term to describe the temperature of an object or area compared to a known temperature. For instance, 50°F in the winter might be considered a warm temperature while in the summer it would be a cool temperature.

Cold Deck: In a multizone or dual duct unit it's the chamber after the air leaves the cooling coil.

Comfort Zone: The range of effective temperatures and humidi-

ties over which the majority of adults feel comfortable. Generally, between 68°F to 79°F and 40% to 60% relative humidity.

Condensation: Condensation is the cooling of a refrigerant vapor to convert it to a liquid.

Cubic Feet Per Minute: Airflow volume.

Constant Volume Single Duct Box: A single inlet terminal box supplied with air at a constant volume and temperature (typically cool air). Air flowing through the box is controlled by a manually operated damper or a mechanical constant volume regulator. The mechanical volume regulator uses springs and perforated plates or damper blades, which decrease or increase the available flow area as the pressure at the inlet to the box, increases or decreases. A reheat coil or cooling coil may be installed in the box or immediately downstream from it. A room thermostat controls the coil.

Cooling Coil: A chilled water or refrigerant coil.

Damper: A device used to regulate airflow.

Density: Density is the weight of a substance per unit volume. For air, density is expressed in pounds per cubic feet. Density is also the reciprocal of specific volume.

Dew Point: The temperature at which moisture starts to condense from the air.

Dry Bulb Temperature: The temperature is air temperature read on an ordinary thermometer.

Diffuser: A supply air outlet generally found in the ceiling with various deflectors arranged to promote mixing of primary air with secondary air. Types of diffusers are: round, square, rect-

angular, linear and troffers. Some diffusers have a fixed airflow pattern while others have field adjusted patterns.

Digital Signal: Representation of a numerical quantity by a number of discrete signals (not continuous) or by the presence or absence of signals in particular positions. Binary digital signals have one of two states (0 or 1) defined by voltage or current levels.

Direct-acting: A direct-acting controller increases its branch output as the condition it's sensing increases (D/A).

Diversity in Constant Air Volume Systems: The total cfm output of the fan is greater than the maximum required volume through the cooling coil.

Diversity in Variable Air Volume Systems: The total cfm output of the fan is less than the maximum required volume through the VAV boxes and outlets.

Draft: A localized feeling of coolness caused by high air velocity, low ambient temperature, or direction of airflow.

Dual Path: A system in which the air flows through heating and cooling coils essentially parallel to each other. The coils may be side-by-side or stacked. Multizone and dual duct systems are dual path. Some systems may not have a heating coil but instead bypass return air or mixed air into the hot deck.

Dumping: The rapidly falling action of cold air caused by a variable air volume box or other device reducing airflow velocity.

Economizer Control: A control system for the changeover between natural cooling with outside air instead of refrigerated mechanical cooling.

Effective Area: The sum of the areas of all the *vena contractas* existing at the outlet and is affected by the number of orifices

and the exact location of the *vena contractas*, and the size and shape of the grille bars, diffuser rings, etc. Manufacturers have conducted airflow tests and based on their findings they've established flow factors or area correction factors for their products. Each flow factor, sometimes called "K-factor" or "AK," applies to a specific type and size of grille, register or diffuser, a specific air measuring instrument, and the correct positioning of that instrument.

Efficiency: Useful energy output divided by the power input.

Energy: A measure of power consumed. The ability to do work. Stored work. The units of energy are foot-pound, Btu, and kilowatt-hour.

Energy Management System: A system based on a microprocessor, microcomputer, or minicomputer whose primary function is the controlling of energy using equipment so as to reduce the amount of energy used. Also called Energy Management Control System.

Enthalpy: Enthalpy of air is a measure of air's heat content expressed in Btu per pound of dry air. Total heat content. The thermodynamic property of a working substance.

Evaporation: Evaporation is the heating of a liquid refrigerant to convert it to a vapor. Vapor is another term for gas.

Evaporator Coil: A coil containing a refrigerant other than water used for cooling the air.

Face Velocity: The average velocity of the air leaving a coil, supply air outlet or entering a return air inlet, exhaust air inlet, or fume hood.

Feet Per Minute: Air velocity (fpm)

Fluid: A liquid or a vapor. A vapor is a compressible fluid and a liquid is a non-compressible fluid.

Grille: A wall, ceiling or floor mounted louvered or perforated covering for an air opening. To control airflow pattern, some grilles have a removable louver. Reversing or rotating the louver changes the air direction. Grilles are also available with adjustable horizontal or vertical bars so the direction, throw, and spread of the supply air stream can be controlled.

Heat: Heat is form of energy transferred by a difference in temperature. Heat always flows from a higher temperature to a lower temperature. In HVAC systems we use fluids such as air, water, and refrigerants to carry or transfer heat from one place to another.

Heat Exchanger: A heat exchanger is a device such as a water or refrigerant coil that is designed to allow for the transfer of heat between two physically separated fluids

High Pressure Systems: Static pressures above 6 in. wg., with velocities above 2000 feet per minute.

Hot Deck: In a multizone or dual duct unit it's the chamber after the air leaves the heating coil.

HVAC: Heating, ventilating and air conditioning a space using the fluids of air, water, steam, and refrigerants.

Latent Heat: The heat that when supplied to, or removed from, a substance causes a change of state without any change in temperature. The units of latent heat are Btu per pound of dry air.

Low Pressure System: Static pressures to 2 in. wg., with velocities to 2000 feet per minute.

Make-up Air: Air introduced into the secondary air system for ventilation, pressurization, and replacement or “make-up” of exhausted air.

Medium Pressure Systems: Static pressures between 2 and 6 in. wg., with velocities between 2000 and 4000 feet per minute.

Mixed Air: Primary air plus secondary air.

Multizone System: Multizones are dual path systems usually having a cooling coil and heating coil. The air passes through the coils into mixing dampers and then into zone ducts to the various conditioned spaces. Multizone systems are designed as constant volume systems but the actual volume may vary up to 10% during normal operation because of the changes in resistance between the smaller heating coil and the larger cooling coil. Generally, multizone systems have between 4 and 12 zones. In most cases, the zones will be similar in flow quantities.

Normally Closed: The position of a controlled device when the power source is removed. A controlled device that moves toward the closed position as the branch line pressure decreases is normally closed. The position of the damper or valve when the actuator is de-energized.

Normally Open: The position of a controlled device when the power source is removed. A controlled device that moves toward the open position as the branch line pressure decreases is normally open. The position of the damper or valve when the actuator is de-energized.

Outlet Velocity: The average velocity of air emerging from a fan, outlet or opening.

Plenum : An air chamber or compartment.

Pressure Dependent Box: The quantity of air passing through this terminal box is dependent on the inlet static pressure.

Pressure Independent Box: The quantity of air passing through this terminal box is independent (within design limits) of the inlet static pressure.

Primary Air: The supply air.

Refrigerants: Refrigerants are fluids that are used in refrigeration systems to absorb heat by evaporation and release heat by condensation.

Refrigeration: Refrigeration is the transfer of heat from one place where it is not wanted to another place where it is unobjectionable. This transfer of heat is through a change in state of a fluid.

Relative Humidity: The ratio of the moisture of a given air sample to the total amount of moisture that air can hold at a given temperature. Relative humidity is expressed as a percentage.

Sensible Heat: The heat that causes a temperature change in a substance. The units of sensible heat are Btu per pound of dry air.

Sensible Heat Factor: Sensible heat factor equals sensible heat divided by total heat in the air.

Single Duct Box: A terminal box usually supplied with cool air through a single inlet duct. The box may be constant or variable volume, pressure dependent or pressure independent. It can also have a hot water coil , steam coil, or electric reheat.

Single Path: A system in which the air flows through coils es-

entially in series to each other. Single zone heating and cooling units and terminal reheat units are examples.

Smudging: The black markings on ceilings and outlets usually made by suspended dirt particles in the room air which is then entrained in the mixed air stream and deposited on the ceilings and outlets.

Specific Heat: The ratio of the amount of heat required to raise the temperature of one pound of a substance one degree Fahrenheit, as compared to the amount required to raise one pound of water one degree Fahrenheit. The specific heat of air is 0.24 Btu/lb.°F. The specific heat of water is 1 Btu/lb.°F.

Specific Humidity: The actual amount of moisture in the air. Units: grains of moisture per pound of air or pounds of moisture per pound of air.

Specific Volume: The volume of a substance per unit weight. For air, specific volume is expressed in cubic feet per pound. Specific volume is the reciprocal of density.

Standard Air Conditions: Standard air is dry air with the following properties:

Temperature = 70°F.

Pressure = 29.92 inches mercury or 14.7 pounds per square inch

Volume (specific volume) = 13.33 cubic feet per pound

Weight (specific density) = 0.075 pounds per cubic foot

Terminal Box: A device or unit, which regulates supply airflow, temperature and humidity to the conditioned space. Terminal boxes are classified as single duct, dual duct, constant volume, variable volume, medium pressure, high pressure, pressure dependent, pressure independent, system powered, fan powered, induction, terminal reheat and bypass. They may also contain

a combination of heating or cooling coils, dampers and sound attenuation. The airflow through the box is normally set at the factory but can also be adjusted in the field. Terminal boxes also reduce the inlet pressures to a level consistent with the low pressure, low velocity duct connected to the discharge of the box. Any noise that's generated within the box in the reduction of the pressure is attenuated. Baffles or other devices are installed which reflect the sound back into the box where it can be absorbed by the box lining. Commonly, the boxes are lined with fiberglass which also provides thermal insulation so the conditioned air within the box won't be heated or cooled by the air in the spaces surrounding the box. Terminal boxes work off static pressure in the duct system. Each box has a minimum inlet static pressure requirement to overcome the pressure losses through the box plus any losses through the discharge duct, volume dampers, and outlets.

Total Heat: The sum of latent heat and sensible heat. The units of total heat are Btu per pound of dry air.

Variable Air Volume Box: VAV boxes are available in many combinations that include: pressure dependent, pressure independent, single duct, dual duct, cooling only, cooling with reheat, induction, bypass and fan powered. VAV boxes can also be classified by (1) volume control: throttling, bypass, or fan powered (2) intake controls and sensors: pneumatic, electric, electronic, DDC, or system powered (3) thermostat action: direct acting or reverse acting and (4) the condition of the box at rest: normally open or normally closed. The basic VAV box has a single inlet duct. The quantity of air through the box is controlled by throttling an internal damper or air valve. If the box is pressure dependent, the volume control device will be controlled just by a room thermostat, whereas, the pressure independent version will also have a regulator to limit the air volume between a preset maximum and minimum. Inside the pressure independent box is a sensor. Mounted on the outside is a controller with connections to the sensor, volume damper and

room thermostat. The quantity of air will vary from a design maximum cfm down to a minimum cfm. The main feature of the VAV box is its ability to vary the air delivered to the conditioned space as the heating load varies. Then, as the total required volume of air is reduced throughout the system, the supply fan will reduce its cfm output. This means a savings of energy and cost to operate the fan. The exception to this is the VAV bypass box. The types of controls used to regulate the flow of air through VAV boxes are as varied as the types of boxes. Many boxes are designed to use external sources of power: pneumatic, electric or electronic DDC. These boxes are sometimes called non-system powered. Other boxes are system powered which means that the operating controls are powered by the static pressure from the main duct system. System powered boxes don't need a separate pneumatic or electric control system. This reduces first costs, however, they usually have a higher required minimum inlet static pressure which means that the supply fan will be required to produce higher static pressures, resulting in increased operating costs. All controllers, except for the bypass box type, reduce airflow.

Water Vapor: In HVAC systems the amount of water vapor or moisture present in the air (OA < RA < MA < SA) is measured in pounds of moisture or grains of moisture per pound of air. There are 7,000 grains of moisture in one pound of moisture. For example, 70 grains is equal to 0.01 pounds.

Wet Bulb Depression: The temperature difference between dry bulb temperature and wet bulb temperature is the wet bulb depression.

Wet Bulb Temperature : Wet bulb temperature is taken with an ordinary thermometer whose sensing bulb is covered by a wick wetted with distilled water and is exposed to air moving at a velocity greater than 900 feet per minute. Wet bulb temperatures below 32° Fahrenheit are taken the same as above except that the water in the wick is frozen.

Chapter 20

HVAC Timeline

A quick look at the history of heating, ventilating and air conditioning in the holistic view... a timeline of purposeful change in the conditioning of ambient air for the industry focused on creature comfort and better process function.

1000s

Roman, Greeks, Chinese, Egyptians use man-powered fans. Indians use rope fans. Romans use a hypocaust (a central heating system with underground furnace and tile flues to distribute the heat) floor panel with radiant heating for rooms and baths for the rich. Others sit in “great halls” where the high society, not hoi polloi, sit close to a central fire with one’s status in the group determining how close they sit from the heat.

1400s

Chimneys allow families to have private rooms. Leonardo da Vinci designs a water driven fan to ventilate a suite of rooms.

1500s

Georgius Agricola publishes treatise on ventilating machines for mines in *De Re Metallica*, which describes and depicts various fans and fan blades used to direct fresh air into a shaft. Agricola wrote “I have hired illustrators to delineate their forms, lest descriptions which are to be conveyed by words should either not be understood by men of our own times, or should cause difficulty to posterity.” The illustrations are so many and so complicated that they delayed the final year of publication. Ideas

for chimneys with a fireplace come from Europe to the Americas with the Pilgrims.

1600s

Large quantities of fuel are consumed. Coal comes into greater use as supplies of wood decrease. Galileo Galilei invents a thermometer but the temperature varies with change in atmospheric pressure—you can get one on eBay. Ferdinand II, Grand Duke of Tuscany, develops a thermometer that is independent of air pressure. Sir Christopher Wren uses a gravity exhaust ventilating system for the House of Parliament.

1700s

China, Germany, Sweden, Russia use stoves made of brick, earthenware, or tile. Gabriel Daniel Fahrenheit's thermometer uses mercury in a glass tube with a graded scale. The name "ventilator" describes the man who turns the crank to power a centrifugal fan invented for ships. Benjamin Franklin credited with greatly improving the stove—as luck would have it—the Franklin stove. First steam heating system is developed. Joseph Black, English chemist and physicist becomes known for his theory of latent heat, only quantitatively verified in 1761. Black notes that different objects, with the same mass, need different amounts of heat to accomplish the same increase in temperature. He finds that different substances require different amounts of heat to raise their temperature 1°C. He is the first modern chemist to identify that air is composed of more than one gas and first to make a clear distinction between temperature and heat. His work leads to the basis of the theory of specific heat. He discovers that melting ice absorbs heat without a change in temperature. James Watt invents the steam engine. Antoine Laurent Lavoisier, the "Father of Modern Chemistry" generates temperatures up to 1750°F (950°C) by focusing sunlight through hollow glass lenses and tubes filled with white wine. Jacques Charles discovers that when a gas is cooled below 0°C its volume will decrease by 1/273. He postulates that the gas will shrink to nothing at -273°C.

The Cackle stove, a furnace for warm air heating, is used in England. It consists of a system of pipes and flues to heat a large cotton factory by gravity. Today this system is a direct-fired heat exchanger.

1800s

The first indirect heating with steam. Fourier and Carnot dispel the theory that heat created by friction is a form of vibration. Nicholas Carnot is the founder of the science of thermodynamics—the movement of heat. James Joule finds that a given amount of work always produces a given amount of heat. Heat is now considered a form of energy. Hot water heating systems are used for large public and commercial buildings. In Massachusetts, the first warm air furnace, similar to today's furnace, is manufactured. It had no recirculation of indoor air and it weighed a ton, 2000 pounds! House of Parliament is steam heated, humidified and cooled by a water spray system. A supply air and exhaust air system uses fans driven by steam engines. Heinrich von Helmholtz drafted the "first law of thermodynamics" which states "energy can be converted from one form to another, but cannot be created or destroyed." This is the "law of conservation of energy": The sum total of all matter will always remain the same. Rudolf Clausius, a German physicist, gives us the "second law of thermodynamics," which states that "heat tends to flow from hot to cold bodies." James Clerk Maxwell, a Scottish physicist, formulates a relationship of the motion of atoms to temperature and heat. His theory shows that temperature and heat involves only molecular movement. This theory means a change from a concept of certainty, that heat is seen as flowing from hot to cold, to one of statistics, that molecules at high temperature have only a high probability of moving toward those at low temperature. This new approach does not reject the earlier studies of thermodynamics; rather, it uses a better theory of the basis of thermodynamics to explain these observations and experiments. Samuel Gold has a new concept of increasing sections of boilers to increase capacity while decreasing danger of explosion. Lord Kelvin suggests that

the volume of gas will not disappear, but that the energy in the molecules of gas will disappear at “absolute zero.”

1900s

B.F. Sturtevant’s catalogue includes a furnace system with centrifugal fans. High-pressure steam heating systems are in usage. Massive fan systems are in common usage. High-speed centrifugal fans and axial flow fans are available with small alternating current electric motors. Buffalo Forge provides a fan-coil dehumidifying system for the Sackett Wilhelm’s Lithographing Company in Buffalo, New York. Buffalo Forge provides the world’s first spray type air conditioning device (later known as the “Air Washer”). Sturtevant supplies the first industrial process air conditioning system to the Walter Baker Company (a chocolate factory in Milton, MA). Sturtevant patents a system for railway car air conditioning. Buffalo Forge designs “The Cyclone Dust Collector” to remove particulate matter from air streams. Sturtevant introduces the first backward inclined blade centrifugal fan. Scotch Maine type boilers with gas and oil burners and forced or induced draft fans with all operating and safety controls are widely used in the HVAC industry. A system installed in the Kuhn and Loeb Bank of New York lowers the temperature 10°F, but raises the relative humidity to uncomfortable levels. Willis Carrier gets a patent for his “Apparatus for Treating Air.” Stuart H. Cramer coins the phrase “air conditioning” in a patent filed for a device that adds water vapor to the air. Carrier presents his basic Rational Psychrometric Formulae to the American society of Mechanical Engineers and it becomes the basis for fundamental calculations for the air conditioning industry. By adding a fan, forced air systems are developed. A furnace fan is on the market. Willis Carrier patents the centrifugal refrigeration machine. The centrifugal chiller is the first practical method for air conditioning large spaces. Three Carrier centrifugal chillers are installed in the J.L. Hudson Department Store in Detroit, Michigan. The Rivoli Theater in New York and other movie theaters get air conditioning. The focus is on creature

comfort rather than industry. Hydronic circulatory pumps that force water through the system with positive pressure are in use. Radiators that are long, low and narrow are used, allowing for inconspicuous heating. General Electric introduces a refrigerator containing a hermetically sealed compressor. Radiant heating is introduced to the U.S. from Europe. Carrier develops one of the first residential air conditioners for private home usage. Frigidaire manufactures the first individual room cooler using technology from the refrigerator. Panels are used to heat floors and ceilings. Solar power, used as an early energy source, is made on a flat-plate collector, but is not used until 1970s. World War II slows the use of non-industrial air conditioning, but after the war, private use begins again. Neil Armstrong and Buzz Aldrin walk on the moon in space suits with life support and cooling systems. Solar power is an alternate energy source. New technology allows heat pumps to operate at lower outdoor temperatures while heating on the reverse refrigeration cycle. The United Nations Montreal Protocol for protection of the earth's ozone layer is signed. The Protocol establishes international cooperation on the phase-out of stratospheric ozone depleting substances, including the chlorofluorocarbon (CFC) refrigerants used in some refrigeration and air conditioning equipment. The Air-Conditioning and Refrigeration Institute in conjunction with the U.S. Department of Energy, initiates the Materials Compatibility Lubricants Research program, which helps manufacturers to develop new non-CFC refrigerants. The R-22 Alternative Refrigeration Evaluation Program begins a four-year program to investigate alternatives to R-502 and HCFC-22. Federal Standard 209-E, "Airborne Particulate Cleanliness Classes in Cleanrooms and Clean Zones" is published. Chlorofluorocarbon (CFC) production in the United States ends. A multi-year, multi-million-dollar research program for air conditioning and refrigeration equipment begins. The objective is to decrease building energy usage while improving indoor air quality. International Standard, ISO 14644, "Cleanrooms and Associated Controlled Environments" is issued. And so it goes...

This page intentionally left blank

Index

A

- absolute temperatures 16
- adjustable motor drive 175
- adjustable speed drive 135, 175
- air-cooled 89
- air-side economizer 11
- air-to-air cooling system 82
- air-to-fuel 273
- air-to-water cooling system 82
- airflow 7, 79
- airfoil 128
 - fan 130
- air conditioning 5, 7
 - components 85
 - cooling systems 80
- air pressures 10, 119
- air quality 1
- air separators 213
- air side economizer 160, 157
- air vents 214
- air volume 11, 137, 163
- atmospheric pressure 50, 137
- automatic control system 218
- automatic temperature control 12
 - damper 9
 - valves 205
- axial fan 119, 124, 134

B

- backward curved 128
- backward inclined 128, 129, 130
- balancing valves 204, 210
- barometric pressure 23, 24
- block tight static pressure 121

- boilers 3, 9, 47, 57, 58, 59, 60, 61, 64, 266
- boiler heating 50
- boiler horsepower 20
- boiler scale 269
- boiler stack temperature 268
- boiling point 107
- boiling temperature 50, 51
- brake horsepower 123, 124
- British thermal unit 18
- Btu 18
- burner 61
- bypass terminal box 179

C

- calculations 64, 72
- calibrated balancing valves 205
- capacity control 101, 102, 103, 104
- carbon dioxide 10, 49, 66, 267
- carbon monoxide 49, 269
- cavitation 195
- ceiling diffuser 9, 151
- centrifugal compressor 103, 104, 105, 106
- centrifugal fans 119, 128, 134
- centrifugal pump 191, 193
- centrifugal water chillers 105, 106
- check valves 205
- chilled water 9
 - systems 5
- chiller optimization 113
- closed system 197
- coils 5, 202, 203, 214, 215, 253
- combustion 49

comfort-to-comfort 252, 254
comfort zone 1, 12
components 1, 2, 3, 7, 218, 293
compression tank 212
compressor 3, 7, 77, 78, 85, 90,
107, 108
lubrication 109
condenser 3, 7, 14, 77, 78, 85, 89,
105, 107
coil 90
water temperature 282, 283
condensing pressure and tem-
perature 111
conduction 17, 253
constant volume 142
controlled devices 220, 232, 233
controller 167, 221, 222, 227, 228,
229, 231, 232
controlling devices 220
control components 227
control devices 105, 167
controls 3, 159, 276
convection 17, 253
cooling 13, 32, 33, 37, 275
coil 14, 88, 281
process line 36
tower 7
counter flow 214, 253
cubic feet per minute 7, 10, 11,
123, 157

D
damper 12, 68, 155, 233, 234
actuators 233, 234
dead band 229, 235
dehumidification 31, 32, 33
dehumidifying 37
demand-side management 278
density 27, 30

desuperheating 78, 79
dew point (DP) temperature 27
differential pressure 209
gauge 209, 210
diffuser 151
direct-return piping system 200
direct acting 185, 227, 228, 229,
230
direct digital control systems 221
discharge dampers 134
diversity 163
diverting 157
dry bulb (DB) temperature 22, 26,
73
ductwork 2, 139
duct pressure 119, 121

E

economizer 108
cycle 160
electric 64
electrical power 19, 20
energy conservation 263
opportunities 264
energy consumption 263
energy management control sys-
tems 223
enthalpy 22, 27
evaporator 3, 7, 14, 76, 85, 88, 105,
106
coil 90
pressure and temperature 112,
282
excess air 268
expansion tank 211

F

fan classes 122
fan curve 121

- fan drive components 293
- fan drive information 295
- fan performance curves 121
- fan performance table 123
- fan powered 148, 177, 179
- fan pressure 119
- fan rotation 296
- fan selection 133
- fan sheaves 293, 294
- fan speed 122, 298
- feet per minute 7
- fire tube 58, 60
- fire tube boilers 57
- fixed pitch vane axial 126
- fixed plate 253
 - exchangers 258
- flash gas 79, 107
- flow characteristic 234
- flow meters 207, 208, 210
- forward curved 128
- four-pipe system 199
- fuel-to-air ratio 49, 63, 273
- fume hoods 10
- furnaces 3

- G**
- gallons per minute 191, 202
- gas burners 61
- grille 154

- H**
- head pressure 202
- heat 15
 - calculations 64, 72
 - content 20
 - exchanger 3, 6, 17, 74, 202, 253, 256
 - cycle 292
 - pipe 253
 - exchangers 258
 - power 18, 19, 20
 - pumps 247, 248
 - recovery 254
 - systems 252
 - comfort-to-comfort 252
 - process-to-comfort 252
 - process-to-process 252
 - transfer 17, 90, 215, 253
 - equation 21, 22, 254
 - surfaces 281
 - wheel 253, 257
- heating 12
 - and humidification 32
 - coils 4, 6, 13, 14
 - water 9
- hermetic compressor 97, 98, 104
- high limit 159
- high pressure 127, 140
- hot gas heat exchangers 259
- hot water heating 55, 57
- humidification 31
- humidistat 230
- humidity control 7
- HVAC 1, 241
 - systems, types of 245
 - all-air 245
 - air and water 245
 - all-water 245
 - unitary 245
- hydronic systems 196

- I**
- impeller 191, 193
- inches of mercury 24
- inches of water column 10
- inches of water gage 10, 119
- indoor fan 2
- inlet dampers 183

inlet guide vanes 134, 174
inlet vanes 134

L

latent heat 21, 51, 52
lighting systems 277
linear slot diffuser 155
low limit 159
low pressure 127
low water cutoff 272
lubrication 100

M

main air 218
make-up air 4, 10, 68
manual dampers 155
manual valves 203
mechanical chiller 105
mechanical compressors 95
medium pressure 140
metering devices 76, 88, 90
microprocessor 221, 222
mixed air 11
 control 159
 economizer 159
 plenum 2, 11
 temperature 36, 65, 72
moisture content (specific humidity) 28
motor cooling 110
motor horsepower 19, 20
motor sheave 294

N

negatively pressurized 10
non-diverting 157
non-overloading 127, 130, 132
normally closed 185, 229, 233, 234, 236, 238

normally open 185, 229, 230, 233, 234, 236, 237

O

oil burners 62
oil pressure 112
one-pipe systems 197
open compressor 96, 97, 104
open system 197
opposed blade damper 156
outdoor fan 3
outlet velocity 122, 123
overloading 128

P

packaged units 91
package HVAC system 2
package units 246
parallel blade damper 157
parallel flow 215, 253
perforated face diffuser 154
performance curves 122
plate heat exchanger 253
plenum 11
pneumatic control system 218
pneumatic systems 220
positive pressurization 10
pounds per square inch absolute 23, 50
pounds per square inch gage 23
pressure 23, 50, 137
 classes 54
 dependent 145, 151, 168, 169
 independent 145, 146, 168, 171
 independent variable air volume 164
pressurization 4
process-to-comfort 252, 255
process-to-process 252, 256

-
- propeller 124
 fan 126
- psychrometric chart 22, 25, 33, 73
- pump operation 191
- R**
- radiation 18, 253
- reciprocating 105
 compressors 95, 96, 98, 99, 101
- refrigerant 5, 6, 14, 76, 77, 78, 89,
 90, 91, 106, 107, 108, 109, 110
 coil 88
 vapor 106
- refrigeration (DX) systems 5
- refrigeration cycle 74, 76
- register 154
- relative humidity 29, 69, 70
- relay 236, 237, 238, 239
- reverse-return piping system 200
- reverse acting 185, 227, 228, 229,
 230
- revolutions per minute 123
- room pressurization 4
- room temperature 22
- rotary compressors 95, 102
- rotary wheel 253, 257
- run-around coil 253
- run-around system 259
- S**
- safety controls 113
- scaling 283
- screw 105
 compressor 103
- sensible cooling 31
- sensible heat 20, 21, 30, 51, 52, 73,
 254, 255, 256
 ratio 28, 34
- service valves 205
- setpoint 228
- soot deposits 270
- space pressurization 11, 68
- specific heat 20, 52, 69
- specific humidity 69, 70
- specific volume 27, 30
- standard air dot 29
- standard temperatures 16
- static pressure 121, 122, 123, 141,
 163, 168, 175
 control 167, 174
 dampers 134
- steam heating 50, 54, 57
- steam traps 54, 55
- strainer 193, 194
- subcooling 79
- superheat 77
- superheated 79
- superheating 77
- supply air fan 14
- supply fan 9
- surge 122, 123, 129
- system design 114
- T**
- temperature 15
- terminal boxes 139, 140, 141, 142,
 166
- thermostat 228, 229
- three-pipe systems 199
- three-way valves 206
- throttling range 227, 235
- tip speed 123
- total heat 21, 52
- total pressure 121
- transducers 222, 223
- tube axial 124
 fan 126
- two-pipe systems 199

two-way valves 206
TXV 90, 91

U

unitary air conditioner 92
unitary heat pump 91
unitary systems 91, 246, 248, 249
units of electrical energy 19
units of heat energy 18

V

valves 100, 102, 234
vane axial 124, 127
 fan 125, 126
vapor-compression system 5
vapor compression 85
vapor pressure 29
variable air volume fans 133
variable air volume terminal box
 145
variable frequency drive 135, 136,
 168, 175
variable pitch vane axial 126

variable speed drive 175
velocity 7
 pressure 121, 193
ventilation 4, 10, 13, 66, 68
volume dampers 9, 156
volume of airflow 7, 11
vortex dampers 134, 174

W

water-cooled 89
water-side economizer 290, 292
water-to-air cooling system 85
water-to-water cooling system 81
water chiller 7
water coil 5, 6, 88
water cooler 7, 88
water pump 13, 14, 193
water systems 23
water tube 60
water valves 9, 203
wet bulb (WB) temperatures 22,
 26, 73
wide-open cfm 121