

# **An Introduction to Orgone Matrix Material**

**AN OVERVIEW OF ORGONE MATRIX MATERIAL**

**ITS MANUFACTURE - ITS APPLICATION - SELECTED RELATED INFO.**

Fifth Edition © 2002-2004 Jon Logan

Published by Wizzer's Workshop - Quality metaphysics tools



☎ 250-446-2032

✉ Mail – PO Box 139, Westbridge BC V0H2B0

🌐 Url – [www.littlemountainmudge.com](http://www.littlemountainmudge.com) Email – [wizzer@littlemountainmudge.com](mailto:wizzer@littlemountainmudge.com)

## What is orgonite?

The word "Orgonite" refers to a new class of materials which are composed of a mixture of metallic particles suspended in an organic medium. The term "Orgonite" was coined by Karl Welz, the man who is generally credited with inventing it. Though initially intended by Welz to refer only to his commercial product, the name stuck- and has come into usage by most people familiar with the material. So... I suppose in the mind of Karl Welz and few other folks, orgonite means Welz's individual recipe, but to most others it has come to mean any material produced using the same basic conceptual approach. In any case, it refers to an orgone matrix material, as opposed to a layered orgone accumulator. To a degree, a piece of orgonite will act as an orgone accumulator in that it will tend to attract orgone from the area around it, but with an added dimension. The added dimension is that it will process the orgone energy as it interacts with it, whereas an orgone accumulator more simply condenses orgone energy.

There are many variations on the basic concept of suspending the metal within the organic element (as opposed to using thin layers of organic and metallic substances like in an orgone accumulator), and many other substances which can be added to the mixture to make it more potent, or to specialize it for different applications. Most of the people producing orgonite wind up developing their own exact recipes, I use several different recipes for slightly different applications. At the end of the day, the basic, fundamental ingredients of orgonite are metal particles and an organic medium to suspend them in, usually resin.

A wide range of metaphysical disciplines all work with the same energy, know it by various names ... (orgone, odic force, reiki energy, prana, chi, etheric energy, bio energy, bio magnetic energy, huna energy, animal magnetism, soft electrons, mass free electricity, radiesthetic color, astral energy, 4th dimensional energy, emotional body energy, life force energy, and no doubt a bunch of other names I have never even heard of) ... and so far orgone matrix material has proven itself a to be a readily adaptable and highly functional conceptual approach for work in these areas. Orgonite, (by any name) both releases orgone energy when stimulated by other forms of energy, and has the capacity to change orgone from one state to another. It is especially suited to taking the energy from an unhealthy state into a healthy, balanced state, and/or adding a selected property to the orgone energy which it processes. This makes it useful in a wide range of applications, from alternative health through to radionics and other traditional metaphysics.

Organic substances attract ORgone energy and soak it up like a sponge, while metallic substances tend to repel it. Basically, ORgonite pulls in the ORgone energy, and while the energy is inside the device, The metal particles and organic resin both push and pull on it in all directions at the same time. This puts the energy in a scrambled, chaotic state. When the energy comes back out of the device, it collapses back into an organized, defined state. As a side effect of being scrambled and put back together, it comes out clean! DOR is converted back into OR as it passes through the orgonite. (DOR=Deadly ORgone Radiation... Harmful ORgone. OR=ORgone Energy, the Healthy kind)

Orgone matrix material, or orgonite, has not only the property of changing OR (Orgone) from one form to another, but also the property of 'generating' OR when stimulated by other kinds of energy... like light, sound, physical motion, or electricity. When using a matrix of randomly arranged particles instead of orderly layers of the two substances (metal and organic) you get a different effect. Some benefits of using a matrix are:

A: Increased efficiency (higher proportionate orgone potential to mass) compared to a traditional ORAC.

B: Changes DOR (harmful ORgone) to OR (Healthy ORgone)... When orgone passes/percolates through the matrix, it is in effect reduced to its component polarities of + (positive/masculine/hot), 0 (zero point/omni potential/infinite), and - (negative/feminine/cool). It is then recombined, and re-emitted. The act of being broken down into its positive and negative charges and recombined basically flashes it across the 0 state and has the effect of restoring the orgone to a 'base' state, i.e.. it is no longer 'healthy' or 'unhealthy' orgone, it is no longer orgone of any specific 'color', rather it comes out of the matrix material as more or less undifferentiated orgone. That which makes the orgone 'colored' or differentiated is (oversimplified a tad) basically encoded in the proportions of +/-, (+/-)0, and in oscillation rate between + and -. When the orgone exits the matrix material, the conditions which 'force' it to exist in an undefined state no longer exist, and so it collapses back into a defined state, and is 'colored' to varying degree by the exact composition of the matrix material and any minerals/other substances included in the matrix.

C: Orgonite does not actually generate orgone, in the truest sense of the word, but I suppose that is a technicality. Orgonite, when excited with other forms of energy, both converts a portion of the energy used to excite it into orgone energy, and draws additional orgone energy from the Aether (the cosmic omni potential 'pool' of orgone energy that has yet to be 'put to work' in 3D terms), and puts it to work as orgone manifest in 3D terms. Thus for practical intents and purposes, orgonite 'generates' ORgone on demand when excited by scalar waves, magnetic fields, heat, sound, light, electrical energy, kinetic energy, etc.

## HHGs and TBs

The type of orgone device which is commonly called a 'Holy hand grenade' is a medium-sized device which attracts harmful ORgone energy, converts it to healthy ORgone energy, and emits it again as a flow of healthy orgone energy. This is different from other orgone devices used up until this point, which had the ability to block or collect harmful energy, but not convert it to healthy energy. The device gets its name from an old Monty Python movie ; )... When placed in an area, buried, or placed in a body of water, the ORgone Holy hand grenade will act to continuously clean the ORgone energy within a surprisingly large radius (average 3/4 mile radius from the device). A TB (Towerbuster) does basically the same thing on a little bit smaller scale. The effective range of a towerbuster is generally somewhere around 1/4 mile.

A basic TB is a small (3 to 8 ounce volume), usually cylindrical or conical mass of orgonite with a quartz crystal embedded in it. Generally the xtal is on the vertical axis if the device is tall, and on the horizontal axis if it is disk-shaped. A basic HHG is a little larger (usually 8 to 32 ounce volume), usually conical or pyramidal mass of orgonite with 5 double terminate quartz xtals embedded in it, one of them on the vertical axis and four of them on the horizontal axis. The vertical xtal is near the small end of the device, and the horizontal xtals are arranged radially, near the wide end of the device. Don Croft invented these two devices to counteract the adverse physical and mental health effects of HAARP, GWEN, ELF, SCALAR and HPRF transmission towers. In addition to serving well for this purpose, the HHG and TB devices are highly effective multipurpose energy cleaners. Think of them as air freshener for your aura.

To use one of these devices, simply place the device within an area and leave it alone. If possible, it increases the effectiveness to put them into a body of water or bury them in the earth. It is not necessary to bury them or put them in water, and most folks who use them have a few in their homes, to provide a constant cleaning action for the orgone envelope in their living space. With the HHGs, it helps a bit to align the device with the magnetic field of the earth, so that one of the xtals in the base of the unit points north. People who are familiar with natural energy vortices, Curry and Hartman lines, Ley lines, and so forth have been using these devices to restore many of the earth's energy centers to healthy state. This process is generally referred to as 'gifting' or 'towerbusting'. As should be no surprise to anyone familiar with orgone (by any name), many of us have noticed beneficial changes in the behavior of people within the effective range of such devices, whether they are aware of its presence or not. They are, in effect- getting the same sort of emotional healing and balancing (and in some cases the commensurate physical benefits) that one would expect from more traditional methods of life energy therapy. For several years I used xtals for basic pain relief and first aid in energy work on myself, and now I use something which is basically a fancy TB.

These devices can also be used as meditation aids, used by holding it between the hands while meditating, or by sitting near it while meditating. They can also be carried on the person in order to afford a constant cleaning action for your personal energy fields, and provide shielding against various forms of energy assault, ranging from psychic attack to EM pollution. And, while the devices can be used as intent amplifiers /radionics boosters, IMO there are more specialized orgonite devices which perform that task better. I have noticed that suspending water over the top of an HHG does charge it with orgone energy, and I regularly use this kind of charged water as a general tonic, I find that it has beneficial effects both physically and energetically (vitality, clarity of thought, emotional balance).

One thing which the HHGs and TBs seem to be good at is serving as a basic life energy therapy device, to speed healing and, in some cases, relieve pain. I of course am not a doctor, and am not giving you medical advice, and that applies to everything on this site, bla bla bla. There are several folks who find a TB or a slightly modified TB to be very useful (when held in the practitioner's hand or over the problematic body area on the person being treated) in Reiki, Reflexology, Massage Therapy, healing hands, and so on and so forth (these are all systems which effect healing by working with the human body's orgone energy).

Unlike orgone accumulators, These devices do not have to be carefully protected from EM pollution and DOR. They convert DOR to OR, so I think it is a good idea for most everyone to make at least one or two and put them in their homes, and enjoy the benefits of a healthy life energy environment where they live. As with some of the other similar devices which are already in use, these devices have applications in agriculture and alternative health, in addition to their primary function as an 'energy cleaner'- a device which processes life energy and removes harmful properties in so doing. Every day, we all take a bath in more energy pollution than most folks care to think about, ranging from huge uses of metaphysics with some very nasty intent behind it, to the modern phenomenon of technological assault on natural weather patterns (HAARP), The human mind and body (GWEN), and the harmful effects that various more mundane electrical systems have on life energy. These devices have been shown time and again to have a beneficial effect on the life energy of a given area, being adapted to many uses beyond the original purpose for them, and for which they are still heavily and successfully used, which is to restore natural weather patterns to the environment around us by mitigating or nullifying the effects of weather control technology.

I have seen no evidence that HHGs or TBs will become saturated with DOR from prolonged exposure, but I have seen that such devices have a processing capacity, and that capacity may be exceeded. I have been able to deal with that in most cases by simply using more devices. The capacity of the device is determined by the mass of the device, (larger mass of orgonite = more capacity) the way the internal components are assembled, and the composition of the orgonite itself. I have not found it necessary to move the HHGs and TBs around in order to keep them working, but I have noticed that doing so excites them and 'stirs things up' quite a bit. The exception to this is when you are using them to create a perimeter or clean field in or around your home or another area, in which case you ought to install them by placing them, rotating them clockwise until it 'feels right'... and then try to avoid moving them. Once moved, it takes some time for the fields to re-establish themselves. Where several devices are linked together to create a shield or ley line, moving one causes the whole thing to wobble. Stimulating one of them also stimulates the whole of the field in which the linked devices are included. If you have an SP, or a wand, or even a favorite xtal you use for a beamer you can go around the perimeter clockwise and touch each of the TBs with the tip of your device as you go around. This assists in linking the devices together.

The reason they work better when buried is that the orgonite works a bit more efficiently when in contact with the earth, since the orgone 'resistance' of air is slightly higher than the orgone 'resistance' of earth. Therefore, when the energy flows through the HHG or TB, it can flow a little more quickly if it is buried, because it has a huge potential (the earth or the body of water) to which it is grounded. Even if you do not bury them, just tossing TBs into a problem area works fine, burying them is a boost, and not absolutely necessary. Good thing, because there are many places where burying them is impractical. If possible, toss them where they will land in water (best) or on earth, as opposed to pavement. Drop one in your annoying neighbor's bushes hahaha ...

### Orgone Accumulators, Orgone generators and Orgonite

The basic difference between orgone accumulators (ORACs) and orgonite is that orgonite processes orgone energy, whereas ORACs condense orgone energy. Some devices employ orgonites processing ability to 'generate' orgone from other forms of energy, and some devices employ orgonites processing ability to change orgone from one state to another. Examples of this latter use are changing orgone that is in an unhealthy state into a orgone that is in a healthy state, or converting orgone into the state which is most suitable for a given purpose at a given time (say, for therapy or radionics, etc.).

An orgone generator is a device that both collects orgone, and translates other forms of energy into orgone energy. It is possible, using orgonite, to convert heat, light, sound, scalar, kinetic, electrical and magnetic energies into orgone energy. Some people call orgone cleaners 'orgone generators', and in fact the man who invented orgonite has patented the term orgone generator, so indeed there are people who would define these terms differently than I do. However, I am trying to make the point that there are different functions involved, and as long as you are aware of them I suppose it does not matter what you call the, except for the sake of convenience in establishing a cohesive terminology with respect to orgonomy. Orgonomy, by the way, is a name for the study and application of orgone energy.

(Sigh), now... Orgonite does not actually generate orgone, in the truest sense of the word, but I suppose that is a technicality. Orgonite, when excited with other forms of energy, both converts a portion of the energy used to excite it into orgone energy, and draws additional orgone energy from the Aether (the cosmic omni potential 'pool' of orgone energy that has yet to be 'put to work' in 3D terms), and puts it to work as orgone manifest in 3D terms. Thus for practical intents and purposes, orgonite 'generates' ORgone on demand when excited by scalar waves, magnetic fields, heat, sound, light, electrical energy, kinetic energy, etc.

An orgone cleaner is a device that allows orgone to pass through it, and in the passing revitalizes the orgone energy. In addition to revitalizing the orgone, cleaner devices which employ orgonite or other similar conceptual approaches selectively remove and add qualities form the orgone. Again, there will be more articles at some point in the future which go into this matter further, but for now bear in mind that a cleaner is different from both a generator and an accumulator. HHGs, TBs, and Chembusters are examples of orgone cleaners. Also, it bears mentioning that orgonite-based orgone cleaners are not filters, though if overloaded or insufficiently grounded they will still function as filters. A filter picks the bad stuff out and collects it, and you have to periodically clean or replace the filter. Some folks have found that when their HHGs are not grounded well enough, they have to periodically refresh them by sitting them on the earth or in running water for a few hours. But, if the HHG is in contact with earth or moving water, or connected electrically to the house electrical ground (I'll be producing a kit for this so you can modify your HHG easily at home... still in the testing phase, looks promising so far... and of course I'll post instruction so you can do it even if you do not want to buy it from me hahaha), then the HHG actually converts the bad stuff into good stuff, as opposed to just filtering it out. That is the chief benefit of orgonite-based orgone cleaners, and that is what they are designed to do, and that is what they do when they are constructed and installed properly.

An orgone accumulator is rather like a big capacitor. It is a device, usually in the form of a closed container, which collects the orgone energy from the surrounding area and stores it inside the container. Like a capacitor, an ORAC will collect as much orgone 'pressure' as it can hold, and then it will release some of the orgone so that more can come in. Therefore, it runs cyclically, if often the cycles may be days and months apart, instead of the fractions of a second which we call Hertz when considering the cycle duration of electrical capacitors. Unlike orgonite, an ORAC does not process the orgone, so it can collect a store of orgone on the inside of it which is either good for you or bad for you, depending on the condition of the orgone energy fields in which it is located. It will just collect whatever kind of orgone energy is around it. It is a good idea to have an HHG or TB inside your ORAC if you plan to build one, since most of our electrical grid produces a kind of orgone energy that is unhealthy, and ORACs operated within the EM fields produces by electrical appliances or high tension power lines tend to become saturated with this unhealthy orgone. Thanks to the higher levels of masonry for the decision that 60 Hz is the frequency of alternating current we use in North America. In terms of pulse rate, orgone is not in a healthy state when it pulses at 60 cycles per second (orgone energy will often pulse in sympathy to an electrical current which passes through it. 60 cycle electricity passes through the earth's orgone fields and puts them into a state which is more or less inimical to most living organisms). Of the places in your home to place an HHG, near your electrical mains (don't shock yourself and don't sue me. i mean to put it near the mains, not electrically connected to them) or fuse box is a likely candidate.

An ORAC is able to collect the energy because the sides of the container are composed of alternate layers of metallic and organic material. This arrangement of layers produces something like an orgone 'diode'. It is easier for the orgone to travel one direction through the lamination of metallic and organic layers, and much harder for it to travel in the other direction. So, like a diode, the layers move orgone in one direction. Build a box out of this material, and it will collect and condense orgone on the inside, since it can get into the box much more easily than it can get out. The ORAC was invented by Wilhelm Reich about 70 years ago.

Another thing to bear in mind is that TBs, HHGs, and chembusters will, to some degree, respond to the energy environment around them, becoming more active when there is a lot of DOR or unbalanced, harmful life energy around them, and less active (unless excited) when there is little problematic energy around them. They also respond to large potentials of healthy life energy when they are near them, and will often appear to sit inactive when the energy around them is relatively clean and undisturbed. If you are using an HHG to charge water, for example, it is a good idea to use sound or light to stimulate it, so that you can make sure it is active. Assuming you have the proportions of metal and resin correct, and the particle size of the metal is within working parameters, It is not possible for a TB or HHG to become saturated with DOR the same way as an ORAC because the orgonite has a quality of processing the orgone from one state to another, whereas an ORAC does not. I and several other use TBs to keep our ORACS clean, and (with a TB in it) I have been using a small cylindrical ORAC less than two miles from a large power line without any problems, this for years now (a/o mar 2004).

## Chembusters and Cloudbusters

There is a lot of controversy on this subject now, and to be honest I consider it important to distinguish between a Croft-style Chembuster and a Reich-style Cloudbuster. After having had a chance to experiment with both devices, I find that they are indeed different in function. A Cloudbuster is a device invented by Wilhelm Reich about seventy years ago, and it uses orgone energy to influence weather patterns. It is basically an array of parallel pipes which are in turn connected by means of rubber or other organic hoses to either an ORAC or a body of moving water. It relies on the circulation of orgone energy within the water bodies of the earth to clean the orgone by virtue of the action of moving water over stone, this action takes place in riverbeds especially. A Chembuster (or Croft-style Cloudbuster) is a slightly different device, which is based on the Cloudbuster in that it uses a parallel array of pipes to channel orgone energy, in order to affect the weather patterns in the area around it. The main difference between a Cloudbuster and a Chembuster are that a Chembuster has a ballast of organite, while a Cloudbuster is grounded directly from the pipes to the earth, or water. And since organite processes orgone energy instead of simply collecting it or moving it around a Chembuster cleans the orgone as it passes through. A cloudbuster does not.

Although both Cloudbusters and Chembusters generally pull orgone in the form of DOR down from the atmosphere and channel it into the Earth, it is possible for both devices to work in the opposite direction and send orgone from the Earth into the atmosphere. In both cases, it is the changing orgone fields which affect weather patterns. I do not approve of novices using Reich-style Cloudbusters, but I do approve of just about anyone using Chembusters. This is because a Chembuster is a great deal more user-friendly than a Cloudbuster. A Cloudbuster, used carelessly, can cause tornadoes, imbalances in the earth's orgone fields, and torrential rains or severe droughts. It is nonetheless a very useful device, but one which requires knowledge both of meteorology and organomy in order to operate beneficially. The Chembuster, on the other hand, functions more like a 'safety release valve' between the earth and atmosphere, so that it becomes more active when there is a large unbalance in the ambient orgone fields and less active when the energy around it is in a balanced and healthy state.

I have some other articles coming which go into this matter further, but for now suffice it to say that you can cause problems with a Cloudbuster if you do not know what you are doing, but this is not true of a Chembuster, and that is because a Chembuster uses organite and quartz crystals to clean the orgone as it passes through, whereas a Cloudbuster does not. It is possible to further enhance the function of a Chembuster by grounding it to the earth. After experimenting with it for some time, I generally ground the organite base of my Chembuster instead of grounding the pipes, because if you ground the pipes, then the device will appear to work more rapidly, but what it is actually doing is dumping the excess DOR into the ground rather than cleaning it. In my opinion, grounding the copper pipes directly is no better than a Reich style cloudbuster, because it is just dumping the DOR into the ground. If you are doing this, then you ought to add some HHGs and TBs or equivalent right near the ground wire where it enters the ground. Also, a wet ground is better than a dry ground. It is better to ground the Chembuster to moving water or wet earth than to dry earth. If you are grounding it to dry earth, you should use a long wire to maximize contact with the earth. You can either attach a length of copper wire to the organite, or just cut the bottom out of your bucket and let the organite touch the earth.

## Organite Density

Not all organite is the same. The size of the particles used makes a lot of difference to the finished product. Below is a short description of some of the different grades of organite with which I have worked. Organite can be used for different devices, and the intended function of the device determines what kind of organite is best to use. Different materials offer differing amounts of resistance to the orgone as it flows through it, and the different grades of organite have sequentially higher 'orgone resistance' values.

### LD - Low Density Organite

Low Density organite offers very little resistance to the orgone as it flows through the device. This means that the device is not very suited to cleaning the orgone, it will not convert DOR to OR with much efficiency. But, since it attracts the orgone and allows it to flow through it very easily, low density organite is useful for sending and receiving orgone energy, and for collecting and moving orgone energy from one place to another. One place I often use LD organite is to make a channel or layer of LD organite within an orgone device, which acts like a wire to conduct the orgone along a chosen path inside the device. LD organite also works well as an orgone 'antenna' to send and receive orgone energy within a network of devices. LD organite does not work well on its own for making TBs and HHGs, but a thin layer of LD or VLD (Very Low Density) organite at the base of an HHG or TB assists the device in grounding to the earth more efficiently. LD organite will release some orgone when excited, but not very much.

### MD - Medium Density organite

MD organite offers enough orgone resistance to foster the cleaning action for which organite is well known, and works as a material from which to make TBs and HHGs. MD organite has a dense enough matrix to convert DOR to OR, but does not work very efficiently in an orgone-on-demand generator. It offers low enough orgone resistance to function well in a passive mode, and high enough orgone resistance to still afford the 'scrubbing' action which is desirable. MD organite will release some orgone energy when excited by external energy sources, but like LD organite, still not very much. The orgone resistance is low enough in MD organite that much of the energy used to excite it either passes through it or is attenuated. It is more suited to use in devices which are meant to operate in a passive mode. TBs, HHGs and Chembusters are generally meant to operate in a passive mode. While MD organite may not be the absolute best thing from which to make TBs and HHGs, it will work nonetheless.

## MHD - Medium High Density orgonite

MHD orgonite is imo the most efficient type of orgonite from which to make TBs, HHGs, Chembusters and other devices which operate in a passive mode. MHD orgonite offers just low enough orgone resistance to operate in a passive mode, but offers high enough orgone resistance to maximize the 'scrubbing' action while still in a passive mode. MHD orgonite will convert DOR to OR efficiently without being excited by external energy sources (other than a potential of DOR to convert into OR). Because of its higher density, MHD orgonite will also release orgone when excited, and it will do so with more efficiency than MD orgonite. MHD orgonite works well to construct devices which are intended to operate in both passive and active modes. The spaces between the larger particles are filled with smaller particles. This is also the grade of orgonite that I make my HHGs and TBs from now. See the 3 small pics below? MHD orgonite can be gotten by either using smaller particles, as in the two cases on the left and center, or by adding superfine particles to the resin and then using larger metal particles which would ordinarily produce MD orgonite. Either way will produce MHD orgonite. I use about 2 teaspoons of mineral 'flour' to a liter of resin.

## HD - High Density orgonite

HD orgonite offers a much higher orgone resistance than MD or MHD orgonite. The scrubbing action provided by HD orgonite is plentiful, provided it is excited in some way. TBs and HHGs made from HD orgonite need to be placed in an area with extreme inimical energy problems if they are to do much. They also benefit from being electrically grounded, though I suppose it is not absolutely necessary. TBs and HHGs made from HD orgonite can be a bit smaller than ones made from MHD orgonite, and still do the same job, provided they are excited in some way, either by external energy sources or by a LARGE potential of DOR to convert into OR. One place in which TBs and HHGs made from HD orgonite work well is on or near household electrical appliances. To make a long story short, HD orgonite processes orgone more efficiently than MHD orgonite, but you need to 'push on it' in order for the orgone to go through it very fast at all. There are few if any large particles, and that there is not very much space between them. HD orgonite does not work very well for devices which are meant to operate in a passive mode, but it does work well for devices which are meant to operate in an active, or 'powered' mode. HD orgonite works well to make orgone-on-demand generators which convert other forms of energy such as heat, light, sound, EM or scalar waves into orgone. HD orgonite works well to make intent amplifiers. HD orgonite can also be used inside an orgone device made from lower density orgonite to control the pattern of energy flow by offering more resistance at select places inside the device, acting like an 'orgone pressure valve' so that orgone will not pass through it until it has reached a sufficient intensity. HD orgonite is the highest density at which orgonite will work both in the passive and active modes, but is more suited to the active or 'powered' mode.

## XHD - Extra High Density orgonite

XHD orgonite does not work very well in a passive mode, and does not appear to be doing much of anything until it is excited by some form of external energy. When excited by heat, light, physical motion, sound, EM fields, electrical current, scalar waves, etc., XHD orgonite is VERY efficient at producing orgone energy. XHD orgonite has uses in the internal composition of orgone devices built from lower densities of orgonite, just like HD orgonite, but is especially suited to making orgone-on-demand generators which are designed to operate in an active or 'powered' mode. Note the particle size, all of the have gone through a 1 mm sieve, the largest are about 1.5 x 1 mm, and the majority of the particles are in the form of a fine powder like flour. When making HD or XHD orgonite, you can add the organic part of the orgonite in the form of small particles, and just use enough resin to hold the mass together. While XHD orgonite works very well for making devices which operate in an active mode, it does not work very well at all for devices which operate in a passive mode, except as a small part of the finished device.

## Different materials for making orgonite

While many people now use polyester resin and metal particles from a machine shop, there are many different materials from which orgonite can be made. In my experience, not all of these combinations produce a very durable substance, but in some cases produce more orgone than the basic polyester resin and metal filing mixture

### Cheap orgonite from waste paint

An extremely cost-effective and colorful variety of orgonite with which I have been experimenting. The orgonite is not especially durable, and needs to be kept indoors or recast in plastic resin to seal it from the elements. It is made from old latex paint (often free at recycling depots) and commercially available waste paint hardener ( about \$3.00 CDN for enough to do 2/3 of a gallon). The waste paint hardener is in the form of a small packet of crystals which, when mixed into the paint, cause it to solidify. The metal has to be mixed into the paint prior to adding the hardener, since it turns stiff almost immediately. The mixture then takes several weeks to dry fully in a large casting like the 3.5" blue TB (with kyanite from revted ;) shown. This can be quickened by making the mixture and spreading it out into a thin sheet, allowing it to dry, and crumbling it into small pieces like the two shown on the right of the picture. The small pieces can then be combined in different colors and recast with just enough resin to hold them together. Doing it this way, you can reduce the cost of polyester resin by 50 to 70 percent, but it takes a lot longer.

Another orgonite recipe is made from polyester autobody filler, mixed with metal shavings and a little aluminum roof patch paint. You have to work quickly, and mix in the metal and paint before adding the catalyst to the autobody filler. While this kind of orgonite is not ideal for TBs and HHGs, it has the advantage of not leaking out of small holes in the molds, and therefore is useful for some hard-to-cast shapes, as it can be forced into the mold in small amounts with a spoon or spatula.

### A few notes about using fine powders in orgonite

You don't need to have NASA grade powdered quartz or ultra fine metal particles. You can use them, but you can also make your own. I make most of my own. One source of copper powder that is easy to get is copper spray paint. Get the cheap kind that rubs off on your fingers after its dry. It is basically metal flakes, solvent, and a little oil. When the solvent evaporates, you are left with fine metal flakes and a little oil. Just spray it into the resin and mix thoroughly. Of course, you have to mix the fine powders into the resin before you pour. Also, if you are using any of the following powders (and probably a few I don't know about)...

copper

paramagnetic earth with high iron content

rust (iron oxide)

white polyester pigment (titanium oxide)

decomposed chalcopyrite (oxidized copper and iron and sulphur)

decomposed iron pyrite (oxidized iron and sulphur)

...then you have to add a bit more catalyst than you normally would, since the copper and paramagnetic earth (some kinds, anyway) slow down the curing (of POLYESTER resin) quite a lot.

There is no answer the question 'which is better, powder or shavings' because the two give different effects. That's kind of like asking whether apples or oranges are better. In short, for an orgone generator (which technically an HHG is NOT) powder is better. For an orgone FILTER/CLEANER (which is what an HHG is) powder can be used as an additive, and you will get a bit more out of it.

If you are trying to make HD orgonite at home, and have problems with the powder settling out, then you can do two things: 1... use less resin! 2... add the organic to the mix in a powdered form and then just use enough resin to stick it all together. To make the higher densities of orgonite, you have to actually mix the ingredients, you cannot just pour the resin over them. Mix all the dry stuff up in a vessel, and then add it to catalyzed resin. Use enough powder that you get a slurry, like oatmeal. Just use a little resin. However, for hhgs and tbs, unless you are gonna put them in a really bad spot or make sure to ground them by burying or tossing in water... you don't want it to be ALL powders. HD max, not XHD. Also, you can make the TBs a bit smaller if they are made from HD than the minimum size they would need to be if they were made from MD. A CB made with HD is a bit different because the pipes create a bit of flow, so there is something to push (or pull) the orgone through the orgonite. Depending on how you have it set up and configured, it may work really well, or not very well at all. Even so, it is possible to get the density too high and 'plug up' the device. I have had that happen before. If you can figure out a way to stimulate it enough, then it will work. One thing you can do is increase the diameter of the pipes a bit to compensate for the density of the ballast. The push or pull provided by the pipes of a CB can act as stimulation for the orgonite if it is of sufficient intensity.

There is one density rating that belongs to the orgonite. Then there is another density rating that belongs to the device as a whole. Ideally, the orgonite density of a TB should be as high as you can get it before it starts to 'plug up'. If you make it too dense, and expect it to work in a passive role, then you will get all discouraged perhaps and say 'it doesn't work'... but that will be because you are basically trying to use a pressure release valve set at 500 psi to relieve 20 psi of peak pressure, understand? Orgonite made with fine particles (high density) works just fine, as long as you use it right. ;)

Anyway, for a TB, the orgonite density should be as high as you can get it and still work, but the overall device density should be a bit lower, so that it will allow energy to flow through it relatively easily. A simple way to say this is the more orgone resistance the device has the better it cleans, but the less orgone resistance the device has, easier energy can flow through it. So you have to find the 'sweet spot' in that range. Imo, for things like TBs and HHGs (as opposed to radionics outputs, pulsers, powerwands, etc) that 'sweet spot' is what I call 'MHD' which stands for 'medium high density'. I also make HD (high density) towerbusters, and they work great... as long as they are deployed CORRECTLY which means being either:

A... right on top (metaphorically speaking) of the tower, or on top of your monitor, or TV, or something else which makes a lot of EM noise...

or B... well buried and spread out a bit in the pattern of gifting.

For HHGs and TBs, what most of us do is to use fine powders as an additive to larger metal particles. Doing this enables us to adjust the density of the orgonite to hit that 'sweet spot' and/or add other energy signatures to the output of the device. So, some people say 'powders are garbage, they don't work' because they try to make TBs with only powders, the density is too high, and (no surprise) it doesn't work. And others say 'well, Welz uses powders so they must be good'. Well... Welz doesn't make devices that have to function in a passive sense, or at least that's not what he's known for. He is not known for making HHGs and TBs. Welz makes devices that use EM (Electro-Magnetic) stimulation to translate EM into orgone, which he then integrates into a radionics machine's output stage. That's why he uses HD/XHD orgonite in his devices. And that's why in devices like my pulsers, ring generators, and so forth, I also use higher densities.

## Ingredients for orgonite

Here are some of the ingredients I have worked with in orgonite, and a brief description of their properties according to my opinion and observations. All pronunciations of usefulness for a given purpose are my own views and based on my own perceptions. I am not giving you medical advice. I am not a medical doctor, but there's a good chance you may be ;) Experiment and form your own opinions. I will do my best to update this page from time to time. By no means are all possible ingredients listed here, nor are all the possible effects of the ingredients listed here. This list is my opinion, and is a work in progress. There are many different ingredients being used in orgonite. There are many different recipes of orgonite being used. Some perform better than others all around, and some perform better for a single purpose. In terms of energy work and metaphysics, whatever minerals are included in the orgonite will, to some degree, impart their energy qualities to the orgonite. The same holds true so far for the energy effects of hertzian frequencies, sounds, colors of light and energy impressions via reiki work or other traditional metaphysical discipline in application. The rate of success with this effect, the orgone signature programmed into the orgonite while it cures, seems to vary. In other words, say you have a little piece of turquoise that you like to use for body work. Or perhaps it is rose quartz. I dunno, it's up to you. Say this little piece of turquoise you have is 1 cc. 1 cubic centimeter. Say you cast it inside of 10 cc of orgonite. Well, now it's like you have between 1.5 and 7.5 cc of turquoise to work with. Suppose you are really finicky and you match the recipe of the orgonite to the turquoise, use minerals and metals that the turquoise likes in the orgonite, and maybe charge the orgonite with the energy signature of turquoise while it cures. Now, it's like you have 11 or 12 cc of turquoise to work with, all from that little 1 cc chunk of turquoise cast inside the orgonite. There are people in the world who know a lot more about the specific effects of various frequencies and minerals than I do, and in fact there is really a substantial body of information on the web dealing with the specific energy effects of minerals, colors, and frequencies. Point being, most or all of this knowledge is transferable to working with orgonite, and orgonite is complimentary to these already well established means of working with energy (sounds, colors, frequencies, minerals, etc.).

*NOTE - Primary indicates that it can be the main ingredient of it's type, and secondary indicates that it can be used as an addition to the orgonite, but should not imo be used as the main ingredient of it's type.. For example, a TB would have to have at least 1 primary ingredient each (or equivalent not listed in the tables below) from the minerals, metals, and organics tables below. Coloration refers to the 'colors' of orgone that a given substance is harmonic to. I am using the same old 7 spectral colors system with which so many of us are familiar.*

### Minerals for orgonite:

Mineral	Coloration	Primary	Secondary	Effect
Quartz Crystal	All	✓	✓	Focuses and directs energy within the orgonite. Holds a program. The basic standby in TBs and HHGs, pulsers, succor punches, chembusters, radionics machines and other orgone devices. Is like the master crystal which will respond to some degree to virtually any orgone energy signature, regardless of color or frequency.
Quartz Powder	All		✓	Enhances overall function of the orgonite. Increases the output and responsiveness of the orgonite. Can be used to adjust the density of the orgonite.
Selenite Crystal	White, Blue, Cream		✓	Provides some coloration. Useful for healing. Useful for cleansing and invigorating.. Holds a program. Similar effects to kyanite but a bit more gentle.
Selenite Powder	White, Blue, Cream		✓	Enhances overall function of the orgonite. Increases the output and responsiveness of the orgonite. Provides some coloration and is useful for healing and cleansing. Can be used to adjust the density of the orgonite.
Kyanite Crystal	Violet, Blue, Silver, White	✓	✓	Focuses and directs energy within the orgonite. A workable substitute for quartz in TBs and HHGs, with the condition that it significantly colors the output into the blue and violet range. Produces a surprisingly sharp energy considering it is mostly in the blue range. Useful for cleansing. Similar to selenite bit more sharp and stronger cleansing influence. Holds a program sometimes, but program parameters are limited to those harmonic to the coloration of the mineral.
Kyanite Powder	Violet, Blue, Silver, White		✓	Enhances overall function of the orgonite. Increases the output and responsiveness of the orgonite. Can be used to adjust the density of the orgonite. Retains most of the properties of kyanite xtals.
Citrine Crystal	Gold, White, Yellow, Red	✓	✓	Focuses and directs energy within the orgonite. A workable substitute for quartz in TBs and HHGs, with the condition that it significantly colors the output into golds, yellow and some reds, depending on how darkly colored the specimen is. Holds a program sometimes, but program parameters are limited to those harmonic to the coloration of the mineral. Useful for cleansing and invigorating.



Minerals cont.

Citrine Powder	Gold, Yellow, Red		✓	Enhances overall function of the orgonite. Increases the output and responsiveness of the orgonite. Can be used to adjust the density of the orgonite. Provides some coloration to the orgonite. Gives a nice warm feel to the energy.
Amethyst Crystal	Violet, Blue, White, Gold	✓	✓	Focuses and directs energy within the orgonite. A workable substitute for quartz in TBs and HHGs, with the condition that it significantly colors the output into the violet and gold range. Useful for healing, and for divining, and for cleansing. Holds a program sometimes, but program parameters are limited to those harmonic to the coloration of the mineral. Useful for divining. Useful also for self-searching.
Amethyst Powder	Violet, Blue, Gold		✓	Enhances overall function of the orgonite. Increases the output and responsiveness of the orgonite. Can be used to adjust the density of the orgonite. Imparts some of the effects of amethyst xtals to the orgonite.
Rose Quartz Crystal	Pink, White, Red, Violet	✓	✓	Focuses and directs energy within the orgonite. A workable substitute for quartz in TBs and HHGs, with the condition that it significantly colors the output into the red range, but a light red, more like pink. Soothing and healing energy, surprisingly mellow considering it is mostly in the red range. Holds a program sometimes, but program parameters are limited to those harmonic to the coloration of the mineral. Invigorating.
Rose Quartz Powder	Pink, Red, Light Blue		✓	Enhances overall function of the orgonite. Increases the output and responsiveness of the orgonite. Can be used to adjust the density of the orgonite. Gives a people-friendly, smooth feel to the energy. Invigorating.
Smoky Quartz	Gold, Brown, Green, White	✓	✓	Focuses and directs energy within the orgonite. A workable substitute for quartz in TBs and HHGs, with the condition that it significantly colors the output into the reds and browns and golds. Strongly masculine energy. Useful for diving and protecting.
Turquoise	Blue		✓	Soothing and healing, useful for pain reduction and physical healing. Strong feminine energy, good for healing and regrowth on many levels. Some shielding action but imo more useful for stimulating recovery from injuries physical or energetic. Strong synergy with blood coral and hematite. Increases orgonite's connection to water.
Hematite	Black, White		✓	Strong connection to the earth imparts a 'stability' to the energy from the orgonite. Increases orgonite's capacity to drain away harmful energy by increasing device's mean energy flow capacity. Use as a grounding stone in place of / in addition to electrically grounding the orgonite to earth. Strong synergy with many minerals, especially imo turquoise and blood coral. Somewhat invigorating.
Lapis Lazuli	Gold, Blue, Red, Violet		✓	Very high energy output from this stone for a variety of possible uses. Too much to go into here. Potent and worth reading upon elsewhere. Invigorating. Manifesting.
Garnet	Red		✓	Provides coloration into the red range. Synergy with amethyst.
Fluorite	Blue, Green, Violet		✓	Provides coloration into the green range, and sometimes into the blue or violet range. Rounds the feel of the energy. Assist orgonite with absorbing program while curing. Useful for healing. Does not hold and execute program terribly well, but stores an impression rather well. Useful as a means of transferring energy signatures from one device to another or storing them for future use. Increases orgonite's connection to water.

Minerals cont.

Mica	Green, White		✓	Enhances overall function of the orgonite. Increases the output and responsiveness of the orgonite. Can be used to adjust the density of the orgonite. Sharpens the feel of the energy from the orgonite. Can be used as an organic. Provides coloration into the high green range. An energy "astringent".
Paramagnetic Earth Chunk	Varies, Generally includes Red and up the spectrum to a variable height.		✓	Strongly increases orgonite's mean output. Provides some grounding action similar to hematite, pyrite and chalcopryrite. Increases orgonite's responsiveness to electromagnetic stimulation. Sometimes invigorating, sometimes soothing. Depends on actual earth being used.
Azurite	Blue, White, Violet		✓	Provides strong coloration into the blue and violet ranges. Similar to kyanite in that it is a sharp blue, not a soft blue. Strong synergy with malachite.
Malachite	Green		✓	Provides coloration into the green range. Strong synergy with azurite. A relatively sharp kind of green energy, useful for cleansing and invigorating.
Agate	Yellow, Brown, Gold, White	✓	✓	Focuses and directs energy within the orgonite. substitute for Quartz in a pinch, but tends to flow more slowly than if quartz were used. Strong connection to earth and fire, useful for some protective/shielding influences.
Pearls	Gold, Silver, Cream		✓	Imparts a lovely smooth 'creamy' feel to the energy hahaha. Useful for cleansing and invigorating. Increases orgonite connection to water somewhat. Helps to bridge between fire and water.
Bloodstone	Red, Green		✓	Very masculine energy. Coloration into both green and red ranges. Useful for soul- search and overcoming obstacles. Tends to be invigorating, perhaps too much so for some.
Glass	All	✓	✓	Focuses and directs energy within the orgonite. A poor substitute for quartz xtal, but useful as a means of controlling energy flow within a device, especially if faceted. Tends to give the energy a bit of a rounding/mellowing effect, and gives some coloration of the orgone if it is colored glass.
Quartzite	White, All	✓	✓	Focuses and directs energy within the orgonite. A slightly Better substitute for quartz Than Cut Glass, But still not as good as quartz. Recommend using at least 3X the mass you would if you were using Quartz Xtal.
Quartzite Powder	White, All		✓	Enhances overall function of the orgonite. Increases the output and responsiveness of the orgonite. Can be used to adjust the density of the orgonite.
Blood Coral	Red		✓	Provides coloration into the red range. Strong synergy with turquoise and hematite. A gentle masculine to balance the strong feminine of turquoise. Increases orgonite connection to water somewhat.
Tourmaline Red	Red, Blue		✓	Provides coloration into the red range. Gentler than garnet.
Tourmaline Green	Green, Blue		✓	Provides coloration into the green range. Gentle and soothing energy.
Tiger Eye	Brown, Gold, Yellow, Red		✓	Increases orgonite's capacity to drain away harmful energy by increasing device's mean energy flow capacity. Use as a grounding stone in place of / in addition to electrically grounding the orgonite to earth. Useful for manifestation and repelling unwanted influences. Useful also for self-searching.
Pyrite Chunk	Dark Red, Gold, White, Black		✓	Increases orgonite's capacity to drain away harmful energy by increasing device's mean energy flow capacity. Use as a grounding stone in place of / in addition to electrically grounding the orgonite to earth.

Metals for orgonite:

Metal	Coloration	Primary	Secondary	Effect
Gold	Gold, White, All	✓	✓	High frequencies. Healing, and lifting of mind upwards. Head in the clouds. Useful for divining, soul-searching, overcoming obstacles, and of course purification. Increases orgonite's response to intent stimulation.
Copper	All, Blue, Red	✓	✓	Very wide response range of frequencies. Boosts flow of orgone through device by increasing dynamic action within orgonite matrix. Gives a smooth feel to the energy. Strong synergy with steel or iron.
Brass	Gold, Silver, White, Blue	✓	✓	High and subtle effects. Quite potent, but may be difficult for some to feel. Good for clearing. Not so good for grounding. Increases orgonite's response to intent stimulation. Boosts flow of orgone through device by increasing dynamic action within orgonite matrix.
Cobalt (in blue glass)	Blue, Silver, White		✓	Provides strong coloration into the blue range. Increases orgonite's connection to water. Boosts flow of orgone through device by increasing dynamic action within orgonite matrix.
Bronze	Red, Gold, Blue, Red	✓	✓	Similar to brass but a bit lower on the scale. Increases orgonite's response to intent stimulation. A bit more grounding influence than brass.
Aluminum	All, White, Blue	✓	✓	Similar to copper but a second to copper in terms of the feel of the energy. A wide range of frequency response and coloration. Strong synergy with steel or iron.
Titanium	White, Silver, Gold		✓	Very high frequencies, and relatively sharp energy. Good for dissolving blockages / clearing / energy astringent. Boosts flow of orgone through device by increasing dynamic action within orgonite matrix.
Steel	Blue, Red, Black	✓	✓	Provides stability to the energy signature of the orgonite. A relatively low response range. Provides some grounding influence. Increases orgonite's responsiveness to EM stimulation.
Iron	Red, Blue, Black	✓	✓	Provides stability to the energy signature of the orgonite. A very low response range. Provides more grounding influence than steel. grounding influence. Increases orgonite's responsiveness to EM stimulation.
Bismuth	Blue, Brown		✓	Strongly increases orgonite's response to magnetic stimulation. Some grounding influence. Boosts flow of orgone through device by increasing dynamic action within orgonite matrix. Increases orgonite's responsiveness to intent stimulation.
Lead	Black, Silver		✓	Very low response range. Provides some stability to energy signature of orgonite. Some synergy with copper and gold.
Zinc	Silver, Blue		✓	Increases synergy between magnetic and non magnetic metals. Strong synergy with copper. Strong catalyst in energy terms, good for manifestation. Boosts flow of orgone through device by increasing dynamic action within orgonite matrix.
Iron Pyrite	Dark Red, Gold, White, Black	✓	✓	Provides a grounding, stable note to the energy form the orgonite. Gentler and a bit rounder feel to the energy than steel or iron.
Chalcopyrite	Gold, Red, Blue, White	✓	✓	Provides some grounding and some uplifting action to the energy form the orgonite. Since it is a combination of iron and copper, it possesses the synergy between these two metals in its natural form. Gives a pleasant smooth and potent energy if used alone, mellows the output and increases the response range of the orgonite if used as an additive.

Metals cont.

Paramagnetic Earth Powder	Varies, Generally includes Red and up the spectrum to a variable height.		✓	Strongly increases both the orgonite's connection to the earth, and the orgonite's responsiveness to EM stimulation. Increases the orgonite's responsiveness to intent stimulation in some cases. May or may not carry it's own potent energy signature to impart to the orgonite. Varies greatly from place to place. Boosts flow of orgone through device by increasing dynamic action within orgonite matrix.
---------------------------	--	--	---	--

Organics for orgonite:

Organic	Primary	Secondary	Comments
Pitch	✓	✓	Wonderful smooth feeling energy. A bit nicer than polyester resin, but less durable. Better imo as a primary than a secondary. I make a fair amount of stuff out of pitch. Will melt in the sun so must be kept indoors or buried. Is ideal for water gifting. Does not dissolve in water. Absorbs a charge well during curing. Strong connection to earth and water.
Beeswax	✓	✓	A workable if not ideal organic primary. Energy output is less than pitch or polyester, and device must be contained somehow. Works better when cold.
Paraffin Wax		✓	Much less functional in orgonite as primary than natural wax. Dunno why.
Carnuba Wax		✓	A little mixed into the pitch gives it a bit 'brighter' feel.
Latex Paint with hardener added		✓	Gives a warm, comfortable, people-friendly feel to the energy when mixed with polyester based orgonite. Often provides coloration according to the color of the paint, but not always. Depends on the chemistry of the paint. With waste paint hardener added, it is a slightly better primary than wax, but not much. Excels as a secondary with polyester., Useful as a means of transferring energy signature form one botch of orgonite to another, for lightening the weight of the orgonite, or for adjusting the density of the orgonite. Absorbs a charge well during curing.
Flour		✓	Gives a warm, comfortable, people-friendly feel to the energy when mixed with polyester based orgonite. Can be used to adjust the density of the orgonite.
Acrylic Plastic	✓		A somewhat smoother feeling yet much more expensive alternative to polyester resin.
Polyester resin	✓		The basic standby against which I measure other organics. Provides some coloration according to the chemistry of the resin. Absorbs a charge well during curing.
Vegetative Matter		✓	Imparts to varying degrees the energy signature of the plants used to the orgonite. Useful for reproducing in orgonite the effects of various herbs. Recommend using well dried, evenly and finely shredded vegetative matter.
Hair		✓	Can be used to permanently link a body of orgonite to an individual. Caution advised. Useful for custom work or tailoring a device to a specific user.
Blood		✓	Can be used to permanently link a body of orgonite to an individual. Caution advised. Useful for custom work or tailoring a device to a specific user.
Dirt		✓	In small amounts can be used to adjust the density. Increases the orgonite's connection to earth.
Incense	✓	✓	Can be used to impart the energy signature of a given incense to the orgonite, if not always the smell.
Sugar	✓		Have not tried this myself yet, but some are reporting success with sugar (hard candy) as an alternative to polyester, similar to pitch.
Honey	✓	✓	Adds a soft, high frequency overtone to the orgonite.
Carbon		✓	Adds a strong grounding influence to the orgonite.

Recipes for orgonite:

Here are some different kinds of orgonite I have been playing with. All pronunciations of usefulness for a given purpose are my own views and based on my own perceptions. I am not giving you medical advice. I am not a medical doctor, but there's a good chance you may be ;) Experiment and form your own opinions. You are responsible for your own safety. *Note - "resin" in recipes refers to catalyzed resin, if applicable. In some recipes, extra catalyst is needed, and given as a percentage value above the regular mix ration. Eg. catalyst +10% means to use the normal amount of catalyst, plus an extra 10% on top of that. The normal resin / catalyst ration for your resin is generally marked on the side of the container you bought your resin in. Particle sizes are given as follows : fine = 0 - 1mm dia., small = 1 - 5 mm dia., large = 5 - 15 mm dia. Proportions of ingredients are approximate.*

<u>Basic LD</u>			
Ingredient	Amount in parts	Process	Comments
Copper - Fine	.05 - .1	Mix the catalyst into resin. Add all other ingredients, stirring continually and pour into mold.	 Useful for creating a path of lower resistance inside of a device, in order to control the flow of energy. On a more basic note, all HHGs and TBS benefit from a thin layer of something like this at their base. Also works nice as cosmetic second coat for orgonite pieces, and has a bit more output than if just resin were used for the second coat. Also some applications in linking modules for radionics devices.
Quartz Powder - Fine	.05 - .1		
Resin	1		
Catalyst	+50%		

<u>Basic MHD</u>			
Ingredient	Amount in parts	Process	Comments
Aluminum - Large	1.5	Mix dry steel and aluminum together. Place mixture into molds. Add xtals / other internal components as applicable. Mix catalyst and resin. Add Quartz Powder to catalyzed resin and stir thoroughly. Pour resin Over metal particles and allow to seep down. Repeat layers as necessary.	 A good all-purpose orgonite recipe. Other items can be added as desired.
Steel - Small	1		
Quartz Powder - Fine	.01 - .25		
Resin	To fill molds		

<u>Basic HD</u>			
Ingredient	Amount in parts	Process	Comments
Steel - Small	1	Mix all dry ingredients together thoroughly. Add catalyzed resin a bit at a time until there is enough resin to just cover the surface of the particles. The mixture should have the consistency of thick oatmeal, and have just enough resin that all the particles are covered. Allow it to sit for a few minute. If there is more than 1/8" (2mm) of resin covering the surface of the particles, add more steel until the mixture is an even thick slurry like oatmeal. Pour into molds. Stir constantly, including while pouring.	 A good basic recipe for use in either heavy-duty TBs and HHGs, or in actively stimulated orgone generators. Different primary and secondary ingredients can be used as desired.
Secondary metal - Fine (copper or pyrite or bronze suggested)	.1 - .25		
Resin	.75 - 1.15		
Catalyst (if using copper or paramagnetic earth)	+50%		
Secondary Mineral - Fine	.1 - .25		
Secondary Organic - Small	.1 - .25		

<u>Basic XHD</u>			
Ingredient	Amount in parts	Process	Comments
Primary Metal - Fine	1	The particles must be fine enough to suspend in the resin. One way to deal with it if this is not the case is to catalyze the resin, wait until it gels, and quickly mix in the other ingredients. Another is to use a thickening agent. In some cases, the thickening agent and the secondary organic can be the same.	 <p>A useful recipe for making orgone generators designed to be driven by outside power sources like zappers, magnetic pulsers, radionics machines and so forth. Also useful in making small orgonite devices to be carried in a pocket and handled a lot.</p>
Secondary Metal - Fine	1		
Resin	3 - 4		
Secondary Organic - Fine	1.3		
Quartz Powder - Fine	.4	Premix all dry ingredients thoroughly, and then add the dry ingredients to the catalyzed resin, stirring continually. Add the dry ingredients a bit at a time. You should get a creamy thick liquid that pours slowly into the molds and still is liquid enough to smooth itself off at the surface. If the particles are settling out, there is too much resin. Usually, resin to dry ingredients should be about 1 to 1, sometimes a little more or less depending on the absorbency of the secondary organic.	
Secondary Mineral - Fine	.3		
Catalyst if using copper	+ 30% - 50%		

<u>Basic EHD</u>			
Ingredient	Amount in parts	Process	Comments
Primary Metal - Small	1	Mix the catalyst into the resin. Add the fine ingredients to the resin. If it is not thick enough at this point to suspend the primary metal particles, add a bit more flour until it is.	 <p>It may take a bit of messing around to get this recipe working right, but it has (especially when made with wheat flour) a gentle, people-friendly feel to it. This orgonite is good for many things, since it basically behaves like MHD. EHD stands for expanded high density. Good for devices which are meant to be used indoors in living space, and / or handled by people a lot. Useful for both passive and active roles.</p>
Secondary Metal - Fine	.10		
Resin	.75 - 1		
Quartz Powder - Fine	.10	Mix all the small ingredients into the resin, a bit at a time. It should come out looking like a thick slurry, with bits of metal visible in it. The metal should not all pile up on the bottom. Internal components of devices (like crystals) need to be supported in some way during curing since this orgonite will most likely not hold them in place during curing like MHD will.	
Secondary Mineral - Small	.25 - .5		
Secondary Organic - Fine (wheat flour suggested)	.75 - 1		

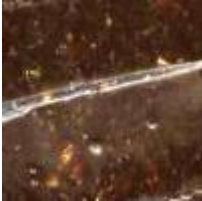
<u>Wood Sprite™</u>			
Ingredient	Amount in parts	Process	Comments
Pitch Resin	2.5 - 3	Melt the pitch slowly over a heat source with no open flame. The fumes from melting pitch may be flammable. Don't burn yourself, wear gloves. Once the pitch is melted, Premix all the dry ingredients except for the citrine. Add the dry ingredients to the pitch and stir well. Then add the citrine. Spoon carefully into molds and allow to cool. You generally have a few minutes only before the mixture sets up once removed from the heat.  Charge with either sunlight or a charged water bath (or both) while cooling.	 <p>A lot of work, but well worth it. Strong connection to the earth, have gotten many obvious reactions from animals when gifting this kind of orgonite to natural energy centers. Also a nice kind to have indoors if protected from hot sun. Mixture will melt if exposed to high heat.</p>
Chalcopyrite or Pyrite - Small	.5		
Aluminum - Large	1.5		
Steel - Small	1		
Paramagnetic Earth - Small or Large	.5		
Dried Crumbled Sage or Chaparral - Small	.3 - .5		
Citrine - Fine	.01		

<u>White Light</u>			
Ingredient	Amount in parts	Process	Comments
Aluminum - Large	1	Mix the catalyst into the resin along with the pigment. The resin should come out bright white and opaque. Place the Large metal in the molds and sprinkle a little of the small metal over it. Place xtals if applicable and pour in enough resin to cover the metal.  Charge during curing with 741 Hz.	 <p>Produces a kind of MHD which is useful for repelling unwanted entities / energies. Also useful for clearing blockages. Energy tends to feel uplifting (as opposed to grounding) and somewhat astringent.</p>
Titanium Oxide White Pigment	Enough to make resin opaque		
Steel or Iron - Small	.25		
Copper or Chalcopyrite - Small	.25		
Resin	To fill molds		
Catalyst	+50%		

<u>Chocolate Shine™</u>			
Ingredient	Amount in parts	Process	Comments
Steel - Small or Large	1	Mix all the fine ingredients together. Mix catalyst into resin and add fine ingredients. If the steel particles are large, then place them in the mold and pour the resin mixture over them stirring as you pour. If the steel particles are small, add them to the resin mixture and stir constantly as you pour the mixture into the molds.  Charge with 15Hz and / or Schumann frequencies while curing.	 <p>Cosmetically appealing and highly EM responsive HD or MHD orgonite. Good for TBS and HHGS as well as generators. Has a warm feel to the energy. Especially suited for work on Geopathic lines, ley lines, Curry / Hartman lines etc. Provided the paramagnetic earth of is sufficient quality, this general recipe has been proven to reduce EMF by conventional testing.</p>
Brass or Copper - Fine	.3		
Paramagnetic earth - Fine	.3		
Citrine Powder - Fine	.05		
Quartz Powder - Fine	.1		
Resin	1.25 - 1.3		
Catalyst	+100%		

<u>Ivory</u>			
Ingredient	Amount in parts	Process	Comments
Copper - Fine	.05	Mix all the dry ingredients together. Add the pigment to the resin along with the catalyst. Sift the dry ingredients into the resin, mixing continually, until you have an event consistency. You should have a slurry with the consistency of oatmeal.  Pour into molds and allow to set. This recipe will usually support the internal components at least somewhat, but is still thin enough to pour into complex shapes.  Charge with both high and low freqs while curing.	 <p>Produces HD organite that tends to exude a milky white color of orgone. Useful for applications in reiki healing hands radionic therapy body work etc. Useful for removing blockages and stimulating energy circulation. Organite tends to have affinity for human body and sunlight. Useful for active roles.</p>
Titanium Oxide Pigment	Enough to make resin opaque		
Paramagnetic Earth - Fine	.05		
Copper or Chalcopyrite - Small	1		
Iron or Steel - Small	1		
Selenite - Small	.3		
Resin	2.5		
Catalyst	+100%		

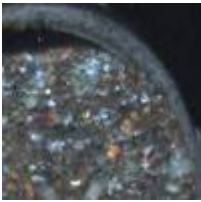
<u>Water Baby™</u>			
Ingredient	Amount in parts	Process	Comments
Blue latex paint with or without charged water added. Paint must be dried out and crumbled.	.3 - .6	The paint is a separate preparation that has to be done ahead of time. Mix 10 drops per liter blue food dye with paint. Then mix the kyanite powder into the paint. Then mix at least .01 part charged water to 1 part paint and dye mixture. Add hardener to paint and / or spread paint out on Wax paper to dry.  The paint has to be dry enough you can crumble it into pieces. It does not have to be fully dry as you will be encasing it in resin. Once the paint has dried enough, crumble it into pieces about 5-15mm dia. (1/4" to 1/2").  Mix the blue paint crumbs and the metal (copper) together. Add catalyst to resin and resin. Place metal mixture in molds and pour resin over the metal.  Use turquoise or blue glass as the secondary mineral.  Charge with the sound of running water while curing, and if possible with moonlight or other silvery blue light. In general, charge in with cool energy as opposed to hot energy.	 <p>Produces MHD or HD with a strong affinity for water. Also can repeat the energy signature of charged water which was added to the paint. Waste paint hardener or other granular, absorbent material is useful to speed the drying out process. Generally the paint takes several weeks to fully dry, so I set a bunch on at time.</p>
Chalcopyrite or copper - Small or Large	1		
Blue food dye.	10 drops per L of paint.		
Kyanite Powder	.01		
Turquoise - Large	At least 1 chunk per unit.		
Resin	To fill molds		This kind of organite is pretty to look at if it comes out right, and it is well suited to water gifting. It also has the quality of not containing any ferromagnetic materials, which is useful for some applications. It is a bit less responsive to EM stimulation than other kinds of organite, but it works very well for charging water when placed in proximity to a glass vessel of water.



## Orgonite and the curing process

In other articles, i have mentioned a few times that charging the orgonite while the resin is curing has a large effect. Here, i will go into that in a bit more detail. All information given here is based on my own experiments / perceptions, and/or things which other researchers / orgonite users / colleagues have confirmed. I am not a medical doctor, and you are responsible for your own discretion.

To start out with, not all organic components are not equally responsive to charging while the resin cures. Polyester resin, acrylic resin and pitch all demonstrate this property in significant degrees. The waxes seem a lot less responsive in this area, something which i attribute to the formation of crystalline structures within the resin while solidification takes place. Polyester resin, for example, is well know in conventional scientific circles to have significant electromagnetic attenuation properties. That means that it absorbs electromagnetic energy. Since energy is never created or destroyed and only changes form, the energy soaked up by the resin has to go somewhere, doesn't it?

After experimenting for a couple of years, i can comfortably say that the way orgonite is treated during construction creates **at least a 70% difference** in the finished product. In other words, by paying some attention to the thoughts, emotions, energies, ect to which the orgonite is exposed when you make it, you can generally get at least 70% more functionality than you would if you did not pay attention to these factors.

Now, i would like to point out that the beauty of orgonite is that you can get that 30% functionality, regardless of how you make it. It is not NECESSARY to charge the resin while it cures, it is an improvement. And in many cases, 30% functionality is more than enough to make a significant difference. But if the orgonite can be made yet more potent, why not do so? If you can optimize the orgonite to work with a specific ailment, or to do a chosen task, then it only seems prudent to do so.

There are, imo, 2 main ways in which the orgonite absorbs a charge / program while it is curing. One way is through the person making it, and the way that they influence the energy while handling the materials. Another way is to expose the orgonite to energies generated by various metaphysical tools while it cures. Obviously, both of these approaches encompass many different techniques. Both of these approaches can be used either alone, or in combination with each other. Myself, i generally use a combination of the two.

It is also possible for the orgonite to turn out with either a sympathetic or a counteractive effect. The frequencies used in the following description are just examples. So, if you expose orgonite to a hertzian frequency of say 15kHz, generated by a device of some kind, the orgonite will become more responsive to that 15kHz frequency. The fact that the orgonite is now more responsive to 15kHz can be applied in one of two primary ways, depending on what thoughts and intent you expose it to, or what other frequencies are present. If you expose the resin to 15kHz and leave it at that, the finished orgonite will tend to amplify the 15kHz frequency effects when stimulated by it. It will tend to produce that frequency effect as part of it's output, converting other energies it is stimulated with INTO the frequency effect of 15kHz. The same applies if you expose the resin to both a weak 10Hz signal and a strong 15kHz signal. It will tend to 'capture' the act of 10Hz being drowned out by 15kHz, and have that function programmed into it. Doing it that way, you are getting a sympathetic effect towards 15kHz.

But suppose you flip it around the other way. Suppose you expose the resin to a 15kHz signal, and at the same time give it a clear mental impression that you want to dampen out and get rid of 15kHz. If you do it that way, you will get a counteractive effect, in proportion to the clarity of the mental impression you give the resin. It will tend to respond well to 15kHz, but instead of amplifying 15kHz, it will dampen it out, and convert 15kHz into other energy 'colors' or frequencies. The same applies if you were to expose the orgonite to a strong 10Hz signal and a weak 15kHz signal. It would then capture the act of 15kHz being drowned out by 10Hz, and have that function as a 'program'.

In reality, the way that different frequencies interact with each other has arguably a bigger effect that the volume of each signal. There are frequencies that are harmonic to 15kHz, and they tend to boost it. There are frequencies that are discordant to 15kHz, and they tend to dampen it. So, both the relative strength of each signal and the effects of signals on each other produce an effect.

By default, orgonite seems to produce a sympathetic effect to that which excites it during curing. In other words, if you want to get a counteractive effect, you have to 'tell' it you want a counteractive effect. This, doubtless, is why some towerbusters have a greater effect than others. Many people are programming the orgonite with a counteractive effect to the tower's signals, whether or not they are consciously aware of it. Many other people are not, and so the orgonite is running at varying degrees of efficiency. Rather than criticizing, it is my hope that this will help people all around to improve their orgonite manufacture.

People who are already doing reiki, visualization, or other traditional metaphysical disciplines will find that whatever energy they put into the mixture will, to some degree at least, become a permanent part of the finished orgonite's energy signature. This applies, of course, whether or not a person is consciously using metaphysical discipline of some variety. Even if a person is not consciously directing energy into the orgonite while it cures, their thoughts and emotions, the state of their mind, the things they are thinking about while working with the materials... these all have some effect on the finished product. It appears to me (so far) that consciously directing your energy into the orgonite often produces a greater change in the finished product than not. The exception to this would be states of great emotional intensity. If you are in a state of emotional excitement, then a part of that emotional energy will be picked up and integrated into the orgonite.

So, if you are a person who uses prayers, affirmations, declarations, visualization, intent or the like, then you can program your orgonite with these techniques. One thing to bear in mind if using minerals other than quartz crystals is the kinds of jobs that various minerals are suited to doing. For example, if you are making orgonite and programming it to get rid of toxins in the body, then you could make that process either more efficient or less efficient, depending on what minerals you include. If you include minerals that have the effect of stimulating the body to release toxins, then the mineral and the program are harmonic. If you use a mineral that stimulates the body to absorb energy but program the orgonite with a purgative effect, then the result will generally be a bit less effective. In short, the orgone output spectrum of the finished orgonite is defined by a COMBINATION of the ingredients and the programming, so it pays to give a little thought to how you put those 2 factors together.

So what if you are making orgonite and you inadvertently put a bunch of nasty thoughts / emotions into it? Well, they WILL affect it somewhat, but not enough to reduce its effectiveness beyond the 30% line, in my experience. They will make it work less well, but not stop it from working entirely imo. One thing i have discovered is that say, for example, you think 'issue X is horrible'. well, you don't want the orgonite to enhance the horrible nature of issue X, obviously. But once you have thought that thought, it is difficult if not impossible to take it back. So give the orgonite a counteractive program with respect to issue X. Immediately think another thought, namely, that you wish to direct the healing / clearing properties of the orgonite toward issue X, and work on the problem. This produces orgonite that works specifically (counteractively) on issue X. Not a bad recovery from a little slip of the mind. Practitioners of radionics will likely be familiar with this concept, point being the concept is of course transferable to orgonite manufacture.

Another example. Some time ago i made some orgonite TBs which had a few flies fall into the resin while it was curing. I didn't think it that important, though maybe i felt a little sorry for the flies. The orgonite came out with a sympathetic effect towards houseflies. It was amazing to watch how they just couldn't leave it alone. They would be buzzing around the light bulb, and kept stopping and landing on the TBs, which i must admit i found rather annoying. But at the same time, others have reported success using TBs to get rid of problematic insect infestations, by including a sample of the insect in the orgonite. Whether they knew it or not, and i must assume they did, they included the intent that they wanted a counteractive effect. And they saw that the insect infestation was reduced. The difference between my TBs attracting the insects cast inside them, and their TBs repelling the insects cast inside them was simply the difference between a counteractive effect and a sympathetic effect. Again, those familiar with metaphysics will probably find this familiar territory.

Bearing that in mind, i am sure you will understand why programming the resin with the intent that you want to counteract the inimical health effects of the HAARP and GWEN towers is worthwhile. Also perhaps this sheds some light on why there exists such variance in the observable effects of TBs. Without the intent to get a counteractive effect (since if you live in area with towers the resin is exposed to the signal from the towers while it cures) you will get the cleansing effect in the 30% range. But if you add the simple thought that you want the orgonite to have a counteractive effect, you will get much more efficiency, up to several hundred percent improvement.

Rather than going into detail about how to do visualization or focus your intent, i will just say that your emotions are a big part of it. For example, if you are making orgonite to help your sore back, then you want to make sure that the orgonite is programmed by imagining a healthy back, free from pain. Or perhaps imagining a sore back turning into a comfortable, pain-free back. You do not want to program the orgonite with you wondering if it will work. That saps efficiency. So if you have doubts, well that just means you are human. We can not always instantly finish up with our doubts or uncertainty. But we can put them out of our minds for a few minutes. And in those few minutes when we have put our doubts out of our mind and have stopped thinking about them, that is the time to do your intent or programming or visualization. For posterity, the same thing applies with prayers, affirmations, declarations, etc., with or without orgonite.

Ideally, you want to charge the orgonite for the duration of time it takes to cure. This may or may not be possible. I have found so far that with the mental impressions, it is best to do it at least 3 times. Since polyester resin actually continues to cure for a long time after it has solidified, you generally have about a 3 day window of opportunity to charge the resin, though the initial period when it is solidifying appears to be the most critical. Once the plastic has cured, you cannot reprogram the resin, but you can reprogram the crystals embedded within it. You can also direct the energy that the orgonite is producing to a given task with your intent. Directing the output from the orgonite is different than charging the resin. Using your orgonite's energy output is giving the output a job to do. Charging the resin while it cures is defining what the output will be.

When using a machine to program the orgonite, depending on how strong the machine is, a ten to 15 minute period of exposure is often enough to produce an effect, but where possible i often give it up to 72 hours of exposure.

If you have a radionics machine, succor punch, pulser, wand, or some other kind of intent amplifier / orgone generator, you can use that to either charge the orgonite or enhance the mental impression (intent) that you give the orgonite. You can also set your favorite xtal (if you work with xtals) near it while it cures and use that to charge the resin. Varying methods of charging give varying degrees of success. Any kind of attention to the charging process will produce a more effect than none, i find.

One way you can charge the resin is to devise some means of connecting a quartz crystal wrapped with a mobius coil to the output of your pc sound card. I have a bit of info about one such device on the ring generator page (<http://www.littlemountainsmudge.com/ringgenerator.htm> ). Even a smaller device such as a succor punch, connected to the output of a pc sound card, provides a very versatile apparatus for charging orgonite. If you are unable to set up something like that, then even using a tone generator and exposing the orgonite to the sound produced will charge the resin. I am amazed at orgonite's ability to accept a program and repeat it almost indefinitely.

Roberto Forcen, at his site Voicesync (<http://www.voicesync.org/> ), has some very impressive sound analysis and sound generation software. One of his programs that i have worked with a fair amount is called mineral sounds. In his own words, it 'Generates resonant three octave compound tones from a list of more than 3000 minerals. Tones are generated using powder X-ray Diffraction parameters.' What i can say is that when i first started playing with it, i was very impressed. When i run the sounds from this program through my big mobius-driven orgone generators, the energy produced is very similar in 'feel' and in 'color' to the energy from the minerals themselves. Aside from using it to program orgonite with the effects of a mineral i would like to have, but don't have on hand (not quite the same as having the actual mineral in the orgonite but close if you let it run several hours), i use it to compliment the ingredients of the orgonite. For example, if the orgonite contains steel, copper and quartz, i will open multiple copies of this program and charge the orgonite with the sounds of iron, copper, quartz, and gold. This gives the orgonite a lot more power when it is finished.

Sunlight is another wonderful thing to expose the resin to while it cures, and so is moonlight. These two methods of charging the orgonite are already in widespread use. Especially with exposing the resin to sunlight, you will often notice a difference in the visible color of the resin when it has cured, indication that you are in fact doing something and this is not all hocus pocus... :)

Astrology also has a certain amount of influence on the orgonite, though not one with which i often work. Using a large orgone generator to charge it can drown out some of the astrological effects, it would appear. One batch i did during the harmonic concordance came out very nice, and it appears to have captured some of the intense catalytic energy of the harmonic concordance.

Another way you can do it is to pour the orgonite outdoors, preferably in contact with the earth, in a clean vortex or ley line. This way tends to both stimulate the vortex or ley line and program the orgonite with a permanent link to the area in which it was poured. Alternately, you can add some dirt or wood chips from the vortex to the orgonite and pour it elsewhere. I have used this technique to link together a few different medicine wheels in the area. Possibly, it could be used to create and/or divert energy lines in the earth's body, leading to or from the vortex.

While i was proofreading this article, i phoned my friend of several years Chris Gozdzik from [diviningmind.com](http://www.diviningmind.com/) (<http://www.diviningmind.com/>), and asked him if he thought i had left out anything glaringly obvious. He reminded me about linking, which is another way that you can do several things with orgonite, including charging it while it cures. Basically, if you link the orgonite to the energy from an existing large source of energy, either by a sample of the source or clear visualization, then the orgonite will not only pick up the energy from the existing source as a program, but will also have a permanent link to the energy source. Thanks, Chris :)

And 2 final notes- If you are building a ring generator, power radionics machine, or other large power-driven orgone generator, first decide what frequencies you plan to use to drive it with. At least pick out a few of the ones you plan to use a lot. Then, charge the orgonite for the generator with the frequencies it will be running at. This increases power in the finished generator. Example, the pulsers run at 5075Hz and 32kHz, so whatever other programming i give them during curing, i give them a good zap of these two frequencies also.

Many of us have noted that orgonite, once cast, sometimes takes a certain amount of time 'start working'. Charging during curing dramatically reduces the amount of time that it takes a device to 'start working'.

Well, that about takes up the time i have today, but here are a few of my favorite hertzian frequencies for charging orgonite, and some the effects i have observed with them.

741Hz (sine wave) - This is one of the solfeggio tones, and is quite potent imo. When i first started using it i immediately felt a buildup of energy and subsequent release in the solar plexus and heart chakras. It may be a bit intense for some people at first, but they should rapidly acclimatize. It appears to have the effect it is reported to by others, that of assisting with finding the solution to a problem. I use it a fair amount these days, and thanks to whomever it was that posted about it on the yahoo cloudbusters (<http://groups.yahoo.com/group/cloudbusters/>) forum some time ago.

528Hz (sine wave) - This is another one of the solfeggio tones, and it has proven useful for me in manifestation.

5075Hz (square wave) - A frequency i chose myself for use in the driver circuits of the pulsers. It tends to have a grounding, stabilizing effect. I use it as a multipurpose frequency to drive generators, and to help me calm down when i get cranky ;)

32kHz (square wave) - Another frequency i chose for use in the pulsers, tends to have the opposite effect than 5075Hz, but meshes well with 5075Hz. I use it for removing blockages in body work, for shielding from energy attacks, and for an aid in the mental 'reach upwards' involved in meditation and remote viewing. When set to a frequency higher than 20 kHz, NCH toner produces a lower harmonic of target frequency. Since square waves especially produce many harmonics ranging up and down the scale, imo you are still getting this frequency (or one close to it) as a harmonic when you use a pc sound card connected to a coil and xtal.

15Hz (square wave) - The frequency many people use to drive their succor punches (<http://www.educate-yourself.org/>). It tends to have a solid, relatively stable effect. Of the low frequencies, it is one commonly used today. It is potent, though imo benefits from the company of a higher frequency. Useful for shielding from energy attacks. Also, if you have a 15Hz driven SP, then charging your orgonite with 15Hz will increase the responsiveness of your orgonite to your SP.

32Hz/31.7Hz (square or sine wave) - A frequency i first heard of from (i believe) Bruce Stenulson (<http://www.stenulson.net/energy/doras.htm>). It has proven very useful as an aid in programming quartz crystals. Because of it's tendency to carry programming information / intent from the user to a quartz crystal, it is useful imo for intent amplification, and as a general purpose frequency for driving mobius-powered orgone generators.

68.635kHz (square or sine wave) - This one of the Hodowanec frequencies. Now, since the upper end of the sound card is well below this frequency, i am not actually getting this frequency when i put it into the NCH toner (<http://www.nch.com.au/tonegen/>) program that i use as a signal generator. When set to a frequency higher than 20 kHz, NCH toner produces a lower harmonic of target frequency. Since square waves especially produce many harmonics ranging up and down the scale, imo you are still getting this frequency (or one close to it) as a harmonic. When run through the nch toner, and a mobius/quartz driven orgone generator, it produces an emission of orgone that is almost all in the violet range. Violet orgone is both soothing and cleansing, good for soul-searching as well as healing.

## EHD Orgonite – Another step

As mentioned earlier, one can produce MHD or MD orgonite either by allowing the particle size to determine density (as in using larger, curly metal shavings, such as one would find in the average TB) or by adding the organic to the mixture in a particulate form. In fact, when making HD or higher densities, you basically have to add the organic in a particle form, along with the metal, since there is not enough space between the metal particles (when they are really small) to produce a ratio close to 50/50 between the metal and organic ingredients. Some time ago I began going a step further and using metal (fine and superfine particles) that would ordinarily produce HD and adding enough organic to bring the density of the orgone matrix material down to MHD or MD. The material produced this way has some very interesting differences from the standard TB / HHG mixture of curly shavings and polyester resin.

It appears that the matrix thus derived has a lot more capacity to store orgone than regular MHD. A given mass of EHD (Expanded High Density) orgone matrix material will have a slower rate at which the orgone flows through it than the same mass of regular MHD, and it will have a higher overall orgone field strength than the same mass of regular MHD, even though the density and the resistance afforded to the orgone as it flows through is about the same. I attribute the slower flow rate of EHD not to a difference in resistance from MHD, but to the fact that adding the organic element in both liquid and particle form increases the overall energy storage capacity of the matrix somehow. This effect is observed much more when superfine metal particles are used along with fine metal and organic particles, as opposed to using fine metal and organic particles alone.

After experimenting with several different organic particles, I have settled on flour as preferred material for the time being. One could use wheat flour, wood flour or other finely powdered absorbent organic substance. The particles should be absorbent enough that they combine with the polyester resin to produce a thick liquid the consistency of stiff pancake batter. The organic powder is mixed into the resin along with catalyst initially. The metal is added last, beginning with the superfine particles and finishing with the fine particles. For a readily available source of superfine metal particles, I suggest cheap metal spray paint. Just add extra catalyst and spray the paint directly on the surface of your resin in the mixing container. Another source of superfine metal particles are the bronzing powders and other metal powders sold by crafts stores for plating.

I have noticed that especially when the organic material is a fibrous material, the orgone matrix material both takes much longer to absorb a charge during curing, and absorbs much more of a charge than regular MHD. It absorbs a program, intent or energy signature with much higher fidelity than regular MHD. It also takes longer to accumulate enough energy to begin working. Regular MHD that I make is usually finished the curing process and has 'come online' by about 3 days after casting. EHD seems to take until about 5 to 7 days after casting to be finished the curing process and 'powered up'.

EHD is also efficient for use in power driven orgone generating devices such as powerwands and ring generators and pulsers. It also affords the cleaning action of converting unhealthy orgone to healthy orgone, but the charging and curing process is much more determinative of the end result, in terms of cleaning capacity, than with MHD. In General, since it takes so long to store a charge and stores such a high potential of orgone, the energy it is subjected to while curing are much more an influence on the finished product than with regular MHD. I would not recommend making EHD orgonite without working in a clean energy environment. Provided you can supply a clean environment or preferably a clean and charged environment in bioenergy terms, EHD will produce TBS that have a higher output than regular TBs and are more 'ergonomic', they feel a bit more alive in the hand. If you make TBs from EHD but do not have a clean energy environment to cast them in, then you will get TBs that are not very efficient at doing anything until you pick them up and play with them, at which point you will still likely be able to feel a strong surge of energy when you hold them in your hand.

For personal orgone devices meant to be held in the hands or carried in a pocket, I now prefer EHD to the other recipes I formerly used.

EHD lends itself not so well to making conventional towerbusters which are designed to be high flow filter cleaners. It lends itself very well to making power driven generators or to making TBs and HHGs for indoor use and human contact. It is like taking a snapshot of an energy field (the field in which it cures), and then it will sit there and broadcast an image of that energy field, continuously and with respectable intensity. It will convert other forms of energy into the energy signature (that snapshot) that it has as its output. So, if you can handle the programming and charging end of it, it will turn out much more potent per cubic inch than regular MHD. Instead of producing devices which are simple filter/cleaner devices, making TBs with EHD produce SELECTIVE filter devices, in that they selectively convert orgone into the orgone signature they have as their output. That's why the charging / curing process is so much more critical with EHD.

Though it produces an orgone energy field of higher intensity than MHD, EHD has an output that is much less chaotic than MHD, and the chaotic energy fields are much more contained within the physical matrix than with regular MHD. With regular MHD, the wave fronts of orgone energy collide within the device as they are reflected by curved surfaces which are relatively close together. The waves of orgone energy inside EHD orgone matrix material react less directly with each other, especially the waves reflected by the more widely spaced fine particles. It's like instead of the waves smacking into each other up close, the matrix has to build enough pressure until the energy ARCS across between the more widely spaced fine particles. All the while, the superfine particles afford the waves the opportunity for up-close collisions but to a lesser degree, providing a stable basis for the matrix, if that makes any sense to you. For this reason, EHD made without superfine and fine particles will not work very well at all.

The mixture should be thick enough that the fine metal particles (say between .5 and 2 mm dia.) are fully suspended in the resin and do not settle out at all. The mixture should be just thin enough that it smoothes itself off at the surface when vibrated, but it should be thick enough that you have to vibrate it to get it to smooth over on the surface. You should be able to count 20 to 50 of the suspended fine metal particles in a square inch of surface area. There should be enough of the superfine metal particles that when wet, the mixture appears to be slight shiny and metallic. When the mixture cures, the surface will become dusty and opaque but a bit of sanding and a clear coat takes care of that. The mixture also takes longer to chemically cure than regular MHD, especially if copper or iron is the superfine metal. Extra time should be allowed for curing. EHD to be exposed to the elements should be protected with a clear coat of spray lacquer or poly resin.

So, in short, as long as it is programmed by a competent energy worker, it works really good for TBs and HHGs designed for human contact as opposed to agricultural and other nature gifting or tower busting. It also works pretty well for generators which will be excited in some active way while in use. And, it absorbs a charge of higher potential and with higher fidelity during the curing process.

Simple HHG instructions	Quantity per HHG:
Item:	
- Double terminate Quartz Crystal	- 5 (or 1 DT and 4 STs)
- Polyester Resin & enough Catalyst to cure it	- About 6 Ounces
- Metal particles	- About 5 Ounces of metal particles
- Suitable container to use for a mold	- 1 (min. 4" dia. plastic funnel)
- Small Jar or Can to sit the funnel in (hold it upright)	- 1

Note: While there are many other suitable vessels which could serve as mold for this device, I have used a plastic funnel for this example as it is readily available in most places and relatively durable. In any case, the same technique of construction applies regardless of the container used for a mold, which can be in the shape of a pyramid, cone, cylinder or hemisphere, so long as it has a volume at least great that of a cone 4" wide x 4" tall. Presently, pyramids and cones are the shape this device is most often built in.

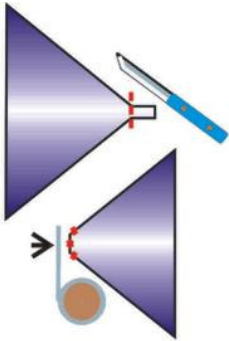

1. - Cut the tip off of the funnel and tape over the hole at the small end of the funnel with aluminum tape (preferable) or parcel tape. Electrical tape, duct tape & masking tape do not work as well for this as aluminum tape. In some way, plug the hole so that the resin does not leak out.

2. - Sit the funnel in the jar so that it is upright and more or less level.

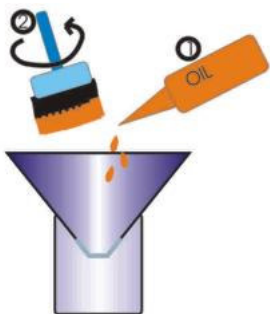
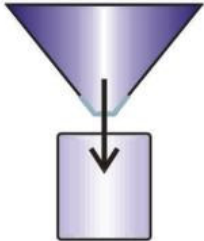

3. - Coat the inside of the funnel with a thin layer of vegetable oil, to keep the resin from sticking to the mold (funnel). Wipe away the excess oil with a brush or clean cloth.

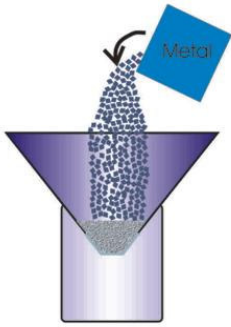

4. - Put about 1" of metal particles in the bottom of the mold.

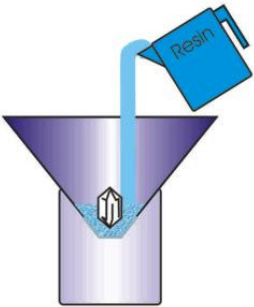

5. - Place one of the Quartz crystals in the tip of the mold, so that it is upright as shown. This one really should be a double terminate, but if you only have a single terminate, put it with the point towards the tip of the funnel. If it is a double terminate, the best tip of the crystal should be pointing towards the tip of the funnel, where you covered the hole with tape.

Mix enough resin and catalyst (be sure to mix well, min. 1 minute of mixing) to come up level with the surface of the metal filings. Pour the resin in and let it run down into the metal filings. Gently shake or tap the mold to release bubbles.

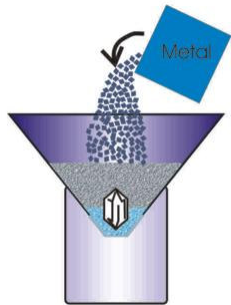

6. - Put in some more metal particles, enough to fill the mold about 1/2 to 2/3 full.

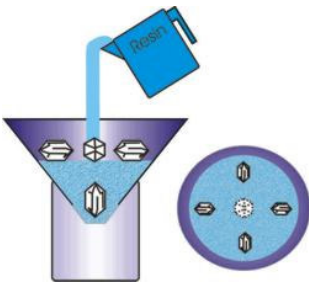

7. - Place the other 4 Quartz crystals on top of the metal filings as shown. They should be arranged like the spokes of a wheel. The better points of the crystals should be pointing towards the outside of the mold. If you have to, you can use single terminate crystals here, and put them with the points either facing in or out (facing out is preferable). Mix some more resin and catalyst, and pour in enough to come up level with the surface of the metal filings again. Gently tap or shake the mold to release bubbles, and let the resin run down into the metal filings.

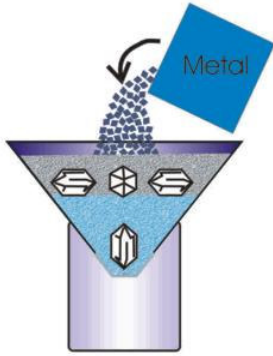

8. - Add some more metal filings, enough to almost (but not quite) fill the mold. Leave about 1/4 inch of empty space at the top of the mold as shown.

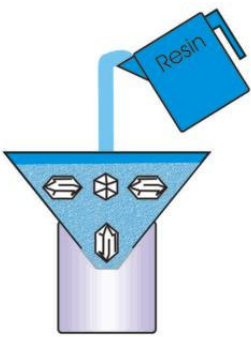

9. - Now, pour in enough resin to finish filling the mold. Let the resin run down into the metal filings, adding a little at a time. Use enough resin to completely cover the metal filings, so that there is a thin layer at the top of the mold which is only resin, no metal. The layer of resin only should be about 1/4" thick. Take a moment to adjust the molds so that they are more or less level at this point.



Time for curing

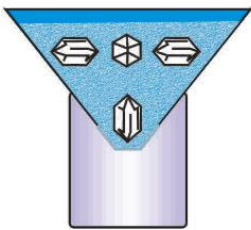

10. - Allow the resin to cure. Keep it warm if possible, cure in a well-ventilated area, and if possible, expose the resin to sunlight while it is curing. If you have a tone generator or other sonotherapy (healing using sound) device, then you can expose the resin to that as well while it cures.

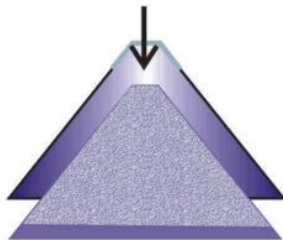

11. - Remove the molds from the jars, turn them upside down, and give them a smack to release the brand new HHG you just made. If the mold sticks, you can either use a thin

bladed knife to push in between the mold and the resin, or you can try spraying penetrating oil around the edges where the mold meets the resin. Dropping it on the floor sometimes works, but sometimes it breaks the resin. There are many ways to modify an HHG for enhanced effects, but the basic model shown above will work just fine the way it is. This is one modification which is easy to perform when you are casting the HHGs. Use an Amethyst point instead of a DT Quartz crystal for the vertical crystal... add a copper SBB coil to the base of the unit, just at the edge of the

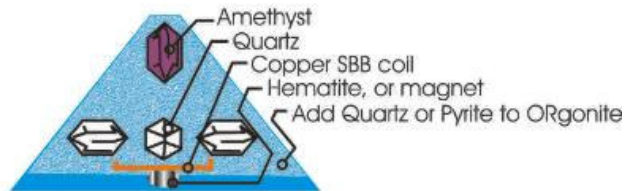

metal filings as shown... add a small piece of hematite, pyrite, or a small permanent magnet to the SBB coil as shown (generally I put the N pole of the magnet facing toward the tip of the HHG)... and mix some crushed quartz, crushed Amethyst, or crushed Pyrite in with the metal particles before you cast it.

Simple TB Instructions	Quantity per Tower Buster:
Item:	
- Quartz Crystal	- 1
- Polyester Resin & enough Catalyst to cure it	- About 3 Ounces
- Metal particles	- About 3 Ounces of metal particles
- Suitable container to use for a mold	- 1 (min. volume about 4 ounces)

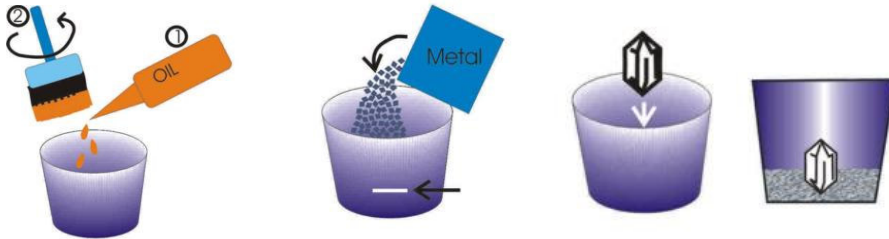

- 1 - Line the containers you will use for molds with a light coat of vegetable oil. This prevents the resin from sticking. Wipe the excess oil off with a brush or clean cloth. cover the surface of the mold evenly.

- 2 - Put about 1" of metal particles in the bottom of each mold.

- 3 - Place the quartz crystal in each mold, using the metal filings to hold it in position. put the crystal in the center of the mold, and if the crystal has a good point on it, most folks put the point towards what will be the top of the unit.

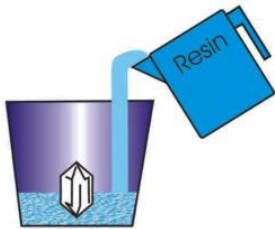

- 4 - Mix enough resin and catalyst to fill each mold level with the metal filings you have placed in the bottom. Pour enough resin into each mold to come up level with the top of the metal filings. Make sure to mix the resin and catalyst well (mix for about 1 full minute) before you pour it into the molds. Allow the resin to run down into the metal filings. Tap the mold lightly or stir carefully to remove bubbles.

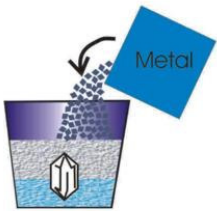

- 5 - Add another inch or so of metal filings to each container, enough to cover the crystal.



- 6 - Mix and add enough resin to cover the metal filings you have placed in the molds. It will not harm the function of the device if some metal filings stick out the bottom, but it is a good idea to use enough resin to fully encase the metal filings. Allow the resin to run down into the metal filings. Tap the mold lightly or stir carefully to remove bubbles.



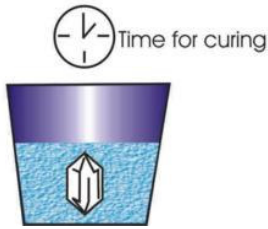

7. - Allow the resin to cure. Keep it warm if possible, cure in a well-ventilated area, and if possible, expose the resin to sunlight while it is curing. If you have a tone generator or other sonotherapy (healing using sound) device, then you can expose the resin to that as well while it cures.

8. - Turn the molds upside down, and give them a smack to release the brand new TB you just made. If the mold sticks, you can either use a thin bladed knife to push in between the mold and the resin, or you can just tear the paper away. Dropping it on the floor sometimes works, but sometimes it breaks the resin. It will not harm the function of the device to leave the paper mold on, but it may be more aesthetically appealing to remove it.

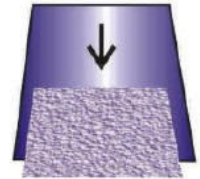

#### Mobius coils and quartz crystals

Many people have also lately begun using devices in conjunction with orgonite or not, which employ a mobius coil and quartz crystal. The coil can either have it's leads simply shorted together, or, more efficiently, be connected to a signal generator circuit or radionics machine. Doing this is like turbo charging your crystal.

One name this kind of device has become commonly known by as a succor punch, this is the name don Croft gave to it when he made it public domain. Since then, many variants of this device have been adapted for use in general metaphysics as an intent amplifier or powered wand. There are several different ways to make a mobius coil, the basic concept is that you want to have magnetic fields canceling each other out by intersecting at 90 degrees. This is accomplished by winding the coil in such a way that the wires cross each other at or close to 90 degrees. Then, when a current is put through the coil, either by induction of by direct stimulation with a signal generator (a common circuit used for these coils is the Beck or Clark or Croft style 'Zapper' devices invented for bioelectrification) the magnetic fields created by the wires cross at 90 degrees and cancel each other out. When the magnetic fields cancel each other out, they are converted into scalar energy. High voltages are not required in order to produce orgone emissions from the crystal, and could be dangerous. Low voltages are commonly used for this type of device.

The scalar energy then excites the crystal and the crystal produces much more orgone energy output that it would without the coil. The frequency used to stimulate such a device is often determinative of the exact effects, but any signal put through it will produce orgone energy output from the crystal as well as RF emissions. This basic device is at the core of a new generation of rife-style devices, since a pulsed orgone/scalar wave is more efficient at stimulating the human body than either radio waves or ultrasonics. Audio signal will also be translated into orgone/scalar waves when put through this type of coil, and people who use sound therapy will find that inserting this device into their apparatus markedly increases the effects. On the following pages, I have included the instructions for making the style of mobius coil that I use most.

With regard to using an audio signal instead of a simple hertzian frequency to drive this kind of coil, it appears that the underlying emotional current of the audio signal is translated into a pulser orgone / scalar emission. This is quite useful for things like sound therapy and manifestation. However, one should exercise care in the choice of audio signal used, I would stay with the classical music for example instead of heavy metal hahaha. In contrast to a TB or HHG, devices like this can do great good or great harm, depending especially on what kind of intent one is projecting into the device (which intent will be picked up and amplified by the crystal) and what frequencies are used to drive the device. Some frequencies that I know are safe to use are (in Hz) 15, 32, 741, 5075, 5100, 15000, 32000, and 68635. This device is at the core of the large orgone generators I use to charge and program orgonite while the resin is curing. There is a lot of information available on the web about the biological effects of different hertzian frequencies, especially with the Royal Raymond Rife crowd. A device like this will afford a low cost, low – tech, but highly functional output for a Rife style treatment system, without requiring the use of high voltage, plasma tubes, or expensive function generators, since it can be driven by the audio output of a home pc, substituting software for the function generator generally used to drive Rife machines.

As for the waveforms being used to drive the coils, bear in mind that using a frequency to drive a mobius coil has slightly different requirements than just using the properties of a sound. There is a reason that most Zapper circuits used to drive these coil employ a square wave.

When using a frequency for driving scalar producing coils, most of us have generally gotten our minds around the concept that we want to have magnetic fields canceling each other out, so they can be converted into scalar potentials and scalar waves. Well, another concept which applies is magnetic flux. The more rapid the magnetic flux, the more scalar energy you are going to coax out of your mobius coil. Magnetic flux is what you call it when you have a magnetic field that is changing.

Now in a waveform, when you look at that little wavy line, think of it as a line traced by something bobbing up and down, perhaps a pencil if you prefer. And the magnetic field is changing as the pencil goes up and down, understand? As the wave passes by you, the pencil traces it's path and bobs up and down in time with the highs and lows of the waves. How high the pencil goes up and how low the pencil goes down is called amplitude. How long the waves are is called frequency, as in 'how frequently does a wave pass by you' in a given time. The base unit of time used to measure this is the second, and a Hertz (Hz) means "waves per second".

so... a sine wave, which has a smooth and equal curve... work great for some applications where you are just using the sound. It also works to generate scalar waves in a mobius coil, but not as efficiently as a square or sawtooth wave. One difference is that a square wave produces more harmonics in the circuit than a sine wave does. In some cases a sine wave is therefore less efficient in terms of input power to output power, but it is more pure and produces a more 'pure tone' which is advantageous in some cases. The magnetic flux is not very abrupt with a sine wave.

For driving mobius coils, a square wave works best of the ones I have experimented with. See, in a square wave, the pencil does not go smoothly up and down (like it does in the sine wave)... it sits still for a little while, and then it jerks up, and then it sits still again for a while and then it jerks down.

And therefore the magnetic field changes very suddenly, that is to say the magnetic flux is much more abrupt in a square wave than in a sine wave. A sawtooth wave, or a triangle wave... is kind of in the middle. (between square waves and sine waves). A sawtooth wave is far better to use in a mobius coil than a sine wave, from my testing so far. The sine wave produces energy that is much more mellow. You have to crank the power up quite a bit to get similar effects to a square wave.

Triangle waves also will work, but a sawtooth wave seems to work a bit better than a triangle wave. Also, if possible, the leading edge of the sawtooth should not be too spiked. I suppose that phi in relation to the amplitude of the wave would be a good height for the spike at the leading edge of the sawtooth wave, but I cannot say for sure at this time. I do know that imo judging from the amount of energy they produce when put through the same device, square waves are best, followed by sawtooth, followed by triangles, followed by sine waves

Tachyon braking, as it applies to scalar wave generation, is basically a fancy way to say that when you are generating scalar waves in a coil, there is also something else happening. See, there is in the aether an infinite potential of scalar energy which already exists ( as opposed to the scalar energy you are 'generating' by converting em fields into scalar energy). When you take magnetic energy and convert it to scalar energy, you also tap into that aether potential and draw on it a little, adding the scalar energy from the aether to the scalar energy you have just produced with your coil.

This in fact is the basic working principle of the majority of the 'free energy' devices out there. That is how you appear to, and in fact do... get more energy out that you put in, because you are tapping on the aether and drawing on it. The 'tachyons' (little bits of energy, or particles in a high energy state, depending on the way you want to look at them) are subject to a process called tachyon braking. They 'brake' (slow down) and change state into something else. From a metaphysics perspective, the energy reduces it's vibratory rate and therefore manifests as another, lower form of energy, which appears to pop out of nowhere. Rampa, Cayce, and a jillion others refer to this in metaphysics teaching, the slowing down of energy to produce effects..

So then if you are trying to get electricity out of it, you want the tachyons to pop out of nowhere as electrical potential. But, if you are only taking the process as far as generating scalar waves to excite quartz or orgonite, then the tachyon braking just makes your mobius coil appear to be more powerful than it actually is hahaha because the scalar energy produced by tachyon braking adds to the scalar energy produced by em fields canceling each other out in the coil.

The more abrupt the magnetic flux is, the more scalar energy you draw from the aether and add to the scalar energy you are generating with your coil.

## How to make a mobius coil

First - Make yourself a "mobius Cable" to wind the coil from. While you can wind a mobius coil from single strands of wire, it certainly seems to be a lot more potent when you use a cable made in the manner described here to wind the coil from. Take a length of wire, and double it back on itself twice as shown to the right. Pull a little slack out at the ends of the wire, this will be the leads of the coil when it is finished. You should leave yourself at least 2" for leads, and it is a good idea to give yourself 6" or so, you can always trim the leads to the required length when the coil is finished. It is much easier to use a drill to twist the wires than doing it by hand. Run the drill in reverse and you will get a clockwise twist to the cable. I recommend that you wind the coil itself clockwise also.

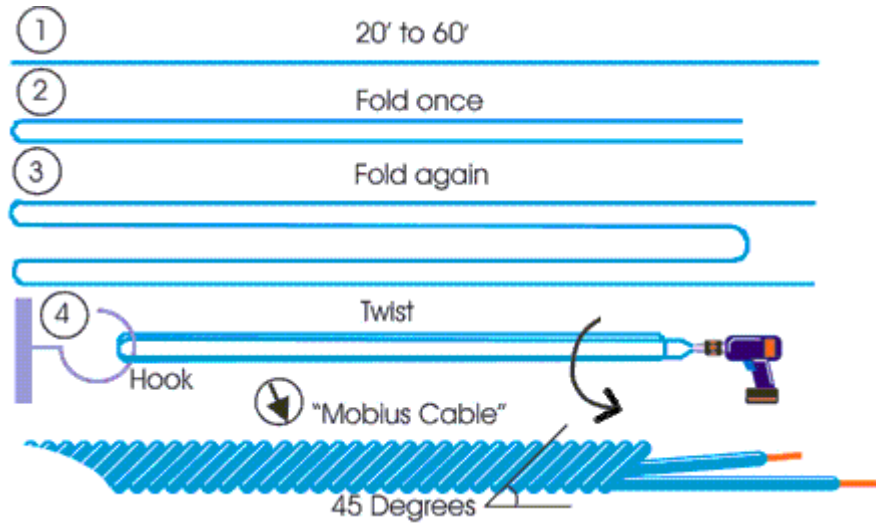

1. - Starting with the end of the cable which does not have the leads, make a circle in the clockwise direction about the size you want your finished coil to be. You can wind the coil around a core (xtal for your SP) or you can wind the coil by itself if you are using stiffer wire.

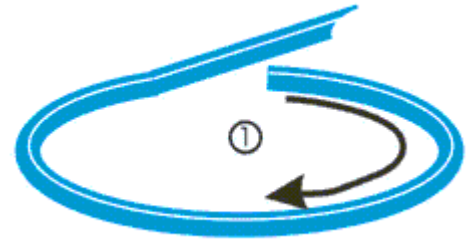

2. - When you complete the first wrap, feed the wire through the center of the circle so it wraps around itself in the clockwise direction as shown. Use a little glue (hot melt or silicone preferable) to hold the wire in place where it crosses over itself.

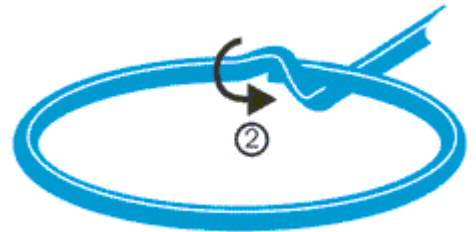

3. - Start winding the wire around the circle in the clockwise direction again.

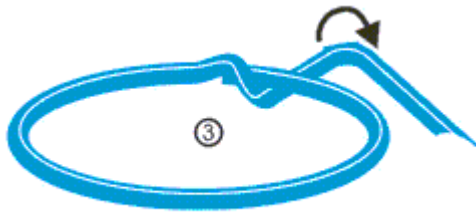

4. - Go around the circle about one third of the way, and wrap the cable around itself again, just like in step 3.

Go around the circle another third of the way, and do the same thing again. You should have 3 wraps around the cable for each time you go around the circle.



5. - Continue this way, repeating step 4, until you have used up all of the cable. As shown to the right, stay on the same side of the previous wrap with each new revolution.

The 'knots' will run together.

When you are finished, use a little glue to hold the end of the cable in place.

The coil should look like this when you are finished.

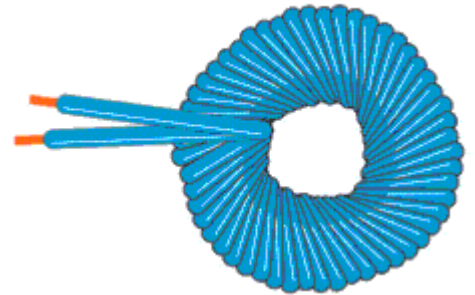
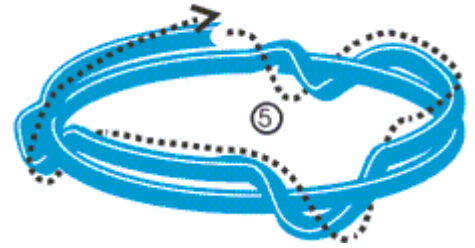

Hopefully, the pictures will be of more use to you than the words, as it is really quite simple to do, just a little cumbersome to try and explain in words. Basically, you just keep wrapping the cable around itself (clockwise) as you go around the circle. With a little practice, you will find that the windings form a pattern, and if you make a mistake it will be obvious as it does not fit the pattern. This coil tends to hold its shape better than the single knot style, and I generally just wind it by itself, not on a core. You should measure the diameter of the object you wish to place in the coil as a core when it is finished, and start with a circle a little larger than the diameter of the intended core.

I recommend using a Quartz, 'Moquis Marble', or Kyanite core for mobius coils, as the energy generated by a mobius coil (scalar waves) can be biologically disruptive when in its raw state. This information is primarily intended for those who wish to use mobius coils as a means of exciting Quartz crystals or ORgonite, and you are responsible for your own safety. By making this coil you agree not to hold me responsible for any damages your experiments may cause to persons or property. Mobius coils generate scalar waves. Scalar waves can interfere with and/or damage electronics when high voltage is put through them. For the purposes of ORgone research, low voltages are sufficient to drive mobius coils.



## High performance – simple construction orgone generator – the Ring Generator

The design illustrated here is crude in execution and simple in construction. That's the point. My later versions of this device are more evolved than the one illustrated here, but I want to emphasize clearly that a device like this will work really well if you put it together right. This was my main generator for some time. I have posted the design here so that anyone who wants can have heavy-duty orgone generation capability without having to pay for a professionally built unit. It has been my experiences that the do it yourselfers will buy what they want to buy and build what they want to build anyways. A professionally built unit has many refinements over this crude design, but if you wanna do it yourself, here is a way to get a kick-ass if unrefined machine from stuff you probably already have... for about 50 bucks US, not counting the cost of the xtal. Interested?

This is a generator design I have been using for some time now. The design given here is highly adaptable, and can be modified to suit your needs. The pics here are from the first one that I built, and I used it for about 8 months for various things, with great success. The versions of this design I am using now are larger and more refined, but the pics shown here are the actual device which I used as my main generator for several months. In fact, the device is simple enough that it may be somewhat anticlimactic for you when you see how it's made.

The main things that I used this device, and continue to use devices based on this design... for, are as follows:

- 1- Heavy duty radionics applications, I.E. using the generator to send energy to persons or other entities through the Aether. Have done healing work, remote influence of persons and events, and in one case used this exact device to cut through the spells of a 'nameless' but well-known metaphysics practitioner like a hot knife through butter. Do not ask me for further details about who and when and why, because I will not provide them. It is immaterial. What matters is that the device works. I use the device for some of the radionics undertakings that require a lot of juice but not so much finesse. Finesse comes with refinement of the design and user skill.
- 2- Heavy duty orgone generation requirements, I.E. weather manipulation experiments, charging of water or other material, or psionics / intent amplification. You will have to figure out how to do that yourself, which if you are familiar with metaphysics should not be too difficult for you. The only input to it from you is by your intent, but you can reach out with your mind and direct the energy from this device same as with any other orgone generator. The frequency used to drive the device makes a lot of difference, and the use of select frequencies or audio signals to achieve desired results is a main aspect of using this device.
- 3- Charging and programming orgonite while the resin is curing, or cleaning, charging and programming quartz crystals. This use is the main reason why I am posting this design instead of limiting myself to offering much larger and more refined versions of it for sale. In due time I will come out with a production model of this device, but in the meantime it can radically improve the quality of orgonite made by the home orgone crafter. The production model of this device will contain much more orgonite than the one shown here. Pulsers can be used to charge resin while it cures as well. This device is a lot more powerful than a pulser, but less user friendly. Not everyone is going to be making enough orgonite to get their money's worth out of a unit like this when I decide to start selling the, but most people are definitely going to get their 50 bucks worth of use out of a homebuilt unit like this if they make much orgonite. Again, Pulsers, Powerwands and SPs are PORTABLE and therein lies one of their main beauties. This device is not portable, but rather requires both a stationary setup and the input of electrical power, and well as a home computer and an old stereo amplifier to drive it. This device offers more flexibility as well in that you can easily change out the core xtal for pretty much anything you want. Some materials may not be especially healthy for you when you expose them to scalar waves, and you are responsible for your own decision to make and use this device. Depending on how much voltage you put through it you may or may not harm electronics in the area. I have found that relatively low voltages on the RingGen suffice.



Some shots of a Ring Generator built by a man named David in New Jersey.



This is what you need to construct this device:

- 30 feet minimum of 18 to 15 gage copper wire.
- One [large quartz crystal](#). There is a picture to the right of the xtal I used for the device shown. It does not have to be a nice DT like the one I used, but it should be about that size. In a pinch, you can also use several; smaller xtals together to get about the same amount of xtal mass. I got this xtal from ZSL, a generous gift on his part. He got it from [the crystal man](#) (in Canada). Another good place to get xtals is from [revted](#) (in America).
- 6 Plastic binder straps.
- Some aluminum tape.
- Enough stuff to make at least 1 liter of [orgonite](#).
- The rings from 2 mason jar lids.
- A small shelving unit made from metal mesh of some kind. I used an old LP record rack, flipped upside down. You could make one from pieces of window screen stretched across a frame, or see what you can find in your garage or the second hand store. It should be a shelf that has the individual shelves made out of a metal GRID or SLATS, so that there is an open mesh, not solid pieces of metal. On the next one I make, I will probably use copper screens for the mesh. I have not tried using aluminum for the shelves, but I think steel or copper would be better for the shelves. Steel works well, I can attest to that.
- A large diameter hemispherical piece of metal to use as a reflector. I used the canister lid of an old steam cleaning rental unit I happened to have, you could use a large wok lid, or a large metal mixing bowl. It does not have to be a perfect parabolic curve, and aluminum will work for the reflector. Again, on the next one I make I will probably try to use copper. I imagine I will have to form a piece of copper sheet into a reflector. The reflector I am using right now is about 24" diameter, I would recommend it be at least 18" diameter. The metal should be bare on the inside of the reflector, it can be covered with paint or enamel on the outside.
- A long section of speaker wire (2 wires) to connect the device to your PC.
- A household stereo, boom box, or any other audio equipment that has an amplifier built into it, and also has a line in or auxiliary input jack so you can route the signal from your PC's sound card through it. I use an ancient 8-track player that has a 50 watt amplifier in it.
- Adapters to connect you PC sound output to the line in of the amplifier.
- Tone generator software for your PC. You can download it off the web, and there are some links provided on the links page of this site where you can find it. [Roberto Forcen's stuff](#) is amazing, as soon as I can afford it I will be sending him something for his efforts, in the meantime I can at least give him a plug, his site is called voicesync. He has wonderful donaware for sound generation and analysis. Also, [NCH toner](#) is a very adaptable and functional tone generator for your PC with a range from 1 to about 20,000 Hz with control over the waveform. You can also run multiple copies of the program and generate multiple tones at the same time.



Building it... Step 1 -

Build yourself a large [mobius coil](#). Make it big enough you can fit a large xtal in the core, about 2.5" to 3" diameter. It does not have to be a fancy xtal. It can be single point. On the old device shown here I used a single knot mobius coil, but on my new one I am using the continuous knot style. Secure the coil with plastic binders to prevent it from losing it's shape. The coil shown here is from 15 gage magnet wire, and while I recommend using at least 18 gage, it does not have to be magnet wire. magnet wire just works a little better. It isn't necessary to use magnet wire.



Step 2 -

Using aluminum tape, connect 2 mason jar lid rings to the coil as shown. Work the tape firmly into place, and use at least one full wrap of tape all the way around. This is not only for the effect of a metal shroud on the coil, it is to keep the orgonite from leaking into the coil. Do your best to line the rings up evenly with each other, so that the ring on one end is parallel to and plumb with the ring on the other end. Pull the leads from the coil out through the center, or if you want to be more precise you can form a little hole in the tape to pass the leads through, and fill the hole with glue so it doesn't leak.



Step 3 -

Find a suitable mold that is cylindrical, and deep enough to come up to the top of the coil assembly you have just built. It should be at least deep enough that you can cast orgonite up to the top of the coil assembly, and wide enough that there is at least one inch of orgonite all the way around the outside of the coil. On the generator I use now there is a lot more orgonite than on the old one shown here. The old one shown here worked well enough to impress me several times with its effectiveness. Coat the mold with release agent of some form, regular vegetable oil or WD40 will both work fine. If you are using orgonite made from polyester autobody filler, you do not have to seal the bottom of the coil assembly to the mold. If you are using orgonite made from resin, you will have to seal the bottom of the coil assembly to the mold so resin does not leak under the coil assembly into the cavity at the center. You want to cast a ring of orgonite with a hollow center where the coil is. A little hot melt glue

works well for this (sealing it), since it will keep the resin from leaking into the hole, and is easily removable. It also sets fast, so you don't have to wait for it to dry like you would silicone or goop glue.



Step 4 -

Cast it with MHD, HD or XHD orgonite. Allow the orgonite to cure, and remove the coil cast in orgonite from the mold. You should now have a hollow cylinder of orgonite with a coil in the center of it. Place the cylinder with the coil in the center of the reflector as shown below. You can fasten it with a little glue if you want. Then place the reflector on the lowest shelf of the metal shelving unit as shown. The quartz xtal goes in the hole inside the coil, as I imagine ought to be obvious. You can also easily remove and change xtals this way. I have a large cluster of kyanite which I use inside the coil too, gives a great energy. Let your imagination be your guide. Experiment with using different minerals and other things inside the coil, but be aware that not everything you put in there will work as well as a quartz xtal. A safer way to experiment is to ADD things in there with the quartz xtal, and see what kind of orgone they produce before you try them alone. Now you're ready to hook it up. If you want to, you can line the metal shelf up with the compass directions (I.E. so that one side of it faces north) but this is not necessary, it just makes it work a bit more efficiently). The metal shelves and reflector should be insulated from each other electrically, or at least that is the way I find it works best so far. The metal rings on the ends of the cylinder do not have to be electrically insulated from the metal of the reflector.

Not only do the metal screens seem to act like an broadcast antenna / amplifier, they also work really slick for making orgonite. Later on, when making orgonite, fire up the generator and put your molds on them while the resin is curing. The metal in the shelves pulses in rhythm to the scalar energy coming off the coil, and although I guess I still haven't figured out exactly why, they emit a strong stream of orgone as well. Further refinements to the design would involve, among other things, the proportions of the metal shelves in relation to the rest of the assembly.

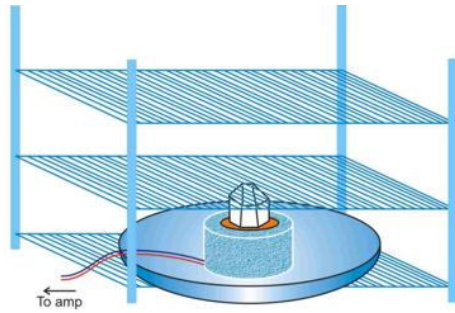

If you are going to use the device for radionics, then use the metal shelves as your witness well. You can also use the cavity inside the coil as witness well, but the energy sent to target that way may not be beneficial unless there is a quartz xtal in the coil along with it. If you just want to generate a big cloud of healthy orgone, then drop a large TB inside the coil and fire it up. If you have a wand or orgone beamer of some form, you can put that inside the coil and supercharge it.

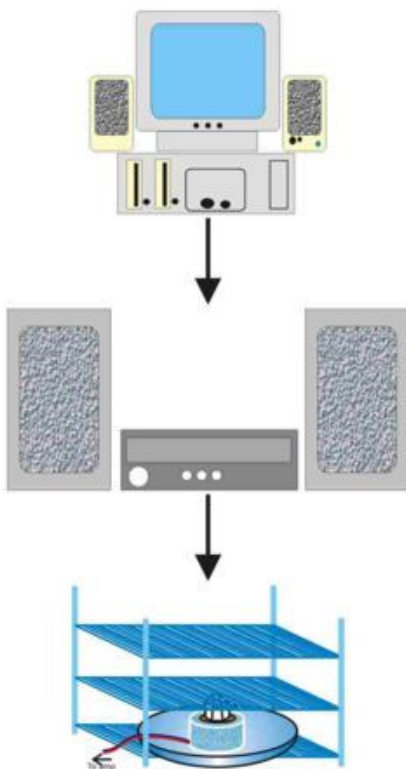

This is basically how you hook it up. You want to take the signal from your PC's sound card, route it through your amplifier, and then run it through the coil in the device. There are several ways you can do this, and no doubt those of you familiar with electronics will see that there are better ways than the method I have illustrated. I chose this method for this page because it is simple. Just use the adapter to connect the sound output from your PC to the line in or aux input of the amplifier. Then take one of the wire pairs leading to a speaker from the stereo, and cut ONE of the wires leading to the speaker. Leave the other wire intact. Preferably, use the positive wire. Then, connect the leads of the coil in the device to either end of the speaker wire which you have cut. This has the downside that you have to listen to the sounds being generated, but it PROTECTS YOUR AMPLIFIER from blowing. Mobius coils have very low resistance, and if you connect it directly to the amplifier output without having enough resistance you may damage your amp. The resistance in the method of connection shown is provided by the speaker. The current comes from the PC, is amplified by the amp, then goes through the coil. After it leaves the coil it goes through the speaker and back into the circuit.

Alternately, you could add a resistor to the mobius coil to give it enough resistance so that the amp would not perceive it as a short. In order to do this, you would need to find out what resistance your speakers are. Usually the speakers are marked (inside the speaker box on the back of the speaker magnet) with a little number beside an ohm symbol. This is the resistance. An ohm symbol looks like a little "O" with the bottom cut off and two little tails (Greek letter omega).

Again, alternately, you could connect the coil directly to your pc sound card by adding 8 ohm resistance to the mobius coil, as I gather 8 ohm is the standard resistance for small speakers like the ones used in PCs. In fact, I may be offering this (the ability to plug it directly into your PC sound output) as an option on the Pro Model Pulsers at some point in the future. For devices the size of the one shown on this page, I think it is better to have the extra power provided by the amp. If you use a device like this to charge your orgonite while it cures, you can increase the potency of your orgonite significantly. Some suggested

frequencies: 15 Hz, 32 Hz, 5075 Hz. Obviously, one could build a more refined device based on this general concept, but hey, I can't give away all of my trade secrets ;). Besides, lots of folks won't mind that it looks hokey as long as it works

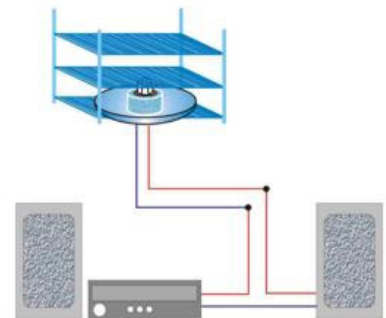



Grow yer own crop circle

Confirmation of subtle energy in action

This was kind of an interesting thing that happened in the backyard a while ago...

The same night as the 'meteor impact' of June 03 2004 near Washington state, this formation appeared in some grass in my backyard. It has some of the earmarks of the much larger and more well-know crop circles, such as bent nodes, grass which continues to grow, and a weaving pattern among the blades of grass which is complex enough it is difficult to photograph.

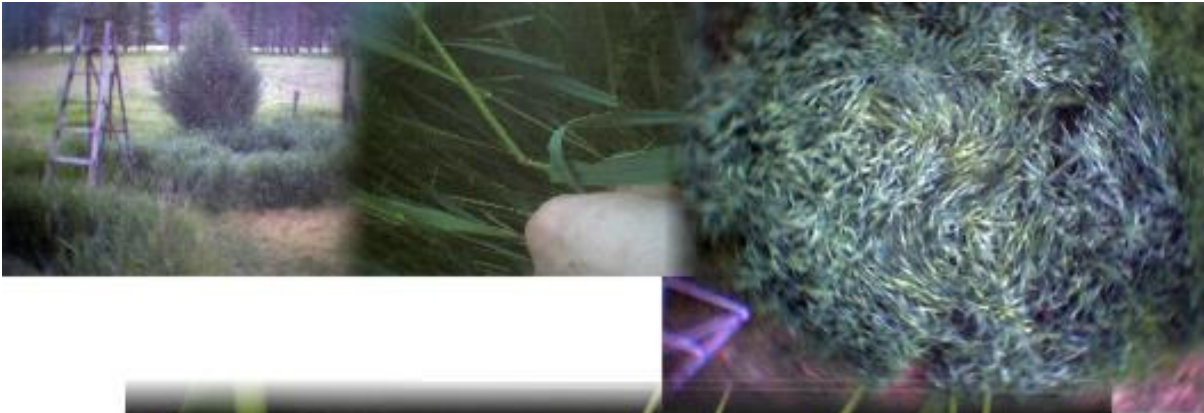

---

The patch of grass that it appeared in is a patch of grass which I let grow instead of mowing, a small energy vortex in my yard. It is a spot where I had my chembuster for about a year, I moved the chembuster to the other side of the yard a few months before the formation appeared. This pic shows the way it looked when it first appeared.

---

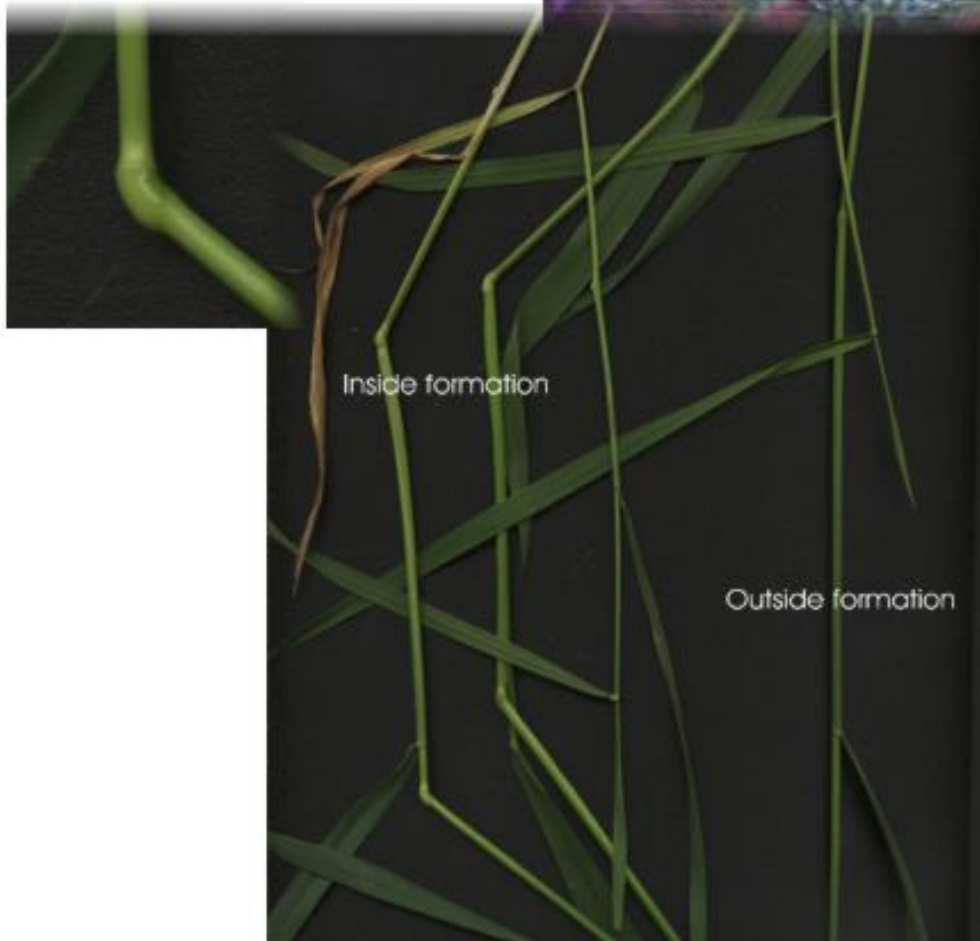

I think that as the energy intensity in the earth's bioenergy and electromagnetic fields continues to build, more formations like this will be observed, if indeed they are not being already. Essentially, I think that anytime an orgone field reaches sufficient strength and excitation, then there is a possibility for that field to be expressed in the plants DNA adaptation. ;) Or something like that. what do I know I never even finished high school hahaha. This pic shows some changes that appeared and some nodes. The nodes in the squared part of the formation appeared to keep bending over a period of several days. The initial pattern formed overnight.

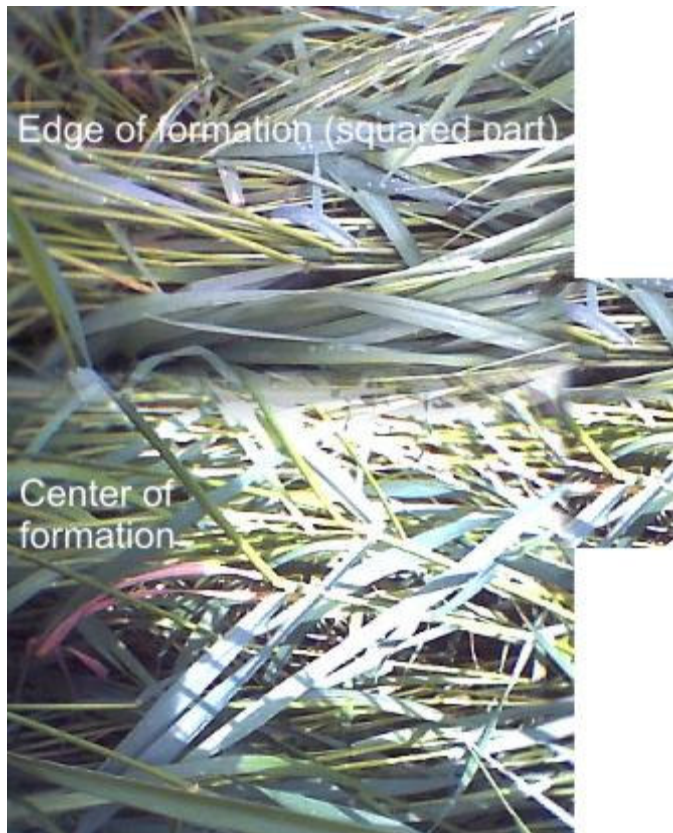
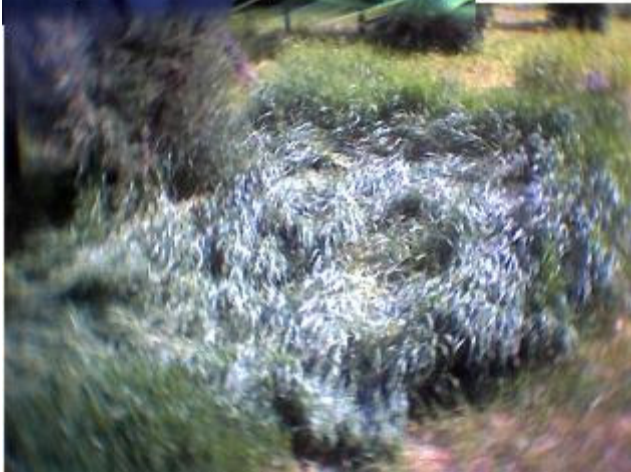

I had planned to post my recollections of the night in question to a different page, but since the two subjects are related in my mind at least, and you may already think I'm nuts;) I will post them here also.

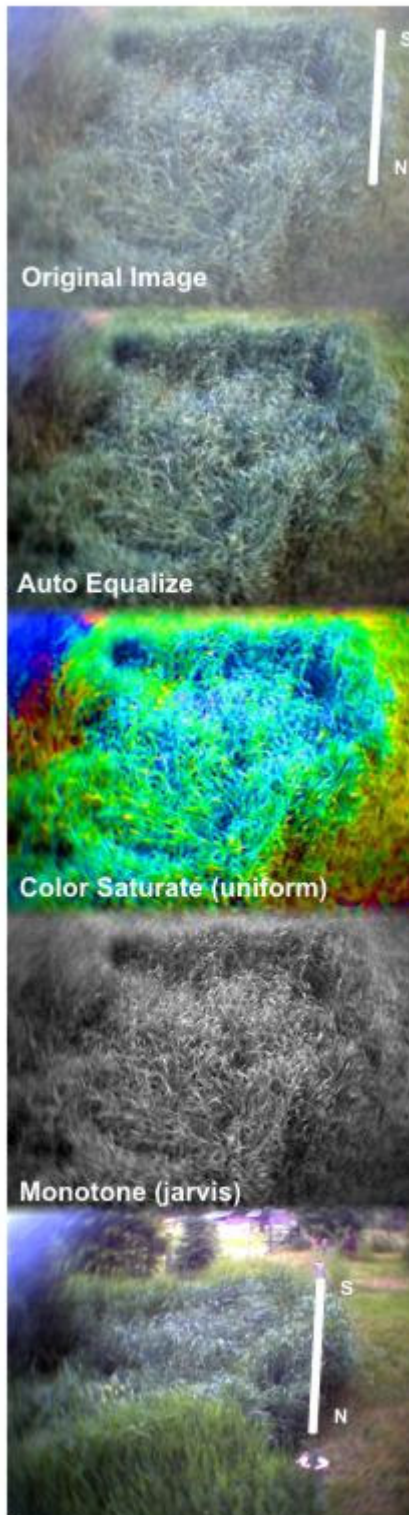

It was a dark and stormy night... \*chuckle\* actually it was dark anyway.... and since sometimes I work nights, I was up and awake at about 3AM, having what amounts to a lunch break. I felt something outside, so I went outside and had a walk around the yard. I decided to do a little energy work, a defensive cleaning action. I had sensed something 'bad' about to happen, thought maybe some idiot was trying to attack with a radionics machine or something again, or maybe the wolves/coyotes/whatever it was that had taken a few neighbors pets was on the prowl. So while I was out there I went over to 'the spot' in my yard where I normally do energy work, it is just a spot in the yard where a few energy lines from the rest of the yard come together, if you are familiar with earth energy lines. It is a vortex I suppose, but a small one, and one I have worked with a fair amount in the past. And as I focused my thoughts and took some of the energy from the spot, I sent it towards the source of my inner warning. I confronted the energy I was going to repel. I was facing east. And right on cue, the whole sky to the east lit up red. Lots of other people saw the same light in the sky, and even then I was quite certain that I was seeing something with my physical eyes and not with the mind's eye. So you know, that kind of startled me a bit, I have to admit. But I just carried on, I kept up the intent that things would work out ok, and that whatever threat I was feeling would be done with. Leap of faith. You know, that's what you do when you are confronting something nasty and perhaps stronger than you. Have faith.

I wandered over to the other side of the yard where the chembuster is, and I was standing there facing south, and, um, 'having faith'. Then right when I felt the energy change again and some of the 'pressure' was relieved, again, right on cue, the whole sky to the south lit up, and there was a big boom, very loud. My memory does admittedly blur up a bit around there, but I do not have missing time. I just spent a few hours in and out of a semi-meditative state, and at some point I could swear the sky lit up again. I am not certain on the number of times that lights flashed in the sky that night. I am quite certain that the number of flashes I saw in the sky does not match the medias account, I seem to remember that sequence of red in the east and then blue in the south as happening twice, but perhaps that is just a trick the mind plays. I by that point was very much trancing, and just figured 'well, it held, it's all good, thanks God, I'm off to bed..'

So I put the flashes in the sky on a little shelf I keep in the back of my mind, a place where I set things that I need to put down for a little while after which I will have to go deal with them in some way ;) ... and went to bed. It took me along time to fall asleep, I was very keyed up. But as I lay in bed, watching the blue light of early morning, I remember hearing a strong wind blow through.

So the next day I was out wandering around in the yard, and I was standing over in the same spot and noticed that some of the grass was bent down. I didn't make anything of it until a few minutes later, and realized that it was bent in a swirl pattern, and from there on in I was all excited. It was a round swirl pattern at first, and then a squared pattern formed around the round swirl part in the center over a few days. Then a triangle shape appeared at one corner of the square, and over about a week the triangle swirled into a circle also. There are some above. I haven't taken any pics of it lately I'm just letting it do it thing. As the weeks have moved on since, the patterns has continued to grow somewhat. The energy from it feels good, it feels cool and soothing. I have been mentioning casually to friends and co workers that I have really small crop circle in my backyard. you should see the looks on their faces.

The air elementals are involved wherever large orgone things are happening. whatever happened that night, I think I saw something get shot down. It was large enough to affect the orgone fields and the resultant weather patterns and emotional states in people across the western seaboard. I dunno if it was a rock or a missile, at first I was leaning toward it having been a rock but now it think it was likely a missile. Whatever it was, it was not a simple meteor impact. The timing of the lights was all wrong. I think something was destroyed in the air over the US / CANADA border near Washington state. Something big changed in the earth's energy field, it took many people time to acclimatize. I think things could have been worse, so I won't complain. to acclimatize. I think that it was a precursor of larger changes to come. The earth (and the human race, kicking and screaming) is changing.

I do not think that this formation is a message from extra terrestrials, though that is indeed IMO what some large crop circles are. I think that whatever happened that night, it moved around enough energy to leave a pattern in the grass in a spot in my backyard. It appeared in a spot were the energy fields are already concentrated compared to the rest of the property. If it can happen in my yard, it can happen in yours. I would not be surprised to learn that the same bent nodes and interweaving associated with crop circles appear in more subtle ways within nature, along ley lines and in vortices. I also think now that if you create strong enough orgone energy patterns, there is a good chance you will be able to impress an outline of them upon a patch of grass, so long as the grass is on a 'high energy' spot and if for some conditions within the earth's energy fields, an outline of what the energy was doing was 'burnt into' the grass. I use the term 'burnt' loosely because the grass remains healthy and continues to grow. I will experiment with some of the seeds when they are finished forming. The neighbors must have thought I was nuts out there with a camera on a pole snapping pics of this thing. Make of it what you will. Feel free to share with me any impression you get from the pics. And remember... It's really hard to see a formation in the grass when you're on the ground.

## A Functional and simple Radionics Machine

A while ago, I started experimenting with using a simple radionics tuner to drive a mobius coil. I was so impressed with the results that I told some of my friends about it, and they asked me to produce a diagram for a simple tuner that could be used to make a 'radionically tuned succor punch'. Better late than never hahaha and here it is. There are many different ways to skin a cat, and there are many refinements to the basic designs shown on this page which could be done. The designs on this page are simple, easy-to-put together from readily available materials, and well within the range of any tinkers' skills. Please feel free to copy these pictures to your hard drive if you find them useful. At some point in the near future, I will be offering printed radionics circuit boards with or without the dials and output in a kit form. But in the meantime, I hope that these schematics will demystify some of the simpler aspects of a radionics machine for the do-it-yourselfers out there who want to make their own. In simple terms, this kind of radionics machine is basically a closed loop circuit, which you tune by adjusting the dials. When you put a sample into the witness well, you are introducing interference into that circuit. when you adjust the dials so that the circuit is resonant to the interference you have introduced, then you are 'tuned in' to that sample. This state of resonance with the sample produces a change in the way that the EM fields of the machine and your body interact, causing the 'stick' where your fingers stick to the pad. With a bit of practice, anyone can use a stick pad. Also, you can use a pendulum over the stick pad and dowse to determine when the dials are adjusted correctly for a given purpose. Pretty simple, huh? Of course there is more to it than that, but that is more than enough to get started with.

First, a brief word about the 'dials' used to make radionics machines. It is not necessary that they be calibrated dials, any variable resistor will work. They are also called variable potentiometers. I have successfully used dials ranging in size from tiny little PCB mount tuning pots up to your average volume dial for a boom box. I have also used slide controls instead of rotary controls, and I like them just fine.

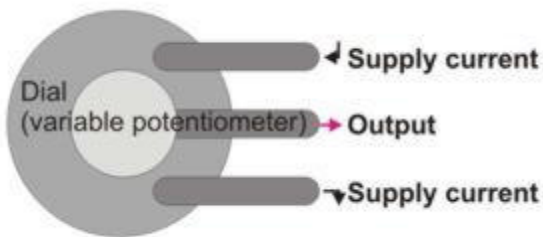

Any potentiometer will work. A potentiometer is just a variable resistor. They do not have to be calibrated dials. However, the number combinations that you wind up with (on the dials) will be unique to your machine. Keep notes on the rates for various samples. They will always be the same on your machine, but they will not be the same number combination on two machines, unless the two machines are identical in componentry, right down to the length of wires used to connect the parts and pieces together.

Many variable potentiometer dials have 3 main terminals. These are the kind I prefer for radionics tuners. Often, the center lead is the output, and for that reason I have drawn the circuits here with the center terminal of the dials shown as the output. When you get your dials, it is a good idea to check and make sure that you know which terminal is the output, and proceed accordingly. A variable potentiometer of this type works by running a supply current across it (that's what the two outside terminals do) and allowing a variable amount of that current to pass through it (which comes out the center terminal). I prefer to use linear dials instead of logarithmic ones, because they are a bit easier to tune. Either will work. (Also included is one of the mini tuners I have been playing with, bottom center. It works ok, but is somewhat awkward to adjust using a precision screwdriver. I also like a solid vessel for the witness well better than the wire coil shown here.) The purple colored tuning pots shown at top left are just about perfect, they are big enough to grasp with your fingers.

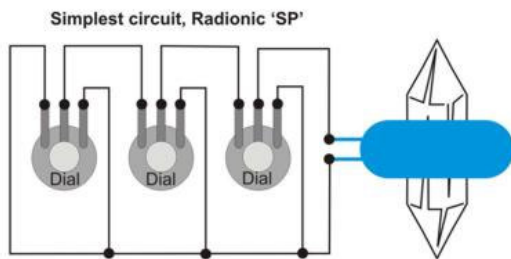

So here it is, the stripped-down, bare essentials radionics circuit for driving your SP, Powerwand, Pulsar, or god knows what. I use (among other things) mobius coils with quartz xtal cores as output devices for radionics circuits. There are many kinds of output devices one can use for radionics machines, and a little later on I will cover the basics in an article. But for this page, I will concentrate more on the tuning section, since that is after all the core of any radionics machine, the tuner. The simple circuit shown here does not have a stick pad, so the person using the device has to be energy sensitive. There are a lot of folks who are more than energy sensitive enough to feel the changes in the energy produced as the dials are adjusted. You can always use the face of the quartz xtal as a stick pad ;)... After thinking about it quite a bit, I have decided not to give specific variable resistor values at this point. I do not see that it matters. I have used many different resistor values and have found that they all work. I

would say that for this kind of a circuit, it is best that they be under 1 mega Ohm maximum resistance. You shouldn't have too much trouble finding dials, as they are fairly common, and easily salvaged from old electronics, or bought from an electronics supply store.

Here is a diagram showing a basic, easy-to-make radionics tuner. This circuit includes a witness well and a stick pad. In circuits like this I often use a 1/8 2-conductor jack to connect to whatever I am going to use as an output. you could also connect the output from this circuit directly to your mobius coil, and leave the jack out. The stick pad is made from a simple piece of copper flashing, covered by a layer of dielectric plastic. You gently rub it with the fingers or thumb of one hand while you adjust the dials with the other hand. When you get the dial 'tuned in' you will feel a sensation in the fingers which are connected to the stick pad. This is imo because of changing static electric properties between your fingers and the pad when resonance with the sample placed in the witness well is achieved. You can use either a simple piece of sheet metal for the witness well, or a small can, cup or bowl. I like to use brass shot glasses.

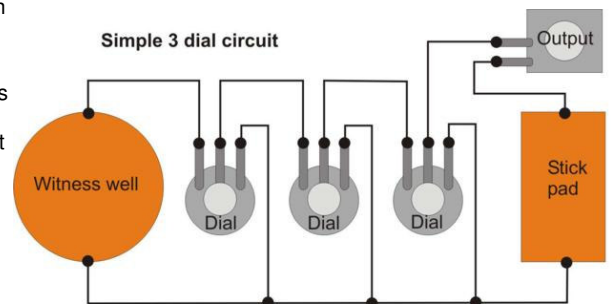

This circuit is a bit more complex, but basically incorporates 3 mobius coils around a common quartz core. One of the circuits is a 'target' circuit. This decides where to send the energy. It is the one with 3 dials, the uppermost coil on the xtal. Next is a basic zapper circuit, a square wave generator. The zapper circuit drives the center mobius on the xtal. In order to prevent the center coil (the one driven by the zapper) from overpowering the other more subtle radionics circuits, the coil is covered with a layer of aluminum which is connected by a wire to a ground ballast provided in the circuit. The aluminum shroud is in turn covered by a dielectric. You could also connect it (the copper pipe) directly to a dry or wet ground. The ground ballast is simply a cylinder of orgonite inside of a section of copper pipe. The radionic circuits are grounded to the orgonite, and shroud around the electrically driven coil is grounded to the copper. The Lower coil is connected to the 'trend' tuning circuit. This circuit decides what kind of energy it is that you are sending. The trend has 6 dials for finer tuning, and the target has 3 which imo is more than enough for accuracy. There are many more complex ways you could go about this, but this circuit is easy to make (relatively) and in my experience performs well. As time permits I will be adding more info about how to use a radionics machine... And the simpler circuit shown above (the one with only 3 dials, the witness well and stick pad) is more than enough to get started with, provided you at least connect it to an antenna of some sort. Have fun :)

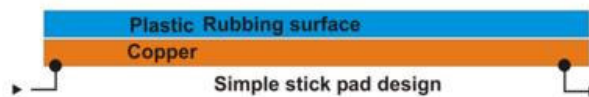
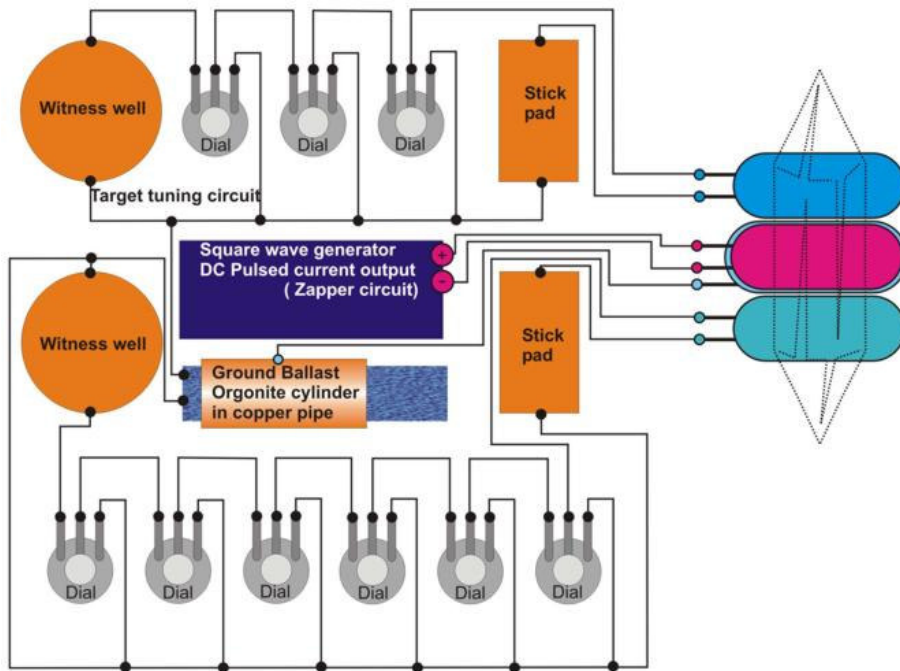

The following is some info (taken from the user manual I give with the machines i make) which might be helpful if you decide to make your own machine.

**Disclaimer:**

***While Radionics Machines have been successfully used for decades in the treatment of various illnesses and the enhancement of various metaphysical discipline's effects, there are two factors which apply:***

A: The fact that I am not a medical doctor and cannot by law give you medical advice, so all such notions put forward by me in this manual or elsewhere are to be taken as my opinion, this machine is to be viewed as an experimental device, and you are responsible for your own decision to purchase and use it. If you have a serious health problem, you should consult a medical doctor whether or not you choose an alternative means of treatment.

B: The fact that skill on the part of the user is a critical parameter in the use of a machine like this one. Practice is involved in gaining the ability to use a stick pad accurately, and in determining the correct methodology as regards the application of your radionics machine for a given purpose.

**Dials** - The dials and/or sliders on your machine should be numbered. Each dial has a number assigned to it, and then a scale of numbers to indicate the dial position. When setting the dials, you should start at the dial marked "1". The dial closest to the witness well is "1".

**Witness Wells** - The witness wells should be a small metal receptacle or plate upon which to place a sample. While you can use your machine without a sample in the well, it is better to have a sample in the well if possible.

**Outputs** - Your machine may have a permanently affixed output and/or removable or additional outputs. These are the part of the machine which transmits energy, and if applicable may be positioned so that the output directs the energy to the desired place.

**Configuration** - Whatever model of machine you have, it is important that when recording the dial setting for a given sample in your log book, you also make a note of how the machine is configured (as regards power on/off, choice of outputs if applicable, signal fed to drive coil if applicable, etc). In short, the conditions which exist when you find a setting should reproduced when you subsequently return to that setting. Those conditions may include more variables than simply the number setting on the dials.

**Radionic Circuits** - Whether your machine has one circuit or more, the circuits themselves are much the same. A radionic circuit combined with an output forms a tunable orgone generator which allows you to tune into and affect (i.e. reproduce, amplify or dampen) orgone energy (bioenergy) signatures. Using two or more circuits on the same machine allows you to combine effects, like for example using one circuit to generate the energy signature you want to use (trend) and another to direct the energy where you want it to go (target). If your machine has only one circuit, then it generally can be thought of as 'trend' and the target is determined by combining two or more samples in the witness well, or by where you point the output (on small 'SP' models).

#### Using a Stick Pad

Pay attention to the sensations in your hand while it is touching the pad, or near the pad. You may notice a tingling sensation in the palm of your hand while it is near the pad, or touching the pad (this for persons more familiar with reiki and other 'hands on' energy work systems than with radionics machines). If so, you will likely notice that the sensation is most pronounced at a certain dial position. That would be what you are looking for, and that is the number setting which (if applicable) you should record for that dial in your log book.

Understand that the 'stick' is a subtle sensation. It will be a slight difference in the amount of friction between your hand and the pad. Do not expect it to suddenly clamp your hand to the pad. Use your fingertips or the side of your thumb, and use a steady and even motion. You can either use a circular motion or go back and forth across the pad.

You may find that you get a stick when turning the dial, but then you go past it (with the dial) and cannot find it when turning the dial in the opposite direction. If so, turn the dial all the way to the start position, remove your hand from the pad, and start over. I believe that this phenomenon comes from a buildup of capacitance in the circuit which discharges when the circuit achieves resonance with a component of the emission spectrum of the sample in the witness well, but I am not certain at this point. In any case, it is a relatively common observation, and easily remedied by simply starting over.

Use a little less pressure on the pad as you go from one dial to the next. Start out rubbing relatively firmly against the pad while you set the first dial, and finish by lightly drawing your fingertips across the pad while you set the last dial. Understand that the 'stick' generated by the last dial you set is 'still there', therefore the next dial you tune will be a bit more subtle than the one before it, and so on and so on, through the series of dials.

The machines are generally configured so that the user stands opposite the machine from the output, or to the side of the output. If you are standing 'in' the output, it may be difficult for you to set the dials or use the stick pad.

Do not look at the dials while you are turning them. Look at something neutral or close your eyes.

Do not 'expect' to get a stick at a certain place on the dial, but rather let it be wherever it works out to be. Under different conditions (see notes on configuration above) the same sample may give a different number setting on the dials.

#### Setting the Dials

1. Place a sample in the witness well.
2. Turn the power on if applicable.
3. Align the machine with the compass direction if applicable (see following page).
4. Set all the dials in the circuit you are working with to the start position. This will be the lowest numerical setting on the scale of numbers for each dial.
  - Start with the first dial in the circuit. This will generally be marked as dial 1, but if your dials are not individually numbered, then it will be the dial closest to the witness well for that circuit.
  - Slowly turn the dial while rubbing the stick pad. When you get a stick, stop turning the dial and wait a second or two before moving on to the next dial.
  - Move on to the next dial in the series and repeat the above step. Keep doing this until all the dials in the series are set to the position that gives the best stick.
  - Alternately, if you are a dowser, you can simply dowse over the stick pad in order to determine when the dial is set correctly.
  - Once the dials for the circuit are set, make a note of the number setting and machine configuration in your log book. Then next time, you can simply put the sample in the witness well and set the dials without having to use the stick pad.
  - Move on to the next circuit if applicable (for systems with 2 or more circuits). You can set either the trend circuit first or the target circuit first.

#### Power Driven Models

On machines with an additional electronic circuit, the function of the electronic circuit is to boost the performance of the radionic circuit(s). These machines have 2 modes of operation, a 'passive' mode (with the power off) and an 'active' mode (with the power on).

The radionic circuits will work either with or without the electronic circuit powered on, but they may produce different number settings on the dials in the two different modes. Also, the electronic circuit, while in operation, has an effect on the radionic circuits. For this reason, it is best to turn the power on if desired, and **then** set the dials (as opposed to setting the dials and then turning the power on).

### Aligning your machine

**It is reasonably important that your radionics machine be lined up with the compass directions**, in order to work properly. Although most tabletop models have a permanent magnet included in the machine to compensate for improper alignment, it is still preferable to line the machine up with the compass directions if at all possible. Unless clearly marked otherwise on your machine, the side of the machine with the witness wells should be to the north.

Generally speaking, the radionics machine should be 'inline' with the lines of force in the earth's EM field (north/south) and the axis of the output should be at 90 degrees to the lines of force in the earth's magnetic field, especially for remote work.

The exception to this is the 'wand' style of output designed for body work, which can be pointed where ever is expedient, so long as the radionics machine driving it is aligned correctly.

### Samples

In the following pages, I give a few examples of minerals suited to various purposes. You could also (if you are familiar with and competent in the use thereof) expose the witness well to hertzian frequencies commonly used for a given purpose.

When writing paper slips to be used as samples, the emotional (primarily) mental (secondarily) state that you are in is what the paper actually records. It is best to keep the wording of the samples as short and to the point as possible. It is best to be in a clear and focused state of mind when you write them. You should, if at all possible, use fresh paper that has not been used for anything before. Once you are finished using the slip of paper, you should burn it (in a safe and contained manner).

When using a physical sample of a person, it is not necessary that living cells be used, nor is it necessary that the cells contain DNA, since there will still be a 'structural link' between the person and the sample. i.e. - a snippet of hair without the follicle will work. However, it is preferable to have living cells if possible, as the structural link between living cells and host organism is stronger than the link between dead cells and former host organism. Once you are finished using the sample, it should be destroyed, preferably by fire (in a contained and safe manner).

Photographs will also work for a sample, and they do not need to be color photographs, but the aspect of the person captured by a photograph is what you are tuning into. Bear this in mind when selecting photographs to use as samples. If the only photograph available reflects an aspect of the sample that you do not want to work with, then attach a note to the photograph clearly stating which aspects you do and do not want to work with.

Another way to obtain a sample is to use fresh, clean water and expose the water to that which you wish to sample. Water records energy signature rather well. This technique is more suited to capturing samples of subtle energy fields and/or hertzian frequencies and/or sounds, or for use in manifestation (hold a vial of water while doing your visualization and use that water as sample).

### Examples of material for samples -

Photographs - Written words - Tissue samples - Saliva samples - Hair samples

Quartz crystals w/recorded energy patterns - Charged water - Minerals harmonic to a given task

Symbols (reiki, runes, other)

Sound recordings (via water or via direct stimulation of witness well with sound)

*(you are responsible for your own safety in handling/choice to handle biological material - determine approved methods and use them - do not attempt to obtain or use samples of contagious diseases - rather, use a photograph of the infected person or write the name of the disease on a slip of paper - disinfect machine between uses if using biological samples - contain sample in clear glass vial)*



### Using Your Machine

#### Using it to repel an energy attack / remove astral parasite

While experiencing the attack, write the word 'attack' (or 'parasite' if applicable) on a slip of paper. Place the slip in the trend witness well. Set the dials for the trend circuit. Then, 'invert the setting'. To do this, adjust the setting each for dial in the trend circuit to its tens complement ((dials marked form 1 to 10). i.e. if you initially came up with 1-4-7-3-8-5, then set the dials to 9-6-3-7-2-5).

Lastly, transfer the slip of paper to the target circuit and set the dials for the target circuit (but **do not** 'invert the setting' for the target circuit by replacing each dial setting with its tens complement).

Alternately, you could use either a sample of yourself or a sample of the source of the attack if you know it... for a sample in the target circuit.

### Using it as an intent amplifier

Write your intent on a slip of paper. Make sure that your thoughts are clear and focused while you write the slip of paper. Place the slip of paper in the trend witness well, and set the dials for the trend circuit.

Place a sample of yourself (or other entity if applicable) in the target witness well and set the dials for the target circuit. Leave the machine to run for up to 3 days, but no longer. Remove and burn the slip of paper (in a safe and contained manner). Turn all the dials to the 'off' position and turn the power off. Allow the machine to sit for at least a few hours before repeating the process if necessary. For intent having to do with beginnings, try to do this on or near the new moon. For intent having to do with endings, try to do this on or near the full moon.

### Using it for simple pain relief

Place a sample of the person to be treated in the target witness well, and set the dials for the target circuit.

Starting with the first dial in the trend circuit, adjust the dial by small increments and monitor the pain. If there is a dial setting that reduces the pain, then move to the next dial and set the dials for the trend circuit. If the first dial does not have a setting that noticeably diminishes the pain, then use a different method of treatment (following pages). This method works sometimes and does not work sometimes.

### Using it to enhance dowsing

#### **Method A:**

Place a sample of yourself in the trend witness well, along with a slip of paper with the word 'clear' (or some other word indicating that you wish your thoughts to be clear and uninfluenced by outside sources) written on it. Set the dials for the trend circuit.

Place your pendulum in the target witness well, and set the dials for the target circuit. Dowse over the output of the machine, or near the output of the machine.

#### **Method B:**

Place a sample of the entity to be examined in the trend witness well, and set the dials for the trend circuit.

Write your question (or the parameters of your analysis) on a slip of paper and place the slip of paper in the target witness well. Set the dials for the target circuit. Dowse over or near the output of the machine.

#### **Method C:**

Place a sample of one of these minerals in the trend witness well and set the dials for the trend circuit.

Amethyst  
Citrine  
Smoky Quartz  
Emerald  
Kyanite  
Azurite  
Malachite  
Diamond

Place your pendulum along with a sample of yourself in the target witness well and set the dials for the target circuit. Dowse (not necessary to be near the output of the machine for this method).

#### **Method D:**

Place a sample of the entity to be examined in the target witness well and set the dials for the target circuit.

Place your pendulum in the trend witness well and set the dials for the trend circuit. Dowse. (this method for sending energy or remote examination i.e. map dowsing)

Be sure to reset dial to zero and turn machine off when not dowsing if using methods B or D.

### Using it to potentize/charge food or water

#### **Method A:**

Place a sample of the energy signature that you want to add to the food or water in the trend witness well. If you are using for example a homeopathic treatment, then you would use a sample of the treatment in powder or elixir form, and generally a small clear glass vial works well to contain the sample (place the sample in a glass vial, and then put the sample into the well). Either suspend a vessel (preferably glass, generally not metal, must be non-reactive non-leeching non-conductive non-toxic) of the food or water over the output of your machine, or immerse the output of your machine in the food or water, whichever is appropriate to your equipment. Allow an hour or two and turn the machine off, and sample the food or water.



Different kinds of food are obviously more suited for different methods of charging, and the foods charged should be raw or at least cold when charged. Heating or cooking the food after charging will likely undo the charge.

**Method B:**

If you have an output that is a quartz crystal and mobius coil on the end of a cable, then you can wrap the output in a clear clean plastic bag (seal with tape around cable) and immerse the whole thing in a vessel for water, this method is often the most convenient.

**Author's Note:**

*You are entirely responsible for the use of this device for self-treatment or the illegal and evil vile nasty healing of friends and neighbors ;) however, the skill of the user in determining which samples to use and determining when the dials are correctly set are significant factors between healing and harming. Share your successes more readily than your experiments, but do experiment. I have given information here based on y own personal experiences with my machines, and from a general metaphysics perspective.*

*I have tried to cover some of the basic techniques used in operating a radionics machine (in general), techniques which can be conceptually adapted to many different machines, not just those made / designed by me.*

*We live in a time of struggle and legal reform, and litigation. It is possible that the improper use of this machine when attempting treatment for illness can cause either nothing to happen, or the reverse of what is desired to happen. While in my experience such mistakes are generally not permanently damaging, and are rectified generally by resetting the machine correctly and or aborting the treatment, mistakes do happen in the process of learning to use the. I maintain that these machines are beneficial when used correctly, acknowledge that they can harm a person's bioenergy fields if used incorrectly, and assume no responsibility for your decision in this matter, having done my best to advise you of the best operating procedures I have found, based on my personal experience with my machines in particular and metaphysics in general.*

*These machines are for experimental purposes. These machines are not intended to be equivalent to a medical doctor's services. Any attempt to use such a machine for healing should be part of a wider picture. This is not a magic wishing machine, it is a device which can record and play back energy signatures. You are responsible for knowing or learning what energy signatures it is appropriate to do what with at a given time, other than the specific samples I have given here in terms of minerals etc. -Jon Logan*

Using it to promote healing

**Method A:**

Take a sample of the person to be treated and place it in the trend witness well, wrapped in a slip of paper with the word 'illness' written on it. If the illness or problem is known, then use the name of the illness or problem on the slip of paper. Set the dials on the trend circuit, tuning the circuit into the energy signature of the **problem**.

Then invert the dials as described in the section on repelling an energy attack. Starting with dial 1, reset each dial in the circuit to it's tens compliment.

Leaving the first sample in the trend witness well, take another sample of the person to be treated and place it in the target witness well. Set the dials on the target witness well and have the person sit to the south of the machine if possible or applicable. Allow no more than an hour for treatment and then shut the machine down and allow the person to rest for an hour or two.

Repeat no more that 2 times per week.

**Method B:**

If the problem is known, and a medicine for it is available though not of sufficient quantity, take a small sample of the medicine and place in the trend witness well. If a sample of the medicine is not available but the medicine is known, then use a photograph of the medicine if available, or the name of the medicine written on a slip of paper. The first case employs the machine to reproduce a sample, and the second case employs an already existing 'cosmic' structural link between the medicine and it's name or image. Set the dials on the trend circuit.

Transfer the sample to the target witness well and set the dials on the target circuit. Transfer the sample back to the trend circuit and use the machine to either treat by proximity as described above, or to charge water with the energy signature of the medicine. Do not expect results quite as strong as the original medicine, but a useful technique nonetheless.

**Method C:**

(For person familiar with bioenergy - body work)

Place a sample of the person to be treated in the target circuit and set the dials for the target circuit. Adjust the first dial of the trend circuit and monitor the effects on the person. See if there is a setting on the dial that shows improvement in the person's bioenergy field characteristic, or a change in the discernible amount of pain the person feels, if applicable. If you are bale to find a setting on the first dial using this method, then continue on through the dials. If you do not find a setting on the first dial that shows improvement, use one of the preceding methods instead.

This method is sometimes useful for pain relief when you do it to yourself, but should only be done on others by competent energy healers / dowzers.

Well, that's it for this edition but you can check for the latest copy of this document at [www.littlemountainsmudge.com](http://www.littlemountainsmudge.com)

Legal notice:

Introduction to Orgonite™ copyright 2003 Jon Logan  
Introduction to Orgonite™ second edition copyright 2002-2004 Jon Logan  
Introduction to Orgonite™ third edition copyright 2002-2004 Jon Logan  
Introduction to Orgonite™ fourth edition copyright 2002-2004 Jon Logan  
Introduction to Orgonite™ fifth edition "An introduction to Orgone Matrix Material" copyright 2002-2004 Jon Logan

"Introduction to Orgonite™" and/or Introduction to Ergonite™ are compilations of articles written by Jon Logan, concerning Orgone Matrix Material, it's manufacture and application, much of which has been previously published on [www.littlemountainsmudge.com](http://www.littlemountainsmudge.com). These compilations will be released in updated form as time progresses.

Orgonite™ is a trademark belonging to Karl Welz, the inventor of orgonite, and is used on littlemountainsmudge.com and in this document for educational purposes

Wizzer's Workshop™, Ergonite™, Welzite™, Wood Sprite™, Water Baby™, Chocolate Shine™, O-Matrix Material™ and all text / images on littlemountainsmudge.com, unless clearly otherwise stated, are copyright 2003 Jon Logan, all rights reserved.

Limited authorization to reproduce: This material may be reproduced or reprinted freely, in whole or in part, in printed paper or digital format for educational purposes. Additionally, the trademarks Ergonite™ and Welzite™ may be used freely by anyone for private or commercial purposes, so long as they are specifically used to refer to Orgone Matrix Material, a mixture of metal particles suspended in organic resin.

Owner of copyright for text and images on littlemountainsmudge.com and trademarks used on littlemountainsmudge.com reserves the right to refuse, suspend or revoke limited authorization to reproduce this material if the material is reproduced inaccurately, or if is sold at a cost in excess of it's production without prior written consent from the owner, or if printed material from this site is used commercially without stating in the printed copy that the material is copyright 2003 Jon Logan.

In reference to "Introduction to Orgonite™", **this document may be reproduced freely by anyone for private or commercial purposes without prior written consent so long as the following conditions are met:**

- The document must be reproduced in it's entirety and not altered in any way.
- You may not charge a fee for distributing or reproducing this document in digital format.
- You may charge a fee for distributing hard copies of this document, of not more than 20 Dollars CDN or 17 Dollars US, whichever is greater.

Email – [wizzer@littlemountainsmudge.com](mailto:wizzer@littlemountainsmudge.com)

Phone – 250-446-2032

Mail – PO Box 139, Westbridge BC V0H2B0

Url – [www.littlemountainsmudge.com](http://www.littlemountainsmudge.com)

Introduction to Orgonite™ fifth edition "An introduction to Orgone Matrix Material" copyright 2002-2004 Jon Logan