

1. Unpack your computer

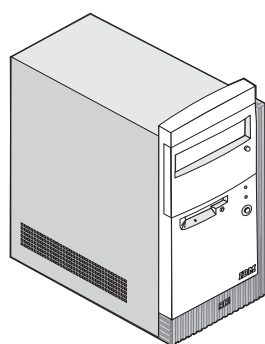

Components included with all models:



System unit (microtower)



Power cord

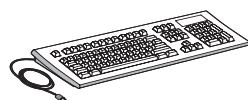

Keyboard



Mouse

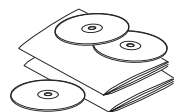

Publications and CD-ROMs

Components included with some models only:



Phone cord



Phone cord adapter (style varies by country)

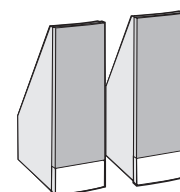

Speakers (unpowered)

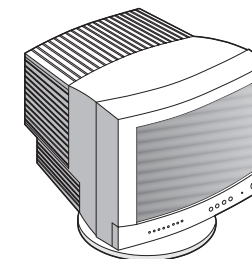

Monitor with stand (may be sold separately)



Headset Microphone

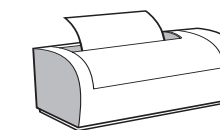

Printer (sold separately)

2. Connect the system components

Attach components to the computer as shown.

If you need setup instructions for components that are not shown here, refer to the back of this sheet or the instructions that came with the component.

Note:

Most cable connectors are color-coded to match the location at the back of the system unit where you connect the cable.

Read "Safety information" in the *User Guide* to learn about connecting cables.

The location of the phone line and telephone cable connectors on your system unit might be different from the locations shown in this illustration. Use the symbols on the back of the system unit as a guide.

To use the Ethernet feature available on certain models, connect the RJ-45 connector of an Ethernet cable to your computer. Contact your network administrator for more information about using your computer on a network.

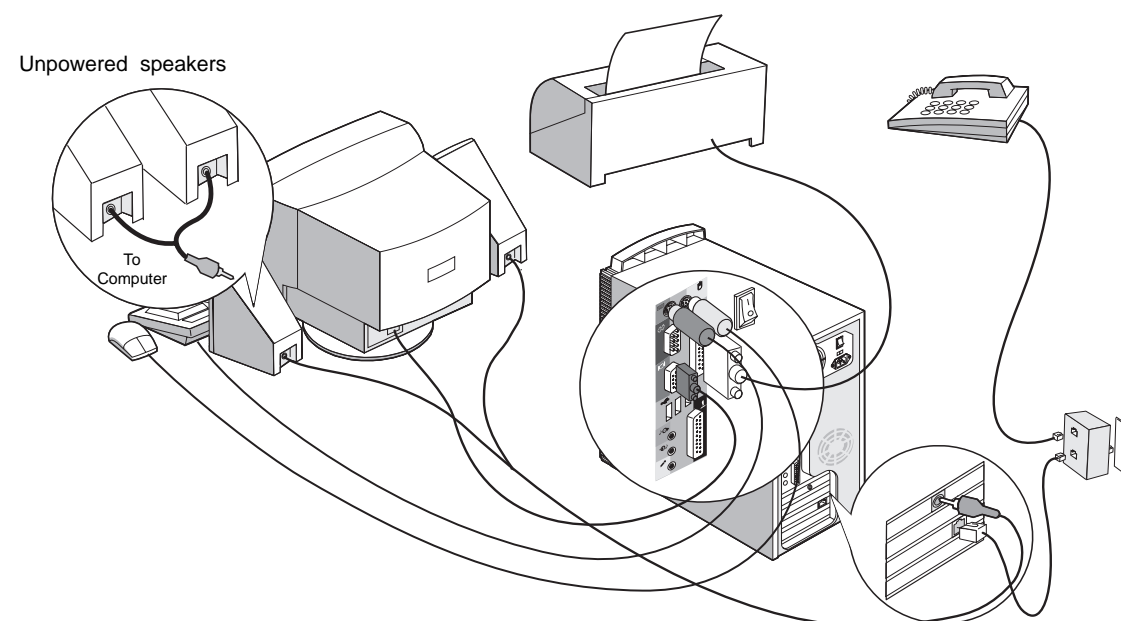

3. Connect power cords

The voltage selector switch should be preset for your area; however, contact your local power company if you are uncertain of the voltage for your area.

- If the voltage supply range in your area is 100-127V, set the voltage selector switch so you can see 115V or 115.
- If the voltage supply range in your area is 200-240V, set the voltage selector switch so you can see 230V or 230.

Connect the power cords to the computer and monitor first, and then connect the power cords to the electrical outlets. For clarity, only the power cords are shown in this picture.

Note: Make sure the power switch on the back of the computer is in the ON position (1=ON).

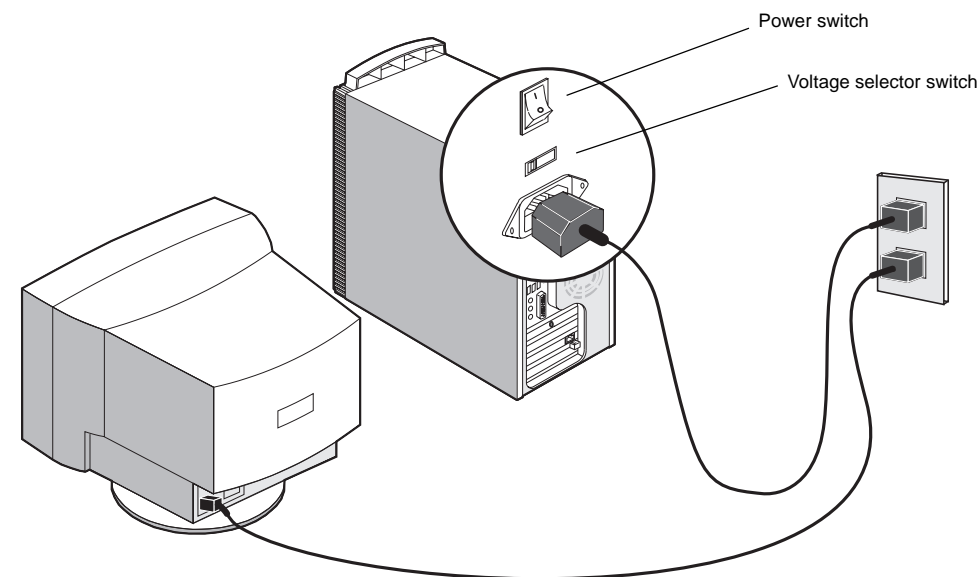

4. What to do next

- A. Turn on the monitor and the computer.

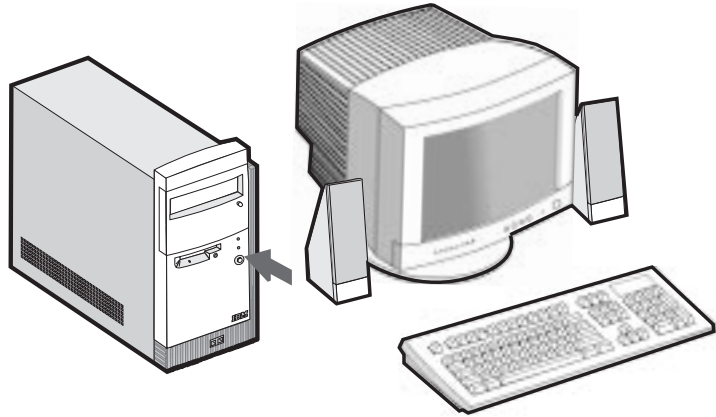

- B. **Important: Please read the license agreements carefully before using the programs included with this system. These agreements detail your rights, obligations, and warranties for the software included with this system. By using the programs, you agree to the terms of these agreements. If you do not accept the agreements included with this system, do not use the programs. Instead, promptly return the system for a full refund.**

When the software setup is completed, the Windows 98 Desktop appears.

Insert the *Software Selections CD-ROM* into your CD-ROM drive. (If you need instructions for operating your CD-ROM drive, refer to the *User Guide*.) The CD will automatically install several important programs. Then, the Software Selections program will start and you will have the opportunity to install additional programs.

If you selected a model without a CD or DVD drive, you can install additional programs using your LAN.

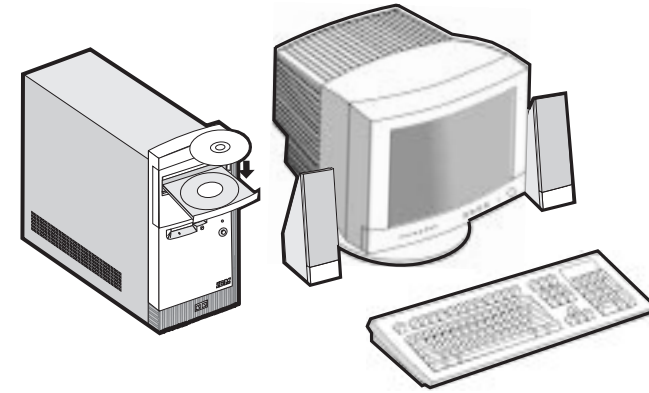

If a computer problem occurs, refer to the "Troubleshooting" and "HelpWare Support and Services" chapters in the *User Guide*. Save this setup sheet for future reference.

5. Connecting additional components

The following illustrations show you how to connect additional components that might have come with your computer (or that you purchased separately). Some components may require software or BIOS setup. Turn the computer off before connecting non-Plug and Play components. Refer to the documentation that came with the component for more information.

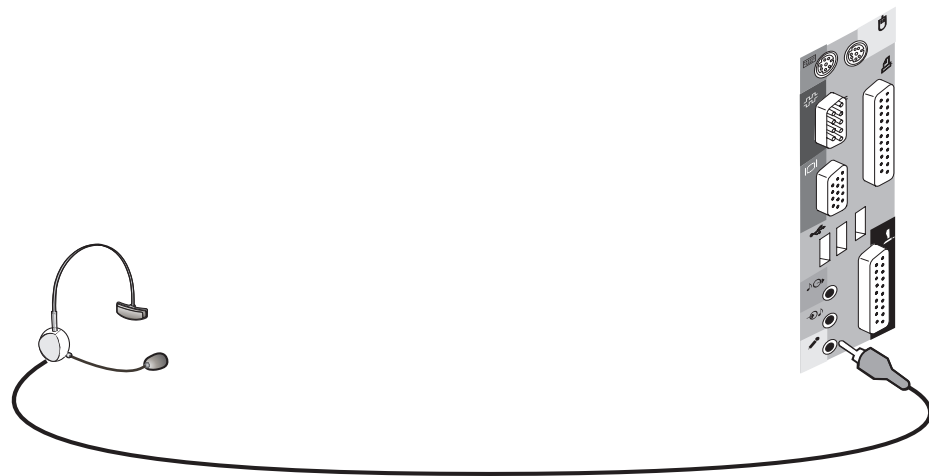

Headset microphone (without speaker)

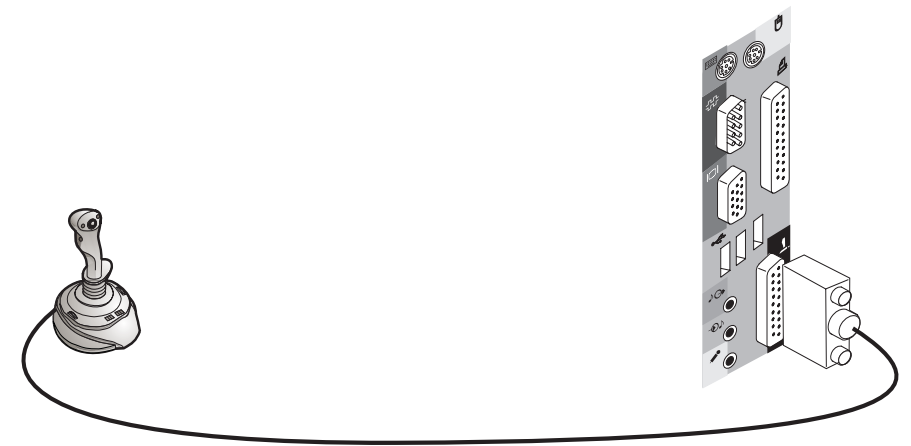

Joystick

