

NetVista™ Thin Client



NetVista N2200w, Thin Client for Windows-based Terminal Standard 1.5 Reference June 2000

To view or print the latest update, go to <http://www.ibm.com/nc/pubs>

NetVista™ Thin Client



NetVista N2200w, Thin Client for Windows-based Terminal Standard 1.5 Reference June 2000

To view or print the latest update, go to <http://www.ibm.com/nc/pubs>

Note

Before using this information and the product that it supports, be sure to read "Safety notices" on page v and "Notices" on page 67.

First Edition (April 2000)

© Copyright International Business Machines Corporation 2000. All rights reserved.

US Government Users Restricted Rights - Use, duplication or disclosure restricted by GSA ADP Schedule Contract with IBM Corp.

Contents

Safety notices	v
Danger notices	v
Caution notices	vi
Handling static-sensitive devices	vi

About this book.	vii
Who should read this book	vii
Information on the Internet	vii
Related information	vii
How to send your comments	vii

Understanding your IBM NetVista N2200w, thin client for Windows-based Terminal Standard 1.5.	1
Thin client software	1

Learning about the hardware	3
Standard hardware	3
Hardware connectors	3
Communication hardware	3
Monitor specifications	4
Power consumption	4
Upgrading hardware features.	4

Setting up your hardware	5
---	----------

Startup sequence	7
-----------------------------------	----------

Configuring your thin client	9
Completing the WBT Setup Wizard.	9
Setting the terminal properties	10
Working with the terminal property tabs	10
General tab	10
Input tab	10
Display tab	11
Network tab	11
System tab.	12
Modem tab	12
Update tab	13
Security tab	13
Export tab	14
Creating a Terminal Server Connection	14
Creating an ICA connection	15
Creating an RDP connection.	16
Creating a TEC connection	16

Configuring multiple thin clients.	21
Setting up your configuration server	21
Exporting the base terminal configuration	21
Reviewing the Saveconfig.reg file	22
Reviewing the Updatereg.xml file	23
Installing the exported configuration to multiple thin clients	25

Working with the Terminal Connection Manager	27
Connecting to a terminal server	27
Disconnecting from a terminal server.	27
Managing terminal server connections	27
Editing a terminal server connection	28
Editing an ICA connection	28
Editing an RDP connection	28
Editing a TEC connection.	29
Setting a startup terminal server connection	31
Deleting a terminal server connection.	31

Printing from your thin client	33
Printing to a network printer	33
ICA and RDP sessions.	33
TEC sessions	33
Printing to a local printer.	34
ICA session	34
RDP session	34
TEC session	35

Updating your software	37
Setting up your update server	37
Downloading the software update.	37
Verifying the package ID in the sample install.xml file	38
Installing the software update	38
Automatic software update	38
Manual software update	39

Resolving hardware problems.	41
Verifying hardware problems	41
Visible hardware failure	42
Audio beep sequences.	44
LED indications	45
Error codes and text messages	47

Appendix A. Windows server requirements	51
--	-----------

Appendix B. Replacing hardware parts	53
Replacing the logic unit	53
Ordering replacement parts	53
Returning hardware parts	55

Appendix C. Upgrading memory.	57
--	-----------

Appendix D. CompactFlash card.	59
---	-----------

Appendix E. Recovering the boot block image	61
--	-----------

Appendix F. Monitor specifications	63
---	-----------

Appendix G. Connector pin information 65

Notices 67

Environmental Design 68

Product Recycling and Disposal 68

Trademarks 69

Electronic Emission Notices 69

 Federal Communications Commission (FCC)
 Statement 69

Glossary of abbreviations 71

Index 73

**Readers' Comments — We'd Like to
Hear from You** 75

Safety notices

Safety notices contain information that is related to using the IBM® NetVista N2200w in a safe manner. These notices can be in the form of a danger, caution, or attention notice.

Danger notices

The following danger notices call attention to situations that are potentially lethal or extremely hazardous. These notices pertain throughout this book.

DANGER

To prevent a possible electrical shock during an electrical storm, do not connect or disconnect cables or station protectors for communications lines, display stations, printers, or telephones. (RSFTD003)

DANGER

To prevent a possible electrical shock from touching two surfaces with different electrical grounds, use one hand, when possible, to connect or disconnect signal cables. (RSFTD004)

DANGER

An electrical outlet that is not correctly wired could place hazardous voltage on metal parts of the system or the products that attach to the system. It is the customer's responsibility to ensure that the outlet is correctly wired and grounded to prevent an electrical shock. (RSFTD201)

DANGER

To prevent a possible electrical shock when installing the system, ensure that the power cords for all devices are unplugged before installing signal cables. (RSFTD202)

DANGER

To prevent a possible electrical shock when adding the device to a system, disconnect all power cords, if possible, from the existing system before connecting the signal cable to that device. (RSFTD205)

DANGER

To prevent a possible electrical shock, disconnect the power cord from the electrical outlet before opening the unit. (RSFTD215)

DANGER

To reduce the risk of electrical shock use only AC power sources approved by IBM. (RSFTD216)

Caution notices

A caution notice applies to a situation that is potentially hazardous to people because of some existing condition.

Handling static-sensitive devices

When you handle components, take these precautions to avoid static electricity damage:

- Do *not* open static-protective packages until you are ready to install their contents.
- Limit your movements to avoid static electricity build-up around you.
- Handle components carefully, and never touch exposed circuitry.
- Prevent others from touching components.
- Place components on static-protective packages while performing hardware removal and installation procedures.
- Do not place components on metal surfaces.

About this book

NetVista N2200w Windows-based Terminal Standard 1.5 Reference (SA23-2801) provides information for the Type 8363 (Model Wxx) IBM NetVista N2200w, Thin Client for Windows-based Terminal Standard 1.5 (5648-C09), hereafter referred to as the **NetVista thin client**.

This publication contains hardware, software, and problem resolution information. This publication also provides new information that is based on Service Pack 1.0 product updates.

Who should read this book

The following should find the information in this publication helpful:

- The person or group who administers the NetVista thin client
- The hardware service and support organization for the NetVista thin client

Information on the Internet

- You can find additional information about your NetVista thin client at the following URL:

<http://www.pc.ibm.com/support>

1. Click **NetVista**.
2. Click **NetVista thin client**.

- You can obtain the latest version of this information at the following URL:

<http://www.ibm.com/nc/pubs>

This is the same URL that is printed on the cover of this document.

Related information

The following publications ship with your NetVista thin client hardware. Refer to these publications for information on your NetVista thin client.

- *IBM Network Station™ Quick Setup Type 8363 (SA23-2800)*
- *IBM License Agreement For Machine Code (Z125-5468)*
- *IBM Network Station Safety Information (SA41-4143)*
- *IBM Network Station Hardware Warranty - Type 8363 and Type 8364 (SA23-2802)*

Refer to the documentation for your server-based software for information on setting up and managing your server-based software.

How to send your comments

Your feedback is important in helping to provide the most accurate and high-quality information. You can submit comments about this publication, or any other IBM information, by mailing the readers' comment form, located at the end of this information.

- If you are mailing comments from a country other than the United States, you can give the form to the local IBM office or IBM representative for postage-paid mailing.
- If you prefer to send comments by FAX, use either of the following telephone numbers:
 - United States and Canada: 1-800-937-3430
 - Other countries: 1-507-253-5192
- If you prefer to send comments electronically, use the following network identification:
 - IBMMAIL, to IBMMAIL(USIB56RZ)
 - RCHCLERK@us.ibm.com

Be sure to include the following:

- The title and publication number of the information
- The page number or topic to which your comment applies

Understanding your IBM NetVista N2200w, thin client for Windows-based Terminal Standard 1.5

The IBM NetVista N2200w, Thin Client for Windows-based Terminal Standard 1.5 (5648-C09) is a fast and simple thin client solution for server-based environments. The NetVista thin client can access Windows® applications and other applications on terminal servers, while enabling rapid application deployment and low total cost of ownership for customers.

The NetVista thin client is an enhanced Windows-based terminal (WBT) that delivers focused, secure, and optimized information for the user. It can access applications on Windows servers (see “Appendix A. Windows server requirements” on page 51) through Remote Desktop Protocol (RDP), or Independent Computing Architecture (ICA). It also includes Terminal Emulation Client (TEC) software for accessing various terminal server applications.

The NetVista thin client comes with IBM thin client hardware (see “Learning about the hardware” on page 3 for more information) that includes a preinstalled and preconfigured CompactFlash card. The CompactFlash card contains software that provides access to Windows applications and other applications on terminal servers. The NetVista thin client boots locally from the CompactFlash card, and communicates to a terminal server through the TCP/IP.

Thin client software

The NetVista thin client includes the following CompactFlash card-based software:

- Windows-based Terminal Standard 1.5
- ICA
- RDP
- Terminal emulation clients

You can find additional information about your NetVista thin client at the following URL:

<http://www.pc.ibm.com/support>

1. Click **NetVista**.
2. Click **NetVista thin client**.

Learning about the hardware

This section provides detailed hardware information about the Type 8363 (Model Wxx) NetVista thin client.

Standard hardware

The standard NetVista thin client hardware includes the following:

- 32 MB of permanent memory, which includes 4 MB dedicated to video memory
- Integrated Ethernet communication
- 16-bit internal and external sound
- One 16 MB CompactFlash card with preloaded software
- 2 USB ports for keyboards and other USB devices

Hardware connectors

Your NetVista thin client hardware includes standard connectors, standard pin, signal, and signal direction configurations. See “Appendix G. Connector pin information” on page 65 for details.

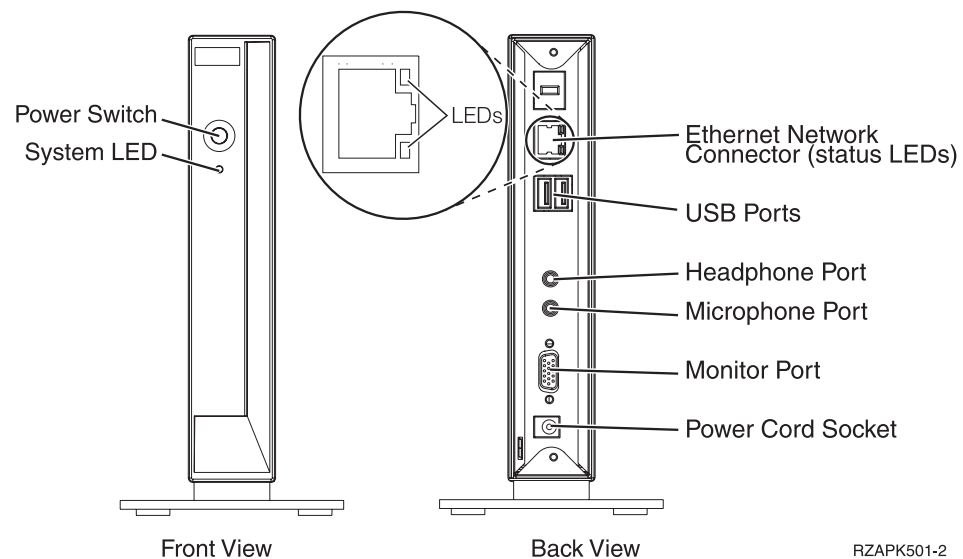

Figure 1. Hardware connectors

Communication hardware

Your NetVista thin client includes integrated Ethernet connection (Model Wxx).

For a 10 MB ring speed operation, you need a category 3 or higher Unshielded Twisted Pair (UTP) type of cable. For a 100 MB ring speed operation, you need a category 5 UTP type of cable.

Refer to “Appendix G. Connector pin information” on page 65 for communication cable specifications.

Monitor specifications

A basic VGA-class monitor that meets the Video Electronics Standards Association (VESA) standards of refresh rate and resolution can function with your NetVista thin client. Your NetVista thin client can support VESA Display Power Management Signaling (DPMS) and VESA Display Data Channel (DDC2B).

Refer to “Appendix F. Monitor specifications” on page 63 for a list of resolutions and refresh rates that your NetVista thin client can support. Your monitor may not support all resolutions and refresh rates.

Power consumption

The normal power consumption for your NetVista thin client, while running applications, is approximately 14 watts. You may see power consumption of up to 18 watts in some applications or configurations. For more information, contact an IBM account representative.

Power reduction occurs when you use your NetVista thin client with a VESA DPMS Standard monitor.

Upgrading hardware features

You can perform the following hardware procedures:

- Connect USB devices

If you plan to use peripheral USB devices with your NetVista thin client, refer to the documentation for your peripheral USB devices for information.

- Upgrade your memory

Your NetVista thin client has one random access memory (RAM) slot that accepts Synchronous Dynamic Random Access Memory (SDRAM) Dual Inline Memory Modules (DIMMs). Your NetVista thin client includes 32 MB of permanent RAM on the system board, and supports memory expansions of up to 288 MB by using 32, 64, 128, or 256 MB DIMMs.

“Appendix C. Upgrading memory” on page 57 provides information on how to upgrade your memory. Refer to “Ordering replacement parts” on page 53 for detailed memory specifications and orderable NetVista thin client parts.

Setting up your hardware

The *IBM Network Station Quick Setup Type 8363 (SA23-2800)* pamphlet, which ships with your hardware, provides the following information. This section repeats the same information for your convenience.

Read "Safety notices" on page v before you continue with these instructions.

Unpacking your hardware

Unpack the hardware. Contact your reseller, or IBM, if you do not have these standard parts:

- 1** Logic unit
- 2** Base
- 3** Mouse
- 4** USB Keyboard
- 5** Power supply
- 6** Power cable

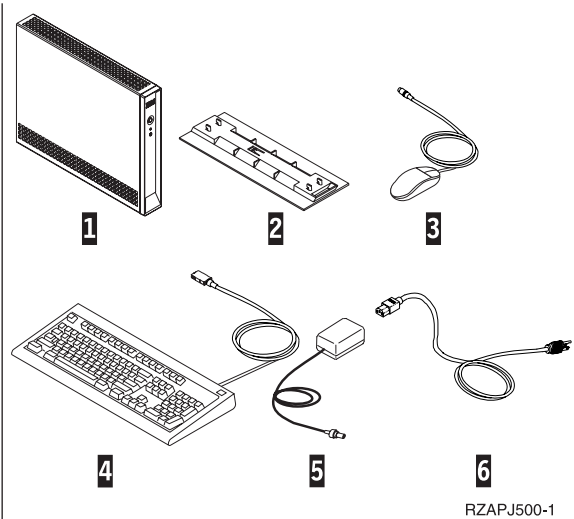

RZAPJ500-1

Options:

- If you have additional memory cards, read "Appendix C. Upgrading memory" on page 57 first, and then continue with "Installing the support base".
- If you would like to restrict access to the logic unit, you can thread a security cable through tab **A**.

Installing the support base

Read "Safety notices" on page v before you continue with these instructions.

IBM recommends that you install the hardware in a vertical position.

1. Align the notches **B** on the support base **C** with the holes on the bottom of the logic unit **D**.
2. Slide the support base **C** onto the bottom of the logic unit **D**.

To remove the support base **C**, lift the latch on the support base and slide the support base off of the logic unit **D**.

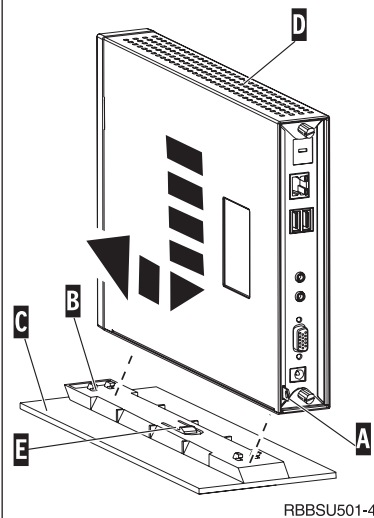

RBBSU501-4

Connecting your hardware

Read “Safety notices” on page v before you continue with these instructions.

1. Connect the devices listed below to the appropriate ports:
 - 1 Network cable
 - 2 USB keyboard and other USB devices
 - 3 Mouse (connects to keyboard)
 - 4 Headphones
 - 5 Microphone
 - 6 Monitor
 - 7 Power supply and power cable
2. Ensure that the monitor cable is securely connected to the NetVista thin client.
3. Plug any power cables into properly grounded working electrical outlets.

Powering on your hardware

1. Power on the monitor and other devices that are attached to the NetVista thin client.
2. Power on your NetVista thin client by pressing the white power button **8**.

The system LED **9** quickly flashes from amber to a solid green. Your NetVista thin client performs its startup sequence. See “Startup sequence” on page 7 for more information.
3. Refer to the following sections for more information on working with your NetVista thin client:
 - “Configuring your thin client” on page 9
 - “Working with the Terminal Connection Manager” on page 27
 - “Updating your software” on page 37

Powering off your hardware

1. Power off your NetVista thin client by pressing the white power button **8**.

The system LED **9** flashes amber once shortly after power off. This indicates that your NetVista thin client has automatically enabled Wake-On-LAN (WOL).
2. Power off your monitor and other devices that are attached to your NetVista thin client.

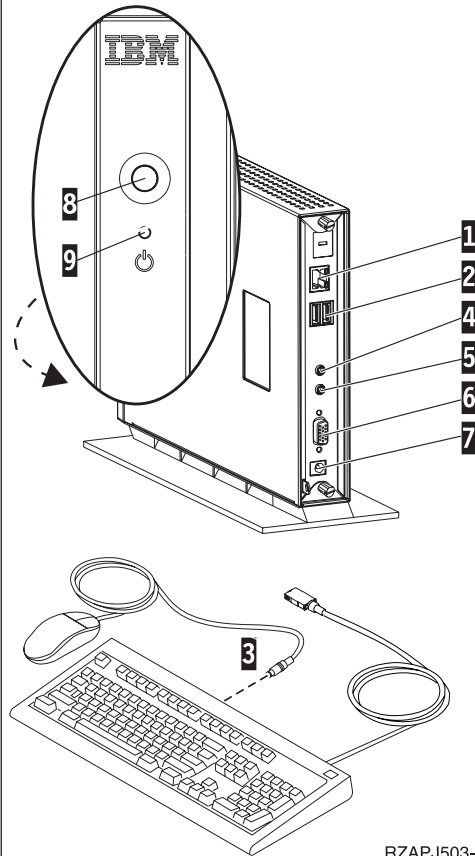

RZAPJ503-1

Startup sequence

This is a typical startup sequence of events for your NetVista thin client. If any of these events do not occur, see “Resolving hardware problems” on page 41.

1. The following devices show LED indications:
 - Logic unit (system LED and network status LED)
 - Power supply
 - Keyboard
 - Monitor¹
 - Any USB devices²
2. The following internal hardware components initialize:
 - Memory
 - L1 cache
 - Video memory
 - Keyboard controller
3. The IBM NetVista thin client screen appears on your monitor.
4. The NetVista thin client detects the CompactFlash card, and loads the operating system into memory.
5. One of the following appears:
 - The WBT Setup Wizard appears in any of the following situations:
 - You start your NetVista thin client for the first time.
 - You reset your NetVista thin client to the factory-default property settings.Refer to “Configuring your thin client” on page 9 for more information on completing the WBT Setup Wizard.
 - The Terminal Connection Manager window appears.
Refer to the following sections for more information on working with your NetVista thin client:
 - “Configuring your thin client” on page 9
 - “Working with the Terminal Connection Manager” on page 27
 - “Updating your software” on page 37
 - If a boot interruption screen appears, see “Resolving hardware problems” on page 41.

1. Refer to the documentation for your monitor if there is no LED indication.

2. Refer to the documentation for your USB devices if there are no LED indications.

Configuring your thin client

Before you can use your NetVista thin client to access applications on your terminal server, you must first configure your NetVista thin client.

This section provides information on the following configuration tasks:

- Completing the WBT Setup Wizard
- Setting the terminal properties
- Creating a connection to the terminal server

Completing the WBT Setup Wizard

The WBT Setup Wizard appears in any of the following situations:

- You start your NetVista thin client for the first time.
- You reset your NetVista thin client to the factory-default property settings.

You initially set your configuration information in the WBT Setup Wizard.

Follow these steps to complete the WBT Setup Wizard:

- __ 1. From the WBT Setup Wizard information box, click **Next**.
- __ 2. Read the Software License Agreement, and click **Accept**.
- __ 3. From the IP Address dialog box, select one of the following options:
 - Select **Yes, use the IP information supplied by DHCP**, and click **Next**.
 - Select **No, I will enter static IP information**, and click **Next**.
 - __ a. From the **Specify an IP Address** dialog box, enter the correct values in the required fields, and click **Next**.
 - __ b. To configure the network name resolution for your NetVista thin client, follow these steps:
 - __ 1) Select **DNS** or **WINS**.
 - __ 2) Enter the correct values in the required fields, and click **Next**.

If you do not plan to configure any network name resolution, leave the fields blank, and click **Next**.

- __ 4. Select a value for the Desktop Area and Refresh Frequency, and click **Next**.
- __ 5. Click **Finish** to apply your settings.

Your NetVista thin client automatically restarts. The Terminal Connection Manager window appears.

From the Terminal Connection Manager window, you can change any information that you entered in the Setup Wizard. Refer to “Setting the terminal properties” on page 10 for information.

From the Terminal Connection Manager window, you can also start creating a connection to your terminal server. Refer to “Creating a Terminal Server Connection” on page 14 for information.

Setting the terminal properties

The Terminal Properties window appears when you press **F2** from the Terminal Connection Manager window.

You set the terminal properties for your NetVista thin client in the Terminal Properties window.

Follow these steps to set the terminal properties for your NetVista thin client:

1. From the Terminal Connection Manager window, press **F2** to open the Terminal Properties window.

The Terminal Properties window appears and displays the property tabs.

2. Select a property tab.

To work with each property tab, see “Working with the terminal property tabs” for more information.

- Click **OK** to save your changes, and close the Terminal Properties window.
- Click **X** to close the Terminal Properties window without saving your changes.

Your NetVista thin client may prompt you to restart your NetVista thin client to apply the configuration changes that you saved.

After the Terminal Properties window closes, the Terminal Connection Manager window appears.

From the Terminal Connection Manager window, you can start creating a connection to your terminal server. Refer to “Creating a Terminal Server Connection” on page 14 for information.

Working with the terminal property tabs

This section provides information on the property tabs in the Terminal Properties window.

General tab

You can find manufacturer company and product information on the General tab. You can also reset the terminal settings to the original factory defaults on this tab.

Attention: Resetting your NetVista thin client to the factory-default property settings completely erases all of your previously configured terminal settings and terminal server connections. Ensure that you notify your technical support before you reset your NetVista thin client.

Follow these steps to reset the terminal settings:

1. Select **Reset the terminal to factory-default property settings**.
2. Click **Yes** to reset your NetVista thin client.

Input tab

You can configure your keyboard settings for a particular language or locale on the Input tab. You can also adjust the character repeat for your keyboard on this tab.

Follow these steps to configure your keyboard for a particular language or locale:

- __ 1. Select a locale from the pulldown menu.
- __ 2. Click **OK** to save your changes, and close the Terminal Properties window.

Notes:

1. To successfully enable your keyboard for a particular language or locale, you must also configure your terminal server for the same language or locale. Refer to the documentation for your terminal server for information.
2. If you work with emulators, you must also configure your emulator software for the same language or locale. See the FutureSoft Terminal Emulation Client help files for more information. Refer to “Viewing the TEC help files” on page 18 for information on how to view the help files.

Follow these steps to adjust the character repeat for your keyboard:

- __ 1. To adjust the repeat delay, move the bar from long to short.
- __ 2. To adjust the repeat rate, move the bar from slow to fast.
- __ 3. Click **OK** to save your changes, and close the Terminal Properties window.

Display tab

You can set the desktop area and refresh frequency for your monitor on the Display tab. You can also perform the following tasks on this tab:

- Enable a screen saver for your NetVista thin client.
- Configure a power down delay for your monitor.

Follow these steps to set the desktop area and refresh frequency for your monitor:

- __ 1. Select a value for Desktop Area and Refresh Frequency from the pulldown menu.

To test if your selection works properly with your monitor, follow these steps:

- __ a. Click **Test**.
 - __ b. Click **OK** to begin the test.
 - __ c. If you like the test image, click **Yes**. If you do not like the test image, click **No**.
 - __ d. Click **OK** to complete the test.
- __ 2. Click **OK** to save your changes, and close the Terminal Properties window.

Follow these steps to enable a screen saver:

- __ 1. Select **Enable Screen Saver**.
- __ 2. Set the number of minutes before launching the screen saver.
- __ 3. Click **OK** to save your changes, and close the Terminal Properties window.

Follow these steps to configure a power down delay for your monitor:

- __ 1. Select **Enable Video Power Down**.
- __ 2. Set the number of minutes before your monitor powers down.
- __ 3. Click **OK** to save your changes, and close the Terminal Properties window.

Network tab

You can set the network information for your NetVista thin client on the Network tab.

Follow these steps to set the network information:

- __ 1. Select one of the following options:
 - Obtain an IP address from a DHCP server.
 - __ a. Enter a valid terminal name for your NetVista thin client.
 - Specify an IP address.
 - __ a. Enter the correct values in the required fields.
 - __ b. Enter a valid terminal name for your NetVista thin client.
 - __ c. To configure the network name resolution for your NetVista thin client, click **Advanced Network**.
 - __ 1) Select **DNS** or **WINS**.
 - __ 2) Enter the correct values in the required fields, and click **OK**.
- __ 2. Click **OK** to save your changes, and close the Terminal Properties window.

If your NetVista thin client obtains its IP address from a DHCP server, you can renew the IP address assigned to your NetVista thin client by clicking **Renew IP Address**. You should renew the IP address of your NetVista thin client if you move it from one subnet to another when you use DHCP.

System tab

You can find memory and system information for your NetVista thin client on the System tab. You can also perform the following tasks on this tab:

- Update the memory statistics for your NetVista thin client.
- Configure global ICA client settings.

Follow these steps to update the memory statistics for your NetVista thin client:

- __ 1. From the Memory Statistics box, click **Update**.
- __ 2. Click **OK** to close the Terminal Properties window.

Follow these steps to configure the global characteristics and settings for your ICA client connections:

- __ 1. From the ICA Client Configuration box, click **Configure**.
- __ 2. Configure the global ICA settings in the **Global ICA Client Settings** window, and click **OK** to save your changes and close the window.
- __ 3. Click **OK** to save your changes, and close the Terminal Properties window.

Modem tab

You can configure and manage modem connections for a NetVista thin client on the Modem tab. You can also dial a modem connection from this tab.

For more information on working with the Modem tab, access the following URL from your browser:

<http://www.pc.ibm.com/support>

- __ 1. Click **NetVista**.
- __ 2. Click **NetVista thin client**.
- __ 3. On the left frame, and under the Technical Information section, click **Hot News**.
- __ 4. Click **NetVista N2200w (8363Wxx) - Service packs**.

Update tab

You can set software update settings on the Update tab. Technical support sets the software update settings during the initial configuration of a NetVista thin client on this tab. Technical support must authorize any changes to the existing update configuration.

Note: If you plan to update your NetVista thin client software, read “Updating your software” on page 37 to obtain detailed information on setting up your update server and configuring your update settings.

Follow these steps to set your update settings:

1. Enter the URL of the update server and directory in the **WBT Update URL** box.

Unless your update server information changes, you only need to enter this URL information during the initial configuration of your NetVista thin client.

The following URL guidelines apply:

- a. Use either HTTP or FTP as the transfer protocol.
- b. Use either the IP address or the server name of your update server.
- c. Specify the update server directory that contains the software update.
- d. Specify the filename of the software update.

For example:

`http://d.d.d.d/wbt_update/wbt.xml`

`http` is the transfer protocol.
`d.d.d.d` is the IP address of your update server.
`wbt_update` is the update server directory
that contains the files for the software update.
`wbt.xml` is the filename of the software update.

2. If you want to automatically update your software every time you power on the NetVista thin client, select **Check for WBT updates at every power on**.
3. Click **OK** to save your changes, and close the Terminal Properties window.

Refer to “Updating your software” on page 37 for detailed information on how to update your NetVista thin client software.

Security tab

You can enable security settings for a NetVista thin client configuration on the Security tab.

The following terminal restrictions take effect when you enable security settings:

- The Configure tab does not appear on the Terminal Connection Manager window.
You cannot create, delete, or edit terminal server connections without the Configure tab. To display the Configure tab, you must disable security settings.
- You must enter a valid password to open the Terminal Properties window.
Unauthorized users cannot open the Terminal Properties window and change the terminal configuration without entering a valid password.

Follow these steps to enable security settings for your NetVista thin client:

- __ 1. Select **Enable Security**.
- __ 2. Click **Change Password**.
- __ 3. From the Change Password dialog box, enter a valid password in the required fields, and click **OK**.
A valid password must have 3 to 25 characters.
- __ 4. Click **OK** to save your changes, and close the Terminal Properties window.

To disable security settings, clear the **Enable Security** checkbox.

Export tab

You can set the export settings for your NetVista thin client configuration on the Export tab. You can export the terminal configuration for one NetVista thin client to a file that is saved on a configuration server on this tab.

Your technical support sets the terminal configuration export settings on the Export tab during the initial configuration of your NetVista thin client. Ensure that you notify your technical support before you change any existing export configuration.

Note: If you plan to configure multiple NetVista thin clients automatically, read “Configuring multiple thin clients” on page 21 to obtain detailed information on setting up your configuration server and configuring your export and update settings.

Follow these steps to set your export settings:

- __ 1. Enter the URL of the configuration server and directory in the **WBT Update URL** box.

The following URL guidelines apply:

- __ a. Use FTP as the transfer protocol.
- __ b. Use either the IP address or the server name of your update server.
- __ c. Specify the configuration server directory where you need to store the export file.

For example:

`ftp://d.d.d.d/wbt_config`

`ftp` is the transfer protocol.
`d.d.d.d` is the IP address of your configuration server.
`wbt_config` is the configuration server directory
where you need to store the Saveconfig.reg file.

- __ 2. Click **OK** to save your changes, and close the Terminal Properties window.

Refer to “Configuring multiple thin clients” on page 21 for detailed information on how to configure multiple NetVista thin clients automatically.

Creating a Terminal Server Connection

To access applications on your terminal server, you need to create a terminal server connection from your NetVista thin client. From the Terminal Connection Manager window, you can create a terminal server connection and use this connection to access applications from your terminal server.

Follow these steps to create a terminal server connection:

- ___ 1. Close all active terminal server connections. Refer to “Disconnecting from a terminal server” on page 27 for more information.
- ___ 2. From the Terminal Connection Manager window, select the **Configure** tab, and click **Add**.
- ___ 3. Select the type of connection from the pulldown menu, and click **OK**.
 - If you select **Citrix ICA Client**, refer to “Creating an ICA connection” for more information.
 - If you select **Microsoft® Remote Desktop Client**, refer to “Creating an RDP connection” on page 16 for more information.
 - If you select **FutureSoft Terminal Emulation Client**, refer to “Creating a TEC connection” on page 16 for more information.

After you complete creating the new connection, the Terminal Connection Manager window lists the new connection on both the Connections tab and the Configure tab.

Creating an ICA connection

Follow these steps to create an ICA connection:

- ___ 1. From the Specify Connection Type dialog box, select one the following options:
 - Select **Network Connection** to make a network connection, and click **Next**.
 - ___ a. To connect to a server, click **Citrix Server**. To connect to a published application, click **Published Application**.
 - ___ b. Enter the name of the server or published application in the box, and click **Next**.
 - Select **Dial-In Connection** to make a dial-in connection, and click **Next**.
 - ___ a. From the Dial-In Devices dialog box, enter the correct values in the required fields, and click **Next**.
- ___ 2. Enter a name for the new ICA connection, and click **Next**.
- ___ 3. To start an application after you connect, enter the correct values in the required fields, and then click **Next**. If you do not plan to start an application after you connect, leave the fields blank, and click **Next**.
- ___ 4. To enable automatic logon for the new ICA connection, enter the correct values for the required fields, and then click **Next**. If you do not plan to enable automatic logon, leave the fields blank, and click **Next**.
- ___ 5. Select the window colors for your connection window.
- ___ 6. To enable printing, data compression, or sound for your connection, select these options, and then click **Next**.
- ___ 7. To configure a SOCKS proxy server, select **Connect via SOCKS proxy**, and enter the correct values in the required fields.
- ___ 8. Click **Finish** to save your ICA connection.

The Terminal Connection Manager window lists the new ICA connection on both the Connections tab and the Configure tab.

To connect to a terminal server through an ICA connection, see “Connecting to a terminal server” on page 27 for information.

To edit an ICA connection, see “Editing an ICA connection” on page 28 for information.

Creating an RDP connection

Follow these steps to create an RDP connection:

- ___ 1. From the WTS Connection Wizard dialog box, enter a name for the new connection and either the network name or IP address of the terminal server, and click **Next**.

If you plan to use this connection across a slow network connection, check the **Low Speed Connection** box.

- ___ 2. To enable automatic logon for the new connection, check the **Automatic Logon** box, enter the correct values for the required fields, and then click **Next**. If you do not plan to enable automatic logon, leave the fields blank, and click **Next**.

- ___ 3. Select the display interface for the new connection, and click **Next**.

Your selection determines the display interface that runs when you connect and logon to your terminal server. You have the following options:

- **Desktop**

The terminal server desktop displays when you connect and logon successfully to your terminal server.

- **Application file name**

A specific application automatically runs and displays its graphical user interface when you connect and logon successfully to your terminal server.

You can also choose to specify a working directory for the application.

- ___ 4. Click **Finish** to save your new terminal server connection.

The Terminal Connection Manager window lists the new RDP connection on both the Connections tab and the Configure tab.

To connect to a terminal server through an RDP connection, see “Connecting to a terminal server” on page 27 for information.

To edit an RDP connection, see “Editing an RDP connection” on page 28 for information.

Creating a TEC connection

Follow these steps to create a terminal emulation client connection:

- ___ 1. From the **Create New Connection** dialog box, enter a name for your new connection.

- ___ 2. Select one of the following options, and click **OK**:

- Store configuration locally on the terminal.
- Download configuration from the web server.

- ___ a. Enter the URL of your web server.

The Session Properties dialog box appears and displays the property tabs.

- ___ 3. Click a tab to set your configuration information.

Table 1 identifies the tasks that you can configure on each tab.

Table 1. TEC Connection tabs

Tabs	Configuration Tasks
Connectors	<ul style="list-style-type: none"> a. Double-click the name of the Telnet connector to display the Telnet Properties dialog box. b. Select the host name or host IP address to which you want to connect from the Host Address pulldown menu, or enter the host name or host IP address in the box. c. Click OK to save your changes, and close the Telnet Properties dialog box.
Emulations	<ul style="list-style-type: none"> a. Select an emulation type from the Emulations scroll list. b. Click Properties to view or set the configuration parameters for the selected emulation type. For more information on setting the configuration parameters, see the FutureSoft Terminal Emulation Client help files. Refer to “Viewing the TEC help files” on page 18 for information on how to view these help files. c. Click OK to save your changes, and close the Emulation Properties dialog box.
Display	<p>The default configuration parameters on this tab may be appropriate for most TEC sessions.</p> <p>For more information on setting the configuration parameters on this tab, see the FutureSoft Terminal Emulation Client help files. Refer to “Viewing the TEC help files” on page 18 for information on how to view these help files.</p> <p>Click OK to save your changes, and close the Session Properties dialog box.</p>
General	<p>The default configuration parameters on this tab may be appropriate for most TEC sessions.</p> <p>For more information on setting the configuration parameters on this tab, see the FutureSoft Terminal Emulation Client help files. Refer to “Viewing the TEC help files” on page 18 for information on how to view these help files.</p> <p>Click OK to save your changes, and close the Session Properties dialog box.</p>
Left Mouse Button	<p>The default configuration parameters on this tab may be appropriate for most TEC sessions.</p> <p>For more information on setting the configuration parameters on this tab, see the FutureSoft Terminal Emulation Client help files. Refer to “Viewing the TEC help files” on page 18 for information on how to view these help files.</p> <p>Click OK to save your changes, and close the Session Properties dialog box.</p>

___ 4. Close the **Create New Connection** dialog box.

The Terminal Connection Manager window lists the new TEC connection on both the Connections tab and the Configure tab.

For detailed information on configuring the TEC connection, refer to the FutureSoft Terminal Emulation Client help files. See “Viewing the TEC help files” for information on how to view these help files.

To connect to a terminal server through a TEC connection, see “Connecting to a terminal server” on page 27 for information.

To edit a TEC connection, see “Editing a TEC connection” on page 29 for information.

Viewing the TEC help files

Table 2 describes the information that you can find in each FutureSoft Terminal Emulation Client help file.

Table 2. FutureSoft Terminal Emulation Client help files

DynaComm Connectivity Series (DCS) Online Reference files	
dynace.exe	The DCS Online Reference provides the following information: <ul style="list-style-type: none"> • Quick-start section for configuring an emulation session • Configuring the telnet connector, and the ANSI, VT420, and Wyse 50/60 emulations • Detailed reference information for systems administrators
IBM Online Reference files	
ibm.exe	The IBM Online Reference for DCS provides detailed information on configuring the IBM terminal emulations (3270, 3270 Print, 5250, and 5250 Print) and supported submodes (TN3270E and TN5250E).
NetPrint Print Server files (optional)	
srvcnfg.exe	The help file for the optional NetPrint Print Server provides detailed information on network printing for your NetVista thin client.

You can download these help files onto your terminal server and view them from your NetVista thin client.

Follow these steps to download the help files and view them from your NetVista thin client:

- ___ 1. From your Windows terminal server desktop, open your internet browser, and go to the following URL:

<http://www.ibm.com/nc/pubs>
- ___ 2. Search for the self-extracting help files described in Table 2.
- ___ 3. Download these self-extracting help files onto your terminal server.

To make it easier to manage these help files, create a separate directory for these help files. Ensure that you save these help files in the same directory.
- ___ 4. Double-click on each self-extracting help file to unzip the file contents onto your directory.
 - ___ a. Click **Unzip** to extract the file contents.
 - ___ b. Read the readme.txt for special instructions on moving or saving certain files.
- ___ 5. To view a help file from your terminal server, double-click on a .HLP file (xxxxxx.hlp) to launch it.

You can only launch the files with the .HLP filename extension. However, you need to keep the files with the .CNT filename extension in the same directory to view the help files correctly.

- ___ 6. To view a help file from your NetVista thin client, follow these steps:
 - ___ a. Create an ICA connection or RDP connection to the terminal server that stores the help files.
Refer to “Creating an ICA connection” on page 15 or “Creating an RDP connection” on page 16 for information.
 - ___ b. Launch the ICA connection or RDP connection that you created.
Refer to “Connecting to a terminal server” on page 27 for information.
 - ___ c. From the Windows desktop, open Windows Explorer to search for your help files.
 - ___ d. Double-click on a .HLP file (xxxxxx.hlp) to launch it.
You can only launch the files with the .HLP filename extension. However, you need to keep the files with the .CNT filename extension in the same directory to view the help files correctly.

Configuring multiple thin clients

After you complete the configuration for a single NetVista thin client (see “Configuring your thin client” on page 9), you can use this base terminal configuration to configure your other NetVista thin clients. You can capture and export the base terminal configuration to a server, and then install this configuration to multiple NetVista thin clients.

This section provides information on the following configuration tasks:

- Setting up your configuration server
- Exporting the base terminal configuration
- Reviewing the Saveconfig.reg file
- Reviewing the Updatereg.xml file
- Installing the exported configuration to multiple thin clients

These configuration tasks enable you to set uniform terminal property settings and terminal server connections for your NetVista thin clients. You can perform these configuration tasks to control and manage the terminal configuration of multiple NetVista thin clients.

Setting up your configuration server

To configure multiple NetVista thin clients, you need to set up a configuration server. Your configuration server can be the same server as your update server. Additionally, your configuration server must meet the following requirements:

- To import the base terminal configuration from your base NetVista thin client, and to update multiple NetVista thin clients with this base terminal configuration, your configuration server must be accessible by your NetVista thin clients through a high-speed TCP/IP connection (for example, a LAN).
- To import the base terminal configuration from your base NetVista thin client, you must configure FTP on your configuration server. Additionally, your configuration server must allow anonymous FTP write access.
- To store the base terminal configuration onto your configuration server, you need to create a new directory on your configuration server (IBM recommends [drive]:\wbt_config). FTP should be able to access this directory.

Exporting the base terminal configuration

After you set up your configuration server, you can export the base terminal configuration of one NetVista thin client to your configuration server.

Important

Before you export a base terminal configuration, verify the system build of your base NetVista thin client. You can only export the base terminal configuration to other NetVista thin clients that have the same system build. You can find the system build of your NetVista thin client in the **Build Version Information** box on the System tab.

Follow these steps to export the base terminal configuration:

- ___ 1. Close all active terminal server connections. Refer to “Disconnecting from a terminal server” on page 27 for more information.
- ___ 2. From the Terminal Connection Manager window, press **F2** to access the Terminal Properties window.
- ___ 3. From the Terminal Properties window, click the **Export** tab.
- ___ 4. Enter the URL of the configuration server and directory in the **WBT Update URL** box.

The following URL guidelines apply:

- ___ a. Use FTP as the transfer protocol.
- ___ b. Use either the IP address or the server name of your update server.
- ___ c. Specify the configuration server directory where you need to store the export file.

For example:

`ftp://d.d.d.d/wbt_config`

`ftp` is the transfer protocol.

`d.d.d.d` is the IP address of your configuration server.

`wbt_config` is the configuration server directory

where you need to store the export file, `Saveconfig.reg`.

- ___ 5. Click **Export Now**.

Your NetVista thin client exports your terminal configuration into an export file, `Saveconfig.reg`, that is saved on the configuration server. If you have TEC connections, your NetVista thin client also saves an `.SES` file for each TEC connection onto your configuration server.

For example, if your base NetVista thin client has three TEC connections when you exported its terminal configuration, your configuration server directory should list three `.SES` files, in addition to the `Saveconfig.reg` file. If you did not export any TEC connections, your configuration server directory should not list any `.SES` files.

- ___ 6. Verify that the `Saveconfig.reg` file and the correct number of `.SES` files were saved on your configuration server.
- ___ 7. Click **OK** on the dialog box that appears.

Attention: Each time you export your terminal configuration on your configuration server directory, your NetVista thin client overwrites any existing `Saveconfig.reg` file. IBM recommends that you set up and specify a different directory each time you plan to export a base terminal configuration. Depending on your work, area, or network requirements, you can save different base terminal configurations for different groups of users in your organization.

Reviewing the `Saveconfig.reg` file

`Saveconfig.reg` is the export file that contains the base terminal configuration of your base NetVista thin client. This file is saved onto your configuration server directory when you exported the base terminal configuration from your base NetVista thin client.

Since you use `Saveconfig.reg` to install the base terminal configuration to your other NetVista thin clients, you need to review the contents of `Saveconfig.reg`. If necessary, you also need to delete any information that should not be passed on to your other NetVista thin clients.

Saveconfig.reg includes some information that is unique to your base NetVista thin client. This unique information includes the network settings of your base NetVista thin client. You must edit Saveconfig.reg to remove this information. Removing this information from Saveconfig.reg prevents any unnecessary duplication of network settings for your other NetVista thin clients.

Follow these steps to edit the Saveconfig.reg file:

- __ 1. From your configuration server, open a text editor.
- __ 2. Open the Saveconfig.reg file.
- __ 3. Locate the section with the heading,
[HKEY_LOCAL_MACHINE\Comm\lance1\Parms\TcpIp].

For example:

```
[HKEY_LOCAL_MACHINE\Comm\lance1\Parms\TcpIp]
"IPInterfaceContext"=dword:2
"WINS"=multi_sz:"9.5.100.79","9.5.100.78"
"DNS"=multi_sz:"9.5.100.76","9.5.100.75"
"DefaultGateway"="9.5.2.1"
"Subnetmask"="255.255.255.0"
"IPAddress"="9.5.2.142"
"EnabledDHCP"=dword:0
"UseZeroBroadcast"=dword:0
"LLInterface"=""
```

- __ 4. Delete this section.
- __ 5. Save and close the Saveconfig.reg file.

Reviewing the Updatereg.xml file

Updatereg.xml is an XML file that contains instructions for the automatic configuration of your NetVista thin clients. This file is saved onto your update server directory when you download a NetVista thin client software update from the IBM NetVista thin client web site.

If you do not have Updatereg.xml, you can create one using a text editor. You can follow the sample format below.

Follow these steps to edit the Updatereg.xml file:

- __ 1. From your update server, open a text editor.
- __ 2. Open the Updatereg.xml file.
 - __ a. Verify that the Updatereg.xml file contains a unique package ID in the header block.

You **must** enter a unique package ID in the <Package ID=" "> tag. This package ID can help you manage and track the terminal configuration for your multiple NetVista thin clients.

For example, you can use <Package ID="071500-Accounting"> to specify the terminal configuration of NetVista thin clients that are used by the accounting group in your organization.

```
<?xml version="1.0" encoding="UTF-8" ?>
<!DOCTYPE Package (View Source for full doctype...)>
<!-- Cloning WBT Configuration -->
<Package ID="071500-Accounting">
```

- ___ b. If you exported any TEC terminal server connections, and your configuration server directory lists the corresponding number of .SES files for each TEC terminal server connection, verify that Updatereg.xml contains the same number of <CopyFile> command blocks.

For example, if your configuration server directory lists three .SES files (for example, 3885abf1.ses, 3885abf2.ses, and 3885abf3.ses), verify that Updatereg.xml contains three <CopyFile> command blocks.

```
<Copyfile OSImage="No" OSImageSize="0" Register="No"
Execute="No" WaitForExit="No">
  <Description>Copy Emulator Session File</Description>
  <Source>ftp://d.d.d.d/wbt_config/3885abf1.ses</Source>
  <Destination>\HardDisk3\3885abf1.ses</Destination>
</CopyFile>

<Copyfile OSImage="No" OSImageSize="0" Register="No"
Execute="No" WaitForExit="No">
  <Description>Copy Emulator Session File</Description>
  <Source>ftp://d.d.d.d/wbt_config/3885abf2.ses</Source>
  <Destination>\HardDisk3\3885abf2.ses</Destination>
</CopyFile>

<Copyfile OSImage="No" OSImageSize="0" Register="No"
Execute="No" WaitForExit="No">
  <Description>Copy Emulator Session File</Description>
  <Source>ftp://d.d.d.d/wbt_config/3885abf3.ses</Source>
  <Destination>\HardDisk3\3885abf3.ses</Destination>
</CopyFile>
```

Note: <Source> contains the server, directory, and filename of an .SES file. <Destination> is always HardDisk3.

- ___ c. If you exported any RDP terminal server connections or ICA terminal server connections, verify that Updatereg.xml contains a <CopyFile> command block.

For example:

```
<Copyfile OSImage="No" OSImageSize="0" Register="No"
Execute="No" WaitForExit="No">
  <Description>Copy Registry File</Description>
  <Source>ftp://d.d.d.d/wbt_config/SaveConfig.reg</Source>
  <Destination>\Program Files\system.reg</Destination>
</CopyFile>
```

- ___ d. Verify that Updatereg.xml contains an <UpdateRegistry> command block.

For example:

```
<UpdateRegistry>
  <Description>Update Registry</Description>
  <FileName>\Program Files\system.reg</FileName>
</UpdateRegistry>

</Package>
```

- ___ 3. Save and close the Updatereg.xml file in your configuration server directory, wbt_config.

Installing the exported configuration to multiple thin clients

After you verify the required information in the Updatereg.xml file, you can automatically configure your NetVista thin clients. You can install the base terminal configuration that you previously exported onto your configuration server to multiple NetVista thin clients in your organization.

Important

Before you install the base terminal configuration to your target NetVista thin clients, verify that the system build of your target NetVista thin clients is the same as the system build of the base NetVista thin client. You can only install the base terminal configuration to your target NetVista thin clients if they have the same system build as the base NetVista thin client. You can find the system build of your NetVista thin client in the **Build Version Information** box on the System tab.

Follow these steps to automatically configure your NetVista thin client:

- ___ 1. Reset your NetVista thin client to the factory-default property settings. Refer to “General tab” on page 10 for more information.
- ___ 2. From the Terminal Connection Manager window, press **F2** to access the Terminal Properties window.
- ___ 3. From the Terminal Properties window, click the **Update** tab.
- ___ 4. Enter the URL of the update server and directory in the **WBT Update URL** box.

The following URL guidelines apply:

- ___ a. Use either HTTP or FTP as the transfer protocol.
- ___ b. Use either the IP address or the server name of your update server.
- ___ c. Specify the update server directory that contains the Updatereg.xml file.
- ___ d. Specify the filename, Updatereg.xml.

For example:

```
ftp://d.d.d.d/wbt_config/Updatereg.xml
```

ftp is the transfer protocol.

d.d.d.d is the IP address of your update server.

wbt_config is the configuration server directory that contains the Updatereg.xml file.

Updatereg.xml is the name of the file that contains XML instructions for the automatic configuration.

- ___ 5. Select **Check for WBT updates at every power on** to automatically update the configuration of your NetVista thin client.
 - ___ a. Click **OK** to save your changes, and close the Terminal Properties window.

Note: You can perform a manual configuration update instead of an automatic configuration update by clicking **Update Now**. Ensure that you clear the **Check for WBT updates at every power on** check box to avoid repeating the configuration update every time your NetVista thin client powers on.

| Your NetVista thin client updates its terminal configuration and restarts with
| the configuration that you previously exported.

| To enable your NetVista thin clients to perform software updates, you need to
| change the URL information on the Update tab to specify the filename of the
| software update, instead of Updatereg.xml. Refer to “Updating your software” on
| page 37 for more information.

Working with the Terminal Connection Manager

The Terminal Connection Manager window appears after you power on your NetVista thin client.

You work with the Connections tab and the Configure tab on the Terminal Connection Manager window. Table 3 identifies the tasks that you can do on each tab.

Table 3. Terminal Connection Manager tabs

Connections tab	Configure tab
<ul style="list-style-type: none">• Connect to a terminal server.• Disconnect from a terminal server.• View all existing terminal server connections.• View terminal server connections that are active.	<ul style="list-style-type: none">• Add a terminal server connection.• Edit a terminal server connection.• Delete a terminal server connection.• Set a terminal server connection to run at startup.

Connecting to a terminal server

Follow these steps to connect to a terminal server:

1. From the Terminal Connection Manager window, click the Connections tab.
2. Select an available connection, and click **Connect**.
3. Enter a valid username and password, and click **OK**.

Disconnecting from a terminal server

Follow these steps to disconnect from a terminal server:

1. From the Terminal Connection Manager window, click the Connections tab.
2. Select an active connection that you want to disconnect, and click **End**.

You can also disconnect your terminal server connection by logging off or exiting from the terminal server desktop.

Managing terminal server connections

The Terminal Connection Manager window displays your terminal server connections on the Connections tab. You can have more than one active connection. The status column on the Connections tab indicates which connections are active.

If you have several active connections, you can switch from one connection session to another. Press **Ctrl-Alt** and either the **Up** arrow key or **Down** arrow key to switch between connection sessions. Pressing this combination of keys lets you scroll through the different desktop displays of your active connections.

If you are in a terminal server connection session, you can access the Terminal Connection Manager window by pressing **Ctrl-Alt-End**. Pressing this combination of keys displays the Terminal Connection Manager window.

Editing a terminal server connection

Follow these steps to edit an existing terminal server connection:

- ___ 1. Close all active terminal server connections. Refer to “Disconnecting from a terminal server” on page 27 for more information.
- ___ 2. From the Terminal Connection Manager window, click the **Configure** tab.
- ___ 3. Select an existing terminal server connection, and click **Edit**.
 - If you select an ICA connection, refer to “Editing an ICA connection” for more information.
 - If you select an RDP connection, refer to “Editing an RDP connection” for more information.
 - If you select an TEC connection, refer to “Editing a TEC connection” on page 29 for more information.

After you complete editing the connection, the Terminal Connection Manager window lists the connection name on both the Connections tab and the Configure tab.

Editing an ICA connection

Follow these steps to edit an ICA connection:

- ___ 1. From the Edit Connection Details dialog box, select a tab.

The Edit Connection Details dialog box displays the following tabs. Table 4 identifies the tasks that you can configure on each tab.

Table 4. ICA Connection Tabs

Tabs	Configuration Tasks
Server	a. To connect to a server, click Citrix Server . To connect to a published application, click Published Application . b. Select the Citrix server or published application to which you want to connect from the scroll list, or type the name of the Citrix server or published application in the box.
Application	To start an application after you connect, enter the correct values in the required fields. If you do not plan to start an application after you connect, leave the fields blank.
Logon	To enable automatic logon, enter the correct values for the required fields. If you do not plan to enable automatic logon, leave the fields blank.
Window	Select the window colors for your connection window.
Options	To enable printing, data compression, or sound for your connection, select these options.
Title	Enter a name for the ICA connection
Firewall Settings	To configure a SOCKS proxy server, select Connect via SOCKS proxy , and enter the correct values in the required fields.

- ___ 2. Click **OK** to save your changes.

Editing an RDP connection

Follow these steps to edit an RDP connection:

- ___ 1. From the Edit Connections window, select a tab.

The Edit Connections window displays the Net Connections tab and the Application tab. Table 5 on page 29 identifies the tasks that you can do on

each tab.

Table 5. RDP Connection Tabs

Net Connections tab	Application tab
<ul style="list-style-type: none"> • Change a connection name. • Change the server name or IP address of the terminal server. • Enable or disable automatic logon. If you enable automatic logon, you need to enter correct values for the username, password, and domain fields. • Enable or disable low-speed connection. 	<ul style="list-style-type: none"> • Set a connection to open an application or desktop at startup. • Change the application filename and working directory.

__ 2. Click **OK** to save your changes.

Editing a TEC connection

Follow these steps to edit a TEC connection:

__ 1. From the Edit an Existing Session dialog box, click **Properties**.

The Session Properties dialog box appears and displays the five property tabs.

__ 2. Click a tab to set your configuration information.

Table 6 identifies the tasks that you can configure on each tab.

Table 6. TEC Connection tabs

Tabs	Configuration Tasks
Connectors	<ol style="list-style-type: none"> Double-click the name of the Telnet connector to display the Telnet Properties dialog box. Select the host name or host IP address to which you want to connect from the Host Address pulldown menu, or enter the host name or host IP address in the box. Click OK to save your changes, and close the Telnet Properties dialog box.
Emulations	<ol style="list-style-type: none"> Select an emulation type from the Emulations scroll list. Click Properties to view or set the configuration parameters for the selected emulation type. For more information on setting the configuration parameters, see the FutureSoft Terminal Emulation Client help files. Refer to “Viewing the TEC help files” on page 18 for information on how to view these help files. Click OK to save your changes, and close the Emulation Properties dialog box.
Display	<p>The default configuration parameters on this tab may be appropriate for most TEC sessions.</p> <p>For more information on setting the configuration parameters on this tab, see the FutureSoft Terminal Emulation Client help files. Refer to “Viewing the TEC help files” on page 18 for information on how to view these help files.</p> <p>Click OK to save your changes, and close the Session Properties dialog box.</p>

Table 6. TEC Connection tabs (continued)

Tabs	Configuration Tasks
General	<p>The default configuration parameters on this tab may be appropriate for most TEC sessions.</p> <p>For more information on setting the configuration parameters on this tab, see the FutureSoft Terminal Emulation Client help files. Refer to “Viewing the TEC help files” on page 18 for information on how to view these help files.</p> <p>Click OK to save your changes, and close the Session Properties dialog box.</p>
Left Mouse Button	<p>The default configuration parameters on this tab may be appropriate for most TEC sessions.</p> <p>For more information on setting the configuration parameters on this tab, see the FutureSoft Terminal Emulation Client help files. Refer to “Viewing the TEC help files” on page 18 for information on how to view these help files.</p> <p>Click OK to save your changes, and close the Session Properties dialog box.</p>

___ 3. Click **OK** to close the Edit an Existing Session dialog box.

After you complete creating the new TEC connection, the Terminal Connection Manager window lists the new TEC connection on both the Connections tab and the Configure tab.

For detailed information on editing a TEC connection, refer to the FutureSoft Terminal Emulation Client help files. See “Viewing the TEC help files” on page 18 for more information.

You can download FutureSoft Terminal Emulation Client help files onto your terminal server and access them from your NetVista thin client. Refer to “Viewing the TEC help files” on page 18 for instructions on how to download the help files and view them from your NetVista thin client.

Exporting a TEC connection

You can export a TEC connection to transfer a session and the following associated files to an FTP server:

- Keyboard map
- Hotspots map
- Attribute map
- Character translation map
- Macro file.

Once you export these files to an FTP server, you can easily store them on a web server. You can obtain a TEC session file with identical configuration options from your NetVista thin client by entering the URL of the TEC session file in the appropriate session properties tabs.

Follow these steps to export a TEC connection:

___ 1. From the Edit an Existing Session dialog box, click **Export**.

The Export Session dialog box appears.

___ 2. Enter the correct values in the required fields, and click **Export**.

- ___ 3. Click **OK** to close the Edit an Existing Session dialog box.

For detailed information on exporting a TEC connection, refer to the FutureSoft Terminal Emulation Client help files. See “Viewing the TEC help files” on page 18 for more information.

You can download FutureSoft Terminal Emulation Client help files onto your terminal server and access them from your NetVista thin client. Refer to “Viewing the TEC help files” on page 18 for instructions on how to download the help files and view them from your NetVista thin client.

Setting a startup terminal server connection

Follow these steps to set an existing terminal server connection to run at startup:

- ___ 1. From the Terminal Connection Manager window, click the **Configure** tab.
- ___ 2. Select an existing terminal server connection, and click **Startup**.
- ___ 3. Click **OK** to save your changes.

Deleting a terminal server connection

Follow these steps to edit an existing terminal server connection:

- ___ 1. From the Terminal Connection Manager window, click the **Configure** tab.
- ___ 2. Select an existing terminal server connection, and click **Delete**.
- ___ 3. Click **Yes** to delete the connection.

Printing from your thin client

NetVista thin clients can print from within any active terminal server session. They can print to the following printers:

- A **network printer** which is a printer that is attached to a print server on a network
- A **local printer** which is a printer that is attached to your NetVista thin client

Print jobs can come from any of the following sources:

- Applications running on a Windows terminal server through an ICA terminal server session
- Applications running on a Windows terminal server through an RDP terminal server session
- Local TEC applications running on your NetVista thin client

Printing to a network printer

ICA and RDP sessions

You can access and run applications that are based on the Windows terminal server through an ICA terminal server connection, or an RDP terminal server connection. When you work with Windows server-based applications through an ICA session or an RDP session, you can print your file by accessing the Print command of your Windows application. Normally, you can access the Print command by clicking the Print icon on your application toolbar, or by accessing **Print** in the menu bar (usually under the **File** menu item).

You can send your print jobs to any printers that are defined on your Windows terminal server. These printers can include printers that are attached to the Windows terminal server, or printers that can be reached through the network. Technical support can set up and define printers on your Windows terminal server.

TEC sessions

The **NetPrint Print Server help file** provides detailed information on network printing for TEC sessions. Refer to “Viewing the TEC help files” on page 18 for more information.

The optional NetPrint Print Server software (NetPrint) provides support for network printing. NetPrint enables printing from within a TEC session to network-defined printers.

NetPrint requires the following software components:

- The client software component is in the CompactFlash card that ships with the NetVista thin client.
- The optional server software component is available separately.

You need this component to enable network printing for your NetVista thin client.

If you have NetPrint, see Table 7 on page 34 to identify the general tasks that your technical support must perform to install and configure NetPrint. Refer to the NetPrint Print Server help file for detailed instructions.

Table 7. NetPrint Print Server Installation and Configuration

1. Set up a Print Server account on your Windows server, and log onto the Windows server using the Print Server account.
2. Make network printers accessible to the Print Server account.
3. Install the NetPrint Print Server software on a system that runs either Windows NT[®] 4.0 Server, or Windows NT 4.0, Terminal Server Edition.
4. Ensure that the NetPrint Print Server service is enabled.
5. Specify users or groups that should have access to a network printer in the NetPrint Print Server account.
6. Configure your NetVista thin client to specify and connect to the Windows NT Server that runs NetPrint.

Follow these steps to print to a network printer:

- ___ 1. From the Connect menu, select **Print Setup**.
- ___ 2. Select a network printer, and click **OK**.
- ___ 3. From the Connect menu, select **Print**.

Printing to a local printer

You can attach a printer to your NetVista thin client through the USB port at the back of the logic unit. Refer to “Setting up your hardware” on page 5 for information on connecting USB devices to your NetVista thin client.

ICA session

You can define a local printer for your NetVista thin client by completing a printer configuration in the ICA Client Printer Configuration Application on your Windows terminal server.

Follow these steps to define a local printer:

- ___ 1. Verify that a printer is attached to your NetVista thin client.
- ___ 2. From the Windows terminal desktop, select **Start->Programs->MetaFrame Tools**.
- ___ 3. Select **ICA Client Printer Configuration**.
- ___ 4. Select **Printer** from the menu, and click **New**.
The Add ICA Client Printer wizard appears.
- ___ 5. Complete the Add ICA Client Printer wizard to map an ICA client printer.

RDP session

Follow these steps to verify that a printer is available for local printing:

- ___ 1. From the Windows terminal desktop, select **Start->Settings->Printers**.
The **Printers** window appears.

If a printer is attached to your NetVista thin client, the configuration name for this printer appears as **Local WBT Printer/[TERMINAL_NAME]/Session [Number]**.

For example:

Local WBT Printer/IBMWB/Session 3

IBMWB is the terminal name.

Session 3 is the session number.

If you do not see a printer configuration name for your NetVista thin client, follow these steps to create a printer configuration for your NetVista thin client:

- ___ a. Verify that a printer is attached to your NetVista thin client.
 - ___ b. From the Windows terminal desktop, select **Start->Settings->Printers**.
 - ___ c. Double-click the **Add Printer** icon.
The Add Printer wizard appears.
 - ___ d. Complete the Add Printer Wizard to create the new printer configuration.
- ___ 2. Close the **Printers** window.

TEC session

To direct an IBM remote host to print to a local printer or to a network printer, use the 3270 Print emulation or 5250 Print emulation. Refer to the IBM Online Reference help file for detailed information on configuring a TEC session for a 3270 Print emulation or a 5250 Print emulation. See “Viewing the TEC help files” on page 18 for more information.

Follow these steps to print to a local printer:

- ___ 1. From the Connect menu, select **Print Setup**.
- ___ 2. Select a local printer, and click **OK**.
- ___ 3. From the Connect menu, select **Print**.

The contents of the session window prints to the local printer.

Updating your software

To take advantage of new functionality from the latest level of software, you need to keep your NetVista thin client software current. Upgrading your NetVista thin client software ensures that your NetVista thin client operates correctly.

This section provides information on the following software update tasks:

- Setting up your update server
- Downloading the software update
- Verifying the package ID in the sample install.xml file
- Installing the software update

Setting up your update server

To perform the software update for your NetVista thin client, you need to set up an update server. Your update server must meet the following requirements:

- To download the software update from the IBM NetVista thin client update web site, your update server must have reliable access to the internet.
- To store the software update onto your update server, you need to create a new directory on your update server (IBM recommends **[drive]:\wbt_update**). HTTP or FTP should be able to access this directory.
- To enable your NetVista thin client to access the software update from your update server, you must configure your update server as an HTTP server (web server) or FTP server. Additionally for FTP servers, you must configure anonymous FTP access.
- The update server must be accessible by your NetVista thin client through a high-speed TCP/IP connection (for example, a LAN).

Downloading the software update

You can find the latest information on software updates for your NetVista thin client on the IBM NetVista thin client web site.

Follow these steps to obtain the software update:

- ___ 1. From your update server, open an internet browser, and go to the following URL:

<http://www.pc.ibm.com/support>

- ___ a. Click **NetVista**.
 - ___ b. Click **NetVista thin client**.
 - ___ c. On the left frame, and under the Technical Information section, click **Hot News**.
 - ___ d. Click **NetVista N2200w (8363Wxx) - Service packs**.
- ___ 2. To download the software update onto your update server, follow the download instructions on the web site.
Ensure that you download the software update to the **[drive]:\wbt_update** directory.

Verifying the package ID in the sample install.xml file

Install.xml is a sample XML file that contains instructions for a NetVista thin client software update. This file is saved onto your update server directory when you download a NetVista thin client software update from the IBM NetVista thin client web site.

The sample install.xml file contains a package ID number that is unique to each software update. If you plan to modify this sample XML file, ensure that you **do not change the original package ID number**. If you plan to create your own XML file, ensure that you **use the original package ID number**.

Installing the software update

A software update consists of the following automated tasks:

1. Checking the update server for the latest version of the NetVista thin client software.
2. Comparing the software version on the update server with the software version that is currently installed and running on the NetVista thin client.
3. Downloading and installing the software on the NetVista thin client.
4. Automatically restarting the NetVista thin client with the new level of NetVista thin client software.

The NetVista thin client can perform the software update either automatically or manually.

- To configure your NetVista thin client for an automatic software update, refer to “Automatic software update” for information.
- To configure your NetVista thin client for a manual software update, refer to “Manual software update” on page 39 for information.

Automatic software update

You can configure your NetVista thin client to automatically check for software updates on your update server every time you power on your NetVista thin client.

Follow these steps to configure an automatic software update:

- ___ 1. Close all active terminal server connections. Refer to “Disconnecting from a terminal server” on page 27 for more information.
- ___ 2. From the Terminal Connection Manager window, press **F2** to access the Terminal Properties window.
- ___ 3. From the Terminal Properties window, click the **Update** tab.
- ___ 4. Enter the URL of the update server and directory in the **WBT Update URL** box:

Unless your update server information changes, you only need to enter this URL information during the initial configuration of your NetVista thin client.

The following URL guidelines apply:

- ___ a. Use either HTTP or FTP as the transfer protocol.
- ___ b. Use either the IP address or the server name of your update server.
- ___ c. Specify the update server directory that contains the software update.
- ___ d. Specify the filename of the software update.

For example:

`http://d.d.d.d/wbt_update/installsp1.xml`

`http` is the transfer protocol.
`d.d.d.d` is the IP address of your update server.
`wbt_update` is the update server directory
that contains the files for the software update.
`installsp1.xml` is the filename of the software update.

- ___ 5. Select **Check for WBT updates at every power on**.
- ___ 6. Click **OK** to save your changes, and close the Terminal Properties window.
Your NetVista thin client automatically updates your software every time you power on your NetVista thin client.

Attention: To avoid damaging the software on your NetVista thin client, do **not** power off during a software update.

If your NetVista thin client experiences any power interruption during the software update, the software on your NetVista thin client might be damaged. Contact IBM Service and Support, and refer to “Appendix E. Recovering the boot block image” on page 61 for information on how to recover the software on your NetVista thin client.

Manual software update

You can configure your NetVista thin client to perform a manual software update for special purposes. For example, you might want to test the software update files on one NetVista thin client before updating all of your NetVista thin clients. In this case, you can perform a manual software update.

Follow these steps to perform a manual software update:

- ___ 1. Ensure that your NetVista thin client has proper network and power connections.
- ___ 2. Close all active terminal server connections. Refer to “Disconnecting from a terminal server” on page 27 for more information.
- ___ 3. From the Terminal Connection Manager window, press **F2** to access the Terminal Properties window.
- ___ 4. From the Terminal Properties window, click the Update tab.
- ___ 5. Enter the URL of the update server and directory in the **WBT Update URL** box.

Unless your update server information changes, you only need to enter this URL information during the initial configuration of your NetVista thin client.

The following URL guidelines apply:

- ___ a. Use either HTTP or FTP as the transfer protocol.
- ___ b. Use either the IP address or the server name of your update server.
- ___ c. Specify the update server directory that contains the software update.
- ___ d. Specify the filename of the software update.

For example:

`http://d.d.d.d/wbt_update/installsp1.xml`

http is the transfer protocol.
d.d.d.d is the IP address of your update server.
wbt_update is the update server directory
that contains the files for the software update.
installsp1.xml is the filename of the software update.

__ 6. Click **Update Now** to start the software update.

Your NetVista thin client performs the software update and automatically restarts.

Attention: To avoid damaging the software on your NetVista thin client, do **not** power off during a software update.

If your NetVista thin client experiences any power interruption during the software update, the software on your NetVista thin client might be damaged. Contact IBM Service and Support, and refer to “Appendix E. Recovering the boot block image” on page 61 for information on how to recover the software on your NetVista thin client.

Resolving hardware problems

This section provides information on verifying and resolving hardware problems.

For the NetVista thin client hardware to function properly when connected to a terminal server, ensure that you do the following tasks:

- Configure the terminal server for your NetVista thin client.
- Install and configure the appropriate server software on the terminal server.

If you cannot identify a hardware problem, you can request technical service and support by contacting IBM. You need to provide the machine type, model, and serial number of your NetVista thin client.

You can obtain additional service and support information at the following URL:

<http://www.pc.ibm.com/support>

Click **NetVista**, and then click **NetVista thin client**.

Notes:

1. If your NetVista thin client is under warranty or a maintenance contract, contact IBM Service and Support to obtain a customer-replaceable unit (CRU). Refer to *IBM Network Station Hardware Warranty - Type 8363 and Type 8364 (SA23-2802)* for more information.
2. To resolve software errors, follow the instructions on the error message. For more information, contact IBM Service and Support.
3. Refer to the documentation for your monitor and USB devices for detailed information on resolving hardware problems that are associated with your monitor and USB devices.

Verifying hardware problems

Table 8 identifies possible hardware problem indications that can occur with your NetVista thin client during its startup sequence (see “Startup sequence” on page 7), or during normal operation.

Table 8. Hardware problem indications

Startup Checkpoints	Visible hardware failure	LED indications (system LED)	Audio beep sequences	Error codes and text messages (NSBxxxx)
Power on	X	X	X	
Monitor initialization	X			X
Keyboard initialization	X			X
Welcome screen	X			X
WBT software	X			

If you experience any hardware problem indications, you need to verify that an easily avoidable problem is not causing the hardware problem indication. Record any hardware problem indications and a description of the problem, and then proceed with the instructions below.

These instructions ensure that you start resolving any hardware problems by resetting the power to your hardware.

To determine the cause of NetVista thin client hardware problems, follow these steps to reset the power to your hardware:

- ___ 1. Power off the NetVista thin client.
- ___ 2. Unplug the power supply from the electrical outlet.
- ___ 3. Ensure that you properly connected all devices to the NetVista thin client. See “Connecting your hardware” on page 6 for more information.
- ___ 4. Plug the NetVista thin client power supply into a properly grounded, working electrical outlet.
- ___ 5. Power on the NetVista thin client.
- ___ 6. Wait for the IBM NetVista thin client screen to appear on your monitor.
 - If the IBM NetVista thin client screen appeared, and your NetVista thin client did not indicate any hardware problems during power-on, you do not have a hardware problem.
 - If the NetVista thin client indicates a hardware problem, record any problem indications and a description of the problem. Consult Table 9 with your hardware problem information.

Table 9. Hardware problem resolution information

Hardware problem indications	Where to find information
Visible hardware failure	“Visible hardware failure”
Audio beep sequences	“Audio beep sequences” on page 44
LED indications	“LED indications” on page 45
Error codes and text messages	“Error codes and text messages” on page 47

Visible hardware failure

You experience visible hardware failure during normal operation when a device that is attached to your logic unit fails to function properly. Visible hardware failure includes the following:

- A device that is attached to your logic unit fails to function at all.
For example:
 - Your mouse cursor stops moving.
 - Your monitor displays a blank screen.
 - Characters do not display on your monitor when you type.
- A device that is attached to your logic unit does not function properly.
For example:
 - Your monitor displays unreadable screens.
 - Your mouse cursor does not move smoothly.
 - Some keys on your keyboard do not respond correctly.

If your NetVista thin client hardware has a visible hardware failure, consult Table 10. Contact your technical support if these steps do not resolve the problem.

Table 10. Visible hardware failure

Symptom	What you should do
Logic Unit	
<p>The system LED does not light up when you press the white power button to power on the NetVista thin client.</p>	<ol style="list-style-type: none"> 1. Verify that you plugged the power supply into a working electrical outlet. 2. Verify that the power supply LED indicates a solid green color. 3. Reset power to the NetVista thin client by pressing the white power button. 4. If the system LED does not work, any of the following devices may be defective: <ul style="list-style-type: none"> • Power supply Verify that the power supply LED indicates a solid green color. • Power cable Substitute a properly working device for a defective device. Repeat the previous steps. See “Appendix B. Replacing hardware parts” on page 53 for more information. 5. If the system LED still does not work, you may need to replace the NetVista thin client logic unit. See “Appendix B. Replacing hardware parts” on page 53 for more information on replacing your defective mouse.
Keyboard	
<ul style="list-style-type: none"> • Your arrow keys do not respond when you press them. • Characters do not display on the monitor when you type. 	<ol style="list-style-type: none"> 1. Verify that you connected the keyboard cable properly to the NetVista thin client. 2. If the problem persists, your keyboard may be defective. <ul style="list-style-type: none"> • Substitute a properly working keyboard, and repeat the previous steps. • See “Appendix B. Replacing hardware parts” on page 53 for more information on replacing your defective keyboard. 3. If the keyboard still does not work, you may need to replace the NetVista thin client logic unit. See “Appendix B. Replacing hardware parts” on page 53 for more information on replacing your defective logic unit.
Monitor	
<ul style="list-style-type: none"> • Your monitor displays a blank screen. • Your monitor displays unreadable screens. 	<p>If the problem persists after you have verified your monitor cable connections, or after you have substituted a properly working monitor, refer to the documentation for your monitor for troubleshooting information.</p>

Table 10. Visible hardware failure (continued)

Symptom	What you should do
Mouse	
<ul style="list-style-type: none"> • Your mouse cursor stops moving; your mouse does not function at all. • Your mouse cursor does not move smoothly. 	<ol style="list-style-type: none"> 1. Verify that you connected the mouse cable properly to the NetVista thin client keyboard. 2. If the mouse does not work, any of the following devices may be defective: <ul style="list-style-type: none"> • Mouse • Keyboard <p>Substitute a properly working device for a defective device. Repeat the previous steps. See “Appendix B. Replacing hardware parts” on page 53 for more information.</p> 3. If the mouse still does not work, you may need to replace the NetVista thin client logic unit. See “Appendix B. Replacing hardware parts” on page 53 for more information on replacing your defective logic unit.

Audio beep sequences

Your NetVista thin client hardware utilizes both audio and visual alerts when reporting hardware problems. In the event of a hardware problem, your NetVista thin client emits audio beeps before your monitor initializes. After your monitor initializes, error codes and text messages appear on the screen (see “Error codes and text messages” on page 47).

Audio beep sequences can include short beeps, long beeps, and brief silent periods. Table 11 on page 45 defines the possible audio beep sequences that can occur when a hardware problem exists.

To verify that a NetVista thin client hardware problem exists, ensure that you complete the instructions in “Verifying hardware problems” on page 41.

If your NetVista thin client is not functioning properly, and it is emitting audio beep sequences, consult Table 11 on page 45. Contact your technical support if these steps do not resolve the problem.

Notes:

1. These beep sequences are in a numeric format which indicates the sequence of the audio output.
2. Audio beep sequences do not occur after the monitor initializes.

Table 11. Audio beep sequences

Symptom	What you should do
The NetVista thin client emits a 1-3-1 beep sequence, and the system LED is flashing amber.	<p>Memory error</p> <ol style="list-style-type: none"> 1. Check or replace your memory card. Refer to “Appendix C. Upgrading memory” on page 57 for instructions. 2. Verify that you properly connected the network cable to the NetVista thin client network connector. 3. Power on the NetVista thin client. 4. If the problem persists, you may need to replace the NetVista thin client logic unit. Refer to “Appendix B. Replacing hardware parts” on page 53 for information.
The NetVista thin client emits a 2-3-2 beep sequence, and the system LED is flashing amber.	<p>Video memory error</p> <ol style="list-style-type: none"> 1. Verify that you properly connected the network cable to the NetVista thin client network port. 2. Power on the NetVista thin client. 3. If the problem persists, you may need to replace the NetVista thin client logic unit. Refer to “Appendix B. Replacing hardware parts” on page 53 for information.

LED indications

The LED indicators of the following devices maintain a solid green color during normal operation:

- Logic unit (system LED and network status LED)
- Power supply
- Monitor
- Keyboard

The network status LED indicates a solid amber color during normal operation. The network status LED indicates a flashing green color during network activity.

The system LED quickly flashes from amber to green during a normal power-on. The system LED indicates hardware problems in the following ways:

- Flashing green indications
- Flashing amber indications
- Steady amber indications
- Failing to function

To verify that a NetVista thin client hardware problem exists, ensure that you complete the instructions in “Verifying hardware problems” on page 41.

If your NetVista thin client is not functioning properly, and the LED indicators of your NetVista thin client hardware indicate anything other than a solid green color, consult Table 12 on page 46. Contact your technical support if these steps do not resolve the problem.

Table 12. LED indications

Symptom	What you should do
System LED	
<p>The system LED fails to function after power on.</p>	<ol style="list-style-type: none"> 1. Verify that you plugged the power supply into a working electrical outlet. 2. Verify that the power supply LED indicates a solid green color. 3. Press the white power button to reset power to the NetVista thin client. 4. If the system LED does not work, any of the following devices may be defective: <ul style="list-style-type: none"> • Power supply Verify that the power supply LED indicates a solid green color. • Power cable <p>Substitute a properly working device for a defective device. Repeat the previous steps. Contact your reseller, or IBM, to request a replacement part (see “Ordering replacement parts” on page 53).</p> 5. If the system LED still does not work, you may need to replace the NetVista thin client logic unit. Contact your reseller, or IBM, to request a replacement part (see “Ordering replacement parts” on page 53).
<p>A power interruption during a software update occurs. When you power on the NetVista thin client, the system LED shows a solid green color, or a flashing amber color, and your monitor does not display any screens.</p>	<p>The software on your NetVista thin client may be damaged. Contact IBM Service and Support, and refer to “Appendix E. Recovering the boot block image” on page 61 for information on recovering the software on your NetVista thin client.</p>
<p>The system LED shows a solid amber color, or a flashing amber color.</p>	<ol style="list-style-type: none"> 1. Press the white power button to reset power to the NetVista thin client. 2. If the system LED still shows a solid amber color, or a flashing amber color, you may need to replace the NetVista thin client logic unit. Contact your reseller, or IBM, to request a replacement part (see “Ordering replacement parts” on page 53).
<p>The system LED flashes amber once shortly after power off.</p>	<p>Your NetVista thin client hardware automatically enables Wake-On-LAN (WOL). This is not an indication of a hardware problem.</p>
Power Supply LED	

Table 12. LED indications (continued)

Symptom	What you should do
The power supply LED fails to function after power on.	<ol style="list-style-type: none"> 1. Verify that you connected the power supply to the NetVista thin client. 2. Verify that you plugged the power supply into a working electrical outlet. 3. If the power supply LED does not indicate a solid green color, any of the following devices may be defective: <ul style="list-style-type: none"> • Power supply • Power cable <p>Substitute a properly working device for a defective device. Repeat the previous steps. Contact your reseller, or IBM, to request a replacement part (see “Ordering replacement parts” on page 53).</p>
Monitor LED	
The monitor LED fails to function after power on.	If the problem still persists after you verified your monitor cable connections, or after you substituted a properly working monitor, refer to the documentation for your monitor for more information.
The monitor LED shows a solid amber color, or a flashing amber color.	If the problem still persists after you verified your monitor cable connections, or after you substituted a properly working monitor, refer to the documentation for your monitor for more information.

Error codes and text messages

Error codes and text messages can appear on the bottom of your screen during the startup sequence of your NetVista thin client. **NSBxxxx** error codes and text messages indicate only hardware problems.

To verify that a NetVista thin client hardware problem exists, ensure that you complete the instructions in “Verifying hardware problems” on page 41.

If your NetVista thin client is not functioning properly, and an error code or text message appears on your screen, consult Table 13. Contact your technical support, reseller, or IBM, if these steps do not resolve the problem.

Table 13. Error codes and text messages

Symptom	What you should do
An error code or text message appears on your screen.	<ol style="list-style-type: none"> 1. Record any error messages, audio beep sequences, or LED indications, and a description of the problem. 2. Perform any actions indicated within the error message. 3. Contact your technical support.
A boot interruption screen appears.	Press F10 to reboot the NetVista thin client.

Table 14 on page 48 defines the error messages that can appear when you power on your NetVista thin client. This table provides information that you must only

follow under the direction of the IBM Service and Support team.

Table 14. NSBxxxx error codes and text messages

Error code	Error message	What you should do
General messages (NSB0xxxx)		
NSB00020	Press a key to continue.	Power off the NetVista thin client. Ensure that the CompactFlash card is installed properly (see "Appendix D. CompactFlash card" on page 59). Power on the NetVista thin client. If the hardware problem persists, replace the NetVista thin client logic unit (see "Appendix B. Replacing hardware parts" on page 53).
NSB00030	Canceled by user.	Power off the NetVista thin client. Ensure that the CompactFlash card is installed properly (see "Appendix D. CompactFlash card" on page 59). Power on the NetVista thin client. If the hardware problem persists, replace the NetVista thin client logic unit (see "Appendix B. Replacing hardware parts" on page 53).
Main memory messages (NSB10xxx)		
NSB11500	On board memory failure.	Ensure that the memory is installed properly, or replace memory (see "Installing a memory card" on page 57).
NSB11510	Slot %d memory failure.	Ensure that the memory is installed properly, or replace the memory (see "Installing a memory card" on page 57).
Non-volatile memory messages (NVRAM) (NSB11xxx)		
NSB12500	Checksum failure for nonvolatile memory.	No action required.
NSB12510	Not able to access nonvolatile memory.	Replace the NetVista thin client logic unit (see "Appendix B. Replacing hardware parts" on page 53).
NSB12520	Setting nonvolatile memory to manufacturing defaults.	No action required.
NSB12530	Detected reset jumper.	No action required.
NSB12540	New nonvolatile memory structure detected.	No action required.
Audio messages (NSB21xxx)		
NSB21500	Audio failure.	Replace the NetVista thin client logic unit (see "Appendix B. Replacing hardware parts" on page 53).
Input messages (NSB3xxxx)		
Keyboard and mouse messages (NSB3xxxx, NSB31xxx, and NSB32xxx)		
NSB30500	No input device detected. NS Boot will continue in 10 seconds.	Check the keyboard and mouse cable connections.
NSB31500	Keyboard did not respond.	Check the keyboard cable connection.

Table 14. NSBxxxx error codes and text messages (continued)

Error code	Error message	What you should do
NSB31510	Keyboard controller did not respond.	Check the keyboard cable connection. If the symptom remains, replace the NetVista thin client logic unit (see “Appendix B. Replacing hardware parts” on page 53).
NSB31520	Keyboard was not recognized.	Check the keyboard cable connection.
NSB32500	Mouse did not respond.	Check the mouse cable connection.
USB messages (NSB4xxxx)		
NSB40500	USB failure.	Disconnect any USB devices from the NetVista thin client and restart the system. If the symptom remains, replace the NetVista thin client logic unit (see “Appendix B. Replacing hardware parts” on page 53).
NSB40510	USB initialization failure.	Disconnect any USB devices from the NetVista thin client and restart the system. If the symptom remains, replace the NetVista thin client logic unit (see “Appendix B. Replacing hardware parts” on page 53).
CompactFlash card messages (NSB51xxx)		
NSB51500	File not found on flash card.	Power off the NetVista thin client. Ensure that the CompactFlash card is installed properly (see “Appendix D. CompactFlash card” on page 59). Power on the NetVista thin client. If the hardware problem persists, replace the NetVista thin client logic unit (see “Appendix B. Replacing hardware parts” on page 53).
NSB51510	Cannot close file on flash card.	Power off the NetVista thin client. Ensure that the CompactFlash card is installed properly (see “Appendix D. CompactFlash card” on page 59). Power on the NetVista thin client. If the hardware problem persists, replace the NetVista thin client logic unit (see “Appendix B. Replacing hardware parts” on page 53).
Ethernet messages (NSB62xxx)		
NSB62500	Line speed automatic negotiation failed.	Verify that you connected the network cable to the NetVista thin client correctly.
NSB62510	No network device found.	Replace the NetVista thin client logic unit (see “Appendix B. Replacing hardware parts” on page 53).
Failure to boot message (NSB83xxx)		
NSB83589	Failed to boot after 3 attempts.	Power off the NetVista thin client. Ensure that the CompactFlash card is installed properly (see “Appendix D. CompactFlash card” on page 59). Power on the NetVista thin client. If the hardware problem persists, replace the NetVista thin client logic unit (see “Appendix B. Replacing hardware parts” on page 53).

Appendix A. Windows server requirements

The NetVista thin client connects to a Windows server in the following situations:

- To access Windows-based applications on a Windows server by using either RDP or ICA.
- To download and install software updates from a Windows web server

Table 15 identifies server requirements for enabling access to Windows-based applications and for downloading software updates.

Table 15. Server requirements

Product	Server Requirements	Where to find more information
Remote Desktop Protocol (RDP)	Intel-based server that runs the following server software: <ol style="list-style-type: none"> 1. Any of these operating systems <ul style="list-style-type: none"> • Windows 2000 servers • Windows NT 4.0, Terminal Server Edition (TSE) 	http://www.microsoft.com
Independent Computing Architecture (ICA)	Intel-based server that runs the following server software: <ol style="list-style-type: none"> 1. Any of these operating systems <ul style="list-style-type: none"> • Windows 2000 servers • Windows NT 4.0, Terminal Server Edition (TSE) 2. Any of these ICA software: <ul style="list-style-type: none"> • Citrix Metaframe • Citrix Device Services 	http://www.microsoft.com http://www.citrix.com
NetVista thin client software updates	Intel-based server that runs the following server software: <ol style="list-style-type: none"> 1. Any of these operating systems <ul style="list-style-type: none"> • Windows 2000 servers • Windows NT 4.0, Terminal Server Edition (TSE) 2. Web Server software that supports FTP or HTTP protocols 3. Reliable internet access 	“Updating your software” on page 37 http://www.pc.ibm.com/support Click NetVista , and then click NetVista thin client . http://www.microsoft.com http://www.citrix.com

Appendix B. Replacing hardware parts

Replacing the logic unit

IBM replaces a defective logic unit as a complete assembly. To replace a logic unit, the customer must transfer features, such as a memory DIMM, to the replacement unit. If customers do not transfer their features, the replacement units cannot operate properly. See “Safety notices” on page v for information about handling Customer Replaceable Unit (CRU) parts.

IBM delivers CRUs to the customers for exchange, and customers return defective parts to IBM under the basic service offering. Customers should return all defective logic units with the cover assembly, and without the support base or memory DIMMs. For upgraded service offerings, a service representative delivers replacement parts, transfers features, and returns defective parts to IBM.

See “Resolving hardware problems” on page 41 to determine whether or not it is necessary to replace the thin client logic unit, or any other parts.

Refer to “Ordering replacement parts” to determine CRU part numbers for replacement parts. All thin client parts in Table 16 on page 53 are CRUs. Warranty service terms and conditions by country apply.

Ordering replacement parts

You can order IBM replacement parts for the thin client. Contact IBM, or your reseller, to order warranty parts and non-warranty parts. IBM provides warranty service without charge for parts during the warranty period on an exchange basis only.

If you need to return a part, refer to “Returning hardware parts” on page 55 for more information.

Use the table below to determine the correct part to order.



Table 16. Type 8363 thin client replacement parts

Description	Country	Part number
Logic unit and associated parts		
Logic Unit for Model Wxx	All Countries	00P2063
Base (Mounting Stand)	All Countries	03N2725
Slotted thumbscrews	All Countries	03N3882
Memory		
Note: This thin client accepts 168 pin, 3.3 V, gold tab, unbuffered, non-parity, and 100MHz SDRAM DIMM memory.		
Memory (32 MB SDRAM DIMM)	All Countries	01K1146
Memory (64 MB SDRAM DIMM)	All Countries	01K1147
Memory (128 MB SDRAM DIMM)	All Countries	01K1148
Memory (256 MB SDRAM DIMM)	All Countries	01K1149
Power supply		

Table 16. Type 8363 thin client replacement parts (continued)











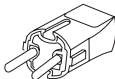







Description	Country	Part number
Power Supply (detachable power cable not included)	All Countries	03N2662
Mouse		
Verify the FRU part number (FRU P/N) on the bottom of your mouse.		
Mouse (two button)	All Countries	76H0889
USB Keyboard		
Verify the FRU part number (FRU P/N) on the bottom of your keyboard.		
Keyboard	Belgian UK	37L2651
Keyboard	Canadian French	37L2645
Keyboard	Czech	37L2653
Keyboard	Danish	37L2654
Keyboard	Dutch	37L2655
Keyboard	French	37L2656
Keyboard	Finnish	37L2671
Keyboard	German	37L2657
Keyboard	Hungarian	37L2660
Keyboard	Italian	37L2662
Keyboard	Japanese	37L2680 ³
Keyboard	Latin America (Spanish)	37L2647
Keyboard	Norwegian	37L2663
Keyboard	Polish	37L2664
Keyboard	Spanish	37L2670
Keyboard	Swedish	37L2671
Keyboard	Swiss (French and German)	37L2672
Keyboard	UK English	37L2675
Keyboard	US English ISO9995	37L2677
Keyboard	US English	37L2644

Table 17. Detachable power cables

Plug	Receptacle	Country	Part number
Detachable power cables			
		Argentina, Australia, New Zealand	13F9940

3. Not yet available.

Table 17. Detachable power cables (continued)

Plug	Receptacle	Country	Part number
		Abu Dhabi, Austria, Belgium, Bulgaria, Botswana, Egypt, Finland, France, Germany, Greece, Iceland, Indonesia, Korea (South), Lebanon, Luxembourg, Netherlands, Norway, Portugal, Saudi Arabia, Spain, Sudan, Sweden, Turkey, Yugoslavia	13F9978
		Bahamas, Barbados, Bolivia, Brazil, Canada, Costa Rica, Dominican Republic, El Salvador, Ecuador, Guatemala, Guyana, Haiti, Honduras, Jamaica, Japan, Netherlands Antilles, Panama, Peru, Philippines, Taiwan, Thailand, Trinidad, Tobago, U.S.A. (except Chicago), Venezuela	1838574
		Bahamas, Barbados, Bermuda, Bolivia, Brazil, Canada, Cayman Islands, Colombia, Costa Rica, Dominican Republic, Ecuador, El Salvador, Guatemala, Guyana, Haiti, Honduras, Jamaica, Japan, Korea (South), Mexico, Netherlands Antilles, Nicaragua, Panama, Peru, Philippines, Puerto Rico, Saudi Arabia, Suriname, Trinidad, Taiwan, U.S.A	6952301
		Bahrain, Bermuda, Brunei, Channel Islands, Cyprus, Ghana, Hong Kong, India, Iraq, Ireland, Jordan, Kenya, Kuwait, Malawi, Malaysia, Nigeria, Oman, People's Republic of China, Qatar, Singapore, Tanzania, Uganda, United Arab Emirates (Dubai), United Kingdom, Zambia	14F0032
		Bangladesh, Burma, Pakistan, South Africa, Sri Lanka	14F0014
		Denmark	13F9996
		Israel	14F0086
		Chile, Ethiopia, Italy	14F0068
		Liechtenstein, Switzerland	14F0050

Returning hardware parts

You may not need to return all defective items to IBM. Always check the replacement part packaging for any instructions regarding the return of defective parts.

To return a defective part to IBM, pack the defective part in the packaging container of the replacement part.

Note: Customers must not ship features, such as memory DIMMs, with defective logic units that they are returning to IBM. It is not possible for IBM to return these features back to customers.

If customers do not follow IBM shipping instructions, they may get charges for any damage to a defective part. IBM covers shipping costs on all warranted hardware and maintenance agreement hardware. Replacement parts become the customer's property in exchange for the defective parts, which become the property of IBM.

For information on ordering thin client parts, refer to "Ordering replacement parts" on page 53.

Appendix C. Upgrading memory

See “Resolving hardware problems” on page 41 to determine whether or not it is necessary to replace the logic unit, or any other parts. For information on ordering thin client hardware parts, refer to “Ordering replacement parts” on page 53.

Read “Safety notices” on page v before you continue with these instructions.

Removing the logic unit

Read “Safety notices” on page v before you continue with these instructions.

1. Power off the thin client, and disconnect all cables to the thin client.
2. Remove the two thumbscrews **A** at the back of the logic unit.
3. Push the logic unit **B** out of the cover.
4. Lay the logic unit on a flat surface.
5. Continue with “Installing a memory card” to install a memory card.

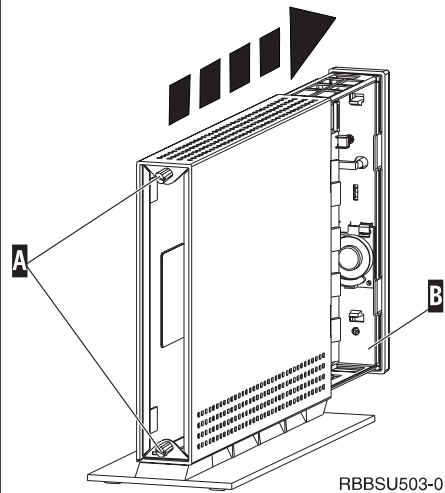

Installing a memory card

Complete the instructions in “Removing the logic unit”, and read “Safety notices” on page v before you continue with these instructions.

1. To remove a previously installed memory card, press the tabs **A**, that are located at each end of the memory card **B**, out until the memory card **B** comes out of the memory socket **C**.
2. To install a memory card, align the notches on the bottom of the memory card **B** with the matching notches on the memory socket **C**.
3. Press the memory card down into the memory socket **C**. The tabs **A** should swing in, holding the memory card in place.
4. Continue with “Reassembling the Network Station” on page 58.

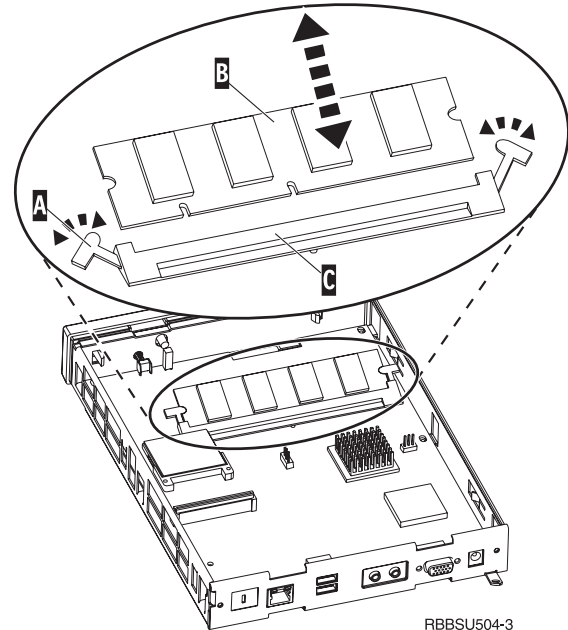

Reassembling the thin client

Read “Safety notices” on page v before you continue with these instructions.

1. To reassemble the thin client, carefully slide the logic unit **D** back into the cover, connectors first.
2. Install and tighten the two thumbscrews **C** at the back of the thin client.
3. Continue with “Installing the support base” on page 5 and “Connecting your hardware” on page 6.

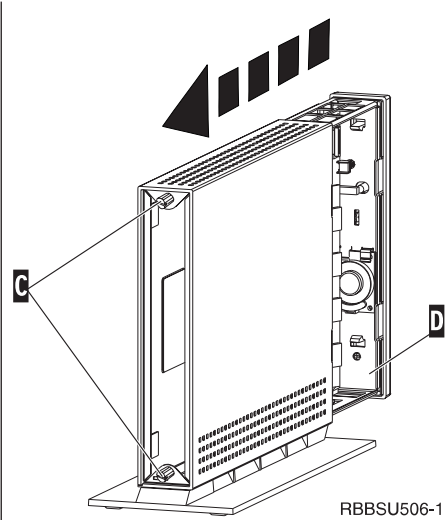

Appendix D. CompactFlash card

Follow these steps to verify if the CompactFlash card is installed properly.

Read “Safety notices” on page v before you continue with these instructions.

1. Perform Steps 1 to 4 in “Removing the logic unit” on page 57.
2. Align the grooves on the sides of the CompactFlash card **A** to the grooves of the flash card slot **B**.
3. Carefully press the CompactFlash card into the flash card slot. To avoid hardware damage, do not force the card into the flash card slot.
4. Perform “Reassembling the Network Station” on page 58.

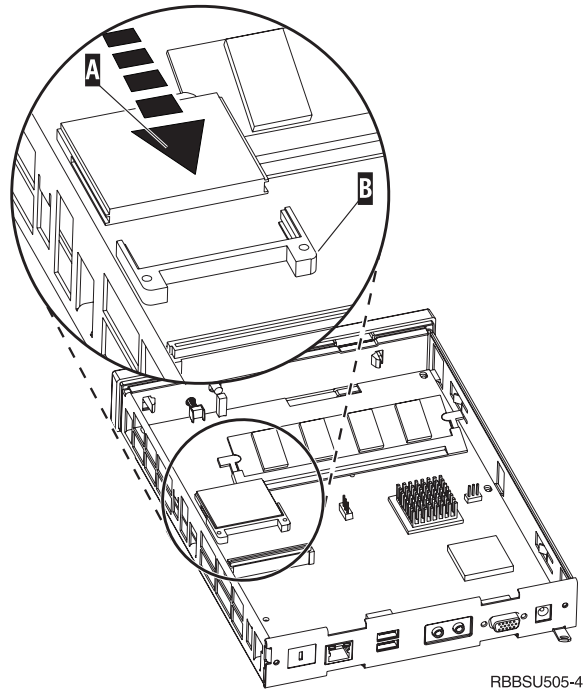

Appendix E. Recovering the boot block image

This section provides instructions that should be followed only under the direction of the IBM Service and Support team. Use these instructions only if you encountered a power interruption during a software update (see “Automatic software update” on page 38 or “Manual software update” on page 39).

Read “Safety notices” on page v before you continue with these instructions.

Creating the boot block recovery CompactFlash card

Read “Safety notices” on page v before you continue with these instructions.

Perform these instructions **from a properly working thin client**:

1. Perform Steps 1 to 4 in “Removing the logic unit” on page 57.
2. Remove the installed CompactFlash card by carefully pulling the card out of the flash card slot.
3. Carefully insert a blank CompactFlash card into the flash card slot.

This CompactFlash card is your recovery CompactFlash card.

4. Move the jumpers on headers **A** and **B** into configuration **2**.
5. Reconnect the power cable to the logic unit.
6. Power on the thin client, and wait for the system LED to flash green.

If the system LED flashes amber, the image was not created. Repeat the procedure with another CompactFlash card, if possible.

7. Power off the thin client.
8. Remove the recovery CompactFlash card.
9. Move the jumpers back into the default configuration **1**.
10. Install the original CompactFlash card into the flash card slot.
11. Perform “Reassembling the Network Station” on page 58.
12. Continue with “Reflashing the boot block from the recovery CompactFlash card” on page 62.

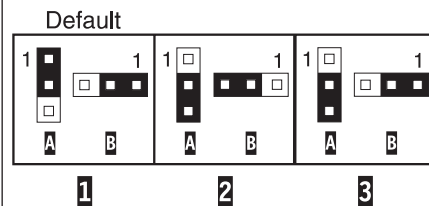
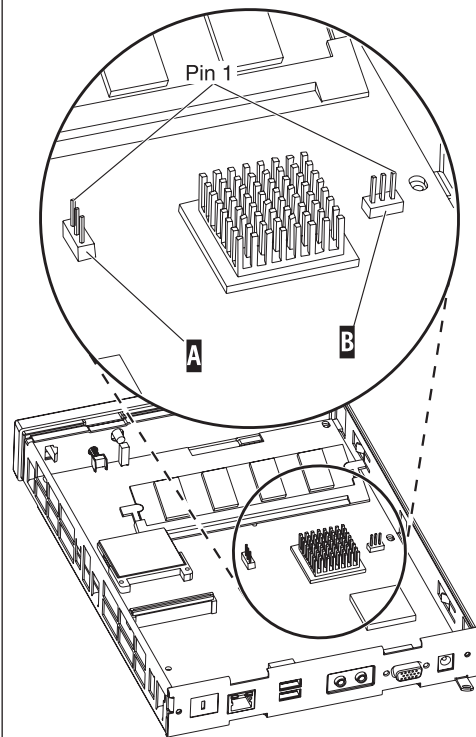

RZAPJ505-2

Reflashing the boot block from the recovery CompactFlash card

Read “Safety notices” on page v before you continue with these instructions.

Perform these instructions **using the thin client that requires the new boot block**:

1. Perform Steps 1 to 4 in “Removing the logic unit” on page 57.
2. Remove the installed CompactFlash card by carefully pulling the card out of the flash card slot.
3. Carefully insert the recovery CompactFlash card into the flash card slot.
4. Move the jumpers on headers **A** and **B** into configuration **3**.
5. Reconnect the power cable to the logic unit.
6. Power on the thin client, and wait for the system LED to flash green.
If the system LED flashes amber, the image was not created. Replace the logic unit (see “Appendix B. Replacing hardware parts” on page 53).
7. Power off the thin client.
8. Remove the recovery CompactFlash card.
9. Move the jumpers back into the default configuration **1**.
10. Install the original CompactFlash card into the flash card slot.
11. Perform “Reassembling the Network Station” on page 58.

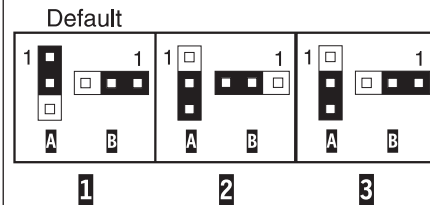
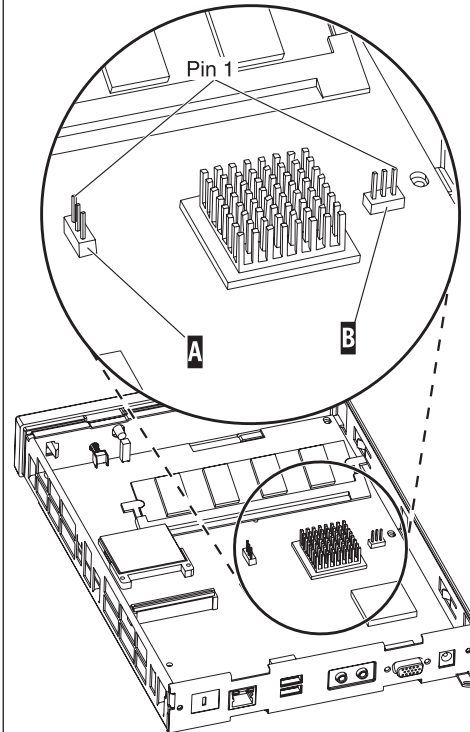

RZAPJ505-2

Appendix F. Monitor specifications

A basic VGA-class monitor that meets the VESA standards of refresh rate and resolution can function with your thin client. Your thin client supports VESA DPMS, and VESA Display Data Channel DDC2B.

Your monitor may not support all resolutions and refresh rates.

Table 18. Monitor support

High color (16 bit) and 256 color (8 bit)	
Resolution (pixels)	Refresh Rate (Hz)
640x480	60, 72, 75
800x600	60, 72, 75
1024x768	60, 70, 75
256 color (8 bit)	
640x480	60, 72, 75
800x600	60, 72, 75
1024x768	60, 70, 75
1280x1024	60

Appendix G. Connector pin information

The following tables define the connector pins that are used with the thin client.

Table 19. Monitor Connector

Pin	Signal	Signal Direction
1	Red Video	Out
2	Green Video	Out
3	Blue Video	Out
4	Monitor Detect 2	In
5	Ground	---
6	Red Video Ground	---
7	Green Video Ground	---
8	Blue Video Ground	---
9	Not connected	---
10	Ground	---
11	Monitor Detect 0	In
12	Monitor Detect 1 / DDCSDA	In / Out
13	Horizontal Sync	Out
14	Vertical Sync	Out
15	Monitor Detect 3 / DDCSCL	In / Out
Connector shell	Protective Ground	---

Table 20. RJ-45 Twisted Pair Connector

Pin	Name	Function
1	TPOP	Transmit +
2	TPON	Transmit -
3	TPIP	Receive +
4/5	Not used	---
6	TPIN	Receive -
7/8	Not used	---

Table 21. USB connector

Pin #	Direction	Description
1	Power	Power (5V) for USB0
2	Bidir	Data positive for USB0
3	Bidir	Data negative for USB0
4	Power	Ground for USB0
5	Power	Power (5V) for USB1
6	Bidir	Data positive for USB1
7	Bidir	Data negative for USB1
8	Power	Ground for USB1

Table 22. Power supply connector

Pin #	Voltage+12V dc input
1	+12V dc
2	Ground
3	Ground

Notices

This information has been developed for products and services that are offered in the U.S.A. IBM may not offer the products, services, or features that are discussed in this document in other countries. Consult your local IBM representative for information on the products and services currently available in your area. Any reference to an IBM product, program, or service is not intended to state or imply that only that IBM product, program, or service may be used. Any functionally equivalent product, program, or service that does not infringe any IBM intellectual property right may be used instead. However, it is the user's responsibility to evaluate and verify the operation of any non-IBM product, program, or service.

IBM may have patents or pending patent applications that cover subject matter that is described in this document. The furnishing of this document does not give you any license to these patents. You can send license inquiries, in writing, to the following address:

IBM Director of Licensing
IBM Corporation
North Castle Drive
Armonk, NY 10504-1785
U.S.A.

For license inquiries regarding double-byte character set (DBCS) information, contact the IBM Intellectual Property Department in your country or send inquiries, in writing, to:

IBM World Trade Asia Corporation
Licensing
2-31 Roppongi 3-chome, Minato-ku
Tokyo 106, Japan

The following paragraph does not apply to the United Kingdom or any other country where such provisions are inconsistent with local law:

INTERNATIONAL BUSINESS MACHINES CORPORATION PROVIDES THIS PUBLICATION "AS IS" WITHOUT WARRANTY OF ANY KIND, EITHER EXPRESS OR IMPLIED, INCLUDING, BUT NOT LIMITED TO, THE IMPLIED WARRANTIES OF NON-INFRINGEMENT, MERCHANTABILITY OR FITNESS FOR A PARTICULAR PURPOSE. Some states do not allow disclaimer of express or implied warranties in certain transactions; therefore, this statement may not apply to you.

This information could include technical inaccuracies or typographical errors. Changes are periodically made to the information herein; these changes will be incorporated in new editions of the publication. IBM may make improvements and changes in both the products and the programs described in this publication at any time without notice.

References in this information to non-IBM Web sites are provided for convenience only and do not in any manner serve as an endorsement of those Web sites. The materials at those Web sites are not part of the materials for this IBM product, and use of those Web sites is at your own risk.

Information concerning non-IBM products was obtained from the suppliers of those products, their published announcements, or other publicly available sources. IBM has not tested those products and cannot confirm the accuracy of performance, compatibility, or any other claims related to non-IBM products. Questions on the capabilities of non-IBM products should be addressed to the suppliers of those products.

All statements regarding IBM's future direction or intent are subject to change or withdrawal without notice, and represent goals and objectives only.

If you are viewing this information softcopy, the photographs and color illustrations may not appear.

The drawings and specifications contained herein shall not be reproduced in whole or in part without the written permission of IBM.

IBM has prepared this publication for use by customer personnel for operating and planning for the specific machines indicated. IBM makes no representations that it is suitable for any other purpose.

As an Energy Star Partner, IBM has determined that the Type 8363 thin client meets the Energy Star Program guidelines for energy efficiency.



Environmental Design

The environmental efforts that have gone into the design of this product signify IBM's commitment to improving the quality of its products and processes. Some of these accomplishments include the following:

- Elimination of the use of Class I ozone-depleting chemicals in the manufacturing process
- Reduction in manufacturing wastes
- Increased product energy efficiency

Normal power consumption for the thin client, while running applications, is approximately 18 Watts. For more information, contact an IBM account representative.

Product Recycling and Disposal

You can recycle components, such as structural parts and circuit cards, where recycling facilities exist. IBM does not currently collect and recycle used IBM products from customers in the United States other than those products that are involved in trade-in programs. Companies are available to disassemble, reuse, recycle, or dispose of electronic products. Contact an IBM account representative for more information.

This IBM thin client contains circuit boards with lead solder. Before you dispose of this unit, remove the circuit boards, and discard them according to local regulations or recycle them where facilities exist.

Trademarks

The following terms are trademarks of International Business Machines Corporation in the United States, or other countries, or both:

IBM
IBM NetVista

Microsoft, Windows, Windows CE, Windows 2000, Windows NT, and the Windows logo are trademarks of Microsoft Corporation in the United States, other countries, or both.

Other company, product, and service names may be the trademarks or service marks of others.

Electronic Emission Notices

The following Statement applies to this IBM product. The statement for other IBM products intended for use with this product will appear in their accompanying manuals.

Federal Communications Commission (FCC) Statement

Note: This equipment has been tested and found to comply with the limits for a class B digital devices, pursuant to Part 15 of the FCC Rules. These limits are designed to provide reasonable protection against harmful interference in a residential installation. This equipment generates, uses, and can radiate radio frequency energy and, if not installed and used in accordance with the instructions, may cause harmful interference to radio communications. However, there is no guarantee that interference will not occur in a particular installation. If this equipment does cause harmful interference to radio or television reception, which can be determined by turning the equipment off and on, the user is encouraged to try to correct the interference by one or more of the following measures:

- Reorient or relocate the receiving antenna.
- Increase the separation between the equipment and receiver.
- Connect the equipment into an outlet on a circuit different from that to which the receiver is connected.
- Consult an IBM authorized dealer or service representative for help.

Properly shielded and grounded cables and connectors must be used in order to meet FCC emission limits. Proper cables and connectors are available from IBM authorized dealers. IBM is not responsible for any radio or television interference caused by using other than recommended cables or connectors or by unauthorized changes or modifications to this equipment. Unauthorized changes or modifications could void the user's authority to operate the equipment.

This device complies with Part 15 of the FCC Rules. Operation is subject to the following two conditions: (1) this device may not cause harmful interferences, and (2) this device must accept any interferences received, including interference that may cause undesired operation.

Responsible Party:

International Business Machines Corporation
New Orchard Road

Armonk, NY 10504

Telephone: 1-919-543-2193

Industry Canada Compliance Statement

This Class B digital apparatus meets the requirements of the Canadian Interference-Causing Equipment Regulations.

Avis de conformité à la réglementation d'Industrie Canada

Cet appareil numérique de la classe B respecte toutes les exigences du Règlement sur le matériel brouilleur du Canada.

European Community Compliance Statement

This product is in conformity with the protection requirements of EC Council Directive 89/336/EEC on the approximation of the laws of the Member States relating to electromagnetic compatibility. IBM cannot accept responsibility for any failure to satisfy the protection requirements resulting from a non-recommended modification of the product, including the fitting of non-IBM option cards.

This product has been tested and found to comply with the limits for Class B Information Technology Equipment according to CISPR 22 / European Standard EN 55022. The limits for Class B equipment were derived for typical residential environments to provide reasonable protection against interference with licensed communication devices.

Properly shielded and grounded cables and connectors (IBM part number 75G5958 or its equivalent) must be used in order to reduce the potential for causing interference to radio and TV communications and to other electrical or electronic equipment. Such cables and connectors are available from IBM authorized dealers. IBM cannot accept responsibility for an interference caused by using other than recommended cables and connectors.

Glossary of abbreviations

C

CRU. Customer-Replaceable Unit

D

d.d.d.d. IP address format

DDC2B. Display Data Channel (version 2B)

DHCP. Dynamic Host Configuration Protocol

DIMM. Dual In-line Memory Module

DNS. Domain Name System

DPMS. Display Power Management Signaling

F

FRU. Field Replaceable Unit

I

IBM. International Business Machines

ICA. Independent Computing Architecture

ID. Identification

IEEE. Institute of Electrical and Electronics Engineers

IP. Internet Protocol

L

LAN. Local Area Network

LED. Light Emitting Diode

M

MB. Megabyte

MHz. Megahertz

N

N2200w. NetVista thin client for Windows-based Terminal Standard 1.5

NSB. Network Station Boot

NSBXXXXX. Network Station Boot message with identification number (XXXXX)

NVRAM. Nonvolatile Random Access Memory

R

RAM. Random Access Memory

RDP. Remote Desktop Protocol

S

SDRAM. Synchronous Dynamic Random Access Memory

T

TCP/IP. Transmission Control Protocol / Internet Protocol

U

URL. Uniform Resource Locator

USB. Universal Serial Bus

V

VESA. Video Electronics Standards Association

W

WBT. Windows-based Terminal

WINS. Windows Name Server

WOL. Wake-on-LAN

Wxx. Ethernet NetVista thin client with country-specific code

Index

B

- boot block image 61
 - recovering 61

C

- caution notices vi
- CompactFlash card 59
- configuration 9
 - Setup Wizard 9
 - terminal properties 10, 11, 12, 13, 14
 - terminal server connection 14
- connection 27, 28, 31
 - creating a connection 14
 - creating ICA connection 15
 - creating RDP connection 16
 - creating TEC connection 16
 - deleting a connection 31
 - terminal server connection 14
- connector pins 3, 65
- creating a connection 14

D

- danger notices v
- deleting a connection 31
- Display tab 11
 - configuration 11

E

- emulation 16, 18, 29, 30
 - help files 18
- emulators 16, 18, 29, 30
 - help files 18
- Export tab 14
 - configuration 14

G

- General tab 10
 - configuration 10

H

- handling static-sensitive devices vi
- hardware
 - boot block image 61
 - communication cables 3
 - CompactFlash card 59
 - connector pins 65
 - connectors 3
 - detailed information 3
 - display resolutions 4
 - ethernet 3
 - hardware procedures 4
 - installation 5
 - memory 57
 - monitor specifications 4, 63

hardware (continued)

- ordering replacement parts 53
- parts 5, 53
- ports 3
- power consumption 4
- power off 5
- power on 5
- power reduction 4
- problem indications 41
- refresh frequency 4
- replacing parts 53
- replacing the logic unit 53
- resolving problems 41
- returning parts 55
- setup 5
- type and model 3
- upgrading memory 4, 57
- USB devices 4
- verifying problems 41
- hardware features
 - memory upgrade 4
 - USB devices 4
- hardware parts 53, 55
- hardware problems
 - audio beep sequences 44
 - error codes and text messages 47
 - LED indications 45
 - visible hardware failure 42
- help files 18
 - downloading 18
 - viewing 18

I

- ICA 15, 28, 51
 - create connection 15
 - editing a terminal server connection 28
 - terminal server connection 15
- Input tab 10
 - configuration 10

M

- memory upgrade 57
- monitor
 - display resolutions 4
 - refresh frequency 4
 - specifications 4
- monitor specifications 63

N

- N2200w
 - boot block image 61
 - CompactFlash card 59
 - configuration 9, 10, 14
 - connection 14, 27, 28, 29, 30, 31
 - general description 1
 - hardware 3, 5
 - hardware parts 53, 55

N2200w (continued)

- hardware problems 41
- memory 57
- ordering replacement parts 53
- replacing hardware parts 53
- returning parts 55
- server requirements 51
- Setup Wizard 9
- software 1
- software update 37, 38, 39
- Terminal Connection Manager 27, 28, 29, 30, 31
- terminal properties 10
- terminal server connection 27, 28, 31
- verifying hardware problems 41
- NetVista thin client
 - boot block image 61
 - CompactFlash card 59
 - configuration 9, 10, 14
 - connection 14, 27, 28, 29, 30, 31
 - general description 1
 - hardware 3, 5
 - hardware parts 53, 55
 - hardware problems 41
 - memory 57
 - ordering replacement parts 53
 - replacing hardware parts 53
 - returning parts 55
 - server requirements 51
 - Setup Wizard 9
 - software 1
 - software update 37, 38, 39
 - Terminal Connection Manager 27, 28, 29, 30, 31
 - terminal properties 10
 - terminal server connection 27, 28, 31
 - verifying hardware problems 41
- network cables 3
- Network tab 11
 - configuration 11

O

- ordering replacement parts 53

P

- power consumption 4
- power on 7
 - startup sequence 7
- publication information
 - audience definition vii
 - comments or feedback vii
 - description of information vii
 - Internet site vii
 - latest version vii
 - product description vii
 - related information vii

R

- RDP 16, 28, 51
 - create connection 16
 - editing a terminal server connection 28
 - terminal server connection 16
- replacing hardware parts 53
- resolving problems 41
- returning hardware parts 55

S

- safety notices v
 - caution notices vi
 - danger notices v
 - handling static-sensitive devices vi
- server requirements 51
- server setup 37
 - software update 37
- Setup Wizard 9
- software
 - CompactFlash card 1
 - installing 38, 39
 - server requirements 51
 - updating 37, 38, 39
 - WBT 1
- software update 37, 38, 39
 - automated tasks 38
 - automatic software update 38
 - downloading 37
 - installing updates 38
 - manual software update 39
 - server setup 37
 - startup 38
 - update file 37
 - update site 37
 - updating 38
- startup connection 31
- startup sequence 7
- System tab 12
 - configuration 12

T

- TEC 16, 18, 29, 30
 - create connection 16
 - editing a terminal server connection 29
 - exporting a terminal server connection 30
 - help files 18
 - terminal server connection 16
- Terminal Connection Manager 27, 28, 29, 30, 31
- terminal properties 10
 - configuration 10, 11, 12, 13, 14
 - Display tab 11
 - Export tab 14
 - General tab 10
 - Input tab 10
 - Network tab 11
 - System tab 12
 - Update tab 13
- terminal server 14
 - connection 14
- terminal server connection 27, 28, 31

- terminal server connection 27, 28, 31
 - (continued)*
 - deleting a connection 31
 - editing a TEC connection 29
 - editing an ICA connection 28
 - editing an RDP connection 28
 - exporting a TEC connection 30
 - startup connection 31
- troubleshooting 41

U

- Update tab 13
 - configuration 13

V

- verifying problems 41

W

- Windows-based terminal (WBT) 1, 27, 28, 31, 59, 61
 - configuration 9, 10, 14
 - connection 14, 27, 28, 29, 30, 31
 - hardware 3, 5
 - hardware parts 53, 55
 - hardware problems 41
 - memory 57
 - ordering replacement parts 53
 - replacing hardware parts 53
 - returning parts 55
 - server requirements 51
 - Setup Wizard 9
 - software 1
 - software update 37, 38, 39
 - Terminal Connection Manager 27, 28, 29, 30, 31
 - terminal properties 10
 - verifying hardware problems 41

Readers' Comments — We'd Like to Hear from You

NetVista™ Thin Client
NetVista N2200w, Thin Client
for Windows-based Terminal Standard 1.5
Reference June 2000

Publication No. SA23-2801-00

Overall, how satisfied are you with the information in this book?

	Very Satisfied	Satisfied	Neutral	Dissatisfied	Very Dissatisfied
Overall satisfaction	<input type="checkbox"/>	<input type="checkbox"/>	<input type="checkbox"/>	<input type="checkbox"/>	<input type="checkbox"/>

How satisfied are you that the information in this book is:

	Very Satisfied	Satisfied	Neutral	Dissatisfied	Very Dissatisfied
Accurate	<input type="checkbox"/>	<input type="checkbox"/>	<input type="checkbox"/>	<input type="checkbox"/>	<input type="checkbox"/>
Complete	<input type="checkbox"/>	<input type="checkbox"/>	<input type="checkbox"/>	<input type="checkbox"/>	<input type="checkbox"/>
Easy to find	<input type="checkbox"/>	<input type="checkbox"/>	<input type="checkbox"/>	<input type="checkbox"/>	<input type="checkbox"/>
Easy to understand	<input type="checkbox"/>	<input type="checkbox"/>	<input type="checkbox"/>	<input type="checkbox"/>	<input type="checkbox"/>
Well organized	<input type="checkbox"/>	<input type="checkbox"/>	<input type="checkbox"/>	<input type="checkbox"/>	<input type="checkbox"/>
Applicable to your tasks	<input type="checkbox"/>	<input type="checkbox"/>	<input type="checkbox"/>	<input type="checkbox"/>	<input type="checkbox"/>

Please tell us how we can improve this book:

Thank you for your responses. May we contact you? Yes No

When you send comments to IBM, you grant IBM a nonexclusive right to use or distribute your comments in any way it believes appropriate without incurring any obligation to you.

Name

Address

Company or Organization

Phone No.



Fold and Tape

Please do not staple

Fold and Tape

PLACE
POSTAGE
STAMP
HERE

IBM CORPORATION
ATTN DEPT 542 IDCLERK
3605 Highway 52 N
ROCHESTER MN
55901-7829

Fold and Tape

Please do not staple

Fold and Tape



SA23-2801-00

