

# E54 Color Monitor

---

**E54**

---

User's Guide

English

## Safety: Read first

Before installing this product, read the Safety Information.

Avant d'installer ce produit, lisez les consignes de sécurité.

Vor der Installation dieses Produkts die Sicherheitshinweise lesen.

Πριν εγκαταστήσετε το προϊόν αυτό, διαβάστε τις πληροφορίες ασφάλειας (safety information).

לפני שתתקינו מוצר זה, קראו את הוראות הבטיחות.

A termék telepítése előtt olvassa el a Biztonsági előírásokat!

Prima di installare questo prodotto, leggere le Informazioni sulla Sicurezza

Antes de instalar este produto, leia as Informações de Segurança.

Läs säkerhetsinformationen innan du installerar den här produkten.

Prije instalacije ovog produkta obavezno pročitajte Sigurnosne Upute.

Les sikkerhetsinformasjonen (Safety Information) før du installerer dette produktet.

Przed zainstalowaniem tego produktu, należy zapoznać się z książką "Informacje dotyczące bezpieczeństwa" (Safety Information).

Пред да се инсталира овој продукт, прочитајте информацијата за безбедност.

Pred inštaláciou tohto zariadenia si peôítajte Bezpeônostné predpisy.

Pred namestitvijo tega proizvoda preberite Varnostne informacije.

Ennen kuin asennat t m n tuotteen, lue turvaohjeet kohdasta Safety Information.

Před instalac tohoto produktu si přečtete příručku bezpečnostních instrukcí.

在安装本产品之前，请仔细阅读 **Safety Information** (安全信息)。

安裝本產品之前，請先閱讀「安全資訊」。

مج، يجب قراءة دات السلامة

Læs sikkerhedsforskrifterne, før du installerer dette produkt.

製品を設置する前に、安全情報をお読みください。

본 제품을 설치하기 전에 안전 정보를 읽으십시오.

Antes de instalar este producto lea la información de seguridad.

Antes de instalar este produto, leia as Informações de Segurança.

Перед установкой продукта прочтите инструкции по технике безопасности.

Lees voordat u dit product installeert eerst de veiligheidsvoorschriften.

## **Second Edition (July 2005)**

This publication could contain technical inaccuracies or typographical errors. Changes are made periodically to the information herein; these changes will be made in later editions. Lenovo may make improvements and/or changes in the product(s) and/or program(s) at any time.

It is possible that this publication may contain reference to, or information about, Lenovo products (machines and programs), programming, or services that are not announced in your country.

Requests for copies of this publication and for technical information about Lenovo products should be made to your Lenovo Authorized Dealer or Lenovo Retailer.

No part of this publication may be reproduced or distributed in any form or by any means without prior permission in writing from the International Business Machines Corporation.

**© Copyright lenovo 2005; portion(c) IBM corp, 2004 .  
All rights reserved.**

Note to U.S. Government Users -- Documentation related to restricted rights -- Use, duplication or disclosure is subject to restrictions set forth in GSA ADP Schedule Contract with Lenovo Corp.

## Notices

Lenovo may not offer the products, services, or features discussed in this document in all countries. Consult your local Lenovo representative for information on the products and services currently available in your area. Any reference to a Lenovo product, program, or service is not intended to state or imply that only that Lenovo product, program, or service may be used. Any functionally equivalent product, program, or service that does not infringe any Lenovo intellectual property right may be used instead. However, it is the user's responsibility to evaluate and verify the operation of any other product, program, or service.

Lenovo may have patents or pending patent applications covering subject matter described in this document. The furnishing of this document does not give you any license to these patents. You can send license inquiries, in writing, to:

*Lenovo (United States), Inc.  
500 Park Offices Drive, Hwy. 54  
Research Triangle Park, NC 27709  
U.S.A.  
Attention: Lenovo Director of Licensing*

Lenovo GROUP LTD. PROVIDES THIS PUBLICATION "AS IS" WITHOUT WARRANTY OF ANY KIND, EITHER EXPRESS OR IMPLIED, INCLUDING, BUT NOT LIMITED TO, THE IMPLIED WARRANTIES OF NON-INFRINGEMENT, MERCHANTABILITY OR FITNESS FOR A PARTICULAR PURPOSE. Some jurisdictions do not allow disclaimer of express or implied warranties in certain transactions, therefore, this statement may not apply to you.

This information could include technical inaccuracies or typographical errors. Changes are periodically made to the information herein; these changes will be incorporated in new editions of the publication. Lenovo may make improvements and/or changes in the product(s) and/or the program(s) described in this publication at any time without notice.

The products described in this document are not intended for use in implantation or other life support applications where malfunction may result in injury or death to persons. The information contained in this document does not affect or change Lenovo product specifications or warranties. Nothing in this document shall operate as an express or implied license or indemnity under the intellectual property rights of Lenovo or third parties. All information contained in this document was obtained in specific environments and is presented as an illustration. The result obtained in other operating environments may vary.

Lenovo may use or distribute any of the information you supply in any way it believes appropriate without incurring any obligation to you.

Any references in this publication to non-Lenovo Web sites are provided for convenience only and do not in any manner serve as an endorsement of those Web sites. The materials at those Web sites are not part of the materials for this Lenovo product, and use of those Web sites is at your own risk.

Any performance data contained herein was determined in a controlled environment. Therefore, the result obtained in other operating environments may vary significantly. Some measurements may have been made on development-level systems and there is no guarantee that these measurements will be the same on generally available systems. Furthermore, some measurements may have been estimated through extrapolation. Actual results may vary. Users of this document should verify the applicable data for their specific environment.

### **Trademarks**

The following terms are trademarks of Lenovo in the United States, other countries, or both:

Lenovo

IBM is a trademark of the IBM Corporation in the United States, other countries, or both, and is used under license.

Microsoft and Windows are trademarks of Microsoft Corporation in the United States, other countries, or both.

Other company, product, and service names may be trademarks or service marks of others.

## Further Help

If you are unable to correct the problem yourself, you may seek further help as follows:

Call the Customer Support Center.

In the US call 1-800-426-7378

In Canada (Toronto Only) call 416-383-3344

In Canada (all others) call 1-800-565-3344

***i** If possible, stay by your computer. Your Technical Support Representative may wish to go through the problem with you during the call.*

In other countries contact your dealer, retailer, or other Lenovo authorized Servicer.

Before calling, please have available as much of the following information as possible:

1. Model and serial number from the label on your monitor.
2. Purchase receipt.
3. Description of problem.
4. Computer type and model.
5. System configuration (hardware fitted, etc.).
6. System BIOS version number.
7. Operating System and version number.
8. Display driver version number.
9. Video Adapter Type.

# Contents

<b>Packing list</b> -----	5
<b>Precautions</b> -----	6
<b>Installation Instructions</b> -----	7
Swivel Base -----	7
Power cord -----	8
Video cable -----	8
<b>Operating Instructions</b> -----	9
General Instructions -----	9
Front panel control -----	10
How to adjust a setting -----	10
Adjusting the picture -----	11
<b>Features</b> -----	12
Green monitor -----	12
Plug and play -----	14
<b>Technical Support (FAQ)</b> -----	14
<b>Appendix A – Specifications</b> -----	15-16
<b>Appendix B – Factory Preset Timing Table</b> -----	17

## PACKING LIST

The product package should include the following items:

1. Monitor
2. Quick set up guide
3. Power cord
4. Swivel base
5. CD manual
6. Monitor Safety, Troubleshooting, and Warranty Guide

# PRECAUTIONS

## Workplace preparation

### Positioning the monitor

Choose a suitable place to position the monitor where it is not near fluorescent desk lighting or any equipment that produces magnetic fields that could cause interference. Ensure that the furniture or equipment can support the weight of the monitor. Allow at least 2 in. (50 mm) ventilation space around the monitor.

### Height

The monitor should be positioned so that the top of the screen is slightly below your eye level when you sit at your workstation.

### Orientation

Choose a position that gives the least reflection from lights and windows, usually at a right angle to any windows. Position the monitor directly in front of you so that you do not have to twist your body. Tilt the monitor to a comfortable viewing angle.

## Work Practices

### Caring for your Monitor

Be sure to disconnect the power cord from your monitor before you perform any maintenance on the monitor. Clean your monitor as follows:

- Gently wipe the covers and the screen with a soft cloth, do not use solvents or abrasives.
- Never drop water or other liquid into your monitor.
- Remove finger marks and grease with a damp cloth and mild detergent.
- Never use flammable cleaning materials to clean your Lenovo monitor or any other electrical apparatus.
- Do not rub, touch, or tap the surface of the screen with sharp or abrasive items such as a ballpoint pen or screwdriver. This type of contact may result in a scratched picture tube.
- Do not use any type of cleaner containing an anti-static solution or similar additive as this may scratch the screen's coating.
- Never apply detergent or other liquid directly to the screen. Dampen the cloth and then wipe.



**Rest**

Take regular breaks. Vary your posture, and stand up and stretch occasionally, as prolonged use of computer workstations can be tiring.

**Back**

Sit back in the chair and use the back rest.

**Hands**

Use a light touch on the keyboard, keeping your hands and fingers relaxed. Allow a space in front of the keyboard to rest your wrists when not typing. Consider using a wristpad.

**Eyesight**

Working with monitors, in common with any prolonged close work, can be visually demanding. Look away from the screen periodically and have your eyesight checked regularly.

**Screen settings**

Set the screen brightness and contrast to a comfortable level. You might have to adjust this as the lighting changes during the day. Many application programs let you select color combinations which can help you to view in comfort.

## INSTALLATION INSTRUCTIONS

### Swivel Base

**To attach the swivel base to the monitor, do the following:**

- Carefully turn the monitor on its side or upside down. (see figure 1)
- Locate the cavities at the bottom front of the monitor.
- Insert the pegs on the swivel base into these cavities. Push the swivel base forward until the swivel base locks in place.
- To remove the swivel base, hold the bottom of the swivel base, and then push it out.

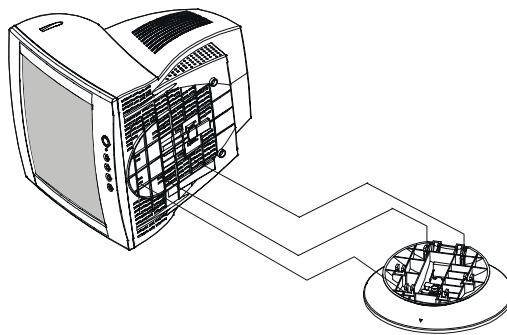

Figure 1 Installing and removing the Swivel Base

## Power Source:

1. Make sure the power cord is the correct type that is required in your area.
2. This monitor has a universal power supply that allows operation in 100/120V ac or 220/240V ac voltage (No user adjustment is required)
3. Connect the power cord into your monitor's power input socket, and then plug the other end into a 3-pin ac power outlet. The power cord can be connected to either a wall power outlet or the power outlet socket on your computer, depending on the type of power cord supplied with your monitor.

## Power cord:

For safe operation, use the power cord supplied with the unit.

## Video cable

**Connecting the video cable:** The monitor comes with a built-in video cable. Plug the signal cable's 15-pin connector into the computer's video port and tighten the two screws on the cable connector. (see figure 2)

**Connecting the power cord:** Plug the power cord into the monitor's ac power socket. Then plug the power cord into a grounded ac outlet or UL-approved power strip or the power output socket on your computer.

**Caution:** *If the AC outlet is not grounded(only two holes), install the proper grounding adapter (not supplied).*

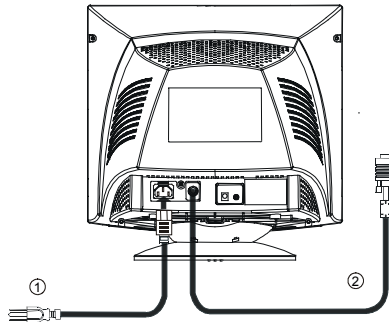

Figure 2 Connecting cables

1.	Power Cord	2.	Signal Cable
----	------------	----	--------------

# OPERATING INSTRUCTIONS

## General Instructions

The power switch is located at front panel of the monitor. Press the power switch to turn the monitor on or off. The other control knobs are located at the base of the monitor (See Figure 3). By changing these settings, the picture can be adjusted to your personal preferences.

- The power cord must be connected.
- Connect the video cable from the monitor to the video card.
- To turn the monitor on, press the POWER switch to ON position. The power indicator will light up.
- Your monitor features a unique quick switch system which provides a picture within seconds after the monitor is switched on.

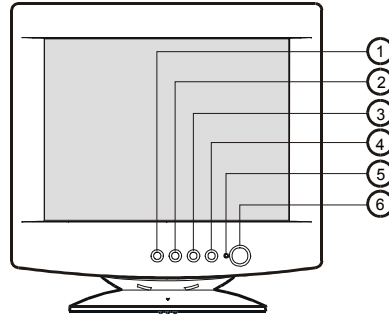

Figure 3 External Control Knob

## EXTERNAL CONTROLS

1.	EXIT Key	4.	MENU
2.	BRIGHTNESS/◀	5.	Power Indicator
3.	CONTRAST/▶	6.	Power Switch

## Notes

- Do not install the monitor in a location near heat sources such as radiators or air ducts, or in a place subject to direct sunlight, or excessive dust or mechanical vibration or shock.
- Save the original shipping carton and packing materials, as they will come in handy if you ever have to ship your monitor.
- For maximum protection, repackage your monitor as it was originally packed at the factory.
- To keep the monitor looking new, periodically clean it with a soft cloth. Stubborn stains can be removed with a cloth lightly dampened with a mild detergent solution. Never use strong solvents such as thinner, benzene, or abrasive cleaners, since these will damage the cabinet. As a safety precaution, always unplug the monitor before cleaning it.

## Front Panel Control

- **Power** : Press this knob to switch ON/OFF of monitor's power.
- **MENU** : Active OSD menu or function adjust confirm.
- **Contrast** / **▶** : Adjust contrast or function adjust.
- **Brightness** / **◀** : Adjust brightness or function adjust.
- **EXIT** : Exit a function or inactive OSD menu.
- **Power Indicator** :
  - Green — Power On mode.
  - Orange — Sleep or Off mode.

## How to adjust a setting

The monitor controls are accessed by pressing button MENU to enable OSD (On-Screen-Display). The main menu will be displayed as follows.

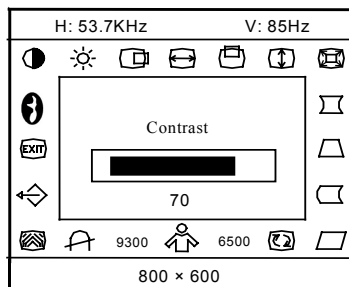



















Figure 4 The OSD Message

**Note:** If adjustment or selection of any OSD menu is not made for more than 10 seconds, the current setup will be saved and the OSD will disappear automatically.

## ADJUSTING THE PICTURE

The description for function control ICONS

1.		CONTRAST	Adjust the picture contrast.
2.		BRIGHTNESS	Adjust the picture brightness.
3.		H- CENTER	Adjust the horizontal position of the picture.
4.		H- SIZE	Adjust the picture's horizontal size.
5.		V- CENTER	Adjust the vertical position of the picture.
6.		V- SIZE	Adjust the picture's vertical size.
7.		ZOOM	Adjust the picture's horizontal and vertical size simultaneously.
8.		PINCUSHION	Adjust the pincushion and barrel
9.		TRAPEZOID	Adjust the picture's trapezoid distortion.
10.		PIN-BALANCE	Adjust to compensate the pincushion unbalance.
11.		PARALLELOGRAM	Adjust the picture to be a rectangle.
12.		ROTATION	Adjust the picture tilt to horizontal position.
13.		6500°K/9300°K (COLOR TEMPERATURE )	The color temperature for 6500°K is $x=0.313$ , $y=0.329$ and 9300°K is $x=0.283$ , $y=0.297$ . It presents two different color sets on the screen. You can select 9300°K or 6500°K by pressing the MENU.
14.		USER COLOR ( Red / Blue )	If the 9300°K normal white or 6500°K warmer white do not satisfy your desire, properly adjust R . B GAIN controls to obtain your optimum whiteness level.
15.		DEGAUSS	If color impurity occurs when moving or swiveling the monitor, press the MENU and degauss to fix the picture condition.
16.		MOIRE REDUCE	Moire is the result of interference between the phosphor layout and the video signal. In some cases, you may find the moire very noticeable. Press the MENU to enter in the moire reduce setting. Please adjust the level to the optimum condition. Note: Too high of a setting will cause the picture to shake.
17.		RECALL	Press RECALL to restore the monitor to factory settings.
18.		EXIT	Close OSD window.
19.		SELECT LANGUAGE	Select the language you like.

## FEATURES

### Green monitor

- The monitor has a power saving function .This feature will switch off your monitor to conserve energy,after a user-specified period of inactivity.

The power-saving mode is indicated by the light-emitting diode (LED) on the front panel:

Mode	Signal				Power	
	Cable	H-Sync	V-Sync	Video	Indicator	Consumption
On*	Attached	Yes	Yes	Active	Green	≤ 60 W
Sleep	Attached	No	No	Blank	Orange	≤ 4 W
Off	Attached	No	No	Blank	Orange	≤ 2 W

- \* 1. Power consumption at on mode is measured at 1024X768@75Hz
- 2. Test conditions are specified in version 4 Energy Star specification.

**THIS MONITOR WILL APPEAR TO BE NON-FUNCTIONAL IF THERE IS NO VIDEO INPUT SIGNAL. IN ORDER FOR THIS MONITOR TO OPERATE PROPERLY, THERE MUST BE A VIDEO INPUT SIGNAL.**

This feature is designed to conserve electrical energy by reducing power consumption when there is no video input signal present. When there is no video input signal present, this monitor, following a time-out period, will automatically switch to an OFF mode. And the LED will turn orange. This reduces the monitor's internal power supply consumption. After the video input signal is restored, full power is restored and the display is automatically redrawn. The appearance is similar to a "Screen Saver" feature except the display is completely off. The display is restored by pressing a key on the keyboard, or clicking the mouse.

## **Plug and play**

### **Plug & Play DDC1/2B Feature**

This monitor is equipped with VESA DDC2B capabilities according to the VESA DDC STANDARD. It allows the monitor to inform the host system of its identity and, depending on the level of DDC used, communicate additional information about its display capabilities.

The DDC2B is a bidirectional data channel based on the I2C protocol. The host can request EDID information over the DDC2B channel.

## TECHNICAL SUPPORT (FAQ)

Problem & Question	Possible Solution
Power LED is not on	<ul style="list-style-type: none"> <li>*Verify that the power switch is in the ON position</li> <li>*Power cord must be connected</li> </ul>
No Plug & Play	<ul style="list-style-type: none"> <li>*Verify that the computer system is Plug &amp; Play compatible</li> <li>*Verify that the video card is Plug &amp; Play compatible</li> <li>*Verify that the D-15 plug pin of video cable is bent</li> <li>*Make sure the monitor device drivers are installed</li> </ul>
No picture	<ul style="list-style-type: none"> <li>*Computer power switch must be in the ON position</li> <li>*Computer video card must be snugly seated in its slot</li> <li>*The signal cable must be completely connected to the computer</li> <li>*Check the color of the power LED indicator. If it is orange, then the monitor and the computer system are in power-saving mode. You need to press your keyboard or move the mouse to reactivate the system.</li> </ul>
Picture is fuzzy	<ul style="list-style-type: none"> <li>*Adjust the Contrast and Brightness Controls.</li> </ul>
Picture bounces or a wave pattern is present in the picture	<ul style="list-style-type: none"> <li>*Move electrical devices that might cause electrical interference.</li> </ul>
Monitor is stuck in "Power Saving Mode"	<ul style="list-style-type: none"> <li>*Make sure monitor's video cable is properly connected to the computer.</li> <li>*Inspect monitor's video cable and make sure none of the pins are bent.</li> <li>*Make sure computer is operational by hitting the CAPS LOCK key on the keyboard while observing the CAPS LOCK LED. The LED should either turn ON or OFF after hitting the CAPS LOCK key.</li> </ul>
Missing one of the primary colors (RED, GREEN, or BLUE)	<ul style="list-style-type: none"> <li>*Inspect the monitor's video cable and make sure that none of the pins are bent.</li> </ul>



## APPENDIX A – SPECIFICATIONS

CRT	CRT Size	38.1 cm (15 in.), 90° deflection, 22.5 mm mini-neck
	Viewable Image Size	35.4 cm (13.9 in.), diagonal
	Type	0.28 mm dot pitch.
Input	Video	0.7 V <sub>pp</sub> , R,G,B Analog
	Separate Sync.	TTL Level
	H./V.- Sync.	Positive / Negative
Scanning Frequency	H-Frequency	30 - 69 kHz
	V-Frequency	50 - 120 Hz
Max. Resolution		1280 x 1024
Video dot rate		110 MHz
Factory Preset mode :		9
User Programmable mode :		8
Power Source		Universal 100 – 240 V ac, 50 Hz / 60 Hz
Operating		0 to 40° C (0 to 104° F)
Humidity		10% to 85% relative, non-condensing
Dimensions	Carton	452 mm (1.5 ft) × 425 mm (1.4 ft) × 454 mm (1.5 ft) (W × H × D)
	Monitor & Base	360 mm (1.2 ft) × 362 mm (1.2 ft) × 387 mm (1.3 ft) (W × H × D)
Weight	Unit (net)	11.5 kg ( Net )
	Carton (gross)	13.0 kg ( Gross )
Signal Cable:		Attached Mini D-sub 15 Male

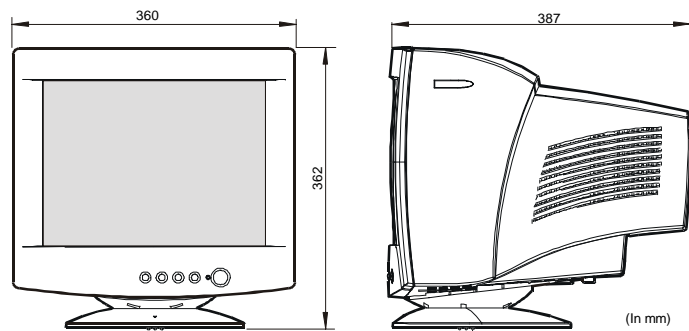

External Controls:	Switch	<ul style="list-style-type: none"> <li>• Power On/Off switch</li> <li>• MENU Key</li> <li>• Contrast/▶UP Key</li> <li>• Brightness/◀Down Key</li> <li>• EXIT Key</li> </ul>
	Functions	<ul style="list-style-type: none"> <li>• Contrast</li> <li>• Brightness</li> <li>• H-Center</li> <li>• H-Size</li> <li>• V-Center</li> <li>• V-Size</li> <li>• Zoom</li> <li>• Pincushion</li> <li>• Trapezoid</li> <li>• Rotation</li> <li>• 6500°K</li> <li>• User Color</li> <li>• 9300°K</li> <li>• Degauss</li> <li>• Moire Reduce</li> <li>• Recall</li> <li>• Exit</li> </ul>
Plug & Play		DDC 2B
Power Consumption*		60 W
Pre-set Display Area		260 mm (10.2 in.) x 195 mm (7.7 in.)
Regulatory Compliance		UL, CSA, FDA, FCC, CE, MPR II TÜV/GS

## APPENDIX B – FACTORY PRESET TIMING TABLE

STANDARD	RESOLUTION	HORIZONTAL FREQUENCY	VERTICAL FREQUENCY
VGA	720 × 400	31.33 kHz	70 Hz
VGA	640 × 480	31.47 kHz	60 Hz
VESA/75	640 × 480	37.50 kHz	75 Hz
VESA/85	640 × 480	43.27 kHz	85 Hz
VESA/75	800 × 600	46.88 kHz	75 Hz
VESA/85	800 × 600	53.67 kHz	85 Hz
VESA/75	1024 × 768	60.02 kHz	75 Hz
VESA/85	1024 × 768	68.68 kHz	85 Hz
VESA/60	1280 × 1024	64.98 kHz	60 Hz

### Connector pin assignment

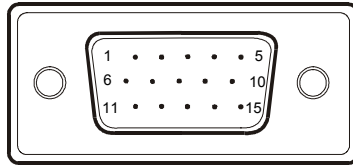

15 - Pin Color Display Signal Cable

PIN NO.	DESCRIPTION	PIN NO.	DESCRIPTION
1.	Red	9.	NC
2.	Green	10.	Ground
3.	Blue	11.	Monitor Ground
4.	Ground	12.	DDC-Serial Data
5.	Ground	13.	H-Sync
6.	R-Ground	14.	V-Sync / *V-CLK
7.	G-Ground	15.	DDC-Serial Clock
8.	B-Ground	*	For DDC

## Service Information

The following parts are for use by Lenovo service, or Lenovo authorized dealers, to support the customer warranty. Parts are for service use only.

Model Type 6331(for E54)

40Y6716	6331-FCN	FRU E54 Monitor - NH, PW, MPR-II APGC, AP-N
40Y6717	6331-PCN	FRU E54 Monitor - NH, BB, MPR-II APGC, AP-N
40Y6718	6331-FCE	FRU E54 Monitor- EQ, PW, MPR-II ASEAN
40Y6719	6331-PCE	FRU E54 Monitor- EQ, BB, MPR-II ASEAN
40Y6720	6331-FCS	FRU E54 Monitor- SH, PW, MPR-II ANZ
40Y6721	6331-PCS	FRU E54 Monitor- SH, BB, MPR-II ANZ
40Y6722	6331-FCN	FRU E54 Monitor- NH, PW, MPR-II US/Canada/Mexico
40Y6723	6331-PCN	FRU E54 Monitor- NH, BB, MPR-II US/Canada/Mexico
40Y6724	6331-FCN	FRU E54 Monitor- NH, PW, MPR-II South Korea
40Y6725	6331-PCN	FRU E54 Monitor- NH, BB, MPR-II South Korea
40Y6880	E54 FRU - Tilt/Swivel for 6331-xCx models --- --- PW WW	
40Y6881	E54 FRU - Tilt/Swivel for 6331-xCx models --- --- BB WW	