

IBM iLM300 微型便携式投影仪



用户指南

IBM iLM300 微型便携式投影仪



用户指南

注: 在使用本资料及其支持的产品之前, 请阅读第 41 页的附录 F, 『Warranty information』和第 51 页的附录 G, 『Notices』中的信息。

目录

安全: 请首先阅读	v
关于本书	vii
注册您的选件	vii
第 1 章 安装投影机	1
介绍	1
图像分辨率	1
兼容性	1
打开投影机包装	1
使用准则	3
安装投影机	4
将计算机与投影机连接	5
连接视频播放器	7
第 2 章 使用投影机	9
调整图像	9
调整图像焦点	9
使用投影机键区和遥控器	10
键区或遥控器	10
使用遥控器	11
向左 (L) 和向右 (R) 遥控按钮	11
向上 / 向下箭头按钮	11
使用屏幕菜单	12
浏览屏幕菜单	12
Basic 菜单	12
Setup 菜单	14
附录 A. 产品规格和附件	25
规格	25
附件	25
替换灯	25
附录 B. 维护和故障诊断	27
清洁镜头	27
更换投影灯	27
更换遥控器中的电池	29
故障诊断	30
添加安全性	31
附录 C. 便携式和移动式计算机的激活	33
附录 D. 使用视频镜像	37
使用 PowerBook 计算机的视频镜像	37
使用 Simulscan	37
附录 E. Projected image size	39
附录 F. Warranty information	41
Warranty period	41

Replacement lamps	41
Service and support	41
Warranty information on the World Wide Web	41
Online technical support	41
Telephone technical support	42
IBM Statement of Limited Warranty Z125-4753-06 8/2000	43
Part 1 - General Terms.	43
Part 2 - Country-unique Terms	45
附录 G. Notices	51
Trademarks.	52
Federal Communications Commission (FCC) statement	52

安全: 请首先阅读

Before installing this product, read the Safety Information

مج، يجب قراءة دات السلامة

Antes de instalar este produto, leia as Informações de Segurança.

在安装本产品之前，请仔细阅读 **Safety Information**
(安全信息)。

Prije instalacije ovog produkta obavezno pročitajte Sigurnosne Upute.

Před instalací tohoto produktu si přečtěte příručku bezpečnostních instrukcí.

Læs sikkerhedsforskrifterne, før du installerer dette produkt.

Ennen kuin asennat tämän tuotteen, lue turvaohjeet kohdasta Safety Information.

Avant d'installer ce produit, lisez les consignes de sécurité.

Vor der Installation dieses Produkts die Sicherheitshinweise lesen.

Πριν εγκαταστήσετε το προϊόν αυτό, διαβάστε τις πληροφορίες ασφάλειας
(safety information).

לפני שתתקינו מוצר זה, קראו את הוראות הבטיחות.

A termék telepítése előtt olvassa el a Biztonsági előírásokat!

Prima di installare questo prodotto, leggere le Informazioni sulla Sicurezza.

製品の設置の前に、安全情報をお読みください。

본 제품을 설치하기 전에 안전 정보를 읽으십시오.

Пред да се инсталира овој продукт, прочитајте информацијата за безбедност.

Lees voordat u dit product installeert eerst de veiligheidsvoorschriften.

Les sikkerhetsinformasjonen (Safety Information) før du installerer dette produktet.

Przed zainstalowaniem tego produktu, należy zapoznać się
z książką "Informacje dotyczące bezpieczeństwa" (Safety Information).

Antes de instalar este produto, leia as Informações sobre Segurança.

Перед установкой продукта прочтите инструкции по
технике безопасности.

Pred inštaláciou tohto zariadenia si pečítajte Bezpečnostné predpisy.

Pred namestitvijo tega proizvoda preberite Varnostne informacije.

Antes de instalar este producto lea la información de seguridad.

Läs säkerhetsinformationen innan du installerar den här produkten.

安裝本產品之前，請先閱讀「安全資訊」。

关于本书

本手册包含有关对 iLM300 IBM® 微型便携式投影仪进行安装、使用、维护和故障诊断的指示信息。

本指南包含以下语言的产品描述、安装和软件指示信息：

法语

德语

意大利语

西班牙语

巴西葡萄牙语

简体中文

繁体中文

附录包含产品规格、附件以及帮助和服务。附录还包含产品保证与声明。

注：本手册中的插图可能和您的机器略有差别。

第 1 章 安装投影仪

本章包含如何安装和使用投影仪的信息。

介绍

IBM® iLM300 微型便携式投影仪是为移动演示用户专门设计的。它使用数字光处理 (Digital Light Processing, DLP) 技术生成鲜明、清晰的图像, 并且具有体现其特色的 M1-DA 接口。此投影仪易于连接、使用、携带和维护。

图像分辨率

投影图像的 XGA 分辨率是 1024 x 768。投影仪可兼容高达 1280 x 1024 的屏幕分辨率。如果您的计算机屏幕分辨率高于 1280 x 1024, 请在连接投影仪之前将其重新设置为较低的分辨率。

注: 该投影仪自动将 640 x 480 和 800 x 600 的图像扩展为 1024 x 768。

兼容性

投影仪与多种计算机和视频设备兼容, 包括:

- IBM 兼容计算机 (包括移动式计算机), 其分辨率高达 1280 x 1024。
- Apple Macintosh 和 PowerBook 计算机, 其分辨率高达 1280 x 1024。
- 大多数标准 VCR、DVD 播放器、可携式摄像机和激光光盘播放器。

打开投影仪包装

警告

本产品包含一个含汞的金属弧光灯。请按照本地法令和法规的要求处理它。

以下插图中显示了随投影仪一起提供的物品。检查以确保包含所有的物品。如有任何物品缺少, 请与购买处联系。

如果您在安装演示系统方面有经验，请使用包含在此选件中的快速入门卡。有关连接和操作投影仪的完整详细信息，请参考 CD 上的《用户指南》。

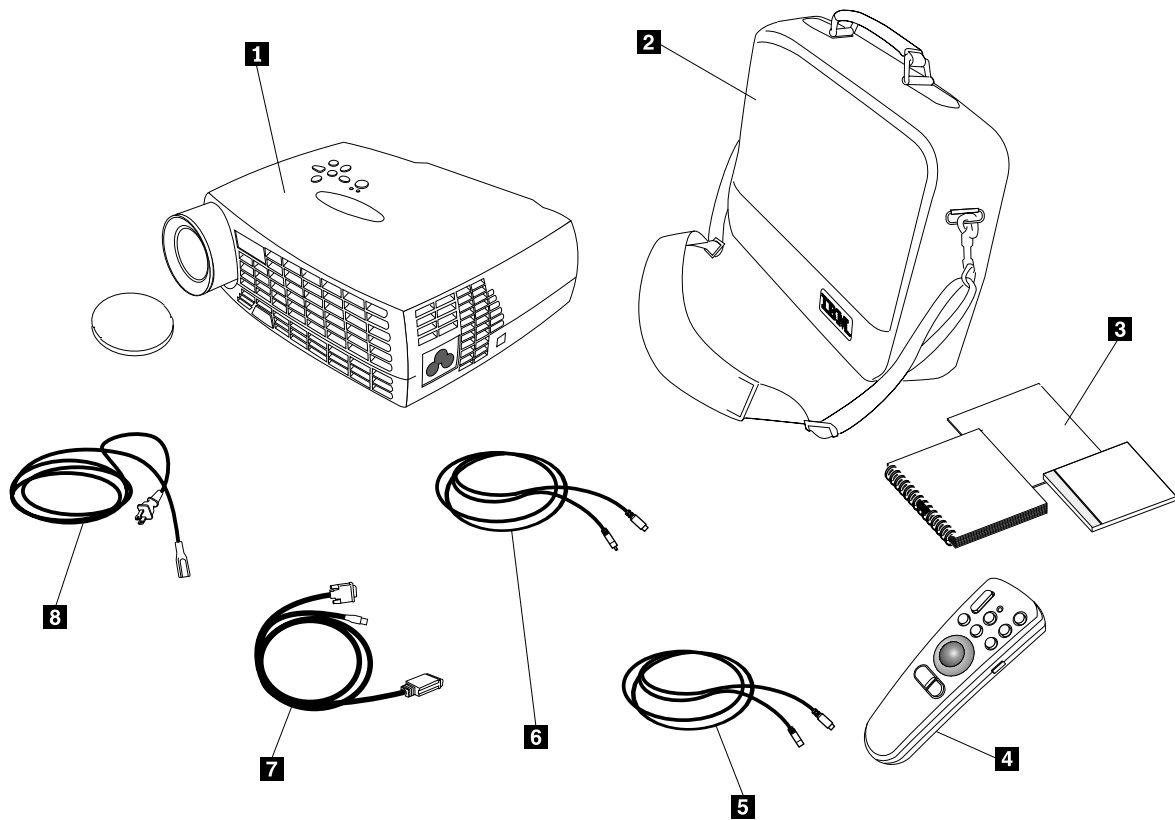

1 iL300 IBM 微型便携式投影仪和镜头盖

2 软背包

3 快速入门卡和多语言联机用户指南 CD

4 遥控器

5 S-Video 电缆

6 复合视频电缆

7 M1-DA 数据电缆（模拟转数字），包括 USB 鼠标

8 电源线

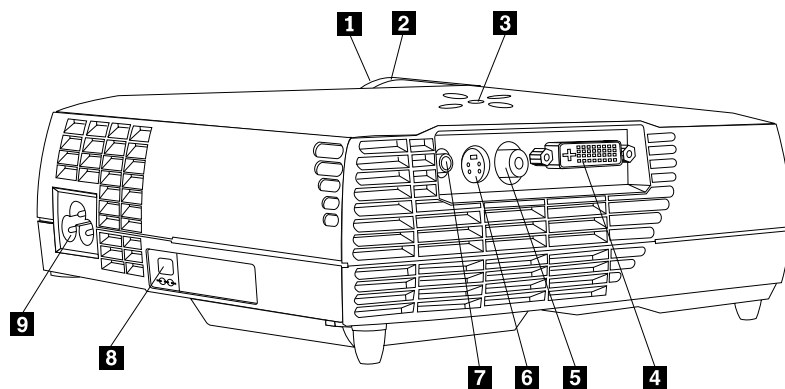

1 缩放环
2 聚焦环
3 键区

4 计算机接口
5 视频
6 S-Video

7 音频输入
8 安全锁
9 电源线

使用准则

使用投影仪时，请遵守以下准则。

警告:

开灯时，不要直视投影镜头。明亮的灯光可能会刺伤您的眼睛。

警告:

使用投影仪时，请遵守以下准则。

- 不要阻塞投影仪上的格栅。限制气流可能使投影仪过热而关闭。如果发生这种情况，必须在再次尝试启动投影仪之前等待一分钟。
- 像处理任何其它带有玻璃组件的产品一样处理投影仪。一定要特别小心，不要将它跌落。
- 避免长时间地将投影仪放在阳光直射处或极冷的地方。如果发生这种情况，请使它达到室温后再使用。
- 将投影仪放在背包中进行携带。请参阅附录 A 中的『附件』，以获取有关订购适用于您的投影仪的背包和其它附件的信息。

安装投影仪

在打开投影仪之前，请确保已进行了所有连接。请使用以下过程来安装投影仪：

1. 将投影仪放在平坦的表面上。
 - 投影仪必须位于距离电源 3 米（10 英尺）、距离计算机 1.8 米（6 英尺）的范围之内。
 - 如果希望从半透明屏幕后投影，请将投影仪安装在屏幕后。有关反转图像的指示信息，请参阅第 18 页的『System 菜单』中有关 Rear 投影的指示信息。
2. 在距屏幕的期望距离处放置投影仪。
 - 如果图像过大或过小，请设置缩放环以调整大小或向前或向后移动投影仪。进行了本节中描述的所有连接后，便可以进行调整。以下插图显示投影图像的三种大小。有关图像大小的更多信息，请参阅第 39 页的附录 E，『Projected image size』。

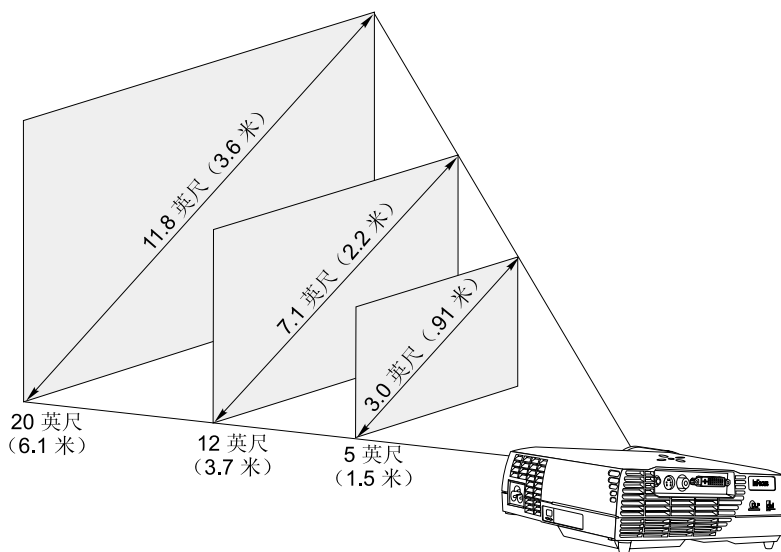

3. 确保投影仪已断开电源并且计算机已关闭。



危险

电源、电话和通信电缆中的电流是有危险的。

要避免电击危险:

- 不要在雷电期间连接（或断开连接）任何电缆或执行本产品的安装、维护或重新配置。
- 将所有电源线连接到正确接线的插座上。
- 将任何要连接到本产品上的设备连接到正确接线的插座上。
- 如果可能，请仅使用单手连接（或断开连接）信号电缆。
- 在有火、水或结构损坏迹象时，切勿打开任何设备。
- 在打开设备外盖之前，断开连接所连接的电源线、电信系统、网络和调制解调器，除非在安装和配置过程中得到另外的指示。
- 在安装、移动或打开本产品或所连接设备的外盖时，请按下表所述连接和断开连接电缆。

要进行连接:

1. 关闭所有设备。
2. 首先，将所有电缆与设备连接。
3. 将信号电缆与接口连接。
4. 将电源线与插座连接。
5. 打开设备。

要断开连接:

1. 关闭所有设备。
2. 首先，从插座中拔出电源线。
3. 从接口中拔出信号电缆。
4. 从设备上拔出所有电缆。

注: 如果要将投影仪与计算机连接，请确保计算机和投影仪之间的距离为 6 英尺或更小。

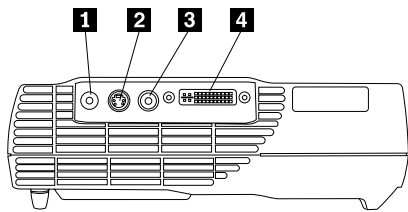

1 音频输入

2 S-Video

3 视频

4 计算机 / USB 鼠标

将计算机与投影仪连接

随投影仪一起提供了一根计算机电缆。如果您的计算机具有数字输出端口，则可以使用另行出售的可选数字计算机电缆。请参阅第 25 页的『附件』以获取订购信息。

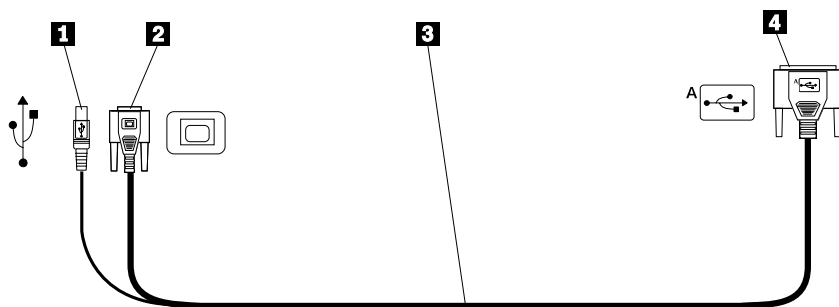

1 至 USB 鼠标

2 至计算机视频

3 至投影仪

4 模拟计算机电缆

1. 将计算机电缆的单个接头的一端插入投影仪上的接口中，如下图所示。
2. 将计算机电缆另一端的蓝色接头插入计算机上的视频接口中。
3. 如果要使用遥控器在 PowerPoint™ 演示中向前移动幻灯片，请将 USB 电缆插入计算机上的 USB 鼠标接口中。

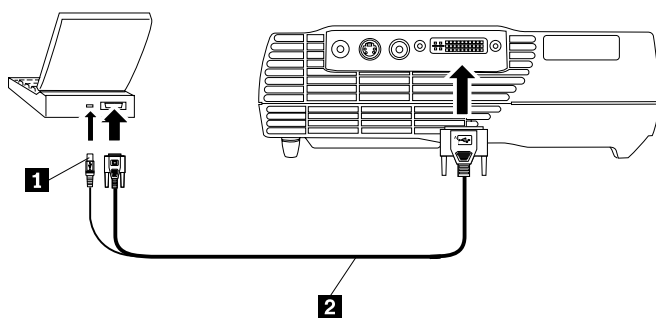

1 USB 鼠标

2 计算机电缆

注:

1. 当连接第二显示设备（例如投影仪）时，许多移动式计算机不会自动打开它们的外部视频端口。有关激活外部视频端口的命令，请参阅计算机手册。按下 IBM ThinkPad® 上的 Fn+F7 以激活外接显示器。请参阅第 33 页的附录 C，『便携式和移动式计算机的激活』中列出用于选择的移动式计算机的激活命令的图表。

2. 如果要连接投影仪与不具有 15 针接口的早期的 Macintosh 计算机连接，则必须在计算机和投影仪之间使用 Macintosh 适配器。
3. USB 鼠标仅在与 Microsoft® Windows® 98、Microsoft Windows 2000 Professional 和 Apple OS 9.0 以及后续版本一起使用时才受支持。
4. 连接 USB 鼠标后，无须重新启动计算机。

有关启动投影仪和计算机的信息，请转至第 7 页的『启动投影仪并调整图像』。

连接视频播放器

请使用以下过程来连接视频播放器。

- 如果您的视频播放器使用一个圆形、单插针复合视频接口，请使用复合视频电缆。
- 如果您的视频播放器使用一个圆形、四插针 S-Video 接口，请使用 S-Video 电缆。S-Video 生成质量较高的图像。

警告： 您的视频播放器可能还具有一个用于同轴电缆连接的“视频输出”接口。“不要”使用此接口与投影仪连接。

1. 将黄色复合视频电缆接头连接到视频播放器上的“视频输出”接口中。此接口可能标有 To Monitor。如果要使用 S-Video 电缆，请将圆形黑色接头与视频播放器上的“视频输出”接口连接。
2. 将圆形黄色接头连接到投影仪上的“复合视频”接口中。

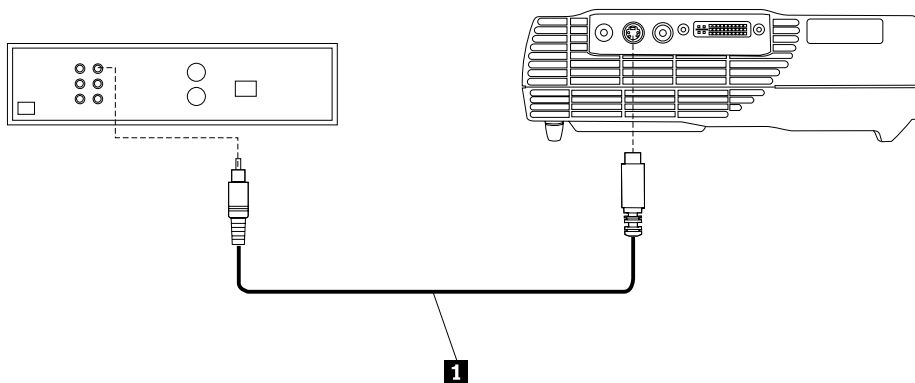

1 S-Video 电缆

投影仪兼容这些主要的广播视频标准：NTSC、NTSC 4.43、PAL、PAL-M、PAL-N、PAL-60 和 SECAM。它对进入的视频进行自动调整以优化其性能。



危险

电源、电话和通信电缆中的电流是有危险的。

要避免电击危险:

- 不要在雷电期间连接（或断开连接）任何电缆或执行本产品的安装、维护或重新配置。
- 将所有电源线连接到正确接线的电气插座上。
- 将任何要连接到本产品上的设备连接到正确接线的插座上。
- 如果可能，请仅使用单手连接（或断开连接）信号电缆。
- 在有火、水或结构损坏迹象时，切勿打开任何设备。
- 在打开设备盖之前，断开连接所连接的电源线、电信系统、网络和调制解调器，除非在安装和配置过程中得到另外的指示。
- 在安装、移动或打开在本产品或所连接设备的外盖时，请按下表中所述连接和断开连接电缆。

要进行连接:

1. 关闭所有设备。
2. 首先，将所有电缆与设备连接。
3. 将信号电缆与接口连接。
4. 将电源线与插座连接。
5. 打开设备。

要断开连接:

1. 关闭所有设备。
2. 首先，从插座中拔出电源线。
3. 从接口中拔出信号电缆。
4. 从设备上拔出所有电缆。

启动投影仪并调整图像

请使用以下过程来启动投影仪并调整图像。

1. 卸下镜头盖。
2. 将电源线连接到投影仪的侧面，然后将它插入电气插座中。使用带有浪涌保护的电源板是一种好的做法。请始终使用随投影仪一起提供的电源线。

注：对于某些计算机，启动设备的顺序非常重要。大多数计算机应该在所有其它外围设备打开后最后打开。请参考计算机文档以确定顺序。

3. 按下投影仪顶部的电源按钮。风扇开始运转，投影仪顶部的 LED 发出绿色的光，直到显示启动屏幕。图像达到最大亮度大约花费一分钟。
4. 如连接了视频播放器，将它打开。
 - 视频图像显示在投影屏幕上。如果没有显示，请按下键区上的 **Select** 按钮或遥控器上的 **Video** 按钮以显示视频图像。
5. 打开计算机。

注：第一次将计算机连接到投影仪时，计算机可能显示一条表明找到新硬件的消息。“添加新硬件向导”窗口可能会打开。使用该向导以安装适用于“即插即用”监视器的正确的设备驱动程序。

- 计算机图像显示在投影屏幕上。如果没有显示，请按下键区上的 **Select** 按钮或遥控器上的 **Computer** 按钮以显示计算机图像。
- 请确保您的移动式计算机外部视频端口是活动的；请参阅第 33 页的附录 C，『便携式和移动式计算机的激活』以获取详细信息。
- 必要的话，请使用投影仪屏幕菜单对图像进行调整。要显示菜单，请按下键区或遥控器上的 **Menu** 按钮。有关菜单的更多信息，请参阅第 12 页的『使用屏幕菜单』。

关闭投影仪

要关闭投影仪，请按下电源按钮。如果想让灯回到打开状态，请允许灯冷却 90 秒钟。如果灯过热，将不会打开。

注：要尽可能延长灯的寿命，请在拔出电源线之前，允许投影仪风扇至少运转五分钟。

第 2 章 使用投影机

本章描述了如何使用投影机以及如何对投影机进行调整。它还提供了有关键区、遥控器按钮和屏幕菜单中的可用选项的参考信息。

调整图像

要调整图像，请执行以下操作：

- 确保已按正确顺序打开了您的设备。请参阅第 7 页的『启动投影机并调整图像』。
- 如果图像没有完全显示，请缩放图像，调整投影机的高度，或通过调整图像的水平或垂直位置使图像居中。确保投影机和屏幕成 90 度角。
- 如果图像不符合投影区域，或者不够方正，请使用投影机顶部的 Keystone 按钮。还可以参阅第 12 页的『Basic 菜单』下的梯形失真功能。
- 如果图像在焦点之外，请旋转聚焦镜头，如下所示。
- 如果颜色显示不正确，请调整亮度、对比度、色调或颜色。请参阅第 14 页的『Setup 菜单』。

调整图像焦点

要使图像聚焦，请旋转下图中的聚焦环 **1**，直到图像清晰。要调整图像大小，请旋转缩放环 **2**。

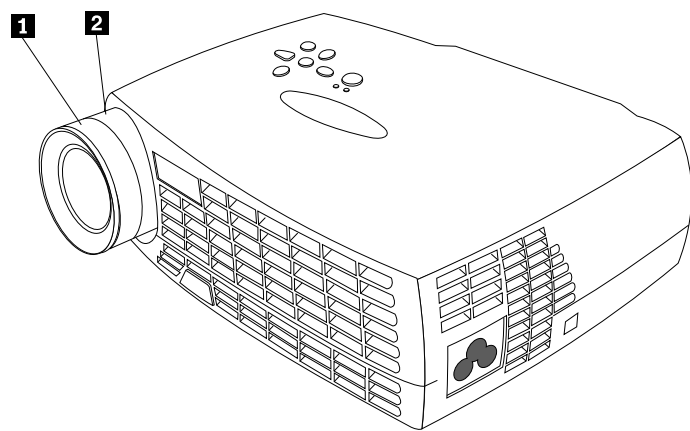

注： 要获得最佳的总体聚焦质量，请打开菜单并聚焦文本。对文本聚焦将确保最佳的总体图像质量。请参阅第 12 页的『浏览屏幕菜单』以获取有关打开菜单的信息。

投影机配有自锁定、快速释放的升降器底座和按钮。要提升投影机：

1. 请按住升降器按钮 **1**。
2. 将投影机提升到希望的高度，然后释放按钮以将升降器底座 **2** 锁定到位。

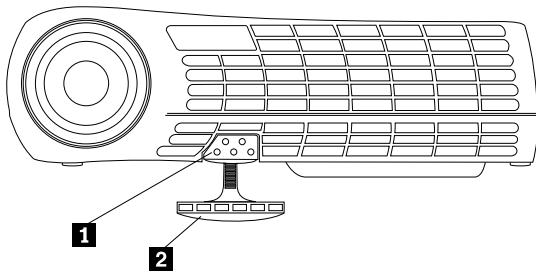

使用投影机键区和遥控器

在投影机键区（左下方）和遥控器（右下方）上，使用 **Menu** 按钮以显示屏幕菜单。使用投影机键区上的 **Select** 按钮或遥控器上的 **Computer** 和 **Video** 按钮（在右下方），以在连接到投影机的设备之间选择。请参阅第 12 页的『使用屏幕菜单』以获取详细信息。

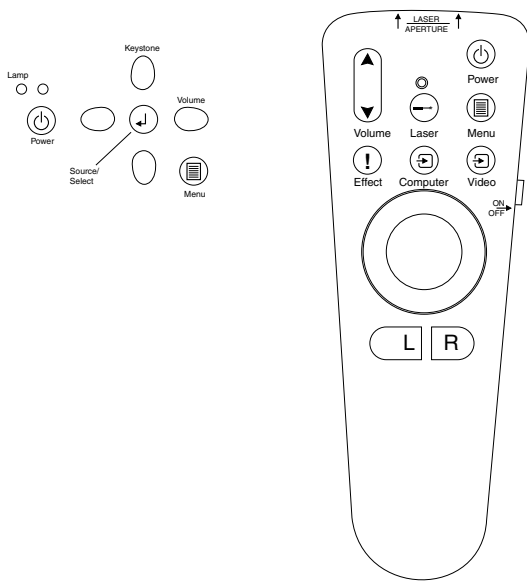

键区或遥控器

如果有不止一个连接到投影机的图像源，请通过以下操作在它们之间选择：

- 按下键区上的 **Select** 按钮
- 按下遥控器上的 **Computer** 或 **Video** 按钮
- 使用屏幕菜单中的 **SourceSearch** 功能以自动检测连接的源的种类。请参阅第 18 页的“SourceSearch”。

注： 如果 **SourceSearch** 功能不是激活的，而您有多个连接到投影机的设备，则可能需要按下 **Select** 按钮不止一次以查找活动的源。如果正在使用 **Select** 按钮，则源将以此顺序循环：数据模拟、数据数字、S-Video 和复合视频。

使用遥控器

请使用遥控器上的 **L** 和 **R** 按钮以在演示中向前移动幻灯片。将投影仪计算机电缆上的 USB 鼠标接口连接到计算机上。请参阅第 5 页的『将计算机与投影仪连接』以获取详细信息。

将遥控器指向投影屏幕或投影仪（而不是计算机）的正面。最佳操作范围大约为 7.6 米（25 英尺）。如果将遥控器指向投影屏幕，而它到屏幕又回到投影仪的距离必须小于或等于 7.6 米（25 英尺）或更小。为了获得最佳效果，请将遥控器直接指向投影仪。

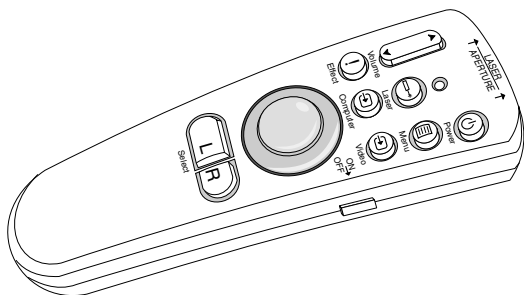

按下红色的 Laser 按钮以使用遥控器正面的激光指示器。使用激光指示器来强调演示的要点。

向左（L）和向右（R）遥控按钮

这些按钮的功能类似与计算机键盘上的向上翻页和向下翻页按钮。可以使用它们在幻灯片放映中前进和后退。要使用此功能，请将计算机电缆上的 USB 鼠标接口连接到计算机。请参阅第 5 页的『将计算机与投影仪连接』。

向上 / 向下箭头按钮

使用这些按钮以浏览屏幕菜单和对屏幕菜单进行调整。请参阅第 12 页的『使用屏幕菜单』。

使用屏幕菜单

投影机具有屏幕菜单，可以从这些菜单上调整和更改不可从键区上直接使用的各种设置。

浏览屏幕菜单

使用屏幕菜单时，适用以下约定：

- 按下遥控器上或投影机键区上的 **Menu** 按钮，以打开屏幕菜单。
- 使用遥控上的轨迹球以及键区和遥控器上的箭头按钮以浏览菜单。
- 通过按下遥控器上的 **L/Select** 按钮来选择菜单选项。

注：某些菜单项可能是不可用的（无效）。这表示该项不适用，或在进行另一项选择之前不启用。

- 再次按下 **Menu** 以关闭菜单。

注：如果没有活动，则菜单将在 30 秒钟后自动关闭。

您进行的任何设置更改都将被保存。在关闭并重新启动投影机之前，某些更改（例如定制徽标）不会变为活动的。

要打开屏幕菜单，请按下键区或遥控器上的 **Menu** 按钮。第一个菜单是 **Basic** 菜单。按下向下箭头按钮以将光标向下移动，按下向上箭头按钮以将光标向上移动。选择的菜单选项会突出显示。



使用箭头按钮以调整设置或打开和关闭设置。完成操作时按下 **L/Select** 按钮。按下向上和向下箭头以移到另一个设置。当调整完成时，导航到退出箭头，然后按下 **L/Select**。返回到先前的菜单。按下 **Menu** 以退出菜单系统，或导航到另一个子菜单。

以下各节提供菜单概述。

Basic 菜单

从 **Basic** 菜单，可以进行对比度、亮度、颜色、梯形失真和复位设置的更改。还可以访问 **Setup** 菜单。

Contrast

在值 0 - 100 中调整对比度（明暗比）。

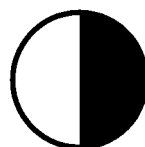

Brightness

在值 0 - 100 中调整图像的常规亮度。

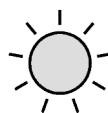

Color

在值 0 - 100 中调整颜色强度。

Keystone

调整图像的角度以获得方形图像，或使图像符合投影区域。

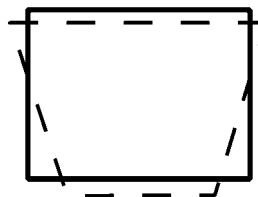

要直接访问梯形失真校正，只要按下投影机键区上的向左和向右箭头，而无须进入屏幕菜单。使用投影机键区上的向上和向下箭头以在值 -63 到 +64 之间调整图像角度。



Keystone



按下 ↑ 按钮以缩减图像上部 **1**，按下 Keystone ↓ 按钮以缩减下部 **2**。

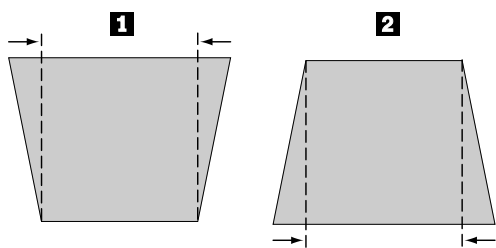

Setup

使用 Setup 选项以访问有关图片质量、菜单语言、图像效果和服务的其它菜单。请参阅『Setup 菜单』。



Reset

使用 Reset 选项以对当前连接的源设备同步设置。



About

使用此选项以获取有关当前使用的功能的信息。



Setup 菜单

要访问 Setup 菜单，请按下 Menu 按钮以显示 Basic 菜单。按下向下箭头以突出显示 Setup，然后按下 Select 以打开 Setup 菜单。

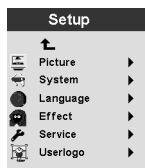

Picture、System、Language、Effect 和 Service 都有子菜单。以下各节说明 Setup 菜单选项。

Picture

使用 Picture 选项以显示 Screen Aspect、Color Temp、Sharpness、Application、ARLS、Tune、Width、Position 和 Tint 的选项菜单。

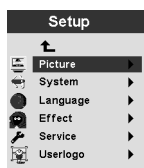

有关 Picture 菜单的更多信息，请参阅第 16 页的『Picture 菜单』。

系统

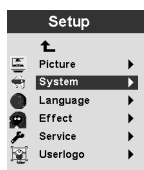

有关 System 菜单的更多信息，请参阅第 18 页的『System 菜单』。

Language



有关 Language 菜单的更多信息，请参阅第 19 页的『Language 菜单』。

Effect



有关 Effect 菜单的更多信息，请参阅第 19 页的『Effect 菜单』。

Service



有关 Service 菜单的更多信息，请参阅第 20 页的『Service 菜单』。

Userlogo



有关 Userlogo 菜单的更多信息，请参阅第 21 页的『User's Logo 菜单』。

Picture 菜单

以下部分说明了 Picture 菜单中的菜单项。

Screen Aspect

选择横纵比。缺省设置为 4:3。

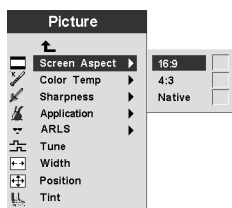

Color Temp

更改投影的颜色的强度。缺省值为 7300 Kelvin.

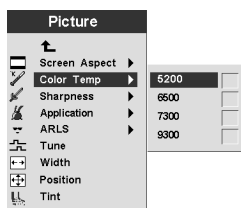

Sharpness

设置视频图像的清晰度和透明度。缺省值设置为 Sharpest.

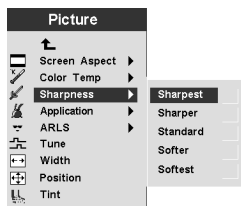

Application

从 Normal、Home theatre 和 Photograph 中设置显示的信息的来源。

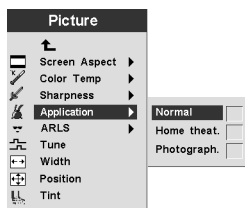

ARLS

使用室内自动光感测（ARLS）可以调整图像设置以补偿室内环境光线的级别。

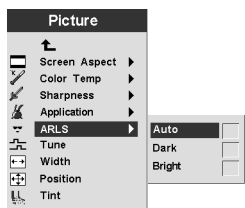

Tune

对计算机模拟图像进行微调。

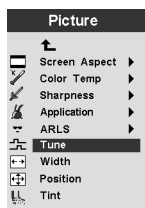

Width

调整计算机模拟图像宽度。

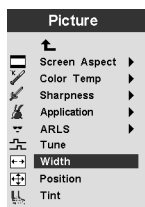

Position

使用遥控器上的轨迹球或键区上的箭头键以调整屏幕上投影的图像的放置。

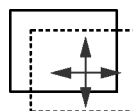
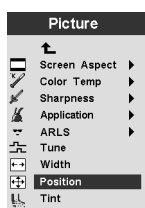

Tint

色调调整所投影的图像中红绿色的平衡。

注：Tint 选项仅可用于视频（NTSC）方式。

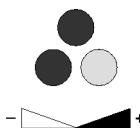
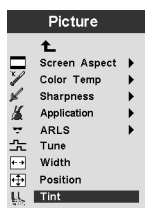

System 菜单

从 Basic 菜单中，选择 **Setup** → **System** 以显示 System 菜单。



Rear

如果要将图像投影到透明投影屏幕的背面，请选择 **Rear**。该设置使图像反转，这样从正面看图像将是清晰可辨的。

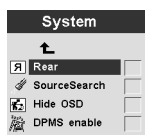

SourceSearch

选择 SourceSearch 以自动让投影仪确定当前图像的源。再次选择 SourceSearch，关闭该自动功能。

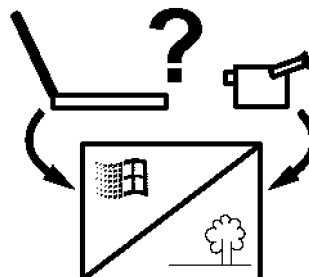

Hide OSD

选择 Hide OSD 以启用 / 禁用屏幕显示。

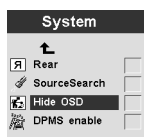

DPMS enable

选择该功能以启用 / 禁用显示投影机电源管理设置。

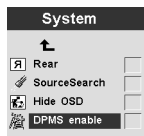

Language 菜单

从 Basic 菜单中，选择 **Setup** → **Language**。导航到您选择的语言。投影机屏幕菜单将以该语言显示。



Effect 菜单

使用该菜单中的一项对遥控器上的 Effect 按钮进行编程。

从 Basic 菜单中，选择 **Setup** → **Effect**。选择您要最频繁使用的功能。可以随时返回该菜单，并为 Effect 按钮选择另一项。

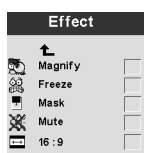

Magnify

要通过放大图像来强调所显示图像的一部分，请选择 Magnify。

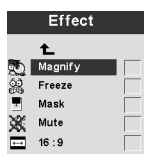

Freeze

要在某个特殊点（包括所有动画）停止演示，请选择 Freeze。

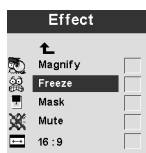

Mask

要隐藏或显示所显示图像的一部分，请选择 Mask。使用遥控轨迹球将 Mask 移到图像上。

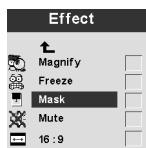

Mute

要使用遥控 Effect 按钮以关闭声音，请选择 Mute。

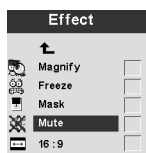

16:9

如果在同一个演示中改变了屏幕大小，该项是有用的。使用 Effect 按钮，选择 16:9 以激活 16:9 的比率。

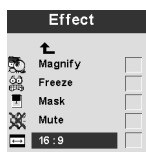

Service 菜单

使用该菜单上的选项以执行维护功能。Service Code 是仅为训练有素的技术人员而保留的。

从 Basic 菜单中，选择 **Setup** → **Service**。

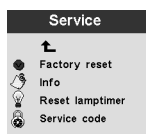

Factory Reset

使用 **Factory Reset** 以自动将所有设置返回到出厂缺省值。

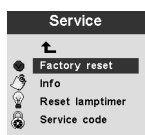

Info

选择 **Info** 以显示有关投影机设置的进一步信息。

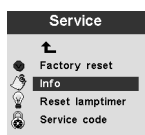

Reset Lamptimer

当更换投影机灯时，请选择该选项。灯定时器显示灯已使用的小时数。请参阅第 27 页的『更换投影灯』。

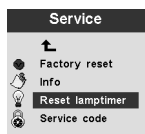

Service Code

此菜单项仅适用于训练有素的服务人员。如果显示了数字代码，请将该数字报告给服务技术人员。

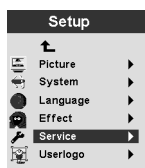

User's Logo 菜单

使用该菜单中的项以确定打开灯时以及没有连接源时投影机显示的徽标。还可以选择该选项以使投影机显示您自己的徽标。

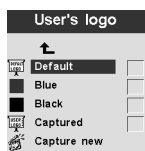

Default

Default 为投影机徽标屏幕。

Blue 和 Black

选择 Blue 或 Black 以在没有连接源时让投影仪显示纯背景。

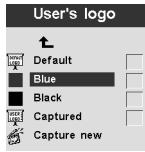
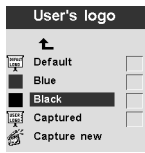

Captured

选择该项后，投影仪将显示您自己已做好的徽标。

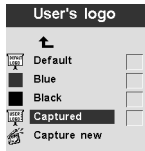

Capture new

选择该项以定义新的徽标。请参阅以下指示信息，以获取新的徽标。

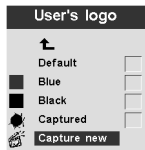

Capture New: 要定义新的徽标，请执行以下操作：

1. 当显示您希望使用的图像时，按下 Menu 按钮。
2. 选择 Basic → Setup → User's Logo → Capture New

3. 使用遥控轨迹球以选择要捕获的区域。

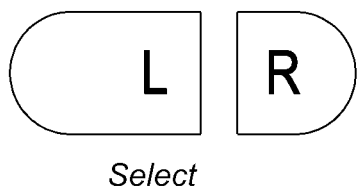
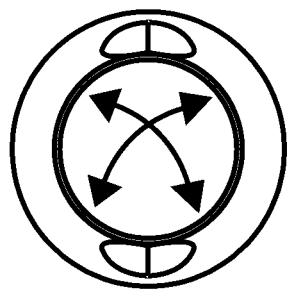

4. 要增加或减小捕获区域的大小，请使用遥控器或键区上的 **Volume** 按钮。向上箭头 ↑ 增加捕获区域，底部的向下箭头 ↓ 减小捕获区域。

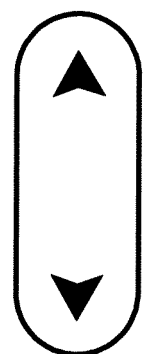

Volume

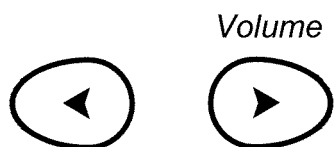

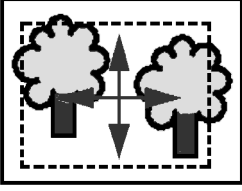

5. 按下遥控器上的 **L/Select** 以进行确认。检查以确认图像捕获是成功的。
6. 关闭并重新启动投影仪以使用为您的徽标新创建的图像。

附录 A. 产品规格和附件

本附录列出了投影仪的规格。

规格

iL300 投影仪必须在指定的温度和湿度范围内运行和存储。

温度

运行时	在海平面处, 50 到 95° F (10 到 35° C) 在 10,000 英尺处, 50 到 77° F (10 到 25° C)
非运行时	-4 到 158° F (-20 到 70° C)

海拔高度

运行时	0 到 10 000 英尺 (3 048 米)
非运行时	0 到 20 000 英尺 (6 096 米)

湿度

运行时和非运行时	10% 到 95% 相对湿度, 非冷凝
----------	---------------------

尺寸

6.06 x 7.83 x 2.48 英寸 (15.4 x 19.9 x 6.3 厘米)

重量

2.4 磅 (1.1 千克) 散装

光学特性

聚焦范围	4.9 - 32.8 英尺 (1.5 - 10 米)
------	----------------------------

灯

类型	120 瓦 UHP 灯
----	-------------

输入电源需求

100-120VAC 2A; 50/60Hz 200-240VAC 1A; 50Hz

附件

您的投影仪有很多可用的附件, 并且会经常添加新的附件。请访问 **IBM Web 站点** <http://www.pc.ibm.com/us/accessories/projectors/index.html> 并从许多附件中选择适用于为您的投影仪的附件。

替换灯

如果您的投影仪灯在保证范围之内, 则请参阅第 42 页的『Telephone technical support』, 以获取有关联系 IBM 并要求获得新投影仪灯的信息。

要获取所有其它的替换灯, 请从 **IBM Web 站点** 订购新投影仪灯:
<http://www.pc.ibm.com/us/accessories/projectors/index.html>

附录 B. 维护和故障诊断

本节描述如何:

- 清洁镜头
- 更换投影灯
- 更换遥控器中的电池
- 使用安全性锁定功能
- 投影仪的故障诊断

清洁镜头

请按照以下步骤以清洁投影镜头:

1. 在一块柔软的干布上涂上非磨蚀性的照相机镜头清洁剂。
 - 避免使用过量的清洁剂, 并且不要将清洁剂直接涂在镜头上。
 - 磨蚀性的清洁剂、溶剂或其它粗糙的化学制品可能擦伤镜头。
2. 以圆周运动用清洁布在镜头上轻轻擦拭。
3. 如果不打算立刻使用投影仪, 请更换镜头盖。

更换投影灯

警告:

为避免灼伤, 请在打开灯之前, 允许投影仪冷却至少 60 分钟。在投影仪运行时, 切勿拔出灯模块。



注意:

以下标签表示附近有灼热表面。



屏幕上的 Service 菜单中的 Lamptimer 对灯已经使用的小时数进行计数。请参阅第 20 页的『Service 菜单』中的 Lamptimer。请定期查看 Lamptimer 以弄清楚灯已耗用了多长时间。当屏幕的左下角出现 Change Lamp 警告时, 请更换灯。请参阅第 41 页的『Replacement lamps』以获取订购信息。

要执行此过程, 请将投影仪底部朝上放在平坦、干净的表面(如桌子)上。要更换投影灯, 请执行以下操作:

1. 关闭投影仪, 并将电源线从投影仪和电气插座中拔出。

2. 等待 60 分钟，让投影仪彻底冷却。
3. 在平坦、干净的表面上操作，翻转投影仪，使其底部面向您。使用螺丝刀拧松罩住它们的灯，轻轻打开灯罩边沿。

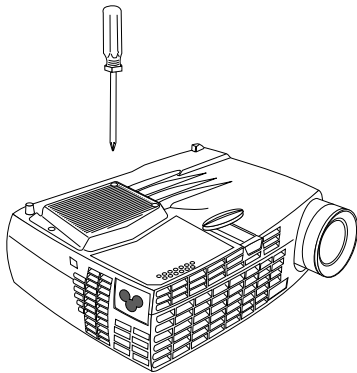

4. 小心卸下灯罩，并以合乎环境要求的正确方式处理它。

警告:

此产品包含一个含汞（一种腐蚀性物质）的金属弧光灯。请按照本地法令和法规的要求处理它。

警告:

卸下灯模块时一定要特别小心。如果灯泡意外破裂，可能会产生小的玻璃碎片。灯模块设计为可以容纳这些碎片，但是卸下灯模块时仍需谨慎。

警告:

不要跌落灯模块或触摸玻璃灯泡。玻璃可能打碎从而导致伤害。您手上的油脂会缩短灯泡的寿命。

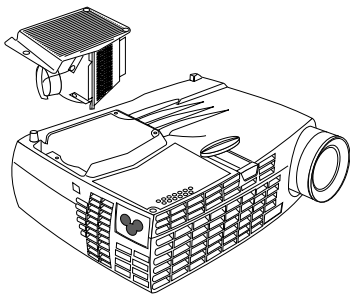

5. 插入新的灯罩。将灯罩轻轻按回恰当的位置。
6. 拧紧螺丝。使投影仪回到垂直位置。
7. 将电源线连接到投影仪背面和电气插座上。按下投影仪顶部的电源按钮来打开投影仪。
8. 要复位灯定时器计数器，请参阅第 21 页的“Reset Lamptimer”以获取详细信息。

更换遥控器中的电池

电池的寿命取决于您使用遥控器的频率和时长。低电池电荷的症状包括使用遥控器时的不稳定响应以及操作范围的减小。

请按照下列步骤以更换电池：

1. 将遥控器面向下握在手中。
2. 朝遥控器后部按电池盖上的卡口，并将盖滑出。
3. 将旧电池卸下，并以合乎环境要求的正确方式处理它们。
4. 安装两个新的 AAA 碱性电池。确保按正确方向安装每节电池。
5. 将电池盖滑到正确、锁定的位置。

故障诊断

问题: 投影仪不运行。

- 确保电源线与全功能交流电气插座正确连接。确保电源线也与投影仪正确连接。
- 如果投影仪已插入电源板, 请确保已打开电源板。
- 确保已打开投影仪。

问题: 投影仪在运行, 但是投影屏幕上未显示任何内容。

- 确保已卸下位于投影仪正面的投影镜头上的镜头盖。
- 检查投影仪灯, 确保它已安全连接在灯模块中。请参阅第 27 页的『更换投影灯』。

问题: 只显示启动屏幕。

- 验证已正确连接了电缆。有关连接过程, 请参阅第 5 页的『将计算机与投影仪连接』。
- 确保电缆不带有任何曲针。
- 验证已连接了正确的输入源。请参阅第 18 页的“SourceSearch”以将投影仪设置为自动检测正在使用的设备的类型。
- 可能需要关闭所有设备, 然后再按正确的顺序打开所有设备。请参考计算机文档以确定正确的顺序。
- 确保计算机外部视频端口是活动的。请参阅第 33 页的附录 C, 『便携式和移动式计算机的激活』以获取某些常规键盘命令, 或参阅您的计算机手册以获取详细信息。
- 确保计算机视频适配器已正确安装和配置。
- 确保计算机具有一个兼容的视频适配器。此投影仪与 CGA 或 EGA 不兼容。

如果使用的是 Windows 98:

1. 单击**我的电脑** → **控制面板** → **显示**。
2. 单击**设置**选项卡。
3. 验证桌面分辨率设置为 **1280 x1024** 或更低。

问题: 投影屏幕上颜色或文本不可见。

尝试调整亮度或对比度, 直到文本可见。要调整亮度或对比度, 请参阅第 12 页的『Basic 菜单』以获取更多信息。

问题: 屏幕分辨率不正确。

- 确保计算机视频适配器设置的分辨率不超过 1280 x 1024。

问题: 图像不在屏幕中央。

- 移动投影仪以改变图像的位置。
- 使用菜单改变图像的位置。请参阅第 9 页的『调整图像』。
- 确保投影仪和屏幕成 90 度角。

问题: 对于屏幕来说, 图像过宽或过窄。

- 调整缩放或投影仪放置。
- 如果视频适配器的分辨率超过 1280 x 1024, 请进行调整。
- 使用投影仪键区上的 Keystone 按钮, 或 Basic 屏幕菜单上的 Keystone 选项来调整所投影图像的角度。

问题: 图像不在焦点上。

- 转动聚焦环将图像集中到焦点。
- 确保投影屏幕距离投影仪至少 1.5 米 (5 英尺)。
- 检查投影镜头, 看是否需要清洁。

问题: 图像和菜单左右反转。

- 可能激活了 Rear 投影方式。关闭 Rear 投影。请参阅第 18 页的“Rear”。

问题: 图像有条纹。

- 请执行出厂复位。请参阅第 20 页的『Service 菜单』。

问题: 投影的颜色与计算机或视频播放器的颜色不匹配。

就像不同监视器在显示上的差别一样, 计算机图像和投影的图像之间经常存在差别。请通过在屏幕上的 Picture 菜单调整亮度、色调和对比度。请参阅第 16 页的『Picture 菜单』。

问题: 灯看起来正在变得更暗淡。

灯经过长时间使用后, 亮度减弱。请使用第 27 页的『更换投影灯』中所述的更换灯的内容来检查灯定时器。

问题: 灯关闭。

- 微小的功率波动便可能导致灯关闭。请断开连接投影仪, 至少等待一分钟, 然后重新连接投影仪。
- 投影仪过热。请确保投影仪通风孔未受阻。打开风扇, 让投影仪冷却五分钟, 然后再次打开灯。

添加安全性

将安全性接口与单独提供的环形电缆一起使用。有关订购信息, 请访问万维网的 <http://www.compu-lock.com>。

对于投影仪安全性接口的位置, 请参阅开始于第 1 页的『打开投影仪包装』的详细的投影仪插图。请参考随电缆提供的信息, 以获取有关如何将电缆固定到投影仪的指示信息。

注: 连接电缆时, 不能卸下灯。

附录 C. 便携式和移动式计算机的激活

当与投影仪连接时，许多移动式计算机不会自动打开它们的外部视频端口。下表中列出了某些移动式计算机的激活命令。（如果您的计算机未列出或给定的命令不工作，请参考计算机文档以获取适当的命令。）在许多移动式计算机上，激活功能键标记为 CRT/LCD 或用一个图标进行标记，如：



注：请访问 <http://www.infocus.com/> 以获取最新的激活图表。它位于 Service and Support 链接中。

注：通常，按一次键命令激活外部视频端口，再按一次激活外部端口和内部端口，按第三次激活内部端口。请参考计算机文档，以获取有关特定型号的详细信息。

计算机	激活端口的键命令	取消激活端口的键命令
Acer	Ctrl+Alt+Esc（对于设置）	Ctrl+Alt+Esc（对于设置）
AST* **	FN+D 或 Ctrl+D Ctrl+FN+D FN+F5 从 A:\IVGA\CRT 输入 FN+F12	FN+D 或 Ctrl+D Ctrl+FN+D FN+F5 从 A:\IVGACRT 输入 FN+F12
AMS	FN+F2	FN+F2
AMT	设置屏幕	设置屏幕
AT&T	FN+F3 FN+F6	FN+F3 F+-F6
Advanced Logic Research	Ctrl+Alt+V	Ctrl+Alt+V
Altima	Shift-Ctrl-Alt-C 设置 VGA/Conf.Simulscan	Shift-Ctrl-Alt-L 设置 VGA/Conf.Simulscan
Ambra**	FN-F12 FN-F5 F2 / 选择选项 / F5	FN-F12 FN-F5 F2 / 选择选项 / F5
Amrel* **	设置菜单 Shift-Ctrl-D	设置菜单 Shift-Ctrl-D
Apple	请参阅 Mac Portable 和 Mac PowerBook	
Aspen	自动	自动
Award	FN-F6	FN-F6
BCC*	自动	重新引导计算机
Bondwell	引导后的 LCD 或 CRT 选项	重新引导以出现 LCD 或 CRT 选项
Chaplet**	设置屏幕 FN-F6 FN-F4	设置屏幕 FN-F6 FN-F4
Chembook	FN-F6	FN-F6
Commax	Ctrl-Alt-#6	Ctrl-Alt-#5
Compaq* **	Ctrl-Alt-< FN-F4 自动 方式 / ?（对于设置选项）	Ctrl-Alt-> FN-F4 自动 方式 / ?（对于设置选项）
Compuadd* **	自动 Alt-F 对于屏幕设置选项	自动 Alt-F 对于屏幕设置选项
Data General	Ctrl-Alt-Command	Ctrl-Alt-Command
Data General Walkabout	DOS 提示符下的 2 CRT/X	重新启动
Datavue	Ctrl-Shift-M	Ctrl-Shift-M

计算机	激活端口的键命令	取消激活端口的键命令
DEC**	FN-F5 FN-F4	FN-F5 FN-F4
Dell**	Ctrl-Alt-< Ctrl-Alt-F10 FN-F8 (CRT/LCD) FN-D FN-F12	Ctrl-Alt-> Ctrl-Alt-F10 FN-F8 FN-D FN-F12
Digital*	自动 FN-F2	重新引导 FN-F2
Dolch	CRT 的双列直插式开关	LCD 的双列直插式开关
Epson	CRT 的双列直插式开关	LCD 的双列直插式开关
Everex*	设置屏幕选项	设置屏幕选项
For-A	Ctrl-Alt-Shift-C	Ctrl-Shift-Alt-L
Fujitsu	FN-F10	
Gateway	FN-F3 FN-F1 / 同时按 FN-F1 两次	FN-F3 FN-F1
Grid* **	FN-F2, 选择 auto 或 simultaneous Ctrl-Alt-Tab	FN-F2 Ctrl-Alt-Tab
Hitachi	FN-F7	FN-F7
Honeywell	FN-F10	FN-F10
Hyundai	设置屏幕选项	设置屏幕选项
IBM 970*	自动	热重新启动
IBM ThinkPad**	重新引导, 进入设置菜单 FN-F7, 从设置菜单中选择选项 FN-F1, 选择选项 FN-F5, 选择选项 PS/2 SC 选择选项 (例如 CRT、LCD)	FN-F2
Infotel	FN-F12	FN-F12
Kaypro	启动, 插上监视器	拔去监视器
Kris Tech	FN-F8	FN-F8
Leading Edge	FN-T	FN-T
Mac Portable 100	无视频端口; 不兼容	
Mac PowerBook		
140, 145, 150, 170	无视频端口; 需要第三方接口	
160, 165, 180, 520, 540, 5300	Control Panel 文件夹, PowerBook Display 文件夹; 激活 Video Mirroring	热重新启动
210, 230, 250, 270, 280, 2300	需要 Apple Docking Station 或 Mini Dock	
Magitronic	FN-F4	FN-F4
Mastersport	FN-F2	FN-F1
Micro Express*	自动	热重新启动
Micron	FN-F2	FN-F2
Microslate*	自动	热重新启动
Mitsubishi	SW2 On-Off-Off-Off	SW2 Off-On-On-On
NCR	设置屏幕选项	设置屏幕选项
NEC* **	设置屏幕选项 DOS 提示符下的 CRT	设置屏幕选项 DOS 提示符下的 LCD
	FN-F3	FN-F3
Olivetti*	自动 FN-O/*	自动 FN-O/*
Packard Bell* **	FN-F0	FN-F0
	Ctrl-Alt-<	Ctrl-Alt->
Panasonic	FN-F2	FN-F2
Prostar	启动时按 Ctrl-Alt-S	启动时按 Ctrl-Alt-S
Samsung*	设置屏幕选项	设置屏幕选项
Sanyo	设置屏幕选项	设置屏幕选项

计算机	激活端口的键命令	取消激活端口的键命令
Sharp	CRT 的双列直插式开关	LCD 的双列直插式开关
Sun SPARC-Dataview	Ctrl-Shift-M	Ctrl-Shift-M
Tandy**	Ctrl-Alt-Insert 设置屏幕选项	Ctrl-Alt-Insert 设置屏幕选项
Tangent	FN-F5	FN-F5
Texas Instruments*	设置屏幕选项	设置屏幕选项
Top-Link* **	设置屏幕选项 FN-F6	设置屏幕选项 FN-F6
Toshiba* **	Ctrl-Alt-End FN-End FN-F5 设置屏幕选项	Ctrl-Alt-Home FN-Home FN-F5 设置屏幕选项
Twinhead*	FN-F7 FN-F5 自动	FN-F7 FN-F5 自动
WinBook	Ctrl-Alt-F10	Ctrl-Alt-F10
Wyse	软件驱动	软件驱动
Zenith**	FN-F10 FN-F2 FN-F1	FN-F10 FN-F2 FN-F1
Zeos **	Ctrl-Shift-D FN-F1	Ctrl-Shift-D FN-F1

* 当连接某一类显示设备时，这些制造商拥有向外部 CRT 端口自动发送视频信号的机型。

** 这些制造商提供不止一个键命令，这取决于计算机型号。

附录 D. 使用视频镜像

使用 PowerBook 计算机的视频镜像

当打开视频镜像（在较新的 PowerBook 计算机中称为 SimulScan）时，投影仪上显示的信息与 PowerBook 内置屏幕上出现的信息相同。当关闭视频镜像时，投影仪像一台独立的显示器一样运行。

要初次打开视频镜像，需执行以下操作：

1. 打开 Monitors 控制面板；单击 **Monitor 2**。
2. 设置想要的颜色编号。
3. 打开 Control Strip，然后单击监视器图标。
4. 选择 **Turn Video Mirroring On**。

现在可以从 Control Strip 打开和关闭视频镜像，而不必再打开监视器控制面板。当使用视频镜像和深色图形（例如幻灯片放映）时，投影的图像有时可能会变成黑白的。如果发生这种情况，请执行以下步骤：

1. 关闭视频镜像。
2. 打开监视器控制面板。
3. 将空白菜单栏移到 **Monitor 2**，以将投影仪设置为主监视器。
4. 重新启动 PowerBook 计算机。

使用 Simulscan

一些较新的 PowerBook 计算机在外接监视器或投影仪上显示的图像不同于先前的图像。当使用 SimulScan 时，此投影仪上显示的信息与您的 PowerBook 计算机上出现的信息相同。要选择 SimulScan：

1. 请打开 Control Panel，然后双击 **Monitors** 和 **Sound**。
2. 在 Resolution 列表中，选择 SimulScan 方式，然后单击 **OK**。
3. 如果该操作更改了您的显示设置，则打开一个窗口。单击 **OK** 以确认更改。

Appendix E. Projected image size

Use the following graph and table to help you determine projected image sizes.

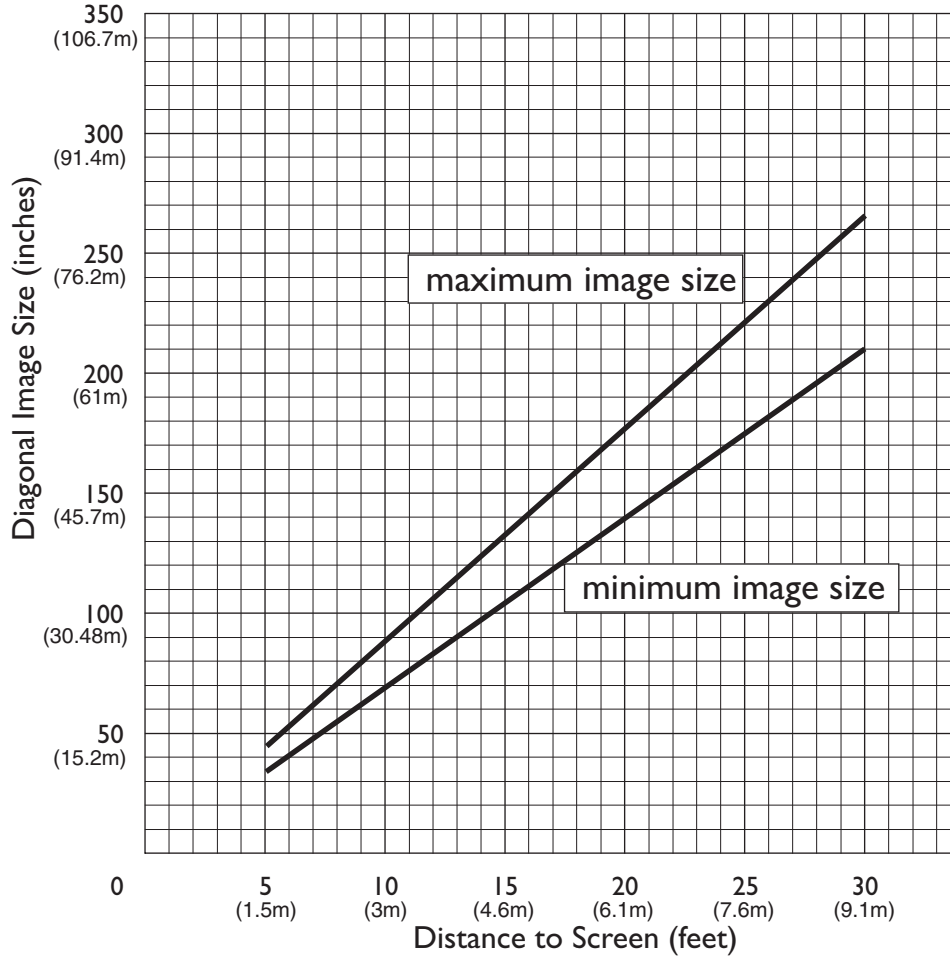

Table 1. Image size, width and height-maximum image size

Diagonal image size	Image width	Maximum distance	Minimum distance
152.4 c (60 in)	121.9 c (48 in)	2.59 m (8.5 ft.)	2.10 m (6.9 ft.)
183 c (72 in)	147.3 c (58 in)	3.1 m (10.2 ft.)	2.53 m (8.3 ft.)
213.4 c (84 in)	170 c (67 in)	3.62 m(11.9 ft.)	2.95 m (9.7 ft.)
229.6 c (90 in)	182.48 c (72 in)	3.87 m (12.7 ft.)	3.13 m (10.4 ft.)
254 c (100 in)	203.2 c (80 in)	4.29 m (14.1 ft.)	3.53 m (11.6 ft.)
304.8 c (120 in)	243.8 c (96 in)	5.18 m (17.0 ft.)	4.23 m (13.9 ft.)
381 c (150 in)	304.8 c (120 in)	6.46 m (21.2 ft.)	5.3 m (17.4 ft.)

附录 F. Warranty information

This section contains the warranty period for your product, information about obtaining warranty service and support, and the IBM Statement of Limited Warranty.

Warranty period

Contact your place of purchase for warranty service information. Some IBM Machines are eligible for on-site warranty service depending on the country or region where service is performed.

Machine - IBM iLM300 MicroPortable Projector

Warranty period - Three years

Machine - IBM iLM300 MicroPortable Projector Lamp module

Warranty period - Three months

Replacement lamps

During the warranty period, order replacement lamps by calling the IBM HelpCenter. See 第 42 页的『Telephone technical support』. Request Part Number 33L3456.

After the warranty period, order replacement lamps (Part Number 33L3456) from IBM using the World Wide Web. The Web site address is <http://www.pc.ibm.com/us/accessories/projectors/index.html>.

Service and support

The following information describes the technical support that is available for your product, during the warranty period or throughout the life of the product. Refer to your IBM Statement of Limited Warranty for a full explanation of IBM warranty terms.

Warranty information on the World Wide Web

The IBM Machine Warranties Web site at http://www.ibm.com/servers/support/machine_warranties/ contains a worldwide overview of the IBM Limited Warranty for IBM Machines, a glossary of terms used in the Statement of Limited Warranty, Frequently Asked Questions (FAQ), and links to Product Support Web pages. The IBM Statement of Limited Warranty is available from this Web site in 29 languages in Portable Document Format (PDF).

Online technical support

Online technical support is available during the life of your product through the Personal Computing Support Web site at <http://www.ibm.com/pc/support/>.

During the warranty period, assistance for replacement or exchange of defective components is available. In addition, if your IBM option is installed in an IBM computer, you might be entitled to service at your location. Your technical support representative can help you determine the best alternative.

Telephone technical support

Installation and configuration support through the IBM HelpCenter® will be withdrawn or made available for a fee, at IBM's discretion, 90 days after the option has been withdrawn from marketing. Additional support offerings, including step-by-step installation assistance, are available for a nominal fee.

To assist the technical support representative, have available as much of the following information as possible:

- Option name
- Option number
- Proof of purchase
- Computer manufacturer, model, serial number (if IBM), and manual
- Exact wording of the error message (if any)
- Description of the problem
- Hardware and software configuration information for your system

If possible, be at your computer. Your technical support representative might want to walk you through the problem during the call.

For the support telephone number and support hours by country, refer to the following table. If the number for your country or region is not listed, contact your IBM reseller or IBM marketing representative. Response time may vary depending on the number and nature of the calls received.

Support 24 hours a day, 7 days a week	
Canada (Toronto only)	416-383-3344
Canada (all other)	1-800-565-3344
U.S.A. and Puerto Rico	1-800-772-2227
All other countries and regions	Go to http://www.ibm.com/pc/support/ , and click Support Phone List .

IBM Statement of Limited Warranty Z125-4753-06 8/2000

Part 1 - General Terms

This Statement of Limited Warranty includes Part 1 - General Terms and Part 2 - Country-unique Terms. The terms of Part 2 replace or modify those of Part 1. The warranties provided by IBM in this Statement of Limited Warranty apply only to Machines you purchase for your use, and not for resale, from IBM or your reseller. The term 『Machine』 means an IBM machine, its features, conversions, upgrades, elements, or accessories, or any combination of them. The term 『Machine』 does not include any software programs, whether pre-loaded with the Machine, installed subsequently or otherwise. Unless IBM specifies otherwise, the following warranties apply only in the country where you acquire the Machine. Nothing in this Statement of Limited Warranty affects any statutory rights of consumers that cannot be waived or limited by contract. If you have any questions, contact IBM or your reseller.

The IBM Warranty for Machines: IBM warrants that each Machine 1) is free from defects in materials and workmanship and 2) conforms to IBM's Official Published Specifications (『Specifications』). The warranty period for a Machine is a specified, fixed period commencing on its Date of Installation. The date on your sales receipt is the Date of Installation unless IBM or your reseller informs you otherwise.

If a Machine does not function as warranted during the warranty period, and IBM or your reseller are unable to either 1) make it do so or 2) replace it with one that is at least functionally equivalent, you may return it to your place of purchase and your money will be refunded.

Extent of Warranty: The warranty does not cover the repair or exchange of a Machine resulting from misuse, accident, modification, unsuitable physical or operating environment, improper maintenance by you, or failure caused by a product for which IBM is not responsible. The warranty is voided by removal or alteration of Machine or parts identification labels.

THESE WARRANTIES ARE YOUR EXCLUSIVE WARRANTIES AND REPLACE ALL OTHER WARRANTIES OR CONDITIONS, EXPRESS OR IMPLIED, INCLUDING, BUT NOT LIMITED TO, THE IMPLIED WARRANTIES OR CONDITIONS OF MERCHANTABILITY AND FITNESS FOR A PARTICULAR PURPOSE. THESE WARRANTIES GIVE YOU SPECIFIC LEGAL RIGHTS AND YOU MAY ALSO HAVE OTHER RIGHTS WHICH VARY FROM JURISDICTION TO JURISDICTION. SOME JURISDICTIONS DO NOT ALLOW THE EXCLUSION OR LIMITATION OF EXPRESS OR IMPLIED WARRANTIES, SO THE ABOVE EXCLUSION OR LIMITATION MAY NOT APPLY TO YOU. IN THAT EVENT, SUCH WARRANTIES ARE LIMITED IN DURATION TO THE WARRANTY PERIOD. NO WARRANTIES APPLY AFTER THAT PERIOD.

Items Not Covered by Warranty: IBM does not warrant uninterrupted or error-free operation of a Machine. Any technical or other support provided for a Machine under warranty, such as assistance via telephone with 『how-to』 questions and those regarding Machine set-up and installation, will be provided **WITHOUT WARRANTIES OF ANY KIND.**

Warranty Service: To obtain warranty service for a Machine, contact IBM or your reseller. If you do not register your Machine with IBM, you may be required to present proof of purchase.

During the warranty period, IBM or your reseller, if approved by IBM to provide warranty service, provides without charge certain types of repair and exchange service to keep Machines in, or restore them to, conformance with their Specifications. IBM or your reseller will inform you of the available types of service for a Machine based on its country of installation. At its discretion, IBM or your reseller will 1) either repair or exchange the

failing Machine and 2) provide the service either at your location or a service center. IBM or your reseller will also manage and install selected engineering changes that apply to the Machine.

Some parts of IBM Machines are designated as Customer Replaceable Units (called 『CRUs』), e.g., keyboards, memory, or hard disk drives. IBM ships CRUs to you for replacement by you. You must return all defective CRUs to IBM within 30 days of your receipt of the replacement CRU. You are responsible for downloading designated Machine Code and Licensed Internal Code updates from an IBM Internet Web site or from other electronic media, and following the instructions that IBM provides.

When warranty service involves the exchange of a Machine or part, the item IBM or your reseller replaces becomes its property and the replacement becomes yours. You represent that all removed items are genuine and unaltered. The replacement may not be new, but will be in good working order and at least functionally equivalent to the item replaced. The replacement assumes the warranty service status of the replaced item. Many features, conversions, or upgrades involve the removal of parts and their return to IBM. A part that replaces a removed part will assume the warranty service status of the removed part.

Before IBM or your reseller exchanges a Machine or part, you agree to remove all features, parts, options, alterations, and attachments not under warranty service.

You also agree to

1. ensure that the Machine is free of any legal obligations or restrictions that prevent its exchange;
2. obtain authorization from the owner to have IBM or your reseller service a Machine that you do not own; and
3. where applicable, before service is provided:
 - a. follow the problem determination, problem analysis, and service request procedures that IBM or your reseller provides;
 - b. secure all programs, data, and funds contained in a Machine;
 - c. provide IBM or your reseller with sufficient, free, and safe access to your facilities to permit them to fulfill their obligations; and
 - d. inform IBM or your reseller of changes in a Machine's location.

IBM is responsible for loss of, or damage to, your Machine while it is 1) in IBM's possession or 2) in transit in those cases where IBM is responsible for the transportation charges.

Neither IBM nor your reseller is responsible for any of your confidential, proprietary or personal information contained in a Machine which you return to IBM or your reseller for any reason. You should remove all such information from the Machine prior to its return.

Limitation of Liability: Circumstances may arise where, because of a default on IBM's part or other liability, you are entitled to recover damages from IBM. In each such instance, regardless of the basis on which you are entitled to claim damages from IBM (including fundamental breach, negligence, misrepresentation, or other contract or tort claim), except for any liability that cannot be waived or limited by applicable laws, IBM is liable for no more than

1. damages for bodily injury (including death) and damage to real property and tangible personal property; and
2. the amount of any other actual direct damages, up to the charges (if recurring, 12 months' charges apply) for the Machine that is subject of the claim. For purposes of this item, the term 『Machine』 includes Machine Code and Licensed Internal Code.

This limit also applies to IBM's suppliers and your reseller. It is the maximum for which IBM, its suppliers, and your reseller are collectively responsible.

UNDER NO CIRCUMSTANCES IS IBM LIABLE FOR ANY OF THE FOLLOWING: 1) THIRD-PARTY CLAIMS AGAINST YOU FOR DAMAGES (OTHER THAN THOSE UNDER THE FIRST ITEM LISTED ABOVE); 2) LOSS OF, OR DAMAGE TO, YOUR RECORDS OR DATA; OR 3) SPECIAL, INCIDENTAL, OR INDIRECT DAMAGES OR FOR ANY ECONOMIC CONSEQUENTIAL DAMAGES, LOST PROFITS OR LOST SAVINGS, EVEN IF IBM, ITS SUPPLIERS OR YOUR RESELLER IS INFORMED OF THEIR POSSIBILITY. SOME JURISDICTIONS DO NOT ALLOW THE EXCLUSION OR LIMITATION OF INCIDENTAL OR CONSEQUENTIAL DAMAGES, SO THE ABOVE LIMITATION OR EXCLUSION MAY NOT APPLY TO YOU.

Governing Law: Both you and IBM consent to the application of the laws of the country in which you acquired the Machine to govern, interpret, and enforce all of your and IBM's rights, duties, and obligations arising from, or relating in any manner to, the subject matter of this Agreement, without regard to conflict of law principles.

Part 2 - Country-unique Terms

AMERICAS

BRAZIL

Governing Law: *The following is added after the first sentence:*

Any litigation arising from this Agreement will be settled exclusively by the court of Rio de Janeiro.

NORTH AMERICA

Warranty Service: *The following is added to this Section:*

To obtain warranty service from IBM in Canada or the United States, call 1-800-IBM-SERV (426-7378).

CANADA

Governing Law: *The following replaces ¶ laws of the country in which you acquired the Machine ¶ in the first sentence:*

laws in the Province of Ontario.

UNITED STATES

Governing Law: *The following replaces ¶ laws of the country in which you acquired the Machine ¶ in the first sentence:*

laws of the State of New York.

ASIA PACIFIC

AUSTRALIA

The IBM Warranty for Machines: *The following paragraph is added to this Section:*

The warranties specified in this Section are in addition to any rights you may have under the Trade Practices Act 1974 or other similar legislation and are only limited to the extent permitted by the applicable legislation.

Limitation of Liability: *The following is added to this Section:*

Where IBM is in breach of a condition or warranty implied by the Trade Practices Act 1974 or other similar legislation, IBM's liability is limited to the repair or replacement of the goods or the supply of equivalent goods.

Where that condition or warranty relates to right to sell, quiet possession or clear title, or the goods are of a kind ordinarily acquired for personal, domestic or household use or consumption, then none of the limitations in this paragraph apply.

Governing Law: *The following replaces ¶ laws of the country in which you acquired the Machine ¶ in the first sentence:*

laws of the State or Territory.

CAMBODIA, LAOS, AND VIETNAM

Governing Law: *The following replaces ¶ laws of the country in which you acquired the Machine ¶ in the first sentence:*

laws of the State of New York.

The following is added to this Section:

Disputes and differences arising out of or in connection with this Agreement shall be finally settled by arbitration which shall be held in Singapore in accordance with the rules of the International Chamber of Commerce (ICC). The arbitrator or arbitrators designated in conformity with those rules shall have the power to rule on their own competence and on the validity of the Agreement to submit to arbitration. The arbitration award shall be final and binding for the parties without appeal and the arbitral award shall be in writing and set forth the findings of fact and the conclusions of law.

All proceedings shall be conducted, including all documents presented in such proceedings, in the English language. The number of arbitrators shall be three, with each side to the dispute being entitled to appoint one arbitrator.

The two arbitrators appointed by the parties shall appoint a third arbitrator before proceeding upon the reference. The third arbitrator shall act as chairman of the proceedings. Vacancies in the post of chairman shall be filled by the president of the ICC. Other vacancies shall be filled by the respective nominating party. Proceedings shall continue from the stage they were at when the vacancy occurred.

If one of the parties refuses or otherwise fails to appoint an arbitrator within 30 days of the date the other party appoints its, the first appointed arbitrator shall be the sole arbitrator, provided that the arbitrator was validly and properly appointed.

The English language version of this Agreement prevails over any other language version.

HONG KONG AND MACAU

Governing Law: *The following replaces ¶ laws of the country in which you acquired the Machine ¶ in the first sentence:*

laws of Hong Kong Special Administrative Region.

INDIA

Limitation of Liability: *The following replaces items 1 and 2 of this Section:*

1. liability for bodily injury (including death) or damage to real property and tangible personal property will be limited to that caused by IBM's negligence;
2. as to any other actual damage arising in any situation involving nonperformance by IBM pursuant to, or in any way related to the subject of this Statement of Limited Warranty, IBM's liability will be limited to the charge paid by you for the individual Machine that is the subject of the claim.

JAPAN

Governing Law: *The following sentence is added to this Section:*

Any doubts concerning this Agreement will be initially resolved between us in good faith and in accordance with the principle of mutual trust.

NEW ZEALAND

The IBM Warranty for Machines: *The following paragraph is added to this Section:*

The warranties specified in this Section are in addition to any rights you may have under the Consumer Guarantees Act 1993 or other legislation which cannot be excluded or limited. The Consumer Guarantees Act 1993 will not apply in respect of any goods which IBM provides, if you require the goods for the purposes of a business as defined in that Act.

Limitation of Liability: *The following is added to this Section:*

Where Machines are not acquired for the purposes of a business as defined in the Consumer Guarantees Act 1993, the limitations in this Section are subject to the limitations in that Act.

PEOPLE'S REPUBLIC OF CHINA (PRC)

Governing Law: *The following replaces this Section:*

Both you and IBM consent to the application of the laws of the State of New York (except when local law requires otherwise) to govern, interpret, and enforce all your and IBM's rights, duties, and obligations arising from, or relating in any manner to, the subject matter of this Agreement, without regard to conflict of law principles.

Any disputes arising from or in connection with this Agreement will first be resolved by friendly negotiations, failing which either of us has the right to submit the dispute to the China International Economic and Trade Arbitration Commission in Beijing, the PRC, for arbitration in accordance with its arbitration rules in force at the time. The arbitration tribunal will consist of three arbitrators. The language to be used therein will be English and Chinese. An arbitral award will be final and binding on all the parties, and will be enforceable under the Convention on the Recognition and Enforcement of Foreign Arbitral Awards (1958).

The arbitration fee will be borne by the losing party unless otherwise determined by the arbitral award.

During the course of arbitration, this Agreement will continue to be performed except for the part which the parties are disputing and which is undergoing arbitration.

EUROPE, MIDDLE EAST, AFRICA (EMEA)

THE FOLLOWING TERMS APPLY TO ALL EMEA COUNTRIES:

The terms of this Statement of Limited Warranty apply to Machines purchased from IBM or an IBM reseller.

Warranty Service: If you purchase an IBM Machine in Austria, Belgium, Denmark, Estonia, Finland, France, Germany, Greece, Iceland, Ireland, Italy, Latvia, Lithuania, Luxembourg, Netherlands, Norway, Portugal, Spain, Sweden, Switzerland or United Kingdom, you may obtain warranty service for that Machine in any of those countries from either (1) an IBM reseller approved to perform warranty service or (2) from IBM. If you purchase an IBM Personal Computer Machine in Albania, Armenia, Belarus, Bosnia and Herzegovina, Bulgaria, Croatia, Czech Republic, Georgia, Hungary, Kazakhstan, Kirghizia, Federal Republic of Yugoslavia, Former Yugoslav Republic of Macedonia (FYROM), Moldova, Poland, Romania, Russia, Slovak Republic, Slovenia, or Ukraine, you may obtain warranty service for that Machine in any of those countries from either (1) an IBM reseller approved to perform warranty service or (2) from IBM.

If you purchase an IBM Machine in a Middle Eastern or African country, you may obtain warranty service for that Machine from the IBM entity within the country of purchase, if that IBM entity provides warranty service in that country, or from an IBM reseller, approved by IBM to perform warranty service on that Machine in that country. Warranty service in Africa is available within 50 kilometers of an IBM authorized service provider. You are responsible for transportation costs for Machines located outside 50 kilometers of an IBM authorized service provider.

Governing Law: The applicable laws that govern, interpret and enforce rights, duties, and obligations of each of us arising from, or relating in any manner to, the subject matter of this Statement, without regard to conflict of laws principles, as well as Country-unique terms and competent court for this Statement are those of the country in which the warranty service is being provided, except that in 1) Albania, Bosnia-Herzegovina, Bulgaria, Croatia, Hungary, Former Yugoslav Republic of Macedonia, Romania, Slovakia, Slovenia, Armenia, Azerbaijan, Belarus, Georgia, Kazakhstan, Kyrgyzstan, Moldova, Russia, Tajikistan, Turkmenistan, Ukraine, and Uzbekistan, the laws of Austria apply; 2) Estonia, Latvia, and Lithuania, the laws of Finland apply; 3) Algeria, Benin, Burkina Faso, Cameroon, Cape Verde, Central African Republic, Chad, Congo, Djibouti, Democratic Republic of Congo, Equatorial Guinea, France, Gabon, Gambia, Guinea, Guinea-Bissau, Ivory Coast, Lebanon, Mali, Mauritania, Morocco, Niger, Senegal, Togo, and Tunisia, this Agreement will be construed and the legal relations between the parties will be determined in accordance with the French laws and all disputes arising out of this Agreement or related to its violation or execution, including summary proceedings, will be settled exclusively by the Commercial Court of Paris; 4) Angola, Bahrain, Botswana, Burundi, Egypt, Eritrea, Ethiopia, Ghana, Jordan, Kenya, Kuwait, Liberia, Malawi, Malta, Mozambique, Nigeria, Oman, Pakistan, Qatar, Rwanda, Sao Tome, Saudi Arabia, Sierra Leone, Somalia, Tanzania, Uganda, United Arab Emirates, United Kingdom, West Bank/Gaza, Yemen, Zambia, and Zimbabwe, this Agreement will be governed by English Law and disputes relating to it will be submitted to the exclusive jurisdiction of the English courts; and 5) in Greece, Israel, Italy, Portugal, and Spain any legal claim arising out of this Statement will be brought before, and finally settled by, the competent court of Athens, Tel Aviv, Milan, Lisbon, and Madrid, respectively.

THE FOLLOWING TERMS APPLY TO THE COUNTRY SPECIFIED:

AUSTRIA AND GERMANY

The IBM Warranty for Machines: *The following replaces the first sentence of the first paragraph of this Section:*

The warranty for an IBM Machine covers the functionality of the Machine for its normal use and the Machine's conformity to its Specifications.

The following paragraphs are added to this Section:

The minimum warranty period for Machines is six months. In case IBM or your reseller is unable to repair an IBM Machine, you can alternatively ask for a partial refund as far as justified by the reduced value of the unrepaired Machine or ask for a cancellation of the respective agreement for such Machine and get your money refunded.

Extent of Warranty: *The second paragraph does not apply.*

Warranty Service: *The following is added to this Section:*

During the warranty period, transportation for delivery of the failing Machine to IBM will be at IBM's expense.

Limitation of Liability: *The following paragraph is added to this Section:*

The limitations and exclusions specified in the Statement of Limited Warranty will not apply to damages caused by IBM with fraud or gross negligence and for express warranty.

The following sentence is added to the end of item 2:

IBM's liability under this item is limited to the violation of essential contractual terms in cases of ordinary negligence.

EGYPT

Limitation of Liability: *The following replaces item 2 in this Section:*

as to any other actual direct damages, IBM's liability will be limited to the total amount you paid for the Machine that is the subject of the claim. For purposes of this item, the term 『Machine』 includes Machine Code and Licensed Internal Code.

Applicability of suppliers and resellers (unchanged).

FRANCE

Limitation of Liability: *The following replaces the second sentence of the first paragraph of this Section:*

In such instances, regardless of the basis on which you are entitled to claim damages from IBM, IBM is liable for no more than: *(items 1 and 2 unchanged).*

IRELAND

Extent of Warranty: *The following is added to this Section:*

Except as expressly provided in these terms and conditions, all statutory conditions, including all warranties implied, but without prejudice to the generality of the foregoing all warranties implied by the Sale of Goods Act 1893 or the Sale of Goods and Supply of Services Act 1980 are hereby excluded.

Limitation of Liability: *The following replaces items one and two of the first paragraph of this Section:*

1. death or personal injury or physical damage to your real property solely caused by IBM's negligence; and
2. the amount of any other actual direct damages, up to 125 percent of the charges (if recurring, the 12 months' charges apply) for the Machine that is the subject of the claim or which otherwise gives rise to the claim.

Applicability of suppliers and resellers (unchanged).

The following paragraph is added at the end of this Section:

IBM's entire liability and your sole remedy, whether in contract or in tort, in respect of any default shall be limited to damages.

ITALY

Limitation of Liability: *The following replaces the second sentence in the first paragraph:*

In each such instance unless otherwise provided by mandatory law, IBM is liable for no more than:

1. *(unchanged)*
2. as to any other actual damage arising in all situations involving nonperformance by IBM pursuant to, or in any way related to the subject matter of this Statement of Warranty, IBM's liability, will be limited to the total amount you paid for the Machine that is the subject of the claim.

Applicability of suppliers and resellers (unchanged).

The following replaces the third paragraph of this Section:

Unless otherwise provided by mandatory law, IBM and your reseller are not liable for any of the following: *(items 1 and 2 unchanged)* 3) indirect damages, even if IBM or your reseller is informed of their possibility.

SOUTH AFRICA, NAMIBIA, BOTSWANA, LESOTHO AND SWAZILAND

Limitation of Liability: *The following is added to this Section:*

IBM's entire liability to you for actual damages arising in all situations involving nonperformance by IBM in respect of the subject matter of this Statement of Warranty will be limited to the charge paid by you for the individual Machine that is the subject of your claim from IBM.

UNITED KINGDOM

Limitation of Liability: *The following replaces items 1 and 2 of the first paragraph of this Section:*

1. death or personal injury or physical damage to your real property solely caused by IBM's negligence;
2. the amount of any other actual direct damages or loss, up to 125 percent of the charges (if recurring, the 12 months' charges apply) for the Machine that is the subject of the claim or which otherwise gives rise to the claim;

The following item is added to this paragraph:

3. breach of IBM's obligations implied by Section 12 of the Sale of Goods Act 1979 or Section 2 of the Supply of Goods and Services Act 1982.

Applicability of suppliers and resellers (unchanged).

The following is added to the end of this Section:

IBM's entire liability and your sole remedy, whether in contract or in tort, in respect of any default shall be limited to damages.

附录 G. Notices

IBM may not offer the products, services, or features discussed in this document in all countries. Consult your local IBM representative for information on the products and services currently available in your area. Any reference to an IBM product, program, or service is not intended to state or imply that only that IBM product, program, or service may be used. Any functionally equivalent product, program, or service that does not infringe any IBM intellectual property right may be used instead. However, it is the user's responsibility to evaluate and verify the operation of any non-IBM product, program, or service.

IBM may have patents or pending patent applications covering subject matter described in this document. The furnishing of this document does not give you any license to these patents. You can send license inquiries, in writing, to:

*IBM Director of Licensing
IBM Corporation
North Castle Drive
Armonk, NY 10504-1785
U.S.A.*

INTERNATIONAL BUSINESS MACHINES CORPORATION PROVIDES THIS PUBLICATION 『AS IS』 WITHOUT WARRANTY OF ANY KIND, EITHER EXPRESS OR IMPLIED, INCLUDING, BUT NOT LIMITED TO, THE IMPLIED WARRANTIES OF NON-INFRINGEMENT, MERCHANTABILITY OR FITNESS FOR A PARTICULAR PURPOSE. Some jurisdictions do not allow disclaimer of express or implied warranties in certain transactions, therefore, this statement may not apply to you.

This information could include technical inaccuracies or typographical errors. Changes are periodically made to the information herein; these changes will be incorporated in new editions of the publication. IBM may make improvements and/or changes in the product(s) and/or the program(s) described in this publication at any time without notice.

IBM may use or distribute any of the information you supply in any way it believes appropriate without incurring any obligation to you.

Any references in this publication to non-IBM Web sites are provided for convenience only and do not in any manner serve as an endorsement of those Web sites. The materials at those Web sites are not part of the materials for this IBM product, and use of those Web sites is at your own risk.

Any performance data contained herein was determined in a controlled environment. Therefore, the result obtained in other operating environments may vary significantly. Some measurements may have been made on development-level systems and there is no guarantee that these measurements will be the same on generally available systems. Furthermore, some measurements may have been estimated through extrapolation. Actual results may vary. Users of this document should verify the applicable data for their specific environment.

Trademarks

The following terms are trademarks of the IBM Corporation in the United States or other countries or both:

IBM

HelpCenter

Microsoft, PowerPoint and Windows are trademarks or registered trademarks of Microsoft in the United States or other countries or both.

Other company, product, and service names may be trademarks or service marks of others.

Federal Communications Commission (FCC) statement

Note: This equipment has been tested and found to comply with the limits for a Class A digital device, pursuant to Part 15 of the FCC Rules. These limits are designed to provide reasonable protection against harmful interference when the equipment is operated in a commercial environment. This equipment generates, uses, and can radiate radio frequency energy and, if not installed and used in accordance with the instruction manual, may cause harmful interference to radio communications. Operation of this equipment in a residential area is likely to cause harmful interference, in which case the user will be required to correct the interference at his own expense.

Properly shielded and grounded cables and connectors must be used in order to meet FCC emission limits. IBM is not responsible for any radio or television interference caused by using other than recommended cables and connectors or by unauthorized changes or modifications to this equipment. Unauthorized changes or modifications could void the user's authority to operate the equipment.

This device complies with Part 15 of the FCC Rules. Operation is subject to the following two conditions: (1) this device may not cause harmful interference, and (2) this device must accept any interference received, including interference that may cause undesired operation.

Industry Canada Class A emission compliance statement

This Class A digital apparatus complies with Canadian ICES-003.

Avis de conformité a la réglementation d'Industrie Canada

Cet appareil numérique de la classe A est conforme à la norme NMB-003 du Canada.

Deutsche EMV-Direktive (electromagnetische Verträglichkeit)

Dieses Gerät ist berechtigt in Übereinstimmung mit dem deutschen EMVG vom 9.Nov.92 das EG-Konformitätszeichen zu führen.

Der Aussteller der Konformitätserklärung ist die IBM UK, Greenock.

Dieses Gerät erfüllt die Bedingungen der EN 55022 Klasse A. Für diese Klasse von Geräten gilt folgende Bestimmung nach dem EMVG:

Geräte dürfen an Orten, für die sie nicht ausreichend entstört sind, nur mit besonderer Genehmigung des Bundesministers für Post und Telekommunikation oder des Bundesamtes für Post und Telekommunikation betrieben werden. Die Genehmigung wird erteilt, wenn keine elektromagnetischen Störungen zu erwarten sind.

(Auszug aus dem EMVG vom 9.Nov.92, Para.3. Abs.4)

Hinweis: Dieses Genehmigungsverfahren ist von der Deutschen Bundespost noch nicht veröffentlicht worden.

European Union - EMC directive

This product is in conformity with the protection requirements of EU Council Directive 89/366/ECC on the approximation of the laws of the Member States relating to electromagnetic compatibility.

IBM cannot accept responsibility for any failure to satisfy the protection requirements resulting from a non-recommended modification of the product, including the fitting of non-IBM option cards.

This product has been tested and found to comply with the limits for Class A Information Technology Equipment according to CISPR 22/European Standard EN 55022. The limits for Class A equipment were derived for commercial and industrial environments to provide reasonable protection against interference with licensed communication equipment.

Warning: This is a Class A product. In a domestic environment this product may cause radio interference in which case the user may be required to take adequate measures.

Union Européenne - Directive Conformité électromagnétique

Ce produit est conforme aux exigences de protection de la Directive 89/336/EEC du Conseil de l'UE sur le rapprochement des lois des États membres en matière de compatibilité électromagnétique.

IBM ne peut accepter aucune responsabilité pour le manquement aux exigences de protection résultant d'une modification non recommandée du produit, y compris l'installation de cartes autres que les cartes IBM.

Ce produit a été testé et il satisfait les conditions de l'équipement informatique de Classe A en vertu de CISPR22/Standard européen EN 55022. Les conditions pour l'équipement de Classe A ont été définies en fonction d'un contexte d'utilisation commercial et industriel afin de fournir une protection raisonnable contre l'interférence d'appareils de communication autorisés.

Avertissement : Ceci est un produit de Classe A. Dans un contexte résidentiel, ce produit peut causer une interférence radio exigeant que l'utilisateur prenne des mesures adéquates.

Union Europea - Normativa EMC

Questo prodotto è conforme alle normative di protezione ai sensi della Direttiva del Consiglio dell'Unione Europea 89/336/CEE sull'armonizzazione legislativa degli stati membri in materia di compatibilità elettromagnetica.

IBM non accetta responsabilità alcuna per la mancata conformità alle normative di protezione dovuta a modifiche non consigliate al prodotto, compresa l'installazione di schede e componenti di marca diversa da IBM.

Le prove effettuate sul presente prodotto hanno accertato che esso rientra nei limiti stabiliti per le apparecchiature di informatica Classe A ai sensi del CISPR 22/Norma Europea EN 55022. I limiti delle apparecchiature della Classe A sono stati stabiliti al fine di fornire ragionevole protezione da interferenze mediante dispositivi di comunicazione in concessione in ambienti commerciali ed industriali.

Avvertimento: Questo è un prodotto appartenente alla Classe A. In ambiente domestico, tale prodotto può essere causa di interferenze radio, nel qual caso l'utente deve prendere misure adeguate.

Unione Europea - Directiva EMC (Conformidad electromagnética)

Este producto satisface los requisitos de protección del Consejo de la UE, Directiva 89/336/CEE en lo que a la legislación de los Estados Miembros sobre compatibilidad electromagnética se refiere.

IBM no puede aceptar responsabilidad alguna si este producto deja de satisfacer dichos requisitos de protección como resultado de una modificación no recomendada del producto, incluyendo el ajuste de tarjetas de opción que no sean IBM.

Este producto ha sido probado y satisface los límites para Equipos Informáticos Clase A de conformidad con el Estándar CISPR22 y el Estándar Europeo EN 55022. Los límites para los equipos de Clase A se han establecido para entornos comerciales e industriales a fin de proporcionar una protección razonable contra las interferencias con dispositivos de comunicación licenciados.

Advertencia: Este es un producto de Clase A. En un entorno doméstico este producto podría causar radiointerferencias en cuyo caso el usuario deberá tomar las medidas adecuadas.

声 明

此为 A 级产品，在生活环境中，
该产品可能会造成无线电干扰。
在这种情况下，可能需要用户对其
干扰采取切实可行的措施。

警告使用者：
這是甲類的資訊產品，在
居住的環境中使用時，可
能會造成射頻干擾，在這
種情況下，使用者會被要
求採取某些適當的對策。

この装置は、情報処理装置等電波障害自主規制協議会（VCCI）の基準に
基づくクラスA情報技術装置です。この装置を家庭環境で使用すると電波妨害を
引き起こすことがあります。この場合には使用者が適切な対策を講ずるよう要求
されることがあります。



部件号: 33L3529

中国印刷

(1P) P/N: 33L3529

