



IBM USB 2.0 便携式多功能刻录机

用户指南



IBM USB 2.0 便携式多功能刻录机

用户指南

注

在使用本资料及其支持的产品之前，请阅读附录 B, 『Service and Support』、附录 C, 『IBM Statement of Limited Warranty - Z125-4753-07 - 11/2002』和附录 D, 『Notices』。对本手册所包含的内容，IBM 公司拥有最终解释权，如有变更，恕不另行通知。

目录

安全	v	第 6 章 应用软件	6-1
常规安全准则	vii	第 7 章 使用多功能刻录机	7-1
维修	vii	开始之前	7-1
电源线和电源适配器	vii	处理和保养光盘	7-1
延长线和相关设备	vii	保养多功能刻录机驱动器	7-2
电源插头和插座	viii	清洁驱动器	7-2
电池	viii	使用驱动器	7-2
发热和产品通风	viii	使用单面和双面 DVD-RAM 介质	7-2
CD 和 DVD 驱动器安全	ix	处理的预防措施	7-3
关于本书	xi	在本驱动器中使用 CD 和 DVD	7-3
注册选件	xi	使用 DVD 播放器软件	7-3
第 1 章 多功能刻录机快速安装	1-1	使用 DVD 功能	7-3
产品描述	1-1	启用 Driver Letter Access (DLA)	7-3
硬件和软件需求	1-2	使用 Intervideo WinDVD Creator Plus	7-4
电源方式配置	1-2	安装 WinDVD 和观看 DVD 电影	7-4
配置 1: 自供电电源 (交流电源适配器) 配置	1-3	启动 WinDVD	7-5
配置 2: 标准 USB 总线电源配置	1-4	使用 CD-R 和 CD-RW 功能	7-6
配置 3: 辅助 USB 电源配置	1-5	使用 DVD-R 和 DVD-RW 功能	7-6
第 2 章 用电缆将多功能刻录机连接到		使用 DVD+R and DVD+RW 功能 (只读)	7-7
ThinkPad 计算机	2-1	备份 CD 或 DVD	7-7
第 3 章 功能	3-1	问题解决	7-7
第 4 章 准备使用多功能刻录机	4-1	附录 A. 产品规格	A-1
第 5 章 在 Windows 2000 和		附录 B. Service and Support	B-1
Windows XP 中的多功能刻录机安装和卸		Online technical support	B-1
载	5-1	Telephone technical support	B-1
卸下多功能刻录机硬件	5-1	附录 C. IBM Statement of Limited	
Windows 2000	5-1	Warranty - Z125-4753-07 - 11/2002	C-1
Windows XP	5-2	Part 2 - Country-unique Terms	C-4
设置介质	5-2	Part 3 - Warranty Information	C-16
弹出介质	5-2	附录 D. Notices	D-1
回放音频 CD	5-3	Trademarks	D-2
Windows 2000	5-3	Electronic emission notices	D-2
Windows XP	5-5	Federal Communications Commission (FCC)	
		statement	D-2

安全

Before installing this product, read the Safety Information.

مج، يجب قراءة دات السلامة

Antes de instalar este produto, leia as Informações de Segurança.

在安装本产品之前，请仔细阅读 **Safety Information**
(安全信息)。

Prije instalacije ovog produkta obavezno pročitajte Sigurnosne Upute.

Před instalací tohoto produktu si přečtěte příručku bezpečnostních instrukcí.

Læs sikkerhedsforskrifterne, før du installerer dette produkt.

Ennen kuin asennat tämän tuotteen, lue turvaohjeet kohdasta Safety Information.

Avant d'installer ce produit, lisez les consignes de sécurité.

Vor der Installation dieses Produkts die Sicherheitshinweise lesen.

Πριν εγκαταστήσετε το προϊόν αυτό, διαβάστε τις πληροφορίες ασφάλειας
(safety information).

לפני שתתקינו מוצר זה, קראו את הוראות הבטיחות.

A termék telepítése előtt olvassa el a Biztonsági előírásokat!

Prima di installare questo prodotto, leggere le Informazioni sulla Sicurezza.

製品の設置の前に、安全情報をお読みください。

본 제품을 설치하기 전에 안전 정보를 읽으십시오.

Пред да се инсталира овој продукт, прочитајте информацијата за безбедност.

Lees voordat u dit product installeert eerst de veiligheidsvoorschriften.

Les sikkerhetsinformasjonen (Safety Information) før du installerer dette produktet.

Przed zainstalowaniem tego produktu, należy zapoznać się
z książką "Informacje dotyczące bezpieczeństwa" (Safety Information).

Antes de instalar este produto, leia as Informações sobre Segurança.

Перед установкой продукта прочтите инструкции по
технике безопасности.

Pred inštaláciou tohto zariadenia si prečítajte Bezpečnostné predpisy.

Pred namestitvijo tega proizvoda preberite Varnostne informacije.

Antes de instalar este producto lea la información de seguridad.

Läs säkerhetsinformationen innan du installerar den här produkten.

安裝本產品之前，請先閱讀「安全資訊」。

常规安全准则

始终遵守以下预防措施以减少伤害和财产损失的危险。

维修

请勿尝试自行维修产品，除非 IBM® HelpCenter® 指示您这样做。只通过得到批准修复您特定产品的 IBM 授权服务供应商进行维修。

注：某些部件可由客户升级或替换。这些部件被称作客户可更换部件或 CRU。IBM 明确地标明了这些 CRU，并提供了文档，文档中含有客户何时可以替换这些部件的指示信息。执行这些替换时，您必须严格按照所有指示信息进行操作。在您尝试替换前，请始终确保电源关闭，并且将产品的任何电源断开。如果您有任何疑问或忧虑，请与 IBM HelpCenter 联系。

电源线和电源适配器

只使用产品制造商提供的电源线和电源适配器。

切勿将电源线缠绕在电源适配器或其它物体上。这样做会拉紧电线，从而引起电线磨损、折断或脆化。这会引发安全隐患。

始终按线路排放电源线，从而使其不会被物体压住、牵绊或夹着。

保护电线和电源适配器使其不接触液体。例如，切勿将电线或电源适配器放在水槽、水盆、盥洗室附近，或放在用液体清洗剂清洁过的地板上。液体会引起短路，尤其是因误用而绷紧电源线或施压于电源适配器时。液体还会引起电源线终端和 / 或适配器上的连接器终端逐渐腐蚀，最终导致适配器过热。

始终以正确的顺序连接电源线和信号电缆，并确保所有的电源线连接器都被牢固而完全地插入插座中。

请勿使用在任何交流电输入引脚上发生腐蚀现象和 / 或在交流电输入端或其它部位出现过热痕迹（如变形的塑料）的电源适配器。

请勿使用任何一端的电气触点出现腐蚀或过热痕迹的电源线，也不要使用出现任何损坏现象的电源线。

延长线和相关设备

确保您所使用的延长线、电涌保护器、不间断电源和配电盘的额定值要达到所使用产品的电气要求。请勿使这些设备过载。如果使用配电盘，载荷不应该超出配电盘的输入额定值。如果您对于电源载荷、电源需求和输入额定值有疑问，请咨询电气人员获取更多信息。

电源插头和插座

如果您想要用于计算机设备的插座（电源插座）出现损坏或腐蚀的情况，请勿使用该插座，直至有资格的电气人员将其替换。

请勿弯曲或改装电源插头。如果电源插头损坏，请与制造商联系以获得替换品。

某些产品装配有三线插头。该插头仅适合于接地的电源插座。这是一个安全功能。请勿尝试将其插入非接地插座而使该安全功能失效。如果无法将插头插入插座，请与电气人员联系以获取经核准的插座适配器或用启用了该安全功能的插座进行替换。请勿使电源插座过载。总体的系统载荷不应该超出分支电路额定的 80%。如果您对于电源载荷、分支电路额定值有疑问，请咨询电气人员以获取更多信息。

请确保您正在使用的电源插座正确连线、使用方便并紧靠设备放置。完全展开电源线时请勿使其紧绷。

请小心地将设备连接到电源插座或断开连接。

电池

全部 IBM 个人计算机都包含不可充电的硬币状电池为系统时钟提供电源。另外，许多移动式产品（例如，ThinkPad 笔记本电脑）在便携方式中利用可充电电池提供系统电源。IBM 提供的用于产品的电池已经过兼容性测试，并且只可用 IBM 批准的部件进行替换。

请勿尝试打开或维修任何电池。请勿压碎、刺穿或焚烧电池或使金属触点短路。请勿将电池投入水或其它液体中。只能严格根据包含于产品文档中的指示信息对电池进行充电。

电池滥用或不正确处理会引起电池过热，而过热会导致电池或硬币状电池释放气体或发出火焰。如果电池损坏，或您注意到电池放电或电池引线上有异物堆积，请停止使用电池并从电池制造商处获取替换品。

电池长期闲置不用后，其性能会下降。对于某些可充电电池（尤其是锂离子电池），将其以放电状态闲置可能会增加发生电路短路的风险，这样会缩短电池寿命，也会引起安全隐患。请勿将可充电锂离子电池完全放电，或将这些电池以放电状态存储。

发热和产品通风

当计算机打开和电池正在充电时，计算机会发热。笔记本 PC 由于其紧凑的尺寸会生成非常大的热量。请始终遵循这些基本预防措施：

- 当计算机运行或电池充电时，请避免使计算机底座与膝盖或身体任何部分的接触时间过长。计算机在正常运行过程中会产生一些热量。如果与身体接触的时间过长，可能会使您感到不适，也有可能导致皮肤烧伤。
- 请勿在可燃物质附近或易爆环境中操作计算机或对电池充电。
- 为了安全、舒适和可靠地操作产品，随产品一起提供通风槽、风扇和 / 或散热器。将产品放置在床、沙发、地毯或其它柔软表面上会无意间阻塞这些功能部件。请勿阻塞、覆盖或禁用这些功能部件。

CD 和 DVD 驱动器安全

CD 和 DVD 驱动器以高速转动光盘。如果 CD 或 DVD 出现裂纹或有其它物理损坏，则在 CD 驱动器中使用时，光盘可能会断裂，甚至破碎。要防止可能由这种情况引起的人身伤害，并减少损坏机器的危险，请执行以下操作：

- 始终将 CD / DVD 光盘存储在其原始包装中
- 始终将 CD / DVD 光盘存储在没有阳光直射且远离热源的地方
- 不使用 CD / DVD 光盘时将其从计算机取出
- 不要弯曲或扭曲 CD / DVD 光盘，或者将其强行放入计算机或包装中
- 每次使用前检查 CD / DVD 光盘是否有裂纹。不要使用有裂纹或损坏的光盘

关于本书

本手册包含了使用多功能刻录机所支持的三种电源方式配置安装 IBM USB 2.0 便携式多功能刻录机硬件的指示信息。

本手册提供了以下语言的安装指示信息:

- 巴西葡萄牙语
- 捷克语
- 英语
- 法语
- 德语
- 意大利语
- 日语
- 简体中文
- 斯洛伐克语
- 西班牙语
- 繁体中文
- 土耳其语

注册选件

感谢您购买本 IBM 产品。请花点时间注册您的产品，并向我们提供有助于 IBM 将来更好地为您服务的信息。您的反馈对于我们在开发对您相当重要的产品和服务，以及寻找更好的方式以便与您沟通方面具有重要价值。请在以下 IBM Web 站点注册选件:

<http://www.ibm.com/pc/register/>

IBM 将向您发送有关您所注册产品的信息和更新材料，除非您在 Web 站点的调查表中表明您不希望接收进一步的信息。

第 1 章 多功能刻录机快速安装

本章包含安装 IBM USB 2.0 便携式多功能刻录机的指示信息。

产品描述

IBM USB 2.0 便携式多功能刻录机是一种轻便型 DVD 和 CD 可刻录驱动器，它可以通过简单的连接快速、方便地连接到您的 IBM ThinkPad® 计算机。该驱动器是一个 USB 2.0 设备并且需要连接到 USB 2.0 端口。可获取的写入速度最大值为 2x (DVD 介质) 和 16x (CDR 介质)。可获取的读速度最大值为 8x (DVD 介质) 和 24x (CD 介质)。

除了本手册以外，选件包包含：

- IBM USB 2.0 便携式多功能驱动器

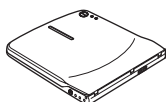

- 标准 USB 电缆和电源线装置（用于第 1-3 页上的配置 1 和第 1-4 页上的配置 2）；
IBM 部件号 22P9188

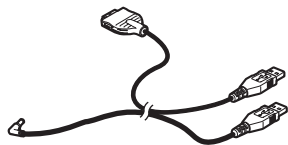

- IBM 支持的 USB 2.0 电缆装置（用于第 1-5 页上的配置 3）；IBM 部件号 22P9189



- 电源适配器

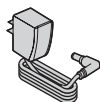

- 电源共享设备



- *IBM USB 2.0 Portable Multi-Burner Software and Guide Super CD*

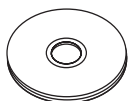

- 《安全信息》手册（两本）



- 携带包

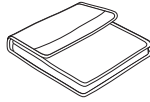

如有任何物品缺少或损坏，请与购买处联系。请务必保留购货凭证和包装材料。接收保修服务可能会需要这些。

硬件和软件需求

为了使用本选件，您的 ThinkPad 计算机上必须装有以下硬件：

- 可用的 USB 2.0 端口

注：第 1-4 页上的配置 2 可能会需要附加的 USB 2.0 端口。

计算机必须安装以下操作系统之一以使用本选件：

- Microsoft® Windows® XP
- Microsoft Windows 2000 Professional (Service Pack 4 或更高版本)

注：除非安装了 Service Pack 4 或更高版本，否则驱动器将不会正常运行。

电源方式配置

本节提供了以下配置的安装指示信息：

- 配置 1：自供电电源（交流电源适配器）
- 配置 2：USB 标准总线电源（只读）
- 配置 3：辅助 USB 电源

配置 1: 自供电电源（交流电源适配器）配置

多功能刻录机通常使用自供电电源（交流电源适配器）配置。

需求

- 标准 USB 电缆和电源线装置（随本选件一起提供）；IBM 部件号 22P9188
- 交流电源适配器（随本选件一起提供）

规格

支持读写 CD 和 DVD 介质。

使用配置 1 连接多功能刻录机

要将多功能刻录机连接到系统，请完成以下过程。在安装过程中请参考图 1-1。



图 1-1. 配置 1: 自供电电源（交流电源适配器）配置

1. 开启计算机。
2. 使用 USB 电缆 **A**，在按连接器上的两个按键的同时，将电缆插头 **1** 插入驱动器的 USB 接口。
3. 将标准 USB 连接器 **2** 插入计算机的 USB 端口。
4. 将交流电源适配器连接到多功能刻录机上的 DC IN 接口 **3**。

注：该配置不需要 USB 电缆 **B**。

配置 2: 标准 USB 总线电源配置

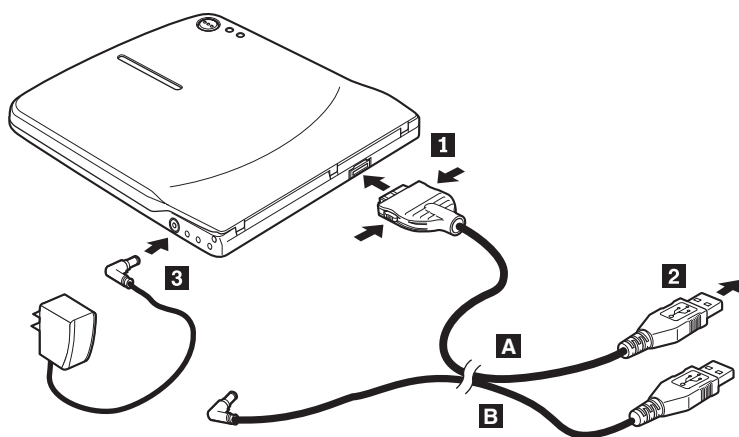
尽管多功能刻录机通常使用自供电电源，但是在以下情况中（不在 USB 标准中）可以使用总线电源，不过只具备有限的功能（只读）。

需求

- 标准 USB 电缆和电源线装置（随本选件一起提供）；IBM 部件号 22P9188
- 系统有两个可用的空闲 USB 端口

规格

支持只读的 CD 和 DVD 介质（除了 DVD-RAM）。

警告： 如果您尝试“写入”或“格式化”操作，或者“DVD-RAM 读取”操作，则将看见以下错误消息之一，并且需要连接外接交流电源适配器以完成该操作。

您的电源配置在 **IBM USB** 设备上不支持该操作。您将需要把外接交流电源适配器连接到 **IBM USB** 设备以完成该操作。

我的计算机
D:\ 不可访问。
不正确的功能。

使用配置 2 连接多功能刻录机

要将多功能刻录机连接到系统，请完成以下过程。在安装过程中请参考图 1-2。



图 1-2. 配置 2: USB 标准总线电源配置

1. 开启计算机。
2. 使用 USB 电缆 **A**，在按连接器上的两个按键的同时，将电缆插头 **1** 插入驱动器的 USB 接口。
3. 将标准 USB 连接器 **2** 插入计算机的 USB 端口。
4. 使用 USB 电缆 **B**，将电缆插头 **3** 插入驱动器的 DC IN 接口。
5. 将标准 USB 连接器 **4** 插入计算机的 USB 端口。

配置 3: 辅助 USB 电源配置

辅助 USB 总线电源配置可用于所选的装配有 IBM 支持的 USB 2.0 端口的 IBM ThinkPad 计算机。

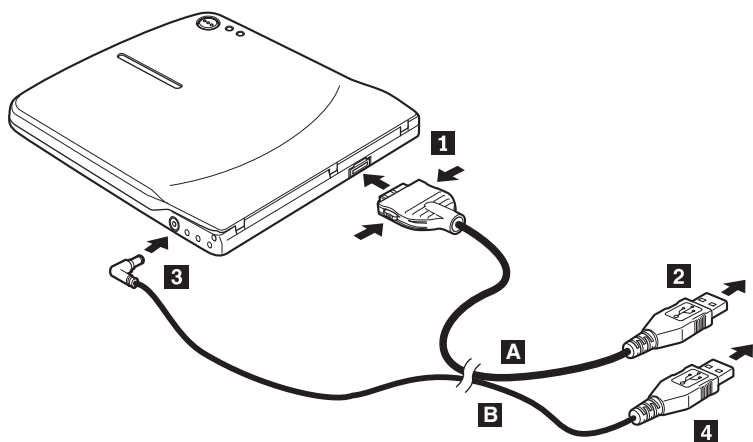
需求

- IBM 支持的 USB 2.0 电缆装置（随本选件一起提供）；IBM 部件号 22P9189
- IBM 支持的 USB 2.0 端口

规格

支持读写 CD 和 DVD 介质。

使用配置 3 连接多功能刻录机

要将多功能刻录机连接到系统，请完成以下过程。在安装过程中请参考图 1-3。



图 1-3. 配置 3: 辅助 USB 电源配置

1. 开启计算机。
2. 使用 USB 电缆 **A**，在按连接器上的两个按钮的同时，将电缆插头 **1** 插入驱动器的 USB 接口。
3. 同时滑动两个连接器 **2** 并且将叠在一起的 USB 和辅助电源连接器插入您计算机上支持的 USB 2.0 端口（可在所选的 IBM ThinkPad 系统上找到）。
4. 通过将插头 **3** 插入多功能刻录机的 DC IN 接口来将电缆 **B** 的另一端连接到驱动器。

第 2 章 用电线将多功能刻录机连接到 ThinkPad 计算机

当用电线将多功能刻录机连接到 ThinkPad 计算机时，下图可能会有帮助。请注意这些图可能与硬件略有差别。

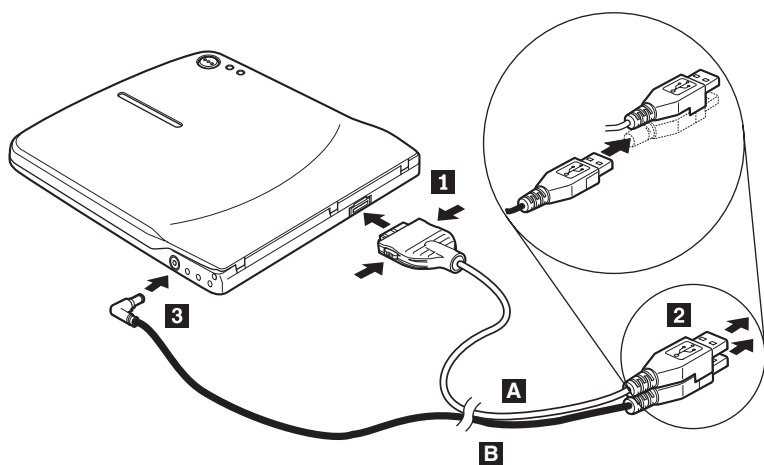
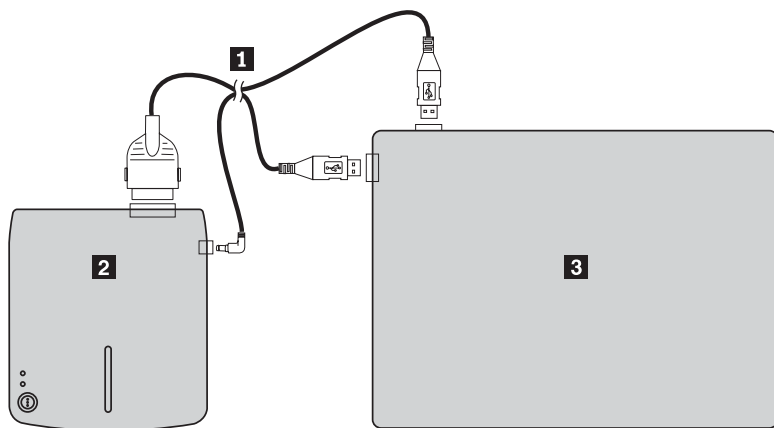

- 1** USB 电缆和电源线装置
- 2** 多功能刻录机
- 3** ThinkPad 计算机

图 2-1. 标准 USB 电缆装置（左侧）

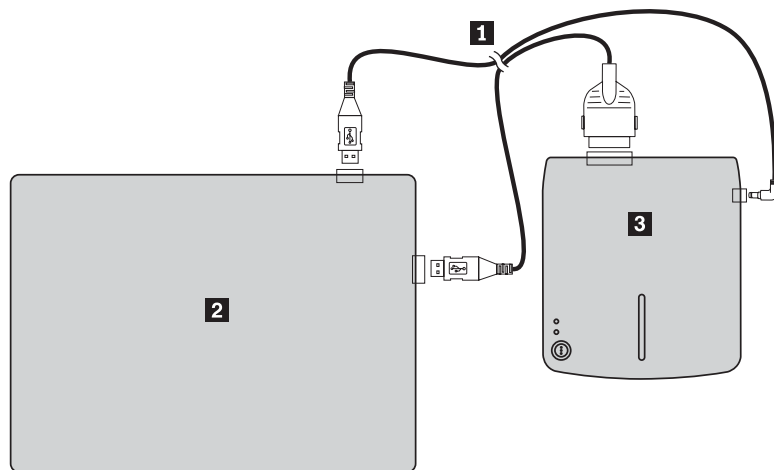

- 1** USB 电缆和电源线装置
- 2** 多功能刻录机
- 3** ThinkPad 计算机

图 2-2. 标准 USB 电缆装置（右侧）

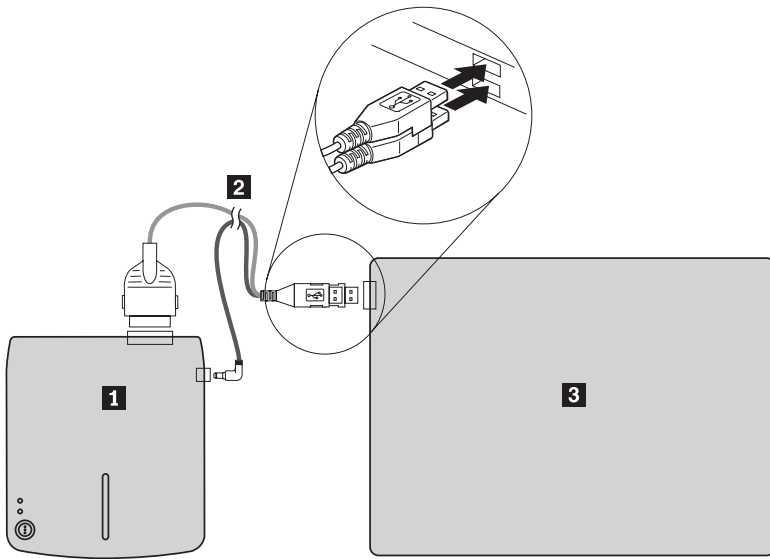

- 1** 多功能刻录机
- 2** IBM 支持的 USB 2.0 电缆装置
- 3** ThinkPad 计算机

图 2-3. 选择带有辅助 USB 电源端口的 IBM 系统

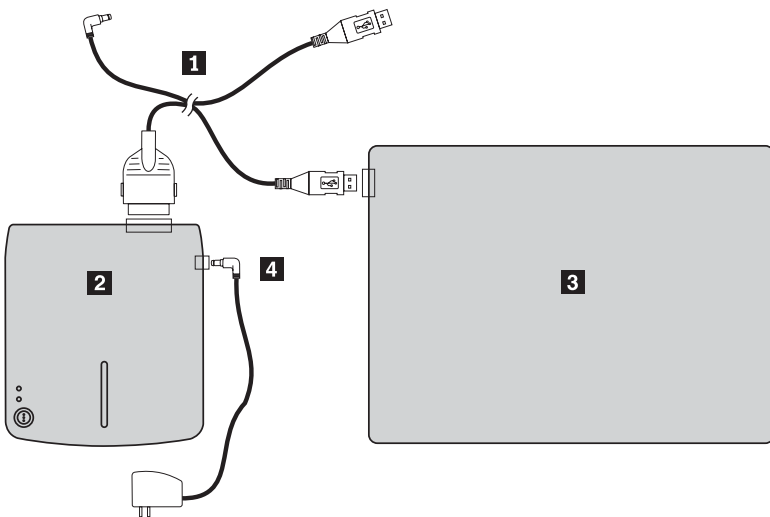

- 1** USB 电缆和电源线装置
- 2** 多功能刻录机
- 3** ThinkPad 计算机
- 4** 电源适配器

图 2-4. 选择带有交流电源的 IBM 系统

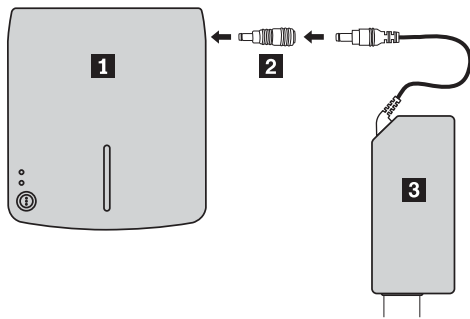

1 多功能刻录机

2 电源共享设备

3 ThinkPad 56W 交流电源适配器、ThinkPad 72W 交流电源适配器或 ThinkPad 72W 交流 / 直流组合电源适配器

图 2-5. 使用电源共享设备

第 3 章 功能

以下列表包含 IBM USB 2.0 便携式多功能刻录机驱动器的功能:

- **方便连接**

因为该产品配有符合 USB 2.0 的高速接口, 所以即使在计算机电源打开的情况下也能方便地连接到计算机, 或从计算机断开连接。支持带有交流电源的 IBM 扩展坞和端口复制器。

- **与主要介质制造商所制造介质的一致性**

该产品已针对主要介质制造商所制造的几乎所有 CD 和 DVD 介质进行了最佳的调整, 并且通过该产品所写入的介质实现了非常高的写入质量。因此, 使用该驱动器几乎可以不考虑兼容性问题。

注: 不支持超高速 CD-RW 介质进行“写”操作。

- **缓存欠载运行预防功能的结合**

该产品结合了缓存欠载运行预防功能, 从而有助于预防缓存欠载运行错误, 此错误会导致向 CD 和 DVD 介质的写操作失败。

- **顶部装入**

该产品有顶部装入装置允许光盘方便地装入和弹出。顶盖能够手工打开, 或使用计算机中运行的软件打开。

- **多个标准的一致性**

该驱动器符合 DVD-RAM、DVD-RW、DVD-R、CD-RW 和 CD-R 介质的工业标准规格。该驱动器符合 DVD+RW 和 DVD+R 规格(只读)。

- **电源配置**

该驱动器运行于以下电源配置:

- **全操作**

当连接到交流电源时(使用随驱动器一起提供的适配器)

- **只读**

当连接到两个标准 USB 端口时(使用装备了两个标准 USB 接口的电缆)

- **全操作**

当连接到所选的 IBM 系统上支持的 USB 2.0 端口时。使用装配了特殊 USB 堆叠连接器(包含于选件中)的电缆。

该选件随附 CD 上的用户手册描述了如何设置多功能刻录机, 如何将其连接到个人计算机, 以及如何进行操作。最好阅读一下您计算机的说明手册。

CD 还包含了用于多功能刻录机的软件应用程序。单击该软件, 它们就会自动地安装。

为了正确地处理和操作多功能刻录机, 请在使用前认真阅读该说明手册。

第 4 章 准备使用多功能刻录机

在使用多功能刻录机之前，请按照以下过程进行操作：

1. 确保多功能刻录机正确地连接到 ThinkPad 计算机。
2. 检查多功能刻录机的功能位置（参考下图）。
3. 插入随本选件一起提供的 *IBM USB 2.0 便携式多功能刻录机软件* 和 *用户指南超级 CD* 以安装 CD-R/CD-RW/DVD 写软件。
4. 双击您希望打开的应用程序，并按照屏幕上的指示信息操作。
5. 检查驱动器运行是否正常，并填完所附的保修单之后将其保存在安全的地方。

当弹出 CD 或 DVD 时进行检查，以保证没有物品放在顶盖上。当不能执行正常的弹出操作时，错误消息可能会出现在计算机上。当弹出操作未正常执行时，请手工打开顶盖，并在取走盖子上的任何东西后将其牢牢关闭。

以下是多功能刻录机的功能部件位置：

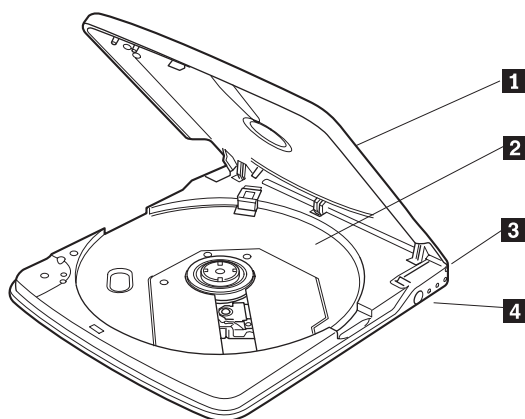

- 1 顶盖
- 2 光盘托架
- 3 USB 接口
- 4 DC IN 接口

顶盖必须关闭才能运行光盘。

在光盘托架上将带有标签的介质面朝上放置。

插入所提供的专用 USB 电缆插头。

将提供的交流电源适配器或电缆装置连接到 DC IN 接口。该驱动器也可在仅 USB 电源下使用，只是有一定的限制（请参考第 1-5 页的『配置 3: 辅助 USB 电源配置』。）

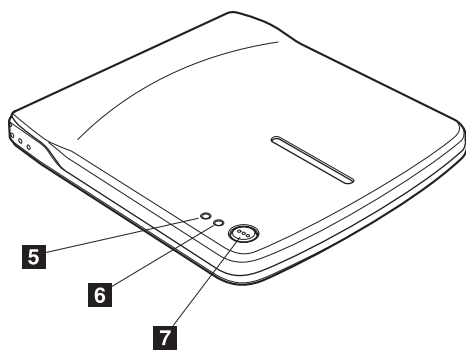

5 电源 / 忙碌指示灯

绿色 LED 表示驱动器的电源状态和操作状态。

- **LED 发亮:** 当驱动器连接到任一受支持的电源配置和计算机的 USB 端口时。
- **LED 发亮:** 数据写入过程中
- **LED 闪烁:** 数据读取过程中
- **LED 熄灭:** 驱动器未连接到 USB 端口时

6 写入指示灯

淡黄色 LED 表示驱动器的写入状态。

- **LED 闪烁:** 数据写入过程中
- **LED 熄灭:** 未进行数据写入操作时

7 弹出按钮

按该按钮以打开顶盖。

警告: 该驱动器使用了电气锁定机制，从而在写入过程中错误的操作不会打开顶盖。按弹出按钮打开顶盖前，请确保电源已打开且驱动器不在操作过程中。

如果即使按了弹出按钮也无法打开顶盖，或者当交流电源适配器未提供电源时需要打开顶盖，请使用位于驱动器底部的紧急弹出杆。

弹出时进行检查，以保证没有物品放在顶盖上。当不能执行正常的弹出操作时，错误消息可能会出现在计算机上。当弹出操作未正常执行时，请手工打开顶盖，并在取走盖子上的任何东西后将其牢牢关闭。

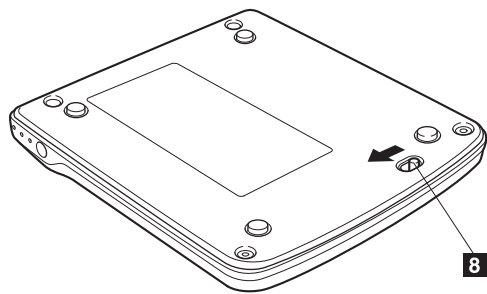

8 紧急弹出杆

当在电源关闭的情况下弹出介质时，请滑动紧急弹出杆以打开顶盖。

警告： 请确保使用紧急弹出杆时电源是关闭的。除非在紧急情况下，否则请使用弹出按钮而不是紧急弹出杆。

第 5 章 在 Windows 2000 和 Windows XP 中的多功能刻录机安装和卸载

Windows 2000 和 Windows XP 操作系统有自带的多功能刻录机驱动程序。因此，当连接该驱动器时，Windows 将会自动安装相应的驱动程序，从而驱动器将作好使用准备。您不必执行任何特殊的安装或卸载过程。

警告:

- 该驱动器将由 Windows 设备管理器识别为“IBM 多功能刻录机”。
- 在 Windows 2000 操作系统中，必须安装 Service Pack 4 或更高版本。

卸下多功能刻录机硬件

由于 USB 电缆与计算机之间的连接支持“热插拔”；因此，您卸下多功能刻录机时不必关闭计算机。请按照以下卸下 Windows 2000 和 Windows XP 中的多功能刻录机过程进行操作。

警告:

请勿将驱动器从计算机卸下后，再立即重新连接上去。驱动器可能会不被识别。卸下驱动器后，请过大约 20 秒再将其重新连接。

对该过程使用“托盘”图标。

Windows 2000

1. 退出使用驱动器的程序。
2. 确认驱动器的“写入”指示灯熄灭。
3. 单击托盘中的**拔下或弹出硬件**图标。



4. 选择卸下驱动器。在这种情况下，选择分配给驱动器的驱动器名称（在该图中为 D:）。



5. “安全删除硬件”确认窗口出现。单击**确定**按钮。

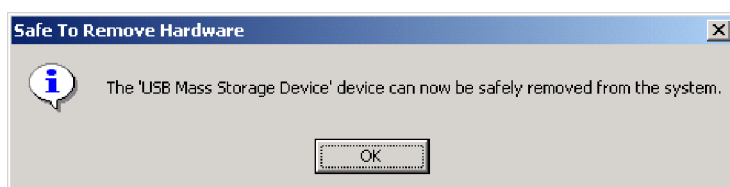

6. 从计算机的 USB 终端拔出 USB 电缆插头。

注：根据操作系统版本，以上显示的消息可能不同。有关详细信息，请参考计算机或操作系统的说明手册。

Windows XP

1. 退出使用驱动器的程序。
2. 确认驱动器的“写入”指示灯熄灭。
3. 单击托盘中的**安全删除硬件**图标。



4. 选择卸下驱动器。在这种情况下，选择分配给驱动器的驱动器名称（在该图中为 D:）。



5. “安全卸下硬件”确认窗口出现。单击**确定**按钮。



6. 从计算机的 USB 终端拔出 USB 电缆插头。

注：根据操作系统版本，以上显示的消息可能不同。有关详细信息，请参考计算机或操作系统的说明手册。

设置介质

1. 按驱动器弹出按钮打开顶盖。
2. 将介质的标签朝上放置在托架中。将光盘中心孔与托架中心的固定夹对齐，按中心孔的外圈以牢固的固定光盘。
3. 轻轻合上顶盖，向下按直到其完全锁定。
4. 当顶盖正确关闭后，介质就被识别出，并且在忙碌指示灯闪烁几秒后可用。

弹出介质

1. 按驱动器弹出按钮自动打开顶盖。
2. 在按固定夹上部的同时，从托架上小心地抬起光盘边缘。
3. 轻轻地合上顶盖直到其完全关闭。检查外盖已锁紧。

回放音频 CD

通过使用 Windows Media Player 或音频 CD 回放软件（比如 Microsoft CD Player）回放使用驱动器的音频 CD。操作方法根据软件和版本而不同。有关详细信息，请参考计算机或软件的操作手册。

Windows 2000

Windows Media Player 中，当您单击“选项”窗口中的“CD 音频”选项卡时，您将会发现“数字回放”复选框（如下图所示）。

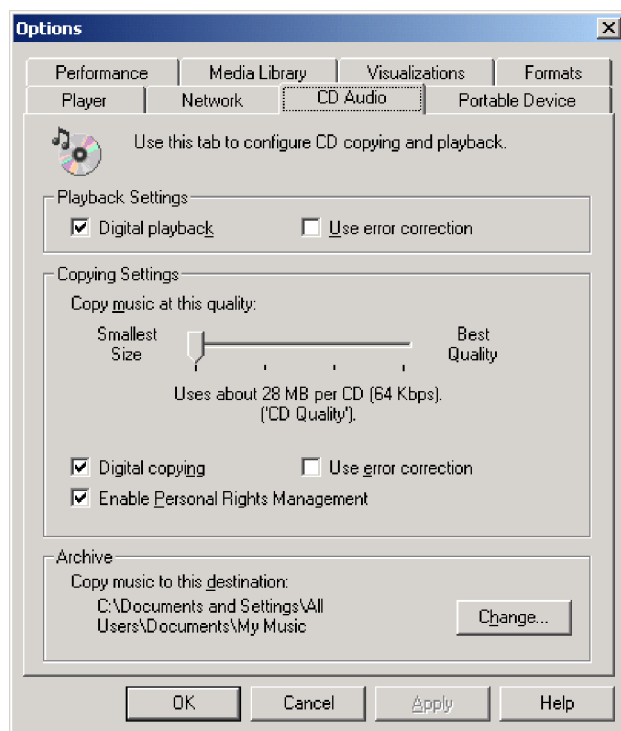

另外，在“设备管理器”的多功能刻录机属性中，将会发现“为多功能刻录机驱动器启用数字音频 CD”复选框，（如下图所示）。当播放器软件中无数字回放的设置项时，

请尝试上面的设置。

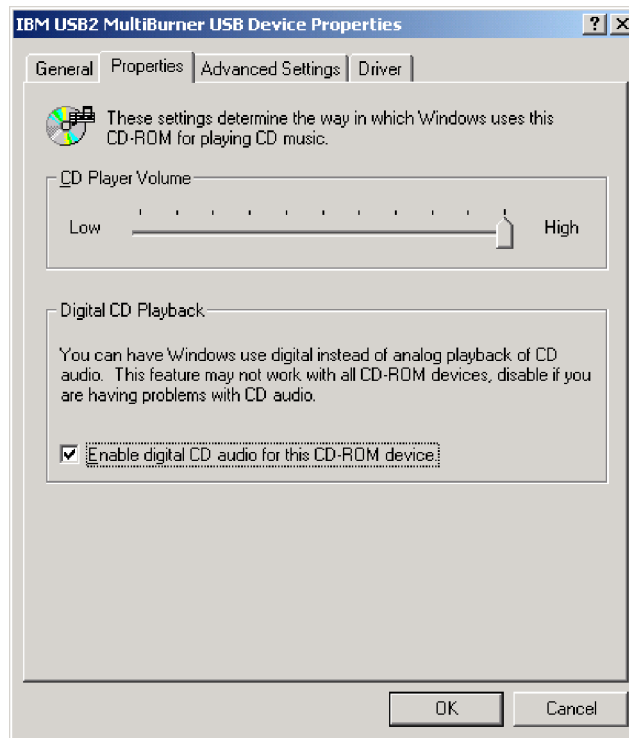

注：根据操作系统版本，上面的窗口可能会不同。有关详细信息，请参考计算机或操作系统的说明手册。

Windows XP

Windows Media Player 中，当您单击“属性”窗口中的“CD 音频”选项卡时，您将会发现“数字播放”复选框（如下图所示）。

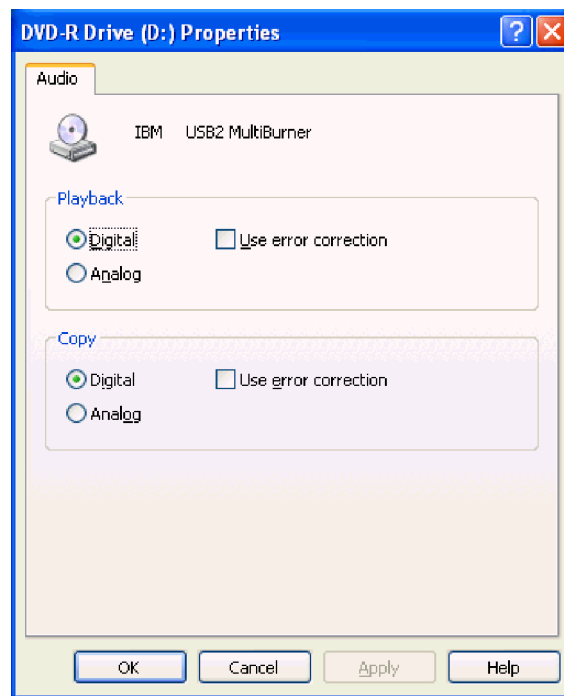

另外，在“设备管理器”的多功能刻录机属性中，将会发现“为多功能刻录机驱动器启用数字音频 CD”复选框（如下图所示）。当播放器软件中无数字回放的设置项时，请尝试上面的设置。

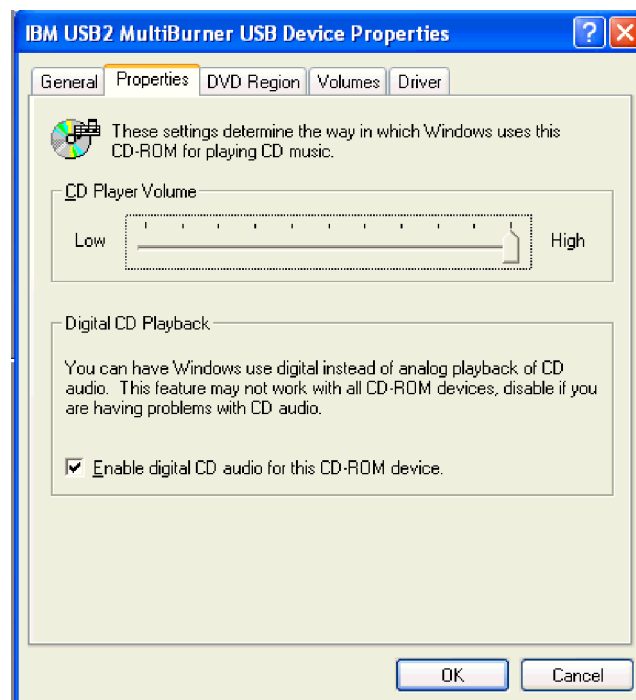

注：根据操作系统版本，上面的窗口可能会不同。有关详细信息，请参考计算机或操作系统的说明手册。

第 6 章 应用软件

您的 *IBM USB 2.0 便携式多功能刻录机软件* 和 *用户指南超级 CD* 包含以下软件:

- **Intervideo WinDVD Creator Plus**

计算机部件	最低	最佳
处理器	Intel Celeron 800Mhz	Intel Pentium® III 600Mhz Direct DVD 支持要求 P4 1.6GHz 或更高性能以适应实时需求
RAM	64Mb	128Mb
操作系统	Windows 2000 或 Windows XP	Windows 2000 或 Windows XP
声音	支持 48KHz 回放的 Windows 兼容声卡	支持 48KHz 回放的 Windows 兼容声卡 (推荐使用 PCI)
视频	Windows 兼容的 AGP 或 PCI 图形卡	Windows 兼容的 AGP 或 PCI 图形卡 (推荐覆盖支持)
硬盘驱动器	<ul style="list-style-type: none">• 70 MB 用于安装• 620 MB 用于每小时 VCD 品质的 MPEG-1 视频• 2 GB 用于每小时 DVD 品质的 MPEG-2 视频	<ul style="list-style-type: none">• 70 MB 用于安装• 620 MB 用于每小时 VCD 品质的 MPEG-1 视频• 2 GB 用于每小时 DVD 品质的 MPEG-2 视频
其它		刻录 VCD 和 DVD 需要 CD 或 DVD 刻录机。需要相应的硬件从外部的信息源导入视频, 如 DV 照相机和便携式摄像机

注: 预装了 DivX codec 的情况下, WinDVD Creator Plus 可以导入和导出 DivX 内容。DivX 是 DivXNetworks, Inc 的商标。

本软件使您能够将视频文件刻录到 DVD-RW 或 DVD-R 介质中, 这些介质可以在大多数独立的 DVD 播放器中播放。您还可以在刻录之前使用此软件来编辑和修改自己的视频资料。

如果在您的计算机中装有模拟或 IEEE 1394 捕获设备, 则可以使用此软件刻录来自照相机的视频。

- **IBM Drive Letter Access (DLA)**

本软件使您能够就像写入软盘一样, 使用盘符直接写入 CD-RW、CD-R 和 DVD-RAM、DVD-RW 以及 DVD-R 介质。所有光盘的格式类型都可由 DLA 进行格式化。使用 DLA, 您可以拖放文件、创建新目录或将文件从任何应用程序直接保存到多功能刻录机。

- **UDF Reader**

此软件使您能够安装使用 DVD 驱动器读取计算机上的 DVD-RAM、DVD-RW 和 CD-RW 介质的软件。它还允许您在没有安装 DLA 的系统上读取 DLA 创建的光盘。

- **IBM RecordNow**

IBM RecordNow 是光盘控制软件，允许您用计算机上的文件或其它光盘介质（例如 CD 或 DVD）来创建自己的音乐或数据光盘。使用 IBM RecordNow 创建的音乐光盘可以在任何 CD 播放器（无论是在家里、在车上，还是通过计算机的 CD-ROM）上播放。IBM RecordNow 还使您能够方便地创建能在任何适当的 CD 或 DVD 光盘阅读器中读取的数据光盘。

注： 某些 DVD 播放器不能读取 CD-R 介质。有关受支持介质的信息，请参考随驱动器提供的文档。

IBM RecordNow 指导您使用简单的向导和直观的用户界面逐步完成刻录过程。

使用 IBM RecordNow 可以创建：

- 现有光盘的精确副本 - 精确复制（Exact Copy）功能可以制作主光盘的副本，将原始光盘的光盘布局传送到您的 CD-R、CD-RW 或 DVD 介质。
- 从硬盘驱动器归档数据的光盘 - 制作数据光盘（Make a Data Disc）功能用于存储电子数据，如驻留在计算机硬盘驱动器中的文件和应用程序。与音乐光盘不同，数据光盘是用于存储仅能用计算机读取的文件，而不能在家里或汽车的立体声系统中播放 - 即使光盘中有音频文件。
- 从 WAV、MP3 或 WMA 文件或者是从现有的音乐光盘编制的音乐 - 制作音乐光盘（Make a Music Disc）功能从硬盘驱动器上的文件或现有的音乐光盘创建定制音乐光盘。CD 音乐数据库功能可以自动地标记文件的轨道信息以帮助您对收集的信息分类。

注： 有关如何使用 IBM RecordNow “制作精确副本”、“创建数据光盘”或“创建音频光盘”的更多信息，请参考 IBM RecordNow 联机帮助。

要启动 RecordNow，请完成以下过程：

1. 单击**开始**。
2. 单击**程序**。
3. 单击 **IBM RecordNow**。
4. 单击 **RecordNow** 以打开主刻录软件窗口。

- **IBM Simple Backup**

本软件使您能够在 DVD-RAM、DVD-RW、DVD-R、CD-R 或 CD-RW 介质上创建系统文件的完整备份或增量备份，并允许您在系统崩溃时恢复计算机。

- **Intervideo WinDVD**

本软件使您能够在计算机上回放 DVD 视频或从硬盘驱动器播放视频文件。

注： 某些图形适配器（如 FIREGL、Intergraph 和 3dLabs）不支持 DVD 视频回放。

第 7 章 使用多功能刻录机

本节提供了有关如何处理、装入和保养 DVD 和 CD 以及如何保养多功能刻录机驱动器的信息。

开始之前

要获得最佳效果，请在使用驱动器前仔细阅读下列准则：

- 在格式化或写光盘的时候不要移动 ThinkPad 计算机，这样可能会导致数据错误。同样，在格式化或写光盘时尽量不要执行输入操作，这样也可能导致数据错误。
- 在写光盘时，使 ThinkPad 计算机处于平面上。
- 关闭屏幕保护程序。使用屏幕保护程序可能会中断正在进行的格式化和写过程。
- 当写光盘时，不要让 ThinkPad 计算机进入休眠或暂挂方式。

注：驱动器的读写结果取决于所使用的 DVD 或 CD 介质的质量和特征。

处理和保养光盘

小心谨慎地处理和清洁光盘，尤其是诸如 CD-R 和 CD-RW 光盘之类的可写介质类型，以使其保持可读。通过使用以下预防措施可以延长光盘寿命：

- 始终将光盘存储在其原始包装中。
- 始终将光盘存放在没有阳光直射的地方。
- 始终使光盘存放在远离直接热源的地方。
- 不使用光盘时将其从计算机中取出。
- 在每次使用光盘“之前”检查光盘是否有裂纹。

要点：请勿使用有裂纹的光盘。

- 请勿强行将光盘放入计算机或包装中。
- 请勿弯曲或扭曲光盘。
- 请勿使用工业用清洗剂来清洁光盘。
- 请勿在光盘表面书写。
- 握住光盘的边缘或中心孔进行拿放。
- 请勿触摸光盘表面。
- 要除去灰尘或指纹，请用柔软、不起毛的布从中心向边缘擦拭光盘。

注意：以圆周运动擦拭光盘可能导致数据丢失。

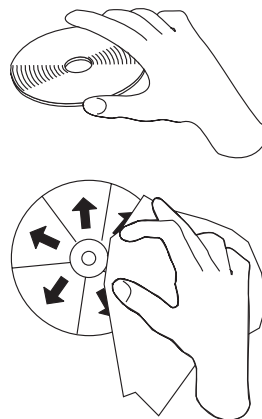

保养多功能刻录机驱动器

要在操作过程中保护您的驱动器，请按照以下预防措施进行操作：

- 在移动驱动器之前从驱动器中取出光盘。
- 不要将异物插入驱动器中。
- 不要将物品堆叠在驱动器上。
- 不要卸下驱动器外盖或试图维修驱动器。
- 不要在以下任一环境中使用驱动器：
 - 高温、高湿度或直接日照
 - 过度振动、意外撞击或倾斜表面
 - 过多灰尘

清洁驱动器

使用软布擦去驱动器上的污渍。如果污渍非常顽固，请在将布绞干后沾上稀释的中性清洁剂。如果让液体进入驱动器，则可能会导致严重的故障、电击或着火。当使用液体进行清洁时，请务必在从计算机断开驱动器连接后，从墙上的电源插座中拔出提供的交流电源适配器。

切勿使用诸如苯或稀释剂之类的溶剂。家庭或工业用途的化学清洗剂可能会损坏驱动器的涂层。

使用驱动器

本节包含了有关使用多功能刻录机的信息。

使用单面和双面 DVD-RAM 介质

DVD-RAM 介质有单面和双面两种类型可供使用。

2.6 GB 和 4.7 GB 的类型是单面的。9.4 GB 类型是双面的。要在介质的两面都存取数据，您必须从驱动器中取出该介质，将其翻过来，再重新插入驱动器中。

处理的预防措施

当处理取出的光盘时要小心。碎屑、灰尘颗粒、指纹、涂抹或刮花可能损害介质的刻录和回放。要清除灰尘或其它碎屑，请使用“CD 清洁工具包”。使用柔软的干布来清洁光盘。不要使用溶剂来清洁光盘表面。当给光盘标号时，只能使用软性的记号笔写在印刷的标签面上或光盘盒上。避免直接阳光照射、高温和潮湿。不要在光盘的任何一面贴标签。

在本驱动器中使用 CD 和 DVD

完成以下过程以读取数据光盘：

1. 打开计算机。
2. 按下驱动器顶部的打开 / 关闭按钮。
3. 将光盘或光盘盒插入托盘中，使其标签朝上。
4. 轻轻地合上顶盖以关闭驱动器。
5. 等待驱动器忙指示灯熄灭；然后双击**我的电脑**。
6. 双击 CD-ROM 或 DVD-RAM/DVD-R/DVD-RW 图标。

使用 DVD 播放器软件

本节描述了如何使用和定制 DVD 播放器软件。您可以在 *IBM USB 2.0 便携式多功能刻录机软件* 和 *用户指南超级 CD* 上的自述文件中找到 DVD 播放器软件的当前信息。

使用 DVD 功能

要使用 DVD 功能，您需要安装 WinDVD（DVD 媒体播放器程序）。

启用 Driver Letter Access (DLA)

所提供的 Drive Letter Access (DLA) 使您可以将数据写入 CD-R、CD-RW、DVD-RAM、DVD-RW 和 DVD-R 介质。DVD-RAM、DVD-RW、CD-RW、DVD-R 和 CD-R 介质可以写入许多次（DVD-R 和 CD-R 介质上的数据可一直追加到这些光盘满了为止）。

要格式化并写入 DVD-R、CD-R、DVD-RAM、DVD-RW 或 CD-RW 介质，请：

1. 将光盘插入驱动器。
2. 双击**我的电脑**。右键单击 USB 2.0 多功能刻录机盘符。
3. 单击**格式化**。格式化时间会根据使用的格式化过程（快速或完全）而有所不同。
4. 格式化完成后，您可以将文件拖放到 USB 2.0 多功能刻录机驱动器图标上，或可以将文件移到 Windows 资源管理器中。

要使 CD-R 介质在其它计算机中兼容：

1. 双击**我的电脑**。右键单击多功能刻录机的盘符。
2. 单击**使兼容**。

为了在其它计算机中使用 UDF 格式化的 DVD-RAM、DVD-RW 或 CD-RW 介质，IBM USB 2.0 便携式多功能刻录机软件 and 用户指南超级 CD 中包含了 UDF reader。IBM USB 2.0 便携式多功能刻录机软件 and 用户指南超级 CD 中要包括 UDF Reader。要使用 UDF Reader，请按照此过程进行操作：

1. 将 IBM USB 2.0 便携式多功能刻录机软件 and 用户指南超级 CD 插入您希望在其中使用 UDF 格式化光盘的计算机的 CD 或 DVD 驱动器中。
2. 单击**开始**。
3. 单击**运行**。
4. 输入 e:\UDF\language (此处 e 是 USB 2.0 多功能刻录机驱动器的盘符，language 是您所使用的语言)。
5. 单击**确定**。
6. 双击 **SETUP.EXE** 并按照屏幕上的指示信息操作。

注： 只有那些没有为 CD-RW 或 DVD-RW 安装另一个 DLA 程序的系统需要 UDF Reader。

使用 Intervideo WinDVD Creator Plus

通过 Intervideo WinDVD Creator Plus，可以捕获、编辑和刻录视频和音频文件。还可以通过 Intervideo WinDVD Creator Plus 来将自己的视频和音频文件创建和刻录成 DVD 视频。有关 Intervideo's WinDVD Creator Plus 功能的更多详细信息，请转至 IBM USB 2.0 便携式多功能刻录机软件 and 用户指南超级 CD 中的 WinDVD Creator Plus User's Guide。

WinDVD Creator Plus 主窗口中的主功能区域是“Capture”、“Edit”、“Author”和“Make Movie”。使用这些功能，可以导入和编辑自己的视频和音频文件，然后将它们保存为任何受支持的格式。受支持的格式包括 MPEG-1、MPEG-2、ASF、WMV 和 AVI。准备好视频和音频文件后，通过“Capture”和“Edit”步骤，就可以在“Author”功能中添加定制菜单。您可以导入自己的静态图像或选择样本图像之一作为菜单背景。当影片已准备就绪时，执行“Make Movie”，在此可以选择创建电影过程中使用的输出格式和视频标准。将电影刻录到光盘或将其保存在硬盘上以后再刻录。如果使用 WinDVD Creator Plus 在硬盘上创建 DVD 图像，可以在“Project”菜单中选择“Load Image to Burn”。

WinDVD Creator Plus 还提供使用“Disk Manager”将视频直接刻录到 DVD 可刻录介质的功能。完成此操作不需要使用任何额外的硬盘空间。使用 Disk Manager 可以捕获新的视频或使用已有的视频文件，然后通过创建定制菜单来完成电影。电影可以用 +VR 或 -VR 视频格式创建。通过 Disk Manager，可以在任何时候编辑电影（添加或删除视频片段或更改定制菜单）。

安装 WinDVD 和观看 DVD 电影

要安装 WinDVD，请转至 IBM USB 2.0 便携式多功能刻录机软件 and 用户指南超级 CD 上的“软件”部分。

安装多功能刻录机驱动器和 WinDVD 软件后，就可以观看 DVD 电影了。但是首先需要设置 DVD 内容的 DVD 区域代码。

DVD 区域代码

DVD 区域代码有助于保护 DVD 的内容。全球分为六个区域，特定的内容只能在相应的区域中观看。例如，区域 1 的内容只能在美国和加拿大观看。WinDVD 也是特定于区域的。

通过查看内容包装背面的区域代码符号可以验证内容的区域代码。

区域代码	区域
1	美国、加拿大
2	欧洲、中东、南非、日本
3	东南亚、台湾、韩国
4	拉丁美洲、澳大利亚、新西兰
5	前苏联、北非、印度
6	中华人民共和国

通过将 DVD 插入到驱动器中启动 WinDVD。区域代码会自动设置，于是您就可以观看电影了。这是初始设置。

在设置了区域代码后，如果插入具有不同区域代码的 DVD，则会提示您更改区域代码。可以将初始设置中的区域代码至多更改四次。

在更改初始设置中的区域代码四次后，它便固定下来，而不能再进行更改。此后，您只能播放该区域的 DVD 内容。

要显示区域代码状态，请单击 WinDVD 用户界面上的 **WinDVD 属性** 按钮。常规选项卡包含该信息。

要更改区域代码，请执行以下操作：

1. 打开计算机并启动操作系统。
2. 单击**开始**。
3. 选择**程序**。
4. 单击 **Intervideo WinDVD**。
5. 单击**属性**图标以打开**属性**窗口。
6. 单击**常规属性**选项卡。
7. 插入一张新区域的单区域 DVD。
8. 选择您国家或地区的正确的区域代码。
9. 单击**确定**。

启动 WinDVD

要启动 WinDVD，请完成以下过程：

1. 单击**开始**。
2. 单击**程序**。
3. 单击 **InterVideo WinDVD**。
4. 单击 **InterVideo WinDVD** 以打开 DVD 电影播放器窗口。

有关如何运行 DVD 电影播放器的更多信息，请参考 *IBM USB 2.0 便携式多功能刻录机软件* 和 *用户指南超级 CD* 上的 WinDVD 帮助信息。如果要用电视机观看 DVD 电影，请参考随计算机提供的联机信息。

注:

1. 您的计算机已配置为提供可用系统资源所能获得的最高质量的音频和视频回放。可以通过更改“控制面板”中的视频分辨率设置来改变缺省设置。某些系统没有足够的资源来在所有分辨率设置中提供最高质量的音频和视频回放。如果遇上较差的回放性能，请将分辨率调整为较低设置。
2. 音频或视频流由软件译码。音频和视频子系统必须功能齐全且已启用。

使用 CD-R 和 CD-RW 功能

多功能刻录机驱动器对 CD-R 和 CD-RW 光盘都可以写入。CD-R 光盘不能擦除，但可在标准的 CD-ROM 驱动器和 CD 播放器中使用。

可以使用 CD-R 光盘来刻录音频磁道、存储数据、归档文件以及从另一张 CD 复制文件。

CD-RW 光盘可以擦除和重写，但只能在较新的 MR 以及兼容 CD-RW 的 CD-ROM 和 DVD-ROM 驱动器中使用。可以使用 CD-RW 光盘来备份、存储和更新文件，或从另一张 CD 复制文件。

注:

1. CD-R 光盘可以在音频 CD 播放器上播放。CD-RW 光盘在大多数音频 CD 播放器中不可播放。
2. 本驱动器的软件不支持 DOS、Windows 3.x 或 IBM OS/2[®] 操作系统中的驱动器 CD 刻录功能。
3. 超高速 CD-RW 介质写入不受支持。

有关使用软件的更多信息，请参考 *IBM USB 2.0 便携式多功能刻录机软件* 和 *用户指南超级 CD* 上的 IBM RecordNow 和 IBM DLA 帮助信息。

使用 DVD-R 和 DVD-RW 功能

多功能刻录机驱动器对 DVD-R 和 DVD-RW 光盘都可以写入。DVD-R 光盘不能擦除，但可以在标准 DVD-ROM 驱动器和 DVD 播放器中使用。

可以使用 DVD-R 光盘来刻录音频磁道、存储数据、归档文件以及从另一张 DVD 复制文件。

DVD-RW 光盘可以擦除和重写，但只能在较新的 MR 和兼容 DVD-RW 的 DVD-ROM 驱动器中使用。可以使用 DVD-RW 光盘来备份、存储和更新文件或从另一张 DVD 复制文件。

有关使用软件的更多信息，请参考 *IBM USB 2.0 便携式多功能刻录机软件* 和 *用户指南超级 CD* 上的 IBM RecordNow 和 IBM DLA 帮助信息。

使用 DVD+R and DVD+RW 功能 (只读)

多功能刻录机驱动器可以读取 DVD+R 和 DVD+RW 光盘。

备份 CD 或 DVD

要复制商用 CD 或 DVD，您必须拥有版权或获得版权所有者的许可。如果没有版权，或未获得版权所有者的许可，则可能会侵犯版权法并可能要支付赔偿金或其它赔偿费。有关版权法的更多信息，请向您的法律顾问咨询。

问题解决

计算机问题可能由硬件、软件或用户错误造成。本节中的信息可能有助于您解决问题或搜集可以传递给服务技术人员的有用信息。您可能还需要参考计算机、操作系统或声音适配器的出版物。

请查看以下列表，以获取可能适合您的情况的任何问题描述。

不能创建多段光盘。

确保光盘上有足够的剩余空间用于另一段。除了要刻录的数据之外，写一段还需要引入和引出空间 (大约 15 MB)。

无法成功写入 CD-R、CD-RW、DVD-R、DVD-RW 或 DVD-RAM 光盘。

请采取以下操作：

1. 验证该过程未被屏幕保护程序、防病毒程序、因特网或电子邮件程序或其它软件中断。请禁用可能会中断写操作的功能。
2. 验证硬盘已进行了碎片整理。
3. 如果在写操作过程中，较旧的硬盘驱动器要进行热重新校准，请咨询硬盘驱动器制造商或供应商。
4. 如果光盘已坏或刮伤，请替换。
5. 禁用 CD-ROM 和 CD-RW 驱动器的“Windows 自动插入通告”功能。

不能弹出 CD 或 DVD 光盘。

在确保驱动器不在写光盘过程中后，请执行以下操作：

1. 通过软件弹出光盘。
2. 使用弹出按钮。
3. 关闭计算机。等待 45 秒；然后打开计算机，并再次尝试使用弹出按钮。
4. 如果其它方法不起作用，请使用紧急弹出杆。有关更多信息，请参阅第 4-1 页的第 4 章，『准备使用多功能刻录机』。

在成功写入 CD 或 DVD 光盘后而不能读取。

请采取以下操作：

1. 如果您能够在其它 CD 或 DVD 播放器中读取 CD 或 DVD 光盘，或者能够看见以前写入的段，则卷上的目录信息可能已损坏，而使其不可读。要获取故障诊断的方法，请查看随软件一起提供的文档。

2. 可能使用了损坏的 CD-R、CD-RW、DVD-R、DVD-RW 或 DVD-RAM 光盘。尝试使用新的光盘或其它品牌的 CD 或 DVD 光盘。
3. 如果可以读取在正在写入的驱动器中（而不是另一 MR 驱动器中）的 CD-RW、DVD-RW 或 DVD-RAM 光盘，请确保计算机中已安装了 UDF Reader 程序。
4. 避免以较慢的 1 倍速执行写操作，除非计算机要求这样。

附录 A. 产品规格

本附录包含以下信息:

- 物理规格
- 电源需求
- 环境需求
- 读速度
- 写速度

物理规格

该驱动器的物理规格¹已列出在下表中。

物理规格	
高度	15 mm (0.6 in.)
宽度	133 mm (5.2 in.)
长度	146 mm (5.7 in.)
重量	290 g (0.6 lb)

电源需求

下表按驱动器的电压级别列出了各电源规格。这些电源规格在驱动器的电源接口处测得，并且都是额定值。

电源规格	电压	平均值	最大值
交流电源	7.5V - 18V dc	1400 mA	2.5 A
辅助电源	5V dc	850 mA	1.3 A

环境需求

规格	运行时	非运行时
温度 (非冷凝)	+5° C 至 +35° C (+41° F 至 +90° F)	-20° C 至 +60° C (-4° F 至 +140° F)
相对湿度 (非冷凝)	8% 到 80%	5% 到 95%

1. 产品描述数据代表 IBM 的设计目标并提供用于比较的用途；实际结果可能基于各种因素而有所变化。本产品数据不构成保证。数据如有更改，恕不另行通知。

读速度

介质	读速度交流 / 辅助电源	USB 电源
DVD-ROM (单层)	最大 8X	最大 4X
DVD-ROM (双层)	最大 4X	最大 4X
DVD-R (4.7 GB)	最大 4X	最大 4X
DVD-RW (4.7 GB)	最大 4X	最大 4X
DVD-RAM (4.7 / 9.4 GB)	最大 2X	不适用
DVD-RAM (2.6 GB)	最大 1X	不适用
DVD+R	最大 4X	最大 4X
DVD+RW	最大 4X	最大 4X
CD-ROM	最大 24X	最大 10X
CD-R	最大 24x	最大 10X
CD-RW	最大 16X	最大 10X
CD-DA (DAE)	8X	4X

写速度

介质	写速度交流 / 辅助电源
DVD-R (一般使用, 650 nm)	2X
DVD-RW (V1.1)	1X
DVD-RAM (V2.1, 4.7 / 9.4 GB)	最大 2X
CD-R	最大 16X
CD-RW	10X

附录 B. Service and Support

The following information describes the technical support that is available for your product, during the warranty period or throughout the life of the product. Refer to your IBM Statement of Limited Warranty for a full explanation of IBM warranty terms.

Online technical support

Online technical support is available during the life of your product through the Personal Computing Support Web site at:

www-3.ibm.com/pc/support/site.wss/

During the warranty period, assistance for replacement or exchange of defective components is available. In addition, if your IBM option is installed in an IBM computer, you might be entitled to service at your location. Your technical support representative can help you determine the best alternative.

Telephone technical support

Installation and configuration support through the IBM HelpCenter[®] will be withdrawn or made available for a fee, at IBM's discretion, 90 days after the option has been withdrawn from marketing. Additional support offerings, including step-by-step installation assistance, are available for a nominal fee.

To assist the technical support representative, have available as much of the following information as possible:

- Option name
- Option number
- Proof of purchase
- Computer manufacturer, model, serial number (if IBM), and manual
- Exact wording of the error message (if any)
- Description of the problem
- Hardware and software configuration information for your system

If possible, be at your computer. Your technical support representative might want to walk you through the problem during the call.

For the support telephone number and support hours by country, refer to the following table. If the number for your country or region is not listed, contact your IBM reseller or IBM marketing representative. Response time may vary depending on the number and nature of the calls received.

Phone numbers are subject to change without notice. For the latest phone number list, go to www-3.ibm.com/pc/support/site.wss/ and click **Support Phone List**.

Country or Region	Telephone Number	Country or Region	Telephone Number
Argentina	0800-666-0011	Malaysia	03-7727-7800
Australia	1300-130-426	Mexico	001-866-434-2080
Austria	01-24592-5901	Netherlands	020-514-5770
Belgium	Dutch 02-210-9820 French 02-210-9800	New Zealand	0800-446-149
Bolivia	0800-0189	Norway	66 81 11 00
Brazil	55-11-3889-8986	Peru	0-800-50-866
Canada	1-800-565-3344 Toronto 416-383-3344	Philippines	632-995-2225
Chile	800-224-488	Portugal	21-791 51 47
China (PRC)	800-810-1818	Russia	095-940-2000
China (Hong Kong S.A.R.)	852-2825-7799	Singapore	1800-840-9911
Columbia	980-912-3021	Spain	91-662 49 16
Denmark	45 20 82 00	Sweden	08-477 4420
Ecuador	1-800-426911 (option #4)	Switzerland	058-333-09-00
Finland	09-459 69 60	Taiwan	886-2-2725-9799
France	02 38 55 74 50	Thailand	66-2-273-4000
Germany	07032-1549 201	Turkey	00-800-446-32-041
Indonesia	021-523-8535	United Kingdom	0-1475-555 055
Ireland	01-815-9202	United States	1-800-426-7378
Italy	02-7031-6101	Uruguay	000-411-005-6649
Japan	Consumer customers 0120-887-870 Business customers 0120-887-874	Venezuela	0-800-100-2011
Luxembourg	298-977 5063	Vietnam	848-8295-160

附录 C. IBM Statement of Limited Warranty - Z125-4753-07 - 11/2002

Part 1 - General Terms

*This Statement of Limited Warranty includes Part 1 - General Terms, Part 2 - Country-unique Terms, and Part 3 - Warranty Information. The terms of Part 2 replace or modify those of Part 1. The warranties provided by IBM in this Statement of Limited Warranty apply only to Machines you purchase for your use, and not for resale. The term "Machine" means an IBM machine, its features, conversions, upgrades, elements, or accessories, or any combination of them. The term "Machine" does not include any software programs, whether pre-loaded with the Machine, installed subsequently or otherwise. **Nothing in this Statement of Limited Warranty affects any statutory rights of consumers that cannot be waived or limited by contract.***

What this Warranty Covers

IBM warrants that each Machine 1) is free from defects in materials and workmanship and 2) conforms to IBM's Official Published Specifications ("Specifications") which are available on request. The warranty period for the Machine starts on the original Date of Installation and is specified in Part 3 - Warranty Information. The date on your invoice or sales receipt is the Date of Installation unless IBM or your reseller informs you otherwise. Many features, conversions, or upgrades involve the removal of parts and their return to IBM. A part that replaces a removed part will assume the warranty service status of the removed part. Unless IBM specifies otherwise, these warranties apply only in the country or region in which you purchased the Machine.

THESE WARRANTIES ARE YOUR EXCLUSIVE WARRANTIES AND REPLACE ALL OTHER WARRANTIES OR CONDITIONS, EXPRESS OR IMPLIED, INCLUDING, BUT NOT LIMITED TO, THE IMPLIED WARRANTIES OR CONDITIONS OF MERCHANTABILITY AND FITNESS FOR A PARTICULAR PURPOSE. SOME STATES OR JURISDICTIONS DO NOT ALLOW THE EXCLUSION OF EXPRESS OR IMPLIED WARRANTIES, SO THE ABOVE EXCLUSION MAY NOT APPLY TO YOU. IN THAT EVENT, SUCH WARRANTIES ARE LIMITED IN DURATION TO THE WARRANTY PERIOD. NO WARRANTIES APPLY AFTER THAT PERIOD. SOME STATES OR JURISDICTIONS DO NOT ALLOW LIMITATIONS ON HOW LONG AN IMPLIED WARRANTY LASTS, SO THE ABOVE LIMITATION MAY NOT APPLY TO YOU.

What this Warranty Does not Cover

This warranty does not cover the following:

- any software programs, whether pre-loaded or shipped with the Machine, or installed subsequently;

- failure resulting from misuse (including but not limited to use of any Machine capacity or capability, other than that authorized by IBM in writing), accident, modification, unsuitable physical or operating environment, or improper maintenance by you;
- failure caused by a product for which IBM is not responsible; and
- any non-IBM products, including those that IBM may procure and provide with or integrate into an IBM Machine at your request.

The warranty is voided by removal or alteration of identification labels on the Machine or its parts.

IBM does not warrant uninterrupted or error-free operation of a Machine.

Any technical or other support provided for a Machine under warranty, such as assistance via telephone with "how-to" questions and those regarding Machine set-up and installation, is provided **WITHOUT WARRANTIES OF ANY KIND**.

How to Obtain Warranty Service

If the Machine does not function as warranted during the warranty period, contact IBM or your reseller to obtain warranty service. If you do not register the Machine with IBM, you may be required to present proof of purchase as evidence of your entitlement to warranty service.

What IBM Will Do to Correct Problems

When you call for service, you must follow the problem determination and resolution procedures that IBM specifies. A technician will attempt to make an initial diagnosis of your problem and help you resolve it over the telephone.

The type of warranty service applicable to your Machine is specified in Part 3 - Warranty Information.

You are responsible for downloading and installing designated Machine Code (microcode, basic input/output system code (called "BIOS"), utility programs, device drivers, and diagnostics delivered with an IBM Machine) and other software updates from an IBM Internet Web site or from other electronic media, and following the instructions that IBM provides.

If your problem can be resolved with a Customer Replaceable Unit ("CRU") (e.g., keyboard, mouse, speaker, memory, hard disk drive and other easily replaceable parts), IBM will ship these parts to you for replacement by you.

If the Machine does not function as warranted during the warranty period and your problem cannot be resolved over the telephone, through your application of Machine Code or software updates, or with a CRU, IBM or your reseller, if approved by IBM to provide warranty service, will either, at its discretion, 1) repair it to make it function as warranted, or 2) replace it with one that is at least functionally equivalent. If IBM is unable to do either, you may return the Machine to your place of purchase and your money will be refunded.

IBM or your reseller will also manage and install selected engineering changes that apply to the Machine.

Exchange of a Machine or Part

When the warranty service involves the exchange of a Machine or part, the item IBM or your reseller replaces becomes its property and the replacement becomes yours. You represent that all removed items are genuine and unaltered. The replacement may not be new, but will be in good working order and at least functionally equivalent to the item replaced. The replacement assumes the warranty service status of the replaced item.

Your Additional Responsibilities

Before IBM or your reseller exchanges a Machine or part, you agree to remove all features, parts, options, alterations, and attachments not under warranty service.

You also agree to:

1. ensure that the Machine is free of any legal obligations or restrictions that prevent its exchange;
2. obtain authorization from the owner to have IBM or your reseller service a Machine that you do not own; and
3. where applicable, before service is provided:
 - a. follow the service request procedures that IBM or your reseller provides;
 - b. backup or secure all programs, data, and funds contained in the Machine;
 - c. IBM or your reseller with sufficient, free, and safe access to your facilities to permit IBM to fulfill its obligations; and
 - d. inform IBM or your reseller of changes in the Machine's location.
4. (a) ensure all information about identified or identifiable individuals (Personal Data) is deleted from the Machine (to the extent technically possible), (b) allow IBM, your reseller or an IBM supplier to process on your behalf any remaining Personal Data as IBM or your reseller considers necessary to fulfill its obligations under this Statement of Limited Warranty (which may include shipping the Machine for such processing to other IBM service locations around the world), and (c) ensure that such processing complies with any laws applicable to such Personal Data.

Limitation of Liability

IBM is responsible for loss of, or damage to, your Machine only while it is 1) in IBM's possession or 2) in transit in those cases where IBM is responsible for the transportation charges.

Neither IBM nor your reseller are responsible for any of your confidential, proprietary or personal information contained in a Machine which you return to IBM for any reason. You should remove all such information from the Machine prior to its return.

Circumstances may arise where, because of a default on IBM's part or other liability, you are entitled to recover damages from IBM. In each such instance, regardless of the basis on which you are entitled to claim damages from IBM (including fundamental breach, negligence, misrepresentation, or other contract or tort claim), except for any liability that cannot be waived or limited by applicable laws, IBM is liable for no more than

1. damages for bodily injury (including death) and damage to real property and tangible personal property; and
2. the amount of any other actual direct damages, up to the charges (if recurring, 12 months' charges apply) for the Machine that is subject of the claim. For purposes of this item, the term "Machine" includes Machine Code and Licensed Internal Code ("LIC").

This limit also applies to IBM's suppliers and your reseller. It is the maximum for which IBM, its suppliers, and your reseller are collectively responsible.

UNDER NO CIRCUMSTANCES IS IBM, ITS SUPPLIERS OR RESELLERS LIABLE FOR ANY OF THE FOLLOWING EVEN IF INFORMED OF THEIR POSSIBILITY: 1) THIRD PARTY CLAIMS AGAINST YOU FOR DAMAGES (OTHER THAN THOSE UNDER THE FIRST ITEM LISTED ABOVE); 2) LOSS OF, OR DAMAGE TO, DATA; 3) SPECIAL, INCIDENTAL, OR INDIRECT DAMAGES OR FOR ANY ECONOMIC CONSEQUENTIAL DAMAGES; OR 4) LOST PROFITS, BUSINESS REVENUE, GOODWILL OR ANTICIPATED SAVINGS. SOME STATES OR JURISDICTIONS DO NOT ALLOW THE EXCLUSION OR LIMITATION OF INCIDENTAL OR CONSEQUENTIAL DAMAGES, SO THE ABOVE LIMITATION OR EXCLUSION MAY NOT APPLY TO YOU. SOME STATES OR JURISDICTIONS DO NOT ALLOW LIMITATIONS ON HOW LONG AN IMPLIED WARRANTY LASTS, SO THE ABOVE LIMITATION MAY NOT APPLY TO YOU.

Governing Law

Both you and IBM consent to the application of the laws of the country in which you acquired the Machine to govern, interpret, and enforce all of your and IBM's rights, duties, and obligations arising from, or relating in any manner to, the subject matter of this Statement of Limited Warranty, without regard to conflict of law principles.

THESE WARRANTIES GIVE YOU SPECIFIC LEGAL RIGHTS AND YOU MAY ALSO HAVE OTHER RIGHTS WHICH VARY FROM STATE TO STATE OR JURISDICTION TO JURISDICTION.

Jurisdiction

All of our rights, duties, and obligations are subject to the courts of the country in which you acquired the Machine.

Part 2 - Country-unique Terms

AMERICAS

ARGENTINA

Governing Law: *The following is added after the first sentence:*

Any litigation arising from this Statement of Limited Warranty will be settled exclusively by the Ordinary Commercial Court of the city of Buenos Aires.

BRAZIL

Governing Law: *The following is added after the first sentence:*

Any litigation arising from this Statement of Limited Warranty will be settled exclusively by the court of Rio de Janeiro, RJ.

Peru

Limitation of Liability: *The following is added at the end of this section:*

In accordance with Article 1328 of the Peruvian Civil Code the limitations and exclusions specified in this section will not apply to damages caused by IBM's willful misconduct ("dolo") or gross negligence ("culpa inexcusable").

NORTH AMERICA

How to Obtain Warranty Service: *The following is added to this Section:*

To obtain warranty service from IBM in Canada or the United States, call 1-800-IBM-SERV (426-7378).

CANADA

Limitation of Liability: *The following replaces item 1 of this section:*

1. damages for bodily injury (including death) or physical harm to real property and tangible personal property caused by IBM's negligence; and

Governing Law: *The following replaces 'laws of the country in which you acquired the Machine' in the first sentence:*
laws in the Province of Ontario.

UNITED STATES

Governing Law: *The following replaces 'laws of the country in which you acquired the Machine' in the first sentence:*
laws of the State of New York.

ASIA PACIFIC

AUSTRALIA

What this Warranty Covers: *The following paragraph is added to this Section:*

The warranties specified in this Section are in addition to any rights you may have under the Trade Practices Act 1974 or other similar legislation and are only limited to the extent permitted by the applicable legislation.

Limitation of Liability: *The following is added to this Section:*

Where IBM is in breach of a condition or warranty implied by the Trade Practices Act 1974 or other similar legislation, IBM's liability is limited to the repair or replacement of the goods or the supply of equivalent goods. Where that condition or warranty relates to right to sell, quiet possession or clear title, or the goods are of a kind ordinarily acquired for personal, domestic or household use or consumption, then none of the limitations in this paragraph apply.

Governing Law: *The following replaces 『laws of the country in which you acquired the Machine』 in the first sentence:*

laws of the State or Territory.

CAMBODIA, LAOS, AND VIETNAM

Governing Law: *The following replaces 『laws of the country in which you acquired the Machine』 in the first sentence:*

laws of the State of New York, United States of America.

CAMBODIA, INDONESIA, LAOS, AND VIETNAM

Arbitration: The following is added under this heading:

Disputes arising out of or in connection with this Statement of Limited Warranty shall be finally settled by arbitration which shall be held in Singapore in accordance with the Arbitration Rules of Singapore International Arbitration Center ("SIAC Rules") then in effect. The arbitration award shall be final and binding for the parties without appeal and shall be in writing and set forth the findings of fact and the conclusions of law.

The number of arbitrators shall be three, with each side to the dispute being entitled to appoint one arbitrator. The two arbitrators appointed by the parties shall appoint a third arbitrator who shall act as chairman of the proceedings. Vacancies in the post of chairman shall be filled by the president of the SIAC. Other vacancies shall be filled by the respective nominating party. Proceedings shall continue from the stage they were at when the vacancy occurred.

If one of the parties refuses or otherwise fails to appoint an arbitrator within 30 days of the date the other party appoints its, the first appointed arbitrator shall be the sole arbitrator, provided that the arbitrator was validly and properly appointed.

All proceedings shall be conducted, including all documents presented in such proceedings, in the English language. The English language version of this Statement of Limited Warranty prevails over any other language version.

HONG KONG S.A.R. OF CHINA AND MACAU S.A.R. OF CHINA

Governing Law: *The following replaces 『laws of the country in which you acquired the Machine』 in the first sentence:*

laws of Hong Kong Special Administrative Region of China.

INDIA

Limitation of Liability: *The following replaces items 1 and 2 of this Section:*

1. liability for bodily injury (including death) or damage to real property and tangible personal property will be limited to that caused by IBM's negligence; and
2. as to any other actual damage arising in any situation involving nonperformance by IBM pursuant to, or in any way related to the subject of this Statement of Limited Warranty, , the charge paid by you for the individual Machine that is the subject of the claim. For purposes of this item, the term "Machine" includes Machine Code and Licensed Internal Code ("LIC").

Arbitration: *The following is added under this heading :*

Disputes arising out of or in connection with this Statement of Limited Warranty shall be finally settled by arbitration which shall be held in Bangalore, India in accordance with the laws of India then in effect. The arbitration award shall be final and binding for the parties without appeal and shall be in writing and set forth the findings of fact and the conclusions of law.

The number of arbitrators shall be three, with each side to the dispute being entitled to appoint one arbitrator. The two arbitrators appointed by the parties shall appoint a third arbitrator who shall act as chairman of the proceedings. Vacancies in the post of chairman shall be filled by the president of the Bar Council of India. Other vacancies shall be filled by the respective nominating party. Proceedings shall continue from the stage they were at when the vacancy occurred.

If one of the parties refuses or otherwise fails to appoint an arbitrator within 30 days of the date the other party appoints its, the first appointed arbitrator shall be the sole arbitrator, provided that the arbitrator was validly and properly appointed.

All proceedings shall be conducted, including all documents presented in such proceedings, in the English language. The English language version of this Statement of Limited Warranty prevails over any other language version.

JAPAN

Governing Law: *The following sentence is added to this section:*

Any doubts concerning this Statement of Limited Warranty will be initially resolved between us in good faith and in accordance with the principle of mutual trust.

MALAYSIA

Limitation of Liability: *The word "SPECIAL" in item 3 of the fifth paragraph is deleted.*

NEW ZEALAND

What this Warranty Covers: *The following paragraph is added to this section:*

The warranties specified in this section are in addition to any rights you may have under the Consumer Guarantees Act 1993 or other legislation which cannot be excluded or limited. The Consumer Guarantees Act 1993 will not apply in respect of any goods which IBM provides, if you require the goods for the purposes of a business as defined in that Act.

Limitation of Liability: *The following is added to this section:*

Where Machines are not acquired for the purposes of a business as defined in the Consumer Guarantees Act 1993, the limitations in this section are subject to the limitations in that Act.

PEOPLE'S REPUBLIC OF CHINA (PRC)

Governing Law: *The following replaces "laws of the country in which you acquired the Machine" in the first sentence:*

laws of the State of New York, United States of America (except when local law requires otherwise).

PHILIPPINES

Limitation of Liability: *Item 3 in the fifth paragraph is replaced by the following:*

SPECIAL (INCLUDING NOMINAL AND EXEMPLARY DAMAGES), MORAL, INCIDENTAL, OR INDIRECT DAMAGES FOR ANY ECONOMIC CONSEQUENTIAL DAMAGES; OR

Arbitration: The following is added under this heading

Disputes arising out of or in connection with this Statement of Limited Warranty shall be finally settled by arbitration which shall be held in Metro Manila, Philippines in accordance with the laws of the Philippines then in effect. The arbitration award shall be final and binding for the parties without appeal and shall be in writing and set forth the findings of fact and the conclusions of law.

The number of arbitrators shall be three, with each side to the dispute being entitled to appoint one arbitrator. The two arbitrators appointed by the parties shall appoint a third arbitrator who shall act as chairman of the proceedings. Vacancies in the post of chairman shall be filled by the president of the Philippine Dispute Resolution Center, Inc.. Other vacancies shall be filled by the respective nominating party. Proceedings shall continue from the stage they were at when the vacancy occurred.

If one of the parties refuses or otherwise fails to appoint an arbitrator within 30 days of the date the other party appoints its, the first appointed arbitrator shall be the sole arbitrator, provided that the arbitrator was validly and properly appointed.

All proceedings shall be conducted, including all documents presented in such proceedings, in the English language. The English language version of this Statement of Limited Warranty prevails over any other language version.

SINGAPORE

Limitation of Liability: The words "**SPECIAL**" and "**ECONOMIC**" in item 3 in the fifth paragraph are deleted.

EUROPE, MIDDLE EAST, AFRICA (EMEA)

THE FOLLOWING TERMS APPLY TO ALL EMEA COUNTRIES:

The terms of this Statement of Limited Warranty apply to Machines purchased from IBM or an IBM reseller.

Hot to Obtain Warranty Service: If you purchase a Machine in Austria, Belgium, Cyprus, Denmark, Estonia, Finland, France, Germany, Greece, Iceland, Ireland, Italy, Latvia, Liechtenstein, Lithuania, Luxembourg, Monaco, Netherlands, Norway, Portugal, Spain, San Marino, Sweden, Switzerland, United Kingdom or Vatican State, you may obtain warranty service for that Machine in any of those countries from either (1) an IBM reseller approved to perform warranty service or (2) from IBM, provided the Machine has been announced and made available by IBM in the country in which you wish to obtain service. If you

purchased a Personal Computer Machine in Albania, Armenia, Belarus, Bosnia and Herzegovina, Bulgaria, Croatia, Czech Republic, Georgia, Hungary, Kazakhstan, Kyrgyzstan, Federal Republic of Yugoslavia, Former Yugoslav Republic of Macedonia (FYROM), Moldova, Poland, Romania, Russia, Slovak Republic, Slovenia, or Ukraine, you may obtain warranty service for that Machine in any of those countries from either (1) an IBM reseller approved to perform warranty service or (2) from IBM.

If you purchase a Machine in a Middle Eastern or African country, you may obtain warranty service for that Machine from the IBM entity within the country of purchase, if that IBM entity provides warranty service in that country, or from an IBM reseller, approved by IBM to perform warranty service on that Machine in that country. Warranty service in Africa is available within 50 kilometers of an IBM approved service provider. You are responsible for transportation costs for Machines located outside 50 kilometers of an IBM approved service provider.

*Add the following paragraph in **Western Europe** (Austria, Belgium, Cyprus, Denmark, Finland, France, Germany, Greece, Iceland, Ireland, Italy, Liechtenstein, Luxembourg, Monaco, Netherlands, Norway, Portugal, Spain, San Marino, Sweden, Switzerland, United Kingdom, Vatican State):*

The warranty for Machines acquired in Western Europe shall be valid and applicable in all Western Europe countries provided the Machines have been announced and made available in such countries.

Governing Law:

The phrase "the laws of the country in which you acquired the Machine" is replaced by:

1) "the laws of Austria" in **Albania, Armenia, Azerbaijan, Belarus, Bosnia-Herzegovina, Bulgaria, Croatia, Georgia, Hungary, Kazakhstan, Kyrgyzstan, FYR Macedonia, Moldova, Poland, Romania, Russia, Slovakia, Slovenia, Tajikistan, Turkmenistan, Ukraine, Uzbekistan, and FR Yugoslavia;**
2) "the laws of France" in **Algeria, Benin, Burkina Faso, Cameroon, Cape Verde, Central African Republic, Chad, Comoros, Congo Republic, Djibouti, Democratic Republic of Congo, Equatorial Guinea, French Guiana, French Polynesia, Gabon, Gambia, Guinea, Guinea-Bissau, Ivory Coast, Lebanon, Madagascar, Mali, Mauritania, Mauritius, Mayotte, Morocco, New Caledonia, Niger, Reunion, Senegal, Seychelles, Togo, Tunisia, Vanuatu, and Wallis & Futuna;** 3) "the laws of Finland" in **Estonia, Latvia, and Lithuania;** 4) "the laws of England" in **Angola, Bahrain, Botswana, Burundi, Egypt, Eritrea, Ethiopia, Ghana, Jordan, Kenya, Kuwait, Liberia, Malawi, Malta, Mozambique, Nigeria, Oman, Pakistan, Qatar, Rwanda, Sao Tome, Saudi Arabia, Sierra Leone, Somalia, Tanzania, Uganda, United Arab Emirates, the United Kingdom, West Bank/Gaza, Yemen, Zambia, and Zimbabwe;** and 5) "the laws of South Africa" in **South Africa, Namibia, Lesotho and Swaziland.**

Jurisdiction: *The following exceptions are added to this section:*

1) **In Austria** the choice of jurisdiction for all disputes arising out of this Statement of Limited Warranty and relating thereto, including its existence, will be the competent court of law in Vienna, Austria (Inner-City); 2) **in Angola, Bahrain, Botswana, Burundi, Egypt, Eritrea, Ethiopia, Ghana, Jordan, Kenya, Kuwait, Liberia, Malawi, Malta, Mozambique, Nigeria, Oman, Pakistan, Qatar, Rwanda, Sao Tome, Saudi Arabia, Sierra Leone, Somalia, Tanzania, Uganda, United Arab Emirates, West Bank/Gaza, Yemen, Zambia, and Zimbabwe** all disputes arising out of this Statement of Limited Warranty or related to its execution, including summary proceedings, will be submitted to the exclusive jurisdiction of the English courts; 3) **in Belgium and Luxembourg**, all disputes arising out of this Statement of Limited Warranty or related to its interpretation or its execution, the law, and the courts of the capital city, of the country of your registered office and/or commercial site location only are competent; 4) **in France, Algeria, Benin, Burkina Faso, Cameroon, Cape Verde, Central African Republic, Chad, Comoros, Congo Republic, Djibouti, Democratic Republic of Congo, Equatorial Guinea, French Guiana, French Polynesia, Gabon, Gambia, Guinea, Guinea-Bissau, Ivory Coast, Lebanon, Madagascar, Mali, Mauritania, Mauritius, Mayotte, Morocco, New Caledonia, Niger, Reunion, Senegal, Seychelles, Togo, Tunisia, Vanuatu, and Wallis & Futuna** all disputes arising out of this Statement of Limited Warranty or related to its violation or execution, including summary proceedings, will be settled exclusively by the Commercial Court of Paris; 5) **in Russia**, all disputes arising out of or in relation to the interpretation, the violation, the termination, the nullity of the execution of this Statement of Limited Warranty shall be settled by Arbitration Court of Moscow; 6) **in South Africa, Namibia, Lesotho and Swaziland**, both of us agree to submit all disputes relating to this Statement of Limited Warranty to the jurisdiction of the High Court in Johannesburg; 7) **in Turkey** all disputes arising out of or in connection with this Statement of Limited Warranty shall be resolved by the Istanbul Central (Sultanahmet) Courts and Execution Directorates of Istanbul, the Republic of Turkey; 8) in each of the following specified countries, any legal claim arising out of this Statement of Limited Warranty will be brought before, and settled exclusively by, the competent court of a) Athens for **Greece**, b) Tel Aviv-Jaffa for **Israel**, c) Milan for **Italy**, d) Lisbon for **Portugal**, and e) Madrid for **Spain**; and 9) **in the United Kingdom**, both of us agree to submit all disputes relating to this Statement of Limited Warranty to the jurisdiction of the English courts.

Arbitration: *The following is added under this heading:*

In Albania, Armenia, Azerbaijan, Belarus, Bosnia-Herzegovina, Bulgaria, Croatia, Georgia, Hungary, Kazakhstan, Kyrgyzstan, FYR Macedonia, Moldova, Poland, Romania, Russia, Slovakia, Slovenia, Tajikistan, Turkmenistan, Ukraine, Uzbekistan, and FR Yugoslavia all disputes arising out of this Statement of Limited Warranty or related to its violation, termination or nullity will be finally settled under the Rules of Arbitration and Conciliation of the International Arbitral Center of the Federal Economic Chamber in Vienna (Vienna Rules) by three arbitrators appointed in accordance with these rules. The arbitration will be held in Vienna, Austria, and the official language of the proceedings will be English. The decision of the arbitrators will be final and binding upon both parties. Therefore, pursuant to paragraph 598 (2) of the Austrian Code of Civil Procedure, the parties expressly waive the application of paragraph 595 (1) figure 7 of the Code. IBM may, however, institute proceedings in a competent court in the country of installation.

In Estonia, Latvia and Lithuania all disputes arising in connection with this Statement of Limited Warranty will be finally settled in arbitration that will be held in Helsinki, Finland in accordance with the arbitration laws of Finland then in effect. Each party will appoint one arbitrator. The arbitrators will then jointly appoint the chairman. If arbitrators cannot agree on the chairman, then the Central Chamber of Commerce in Helsinki will appoint the chairman.

EUROPEAN UNION (EU)

THE FOLLOWING TERMS APPLY TO ALL EU COUNTRIES:

Consumers have legal rights under applicable national legislation governing the sale of consumer goods. Such rights are not affected by the warranties provided in this Statement of Limited Warranty.

How to Obtain Warranty Service: *The following is added to this section:*

To obtain warranty service from IBM in EU countries, see the telephone listing in Part 3 - Warranty Information.

You may contact IBM at the following address:

IBM Warranty & Service Quality Dept.

PO Box 30

Spango Valley

Greenock

Scotland PA 16 OAH

AUSTRIA, DENMARK, FINLAND, GREECE, ITALY, NETHERLANDS, PORTUGAL, SPAIN, SWEDEN AND SWITZERLAND

Limitation of Liability: *The following replaces the terms of this section in its entirety:*

Except as otherwise provided by mandatory law:

1. IBM's liability for any damages and losses that may arise as a consequence of the fulfillment of its obligations under or in connection with this Statement of Limited Warranty or due to any other cause related to this Statement of Limited Warranty is limited to the compensation of only those damages and losses proved and actually arising as an immediate and direct consequence of the non-fulfillment of such obligations (if IBM is at fault) or of such cause, for a maximum amount equal to the charges you paid for the Machine. For purposes of this item, the term "Machine" includes Machine Code and Licensed Internal Code ("LIC").

The above limitation shall not apply to damages for bodily injuries (including death) and damages to real property and tangible personal property for which IBM is legally liable.

2. **UNDER NO CIRCUMSTANCES IS IBM, ITS SUPPLIERS OR RESELLERS LIABLE FOR ANY OF THE FOLLOWING, EVEN IF INFORMED OF THEIR**

POSSIBILITY: 1) LOSS OF, OR DAMAGE TO, DATA; 2) INCIDENTAL OR INDIRECT DAMAGES, OR FOR ANY ECONOMIC CONSEQUENTIAL DAMAGES; 3) LOST PROFITS, EVEN IF THEY ARISE AS AN IMMEDIATE CONSEQUENCE OF THE EVENT THAT GENERATED THE DAMAGES; OR 4) LOSS OF BUSINESS, REVENUE, GOODWILL, OR ANTICIPATED SAVINGS.

FRANCE AND BELGIUM

Limitation of Liability: *The following replaces the terms of this section in its entirety:*

Except as otherwise provided by mandatory law:

1. IBM's liability for any damages and losses that may arise as a consequence of the fulfillment of its obligations under or in connection with this Statement of Limited Warranty is limited to the compensation of only those damages and losses proved and actually arising as an immediate and direct consequence of the non-fulfillment of such obligations (if IBM is at fault), for a maximum amount equal to the charges you paid for the Machine that has caused the damages. For purposes of this item, the term "Machine" includes Machine Code and Licensed Internal Code ("LIC").

The above limitation shall not apply to damages for bodily injuries (including death) and damages to real property and tangible personal property for which IBM is legally liable.

2. **UNDER NO CIRCUMSTANCES IS IBM, ITS SUPPLIERS OR RESELLERS LIABLE FOR ANY OF THE FOLLOWING, EVEN IF INFORMED OF THEIR POSSIBILITY: 1) LOSS OF, OR DAMAGE TO, DATA; 2) INCIDENTAL OR INDIRECT DAMAGES, OR FOR ANY ECONOMIC CONSEQUENTIAL DAMAGES; 3) LOST PROFITS, EVEN IF THEY ARISE AS AN IMMEDIATE CONSEQUENCE OF THE EVENT THAT GENERATED THE DAMAGES; OR 4) LOSS OF BUSINESS, REVENUE, GOODWILL, OR ANTICIPATED SAVINGS.**

THE FOLLOWING TERMS APPLY TO THE COUNTRY SPECIFIED:

AUSTRIA

What this Warranty Covers: *The following replaces the first sentence of the first paragraph of this section:*

The warranty for an IBM Machine covers the functionality of the Machine for its normal use and the Machine's conformity to its Specifications.

The following paragraphs are added to this Section:

The minimum warranty period for Machines is 12 months from the date of delivery. . The limitation period for consumers in action for breach of warranty is the statutory period as a minimum. In case IBM or your reseller is unable to repair an IBM Machine, you can alternatively ask for a partial refund as far as justified by the reduced value of the unrepaired Machine or ask for a cancellation of the respective agreement for such Machine and get your money refunded.

The second paragraph does not apply.

What IBM Will Do to Correct Problems: *The following is added to this section:*

During the warranty period, transportation for delivery of the failing Machine to IBM will be at IBM's expense.

Limitation of Liability: *The following paragraph is added to this section:*

The limitations and exclusions specified in the Statement of Limited Warranty will not apply to damages caused by IBM with fraud or gross negligence and for express warranty.

The following sentence is added to the end of item 2:

IBM's liability under this item is limited to the violation of essential contractual terms in cases of ordinary negligence.

EGYPT

Limitation of Liability: *The following replaces item 2 in this section:*

as to any other actual direct damages, IBM's liability will be limited to the total amount you paid for the Machine that is the subject of the claim. For purposes of this item, the term 『Machine』 includes Machine Code and Licensed Internal Code (LIC).

Applicability of suppliers and resellers (unchanged).

FRANCE

Limitation of Liability: *The following replaces the second sentence of the first paragraph of this section:*

In such instances, regardless of the basis on which you are entitled to claim damages from IBM, IBM is liable for no more than: *(items 1 and 2 unchanged).*

GERMANY

What this Warranty Covers: *The following replaces the first sentence of the first paragraph of this section:*

The warranty for an IBM Machine covers the functionality of the Machine for its normal use and the Machine's conformity to its Specifications.

The following paragraphs are added to this section:

The minimum warranty period for Machines is twelve months. In case IBM or your reseller is unable to repair an IBM Machine, you can alternatively ask for a partial refund as far as justified by the reduced value of the unrepaired Machine or ask for a cancellation of the respective agreement for such Machine and get your money refunded.

The second paragraph does not apply.

What IBM Will Do to Correct Problems: *The following is added to this section:*

During the warranty period, transportation for delivery of the failing Machine to IBM will be at IBM's expense.

Limitation of Liability: *The following paragraph is added to this section:*

The limitations and exclusions specified in the Statement of Limited Warranty will not apply to damages caused by IBM with fraud or gross negligence and for express warranty.

The following sentence is added to the end of item 2:

IBM's liability under this item is limited to the violation of essential contractual terms in cases of ordinary negligence.

HUNGARY

Limitation of Liability: *The following is added at the end of this section:*

The limitation and exclusion specified herein shall not apply to liability for a breach of contract damaging life, physical well-being, or health that has been caused intentionally, by gross negligence, or by a criminal act.

The parties accept the limitations of liability as valid provisions and state that the Section 314.(2) of the Hungarian Civil Code applies as the acquisition price as well as other advantages arising out of the present Statement of Limited Warranty balance this limitation of liability.

IRELAND

What this Warranty Covers: *The following is added to this section:*

Except as expressly provided in these terms and conditions, all statutory conditions, including all warranties implied, but without prejudice to the generality of the foregoing all warranties implied by the Sale of Goods Act 1893 or the Sale of Goods and Supply of Services Act 1980 are hereby excluded.

Limitation of Liability: *The following replaces the terms of this section in its entirety:*

For the purposes of this section, a "Default" means any act, statement, omission, or negligence on the part of IBM in connection with, or in relation to, the subject matter of this Statement of Limited Warranty in respect of which IBM is legally liable to you, whether in contract or tort. A number of Defaults which together result in, or contribute to, substantially the same loss or damage will be treated as one Default occurring on the date of occurrence of the last such Default.

Circumstances may arise where, because of a Default, you are entitled to recover damages from IBM.

This section sets out the extent of IBM's liability and your sole remedy.

1. IBM will accept unlimited liability for death or personal injury caused by the negligence of IBM.
2. Subject always to the Items for Which IBM is Not Liable below, IBM will accept unlimited liability for physical damage to your tangible property resulting from the negligence of IBM.
3. Except as provided in items 1 and 2 above, IBM's entire liability for actual damages for any one Default will not in any event exceed the greater of 1) EUR 125,000, or 2) 125% of the amount you paid for the Machine directly relating to the Default.

Items for Which IBM is Not Liable

Save with respect to any liability referred to in item 1 above, under no circumstances is IBM, its suppliers or resellers liable for any of the following, even if IBM or they were informed of the possibility of such losses:

1. loss of, or damage to, data;
2. special, indirect, or consequential loss; or
3. loss of profits, business, revenue, goodwill, or anticipated savings.

SLOVAKIA

Limitation of Liability: *The following is added to the end of the last paragraph:*

The limitations apply to the extent they are not prohibited under §§ 373-386 of the Slovak Commercial Code.

SOUTH AFRICA, NAMIBIA, BOTSWANA, LESOTHO AND SWAZILAND

Limitation of Liability: *The following is added to this section:*

IBM's entire liability to you for actual damages arising in all situations involving nonperformance by IBM in respect of the subject matter of this Statement of Warranty will be limited to the charge paid by you for the individual Machine that is the subject of your claim from IBM.

UNITED KINGDOM

Limitation of Liability: *The following replaces the terms of this section in its entirety:*

For the purposes of this section, a "Default" means any act, statement, omission, or negligence on the part of IBM in connection with, or in relation to, the subject matter of this Statement of Limited Warranty in respect of which IBM is legally liable to you, whether in contract or tort. A number of Defaults which together result in, or contribute to, substantially the same loss or damage will be treated as one Default.

Circumstances may arise where, because of a Default, you are entitled to recover damages from IBM.

This section sets out the extent of IBM's liability and your sole remedy.

1. IBM will accept unlimited liability for:
 - a. death or personal injury caused by the negligence of IBM; and
 - b. any breach of its obligations implied by Section 12 of the Sale of Goods Act 1979 or Section 2 of the Supply of Goods and Services Act 1982, or any statutory modification or re-enactment of either such Section.
2. IBM will accept unlimited liability, subject always to the Items for Which IBM is Not Liable below, for physical damage to your tangible property resulting from the negligence of IBM.

3. IBM's entire liability for actual damages for any one Default will not in any event, except as provided in items 1 and 2 above, exceed the greater of 1) Pounds Sterling 75,000, or 2) 125% of the total purchase price payable or the charges for the Machine directly relating to the Default.

These limits also apply to IBM's suppliers and resellers. They state the maximum for which IBM and such suppliers and resellers are collectively responsible.

Items for Which IBM is Not Liable

Save with respect to any liability referred to in item 1 above, under no circumstances is IBM or any of its suppliers or resellers liable for any of the following, even if IBM or they were informed of the possibility of such losses:

1. loss of, or damage to, data:
2. special, indirect, or consequential loss; or
3. loss of profits, business, revenue, goodwill, or anticipated savings.

Part 3 - Warranty Information

This Part 3 provides information regarding the warranty applicable to your Machine, including the warranty period and type of warranty service IBM provides.

Warranty Period

The warranty period may vary by country or region and is specified in the table below. NOTE: "Region" means either Hong Kong or Macau Special Administrative Region of China.

IBM USB 2.0 Portable Multi-Burner

Country or Region of Purchase	Warranty Period	Type of Warranty Service
Worldwide	1 year	1, 4

A warranty period of 1 year on parts and 1 year on labor means that IBM provides warranty service without charge for parts and labor during the 1 year warranty period.

Types of Warranty Service

If required, IBM provides repair or exchange service depending on the type of warranty service specified for your Machine in the above table and as described below. Warranty service may be provided by your reseller if approved by IBM to perform warranty service. Scheduling of service will depend upon the time of your call and is subject to parts availability. Service levels are response time objectives and are not guaranteed. The specified level of warranty service may not be available in all worldwide locations, additional charges may apply outside IBM's normal service area, contact your local IBM representative or your reseller for country and location specific information.

1. Customer Replaceable Unit ("CRU") Service

IBM will ship CRU parts to you for your replacement. If IBM instructs you to return the replaced CRU, you are responsible for returning it to IBM in accordance with IBM's instructions. If you do not return the defective CRU, if IBM so instructs, within 30 days of your receipt of the replacement CRU, IBM may charge you for the replacement.

2. On-site Service

IBM or your reseller will either repair or exchange the failing Machine at your location and verify its operation. You must provide suitable working area to allow disassembly and reassembly of the IBM Machine. The area must be clean, well lit and suitable for the purpose. **For some Machines, certain repairs may require sending the Machine to an IBM service center.**

3. Courier or Depot Service¹

You will disconnect the failing Machine for collection arranged by IBM. IBM will provide you with a shipping container for you to return your Machine to a designated service center. A courier will pick up your Machine and deliver it to the designated service center. Following its repair or exchange, IBM will arrange the return delivery of the Machine to your location. You are responsible for its installation and verification.

4. Customer Carry-In or Mail-In Service

You will deliver or mail as IBM specifies (prepaid unless IBM specifies otherwise) the failing Machine suitably packaged to a location IBM designates. After IBM has repaired or exchanged the Machine, IBM will make it available for your collection or, for Mail-in Service, IBM will return it to you at IBM's expense, unless IBM specifies otherwise. You are responsible for the subsequent installation and verification of the Machine.

The IBM Machine Warranty worldwide web site at http://www.ibm.com/servers/support/machine_warranties/ provides a worldwide overview of IBM's Limited Warranty for Machines, a Glossary of IBM definitions, Frequently Asked Questions (FAQs) and Support by Product (Machine) with links to Product Support pages. **The IBM Statement of Limited Warranty is also available on this site in 29 languages.**

To obtain warranty service contact IBM or your IBM reseller. In Canada or the United States, call 1-800-IBM-SERV (426-7378). For other countries, see the telephone numbers below.

Phone numbers are subject to change without notice. For the latest phone number list, go to www-3.ibm.com/pc/support/site.wss/ and click **Support Phone List**.

Country or Region	Telephone Number	Country or Region	Telephone Number
Argentina	0800-666-0011	Malaysia	03-7727-7800
Australia	1300-130-426	Mexico	001-866-434-2080
Austria	01-24592-5901	Netherlands	020-514-5770

1. This type of service is called ThinkPad EasyServ or EasyServ in some countries.

Country or Region	Telephone Number	Country or Region	Telephone Number
Belgium	Dutch 02-210-9820	New Zealand	0800-446-149
	French 02-210-9800		
Bolivia	0800-0189	Norway	66 81 11 00
Brazil	55-11-3889-8986	Peru	0-800-50-866
Canada	1-800-565-3344	Philippines	632-995-2225
	Toronto 416-383-3344		
Chile	800-224-488	Portugal	21-791 51 47
China (PRC)	800-810-1818	Russia	095-940-2000
China (Hong Kong S.A.R.)	852-2825-7799	Singapore	1800-840-9911
Columbia	980-912-3021	Spain	91-662 49 16
Denmark	45 20 82 00	Sweden	08-477 4420
Ecuador	1-800-426911 (option #4)	Switzerland	058-333-09-00
Finland	09-459 69 60	Taiwan	886-2-2725-9799
France	02 38 55 74 50	Thailand	66-2-273-4000
Germany	07032-1549 201	Turkey	00-800-446-32-041
Indonesia	021-523-8535	United Kingdom	0-1475-555 055
Ireland	01-815-9202	United States	1-800-426-7378
Italy	02-7031-6101	Uruguay	000-411-005-6649
Japan	Consumer customers 0120-887-870	Venezuela	0-800-100-2011
	Business customers 0120-887-874		
Luxembourg	298-977 5063	Vietnam	848-8295-160

附录 D. Notices

IBM may not offer the products, services, or features discussed in this document in all countries. Consult your local IBM representative for information on the products and services currently available in your area. Any reference to an IBM product, program, or service is not intended to state or imply that only that IBM product, program, or service may be used. Any functionally equivalent product, program, or service that does not infringe any IBM intellectual property right may be used instead. However, it is the user's responsibility to evaluate and verify the operation of any non-IBM product, program, or service.

IBM may have patents or pending patent applications covering subject matter described in this document. The furnishing of this document does not give you any license to these patents. You can send license inquiries, in writing, to:

*IBM Director of Licensing
IBM Corporation
North Castle Drive
Armonk, NY 10504-1785
U.S.A.*

INTERNATIONAL BUSINESS MACHINES CORPORATION PROVIDES THIS PUBLICATION 『AS IS』 WITHOUT WARRANTY OF ANY KIND, EITHER EXPRESS OR IMPLIED, INCLUDING, BUT NOT LIMITED TO, THE IMPLIED WARRANTIES OF NON-INFRINGEMENT, MERCHANTABILITY OR FITNESS FOR A PARTICULAR PURPOSE. Some jurisdictions do not allow disclaimer of express or implied warranties in certain transactions, therefore, this statement may not apply to you.

This information could include technical inaccuracies or typographical errors. Changes are periodically made to the information herein; these changes will be incorporated in new editions of the publication. IBM may make improvements and/or changes in the product(s) and/or the program(s) described in this publication at any time without notice.

The products described in this document are not intended for use in implantation or other life support applications where malfunction may result in injury or death to persons. The information contained in this document does not affect or change IBM product specifications or warranties. Nothing in this document shall operate as an express or implied license or indemnity under the intellectual property rights of IBM or third parties. All information contained in this document was obtained in specific environments and is presented as an illustration. The result obtained in other operating environments may vary.

IBM may use or distribute any of the information you supply in any way it believes appropriate without incurring any obligation to you.

Any references in this publication to non-IBM Web sites are provided for convenience only and do not in any manner serve as an endorsement of those Web sites. The materials at those Web sites are not part of the materials for this IBM product, and use of those Web sites is at your own risk.

Any performance data contained herein was determined in a controlled environment. Therefore, the result obtained in other operating environments may vary significantly. Some measurements may have been made on development-level systems and there is no guarantee that these measurements will be the same on generally available systems. Furthermore, some measurements may have been estimated through extrapolation. Actual results may vary. Users of this document should verify the applicable data for their specific environment.

Trademarks

The following terms are trademarks of International Business Machines Corporation in the United States, other countries, or both:

HelpCenter
IBM
IBM logo
OS/2
ThinkPad

Microsoft and Windows are trademarks of Microsoft Corporation in the United States, other countries, or both.

Pentium is a trademark of Intel Corporation in the United States, other countries, or both.

Other company, product, or service names may be trademarks or service marks of others.

Electronic emission notices

IBM USB 2.0 Portable Multi-Burner

Federal Communications Commission (FCC) statement

Note: This equipment has been tested and found to comply with the limits for a Class B digital device, pursuant to Part 15 of the FCC Rules. These limits are designed to provide reasonable protection against harmful interference in a residential installation. This equipment generates, uses, and can radiate radio frequency energy and, if not installed and used in accordance with the instructions, may cause harmful interference to radio communications. However, there is no guarantee that interference will not occur in a particular installation. If this equipment does cause harmful interference to radio or television reception, which can be determined by turning the equipment off and on, the user is encouraged to try to correct the interference by one or more of the following measures:

- Reorient or relocate the receiving antenna.
- Increase the separation between the equipment and receiver.
- Connect the equipment into an outlet on a circuit different from that to which the receiver is connected.
- Consult an IBM authorized dealer or service representative for help.

Properly shielded and grounded cables and connectors must be used in order to meet FCC emission limits. Proper cables and connectors are available from IBM authorized dealers. IBM is not responsible for any radio or television interference caused by using other than

recommended cables and connectors or by unauthorized changes or modifications to this equipment. Unauthorized changes or modifications could void the user's authority to operate the equipment.

This device complies with Part 15 of the FCC Rules. Operation is subject to the following two conditions: (1) this device may not cause harmful interference, and (2) this device must accept any interference received, including interference that may cause undesired operation.

Responsible party:

International Business Machines Corporation
New Orchard Road
Armonk, NY 10504
Telephone: 1-919-543-2193



Tested To Comply
With FCC Standards

FOR HOME OR OFFICE USE

Industry Canada Class B emission compliance statement

This Class B digital apparatus complies with Canadian ICES-003.

Avis de conformite a la reglementation d'Industrie Canada

Cet appareil numérique de la classe B est conforme à la norme NMB-003 du Canada.

Deutsche EMV-Direktive (electromagnetische Verträglichkeit)

Zulassungsbesccheinigung laut dem Deutschen Gesetz über die elektromagnetische Verträglichkeit von Geräten (EMVG) vom 30. August 1995 (bzw. der EMC EG Richtlinie 89/336):

Dieses Gerät ist berechtigt in Übereinstimmung mit dem Deutschen EMVG das EG-Konformitätszeichen - CE - zu führen. Verantwortlich für die Konformitätserklärung nach Paragraph 5 des EMVG ist die:

IBM Deutschland Informationssysteme GmbH, 70548 Stuttgart.

Informationen in Hinsicht EMVG Paragraph 3 Abs. (2) 2:

Das Gerät erfüllt die Schutzanforderungen nach EN 55024:1998 und EN 55022:1998 Klasse B.
--

EN 55022 Hinweis:

『 Wird dieses Gerät in einer industriellen Umgebung betrieben (wie in EN 55022:B festgelegt), dann kann es dabei eventuell gestört werden. In solch einem FA11 ist der Abstand bzw. die Abschirmung zu der industriellen Störquelle zu vergrößern. 』

Anmerkung:

Um die Einhaltung des EMVG sicherzustellen sind die Geräte, wie in den IBM Handbüchern angegeben, zu installieren und zu betreiben.

European Union - emission directive

This product is in conformity with the protection requirements of EU Council Directive 89/336/ECC on the approximation of the laws of the Member States relating to electromagnetic compatibility.

IBM can not accept responsibility for any failure to satisfy the protection requirements resulting from a non-recommended modification of the product, including the fitting of non-IBM option cards.

This product has been tested and found to comply with the limits for Class B Information Technology Equipment according to European Standard EN 55022. The limits for Class B equipment were derived for typical residential environments to provide reasonable protection against interference with licensed communication devices.

Union Européenne - Directive Conformité électromagnétique

Ce produit est conforme aux exigences de protection de la Directive 89/336/EEC du Conseil de l'UE sur le rapprochement des lois des États membres en matière de compatibilité électromagnétique.

IBM ne peut accepter aucune responsabilité pour le manquement aux exigences de protection résultant d'une modification non recommandée du produit, y compris l'installation de cartes autres que les cartes IBM.

Ce produit a été testé et il satisfait les conditions de l'équipement informatique de Classe B en vertu de Standard européen EN 55022. Les conditions pour l'équipement de Classe B ont été définies en fonction d'un contexte résidentiel ordinaire afin de fournir une protection raisonnable contre l'interférence d'appareils de communication autorisés.

Unione Europea - Directiva EMC (Conformidad electromagnética)

Este producto satisface los requisitos de protección del Consejo de la UE, Directiva 89/336/CEE en lo que a la legislación de los Estados Miembros sobre compatibilidad electromagnética se refiere.

IBM no puede aceptar responsabilidad alguna si este producto deja de satisfacer dichos requisitos de protección como resultado de una modificación no recomendada del producto, incluyendo el ajuste de tarjetas de opción que no sean IBM.

Este producto ha sido probado y satisface los límites para Equipos Informáticos Clase B de conformidad con el Estándar Europeo EN 55022. Los límites para los equipos de Clase B se han establecido para entornos residenciales típicos a fin de proporcionar una protección razonable contra las interferencias con dispositivos de comunicación licenciados.

Union Europea - Normativa EMC

Questo prodotto è conforme alle normative di protezione ai sensi della Direttiva del Consiglio dell'Unione Europea 89/336/CEE sull'armonizzazione legislativa degli stati membri in materia di compatibilità elettromagnetica.

IBM non accetta responsabilità alcuna per la mancata conformità alle normative di protezione dovuta a modifiche non consigliate al prodotto, compresa l'installazione di schede e componenti di marca diversa da IBM.

Le prove effettuate sul presente prodotto hanno accertato che esso rientra nei limiti stabiliti per le apparecchiature di informatica Classe B ai sensi della Norma Europea EN 55022. I limiti delle apparecchiature della Classe B sono stati stabiliti al fine di fornire ragionevole protezione da interferenze mediante dispositivi di comunicazione in concessione in ambienti residenziali tipici.

이 기기는 가정용으로 전자파 적합등록을 한 기기로서
주거지역에서는 물론 모든 지역에서 사용할 수 있습니다.

この装置は、情報処理装置等電波障害自主規制協議会（VCCI）の基準に基づきクラスB情報技術装置です。この装置は、家庭環境で使用することを目的としていますが、この装置がラジオやテレビジョン受信機に近接して使用されると、受信障害を引き起こすことがあります。
取扱説明書に従って正しい取り扱いをして下さい。

Japanese statement of compliance for products less than or equal to 20 A per phase

高調波ガイドライン適合品



部件号: 22P9176

中国印刷

(1P) P/N: 22P9176

