

IBM @server xSeries Rack



# Planning Guide



IBM @server xSeries Rack



# Planning Guide

**Note:** Before using this information and the product it supports, be sure to read the notices information in Appendix C, "Notices," on page 55.

**Fourth Edition (October 2004)**

**© Copyright International Business Machines Corporation 2001, 2004. All rights reserved.**

US Government Users Restricted Rights – Use, duplication or disclosure restricted by GSA ADP Schedule Contract with IBM Corp.

---

# Contents

<b>Safety</b> . . . . .	v
<b>Chapter 1. Introduction</b> . . . . .	1
NetBAY11 racks . . . . .	1
IBM S2 25U racks . . . . .	2
IBM S2 42U racks . . . . .	3
IBM NetBAY42 enterprise racks . . . . .	5
<b>Chapter 2. Planning for your rack</b> . . . . .	7
Defining rack physical dimensions and clearances . . . . .	8
Defining rack electrical requirements . . . . .	14
Defining rack and optional-device limitations . . . . .	15
<b>Chapter 3. Preparing a location for your rack</b> . . . . .	17
Creating a floor plan . . . . .	18
Moving a NetBAY11 rack . . . . .	19
Moving an S2 25U or 42U rack . . . . .	20
Moving a NetBAY42 enterprise rack . . . . .	22
<b>Chapter 4. Preparing to install optional devices</b> . . . . .	25
Using the rack-mounting flanges . . . . .	25
Installing threaded rails . . . . .	27
Installing cage nuts . . . . .	27
Installing clip nuts . . . . .	29
<b>Chapter 5. Thermal management</b> . . . . .	31
Getting started . . . . .	31
Thermal management for servers . . . . .	31
Thermal management for racks . . . . .	32
Thermal management for the facility . . . . .	32
Hot-aisle, cold-aisle air delivery path . . . . .	33
Floor-tile placement . . . . .	35
Balancing heat load . . . . .	36
<b>Appendix A. Optional device specifications</b> . . . . .	37
Console kits . . . . .	37
Console switches . . . . .	38
Distributed Power Interconnect PDUs . . . . .	39
PDU specifications . . . . .	40
PDU connector and outlet information . . . . .	44
Uninterruptible power supplies . . . . .	48
<b>Appendix B. Getting help and technical assistance</b> . . . . .	53
Before you call . . . . .	53
Using the documentation . . . . .	53
Getting help and information from the World Wide Web . . . . .	54
Software service and support . . . . .	54
Hardware service and support . . . . .	54
<b>Appendix C. Notices</b> . . . . .	55
Edition notice . . . . .	55
Trademarks . . . . .	56
Important notes . . . . .	56



## Safety

Before installing this product, read the Safety Information.

قبل تركيب هذا المنتج، يجب قراءة الملاحظات الأمنية

Antes de instalar este produto, leia as Informações de Segurança.

在安装本产品之前，请仔细阅读 **Safety Information** (安全信息)。

安裝本產品之前，請先閱讀「安全資訊」。

Prije instalacije ovog produkta obavezno pročitajte Sigurnosne Upute.

Před instalací tohoto produktu si přečtěte příručku bezpečnostních instrukcí.

Læs sikkerhedsforskrifterne, før du installerer dette produkt.

Lees voordat u dit product installeert eerst de veiligheidsvoorschriften.

Ennen kuin asennat tämän tuotteen, lue turvaohjeet kohdasta Safety Information.

Avant d'installer ce produit, lisez les consignes de sécurité.

Vor der Installation dieses Produkts die Sicherheitshinweise lesen.

Πριν εγκαταστήσετε το προϊόν αυτό, διαβάστε τις πληροφορίες ασφάλειας (safety information).

לפני שתתקינו מוצר זה, קראו את הוראות הבטיחות.

A termék telepítése előtt olvassa el a Biztonsági előírásokat!

Prima di installare questo prodotto, leggere le Informazioni sulla Sicurezza.

製品の設置の前に、安全情報をお読みください。

본 제품을 설치하기 전에 안전 정보를 읽으십시오.

Пред да се инсталира овој продукт, прочитајте информацијата за безбедност.

Les sikkerhetsinformasjonen (Safety Information) før du installerer dette produktet.

Przed zainstalowaniem tego produktu, należy zapoznać się z książką "Informacje dotyczące bezpieczeństwa" (Safety Information).

Antes de instalar este produto, leia as Informações sobre Segurança.

Перед установкой продукта прочтите инструкции по технике безопасности.

Pred inštaláciou tohto zariadenia si pečítajte Bezpečnostné predpisy.

Pred namestitvijo tega proizvoda preberite Varnostne informacije.

Antes de instalar este producto, lea la información de seguridad.

Läs säkerhetsinformationen innan du installerar den här produkten.

**Important:**

All caution and danger statements in this documentation begin with a number. This number is used to cross reference an English caution or danger statement with translated versions of the caution or danger statement in the *IBM NetBAY Rack Safety Information* book.

For example, if a caution statement begins with a number 1, translations for that caution statement appear in the *IBM NetBAY Rack Safety Information* book under statement 1.

Be sure to read all caution and danger statements in this documentation before performing the instructions. Read any additional safety information that comes with your server or optional device before you install the device.

**Statement 1:**



**CAUTION:**

To ensure safety, all configurations of the rack cabinet must be certified by a nationally recognized testing laboratory in order to verify compliance with country-specific safety regulations. This process ensures that the end product remains safe for the operator and service personnel under normal and foreseeable misuse conditions.

**Statement 2:**



**DANGER**

- Always lower the leveling pads on the rack cabinet.
- Always install stabilizer brackets on the rack cabinet.
- Always install servers and optional devices starting from the bottom of the rack cabinet.
- Always install the heaviest devices in the bottom of the rack cabinet.



**Statement 3:**



**DANGER**

- Do not extend more than one sliding device at a time.
- The maximum allowable weight for devices on slide rails is 80 kg (176 lb). Do not install sliding devices that exceed this weight.

**Statement 4:**



**DANGER**

**Electrical current from power, telephone, and communication cables is hazardous.**

**To avoid a shock hazard:**

- Do not connect or disconnect any cables or perform installation, maintenance, or reconfiguration of this product during an electrical storm.
- Connect all power cords to a properly wired and grounded electrical outlet.
- Connect to properly wired outlets any equipment that will be attached to this product.
- When possible, use one hand only to connect or disconnect signal cables.
- Never turn on any equipment when there is evidence of fire, water, or structural damage.
- Disconnect the attached power cords, telecommunications systems, networks, and modems before you open the device covers, unless instructed otherwise in the installation and configuration procedures.
- Connect and disconnect cables as described in the following table when installing, moving, or opening covers on this product or attached devices.

**To Connect:**

1. Turn everything OFF.
2. First, attach all cables to devices.
3. Attach signal cables to connectors.
4. Attach power cords to outlet.
5. Turn device ON.

**To Disconnect:**

1. Turn everything OFF.
2. First, remove power cords from outlet.
3. Remove signal cables from connectors.
4. Remove all cables from devices.

**Statement 5:**

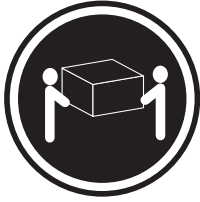

≥ 18 kg (39.7 lb)



≥ 32 kg (70.5 lb)

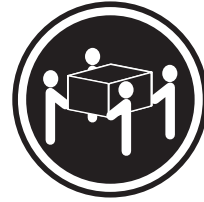

≥ 55 kg (121.2 lb)

**CAUTION:**  
Use safe practices when lifting.

**Statement 6:**



**CAUTION:**  
Do not place any object on top of a rack-mounted device unless that rack-mounted device is intended for use as a shelf.

**Statement 7:**



**CAUTION:**  
The power control button on the device and the power switch on the power supply do not turn off the electrical current supplied to the device. The device also might have more than one power cord. To remove all electrical current from the device, ensure that all power cords are disconnected from the power source.

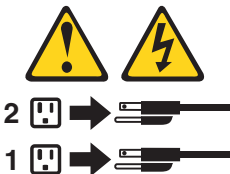

**Statement 8:**



**DANGER**

- Plug power cords from devices in the rack cabinet into electrical outlets that are located near the rack cabinet and are easily accessible.
- Each rack cabinet might have more than one power cord. Be sure to disconnect all power cords in the rack cabinet before servicing any device in the rack cabinet.
- Install an emergency-power-off switch if more than one power device (power distribution unit or uninterruptible power supply) is installed in the same rack cabinet.
- Connect all devices installed in a rack cabinet to power devices installed in the same rack cabinet. Do not plug a power cord from a device installed in one rack cabinet into a power device installed in a different rack cabinet.

**Statement 9:**



**DANGER**

Overloading a branch circuit is potentially a fire hazard and a shock hazard under certain conditions. To avoid these hazards, ensure that your system electrical requirements do not exceed branch circuit protection requirements. Refer to the information that is provided with your device for electrical specifications.

**Statement 10:**



**CAUTION:**

Removing components from the upper positions in the Enterprise Rack cabinet improves rack stability during relocation. Follow these general guidelines whenever you relocate a populated rack cabinet within a room or building:

- Reduce the weight of the rack cabinet by removing equipment starting at the top of the rack cabinet. When possible, restore the rack cabinet to the configuration of the rack cabinet as you received it. If this configuration is not known, you must do the following:
  - Remove all devices in the 32U position and above.
  - Ensure that the heaviest devices are installed in the bottom of the rack cabinet.
  - Ensure that there are no empty U-levels between devices installed in the rack cabinet below the 32U level.
- If the rack cabinet you are relocating is part of a suite of rack cabinets, detach the rack cabinet from the suite.
- Inspect the route that you plan to take to eliminate potential hazards.
- Verify that the route that you choose can support the weight of the loaded rack cabinet. Refer to the documentation that comes with your rack cabinet for the weight of a loaded rack cabinet.
- Verify that all door openings are at least 760 x 2030 mm (30 x 80 in.)
- Ensure that all devices, shelves, drawers, doors, and cables are secure.
- Ensure that the four leveling pads are raised to their highest position.
- Ensure that there is no stabilizer bracket installed on the rack cabinet.
- Do not use a ramp inclined at more than ten degrees.
- Once the rack cabinet is in the new location, do the following:
  - Lower the four leveling pads.
  - Install stabilizer brackets on the rack cabinet.
  - If you removed any devices from the rack cabinet, repopulate the rack cabinet from the lowest position to the highest position.

If a long distance relocation is required, restore the rack cabinet to the configuration of the rack cabinet as you received it. Pack the rack cabinet in the original packaging material, or equivalent. Also, lower the leveling pads to raise the casters off of the pallet and bolt the rack cabinet to the pallet.

**Statement 11:**



**CAUTION:**

Removing components from the upper positions in the rack cabinet improves rack stability during relocation. Follow these general guidelines whenever you relocate a populated rack cabinet within a room or building:

- Reduce the weight of the rack cabinet by removing equipment starting at the top of the rack cabinet. When possible, restore the rack cabinet to the configuration of the rack cabinet as you received it. If this configuration is not known, you must do the following:
  - Remove all devices in the 22U position and above.
  - Ensure that the heaviest devices are installed in the bottom of the rack cabinet.
  - Ensure that there are no empty U-levels between devices installed in the rack cabinet below the 22U level.
- If the rack cabinet you are relocating is part of a suite of rack cabinets, detach the rack cabinet from the suite.
- Inspect the route that you plan to take to eliminate potential hazards.
- Verify that the route that you choose can support the weight of the loaded rack cabinet. Refer to the documentation that comes with your rack cabinet for the weight of a loaded rack cabinet.
- Verify that all door openings are at least 760 x 2083 mm (30 x 82 in.)
- Ensure that all devices, shelves, drawers, doors, and cables are secure.
- Ensure that the four leveling pads are raised to their highest position.
- Ensure that there is no stabilizer bracket installed on the rack cabinet.
- Do not use a ramp inclined at more than ten degrees.
- Once the rack cabinet is in the new location, do the following:
  - Lower the four leveling pads.
  - Install stabilizer brackets on the rack cabinet.
  - If you removed any devices from the rack cabinet, repopulate the rack cabinet from the lowest position to the highest position.

If a long distance relocation is required, restore the rack cabinet to the configuration of the rack cabinet as you received it. Pack the rack cabinet in the original packaging material, or equivalent. Also, lower the leveling pads to raise the casters off of the pallet and strap the rack cabinet to the pallet.

**WARNING:** Handling the cord on this product or cords associated with accessories sold with this product, will expose you to lead, a chemical known to the State of California to cause cancer, and birth defects or other reproductive harm. ***Wash hands after handling.***

**ADVERTENCIA:** El contacto con el cable de este producto o con cables de accesorios que se venden junto con este producto, pueden exponerle al plomo, un elemento químico que en el estado de California de los Estados Unidos está considerado como un causante de cancer y de defectos congénitos, además de otros riesgos reproductivos. ***Lávese las manos después de usar el producto.***

---

## Chapter 1. Introduction

This documentation contains information that will help you plan the installation of your IBM® NetBAY™ Rack, IBM S2 Rack, and optional devices. Always refer to the documentation that comes with your rack, server, or optional device for detailed installation instructions. See the rack unpacking instructions for information about unpacking and locating the rack.

**Note:** The illustrations in this document might differ slightly from your hardware.

---

### NetBAY11 racks

The NetBAY11 rack comes with a front door installed. The side panels are not removable, and there is no rear door. The NetBAY11 rack has the following features:

- Lockable front door
- Retractable stabilizer foot
- Lockable front casters
- Capable of preconfigured shipment

The NetBAY11 rack has the following dimensions.

Height	Width	Depth
61.1 cm (24 in.)	51.8 cm (20.4 in.)	87.3 cm (34.4 in.)

#### IBM NetBAY11 Standard Rack

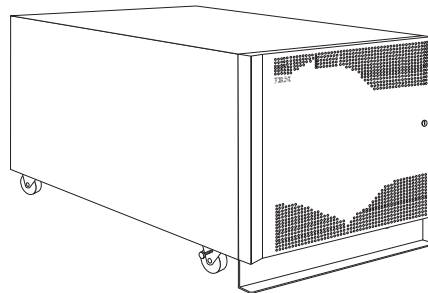

---

## IBM S2 25U racks

The IBM S2 25U rack comes with a front door, rear doors, and side panels installed and has the following features:

- Front stabilizer foot
- Two 1-U side-wall compartments
- Lockable doors and side panels

The IBM S2 25U rack has the following dimensions.

Height	Width	Depth
124 cm (49 in.)	61 cm (24 in.)	100 cm (39.4 in.)

### IBM S2 25U Standard Rack

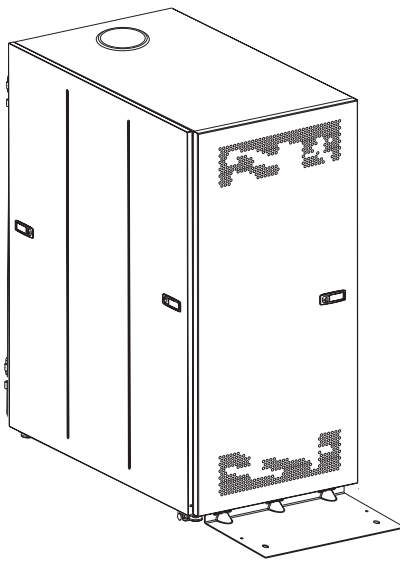



---

## IBM S2 42U racks

The IBM S2 42U standard rack comes with a front door, rear doors, and side panels installed. You need only one standard rack per suite. The S2 42U expansion rack comes without side panels and includes the required hardware for attaching the racks together to form a suite.

The S2 42U standard rack has the following features:

- Front stabilizer foot
- Six 1-U side-wall compartments
- Lockable doors and side panels
- Room for cable management

The S2 42U standard rack and the S2 42U expansion rack have the following dimensions.

Height	Width	Depth
200 cm (78.7 in.)	61 cm (24 in.)	100 cm (39.4 in.)

### IBM S2 42U Standard Rack

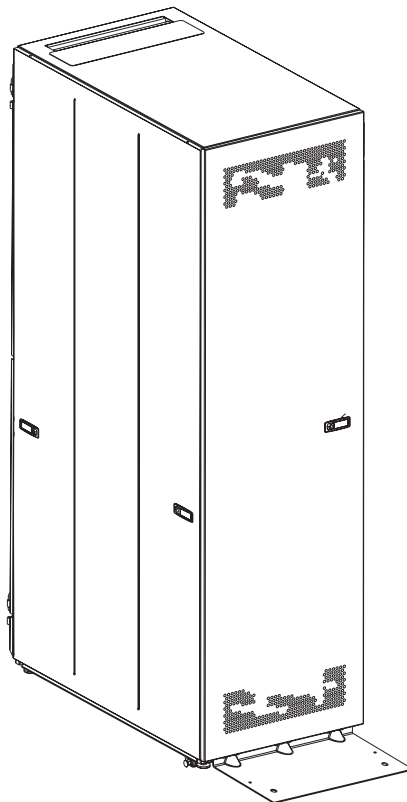

The S2 42U expansion rack has the following features:

- Front stabilizer foot
- Six 1-U side-wall compartments
- Lockable doors
- Room for cable management
- Rack attachment kit

### IBM S2 42U Expansion Rack

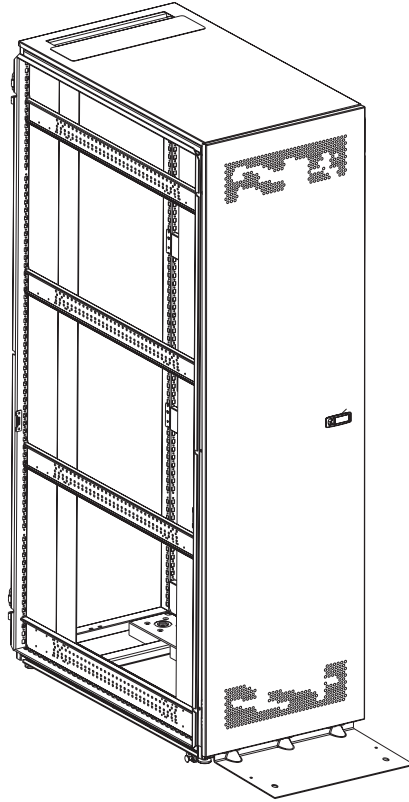

---

## IBM NetBAY42 enterprise racks

The primary NetBAY42 enterprise rack comes with a front door, a rear door, and side panels installed. You need only one primary rack per suite. The expansion NetBAY42 enterprise rack comes without side panels and includes the required hardware for attaching the racks together to form a suite.

The primary NetBAY42 enterprise rack has the following features:

- Front stabilizers
- Four 1-U side-wall compartments, accessible from the rear of the rack
- Lockable doors and side panels
- Heavy-duty lockable casters
- Available preconfigured shipments

The primary NetBAY42 enterprise rack and the expansion NetBAY42 enterprise rack have the following dimensions.

Height	Width	Depth
202 cm (79.5 in.)	65 cm (25.6 in.)	110 cm (43.3 in.)

### IBM primary NetBAY42 Enterprise Rack

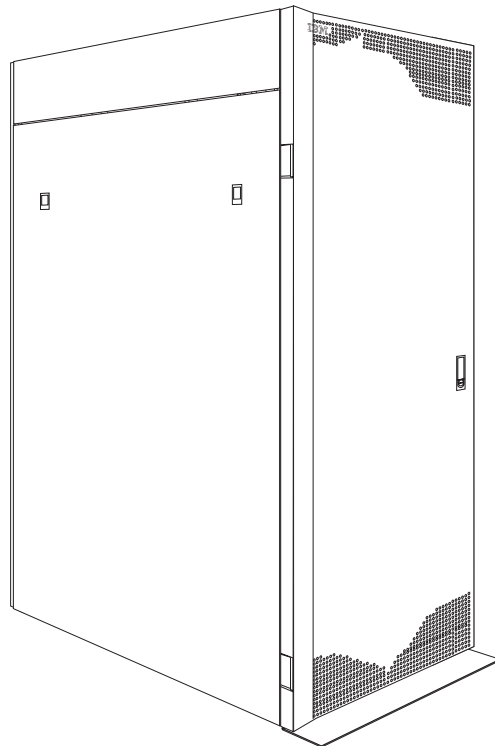

The expansion NetBAY42 enterprise rack has the following features:

- Front stabilizers
- Four 1-U side-wall compartments, accessible from the rear of the rack
- Lockable door
- Rack attachment kit
- Heavy-duty lockable casters
- Available preconfigured shipments

### **IBM expansion NetBAY42 Enterprise Rack**

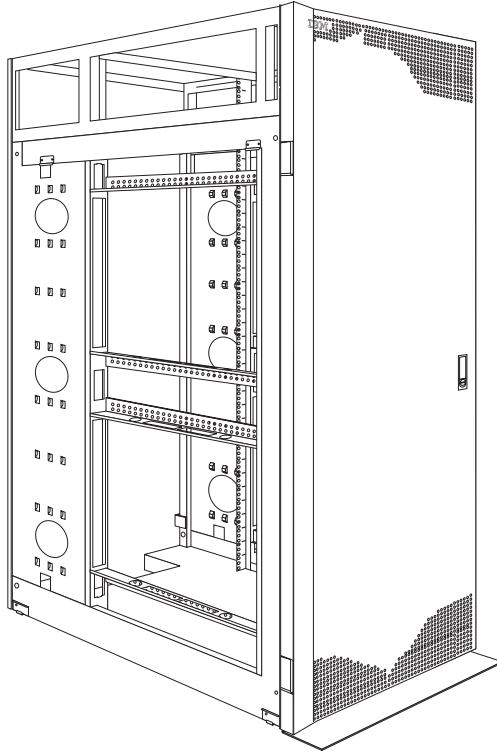

---

## Chapter 2. Planning for your rack

A rack configurator program is available to help you plan your rack and optional device installation. Go to <http://www.ibm.com/pc/ww/eserver/xseries/rack.html> and select **Rack Configurator**. This program provides an intuitive, graphical interface to help you configure the rack and optional devices. The rack configurator program also provides the following information about your rack:

- Weight and stability limits
- Power requirements
- Thermal calculations
- Internal space dimensions
- External space requirements
- Human factors considerations

### Statement 1:



### CAUTION:

**To ensure safety, all configurations of the rack cabinet must be certified by a nationally recognized testing laboratory in order to verify compliance with country-specific safety regulations. This process ensures that the end product remains safe for the operator and service personnel under normal and foreseeable misuse conditions.**

Using the rack configurator program, you can select components from the Component Catalog and place them in the Configuration Workspace to create a configuration. The program also contains a parts list, specifications, and a top-view floor plan. With this information, you can then configure a single rack or a suite of racks.

Rack configurator functions such as **AutoArrange**, **AutoConnect**, **Validate**, and **Build** ensure correct placement of optional devices within the rack. The rack configurator program guides the connection of optional devices, helping you to select the appropriate cables for connections.

## Defining rack physical dimensions and clearances

All NetBAY racks and S2 racks are Electronic Industries Association (EIA) standard racks. See Table 1 for the dimensions and weights for the racks.

**Note:** The dimensions and weights that are shown are for the primary or standard racks. Expansion racks, where applicable, have the same physical dimensions but weigh less because they do not have side panels.

Table 1. Rack physical dimensions and weights

	NetBAY11	S2 25U
<b>Dimensions</b>	61.1 x 51.8 x 87.3 cm (24 x 20.4 x 34.4 in.)	124 x 61 x 100 cm (49 x 24 x 39.4 in.)
<b>Empty weight</b>	36 kg (80 lb)	98 kg (217 lb)
<b>Populated weight*</b>	218 kg (481 lb)	665 kg (1467 lb)
	S2 42U	NetBAY42 enterprise
<b>Dimensions</b>	200 x 61 x 100 cm (78.7 x 24 x 39.4 in.)	202 x 65 x 110 cm (79.5 x 25.6 x 43.3 in.)
<b>Empty weight</b>	138 kg (303 lb)	261 kg (575 lb)
<b>Populated weight*</b>	1090 kg (2403 lb)	1213 kg (2675 lb)

\* The weight when the rack is loaded to maximum capacity when in the final location (not shippable).

A rack requires a minimal operational clearance on all sides to ensure proper ventilation and access to open the front and rear doors. An extended service clearance provides easier access to the rack so that you can install and service optional devices.

### NetBAY11 rack service and operational clearances

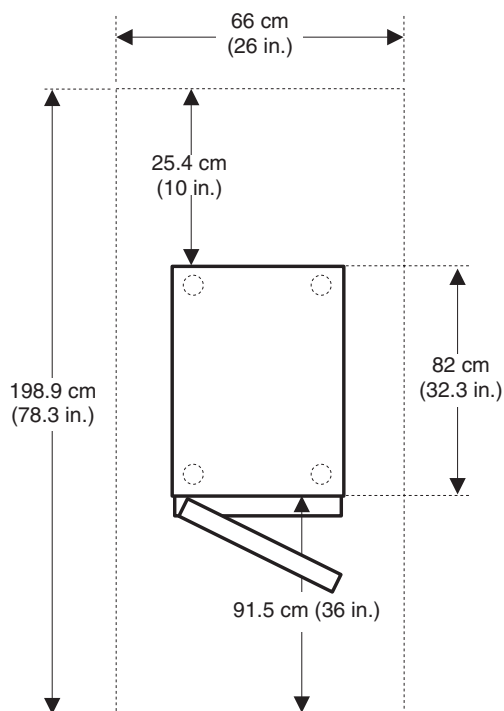

### S2 25U and S2 42U rack service clearances

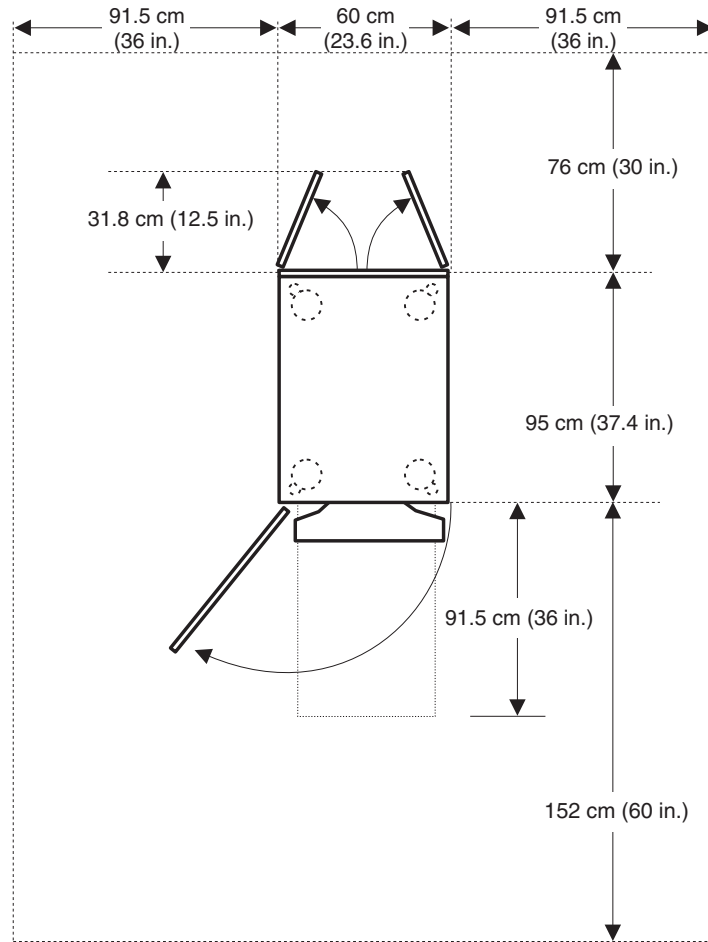

### S2 25U and S2 42U rack operational clearances

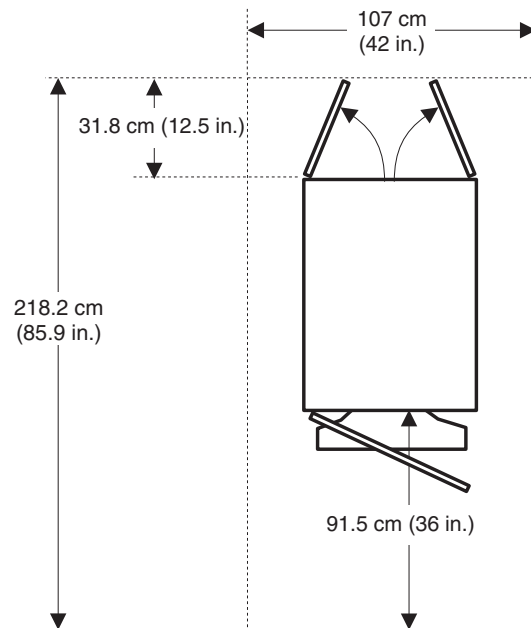

### NetBAY42 enterprise rack service clearances

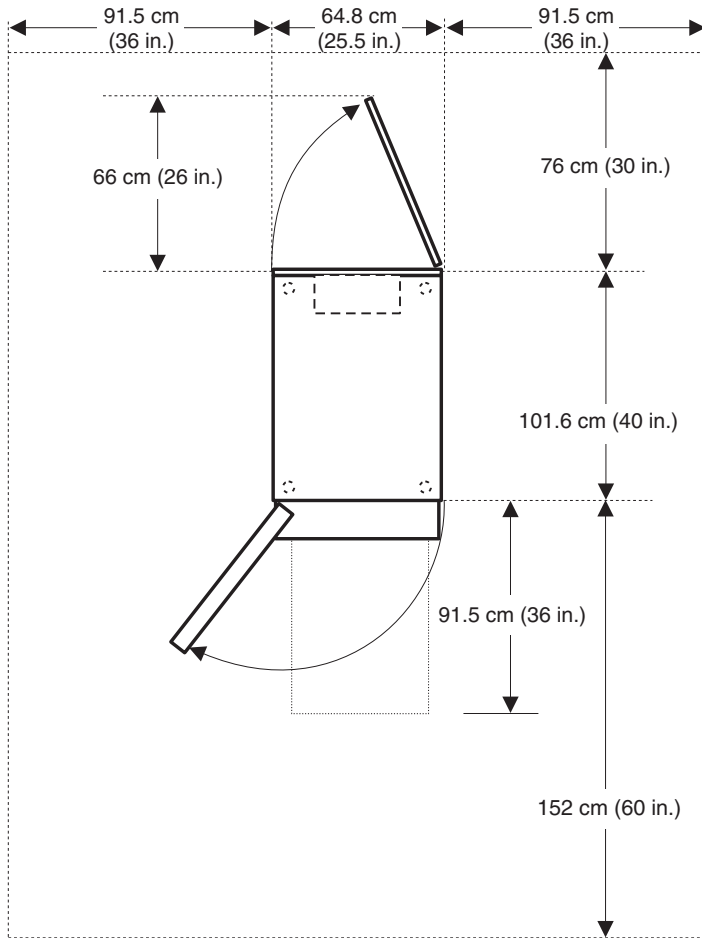



### NetBAY42 enterprise rack operational clearances

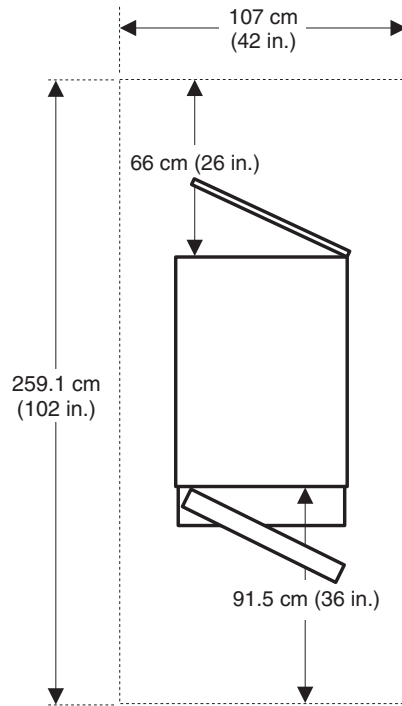

When you attach primary or standard racks, and expansion racks together to form a suite of racks, you must leave 152 cm (60 in.) between the suites in the same room. Make sure that the fronts of the rack suites face each other or the rears of the rack suites face each other. This will help provide ventilation for the equipment in the racks and allow access to install and service optional devices. For more information about thermal requirements, see Chapter 5, "Thermal management," on page 31.

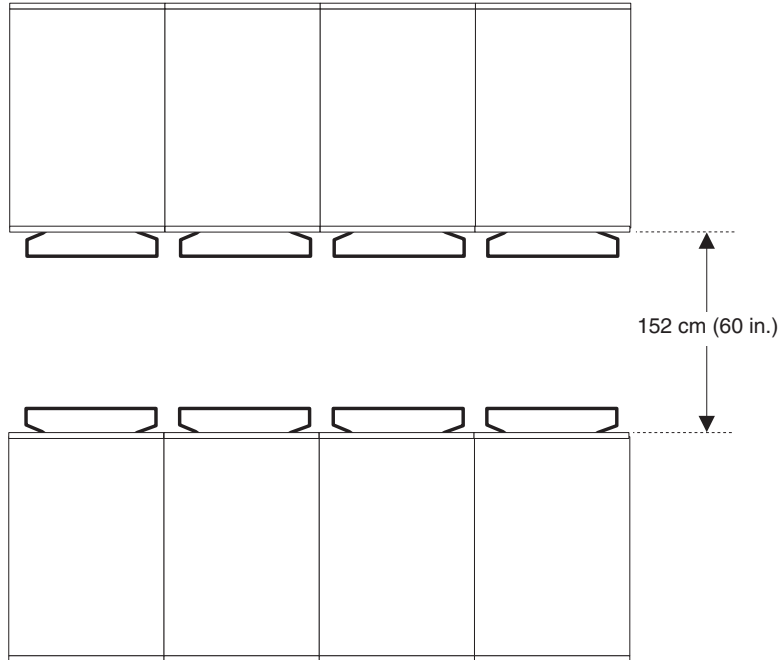

The internal dimensions of the racks conform to the EIA standard *EIA-310-D Cabinets, Racks, Panels, and Associated Equipment (1992)*. See the following illustration for rack internal dimensions.

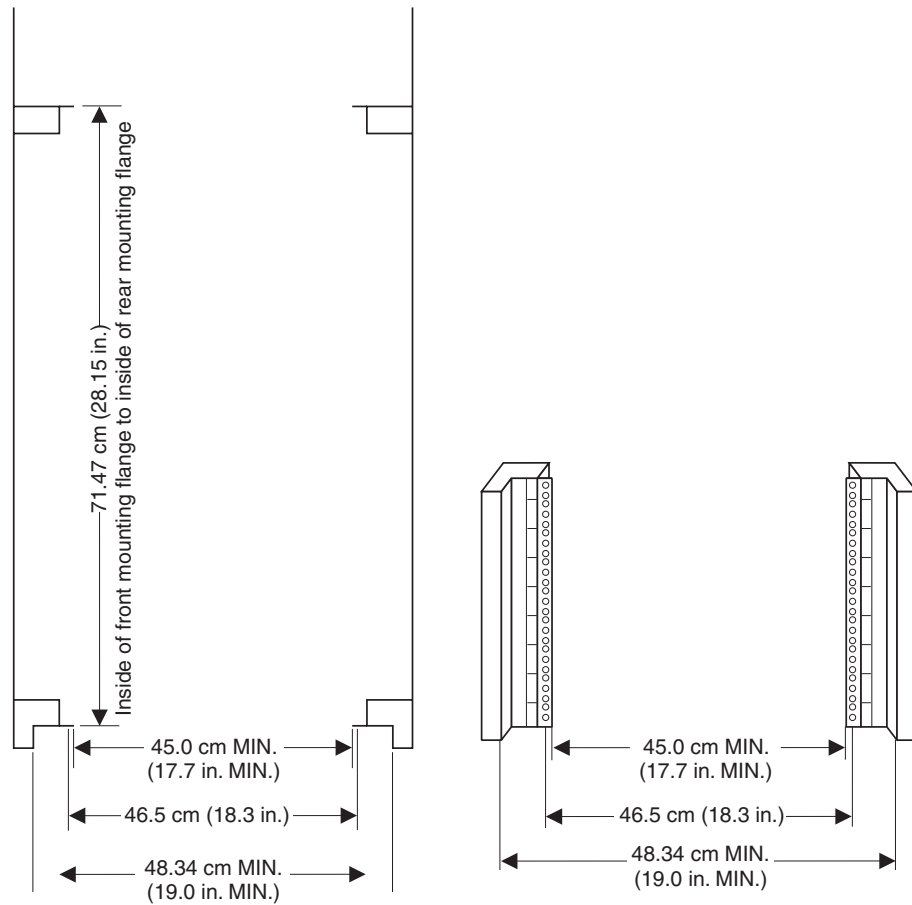

All vertical rack measurements are given in rack units (U), where 1 U is equal to 4.45 cm (1.75 in.). The U levels are marked on labels on the front and rear mounting flanges inside of the rack, as shown in the following illustration.

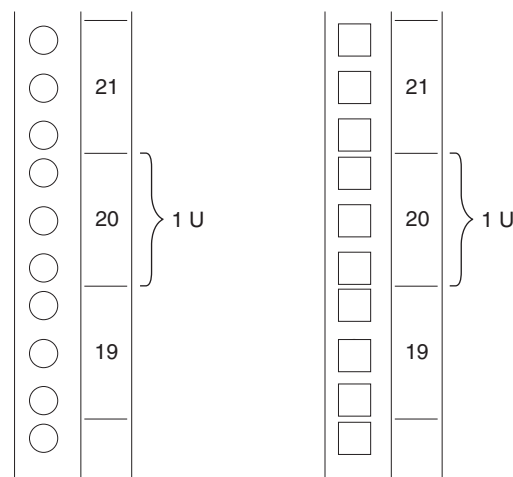

---

## Defining rack electrical requirements

The rack does not require electricity, but the servers and optional devices that you install in the rack do require connection to properly wired and grounded electrical outlets. All IBM racks are designed to be used with power distribution units (PDUs) and uninterruptible power supplies. You might need an electrician to assist you with planning for electrical requirements. For example, you must consider the following requirements:

- Each PDU or uninterruptible power supply requires a separate ac power branch circuit.
- The input voltage-selection switch, if present, on each device that you install in the rack must match the output voltage on the uninterruptible power supply or PDU.
- Power cords must match the electrical outlets at the location where you install the rack.

Review the following safety information as you plan for your rack.

### Statement 8:



### DANGER

- **Plug power cords from devices in the rack cabinet into electrical outlets that are located near the rack cabinet and are easily accessible.**
- **Each rack cabinet might have more than one power cord. Be sure to disconnect all power cords in the rack cabinet before servicing any device in the rack cabinet.**
- **Install an emergency-power-off switch if more than one power device (power distribution unit or uninterruptible power supply) is installed in the same rack cabinet.**
- **Connect all devices installed in a rack cabinet to power devices installed in the same rack cabinet. Do not plug a power cord from a device installed in one rack cabinet into a power device installed in a different rack cabinet.**

---

## Defining rack and optional-device limitations

As you prepare for the installation of the rack, be aware of the physical limitations of the rack. This is especially important if you plan to install non-IBM equipment in the rack.

**Attention:** The weight of devices that you install on the four corner posts of the rack must not exceed 20 kg (44.1 lb) total per U level, with no more than 7.5 kg (16.5 lb) to be applied to any single corner post. Take extra care when installing cantilevered devices. Cantilevered devices must not exceed 5 kg (11 lb) per U level.

The rack has been tested under certain conditions for stability and safety. Make sure that the rack and optional devices you install meet the following safety requirements.

### Statement 2:



#### DANGER

- Always lower the leveling pads on the rack cabinet.
- Always install stabilizer brackets on the rack cabinet.
- Always install servers and optional devices starting from the bottom of the rack cabinet.
- Always install the heaviest devices in the bottom of the rack cabinet.

### Statement 3:



#### DANGER

- Do not extend more than one sliding device at a time.
- The maximum allowable weight for devices on slide rails is 80 kg (176 lb). Do not install sliding devices that exceed this weight.



---

## Chapter 3. Preparing a location for your rack

Before you unpack or install a rack, make sure that you perform the following tasks:

- Understand the rack specifications and requirements.
- Prepare a layout for the rack or suite of racks.
- Prepare the physical site (location) where you will install the rack.
- Read the unpacking instructions and *Installation Guide* that come with the rack.

Physical site planning includes determining the following factors:

- Floor area that is required by the equipment
- Floor-load capacity
- Space that is needed for future expansion
- Location of columns or other unmovable building structures
- Power and environmental requirements
- Thermal requirements

Create a floor plan to check for clearance problems. Make a full-scale template of the rack, if needed, and carry it along the access route to check for potential clearance problems through doorways and passageways, around corners, and in elevators.

**Note:** Some racks might have removable parts that you can temporarily remove so that you can move the rack through nonstandard doorways, if required. See the *Installation Guide* that comes with your rack for additional information.

Remember to provide space for storage cabinets, card files, desks, communication facilities, daily storage of tapes, and other supplies.

---

## Creating a floor plan

To make sure that you have enough space for the rack or suite of racks, create a floor plan before installing any racks. You might have to prepare and analyze several plans before choosing a final one. If you install more than one rack in more than one installation stage, prepare a separate plan for each installation stage.

Consider the following factors when you prepare each plan:

- Flow of work and personnel within the area
- Operator access to units, as required
- If the placement will be on a raised floor:
  - Positioning over a cooling register
  - Leaving the bottom of the rack open to facilitate cooling
- If the placement will not be on a raised floor:
  - Maximum cable lengths
  - Need for cable guards, ramps, or other similar items to protect equipment and personnel
- Location of any planned safety equipment
- Future expansion

Begin with an accurate drawing of the installation area (blueprints and floor plans are appropriate). Make sure that you include the following information in your floor plan:

- Service clearances that are required for each rack or suite of racks
- If the placement will be on a raised floor:
  - Things that might obstruct cable routing or airflow
  - The height of the raised floor
- If the placement will not be on a raised floor:
  - The placement of cables to minimize obstruction
  - The amount of cable that is required. (If the cable is routed indirectly between rack cabinets, such as along walls or suspended from the ceiling, additional cable might be required.)
- Locations of the following items:
  - Power receptacles.
  - Air conditioning equipment and controls. (Air conditioning outlets must be located between fronts of facing suites of rack cabinets. Exhausts in the ceilings must be located between rears of rack suites.)
  - File cabinets, desks, and other office equipment.
  - Room emergency power-off controls.
  - All entrances, exits, windows, columns, and pillars.

Review the final floor plan to make sure that cable lengths are not too long and that the racks have enough clearance. See the *Installation Guide* that comes with your rack for additional information.



---

## Moving a NetBAY11 rack

The fully populated NetBAY11 rack has been evaluated and found to meet UL-1950, CSA-950, and IEC-950 stability test standards. Because these standards apply only to a rack in an installed location, IBM enforces additional standards to ensure stability when you are rolling the rack cabinet on its casters. See Table 2 for weights of empty and fully populated racks.

Table 2. NetBAY11 rack weights

	Weight
Empty	36 kg (80 lb)
Populated*	218 kg (481 lb)

\* The weight when the rack is loaded to the maximum capacity allowed for moving.

Before you move a rack, make sure that the stabilizer bracket is retracted on the rack. When you move a rack to a new location, adhere to the safety requirements.

### Statement 8:



### DANGER

- **Plug power cords from devices in the rack cabinet into electrical outlets that are located near the rack cabinet and are easily accessible.**
- **Each rack cabinet might have more than one power cord. Be sure to disconnect all power cords in the rack cabinet before servicing any device in the rack cabinet.**
- **Install an emergency-power-off switch if more than one power device (power distribution unit or uninterruptible power supply) is installed in the same rack cabinet.**
- **Connect all devices installed in a rack cabinet to power devices installed in the same rack cabinet. Do not plug a power cord from a device installed in one rack cabinet into a power device installed in a different rack cabinet.**

## Moving an S2 25U or 42U rack

Fully populated S2 25U and S2 42U racks have been evaluated and found to meet UL-60950, CSA-60950, and IEC-60950 stability test standards. Because these standards apply only to a rack in an installed location, IBM enforces additional standards to ensure stability when you are rolling the rack on its casters. See Table 3 for weights of empty and fully populated racks.

Table 3. S2 25U and 42U rack weights

	S2 25U	S2 42U standard	S2 42U expansion
<b>Empty</b>	98 kg (217 lb)	138 kg (303 lb)	107 kg (236 lb)
<b>Populated*</b>	597 kg (1317 lb)	636 kg (1404 lb)	606 kg (1336 lb)

\* The weight when the rack is loaded to the maximum capacity allowed for moving.

When you move a rack to a new location, adhere to the following safety requirements:

### Statement 8:



### DANGER

- **Plug power cords from devices in the rack cabinet into electrical outlets that are located near the rack cabinet and are easily accessible.**
- **Each rack cabinet might have more than one power cord. Be sure to disconnect all power cords in the rack cabinet before servicing any device in the rack cabinet.**
- **Install an emergency-power-off switch if more than one power device (power distribution unit or uninterruptible power supply) is installed in the same rack cabinet.**
- **Connect all devices installed in a rack cabinet to power devices installed in the same rack cabinet. Do not plug a power cord from a device installed in one rack cabinet into a power device installed in a different rack cabinet.**

**Statement 11:**



**CAUTION:**

Removing components from the upper positions in the rack cabinet improves rack stability during relocation. Follow these general guidelines whenever you relocate a populated rack cabinet within a room or building:

- Reduce the weight of the rack cabinet by removing equipment starting at the top of the rack cabinet. When possible, restore the rack cabinet to the configuration of the rack cabinet as you received it. If this configuration is not known, you must do the following:
  - Remove all devices in the 22U position and above.
  - Ensure that the heaviest devices are installed in the bottom of the rack cabinet.
  - Ensure that there are no empty U-levels between devices installed in the rack cabinet below the 22U level.
- If the rack cabinet you are relocating is part of a suite of rack cabinets, detach the rack cabinet from the suite.
- Inspect the route that you plan to take to eliminate potential hazards.
- Verify that the route that you choose can support the weight of the loaded rack cabinet. Refer to the documentation that comes with your rack cabinet for the weight of a loaded rack cabinet.
- Verify that all door openings are at least 760 x 2083 mm (30 x 82 in.)
- Ensure that all devices, shelves, drawers, doors, and cables are secure.
- Ensure that the four leveling pads are raised to their highest position.
- Ensure that there is no stabilizer bracket installed on the rack cabinet.
- Do not use a ramp inclined at more than ten degrees.
- Once the rack cabinet is in the new location, do the following:
  - Lower the four leveling pads.
  - Install stabilizer brackets on the rack cabinet.
  - If you removed any devices from the rack cabinet, repopulate the rack cabinet from the lowest position to the highest position.

If a long distance relocation is required, restore the rack cabinet to the configuration of the rack cabinet as you received it. Pack the rack cabinet in the original packaging material, or equivalent. Also, lower the leveling pads to raise the casters off of the pallet and strap the rack cabinet to the pallet.

---

## Moving a NetBAY42 enterprise rack

The fully populated NetBAY42 enterprise rack has been evaluated and found to meet UL-1950, CSA-950, and IEC-950 stability test standards. Because these standards apply only to a rack in an installed location, IBM enforces additional standards to ensure stability when you are rolling the rack on its casters. See Table 4 for weights of empty and fully populated racks.

Table 4. NetBAY42 enterprise rack weights

	Primary NetBAY42 enterprise	Expansion NetBAY42 enterprise
Empty	261 kg (575 lb)	234 kg (515 lb)
Populated*	928 kg (2045 lb)	901 kg (1986 lb)

\* The weight when the rack is loaded to the maximum capacity allowed for moving.

When you move a rack to a new location, adhere to the following safety requirements:

### Statement 8:



### DANGER

- **Plug power cords from devices in the rack cabinet into electrical outlets that are located near the rack cabinet and are easily accessible.**
- **Each rack cabinet might have more than one power cord. Be sure to disconnect all power cords in the rack cabinet before servicing any device in the rack cabinet.**
- **Install an emergency-power-off switch if more than one power device (power distribution unit or uninterruptible power supply) is installed in the same rack cabinet.**
- **Connect all devices installed in a rack cabinet to power devices installed in the same rack cabinet. Do not plug a power cord from a device installed in one rack cabinet into a power device installed in a different rack cabinet.**

**Statement 10:**



**CAUTION:**

Removing components from the upper positions in the Enterprise Rack cabinet improves rack stability during relocation. Follow these general guidelines whenever you relocate a populated rack cabinet within a room or building:

- Reduce the weight of the rack cabinet by removing equipment starting at the top of the rack cabinet. When possible, restore the rack cabinet to the configuration of the rack cabinet as you received it. If this configuration is not known, you must do the following:
  - Remove all devices in the 32U position and above.
  - Ensure that the heaviest devices are installed in the bottom of the rack cabinet.
  - Ensure that there are no empty U-levels between devices installed in the rack cabinet below the 32U level.
- If the rack cabinet you are relocating is part of a suite of rack cabinets, detach the rack cabinet from the suite.
- Inspect the route that you plan to take to eliminate potential hazards.
- Verify that the route that you choose can support the weight of the loaded rack cabinet. Refer to the documentation that comes with your rack cabinet for the weight of a loaded rack cabinet.
- Verify that all door openings are at least 760 x 2030 mm (30 x 80 in.)
- Ensure that all devices, shelves, drawers, doors, and cables are secure.
- Ensure that the four leveling pads are raised to their highest position.
- Ensure that there is no stabilizer bracket installed on the rack cabinet.
- Do not use a ramp inclined at more than ten degrees.
- Once the rack cabinet is in the new location, do the following:
  - Lower the four leveling pads.
  - Install stabilizer brackets on the rack cabinet.
  - If you removed any devices from the rack cabinet, repopulate the rack cabinet from the lowest position to the highest position.

If a long distance relocation is required, restore the rack cabinet to the configuration of the rack cabinet as you received it. Pack the rack cabinet in the original packaging material, or equivalent. Also, lower the leveling pads to raise the casters off of the pallet and bolt the rack cabinet to the pallet.



---

## Chapter 4. Preparing to install optional devices

There are many servers and optional devices that you can install in your rack. Always read the documentation that comes with your server or optional device for detailed installation instructions.

---

### Using the rack-mounting flanges

When you install optional devices in the rack, secure the device or the rails for that device on rack-mounting flanges. Some devices come with threaded holes in the rails. Other devices require that you use cage nuts or clip nuts to install them in the rack.

**Note:** NetBAY11, S2 25U, and S2 42U racks require cage nuts; the NetBAY42 Enterprise racks require clip nuts.

**Statement 2:**



**DANGER**

- Always lower the leveling pads on the rack cabinet.
- Always install stabilizer brackets on the rack cabinet.
- Always install servers and optional devices starting from the bottom of the rack cabinet.
- Always install the heaviest devices in the bottom of the rack cabinet.

**Statement 3:**



**DANGER**

- Do not extend more than one sliding device at a time.
- The maximum allowable weight for devices on slide rails is 80 kg (176 lb). Do not install sliding devices that exceed this weight.

Statement 4:



**DANGER**

**Electrical current from power, telephone, and communication cables is hazardous.**

**To avoid a shock hazard:**

- **Do not connect or disconnect any cables or perform installation, maintenance, or reconfiguration of this product during an electrical storm.**
- **Connect all power cords to a properly wired and grounded electrical outlet.**
- **Connect to properly wired outlets any equipment that will be attached to this product.**
- **When possible, use one hand only to connect or disconnect signal cables.**
- **Never turn on any equipment when there is evidence of fire, water, or structural damage.**
- **Disconnect the attached power cords, telecommunications systems, networks, and modems before you open the device covers, unless instructed otherwise in the installation and configuration procedures.**
- **Connect and disconnect cables as described in the following table when installing, moving, or opening covers on this product or attached devices.**

**To Connect:**

1. Turn everything OFF.
2. First, attach all cables to devices.
3. Attach signal cables to connectors.
4. Attach power cords to outlet.
5. Turn device ON.

**To Disconnect:**

1. Turn everything OFF.
2. First, remove power cords from outlet.
3. Remove signal cables from connectors.
4. Remove all cables from devices.



**Statement 5:**

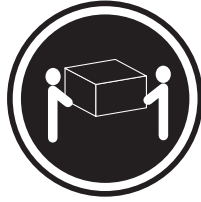

≥ 18 kg (39.7 lb)



≥ 32 kg (70.5 lb)

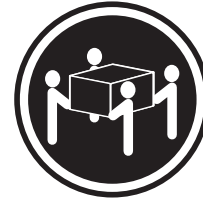

≥ 55 kg (121.2 lb)

**CAUTION:**  
Use safe practices when lifting.

**Statement 6:**



**CAUTION:**  
Do not place any object on top of a rack-mounted device unless that rack-mounted device is intended for use as a shelf.

## Installing threaded rails

You must install devices that have threaded holes or device rails that have threaded holes on the inside of the rack-mounting flanges. See the device documentation for detailed information about how to use threaded rails.

## Installing cage nuts

You must use either cage nuts or clip nuts for optional devices that do not have threaded holes. See the device documentation for information about whether you must install clip nuts instead of cage nuts. See “Installing clip nuts” on page 29 for instructions for installing clip nuts.

Cage nuts are installed on the inside of the rack-mounting flanges with either the cage-nut-insertion tool or a flat-blade screwdriver. The cage-nut-insertion tool comes with the rack and some optional devices.

**Note:** Your rack comes with a supply of cage nuts that you can use to install optional devices. Most devices that require cage nuts will come with them.

## Using the cage-nut-insertion tool

Complete the following steps to install a cage nut with the cage-nut-insertion tool.

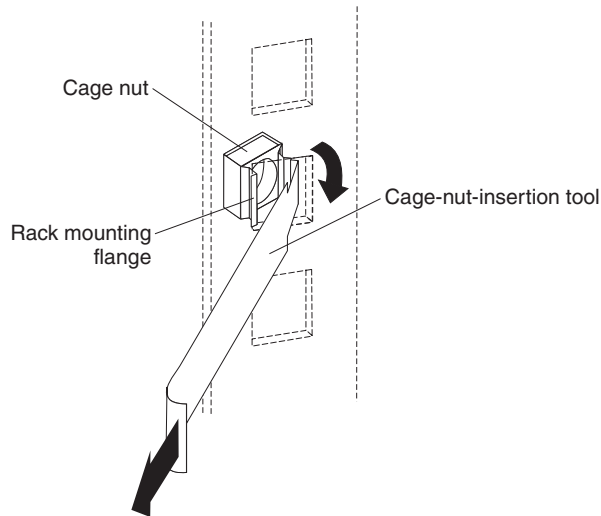

1. Determine the hole where you want to install the cage nut.
2. From the inside of the rack-mounting flange, insert one edge of the cage nut into the hole.
3. Push the tool through the hole and hook the other edge of the cage nut.
4. Pull the tool and the cage nut back through the hole to complete the installation of the cage nut.

## Using a flat-blade screwdriver

Complete the following steps to install a cage nut with a flat-blade screwdriver.

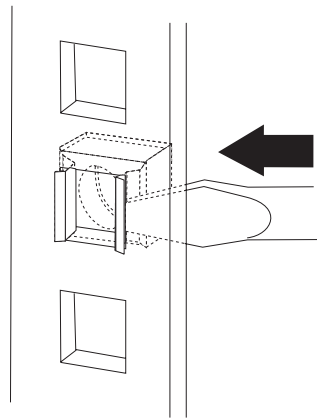

1. Determine the hole where you want to install the cage nut.
2. Hold the cage nut in one hand and compress the cage-nut clip with a flat-blade screwdriver.
3. With the clip compressed, push the edge of the cage nut fully into the hole from the inside of the rack-mounting flange.
4. Release the screwdriver pressure on the clip to lock the cage nut into place.

## Installing clip nuts

Some devices that do not have threaded holes might require that you install clip nuts instead of cage nuts on the rack. Clip nuts are installed on the rack-mounting flanges as shown below.

**Note:** Most devices that require clip nuts will come with them.

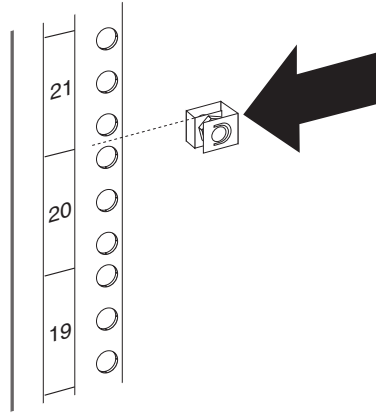

**Note:** See the device documentation for information about whether you must install cage nuts or clip nuts. See “Installing cage nuts” on page 27 for instructions about installing cage nuts.



---

## Chapter 5. Thermal management

The air-conditioning system in your data center must provide year-round temperature and humidity control for your servers to run reliably. Increasing power requirements of the processors, hard disk drives, and other electronic components require additional cooling. It is important to analyze the cooling requirements of the equipment in your data center at the server, rack, and facility level to optimize the cooling for the data center.

**Note:** These guidelines are meant to give you a starting point for engineering the thermal requirements for your data center.

---

### Getting started

Before installing your equipment, make sure that the computer room meets the following requirements:

- There is enough cooling tonnage available to the computer room to cool all new and existing equipment.
- The air-supply and air-return temperatures are within the manufacturer specifications for the computer room air-conditioning units.
- If the computer room has a raised floor, all unnecessary subfloor obstructions, including obsolete cables, are removed.
- If the computer room has a raised floor, all floor openings that are not specifically designed to supply cool air to computer intakes are sealed.

Guidelines are available from the American Society of Heating, Refrigerating and Air-Conditioning Engineers (ASHRAE) Web site for a fee. *Thermal Guidelines for Data Processing Environments*, dated January 2004, includes a detailed procedure for assessing the cooling of a data center and includes information about optimizing the data center for efficient cooling-system operation. For more information, go to <http://www.ashrae.org/>.

---

### Thermal management for servers

An IBM server is designed to pull cool air through the front of the server and exhaust hot air out of the rear of the server. The air temperature at the front of the server must not exceed the IBM environmental specification for the server. Follow the specifications that come with your server and other optional devices to ensure correct operation for the server and devices.

After you install the equipment, make sure that the air inlet and exit areas of the servers and devices are not blocked by paper, cables, or other obstructions. When upgrading or repairing a server, make sure that you do not exceed the maximum allowed time for having the cover removed with the unit running. After your work is complete, make sure that you reinstall all fans, heat sinks, air baffles, and other devices according to IBM documentation.

---

## Thermal management for racks

IBM racks are designed with perforated front and rear doors to allow maximum airflow through the components in the rack. Cool air is pulled through the front door of the rack, and hot air is exhausted through the rear door.

To avoid the recirculation of hot air from the rear of the rack to the front of the rack, follow these guidelines:

- Fill all unoccupied rack space with filler panels.
- Allow correct clearances around all racks as specified in this document.
- Use racks with fully perforated front and rear doors.
- Do not use racks with solid or glass doors.
- Do not allow the hot air exiting from the rear of one rack to flow into the front of another rack.
- Route and tie cables so that they do not impede the flow of air through the rack cabinet.
- Avoid using fan-assisted rack cabinets. In some applications, they have not shown to provide adequate airflow for xSeries servers.
- Seal openings around monitors or tower servers in the rack.
- Install all IT equipment in the rack so that the direction of airflow follows one of the following airflow protocols that are described in the ASHRAE document *Thermal Guidelines for Data Processing Environments*:
  - Front to back
  - Front to top
  - Front to back and top

---

## Thermal management for the facility

There are several ways in which to design a computer room for a large-scale high-powered server environment. One way is to provide maximum cooling across the entire computer room according to the maximum power requirements. This approach can be expensive and is more suited to new construction of a facility.

Another way is to provide an average amount of cooling to the facility and increase the cooling in limited localized areas. Rack cabinet design, equipment layout, air delivery paths, heat load distribution, floor tile placement, and the control of floor openings must be considered. You can optimize cooling levels in a facility in any of the following ways:

- Follow the server guidelines on page 31.
- Follow the rack guidelines on page 32.
- Use a hot-aisle, cold-aisle arrangement for placement of the racks as shown in the illustration on page 33.
- Follow the floor-tile placement guidelines in a raised-floor system. See page 35 for more information.
- Understand the heat-load distribution requirements of the facility.

## Hot-aisle, cold-aisle air delivery path

An effective method for equipment layout and air delivery paths is the hot-aisle, cold aisle arrangement. The racks are placed so that the air intakes in the front of the racks face each other across an aisle, creating a cold aisle. The rear of the racks face each other so that hot-air exiting the racks creates a hot aisle. The hot air is then returned to the air-conditioning units. An example of a hot-aisle, cold aisle equipment layout is shown in the following illustration.

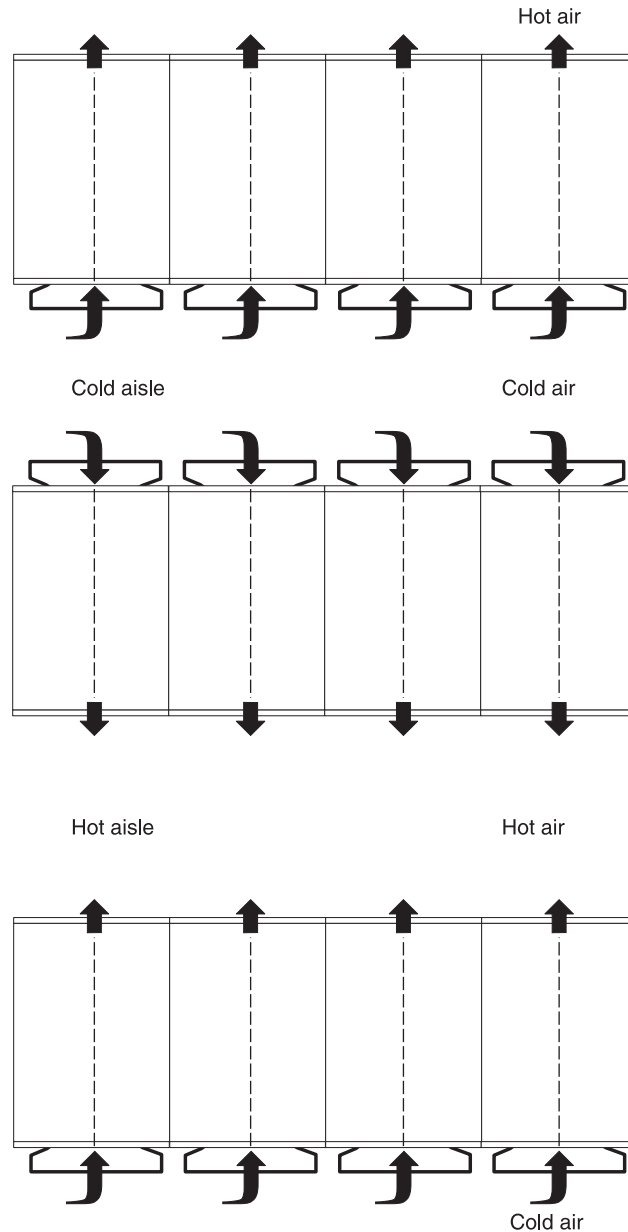

It is important to keep the air from mixing between the hot and the cold aisles. If hot air migrates to the top of the inlet side of the servers, a hot spot can occur.

There are two methods that can be used to provide air to the servers from the air-conditioning units: the raised-floor plenum system or the overhead system.

A raised-floor plenum system can be used to implement a hot-aisle, cold-aisle arrangement. Cool air from the air-conditioning units is discharged into a raised-floor plenum. The air is delivered to the cold aisles through perforated floor tiles. Solid floor tiles are placed in the hot aisles. Openings in the floor that are not used for cooling must be sealed with brushes or foam material. However, it might be necessary to leave some openings unsealed to allow adequate airflow in specific areas. Commercial software is available that can be used to model the performance of a raised-floor plenum system. The software takes into account the types and layout of air-conditioning units, equipment, perforated tiles, and miscellaneous floor openings in the data center.

The overhead system is less common. It uses a ducted air-supply delivery system and uses either a ducted or ceiling-plenum return system. The air-conditioning supply registers are aligned with the cold aisles, and return grilles are aligned with the hot aisles. The air discharge supplies cold air straight down into the cold aisles. The hot air that exits from the back of the racks into the hot aisles is then returned to the air-conditioning units through the return grilles.

**Note:** Do not use air diffusers that distribute the air laterally across the cold aisles.



## Floor-tile placement

Correctly placed floor tiles in a raised-floor system can help create an efficient cooling system for your data center. Solid tiles must be placed in hot aisles. Perforated tiles must be placed in the cold aisles, aligned with the air intakes of equipment in the racks. Perforated tiles must not be placed too close to air-conditioning units.

A Venturi effect, in which room air flows down into the raised floor, might be created when perforated floor tiles are placed too close to air-conditioning discharges. The Venturi effect can be created when the air velocity under the raised floor is about 530 feet per minute and above and can happen when perforated tiles are placed within six tiles of the air-conditioning unit discharge.

Typical data center tiles deliver between 100 and 300 cubic feet per minute. Tiles with the highest percent-open rating can deliver as much as 700 to 800 cubic feet per minute.

The flow rate of floor tiles with different percent-open ratings are shown in the following illustration.

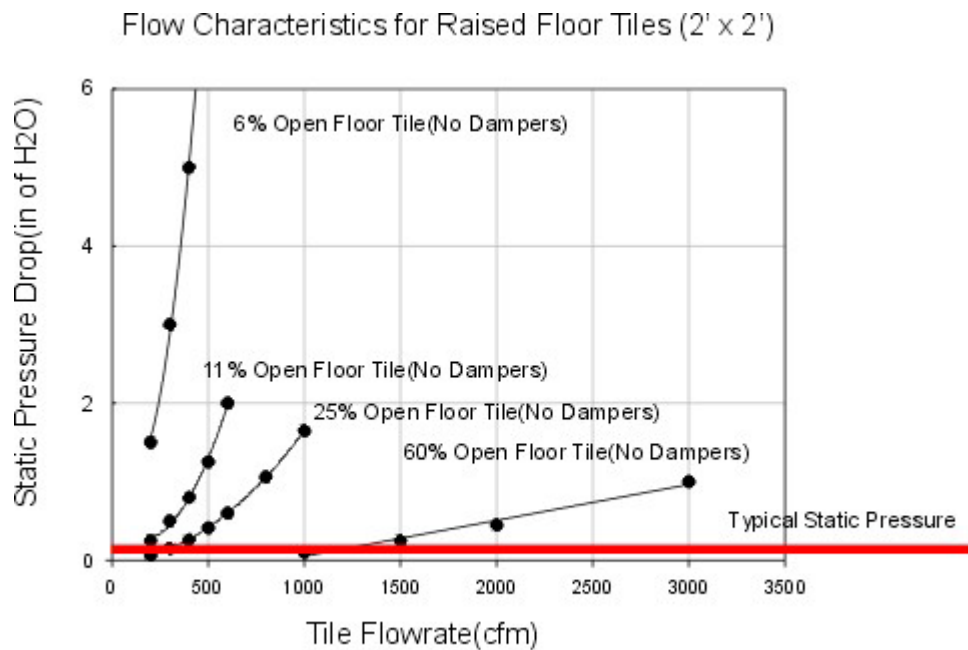

IPHAD802-0

## Balancing heat load

The heat-load distribution of servers and equipment in a data center must be analyzed to ensure correct air-conditioning coverage for the data center. In data centers where heat loads are concentrated in a small area, there are several ways to help create an efficient cooling system:

- Depopulate the racks with high heat loads and spread the equipment throughout the racks in the data center.
- Place floor tiles with higher percent-open and higher flow ratings in front of racks with higher-density heat loads.
- Add special baffling or air ducts at the back of the racks to carry hot air directly to the air-conditioning units.
- Place air-conditioning units in the hot aisles to allow hot air to be drawn directly into the returns at the top of the air-conditioning units. The effect that this solution has on the subfloor pressure and air flow distribution systems must be studied.

In data centers where space is not an issue, depopulate the racks to distribute the heat load. In data centers where space is an issue, the rearrangement of floor tiles and air-conditioning units, the addition of special duct work to remove heat more efficiently, or a combination might be used to create an efficient data center cooling system.

---

## Appendix A. Optional device specifications

This section contains specifications for power distribution units (PDUs), console kits, and console switches. See the documentation that comes with your servers or optional devices for additional information.

---

### Console kits

The IBM Console Kit family consists of the following models:

- IBM 2U Flat Panel Monitor Console Kit (15 inch)
- IBM 17-inch 1U Flat Panel Monitor Console Kit

The following table contains the product specifications for these models.

*Table 5. 2U Flat Panel Monitor Console Kit and 17" 1 U Flat Panel Monitor Console Kit specifications*

	<b>2U Flat Panel Monitor Console Kit (15 inch)</b>	<b>17" 1 U Flat Panel Monitor Console Kit</b>
<b>Height</b>	8.3 cm (3.3 in.)	4.45 cm (1.75 in.)
<b>Depth</b>	68.0 cm (26.8 in.)	72.39 cm (28.5 in.)
<b>Width</b>	42.0 cm (16.5 in.)	48.26 cm (19 in.)
<b>Weight</b>	14.9 kg (32.8 lb)	10.8 kg (23.8 lb)

## Console switches

The IBM Console Switch family consists of the following models:

- NetBAY 1x4 Console Switch
- NetBAY 2x8 Console Switch
- NetBAY Advanced Connectivity Technology Local Console Manager (LCM)
- NetBAY Advanced Connectivity Technology Remote Console Manager (RCM)

The following tables contain the product specifications for these models.

*Table 6. 1x4 Console Switch and 2x8 Console Switch specifications*

	<b>1x4 Console Switch</b>	<b>2x8 Console Switch</b>
<b>Height</b>	4.3 cm (1.7 in.)	4.3 cm (1.7 in.)
<b>Depth</b>	20.3 cm (8.0 in.)	20.3 cm (8.0 in.)
<b>Width</b>	43.2 cm (17 in.)	43.2 cm (17 in.)
<b>Weight</b>	2.38 kg (5.25 lb)	2.59 kg (5.7 lb)
<b>Rated voltage</b>	100-240 V ac	100-240 V ac
<b>Rated frequency</b>	50 to 60 Hz	50 to 60 Hz
<b>Rated input current</b>	1.0 amp maximum	1.0 amp maximum
<b>Operating temperature at 0–914 m (0–3000 ft)</b>	10° to 35°C (50° to 95°F)	10° to 35°C (50° to 95°F)
<b>Operating temperature at 914–2133 m (3000–7000 ft)</b>	10° to 32°C (50° to 90°F)	10° to 32°C (50° to 90°F)
<b>Operating humidity (noncondensing)</b>	8% to 80%	8% to 80%
<b>Supported video modes</b>	VGA, SVGA, XGA	VGA, SVGA, XGA

*Table 7. LCM and RCM Console Switch specifications*

	<b>LCM</b>	<b>RCM</b>
<b>Height</b>	4.3 cm (1.7 in.)	4.3 cm (1.7 in.)
<b>Depth</b>	14.6 cm (5.7 in.)	28 cm (11.0 in.)
<b>Width</b>	43.2 cm (17 in.)	43.2 cm (17 in.)
<b>Weight</b>	1.65 kg (3.63 lb)	3.69 kg (8.1 lb)
<b>Rated voltage</b>	100-240 V ac	100-240 V ac
<b>Rated frequency</b>	50 to 60 Hz	50 to 60 Hz
<b>Rated input current</b>	1.0 amp maximum	1.0 amp maximum
<b>Operating temperature at 0–914 m (0–3000 ft)</b>	10° to 35°C (50° to 95°F)	10° to 35°C (50° to 95°F)
<b>Operating temperature at 914–2133 m (3000–7000 ft)</b>	10° to 32°C (50° to 90°F)	10° to 32°C (50° to 90°F)
<b>Operating humidity (noncondensing)</b>	8% to 80%	8% to 80%
<b>Supported video modes</b>	VGA, SVGA, XGA	VGA, SVGA, XGA

---

## Distributed Power Interconnect PDUs

The IBM Distributed Power Interconnect (DPI) PDU family consists of the following types and models of PDUs. The key assigned to each PDU is used to identify the PDUs in the tables in “PDU specifications” on page 40.

<b>Front-end PDUs</b>	<b>Key</b>
DPI 30 amp/125 V Front-end PDU with NEMA L5-30P connector (USA)	A
DPI 30 amp/250 V Front-end PDU with NEMA L6-30P connector (USA)	B
DPI 32 amp/250 V Front-end PDU with IEC 309 2P+Gnd connector (International)	C
DPI 60 amp/250 V Front-end PDU with IEC 309 2P+Gnd connector (USA)	D
DPI 63 amp/250 V Front-end PDU with IEC 309 2P+Gnd connector (International)	E
<b>100-127 V and Universal Rack PDUs</b>	
DPI 100-127 V Rack PDU with NEMA L5-15P connector (USA)	F
DPI Universal Rack PDU with NEMA L5-15P and L6-20P connector (USA)	G
<b>High-density PDUs</b>	
DPI 60 amp/208 V 1-phase High Density C19 PDU with IEC 309 2P+Gnd connector (USA)	H
DPI 63 amp/230 V 1-phase High Density C19 PDU with IEC 309 P+N+Gnd connector (International)	I
DPI 32 amp 400/230 V 3-phase High Density C19 PDU with IEC 309 3P+N+Gnd connector (International)	J
DPI 60 amp/208 V 3-phase High Density C19 PDU with IEC 309 3P+Gnd connector (USA)	K
<b>Enterprise PDUs</b>	
DPI 32 amp/250 V 1-phase Enterprise C13 PDU with IEC 309 2P+N+Gnd connector	L
DPI 60 amp/208 V 1-phase Enterprise C13 PDU with IEC 309 2P+Gnd connector	M
DPI 63 amp/250 V 1-phase Enterprise C13 PDU with IEC 309 2P+N+Gnd connector	N
DPI 32 amp/250 V 3-phase Enterprise C13 PDU with IEC 309 3P+N+Gnd connector	O
DPI 30 amp/208 V 1-phase Enterprise C13 PDU with Nema L6-30P connector	P
DPI 60 amp/208 V 3-phase Enterprise C13 PDU with IEC 309 3P+Gnd connector	Q
DPI 60 amp/208 V 1-phase Enterprise C19 PDU with IEC 309 2P+Gnd connector	R
DPI 63 amp/250 V 1-phase Enterprise C19 PDU with IEC 309 2P+N+Gnd connector	S
DPI 32 amp/250 V 3-phase Enterprise C19 PDU with IEC 309 3P+N+Gnd connector	T
DPI 60 amp/208 V 3-phase Enterprise C19 PDU with IEC 309 3P+Gnd connector	U

## PDU specifications

The tables in this section contain the product specifications for these models. The letters before some items are keys to the PDUs identified beginning on page 39.

Table 8. Front-end PDU specifications

<b>Height</b>	41.5 mm (1.63 in.)
<b>Width</b>	222.5 mm (8.76 in.)
<b>Depth</b>	222.5 mm (8.76 in.)
<b>Additional clearance</b>	19 mm (0.75 in.) for inlet connector 2 mm (0.08 in.) above PDU for inlet connector 3.3 mm (0.13 in.) for outlets
<b>Weight (without mounting hardware)</b>	1.8 kg (3.9 lb), without power cord
<b>Operating temperature at 0 to 914 m (0 to 3000 ft)</b>	10° to 35°C (50° to 95°F)
<b>Operating temperature at 914 to 2133 m (3000 to 7000 ft)</b>	10° to 32°C (50° to 90°F)
<b>Operating humidity</b>	8 to 80% (noncondensing)
<b>Rated input voltage and current</b>	<b>A:</b> 100-127 V ac, 30 amps, single-phase <b>B:</b> 200-240 V ac, 30 amps, single-phase <b>C:</b> 220-240 V ac, 32 amps, single-phase <b>D:</b> 200-208 V ac, 60 amps, single-phase <b>E:</b> 220-240 V ac, 63 amps, single-phase
<b>Rated frequency</b>	50 to 60 Hz
<b>Maximum power rating</b>	<b>A:</b> 2880 VA <b>B:</b> 5760 VA <b>C:</b> 7680 VA <b>D:</b> 9984 VA <b>E:</b> 15120 VA
<b>Power inlet</b>	One proprietary inlet rated at 63 amps
<b>Power outlets</b>	Three IEC 320-C19 outlets rated at 16 amps (VDE) / 20 amps (UL/CSA)

Table 9. 100-127 V and Universal Rack PDU specifications

<b>Height</b>	41.5 mm (1.63 in.)
<b>Width</b>	222.5 mm (8.76 in.)
<b>Depth</b>	114.5 mm (4.51 in.)
<b>Additional clearance</b>	<b>F:</b> 20 mm (0.79 in.) for circuit breaker; 2.5 mm (0.1 in.) for outlets <b>G:</b> 20 mm (0.79 in.) for circuit breaker; 3.0 mm (0.12 in.) for outlets
<b>Weight</b>	<b>F:</b> 1.7 kg (3.7 lb), with fixed line cord <b>G:</b> 1.3 kg (2.8 lb), without power cord
<b>Operating temperature at 0 to 914 m (0 to 3000 ft)</b>	10° to 35°C (50° to 95°F)
<b>Operating temperature at 914 to 2133 m (3000 to 7000 ft)</b>	10° to 32°C (50° to 90°F)
<b>Operating humidity</b>	8 to 80% (noncondensing)
<b>Rated voltage and current</b>	<b>F:</b> 100-127 V ac, 15 amps, single-phase <b>G:</b> 100-240 V ac, 15 amps, single-phase
<b>Rated frequency</b>	50 to 60 Hz
<b>Maximum power rating</b>	<b>F:</b> 1900 VA <b>G:</b> 3600 VA
<b>Circuit breaker</b>	Two-pole, 15 amps with time-delay protection
<b>Power inlet</b>	<b>F:</b> Fixed line cord with L5-15P connector rated at 15 amps <b>G:</b> IEC 320-C20 inlet rated at 16 amps (VDE) / 20 amps (UL/CSA)
<b>Power outlets</b>	<b>F:</b> Six NEMA 5-15 outlets rated at 10 amps (VDE) / 15 amps (UL/CSA) <b>G:</b> Seven IEC 320-C13 outlets rated at 10 amps (VDE) / 15 amps (UL/CSA)

Table 10. High-density PDU specifications

<b>Height</b>	43.9 mm (1.73 in.)
<b>Width</b>	448 mm (17.6 in.)
<b>Depth</b>	213 mm (8.4 in.)
<b>Additional clearance</b>	25 mm (0.98 in.) for circuit breakers 3 mm (0.12 in.) for outlets
<b>Weight (without mounting hardware)</b>	11.3 kg (25 lb)
<b>Operating temperature at 0 to 914 m (0 to 3000 ft)</b>	10° to 35°C (50° to 95°F)
<b>Operating temperature at 914 to 2133 m (3000 to 7000 ft)</b>	10° to 32°C (50° to 90°F)
<b>Operating humidity</b>	8 to 80% (noncondensing)
<b>Rated input voltage and current</b>	<b>H:</b> 200-208 V ac, 60 amps, single-phase <b>I:</b> 220-240 V ac, 63 amps, single-phase <b>J:</b> 220-240 V ac, 32 amps, three-phase <b>K:</b> 200-208 V ac, 60 amps, three-phase
<b>Rated frequency</b>	50 to 60 Hz
<b>Maximum power rating</b>	<b>H:</b> 9984 VA <b>I:</b> 14490 VA <b>J:</b> 22080 VA <b>K:</b> 17292 VA
<b>Circuit breakers</b>	Twelve supplemental circuit breakers rated at 15 amps
<b>Power cord</b>	<b>H:</b> One IEC 309 2P+Gnd connector rated at 60 amps <b>I:</b> One IEC 309 P+N+Gnd connector rated at 63 amps <b>J:</b> One IEC 309 3P+N+Gnd connector rated at 32 amps <b>K:</b> One IEC 309 3P+Gnd connector rated at 60 amps
<b>Power outlets</b>	Twelve IEC 320-C19 outlets rated at 16 amps (VDE) / 20 amps (UL/CSA)



Table 11. Enterprise PDU specifications

<b>Height</b>	43.9 mm (1.73 in.)
<b>Width</b>	448 mm (17.6 in.)
<b>Depth</b>	213 mm (8.4 in.)
<b>Additional clearance</b>	25 mm (0.98 in.) for circuit breakers 3 mm (0.12 in.) for outlets
<b>Weight (not including line cord)</b>	4.2 kg (9.2 lb)
<b>Weight of line cord (approximate, varies by model of PDU)</b>	5.4 kg (11.8 lb)
<b>Operating temperature at 0 to 914 m (0 to 3000 ft)</b>	10° to 35°C (50° to 95°F)
<b>Operating temperature at 914 to 2133 m (3000 to 7000 ft)</b>	10° to 32°C (50° to 90°F)
<b>Operating humidity</b>	8 to 80% (noncondensing)
<b>Rated input voltage and current</b>	<b>L:</b> 220-240 V ac, 32 amps, single-phase <b>M:</b> 200-208 V ac, 48 amps, single-phase <b>N:</b> 220-240 V ac, 63 amps, single-phase <b>O:</b> 220-240 V ac, 32 amps, three-phase Wye <b>P:</b> 200-208 V ac, 24 amps, single-phase <b>Q:</b> 200-208 V ac, 48 amps, three-phase Delta <b>R:</b> 200-208 V ac, 48 amps, single-phase <b>S:</b> 220-240 V ac, 63 amps, single-phase <b>T:</b> 220-240 V ac, 32 amps, three-phase Wye <b>U:</b> 200-208 V ac, 48 amps, three-phase Delta
<b>Rated frequency</b>	50 to 60 Hz
<b>Maximum power rating</b>	<b>L:</b> 7680 VA <b>M:</b> 9984 VA <b>N:</b> 15120 VA <b>O:</b> 23040 VA <b>P:</b> 4992 VA <b>Q:</b> 17292 VA <b>R:</b> 9984 VA <b>S:</b> 15120 VA <b>T:</b> 23040 VA <b>U:</b> 17292 VA
<b>Circuit breakers</b>	Six double-pole branch rated circuit breakers rated at 20 amps

Table 11. Enterprise PDU specifications (continued)

<b>Power cord</b>	<p><b>L:</b> One IEC 309 2P+N+Gnd connector rated at 32 amps</p> <p><b>M:</b> One IEC 309 2P+Gnd connector rated at 60 amps</p> <p><b>N:</b> One IEC 309 2P+N+Gnd connector rated at 63 amps</p> <p><b>O:</b> One IEC 309 3P+N+Gnd connector rated at 32 amps</p> <p><b>P:</b> One Nema L6-30P connector rated at 30 amps</p> <p><b>Q:</b> One IEC 309 3P+Gnd connector rated at 60 amps</p> <p><b>R:</b> One IEC 309 2P+Gnd connector rated at 60 amps</p> <p><b>S:</b> One IEC 309 2P+N+Gnd connector rated at 63 amps</p> <p><b>T:</b> One IEC 309 3P+N+Gnd connector rated at 32 amps</p> <p><b>U:</b> One IEC 309 3P+Gnd connector rated at 60 amps</p>
<b>Power outlets</b>	<p><b>L, M, N, O, P, and Q:</b> Twelve IEC 320-C13 outlets rated at 10 amps (VDE) / 15 amps (UL/CSA)</p> <p><b>R, S, T, and U:</b> Six IEC 320-C19 outlets rated at 16 amps (VDE) / 20 amps (UL/CSA)</p>

## PDU connector and outlet information

If you are connecting rack PDUs to a 120-127 V ac power source, connect each rack PDU power cord to a separate branch circuit.

If you are connecting rack PDUs to a 200-240 V ac power source, follow these guidelines:

- If the branch circuit rating is 13 amps or less, connect each rack PDU power cord to a separate branch circuit.
- If the branch circuit rating is 14 to 19 amps, do not connect more than two rack PDU power cords to the same branch circuit.
- If the branch circuit rating is 20 amps or greater, you can connect up to three rack PDU power cords to the same branch circuit.

Connect the power cord that comes with your PDU to a properly wired and grounded outlet. The tables in this section contain connector and outlet information for the front-end PDUs (see Table 12 on page 45), the high-density PDUs (see Table 13 on page 46), and the enterprise PDUs (see Table 14 on page 47).

Table 12. Front-end PDU connector and outlet information



Front-end PDU	Connector	Outlet
DPI 30 amp/125 V front-end PDU with NEMA L5-30P connector		
DPI 30 amp/250 V front-end PDU with NEMA L6-30P connector		
DPI 32 amp/250 V front-end PDU with IEC 309 2P+Gnd connector		
DPI 60 amp/250 V front-end PDU with IEC 309 2P+Gnd connector		
DPI 63 amp/250 V front-end PDU with IEC 309 2P+Gnd connector		

Table 13. High-density PDU connector and outlet information



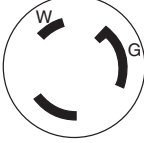
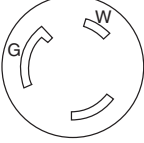
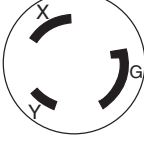
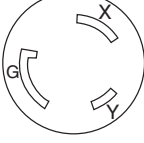

High-density PDU	Connector	Outlet	Rating
DPI 60 amp/208 V 1-phase High Density C19 PDU with IEC 309 2P+Gnd connector			60 amps, 250 V ac IEC 309 2P+Gnd
DPI 63 amp/230 V 1-phase High Density C19 PDU with IEC 309 P+N+Gnd connector			63 amps, 250 V ac IEC 309 P+N+Gnd
DPI 32 amp 400/230 V 3-phase High Density C19 PDU with IEC 309 3P+N+Gnd connector			32 amps, 250 V ac IEC 309 3P+N+Gnd
DPI 60 amp/208 V 3-phase High Density C19 PDU with IEC 309 3P+Gnd connector			60 amps, 250 V ac IEC 309 3P+Gnd

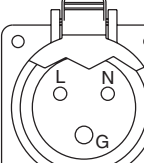
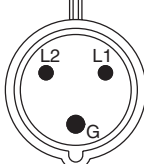
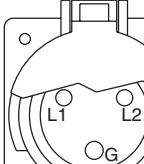
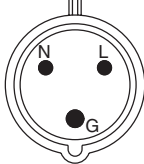
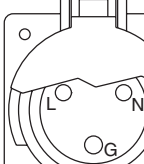
Table 14. Enterprise PDU connector and outlet information

High-density PDU	Connector	Outlet	Rating
<ul style="list-style-type: none"> <li>DPI 32 amp/250 V 3-phase Enterprise C13 PDU with IEC 309 3P+N+Gnd connector</li> <li>DPI 32 amp/250 V 3-phase Enterprise C19 PDU with IEC 309 3P+N+Gnd connector</li> </ul>			32 amps, 220-240/380-415 V ac IEC 309 3P+N+Gnd
<ul style="list-style-type: none"> <li>DPI 32 amp/250 V 1-phase Enterprise C13 PDU with IEC 309 2P+N+Gnd connector</li> </ul>			32 amps, 250 V ac IEC 309 P+N+Gnd
<ul style="list-style-type: none"> <li>DPI 63 amp/250 V 1-phase Enterprise C13 PDU with IEC 309 2P+N+Gnd connector</li> <li>DPI 63 amp/250 V 1-phase Enterprise C19 PDU with IEC 309 2P+N+Gnd connector</li> </ul>			63 amps, 250 V ac IEC 309 3P+N+Gnd
<ul style="list-style-type: none"> <li>DPI 30 amp/208 V 1-phase Enterprise C13 PDU with Nema L6-30P connector</li> </ul>			30 amps, 250 V ac NEMA L6-30
<ul style="list-style-type: none"> <li>DPI 60 amp/208 V 1-phase Enterprise C13 PDU with IEC 309 2P+Gnd connector</li> <li>DPI 60 amp/208 V 1-phase Enterprise C19 PDU with IEC 309 2P+Gnd connector</li> </ul>			60 amps, 250 V ac IEC 309 2P+Gnd

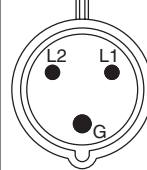
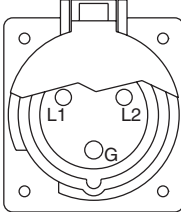
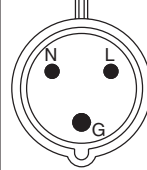
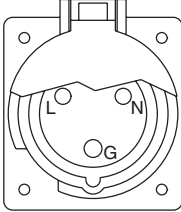
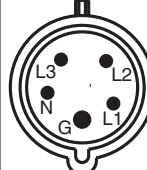
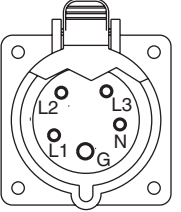
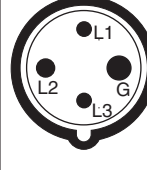
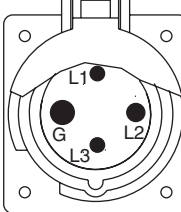
---

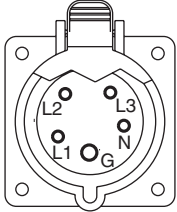
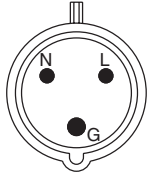
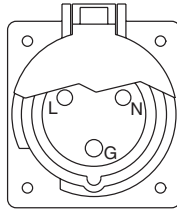
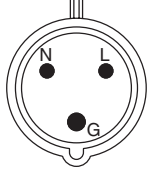
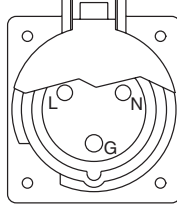
## Uninterruptible power supplies

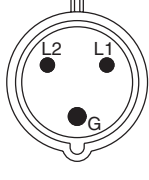
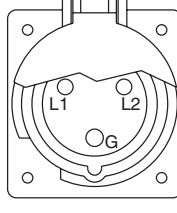
The IBM Uninterruptible Power Supply family consists of the following models:

- UPS3000XLV Uninterruptible Power Supply
- UPS3000XHV Uninterruptible Power Supply
- Smart-UPS 1400 RMB (950 Watts) Uninterruptible Power Supply
- Smart-UPS 1400 RMIB (950 Watts) Uninterruptible Power Supply
- Smart-UPS 5000 RMB (3750 Watts) Uninterruptible Power Supply
- Smart-UPS 5000 RMIB (3750 Watts) Uninterruptible Power Supply

The tables in this section contain the product specifications for these models.

Table 15. UPS3000XLV and UPS3000XHV specifications

	<b>UPS3000XLV</b>	<b>UPS3000XHV</b>
<b>Height</b>	88.9 mm (3.5 in.)	88.9 mm (3.5 in.)
<b>Width</b>	482.6 mm (19.0 in.)	482.6 mm (19.0 in.)
<b>Depth</b>	457.2 mm (18.0 in.)	457.2 mm (18.0 in.)
<b>Additional clearance</b>	25 mm (0.98 in.) for circuit breakers 3 mm (0.12 in.) for outlets	25 mm (0.98 in.) for circuit breakers 3 mm (0.12 in.) for outlets
<b>Weight</b>	28.64 kg (63.0 lb)	28.64 kg (63.0 lb)
<b>Operating temperature at 0 to 3000 m (0 to 10,000 ft)</b>	0° to 40°C (32° to 104°F)	0° to 40°C (32° to 104°F)
<b>Maximum altitude</b>	3000 m (10000 ft)	3000 m (10000 ft)
<b>Relative humidity</b>	0 to 95%	0 to 95%
<b>Nominal input voltage</b>	100-127 V (selectable)	220 V ac (selectable from 200-240 V ac)
<b>Maximum input current</b>	12 amps	6 amps
<b>Input voltage range for main operations</b>	82-147 V	160-286 V
<b>Input voltage adjustable range for main operations</b>	75-154 V	151-302 V
<b>Nominal output voltage</b>	100-127 V (selectable)	220 V, configurable for 200, 220, 230, or 240 V
<b>Input frequency</b>	50/60 Hz +/-3 Hz (auto sensing)	50/60 Hz +/-3 Hz (auto sensing)
<b>Rated power output</b>	3000 VA	3000 VA
<b>Output power capacity in watts</b>	2750 W	2750 W
<b>Circuit breakers</b>	Three supplemental circuit breakers rated at 15 amps	Three supplemental circuit breakers rated at 15 amps
<b>Fixed power cord</b>	Length: 6 ft; Nema L5-30P connection to source	
<b>Input connection type</b>		IEC-320 C20, connection to source using country specific line cords
<b>Power outlets</b>	Six IEC C13 outlets One IEC C19 outlet	Six IEC C13 outlets One IEC C19 outlet
<b>Audible noise at 1 meter</b>	46 dBA	46 dBA
<b>Online thermal dissipation</b>	171 Btu per hour	171 Btu per hour

Table 16. SMART-UPS 1400 RMB and SMART-UPS 1400 RMIB specifications

	<b>SMART-UPS 1400 RMB</b>	<b>SMART-UPS 1400 RMIB</b>
<b>Height</b>	88.9 mm (3.5 in.)	88.9 mm (3.5 in.)
<b>Width</b>	482.6 mm (19.0 in.)	482.6 mm (19.0 in.)
<b>Depth</b>	457.2 mm (18.0 in.)	457.2 mm (18.0 in.)
<b>Additional clearance</b>	25 mm (0.98 in.) for circuit breakers 3 mm (0.12 in.) for outlets	25 mm (0.98 in.) for circuit breakers 3 mm (0.12 in.) for outlets
<b>Weight</b>	28.64 kg (63.0 lb)	28.64 kg (63.0 lb)
<b>Operating temperature at 0 to 3000 m (0 to 10,000 ft)</b>	0° to 40°C (32° to 104°F)	0° to 40°C (32° to 104°F)
<b>Maximum altitude</b>	3000 m (10000 ft)	3000 m (10000 ft)
<b>Relative humidity</b>	0 to 95%	0 to 95%
<b>Nominal input voltage</b>	120 V	230 V, single phase
<b>Maximum input current</b>	12 amps	6 amps
<b>Input voltage range for main operations</b>	82-147 V	160-286 V
<b>Input voltage adjustable range for main operations</b>	75-154 V	151-302 V
<b>Nominal output voltage</b>	120 V	230 V, configurable for 220, 225, 230, or 240 V
<b>Input frequency</b>	50/60 Hz +/-3 Hz (auto sensing)	50/60 Hz +/-3 Hz (auto sensing)
<b>Rated power output</b>	1400 VA	1400 VA
<b>Output power capacity in watts</b>	950 W	950 W
<b>Circuit breakers</b>	One	One
<b>Fixed power cord</b>	length - 6 ft - Nema L5-15P connection to source	
<b>Power cord</b>		IEC-320 C14
<b>Power outlets</b>	Six Nema 5-15R outlets	Four IEC 320 C13 outlets
<b>Audible noise at 1 meter</b>	46 dBA	46 dBA
<b>Online thermal dissipation</b>	171 Btu per hour	171 Btu per hour
<b>Emergency power off (EPO)</b>	Provided through a cable included with the unit	Provided through a cable included with the unit



Table 17. SMART-UPS 5000 RMB and SMART-UPS 5000 RMIB specifications

	<b>SMART-UPS 5000 RMB</b>	<b>SMART-UPS 5000 RMIB</b>
<b>Height</b>	222.3 mm (8.75 in.)	222.3 mm (8.75 in.)
<b>Width</b>	483.0 mm (19.0 in.)	483.0 mm (19.0 in.)
<b>Depth</b>	635.0 mm (25.0 in.)	635.0 mm (25.0 in.)
<b>Additional clearance</b>	25 mm (0.98 in.) for circuit breakers 3 mm (0.12 in.) for outlets	25 mm (0.98 in.) for circuit breakers 3 mm (0.12 in.) for outlets
<b>Weight</b>	102 kg (225.0 lb)	102 kg (225.0 lb)
<b>Operating temperature at 0 to 2133 m (0 to 7000 ft)</b>	10°– 35°C (50° to 95°F) at 0 to 914 m (0 to 3000 ft) 10° to 32°C (50° to 90°F) at 914 to 2133 m (3000 to 7000 ft)	10°– 35°C (50° to 95°F) at 0 to 914 m (0 to 3000 ft) 10° to 32°C (50° to 90°F) at 914 to 2133 m (3000 to 7000 ft)
<b>Maximum altitude</b>	2133 m (7000 ft)	2133 m (7000 ft)
<b>Relative humidity</b>	0 to 95%	0 to 95%
<b>Nominal input voltage</b>	208 V ac, single phase	220-240 V ac, single phase
<b>Maximum input current</b>	24 amps	22 amps
<b>Input voltage range for main operations</b>	160-286 V	160-286 V
<b>Input voltage adjustable range for main operations</b>	151-302 V	151-302 V
<b>Nominal output voltage</b>	208 V	230 V, configurable for 220, 225, 230, or 240 V
<b>Input frequency</b>	50/60 Hz +/-3 Hz (auto sensing)	50/60 Hz +/-3 Hz (auto sensing)
<b>Rated power output</b>	5000 VA	5000 VA
<b>Output power capacity in watts</b>	3750 W	3750 W
<b>Circuit breakers</b>	One	One
<b>Power cord</b>	IEC-320 C14	IEC-320 C14
<b>Power outlets</b>	Eight 10 amps IEC-320 C13 connectors for direct device attachment Two 16 amps IEC-320 C19	Eight 10 amps IEC-320 C13 connectors for direct device attachment Two 16 amps IEC-320 C19
<b>Audible noise at 1 meter</b>	46 dBA	46 dBA
<b>Online thermal dissipation</b>	171 BTU/hr	171 BTU/hr
<b>Emergency power off (EPO)</b>	Provided through a cable included with the unit	Provided through a cable included with the unit



---

## Appendix B. Getting help and technical assistance

If you need help, service, or technical assistance or just want more information about IBM products, you will find a wide variety of sources available from IBM to assist you. This appendix contains information about where to go for additional information about IBM and IBM products, what to do if you experience a problem with your xSeries or IntelliStation® system, and whom to call for service, if it is necessary.

---

### Before you call

Before you call, make sure that you have taken these steps to try to solve the problem yourself:

- Check all cables to make sure that they are connected.
- Check the power switches to make sure that the system is turned on.
- Use the troubleshooting information in your system documentation, and use the diagnostic tools that come with your system. Information about diagnostic tools is in the *Hardware Maintenance Manual and Troubleshooting Guide* on the IBM *xSeries Documentation* CD or in the *IntelliStation Hardware Maintenance Manual* at the IBM Support Web site.
- Go to the IBM Support Web site at <http://www.ibm.com/pc/support/> to check for technical information, hints, tips, and new device drivers or to submit a request for information.

You can solve many problems without outside assistance by following the troubleshooting procedures that IBM provides in the online help or in the publications that are provided with your system and software. The information that comes with your system also describes the diagnostic tests that you can perform. Most xSeries and IntelliStation systems, operating systems, and programs come with information that contains troubleshooting procedures and explanations of error messages and error codes. If you suspect a software problem, see the information for the operating system or program.

---

### Using the documentation

Information about your IBM xSeries or IntelliStation system and preinstalled software, if any, is available in the documentation that comes with your system. That documentation includes printed books, online books, readme files, and help files. See the troubleshooting information in your system documentation for instructions for using the diagnostic programs. The troubleshooting information or the diagnostic programs might tell you that you need additional or updated device drivers or other software. IBM maintains pages on the World Wide Web where you can get the latest technical information and download device drivers and updates. To access these pages, go to <http://www.ibm.com/pc/support/> and follow the instructions. Also, you can order publications through the IBM Publications Ordering System at <http://www.elink.ibm.com/public/applications/publications/cgibin/pbi.cgi>.

---

## Getting help and information from the World Wide Web

On the World Wide Web, the IBM Web site has up-to-date information about IBM xSeries and IntelliStation products, services, and support. The address for IBM xSeries information is <http://www.ibm.com/eserver/xseries/>. The address for IBM IntelliStation information is <http://www.ibm.com/pc/intellistation/>.

You can find service information for your IBM products, including supported options, at <http://www.ibm.com/pc/support/>.

---

## Software service and support

Through IBM Support Line, you can get telephone assistance, for a fee, with usage, configuration, and software problems with xSeries servers, IntelliStation workstations, and appliances. For information about which products are supported by Support Line in your country or region, go to <http://www.ibm.com/services/sl/products/>.

For more information about Support Line and other IBM services, go to <http://www.ibm.com/services/>, or go to <http://www.ibm.com/planetwide/> for support telephone numbers. In the U.S. and Canada, call 1-800-IBM-SERV (1-800-426-7378).

---

## Hardware service and support

You can receive hardware service through IBM Services or through your IBM reseller, if your reseller is authorized by IBM to provide warranty service. Go to <http://www.ibm.com/planetwide/> for support telephone numbers, or in the U.S. and Canada, call 1-800-IBM-SERV (1-800-426-7378).

In the U.S. and Canada, hardware service and support is available 24 hours a day, 7 days a week. In the U.K., these services are available Monday through Friday, from 9 a.m. to 6 p.m.

---

## Appendix C. Notices

This information was developed for products and services offered in the U.S.A.

IBM may not offer the products, services, or features discussed in this document in other countries. Consult your local IBM representative for information on the products and services currently available in your area. Any reference to an IBM product, program, or service is not intended to state or imply that only that IBM product, program, or service may be used. Any functionally equivalent product, program, or service that does not infringe any IBM intellectual property right may be used instead. However, it is the user's responsibility to evaluate and verify the operation of any non-IBM product, program, or service.

IBM may have patents or pending patent applications covering subject matter described in this document. The furnishing of this document does not give you any license to these patents. You can send license inquiries, in writing, to:

*IBM Director of Licensing  
IBM Corporation  
North Castle Drive  
Armonk, NY 10504-1785  
U.S.A.*

INTERNATIONAL BUSINESS MACHINES CORPORATION PROVIDES THIS PUBLICATION "AS IS" WITHOUT WARRANTY OF ANY KIND, EITHER EXPRESS OR IMPLIED, INCLUDING, BUT NOT LIMITED TO, THE IMPLIED WARRANTIES OF NON-INFRINGEMENT, MERCHANTABILITY OR FITNESS FOR A PARTICULAR PURPOSE. Some states do not allow disclaimer of express or implied warranties in certain transactions, therefore, this statement may not apply to you.

This information could include technical inaccuracies or typographical errors. Changes are periodically made to the information herein; these changes will be incorporated in new editions of the publication. IBM may make improvements and/or changes in the product(s) and/or the program(s) described in this publication at any time without notice.

Any references in this information to non-IBM Web sites are provided for convenience only and do not in any manner serve as an endorsement of those Web sites. The materials at those Web sites are not part of the materials for this IBM product, and use of those Web sites is at your own risk.

IBM may use or distribute any of the information you supply in any way it believes appropriate without incurring any obligation to you.

---

### Edition notice

**© Copyright International Business Machines Corporation 2001, 2004. All rights reserved.**

U.S. Government Users Restricted Rights — Use, duplication, or disclosure restricted by GSA ADP Schedule Contract with IBM Corp.

---

## Trademarks

The following terms are trademarks of International Business Machines Corporation in the United States, other countries, or both:

e-business logo  
@server  
IBM  
IntelliStation

NetBAY  
ServerProven  
Thinkpad  
xSeries

Other company, product, or service names may be trademarks or service marks of others.

---

## Important notes

Processor speeds indicate the internal clock speed of the microprocessor; other factors also affect application performance.

CD-ROM drive speeds list the variable read rate. Actual speeds vary and are often less than the maximum possible.

When referring to processor storage, real and virtual storage, or channel volume, KB stands for approximately 1000 bytes, MB stands for approximately 1 000 000 bytes, and GB stands for approximately 1 000 000 000 bytes.

When referring to hard disk drive capacity or communications volume, MB stands for 1 000 000 bytes, and GB stands for 1 000 000 000 bytes. Total user-accessible capacity may vary depending on operating environments.

Maximum internal hard disk drive capacities assume the replacement of any standard hard disk drives and population of all hard disk drive bays with the largest currently supported drives available from IBM.

Maximum memory may require replacement of the standard memory with an optional memory module.

IBM makes no representation or warranties regarding non-IBM products and services that are ServerProven<sup>®</sup>, including but not limited to the implied warranties of merchantability and fitness for a particular purpose. These products are offered and warranted solely by third parties.

IBM makes no representations or warranties with respect to non-IBM products. Support (if any) for the non-IBM products is provided by the third party, not IBM.

Some software may differ from its retail version (if available), and may not include user manuals or all program functionality.





Part Number: 02R2777

Printed in USA

(1P) P/N: 02R2777

