

xSeries 440



Installation Guide

Note: Before using this information and the product it supports, be sure to read the general information in Appendix A, "Warranty information" on page 53 and Appendix B, "Notices" on page 65.

First Edition (April 2002)

© Copyright International Business Machines Corporation 2002. All rights reserved.

US Government Users Restricted Rights – Use, duplication or disclosure restricted by GSA ADP Schedule Contract with IBM Corp.

Contents

Safety	viii
Chapter 1. Introduction	1
Features and specifications	2
Notices and statements used in this book	3
Before you begin	3
Working inside a server with power on.	3
Handling static-sensitive devices	4
Major components of the xSeries 440 server	5
Chapter 2. Installing options	7
Opening the cover	7
PCI and PCI-X adapters	8
PCI and PCI-X adapter considerations.	8
Installing adapters	9
Cabling a ServeRAID™ adapter	11
SMP Expansion Module	13
Removing an SMP Expansion Module and cover	14
DIMMs	18
Installing DIMMs	19
Reinstalling an SMP Expansion Module and cover.	21
Completing the installation.	24
Working with cables	25
Connecting cables	26
SMP expansion cabling.	26
Power cabling	26
RXE expansion cabling	26
SCSI cabling.	27
USB cabling	27
Video cabling	27
Auxiliary pointing device cabling	27
Gigabit Ethernet cabling	27
RXE Management cabling.	27
Chapter 3. Configuring your server	29
Using the Configuration/Setup Utility program	30
Using the SCSISelect utility program	30
Using the ServerGuide CD	31
Using the Remote Supervisor Adapter	31
Using the ServeRAID configuration programs.	32
Chapter 4. Server power, controls, and options	33
Turning on the server	33
Turning off the server	33
Standby mode	34
Server controls and indicators	35
Front view	35
Rear view.	37
Chapter 5. Solving problems	39
Diagnostic tools overview	39
POST beep code descriptions	39
ServerGuide startup problems	40

Troubleshooting charts	41
Light Path Diagnostics feature overview.	44
Identifying problems using the Light Path Diagnostics.	46
The diagnostic panel.	46
LEDs on the top of the server	46
LEDs on the SMP Modules and system boards	46
Light Path Diagnostics table	47
Chapter 6. Getting help and service	49
Getting information, help, and service	49
Getting information	49
Using the World Wide Web	49
Getting information by fax	49
Getting help and service	49
Using the documentation and diagnostic programs.	50
Calling for service	50
Telephone numbers	51
International Warranty Service	51
Purchasing additional services	52
Appendix A. Warranty information	53
Warranty period	53
Warranty service and support	53
Before you call for service.	53
Calling for service.	54
IBM Statement of Limited Warranty Z125-4753-06 8/2000	55
Part 1 - General Terms	55
Part 2 - Country-unique Terms	57
Appendix B. Notices	65
Edition notice	65
Trademarks	66
Important notes.	66
Electronic emission notices	67
Federal Communications Commission (FCC) statement	67
Industry Canada Class A emission compliance statement	67
Australia and New Zealand Class A statement	68
United Kingdom telecommunications safety requirement.	68
European Union EMC Directive conformance statement.	68
Taiwan electrical emission statement	68
Japanese Voluntary Control Council for Interference (VCCI) statement	69
Power cords	69
Index	71

Safety

Before installing this product, read the Safety Information.

قبل تركيب هذا المنتج، يجب قراءة الملاحظات الأمنية

Antes de instalar este produto, leia as Informações de Segurança.

在安装本产品之前，请仔细阅读 **Safety Information** (安全信息)。

安裝本產品之前，請先閱讀「安全資訊」。

Prije instalacije ovog produkta obavezno pročitajte Sigurnosne Upute.

Před instalací tohoto produktu si přečtěte příručku bezpečnostních instrukcí.

Læs sikkerhedsforskrifterne, før du installerer dette produkt.

Lees voordat u dit product installeert eerst de veiligheidsvoorschriften.

Ennen kuin asennat tämän tuotteen, lue turvaohjeet kohdasta Safety Information.

Avant d'installer ce produit, lisez les consignes de sécurité.

Vor der Installation dieses Produkts die Sicherheitshinweise lesen.

Πριν εγκαταστήσετε το προϊόν αυτό, διαβάστε τις πληροφορίες ασφάλειας (safety information).

לפני שתתקינו מוצר זה, קראו את הוראות הבטיחות.

A termék telepítése előtt olvassa el a Biztonsági előírásokat!

Prima di installare questo prodotto, leggere le Informazioni sulla Sicurezza

製品の設置の前に、安全情報をお読みください。

본 제품을 설치하기 전에 안전 정보를 읽으십시오.

Пред да се инсталира овој продукт, прочитајте информацијата за безбедност.

Les sikkerhetsinformasjonen (Safety Information) før du installerer dette produktet.

Przed zainstalowaniem tego produktu, należy zapoznać się z książką "Informacje dotyczące bezpieczeństwa" (Safety Information).

Antes de instalar este produto, leia as Informações sobre Segurança.

Перед установкой продукта прочтите инструкции по технике безопасности.

Pred inštaláciou tohto zariadenia si pečítajte Bezpečnostné predpisy.

Pred namestitvijo tega proizvoda preberite Varnostne informacije.

Antes de instalar este producto lea la información de seguridad.

Läs säkerhetsinformationen innan du installerar den här produkten.

Statement 1:



DANGER

Electrical current from power, telephone, and communication cables is hazardous. To avoid a shock hazard:

- **Do not connect or disconnect any cables or perform installation, maintenance, or reconfiguration of this product during an electrical storm.**
- **Connect all power cords to a properly wired and grounded electrical outlet.**
- **Connect to properly wired outlets any equipment that will be attached to this product.**
- **When possible, use one hand only to connect or disconnect signal cables.**
- **Never turn on any equipment when there is evidence of fire, water, or structural damage.**
- **Disconnect the attached power cords, telecommunications systems, networks, and modems before you open the device covers, unless instructed otherwise in the installation and configuration procedures.**
- **Connect and disconnect cables as described in the following table when installing, moving, or opening covers on this product or attached devices.**

To connect:

1. Turn everything OFF.
2. First, attach all cables to devices.
3. Attach signal cables to connectors.
4. Attach power cords to outlet.
5. Turn device ON.

To disconnect:

1. Turn everything OFF.
2. First, remove power cords from outlet.
3. Remove signal cables from connectors.
4. Remove all cables from devices.

Statement 2:

CAUTION:



When replacing the lithium battery, use only IBM Part Number 33F8354 or an equivalent type battery recommended by the manufacturer. If your system has a module containing a lithium battery, replace it only with the same module type made by the same manufacturer. The battery contains lithium and can explode if not properly used, handled, or disposed of.

Do not:

- Throw or immerse into water.
- Heat to more than 100° C (212° F)
- Repair or disassemble

Dispose of the battery as required by local ordinances or regulations.

Statement 3:



CAUTION:

When laser products (such as CD-ROMs, DVD drives, fiber optic devices, or transmitters) are installed, note the following:

- Do not remove the covers. Removing the covers of the laser product could result in exposure to hazardous laser radiation. There are no serviceable parts inside the device.
- Use of controls or adjustments or performance of procedures other than those specified herein might result in hazardous radiation exposure.



DANGER

Some laser products contain an embedded Class 3A or Class 3B laser diode. Note the following.

Laser radiation when open. Do not stare into the beam, do not view directly with optical instruments, and avoid direct exposure to the beam.

Statement 4:



≥18 kg (39.7 lbs)



≥32 kg (70.5 lbs)

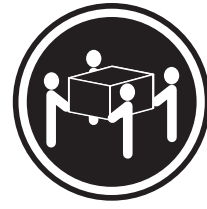

≥55 kg (121.2 lbs)

CAUTION:

Use safe practices when lifting.

Statement 5:



CAUTION:

The power control button on the device and the power switch on the power supply do not turn off the electrical current supplied to the device. The device also might have more than one power cord. To remove all electrical current from the device, ensure that all power cords are disconnected from the power source.



Statement 8:



CAUTION:

Never remove the cover on a power supply or any part that has the following label attached.



Hazardous voltage, current, and energy levels are present inside any component that has this label attached. There are no serviceable parts inside these components. If you suspect a problem with one of these parts, contact a service technician.

Chapter 1. Introduction

Thank you for purchasing an IBM® *eServer* xSeries 440 server with IBM X-Architecture™ Enterprise technologies¹.

This *Installation Guide* provides the information that is needed to:

- Set up and cable your server
- Start and configure your server
- Install options
- Install your network operating system (NOS)
- Perform basic troubleshooting of your server

Packaged with the *Installation Guide* are software CDs that help you to configure hardware, install device drivers, and install the network operating system.

Also included is an *IBM xSeries Documentation CD*, which provides detailed information about your server.

Your server comes with a limited warranty. If you have access to the World Wide Web, you can obtain up-to-date information about your xSeries 440 model and other IBM server products at <http://www.ibm.com/eserver/xseries/>.

Record your product information in this table.	
Product name	_____
Type	_____
Model number	_____
Serial number	_____

The machine type and serial number are located on the ID label located on the left side of the bezel just above the hard disk drives.

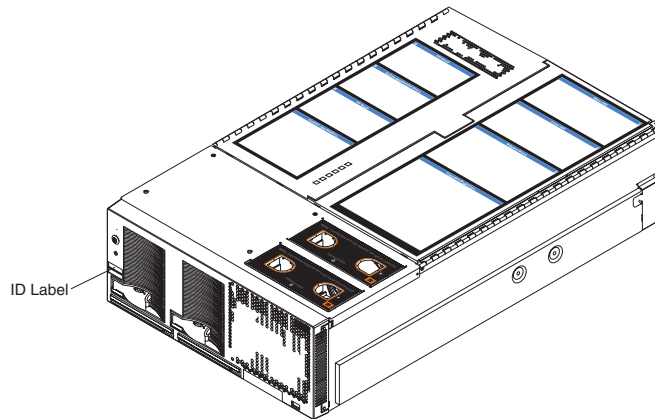

1. Enterprise X-Architecture is an IBM design blueprint that takes full advantage of existing IBM technologies to build powerful, scalable and reliable Intel processor-based servers. For more information about IBM Enterprise X-Architecture, refer to <http://www.ibm.com/pc/us/eserver/xseries/xarchitecture/enterprise/index.html>.

Features and specifications

The following table provides a summary of the features and specifications for your xSeries 440.

<p>Microprocessor:</p> <p>Supports up to 8 microprocessors (depending on your configuration)</p> <ul style="list-style-type: none"> • The Intel Xeon™ MP 1.4 GHz with 512 KB, 1.5 GHz with 512 KB, or 1.6 GHz with 1 MB Level-3 cache • IBMXA-32™ chip set with integrated memory, I/O, system cache, and remote I/O controllers <p>Memory:</p> <ul style="list-style-type: none"> • Minimum: 2 GB • Maximum: 32 GB (depending on your configuration) • Type: 4-way interleaved PC133 MHz, ECC SDRAM, registered DIMMs only • Supports 512 MB and 1GB dual inline memory modules (DIMMs) • Xcel4™ Server Accelerator Cache (up to 64 MB depending on your configuration) <p>Drives:</p> <ul style="list-style-type: none"> • Diskette: 1.44 MB • CD-ROM: 24X IDE • Supports up to two internal Ultra160 SCSI hard disk drives <p>Active™ PCI-X expansion slots:</p> <p>Six 64-bit Active PCI-X expansion slots:</p> <ul style="list-style-type: none"> • Two 66 MHz PCI-X slots • Two 100 MHz PCI-X slots • Two 133 MHz PCI-X slots • Additional PCI-X slots available in an optional Remote Expansion Enclosure <p>Cooling:</p> <p>Four hot-swap fans</p> <ul style="list-style-type: none"> • Two 150 mm x 51 mm redundant fans • Two 150 mm x 38 mm fans 	<p>Power supply:</p> <p>Two hot-swap power supplies (550 watts at 110 V ac or 1050 watts at 220 V ac) Video:</p> <ul style="list-style-type: none"> • S3 Savage4 Pro video on system board • PCI bus interface • Compatible with SVGA • 8 MB SDRAM video memory at 125 MHz <p>Size (4U):</p> <ul style="list-style-type: none"> • Height: 17.8 cm (7 inches, 4U) • Depth: 69.85 cm (27.5 inches) • Width: 48.3 cm (19 inches) • Maximum weight: 50 kg (110 lb) depending on your configuration <p>Integrated functions:</p> <ul style="list-style-type: none"> • Broadcom 5700 10/100/1000 Ethernet controller • Light Path Diagnostics™ • Adaptec 7899W Dual Ultra160 SCSI controller • Remote Supervisor Adapter (service processor) <ul style="list-style-type: none"> – ASM interconnect (peer-to-peer) port – Ethernet port – Serial port • IDE diskette controller • RXE Management Port • Three USB ports • Keyboard port • SCSI port • Mouse port • Symmetrical multiprocessor (SMP) Expansion Ports (up to six ports depending on your configuration) • Two remote expansion enclosure (RXE) Expansion Ports 	<p>Acoustical noise emissions:</p> <ul style="list-style-type: none"> • Sound power, idling: 6.2 bel maximum • Sound power, operating: 6.2 bel maximum <p>Environment:</p> <ul style="list-style-type: none"> • Air temperature: <ul style="list-style-type: none"> – Server on: 10° to 35°C (50.0° to 95.0°F). Altitude: 0 to 914 m (2998.7 ft) – Server on: 10° to 32° C (50.0° to 89.6° F). Altitude: 914 m (2998.7 ft) to 2133 m (6998.0 ft) – Server off: -40° to 60° C (-104° to 140° F). Maximum altitude: 2133 m (6998.0 ft) • Humidity: <ul style="list-style-type: none"> – Server on: 8% to 80% – Server off: 5% to 100% <p>Heat output:</p> <p>Approximate heat output in British thermal units (Btu) per hour</p> <ul style="list-style-type: none"> • Minimum configuration: 855 Btu (250 watts) • Maximum configuration: 2726 Btu (800 watts) <p>Electrical input:</p> <ul style="list-style-type: none"> • Sine-wave input (47-53 or 57-63 Hz) required • Input voltage low range: <ul style="list-style-type: none"> – Minimum: 100 V ac – Maximum: 127 V ac • Input voltage high range: <ul style="list-style-type: none"> – Minimum: 200 V ac – Maximum: 240 V ac • Input kilovolt-amperes (kVA) approximately: <ul style="list-style-type: none"> – Minimum: 0.250 kVA – Maximum: 0.800 kVA
--	---	---

Notices and statements used in this book

The caution and danger statements used in this book also appear in the multilingual Safety Information book provided on the *IBM xSeries Documentation* CD. Each caution and danger statement is numbered for easy reference to the corresponding statement in the safety book.

The notice and statement definitions are as follows:

- **Note:** These notices provide important tips, guidance, or advice.
- **Important:** These notices provide information or advice that might help you avoid inconvenient or problem situations.
- **Attention:** These notices indicate possible damage to programs, devices, or data. An attention notice is placed just before the instruction or situation in which damage could occur.
- **Caution:** These statements indicate situations that can be potentially hazardous to you. A caution statement is placed just before the description of a potentially hazardous procedure step or situation.
- **Danger:** These statements indicate situations that can be potentially lethal or extremely hazardous to you. A danger statement is placed just before the description of a potentially lethal or extremely hazardous procedure step or situation.

Before you begin

Before you begin to install options in your server, read the following information:

- Become familiar with the information provided in "Safety" beginning on page v, and "Handling static-sensitive devices" on page 4. These guidelines will help you work safely while working with your server or options.
- Make sure that you have an adequate number of properly grounded electrical outlets for your server, monitor, and any other options that you intend to install.
- Back up all important data before you make changes to disk drives.
- For a list of supported options for the xSeries 440, refer to <http://www.ibm.com/pc/us/compat/> on the World Wide Web.

Working inside a server with power on

Your server supports hot-swap devices and is designed to operate safely while turned on with the cover removed. Follow these guidelines when you work inside a server that is turned on:

- Avoid loose-fitting clothing on your forearms. Button long-sleeved shirts before working inside the server; do not wear cuff links while you are working inside the server.
- Do not allow your necktie or scarf to hang inside the server.
- Remove jewelry, such as bracelets, rings, necklaces, and loose-fitting wrist watches.
- Remove items from your shirt pocket (such as pens or pencils) that could fall into the server as you lean over it.
- Take care to avoid dropping any metallic objects, such as paper clips, hair pins, or screws, into the server.

Handling static-sensitive devices

Attention: Static electricity can damage electronic devices and your system. To avoid damage, keep static-sensitive devices in their static-protective package until you are ready to install them.

To reduce the possibility of electrostatic discharge, observe the following precautions:

- Limit your movement. Movement can cause static electricity to build up around you.
- Handle the device carefully, holding it by its edges or its frame.
- Do not touch solder joints, pins, or exposed printed circuitry.
- Do not leave the device where others can handle and possibly damage the device.
- While the device is still in its anti-static package, touch it to an unpainted metal part of the system unit for at least 2 seconds. (This drains static electricity from the package and from your body.)
- Remove the device from its package and install it directly into your system unit without setting it down. If it is necessary to set the device down, place it in its static-protective package. Do not place the device on your system unit cover or on a metal table.
- Take additional care when handling devices during cold weather as heating reduces indoor humidity and increases static electricity.

Major components of the xSeries 440 server

The following illustration shows the locations of major components in your server.

Note: The illustrations in this document might differ slightly from your hardware.

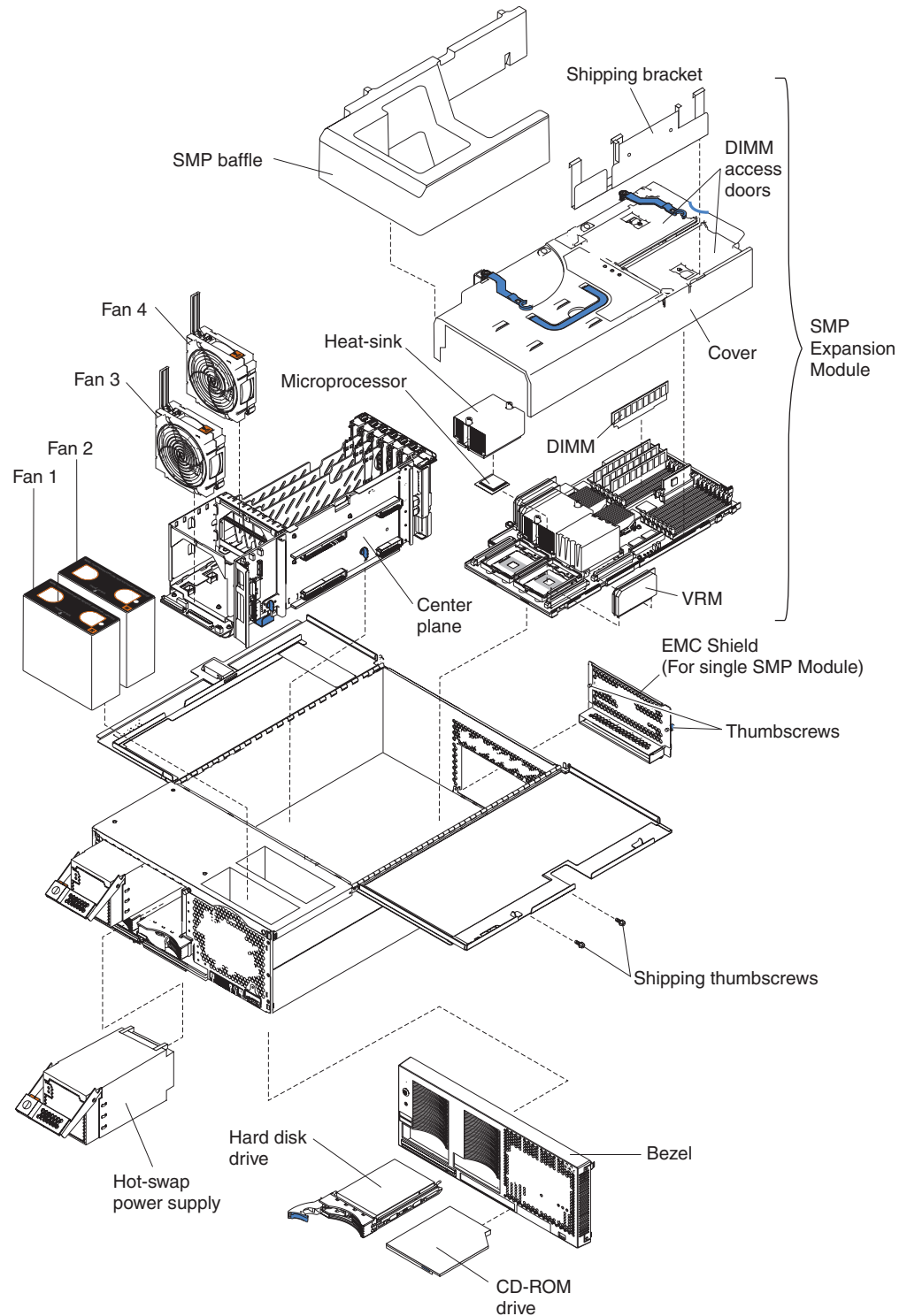

Chapter 2. Installing options

This section provides basic information that is needed to install PCI or PCI-X adapters, symmetrical multiprocessor (SMP) Expansion Modules, and DIMMs; properly cable your server; and prepare your server for installation into a rack. For more detailed information, refer to the *Option Installation Guide* on the *IBM xSeries Documentation CD*.

Opening the cover

Complete the following steps to open the server cover:

Note: Before opening the top cover, you must remove the rack-support wheels and handles from the server. Refer to the *Rack Installation Instructions* for information on how to remove them.

1. Review the information in “Before you begin” on page 3, “Working inside a server with power on” on page 3, and “Handling static-sensitive devices” on page 4.

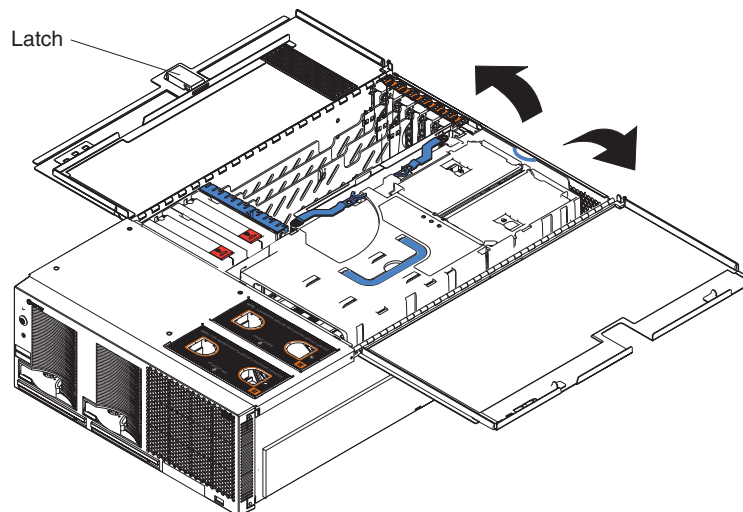

2. Press the release latch on the left half of the top cover to the left.
3. Using the finger hole in the release latch, open the left half of the cover; then, open the right half of the cover.

Attention: For proper cooling and airflow, close the cover before turning on the server. Operating the server for extended periods of time (over 30 minutes) with the cover open might damage server components.

PCI and PCI-X adapters

This section provides information about the PCI-X expansion slots on the I/O board, and peripheral component interconnect (PCI) adapters.

The following illustration shows the location of the PCI-X expansion slots on the I/O board.

Note: The illustrations in this document might differ slightly from your hardware.

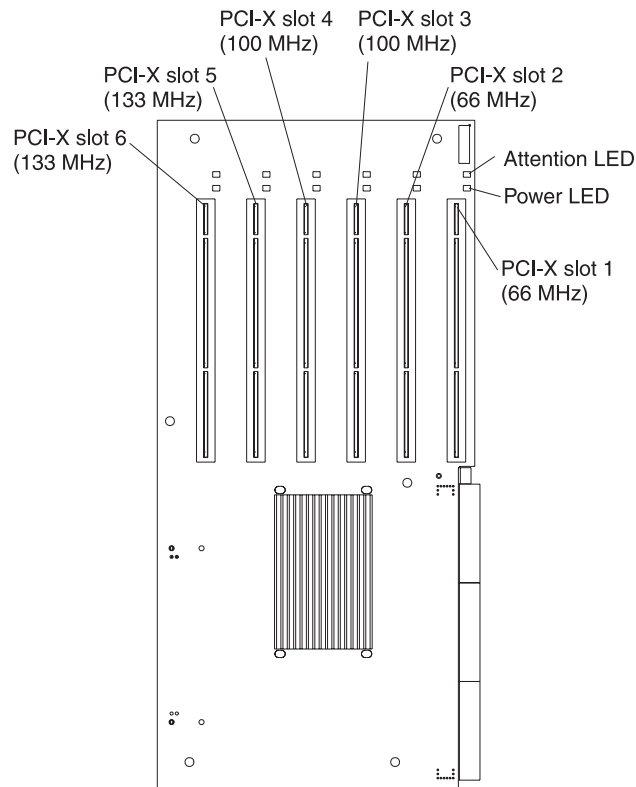

PCI and PCI-X adapter considerations

Before you install adapters, review the following:

- Locate the documentation that comes with the adapter and follow those instructions in addition to the instructions in this chapter.
- If you need to change the switch settings or jumper settings on your adapter, follow the instructions that come with the adapter.
- Video adapters are not supported.
- You can install PCI or PCI-X adapters, but they cannot occupy the same bus. If you install a PCI adapter in slot 1 and a PCI-X adapter in slot 2, neither adapter will operate properly or might not operate at all.
- You cannot install PCI or PCI-X adapters of speeds faster than what is labeled for a particular PCI-X slot. For instance, if you install a 133 MHz adapter into slot 3, which is labeled as a 100 MHz slot, the adapters installed in slots 3 and 4 will not operate properly.
- You can install PCI or PCI-X adapters of speeds slower than what is labeled for a particular PCI-X slot. For instance, if you install a 33 MHz and a 66 MHz adapter in slots one and two, the bus speed will match that of the slowest adapter speed.

- Your server supports six hot-plug 64-bit adapters in the expansion slots located on the PCI-X board.

Note: You can add up to 12 additional PCI-X slots to your server by connecting your server to a remote expansion enclosure. For more information about the expansion enclosure and how to connect your server to it, refer to the documentation that comes with your expansion enclosure.

- Your server supports 3.3 V adapters; it does not support 5.0 V adapters.
- Your server uses a rotational interrupt technique to configure PCI-X adapters. You can use this technique to install PCI-X adapters that currently do not support sharing of PCI-X interrupts.
- The system scans PCI-X slots to assign system resources. The system attempts to start the first device found. The search order is: CD-ROM, disk drives, integrated SCSI devices, PCI-X slots (1, 2, 6, 5, 3, 4), and the integrated Ethernet.

Note: You can use the Configuration/Setup Utility program to change the boot precedence for your server. Select **Start Options** from the Configuration/Setup Utility program main menu.

Installing adapters

The Active PCI-X slots in your server must be disabled by the operating system before you insert or remove a PCI or PCI-X adapter.

Note: Before hot-swapping any of the PCI-X adapters, read the information in “Working inside a server with power on” on page 3.

Complete the following steps to install an adapter:

1. Review the information in “Safety” on page v, “Before you begin” on page 3, “Working inside a server with power on” on page 3, and “Handling static-sensitive devices” on page 4.
2. Open the top cover.

Note: Inside your server there are six PCI-X slots: two 66 MHz, two 100 MHz, and two 133 MHz. Before attempting to install a new adapter, be sure that there is an available slot for it. If you need additional PCI-X slots, you can purchase a Remote Expansion Enclosure either from your

dealer or through IBM at <http://www.ibm.com/>.

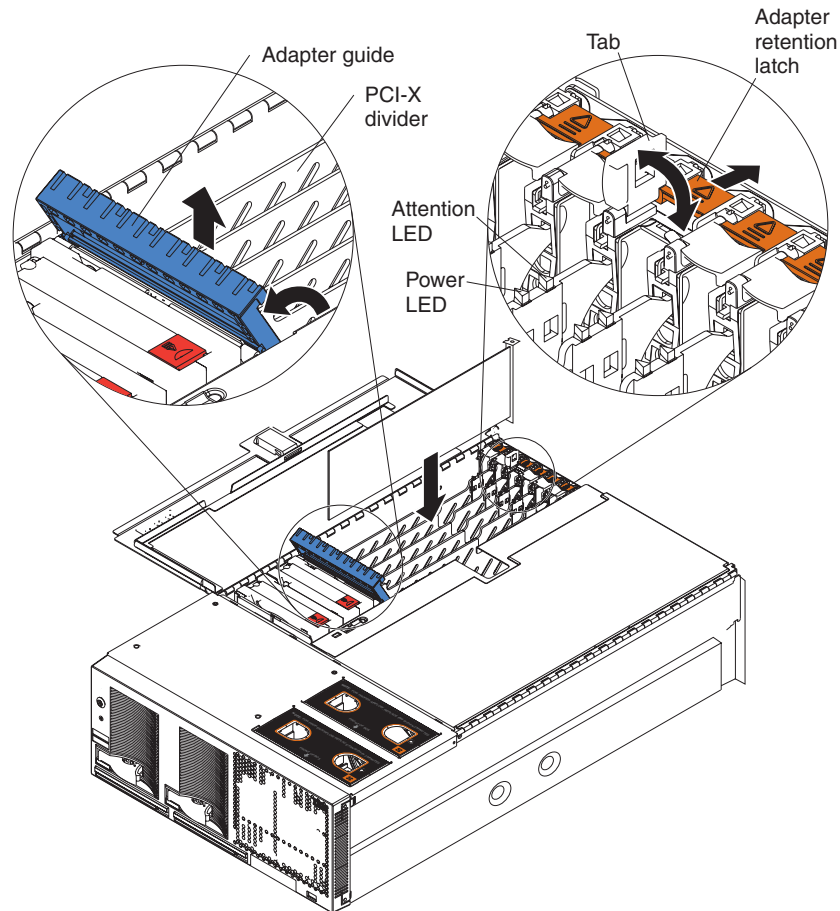

3. Refer to the documentation that comes with your adapter for any cabling instructions.

Note: Route adapter cables before you install the adapter.

4. Set any jumpers or switches as described by the adapter manufacturer.
5. Install the adapter:
 - a. Open the blue adapter guide by lifting the front edge, as shown in the illustration.
 - b. Carefully grasp the adapter by its top edge or upper corners, and align it with the connector on the I/O board.
 - c. Press the adapter *firmly* into the adapter connector.

Attention: When you install an adapter, be sure the adapter is correctly seated in the connector before you turn on the server. Improperly seated adapters might cause damage to the I/O board or to the adapter.
 - d. Push down on the blue adapter guide to keep the adapter steady.
 - e. Close the tab; then, push down on the blue adapter retention latch until it clicks into place, securing the adapter.
6. Connect the internal cables to the adapter.
7. If you have other options to install or remove, do so now.
8. Go to “Completing the installation” on page 24.

Cabling a ServeRAID™ adapter

You can install an optional IBM ServeRAID adapter in your server to control the internal hot-swap hard disk drives and external hard disk drives. Refer to your ServeRAID adapter option documentation for complete instructions on installing a ServeRAID adapter in your server and for additional information on ServeRAID adapters.

As shipped, your server comes with two SCSI cables:

- One end of the first SCSI cable is attached to the connector on the SCSI backplane, and the other end is attached to the connector for the integrated SCSI controller behind fans 3 and 4.
- The second SCSI cable is preinstalled along the inside of the server chassis and both ends are loose inside the server. When you install a ServeRAID adapter, you will connect this cable to the adapter and the SCSI backplane.

The following procedure describes the internal cabling needed to install a ServeRAID adapter.

Complete the following steps to cable the ServeRAID adapter.

1. Review the information in “Safety” on page v, “Before you begin” on page 3, and “Handling static-sensitive devices” on page 4.
2. Turn off the server and disconnect all power cords and external cables; then, open the server cover (see “Opening the cover” on page 7).
3. Remove fans 3 and 4, which are located just behind the PCI-X slots (see the illustration on page 5 for the location of the fans).
4. Disconnect the short SCSI cable from the SCSI backplane and the integrated SCSI controller; then, store this short cable in a safe place for future use.
5. Install the ServeRAID adapter in a PCI-X slot (see “Installing adapters” on page 9).

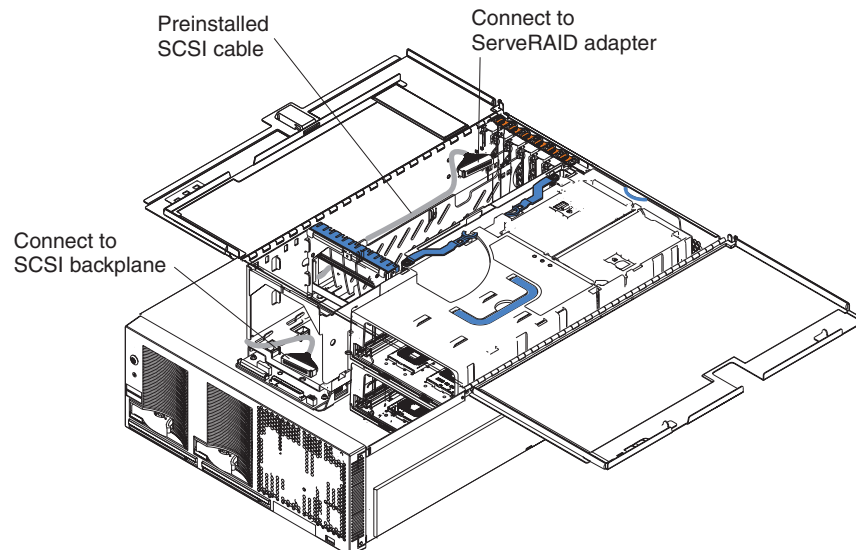

6. Locate the preinstalled SCSI cable; then, attach a connector on the cable to the ServeRAID adapter.

7. Locate the connector on the opposite end of the SCSI cable and connect it to the SCSI backplane connector.

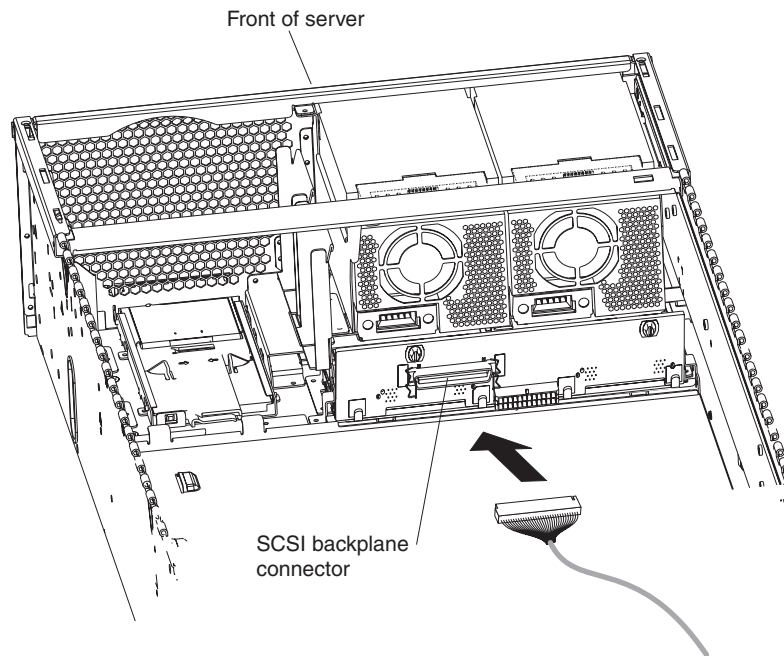

8. Reinstall fans 3 and 4.
9. If you have other options to install or remove, do so now.
10. Go to "Completing the installation" on page 24.

SMP Expansion Module

The SMP Expansion Module contains the Xcel4 system cache, DIMMs, microprocessors, and voltage regulator modules (VRMs) needed to run your server. In this section, you will find the information needed to remove and install the SMP Expansion Module and DIMMs.

SMP Expansion Module considerations:

- For your server to operate properly, there must be a minimum of one SMP module installed.
- An SMP Expansion Module must contain at least one microprocessor and four DIMMs.
- If there is only one SMP Expansion Module installed in the server, an SMP baffle must be installed in place of the upper SMP module to ensure proper cooling of the server.
- When the minimum number of microprocessors are present in the SMP Expansion Module, a microprocessor baffle must be installed in microprocessor socket 4 to ensure proper cooling within the server.
- Before removing or installing SMP Expansion Modules, you must remove the shipping bracket or brackets and electromagnetic compatibility (EMC) shield from the rear of the server.
- You must run the Configuration/Setup Utility whenever you remove or replace an SMP Expansion Module or one of its associated options.

Note: The illustrations in this document might differ slightly from your hardware.

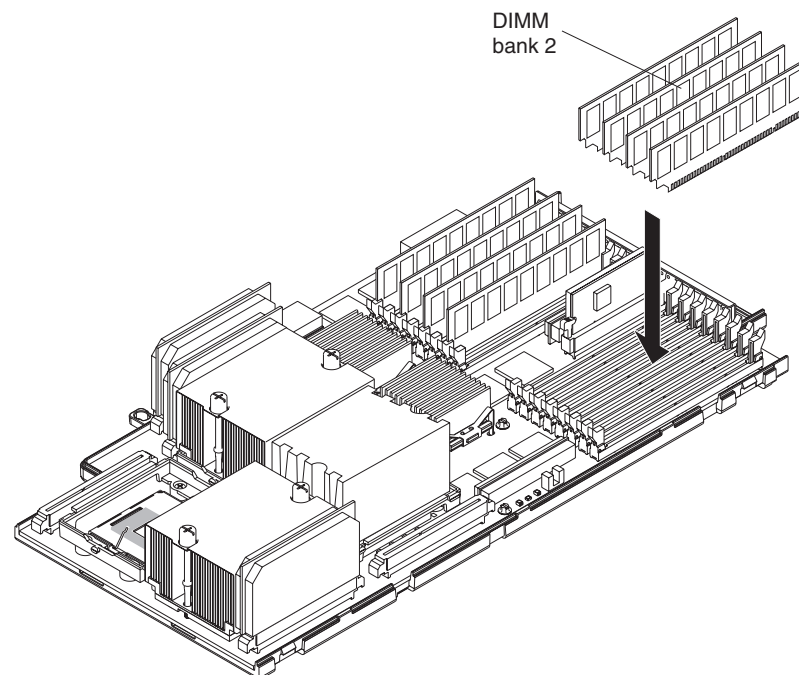

Removing an SMP Expansion Module and cover

While installing options, you might need to remove one or both of the SMP Expansion Modules. This section describes how to properly remove an SMP Expansion Module from the server and how to remove the cover from the module.

Complete the following steps to remove an SMP Expansion Module from the server:

1. Review the information in “Safety” on page v, “Before you begin” on page 3, and “Handling static-sensitive devices” on page 4.
2. If necessary, turn off the server and peripheral devices, and disconnect the external cables and power cords.
3. Remove the shipping bracket or brackets from the server.
 - a. Remove the shipping screws from the right side of the server.

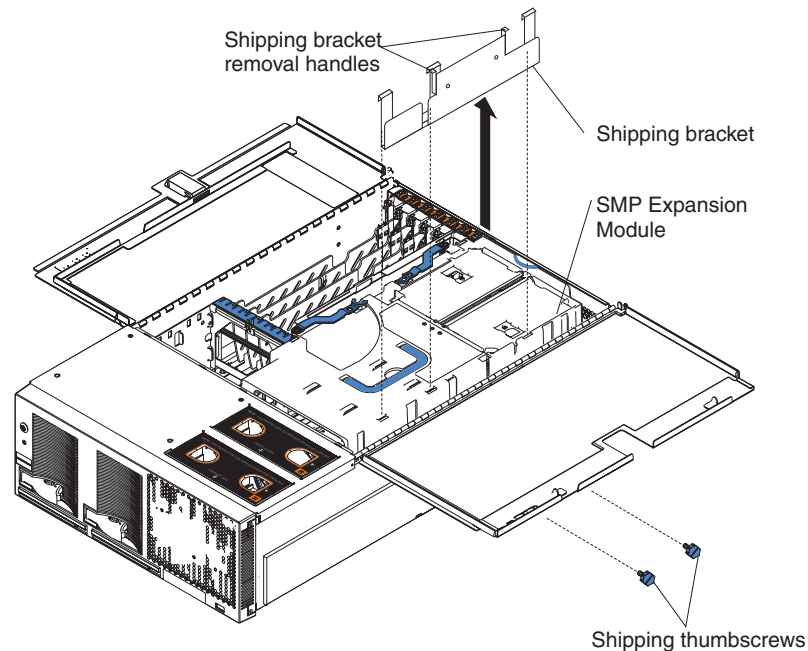

- b. Open the cover.
- c. Grasp the bracket by the right edge and lift it up and out of the server.

Note: If there is one SMP Module installed, you will need to remove the SMP baffle from the server; then, remove the shipping bracket from the lower SMP Module.

4. Remove the EMC shield from the rear of the server.
 - a. If there are two SMP Expansion Modules installed in the server, you must disconnect the Scalability Cables that are connected to the SMP Expansion Modules.

- b. Remove the blue thumbscrews holding the EMC shield to the server.

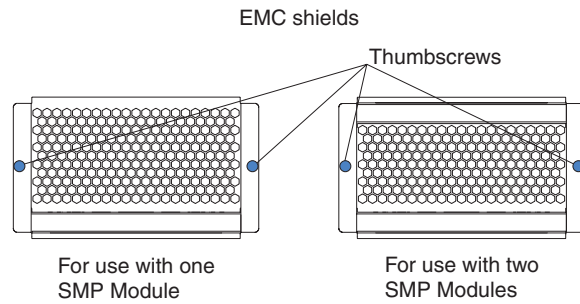

- c. Remove the EMC shield from the rear of the server.

Note: The illustrations in this document might differ slightly from your hardware.

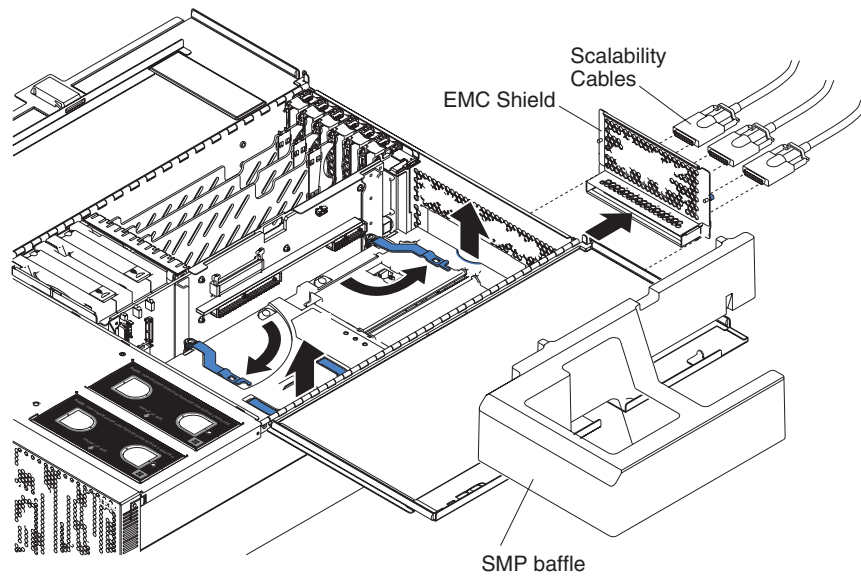

5. Grasp each of the locking levers on the top of the SMP modules, and lift them up slightly.
6. Working from the right side of the server, rotate the two locking levers toward you until they are fully extended, as shown.

Note: The illustrations in this document might differ slightly from your hardware.

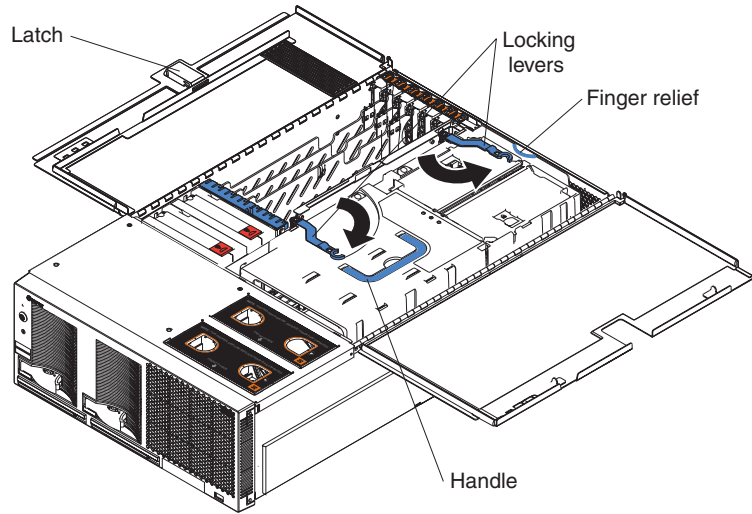

7. Being careful not to damage the components on the center plane, use the handle and the finger relief on the SMP Expansion Module cover to lift the SMP Expansion Module out of the server.
8. Remove the SMP Expansion Module cover:
 - a. Place the SMP Expansion Module on a flat, level surface.
 - b. Rotate the two locking levers until they are fully extended beyond the edge of the SMP Expansion Module cover. Do not force the locking levers past the position shown in the illustration.

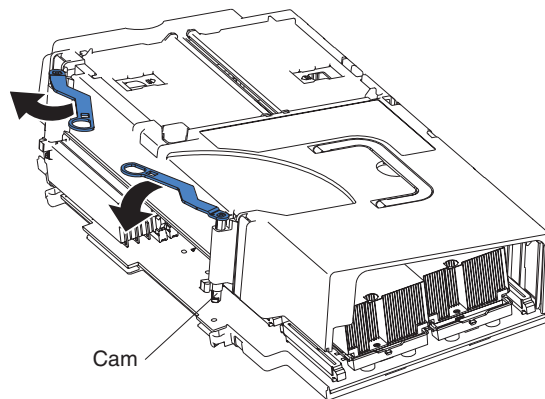

- c. Using the locking levers, lift the front edge of the cover off the SMP Module.

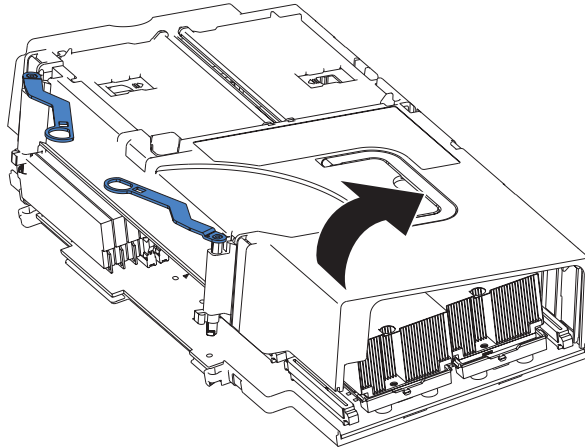

- d. Lift the cover off the SMP Expansion Module.

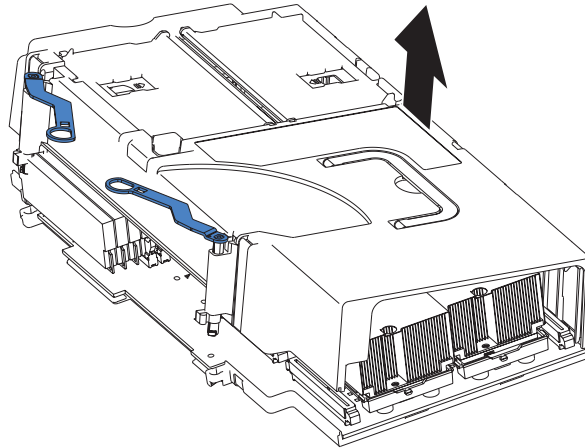

DIMMs

This section describes how to install and remove DIMMs. Before performing any of the procedures in this section, read “Safety” on page v, “Handling static-sensitive devices” on page 4, and the memory considerations on page 18.

DIMM considerations:

- IBM periodically makes updates available to provide enhancements to the standard features of your server. Currently, your xSeries 440 supports the Memory Mirroring and Memory ProteXion™ features of the Active Memory™ technology. However in the future, IBM might also support the hot-swap feature of the Active Memory technology. Be sure to check the IBM support web site occasionally to ensure that you have the most current levels of system software installed.
- Your server comes with four 512 MB DIMMs installed in slots 1, 3, 5, and 7 in the SMP Expansion Module. When installing additional memory modules, you must install four DIMMs at a time and in the order described in this section, using the instructions in the “Installing DIMMs” procedure on page 19 to maintain performance. See the ServerProven® list at <http://www.ibm.com/pc/compat> for a list of memory modules for use with your server.
- When installing or removing DIMMs, it must be done in banks of four and in the following order:
 - Bank 1 = DIMM connectors 1, 3, 5, 7
 - Bank 2 = DIMM connectors 9, 11, 13, 15
 - Bank 3 = DIMM connectors 2, 4, 6, 8
 - Bank 4 = DIMM connectors 10, 12, 14, 16

Note: The illustrations in this document might differ slightly from your hardware.

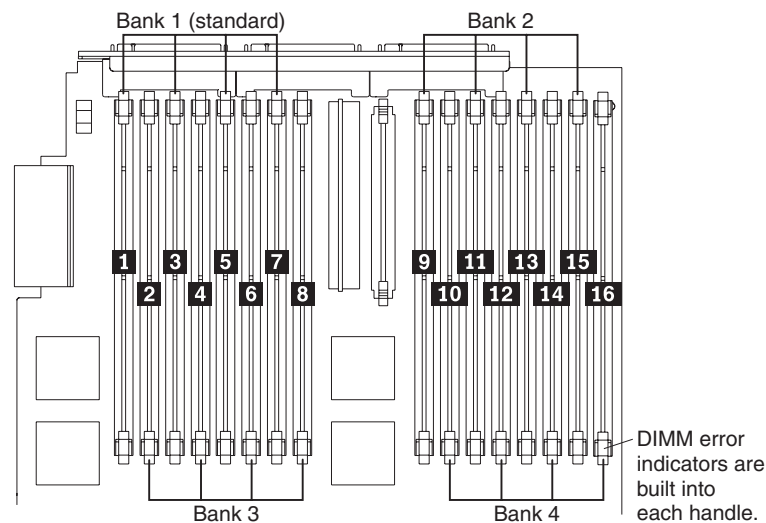

- Each DIMM in an individual bank must be of the same size and clock speed to ensure the server will operate properly. For example, your server came with four 512 MB DIMMs installed in bank 1. In each of the other banks, you can install four 512 MB, or four 1 GB DIMMs.

- The installing or removing of DIMMs changes the configuration information in the server. Therefore, you must change and save the new configuration information by using the Configuration/Setup Utility program. When you restart the server, the system displays a message indicating that the memory configuration has changed. Start the Configuration/Setup Utility program and select **Save Settings**. Refer to the *User's Guide* on the *IBM xSeries Documentation CD* for additional information.
- You can configure your server to use Memory Mirroring and Memory Scrubbing. For detailed information on configuring your server and using these features, refer to the *User's Guide* on the *IBM xSeries Documentation CD*.

Installing DIMMs

Complete the following steps to install a DIMM in your server.

Attention: When you handle static-sensitive devices, take precautions to avoid damage from static electricity. For details on handling these devices, see “Handling static-sensitive devices” on page 4.

1. Review the information in “Safety” on page v, “Before you begin” on page 3, and “Handling static-sensitive devices” on page 4.
2. If necessary, turn off the server and peripheral devices, and disconnect all external cables and power cords. Then, open the cover (see “Opening the cover” on page 7 for details).
3. If necessary, remove the top SMP Expansion Module from the server. Refer to “Removing an SMP Expansion Module and cover” on page 14 for instructions.
4. Open the memory access door on the SMP Expansion Module cover that covers the memory bank in which you will be installing the new DIMMs.

Note: The illustrations in this document might differ slightly from your hardware.

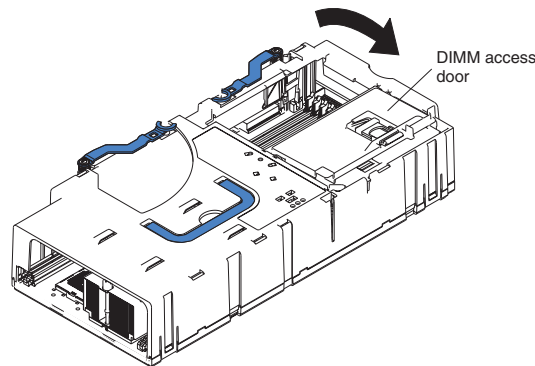

5. Touch the static-protective package containing the DIMM to any unpainted metal surface on the server. Then, remove the DIMM from the package.

6. Install the DIMM:

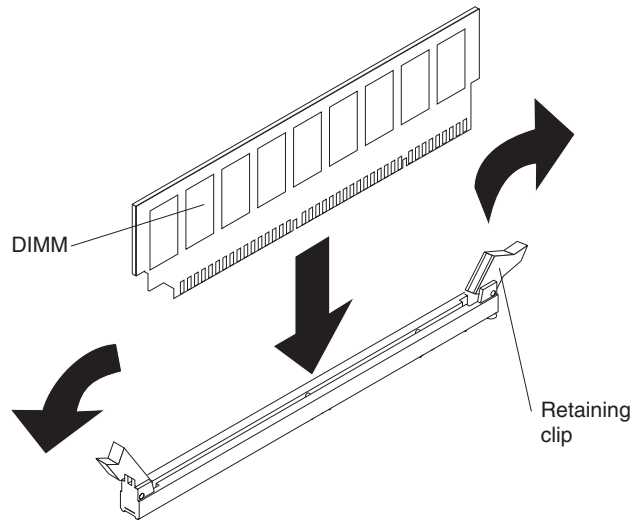

- a. Open the retaining clip on each end of the DIMM connector. Turn the DIMM so that the pins align correctly with the connector.
Attention: To avoid breaking the retaining clips or damaging the DIMM connectors, open and close the clips gently.
- b. Insert the DIMM into the connector by aligning the DIMM edges with the slots at each end of the DIMM connector. Firmly press the DIMM straight down into the connector by applying pressure on both ends of the DIMM simultaneously. Be sure that the retaining clips snap into the locked position when the DIMM is firmly seated in the connector.
- c. If a gap exists between the DIMM and the retaining clips, the DIMM has not been properly installed. In this case, open the retaining clips and remove the DIMM; then, reinsert the DIMM.

7. If you have other options to install or remove, do so now.
8. Close the cover. See “Completing the installation” on page 24.

Note: The installing or removing of DIMMs changes the configuration information in the server. Therefore, you must change and save the new configuration information by using the Configuration/Setup Utility program. Refer to “Using the Configuration/Setup Utility program” on page 30 for more information.

Reinstalling an SMP Expansion Module and cover

After installing options in the SMP Expansion Module, you will need to reinstall the SMP Expansion Module cover and reinstall the SMP Expansion Module in the server.

Complete the following steps to reinstall the SMP Expansion Module cover:

1. Install the cover on the SMP Expansion Module:
 - a. Set the cover on top of the expansion module.
 - b. Extend the locking levers as shown in the illustration; then, let the cam on the front of the cover fall into the cam opening on the SMP Expansion Module circuit board.

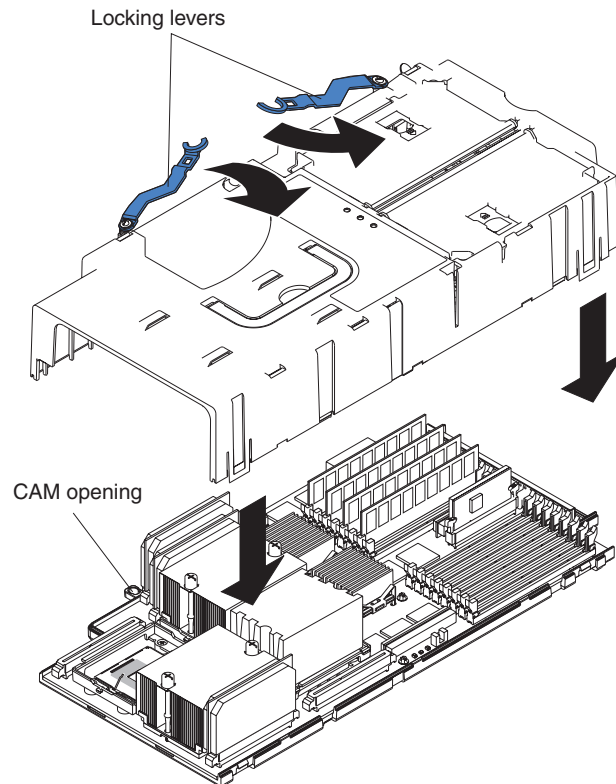

- c. Release the locking levers and align the rear of the cover with the rear edge of the circuit board.
 - d. Press down on the cover until it snaps into place.

- e. Lift slightly on the locking levers and rotate them back until they stop.

Note: The illustrations in this document might differ slightly from your hardware.

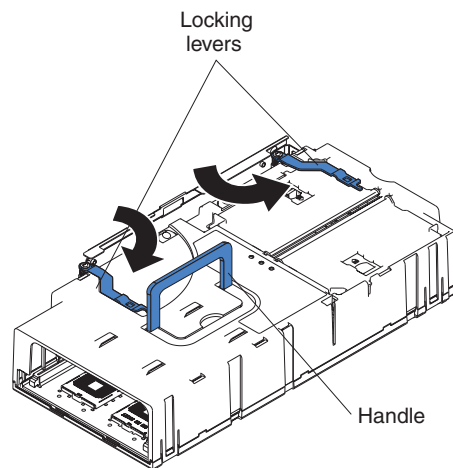

2. Install the SMP Expansion Module into the server.

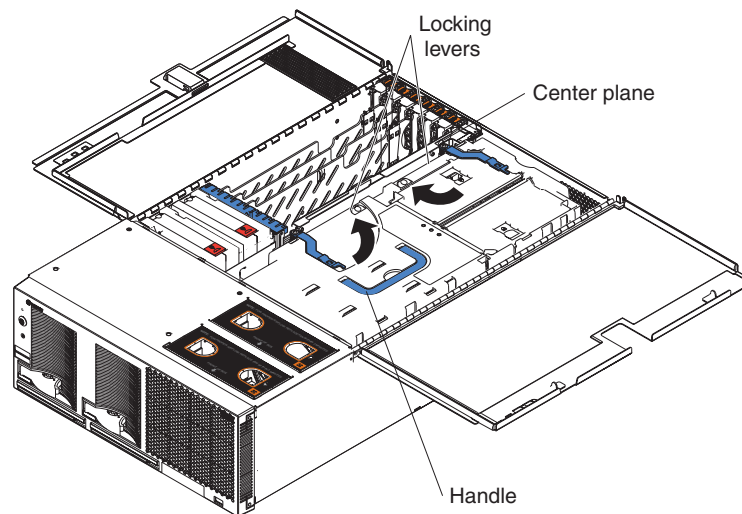

- a. Lift the SMP Expansion Module by its handle and use the finger relief to hold the SMP module steady.
- b. Being careful not to damage the components on the center plane, place the SMP Expansion Module into the server.
- c. Release the handle and slide the SMP Expansion Module toward the center plane until it stops.

- d. Rotate the SMP Expansion Module locking levers forward until the SMP Expansion Module is securely fastened in place. Refer to the following illustration.

Note: The illustrations in this document might differ slightly from your hardware.

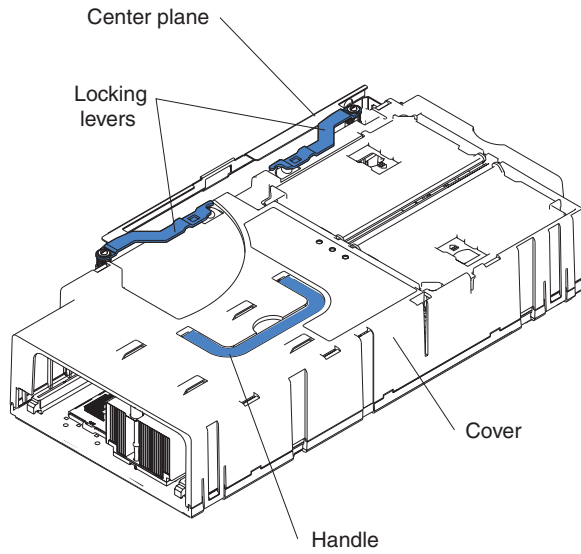

Completing the installation

1. Put the right side of the cover in place first, and then put the left side in place. Press down to latch the two halves of the cover in place.

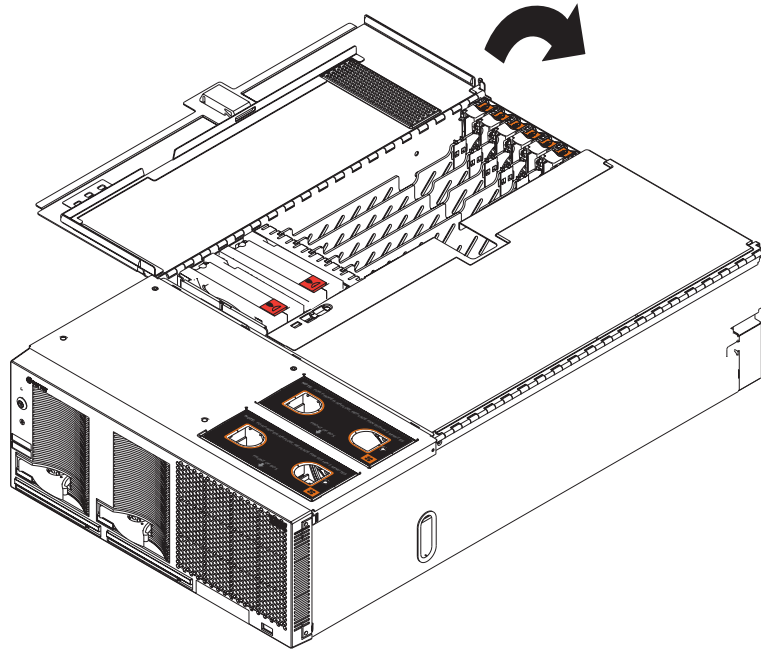

2. Install the server in the rack. Refer to the *Rack Installation Instructions* that came with your server for detailed information on how to install the server in a rack.
3. Connect the external cables and power cords; then, turn on the peripheral devices and the server.

Working with cables

You can connect the following cables to the rear of your server: SMP Expansion, power, RXE Expansion, SCSI, Ethernet, USB, video, auxiliary pointing device, and RXE management cables.

Notes:

1. Refer to the following illustration to locate the connectors on the back of your server.
2. The illustrations in this document might differ slightly from your hardware.

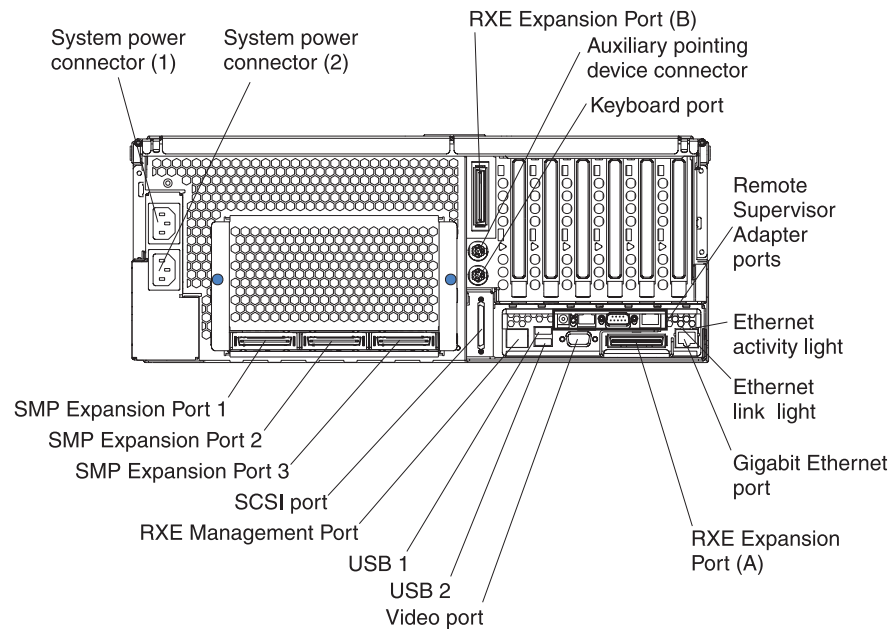

To effectively manage the cables on this server, keep groups of cables secured together, and do not run cables across the back of the server.

Notes:

1. Use cable ties to bundle similar cables together.
2. Use hook-and-loop straps to secure the cable bundles to the vertical rails of the rack.
3. When possible, separate data and power cables. (For more information on cable routing, see the cabling instructions for your xSeries 440 server on the World Wide Web at <http://www.ibm.com/pc/support>).
4. Do not secure cables too tightly. Overtightening can cause internal damage to the cables.

Connecting cables

This section describes how to connect cables to the SMP Expansion Port, system power connectors, RXE Expansion Port, SCSI port, USB port, video port, auxiliary pointing device, Ethernet port, and RXE Management port. When instructed, refer to the appropriate documentation for more details.

For details about the locations and functions of all of the ports, indicators, and connectors refer to “Server controls and indicators” on page 35.

SMP expansion cabling: Your server has up to six SMP Expansion Ports located on the back of the server, depending on your configuration. Three ports are located on each SMP Module.

Cable two SMP Expansion Modules together as follows:

1. Using the SMP Expansion cable (also know as a scalability cable) that came with your server, connect one end of the cable to SMP Expansion port 1 on the lower SMP Expansion Module; then, connect the opposite end of the cable to the SMP Expansion port 1 of the upper SMP Expansion Module.
2. Connect the second SMP Expansion cable that came either with the server or the optional second SMP Expansion Module to SMP Expansion port 2 on the upper and lower SMP Expansion Modules.

Power cabling: Your server uses two power cords that can be connected to a primary power unit inside the rack, such as a properly grounded distribution unit or uninterruptable power supply (UPS), or to an external source, such as a properly grounded electrical outlet.

Attach the power supply power cords as follows:

1. Connect a power supply cord to one of the system power connectors on the rear of the server.
2. Plug the other end of the power supply cord into a properly grounded electrical outlet or a primary power unit inside the rack.

Note: Plugging the power-supply cords into an electrical outlet might cause the server to start automatically. This is an acceptable action.

3. Refer to “Turning on the server” on page 33 for detailed information about turning on the server.

RXE expansion cabling: Your server has two RXE Expansion Ports located on the rear of the server. Use these ports to connect the server to a remote I/O enclosure and to expand the number of PCI-X slots that are available for use by the server. For detailed information about cabling the RXE Expansion Ports, refer to the documentation that comes with the remote I/O enclosure.

Cabling the server to a remote I/O enclosure if one SMP Expansion Module is installed:

1. Using an RXE Expansion cable, connect one end of the cable to RXE Expansion port A on the server.
2. Connect the opposite end of the cable to a RXE port on the remote I/O enclosure.

Cabling the server to a remote I/O enclosure if two SMP Expansion Modules are installed:

1. Using an RXE Expansion cable, connect one end of the cable to RXE Expansion port B or A on the server.
2. Connect the opposite end of the cable to a RXE port on the remote I/O enclosure.

Note: When two SMP modules are installed, both of the RXE Expansion ports are active.

SCSI cabling: Your server has one SCSI port located on the back of the server. Use this port to connect the server to an optional SCSI device such as the IBM FASTT series of extended enclosures. For detailed information about this option and how to connect it to your server, refer to the documentation that comes with the option.

USB cabling: Your server has three USB ports, one on the front and two located on the back of the server. Use these ports to connect the server to an optional USB device. For detailed information about this USB option and how to connect it to your server, refer to the documentation that comes with the option.

Video cabling: Your server has one video port located on the back of the server. Use this port to connect the server to a monitor or optional console. For detailed information about this option and how to connect it to your server, refer to the documentation that comes with the option.

Auxiliary pointing device cabling: Your server has one auxiliary pointing device port located on the back of the server. Use this port to connect the server to a pointing device or optional console. For detailed information about this option and how to connect it to your server, refer to the documentation that comes with the option.

Gigabit Ethernet cabling: Your server has one Ethernet port located on the back of the server. Use this port to connect the server to a LAN.

Note: A second Ethernet port is located on the Remote Supervisor Adapter. This port is used for specific supervisory functions and should not be confused with the systems Gigabit Ethernet port located next to the USB ports.

RXE Management cabling: Your server has one RXE Management port located on the back of the server. Use this port to connect the server to the management port of an optional remote I/O enclosure. This port is used to manage the PCI-X slots in a remote I/O enclosure, including slot assignments, and managing access.

Cabling the server RXE Management port to a remote I/O enclosure:

1. Using an RXE Management cable, connect one end of the cable to the RXE Management on the server.
2. Connect the opposite end of the cable to the RXE Management port on the remote I/O enclosure.

Note: For details about cabling the server to the remote I/O enclosure and how the server and remote I/O work together, refer to the documentation that comes with the enclosure.

Chapter 3. Configuring your server

The following configuration programs are provided with your server:

- **Configuration/Setup Utility**

This program is part of the basic input/output system (BIOS) code that comes with your server. You can use this program to configure the serial connector assignment, change the drive startup sequence, set the date and time, and set passwords. See “Using the Configuration/Setup Utility program” on page 30 for more information.

- **SCSISelect Utility**

With the SCSISelect Utility program, you can configure the devices that are attached to the SCSI controller. Use this program to change default values and to resolve configuration conflicts. See “Using the SCSISelect utility program” on page 30 for more information.

- **ServerGuide™ CD**

The *ServerGuide* CD includes software setup and installation tools that are specifically designed for IBM xSeries 440 servers. You can use this CD during the initial installation of your server to configure the server hardware and to simplify your operating system installation. The *ServerGuide* CD also contains a collection of application programs, which you can install after your server is up and running. See the *User's Guide* on the *IBM Documentation* CD for more detailed information.

- **Remote Supervisor Adapter configuration process**

Configuration activities are also required for the Remote Supervisor Adapter. See “Using the Remote Supervisor Adapter” on page 31 for a description of Remote Supervisor Adapter features. For information about cabling, configuring, and using the Remote Supervisor Adapter to manage the server remotely, see “Using the Remote Supervisor Adapter” on page 31 and the *Remote Supervisor Adapter User's Guide* on the *IBM Documentation* CD.

- **ServeRAID configuration program**

This program comes with the optional ServeRAID adapters and with server models that have a ServeRAID adapter preinstalled. If the server has a ServeRAID adapter installed, you must use the ServeRAID configuration program to define and configure the disk-array subsystem *before* you install the operating system. For more information about using the ServeRAID configuration program, see the ServeRAID information on the *IBM Documentation* CD.

Using the Configuration/Setup Utility program

Configuration/Setup is a menu-driven utility that is part of the BIOS code that comes with your server. You can use it to:

- Configure system devices and ports
- Change the drive startup sequence
- Enable USB keyboard and mouse support
- Resolve configuration conflicts
- Set the date and time
- Set passwords and security settings

Complete the following steps to start the Configuration/Setup Utility program:

1. Turn on the server and watch the monitor screen.
2. When the message Press F1 for Configuration/Setup appears, press F1.
3. Follow the instructions that appear on the screen.

For more information about using the Configuration/Setup Utility program, see the section on the Configuration/Setup Utility program in the *User's Guide* on the *IBM Documentation CD*.

Using the SCSISelect utility program

SCSISelect is a built-in, menu-driven configuration utility program that you can use to:

- View the default SCSI IDs
- Locate and correct configuration conflicts

The following sections provide instructions for starting the SCSISelect Utility program.

Note: If your server has a redundant arrays of independent disks (RAID) adapter installed, use the configuration method that is supplied with the RAID adapter to view or change SCSI settings for devices attached to the adapter.

Complete the following steps to start the SCSISelect Utility program:

1. Turn on the server.
2. When the <<< Press <CTRL><A> for SCSISelect Utility! >>> prompt appears, press Ctrl+A.
3. When the Would you like to configure the host adapter or run the SCSI disk utility? question appears, make your selection and press Enter.
4. Use the arrow keys to select a choice from the menu.
 - Press Esc to exit the SCSISelect Utility program.
 - Press the F5 key to switch between color and monochrome modes (if your monitor permits).
5. Follow the instructions on the screen to change the settings of the selected items; then, press Enter.

For more information about using the SCSISelect utility program, see the section on the SCSISelect utility program in the *User's Guide* on the *IBM Documentation CD*.

Using the ServerGuide CD

The ServerGuide CD provides state-of-the-art programs to detect the server model and hardware options that are installed, configure the server hardware, provide device drivers, and install your network operating system (NOS).

Note: If the ServerGuide CD does not start, see "ServerGuide problems" on *IBM Documentation CD*.

1. Insert the *Setup and Installation CD*, and restart the server.
2. Follow the instructions on the screen to:
 - a. Select your language.
 - b. Select your country and keyboard layout.
 - c. View the Overview to learn about ServerGuide features.
 - d. View the README file to review installation tips about your NOS and adapter.
 - e. Start the setup and hardware configuration programs.
 - f. Start the NOS installation. You will need your copy of the NOS CD.

Note: For information on the supported NOS versions, refer to the *Setup and Installation CD* label.

Using the Remote Supervisor Adapter

The Remote Supervisor Adapter is one of the products in the Advanced System Management (ASM) family. It provides around-the-clock remote access and system management of your server and supports the following:

- Remote management regardless of the status of the server
- Remote control of hardware and operating systems
- Web-based management with standard Web browsers (no other software is required)
- Text-based user interface terminal access

The Remote Supervisor Adapter provides the following specific features:

- Continuous health monitoring and control
- Advanced Predictive Failure Analysis[®] (PFA)
- Configurable automatic notification and alerts
- Remote access through Ethernet, point-to-point protocol (PPP) connection, serial port, and ASM interconnect peer-to-peer network
- Simple Network management Protocol (SNMP)
- Domain Name system (DNS) and Dynamic Host Configuration Protocol (DHCP) support
- Remote power control
- Remote firmware update and access to critical server settings
- Microsoft[®] Windows NT[®] and Windows[®] 2000 blue screen capture
- Independent power, which enables around-the-clock access to the server even when the server power is off
- E-mail alerts
- Event logs that are timestamped, saved by a battery power unit, and can be attached to e-mail alerts
- Redirection of the server graphical or text console

- Access to Vital Product Data (VPD)
- Alphanumeric or numeric pager alerts

For information about cabling, configuring, and using the Remote Supervisor Adapter to manage the server remotely, see the *User's Guide* and the *Remote Supervisor Adapter User's Guide* on the *IBM Documentation CD*.

Using the ServeRAID configuration programs

A ServeRAID adapter enables you to use multiple physical SCSI hard-disk drives as logical drives, operating as a disk array. To enable you to configure the ServeRAID controller, the adapter comes with a CD containing the ServeRAID Manager program and the ServeRAID Mini-Configuration program. For details about using these programs, see the documentation that comes with the ServeRAID adapter.

Chapter 4. Server power, controls, and options

This chapter describes how to turn on and turn off the server, and what the controls and indicators mean.

Turning on the server

Turning on the server refers to the act of plugging the power cord of your server into the power source and starting the operating system.

You can turn on the server in any of the following ways:

- If the power cords are connected to a power source, you can press the power-control button on the front of the server.
- If the server is turned on and a power failure occurs, it restarts automatically when power is restored.
- You can turn on the server remotely by means of the Remote Supervisor Adapter.

Complete the following steps to turn on the server manually:

1. Turn on all external devices, such as the monitor.
2. Plug the server power cords into the power source.
3. Wait 30 seconds; then, press the power-control button on the front of the server.

Note: While the server is powering up, the power light on the front bezel blinks.

Turning off the server

Turning off the server refers to the act of disconnecting the server from the power source.

Complete the following steps to turn off the server:

1. Refer to your operating system documentation for the proper procedure to shut down the operating system.

Statement 5:



CAUTION:

The power control button on the device and the power switch on the power supply do not turn off the electrical current supplied to the device. The device also might have more than one power cord. To remove all electrical current from the device, ensure that all power cords are disconnected from the power source.

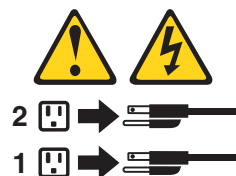

2. Press the power-control button on the front of the server. This will put the server in Standby mode.
3. Disconnect the server from the power source.

Note: After you turn off the server, wait at least 5 seconds before you turn on the server again.

Standby mode

Standby mode refers to the condition in which the server operating system is not running and all core logic is shut down except for the Remote Supervisor Adapter.

Complete the following steps to put the server into Standby mode:

1. See the operating system documentation for the proper procedure to shut down the operating system.

Note: Each operating system is different. Read all the documentation about shutting down the operating system before continuing.

2. Press the power-control button on the front of the server.
3. You can put the server into Standby mode remotely by means of the Remote Supervisor Adapter.

Server controls and indicators

The following section identifies the controls and indicators on the front and rear of your server.

Front view

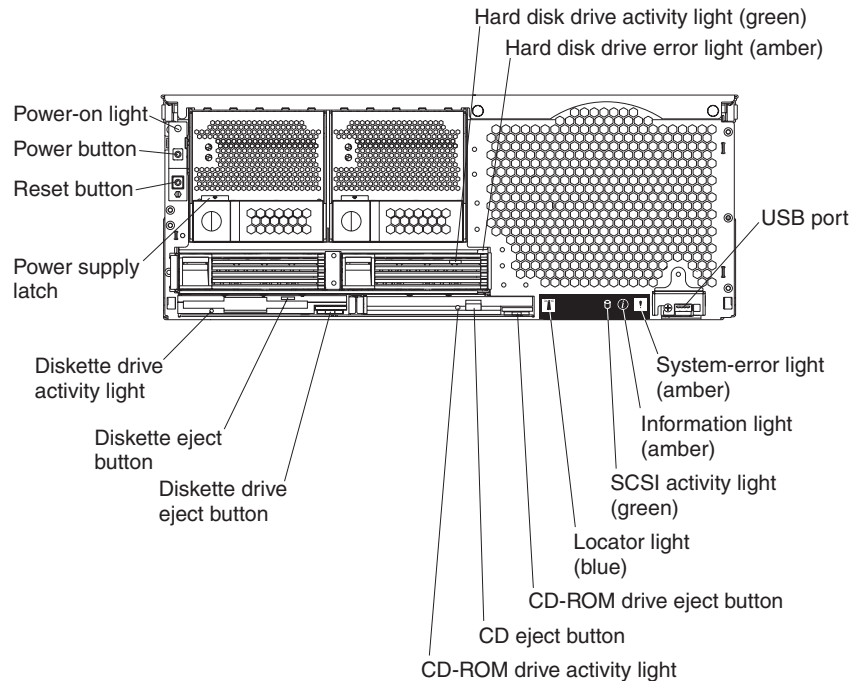

Power-on light: This green light turns on and stays on when you turn on your server, and it blinks when the server is in Standby mode.

Hard disk drive activity light: When this green light is on, it indicates that the hard disk drive is in use.

Hard disk drive error light: When this amber light is on, it indicates that there is a problem with the hard disk drive.

USB port: This is an automatically configured port that you can use to connect one or more USB devices to the front of the server, using Plug and Play technology.

System-error light: When this amber light is on, it indicates a system error has occurred.

Information light: When this amber light is on, it indicates information about a system error has been placed in the System Error log.

SCSI activity light: When this green light is on, it indicates that the hard disk drive is in use.

Locator light: This blue light is used to help you locate other servers connected to the server.

CD-ROM drive eject button: Push this button to release a CD-ROM drive from the server.

CD eject button: Push this button to release a CD from the drive.

CD-ROM drive activity light: When this light is on, it indicates that the CD-ROM drive is in use.

Diskette drive eject button: Push this button to release a diskette drive from the server.

Diskette eject button: Push this button to release a diskette from the drive.

Diskette drive activity light: When this light is on, it indicates that the diskette drive is in use.

Power supply latch: This latch is used to secure the power-supply in place.

Reset button: Press this button to reset the server and run the power-on self-test (POST). You might need to use a pen or the end of a straightened paper clip to press the button.

Power button: Press this button to manually turn the server on or off.

Rear view

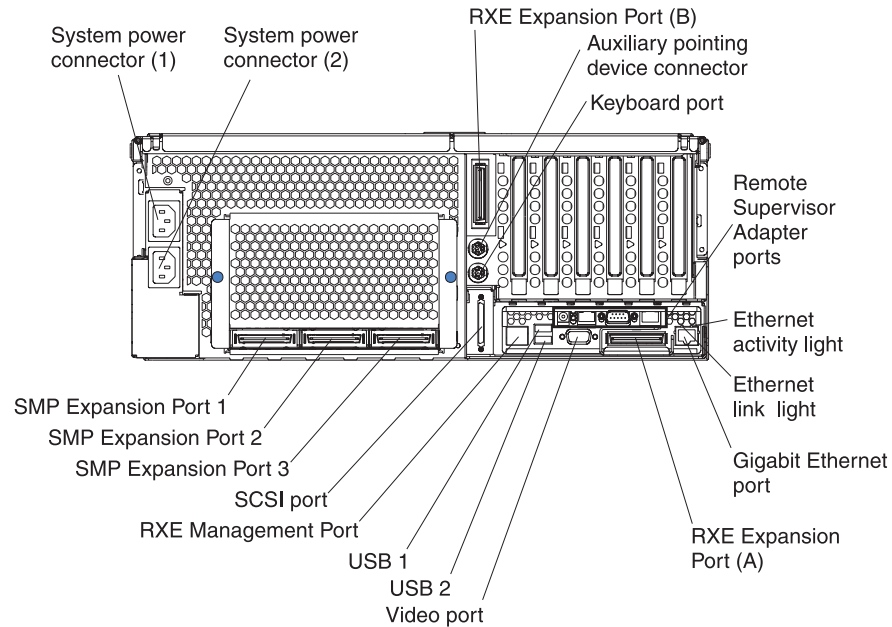

System power connectors (1 and 2): The system power cords are connected to these two connectors to provide power to the system.

RXE Expansion Port B: Use this port to connect the server to a remote I/O enclosure when two SMP Expansion Modules are installed.

Auxiliary pointing device connector: Signal cables for a mouse, trackball, or other pointing device are connected to the auxiliary pointing device connector.

Keyboard port: Signal cables for a keyboard are connected to the keyboard port.

Remote Supervisor Adapter ports and indicators: This group of ports and indicators located on the back of the server are used for system management information and control.

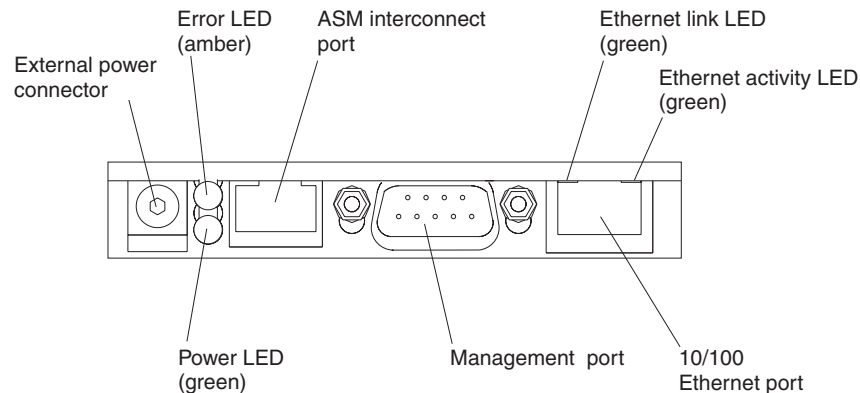

- **External power connector** - This cable connector is used to connect an external power supply to the Remote Supervisor Adapter.

Note: This connector is not supported on this server.

- **Error LED** - This amber light goes on when a system management error has occurred.

- **ASM interconnect port** - Signal cables for managing expansion module resources are connected to this port.
- **Ethernet link light:** This green light, located on the right of the Ethernet port, goes on when there is an active link connection on the Ethernet controller for the Ethernet port.
- **Ethernet activity light:** This green light, located on the left of the Ethernet port, goes on when there is activity on the Ethernet LAN connected to the Ethernet port.
- **10/100 Ethernet port** - Ethernet Signal cables are connected to the Ethernet port.
- **Management port** - Signal cables for modems or other serial devices are connected to this port.
- **Power LED** - This green light goes on and stays on when you plug in your server.

Ethernet activity light: This green light, located on the left of the Gigabit Ethernet port, blinks when there is activity on the Ethernet LAN.

Ethernet link light: This green light, located on the right of the Gigabit Ethernet port, goes on when there is an active link connection on the Gigabit Ethernet controller for Ethernet port 1.

Gigabit Ethernet port: Gigabit Ethernet Signal cables are connected to the Gigabit Ethernet port. This port supports 10/100/1000 speed connections.

RXE Expansion Port A: Use this port to connect the server to a remote I/O enclosure.

Video port: The signal cable for a monitor connects to the video port.

USB 2: This is an automatically configured port that you can use to connect one or more USB devices to the server, using Plug and Play technology.

USB 1: This is an automatically configured port that you can use to connect one or more USB devices to the server, using Plug and Play technology.

RXE Management Port: Use this port to connect a management cable from the server to a remote I/O enclosure.

SCSI port: This port is used to connect external SCSI devices to the server.

SMP Expansion port 3: This port is used to connect one server to another.

SMP Expansion port 2: This port is used to connect one server to another or to make a redundant interconnection between two SMP Expansion Modules.

SMP Expansion port 1: This port is used to interconnect two SMP Expansion Modules together.

Chapter 5. Solving problems

This section provides basic troubleshooting information to help you resolve some common problems that might occur while setting up your server.

If you cannot locate and correct the problem using the information in this section, refer to the *Troubleshooting Guide* on the *IBM xSeries Documentation* CD for more information.

Diagnostic tools overview

The following tools are available to help you identify and resolve hardware-related problems:

- **POST beep codes**

The power-on self-test beep codes indicate the detection of a problem.

- One beep indicates successful completion of POST.
- More than one beep indicates that POST detected a problem. Error messages also appear during startup if POST detects a hardware-configuration problem.

See “POST beep code descriptions” and the *Troubleshooting Guide* on the *IBM xSeries Documentation* CD for more information.

- **Troubleshooting charts**

These charts list problem symptoms and steps to correct the problems. See the “Troubleshooting charts” on page 41 for more information.

- **Diagnostic programs and error messages**

The system diagnostic programs are provided in ROM. These programs test the major components of your server.

Note: Refer to the *Troubleshooting Guide* on the *IBM xSeries Documentation* CD for more information.

- **Light Path Diagnostics feature** Use the Light Path Diagnostics feature to identify system errors quickly.

POST beep code descriptions

One beep

Indicates successful completion of POST.

Repeating long beeps

Indicates that a memory error has occurred. Ensure that all DIMMs are correctly installed.

One long beep and two short beeps

Indicates that a video error has occurred and the BIOS code cannot initialize the video screen to display any additional information.

Solving problems

ServerGuide startup problems

Look for the symptom in the left column of the chart. Probable solutions to the problem are in the right column.

Table 1. ServerGuide startup problems

Setup	Suggested action
<i>Setup and Installation</i> CD will not start.	<ul style="list-style-type: none">• Ensure that the system is a supported server with a startable (bootable) CD-ROM drive.• If the startup (boot) sequence settings have been altered, be sure the CD-ROM is first in the boot sequence.
ServeRAID program cannot view all installed drives - or - cannot install NOS.	If you installed an optional ServeRAID adapter: <ul style="list-style-type: none">• Ensure that there are no duplicate SCSI IDs or IRQ assignments.• Ensure that the hard disk drive is connected properly.
The <i>Operating System Installation</i> program continuously loops.	Free up more space on the hard disk drive.
ServerGuide will not start your NOS CD.	Ensure that the NOS CD you have is supported by ServerGuide. See the <i>Setup and Installation</i> CD label for a list of NOS versions supported.
Cannot install NOS - option is grayed out.	Either there is no logical drive defined (ServeRAID systems) or the ServerGuide system partition is not present. Run the ServerGuide setup and configuration program and ensure that setup is complete

Troubleshooting charts

You can use the troubleshooting charts in this section to find solutions to problems that have definite symptoms.

Attention: If diagnostic error messages appear that are not listed in the following tables, make sure that your system has the latest level of BIOS code installed.

Refer to the *Troubleshooting Guide* on the *IBM xSeries Documentation CD* for more detailed information about testing the system. If you have run the diagnostic test programs or if running the tests does not reveal the problem, call for service.

Look for the symptom in the left column of the chart. Instructions and probable solutions to the problem are in the right column. If you have just added new software or a new option and your system is not working, do the following before using the troubleshooting charts:

- Remove the software or device that you just added.
- Run the diagnostic tests to determine if your system is running correctly.
- Reinstall the new software or new device.

Table 2. Troubleshooting charts

Device	Suggested action
CD-ROM drive	Verify that:
CD-ROM drive is not recognized.	<ol style="list-style-type: none"> 1. The primary IDE channel is enabled in the Configuration/Setup Utility program. 2. All cables and jumpers are installed correctly. 3. The correct device driver is installed for the CD-ROM drive.
Diskette drive	If there is a diskette in the drive, verify that:
Diskette drive in-use light stays on, or the system bypasses the diskette drive.	<ol style="list-style-type: none"> 1. The diskette drive is enabled in the Configuration/Setup Utility program. 2. The diskette is good and not damaged. (Try another diskette if you have one.) 3. The diskette contains the necessary files to start the system. 4. Your software program is working properly. <p>If the diskette drive in-use light stays on, or the system continues to bypass the diskette drive, call for service.</p>
Other devices	Call for service.
Problems such as broken cover locks or indicator lights not working.	
Intermittent problems	Verify that:
A problem occurs only occasionally and is difficult to detect.	<ol style="list-style-type: none"> 1. All cables and cords are connected securely to the rear of the system and attached options. 2. When the system is turned on, air is flowing from the rear of the system at the fan grille. If there is no air flow, the fan is not working. This causes the system to overheat and shut down. 3. Ensure that the SCSI bus and devices are configured correctly and that the last external device in each SCSI chain is terminated correctly. <p>If the items above are correct, call for service.</p>
Keyboard, mouse, or pointing-device	<ol style="list-style-type: none"> 1. Make sure that the keyboard cable is properly connected to the system. 2. Make sure that the system and the monitor are turned on. 3. Try using another keyboard.
All or some keys on the keyboard do not work.	If the problem remains, call for service.

Solving problems

Table 2. Troubleshooting charts (continued)

Device	Suggested action
The mouse or pointing device does not work.	<ol style="list-style-type: none"> 1. Verify that the mouse or pointing-device cable is securely connected and the device drivers are installed correctly. 2. Try using another mouse or pointing device. <p>If the problem remains, call for service.</p>
USB Keyboard, mouse, or pointing-device	<ol style="list-style-type: none"> 1. Make sure that the keyboard USB cable is properly connected to the system. 2. Make sure that the system and the monitor are turned on. 3. Ensure that the USB mouse and keyboard support are enabled in BIOS. 4. Try using another keyboard.
All or some keys on the keyboard do not work.	<p>If the problem remains, call for service.</p>
The USB mouse or USB pointing device does not work.	<ol style="list-style-type: none"> 1. Make sure that the mouse or pointing-device USB cable is properly connected to the system. 2. Make sure that the system and the monitor are turned on. 3. Ensure that the USB mouse and keyboard support are enabled in BIOS. 4. Try using another mouse or pointing-device. <p>If the problem remains, call for service.</p>
Memory	<p>Verify that:</p> <ol style="list-style-type: none"> 1. The memory modules are seated properly. 2. You have installed the correct type of memory. 3. If you changed the memory, you must update the memory configuration with the Configuration/Setup Utility program. 4. All banks of memory on the DIMMs are enabled. The system might have automatically disabled a DIMM bank if it detected a problem, or a DIMM bank could have been manually disabled.
The amount of memory displayed is less than the amount of memory installed.	<p>If the items above are correct and the screen remains blank, call for service.</p>
Monitor	<p>Verify that:</p> <ol style="list-style-type: none"> 1. The primary monitor cable is connected to the video port. 2. You installed the necessary device drivers for the applications.
The monitor works when you turn on the system, but goes blank when you start some application programs.	<p>Some IBM monitors have their own self-tests. If you suspect a problem with your monitor, refer to the information that comes with the monitor for adjusting and testing instructions.</p> <p>If you still cannot find the problem, call for service.</p>
The screen is blank.	<p>Verify that:</p> <ol style="list-style-type: none"> 1. The system power cord is plugged into the server and a working electrical outlet. 2. The monitor cables are connected properly. 3. The monitor is turned on and the brightness and contrast controls are adjusted correctly. <p>If the items above are correct and the screen remains blank, call for service.</p>
Only the cursor appears.	<p>Call for service.</p>

Table 2. Troubleshooting charts (continued)

Device	Suggested action
Wavy, unreadable, rolling, distorted screen, or screen jitter.	<p>If the monitor self-tests show the monitor is working properly, consider the location of the monitor. Magnetic fields around other devices (such as transformers, appliances, fluorescent lights, and other monitors) can cause screen jitter or wavy, unreadable, rolling, or distorted screen images. If this happens, turn off the monitor. (Moving a color monitor while it is turned on might cause screen discoloration.) Then move the device and the monitor at least 305 mm (12 in.) apart. Turn on the monitor.</p> <p>Notes:</p> <ol style="list-style-type: none"> To prevent diskette drive read/write errors, be sure the distance between monitors and diskette drives is at least 76 mm (3 in.). Non-IBM monitor cables might cause unpredictable problems. An enhanced monitor cable with additional shielding is available for the 9521 and 9527 monitors. For information about the enhanced monitor cable, see your IBM reseller or IBM marketing representative. <p>If the problem remains, call for service.</p>
Wrong characters appear on the screen.	<p>If the wrong language is displayed, update the BIOS code with the correct language.</p> <p>If the problem remains, call for service.</p>
Option	<p>Verify that:</p> <ol style="list-style-type: none"> The option is designed for the server. Refer to the "Server Support" flowchart on the inside of the front cover for information about obtaining ServerProven compatibility information from the World Wide Web. You followed the installation instructions that came with the option. The option is installed correctly. You have not loosened any other installed options or cables. You updated the configuration information in the Configuration/Setup Utility program. Whenever memory or an option is changed, you must update the configuration.
An IBM option that was just installed does not work.	<p>If the problem remains, call for service.</p>
An IBM option that used to work does not work now.	<p>Verify that all of the option hardware and cable connections are secure.</p> <p>If the option comes with its own test instructions, use those instructions to test the option.</p> <p>If the failing option is a SCSI option, verify that:</p> <ol style="list-style-type: none"> The cables for all external SCSI options are connected correctly. The last option in each SCSI chain, or the end of the SCSI cable, is terminated correctly. All external SCSI options are turned on. You must turn on external SCSI options before turning on the server. <p>If the problem remains, call for service.</p>
Power	<p>Verify that:</p> <ol style="list-style-type: none"> The power cables are properly connected to the server. The electrical outlet functions properly. The type of memory installed is correct. If you just installed an option, remove it, and restart the server. If the server now turns on, you might have installed more options than the power supply supports.
The system does not power on.	<ol style="list-style-type: none"> The LEDs on the power supply are on. <p>If the problem remains, call for service.</p>

Solving problems

Table 2. Troubleshooting charts (continued)

Device	Suggested action
<p>Serial port</p> <p>The number of serial ports identified by the operating system is less than the number of serial ports installed.</p>	<p>Verify that:</p> <ol style="list-style-type: none"> Each port is assigned a unique address by the Configuration/Setup Utility program and none of the serial ports are disabled. The serial-port adapter, if you installed one, is seated properly. <p>If the problem remains, call for service.</p>
<p>A serial device does not work.</p>	<p>Verify that:</p> <ol style="list-style-type: none"> The device is compatible with the server. The serial port is enabled and is assigned a unique address. <p>If the problem remains, call for service.</p>
<p>Software</p> <p>Suspected software problem.</p>	<p>To determine if problems are caused by the software, verify that:</p> <ol style="list-style-type: none"> Your system has the minimum memory requirements needed to use the software. For memory requirements, refer to the information that comes with the software. Note: If you have just installed an adapter or memory, you might have a memory address conflict. The software is designed to operate on your system. Other software works on your system. The software that you are trying to use works on another system. <p>If you received any error messages when using the software program, refer to the information that comes with the software for a description of the messages and solutions to the problem.</p> <p>If the items above are correct and the problem remains, contact your place of purchase.</p>
<p>Universal Serial Bus (USB) ports</p> <p>A USB device does not work.</p>	<p>Verify that:</p> <ol style="list-style-type: none"> You are not trying to use a USB device during POST, if you have a standard (non-USB) keyboard attached to the keyboard port. Note: If a standard (non-USB) keyboard is attached to the keyboard port, then the USB is disabled and the USB device might not work during POST. The correct USB device driver is installed. Your operating system supports USB devices. <p>If the problem remains, call for service.</p>

Light Path Diagnostics feature overview

If the System Error light on the operator information panel on the front of the server is on, one or more LEDs inside the server might be on. Use the Light Path Diagnostics panel to identify the type of error that occurred.

For LED locations, see the illustration on page 45.

You can use the Light Path Diagnostics feature in your server to quickly identify the type of system error that occurred. The Light Path Diagnostics panel is located on the system board, just behind PCI adapter slot 1. When you press the Light Path Diagnostics button, the LED on the top-right corner of the panel will illuminate. This shows that the diagnostic circuitry is working correctly.

Your server is designed so that any LEDs that have illuminated, can be illuminated again without ac power after you open the cover. This feature helps you isolate a problem if an error causes the server to shut down. See “Light Path Diagnostics table” on page 47.

Solving problems

Important: You have up to 12 hours to use the Light Path Diagnostic LEDs after ac power has been removed from the server. After 12 hours, you must power-on the server again to be able to use the Light Path Diagnostic LEDs to help locate system errors.

To view the LEDs when the server cover has been opened:

1. Turn off the server and all peripheral devices.
2. Press and hold the Light Path Diagnostics (blue) button on the diagnostics panel. The LEDs will be illuminated while the button is pressed.

Note: You can illuminate the LEDs for a maximum of two minutes. After that time, the circuit that powers the LEDs is exhausted.

3. Replace the cover on the server; then, reinstall the server in the rack and connect all external cables. For more information, see “Completing the installation” on page 24 for instructions.

The following illustration shows the LEDs on the diagnostics panel on the system board. See “Light Path Diagnostics table” on page 47 for information on identifying problems using these LEDs.

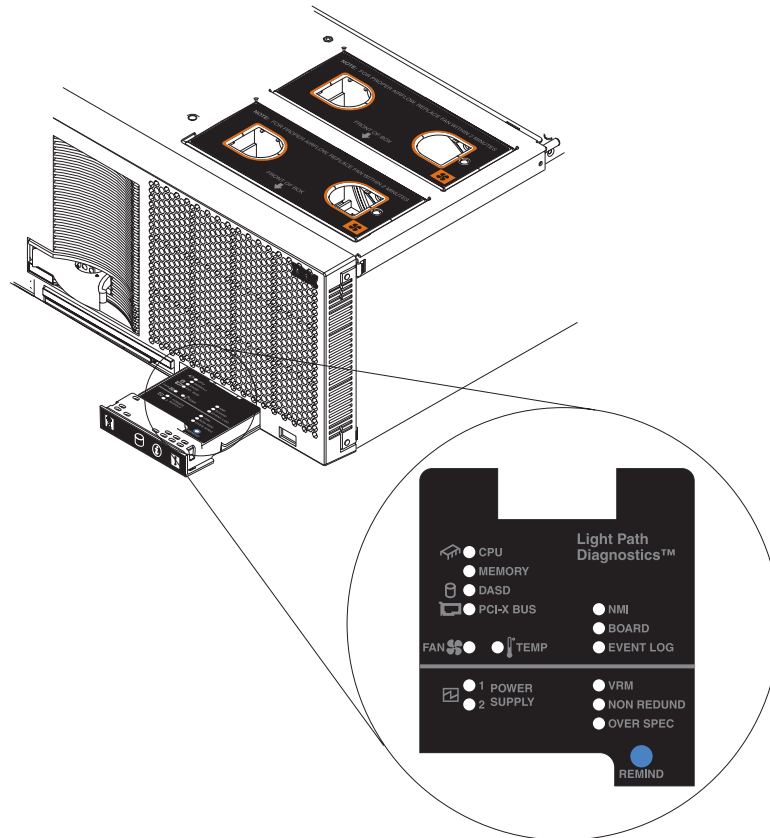

Solving problems

Identifying problems using the Light Path Diagnostics

This section provides the information needed to identify problems that might arise during installation using the Light Path Diagnostic feature.

The diagnostic panel

The diagnostics panel should be the first place you look for help in identifying problems. If a system error occurs, the system error light on the front of this panel is lit. Press the front of the panel to open it and look for any lit LEDs. These lit LEDs can help you identify the possible cause of the error. Make a note of any LEDs that are lit, then close the panel.

LEDs on the top of the server

Another location you can use to find an error is on the top of the server. After viewing the diagnostic panel, pull the server out and view the top cover. In the center of the top cover is a set of 6 LEDs and the system service labels. The numbers next to the LEDs correspond to the numbers located on the system service label. Note the lit LED, and refer to the numbered block on the system service label that corresponds to the lit LED. Then, follow the instructions, if any, in the numbered block.

LEDs on the SMP Modules and system boards

To locate the actual component that caused the error, you must locate the lit LED next to that component.

For example:

A system error has occurred and you have noted that the CPU LED is lit on the diagnostic panel. Referring to the LEDs on the top cover, you see that LED #2 is lit. You then locate the panel on the system service label with the number 2 on it. In this case, the instructions in the panel tell you to remove the lower SMP Expansion Module. This tells you that the problem occurred with one of the microprocessors in the lower SMP Module. Follow the instructions to remove the lower SMP Module; then, remove the cover from the SMP Module. Located near the edge connectors on the circuit board is the light-path capacitor switch. Press and hold the switch until you locate the lit LED next to the defective microprocessor. Follow the instructions in the *Option Installation Guide* on the *IBM Documentation CD* to remove and replace the microprocessor.

Light Path Diagnostics table

The system-error LED on the operator information panel is lit when certain system errors occur. If the system-error LED on your server is lit, use the following table to help determine the cause of the error and the action you should take.

Table 3. Light Path Diagnostics

Lit LED on diagnostics panel	Cause	Action
None	An error has occurred and can not be isolated, or the ASM processor has failed.	An error has occurred that is not represented by a Light Path Diagnostics LED. Check the system error log for more information about the error.
PS	Power supply has failed.	Have the system serviced.
TEMP	The system temperature has exceeded a threshold level.	<ol style="list-style-type: none"> 1. Check to see if a fan has failed. If it has, replace the fan. 2. Make sure the room temperature is not too hot. (See “Features and specifications” on page 2 for temperature information.) <p>If the problem remains, have the system serviced.</p>
FAN	A fan has failed or is operating too slowly. Note: A failing fan can also cause the TEMP LED to be on.	Check the LEDs on the fans and replace the indicated fan.
SP	The service processor has failed.	<p>Remove ac power from the server and then restart the server.</p> <p>If the problem remains, have the system serviced.</p>
MEM	A memory error occurred.	<ol style="list-style-type: none"> 1. Check the DIMM failure LEDs on the system board. 2. Replace the DIMM indicated by the lit DIMM failure LED.
CPU	One of the microprocessors has failed.	<ol style="list-style-type: none"> 1. Check the microprocessor failure LEDs on the system board. 2. If a microprocessor failure LED is on, make sure the microprocessor is installed correctly. (See the <i>Option Installation Guide</i> on the <i>IBM xSeries Documentation CD</i> for installation instructions). <p>If the problem remains, have the system serviced.</p>
VRM	One of the VRMs on one of the SMP Expansion Module boards has failed.	<p>Remove ac power from the server and then restart the server.</p> <p>If the problem remains, have the system serviced.</p>

Solving problems

Table 3. Light Path Diagnostics (continued)

Lit LED on diagnostics panel	Cause	Action
PCI	An error occurred on a PCI bus.	<ol style="list-style-type: none"><li data-bbox="911 296 1417 348">1. Check the error log for additional information.<li data-bbox="911 359 1417 537">2. If you cannot isolate the failing adapter from the information in the error log, try to determine the failing adapter by removing one adapter at a time from PCI bus A (PCI-X slots 1 and 2) and restarting the server after each adapter is removed.<li data-bbox="911 548 1417 632">3. If the problem remains repeat step two, removing the PCI-X adapters one at a time from each of the busses. <p data-bbox="911 653 1417 705">If the problem remains, have the system serviced.</p>

Chapter 6. Getting help and service

This section provides information on how to get help and service.

If you cannot locate and correct the problem using the information in the "Troubleshooting Guide" on the *IBM Documentation* CD; then, use the information provided in this section to get help and service.

Getting information, help, and service

If you need help, service, or technical assistance or just want more information about IBM products, you will find a wide variety of sources available from IBM to assist you. This section contains information about where to go for additional information about IBM and IBM products, what to do if you experience a problem with your computer, and whom to call for service should it be necessary.

Getting information

Information about your IBM server product and preinstalled software, if any, is available in the documentation that comes with your server. That documentation includes printed books, online books, README files, and help files. In addition, information about IBM products is available on the World Wide Web and through the IBM Automated Fax System.

Using the World Wide Web

On the World Wide Web, the IBM Web site has up-to-date information about IBM products and support. The address for the IBM Personal Computing home page is <http://www.ibm.com/pc/>.

You can find support information for your IBM products at <http://www.ibm.com/pc/support/>.

If you click **Profile** from the support page, you can create a customized support page that is specific to your hardware, complete with Frequently Asked Questions, Parts Information, Technical Hints and Tips, and Downloadable Files. In addition, you can choose to receive e-mail notifications whenever new information becomes available about your registered products.

You also can order publications through the IBM Publications Ordering System at <http://www.elink.ibm.com/public/applications/publications/cgibin/pbi.cgi>.

Getting information by fax

If you have a touch-tone telephone and access to a fax machine, in the U.S. and Canada, you can receive, by fax, marketing and technical information on many topics, including hardware, operating systems, and local area networks (LANs).

You can call the IBM Automated Fax System 24 hours a day, 7 days a week. Follow the recorded instructions, and the requested information will be sent to your fax machine. In the U.S. and Canada, to access the IBM Automated Fax System, call 1-800-426-3395.

Getting help and service

If you have a problem with your server product, you will find a wide variety of sources available to help you.

Using the documentation and diagnostic programs

Many problems can be solved without outside assistance. If you experience a problem with your server product, the first place to start is the troubleshooting information in your IBM documentation. If you suspect a software problem, see the documentation, including README files and online help, that comes with the operating system or application program.

Most IBM server products come with a set of diagnostic programs that you can use to help you identify hardware problems. See the troubleshooting information in your IBM documentation for instructions on using the diagnostic programs.

The troubleshooting information or the diagnostic programs might tell you that you need additional or updated device drivers or other software. IBM maintains pages on the World Wide Web where you can get the latest technical information and download device drivers and updates. To access these pages, go to <http://www.ibm.com/pc/support/> and follow the instructions.

Calling for service

If you have tried to correct the problem yourself and still need help, during the warranty period, you can get help and information by telephone through the IBM HelpCenter[®]. The following services are available during the warranty period:

- **Problem determination** - Trained personnel are available to assist you with determining if you have a hardware problem and deciding what action is necessary to fix the problem.
- **IBM hardware repair** - If the problem is determined to be caused by IBM hardware under warranty, trained service personnel are available to provide the applicable level of service.
- **Engineering Change management** - Occasionally, there might be changes that are required after a product has been sold. IBM or your reseller, if authorized by IBM, will make selected Engineering Changes (ECs) available that apply to your hardware.

The following items are not covered:

- Replacement or use of non-IBM parts or nonwarranted IBM parts. All warranted parts contain a 7-character identification in the format IBM FRU XXXXXXX.
- Identification of software problem sources.
- Configuration of BIOS as part of an installation or upgrade.
- Changes, modifications, or upgrades to device drivers.
- Installation and maintenance of network operating systems (NOS).
- Installation and maintenance of application programs.

Refer to your IBM Statement of Limited Warranty for a full explanation of IBM warranty terms. Be sure to retain your proof of purchase to obtain warranty service.

In the U.S. and Canada, these services are available 24 hours a day, 7 days a week. In the U.K., these services are available Monday through Friday, from 9:00 a.m. to 6:00 p.m.

Note: Response times vary; may exclude some holidays.

Please have the following information ready when you call:

- Machine type and model
- Serial numbers of your IBM hardware products
- Description of the problem
- Exact wording of any error messages

- Hardware and software configuration information

Telephone numbers

Phone numbers are subject to change without notice. For the most up-to-date phone numbers, go to <http://www.ibm.com/pc/support/> and click **Support Phone List**.

Country		Telephone number
Austria	Österreich	01-24 592 5901
Belgium - Dutch	Belgie	02-210 9820
Belgium - French	Belgique	02-210 9800
Canada	Toronto only	416-383-3344
Canada	Canada - all other	1-800-565-3344
Denmark	Danmark	45 20 82 00
Finland	Suomi	09-22 931 840
France	France	02 38 55 74 50
Germany	Deutschland	07032-1549 201
Ireland	Ireland	01-815 9202
Italy	Italia	02-7031 6101
Luxembourg	Luxembourg	298-977 5063
Netherlands	Nederland	020-514 5770
Norway	Norge	23 05 32 40
Portugal	Portugal	21-791 51 47
Spain	España	91-662 49 16
Sweden	Sverige	08-477 4420
Switzerland	Schweiz/Suisse/Svizzera	058-333 0900
United Kingdom	United Kingdom	01475-555 055
U.S.A. and Puerto Rico	U.S.A. and Puerto Rico	1-800-772-2227

In all other countries or regions, contact your IBM reseller or IBM marketing representative.

International Warranty Service

If you travel with your server product or relocate it to a country where your server machine type is sold and serviced by IBM or by IBM resellers who are authorized to perform warranty service, International Warranty Service is available for your server product.

Service methods and procedures vary by country, and some services might not be available in all countries. International Warranty Service is delivered through the method of service (such as depot, carry-in, or on-site service) that is provided in the servicing country. Service centers in certain countries might not be able to service all models of a particular machine type. In some countries, fees and restrictions might apply at the time of service.

To determine whether your server product is eligible for International Warranty Service and to view a list of the countries where service is available, go to <http://www.ibm.com/pc/support/>, and click **Warranty Lookup**. Eligible IBM server

products are identified by their four-digit machine types. For more information about International Warranty Service, see Service Announcement 601-034 at <http://www.ibm.com/>. Click **Support & downloads**, click **Announcement letters**, and click **Announcements search**. In the **Search by letter number only** field, type 601-034, and click **Search**.

Purchasing additional services

During and after the warranty period, you can purchase additional services, such as support for IBM and non-IBM hardware, operating systems, and application programs; network setup and configuration; upgraded or extended hardware repair services; and custom installations. Service availability and service name might vary by country or region.

For more information about these services, contact your IBM marketing representative.

Appendix A. Warranty information

This appendix contains the warranty period for your product, information about obtaining warranty service and support, and the IBM Statement of Limited Warranty.

Warranty period

Contact your place of purchase for warranty service information. Some IBM Machines are eligible for on-site warranty service depending on the country or region where service is performed.

Machine - @server xSeries 440™ Type 8687

Warranty period - One year

Warranty service and support

With the original purchase of an IBM server product, you have access to extensive support. During the IBM Machine warranty period, you may call IBM or your reseller for problem-determination assistance under the terms of the IBM Statement of Limited Warranty.

The following services are available during the warranty period:

- **Problem determination** - Trained personnel are available to assist you with determining if you have a hardware problem and deciding what action is necessary to fix the problem.
- **IBM hardware repair** - If the problem is determined to be caused by IBM hardware under warranty, trained service personnel are available to provide the applicable level of service, either on-site or at an IBM service center as determined by IBM.
- **Engineering Change management** - Occasionally, there might be changes that are required after a product has been shipped from IBM. In those instances, IBM will make Engineering Changes (ECs) available that apply to your hardware.

The following items are not covered under warranty service:

- Replacement or use of non-IBM parts. All IBM parts contain a 7-character identification in the format IBM FRU XXXXXXX.
- Identification of non-IBM software problem sources.
- Installation of customer replaceable units (CRUs).
- Installation and configuration of machine code or licensed internal code that is designated as customer installable.

If you do not register your server with IBM, you might be required to present proof of purchase to obtain warranty service.

Before you call for service

You can solve many problems without outside assistance by following the troubleshooting procedures that IBM provides in the online help or in the publications that are provided with your server and software.

Most computers, operating systems, and application programs come with information that contains troubleshooting procedures and explanations of error

messages and error codes. The information that comes with your server also describes the diagnostic tests that you can perform.

If you suspect a software problem, refer to the information for the operating system or application program.

Calling for service

Please have the following information ready:

- Machine type, model, and serial number
- Description of the problem
- Exact wording of any error messages
- Hardware and software configuration information

To find the telephone number for the HelpCenter nearest you, see “Telephone numbers” on page 51.

IBM Statement of Limited Warranty Z125-4753-06 8/2000

This warranty statement consists of two parts: Part 1 and Part 2. Be sure to read Part 1 and the country-unique terms in Part 2 that apply to your country or region.

Part 1 - General Terms

This Statement of Limited Warranty includes Part 1 - General Terms and Part 2 - Country-unique Terms. The terms of Part 2 replace or modify those of Part 1. The warranties provided by IBM in this Statement of Limited Warranty apply only to Machines you purchase for your use, and not for resale, from IBM or your reseller. The term "Machine" means an IBM machine, its features, conversions, upgrades, elements, or accessories, or any combination of them. The term "Machine" does not include any software programs, whether pre-loaded with the Machine, installed subsequently or otherwise. Unless IBM specifies otherwise, the following warranties apply only in the country where you acquire the Machine. Nothing in this Statement of Limited Warranty affects any statutory rights of consumers that cannot be waived or limited by contract. If you have any questions, contact IBM or your reseller.

The IBM Warranty for Machines

IBM warrants that each Machine 1) is free from defects in materials and workmanship and 2) conforms to IBM's Official Published Specifications ("Specifications"). The warranty period for a Machine is a specified, fixed period commencing on its Date of Installation. The date on your sales receipt is the Date of Installation unless IBM or your reseller informs you otherwise.

If a Machine does not function as warranted during the warranty period, and IBM or your reseller are unable to either 1) make it do so or 2) replace it with one that is at least functionally equivalent, you may return it to your place of purchase and your money will be refunded.

Extent of Warranty

The warranty does not cover the repair or exchange of a Machine resulting from misuse, accident, modification, unsuitable physical or operating environment, improper maintenance by you, or failure caused by a product for which IBM is not responsible. The warranty is voided by removal or alteration of Machine or parts identification labels.

THESE WARRANTIES ARE YOUR EXCLUSIVE WARRANTIES AND REPLACE ALL OTHER WARRANTIES OR CONDITIONS, EXPRESS OR IMPLIED, INCLUDING, BUT NOT LIMITED TO, THE IMPLIED WARRANTIES OR CONDITIONS OF MERCHANTABILITY AND FITNESS FOR A PARTICULAR PURPOSE. THESE WARRANTIES GIVE YOU SPECIFIC LEGAL RIGHTS AND YOU MAY ALSO HAVE OTHER RIGHTS WHICH VARY FROM JURISDICTION TO JURISDICTION. SOME JURISDICTIONS DO NOT ALLOW THE EXCLUSION OR LIMITATION OF EXPRESS OR IMPLIED WARRANTIES, SO THE ABOVE EXCLUSION OR LIMITATION MAY NOT APPLY TO YOU. IN THAT EVENT, SUCH WARRANTIES ARE LIMITED IN DURATION TO THE WARRANTY PERIOD. NO WARRANTIES APPLY AFTER THAT PERIOD.

Items Not Covered by Warranty

IBM does not warrant uninterrupted or error-free operation of a Machine.

Any technical or other support provided for a Machine under warranty, such as assistance via telephone with “how-to” questions and those regarding Machine set-up and installation, will be provided **WITHOUT WARRANTIES OF ANY KIND.**

Warranty Service

To obtain warranty service for a Machine, contact IBM or your reseller. If you do not register your Machine with IBM, you may be required to present proof of purchase.

During the warranty period, IBM or your reseller, if approved by IBM to provide warranty service, provides without charge certain types of repair and exchange service to keep Machines in, or restore them to, conformance with their Specifications. IBM or your reseller will inform you of the available types of service for a Machine based on its country of installation. At its discretion, IBM or your reseller will 1) either repair or exchange the failing Machine and 2) provide the service either at your location or a service center. IBM or your reseller will also manage and install selected engineering changes that apply to the Machine.

Some parts of IBM Machines are designated as Customer Replaceable Units (called “CRUs”), e.g., keyboards, memory, or hard disk drives. IBM ships CRUs to you for replacement by you. You must return all defective CRUs to IBM within 30 days of your receipt of the replacement CRU. You are responsible for downloading designated Machine Code and Licensed Internal Code updates from an IBM Internet Web site or from other electronic media, and following the instructions that IBM provides.

When warranty service involves the exchange of a Machine or part, the item IBM or your reseller replaces becomes its property and the replacement becomes yours. You represent that all removed items are genuine and unaltered. The replacement may not be new, but will be in good working order and at least functionally equivalent to the item replaced. The replacement assumes the warranty service status of the replaced item. Many features, conversions, or upgrades involve the removal of parts and their return to IBM. A part that replaces a removed part will assume the warranty service status of the removed part.

Before IBM or your reseller exchanges a Machine or part, you agree to remove all features, parts, options, alterations, and attachments not under warranty service.

You also agree to

1. ensure that the Machine is free of any legal obligations or restrictions that prevent its exchange;
2. obtain authorization from the owner to have IBM or your reseller service a Machine that you do not own; and
3. where applicable, before service is provided:
 - a. follow the problem determination, problem analysis, and service request procedures that IBM or your reseller provides;
 - b. secure all programs, data, and funds contained in a Machine;
 - c. provide IBM or your reseller with sufficient, free, and safe access to your facilities to permit them to fulfill their obligations; and
 - d. inform IBM or your reseller of changes in a Machine’s location.

IBM is responsible for loss of, or damage to, your Machine while it is 1) in IBM’s possession or 2) in transit in those cases where IBM is responsible for the transportation charges.

Neither IBM nor your reseller is responsible for any of your confidential, proprietary or personal information contained in a Machine which you return to IBM or your reseller for any reason. You should remove all such information from the Machine prior to its return.

Limitation of Liability

Circumstances may arise where, because of a default on IBM's part or other liability, you are entitled to recover damages from IBM. In each such instance, regardless of the basis on which you are entitled to claim damages from IBM (including fundamental breach, negligence, misrepresentation, or other contract or tort claim), except for any liability that cannot be waived or limited by applicable laws, IBM is liable for no more than

1. damages for bodily injury (including death) and damage to real property and tangible personal property; and
2. the amount of any other actual direct damages, up to the charges (if recurring, 12 months' charges apply) for the Machine that is subject of the claim. For purposes of this item, the term "Machine" includes Machine Code and Licensed Internal Code.

This limit also applies to IBM's suppliers and your reseller. It is the maximum for which IBM, its suppliers, and your reseller are collectively responsible.

UNDER NO CIRCUMSTANCES IS IBM LIABLE FOR ANY OF THE FOLLOWING: 1) THIRD-PARTY CLAIMS AGAINST YOU FOR DAMAGES (OTHER THAN THOSE UNDER THE FIRST ITEM LISTED ABOVE); 2) LOSS OF, OR DAMAGE TO, YOUR RECORDS OR DATA; OR 3) SPECIAL, INCIDENTAL, OR INDIRECT DAMAGES OR FOR ANY ECONOMIC CONSEQUENTIAL DAMAGES, LOST PROFITS OR LOST SAVINGS, EVEN IF IBM, ITS SUPPLIERS OR YOUR RESELLER IS INFORMED OF THEIR POSSIBILITY. SOME JURISDICTIONS DO NOT ALLOW THE EXCLUSION OR LIMITATION OF INCIDENTAL OR CONSEQUENTIAL DAMAGES, SO THE ABOVE LIMITATION OR EXCLUSION MAY NOT APPLY TO YOU.

Governing Law

Both you and IBM consent to the application of the laws of the country in which you acquired the Machine to govern, interpret, and enforce all of your and IBM's rights, duties, and obligations arising from, or relating in any manner to, the subject matter of this Agreement, without regard to conflict of law principles.

Part 2 - Country-unique Terms

AMERICAS

BRAZIL

Governing Law: *The following is added after the first sentence:* Any litigation arising from this Agreement will be settled exclusively by the court of Rio de Janeiro.

NORTH AMERICA

Warranty Service: *The following is added to this Section:* To obtain warranty service from IBM in Canada or the United States, call 1-800-IBM-SERV (426-7378).

CANADA

Governing Law: *The following replaces “laws of the country in which you acquired the Machine” in the first sentence: laws in the Province of Ontario.*

UNITED STATES

Governing Law: *The following replaces “laws of the country in which you acquired the Machine” in the first sentence: laws of the State of New York.*

ASIA PACIFIC

AUSTRALIA

The IBM Warranty for Machines: *The following paragraph is added to this Section:* The warranties specified in this Section are in addition to any rights you may have under the Trade Practices Act 1974 or other similar legislation and are only limited to the extent permitted by the applicable legislation.

Limitation of Liability: *The following is added to this Section:* Where IBM is in breach of a condition or warranty implied by the Trade Practices Act 1974 or other similar legislation, IBM’s liability is limited to the repair or replacement of the goods or the supply of equivalent goods. Where that condition or warranty relates to right to sell, quiet possession or clear title, or the goods are of a kind ordinarily acquired for personal, domestic or household use or consumption, then none of the limitations in this paragraph apply.

Governing Law: *The following replaces “laws of the country in which you acquired the Machine” in the first sentence: laws of the State or Territory.*

CAMBODIA, LAOS, AND VIETNAM

Governing Law: *The following replaces “laws of the country in which you acquired the Machine” in the first sentence: laws of the State of New York.*

The following is added to this Section: Disputes and differences arising out of or in connection with this Agreement shall be finally settled by arbitration which shall be held in Singapore in accordance with the rules of the International Chamber of Commerce (ICC). The arbitrator or arbitrators designated in conformity with those rules shall have the power to rule on their own competence and on the validity of the Agreement to submit to arbitration. The arbitration award shall be final and binding for the parties without appeal and the arbitral award shall be in writing and set forth the findings of fact and the conclusions of law.

All proceedings shall be conducted, including all documents presented in such proceedings, in the English language. The number of arbitrators shall be three, with each side to the dispute being entitled to appoint one arbitrator.

The two arbitrators appointed by the parties shall appoint a third arbitrator before proceeding upon the reference. The third arbitrator shall act as chairman of the proceedings. Vacancies in the post of chairman shall be filled by the president of the ICC. Other vacancies shall be filled by the respective nominating party. Proceedings shall continue from the stage they were at when the vacancy occurred.

If one of the parties refuses or otherwise fails to appoint an arbitrator within 30 days of the date the other party appoints its, the first appointed arbitrator shall be the sole arbitrator, provided that the arbitrator was validly and properly appointed.

The English language version of this Agreement prevails over any other language version.

HONG KONG AND MACAU

Governing Law: *The following replaces “laws of the country in which you acquired the Machine” in the first sentence: laws of Hong Kong Special Administrative Region.*

INDIA

Limitation of Liability: *The following replaces items 1 and 2 of this Section:*

1. liability for bodily injury (including death) or damage to real property and tangible personal property will be limited to that caused by IBM’s negligence;
2. as to any other actual damage arising in any situation involving nonperformance by IBM pursuant to, or in any way related to the subject of this Statement of Limited Warranty, IBM’s liability will be limited to the charge paid by you for the individual Machine that is the subject of the claim.

JAPAN

Governing Law: *The following sentence is added to this Section: Any doubts concerning this Agreement will be initially resolved between us in good faith and in accordance with the principle of mutual trust.*

NEW ZEALAND

The IBM Warranty for Machines: *The following paragraph is added to this Section: The warranties specified in this Section are in addition to any rights you may have under the Consumer Guarantees Act 1993 or other legislation which cannot be excluded or limited. The Consumer Guarantees Act 1993 will not apply in respect of any goods which IBM provides, if you require the goods for the purposes of a business as defined in that Act.*

Limitation of Liability: *The following is added to this Section: Where Machines are not acquired for the purposes of a business as defined in the Consumer Guarantees Act 1993, the limitations in this Section are subject to the limitations in that Act.*

PEOPLE’S REPUBLIC OF CHINA (PRC)

Governing Law: *The following replaces this Section: Both you and IBM consent to the application of the laws of the State of New York (except when local law requires otherwise) to govern, interpret, and enforce all your and IBM’s rights, duties, and obligations arising from, or relating in any manner to, the subject matter of this Agreement, without regard to conflict of law principles.*

Any disputes arising from or in connection with this Agreement will first be resolved by friendly negotiations, failing which either of us has the right to submit the dispute to the China International Economic and Trade Arbitration Commission in Beijing, the PRC, for arbitration in accordance with its arbitration rules in force at the time. The arbitration tribunal will consist of three arbitrators. The language to be used therein will be English and Chinese. An arbitral award will be final and binding on all the parties, and will be enforceable under the Convention on the Recognition and Enforcement of Foreign Arbitral Awards (1958).

The arbitration fee will be borne by the losing party unless otherwise determined by the arbitral award.

During the course of arbitration, this Agreement will continue to be performed except for the part which the parties are disputing and which is undergoing arbitration.

EUROPE, MIDDLE EAST, AFRICA (EMEA)

THE FOLLOWING TERMS APPLY TO ALL EMEA COUNTRIES: The terms of this Statement of Limited Warranty apply to Machines purchased from IBM or an IBM reseller.

Warranty Service:

If you purchase an IBM Machine in Austria, Belgium, Denmark, Estonia, Finland, France, Germany, Greece, Iceland, Ireland, Italy, Latvia, Lithuania, Luxembourg, Netherlands, Norway, Portugal, Spain, Sweden, Switzerland or United Kingdom, you may obtain warranty service for that Machine in any of those countries from either (1) an IBM reseller approved to perform warranty service or (2) from IBM. If you purchase an IBM Personal Computer Machine in Albania, Armenia, Belarus, Bosnia and Herzegovina, Bulgaria, Croatia, Czech Republic, Georgia, Hungary, Kazakhstan, Kirghizia, Federal Republic of Yugoslavia, Former Yugoslav Republic of Macedonia (FYROM), Moldova, Poland, Romania, Russia, Slovak Republic, Slovenia, or Ukraine, you may obtain warranty service for that Machine in any of those countries from either (1) an IBM reseller approved to perform warranty service or (2) from IBM.

If you purchase an IBM Machine in a Middle Eastern or African country, you may obtain warranty service for that Machine from the IBM entity within the country of purchase, if that IBM entity provides warranty service in that country, or from an IBM reseller, approved by IBM to perform warranty service on that Machine in that country. Warranty service in Africa is available within 50 kilometers of an IBM authorized service provider. You are responsible for transportation costs for Machines located outside 50 kilometers of an IBM authorized service provider.

Governing Law:

The applicable laws that govern, interpret and enforce rights, duties, and obligations of each of us arising from, or relating in any manner to, the subject matter of this Statement, without regard to conflict of laws principles, as well as Country-unique terms and competent court for this Statement are those of the country in which the warranty service is being provided, except that in 1) Albania, Bosnia-Herzegovina, Bulgaria, Croatia, Hungary, Former Yugoslav Republic of Macedonia, Romania, Slovakia, Slovenia, Armenia, Azerbaijan, Belarus, Georgia, Kazakhstan, Kyrgyzstan, Moldova, Russia, Tajikistan, Turkmenistan, Ukraine, and Uzbekistan, the laws of Austria apply; 2) Estonia, Latvia, and Lithuania, the laws of Finland apply; 3) Algeria, Benin, Burkina Faso, Cameroon, Cape Verde, Central African Republic, Chad, Congo, Djibouti, Democratic Republic of Congo, Equatorial Guinea, France, Gabon, Gambia, Guinea, Guinea-Bissau, Ivory Coast, Lebanon, Mali, Mauritania, Morocco, Niger, Senegal, Togo, and Tunisia, this Agreement will be construed and the legal relations between the parties will be determined in accordance with the French laws and all disputes arising out of this Agreement or related to its violation or execution, including summary proceedings, will be settled exclusively by the Commercial Court of Paris; 4) Angola, Bahrain, Botswana, Burundi, Egypt, Eritrea, Ethiopia, Ghana, Jordan, Kenya, Kuwait, Liberia, Malawi, Malta, Mozambique,

Nigeria, Oman, Pakistan, Qatar, Rwanda, Sao Tome, Saudi Arabia, Sierra Leone, Somalia, Tanzania, Uganda, United Arab Emirates, United Kingdom, West Bank/Gaza, Yemen, Zambia, and Zimbabwe, this Agreement will be governed by English Law and disputes relating to it will be submitted to the exclusive jurisdiction of the English courts; and 5) in Greece, Israel, Italy, Portugal, and Spain any legal claim arising out of this Statement will be brought before, and finally settled by, the competent court of Athens, Tel Aviv, Milan, Lisbon, and Madrid, respectively.

THE FOLLOWING TERMS APPLY TO THE COUNTRY SPECIFIED:

AUSTRIA AND GERMANY

The IBM Warranty for Machines: *The following replaces the first sentence of the first paragraph of this Section:* The warranty for an IBM Machine covers the functionality of the Machine for its normal use and the Machine's conformity to its Specifications.

The following paragraphs are added to this Section:

The minimum warranty period for Machines is six months. In case IBM or your reseller is unable to repair an IBM Machine, you can alternatively ask for a partial refund as far as justified by the reduced value of the unrepaired Machine or ask for a cancellation of the respective agreement for such Machine and get your money refunded.

Extent of Warranty: *The second paragraph does not apply.*

Warranty Service: *The following is added to this Section:* During the warranty period, transportation for delivery of the failing Machine to IBM will be at IBM's expense.

Limitation of Liability: *The following paragraph is added to this Section:* The limitations and exclusions specified in the Statement of Limited Warranty will not apply to damages caused by IBM with fraud or gross negligence and for express warranty.

The following sentence is added to the end of item 2: IBM's liability under this item is limited to the violation of essential contractual terms in cases of ordinary negligence.

EGYPT

Limitation of Liability: *The following replaces item 2 in this Section:* as to any other actual direct damages, IBM's liability will be limited to the total amount you paid for the Machine that is the subject of the claim. For purposes of this item, the term "Machine" includes Machine Code and Licensed Internal Code.

Applicability of suppliers and resellers (unchanged).

FRANCE

Limitation of Liability: *The following replaces the second sentence of the first paragraph of this Section:* In such instances, regardless of the basis on which you are entitled to claim damages from IBM, IBM is liable for no more than: *(items 1 and 2 unchanged).*

IRELAND

Extent of Warranty: *The following is added to this Section:* Except as expressly provided in these terms and conditions, all statutory conditions, including all warranties implied, but without prejudice to the generality of the foregoing all warranties implied by the Sale of Goods Act 1893 or the Sale of Goods and Supply of Services Act 1980 are hereby excluded.

Limitation of Liability: *The following replaces items one and two of the first paragraph of this Section:* 1. death or personal injury or physical damage to your real property solely caused by IBM's negligence; and 2. the amount of any other actual direct damages, up to 125 percent of the charges (if recurring, the 12 months' charges apply) for the Machine that is the subject of the claim or which otherwise gives rise to the claim.

Applicability of suppliers and resellers (unchanged).

The following paragraph is added at the end of this Section: IBM's entire liability and your sole remedy, whether in contract or in tort, in respect of any default shall be limited to damages.

ITALY

Limitation of Liability: *The following replaces the second sentence in the first paragraph:* In each such instance unless otherwise provided by mandatory law, IBM is liable for no more than: 1. *(unchanged)* 2. as to any other actual damage arising in all situations involving nonperformance by IBM pursuant to, or in any way related to the subject matter of this Statement of Warranty, IBM's liability, will be limited to the total amount you paid for the Machine that is the subject of the claim.

Applicability of suppliers and resellers (unchanged).

The following replaces the third paragraph of this Section: Unless otherwise provided by mandatory law, IBM and your reseller are not liable for any of the following: *(items 1 and 2 unchanged)* 3) indirect damages, even if IBM or your reseller is informed of their possibility.

SOUTH AFRICA, NAMIBIA, BOTSWANA, LESOTHO AND SWAZILAND

Limitation of Liability: *The following is added to this Section:* IBM's entire liability to you for actual damages arising in all situations involving nonperformance by IBM in respect of the subject matter of this Statement of Warranty will be limited to the charge paid by you for the individual Machine that is the subject of your claim from IBM.

UNITED KINGDOM

Limitation of Liability: *The following replaces items 1 and 2 of the first paragraph of this Section:*

1. death or personal injury or physical damage to your real property solely caused by IBM's negligence;
2. the amount of any other actual direct damages or loss, up to 125 percent of the charges (if recurring, the 12 months' charges apply) for the Machine that is the subject of the claim or which otherwise gives rise to the claim;

The following item is added to this paragraph: 3. breach of IBM's obligations implied by Section 12 of the Sale of Goods Act 1979 or Section 2 of the Supply of Goods and Services Act 1982.

Applicability of suppliers and resellers (unchanged).

The following is added to the end of this Section: IBM's entire liability and your sole remedy, whether in contract or in tort, in respect of any default shall be limited to damages.

Appendix B. Notices

This publication was developed for products and services offered in the U.S.A.

IBM may not offer the products, services, or features discussed in this document in other countries. Consult your local IBM representative for information on the products and services currently available in your area. Any reference to an IBM product, program, or service is not intended to state or imply that only that IBM product, program, or service may be used. Any functionally equivalent product, program, or service that does not infringe any IBM intellectual property right may be used instead. However, it is the user's responsibility to evaluate and verify the operation of any non-IBM product, program, or service.

IBM may have patents or pending patent applications covering subject matter described in this document. The furnishing of this document does not give you any license to these patents. You can send license inquiries, in writing, to: *IBM Director of Licensing IBM Corporation North Castle Drive Armonk, NY 10504-1785 U.S.A.*

INTERNATIONAL BUSINESS MACHINES CORPORATION PROVIDES THIS PUBLICATION "AS IS" WITHOUT WARRANTY OF ANY KIND, EITHER EXPRESS OR IMPLIED, INCLUDING, BUT NOT LIMITED TO, THE IMPLIED WARRANTIES OF NON-INFRINGEMENT, MERCHANTABILITY OR FITNESS FOR A PARTICULAR PURPOSE. Some states do not allow disclaimer of express or implied warranties in certain transactions, therefore, this statement may not apply to you.

This information could include technical inaccuracies or typographical errors. Changes are periodically made to the information herein; these changes will be incorporated in new editions of the publication. IBM may make improvements and/or changes in the product(s) and/or the program(s) described in this publication at any time without notice.

Any references in this publication to non-IBM Web sites are provided for convenience only and do not in any manner serve as an endorsement of those Web sites. The materials at those Web sites are not part of the materials for this IBM product, and use of those Web sites is at your own risk.

IBM may use or distribute any of the information you supply in any way it believes appropriate without incurring any obligation to you.

Edition notice

**© COPYRIGHT INTERNATIONAL BUSINESS MACHINES CORPORATION, 2002.
All rights reserved.**

Note to U.S. Government Users — Documentation related to restricted rights — Use, duplication or disclosure is subject to restrictions set forth in GSA ADP Schedule Contract with IBM Corp.

Trademarks

The following terms are trademarks of International Business Machines Corporation in the United States, other countries, or both:

Alert on LAN	Predictive Failure Analysis
Active PCI-X	ServeRAID
Active PCI	ServerGuide
Active Memory	ServerProven
Chipkill	TechConnect
EtherJet	Tivoli
e-business logo	Tivoli Enterprise
HelpCenter	Update Connector
HelpWare	Wake on LAN
IBM	X-Architecture
Light Path Diagnostics	XA-32
Memory ProteXion	XceL4
NetBAY	XpandOnDemand
OS/2 WARP	xSeries

Lotus and Domino are trademarks of Lotus Development Corporation and/or IBM Corporation in the United States, other countries, or both.

Intel, Celeron, MMX, LANDesk, Pentium, Pentium II Xeon, Pentium III Xeon, and Xeon are trademarks of Intel Corporation in the United States, other countries, or both.

Microsoft, Windows, and Windows NT are trademarks of Microsoft Corporation in the United States, other countries, or both.

UNIX is a registered trademark of The Open Group in the United States and other countries.

Java and all Java-based trademarks and logos are trademarks or registered trademarks of Sun Microsystems, Inc. in the United States, other countries, or both.

Linux is a registered trademark of Linus Torvalds.

Other company, product, or service names may be the trademarks or service marks of others.

Important notes

Processor speeds indicate the internal clock speed of the microprocessor; other factors also affect application performance.

CD-ROM drive speeds list the variable read rate. Actual speeds vary and are often less than the maximum possible.

When referring to processor storage, real and virtual storage, or channel volume, KB stands for approximately 1000 bytes, MB stands for approximately 1000000 bytes, and GB stands for approximately 1000000000 bytes.

When referring to hard disk drive capacity or communications volume, MB stands for 1 000 000 bytes, and GB stands for 1 000 000 000 bytes. Total user-accessible capacity may vary depending on operating environments.

Maximum internal hard disk drive capacities assume the replacement of any standard hard disk drives and population of all hard disk drive bays with the largest currently supported drives available from IBM.

Maximum memory may require replacement of the standard memory with an optional memory module.

IBM makes no representation or warranties regarding non-IBM products and services that are ServerProven, including but not limited to the implied warranties of merchantability and fitness for a particular purpose. These products are offered and warranted solely by third parties.

Unless otherwise stated, IBM makes no representations or warranties with respect to non-IBM products. Support (if any) for the non-IBM products is provided by the third party, not IBM.

Some software may differ from its retail version (if available), and may not include user manuals or all program functionality.

Electronic emission notices

Federal Communications Commission (FCC) statement

Note: This equipment has been tested and found to comply with the limits for a Class A digital device, pursuant to Part 15 of the FCC Rules. These limits are designed to provide reasonable protection against harmful interference when the equipment is operated in a commercial environment. This equipment generates, uses, and can radiate radio frequency energy and, if not installed and used in accordance with the instruction manual, may cause harmful interference to radio communications. Operation of this equipment in a residential area is likely to cause harmful interference, in which case the user will be required to correct the interference at his own expense.

Properly shielded and grounded cables and connectors must be used in order to meet FCC emission limits. Properly shielded and grounded cables and connectors must be used in order to meet FCC emission limits. IBM is not responsible for any radio or television interference caused by using other than recommended cables and connectors or by using other than recommended cables and connectors or by unauthorized changes or modifications to this equipment. Unauthorized changes or modifications could void the user's authority to operate the equipment.

This device complies with Part 15 of the FCC Rules. Operation is subject to the following two conditions: (1) this device may not cause harmful interference, and (2) this device must accept any interference received, including interference that may cause undesired operation.

Industry Canada Class A emission compliance statement

This Class A digital apparatus complies with Canadian ICES-003.

Avis de conformité à la réglementation d'Industrie Canada

Cet appareil numérique de la classe A est conforme à la norme NMB-003 du Canada.

Australia and New Zealand Class A statement

Attention: This is a Class A product. In a domestic environment this product may cause radio interference in which case the user may be required to take adequate measures.

United Kingdom telecommunications safety requirement

Notice to Customers

This apparatus is approved under approval number NS/G/1234/J/100003 for indirect connection to public telecommunication systems in the United Kingdom.

European Union EMC Directive conformance statement

This product is in conformity with the protection requirements of EU Council Directive 89/336/EEC on the approximation of the laws of the Member States relating to electromagnetic compatibility. IBM cannot accept responsibility for any failure to satisfy the protection requirements resulting from a nonrecommended modification of the product, including the fitting of non-IBM option cards.

This product has been tested and found to comply with the limits for Class A Information Technology Equipment according to CISPR 22/European Standard EN 55022. The limits for Class A equipment were derived for commercial and industrial environments to provide reasonable protection against interference with licensed communication equipment.

Attention: This is a Class A product. In a domestic environment this product may cause radio interference in which case the user may be required to take adequate measures.

Taiwan electrical emission statement

警告使用者：
這是甲類的資訊產品，在居住的環境中使用時，可能會造成射頻干擾，在這種情況下，使用者會被要求採取某些適當的對策。

Japanese Voluntary Control Council for Interference (VCCI) statement

この装置は、情報処理装置等電波障害自主規制協議会（VCCI）の基準に基づくクラスA情報技術装置です。この装置を家庭環境で使用すると電波妨害を引き起こすことがあります。この場合には使用者が適切な対策を講ずるよう要求されることがあります。

Power cords

For your safety, IBM provides a power cord with a grounded attachment plug to use with this IBM product. To avoid electrical shock, always use the power cord and plug with a properly grounded outlet.

IBM power cords used in the United States and Canada are listed by Underwriter's Laboratories (UL) and certified by the Canadian Standards Association (CSA).

For units intended to be operated at 115 volts: Use a UL-listed and CSA-certified cord set consisting of a minimum 18 AWG, Type SVT or SJT, three-conductor cord, a maximum of 15 feet in length and a parallel blade, grounding-type attachment plug rated 15 amperes, 125 volts.

For units intended to be operated at 230 volts (U.S. use): Use a UL-listed and CSA-certified cord set consisting of a minimum 18 AWG, Type SVT or SJT, three-conductor cord, a maximum of 15 feet in length and a tandem blade, grounding-type attachment plug rated 15 amperes, 250 volts.

For units intended to be operated at 230 volts (outside the U.S.): Use a cord set with a grounding-type attachment plug. The cord set should have the appropriate safety approvals for the country in which the equipment will be installed.

IBM power cords for a specific country or region are usually available only in that country or region.

IBM power cord part number	Used in these countries and regions
13F9940	Argentina, Australia, China (PRC), New Zealand, Papua New Guinea, Paraguay, Uruguay, Western Samoa
13F9979	Afghanistan, Algeria, Andorra, Angola, Austria, Belgium, Benin, Bulgaria, Burkina Faso, Burundi, Cameroon, Central African Rep., Chad, China (Macau S.A.R.), Czech Republic, Egypt, Finland, France, French Guiana, Germany, Greece, Guinea, Hungary, Iceland, Indonesia, Iran, Ivory Coast, Jordan, Lebanon, Luxembourg, Malagasy, Mali, Martinique, Mauritania, Mauritius, Monaco, Morocco, Mozambique, Netherlands, New Caledonia, Niger, Norway, Poland, Portugal, Romania, Senegal, Slovakia, Spain, Sudan, Sweden, Syria, Togo, Tunisia, Turkey, former USSR, Vietnam, former Yugoslavia, Zaire, Zimbabwe
13F9997	Denmark
14F0015	Bangladesh, Burma, Pakistan, South Africa, Sri Lanka

IBM power cord part number	Used in these countries and regions
14F0033	Antigua, Bahrain, Brunei, Channel Islands, China (Hong Kong S.A.R.), Cyprus, Dubai, Fiji, Ghana, India, Iraq, Ireland, Kenya, Kuwait, Malawi, Malaysia, Malta, Nepal, Nigeria, Polynesia, Qatar, Sierra Leone, Singapore, Tanzania, Uganda, United Kingdom, Yemen, Zambia
14F0051	Liechtenstein, Switzerland
14F0069	Chile, Ethiopia, Italy, Libya, Somalia
14F0087	Israel
1838574	Thailand
6952301	Bahamas, Barbados, Bermuda, Bolivia, Brazil, Canada, Cayman Islands, Colombia, Costa Rica, Dominican Republic, Ecuador, El Salvador, Guatemala, Guyana, Haiti, Honduras, Jamaica, Japan, Korea (South), Liberia, Mexico, Netherlands Antilles, Nicaragua, Panama, Peru, Philippines, Saudi Arabia, Suriname, Taiwan, Trinidad (West Indies), United States of America, Venezuela

Index

A

- acoustical noise emissions 2
- adapter
 - installing 8, 9
 - PCI bus 9
 - ServeRAID 11
 - working with 8

C

- cable
 - connectors on back 25
 - management 25
- cabling
 - ServeRAID adapter 11
- CD-ROM
 - drive specification 2
 - problems 41
- Class A electronic emission notice 67
- components
 - location of 5
 - major 5
- configuration
 - ServeRAID program 29
- Configuration/Setup Utility 29, 30
- configuring
 - your server 29
- cover
 - close 24
 - removing 7

D

- diagnostic tools 39
- DIMMs
 - connector locations 19
 - considerations 18
 - specifications 2
 - supported 2
- diskette drive
 - problem 41
 - specifications 2
- documentation CD 1

E

- electrical input 2
- electronic emission Class A notice 67
- environment
 - air temperature 2
 - humidity 2
- expansion slots 2
 - location 8
 - type 8

F

- FCC Class A notice 67

H

- handling static-sensitive devices 4
- hardware problems 39
- heat output 2

I

- installing
 - adapters 8
 - options 7
- integrated functions 2

K

- keyboard problem 41, 42

L

- LEDs
 - front view 35
 - rear view 37
- Light Path Diagnostics
 - feature 44
 - using 44
- Light Path Diagnostics table 47

M

- major components 5
- management cable 25
- memory
 - configuration changes 19
 - problem 42
 - specifications 2
- memory module specifications 2
- microprocessor specifications 2
- mouse problem 42

N

- NOS
 - controlling remotely 31
 - installing 31
- notes, important 66
- notices
 - electronic emission 67
 - FCC, Class A 67

O

- operating system
 - controlling remotely 31

- operating system *(continued)*
 - installing 31
- option
 - problem 43
- options
 - installing 7

P

- PCI
 - expansion slots 8
- pointing device
 - problem 42
- POST
 - beep codes 39
- POST (Power-on self test)
 - error logs 39
- power
 - problem 43
 - supply specifications 2
- problem
 - CD-ROM 41
 - diskette drive 41
 - hardware 39
 - intermittent 41
 - keyboard or mouse 41, 42
 - memory 42
 - option 43
 - power 43
 - serial port 44
 - software 44
 - solving 39
 - USB port 44
- problems
 - solving 49
- product
 - data 1

R

- reinstalling
 - the SMP Expansion Module 21
- Remote Supervisor Adapter 31
 - configuration 29

S

- SCSISelect
 - Utility 29
- SCSISelect utility program
 - using 30

- serial port
 - problem 44
- ServeRAID
 - configuration program 29, 32
- ServeRAID adapter
 - cabling 11
- ServerGuide
 - CDs 29, 31
 - startup problems 40
- service summary 49
- slots See expansion slots 8
- SMP Expansion Module 13
 - reinstalling the cover 21
 - reinstalling the SMP Expansion Module 21
 - removing 14
 - removing the cover 14
- software
 - problem 44
- static sensitive devices, handling 4

T

- temperature
 - air 2
- trademarks 66
- troubleshooting 39
 - charts 41, 49

U

- United States electronic emission Class A notice 67
- United States FCC Class A notice 67
- USB port
 - problem 44
- utility
 - Configuration/Setup 30
 - ServeRAID configuration programs 32

V

- video controller
 - specifications 2

W

- Web site
 - compatible options 18
- working inside server with power on 3