



The IBM eServer™ xSeries® 440 Product Guide

xSeries 440 – Business Overview

The IBM eServer xSeries 440 is the standard bearer of Enterprise X-Architecture™ technology and the flagship of the xSeries server brand. A revolution in technology and design, the x440 represents the dawn of a new age in high-performance industry-standard computing. Pushing industry-standard servers deeper into the enterprise datacenter than ever before, the xSeries 440 is the mission-critical server that revolutionizes the industry-standard server market. If the game is e-business, then the x440 is game changing. Available a full twelve months ahead of any 8-way competitive product, the x440 is the industry's first Intel® Xeon™ processor-based scalable enterprise server powered by Enterprise X-Architecture, delivering a revolutionary economic model for optimizing IT.

In today's difficult economic environment, CIO's are forced to contend with numerous IT challenges, not least of which are how to cope with a flat to declining IT budget and how to manage a burgeoning infrastructure with fewer qualified IT administrators. At the same time that CIO's are facing these challenges, CEO's are asking them to prepare their firms for growth opportunities in e-business such as wireless or e-commerce while better linking their supply chain to improve operational efficiencies with suppliers, customers and employees.

The x440 is the answer to today's CIO dilemma. With the support for up to 16-way SMP and remote I/O, the x440 is IBM's first "pay-as-you-grow" building block design that allows you to purchase only the performance and I/O capacity that you need, when you need it, without buying costly upfront infrastructure. Called XpandOnDemand™ scalability, this "pay-as-you-grow" capability is unmatched by any server in the industry-standard server market. By bridging the gap between performance and headroom, the x440 helps CIO's prepare for tomorrow by investing their IT dollars intelligently today.

Leveraging over 50 years of enterprise expertise and the advances of the IBM Server Group, the x440 delivers mainframe-inspired technologies at a fraction of the cost of a true mainframe system. Built upon industry-standard processors, memory, and I/O, the Enterprise X-Architecture design makes these technologies work together better. Furthermore, the x440 delivers OnForever™ availability through subsystem and component fault tolerance tied together with industry-leading systems management tools. In addition Active™ PCI-X and Active Memory™ magnify OnForever availability by offering hot-add and hot-swap of PCI and PCI-X adapters and a suite of industry-first memory technologies including memory mirroring and Memory ProteXion™. With the IBM autonomic computing initiative, the x440 introduces new tools for improved reliability for self-healing and self-optimization. With the latest in server management built into the x440, IT administrators are able to more easily monitor and maintain their mission-critical servers remotely. This helps IT administrators work smarter in managing their infrastructure, not harder. And now with scalability up to 16-way, IT administrators have more flexibility, more IT alternatives than ever before.

In addition to scalability and availability, the x440 is optimized for performance. As the premiere IA-32 database engine, the x440 delivers unprecedented performance for SQL, DB2®, and Oracle. In designing and developing the x440, IBM walked the fine line of high-octane with fewer bottlenecks. Optimal performance is not achieved by forcing the fastest components together into a system. Rather, optimal performance is achieved by intuitive innovation. With the x440, this innovation takes the form of the XcelL4™ Server Accelerator Cache. With 32 megabytes of level-4 system cache per SMP Expansion Module (up to 128 MB per 16-way), the x440 screams to leadership in industry-standard benchmarks. When combined with the latest Intel Xeon processors, Active PCI-X with up to 133 megahertz performance, gigabit Ethernet for high-speed networking, and Ultra160 SCSI, what results is a high-performance system nothing short of phenomenal.

As the world's most advanced IA-32 server, the x440 also introduces a new breed of industry-standard server optimized for server consolidation of file/print, messaging (Microsoft® Exchange, Lotus® Notes®), and custom applications through advanced system partitioning or in combination with client consolidation software such as Citrix®. And with such a suite of high availability features, the x440 is best suited for mission-critical applications such as CRM, ERP, business intelligence, and web serving found in the enterprise datacenter today.

In summary, how impressive is the x440? Well, judging by the numerous industry awards the x440 has claimed since its introduction including PC Expo Enterprise Hardware and Overall Best of Show Awards, Network World Best of the Tests and World Class Awards, PC Magazine Technical Excellence Award for Enterprise Servers, and China Computer World Product of the Year Award, just to name a few, we're guessing that people are starting to recognize just how game changing the x440 really is. And that's before we mention that the x440 now claims the #1 market share position for 8-way servers, having surpassed Hewlett-Packard after only two quarters of sales. As the standard bearer for Enterprise X-Architecture, the x440 redefines performance, scalability, availability and management for industry-standard servers. Now, more than ever, IBM is primed to assert its leadership in server technology and its value as a trusted business partner of enterprise customers. The x440 is your answer for e-business and IBM is your company for making the vision of On Demand computing a reality.

Donn Bullock is the Worldwide Product Manager for the x440 and the Global Brand Manager for Enterprise X-Architecture, responsible for product marketing and new product development in the IBM eServer xSeries product division, based in Research Triangle Park, North Carolina, USA. Email: donn@us.ibm.com

xSeries 440 – Key Differentiators

- The industry's first 8-way Xeon MP at 4U height (7 inches, 17.78 cm) – fits up to 80 CPUs per 42U rack – 150% more than Unisys.
- The industry's most rack-dense 16-way at 8U height (14 inches, 35.56 cm) – 22% of the rack space of the 36U Unisys ES7000.
- Modular building block design takes you from 2-way to 16-way SMP for investment protection and flexible scalability.
- First to market 8-way server introduced 12 months ahead of Hewlett-Packard with the next-generation Intel Xeon Processor MP.
- First to market and still the only server manufacturer with 4-way SMP based upon cost-effective Intel Xeon (DP) at 2.4 GHz.
- XceL4 Server Accelerator Cache powering high performance scalability from 4-way to 8-way to 16-way.
- First to market with Active Memory – designed to reduce downtime through memory mirroring and Memory ProteXion.
- Flexible Remote I/O – enhanced PCI-X expansion external to the base system for “pay-as-you-grow” I/O scalability.
- Light Path Diagnostics™ – reduce your repair time through quick identification of failed or failing components.
- Active PCI-X and Gigabit Ethernet – reduce network bottlenecks with up to 133 MHz PCI-X performance and Gigabit throughput.
- System Partitioning – consolidate servers or setup high-speed clustering configurations using logical or physical partitioning.
- Leadership performance accumulating thirty-five #1 industry-standard benchmarks since its announcement in March 2002.

xSeries 440 – Technology Overview

The IBM XA-32™ Chipset

The IBM XA-32 Chipset is the product name describing the Project “Summit” chipset for the IA-32 platform. The IA-64 counterpart is the IBM XA-64™ chipset, which will be leveraged for the forthcoming Itanium2-based EXA server. A product of the IBM Microelectronics Division in Austin, Texas, the XA-32 chipset is fabricated using the latest in copper technology and is composed of the following components:

1. **Memory Controller:** there is one high-performance memory controller per SMP Expansion Module. This memory controller delivers 5.0 GB/sec aggregate I/O bandwidth and 12.8 GB/sec aggregate memory bandwidth per chassis. With its multi-memory controller architecture, the x440 does not have the bottleneck of a single memory controller that handicaps the performance and scaling of other chipset designs such as Intel's Profusion and Hewlett Packard's F8 (used in the DL740 and DL760 G2). While these systems are limited to 8-way scaling, XA-32 based systems are thus capable of effectively scaling well beyond 8-way, up to 32-way in the future.
2. **Processor & Cache Controller:** there is one processor & cache controller per SMP Expansion Module.
3. **PCI Bridge:** there are two PCI Bridge I/O controllers per chassis located on the centerplane and the I/O board that control both the PCI-X and Remote I/O. As a demonstration of interoperability among eServer systems, this same I/O controller is also developed for and used by the eServer iSeries and pSeries.

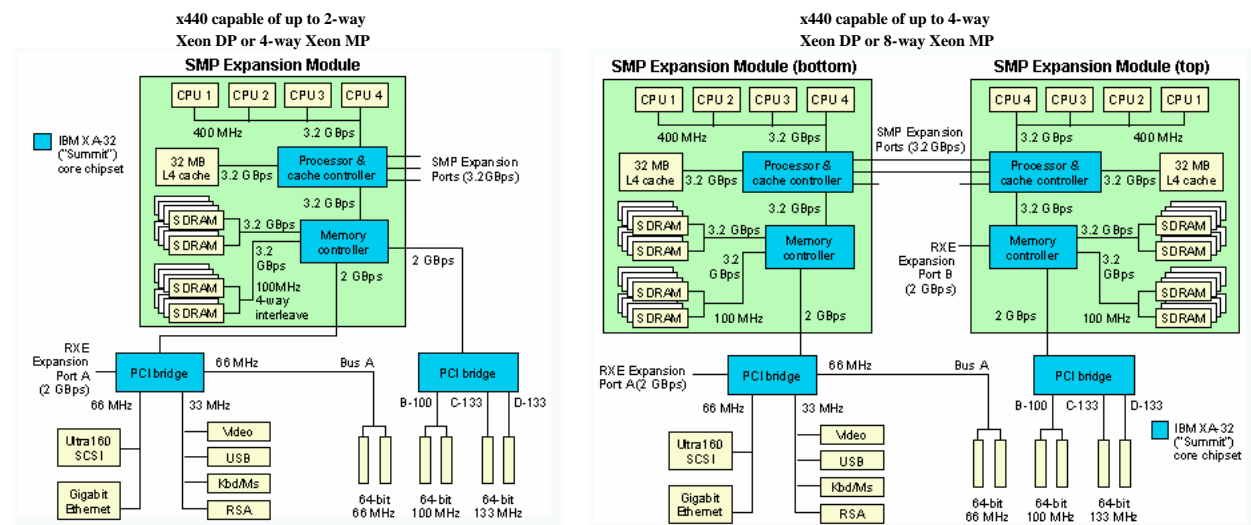

As the “glue” that binds the processors, memory, and I/O together, the XA-32 chipset is the “secret sauce” of the x440, allowing IBM to optimize the x440 for performance and build in differentiation versus other Intel-based server designs. This break-through design allows IBM to build an exceptionally rack-dense 8-way, optimize it for performance, then combine two of these systems together in a single configuration for the most rack-dense 16-way in the world. In addition, the XA-32 introduces an industry exclusive with the Xeon DP (Dual Processor). By using this less expensive Xeon, you can combine four Xeon DP processors – limited to a two-way in servers offered by HP and Dell – into a 4-way SMP server, resulting in comparable performance to a Xeon MP 4-way but at a lower entry price point. Though limited to 4-way with the Xeon DP, you can rest assured that you are still purchasing an x440 with the promise of XpandOnDemand™ scalability with Xeon MP up to 16-way. For a graphical lay-out of a Xeon MP 4-way or 8-way server, see the block diagrams above. To create a 2-way or 4-way Xeon DP-based server, simply ignore CPU2 and CPU3 (pre-populated with air baffles) in each SMP Expansion Module. For 16-way SMP, you will simply connect two 8-way Xeon MP x440 servers together via the SMP Expansion ports and cables (see page 9 for further details).

The Intel Xeon: delivering ultimate price-performance with IA-32

Since April 2002, the x440 was the first industry-standard 8-way server with Intel's next-generation, high-performance Xeon processor – a feat that required twelve additional months for HP to match, a feat that Dell is yet to accomplish. A true server processor, the Intel Xeon processor is the follow-on to the now-outdated Pentium® III Xeon™ Processor that is still being shipped by Dell. There are two versions of this new processor – the Xeon (DP) with up to 2.4 GHz performance and scalability up to 4-way SMP on the x440 (an industry-exclusive capability) and the Xeon MP (Multi Processor) with up to 2.0 GHz performance and scalability up to 16-way SMP on the x440.



Frequency	L1 Cache	L2 Cache	Max CPUs	Frequency	L2 Cache	iL3 Cache	Max CPUs
700 MHz	32 KB	1 MB	8	1.4 GHz	256 KB	512 KB	16
700 MHz	32 KB	2 MB	8	1.5 GHz	256 KB	512 KB	16
900 MHz	32 KB	2 MB	8	1.6 GHz	256 KB	1 MB	16
				1.5 GHz	512 KB	1 MB	16
				1.9 GHz	512 KB	1 MB	16
				2.0 GHz	512 KB	2 MB	16
				2.4 GHz	512 KB	0 KB	4

With the return to the ZIF socket design, the Xeon processor provides a substantially smaller footprint than the previous Pentium III Xeon enabling the x440 to achieve leadership rack density as the industry's first 8-way Xeon MP in a 4U chassis. As a result of this leadership rack density, you are able to fit 66% more 8-way servers in a standard 42U rack than the 7U 8-way available from Dell and HP (ten 4U servers versus six 7U servers). Although Intel had to initially reduce the size of the processor caches to accommodate the smaller die size, Intel was able to integrate them onto the processor die itself. The level-1 cache of the Pentium III Xeon has been re-labeled as level-2 in Xeon, but increases from 32 KB to up to 512 KB for Xeon MP and Xeon DP. Similarly, the level-2 cache of the Pentium III Xeon has been re-labeled as iL3 (integrated level-3) in Xeon MP and with the latest generation introduced in November 2002 now matches the 2 MB of iL3 previously found on the Pentium III Xeon. Although the Xeon DP offers the same level of L2 cache (512 KB) as the Xeon MP, the Xeon DP has no iL3 cache. What makes the x440 with the Xeon DP processors so innovative is that because of the XA-32-based architecture, the Xeon DP is actually able to use the 32MB of XcelL4™ cache (per 2-way DP) to compensate for its lack of iL3, resulting in a higher performing system than would be expected.

In addition to increasing the frequency of the processor, Intel also introduced a number of performance features associated with its NetBurst™ microarchitecture. These features include a faster front-side bus and a new virtual processor technology. By quad-pumping data over a 100 MHz clocked system bus, the new Xeon processor achieves 400 MHz front-side bus performance. This delivers data in and out of the processor at 3.2 GB/s, a substantial improvement over the 1.06 GB/s of the Pentium® III Xeon processor's 133 MHz design.

In addition to a faster front-side bus, the Xeon processor also supports Hyper-threading. Estimated by Intel to increase processing performance by up to 30%, Intel's simultaneous multi-threading design allows a single physical processor to manage data as if it were two virtual processors by handling data instructions in parallel rather than one at a time. The multi-threading design also has implications for the operating system as the OS sees the single physical processor as two logical processors. Because of Microsoft's licensing of the Windows® Server operating systems by number of processors (see chart below), the appearance of twice as many logical processors can potentially affect the install of the operating system. As a result, hyper-threading is initially turned off in BIOS to ensure proper OS installation and can be re-enabled at any time. Although the Windows 2000 and Windows Server 2003 operating systems understand and correctly report hyper-threading, Windows NT 4.0 does not. Therefore, the x440 is able to support only Windows NT 4.0 Enterprise Edition in a 4-way configuration with Xeon MP (2-way only with Xeon DP) as Windows NT sees eight logical processors instead of the four physical processors. At this time, no patch is planned by Microsoft to address this. Furthermore, because Windows NT does not understand NUMA, a change to the NT kernel would be required for Windows NT to support a 4-way with Xeon DP – a change that is not possible as Windows NT is no longer being developed by Microsoft.

Microsoft OS Scalability	Windows 2000 Server	Windows 2000 Advanced Server	Windows 2000 Datacenter Server	Windows Server 2003 Standard Edition	Windows Server 2003 Enterprise Edition	Windows Server 2003 Datacenter Edition
Max # supported CPUs	4	8	32	2	8	32
Max supported memory	4 GB	8 GB	64 GB	4 GB	32 GB	64 GB
Clustering Max # nodes	0	2	4	0	8	8
NUMA Support	Compatible	Compatible	Compatible	Optimized	Optimized	Optimized

At this time, interconnecting nodes of different speed processors or installing different speed processors into different SMP Expansion Modules is not supported by IBM. This is because of the differences in cache sizes between the processors and the cache coherency problems that this introduces for the operating system. In addition, because of the electrical differences between the first generation of Xeon MP (up to 1.6GHz) and the second-generation of Xeon MP (up to 2.0GHz), if you wish to upgrade your existing x440 MP-based systems from the first-generation to the second-generation, you will need the new SMP Expansion Module (Option Part# 59P5188). If you purchased the x440 as a Xeon DP-based system, you do not need to purchase this new SMP Expansion Module as the changes necessary to support the second-generation of Xeon MP were made in those Xeon DP-based SMP Expansion Modules prior to the introduction of those models. If you wish to upgrade an existing x440 system(s) to 16-way, you may do so by contacting IBM or your authorized IBM EXAct Business Partner (see page 9 for more details).

Industry Exclusive with Xeon DP

Although architected by other server manufacturers such as Dell and Hewlett-Packard to support only up to 2-way SMP, the Xeon DP when combined with the innovation of the x440 design introduces an industry-exclusive scalable solution. By virtue of the XA-32 chipset, the x440 offers the world's first 4-way SMP server using the Xeon DP processor. Although only 2 processors can be supported in a single SMP Expansion Module, by combining two SMP Expansion Modules into a single 4U chassis (similar to the means by which one would build an 8-way SMP), you can acquire one of the highest performing 4-way industry-standard servers in the world. Not only that, but because this is an x440 system, you can still grow that system to 16-way SMP at any time by swapping out the Xeon DP processors for Xeon MP processors. Besides the higher frequency of the processor, you can also benefit from the lower price of the processor to tailor a scalability solution for your datacenter today. The x440 with Xeon DP not only creates value scalability but once again proves that the x440 is the ultimate XpandOnDemand™ solution.

SMP Expansion Module

The SMP Expansion Module is the central electronics complex (CEC) that contains the processors, memory, chipset controllers, and level-4 system cache. Depending upon the model, the x440 system includes either one or two SMP Expansion Modules, each with sockets for up to four Intel Xeon MP Processors or up to two Xeon DP processors, 32 MB of XceL4™ cache, and 16 DIMM slots. Although the Xeon DP and Xeon MP are similar in architecture, mixing of DP and MP in the same CEC or between two CECs is not supported.

The processor upgrade path differs between the Xeon MP-based and Xeon DP-based x440. While the Xeon MP-based x440 can be upgraded by adding an empty SMP Expansion Module (Option Part# 59P5188) and Xeon MP processor option kits, the Xeon DP-based x440 can only be upgraded from 2-way to 4-way by adding the SMP Expansion Module pre-populated with two Xeon 2.4 GHz processors (Option Part# 71P7919). There are no Xeon 2.4 GHz processor option kits available for the x440. Note: The 8687-4RY model is a 4-way Xeon DP-based x440 that already contains both SMP Expansion Modules.

By adding that second SMP Expansion Module, you can grow the 2-way or 4-way Xeon MP to an 8-way SMP or the 2-way Xeon DP to a 4-way SMP, while still retaining the 4U rack density. When adding the second CEC, you also get an additional 32 MB of XceL4 cache (for a maximum of 64 MB) and 16 more DIMM slots to support up to a maximum of 32 GB per chassis. The SMP Expansion Module is installed from the top of the server and easily mounts to the side of the centerplane using two levers on the top of the CEC. These same levers are used to remove the top of the CEC when adding additional processors or memory. Remember: because of 4-way memory interleaving, you should always have at least 4 DIMMs in the top SMP Expansion Module.

Each SMP Expansion Module is also equipped with LEDs for Light Path Diagnostics. LEDs are available for each memory DIMM, processor, and VRM to aid in the quick identification of failed or failing components. LEDs are also located on the top of the CEC to identify when Active Memory™ mirroring is enabled. A black button located within the CEC (see red circle in graphic above) controls the capacitor that powers the LEDs for identification of any failed components after the CEC is removed from the system for maintenance.

Because of the electrical differences between the first generation of Xeon MP (up to 1.6 GHz) and the second-generation of Xeon MP (up to 2.0 GHz), if you wish to upgrade your existing x440 Xeon MP-based systems from the first-generation to the second-generation, you will need the new SMP Expansion Module (Option Part# 59P5188). If you purchased the x440 as a Xeon DP-based system, you do not need to purchase this new SMP Expansion Module as the changes necessary to support the second-generation Xeon MP were made in those Xeon DP-based SMP Expansion Modules prior to the introduction of those DP-based models.



SMP Expansion Module with cover on



SMP Expansion Module with cover off

XceL4™ Server Accelerator Cache

Integrated into the SMP Expansion Module, XceL4 Server Accelerator Cache powers high-speed performance between the processors, main memory, and I/O devices. With transfer speeds three times faster than main memory, XceL4 cache becomes a necessity to alleviate the bottlenecks associated with high speed technologies. In some x440 lab configurations, the XceL4 cache improved overall system performance from 20% up to 60% versus other xSeries platforms depending upon the application.

Each SMP Expansion Module contains 32 MB of DDR-based XceL4 cache memory. As you expand from 4-way to 8-way with Xeon MP or 2-way to 4-way with Xeon DP, the XceL4 cache is doubled to 64MB. In a 16-way configuration, the cache doubles again to 128 MB. This cache becomes critical at 8-way and above in limiting the number of far memory accesses to reduce the latency associated with such transfers. The next-generation x440 will double the amount of system cache memory available per SMP Expansion Module and further reduce this latency.

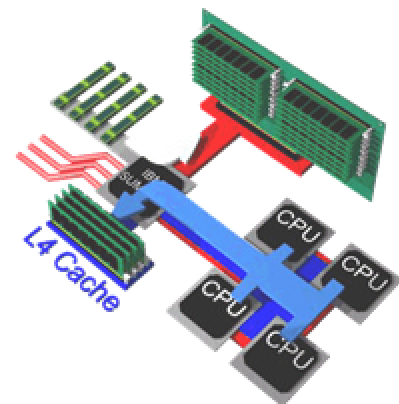

New Modular Rack Design

The x440 introduces a new mechanical design with leadership rack density and modular upgradeability. With expansion up to 8-way in a 4U chassis, the x440 was the first 4U rack dense 8-way Xeon MP server available in the industry-standard server market, available 12 months ahead of HP and Unisys. A feat of cooling given the expansion capabilities and the number of electrical components integrated into the system, the x440 chassis is designed to give quick, easy, and tool-free access to the hot-swap power supplies, hot-swap fans, I/O, SMP Expansion Module(s) and Light Path Diagnostics. Because of the layout of the mechanical and the use of ThinkPad® UltraBay™ devices for CD and Floppy, DLT and other Tape Backup Solutions are not supported internally in the x440. Instead you should take advantage of the external SCSI port for connection of any external tape devices. At 27.5 inches (698 mm) deep, the x440 should only be installed in the IBM Netfinity Enterprise Rack.



High-Performance Active™ PCI-X

As the second xSeries server to introduce the PCI-X standard into the IBM product portfolio (the first was the x360 announced in November 2001), the x440 brings ultra-fast I/O performance to this already high-speed system. The x440 is equipped with six full-length 64-bit Active™ PCI-X slots, capable of hot-adding, hot-swapping, and hot-deleting adapters at any time while the operating system is still running.

With four I/O buses, the x440 adapter slots will support two 133 MHz cards (each slot with its own bus), two 100 MHz cards (these slots share a bus), and two 66 MHz cards (these slots also share a bus). From the rear, the slots are oriented in order of ascending speed from left to right. Important Notes: 1) All slots support 3.3V adapters only and 2) because of the system depth, the blue handle must be removed when installing full-length PCI adapters.

66 MHz → 100 MHz → 133 MHz



Hot-Swap Redundant Power Supplies

The x440 is equipped with two hot-swap, redundant power supplies (N+N) that are front accessible by removing the bezel. At 1050W, the x440 power supply has been described as the most power-dense power supply in the world. Maintaining tool-free serviceability, the x440 power supplies can be easily removed and re-installed using the lever on the front of the power supply. The x440 ships with two 1050W power supplies standard. Since two power supplies are the maximum, no power supply option part is available.

Because of the increased power consumption required of the new Intel Xeon processors especially when combined with a fully loaded system, the x440 can be connected to power through two means only: 1) the 220V power cord supplied with each system (two wall outlet line cords are provided) and 2) the 220V PDU adapters intended to connect the x440 to the Power Distribution Unit in the rack (two intra-rack cables are also provided). Because most companies will install the x440 in the 42U Enterprise Rack, the PDU adapters will be the most common means for connecting to power. However, the 220V cords are supplied for those companies wishing to configure the x440 in the new NetBay11™ rack. Note: The x440 does not ship with 110V power cords as the system loses power redundancy at the highest configurations using this power setting. As illustrated in the photo at right, there are two power connections on the rear of the server.

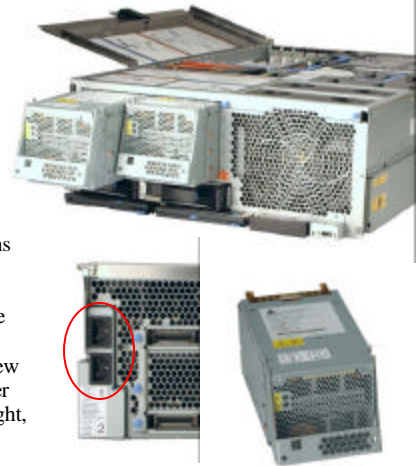

Hot-Swap Redundant Cooling Fans

With four hot-swap redundant fans, the x440 has adequate cooling for each of its major component areas. There are two fans located at the front of the server that direct air through the SMP Expansion Modules. These fans are accessible from the top of the server without having to open the system panels. In the event of a fan failure, the other fan will speed up to continue to provide adequate cooling until the failed fan can be hot-swapped by the IT administrator within 24 hours.

The other two fans are located just behind the power supplies and provide cooling for the I/O devices. Similar to the CEC fans, these fans will speed up in the event that one should fail to compensate for the reduction in air flow. All four fans are equipped with Light Path LEDs to enable easy identification of failed fans.

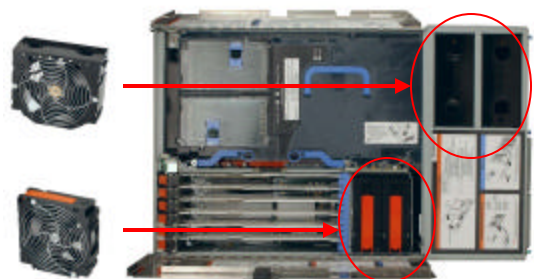

x440 Top View

Floppy Drive & CD-ROM Drive

In an effort to achieve the highest rack density without sacrificing essential functionality, the x440 leverages the UltraBay devices of the ThinkPad laptops. Located on the front of the server below the power supplies, the 3.5-inch floppy drive and the 24X CD-ROM are space efficient and interchangeable with other ThinkPad UltraBay devices including DVD-ROM drives and CD-RW drives (check the ServerProven® list for the officially supported options).

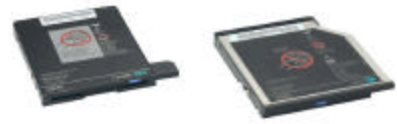

Light Path Diagnostics™

Continuing with the break-through technology of Light Path Diagnostics, the x440 brings greater ease of use and functionality to this critical Enterprise X-Architecture offering. To limit the need to slide the server out of the rack to diagnose problems, a new Light Path panel has been added to the front of the x440. This panel can be ejected from the server and folded down to view all Light Path monitored server subsystems. In the event that maintenance is then required, you can slide the server from the rack and using the LEDs, find the failed or failing component.

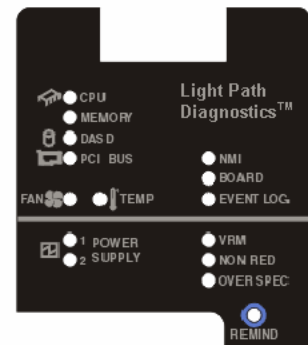

As illustrated in the graphic at right, Light Path Diagnostics is able to monitor and report on the health of CPUs, Main Memory, Hard disk drives, PCI-X and PCI adapters, fans, power supplies, VRMs, and the internal system temperature. Light Path in the x440 is now divided into three levels: 1) front of server with Light Path panel identifies failure and sub-system, 2) LEDs on top of x440 identify to which board the failed component is attached, i.e. CEC1, CEC2, I/O, and 3) LEDs in the system help locate that component.



Remote Supervisor Adapter

The x440 includes a Remote Supervisor Adapter (RSA) standard in the system. Positioned horizontally in a dedicated PCI slot beneath the PCI-X adapter area of the system, the Remote Supervisor Adapter is one of the most sophisticated adapters ever introduced by IBM. The Remote Supervisor Adapter offers the following capabilities: independent power, in-band and out-band support through IBM Director; full web browser support with no other software required; enhanced security features; graphics/text console redirection for remote control; Windows NT and Windows 2000 blue screen capture; dedicated 10/100 Ethernet access port; IBM interconnect (RS485) with alerts including downstream support for previous generation RSA; serial dial in/out; email, pager and SNMP alerting; event log; Predictive Failure Analysis® on memory, power, hard drives, and L4 cache; temperature and voltage monitoring with settable threshold; Light Path Diagnostics; ASR for operating system and POST; Remote Firmware update; LAN Access; and alert forwarding.

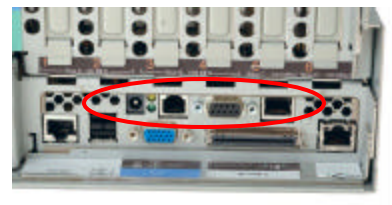

Video Graphics

The x440 has an integrated video graphics chip standard in the system. This chip is the S3 Savage4 LT Video Accelerator chip featuring a 128-bit graphics engine, a PCI bus interface, and 8 MB of SDRAM at 125 MHz. It will support up to the following video settings: 1920x1440x256 colors at 75 Hz, 1600x1200x64K colors at 75 Hz, 1024x768x16.7M colors at 75 Hz. The 15-pin port on the rear of the server will support any SVGA compatible monitor.



Broadcom Gigabit Ethernet Controller



The x440 is the first xSeries server to offer an integrated Gigabit Ethernet controller. The x440 includes one single-port Broadcom BCM5700 10/100/1000 BASE-T MAC (Media Access Controller) on a PCI 64-bit 66 MHz bus (port circled in graphic at right). The BCM5700 supports full & half-duplex performance at all speeds (10/100/1000 Mbps) and includes integrated on-chip memory for buffering data transmissions to ensure the highest network performance and dual on-board RISC processors for advanced packet parsing and backwards compatibility with today's 10/100 networks. Because of OS dependencies, the x440 can only support WakeOnLAN up to 100 Mbps with Windows 2000, rather than the full 1000Mbps, 10 Mbps on others. The Broadcom controller also includes software support for fail-over, layer-3 load balancing, and comprehensive diagnostics. For redundancy, failover, teaming, and load-balancing, refer to the IBM Gigabit Ethernet Adapter, Option part# 31P6301.



Gigabit Ethernet boosts data transmission over existing Category 5 cabling, the dominant cabling infrastructure in today's corporate networks, by up to ten times compared to today's Fast Ethernet solutions. This leap in performance is especially critical for today's servers, workstations, and faster desktop computers that are already being bottlenecked by aging 10/100 Ethernet networks. This congestion is the result of an increased utilization of network-oriented applications such as automatic file backup, e-mail & messaging, streaming video and Network Attached Storage. Broadcom is recognized as the first-to-market leader in Gigabit Ethernet thanks in part to their competitive performance, advanced capabilities, and feature roadmap. The follow-on product to the x440 will include an updated Broadcom dual-port gigabit Ethernet controller.

Ultra160 SCSI Controller, ServeRAID™ Controllers, & Hard Disk Drives

The x440 includes an integrated dual-port Adaptec 7899 Ultra160 SCSI controller. This controller is capable of transmitting data at 160 MB per second. The controller is connected to the hot-plug back plane for the two internal drives and the external SCSI port. This controller uses a 64-bit PCI interface at 66 MHz. An optional ServeRAID card can be added to the x440 to mirror the internal drives. A second, longer SCSI cable ships standard in the x440. This cable is required when connecting the internal drives to the ServeRAID adapter versus the embedded SCSI. The ServeRAID 4Mx and 4Lx are both supported on the x440 for mirroring the internal drives. Note: because of the 4U height of the x440 and the lack of an indented internal connector on the ServeRAID 4H (this applies to the 4H only), the 4H controller can only be connected to external devices as there is not enough room within the system to cable the internal connector. The next-generation x440 will support the Ultra320 SCSI standard and introduce integrated RAID 1 for mirroring the drives. The x440 only supports Ultra160 hard disk drives including the 18 GB, 36 GB, and 73 GB drives. The 18 GB and 36 GB hard drives support both 10,000 rpm and 15,000 rpm performance while the 73 GB drive is currently only available at 10,000 rpm.



The Memory Subsystem

The x440 memory subsystem includes 16 DIMM sockets per CEC spread out across two banks. There are two memory ports (one for each bank) and one memory controller in each CEC. DIMMs 1-8 operate on port 1 and DIMMs 9-16 operate on port 2. Because the x440 employs four-way interleaving, DIMMs must be installed four at a time in matching size. A minimum of four DIMMs (all 512 MB) are shipped standard in the x440. Only the 512 MB and 1 GB DIMM are supported on the x440 and listed on the ServerProven® list. The x440 is capable of supporting up to 32 GB of total main memory in a single 4U chassis or up to 64GB across two chassis in a 16-way. The DIMMs supported by the x440 are 3.3V 168-pin 133 MHz Registered ECC SDRAM, but run at 100 MHz in the x440. The interface from the Memory Controller to the four System Memory Interface chips (SMI-Ls) is 8 bytes per port at 400 MHz (6.4 GB/sec of total memory bandwidth per SMP Expansion Module). SMI-L data is transferred to the DIMM at 32 bytes per port at 100 MHz. Therefore, the x440 offers equal performance of DDR (16-bytes at 200 MHz) while using less expensive PC133 SDRAM, which when purchasing 64 GB of PC133 versus DDR, can result in a substantial savings.

Active Memory™

Introducing the first memory mirroring capability into the industry-standard server market, the x440 brings an exceptional level of availability and redundancy to mission-critical environments. With Active Memory, you can mirror the physical memory within the x440 system across the two memory ports. Shipping as default off in all x440 systems, Active Memory can be easily configured in BIOS followed by a re-boot. After re-boot, the physical memory available to the operating system will be halved, i.e. if 8GB before enabling, then 4GB after, but all data will be written to both banks of memory. You need to ensure that you install equal amounts of memory in each of the redundant banks in matching memory DIMMs to ensure that all data is mirrored properly down to the same DIMM. Unlike HP RAID Memory that involves costly memory controllers and is mandatory in the HP ProLiant servers for anything greater than ECC, Active Memory has no performance penalty associated with stripping data in a RAID configuration, does not carry the cost burden of multiple memory controllers, does not require extra memory expense to support Chipkill and double-bit errors correction, yet still provides more memory availability than HP at no additional cost.



The primary benefit of memory mirroring is that in the event of a DIMM failure, the system remains operational; allowing the IT administrator to schedule maintenance versus being forced to contend with unscheduled downtime. The secondary benefit of memory mirroring is that future generations of the x440 product family will be capable of hot-swapping a memory DIMM into either of the memory banks without taking the system down. Again because this capability is built into the memory controller, memory mirroring is operating system independent, running on systems with Linux as easily as in systems with Microsoft Windows. Though not available on the x440, hot-swap and hot-add memory will be supported in the follow-on to the x440 to be released in 2003.

Here's how it will work:

1. Enable memory mirroring in BIOS and re-boot.
2. Once a bad DIMM is detected, Light Path is enabled to the bad DIMM and the memory controller reads from the other port.
3. IT Administrator receives a Service Processor alert or sees System Error and Light Path LEDs on.
4. Opens system top cover and sees DIMM Error LED on.
5. Sees Memory Hot Plug Enable LED on and opens memory access door where failed DIMM is located.
6. Opening door sends signal to turn off port. Port Power LED and Memory Hot Plug Enable LED turn off.
7. Removes failed DIMM, installs new one, and closes access door.
8. Closing door sends signal to turn on port. Port Power LED turns on. Basic DIMM test is run. Failed DIMM LED turns off.

9. Data is recopied to that port at the rate of 6 seconds per GB. Memory Hot Plug Enable LED blinks during testing and data recopy.
10. Memory Hot Plug Enable LED stops blinking and remains on when recopy is complete. The x440 is back in mirrored mode.

There are several important rules to remember with regard to the installing memory and setting up memory mirroring in the CECs.

1. The x440 will not operate if the bottom CEC contains no memory. Therefore, you cannot add a second SMP Expansion Module and move all the memory to the top CEC for hot-swapping memory in mirrored mode.
2. If you upgrade to an 8-way by adding the second CEC, you need to evenly divide the memory between the two CECs to realize optimal performance. For example, if you start with the base 2 GB memory (four 512 MB DIMMs) but later add a second CEC to take the x440 to an 8-way Xeon MP, you need to add four more 512 MB DIMMs in the top CEC (to make it 4 GB of total memory). Similarly, if you already have 4 GB of memory in a 4-way Xeon MP and add a second CEC to take the x440 to an 8-way, you need to remove the four 512 MB DIMMs from slots 9, 11, 13, and 15 and re-install them in the top CEC in slots 1, 3, 5, and 7. Similarly, when upgrading from 8-way to 16-way, memory needs to be evenly divided among all four CECs in the two chassis configuration to ensure optimal performance and equal access to memory for all processors.
3. Even though you cannot access the memory in the bottom CEC while in mirrored mode for hot-swapping failed DIMMs, the advantage of having the bottom CEC mirrored is that a DIMM failure will keep the system running and allow for scheduled maintenance by the IT administrator versus unscheduled downtime. Reducing unplanned downtime is the real benefit of high availability mirroring memory, not necessarily the need to replace the DIMM without a re-boot.
4. SMP Expansion Modules are setup for memory mirroring individually in BIOS. Thus, you could setup memory mirroring in the top CEC only or the bottom CEC only, though IBM recommends against this.
5. Memory mirroring requires that memory banks contain not only identical quantities of memory but identical DIMM configurations as well to enable mirroring down to the DIMM level. When enabling memory mirroring, an example of a supported configuration would be eight 512 MB DIMMs in each bank for 4GB of memory mirrored, but not eight 512 MB DIMMs in one bank mirrored to four 1 GB DIMMs in the redundant bank.
6. Memory mirroring does not work across CECs. You cannot setup four 512 MB DIMMs in the bottom CEC to be mirrored by four 512 MB DIMMs in the top CEC. Memory mirroring only operates across banks in the same CEC. Thus, with regard to #2 above, if you add a second CEC to expand from a 4-way Xeon MP to an 8-way Xeon MP, you must balance the memory between the two CECs, i.e. four 512 MB DIMMs in each CEC, then add four 512 MB DIMMs to port 2 in each CEC to enable memory mirroring.

Chipkill™ Memory

With the introduction of Enterprise X-Architecture, Chipkill, now in its third-generation (1st: 7000 M10, 2nd: 7600 & 6000), is integrated into the XA-32 chipset. With Chipkill now a part of the memory controller, you can use industry-standard off-the-shelf ECC SDRAM and enjoy native Chipkill support. Although now a more reliable algorithm, Chipkill remains unchanged in its functionality of correcting multiple single-bit errors to keep a DIMM from failing. When combining Chipkill with Active Memory, the x440 is designed to provide near bullet-proof reliability in the memory subsystem. Although formerly supported in the ProLiant 8-way server, HP now requires RAID Memory and its associated expense of extra memory and memory controllers to support Chipkill functionality, a feature that is supported in the x440 at no additional cost.

Memory ProteXion™

As another layer of memory reliability, Memory ProteXion, also known as “redundant bit steering” is the technology behind using redundant bits in a data packet to provide back-up in the event of a DIMM failure. Similar to Chipkill, Memory ProteXion is integrated into the XA-32 memory controller supporting the use of off-the-shelf industry-standard ECC SDRAM. Here’s how it works: because of the structure of a data stream, not all bits are used in a particular data transfer. With current 72-bit data packets, 64 bits are used for data, 6 bits are used for ECC, and in all other industry-standard servers besides the x440, the remaining 2 bits go unused. IBM leverages these “extra” unused bits to provide back-up to that data transfer, similar to the Hot-spare drive of RAID. In the event of a chip failure on the DIMM detected by memory scrubbing, the memory controller can re-route data around that failed chip through the spare bits. It can do this automatically without issuing a PFA or Light Path alert to the administrator. After the second DIMM failure, a PFA and Light Path would occur on that DIMM as normal to swap it out. Available in the x440 at no additional cost, Memory ProteXion is available from neither HP nor Unisys.

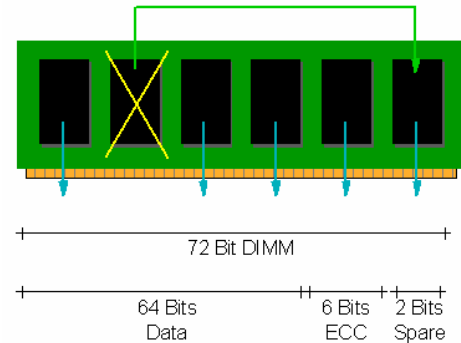

The final assessment: Active Memory, Chipkill, and Memory ProteXion provide multiple levels of redundancy to the memory subsystem never before seen in the Intel-based server market at a much lower cost than the competition. Combining Chipkill with Memory ProteXion doubles the number of possible chipkills in the system, enabling up to 2 chipkills per memory port on the x440. A 16-way x440 with its eight memory ports could sustain up to 16 chipkills. The first chipkill on each port wouldn't even generate a Light Path error as Memory ProteXion would provide the first-layer of defense. Each memory port could then sustain a second chipkill without shutting down. Providing that Active Memory with memory mirroring is enabled, the third chipkill on that port would send the alert and take down the DIMM, but keep the system running out of the redundant memory bank.

XpandOnDemand™ Scalability

SMP Expansion Ports

For the first time in the history of the xSeries server division, the x440 introduces the capability to grow a system from smaller SMP to larger SMP using rack-dense scalable enterprise server nodes. At their most basic, these server nodes can be comprised of 2-way or 4-way SMP systems with processors, memory, and I/O devices. These nodes can then be upgraded in the future to 8-way Xeon MP or 4-way Xeon DP using the SMP Expansion Module or all the way up to 16-way with Xeon MP by connecting the systems together under a single operating system image using the SMP Expansion Ports. Also called scalability ports, the SMP Expansion Ports are InfiniBand™-type connectors (they ARE NOT InfiniBand, just similar to the connectors used by InfiniBand today) that have been developed by IBM to enable you to connect multiple x440 chassis together to achieve high-performance scalability, but in a more rack-dense space than available from any other vendor.

Each SMP Expansion Module includes three SMP Expansion Ports, labeled 1, 2, and 3 that power the industry's first direct bus-to-bus interconnect, a bi-directional high-speed connection at 3.2 GB per second. When adding a second SMP Expansion Module, these ports become the primary means of communication between the processors in the top CEC and the processors in the bottom CEC as well as for attaching to a separate chassis for multi-chassis 16-way SMP. The SMP Expansion Module Option Kit (part # 59P5188) includes two 12-inch (30.5 cm) Scalability Cables. By connecting port 1 of the top CEC to port 1 of the bottom CEC and then port 2 of the top CEC to port 2 of the bottom CEC, the x440 achieves 4-way SMP with Xeon DP or 8-way SMP with Xeon MP as well as optimal "double-barrel" performance for load balancing. The third port is not used until configuring 8-way nodes into a 16-way SMP configuration. Below you will see the supported cabling configuration for the 16-way and the 16-way with Remote I/O.

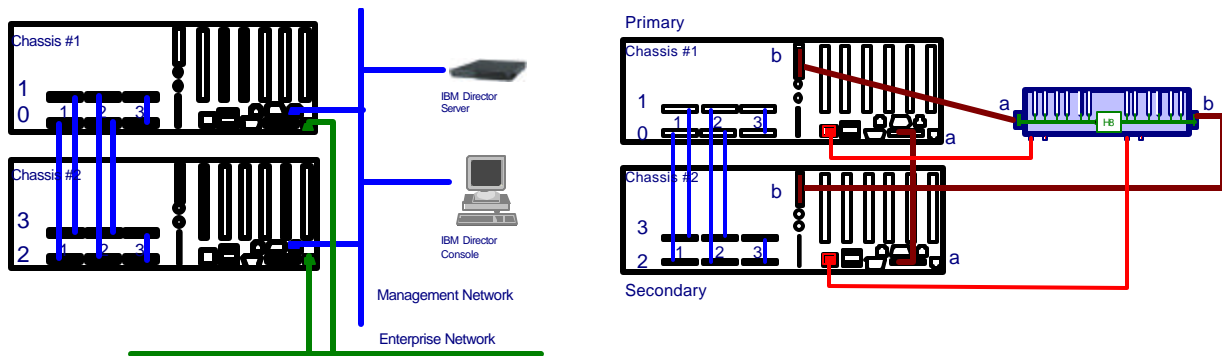

There are two types of SMP Expansion Ports: forwarding ports and non-forwarding ports. CEC Ports 1 and 2 are forwarding ports. These ports are capable of forwarding data through that CEC when that data is requested of or being sent to another CEC in the configuration. Forwarding capability becomes important in providing cable redundancy for 16-way SMP. CEC Port 3 is a non-forwarding port. This port can only receive information intended for that CEC but cannot forward data through that CEC to other CECs in the configuration. We expect that the 16-way SMP configuration will be able to lose one cable and still stay in 16-way mode, regardless of whether it is a forwarding or non-forwarding port. Upon detection of a cable failure (regardless of 8-way or 16-way), the system will re-boot without the failed cable and the Service Processor will alert the administrator to swap out that cable.

16-way Processing: XpandOnDemand in Overdrive!

With the support and availability of 16-way processing having arrived, the advent of 16-way ushers in a whole new way of thinking regarding scalability, price-performance, and e-business on demand. XpandOnDemand just went into overdrive! Never before has the industry-standard server market witnessed such a game-changing technology for scalable SMP, built upon today's industry standards combined with flexibility of future upgradeability of XpandOnDemand. More than ever, the x440 is prepared to take you to higher levels of performance and unlock the capabilities of your datacenter. The x440 with 16-way SMP is designed for high-performance database applications such as Microsoft SQL Server and IBM DB2 as well as for ERP applications such as SAP. But unlike other 16-way solutions, the x440 allows you to leverage your existing administration tools and IT skills with your existing applications that already have support for higher scalability built in. And with the promise of XpandOnDemand, you are able to enjoy these benefits at any time, upgrading to that increased performance whenever it is required.

For ease of purchasing and manufacturing a new 16-way configuration, IBM has created two new groups of systems, both groups comprised of eight-processor x440 models that are built ready for custom configuration. These models are in addition to the RX models that IBM continues to manufacture and support that can be upgraded to 16-way at any time. The first group of eight-processor models (8X models, see page 16 for details) are designed to be purchased and configured with Microsoft Windows 2000 Datacenter Server or Windows Server 2003 Datacenter Edition. The second group of eight-processor models (VX models) are designed for configuration with VMware ESX Server. All models must be ordered in matched pairs (each system again containing eight processors) with either the Microsoft Datacenter operating system (16-processor license) or the VMware ESX Server application (16-processor license) respectively. Custom configuration with additional options including pre-load of the OS and on-site cabling by an IBM service technician are included in the purchase price. Each eight-processor model also includes two of the new 2.5-meter copper-colored scalability cables – four total cables required per 16-way – for improved cable management and easier identification in the rack.

If you are interested in upgrading your existing x440 RX model(s) to 16-way, either with Datacenter or VMware, contact your IBM Sales representative or your IBM EXAct Business Partner to work with you in building a certified solution for your datacenter. Following the

completion of a Solutions Assurance Review, each existing x440 will require a 16-way configuration kit (see page 28 for part numbers) that will contain all of the cables needed to upgrade that 4-way or 8-way system(s) to 16-way processing. The contents of this 16-way configuration kit are already included in the 8X and VX models. Thus organized, you will have the highest degree of flexibility, being able to combine two existing 4-way or 8-way x440 systems by purchasing two kits plus the requisite operating system and options or upgrade an existing system to be combined with a newly purchased eight-processor 8X or VX model plus the requisite operating system and options. Regardless of the upgrade path or configuration, IBM will provide the service installation at your location to ensure proper cabling setup. Half of the cost of this service installation is included in each 8X and VX model and in the 16-way configuration kit.

RXE Expansion Ports

Every x440 includes two RXE Expansion Ports and one RXE Management Port. However, because RXE Expansion Port #2 is on the centerplane I/O board, it is not enabled until the second SMP Expansion Module is added to the base x440 system. The RXE Expansion Ports are used to connect the x440 to the RXE-100 Remote Expansion Enclosure. By leveraging the remote I/O capabilities of the XA-32 chipset, the x440 is able to expand the total I/O capacity from the six Active PCI-X slots in a single 4U chassis up to twenty-four Active PCI-X slots by adding the RXE-100 with six Active PCI-X slots and the optional PCI-X 6-pack upgrade kit (Option part# 31P5998) in a 16-way configuration. By connecting the RXE Management Port on the x440 to the corresponding port on the RXE-100, the XA-32 chipset ensures that the operating system sees the RXE-100 as a part of the main system configuration. The RXE Expansion Ports use the same connector type as the Scalability ports, but cannot be used as scalability ports. These ports are for connecting to remote I/O only. The RXE Expansion Ports communicate with the RXE-100 using a unidirectional signal at 1 GB per second designed to provide data integrity at optimal performance.

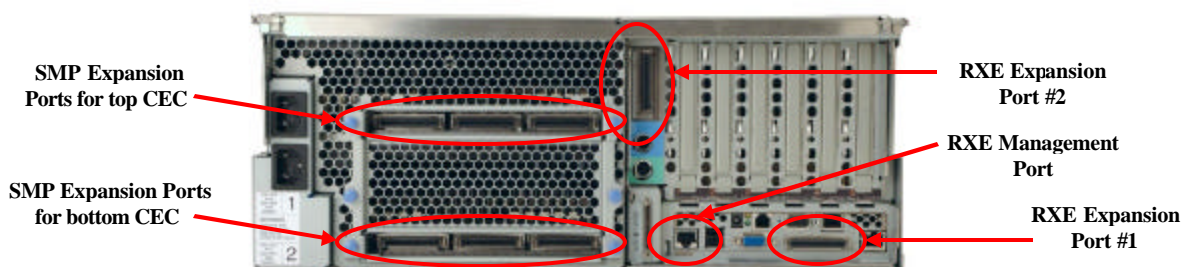

Scalability, Remote I/O & RXE Management Cables

To support interconnecting x440 systems and remote I/O enclosures, several cables of varying lengths have been developed. The 3.5-meter Remote I/O cable (Option part# 31P6102, shown at right) provides connectivity between the x440 chassis and the remote I/O. The 16-way SMP configuration will use a similar 2.5-meter cable that has been specially colored (copper to signify copper technology) to more easily identify these cables in the rack. Although the ports i.e. scalability and remote I/O, are not interchangeable in terms of their usage, the connectors for these ports are identical. The 3.5-meter Remote I/O cable and the 2.5-meter 16-way Scalability cable have a similar appearance and flexibility as a SCSI cable used to connect external SCSI devices. While the 3.5-meter Remote I/O cable is available through either the EXAct channel or IBM Direct, the 16-way copper-colored scalability cable can only be purchased with a 16-way system or as part of the 16-way configuration kit with Windows 2000 Datacenter, Windows Server 2003 Datacenter Edition, or VMware ESX Server.



Along with these cables, there is also a corresponding 3.5-meter Interconnect Management Cable used to connect the RXE Management Port on the x440 to the RXE Management Port on the RXE-100. This cable (Option part# 31P6087) is also required for connecting multiple x440 systems together to ensure that the Service Processor is able to configure the systems under a single OS image.

In addition to the 3.5-meter Remote I/O Cable and the 3.5-meter Interconnect Management Cable, there is also an 8-meter Remote I/O cable and corresponding 8-meter Interconnect Management Cable. This cable is only for use in connecting the x440 to the RXE-100. Because of latency and data integrity, this cable cannot be used to connect multiple x440 systems together for larger SMP. The 8-meter cable is identical in composition and connector type to the 3.5-meter cable, only longer for connecting the x440 to an RXE-100 in an adjacent rack.

Extended Life of Key Options for XpandOnDemand

XpandOnDemand scalability is more than just an industry-leading solution for scaling processor and I/O capacity to meet your needs. It is also a commitment to you to deliver on that upgrade capability longer into the future. Because of the pace of the industry-standard server market, new technological breakthroughs in processors, memory, hard drives, and networking drive a relentless churn of new system introductions. Sometimes, this churn can be difficult for customers to manage, especially for their most mission-critical servers that are designed to be deployed and left alone. With the promise of XpandOnDemand, businesses eagerly deploy the x440 with the expectation of being able to leverage the expandability when needed in the future. To mitigate the churn associated with the migration of technology and to support our commitment to XpandOnDemand, IBM has extended the period through which key options such as Xeon DP and Xeon MP Processors and SMP Expansion Modules are available from IBM into mid-2004. In addition, IBM has partnered with I.T. Xchange, a global distributor of computer products and a key participant in IBM's Option Continuation Program, to continue to offer these options into mid-2005 – three years after the introduction of the x440. For more information about option availability through I.T. Xchange, visit www.itxchange.com/ibm/xpandondemand.

xSeries 440 – Software & Solutions Overview

Operating Systems

In line with the overall eServer message of providing application flexibility to meet your varying enterprise needs, the x440 is optimized for numerous operating system and application solutions. Below you will find the Operating System Support Matrix for the x440.

ServerProven® Supported Operating Systems	Windows 2000 Server Family	Windows Server 2003	Windows NT 4.0 Enterprise Edition	Red Hat Enterprise Linux AS 2.1	SuSE Linux Enterprise Server 8.0	Novell Netware 6.0	SCO UnixWare 7.1.3	VMware ESX Server 1.5.2
Max # supported CPUs	16	16	4 (Xeon MP) 2 (Xeon DP)	8	8	8	8	16
Max supported memory	64GB	64GB	8 GB	16 GB	16 GB	8 GB	8GB	64 GB
Additional Information	See page 3	See page 3	No Hot-Plug PCI-X				No Hot-Plug PCI-X	64 VMs Max

In addition to a faster front-side bus, the new Xeon processor also introduces Hyper-threading. Estimated by Intel to increase processing performance by up to 30%, Intel’s simultaneous multithreading design allows a single physical processor to manage data as if it were two virtual processors by handling data instructions in parallel rather than one at a time. The multithreading design also has implications for the operating system as the OS sees the single physical processor as two logical processors. Because of Microsoft’s licensing of the Windows® Server operating systems by number of processors (see page 3 for summation), the appearance of twice as many logical processors can potentially affect the install of the operating system. As a result, hyper-threading is initially turned off in BIOS to ensure proper OS installation and can be re-enabled at any time. Although Windows 2000 Server and the forthcoming Windows .Net2003 Server operating systems understand and correctly report hyper-threading, Windows NT 4.0 does not. Therefore, the x440 is able to support only Windows NT 4.0 Enterprise Edition in a 4-way configuration with Xeon MP (2-way only with Xeon DP) as Windows NT sees eight logical processors instead of the four physical processors. At this time, no patch is planned by Microsoft to address this. Furthermore, because Windows NT does not understand NUMA, a change to the NT kernel would be required for Windows NT to support a 4-way with Xeon DP– a change that is not possible as Windows NT is no longer supported by Microsoft.

In addition to hyper-threading, the x440 performance also benefits from NUMA code that Microsoft has included in the Windows Server 2003 Enterprise and Datacenter Editions. According to internal lab estimates, these NUMA enhancements are expected to yield a 3-5% performance boost for NUMA-based systems. Because of this performance benefit, Windows Server 2003 has been the preferred OS for our TPC 8-way benchmarks and will become the operating system of choice for future x440 deployments. In order to unlock innovation in the x440, to differentiate its features from competition, and to perform above the capabilities of the base operating system, IBM has developed a Windows HAL (Hardware Abstraction Layer) for use with the x440. Working with this HAL is only necessary at initial setup of the x440 to ensure that the system performs properly as an 8-way running on Windows. The HAL can be downloaded from the IBM.com web site. Similarly, a patch for the x440 is required for running Linux properly as an 8-way. You must install either Red Hat Linux Advanced Server 2.1 or SuSE Linux Enterprise Server 8.0 as only these releases contain the kernel required to support the Xeon processor MP up to 8-way on the x440.



IBM Director: PC Magazine Editors’ Choice for Server Management Tools



The x440 ships with IBM Director 4.1 that was released in March 2003. Director 4.1 provides systems management support up to 16-way. Selected by PC Magazine for its Editors’ Choice award in October 2002, IBM Director is the industry’s leading systems management software suite for managing enterprise systems. Commended for its ease of use and deployment, comprehensive capabilities, and compatibility with non-IBM equipment, IBM Director is the preferred tool for lowering TCO and better maintaining

the investment that you make in your IT infrastructure. As part of this key software deliverable, IBM delivers support for the Linux 2.4 kernel-based releases, headless remote control, RAID support and Service Processor support with Red Hat and SuSE, Linux Agents for Red Hat and SuSE for Software Rejuvenation, and support for Remote I/O. In addition to these and other feature additions, the x440 can take advantage of several IBM Director Extensions developed specifically for the XpandOnDemand™ servers (x360, x440) – Scalable Systems Manager and Active PCI Manager.

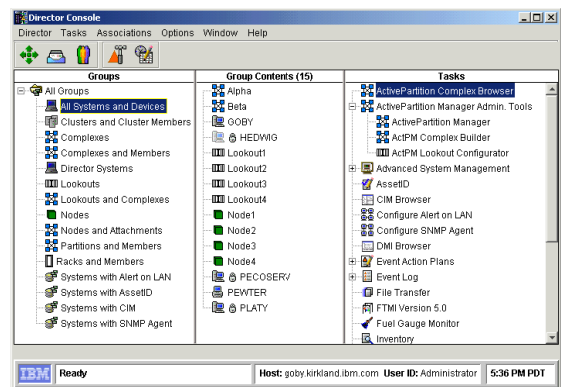

The Scalable Systems Manager is a new IBM Director extension planned for release in the third quarter of 2003. This tool allows easier management of multi-node configurations, building 16-way configurations using a GUI rather than BIOS. The Scalable Systems Manager (screen shot above) is at its most basic a configuration browser that displays information about scalable systems (nodes and partitions) and provides the ability to activate or deactivate partitions for changing business needs. As part of the basic browser interface, the Scalable Systems Manager can be used to add and delete nodes to form a configuration and to create/delete partitions and add/delete nodes to/from a given partition.

The Active PCI Manager (screen shot at right) is part of the IBM Director Server Plus Pack. This tool enables IT administrators to optimize I/O performance by determining the best placement for their PCI and PCI-X adapters. By allowing users to analyze the current configuration of PCI and PCI-X adapters across a base system and an attached RXE-100, an administrator can see if the cards and slots are being optimally paired. For example, because the x440 includes slots that are capable of performing at different speeds, it is critical that you use 66 MHz slots for the 66 MHz cards, rather than the 133 MHz slots. This tool helps the administrator confirm that the slots are being installed for optimal performance. Similarly, because the RXE-100 includes slots that are capable of performing at different speeds based upon how the buses are shared or dedicated, the Active PCI Manager can help to ensure that these remote I/O slots are optimally paired with the adapters. This tool will also be helpful for x440 multi-chassis configurations connected together in the same OS image. Under this scenario, when a NIC or other adapter fails, this tool will aid the administrator in quickly locating the individual chassis that contains that failed adapter so that the adapter can be quickly hot-swapped.

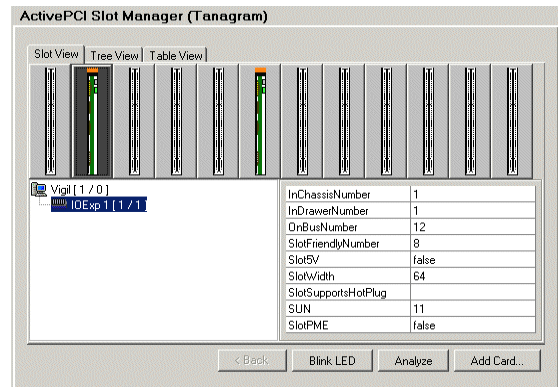

Physical Partitioning for High-Performance Clustering

Because of its flexibility of configuration and high performance suitable for database applications, the x440 is optimized for physical partitioning. By configuring into physical partitions using Microsoft Cluster Server (MSCS), SteelEye, Veritas, or Oracle RAC, the x440 can be leveraged to create the ultimate high-availability, high-performance database cluster.

Although each physical partition is fixed at the chassis level, i.e. you cannot have more than one physical partition per x440 server, you are able to configure a solution suitable to your availability requirements by combining the x440 with the desired operating system or database according to the number of desired nodes. For example, with Microsoft Windows 2000 or Windows Server 2003, you can configure a 2-node (the most prevalent cluster configuration today) or 4-node cluster with SQL Server leveraging MSCS and the integrated gigabit Ethernet adapter of the x440. With Windows Server 2003, you will be able to partition up to 8-node configurations with either Windows Server 2003 Enterprise Edition or Datacenter Edition while still leveraging industry-standard gigabit Ethernet. With Red Hat or SuSE Linux, you can configure a 2-node cluster with DB2 or Oracle leveraging SteelEye LifeKeeper. Other multi-node solutions include Oracle 9i Real Application Cluster (RAC), Veritas Cluster Server, PolyServe, and Novell Cluster Server.

Logical Partitioning for Server Consolidation

For the first time in the history of the industry-standard server market, servers are taking on more mainframe characteristics such as logical partitioning. Working with VMware™, the x440 offers a best-in-class solution for logical partitioning on an Intel-based server. VMware ESX Server brings mainframe-type virtualized dynamic partitioning capabilities to the industry-standard server market, enabling you to partition the physical hardware into virtual machines capable of acting as independent and secure servers. VMware is a virtualization layer that sits between the operating system-application stack and the physical hardware turning the x440 into a pool of logical computing resources that can then be dynamically allocated to any operating system or application at varying levels of granularity. This technology dramatically reduces the cost and complexity of delivering such enterprise applications as web serving, application serving, database, and email. In addition, because it can support multiple similar or dissimilar operating systems, it gives the IT administrator the opportunity and flexibility to optimize the application by operating system in secure, partitioned virtual machines. For example, while some applications run better on Windows, other applications are more suitable or are only available on Linux. In addition, not every application requires the most recent version of Windows 2000 or Windows Server 2003. Some administrators may wish to deploy on Windows NT (perhaps because the company has already purchased these licenses and wishes to continue to use them). Using VMware, ALL of these application and operating system combinations could be run from the same x440 system, allowing you to take advantage of higher system utilization, better performance, and improved reliability with control from a single management console versus more numerous, single-use servers.

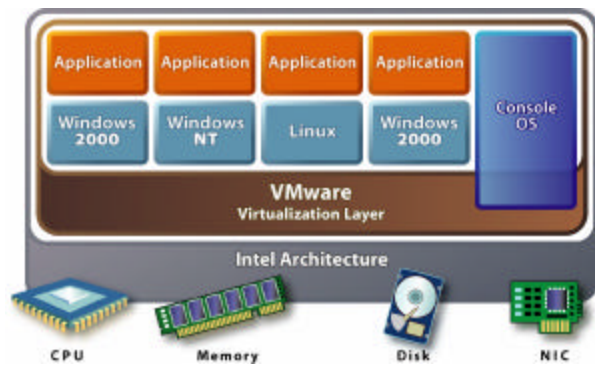

As part of ServerProven® support, the x440 fully supports the “off-the-shelf” VMware ESX Server software application up to 16 CPUs, backed by IBM Service worldwide to ensure that you clearly understand our commitment to this capability in the x440 and our desire to provide you with world-class support 24x7 around the world. IBM is the only company in the world that offers this level of support for VMware on its servers. By working closely with VMware, the current and future versions of ESX Server now contain IBM Director Agents allowing you to use IBM Director with which you are familiar instead of the VMware interface, which might require additional training, for more integrated management of the virtual machines.

For true cost savings in the enterprise environment, VMware ESX Server becomes the critical software enabler for server consolidation, combining the workloads of many low-end servers in a distributed computing network onto fewer more reliable, centralized enterprise-class servers. Ideally suited for corporate data centers, VMware ESX Server provides a cost-effective, high-performance virtualization platform that when combined with the performance and high-availability benefits of the x440 create the ultimate solution for server consolidation. The combination of Citrix with VMware ESX Server on the x440 (see benchmarks on page 24) provides an illustrative proof point of the performance capabilities of the x440 in creating a unique value proposition as the ultimate solution for server consolidation.

It is easier now to realize the value and flexibility of this solution for consolidating servers onto the x440 with VMware ESX. Conesco is an example of one customer that has realized this flexibility and translated it into savings. Conesco Finance reduced the number of physical servers required to support 2,000 Citrix users from 135 HP ProLiant DL360 2-way servers to five x440 8-way servers, reducing hardware and software costs by 62%. A second example is Saks Incorporated. Saks consolidated 26 physical test & development servers running Windows NT and Windows 2000 onto a single x440 8-way server connected to an IBM ESS "Shark" storage for a hardware savings of 43%. And for yet another example, there is The Lego Group, the maker of Lego toys and a customer that clearly understands the "building-block" approach! Lego consolidated 175 HP ProLiant servers onto 20 x440 4-ways for Microsoft Exchange clustering, Web applications, File/print, & SQL databases, increasing server utilization to over 40%. These and other customers serve to illustrate that IBM, in fact, has a solution for server consolidation that is unmatched in the industry.

The core challenges associated with server consolidation are:

- Running multiple applications on the same server, when each application requires a fine-tuned operating system and hardware
- Ensuring peak performance, scalability, availability, and security

The x440 with VMware solves these challenges by isolating operating systems and applications in virtual machines that can co-exist on the same physical server. Server resources can be dynamically allocated to each virtual machine at your preferred choice of granularity. The result is better server utilization while ensuring performance and availability.

Goals of Server Consolidation	Benefits of x440 with VMware ESX Server
Increase hardware utilization	Maximize server management efficiency to help IT staff work smarter, not harder Rapidly deploy, easily manage, and remotely control more servers while saving space, management effort, and hardware costs
Ease deployment	Speed deployment of replicated or distributed applications Reduce number of development and test servers required for new applications
Guarantee service levels	Deliver guaranteed resources at near-native performance levels and high scalability Run IT as an internal service provider, gaining control over IT performance metrics
Support legacy applications	Ensure continuous service of older, special purpose applications Reduce complexity, risk, and downtime associated with maintaining older hardware

Questions from companies regarding the benefits or downside to using VMware have included performance penalties associated with virtualization and security associated with running different operating systems and applications on the same hardware. VMware ESX Server provides fully dynamic resource allocation of CPU and memory with affinity for I/O and disk. Virtualization is available with only an estimated 10% performance overhead. Of the companies polled regarding this performance penalty, all were more focused on the cost savings associated with server consolidation and less concerned with any performance penalty that might exist from using virtualization. Again, saving money outweighed any reduction in performance, which was often masked because the workloads were being consolidated off of older, lower performing servers. Regarding security, VMware ESX introduces fully fault-isolated virtual machines that are totally secure, i.e. a user cannot get access to another virtual server while operating within an adjacent virtual server. Users see their host system as an independent system providing them with the enterprise services that they require. What they do not realize is that in reality they are sharing that physical hardware with up to dozens of other virtual machines supporting dozens of heterogeneous applications with numerous other network users.

Although the capabilities of today's VMware ESX Server are outstanding, future versions will continue to add capabilities that will more fully take advantage of the superior capabilities in the x440. In the chart below, you will find the specifications of the version of ESX Server supported on the x440 up to 16 CPUs.

ESX Server	v1.5.2
Max Processors per System	16
Max Processors per Partition	Fractional up to 1
Max Partitions per System	64
Max Memory per System	64 GB
Max Memory per Partition	4 GB

Enterprise Applications & ISV Solutions

As the flagship of the xSeries enterprise server line, the x440 is a centerpiece of xSeries e-business on demand. IBM diligently works with a core set of integrated solutions vendors (ISV) for performance testing, optimization, and certification of the x440 on key applications in the areas of customer relationship management, enterprise resource planning, supply chain management, business intelligence, and collaboration. The following summary of our work to date with ISVs and partners is a testament to the unprecedented excitement created by the x440.



#1 Benchmark: 4-way Xeon MP & Xeon
#1 Benchmark: 8-way, Windows & Linux
Sales brochure available 2Q02
Certified for SAP R/3 R4.6C



Executive Announcement Quote
Sales brochure available 2Q02
#1 Benchmark with Siebel 7: 4-way



Executive Announcement Quote
Sales brochure available 2Q02
#1 Benchmark: 4-way and 8-way
Certified for Baan ERP



Executive Announcement Quote
Sales brochure available 2Q02
#1 Benchmark with JDE 5: 4-way
Certification of J.D. Edwards OneWorld



#1 Benchmark: Oracle 9i for Intel-based server
#1 Benchmark: Oracle 9i RAC, single & 4-node
Certification for Oracle 9i RAC 4-node cluster



Executive Announcement Quote
Sales brochure available as of 2Q02
ServerProven Certified, ESX Server
VMware Premier Partner



Executive Announcement Quote
Sales brochure available as of 2Q02
#1 Benchmark on SAP: Windows & Linux



Executive Announcement Quote
#1 Benchmark: 4-way TPC-C and TPC-W
#1 Benchmark: 8-way and 16-way TPC-C



Executive Announcement Quote
Sales brochure available 3Q02
#1 Benchmark: 4-way, 8-way

Jim Allchin, Group Vice President, Platforms Group, Microsoft: "We are excited to see IBM plan to extend their xSeries line to 16-way in response to the accelerating customer demand for Windows-based systems in high-end, mission critical computing environments. IBM's new modular xSeries combined with Windows 2000 Datacenter Server, delivers a solution that grows as customers' datacenter requirements change, at an aggressive price/performance."

Mike Fister, VP and General Manager, Enterprise Platform Group, Intel: "Intel is excited to see the great progress IBM has made with the Enterprise X-Architecture chipset, as it offers Intel-based server customers additional platform flexibility and choice. We specifically designed the Intel Xeon processor family for superior scalability in high-end servers and worked closely with IBM to optimize its Enterprise X-Architecture platforms using these processors. Our testing of the chipset with the Xeon processors has me convinced that this is a great product and can be considered something of a watershed announcement."

Steve Maegdlin, Senior Director of Product and Industry Marketing, J.D. Edwards: "The IBM eServer xSeries 440 allows companies implementing or migrating to J.D. Edwards ERP software to run our applications, DB2 database and Web servers on just one server instead of as many as five. It allows us to provide customers unprecedented simplicity, scalability, availability and performance at a much more competitive price. This simplifies and reduces customers' maintenance, enables faster changes to the system with less downtime, lowers the up-front purchase price, and cuts ongoing IT expenses, all to make it easier for our customers to do business."

Holger Rasig, Global Partner Director IBM, SAP: "With the introduction of the IBM eServer x440 IBM delivers a solid and powerful foundation for mySAP Technology. The xSeries strategy of introducing mainframe technologies to Intel-based servers is in the best interest of our joint customers."

Carlos Chou, Vice President of Alliances, Siebel: "Siebel Systems, the world's leading provider of eBusiness Applications Software, will confidently partner with IBM to deliver Siebel 7 in industry applications on the IBM eServer x440 platform. IBM Enterprise X-Architecture enables customers to leverage Siebel 7 Smart Web Architecture and ensure the best CRM and ERM solutions at the lowest total cost of ownership."

Lauren Flaherty, Vice President of Data Management Marketing, DB2, IBM: "The performance and scalability delivered by Enterprise X-Architecture is showcased by the numerous leadership application and industry-standard benchmarks posted by the IBM eServer x440. The x440, based on the new Intel Xeon Processor MP, coupled with the scalability and performance of DB2 will drive new levels of productivity for database applications."

Leen van der Maas, VP of Global Alliances, Baan/Invensys: "Baan/Invensys believes that the IBM eServer xSeries 440 is at the highest level of performance, scalability and flexibility within the industry-standard server market. The x440 provides a strong platform for our ERP solutions to our customers. Enterprise X-Architecture technology and its flagship product the x440 are a testament to the vision and leadership that IBM brings to the market for industry-standard servers running mission-critical applications. The performance, mainframe-class availability and scalability of the x440 place it among the strongest industry-standard server platforms for ERP that we have seen."

Peter Gassner, VP and General Manager, PeopleTools and Technology, PeopleSoft: "We are excited to see the next generation of IBM eServer xSeries high-end Intel based servers built on Enterprise X-Architecture innovations allowing PeopleSoft to provide highly available and scalable platform to our customers."

Diane Greene, Chief Executive Officer, VMware: "The x440 is an ideal platform for VMware's industry leading virtualization software. The x440's Enterprise X-Architecture demonstrates IBM's leadership in bringing mainframe-class performance to industry standard servers and its 16 processors and remote I/O capability raise the bar for all competitors in its class. With VMware ESX Server on the x440, customers now can combine one of the fastest industry standard servers with logical partitioning for a more complete server consolidation solution and the benefits of unmatched improvements in workload management and TCO."

Peter Conway, Senior Director, Windows .Net Server Group, Microsoft: "IBM has proven its market leadership in high-end Intel-based server computing with its Enterprise X-Architecture technology. With the advancements in Microsoft operating systems coupled with the high-end capabilities of IBM Enterprise X-Architecture technology, customers will have one of the most highly reliable solutions in the marketplace for server consolidation, ERP and CRM workloads."

Doug Cockrell, Senior Research & Development Director, SAS Institute: "Companies rely on SAS software to help turn huge volumes of data from across their enterprises into intelligence for better business decisions. With this flood of data pouring in, application flexibility, availability and scalability are crucial. The new IBM eServer x440, featuring Intel's latest processor technology, is a solid option for organizations selecting a server architecture that's best suited for their mission-critical SAS solutions. The Enterprise X-Architecture technology found in xSeries servers gives companies dramatically improved speed and performance. This is particularly important for compute-intensive business-intelligence solutions such as analytical customer relationship management, data mining, data warehousing and other core business functions."

Roger Rose, Vice President of Enterprise Partner Sales, Citrix Systems, Inc.: "Enterprises are constantly challenged to find more effective ways to run varied, conflicting applications on the same server to save space and power, and scale their MetaFrame deployments with minimal hardware investments. Working together with IBM and VMware, we have created a compelling solution with the x440 that addresses these pain points - taking stress off the physical data center and the enterprise IT administrator. We believe this joint solution offers customers real benefits for last mile control, while minimizing data center and server administration costs."

Chris Grejtak, EVP and Chief Marketing Officer, BroadVision: "BroadVision believes that the IBM eServer xSeries 440 will bring a new level of performance and flexibility within the industry-standard server space. The x440 is a great match for BroadVision's multi-tiered, scalable server architecture and will offer medium-sized enterprises a cost-effective platform for BroadVision enterprise self-service applications."

Scott Hebner, Director of Marketing, WebSphere Software, IBM: "The combination of scalability and high-availability features, along with lower total cost of ownership, makes the x440 the Intel® platform enterprise server of choice for our WebSphere® customers running mission-critical workloads."

Perry Moss, Director of Technology Marketing, J.D. Edwards: "We are very excited about the IBM eServer xSeries 440 and the promise of its new technology to help deliver J.D. Edwards supply chain, CRM and enterprise software in new ways. This new, flexible and robust Intel processor-based server design, plus the ability to add capacity to meet increasing workload, will be especially attractive as our customers grow and want to add more J.D. Edwards extended enterprise solutions."

David Ridout, VP of Knowledge Solutions' Worldwide Business Development, Primus: "The x440 is something new, something we believe customers will adopt to reap the improved availability, scalability and performance benefits delivered via Enterprise X-Architecture systems running Primus applications. The x440, coupled with IBM Director management technology, will help our customers lower their total cost of ownership. I believe the x440 is one of the most impressive entries into the industry-standard server space and raises the bar for Intel processor-based servers running Primus solutions."

Nazhin Zargharmee, Chief Marketing Officer, Hyperion: "Hyperion customers looking to implement strategic business intelligence applications require solutions that can be deployed, administered and scaled across the enterprise. With the IBM eServer xSeries 440, customers will be able to consolidate hardware systems and easily extend usage of analytics to greater numbers of people and to support larger volumes of data. This results in a low total cost of ownership and improves the ability to manage business performance across the organization."

Paul Rivot, Director of Database Servers and Transaction Processing, DB2, IBM: "The x440 implementation of Enterprise X-Architecture delivers the scalability, manageability and reliability features that perfectly compliment the capabilities of DB2. IBM DB2 database software, in combination with the x440, provides an enterprise-class data management solution of unmatched value and capability on the Intel platform."

Jeanette Horan, Vice President of Development and Support, IBM Lotus Software: "Lotus® is excited about the prospect of working with IBM eServer as it delivers its Enterprise X-Architecture-based servers to customers requiring a cost-effective platform for mission-critical applications. Our goal is to continue to deliver remarkable total cost of ownership benefits to our customers."

Bill Bunker, Vice President of Marketing & Product Management, Onyx Software: "We are confident the new xSeries server from IBM will provide our large customers the scalability and reliability they need. Building on the scalability benchmarks Onyx has already achieved, this box push the envelope even further."

Michael Schmitt, Executive Vice President of Marketing, Ariba: "We know our customers like Intel processor-based servers, but need the expanded capabilities of a mainframe. The new IBM Enterprise X-Architecture servers have the capabilities at price points they are looking for with the ability to scale as needed. That's going to be hard to beat."

Mike Tice, Group Vice President of Global Alliances, Business Objects: "The IBM eServer xSeries 440 provides a robust foundation upon which to deploy and implement successful Business Objects solutions. As our customers continue to expand the size and scope of their business intelligence deployments, the x440 will provide a strong server platform that can meet their performance and scalability requirements."

xSeries 440 – Base Models & Supported Configurations

Part#	Base Model– CPU / Cache	CPU#	Memory	Additional Detail
8687-1RX	Intel Xeon MP 1.4 GHz / 512 KB iL3	2	2 GB (4x512)	One CEC, 2 Power Supplies, No DASD – Retired
8687-2RX	Intel Xeon MP 1.5 GHz / 512 KB iL3	2	2 GB (4x512)	One CEC, 2 Power Supplies, No DASD – Retired
8687-3RX	Intel Xeon MP 1.6 GHz / 1 MB iL3	2	2 GB (4x512)	One CEC, 2 Power Supplies, No DASD – Retired
8687-4RX	Intel Xeon MP 1.5 GHz / 1 MB iL3	2	2 GB (4x512)	One CEC, 2 Power Supplies, No DASD
8687-5RX	Intel Xeon MP 1.9 GHz / 1 MB iL3	2	2 GB (4x512)	One CEC, 2 Power Supplies, No DASD
8687-7RX	Intel Xeon MP 2.0 GHz / 2 MB iL3	4	2 GB (4x512)	One CEC, 2 Power Supplies, No DASD
8687-3RY	Intel Xeon 2.4 GHz / 512 KB L2	2	2 GB (4x512)	One CEC, 2 Power Supplies, No DASD
8687-4RY	Intel Xeon 2.4 GHz / 512 KB L2	4	4 GB (8x512)	Two CECs, 2 Power Supplies, No DASD
8687-18X	Intel Xeon MP 1.4 GHz / 512 KB iL3	8	0 GB	Two CECs, 2 Cables, Requires MS Datacenter
8687-28X	Intel Xeon MP 1.5 GHz / 512 KB iL3	8	0 GB	Two CECs, 2 Cables, Requires MS Datacenter
8687-38X	Intel Xeon MP 1.6 GHz / 1 MB iL3	8	0 GB	Two CECs, 2 Cables, Requires MS Datacenter
8687-48X	Intel Xeon MP 1.5 GHz / 1 MB iL3	8	0 GB	Two CECs, 2 Cables, Requires MS Datacenter
8687-58X	Intel Xeon MP 1.9 GHz / 1 MB iL3	8	0 GB	Two CECs, 2 Cables, Requires MS Datacenter
8687-78X	Intel Xeon MP 2.0 GHz / 2 MB iL3	8	0 GB	Two CECs, 2 Cables, Requires MS Datacenter
8687-1VX	Intel Xeon MP 1.4 GHz / 512 KB iL3	8	4 GB (8x512)	Two CECs, 2 Cables, Requires VMware ESX
8687-2VX	Intel Xeon MP 1.5 GHz / 512 KB iL3	8	4 GB (8x512)	Two CECs, 2 Cables, Requires VMware ESX
8687-3VX	Intel Xeon MP 1.6 GHz / 1 MB iL3	8	4 GB (8x512)	Two CECs, 2 Cables, Requires VMware ESX
8687-4VX	Intel Xeon MP 1.5 GHz / 1 MB iL3	8	4 GB (8x512)	Two CECs, 2 Cables, Requires VMware ESX
8687-5VX	Intel Xeon MP 1.9 GHz / 1 MB iL3	8	4 GB (8x512)	Two CECs, 2 Cables, Requires VMware ESX
8687-7VX	Intel Xeon MP 2.0 GHz / 2 MB iL3	8	4 GB (8x512)	Two CECs, 2 Cables, Requires VMware ESX

The x440 was announced in March 2002 at CeBIT in Germany with systems made generally available in April. With the announcement of 16-way processing support in December 2002, the x440 now supports a single-chassis 2-way Xeon MP or DP, 4-way Xeon MP or DP, 8-way Xeon MP or 16-way Xeon MP. At this time, the x440 only supports processor configurations of 2, 4, 8, and 16 processors. This is also in line with the anticipated upgrade path given the high-performance, mission-critical nature of the x440 and the high-end enterprise customers that will purchase the system.

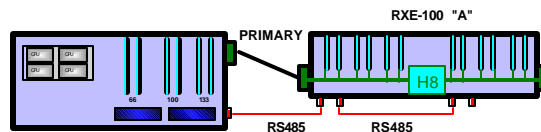

In addition to the single-chassis 2-way to 8-way, the x440 also supports the connection of a single RXE-100 Remote Expansion Enclosure to that single-system-image configuration, i.e. one RXE-100 per 4-way, per 8-way, or per 16-way. Within the RXE-100, you have the choice of either a 6-slot or 12-slot configuration depending upon your operating system (limitations in Linux restrict you to the 6-slot configuration; with Windows you can use either the 6-slot or 12-slot configuration for 8-way or 16-way), giving you up to a total of 24 PCI-X slots.

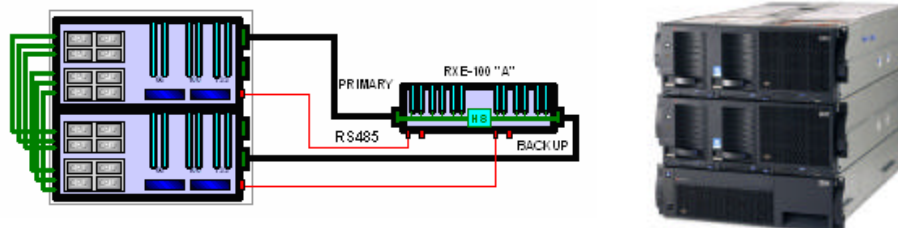

With the second phase of the x440 introduced in December, you can now experience the true SMP scalability of the x440. Leveraging the rack-optimized design of the x440, phase two introduces the most rack-dense 16-way in the world. By connecting two 8-way x440 systems using the high-speed scalability ports together with Windows 2000 Datacenter Server or Windows Server 2003 Datacenter Edition, you will be able to scale your applications to take advantage of 16-way SMP. You can even have your existing systems upgraded in the field from either Advanced Server or Datacenter 8-way to Datacenter 16-way or purchase a new 16-way system custom configured and installed by IBM (see page 9 for more details). Applications that are best suited for 16-way SMP include database applications such as Microsoft SQL Server as well as ERP solutions such as SAP and JD Edwards. Phase 2 also continues support for a single remote I/O connected to each of the chassis. If server consolidation is your solution need, then you could alternatively choose to deploy VMware ESX Server v1.5 to take advantage of more physical resources for managing more virtual machines across a two-chassis, sixteen processor configuration. No other system in the industry-standard server market offers the flexibility combined with the availability punctuated with industry-leading performance and manageability that the x440 offers. Our XpandOnDemand scalability is proof that IBM is changing the game in e-business. This is why so many realize that when comparing the x440 to competition, they easily conclude...there is no competition.

xSeries 440 – Selling Features

Performance

Business

- Leadership performance demonstrated in thirty-five #1 industry-standard benchmarks relevant to enterprise e-business.
- Highest performance IA-32 server to run your mission-critical applications such as database, ERP, CRM, and business intelligence.
- Faster performance translates into more e-commerce transactions processed on fewer systems as well as faster access to information.
- Faster access to e-business information translates into better customer service, better supply chain management, and faster decision-making, all of which contribute to improved cost savings, higher revenue, and increased customer loyalty.
- Flexibility tailored for your budget to allow scalability from 2-way Xeon DP all the way up to 16-way Xeon MP.
- DDR-equivalent memory performance using lower priced PC133 DIMMs.

Technology

- First to market 8-way with the next-generation Intel Xeon MP processor up to 2.0 GHz with 2 MB L3 cache and 400 MHz front side bus.
- First to market with XcelL4™ Server Accelerator Cache designed to improve overall system performance. With 32 MB of level-4 system cache available per SMP Expansion Module, you can achieve up to 128 MB in a 16-way SMP configuration.
- First to market with 4-way Xeon DP for affordable high performance mission-critical computing with a growth path to 16-way SMP.
- High-performance memory controller powers 5.0 GB/sec aggregate I/O bandwidth and 12.8GB/sec aggregate memory bandwidth per 8-way.
- Active PCI-X delivers 2X (up to 1 GB/s) data throughput versus the fastest PCI using 64-bit 133 MHz I/O slots.
- First xSeries server with integrated Gigabit Ethernet for up to 1000 Mbps network throughput performance.

Scalability

Business

- The x440 delivers 8-way SMP power in a 4U rack-dense package – 42% more rack dense than the 7U HP DL760 G2 8-way – with the flexibility to grow without penalty up to 16 processors.
- The x440 is the most rack dense 8-way ever offered by IBM xSeries and can be configured into the most rack dense 16-way in the world, helping save money in the datacenter by being able to concentrate more performance in a smaller area to support more applications.
- The only 4-way SMP Xeon DP server available in the world.
- Triple your I/O capacity at any time without the expense of a full system upgrade with the optional RXE-100 Remote Expansion Enclosure
- XpandOnDemand™ Scalability powers the “pay-as-you-grow” upgrade path for value scalability with Xeon DP or extreme scalability with Xeon MP for adding processing power and I/O capacity as you need it, without having to purchase expensive up-front infrastructure.

Technology

- Able to easily grow base system from 2-way Xeon DP or Xeon MP to 4-way, then from 4-way to 8-way Xeon MP by easily adding an additional SMP Expansion Module and processors.
- Systems are available with Xeon MP processors up to 2.0 GHz and 2 MB iL3 cache or Xeon DP processors up to 2.4 GHz and 512 L2 cache.
- Base models are available with a robust and more cost-effective 2 GB base memory minimum, expandable up to 32 GB of memory per chassis, up to 64GB maximum with a 16-way.
- The x440 is optimized for external storage, capable of managing terabytes of data using the FAST Family of Storage Servers and Enclosures across fiber or SCSI. The x440 contains two hard disk drive bays capable of 146 GB of maximum internal storage.

Availability

Business

- Designed to create a near-bulletproof memory subsystem, Active Memory combines the capabilities of memory mirroring, Chipkill, and Memory ProteXion to introduce a system most suitable for your mission-critical data. With native Chipkill support now built into the XA-32 chipset, memory reliability is dramatically improved while using more cost-effective industry-standard DIMMs.
- Marrying advanced hardware with the break-through autonomic computing technology, the x440 high availability features, such as redundant, hot-swap power supplies, fans, and hard drives combined with advanced systems management to drive increased productivity, reduced downtime with the ultimate goal of saving 30% of IT maintenance dollars.
- Award-winning IBM Director offers the industry's leading suite of system management tools to make managing a burgeoning IT infrastructure easier with various alerts and diagnostic tools to improve uptime by identifying problems before they result in downtime.

Technology

- Active Memory with Memory Mirroring and Memory ProteXion provide multiple levels of memory fault tolerance to ensure that mission-critical data is always available and that in-memory databases was constantly accessible.
- MEDIC™ Diagnostics allows the system to return to operation in the event of a catastrophic failure to return users to productivity while IT administrators diagnose using Real-Time Diagnostics the cause of the failure.
- Software Rejuvenation, Capacity Manager, and Predictive Failure Analysis® collaborate to monitor system health without user intervention.
- N+N power eases the transition of the x440 into the data center ensuring quick setup, environmental efficiency, and optimal failover.

Manageability

Business

- The x440 offers world-class systems management designed for the lowest total cost of ownership of any industry-standard server in its class.
- As an industry-leading systems management application, IBM Director requires little re-training for IT administrators, yet extends the remote capabilities beyond those offered by competitive applications.
- From Predictive Failure Analysis to Light Path Diagnostics, every xSeries server is designed with reliability and uptime in mind. When combined with IBM Director, these system management capabilities help to proactively manage your servers to prevent costly downtime.
- With the standard Remote Supervisor Adapter, you can manage the x440 and link other systems together to manage collectively.

Technology

- New IBM Director Extensions such as Active PCI Manager and Scalable Systems Manager ease the administrative burden and improve integration of the new XpandOnDemand systems into your existing environment.
- Light Path Diagnostics is the premier quick-find trouble-shooter for diagnosing and resolving alerts and failures in your xSeries systems.
- The integrated Remote Supervisor Adapter is the most sophisticated solution for remote management offered by xSeries. Integrated into every x440 server, the Remote Supervisor Adapter is installed in a dedicated slot and does not require an Active PCI-X slot from the system.
- Other autonomic computing technologies such as Software Rejuvenation and Capacity Manager aid in managing these environments for lower total cost of ownership and improved return on investment through increased uptime.

Serviceability

Business

- Light Path Panel on the front of the system makes identifying alerts and failures quick and easy.
- With tool-free access to all subsystems through the split top panels, the x440 sets a new standard in ease of serviceability and maintenance.
- The new IBM Director Extension tools – Active PCI Manager and Scalable Systems Manager – make administration and servicing of the x440 much quicker by pinpointing problem adapters or adding in faster system updates for new software drivers.
- The x440 includes an enterprise-class high-availability warranty offering one-year 24x7 Same Business Day response time for any required servicing including all parts & labor. This warranty can be easily upgraded to include a three-year warranty through the ServiceSuite and ServicePac offerings (depending upon your country).

Technology

- Access to covers, redundant components, and cables make setup, configuration, and maintenance easy.
- The modular SMP Expansion Module makes upgrades quick and efficient, minimizing downtime and maximizing productivity. Its unique lever design also makes removal for diagnostics a painless and tool-free process for accessing all processors and memory.
- Front-accessible Light Path Panel provides Level-1 and Level-2 diagnostics to system alerts without having to pull the system from the rack.
- System Service Label lists FRUs, web site, and installation and configuration information for quick access when needed.

Customer & Analyst Endorsements

Clint Parrish, Systems Architect and Lead System Administrator, Saks Inc.: "IBM eServer systems and VMware ESX Server are proving to be an ideal combination for server consolidation in our development and test environment. We plan to run as many as 32 virtual machines on a single eServer x440 and expect to significantly lower total cost of ownership as a result."

Jevin Jensen, Director of Technical Services, Mohawk Industries, Inc.

"The IBM eServer x440 has helped us reduce costs by consolidating some of our mission-critical applications onto a single, powerful server. Based on the results we've seen, we're very interested in having the ability to scale to 16-processor eServer x440 models."

Steven Gittleson, Vice President of Technology, NetCreations, Inc.

"The IBM eServer x440 helps manage our more than 80,000 e-mail lists and 48 million opt in e-mails as well as push marketing services out to our customers. We needed a solution that could give us high performance and scalability. No other server vendor has the option to scale to 16 processors. We are looking forward to expanding our 8-way x440 platform to 16 processors allowing us to upgrade processing power rather than replacing processing power."

Michael Ronquillo, Senior Systems Architect, Prudential Financial: "Citrix MetaFrame XP and VMware ESX Server running on IBM's highly scalable x440 system is a powerful solution that will help us standardize our infrastructure and simplify our production IT environment. We expect that this solution will increase the availability of our production systems, at a marginal cost."

Laurent Masse, IT Manager, Suncor Energy

"In the Intel space, this is by far the fastest server we have ever used. Without its ability to drive 20,000 heavy users during the Exchange Loadsim benchmarking, we would not have been able to saturate the disks in our SAN testing. The x440 excels in performance, technology and serviceability."

Rob Krumwiede, Director of Systems Integration & Operations, Gibson Dunn & Crutcher LLP: "The IBM eServer x440 is expected to provide exceptional availability and performance at industry leading total cost of ownership for organizations like Gibson Dunn & Crutcher LLP to handle their business-critical applications."

John Gayer, Senior Integration Architect, Ford Motor Company: "The x440 offers an improvement over the x370, which is the current Ford 8-way platform. We appreciate the reduction in size, scalability possibilities, and modular design approach. The x440 should be easier to service, and has improved redundancy features. We look forward to working with this new server."

Richard Anfang, Managing Director, Head of Enterprise Infrastructure for Institutional Securities IT, Morgan Stanley: "At Morgan Stanley, we have been very interested in leveraging the commodity of Intel-based servers to support some of our application and infrastructure workload. Working very closely with the IBM support team, we are hoping to utilize the power, reliability and scalability of the IBM eServer x440 that are the minimum requirements for these distributed applications."

Brent Adam, Senior Windows System Engineer, Agilera, Inc.: "In the past six months, IBM has exhibited leadership in the industry that we're not finding elsewhere. They're really exciting us with new technology and we think they have a lot to offer on their platform. Certainly the relationship between IBM and VMware adds credibility to the solutions we are proposing internally as well as to our clients."

Giga Information Group, IBM eServer xSeries 440 – Performance Scalability Landscape Changes

"In the case of IBM's eServer xSeries 440, the 67 percent linearity in applications scalability indicated by the TPC-C results from IBM's four-way to eight-way xSeries 440 is indeed impressive. ... The bottom line here is that IBM now owns performance scalability bragging rights (vs. Dell and HP) when comparing the online transaction processing results (TPC-C results) of its four-way Xeon MP server vs. its eight-way."

The Meta Group, X Marks the Box for IBM Servers

"...The x440 provides an initial 25%-40% price/performance advantage for IBM, leapfrogging Compaq, and isolates the niche, expensive 32-way Unisys CMP. IBM will experience approximately a one-year technology advantage over Compaq and a two-year advantage over Dell for high-end Intel servers."

IDC, Enterprise Server Fundamentals, IBM Leverages Scale-Up technology in Intel-based eServer x440

"The road ahead looks very promising for IBM, as its long experience with scale-up systems helps put it in a leadership position for this emerging scale-up Xeon server marketplace....This is the first time end users can purchase high-end Intel-based servers without buying tens of thousands of dollars of server infrastructure. Opportunities to differentiate servers are rare occurrences in near commodity markets. Core logic chipset development is not a game for under-funded start-ups or vendors that assemble off-the-shelf technologies. IDC believes few other companies besides IBM and Intel will be able to deliver chipset technology for the last generations of IA32 and the next generations of IPF."

Illuminata, Race To The Top 2002

"Summit, formally announced as the Enterprise X-Architecture (EXA), is the next step. It extends the original vision with a specific blueprint for highly robust, modular, partitionable, and yet inexpensive servers based on Intel's emerging Pentium 4 Xeon (Foster) processor (and in the future, McKinley generation of Itanium). From a strategic point of view, EXA is the step up. Similar to the S80 that rekindled IBM's Unix efforts, EXA servers are the utterly compelling products through which IBM will gain Intel-based server mindshare, then market share."

Sageza, IBM's xSeries Modular Architecture Provides Increased Flexibility

"With the announcement of the new IBM eServer x440, IBM has raised the stakes for Intel-based servers and created an offering that all serious Microsoft users should consider, as they continue to invest in server infrastructure. The new x440 not only takes the technology to the next level, it is also a clear demonstration of the company's commitment to make it easier for customers to do business with IBM."

Software Strategies, IBM Reinvents High-End Intel Servers

"Also first to debut the fastest new Intel Xeon Processor MP 1.6GHz server chip, the x440 brings a unique, new building-block approach to configuring high-performance 4-, 8-, and 16-way Intel-based servers, with all system resources scaling pro-rata, for segment-leading performance at ultra-competitive price points. The new x440 has posted a strikingly strong set of performance results, beating existing comparable systems on 6 major benchmarks by wide margins, and setting several new records."

D.H. Brown, HP/Compaq Merger Heats up the Competition in the Intel Server Market

"IBM was the first to deliver the Intel Xeon MP processors with its Enterprise X-Architecture (EXA) servers and has been the only vendor in the market so far with an eight-way Xeon MP offering. The key differentiator for the IBM enterprise server products is the EXA chipset, which scales up to 16-way configurations using four-way SMP Expansion Modules...and demonstrated outstanding performance capability."

Network World Fusion, 2002 World Class Award and 2002 Best of the Tests Award for Enterprise Servers

"The x440 scales perfectly with each increase in processor horsepower. This is quite an achievement considering most multiprocessor machines we have tested only show an 80% increase in performance with a 100% increase in the number of processors. ... Because of its abundance of features, the x440 gets another perfect score. Compute scalability is the most impressive of the x440 features. ... The x440 is an impressive package of computing performance, scalability, availability and manageability. If you are considering server consolidation, this could be the server for you."

PC Magazine, 2002 Technical Excellence Award, Network & Enterprise Hardware

"It's the server that's almost a mainframe. The IBM eServer xSeries 440, the flagship of the IBM xSeries server line, is...at the top of the Intel-based server market. Most high-end machines don't use the Xeon MP. But what's most amazing about the 440 is how well it handles system failures and repairs."

PC Magazine, 2002 PC Expo Enterprise Hardware & Overall Best of Show

"The first product to include memory mirroring brings the high availability, redundancy, and scalability previously found only in mainframes to the rack-optimized server market. An ingenious modular design features SMP Expansion Modules and a high-speed bus-to-bus interconnect."



xSeries 440: 8-way+ Competitive Comparison (As of 10 June 2003)



8-Way+	IBM	HP	HP	Dell	Sun	Unisys	Unisys
Model	xSeries 440	ProLiant DL740	ProLiant DL760 G2	PowerEdge 8450	Fire V880	ES7000 Aries 510	ES7000 Orion 540
Chassis	4U	4U	7U	7U	16U	4U + 1U Serv Proc	36U
Processor	Xeon MP 2.0 GHz	Xeon MP 2.0 GHz	Xeon MP 2.0 GHz	PIII Xeon 900 MHz	UltraSPARCIII 1GHz	Xeon MP 2.0GHz	Xeon MP 2.0GHz
Front Side Bus	400 MHz	400 MHz	400 MHz	100 MHz	100 MHz	400 MHz	400 MHz
8-way SMP	YES	YES	YES	YES	YES	YES	YES
16-way SMP	YES	NO	NO	NO	NO	NO	YES
Chipset	IBM XA-32	HP F8	HP F8	Intel Profusion	Superscalar SPARC 9	Unisys CMP	Unisys CMP
Memory, Std.	2 GB	2GB (1.5), 4GB (2.0)	2GB (1.5), 4GB (2.0)	256 MB	4 GB	4 GB	4 GB per cell
Memory, Max	64 GB	32 GB	32 GB	32 GB	64 GB	16 GB	64 GB
Chipkill	YES	NO	NO	YES	NO	NO	NO
Memory ProteXion	YES	NO	NO	NO	NO	NO	NO
L4 Cache (Max)	32MB/4-way (128)	NO	NO	NO	NO	16 MB/4-way (32)	16MB 4-way (128)
Hard drive bays	2	4	4	2	12	1	1 per cell
Max Int. Storage	146 GB	587 GB	587 GB	146 GB	876 GB	30 GB	30 GB per cell
SCSI	Ultra160	Ultra160	Ultra160	Ultra2	NO (FC)	NO (IDE)	NO (IDE)
Hot-Swap HDDs	YES	YES	YES	YES	NO	NO	NO
Redundant HDDs	YES	YES	YES	YES	YES	NO	NO
RAID	Optional	Int. Smart Array 5i	Int. Smart Array 5i	Optional	Optional	NO	NO
NIC	Gigabit Ethernet	Dual Gigabit Ethernet	Gigabit Ethernet	10/100	Gigabit Ethernet	10/100	10/100
Hot-Swap PCI	YES	YES	YES	YES	YES	NO	NO
PCI/PCI-X (Open)	0/6 (6)	0/6 (6)	1/10 (11)	10/0 (10), No PCI-X	9/0 (9), No PCI-X	8/0 (8), No PCI-X	32/0 (32), No PCI-X
64-bit/133 MHz	2 PCI-X	0	0	0	0	0	0
64-bit/100 MHz	2 PCI-X	6 PCI-X	10 PCI-X	0	0	0	0
64-bit/66 MHz	2 PCI-X	0	0	4 PCI	2 PCI	8 PCI	32 PCI
64-bit/33 MHz	0	0	1 PCI	6 PCI	7 PCI	0	0
Systems Mgmt Software	IBM Director	Insight Manager	Insight Manager	Dell OpenManage	Solaris/Solstice Mgr	Unisys Server Sentinel	Unisys Server Sentinel
Service Processor	Integrated Remote Supervisor Adapter 1	Integrated Lights Out	Optional	Optional	Sun Remote System Control	Optional 1U Server	Optional 1U Server
Power Supplies	2 x 1050W standard	2 x 1100 W standard	2 x 1100 W standard	3 x750 W standard	3 x 1500 W (N+1)	1 x 1200W standard	1 per cell standard
Redundant Power	YES	YES	YES	YES	YES	Optional	Optional
Hot-Swap Power	YES	YES	YES	YES	YES	NO	NO
Hot-Swap Fans	YES	YES	YES	YES	YES	NO	NO
Remote I/O	YES	NO	NO	NO	NO	NO	NO
Light Path Diagnostics	YES	YES	YES	NO	NO	NO	NO
Predictive Failure Analysis	HDD, Memory, CPU, Fans, Power Supplies	HDD, Memory, CPU	HDD, Memory, CPU	Fans, Power Supplies	NO	CPU	CPU
Operating Systems	WinNT, W2K, Win2003, Red Hat, SuSE, NetWare, SCO UnixWare, VMware	W2K, Win2003, Red Hat, SuSE	W2K, Win2003, Red Hat, SuSE	WinNT/2K, Linux, NetWare	Solaris only	W2K, Win2003, SCO UnixWare (No Linux)	W2K, Win2003, SCO UnixWare (No Linux)

xSeries 440: 4-way Competitive Comparison (As of 10 June 2003)



4-way	IBM	HP	HP	Dell	Dell	Sun
Model	xSeries 440	ProLiant DL580 G2	rx5670	PowerEdge 6650	PowerEdge 6600	Fire V480
Chassis	4U	4U	7U	4U	7U	5U
Processor	Xeon MP 2.0 GHz or Xeon DP 2.4GHz	Xeon MP 2.0 GHz	Itanium 2 1.0GHz	Xeon MP 2.0GHz	Xeon MP 2.0GHz	UltraSPARC III 900 MHz
Front Side Bus	400 MHz	400 MHz	400 MHz	400 MHz	400 MHz	100 MHz
8-16-way Capable	YES	NO	NO	NO	NO	NO
Chipset	IBM XA-32	ServerWorks GC-HE	HP zx1	ServerWorks GC-HE	ServerWorks GC-HE	Superscalar SPARC 9
Memory, Std.	2 GB PC133	2 GB DDR	2 GB DDR 266	512 MB DDR	512 MB DDR	4 GB
Memory, Max	16 GB per 4-way	32 GB	48 GB	16GB	16 GB	32 GB
Chipkill	YES	YES	NO	YES	YES	NO
Memory ProteXion	YES	NO	NO	NO	NO	NO
L4 Cache (Max)	32 MB (64)	NO	NO	NO	NO	NO
Hard drive bays	2	4	4	5	12	2
Max Int. Storage	146 GB	291 GB	292 GB	365 GB	876 GB	146 GB
SCSI	Dual Ultra160	Dual Ultra160	Ultra160	Single Ultra160	Single Ultra160	NO (FC)
Hot-swap HDDs	YES	YES	NO	YES	YES	YES
Redundant HDDs	YES	YES	YES	YES	YES	YES
RAID	Optional	Int. Smart Array	Optional	Optional	Optional	Optional
NIC	Gigabit Ethernet	Gb Ethernet in slot	Gigabit Ethernet	Dual Gigabit Ethernet	Dual Gigabit Ethernet	Dual Gigabit Ethernet
Hot-swap PCI	YES	YES	NO	YES	YES	YES
PCI/PCI-X (Open)	0/6 (6)	0/6 (5), 4 HS	1/9 (10)	1/7 (7)	0/11 (11)	6/0 (6), No PCI-X
64-bit/133 MHz	2 PCI-X	0	3 PCI-X	0	0	0
64-bit/100 MHz	2 PCI-X	6 PCI-X	0	7 PCI-X	11 PCI-X	0
64-bit/66 MHz	2 PCI-X	0	6 PCI-X	0	0	2 PCI
64-bit/33 MHz	0	0	1 PCI	0	0	4 PCI
Systems Mgmt Software	IBM Director	Insight Manager	HP Service Control Suite & TopTools	Dell OpenManage	Dell OpenManage	Solaris/Solstice Mgr
Service Processor	Integrated Remote Supervisor Adapter 1	Integrated Light Out	Int. Service Processor	Optional	Optional	Sun Remote System Control
Power Supplies	2 x 1050W	2 x 800W	3 x 930W (N+1)	2 x 900 W	3 x 600 W	2 x 1440 W (N+1)
Redundant Power	YES	YES	YES	YES	YES	YES
Hot-swap Power	YES	YES	NO	YES	YES	YES
Hot-swap Fans	YES	YES	NO	YES	YES	YES
Remote I/O	YES	NO	NO	NO	NO	NO
Light Path Diagnostics	YES	YES	NO	NO	NO	NO
Predictive Failure Analysis	HDD, Memory, CPU, Fans, Power Supplies WinNT, W2K, Win2003, Red Hat, SuSE, NetWare, SCO UnixWare, VMware	HDD, Memory, CPU	NO	Fans, Power Supplies	Fans, Power Supplies	NO
Operating Systems	WinNT, W2K, Win2003, Red Hat, SuSE, NetWare, SCO UnixWare, VMware	W2K, Win2003, Red Hat, SuSE	HP-UX, Windows 2000 AS, Linux 64-bit	WinNT/2K, Linux, NetWare	WinNT/2K, Linux, NetWare	Solaris only

IBM versus the Unisys ES7000 Aries and Orion 500 Series

CNet News: "Unisys, Microsoft to launch anti-Unix ads" (<http://news.com.com/2100-1001-870805.html>)

"The Unisys ES7000 server can accommodate as many as 32 Intel processors and can be divided into independent 'partitions,' each with its own operating system. The Datacenter version of Windows 2000 can run on machines with as many as 32 processors. These top-end configurations are rare, Unisys has said, with eight-, 12-, or 16-processor partitions more common."

IBM Response: By their own admission, Unisys sells few 32-way SMP systems. Unisys is basically selling multiple 8-way and 16-way servers as partitions in an extremely expensive rack...but not even doing that very well. While Unisys can get as many as four 8-way partitions in its 36U Orion 540, IBM can get up to TEN 8-way partitions in a 42U industry-standard rack, all manageable from the same IBM Director console and each running its own operating system.

"Unisys faces competition not only from Unix servers, which have accommodated dozens of processors for years, but also from IBM's new Summit servers, which top out at 16 processors but cost considerably less than the ES7000."

IBM Response: "Considerably less" was an understatement. As a result of competition from the x440, Unisys has reduced the price of the Orion server by over \$150,000 for its 16-way but is still more expensive than the x440. Not only is the x440 16-way 3/4th the price of the Orion 540, taking up only 1/4th of the rack space (8U rack space for two x440 chassis connected together as a 16-way SMP versus 36U for the Unisys ES7000 Orion 540), but you get four times the transactions (as measured by tpmC) in the same amount of rack space as the Orion 540.

Unisys ES7000 Orion 540 16-way (36U)

Qty	Description	Price (USD)*
1	ES7000 16-way Xeon 2.0GHz, 64GB RAM, 30GB HDD, 32 PCI slots	\$251,750
4	Fiber Channel Host Bus Adapters	\$11,400
4	cLAN Controllers	\$3,020
1	36U Cabinet	\$2,537
1	1U Service Processor Server	\$4,576
1	3-year Maintenance	\$13,692
		Total: formerly \$436,850, now \$286,975

IBM x440 16-way (8U)

Qty	Description	Price (USD)*
2	Two x440 servers, each with 8 Xeon MP 2.0GHz CPUs	\$144,798
64	1 GB DIMM (Match at 64 GB total)	\$63,296
1	36 GB 10K Hard disk drives	\$439
4	TotalStorage Fiber Channel Host Bus Adapters	\$5,940
1	3-year Maintenance	\$6,442
		Total: \$220,915

*Source: TPC-C benchmark, disclosure posted to www.tpc.org

"Another obstacle for Unisys: Only a few hundred ES7000 servers have been sold so far, and sales partnerships with Dell, Compaq and Hewlett-Packard have all fallen apart."

CNet News: "Dell drops plan to sell Unisys server" (<http://news.com.com/2100-1001-857174.html>)

"The ES7000 servers have commonly been selling for \$480,000 with an average of 22 processors, Weber said. About 600 CMP systems have been sold so far, Krempasky said." Since this article was published in March 2002, CNet published a new article in April 2003 in which Unisys updated its sales for the ES7000 to 1000 servers...an average of 30 systems per month. (<http://news.com.com/2100-1001-995660.html>)

IBM Response: By contrast, IBM will sell over 1000 x440 every 30 days! This is what happens when you are the overall #1 server vendor in the world including the #1 market share position worldwide in the 8-way segment (as of 3Q2002 and continuing through 1Q2003 according to IDC).

CNet News: "IBM to release high-end Intel server" (<http://news.com.com/2100-1001-858833.html>)

"Unisys counters that it's got a track record with its ES7000, which has been on the market with other Intel processors since 2000. And an ES7000 can continue running even when a processor fails, a feature IBM can't match, Unisys said."

IBM Response #1: some track record. 1000 servers in 4 years, 3 failed OEM partnerships, and 10 benchmarks. By contrast, the x440 has ranked first in 35 industry-standard benchmarks from SAP to TPC.

IBM Response #2: The feature claim above against IBM is false. This is called MEDIC Diagnostics and was first introduced on the x440.

Processor Failure on Unisys: In the statement above, Unisys is referring to its partitions not the whole system. No Windows operating system can survive a processor failure. However, an ES7000 4-way partition can crash following a processor failure without taking the other three partitions down in the Unisys rack, the same as an x440 in an industry-standard rack with up to ten other partitions.

IBM's Response: MEDIC™ Diagnostics (MEDIC = Module Error Detection, Isolation & Correction): Advancing autonomic computing

- MEDIC enables an 8-way to lose the top SMP Expansion Module as a result of a CEC failure and re-boot using Automatic Server Re-boot (ASR) back up into a 4-way while holding that the top SMP Expansion Module in isolation for diagnosis of the failure. Using Real Time Diagnostics while the system remains operational, the IT administrator can diagnosis the failure. This applies only to the top CEC because the bottom CEC controls the I/O and has to be functional for the server to boot. MEDIC enables a 16-way to lose a SMP Expansion Module or entire node as a result of a processor failure and re-boot using ASR back up into an operational configuration for Real Time Diagnostics according to the following rules:

- o 16-way as 2x8-way: lose top SMP Exp Module -- re-boot back as 12-way
- o 16-way as 2x8-way: lose bottom SMP Exp Module -- re-boot back as 8-way
- o As implemented in a physical partitioning scenario: this would be identical to the Unisys claim. The physical partition would crash with a CPU failure but the other partitions would remain operational.
- o As implemented in the 4-way up to 16-way, in the event of a processor failure only (not CEC failure), MEDIC will detect the CPU failure and re-boot that physical partition holding just that processor in isolation.

Bottom Line: The Unisys claim is exaggerated. The x440 has the same physical partitioning capability available in the Unisys system with additional logical partitioning capabilities available through VMware including support for Linux that Unisys does not offer.

Following the lead of the IBM autonomic computing initiative, Unisys is developing self-optimizing features into the ES7000. But Unisys forgets that it is making claims against the company that invented autonomic computing.

Their Autonomic Computing capabilities

- Configuration Management and Setup including partitioning, automatic discovery
- Application Resource Management
- System Health Monitoring
- System Health Advisor
- Automatic fault handling, alerts and diagnosis.
- Automating manual tasks
- Managing the CPU workload within partitions.
- Anytime/Anywhere Remote Management
- Call Home

True autonomic computing delivered from IBM today

- Configuration Management and Partitioning Setup: Got it. Called Scalable Systems Manager.
- Application Resource Management: Got it. Called Application Workload Manager.
- System Health Monitoring: Got it. Standard with IBM Director.
- System Health Advisor: Got it. Standard IBM Director.
- Automatic fault handling, alerts and diagnosis: Got it. Standard with IBM Director.
- Automating manual tasks: Got it. Standard with IBM Director.
- Managing the CPU workload within partitions: Got it. Called Capacity Manager.
- Anytime/Anywhere Remote Management: Got it. Called Remote Supervisor Adapter.
- Call Home: Got it. Standard with IBM Director and the integrated Remote Supervisor Adapter.



What they left out that we deliver

- Real-Time Diagnostics for diagnostics while the system is running
- Software Rejuvenation for improved software performance
- Chipkill memory for higher reliability
- Active Memory with Memory Mirroring
- Memory ProteXion for more reliable memory subsystem
- Predictive Failure Analysis on all major subsystems

- Light Path Diagnostics for easy identification of failing parts
- Active PCI-X for hot-swapping failed PCI/PCI-X adapters
- Active PCI Manager for optimizing slot-adaptor performance
- Remote Deployment Manager for easier remote deployment
- UpdateXpress for easier remote management of software updates
- Virtual Server Manager for managing virtualized servers remotely

In addition to omitting numerous systems management features, the Unisys ES7000 lacks most of the high -availability features that customers have come to expect from a mission-critical server.

	Unisys ES7000	IBM x440
Service Processor	☑ Optional 1U (\$5K)	☑ Standard
ECC Memory	☑ Standard	☑ Standard
Chipkill Memory	☒ Not Offered	☑ Standard
Memory ProteXion	☒ Not Offered	☑ Standard
Memory Mirroring	☒ Memory Not Accessible	☑ Optional
Hot-swap Hard disk drives	☒ Not Offered	☑ Standard
Mirrored Hard disk drives	☒ Not Offered: 1 IDE HDD	☑ Standard: 2 SCSI HDDs
Hot-swap Power Supplies	☒ Not Offered	☑ Standard
PCI-X I/O Signal integrity	☒ Not Offered	☑ Standard
Hot-swap PCI	☒ Not Offered	☑ PCI-X Standard
Hot-swap Fans	☒ Not Offered	☑ Standard
Predictive Failure Analysis	☒ Not Offered	☑ HDDs, Power, Fans, L4 cache, Memory
Light Path Diagnostics	☒ Not Offered	☑ Standard

In summary, Unisys is desperate for business and is striving to gain attention with a product indicative of its lack of leadership.

- As stated in CNET News, after four years, Unisys has only sold 1000 ES7000 servers, suffered through three failed OEM relationships (Dell, Compaq, HP) and have had to drop prices on their high -end system by as much as 35% just to compete!
- Unisys is a distant #6 in worldwide market share according to Gartner for 4Q 2002 (<http://news.com/2100-1001-995660.html>)
- Because of poor I/O performance, Unisys only publishes benchmarks that are CPU dependent, i.e. TPC-C and SAP. This is the reason that Unisys could only use the 36U Orion 540 for the TPC-C, because it needed the aggregate bandwidth and memory scalability of four cells just to compete against the two-chassis 8U x440.
- Unisys lacks most of the high availability features that are indicative of a mission-critical server.

By contrast, IBM with the eServer xSeries 440 has seen and continues to enjoy phenomenal success including:

- Catapulting from #3 to #1 in 8-way worldwide market share in only 2 quarters, a lead maintained through 1Q2003.
- 35 #1 benchmarks in 15 months including TPC-C/H/W, SAP, Siebel, Baan, Citrix, and Oracle.
- Over two dozen customer and ISV endorsements (see <http://www.pc.ibm.com/us/eserver/xseries/x440.html>)
- Four major industry awards including PC Expo Overall Best of Show, PC Expo Enterprise Hardware Best of Show, PC Magazine Technical Excellence for Enterprise Servers, and Network World Best Enterprise Server of 2002.
- 10,000 units sold worldwide in only 12 months
- Enterprise X-Architecture that leads the market with the message of "Do More With Less" pay-as-you-grow scalability, echoed in the recent Windows Server 2003 launch and now in Unisys marketing literature.

And what about Hewlett-Packard and their late-to-market F8-based 8-way Server?

Back in March 2002 when the x440 was first announced, Hewlett-Packard stated publicly that they were waiting on the introduction of Intel's follow-on Xeon MP "Gallatin" processor to launch their 8-way Xeon MP-based server because of the increased processor cache needed for performance. FACT: the claim by HP that the first -generation Xeon MP "Foster" processor didn't provide adequate performance was an excuse for not having a product to compete against the x440. FACT :the F8 chipset did not work.

If you were losing market share at the rate of 12% per quarter in the most profitable segment in the industry-standard market, wouldn't you introduce a new system even if it only MATCHED the performance of your previous generation just to be able to say you have the latest technology? Never in Compaq/HP's history have they ever passed on an Intel processor introduction. I know. I used to work in the ProLiant marketing organization in Houston, Texas. Why would they suddenly do otherwise unless F8 flat out didn't work? Why did they introduce a 4-way Xeon MP in a 4U when they were offering a 4-way in a 4U with Pentium III Xeon? What value did they offer the customer then besides latest technology if in fact the Xeon MP CPU didn't out-perform the previous generation? The difference? The 4-way was powered by the readily-available ServerWorks Grand Champion HE chipset..F8 didn't work. The result: 12 months late to market and surrender of the #1 worldwide market share position in 8-way servers, a segment invented by Compaq with the first Profusion 8-way in 1998.

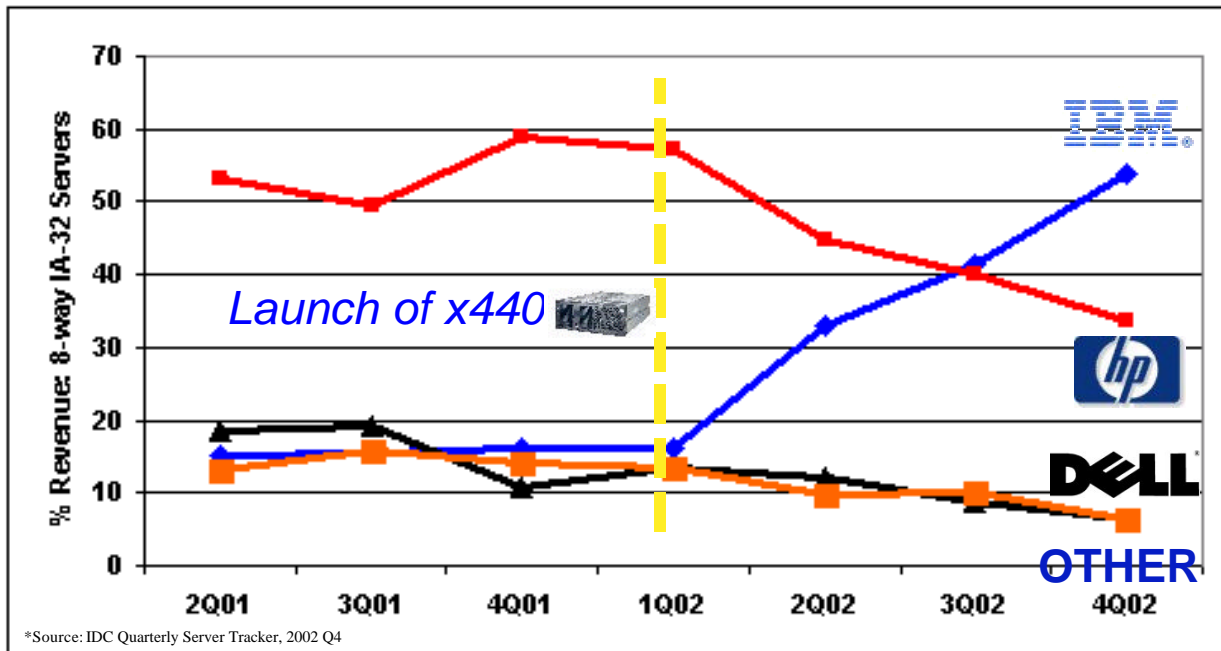

*Source: IDC Quarterly Server Tracker, 2002 Q4

SIAS	Revenue		Revenue Growth		Market Share			Share Gains	
	Q402	YTY	Q401	Q302	Q401	Q302	Q402	YTY	Q402
8 Way									
IBM	\$145	237.2%	66.7%	19.4%	41.4%	53.7%	34.3 Pts	12.3 Pts	
HP	\$91	-27.2%	8.3%	56.3%	40.0%	33.7%	(22.6 Pts)	(6.3 Pts)	
Dell	\$17	-32.0%	-5.6%	11.3%	8.6%	6.3%	(5.0 Pts)	(2.3 Pts)	
Others	\$17	-41.4%	-19.0%	13.1%	10.0%	6.3%	(6.8 Pts)	(3.7 Pts)	
Total	\$270	21.6%	28.6%	100%	100%	100%	0 Pts	0 Pts	

Now that HP has introduced its 8-way Xeon MP-based servers, compared to the x440, this is what you get:

	IBM eServer x440	HP ProLiant DL740	HP ProLiant DL760 G2
Processors	Intel Xeon MP 1.5/1M, 1.9/1M, 2.0GHz/2M	Intel Xeon MP 1.5/1M, 2.0GHz/2M only	Intel Xeon MP 1.5/1M, 2.0GHz/2M only
Supported Configs	2-way up to 16-way	4-way and 8-way only	4-way and 8-way only
Level-4 System Cache	64MB XceL4 per 8-way	None	None
4-way SMP with Xeon	Yes, 4-way with 2.4GHz Xeon DP	Never	Never
8-way SMP	Yes	Yes	Yes
16-way SMP	Yes	Never	Never
Max Memory	64GB, Max for 32-bit (populated in banks of 4)	80GB needed for RAID (populated in banks of 10)	80GB needed for RAID (populated in banks of 10)
Memory Availability	ECC, Chipkill, Memory ProteXion, Active Memory Mirroring	Basic ECC, Optional RAID Memory	Basic ECC, Optional RAID Memory
I/O	6 Active PCI-X Slots	6 Hot-swap PCI-X Slots	11 Hot-swap PCI-X Slots
Remote I/O	Yes, 12 additional PCI-X slots in 3U	Never	Never
Base I/O Configuration	2@133MHz, 2@100MHz, 2@66MHz	6@100MHz (No 133MHz)	10@100MHz, 1@33MHz (No 133MHz)
RIO Configuration	Up to 12@100MHz	None	None
NIC	Int. Broadcom 10/100/1000 Ethernet	Int. Dual 10/100/1000 Ethernet	Int. 10/100/1000 Ethernet
Internal Storage	2 HDDs x 73GB = 146GB	4 HDDs x 146GB = 584GB + Int RAID5	4 HDDs x 146GB = 584GB + Int RAID5
Supported OS	W2K, Win2003, NT4, RHAS, SuSE, Netware, SCO Unix	W2K, Win2003, RHAS, SLES8	W2K, Win2003, RHAS, SLES8, SCO Unix
8-way \$ per tpmC	\$6.56/tpmC	No Available Benchmark	\$7.69/tpmC
16-way \$ per tpmC	\$11.03/tpmC	Never	Never
Chassis	4U	4U	7U
Total #1 Benchmarks	34	1	2
General Availability	Since April 2002	Since March 2003	Since March 2003

In spite of having 12 months of additional development time to get it right, the DL740 and DL760 G2 are barely competitive with the x440. But what HP lacked in leadership, they tried unsuccessfully to make up for with innovation. Unfortunately, this innovation too lacks compelling value when compared with the more cost-effective x440. Touted by HP for its high availability, the DL740 and DL760 G2 introduced the new RAID Memory capability of the F8 chipset. "A marvel of costly, proprietary technology" to quote a Compaq sales manager, RAID Memory is an expensive way of addressing the need for high availability in the memory subsystem, but at a substantial premium when compared to the x440.

Thanks to the integration of ECC, Chipkill and Memory ProteXion into the XA-32 chipset, the x440 is able to offer single-bit and double-bit error detection and correction at no additional cost using off-the-shelf industry-standard DIMMs. By contrast, the HP 8-way servers require the investment of 20% additional memory expense to create the RAID portion of the memory array plus the added cost of five memory controllers to enable anything greater than ECC in the DL740 and DL760 G2. When powering a 64GB high-performance database engine, this adds an additional \$40,000 in memory to the price of the HP server just to power RAID Memory, dollars saved if invested in the x440.

Memory Error	HP DL740	HP DL760 G2	IBM x440
Single-bit Error	Basic ECC Standard, No Added Cost	Basic ECC Standard, No Added Cost	Basic ECC Standard, No Added Cost
Chipkill	No Protection Requires Optional RAID	No Protection Requires Optional RAID	Chipkill Standard, No Added Cost
Double-bit Error	No Protection Detect Only, Requires RAID	No Protection Detect Only, Requires RAID	Memory ProteXion Standard, No Added Cost
Entire DIMM*	No Protection Requires Optional RAID	No Protection Requires Optional RAID	Memory Mirroring Advanced Active Memory™

The memory subsystem is not the only place where IBM is able to save you money. Overall, the x440 is less expensive than either of its F8-based competitors as either a scalable 4-way or an 8-way server. While the x440 is a less expensive 8-way server, it still provides scalability up to 16-way by combining it with a second x440 chassis, expandability that cannot be matched by the DL740 and DL760 G2, in spite of their higher price tags.

IBM xSeries 440 8-way			HP DL740 8-way			HP DL760 G2 8-way		
Qty	Description	Price	Qty	Description	Price	Qty	Description	Price
1	x440 4x2.0GHz, 2GB RAM	\$40,299	1	DL740 4x2.0GHz, 4GB RAM	\$44,999	1	DL760G2 4x2.0GHz, 4GB RAM	\$47,999
1	SMP Expansion Module	\$5,199	1	4-CPU Option Kit	\$28,399	1	4-CPU Option Kit	\$28,399
28	512 MB DIMMs (16GB Total)	\$13,972	20	1GB DIMMs (16GB+4GB RAID)	\$19,788	20	1GB DIMMs (16GB+4GB RAID)	\$19,788
4	Xeon MP 2.0GHz/2MB L3	\$26,396	2	36 GB 10K SCSI HDD	\$678	2	36 GB 10K SCSI HDD	\$678
2	36 GB 10K SCSI HDD	\$598	1	Remote Insight Board - LOE II	\$634	1	Remote Insight Board - LOE II	\$634
1	3-year SBD 24x7 Upgrade	\$3,200	1	3-year SBD 24x7 Upgrade	\$3,390	1	3-year SBD 24x7 Upgrade	\$3,390
	TOTAL	\$89,664		TOTAL (9% higher than x440)	\$97,888		TOTAL (12% higher than x440)	\$100,888

IBM xSeries 440 4-way			HP DL740 4-way			HP DL760 G2 4-way		
Qty	Description	Price	Qty	Description	Price	Qty	Description	Price
1	x440 4x2.4GHz, 4GB RAM	\$23,399	1	DL740 4x2.0GHz, 4GB RAM	\$44,999	1	DL760G2 4x2.0GHz, 4GB RAM	\$47,999
8	512 MB DIMMs (8GB Total)	\$3,992	30	256MB DIMMs (8GB+2GB RAID)	\$7,367	30	256MB DIMMs (8GB+2GB RAID)	\$7,367
2	36 GB 10K SCSI HDD	\$598	2	36 GB 10K SCSI HDD	\$678	2	36 GB 10K SCSI HDD	\$678
1	3-year SBD 24x7 Upgrade	\$3,200	1	Remote Insight Board – LOE II	\$634	1	Remote Insight Board – LOE II	\$634
			1	3-year SBD 24x7 Upgrade	\$3,390	1	3-year SBD 24x7 Upgrade	\$3,390
		TOTAL			TOTAL (83% higher than x440)			TOTAL (92% higher than x440)
		\$31,189			\$57,068			\$60,068

Why should you buy the x440 versus Unisys or Hewlett-Packard?

- x440: 10 times the sales of the Unisys ES7000 in 1/4th the time...proof that customers invest in IBM.
 - 10,000 x440 units in one year versus 1000 ES7000 units in 4 years
 - While IBM is #1 on the 8-way market share chart, Unisys is relegated to the "Other" category.
- Twelve months time-to-market lead over the F8-based HP DL740 and DL760 G2...proof that IBM is leading the market in innovation.
 - IBM catapulted from #3 to #1 in 8-way worldwide market share after only 2 quarters, taking that #1 position from HP.
- The vision and commitment to leadership with Enterprise X-Architecture.
 - IBM will deliver the 2nd generation of XA-32 in 3Q 2003 and have commenced work on the 3rd generation for 2005.
 - Unisys may not be committed to ES7000 long term because it appears to be a money-losing business. According to Wall Street rumors, they are actively shopping for a buyer. Why should you invest in ES7000 when even Unisys does not appear to be?
 - After a 3-year development effort, HP just introduced their first-generation F8 chipset-based systems. It should be at least a year before they are able to introduce the second generation of F8 products.
- 3½ times more #1 benchmarks than Unisys ES7000, over two dozen customer and ISV endorsements and four major industry awards.
 - 35 #1 benchmarks for x440 in 15 months versus 10 for the ES7000 in almost 2 years
 - See <http://www.pc.ibm.com/us/eserver/xseries/x440.html> for over two dozen customer and ISV endorsements of the x440
 - x440: Winner of the PC Expo Overall Best of Show, PC Expo Enterprise Hardware Best of Show, PC Magazine Technical Excellence for Enterprise Servers, and Network World Best Enterprise Server of 2002.
- Over 10 times more #1 benchmarks than both the HP DL740 and DL760 G2 combined with lower pricing and better availability.
 - Only 3 known benchmarks for both the DL760 G2 and DL740 in 7 months, only one of which is still a #1.
 - x440 enjoys both 3% better raw performance and 15% better price-performance advantage over the HP DL760 G2.
 - The x440 industry-exclusive 4-way with Intel Xeon DP is up to 48% less expensive than the HP F8-based servers.
- x440 16-way: 1/4th the rack space and 3/4th the price versus the Unisys ES7000 Orion 540 16-way. 4 times the transactions and 2½ times the partitions in the same amount of rack space versus the Unisys ES7000 Orion 540 16-way.
- x440 16-way: 1/5th the rack space, 1/10th the price of the HP Superdome 16-way.
 - As HP offers no IA-32 16-way solution, if you want 16-way from HP, you have to buy the HP Superdome.
 - In the same amount of rack space as the Superdome 64-way, the IBM x440 16-way can deliver 2 times the transactions at 20% of the hardware price (comparing nine x440 16-ways versus one HP Superdome 64-way, both requiring two racks).
- x440 8-way: 4 times the I/O bandwidth, 5 times the memory bandwidth, 20% more rack dense and 4/5th the price including integrated Remote Management vs. the Unisys ES7000 Aries 510 8-way which requires an additional 1U service processor.
 - The Aries 510 offers very few high availability features and no integrated service processor. Customers must add a \$4500 1U server to manage the system remotely, a capability that is standard in the more highly available x440.
- x440: hot-swap redundancy for all high availability components versus Unisys ES7000 which has hot-swap redundant nothing, which when combined with the need to connect systems via the Unisys Cell Interconnect Module creates a potential service nightmare.
- x440: Active Memory delivers support for ECC, Chipkill, and Memory ProteXion at no additional cost. For memory fault tolerance beyond ECC, HP requires that customers enable RAID Memory with its 20% extra memory expense and five memory controllers to match what IBM can provide at no additional cost. Other than ECC, Unisys has no such solution for high availability memory.

The Competitive Bottom line

- Buy for Scalability: no other Tier-1 system vendor offers scalability up to 16-way SMP. And no other vendor (Unisys included) will enable this 16-way scalability in 8U rack space without having to buy all the infrastructure at once (i.e. Unisys). In addition, no other vendor offers the most affordable, yet highest performing 4-way with Xeon DP.
- Buy for Remote I/O: no other industry-standard server vendor will offer Remote I/O capability. Period.
- Buy for Enterprise X-Architecture: this is our strategy for leadership. Learn about the vision of Enterprise X-Architecture and all that is included within the XpandOnDemand servers.
- Buy for Performance: the x440 is a leadership performance server. Our benchmarks provide proof-points that illustrate that we are far ahead of our competitors. Remember that our XpandOnDemand servers were the platform used by Intel to validate the Xeon processor MP.
- Buy for High Availability: with Active Memory, Active PCI-X, Memory ProteXion, Light Path Diagnostics, and the whole suite of autonomic computing technologies, such as Predictive Failure Analysis, Software Rejuvenation, Capacity Manager, no other server manufacturer even comes close to the promise that IBM makes for OnForever availability.
- Buy from IBM: this continues to be the year for IBM. The investment that we have made in Enterprise X-Architecture is paying off. No other company can provide the technology leadership that IBM can. Combined with the formidable services and finance capabilities of IBM Global Services and IBM Global Finance, IBM is clearly the solutions leader for the server marketplace. Customers are voting with their wallets because they, like us, realize that technology does matter and that the future of IT is NOT commodity driven. You know what's best for your business. So does IBM.

xSeries 440 – Performance Benchmarks

The IBM eServer x440 has demonstrated #1 performance in thirty-five benchmarks since its introduction in March 2002!

Benchmark	Result	Configuration
SAP 2-Tier 16-way (1)	1090 SD Users	Two x440 each with eight 2.0 GHz/2MB L3 CPUs, 64MB Xcel4 cache, 16GB RAM (32GB Total), Microsoft Windows 2003 Datacenter, IBM DB2 8.1, SAP R/3 v4.6C
SAP 2-Tier 8-way (1)	690 SD Users	x440 with eight 2.0 GHz/2MB iL3 cache, 64MB Xcel4 cache, 8GB RAM, Red Hat Linux, IBM DB2 v7.2, SAP R/3 v4.6C
	520 SD Users	x440 with eight 1.6 GHz/1MB iL3 cache, 64MB Xcel4 cache, 8GB RAM, Windows 2000, IBM DB2 v7.2, SAP R/3 v4.6C
	575 SD Users	x440 with eight 1.6 GHz/1MB iL3 cache, 64MB Xcel4 cache, 8GB RAM, Red Hat Linux, IBM DB2 v7.2, SAP R/3 v4.6C
SAP 2-Tier 4-way (1)	312 SD Users	x440 with four 1.6 GHz/1MB iL3 cache, 32MB Xcel4 cache, 8GB memory, Windows 2000, IBM DB2 v7.2, SAP R/3 v4.6C
	396 SD Users	x440 with four 2.4GHz/512K L2 CPUs, 8GB RAM, Windows 2003 Enterprise Edition, IBM DB2 8.1, SAP R/3 v4.6C
SAP 3-Tier 4-way Database Server, 8-way Application Servers, 4-way Messaging Server (1)	5790 SD Users	Database Server & Messaging Server (one server for each): x440 with four 2.0 GHz/1MB iL3 cache, 32MB Xcel4 cache, 4GB memory, SuSE Linux Enterprise 8.0, IBM DB2 v8.1, SAP R/3 v4.6C. Application Servers: Ten x440 with eight 2.0 GHz/2MB iL3 cache, 64MB Xcel4 cache, 4GB memory, SuSE Linux Enterprise 8.0, IBM DB2 v8.1, SAP R/3 v4.6C.
Microsoft Exchange 4-way (3)	11,300 MMB2 Users	x440 with four 1.6 GHz CPUs with 1MB iL3 cache, 32MB Xcel4 cache, 4GB RAM, Windows 2000, Exchange 2000
TPC-C 4-way (4)	74,206 tpmC, \$5.75/tpmC	x440: 4x2.0 GHz CPUs/1MB iL3, 32MB Xcel4 cache, Windows 2003 EE, SQL Server 2000*
	55,138.6 tpmC, \$6.98/ tpmC	x440: 4x1.6 GHz CPUs with 1MB iL3 cache, 32MB Xcel4 cache, Windows 2000 Datacenter, SQL Server 2000 EE*
	61,168 tpmC / \$5.14/ tpmC	x440: 4x2.4 GHz/512KB L2, 64MB Xcel4, 64 GB RAM, Windows 2000 Datacenter, SQL Server 2000*
TPC-C 8-way (4)	119,115 tpmC, \$6.56/tpmC	x440: 8x2.0 GHz/2MB iL3, 64MB Xcel4 cache, 64 GB RAM, Windows 2003 Datacenter, SQL Server 2000 (Avail: 10/4/03)
	92,398 tpmC, \$7.70/ tpmC	x440 with eight 1.6 GHz/1MB iL3 cache, 64MB Xcel4 cache, 64 GB RAM, Windows 2003 Datacenter, SQL Server 2000 EE*
TPC-C 16-way (4)	151,744 tpmC, \$11.03/tpmC	Two x440 each with eight 2.0 GHz/2MB iL3 cache, 64MB Xcel4 cache, 32 GB RAM (64GB Total), Windows 2003 Datacenter, SQL Server 2000 EE (Avail: 9/25/03)
TPC-H 4-way (5)	1486 QphH@ 100 GB, \$122/QphH@100GB	x440 with four 1.6 GHz CPUs with 1MB iL3 cache, 32MB Xcel4 cache, 4 GB RAM, Windows 2000, SQL Server 2000*
TPC-H 8-way (5)	3861 QphH@ 100 GB, \$102/QphH@100GB	x440 with eight 2.0 GHz /2MB L3 CPUs, 32MB Xcel4 cache, 16GB RAM, Windows 2003 EE, IBM DB2 v8.1 (Avail:7/15/03)
TPC-W 4-way (6)	14356 WIPS@ 10K, \$32.04/WIP	x440 with four 1.6 GHz CPUs with 1MB iL3 cache, 32MB Xcel4 cache, 4 GB RAM, Windows 2000, SQL Server 2000*
TPC-W 8-way (6)	21139 WIPS@ 10K, \$32.62/WIP	x440: 8x1.6 GHz/1MB iL3, 64MB Xcel4 cache, 8 GB RAM, Windows 2003 EE, SQL Server 2000 (Avail: 12/31/02)
Baan ERP 4-way (7)	2170 BRUs	x440 with four 2.0 GHz CPUs with 2MB iL3 cache, 32MB Xcel4 cache, Windows 2000 Datacenter, Microsoft SQL Server
	1890 BRUs	x440 with four 1.6 GHz CPUs with 1MB iL3 cache, 32MB Xcel4 cache, Windows 2000, IBM DB2 UDB
	1575 BRUs	x440 with four 1.6 GHz CPUs with 1MB iL3 cache, 32MB Xcel4 cache, Windows 2000, Microsoft SQL Server
Baan ERP 8-way (7)	2940 BRUs	x440 with eight 2.0 GHz CPUs with 2MB iL3 cache, 32MB Xcel4 cache, Windows 2000 Datacenter, Microsoft SQL Server
	2695 BRUs	x440 with eight 1.6 GHz CPUs with 1MB iL3 cache, 64MB Xcel4 cache, Windows 2000, IBM DB2 UDB
	2380 BRUs	x440 with eight 1.6 GHz CPUs with 1MB iL3 cache, 64MB Xcel4 cache, Windows 2000, Microsoft SQL Server
SPECweb99_SSL 4-way (8)	1169 Simul. Connections	x440 with four 1.6 GHz CPUs with 1MB iL3 cache, 32MB Xcel4 cache, Red Hat Linux
SPECweb99_SSL 8-way (8)	1738 Simul. Connections	x440 with eight 1.6 GHz CPUs with 1MB iL3 cache, 64MB Xcel4 cache, Red Hat Linux
SPECjapp 4-way (8)	297.65 Bops, \$1108.14/Bops	x440 with four 1.6 GHz CPUs with 1MB iL3 cache, 64MB Xcel4 cache, Windows 2000, IBM DB2
Siebel 7 (11)	4500 Concurrent Users	x440 with four 1.6 GHz CPUs with 1MB iL3 cache, 32MB Xcel4 cache, 8 GB RAM, Windows 2000, IBM DB2 v7.2
PeopleSoft 8 (2)	8.1M Journal Lines per hour	x440 with eight 1.6 GHz/1MB iL3 cache, 64MB Xcel4 cache, 8GB RAM, Windows 2000 Datacenter, IBM DB2 v7.2
Oracle 9i (9)	3472 Concurrent Users	x440 with five 1.6 GHz CPUs with 1MB iL3 cache, 64MB Xcel4 cache, 32 GB RAM, Red Hat Linux, Oracle 9i
	5656 OASB Users	x440 with eight 2.0GHz/2MB L3 CPUs, 32GB Memory, 64MB Xcel4 cache, SuSE Linux Enterprise Server, Oracle OASB v11.5.6 single node
Citrix 4-way	160 Medium & 160 Heavy Users	x440 with four 1.6 GHz CPUs with 1MB iL3 cache, 32MB Xcel4 cache, 16 GB RAM, VMware ESX Server v1.5, Citrix
Citrix 8-way	300 Medium & 300 Heavy Users	x440 with eight 1.6 GHz CPUs with 1MB iL3 cache, 32MB Xcel4 cache, 32 GB RAM, VMware ESX Server v1.5, Citrix
J.D.Edwards ERP (12)	200 Simul. Users	x440: 4x1.6 GHz/1MB iL3, 32MB Xcel4 cache, 2GB RAM, 40GB HDD, JD Edwards 5 Enterprise, Windows 2000 AS
ECperf (10)	32,581.47 BBops/min@Std	x440 as database server with four 1.6 GHz CPUs with 1MB iL3 cache, 32MB Xcel4 cache, 4 GB RAM, Windows 2000, DB2 v7.2, x330 as application server

1 Source: <http://www.sap.com/solutions/technology/benchmark/sd2tier.asp>

2 Source: <http://www.peoplesoft.com>

3 Source: <http://www.microsoft.com/exchange/techinfo/planning/2000/PerfScal.asp>

4 Source: http://www.tpc.org/tpcc/results/tpcc_results.asp

5 Source: <http://www.tpc.org/tpch/results/h-results.idc>

6 Source: http://www.tpc.org/tpcw/results/tpcw_results.asp

*Withdrawn

7 Source: <http://www.pc.ibm.com/ww/eserver/xseries/benchmarks/index.html>

8 Source: <http://www.spec.org>

9 Source: http://www.oracle.com/apps_benchmark

10 Source: http://ecperf.theserverside.com/ecperf/index.jsp?page=results/top_ten_performance

11 Source: ftp://ftp.pc.ibm.com/pub/special/serverperformance/news/newsblurb_x440_siebel_oct02.pdf

12 Source: <http://www.jdedwards.com/public/0,1413,0%257E87%257E5989%257E,00.html>

xSeries 440 – Easy Configurator

2-way and 4-way base models

8687 – 1RX	2 x 1.4 GHz/512K L3 Xeon MP, 2 GB Memory
8687 – 2RX	2 x 1.5 GHz/512K L3 Xeon MP, 2 GB Memory
8687 – 3RX	2 x 1.6 GHz/1MB L3 Xeon MP, 2 GB Memory
8687 – 4RX	2 x 1.5 GHz/1MB L3 Xeon MP, 2 GB Memory
8687 – 5RX	2 x 1.9 GHz/1MB L3 Xeon MP, 2 GB Memory
8687 – 7RX	4 x 2.0 GHz/2MB L3 Xeon MP, 2 GB Memory
8687 – 3RY	2 x 2.4 GHz/512K L2 Xeon DP, 2 GB Memory
8687 – 4RY	4 x 2.4 GHz/512K L2 Xeon DP, 4 GB Memory



8-processor models for configuring or upgrading to 16-way

Purchase in matched pairs with Datacenter 16-CPU License

8687 – 18X	8 x 1.4 GHz/512K L3 Xeon MP, 0 GB Memory
8687 – 28X	8 x 1.5 GHz/512K L3 Xeon MP, 0 GB Memory
8687 – 38X	8 x 1.6 GHz/1MB L3 Xeon MP, 0 GB Memory
8687 – 48X	8 x 1.5 GHz/1MB L3 Xeon MP, 0 GB Memory
8687 – 58X	8 x 1.9 GHz/1MB L3 Xeon MP, 0 GB Memory
8687 – 78X	8 x 2.0 GHz/2MB L3 Xeon MP, 0 GB Memory

Purchase in match pairs with VMware ESX Server 16-CPU License

8687 – 1VX	8 x 1.4 GHz/512K L3 Xeon MP, 4 GB Memory
8687 – 2VX	8 x 1.5 GHz/512K L3 Xeon MP, 4 GB Memory
8687 – 3VX	8 x 1.6 GHz/1MB L3 Xeon MP, 4 GB Memory
8687 – 4VX	8 x 1.5 GHz/1MB L3 Xeon MP, 4 GB Memory
8687 – 5VX	8 x 1.9 GHz/1MB L3 Xeon MP, 4 GB Memory
8687 – 7VX	8 x 2.0 GHz/2MB L3 Xeon MP, 4 GB Memory

RXE-100 Remote Expansion Enclosure & Options

8684 – 1RX	6 Active PCI-X Slots, 2 Power Supplies
31P5998	xSeries Remote I/O PCI-X 6-pack Upgrade Kit
31P6087	3.5m Interconnect Management Cable Kit
31P6088	8m Interconnect Management Cable Kit
31P6102	3.5m Remote I/O Cable Kit
31P6103	8m Remote I/O Cable Kit



Processor Upgrades

Xeon MP Option 1.4GHz / 512KB L3 32P8705	Xeon MP Option 1.5GHz / 512KB L3 32P8706	Xeon MP Option 1.6GHz / 1MB L3 32P8707	Xeon DP w/ CEC 2.4GHz / 512KB L3 71P7919
Xeon MP Option 1.5GHz / 1MB L3 59P5171	Xeon MP Option 1.9GHz / 1MB L3 59P5172	Xeon MP Option 2.0GHz / 2MB L3 59P5173	

Memory Upgrades: Must be added in groups of four

512 MB PC133 ECC SDRAM DIMM 33L3324	1 GB PC133 ECC SDRAM DIMM 31P8300

Hot-Swap Hard Disk Drive s

18.2 GB Ultra160 10K: 06P5754 15K: 06P5767	36.4 GB Ultra160 10K: 06P5755 15K: 06P5768	73.4 GB Ultra160 10K: 06P5756

CEC Options

SMP Expansion Module (For all Xeon MP CPUs) 59P5188	SMP Expansion Module with Dual Xeon 2.4 GHz 71P7919

ServeRAID Adapter Options

IBM ServeRAID- 4H Ultra160 SCSI 37L6889	IBM ServeRAID- 4Lx Ultra160 SCSI 06P5740	IBM ServeRAID- 4Mx Ultra160 SCSI 06P5736

Networking & Storage Options

IBM Gigabit Ethernet Adapter 31P6301	FASiT Host Adapter 00N6881	2Gb Fiber Channel PCI-X Adapter 19K1246

Other Options

Service Processor Power Adapter 02K6699	USB to Serial Adapter for UPS Mgmt 10K3661	16X/40X DVD-ROM IDE Option Kit 10K3576

x440 16-way Upgrade Configuration Kits

4-way to 16-way Configuration Kit 73P8734	8-way to 16-way Configuration Kit 73P8735

Need more information?**World Wide Web**

IBM eServer xSeries 440

IBM Enterprise X-Architecture

IBM Benchmarks

x440 ServerProven

VMware ESX Server

Microsoft Datacenter

Systems Management

PC Magazine PC Expo Best of Show

PC Magazine Technical Excellence Award

Network World Fusion World Class Award

Network World Best of the Tests Award

PC Magazine Editors' Choice

Conseco Finance, VMware & x440

XpandOnDemand @ I.T. Xchange

www.pc.ibm.com/us/eserver/xseries/x440.htmlwww.ibm.com/enterprisearchitecturewww.pc.ibm.com/ww/eserver/xseries/benchmarks/www.pc.ibm.com/us/compat/machines/x440.htmlwww.pc.ibm.com/ww/eserver/xseries/vmware.htmlwww.pc.ibm.com/ww/eserver/xseries/windows/datacenter.htmlwww.pc.ibm.com/ww/eserver/xseries/systems_management/www.pcmag.com/article2/0,4149,273123,00.aspwww.pcmag.com/article2/0,4149,728675,00.aspwww.nwfusion.com/reviews/2002/1007rev1.htmlwww.nwfusion.com/best/2002/tests.htmlwww.pcmag.com/article2/0,4149,530298,00.aspwww.vmware.com/solutions/stories/conseco.htmlwww.itxchange.com/ibm/xpandondemand

© Copyright IBM Corporation 2003. All rights reserved.

IBM Corporation

3039 Cornwallis Road

Research Triangle Park, North Carolina 27709 USA

June 2003

All Rights Reserved

IBM reserves the right to change specifications or other product information without notice. This publication could include technical inaccuracies or typographical errors. References herein to IBM products and services do not imply that IBM intends to make them available in other countries. IBM PROVIDES THE PUBLICATION "AS IS" WITHOUT WARRANTY OF ANY KIND, EITHER EXPRESS OR IMPLIED, INCLUDING THE IMPLIED WARRANTIES OF MERCHANTABILITY OR FITNESS FOR A PARTICULAR PURPOSE. SOME JURISDICTIONS DO NOT ALLOW DISCLAIMER OF EXPRESS OR IMPLIED WARRANTIES IN CERTAIN TRANSACTION; THEREFORE, THIS DISCLAIMER MAY NOT APPLY TO YOU.

IBM, the IBM logo, the e-business logo, Active Memory, Active PCI, Active PCI-X, C2T Interconnect, Chipkill, DB2, DB2 Universal Database, Informix, Light Path Diagnostics, Memory ProteXion, NetBAY, Predictive Failure Analysis, ServerGuide, ServerProven, ServeRAID, Tivoli, WebSphere, X-Architecture, Xcel4, XpandOnDemand, and zSeries, iSeries, pSeries, and xSeries are trademarks or registered trademarks of International Business Machines Corporation or Tivoli Systems Inc. in the United States, other countries, or both.

Lotus Notes is a trademark of Lotus Development Corporation in the United States or other countries or both.

Intel, Pentium, Itanium and Xeon are trademarks of Intel Corporation.

UNIX is a registered trademark of The Open Group in the United States and other countries.

VMware is a trademark of VMware Inc. in the United States, other countries or both.

Java and all Java-based trademarks are registered trademarks or trademarks of Sun Microsystems, Inc., in the United States, other countries, or both.

Microsoft, Windows, Windows NT, and the Windows logo are registered trademarks of Microsoft Corporation in the United States, other countries, or both.

Other company, product and service names may be trademarks or service marks of others.

References in this publication to IBM products, programs or services do not imply that IBM intends to make these available in all countries in which IBM operates. Any reference to an IBM product, program or service is not intended to imply that only IBM's product, program or service may be used. Any functionally equivalent product, program or service may be used instead. All information is subject to change with notice and is provided as is with no warranties. This publication is for general guidance only. Photographs may show design models.

