

7331 and 3449 8mm Tape Library

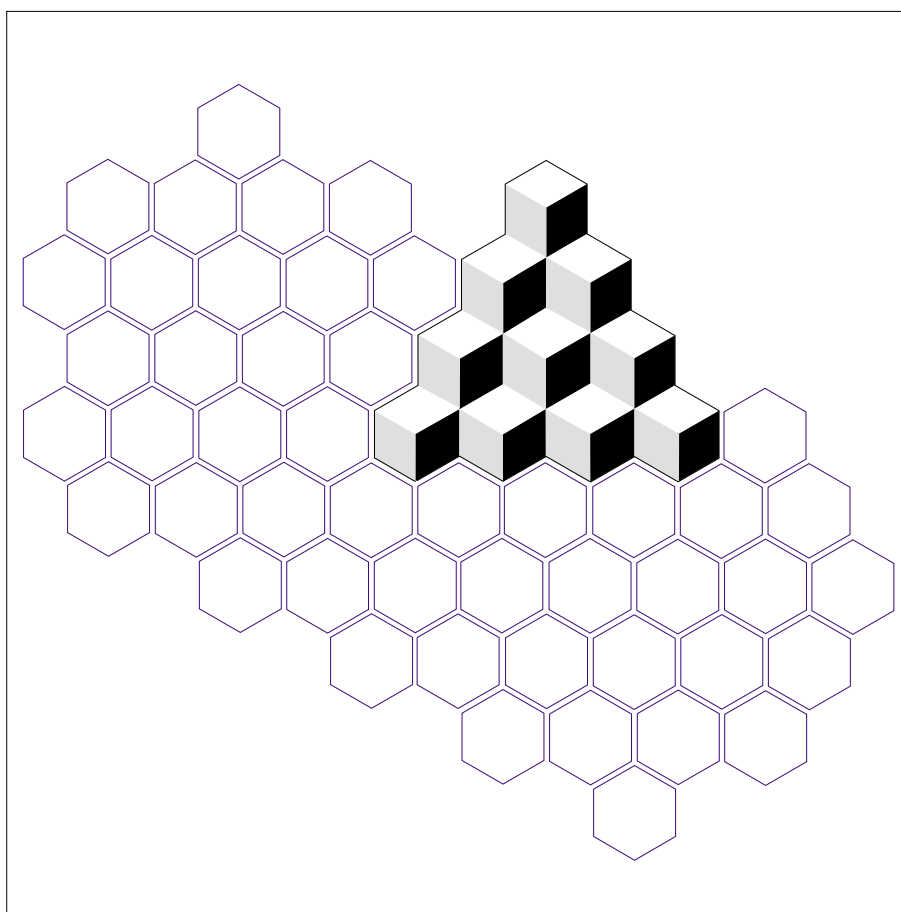

Model 3xx

Operator Guide



7331 and 3449 8mm Tape Library



Model 3xx

Operator Guide

Note!

Before using this information and the product it supports, be sure to read the general information under "Notices" on page ix.

First Edition (October 1997)

The following paragraph does not apply to any country where such provisions are inconsistent with local law.

INTERNATIONAL BUSINESS MACHINES CORPORATION PROVIDES THIS PUBLICATION "AS IS" WITHOUT WARRANTY OF ANY KIND, EITHER EXPRESS OR IMPLIED, INCLUDING BUT NOT LIMITED TO THE IMPLIED WARRANTIES OF MERCHANTABILITY OR FITNESS FOR A PARTICULAR PURPOSE.

Some states do not allow disclaimer of express or implied warranties in certain transactions; therefore, this statement may not apply to you.

Order publications through your IBM representative or the IBM branch office serving your locality. Publications are not stocked at the address given below.

A reader's comment form is provided at the back of this publication. Either mail the completed form or fax it to (520) 799-2906. If the form has been removed, address your comments about this book to:

IBM Corporation, Department 61C, 9000 South Rita Road, Tucson, AZ 85744-0001, U.S.A.

When you send information to IBM, you grant IBM a nonexclusive right to use or distribute the information in any way it believes appropriate without incurring any obligation to you.

© **Copyright International Business Machines Corporation 1997. All rights reserved.**

US Government Users Restricted Rights – Use, duplication or disclosure restricted by GSA ADP Schedule Contract with IBM Corp.

Contents

Figures	v
Notices	ix
Safety Notices	ix
Danger Notices	ix
Caution Notices	x
Attention Notices	x
Safety Inspection Procedures	x
Environmental Notices	xi
Product Recycling	xi
Product Disposal	xii
Environmental Design	xii
Trademarks	xii
IBM Agreement for Licensed Internal Code	xii
Actions You May Not Take	xiii
Electronic Emission Notices	xiii
Preface	xv
Related Publications	xv
Related Webpage Sources	xv
About This Guide	xv
Chapter 1. Introduction	1
System Requirement for 7331 Model 305	1
System Requirement for 3449 Models 355 and 356	1
Enabling the 7331 Library as an IPL Device	1
7331 Model 305 SCSI Adapter/Cabling Reference Guide	3
3449 Models 355 and 356 SCSI Adapter/Cabling Reference Guide	3
8mm Tape Library SCSI Bus Configurations	3
Single Host Configuration (Single or Dual Drives)	3
Dual Drive - Dual Host Configuration	4
8mm Tape Library Configurations	4
Base Library Configuration	4
Base Configuration External Cabling Requirements	4
Modes of Operation in Base Configuration	4
Split Library Configuration	6
Split Configuration External Cabling Requirements	7
Modes of Operation in Split Configuration	7
Sequential/Random Mode	9
Random/Sequential Mode	9
Mapping Element Address to Physical Locations	9
8mm Tape Library Tape Drive Cleaning Requirements	9
Automatic Drive Cleaning	10
Chapter 2. Operating the 8mm Tape Library	11
Control Panel	11
Power Switch and Power-On Indicator	12
Door Unlock Button	12
Door Lock Indicator	13
Key Lock	13
Control Buttons	14
Control Panel Liquid Crystal Display (LCD)	14
Tape Drive Unload Button and Status Lights	17

Unload Button	17
Status Lights.	17
Control Panel Operations	18
Powering On the Library	19
Powering Off the Library	22
8mm Tape Library Menu Structure	24
Displaying the Main Menu	24
Displaying the Mode Menu	25
Random Mode	26
Sequential Mode	29
Random/Sequential Mode	39
Sequential/Random Mode	42
Selecting the Command Menu	46
Performing Inventory of the Tape Library Contents	46
Moving a Tape	48
Move Error Condition and Recovery (Manual Mode)	50
Manually Cleaning the Tape Path: Cleaning Cartridge Present	50
Setting the 8mm Tape Library Configurations	53
Setting Base Library Configuration	53
Setting Split Library Configuration	54
Setting Up the Tape Library Operation Parameters	56
Setting the Tape Drive Cleaning Schedule	56
Cleaning Cartridge Bar Code Label Mask	66
Selecting the SCSI ID	67
Setting the Library Clock Time and Date	70
Adjusting the Display Brightness and Contrast	73
Selecting the Control Panel Display Language	75
Enabling and Disabling Sequential Autorestarts	76
Service	77
Library Operations	77
Opening the Tape Library Front Door	77
Manually Cleaning the Tape Path: Cleaning Cartridge Not Present	80
Applying Bar Code Labels to a Tape Cartridge	81
Inserting and Removing a Tape Cartridge in a Tape Cartridge Magazine	82
Installing and Removing a Tape Cartridge Magazine	83
Inserting and Removing a Tape Cartridge in the 2-Slot Tape Cartridge Holder	85
Loading and Unloading Tape Cartridges in a Tape Drive	86
Chapter 3. Media	89
Types of 8mm Cartridges	89
Bar Code Label Specifications	90
Recommendations and User Environments for 8mm Cartridges	90
8mm Data Cartridge Erasure	91
Operating, Storage, and Shipping Environments	91
Operating in Harsh Environments	92
Setting the Write-Protect Switch	93
Chapter 4. Operator Corrective Actions	95
Appendix A. Bar Code Label Vendor List	99
Bar Code Labels	99
Appendix B. Statement of Limited Warranty	101
Index	105

Figures

1. AC Grounding Diagram (50 Hz and 60 Hz)	xi
2. 8mm Tape Library	1
3. Control Panel	11
4. Move Picker Buttons inside Library Front Door	12
5. Random Mode Display	15
6. Random, Sequential, and Manual Mode Displays	15
7. Magazine and Tape Drive Status Displays	16
8. Tape Cartridge Display Icons	16
9. Tape Drive Unload Button and Status Lights	17
10. Control Panel	19
11. Power On Selftest in Progress Display	20
12. Power On Selftest Failure Display	21
13. Power On Selftest Warning Display	21
14. Power On Selftest Complete Display	22
15. Initializing Display	22
16. Control Panel	23
17. Menu Structure	24
18. Main Menu Display	26
19. Random Mode Display	26
20. Split Random Mode Display	27
21. Moving Display	27
22. Random Mode Display	28
23. Cancel Display	28
24. Manual Display	29
25. Mode Menu Display	29
26. Main Menu Display	29
27. Sequential Mode Menu Display	30
28. Sequence of Operation when Loading to One Drive in a Two Drive Configuration	31
29. Sequence of Operation when Loading to Both Drives	31
30. Sequence Mode Tapes Loaded Display	31
31. Sequence Mode Paused Display	32
32. Sequential Setup Menu	33
33. Sequential Status	33
34. Sequential Setup Menu	34
35. Sequential Status	35
36. Error Display	35
37. Sequential Mode Paused Display	36
38. Sequential Mode Paused Restart Display	36
39. Sequential Mode Display	37
40. End Sequential Mode Display	37
41. Sequential Mode Paused Display	38
42. Mode Menu Display	39
43. Main Menu Display	39
44. Main Modes Menu Display	40
45. Split, Random, Sequential Modes Menu Display	40
46. Motion Commands Display	40
47. Off-Line Error Display	41
48. Cancel Display	41
49. Operator Canceled Display	42
50. Random Sequential Display	42
51. Main Menu Display	42
52. Main Menu Display	43
53. Sequential Random Mode Display	43

54. Motion Commands Display	44
55. Motion Commands Display	44
56. Cancel Display	45
57. Operator Canceled Display	45
58. Mode Menu Display	45
59. Main Menu Display	46
60. Commands Display	46
61. Inventory Select Display	47
62. Inventory Display	47
63. Inventory Select Display	48
64. Main Menu Display	48
65. Off Line Menu Display	49
66. Off Line Selection Display	49
67. Off Line Command Menu Display	50
68. Off Line Error Display	50
69. Off Line Command Menu Display	51
70. Off Line Cleaning Menu Display	52
71. Off Line Cleaning Operation Display	52
72. Off Line Error Display	53
73. Main Menu Display	54
74. Off Line Configuration Menu Display	54
75. Main Menu Display	55
76. Off Line Configuration Menu Display	55
77. Main Menu Display	56
78. Off Line Set-up Menu Display	57
79. Off Line Cleaning Options Menu Display	58
80. Off Line Disabled Menu Display	58
81. Off Line Cleaning Mask Display	59
82. Off Line Drive Status Display	60
83. Off Line Cleaning Mask Display	60
84. Off Line Cleaning Daily Display	61
85. Off Line Cleaning Hour Display	61
86. Off Line Cleaning Minute Display	62
87. Off Line Cleaning Second Display	62
88. Off Line Cleaning Mask Display	63
89. Off Line Cleaning Weekly Display	63
90. Off Line Cleaning Day Display	64
91. Off Line Cleaning Hour Display	64
92. Off Line Cleaning Minute Display	64
93. Off Line Cleaning Second Display	65
94. Off Line Select Cleaning Mask Display	65
95. Off Line Select Cleaning Mask Display	66
96. Off Line Set-up Menu Display	68
97. Off Line SCSI ID Display	68
98. Off Line SCSI ID Match Display	69
99. SCSI ID Warning Display	69
100. Power Off Message Display	70
101. Off Line Set-up Menu Display	70
102. Off Line Set-up Menu Display	71
103. Off Line Select Format Display	71
104. Off Line Select Hour Display	71
105. Off Line Select Minute Display	72
106. Off Line Select Second Display	72
107. Off Line Select Month Display	72
108. Off Line Select Day Display	73
109. Off Line Select Year Display	73

110. Off Line Set-up Menu Display	73
111. Off Line Set-up Menu Display	74
112. Off Line Select Brightness Display	74
113. Off Line Select Contrast Display	75
114. Off Line Main Menu Display	75
115. Off Line Language Display	76
116. Off Line Main Menu Display	76
117. Off Line Sequential Display	77
118. Control Panel Door Opening Controls	78
119. Message Display	79
120. Opening Door Display	79
121. Loading the Cleaning Cartridge in a Tape Drive	80
122. Tape Cartridge Bar Code Label Placement	82
123. Inserting a Tape Cartridge into a Magazine	83
124. Tape Library 10-Slot Magazine	84
125. Inserting a Tape Cartridge into a 2-Slot Cartridge Holder	85
126. Loading a Tape Cartridge in a Tape Drive	86
127. Tape Drive Front Panel	87
128. Tape Cartridge Bar Code Label Placement	90
129. Operating Environment	92
130. Recommended Environment for 8mm Data Cartridges	92
131. Cartridge Showing Read/Write Window	93

Notices

References in this publication to IBM products, programs, or services do not imply that IBM intends to make these available in all countries in which IBM operates.

Any reference to an IBM program or other IBM product in this publication is not intended to state or imply that only IBM's program or other product may be used. Any functionally equivalent program that does not infringe any of IBM's intellectual property rights may be used instead of the IBM product. Evaluation and verification of operation in conjunction with other products, except those expressly designated by IBM, is the user's responsibility.

IBM may have patents or pending patent applications covering subject matter in this document. The furnishing of this document does not give you any license to these patents. You can send license inquiries, in writing, to the IBM Director of Licensing, IBM Corporation, 500 Columbus Avenue, Thornwood, NY 10594, U.S.A.

Safety Notices

Listed below are the safety requirements for operating this product.

Each danger and caution notice contains a reference number (RSFTxxxx). Use the reference number to check the translation in *External Devices Translated Safety Notices*, SA26-7192.

Danger Notices

A danger notice calls attention to a situation that is potentially lethal or extremely hazardous to people.

The following danger notices appear in this publication:

DANGER

To prevent a possible electrical shock from touching two surfaces with different electrical grounds, use one hand, when possible, to connect or disconnect signal cables. (RSFTD004)

DANGER

An electrical outlet that is not correctly wired could place hazardous voltage on metal parts of the system or the products that attach to the system. It is the customer's responsibility to ensure that the outlet is correctly wired and grounded to prevent an electrical shock. (RSFTD201)

DANGER

To prevent a possible electrical shock when adding or removing any devices to or from the system, ensure that the power cords for those devices are unplugged before the signal cables are connected or disconnected. If possible, disconnect all power cords from the existing system before you add or remove a device.

DANGER

To prevent a possible electrical shock when installing the device, ensure that the power cord for that device is unplugged before installing signal cables. (RSFTD204)

Caution Notices

A caution notice calls attention to a situation that is potentially hazardous to people because of some existing condition.



The general caution symbol identifies conditions where caution must be used.



The electrical caution symbol identifies electrical hazards where extreme caution must be used.



The weight caution symbol indicates that the 7331 8mm Tape Library weighs 42 kilograms (92.5 pounds). It takes three persons to safely lift the unit.



The laser caution symbol indicates a laser device is present. Handling laser devices requires trained and knowledgeable personnel. Extreme caution is required.

Laser Safety Cautions

The following laser safety cautions appear in this document:

CAUTION:

The bar-code reader contains a Class II laser component. Only trained service personnel may repair the bar-code reader. (RSFTC237)

CAUTION:

Do not place a highly reflective surface between either the picker assembly and the tape cartridge magazines or between the picker assembly and the tape drives. This may cause damage to your eyes. (RSFTC238)

CAUTION:

If the automatic lock on the front door is not functioning and the door is open, do not look directly at the laser beam. Staring at the beam may cause damage to your eyes. (RSFTC239)

Attention Notices

An attention notice indicates the possibility of damage to a program, device, system, or data.

Safety Inspection Procedures

Perform the following safety inspection prior to the normal maintenance agreement inspection. **Suspect the 8mm Tape Library is unsafe until verified it is safe.** If unsafe conditions are present, decide how serious the hazard is and whether you can continue without correcting the problem. Possible safety hazards are:

Electrical

An electrically charged frame can cause serious or lethal electrical shock.

Mechanical

Hazards, such as a missing safety cover, are potentially harmful to people.

Chemical

Do not use solvents, cleaners, or other chemicals not approved for use on the product.

Use Figure 1 to perform the following safety procedures. Before starting the procedures, ensure the existing room and electrical conditions are safe.

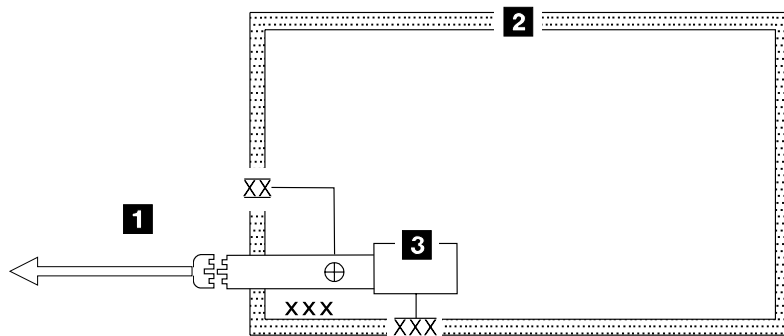

Legend:

- XX External tooth lock washer
Green/yellow ground wire terminated to chassis or ground
- ⊕ Green/yellow ground wire terminated with slip-on spade terminal
- XXX Redundant ground path to frame
- XXX External tooth lock washer

34M0139

Figure 1. AC Grounding Diagram (50 Hz and 60 Hz)

1. Power off the 8mm Tape Library.
2. Disconnect the channel cables.
3. Disconnect the power cord **1** from its source.
4. Check that no voltage exists between the housing on the power source and the building ground.
5. Verify that resistance is less than 0.1 ohm from the building ground to the power supply enclosure **3**.
6. Inspect the power cable **1** for visible cracks, wear, or damage.
7. Check that resistance between the power cable ground and the 8mm Tape Library frame **2** is less than 0.1 ohm.
8. Inspect the power supply enclosure covers **3** to ensure that all screws are installed and are tight.

Environmental Notices

The following is environmental information pertaining to the 8mm Tape Library.

Product Recycling

This unit contains recyclable materials. The materials should be recycled where facilities are available and according to local regulations. In some areas, IBM will

provide a product take-back program that ensures proper handling of the product. Contact your IBM representative for more information.

Product Disposal

This unit may contain batteries. The batteries must be removed and discarded, or recycled according to local regulations and where facilities exist. Specific information per battery type will be referenced throughout the manual where applicable.

Environmental Design

The environmental efforts that have gone into the design of this unit signifies IBM's commitment to improve the quality of its products and processes. Some of these activities include elimination of the use of CFCs, development of reusable or recyclable packaging, and reductions in manufacturing wastes.

Trademarks

The following terms are trademarks of the IBM Corporation in the United States or other countries or both:

IBM
AIX
IBMLINK
RS/6000
AIX System Backup and Recovery/6000

The following terms are trademarks of other companies:

CSA Canadian Standards Association
UL Underwriter's Laboratories
EXATAPE
Exabyte

IBM Agreement for Licensed Internal Code

You accept the terms of this Agreement by your initial use of a machine that contains IBM Licensed Internal Code (called "Code").

These terms apply to Code used by certain machines IBM or your reseller specifies (called "Specific Machines"). International Business Machines Corporation or one of its subsidiaries ("IBM") owns copyrights in Code or has the right to license Code. IBM or a third party owns all copies of Code, including all copies made from them.

If you are the rightful possessor of a Specific Machine, IBM grants you a license to use the Code (or any replacement IBM provides) on, or in conjunction with, only the Specific Machine for which the Code is provided. IBM licenses the Code to only one rightful possessor at a time.

Under each license, IBM authorizes you to do only the following:

1. Execute the Code to enable the Specific Machine to function according to its Official Published Specifications (called "Specifications");
2. Make a backup or archival copy of the Code (unless IBM makes one available for your use), provided you reproduce the copyright notice and any other legend of ownership on the copy. You may use the copy only to replace the original, when necessary; and
3. Execute and display the Code as necessary to maintain the Specific Machine.

You agree to acquire any replacement for, or additional copy of, Code directly from IBM in accordance with IBM's standard policies and practices. You also agree to use that Code under these terms.

You may transfer possession of the Code to another party only with the transfer of the Specific Machine. If you do so, you must 1) destroy all your copies of the Code that were not provided by IBM, 2) either give the other party all your IBM-provided copies of the Code or destroy them, and 3) notify the other party of these terms. IBM licenses the other party when it accepts these terms. These terms apply to all Code you acquire from any source.

Your license terminates when you no longer rightfully possess the Specific Machine.

Actions You May Not Take

You agree to use the Code only as authorized above. You may not do, for example, any of the following:

1. Otherwise copy, display, transfer, adapt, modify, or distribute the Code (electronically or otherwise), except as IBM may authorize in the Specific Machine's Specifications or in writing to you;
2. Reverse assemble, reverse compile, or otherwise translate the Code unless expressly permitted by applicable law without the possibility of contractual waiver;
3. Sublicense or assign the license for the Code; or
4. Lease the Code or any copy of it.

Electronic Emission Notices

Industry Canada Compliance Statement

This Class A digital apparatus meets all requirements of the Canadian Interference-Causing Equipment Regulations.

Avis de conformité à la réglementation d'Industrie Canada

Cet appareil numérique de la classe A respecte toutes les exigences du Règlement sur le matériel brouilleur du Canada.

European Community Compliance Statement

This product is in conformity with the protection requirements of EC Council Directive 89/336/EEC on the approximation of the laws of the Member States relating to electromagnetic compatibility. IBM cannot accept responsibility for any failure to satisfy the protection requirements resulting from a non-recommended modification of the product, including the fitting of non-IBM option cards.

This product has been tested and found to comply with the limits for Class B Information Technology Equipment according to CISPR 22 / European Standard EN 55022. The limits for Class B equipment were derived for typical residential environments to provide reasonable protection against interference with licensed communication devices.

Properly shielded and grounded cables and connectors (IBM part number 21H1955 or its equivalent) must be used in order to reduce the potential for causing interference to radio and TV communications and to other electrical or electronic

equipment. Such cables and connectors are available from IBM authorized dealers. IBM cannot accept responsibility for an interference caused by using other than recommended cables and connectors.

Germany Only: This product is in conformity with the EN55022 class B emission limits.

Japanese Voluntary Control Council for Interference (VCCI) Statement

この装置は、情報処理装置等電波障害自主規制協議会（VCCI）の基準に基づく第一種情報技術装置です。この装置を家庭環境で使用すると電波妨害を引き起こすことがあります。この場合には使用者が適切な対策を講ずるよう要求されることがあります。

Korean Government Ministry of Communication (MOC) Statement

Please note that this device has been approved for non-business purposes and may be used in any environment including residential areas.

Preface

This publication provides operator knowledge to both set up a 7331 and 3449 8mm Tape Library environment and operate the library.

Note: Figures of the operator panels display **7331–3xx**. These are for reference only. Panels on the actual product will display **7331–305**, **3449–355**, or **3449–356**.

Related Publications

- *External Devices Translated Safety Notices*, SA26-7192 provides translations of danger and caution notices.
- *7331 8mm Tape Library, Model 3xx Installation Guide* provides installation information for the Tape Library.
- *7331 8mm Tape Library, Model 3xx Operator Guide* provides information about operating the Tape Library.

Related Webpage Sources

- <http://www.us.pc.ibm.com/server> for information regarding the current IBM PC Company Compatible Systems and Applications for 3449 Models 355 and 356.

About This Guide

This Operator's Guide provides instruction on the use and care of the 8mm Tape Library Model 3xx. It contains the following:

- "Chapter 1. Introduction" on page 1 provides general information about the 8mm Tape Library Model 3xx.
- "Chapter 2. Operating the 8mm Tape Library" on page 11 provides instruction on operating the 8mm Tape Library Model 3xx.
- "Chapter 3. Media" on page 89 describes the use and care of media used in the 8mm Tape Library Model 3xx.
- "Chapter 4. Operator Corrective Actions" on page 95 provides a list of library error codes and appropriate required operator action.
- "Appendix A. Bar Code Label Vendor List" on page 99 shows the sources from which bar code labels may be purchased.
- "Appendix B. Statement of Limited Warranty" on page 101 is the 7331 and 3449 8mm Tape Library, Model 3xx Operator Guide warranty.

Chapter 1. Introduction

This chapter provides a brief description of the 7331 and 3449 Tape Libraries, their operational modes, and configuration options. 7331 Model 305 is used in an RS/6000 environment, 3449 Model 355 is used in a PC Tower environment, and 3449 Model 356 is used in a PC Rack Mount environment.

System Requirement for 7331 Model 305

The system requirement for the 7331 Model 305 Library is any RISC System/6000 platform with an AIX operating system at level 4.1.5, 4.2, or higher.

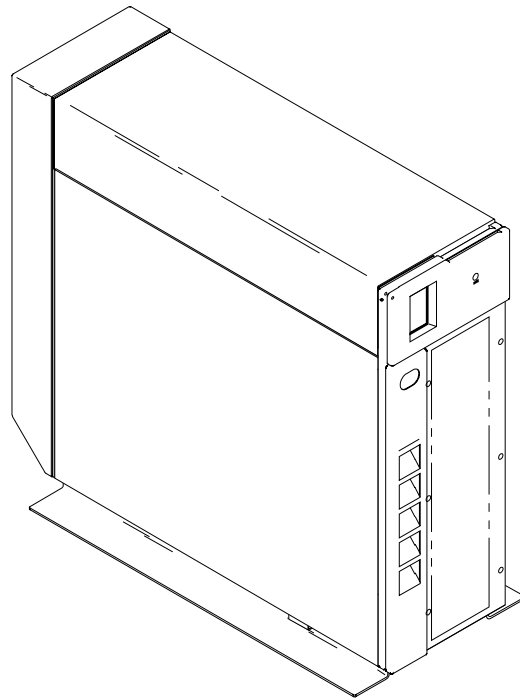

ASFNLASM-00

Figure 2. 8mm Tape Library

The 8mm Tape Library, (see Figure 2), provide an automated tape library solution. They can be used as a 20-cartridge library, two 10-cartridge libraries, or as an autoloader library.

System Requirement for 3449 Models 355 and 356

The current IBM PC Company Compatible Systems and Applications, for 3449 Models 355 and 356, can be found on the PC Company webpage at <http://www.us.pc.ibm.com/server>.

Enabling the 7331 Library as an IPL Device

The 7331 Tape Drive can be enabled as an initial program load (IPL) device capable of powering certain models of the RS/6000. The applicable RS/6000 models and their required firmware are listed as follows:

7043 Model 140

System firmware level must be at TIG97038 or later

7043 Model 240

System firmware level must be at DOR97038 or later

7025-F40

System firmware level must be at TR97038 or later

7026-H10

System firmware level must be at TR97038 or later

Firmware and installation instructions may be downloaded from:

<http://www.rs6000.ibm.com/support/micro>

To determine the firmware version your RS/6000 is running:

- **If you are using a graphical user interface (GUI) display:**

The firmware version number is shown at the bottom right of the initial power-on screen.

- **If you are using an ASYNC terminal connected to one of your system's serial ports:**

The firmware version is shown at the top of all System Management Services (SMS) menus.

To get to the SMS main menu:

1. Turn the power on to your RS/6000.
2. Watch for network to display at the bottom of the screen.
3. Press the num sign.1 key. After a few seconds, the SMS main menu displays.

The 7331 8mm Tape Library has the following features:

- The library is configured as a stand-alone tower.
- An internal power supply that provides power for the tape library and the tape drives.
- Two internally mounted drives.
- A picker (transport mechanism) that moves the cartridges between the magazine slots and drives.
- Two removable 10-cartridge magazines.
- Two bonus slots:
 - One cleaning cartridge slot.
 - One custom slot for either a second cleaning cartridge, drive diagnostic cartridge, drive test cartridge, data cartridge, or special user application cartridges.
- A front door, which provides access to the tape magazines and tape drives. Two locks on the door, a key lock and a software controlled lock, provide security and safety.
- An optional bar code reader for cartridge identification.
- An operator control panel with an operator key pad and a graphical liquid crystal display (LCD).

The 7331 8mm Tape Library comes with a wide differential Small Computer System Interface (SCSI-2), which attaches to the RISC System/6000* (RS/6000*) computer.

7331 Model 305 SCSI Adapter/Cabling Reference Guide

Table 1. Model 305 SCSI Reference Guide

Adapter Feature	Description	SCSI Cable Length	SCSI Cable Features		Terminator Features		Interposer Features	
			Plant	MES	Plant	MES	Plant	MES
2409 or 6209	PCI SCSI-2 Diff F/W PCI SCSI-2 F/W Diff	2.5m	9132	2846	9166	2890	Not Needed	Not Needed
		4.5m	9172	2893	9166	2890	Not Needed	Not Needed
		14.0m	9173	2894	9166	2890	Not Needed	Not Needed
2412 or 2416	Enhanced SCSI-2 Diff SCSI-2 Diff F/W	1.5m	9130	2844	Included	Included	Not Needed	Not Needed
		2.5m	9132	2846	9166	2890	9171	2892
		2.5m	9143	2867	Included	Included	9171	2892
		4.5m	9172	2893	9166	2890	9171	2892
		14.0m	9173	2894	9166	2890	9171	2892
2420	SCSI-2 Diff High Performance External I/O Controller	2.5m	9142	2866	Included	Included	Included	Included
		4.5m	9172	2893	9166	2890	9170	2891
		14.0m	9140	2861	Included	Included	Included	Included
	Non-IBM F/W Diff	2.5m	9142	2866	Included	Included	Included	Included
		14.0m	9140	2861	Included	Included	Included	Included
	Non-IBM F/W Diff	2.5m	9143	2867	Included	Included	N/A	N/A
		14.0m	9173	2894	9166	2890	N/A	N/A

3449 Models 355 and 356 SCSI Adapter/Cabling Reference Guide

3449 Models 355 and 356 are shipped with an 3449 Fastwide SCSI adapter card and a 4.5m SCSI cable. No other adapters or cabling configurations are supported.

8mm Tape Library SCSI Bus Configurations

The 8mm Tape Library can be set in the following SCSI bus configurations:

- Single host computer system
- Dual drive - dual host computer system

Refer to the *7331 8mm Tape Cartridge Library Model 3xx Installation Guide* GA32-0375, for information on SCSI cable installation.

Single Host Configuration (Single or Dual Drives)

The 8mm Tape Library is configured as a single host computer system when the tape library is attached to a single host computer system or adapter. During random mode, in the single host configuration, the library and all tape drives are controlled by the single adapter. During sequential mode, in the single host configuration, all tape drives are controlled by the single adapter.

Dual Drive - Dual Host Configuration

A dual host configuration is used when the tape library is shared between two host computer systems. Tape Drive 1 is controlled by the host computer system attached to the library ports 1 and 2 (accessed using connectors 1 and 2 on the rear of the Tape Library). Tape Drive 2 is controlled by the host computer system attached to the library ports 3 and 4 (accessed using connectors 3 and 4 on the rear of the Tape Library).

8mm Tape Library Configurations

The following configurations are supported by the 8mm Tape Library:

1. Base library configuration.
2. Split library configuration.

A library configuration is characterized by the differences in the following components available to the host over the SCSI interface:

- Media Changer Components
 - Number of addressable storage elements (slots)
 - Storage element accessibility (cartridges)
 - Data transfer element accessibility (drives)
 - Medium transfer element accessibility (accessor)
- Drive Accessibility and Operation

Base Library Configuration

In the base library configuration, the library elements are only accessible to the host through the primary port (accessed using connectors on the rear of the Tape Library). The secondary port is not enabled as a target.

Base Configuration External Cabling Requirements

The base library configuration supports two SCSI BUS configurations. Prior to entering the base library configuration, ensure the library is cabled in one of the following two SCSI BUS configuration options:

1. Single Drive - Single Host SCSI Configuration
2. Dual Drive - Single Host SCSI Configuration

Note: Refer to the 7331 and 3449 8mm Tape Library, Model 3xx Installation Guide for more information.

Modes of Operation in Base Configuration

The 8mm Tape Library base configuration supports the following three modes of operation that are selected using the operator control panel:

- Manual Mode (offline)
- Sequential Mode
- Random Mode

Manual Mode in Base Configuration

When the library is not in random mode or sequential mode it is in manual mode and considered off-line. During manual mode the operator uses the control panel to manually operate the library to move cartridges, load drives, or to perform maintenance and service.

If a library door is open or an error condition occurs, the system interrupts the manual mode operation and displays a message on the operator control panel.

Sequential Mode in Base Configuration

Sequential mode is selected on the 8mm Tape Library from the operator panel. Sequential mode is to be used with operating systems that do not support media changers but still want library automation.

Sequential mode continually feeds tape drive 1 with tape cartridges from the magazines. During sequential mode operation, the host computer system controls drive functions and the unload of the tape cartridge from the tape drive. The library rejects any motion commands issued by the host computer system.

Note: The bonus slots are not used in sequential mode except when required for cleaning.

Sequential mode will not start if there is a tape cartridge in drive 1 or in the unloaded position of drive 1. In either condition, an error message is displayed on the operator control panel, and the error message is returned to the host computer.

Sequential Operation in Base Configuration

When in sequential mode, the library picks the first tape cartridge (the cartridge that is in the lowest slot of the magazines) and places it into drive 1. When the cartridge is ejected from the drive, it is returned to the same magazine slot from which it was removed.

The library automatically picks the next cartridge (the cartridge above the returned tape cartridge), and places it into drive 1. This cycle continues until all cartridges from both magazines have been processed.

When all cartridges are processed (picked, loaded into a drive, unloaded, and returned to the magazine slot from which it was removed) the operator control panel displays a message indicating that all of the tape cartridges are processed.

If either the front door is opened prior to completion or an error condition is detected by the library, the 8mm Tape Library will stop sequential mode operation and display a message on the operator control panel. Once the condition is corrected, the operator can choose to either continue at the point sequential mode was interrupted, or to restart with the cartridge in the lowest slot of the bottom magazine.

Random Mode in Base Configuration

Random mode allows the library to function as a self-contained library system composed of 20 cartridges and two bonus slots, controlled by a host computer system. The host computer system uses commands to select a cartridge in a given slot or drive and move it to a destination slot or drive. The source and destination are controlled by the host computer system.

Random mode is selected from the control panel or through the mode select command issued by the host system. Random mode continues until another mode is selected.

If the door is opened and then closed while in random mode, the library responds to the next host command with a Unit Attention.

If the front door is opened before the operation is complete or an error condition is detected, random mode operation stops, a message displays on the operator control panel, and the condition is reported to the host computer system.

Split Library Configuration

The 8mm Tape Library, as referenced in Table 2, has the ability to be shared between host systems. However, not all applications and systems allow sharing devices between systems. Split library configuration allows for a single Tape Library to be used by multiple systems. This is accomplished by having the library appear as two separate libraries on the SCSI bus.

Split configuration allows the library to function as two self-contained library systems (items **2** and **3**) composed of 10 cartridges each and two bonus slots (item **1**), controlled by a host computer system. The host computer system uses commands to select a cartridge in a given slot or drive and move it to a destination slot or drive. The source and destination are controlled by the host computer system.

- Tape cartridges in magazine 1 (item **3**), tape drive 1 (item **5**), and the bonus slots (item **1**) are accessible to host systems through the primary port (item **8**).
- Tape cartridges in magazine 2 (item **2**), tape drive 2 (item **4**), and the bonus slots (item **1**) are accessible to host systems through the secondary port (item **7**).
- Bonus slots are accessible through both ports (see item **6**).

Table 2. Split Configuration Element Assignments

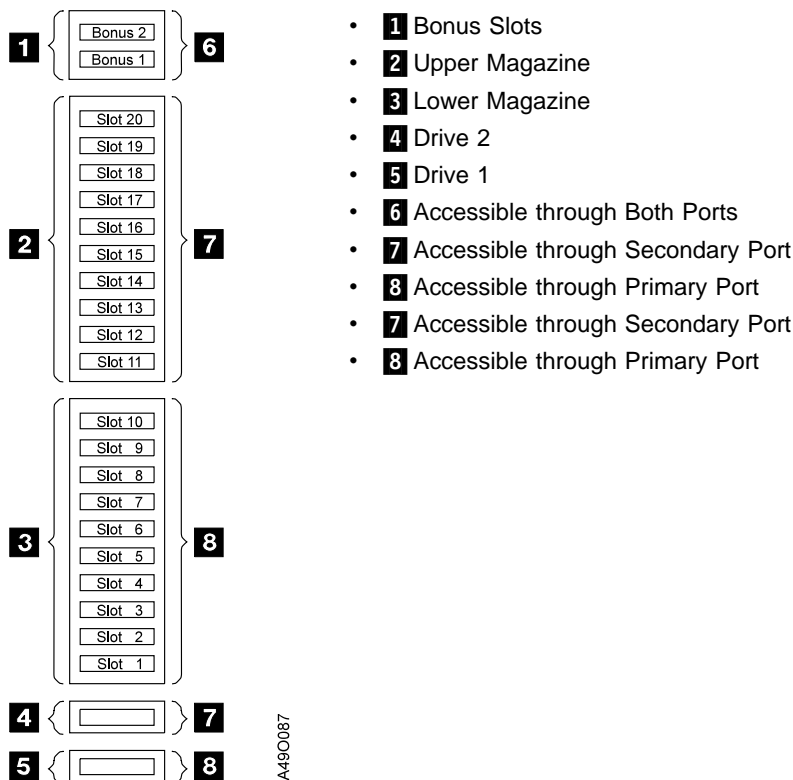

Notes:

1. The ports are accessed using the connectors at the rear of the 8mm Tape Library.
2. The bonus slots are available to both sets and may be accessed by host systems through either port. This is to allow the bonus slots to be used as a system interconnection for sharing information between systems.

Attention: Using the bonus slots in a split library configuration can result in a tape cartridge being moved to a slot in either half of the split library. Since each host has access to only one half of the library, the tape cartridge may become inaccessible to one of the hosts after the move.

Split Configuration External Cabling Requirements

The split library configuration supports the following SCSI BUS configurations. Prior to entering the split library configuration, ensure the library is cabled in one of the following SCSI BUS configurations:

- Dual Drive - Single Host SCSI Configuration
- Dual Drive - Dual Host SCSI Configuration

Note: Although dual drive, dual host is used most commonly, the Tape Library can be cabled as a dual drive, single host configuration, giving the user the ability to use sequential mode to load to both drives when cabled to one host. Refer to the 7331 and 3449 8mm Tape Library, Model 3xx Installation Guide for more information.

Modes of Operation in Split Configuration

The 8mm Tape Library Split Configuration supports the following modes of operation:

1. Manual Mode (Offline)
2. Sequential Mode (Selectable)
3. Random Mode (Selectable)
4. Sequential/Random Mode (Available only in Split configuration)
5. Random/Sequential Mode (Available only in Split configuration)

Sequential/Random mode and Random/Sequential mode allow the 7331 8mm Tape Library to be logically split in half with one half operating in sequential mode and the other half operating in random mode.

Manual Mode in Split Configuration

When the library is not in random mode or sequential mode it is in manual mode and considered off-line. Manual mode operation in split configuration is identical to manual mode in base configuration. See “Manual Mode in Base Configuration” on page 4 for more information.

If the front door is opened prematurely (before the operation is complete) or an error condition is detected, the system interrupts the manual mode operation and displays a message on the operator control panel.

Sequential Mode in Split Configuration

Sequential mode is selected on the 8mm Tape Library from the operator panel. Sequential mode is to be used with operating systems that do not support media changers but still want library automation.

Sequential mode continually feeds both tape drives one and two with tape cartridges from the magazines. During sequential mode operation, the host computer system controls drive functions and the unload of the tape cartridge from the tape drive. The library rejects any motion commands issued by the host computer system.

Note: The bonus slots are not used in sequential mode except when required for cleaning.

Sequential mode will not start if there is a tape cartridge in one of the drives or in the unloaded position of one of the drives. In either condition, an error message is displayed on the operator control panel and the error message is returned to the host computer.

Sequential Operation in Split Configuration

When in sequential mode, the library picks the first tape cartridge in the lower magazine (the cartridge that is in the lowest slot of the magazine) and places it into drive 1. The picker then picks the first tape cartridge in the upper magazine (the cartridge that is in the lowest slot of the magazine) and places it into drive 2. When a tape cartridge is ejected from either drive, it is returned to the magazine slot from which it was removed. The picker automatically gets the next cartridge above the returned tape cartridge, and places it into the appropriate drive.

This cycle continues until the top most cartridge in the each magazine is processed.

When all cartridges are processed (picked, loaded into a drive, unloaded, and returned to the magazine slot from which it was removed) the operator control panel displays a message indicating that all of the tape cartridges are processed.

If the front door is opened prematurely (before the operation is complete) or an error condition is detected, the 8mm Tape Library stops sequential mode operation and displays a message on the operator control panel. Once the condition is corrected, the operator can choose to either continue at the point sequential mode was interrupted, or restart with the cartridge in the lowest slot of each magazine.

Random Mode in Split Configuration

Random mode is selected from the control panel or through the mode select command issued by the host system. Random mode continues until another mode is selected.

If the door is opened and then closed while in random mode, the library responds to the next host command with a Unit Attention.

If the front door is opened prematurely (before the operation is complete) or an error condition is detected, random mode operation stops, a message displays on the operator control panel, and the condition is reported to the host computer system.

Note: The bonus slots are available to both sets and may be accessed by host systems through either port. This is to allow the bonus slots to be used as a system interconnection for sharing information between systems.

Attention: Using the bonus slots in a split library configuration can result in a tape cartridge being moved to a slot in either half of the split library. Since each host has access to only one half of the library, the tape cartridge may become inaccessible to one of the hosts after the move.

Sequential/Random Mode

When the 8mm Tape Library has been placed in a split configuration (see “8mm Tape Library Configurations” on page 4), the sequential/random mode of operation can be selected. Sequential/random mode splits the Tape Library so that Drive 1 and the lower magazine are operating in sequential mode while Drive 2 and the upper magazine are operating in random mode.

Random/Sequential Mode

When the 8mm Tape Library has been placed in a split configuration (see “8mm Tape Library Configurations” on page 4), the random/sequential mode of operation can be selected. Random/sequential mode splits the Tape Library so that Drive 1 and the lower magazine are operating in random mode while Drive 2 and the upper magazine are operating in sequential mode.

Mapping Element Address to Physical Locations

The 8mm Tape Library is shipped with each physical location capable of holding a tape cartridge assigned an initial element address value. The physical cartridge locations and the initial element address values are shown in Table 3:

Table 3. Initial Element Addresses

Initial Element Address	Element Class	Physical Component
0	Medium Transport	picker
1 (bottom) 10 (top)	Storage	lower magazine cartridges
11 (bottom) 20 (top)	Storage	upper magazine cartridges
21 (bottom) 22 (top)	Storage	bonus slot cartridges
23 (bottom)	Data Transfer	Drive 1
24 (top)	Data Transfer	Drive 2

The host may change the element address of the physical components with the Mode Select command. The host provides the starting address for the element class and the Tape Library assigns the starting addresses to the first physical component of that element class. The Tape Library then proceeds to assign, in ascending order, an element address to all physical components of that element class. The Mode Select command also allows the host to specify whether the element address changes are to be temporary (lost during a reset) or permanent (written to and restored from NVRAM after a reset).

Note: The element address values are checked by the 8mm Tape Library to ensure that duplicate element addresses do not exist across the different element classes. If a duplication would result, the Mode Select command returns a **CHECK CONDITION** message and the previous element address assignments are not altered.

8mm Tape Library Tape Drive Cleaning Requirements

The 8mm tape drive tape path should be cleaned for the following conditions:

- At least every 72 hours of tape motion. The tape drive counts the number of hours of tape motion and indicates when it is time to clean the tape path by turning on the amber disturbance (
 - ↳
) status light.
- As error rates exceed an acceptable value determined by the drive microcode.
- When Metal Particle (MP) media has been read and Advanced Metal Evaporated (AME) media has been loaded.

Attention: Failure to clean the 8mm tape path on a regular basis will void the tape drive warranty.

The 8mm Tape Library features manual and scheduled automatic tape path cleaning. Manual cleaning requires the operator to be present and to manually choose cleaning from the Command Menu on the library control panel. Scheduled automatic cleaning occurs when a schedule has been previously set in the library using the library Set-up Menu.

The automatic cleaning schedule may be set to clean the tape drives based on:

- The drive reports that cleaning is required in the request sense information to the library controller card.
- The operator sets the schedule for daily or weekly cleaning (see “Setting the Tape Drive Cleaning Schedule” on page 56).

Automatic Drive Cleaning

Although not strictly considered a mode of operation, enabling automatic cleaning initiates a unique mode of operation for the 8mm Tape Library.

The automatic cleaning mode is enabled at the operator panel. The operator may select one of the following events to initiate an automatic cleaning operation:

- Scheduled Daily
- Scheduled Weekly
- When the drive sets the clean (CLN) bit.

Note: See “Setting the Tape Drive Cleaning Schedule” on page 56 for more information on cleaning.

Chapter 2. Operating the 8mm Tape Library

This chapter provides instructions on how to operate the 8mm Tape Library. Procedures requiring the use of the control panel are described under Control Panel Operations and procedures performed independent of the control panel are described under Library Operations.

Control Panel

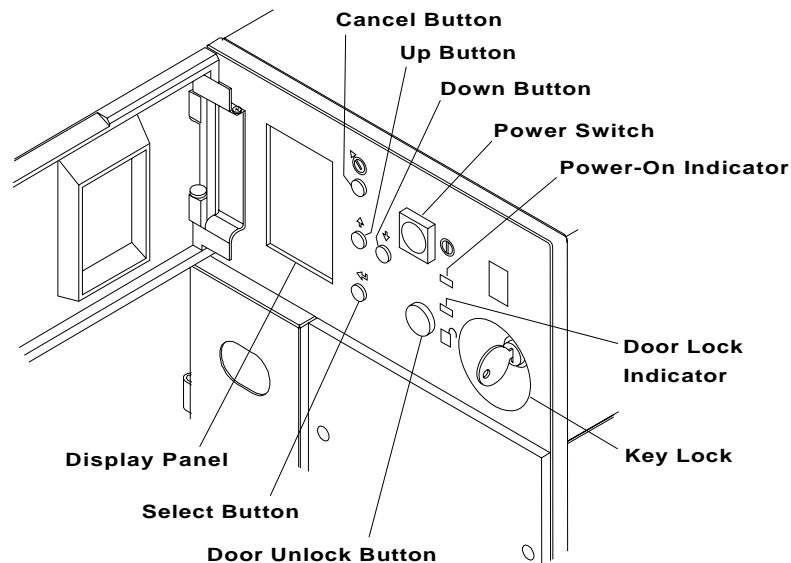

ASOPISX-00

Figure 3. Control Panel

The 8mm Tape Library control panel (see Figure 3) is located behind the small access door on the front of the library and has the following features:

- Power switch and power-on indicator
- Door Unlock button and door lock indicator
- Key lock
- Control buttons
- Liquid crystal display (LCD) panel

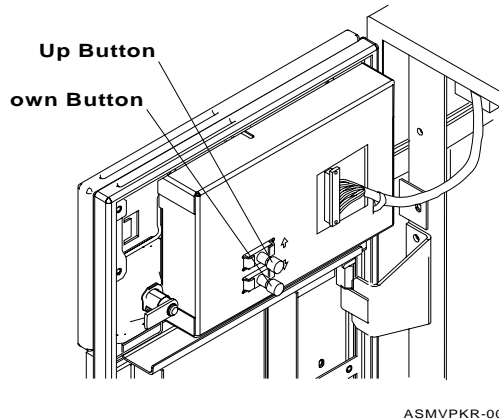

Figure 4. Move Picker Buttons inside Library Front Door

The 8mm Tape Library move-picker buttons (see Figure 4) are located inside the library front door on the back of the control panel. These buttons are used to move the picker up and down when the library front door is open.

Power Switch and Power-On Indicator

The power switch (



), located on the control panel, controls power to the 8mm Tape Library. The power switch is a mechanical switch that retains its state when power is cycled. The switch does not provide a visual indication of its On or Off state. When the switch is On the library cooling fan operates and DC power is distributed to the components in the library.

The power-on indicator is a green LED located on the front panel adjacent to the power switch. The power-on indicator is software controlled. During initial power-on, the power-on indicator is illuminated, indicating the start of Power-On Self Test (POST). If no errors are detected during POST, the power-on indicator remains lit continuously. If an error is detected during POST, the power-on indicator blinks a sequence that indicates a specific error (see “Chapter 4. Operator Corrective Actions” on page 95). The only time the power-on indicator blinks other than POST is following an unsuccessful microcode download command.

Note: The power-on indicator blink rate is twice per second with 1 second off between repetitions of the specific error sequence. See “Chapter 4. Operator Corrective Actions” on page 95 for more information about irrecoverable 8mm Tape Library errors.

Door Unlock Button

The library provides a software controlled door lock and door lock indicator. When the library power is off, the door lock is unlocked to allow the operator access to the library contents. When initially powering on the library and during POST, the door remains unlocked. At the completion of POST, if the door sensor indicates the door is closed, the door is locked. If the sensor indicates the door is open, the door is not locked until it is closed.

Pressing the Door Unlock (



) button on the control panel signals the library that the operator wants to open the library front door. When the Unlock (



) button is pressed, the control panel display shows the message,



DOOR PRESSED, indicating that the button was pressed. If there is no host computer system command (prevent/allow media removal) when the button is pressed, the library completes any move operation in progress and then parks the picker. When the picker is parked, the library displays the message, DOOR UNLOCKED The door may now be opened.

Whenever the library door is opened, software assumes that the contents of the library have been altered and clears the current inventory. If the Unlock button was inadvertently pressed, pressing the Cancel (



) button without opening the library door relocks the library and retains the current library inventory.

Library access can be prevented with a software controlled lock from the host computer system or by the operator manually locking the door with the key lock. If the Unlock (



) button is pressed when a host computer system software controlled lock is present the library displays the message, UNLOCK NOT ALLOWED BY HOST.

The library does not accept any move commands from either the host computer system or the library control panel while the door is open. The tape drives in the library can operate independent of other library operations and can be accessed directly by the host computer system for running a manually inserted tape such as a diagnostics tape. When the door is open and library power is on, the picker can be moved using the move-picker buttons located on the inside of the front door.

The library door automatically locks when the door is closed. After the door locks, move commands from either the host computer system or the control panel will be accepted by the library.

Door Lock Indicator

The Door Lock indicator is a green LED located on the front panel adjacent to the door unlock button. The Door Lock indicator is software controlled. When initially powering on the library and during POST, the Door Lock indicator is Off. After POST completes, the Door Lock indicator is illuminated if the door is locked. During library operation the software controls the state of the Door Lock indicator so that it matches the state of the Door Lock.

Key Lock

The key lock, located on the right side of the control panel, is a mechanical lock. This lock prevents unauthorized access to the library. Both the key lock and the software controlled lock must be unlocked to gain access to the library.

Control Buttons

There are four control buttons on the control panel to the right of the control panel display; two scroll buttons (Up and Down), a Select button, and a Cancel button. These buttons are functional after the completion of POST. When a button is pressed, an audible beep sounds. The beep is an audio confirmation for the operator that the button was pressed.

- The scroll buttons (Up (



) and Down (



) are used to move through the displayed menu list and highlight a menu item for selection or to advance to additional selections not currently displayed.

- The Select (



) button is used to choose the highlighted menu item.

- The Cancel (



) button moves the highlight back one menu item, returns the control panel display to the previous menu, or cancels the operation.

Note: Canceling an operation in progress may cause an error that displays a UEC. Also, a tape cartridge may be left in a tape drive or the picker.

Control Panel Liquid Crystal Display (LCD)

The control panel LCD is the primary method of displaying information for the operator. The operator can adjust the panel brightness and contrast using the control panel buttons on the Set-up Menu.

The control panel display in Figure 5 on page 15, shows status information, menu options, and operator prompts. The upper portion of the control display shows the current **library state** (item **1**). When the library is performing a function, such as a host initiated tape cartridge move command, the upper portion of the display changes to indicate the new state. The lower portion of the display shows **drive status** or **user menus** (item **2**). The right side of the display graphically depicts the **status of the magazines** (item **4**) and **tape drives** (items **5** and **6**) as shown in “Magazine and Tape Drive Status Displays” on page 16.

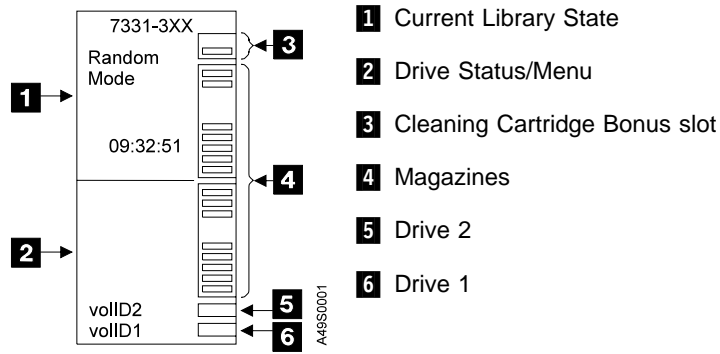

Figure 5. Random Mode Display

Library State

The library state display is determined by the current operation mode (**random**, **sequential**, or **manual**) and the operation in progress. See Figure 6. See “Modes of Operation in Base Configuration” on page 4, for more information.

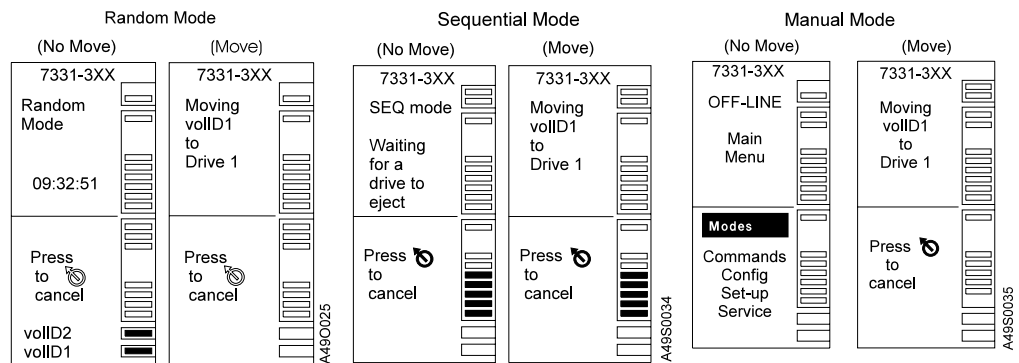

Figure 6. Random, Sequential, and Manual Mode Displays

When a manual mode operation is initiated, the library state display initialization messages to inform the operator that an operation is starting or that a programmed delay is occurring. During the processing of an operation, the control panel display shows messages that provide information about the current operation. If an error occurs during an operation, the error messages are shown on the display.

Drive Status or User Menu

The drive status or user menu display shows the current status of the tape drives and information about the tape cartridges in the tape drive.

When a menu is displayed, the drive status or user menu section shows the menu items available.

Examples of tape drive status displays and user menus can be seen in any of the procedures under “Control Panel Operations” on page 18.

Magazine and Tape Drive Status

See Figure 7 on page 16 which displays the drives, magazines, and magazine slots.

Although columns **1**, **2**, and **3** represent different modes, they are identical in their physical make up.

- Item **4** represents two bonus slots which, as with the magazines, uses a symbol to indicate the presence of a tape cartridge in each slot location where a tape cartridge is located.
- The items **5** and **6** represent the tape cartridge magazines. These magazines use a symbol to indicate the presence of a tape cartridge in each slot location where a tape cartridge is located.
- Items **7** and **8** represent the drives. A symbol is shown in the rectangle if a tape cartridge is loaded in the tape drive.

Magazine and Tape Drive Status Displays:

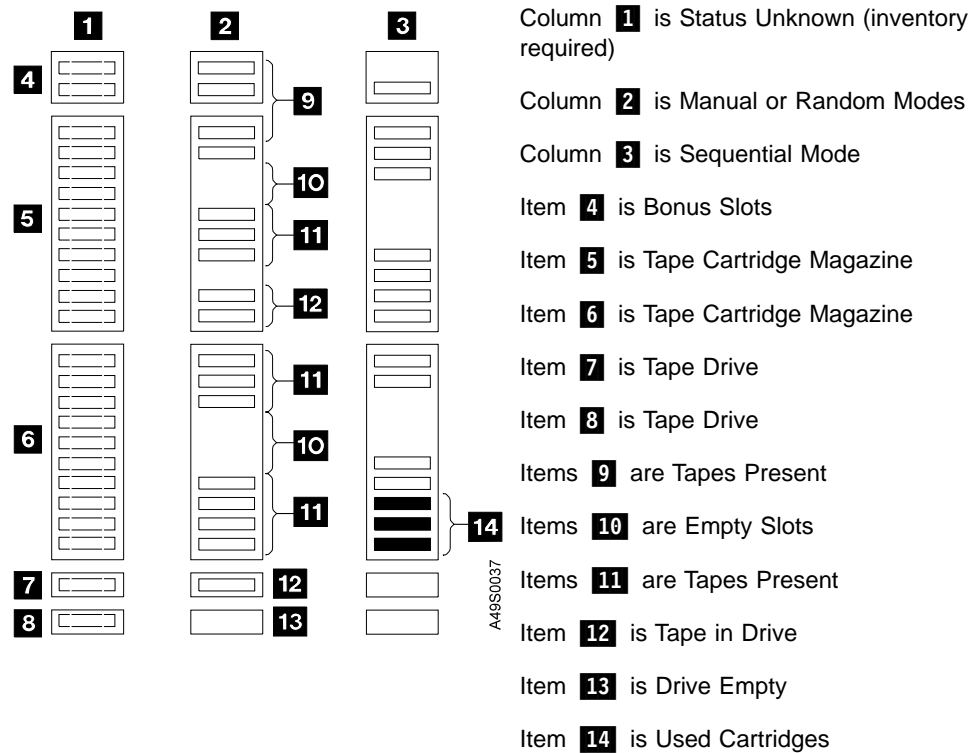
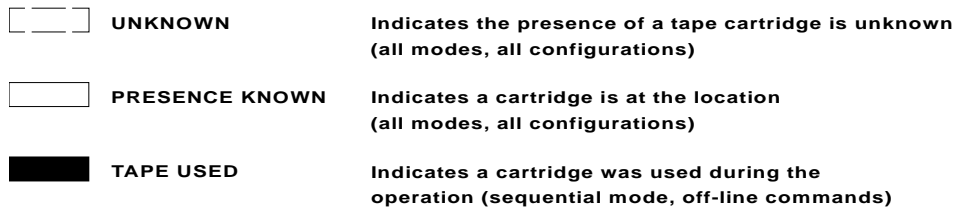

Figure 7. Magazine and Tape Drive Status Displays

Note: The dashed slots or drives in column **1** represent an unknown status. In the sequential mode (item **3**) column, used tape cartridges are shown as a solid graphic.



ASICON-01

Figure 8. Tape Cartridge Display Icons

Tape Drive Unload Button and Status Lights

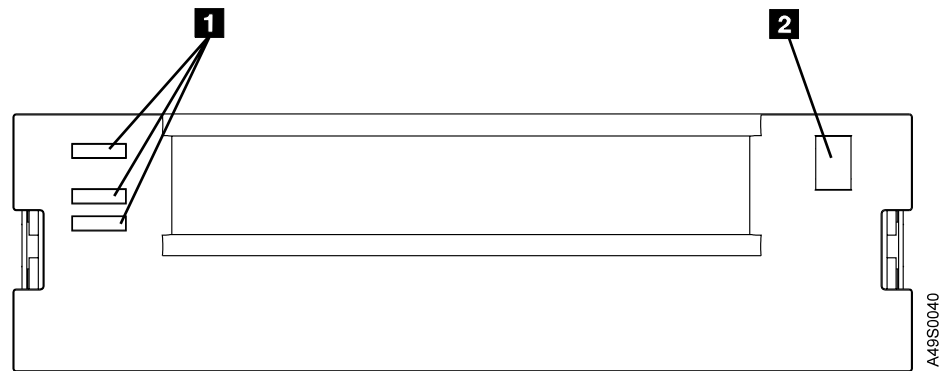

Figure 9. Tape Drive Unload Button and Status Lights

- In Figure 9, item **1** is the column of status lights made up of (top to bottom) DISTURBANCE, READY, and READ-WRITE indicators, and
- Item **2** is the UNLOAD BUTTON.

Unload Button

Pressing the unload button unloads and ejects any tape cartridge loaded in the tape drive.

The unload button operates only when power is applied to the 8mm Tape Library.

Status Lights

There are three status lights on the tape drive: two green and one amber. These status lights are turned on and off in various combinations to indicate the status of the tape drive.

The symbols located next to the status lights are International Organization for Standardization (ISO) symbols that define the general function of the status lights as follows:



Disturbance

The amber status light flashes whenever the tape drive encounters an unrecoverable fault. It is on solid whenever the tape drive requires cleaning.



Ready This green status light is on solid whenever the tape drive is ready to receive tape backup commands.















































Read-Write

This green status light flashes whenever the tape drive is moving tape.

The various on/off combinations of the status lights are shown in Table 4 on page 18.

Table 4. Status Lights on the Tape Drive

Status Lights	State	Status
     	<p>On</p> <p>On</p> <p>On</p>	<p>The Power-on Self Test (POST) is running or the system has issued a reset to the drive.</p> <p>Note: The POST condition can occur either when the power is first applied or after use of the diagnostic cartridge.</p>
     	<p>Off</p> <p>Off</p> <p>Off</p>	<p>The POST has completed successfully, but no tape cartridge has been inserted.</p>
     	<p>Off</p> <p>Off</p> <p>Flashing</p>	<p>A tape cartridge has been inserted and the tape drive is performing a tape load/unload operation.</p>
     	<p>Off</p> <p>On</p> <p>Off</p>	<p>The tape load operation has completed and the tape drive is ready to receive commands from the system.</p>
     	<p>Off</p> <p>On</p> <p>Flashing</p>	<p>The tape is in motion and the tape drive is busy running a device operation.</p>
     	<p>Flashing</p> <p>Off</p> <p>Off</p>	<p>The tape drive has detected an internal fault that requires corrective action.</p>
    or    or 	<p>On</p> <p>Off or On</p> <p>Off or Flashing</p>	<p>The tape path requires cleaning.</p>

Control Panel Operations



The power switch (



), located on the control panel, is used to power-on and power-off the library. The power-on indicator is a green LED located adjacent to the power switch.

The control panel Up (



), Down (), or Select () buttons are used to select and start library operations. The control panel Cancel () button is used to cancel a selection or stop an operation.

Note: Canceling an operation in progress, may cause an error that displays a UEC (Unit Error Code). Also, a tape cartridge may be left in a tape drive or the picker mechanism.

Powering On the Library

The following procedure should be used the first time the library is powered on or any time library operation is suspect. Performing this procedure ensures that all self-tests are performed by the library and that the library initializes to a known state.

1. If the library power is On, vary off the library and internal drives from the host system. Then, open the control panel access cover (see Figure 10) and press the control panel power switch () to turn the library power Off.

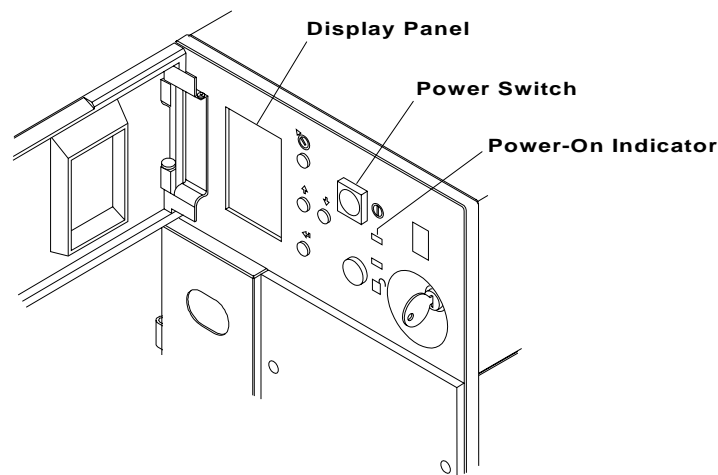

ASOP03-00

Figure 10. Control Panel

2. Unplug the library power cord from the power outlet and wait 10 seconds. (This ensures a power supply reset.)
3. Make sure the library door is closed (required for initialization).
4. Plug the library power cord into the power outlet. (This may or may not power on the library depending upon the state of the power switch.)
5. If the library power-on indicator lights and the display shows the message, Power On Selftest in Progress, go to step 14 on page 21.

- ___ 6. If the library control panel does not display information, open the control panel access cover and press the control panel power switch ().
- ___ 7. If the library control panel still does not display information, call the 7331 8mm Tape Library service representative.
- ___ 8. At the start of POST, the power-on indicator is illuminated and the display shows the message in Figure 11:

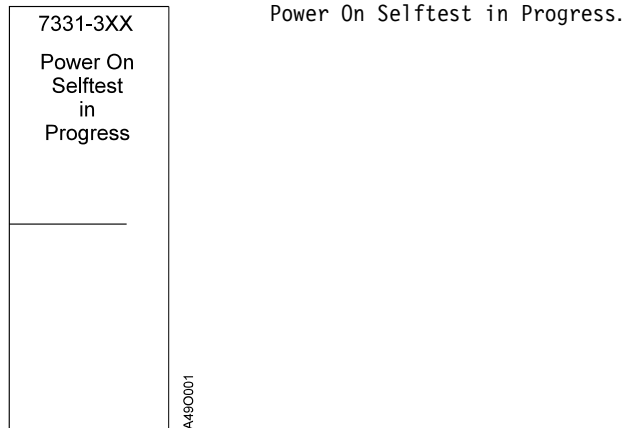

Figure 11. Power On Selftest in Progress Display

- ___ 9. If an irrecoverable error is detected, the library beeps and the power-on indicator blinks to indicate a specific error occurred.
- ___ 10. The control panel display shows the message:

Irrecoverable error

The library Power-On Self Test (POST) stops and the control panel display shows failure information to identify the cause of the error.

Note: The library may also beep and the power-on indicator may blink one of four sequences to indicate a specific error. See “Chapter 4. Operator Corrective Actions” on page 95 to determine if the error can be corrected by the operator. These errors are also defined in the *7331 and 3449 8mm Tape Library Model 3xx Service Guide*.

- ___ 11. Errors will display in Figure 12 on page 21:

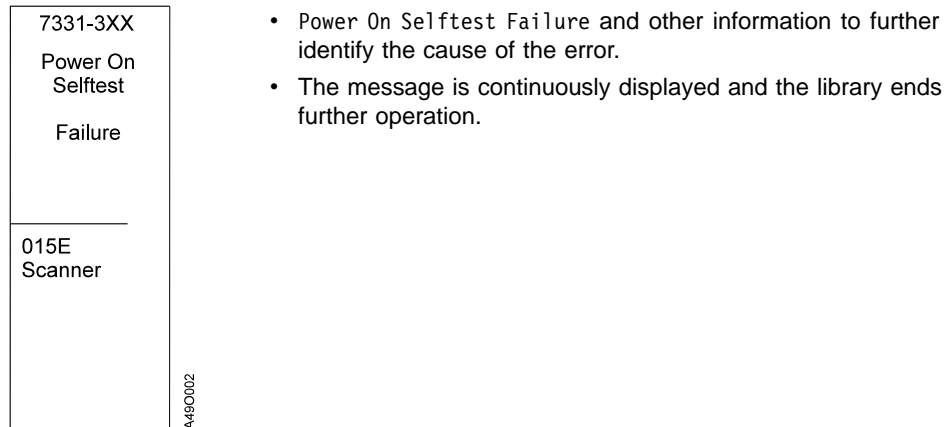

Figure 12. Power On Selftest Failure Display

___ 12. After checking for irrecoverable errors, POST checks for recoverable errors.

Recoverable error

Causes the library to beep once when the error is encountered and to display the message, Power On Selftest Warning and other information to further identify the cause of the error. The library resumes operation after 3 seconds.

___ 13. If a recoverable error is detected, the library beeps once and the display, Figure 13, shows the message:

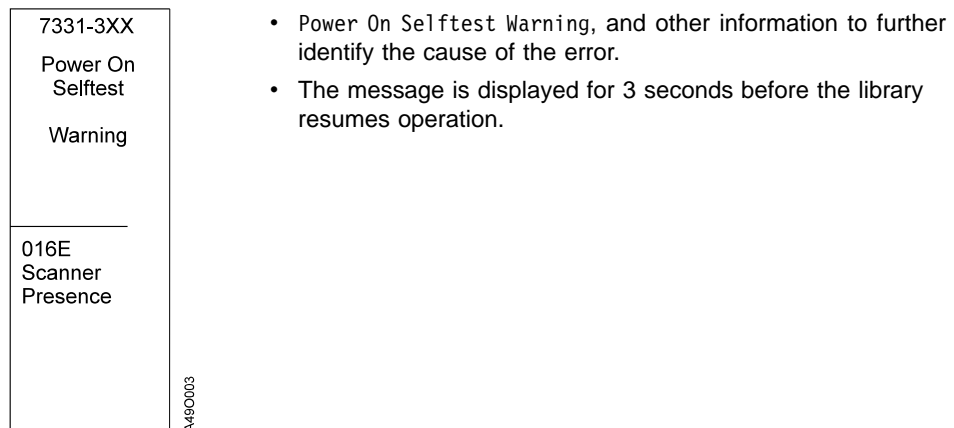

Figure 13. Power On Selftest Warning Display

___ 14. Wait for Power-On Self Test (POST) to complete.

A single 1 second beep

Indicates that the library Power-On Self Test (POST) completed successfully.

Any combination of a beep and displayed failure information or a sequence of beeps and blinks indicates an irrecoverable error as described below.

- ___ 15. If no errors are detected when POST is completed, the library beeps for 1 second and the control panel in Figure 14, displays the message:

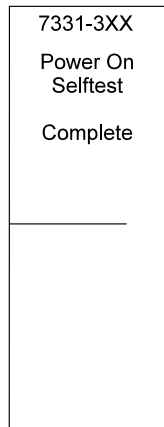

Power On Selftest Complete, 3 seconds before the library resumes operation.

Figure 14. Power On Selftest Complete Display

- ___ 16. If any of the following exist, call the 8mm Tape Library service representative.
- The control panel display is blank.
 - The power-on indicator continuously beeps and blinks an error code.
 - The power-on indicator does not light.
 - The library does not beep.
- ___ 17. After POST is complete, and the door is closed, wait for the library initialization to complete. During initialization the control panel display (see Figure 15) shows the message:

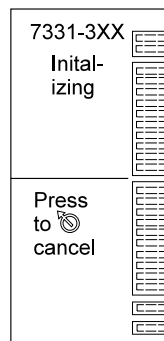

- INITIALIZING.
- The library door is locked.
- The picker and accessor are initialized to a known state to permit safe movement.
- The bar code reader is enabled if installed.



Figure 15. Initializing Display

- ___ 18. Upon successful completion of initialization, the library returns to the mode of operation it was in before the library was powered off.
- ___ 19. You may now vary on the library and the library drives at the host system.

Powering Off the Library

To power-off the 8mm Tape Library, use the following procedure:

1. If the 8mm Tape Library is performing an operation, wait until the operation is complete before continuing.

2. At the host system, verify the drives are not performing an operation.
3. Open the control panel access cover (see Figure 16) and press the control panel power switch () to turn the library power Off. The green power-on indicator turns Off.
4. If the power-on indicator does not go out or the library does not power off, press the control panel power switch () twice to cycle the library power.

If the power-on indicator still does not go out or the library does not power off, call the 8mm Tape Library service representative.

Note: To ensure that the power supply resets any time power is removed from the library, wait a minimum of 10 seconds before re-applying power to the library.

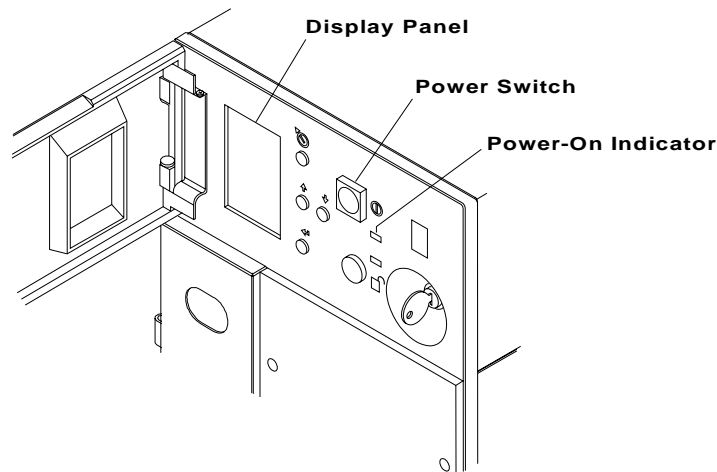

ASOP03-00

Figure 16. Control Panel

8mm Tape Library Menu Structure

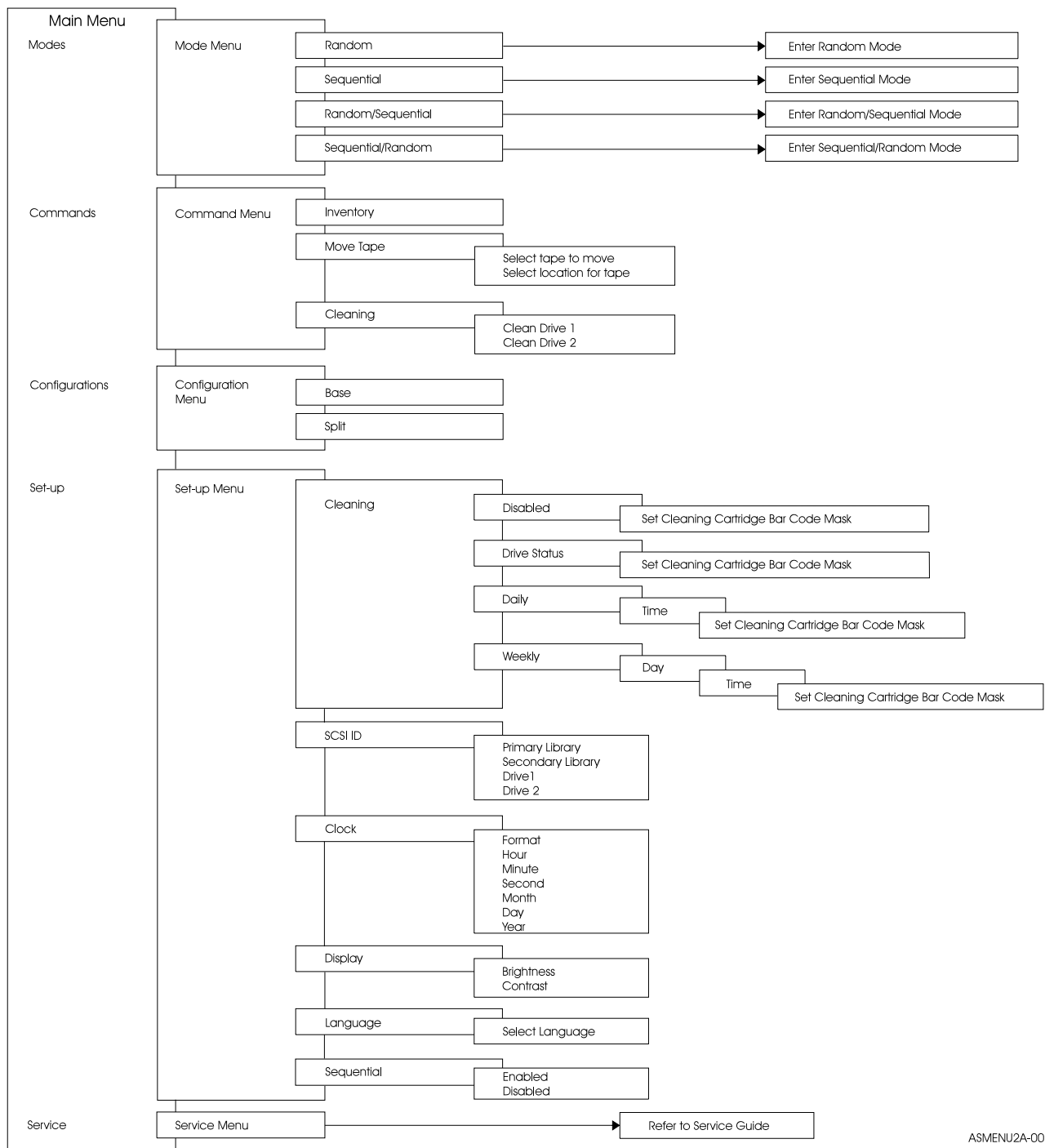

ASMENU2A-00

Figure 17. Menu Structure

Displaying the Main Menu

When the library power is turned on, the library returns to the mode of operation it was in when powered-off (random mode, sequential mode, or manual mode).

Displaying the Main Menu in Manual Mode

When the library is being operated in manual mode, see the specific operation procedure for instructions on displaying the Main Menu.

Displaying the Main Menu from Random Mode

To display the Main Menu from random mode, go to “Ending Random Mode or Stopping a Host Directed Command” on page 28.

Displaying the Main Menu from Sequential Mode

To display the Main Menu from sequential mode, go to “Ending Sequential Mode” on page 37.

Displaying the Main Menu from Sequential/Random or Random/Sequential Mode

To display the Main Menu from sequential/random or random sequential mode, go to “Ending Random Mode or Stopping a Host Directed Command” on page 28.

Displaying the Mode Menu

Selecting Modes on the Main Menu displays the Mode Menu for selecting the operating mode of the library. The following modes are available in the 8mm Tape Library:

- Manual
- Random
- Sequential
- Random/sequential
- Sequential/random

Note: When the library is not in random or sequential mode it is in manual mode and considered off-line.

To display the Mode Menu from random mode, see “Ending Random Mode or Stopping a Host Directed Command” on page 28, or from sequential mode, “Ending Sequential Mode” on page 37.

To display the Mode Menu from manual mode (other than random or sequential mode), use the following procedure:

Note: When selecting menu items or menus in this procedure, pressing the Cancel

(



) button cancels the selection or returns the display to the previous menu.

1. If not already displayed, display the Main Menu. See “Displaying the Main Menu” on page 24 and see Figure 18 on page 26.

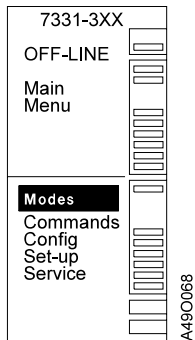

- If required, use the Up (↑) or Down (↓) button to highlight Modes on the Main Menu.
- Press the Select (↵) button to display the Mode Menu.

Figure 18. Main Menu Display

Random Mode

Selecting Random from the Mode Menu switches the library from the current mode to random mode. While the library is in random mode the library is under the control of the host computer system.

Selecting Random Mode

To select random mode, use the following procedure:

Note: When selecting menu items or menus in this procedure, pressing the Cancel (⌫) button



cancels the selection or returns the display to the previous menu.

1. Display the Main Menu. See “Displaying the Main Menu” on page 24.
2. Display the Mode Menu. See “Displaying the Mode Menu” on page 25.
3. Using the Up (↑) or Down (↓) button, highlight Figure 19:



or Down (↓)



button, highlight Figure 19:

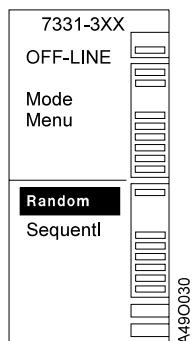

- Random on the Mode Menu.
- Press the Select (↵) button to choose random mode.

Figure 19. Random Mode Display

4. The control panel (see Figure 20 on page 27) displays:

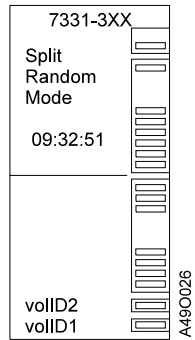

- Split Random Mode.
- Select Random Mode.
- In random mode all commands are initiated from the host computer system.

Figure 20. Split Random Mode Display

Operation Status

This section of the display screen shows the current drive operation in progress (for example, read, write, or rewind). A count of the total data written or read since the tape cartridge was loaded in the drive is also shown for write or read commands.

5. The library is now under the control of the host computer system. The control panel display shows motion commands when they are sent from the host computer system (see Figure 21).

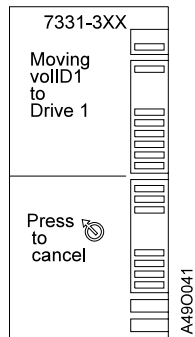

Figure 21. Moving Display

Random Mode Error Condition and Recovery

When an error is detected during processing of a host directed command, the library returns a check condition to the host computer system and shows an error message on the control panel display. see Figure 22 on page 28.

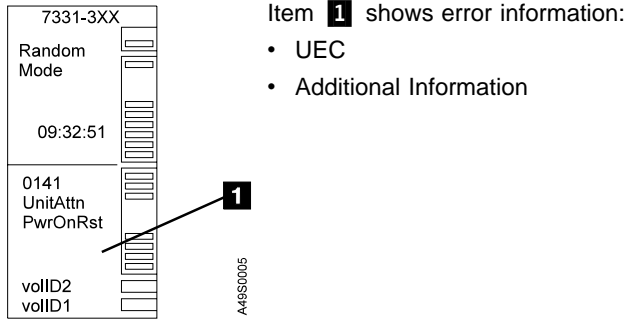

Figure 22. Random Mode Display

1. When a recoverable error message is displayed, the library will accept another command from the host computer system after the library recovers from the error.
2. If the host computer system can not recover from an error, record the error message and unit error code (UEC), then go to Chapter 4. Operator Corrective Actions.

Ending Random Mode or Stopping a Host Directed Command

The operator can use the control panel to end random mode and go to manual mode.

1. Press the Cancel (



) button. (See Figure 23.)

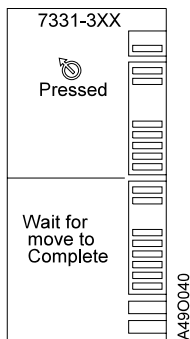
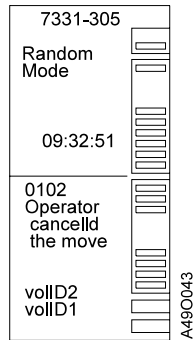



Figure 23. Cancel Display

2. If a host directed command was in progress, the control panel in Figure 24 on page 29 displays:



- Operator canceled the move, and a check condition is sent to the host computer system.
- Press the Cancel () button.

Note: Canceling an operation in progress, may cause an error that displays a UEC. Also, a tape cartridge may be left in a tape drive or the picker.

Figure 24. Manual Display

3. The library is placed in manual mode and the Mode Menu is shown (see Figure 25) on the control panel display.

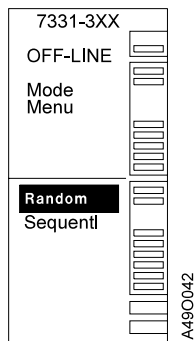



Figure 25. Mode Menu Display

4. Press the Cancel ()

button again to display (see Figure 26) the Main Menu.

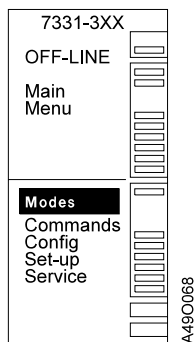

Figure 26. Main Menu Display

Sequential Mode

Sequential mode continuously feeds tape drive 1 or both tape drives with tape cartridges from the magazines. During sequential mode operation, the host computer system controls drive functions and the unloading of the tape cartridge

from the tape drive. The library rejects any motion commands issued by the host computer system. The bonus slots are not used in sequential mode except when required for cleaning.

Selecting Sequential Mode

To select sequential mode, use the following procedure:

1. Display the Main Menu. See “Displaying the Main Menu” on page 24.
2. Display the Mode Menu. See “Displaying the Mode Menu” on page 25.
3. Selecting Sequent1 on the Mode Menu switches the library from manual mode to sequential mode.
4. Using the Up (



) or Down (



) button, highlight (see Figure 27):

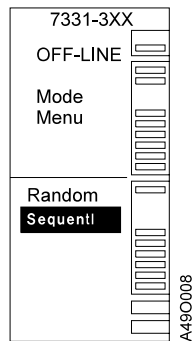

- Sequent1 on the Mode Menu.
- Press the Select () button to choose sequential mode.

Figure 27. Sequential Mode Menu Display

5. Press the Select (



) button to start the sequential mode operation.

Note: During sequential mode the control panel display (see Figure 28 on page 31 and Figure 29 on page 31) shows the current operation, the tape drive, and the tape magazine slot involved in the operation.

The tape cartridge is displayed as a solid symbol after it is loaded in the tape drive.

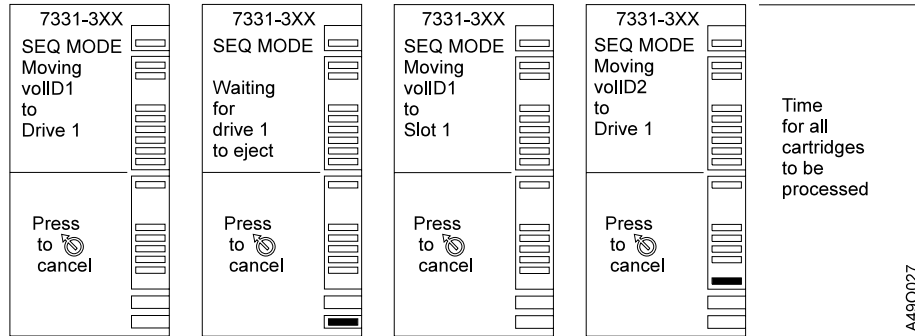

Figure 28. Sequence of Operation when Loading to One Drive in a Two Drive Configuration

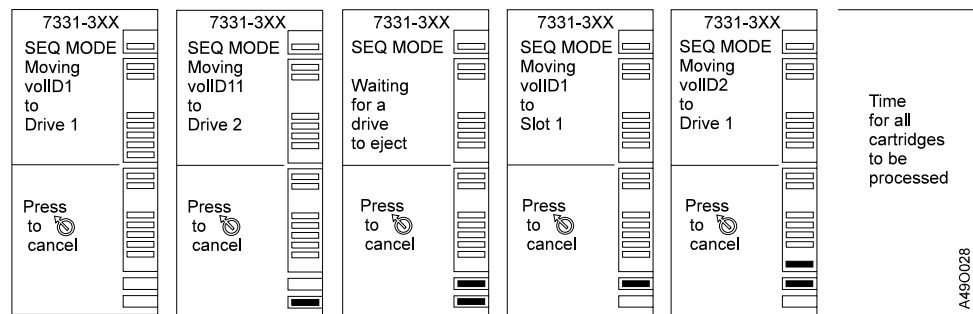
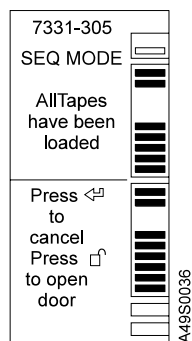

Figure 29. Sequence of Operation when Loading to Both Drives

Note: The status information of the tape cartridges being processed is displayed on the bottom half of the screen while the 7331 8mm Tape Library is waiting.

6. When all the tape cartridges are processed, the picker parks in front of the tape drive.
7. The control panel (see Figure 30) display shows the message:



- All Tapes have been loaded.

Figure 30. Sequence Mode Tapes Loaded Display

8. The following choices are available after all tapes have been processed.
 - a. Press the Select (



) button to restart sequential mode with the tapes that are currently in the library. Sequential mode runs using the drive load selection chosen in the previous run.

- b. Press the door Unlock (



) button to unlock the door and load new tape cartridges into the library. The door locks when it is closed and the library initializes and performs an inventory.

Attention: Depending on the operation to be resumed, using the tape cartridges that are currently in the library could overwrite the data currently on the tape cartridge.

9. If all new cartridges were loaded in the library, sequential mode restarts.
10. If any tape cartridges from the previous run are left in the library (refer to Figure 31), the control panel display shows the message:

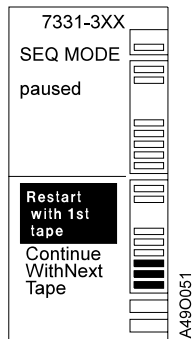

- Restart with 1st tape or Continue With Next Tape.

Figure 31. Sequence Mode Paused Display

11. Using the Up (



) or Down (



) button, highlight the desired method of continuing sequential mode.

12. Press the Select (



) button to continue sequential mode. See “Selecting Sequential Mode” on page 30 for sequential mode processing displays.

13. Press the Cancel (



) button to end sequential mode and display the Mode Menu.

Restarting Sequential Mode Automatically

The library can be set up to restart the sequential load without prompting the operator. After the last tape has been loaded and returned to its storage element, the library will automatically restart with the first tape in the sequential stack. In split configuration, the loads to drive 1 and drive 2 restart independently. For Example, the load to drive 1 restarts when the last tape from magazine 1 has completed, even if the sequential load to drive 2 is not finished.

To disable the operator prompt for restarting the sequential load, use the following procedure:

1. Display the Set-up Menu. See Figure 32.
2. Using the Up (



) or Down (



) button, on the Set-up Menu.

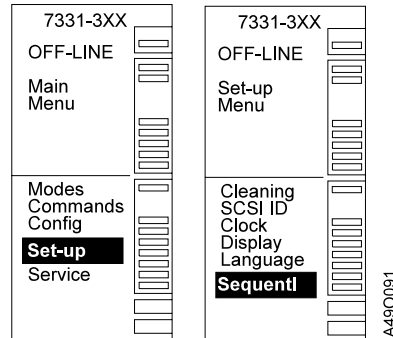

- Highlight Sequential

Figure 32. Sequential Setup Menu

3. Press the Select (



) button to display the Sequential Restart Prompt Menu. This menu shows the current status of the Sequential Restart Prompt.

4. Using the Up (



) or Down (



) button,

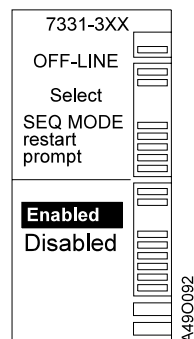

- Highlight Disabled

Figure 33. Sequential Status

5. Press the Select (



) button to disable the operator prompt, which occurs when the sequential load has completed. The display returns to the Set-up Menu.

Note: Pressing the Cancel (



) button cancels the selection and returns the display to the Set-up Menu.

Prompting the Operator for Sequential Restarts

The library can be set up to prompt the operator after the sequential load has finished. After the last tape has been loaded and returned to its storage element, the library stops and prompts the operator, indicating all tapes have been loaded.

To enable the operator prompt for restarting sequential, use the following procedure:

1. Display the Set-up Menu. See Figure 34.
2. Using the Up (



) or Down (



) button, on the Set-up Menu.

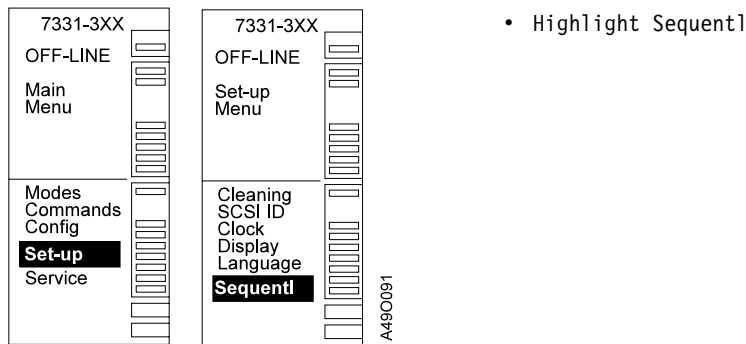

Figure 34. Sequential Setup Menu

3. Press the Select (



) button to display the Sequential Restart Prompt Menu. This menu shows the current status of the Sequential Restart Prompt.

4. Using the Up (



) or Down (



) button,

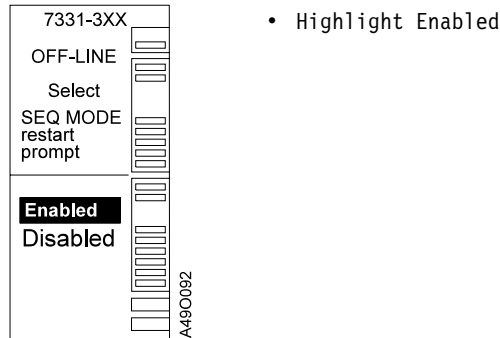

- Highlight Enabled

Figure 35. Sequential Status

5. Press the Select (



) button to enable the operator prompt, which occurs when the sequential load has completed. The display returns to the Set-up Menu.

Note: Pressing the Cancel (



) button cancels the selection and returns the display to the Set-up Menu.

Sequential Mode Error Conditions

Sequential mode is interrupted when an error condition is encountered. After the error condition is cleared, sequential mode can be continued or ended.

To clear a sequential mode error condition, use the following procedure:

1. When an error condition occurs see Figure 36, the control panel display shows ERROR and the error information.

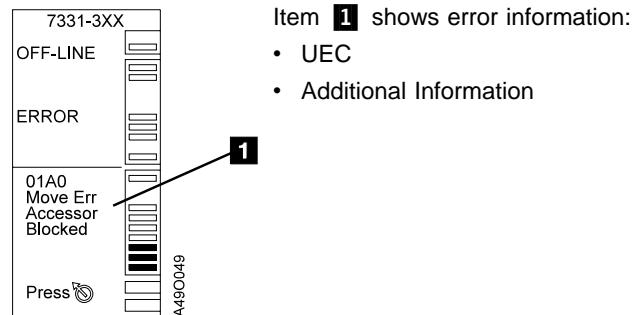

Item **1** shows error information:

- UEC
- Additional Information

Figure 36. Error Display

2. Record the UEC and error description, then press the Cancel (



) button to clear the error screen.

3. The control panel display (see Figure 37 on page 36) shows the message:

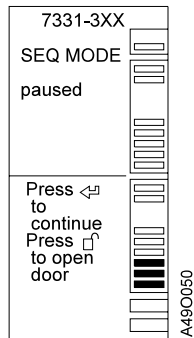



- SEQ MODE paused.
- Note:** Pressing the Select () button to continue sequential mode will cause the error to reoccur if the error is an irrecoverable error or is not corrected before pressing the Select button.

Figure 37. Sequential Mode Paused Display

4. Go to Chapter 4. Operator Corrective Actions.
5. If the Select ()

button is pressed or when the door is closed after correcting the error (see Figure 38), the control panel display shows the message:



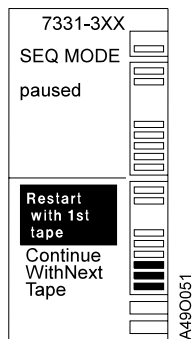

- Restart with 1st tape or Continue With Next Tape.
- Using the Up () or Down () button, highlight the desired method of continuing sequential mode.

Figure 38. Sequential Mode Paused Restart Display

6. Press the Select ()

button to continue sequential mode. See “Selecting Sequential Mode” on page 30 for sequential mode processing displays and refer to Figure 39 on page 37

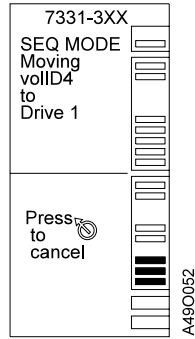
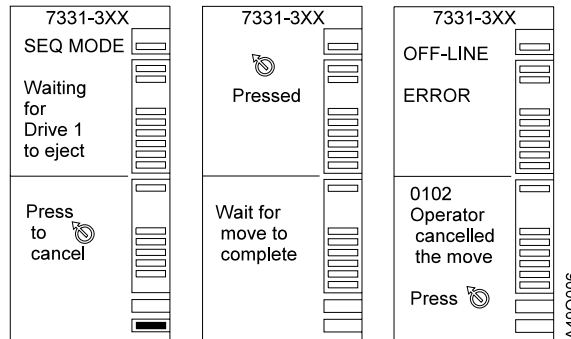

Figure 39. Sequential Mode Display

Ending Sequential Mode

The operator can use the control panel to end sequential mode and go to manual mode.

1. To end sequential mode (see Figure 40), press:



- the Cancel () button.
- Sequential mode then stops.
- Any move in progress is completed (actual movement of a tape cartridge).
- The display shows UEC 0102 and Operator canceled the move.

Figure 40. End Sequential Mode Display

Note: Canceling an operation in progress may cause a tape cartridge to be left in a tape drive or the picker. The middle display shown above is only displayed when a tape cartridge is being moved at the time the Cancel (



) button is pressed.

2. Press the Cancel (



) button.

3. The Figure 41 on page 38 will give directions.

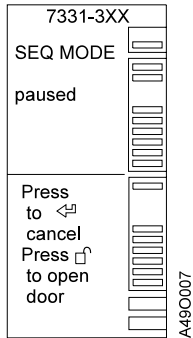

- SEQ MODE paused is shown on the control panel display.

Figure 41. Sequential Mode Paused Display

4. The following options are now available:

a. Press the Select (



) button to restart sequential mode.

- 1) If a tape cartridge was left in a tape drive when sequential mode was stopped, sequential mode restarts the interrupted operation where it stopped.
- 2) If a tape cartridge was left in the picker, you may not be able to restart sequential mode. If an error occurs, press the Cancel (



) button until the Mode Menu is displayed, then enter sequential mode again. See “Selecting Sequential Mode” on page 30.

b. Press the door unlock (



) button to open the library door. This option would be used when replacing tapes or to check some other condition inside the library. When the door is closed the library performs an inventory and restarts sequential mode.

Note: If a tape was left in the picker when sequential mode was stopped, the inventory may not be correct.

c. Press the Cancel (



) button. See the following step.

5. If the Mode Menu is not displayed, press the Cancel (



) button again to display the Mode Menu (see Figure 42 on page 39).

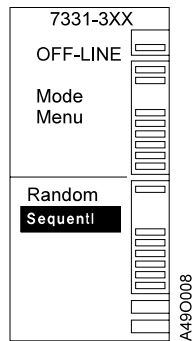

Figure 42. Mode Menu Display

6. Press the Cancel (



) button again to display the Main Menu (see Figure 43).

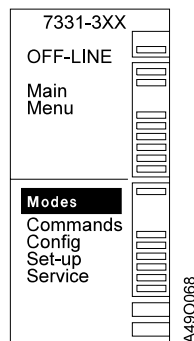

Figure 43. Main Menu Display

Random/Sequential Mode

When the Tape Library is in a split configuration, you have the option of selecting the Random/Sequential mode. Selecting Random/Sequential from the Mode Menu switches the library from the current mode to random/sequential mode. While the library is in random/sequential mode the random mode section of the library is under the control of the host computer system.

Note: Random/Sequential mode is only available when the 8mm Tape Library has first been placed in a split configuration.

Selecting Random/Sequential Mode

To select random/sequential mode, use the following procedure:

Note: When selecting menu items or menus in this procedure, pressing the Cancel (



) button cancels the selection or returns the display to the previous menu.

1. Display the Main Menu. See Figure 44 on page 40.
2. Display:

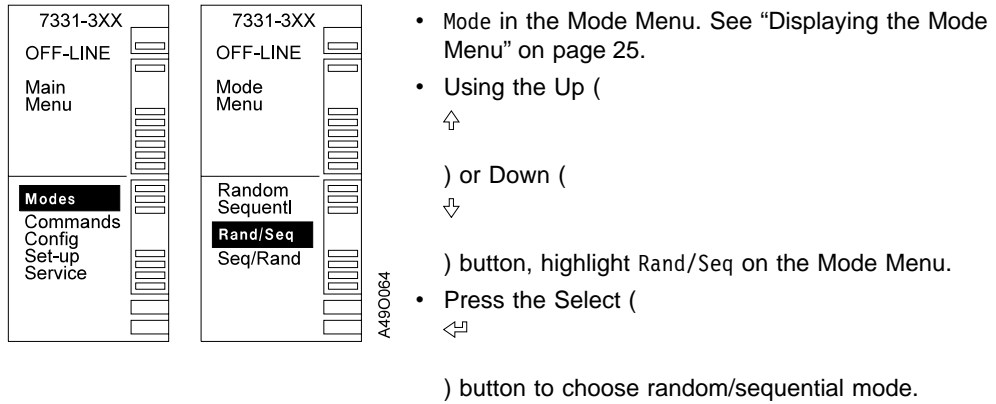

Figure 44. Main Modes Menu Display

3. The control panel display (see Figure 45) shows:

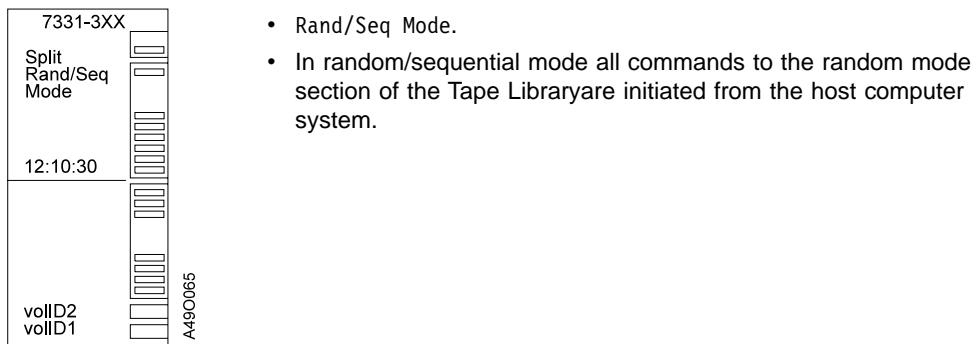

Figure 45. Split, Random, Sequential Modes Menu Display

4. The library is now under the control of the host computer system. The control panel display shows motion commands.

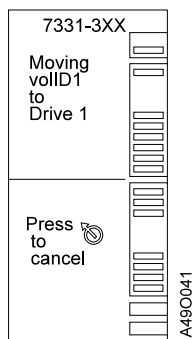

Figure 46. Motion Commands Display

Random/Sequential Mode Error Condition and Recovery

When an error is detected during processing of a host directed command (see Figure 47 on page 41), the library returns a check condition to the host computer system and shows an error message on the control panel display.

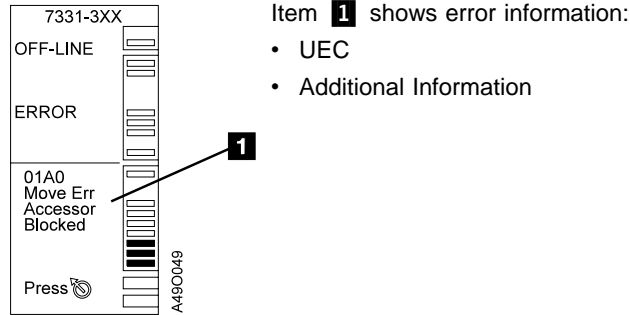

Figure 47. Off-Line Error Display

1. When a recoverable error message is displayed, the library will accept another command from the host computer system after the library recovers from the error.
2. If the host computer system can not recover from an error, record the error message and unit error code (UEC), then go to Chapter 4. Operator Corrective Actions.

Ending Random/Sequential Mode or Stopping a Host Directed Command

The operator can use the control panel to end random/sequential mode and go to manual mode.

1. Press the Cancel (



) button (see Figure 48).

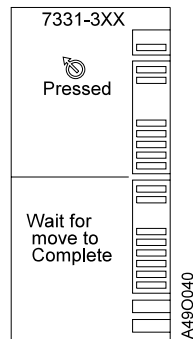
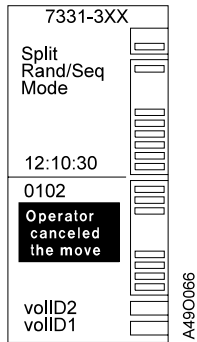



Figure 48. Cancel Display

2. If a host directed command was in progress, the control panel displays the message (see Figure 49 on page 42):



- Operator canceled the move, and a check condition is sent to the host computer system.
- Press the Cancel () button.

Note: Canceling an operation in progress, may cause an error that displays a UEC. Also, a tape cartridge may be left in a tape drive or the picker.

Figure 49. Operator Canceled Display

3. The library is placed in manual mode (see Figure 50) and the Mode Menu is shown on the control panel display.

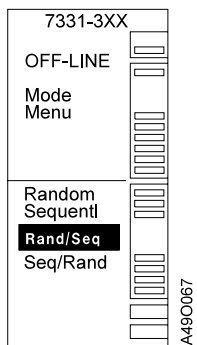



Figure 50. Random Sequential Display

4. Press the Cancel ()

) button again to display the Main Menu (see Figure 51).

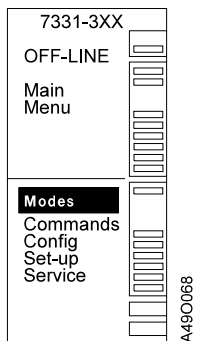

Figure 51. Main Menu Display

Sequential/Random Mode

When the Tape Library is in a split configuration, you have the option of selecting the Sequential/Random mode. Selecting Sequential/Random from the Mode Menu

switches the library from the current mode to sequential/random mode. While the library is in sequential/random mode, the random half of the library is under the control of the host computer system.

Note: Sequential/Random mode is only available when the 8mm Tape Library has first been placed in a split configuration.

Selecting Sequential/Random Mode

To select sequential/random mode, use the following procedure:

Note: When selecting menu items or menus in this procedure, pressing the Cancel (



) button cancels the selection or returns the display to the previous menu.

1. Display the Main Menu. See “Displaying the Main Menu” on page 24 and refer to Figure 52.

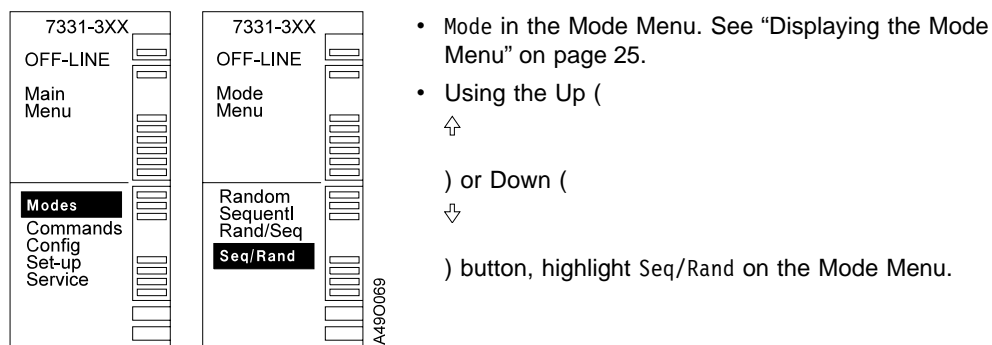

Figure 52. Main Menu Display

2. Press the Select (



) button (see Figure 53) and the control panel displays:

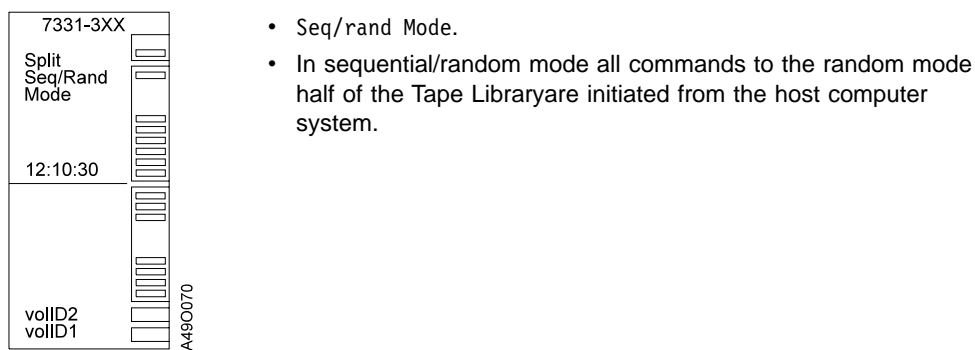

Figure 53. Sequential Random Mode Display

3. The random mode half of the library is now under the control of the host computer system. The control panel display shows motion commands (see Figure 54 on page 44).

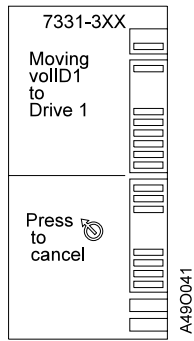

Figure 54. Motion Commands Display

Sequential/Random Mode Error Condition and Recovery

When an error is detected during processing of a host directed command, the library returns a check condition to the host computer system and shows an error message (see Figure 55) on the control panel display.

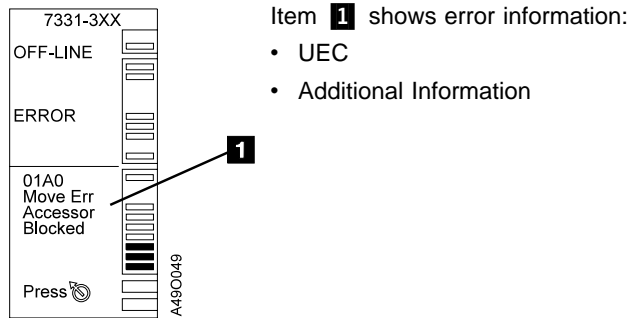

Figure 55. Motion Commands Display

1. When a recoverable error message is displayed, the library will accept another command from the host computer system after the library recovers from the error.
2. If the host computer system can not recover from an error, record the error message and unit error code (UEC), then go to Chapter 4. Operator Corrective Actions.

Ending Sequential/Random Mode or Stopping a Host Directed Command

The operator can use the control panel to end sequential/random mode and go to manual mode.

1. Press the Cancel (



) button (see Figure 56 on page 45).

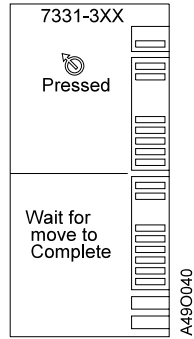
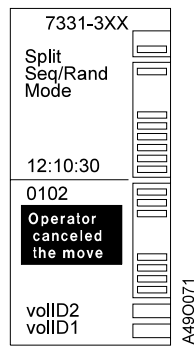



Figure 56. Cancel Display

2. If a host directed command was in progress, the control panel displays the message (see Figure 57):



- a. Operator canceled the move, and a check condition is sent to the host computer system.
- b. Press the Cancel () button.

Note: Canceling an operation in progress, may cause an error that displays a UEC. Also, a tape cartridge may be left in a tape drive or the picker.

Figure 57. Operator Canceled Display

3. The library is placed in manual mode and the Mode Menu (see Figure 58) is shown on the control panel display.

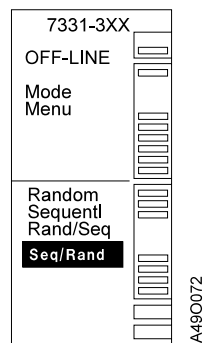

Figure 58. Mode Menu Display

4. Press the Cancel () button again to display the Main Menu (see Figure 59 on page 46).

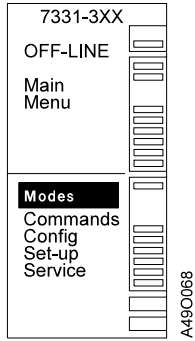

Figure 59. Main Menu Display

Selecting the Command Menu

Selecting Commands on the Main Menu displays the Command Menu. The Command Menu shows a list of commands that are operator initiated and controlled.

- Inventory
- Move Tape
- Cleaning

Note: The operation of these tape library commands is not affected by the configuration of the Tape Library (base or split). These commands operate only on the tape cartridges selected.

To select the Command Menu, use the following procedure:

- Display the Main Menu. See “Displaying the Main Menu” on page 24.
- Using the Up (



) or Down (



) button (see Figure 60), highlight:

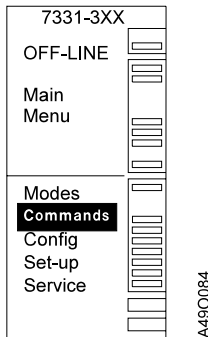

- Commands on the Main Menu.

- Press the Select (



) button to display the Command Menu.

Note: Pressing the Cancel (



) button cancels the selection and returns the control panel display to the Main Menu.

Figure 60. Commands Display

Performing Inventory of the Tape Library Contents

An inventory of the library media contents should be run whenever one of the following conditions occurs:

- The status on the control panel display is shown as unknown.

- When the library is turned on.
- Any time the door is opened and then closed.

During an inventory, each tape drive and tape magazine slot is checked for the presence of a tape cartridge. When a tape cartridge is found, the bar code label is read and the status is recorded.

To perform an Inventory, use the following procedure:

1. Display the Main Menu. See “Displaying the Main Menu” on page 24.
2. Select the Command Menu. See “Selecting the Command Menu” on page 46.
3. Using the Up (



) and Down (



) buttons highlight (see Figure 61):

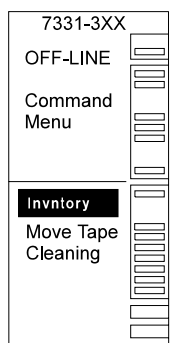

- Inventory on the Command Menu.
- Press the Select () button to perform the inventory.

Figure 61. Inventory Select Display

Note: During the inventory, (see Figure 62) each tape drive and tape magazine slot is checked for the presence of a tape cartridge. When a tape cartridge is detected, the bar code information and tape cartridge location is recorded if a bar code reader is installed. Empty magazine slots are also recorded.

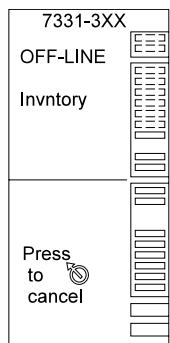
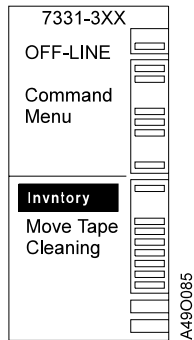

Figure 62. Inventory Display

4. At the end of the inventory operation, the Command Menu is displayed with (see Figure 63 on page 48):



- Inventory highlighted.

Figure 63. Inventory Select Display

5. Press the Cancel (



) button to return to the Main Menu.

Moving a Tape

The Move Tape command is used in the manual mode to move a tape cartridge from a slot to a drive, from a drive to a slot, or between slots. If the status of either location is unknown when a move command is initiated, the status of the unknown location is checked before the move.

To move a tape cartridge, use the following procedure:

1. Display the Main Menu. See “Displaying the Main Menu” on page 24. and see Figure 64 then select:

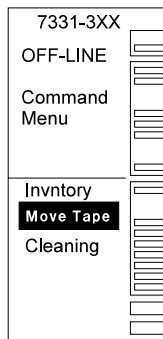
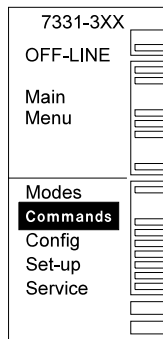



- Commands from the Command Menu. See “Selecting the Command Menu” on page 46.
- Using the Up () and Down () buttons, highlight Move Tape on the Command Menu.
- Press the Select () button to choose the Move Tape operation.

Figure 64. Main Menu Display

2. See Figure 65 on page 49:

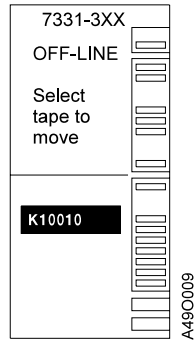

- If the control panel display prompts you to Select tape to move, the picker is empty. Continue with step 3.
- Note:** If the tape cartridge to be moved is in a tape drive, the drive will automatically eject the tape cartridge when the move operation starts in step 6.

Figure 65. Off Line Menu Display

3. Using the Up (



) and Down (



) buttons, select the tape cartridge to move. As you move through the tape cartridge positions, the tape cartridge graphic flashes and the location and if a bar code reader is installed, bar code information of that tape cartridge is displayed.

4. Press the Select (



) button to choose the tape to move location.

5. The control panel display at Figure 66 prompts for:

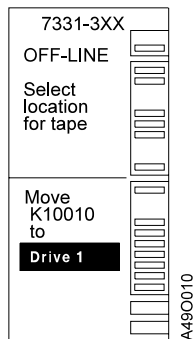

- Select location for tape.
- Using the Up (
 - ↑
) and Down (
 - ↓
) buttons, highlight the location for the tape cartridge to be moved to.
- Note:** Locations that currently hold a tape cartridge are not selectable, only empty positions can be selected for a tape to be moved to.
- Press the Select (
 - ←
) button to choose the highlighted location.

Figure 66. Off Line Selection Display

6. The tape to move location and the tapes destination are displayed as the selected tape cartridge is moved.
7. On completion of the operation Figure 67 on page 50) displays.

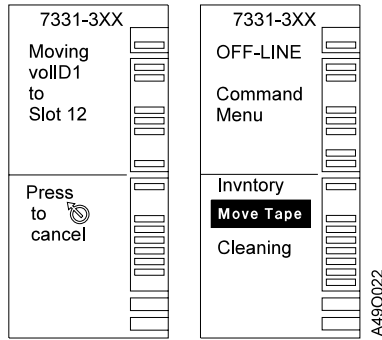

- Move Tape command on the Command Menu is displayed.
- Press the Cancel () button to return to the Main Menu.

Figure 67. Off Line Command Menu Display

Move Error Condition and Recovery (Manual Mode)

1. When a library error occurs during the move tape operation (see Figure 68), the control panel display shows:

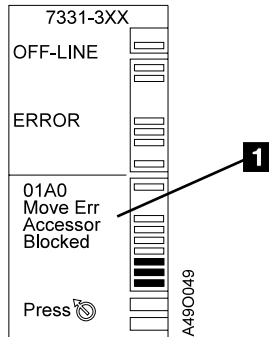

- ERROR and the type of error.
- Note the error and press the Cancel () button to return to the Main Menu.

Figure 68. Off Line Error Display

2. Go to Chapter 4. Operator Corrective Actions.

Manually Cleaning the Tape Path: Cleaning Cartridge Present

Note: This procedure is for manual cleaning when a cleaning cartridge is in the library. If a cleaning cartridge **is not** in the library, use “Manually Cleaning the Tape Path: Cleaning Cartridge Not Present” on page 80.

The 8mm tape path requires cleaning periodically. However, prior to setting a schedule for automatic cleaning or when the scheduled cleaning is not sufficient to maintain a properly cleaned tape path, the tape path should be cleaned using the manual cleaning procedure.

The 8mm tape path should be cleaned at least every 72 hours of tape motion or once a month, whichever occurs first. The tape drive keeps track of the number of hours of tape motion. The tape drive amber disturbance (

↳

) status light is On continuously (see Table 4 on page 18) when the tape drive determines the tape path requires cleaning.

The 8mm tape drive tape path should be cleaned for the following conditions:

- At least every 72 hours of tape motion. The tape drive counts the number of hours of tape motion and indicates when it is time to clean the tape path by turning on the amber disturbance (

↳

) status light.

- As error rates exceed an acceptable value determined by the drive microcode.
- When Metal Particle (MP) media has been read and Advanced Metal Evaporated (AME) media has been loaded.

Attention: Failure to clean the 8mm tape path on a regular basis will void the tape drive warranty.

To perform manual cleaning, use the following procedure:

Note: The cleaning cartridge bar code mask must be set in the library even when using a cleaning cartridge without a bar code label.

1. Make sure a cleaning cartridge is in the library.

Notes:

- a. If the cleaning cartridge does not have a bar code label attached or the cleaning cartridge is not identified as a cleaning cartridge, the cleaning cartridge must be in bonus slot 2.
- b. An 8mm cleaning cartridge can be used for a minimum of 18 cleaning operations. The tape drive detects when the cleaning cartridge is no longer usable, and it ejects the cleaning cartridge without turning off the tape drive amber disturbance (

↳

) status light.

2. Make sure the bar code mask is set so the library can locate the cleaning cartridge. See “Disable Automatic Cleaning” on page 58.
3. Select the Command Menu (see Figure 69).
4. Using the Up (

↑

) and Down (

↓

) buttons, highlight:

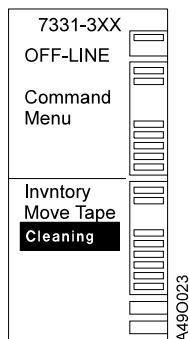

- Cleaning on the Command Menu.
- Press the Select () button to display the Cleaning Menu.

Figure 69. Off Line Command Menu Display

5. Using the Up (



) and Down (



) buttons on the Figure 70, highlight:

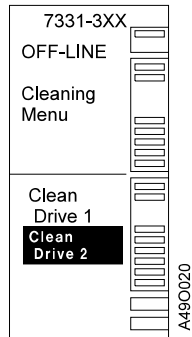

- Clean Drive 1 or Clean Drive 2.
- Press the Select () button to start the cleaning operation.

Figure 70. Off Line Cleaning Menu Display

6. During a manual cleaning operation (see Figure 71):

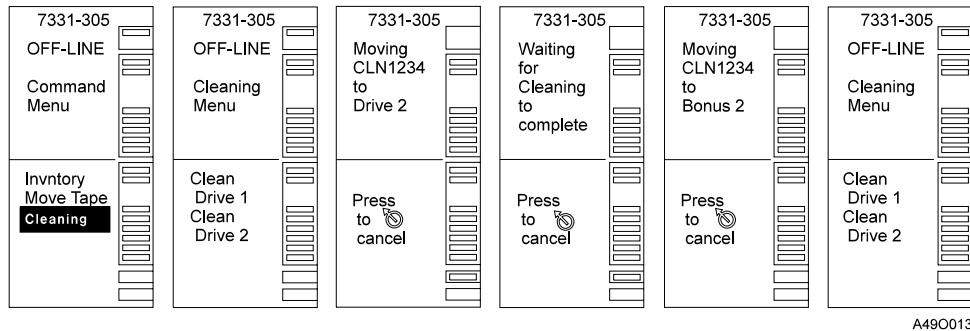

Figure 71. Off Line Cleaning Operation Display

- The tape drive loads the cleaning cartridge into the selected tape drive.
- The control panel display shows the message Waiting for Cleaning to complete while the tape drive uses a small section of the cleaning cartridge to clean the drive. This operation takes approximately 2 minutes.
- The cleaning cartridge ejects from the drive when the cleaning operation is complete.
- The tape drive indicates a successful cleaning operation by turning off the amber disturbance (



) status light.

7. If an error message (see Figure 72 on page 53):

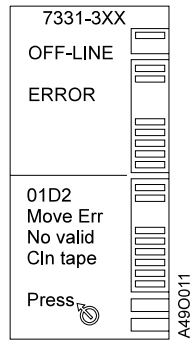

- Move Err No valid Cln tape appears, go to Chapter 4. Operator Corrective Actions.

Figure 72. Off Line Error Display

8. If the cleaning operation continues for an extended time beyond that specified in step 52 or the cleaning cartridge does not eject at the end of the cleaning operation, go to Chapter 4. Operator Corrective Actions.
9. At the end of the tape drive cleaning operation, the cleaning cartridge is returned to the cleaning cartridge storage slot and the Cleaning Menu is displayed.
10. Press the Cancel (



) button to display the Command Menu.

Setting the 8mm Tape Library Configurations

The 8mm Tape Library can be configured in the following modes:

1. Base library configuration
2. Split library configuration

These configurations are accessed through the control panel using the **Config** display. Once a configuration is selected, the 8mm Tape Library remains in that configuration until the **Config** display is accessed again and the configuration is changed or the configuration is changed by a host SCSI command.

Setting Base Library Configuration

The base library configuration allows a single host access to the entire 8mm Tape Library and use of both drives and all slots for the operations. See "Base Library Configuration" on page 4 for more information.

To place the Tape Library in a base library configuration, use the following procedure:

Note: When selecting menu items or menus in this procedure, pressing the Cancel

(



) button cancels the selection or returns the display to the previous menu.

1. Display the Main Menu. See "Displaying the Main Menu" on page 24 and see Figure 73 on page 54.
2. Using the Up (



) or Down (



) button, highlight:

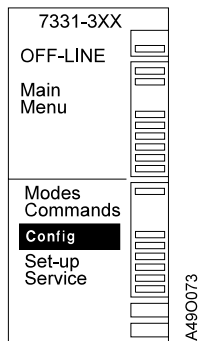

- Config on the Main Menu.
- Press the Select () button to display the Configuration Menu.

Figure 73. Main Menu Display

3. See Figure 74. Using the Up (



) or Down (



) button, highlight:

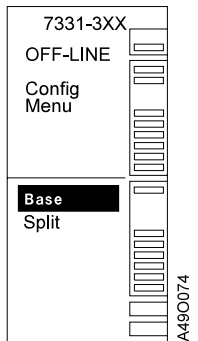

- Base on the Configuration Menu.
- Press the Select () button to choose base configuration.

Figure 74. Off Line Configuration Menu Display

4. The control panel returns to the Main Menu in the base configuration.
5. If one or both tape drives are currently being accessed by the host system, the Tape Library will return a warning message if the configuration change will affect the use of the tape drives.

Setting Split Library Configuration

The split library configuration divides the 8mm Tape Library into two separate libraries, each having access to a single drive and one magazine of tape cartridges. See "Split Library Configuration" on page 6 for more information.

To place the Tape Library in a split library configuration, use the following procedure:

Note: When selecting menu items or menus in this procedure, pressing the Cancel (



) button cancels the selection or returns the display to the previous menu.

1. Display the Main Menu. See “Displaying the Main Menu” on page 24 and see Figure 75.

2. Using the Up (



) or Down (



) button, highlight:

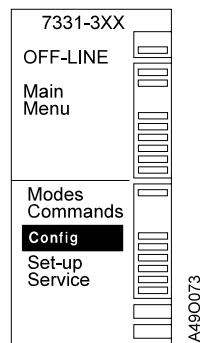

- Config on the Main Menu.
- Press the Select () button to display the Configuration Menu.

Figure 75. Main Menu Display

3. See Figure 76. Using the Up (



) or Down (



) button, highlight:

The control panel returns to the Main Menu in the split configuration.

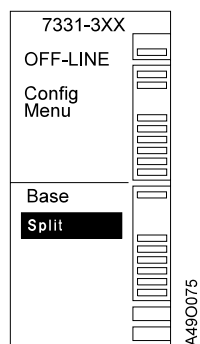

- Split on the Configuration Menu.
- Press the Select () button to choose split configuration.

Figure 76. Off Line Configuration Menu Display

4. If one or both tape drives are currently being accessed by the host system, the Tape Library will return a warning message if the configuration change will affect the use of the tape drives.

Setting Up the Tape Library Operation Parameters

Selecting Set-up on the Main Menu displays the Set-up Menu for setting the following library parameters:

- Cleaning (scheduled)
- SCSI IDs (selecting)
- Clock (time and date)
- Display (brightness and contrast)
- Language (display)
- Sequential (restart prompt)

To select the Set-up Menu, use the following procedure:

1. Display the Main Menu. See “Displaying the Main Menu” on page 24 and refer to Figure 77.

2. Using the Up (



) or Down (



) button, highlight:

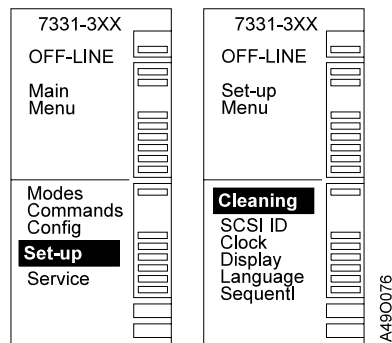

- Set-up on the Main Menu.

- Press the Select (



) button to display the Set-up Menu.

Figure 77. Main Menu Display

3. Pressing the Cancel (



) button cancels the selection and returns the control panel display to the Main Menu.

Setting the Tape Drive Cleaning Schedule

The 8mm tape drive tape path should be cleaned at least every 72 hours of tape motion or once a month, whichever occurs first. The tape drive counts the number of hours of tape motion and indicates when it is time to clean the tape path by turning on the amber disturbance (



) status light (see Table 4 on page 18).

Attention: Failure to clean the 8mm tape path on a regular basis will void the tape drive warranty.

To clean the 8mm Tape Library tape path immediately (manually), see “Manually Cleaning the Tape Path: Cleaning Cartridge Present” on page 50 or “Manually Cleaning the Tape Path: Cleaning Cartridge Not Present” on page 80. To set a cleaning schedule for automatic cleaning, see below.

Attention: The 8mm Tape Library supports the use of mixed media types (i.e. 5/7 GB MP media and 20 GB AME media). The 8mm Tape Library is read compatible ONLY with the 5/7 GB MP media.

Using the 5/7 GB (MP) media will cause the 8mm Tape Library to clean the tape drives automatically before the 20 GB (AME) media can be used. This cleaning operation is a requirement of the tape drive(s) in the 8mm Tape Library.

This mode of operation could/will cause greater cleaner cartridge usage and potentially degraded system performance. Therefore, it is highly recommended to limit the use of 5/7 GB (MP) media to data transfer to the 20 GB (AME) media or for system recovery operations only.

The cleaning schedule can be set to clean the tape drives based on:

- The drive reports it needs cleaning. This method relies on the drive reporting that cleaning is required in the request sense information.
- A given date. This method allows the operator to select daily, weekly, or day of the week (if rate is weekly), and the time of the day to perform the cleaning.

To set the cleaning schedule for automatic 8mm tape path cleaning, use the following procedure:

1. Display the Main Menu. See “Displaying the Main Menu” on page 24.
2. Select the Set-up Menu. See , Figure 78 and Figure 79 on page 58.
3. Using the Up (



) or Down (



) button, highlight:

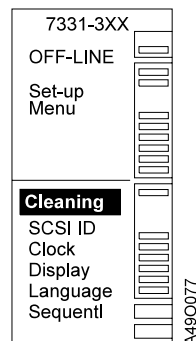

- Cleaning on the Set-up Menu.
- Press the Select () button to display the Select Cleaning Rate options.

Figure 78. Off Line Set-up Menu Display

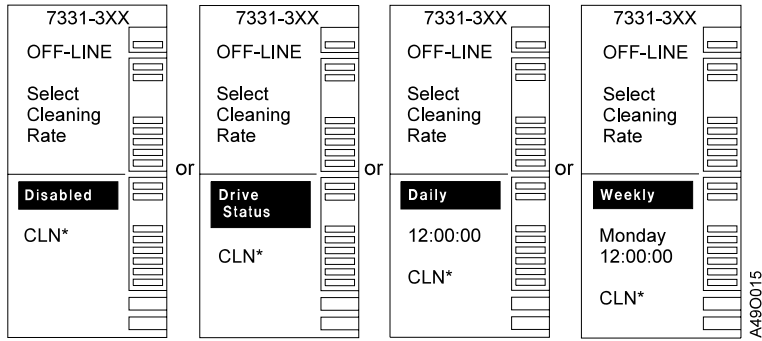

Figure 79. Off Line Cleaning Options Menu Display

4. Using the Up (



) and Down (



) buttons, toggle the lower display to show the desired rate of cleaning then go to the appropriate procedure as follows:

- Disabled - go to “Disable Automatic Cleaning”
- Drive Status - go to “Drive Status Cleaning” on page 59
- Daily - go to “Daily Cleaning” on page 61
- Weekly - go to “Weekly Cleaning” on page 63

Disable Automatic Cleaning

See Figure 80.

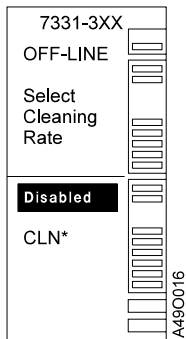

- This procedure must be entered from step 4 of “Setting the Tape Drive Cleaning Schedule” on page 56.

Figure 80. Off Line Disabled Menu Display

1. Press the Select (



) button to disable automatic cleaning (see Figure 81 on page 59).

2. Advance to the:

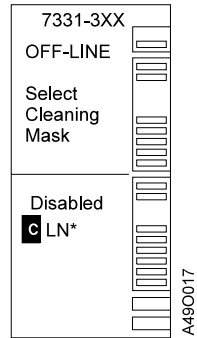







- Select Cleaning Mask screen.
Note: The cleaning mask is set even when the automatic cleaning is disabled. The cleaning mask is used when cleaning is automatic or when cleaning is manually selected from the control panel. When using a cleaning cartridge without a bar code label or reader, the bar code mask must be set.
- Refer to “Cleaning Cartridge Bar Code Label Mask” on page 66 to determine the acceptable characters for a bar code mask or if the bar code mask shown is correct for the current configuration of the library. If the correct bar code mask is shown, go to step 3. Otherwise continue with next step.
- Use the Up () and Down () buttons to display the desired cleaning mask characters. When the desired character is displayed, press the Select () button to select that character and advance to the next character. When the last character is selected, the Set-up Menu displays and you are done setting the cleaning schedule. Go to step 4.

Figure 81. Off Line Cleaning Mask Display

3. Press the Select () button to advance through the bar code characters. After the last character is selected, the Set-up Menu displays and you are done setting the cleaning schedule.
4. Press the Cancel () button to display the Main Menu.

Drive Status Cleaning

1. Press the Select () button to select (see Figure 82 on page 60):

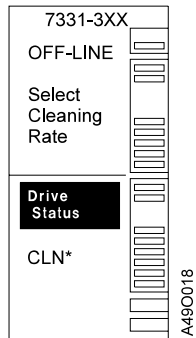

- Drive Status cleaning rate.
- **Attention:** This procedure must be entered from step 4 on page 58 of “Setting the Tape Drive Cleaning Schedule” on page 56.

Figure 82. Off Line Drive Status Display

2. See Figure 83 and advance to:

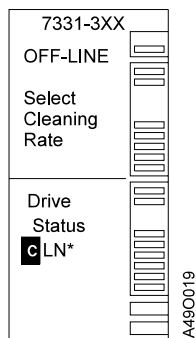





- Select Cleaning Mask screen.
- Refer to “Cleaning Cartridge Bar Code Label Mask” on page 66 to determine the acceptable characters for a bar code mask. If the correct bar code mask is shown, go to step 3. Otherwise continue with next step.
- Use the Up () and Down () buttons to display the desired cleaning mask characters. When the desired character is displayed, press the Select () button to select that character and advance to the next character. When the last character is selected, the Set-up Menu displays and you are done setting the cleaning schedule. Go to step 4.

Figure 83. Off Line Cleaning Mask Display

3. Press the Select ()

button to advance through the bar code characters. After the last character is selected, the Set-up Menu displays and you are done setting the cleaning schedule.

4. Press the Cancel ()

button to display the Main Menu.

Daily Cleaning

Attention:

This procedure must be entered from step 4 on page 58 of “Setting the Tape Drive Cleaning Schedule” on page 56.

1. See Figure 84. Press the Select (



) button to:

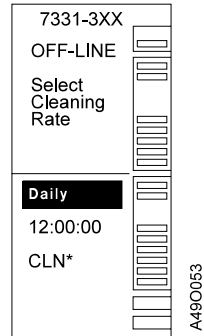

- Select the daily cleaning rate.

Figure 84. Off Line Cleaning Daily Display

2. See Figure 85. Advance to:

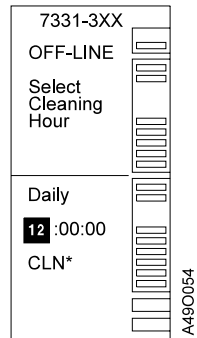



- Select Cleaning Hour screen.
Note: Time is shown in the 24 hour format in the following displays:
- Use the Up () and Down () buttons to display the cleaning **hour** desired.
- Press the Select () button to select the **hour** setting.

Figure 85. Off Line Cleaning Hour Display

3. See Figure 86 on page 62. Advance to:



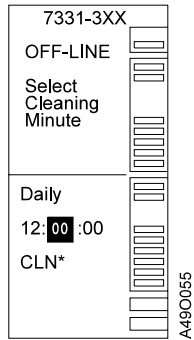

- Select Cleaning Minute screen.
- Use the Up () and Down () buttons to display the cleaning **minute** desired.
- Press the Select () button to select the **minute** setting.

Figure 86. Off Line Cleaning Minute Display

4. See Figure 87. Advance to:



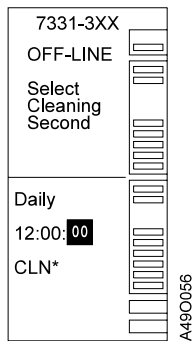

- Select Cleaning Second screen.
- Use the Up () and Down () buttons to display the cleaning **second** desired.
- Press the Select () button to select the **second** setting.

Figure 87. Off Line Cleaning Second Display

5. See Figure 88 on page 63. Advance to:





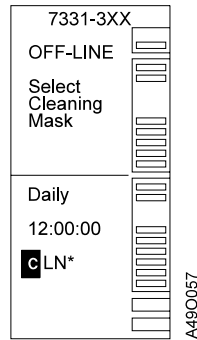

- Select Cleaning Mask screen.
- Refer to “Cleaning Cartridge Bar Code Label Mask” on page 66 to determine the acceptable characters for a bar code mask. If the correct bar code mask is shown, go to step 63. Otherwise continue with next step.
- Use the Up () and Down () buttons to display the desired cleaning mask characters. When the desired character is displayed, press the Select () button to select that character and advance to the next character. When the last character is selected, the Set-up Menu displays and you are done setting the cleaning schedule. Go to step 6.
- Press the Select () button to advance through the bar code characters. After the last character is selected, the Set-up Menu displays and you are done setting the cleaning schedule.

Figure 88. Off Line Cleaning Mask Display

6. Press the Cancel (



) button to display the Main Menu.

Weekly Cleaning

Attention: This procedure must be entered from step 4 on page 58 of “Setting the Tape Drive Cleaning Schedule” on page 56.

1. See Figure 89 and press the select (



) button.

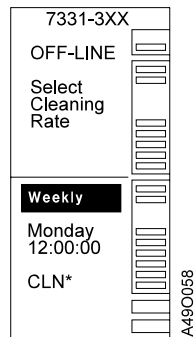

- Select the weekly cleaning rate.

Figure 89. Off Line Cleaning Weekly Display

2. See to Figure 90. Advance to:

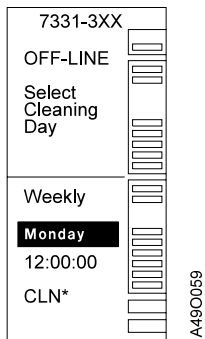



- Select Cleaning Day screen.
- Use the Up () and Down () buttons to display the cleaning day desired.
- Press the Select () button to select the day setting.

Figure 90. Off Line Cleaning Day Display

Note: Time is shown in the 24-hour format in the following displays.

3. See Figure 91. Advance to:



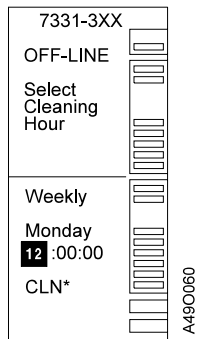

- Select Cleaning Hour screen.
- Use the Up () and Down () buttons to display the cleaning **hour** desired.
- Press the Select () button to select the **hour** setting and advance to the Select Cleaning Minute screen.

Figure 91. Off Line Cleaning Hour Display

4. See Figure 92. Advance to:



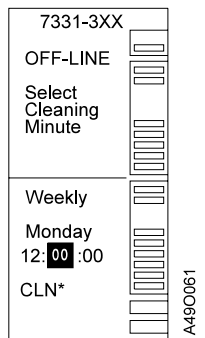

- Select Cleaning Minute screen.
- Use the Up () and Down () buttons to display the cleaning **minute** desired.
- Press the Select () button to select the **minute** setting and advance to the Select Cleaning Second screen.

Figure 92. Off Line Cleaning Minute Display

5. See Figure 93 on page 65. Advance to:



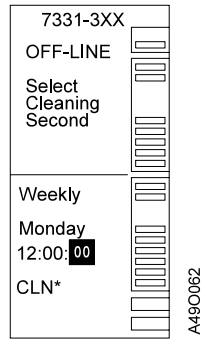

- Select Cleaning Second screen.
- Use the Up () and Down () buttons to display the cleaning **second** desired.
- Press the Select () button to select the **second** setting.

Figure 93. Off Line Cleaning Second Display

6. See Figure 94. Advance to:

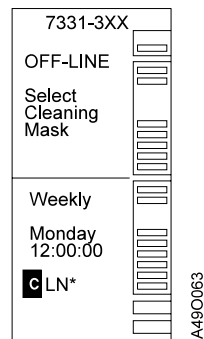

- Select Cleaning Mask screen.

Figure 94. Off Line Select Cleaning Mask Display

7. See “Cleaning Cartridge Bar Code Label Mask” on page 66 to determine the acceptable characters for a bar code mask. If the correct bar code mask is shown, go to step 9. Otherwise continue with next step.

8. Use the Up (



) and Down (



) buttons to display the desired cleaning mask characters. When the desired character is displayed, press the Select (



) button to select that character and advance to the next character. When the last character is selected, the Set-up Menu displays and you are done setting the cleaning schedule. Go to step 10.

9. Press the Select (



) button to advance through the bar code characters. After the last character is selected, the Set-up Menu displays and you are done setting the cleaning schedule.

10. Press the Cancel (





) button to display the Main Menu.

Cleaning Cartridge Bar Code Label Mask

The operator can set a bar code label mask in the library. Setting a mask gives the library the ability to locate a cleaning cartridge positioned in any library slot or to use cleaning cartridges with nonstandard bar coded labels. See Figure 95. The cleaning cartridge bar code mask is used when cleaning is automatic or when cleaning is manually selected from the control panel. For instructions on setting the bar code mask, see “Setting the Tape Drive Cleaning Schedule” on page 56.

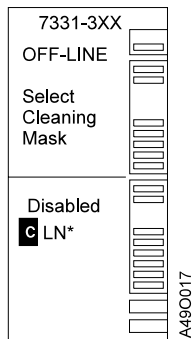

Figure 95. Off Line Select Cleaning Mask Display

Bar code mask characters 1 through 8 can be any of the following characters:

- A space character (' ')
- A question mark (?)
- An asterisk (*)
- Letters A through Z
- Numbers 0 through 9
- Special characters (\$, #, or period (.))

The characters in the mask must match the corresponding characters in the bar code label with the following exceptions (see Table 5):

Table 5. Label Mask Exceptions

Character	Description
' '	Space characters at the end of the bar code mask indicate the end of the mask. ' ' can not appear within a bar code label or the mask. All characters before the ' ' must match the bar code label for a match. If the entire mask is ' ' characters the mask prompt will show, No label and any cartridge that does NOT have a bar code label will be used.
'?'	Single wild card character. Any character at the bar code label position corresponding to the '?' in the mask will match.
'*'	Multi-character wild card. If present, it must be at the end of the mask. Any bar code label matching the characters before '*' will be used. If the first character of the mask is '*' character, then any cartridge with or without a label will match the mask.

Table 6. Examples of Valid Masks

Label	Remarks
No Label	Any cartridge in bonus slot 2 without a bar code label will be used as the cleaning cartridge.
'? '	Any cartridge in bonus slot 2 with a single character in the bar code label will be used as the cleaning cartridge.
'* '	Any cartridge in bonus slot 2 with or without a bar code label will be used as the cleaning cartridge.
'CLN '	The cartridge labeled 'CLN' is used as the cleaning cartridge.
'CLN* '	Any cartridge labeled 'CLN*' followed by additional characters is used as the cleaning cartridge.
'CLN? '	Any cartridge labeled 'CLN' followed by one additional character is used as the cleaning cartridge. 'CLN' and 'CLN12' are examples of labels that would NOT match this mask.
'CLN?1 '	Any cartridge labeled 'CLN' followed by any character, followed by '1' will be used.
'USERSLBL'	'USERSLBL' is any label, from 1 - 8 characters long, defined by the operator. Any cartridge that has a matching user defined label will be used.

Note: If the fixed characters (A..Z, 0..9) do not appear in the cleaning cartridge bar code label or the cleaning cartridge does not have a label, the cleaning cartridge must be located in bonus slot 2.

Selecting the SCSI ID

The SCSI ID of the library and the drives within the library can be set, changed, or verified by selecting SCSI ID from the Set-up Menu.

Use the following procedure to set, change, or verify the SCSI ID:

1. Select the Set-up Menu. See and refer to Figure 96 on page 68.
2. Using the Up (



) and Down (



) buttons, highlight:

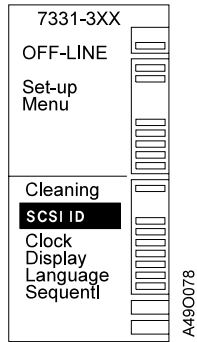

- SCSI ID on the Set-up Menu.
- Press the Select () button to display the SCSI ID menu.

Figure 96. Off Line Set-up Menu Display

3. See Figure 97. The SCSI ID menu displays:

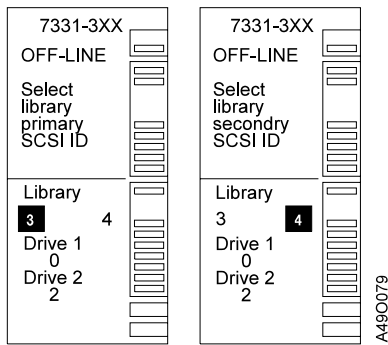

- The current SCSI assignment.
- The library devices with the SCSI ID for the library highlighted.

Figure 97. Off Line SCSI ID Display

Notes:

- During the SCSI ID selection operation, pressing the Cancel () button moves back one menu item or back to the previous menu if the selection is on the first menu item.
- If the SCSI ID shown on the display for a device does not match the ID set for the device (see Figure 98 on page 69), the difference will be indicated with an asterisk (*).

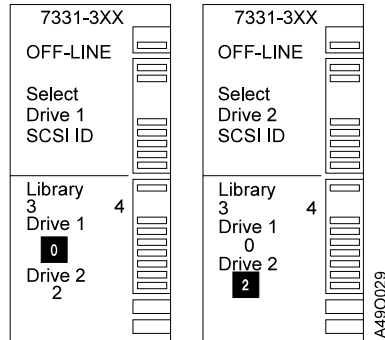

- The SCSI IDs for the 7331 8mm Tape Library in split configuration have the following default values:

- Primary Library, set to 3
- Secondary Library, set to 4
- Drive 1, set to 0
- Drive 2, set to 2

- Using the Up (



) and Down (



) buttons, change the library SCSI ID to the correct settings if required.

Note: If the SCSI ID desired is already assigned to one of the tape drives, change the SCSI ID selection for the drive. Afterwards, change the library SCSI ID to the desired SCSI ID.

- Press the Select (



) button to choose the new SCSI ID.

Figure 98. Off Line SCSI ID Match Display

4. Advance to the next device SCSI ID, or press Cancel (



) button go back to a previous menu item.

5. See Figure 99. The system will return a message if any SCSI IDs conflict.

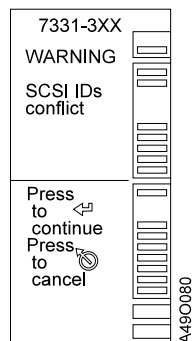
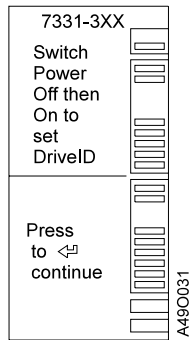

Figure 99. SCSI ID Warning Display

6. See Figure 100 on page 70 If a tape drive SCSI ID was changed, the display shows the message:





- Switch Power Off then On to set DriveID after you press the Select () button to set the SCSI ID for the last device listed. Otherwise, the display returns to the Set-up Menu. **Note:** The tape drive SCSI IDs that were changed will not be used by the library until the library is powered Off, and then powered On.

Figure 100. Power Off Message Display

7. If a tape drive SCSI ID was changed, press the Select () button to continue and to display the Set-up Menu (see Figure 101).

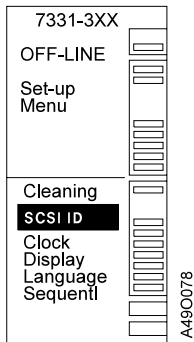

Figure 101. Off Line Set-up Menu Display

Setting the Library Clock Time and Date

The 8mm Tape Library date/time clock is used to time stamp the history and error logs, and for scheduled cleaning.

Use the following procedure to set the library clock time and date.

1. Select the Set-up Menu. See .
2. See Figure 102 on page 71. Using the Up (



) and Down (



) buttons, highlight:

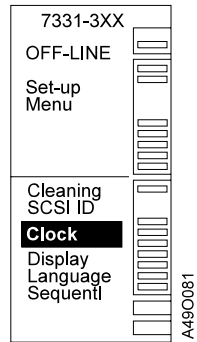

- Clock on the Set-up Menu.

Figure 102. Off Line Set-up Menu Display

3. See Figure 103. Press the Select (



) button to display:

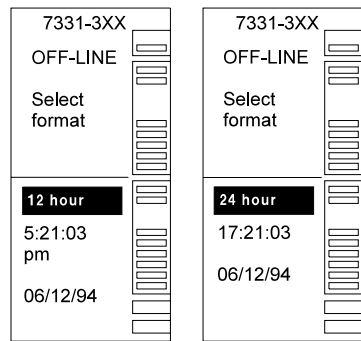

- Select format screen.
- Select either a 12- or a 24-hour format.
- Use the Up (
 - ↑
) and Down (
 - ↓
) buttons to display the format desired.
- Press the Select (
 - ←
) button to select the format.

Figure 103. Off Line Select Format Display

4. See Figure 104. Advance to:

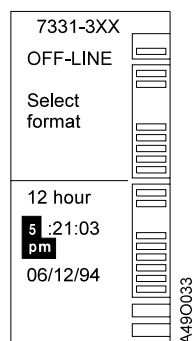

- Select hour screen.
- Use the Up (
 - ↑
) and Down (
 - ↓
) buttons to display the current hour. Make sure you advance through the hour settings to show the desired am or pm setting.
- Press the Select (
 - ←
) button to select the **hour** setting.

Figure 104. Off Line Select Hour Display

5. See Figure 105 on page 72. Advance to:

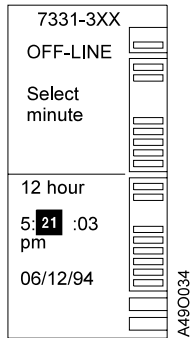



- Select minute screen.
- Use the Up () and Down () buttons to display the current **minute**.
- Press the Select () button to select the **minute** setting.

Figure 105. Off Line Select Minute Display

6. See Figure 106. Advance to:



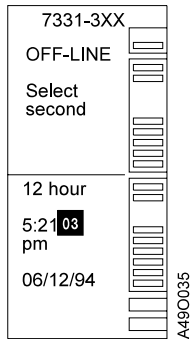

- Select second screen.
- Use the Up () and Down () buttons to display the current **second**.
- Press the Select () button to select the **second** setting.

Figure 106. Off Line Select Second Display

7. See Figure 107. Advance to:



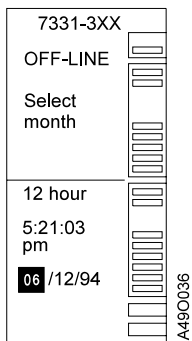

- Select month screen.
- Use the Up () and Down () buttons to display the current **month**.
- Press the Select () button to select the **month** setting.

Figure 107. Off Line Select Month Display

8. See Figure 108 on page 73. Advance to:



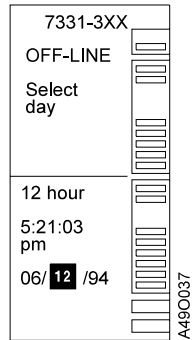

- Select day screen.
- Use the Up () and Down () buttons to display the current **day**.
- Press the Select () button to select the **day** setting.

Figure 108. Off Line Select Day Display

9. See Figure 109. Advance to:



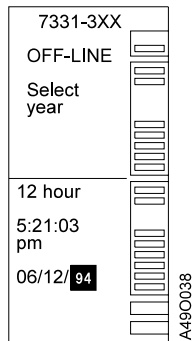

- Select year screen.
- Use the Up () and Down () buttons to display the current **year**.
- Press the Select () button to select the **year** setting.

Figure 109. Off Line Select Year Display

10. See Figure 110.

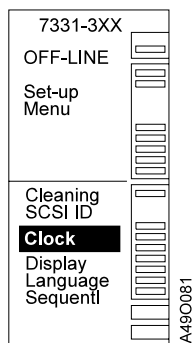

Figure 110. Off Line Set-up Menu Display

Adjusting the Display Brightness and Contrast

The brightness (background) and contrast (degree of difference between the background and the display image) of the control panel display are set by selecting Display from the Set-up Menu.

Use the following procedure to adjust the brightness and contrast of the control panel display.

1. Select the Set-up Menu. See and refer to Figure 111.
2. Using the Up (



) and Down (



) buttons, highlight:

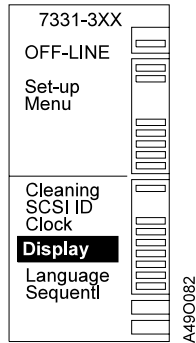

- Display on the Set-up Menu.

Figure 111. Off Line Set-up Menu Display

3. Press the Select (



) button to advance to (see Figure 112):

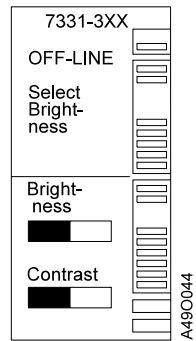

- Select Brightness display.
Note: While adjusting the control panel display for brightness and contrast, pressing the Cancel (



) button moves the selection back one menu item or back to the previous menu if the selection is on the first menu item.

- Use the Up (



) and Down (



) buttons to adjust the display brightness.

- Press the Select (



) button to set the brightness.

Figure 112. Off Line Select Brightness Display

4. See Figure 113 on page 75. Advance to:

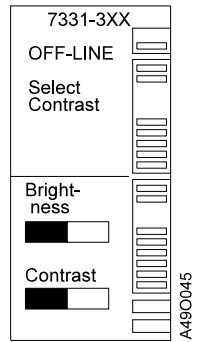

- Select Contrast display.
- Use the Up (↑) and Down (↓) buttons to adjust the display contrast.
- Press the Select (↵) button to set the contrast.

Figure 113. Off Line Select Contrast Display

5. Return to the Set-up Menu.

Selecting the Control Panel Display Language

The 8mm Tape Library has several different display languages available for the menus and options shown on the control panel display.

Use the following procedure to select the display language:

1. From the Main Menu (see Figure 115 on page 76), select the Set-up Menu. See

2. Using the Up (↑)



) and Down (↓)



) buttons:

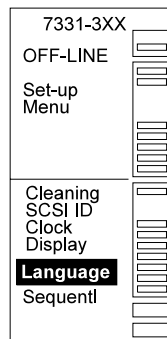
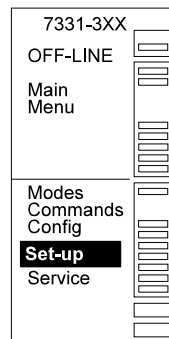

- Highlight Language on the Set-up Menu.
- Press the Select (↵) button to advance to the Language Menu.

Figure 114. Off Line Main Menu Display

3. The current display language setting is highlighted (see Figure 115 on page 76).

4. Using the Up (↑)



) and Down (↓)



) buttons:

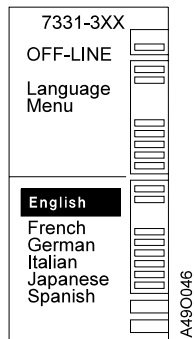

- Highlight the display language you want to select.
- Press the Select ()

) button to choose the selected language.

Note: All control panel menu items and messages are displayed in the selected language, except for bar code label information and the display header (library model number).

Figure 115. Off Line Language Display



5. Return to the Set-up Menu.

Enabling and Disabling Sequential Autorestarts

The library can be set up to prompt the operator after a sequential load has finished or to automatically restart the load without prompting the operator.

To enable or disable autorestarts of sequential loads, use the `Sequent1` option on the Set-up Menu. For an explanation of these modes, see “Restarting Sequential Mode Automatically” on page 32 or “Prompting the Operator for Sequential Restarts” on page 34.

Use the following procedure to enable or disable Sequential Mode restart prompt:

1. From the Main Menu (see Figure 116), select the Set-up Menu. See .
2. Using the Up () and Down () buttons:



) and Down (



) buttons:

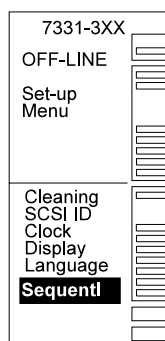
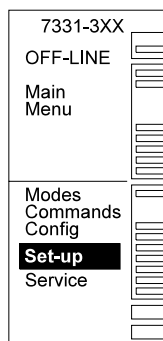

- Highlight `Sequent1` on the Set-up Menu.
- Press the Select ()

) button to advance to the Sequential Menu.

Figure 116. Off Line Main Menu Display

3. The current sequential mode restart prompt setting is highlighted (see Figure 117 on page 77).

4. Using the Up (



) and Down (



) buttons:

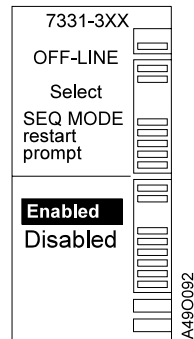

- Highlight Enable or Disable Sequential Mode restart prompt.
- Press the Select () button to choose the action.

Figure 117. Off Line Sequential Display

5. Return to the Set-up Menu.

Service

The control panel is also used to access service and diagnostics utilities. These operations are accessed by selecting Service from the Main Menu. The following service and diagnostic utilities are accessible from the Service Menu:

- History Log
- Selftest
- Calibrate

Attention: The service procedures listed in the Service guide are to be performed by trained service personnel only. Refer to the *7331 and 3449 8mm Tape Library Model 3xx Service Guide*, GA32-0377, for detailed service and diagnostic procedures.

Library Operations

The following procedures are performed by the operator. These procedures may or may not require the use of the control panel:

- Opening the front door
- Cleaning the 8mm tape path when a cleaning cartridge IS NOT in the library
- Applying bar code labels to a tape cartridge
- Inserting and removing tape cartridges in a tape cartridge magazine
- Installing or removing a tape cartridge magazine
- Inserting and removing tape cartridges in the 2-slot cartridge holder
- Loading and unloading tape cartridges in a tape drive

Opening the Tape Library Front Door

Open the library front door to gain access to the inside of the library. The library door is equipped with an automatic door lock in addition to the manual key lock. The automatic door lock is always engaged when the library is being operated from the host computer system or from the library control panel. The automatic door lock

is disengaged by pressing the Unlock (



) button. When library power is Off, the automatic door lock is unlocked. The key lock is a mechanical lock and must be unlocked before the door can be opened.

Use the following procedure to unlock and open the front door:

1. If required, turn the key lock to mechanically unlock the door. See Figure 118.

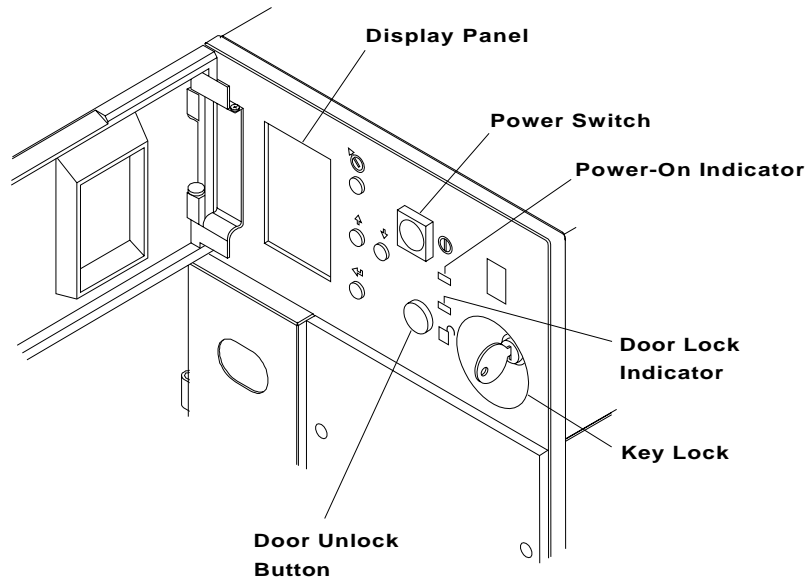

ASOP04-00

Figure 118. Control Panel Door Opening Controls

2. Press the unlock (



) button. The control panel display shows the message UNLOCK DOOR PRESSED indicating that the button was pressed. The library completes any move operation in progress when the button was pressed, and then parks the picker.

3. The manual key lock or a software controlled lock prevents unauthorized opening of the library door. If the operator attempts to open the library door (see Figure 119 on page 79) when a software controlled lock is present the library displays the message:

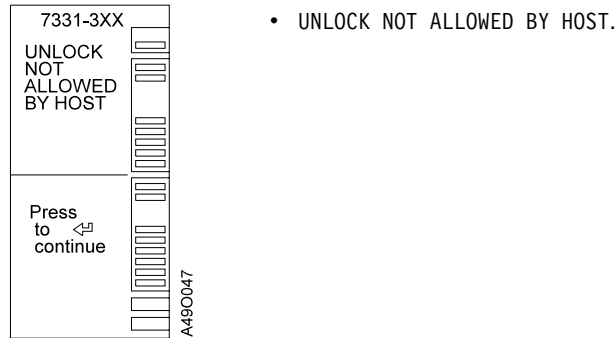

- UNLOCK NOT ALLOWED BY HOST.

Figure 119. Message Display

4. See Figure 120.
5. When all motion is complete the library door is unlocked, the door unlock indicator goes Off, and the display shows the message, The door may now be opened.

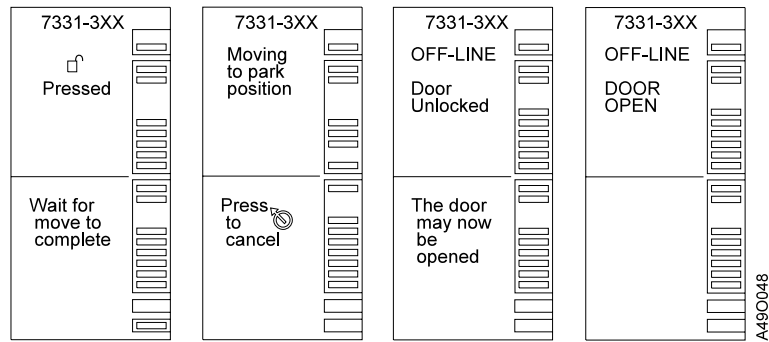

Figure 120. Opening Door Display

6. You can now open the library door or press the Cancel (



) button to relock the door. While the library door is open, the control panel display shows the message, DOOR OPEN.

7. While the door is open and power is applied to the library, the picker can be moved up and down with the Move Picker buttons, located on the inside of the front door, behind the control panel.

Note: While the library door is open, the library does not accept any move commands from the host computer system or the library control panel, and the tape cartridge inventory status becomes unknown.

8. When the actions that required the door to be opened are completed, close the library door.
9. When the library senses that the door is closed:
 - The door automatically locks.
 - The door unlock indicator lights.
 - The library returns to the mode it was in when the door unlock button was pressed.
 - Perform an inventory. Go to “Performing Inventory of the Tape Library Contents” on page 46.

Manually Cleaning the Tape Path: Cleaning Cartridge Not Present

Note: This procedure is for manual cleaning when a cleaning cartridge **is not** in the library. If a cleaning cartridge is in the library, use “Manually Cleaning the Tape Path: Cleaning Cartridge Present” on page 50 to perform manual cleaning.

The 8mm tape path requires manual cleaning when the tape drive is used excessively prior to a scheduled cleaning or when the scheduled cleaning is not sufficient to maintain a properly cleaned tape path.

Attention: Failure to clean the 8mm tape path on a regular basis will void the tape drive warranty.

See Figure 121. Use the following procedure to perform manual cleaning:

To load a cleaning cartridge into a tape drive, use the following procedure:

1. Open the library door. See “Opening the Tape Library Front Door” on page 77.
2. Make sure the library power is on and the drive has completed the Power-on Self Test (POST).

Note: When the library power is on and the library front door is open, the Move Picker buttons on the inside of the library door are used to move the picker up and down.

3. If required, use the Move Picker buttons to move the picker to a position where it does not block access to the tape drives.
4. Grasp the cleaning cartridge by the outer edges with the window side up and the write protect switch facing you.

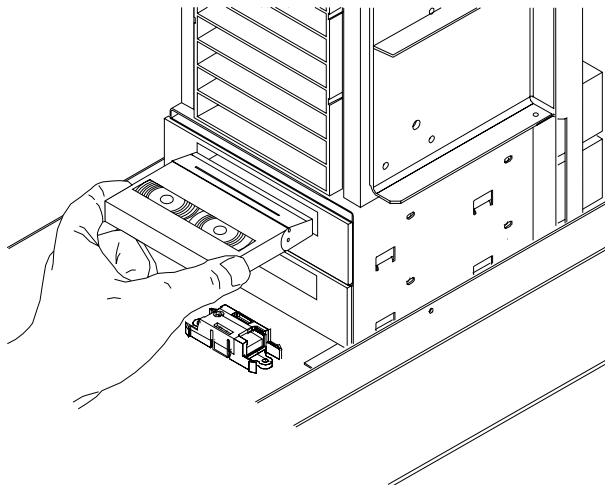

ASCRT3-00

Figure 121. Loading the Cleaning Cartridge in a Tape Drive

5. Reach inside the library and insert the cleaning cartridge into the tape drive. Slide the cleaning cartridge into the opening of the tape drive until the tape drive loading mechanism pulls the cleaning cartridge into the drive and the drive door closes.

Note: The 8mm cleaning cartridge can be used for a minimum of 18 cleaning operations. The tape drive detects when the cleaning cartridge is no longer usable and ejects the cleaning cartridge without turning off the tape drive amber disturbance (

↳
) status light.

6. After the cleaning cartridge is loaded into the drive, the remainder of the cleaning process is automatic. If the cleaning cartridge is immediately ejected, replace the cleaning cartridge and repeat this procedure.

During the cleaning operation:

- The control panel display shows, DOOR OPEN.
- The tape drive loads the cleaning cartridge into the tape path.
- The tape drive uses a small section of the cleaning cartridge to clean the drive. This operation takes approximately 2 minutes.
- The cleaning cartridge ejects from the drive when the cleaning operation is complete.
- The tape drive indicates a successful cleaning operation by turning off the amber disturbance (

↳
) status light.

7. If the cleaning operation continues for an extended time beyond that specified in step 52 or the cleaning cartridge does not eject at the end of the cleaning operation, go to Chapter 4. Operator Corrective Actions.
8. After the cleaning cartridge is ejected from the drive, reach inside the library, grasp the cleaning cartridge by the outer edges and pull the cleaning cartridge out of the tape drive.
9. Close the library front door.

Applying Bar Code Labels to a Tape Cartridge

The 7331 8mm Tape Library Model 305 is equipped with an optional bar code reader. 3449 Models 355 and 356 come standard with the bar code reader. Sample bar code labels are supplied with the library. Bar code label placement on tape cartridges used in the library must be as outlined in this procedure.

Bar code labels can be printed as required or ordered preprinted from various sources. See Appendix A. Bar Code Label Vendor List, for a list of sources from which bar code labels can be ordered. Bar code labels should meet the specifications listed in Chapter 3. Media.

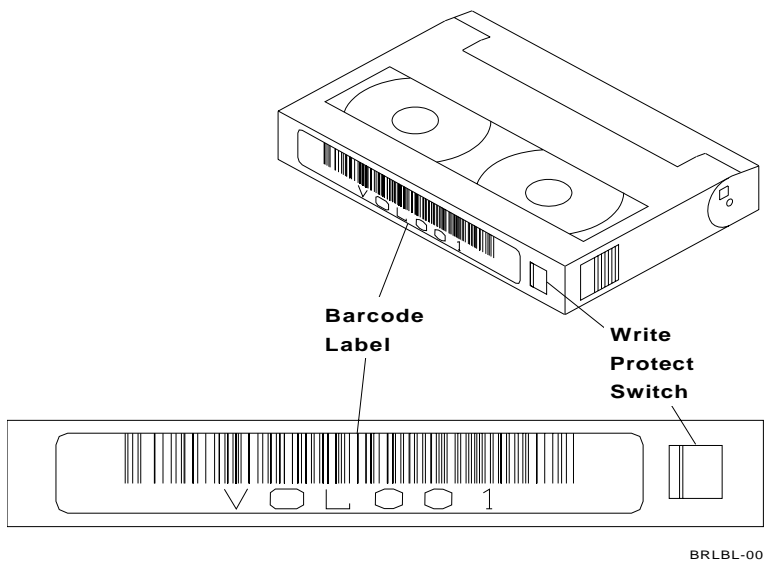

Figure 122. Tape Cartridge Bar Code Label Placement

Use the following procedure to apply a bar code label to a tape cartridge:

Note: To ensure optimum performance of the bar code reader, make sure bar code labels are correctly formatted and positioned on the tape cartridge.

1. Obtain required bar code labels and tape cartridges.
2. Ensure the tape cartridge is clean and free of any material that may prevent the label from properly adhering to the cartridge. If possible, peel off any old labels.

Note: Make sure the bar code label is positioned so that when you look at the back of the cartridge the label is to the left of the write protect switch, and the label bars are towards the top of the cartridge.

3. Apply bar code label to tape cartridge (see Figure 122).

Inserting and Removing a Tape Cartridge in a Tape Cartridge Magazine

Tape cartridges can be inserted in a tape cartridge magazine with the magazine installed in or removed from the library.

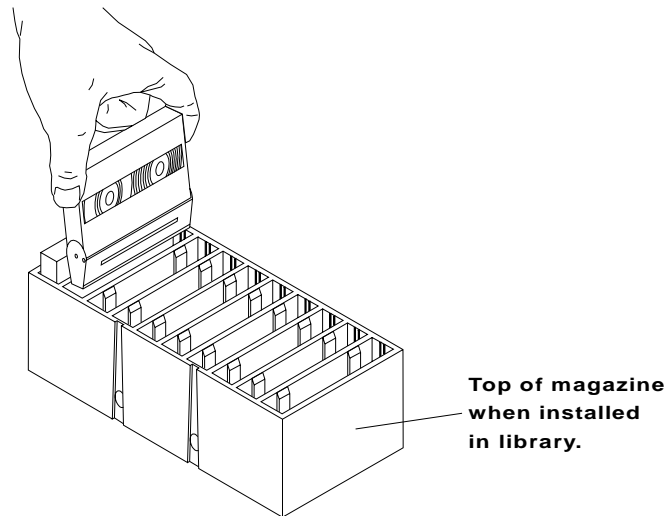

ASCRT2-00

Figure 123. Inserting a Tape Cartridge into a Magazine

To insert a tape cartridge into a magazine that is not in the library, use the following procedure:

1. Obtain a tape cartridge magazine and tape cartridges. If a bar code reader is installed, make sure bar code labels are installed on the tape cartridges. If bar code labels need to be applied, see "Applying Bar Code Labels to a Tape Cartridge" on page 81.
2. Position magazine as shown in Figure 123. If tape cartridges are being inserted in a magazine that is installed in the library, make sure the tape cartridge is aligned with the magazine as shown in the figure.

Note: Make sure the write protect switch is properly set on the tape cartridges. See "Setting the Write-Protect Switch" on page 93.

3. Grasp the tape cartridge by the outer edges.
4. With the window side of the tape cartridge facing the end of the magazine that will be the top of the magazine when the magazine is installed in the library, insert the tape cartridge into a magazine slot until the tape cartridge is firmly seated. The tape cartridge should fit firmly into the magazine slot and latch into place.
5. Repeat steps 2 - 4 for remainder of tape cartridges to be inserted.

To remove a tape cartridge from a magazine, use the following procedure:

1. Position the magazine as shown in Figure 123.
2. While holding the magazine, grasp the tape cartridge by the outer edges and pull the tape cartridge straight out of the magazine slot.
3. Repeat step 2 for any other tape cartridges to be removed.

Installing and Removing a Tape Cartridge Magazine

The 8mm Tape Library can be configured with two removable tape cartridge magazines. Each magazine is normally loaded with tape cartridges used for saving and restoring system data files or for archiving important records. If neither magazine is installed, the library only operates with one of the slots in the 2-slot cartridge holder.

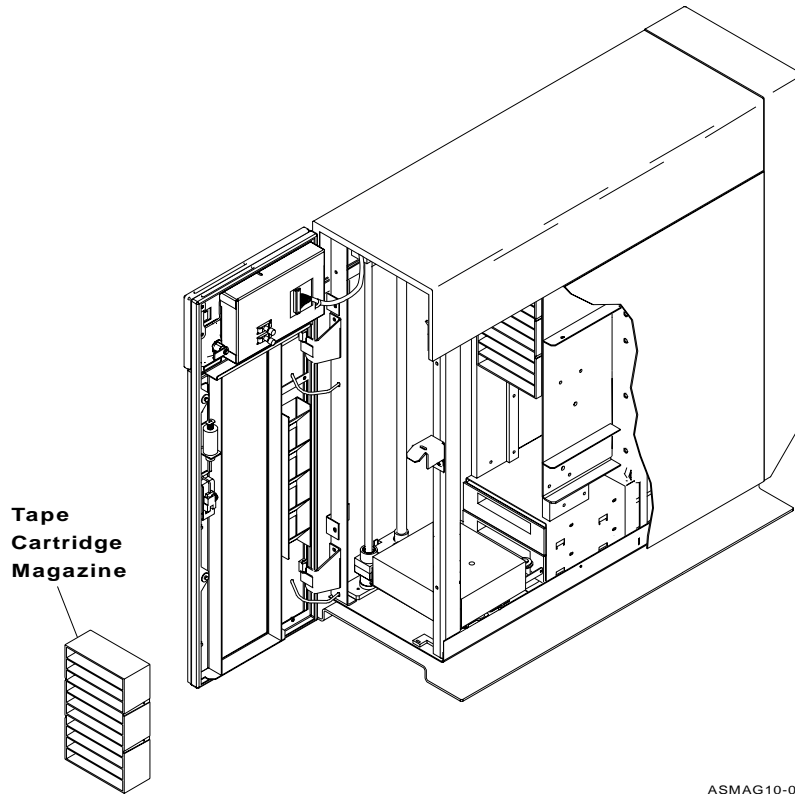

ASMAG10-00

Figure 124. Tape Library 10-Slot Magazine

To install a tape cartridge magazine, see Figure 124 and use the following procedure:

1. If not already open, open the library door. See “Opening the Tape Library Front Door” on page 77.

Note: When the library power is on and the library front door is open, the Move Picker buttons on the inside of the library door are used to move the picker up and down.

2. If the picker is not at the bottom of the library, use the Move Picker buttons to move the picker to the bottom of the library.
3. Make sure there is an empty location for the tape cartridge magazine.
4. Obtain the tape cartridge magazine to be installed.
5. If not already removed, remove and store magazine dust cover.
6. Grasping the magazine by the sides, position the magazine on the mounting plate and push firmly until the magazine seats on the mounting plates. There may be a slight clicking sound as the magazine seats in the mounting plates. The magazine should fit firmly on the mounting plates and latch into place.
7. Close the library front door.
8. Perform an inventory of the library contents. See “Performing Inventory of the Tape Library Contents” on page 46.

To remove a tape cartridge magazine, use the following procedure:

1. If not already open, open the library door. See “Opening the Tape Library Front Door” on page 77.
2. Once the library door is open, either magazine can be removed.

Note: When the library power is on and the library front door is open, the Move Picker buttons on the inside of the library door are used to move the picker up and down.

3. If the picker is not at the bottom of the library, use the Move Picker buttons to move the picker to the bottom of the library.
4. Grasp the magazine by the sides and pull the magazine straight out of the magazine mounting plates. If both magazines are to be removed, repeat this step to remove the other magazine.
5. Place dust cover on the magazine and store the magazine.
6. If a magazine will not be installed at this time, close the library door.

Inserting and Removing a Tape Cartridge in the 2-Slot Tape Cartridge Holder

In addition to the tape magazines, the 8mm Tape Library has available a permanently installed 2-slot cartridge holder located above the two removable magazines. These slots can be used for a cleaning tape, diagnostic tape, additional data tapes, or left empty. This section explains how to insert or remove a tape from one of these locations.

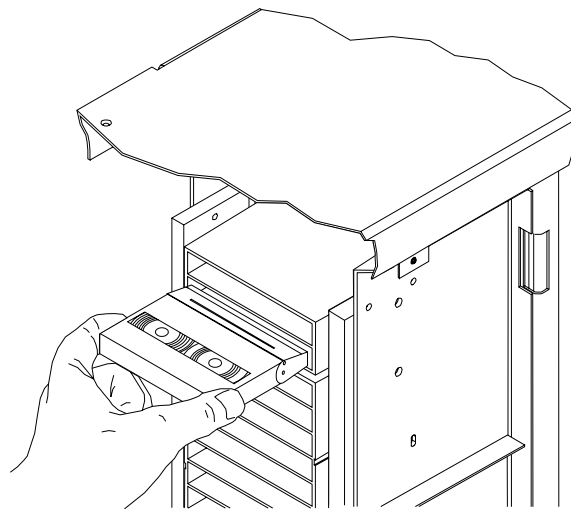

ASCRT1-00

Figure 125. Inserting a Tape Cartridge into a 2-Slot Cartridge Holder

To insert a tape cartridge into the 2-Slot tape cartridge holder, refer to Figure 125 and use the following procedure:

1. If not already open, open the library door. See “Opening the Tape Library Front Door” on page 77.

Note: When the library power is on and the library front door is open, the Move Picker buttons on the inside of the library door are used to move the picker up and down.

2. If the picker is not at the bottom of the library, use the Move Picker buttons to move the picker to the bottom of the library.
3. Grasp the tape cartridge to be installed by outer edges with the window side up.
4. Reach inside the library and insert the tape cartridge into a 2-slot cartridge holder slot until the tape cartridge is firmly seated. The tape cartridge should fit firmly into the holder slot and latch into place.

5. Repeat step 4 on page 85 if another tape cartridge needs to be inserted into the 2-slot cartridge holder.
6. Close the library front door.
7. Perform an inventory of the library contents. See “Performing Inventory of the Tape Library Contents” on page 46

To remove a tape cartridge from the 2-slot tape cartridge holder, use the following procedure:

1. If not already open, open the library door. See “Opening the Tape Library Front Door” on page 77.

Note: When the library power is on and the library front door is open, the Move Picker buttons on the inside of the library door are used to move the picker up and down.

2. If the picker is not at the bottom of the library, use the Move Picker buttons to move the picker to the bottom of the library.
3. Reach inside the library, grasp the tape cartridge by its outer edges and pull the tape cartridge out of the 2-slot cartridge holder.
4. Repeat step 3 if another tape cartridge needs to be removed.
5. If no tape cartridges are to be installed at this time, close the library front door.
6. Perform an inventory of the library contents. See “Performing Inventory of the Tape Library Contents” on page 46

Loading and Unloading Tape Cartridges in a Tape Drive

The tape drives in the library can operate independent of other library operations and can be accessed directly by the host computer system for running a manually inserted tape such as a diagnostics tape.

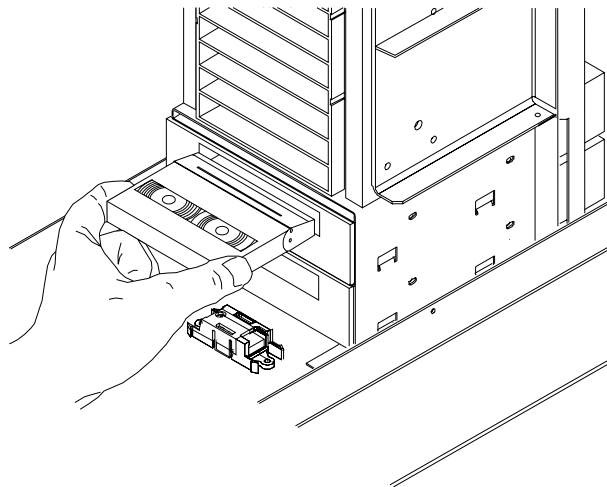

ASCRT3-00

Figure 126. Loading a Tape Cartridge in a Tape Drive

To load a tape cartridge into a tape drive, see Figure 126 and use the following procedure:

1. If not already open, open the library door. See “Opening the Tape Library Front Door” on page 77.
2. Make sure the library power is on and the drive has completed the Power-on Self Test (POST).

Note: When the library power is on and the library front door is open, the Move Picker buttons on the inside of the library door are used to move the picker up and down.

3. If required, use the Move Picker buttons to move the picker to a position where it does not block access to the tape drive.
4. Grasp the tape cartridge, to be installed, by outer edges with the window side up and the write protect switch facing you.
5. Reach inside the library and insert the tape cartridge into the tape drive. Slide the tape cartridge into the opening of the tape drive until the tape drive loading mechanism pulls the tape cartridge into the drive and the drive door closes.
6. There will be some mild mechanical noises and the green read-write (



) status light flashes as the tape drive loads the tape cartridge.

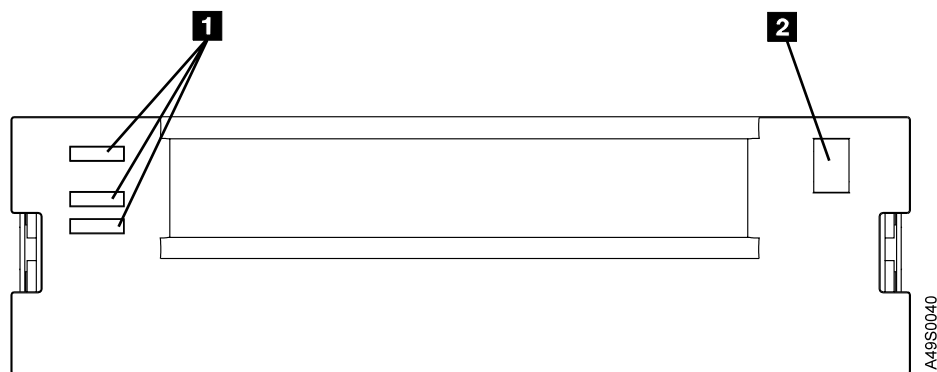

Figure 127. Tape Drive Front Panel

- Item **1**, in Figure 127, is the column of status lights made up of (top to bottom) DISTURBANCE, READY, and READ-WRITE indicators.
- Item **2**, above, is the UNLOAD BUTTON.

7. The green ready (



) status light turns On if the load operation was successful.



8. Once the tape cartridge is loaded into the tape drive, the specific tape operation is performed.

To unload and eject a tape cartridge, use the following procedure:

1. If not already open, open the library door. See “Opening the Tape Library Front Door” on page 77.
2. Make sure the library power is on.

Note: When the library power is on and the library front door is open, the Move Picker buttons on the inside of the library door are used to move the picker up and down.

3. If required, use the Move Picker buttons to move the picker to a position that does not block access to the tape drive.
4. If the tape drive has not ejected the tape cartridge, press the tape drive unload button. When the unload button is pressed, the following occurs:

- The green ready () status light turns off.
 - The green read-write () status light flashes during the unload operation.
 - The green read-write () status light turns off when the cartridge is ejected from the tape drive.
5. If the tape cartridge does not eject when the unload button is pressed, go to Chapter 4. Operator Corrective Actions.
 6. After the tape cartridge ejects from the drive, grasp the tape cartridge by the outer edges and pull the tape cartridge out of the tape drive.
 7. Close the library front door.
 8. Perform an inventory of the library contents. See “Performing Inventory of the Tape Library Contents” on page 46.

Chapter 3. Media

The 8mm Tape Library uses an 8mm data cartridge for saving and restoring system data. For optimum performance it is recommended that only the type of 8mm cartridges shipped with the machine be used.

Types of 8mm Cartridges

8mm Data Cartridge

Use the data cartridge for saving or restoring your programs or data. Additional data cartridges can be ordered. If the optional bar code reader is installed, data tape cartridges for the 8mm Tape Library must have external labels that are bar coded with a serial number. These labels are read by the library bar code reader and the information about the tape recorded in the library memory. The tape cartridge ID on the labels must be six characters.

Maximum capacity can be achieved by using 170 meter Advanced Metal Evaporated (AME) 8mm data cartridges with Media Recognition System (MRS).

Contact your supplier for appropriate external labels for the tape cartridges. Appendix A. Bar Code Label Vendor List lists sources for bar code labels. The user is required to install the external labels on the data cartridges. This must be done to allow cartridges to be read by the optional bar code reader in the 8mm Tape Library.

Test Cartridge

The test cartridge supplied with the 8mm Tape Library is for service purposes. Please reserve this specially labeled cartridge as a test cartridge. It should be used with your system initiated diagnostic test. Do not use it to save or restore programs or data. The test cartridge can be placed in the second bonus slot.

Cleaning Cartridge

A cleaning cartridge is supplied with the 8mm Tape Library. The number of cleaning cycles per cleaner cartridge is 18 cycles minimum; typical is 40 cycles.

The cleaning cartridge should be placed in bonus slot two. Cleaning can be based upon a tape drive reporting it needs cleaning, or at a scheduled time of the day or night during the week. The scheduled time option allows the operator to schedule cleanings to run at a time when the library is not likely to be running critical tape applications.

A cleaning cartridge installed in the library is recognized by the library using a bar code mask that is set by the operator when setting the cleaning schedule for the library tape drives. See "Cleaning Cartridge Bar Code Label Mask" on page 66 for details on cleaning cartridge bar code masking.

Bar Code Label Specifications

Contact your supplier for appropriate external bar code labels for the data and cleaning cartridges. Appendix A. Bar Code Label Vendor List lists sources for bar code labels. Sample bar code labels are supplied with the library. Bar code labels printed locally or ordered preprinted should meet the specifications listed below. The user is required to install the bar code labels on the data and cleaning cartridges. Refer to Figure 128 for placement. This must be done to allow cartridges to be read by the bar code reader in the 8mm Tape Library.

Bar code label format for tape cartridges used with an RS/6000 system require the following:

The bar code label must begin with an alphabetic character (A...Z, \$, or #) and can be followed by alphanumeric characters (A...Z, \$, #, or period (.)). Blanks between characters are never allowed in a name. It is highly recommended that the first six characters of the cartridge ID be the same as the volume ID for the tape.

Description	Specification
Preferred Label Material:	Kimdura** (synthetic label)
Label Surface:	Matte Finish
Label Backing:	Permanent Adhesive
Preferred Print Method:	Thermal Transfer w/ high quality carbon ribbon
Minimum Reflectance Difference:	55% or better
ANSI grade:	B
STI grade:	90% or equivalent
Bar code density:	Medium density (14.8 mils minimum)
Bar code Symbology:	Code 39
Quiet Zone:	10X or better (0.148 inches)
Shelf Life:	1 year or more
Check Sum Digit:	Modulus 43

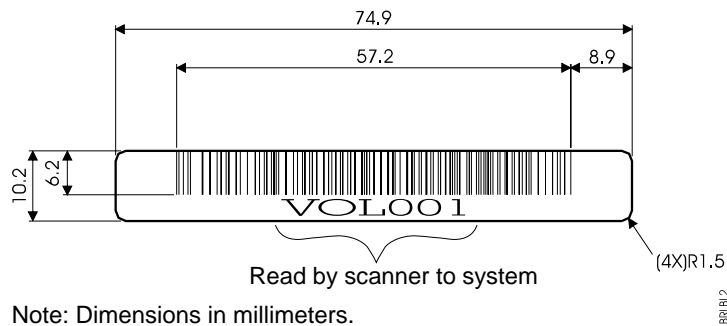

Figure 128. Tape Cartridge Bar Code Label Placement

Recommendations and User Environments for 8mm Cartridges

Use only high quality, data grade media, such as IBM's 8mm Data Cartridge.

Attention: Use of video grade cartridges can be hazardous to your 8mm Tape Library and will void your warranty.

Do keep the door on the library closed when the library is not in use.

Do clean the tape path by using the recommended cleaning cartridge. Follow the instructions on the cartridge.

Attention: Use of other than recommended cleaning cartridges can be hazardous to your 8mm Tape Library and will void your warranty.

Do assign a unique volume identification (ID) to every data cartridge when you initialize the cartridge.

Do back up and then discard any tape that repeatedly produces error messages. (The error information is in the System Error Log. Identify the cartridge by its volume ID.)

Do not open the door on the data cartridge that covers the tape. This door protects the magnetic tape material from dirt, dust, and damage.

Do not operate in a dusty environment.

Do not touch the tape material. Any substance transferred to the tape by touching could cause loss of data.

8mm Data Cartridge Erasure

Most bulk eraser devices do not have the capability to erase the 8mm data cartridge. To properly erase an 8mm data cartridge with a bulk eraser device, the erasure coercivity rating must be 1500 oersted minimum.

The 8mm Tape Library has direct overwrite of any existing data on the data cartridge.

Operating, Storage, and Shipping Environments

Before using the cartridges, let them adjust (acclimate) to the operating environment by placing the cartridge in the operating environment for as long as it has been away from this environment, or for 24 hours, whichever is less.

Acclimation is necessary on any data cartridge exposed to a different humidity environment or temperature changes of 11°C (20°F) or more.

The recommended environment for operation, storage, and shipment of 8mm data cartridges is 23°C (73°F) and 50% relative humidity. However, the 8mm data cartridge can be operated, stored, and shipped in a wide variety of environments. Refer to Figure 129 on page 92 for a description of these environments.

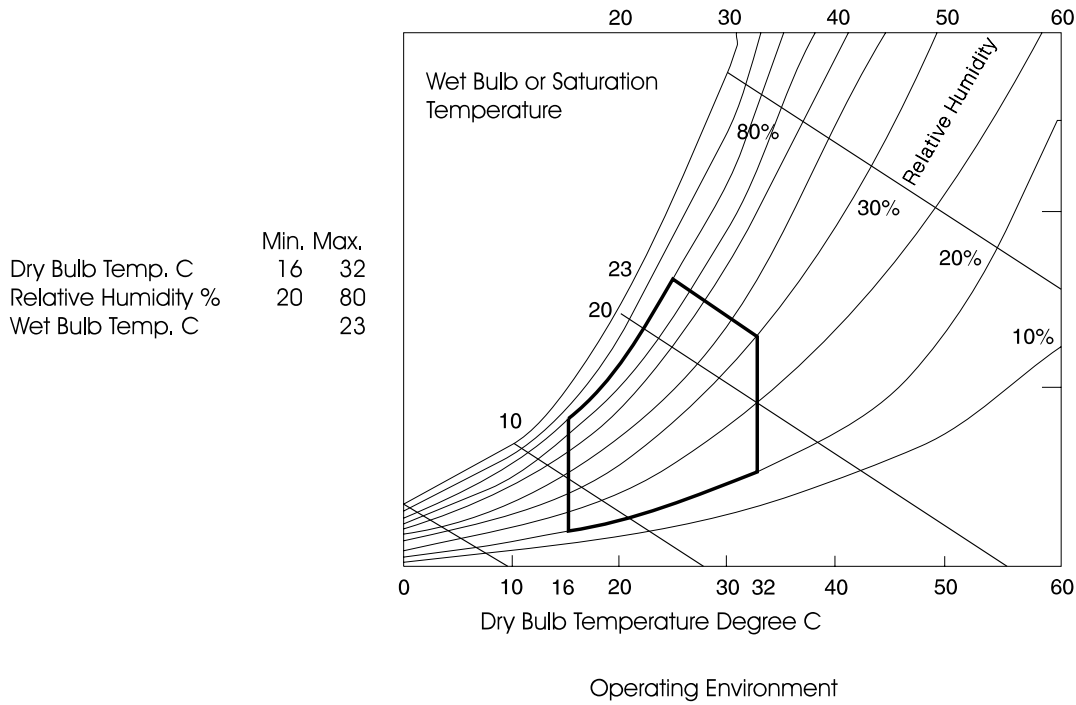

Figure 129. Operating Environment

	Operating	Storage	Shipping
Temperature	16 to 32°C (60 to 90°F)	5°C to 32°C (40° to 90°F)	-40 to 45°C (-40 to 125°F)
Relative Humidity	20 to 80%	20 to 80%	5 to 80%
Maximum Wet Bulb	23°C (73°F)	26°C (79°F)	26°C (79°F)

Figure 130. Recommended Environment for 8mm Data Cartridges

Attention: Operation within the OPERATING region requires only regular cleaning as described in “Manually Cleaning the Tape Path: Cleaning Cartridge Present” on page 50 and “Setting the Tape Drive Cleaning Schedule” on page 56. Operation outside of the operating area can result in possible loss of data and/or drive failure.

Operating in Harsh Environments

Do not use as an archival tape any tape that has been used outside of the ranges specified in Figure 130 for an extended period of time (50 passes in 40 hours of nonstop operation). The magnetic and physical strength of the tape will have deteriorated as a result of its exposure to the environment. Do not store important data on such a tape; transfer the data to a newer tape for reliable archiving.

Setting the Write-Protect Switch

The window on a tape cartridge determines when you can write to the 8mm data cartridge. When the window is opened, data can be both written to and read from the tape cartridge. Refer to Figure 131. Trying to write to an 8mm data cartridge with the window closed causes an error.

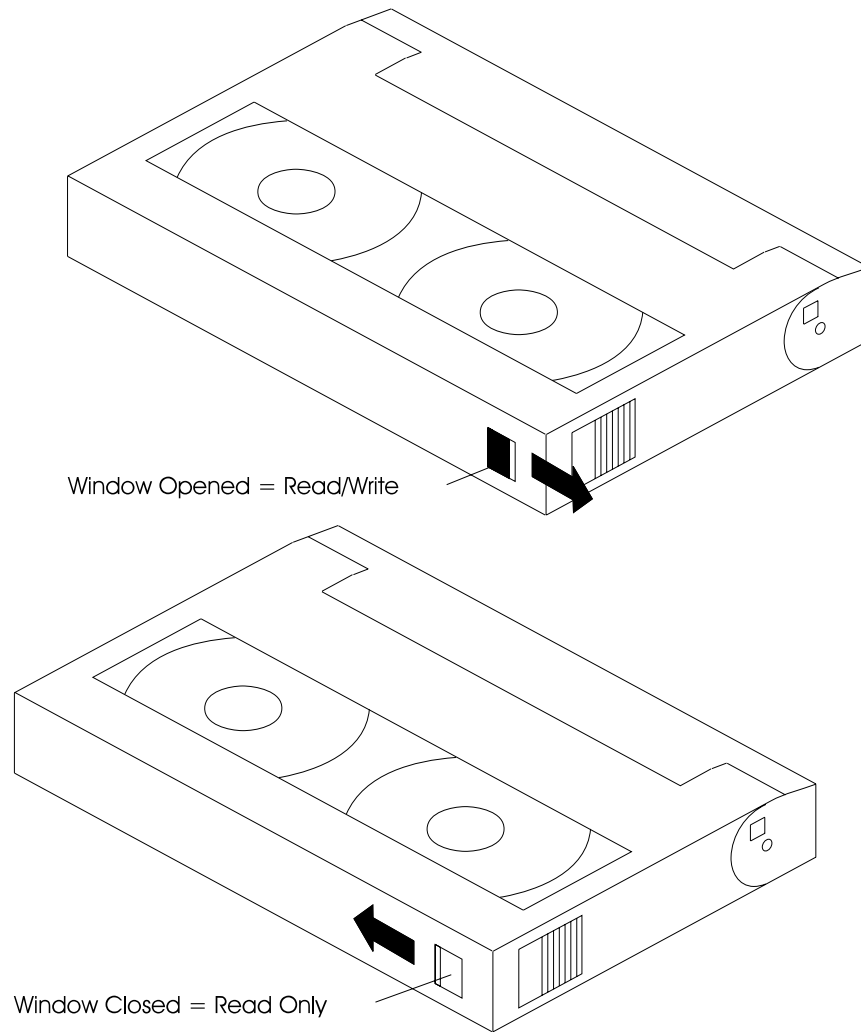

Figure 131. Cartridge Showing Read/Write Window

Chapter 4. Operator Corrective Actions

The four digit unit error codes listed in the following table are reported by the library when a library failure occurs. This table only list the codes that are operator correctable. All other unit error codes reported by the library or error conditions are to be reported to the service representative for isolation and repair. See the *7331 and 3449 8mm Tape Library Model 3xx Service Guide*, GA32-0377, for replacement of the failed component.

Note: For irrecoverable errors, call your authorized service representative.

Table 7. 8mm Tape Library Error Conditions and Operator Corrective Actions

Error Condition	Unit Error Code	Corrective Action
No empty slots in the library No tape cartridges in the library	018E 018F	<ol style="list-style-type: none"> 1. Open the library front door. See "Opening the Tape Library Front Door" on page 77. 2. Take the necessary action to correct the specific problem. 3. Close the library front door and continue operations. If the error still reports, call the 8mm Tape Library service representative.
Media in tape drive - sequential mode not allowed Media not accessible - in loaded position	01C9 01CD	<ol style="list-style-type: none"> 1. Wait for the library to unload the tape cartridge. If the library does not unload the tape cartridge, continue with the next step. 2. Open the library front door. See "Opening the Tape Library Front Door" on page 77. 3. Press the tape drive unload button. 4. If the tape drive does not eject the tape cartridge, call the 8mm Tape Library service representative. If the tape cartridge ejects, continue with next step. 5. Close the library front door and continue operations. If the error still reports, call the 8mm Tape Library service representative.
Accessor Path Not Clear	01A0	<ol style="list-style-type: none"> 1. Open the library front door. See "Opening the Tape Library Front Door" on page 77. 2. Make sure both tape cartridge magazines are fully inserted. 3. Make sure all tape cartridges are fully inserted into the magazines. 4. Remove any tape cartridges sticking out of either tape drive. Note: Because it is difficult to position a tape cartridge in the same position that the drive would eject to, it is recommended that the tape cartridge be removed from the tape drive rather than repositioned. This prevents the possibility of causing a move error. 5. Close the library front door and continue operations. If the error still reports, call the 8mm Tape Library service representative.

Table 7. 8mm Tape Library Error Conditions and Operator Corrective Actions (continued)

Error Condition	Unit Error Code	Corrective Action
Open Door	01BF	<ol style="list-style-type: none"> 1. Make sure library door is closed. 2. If library door is closed and error reports, call the 8mm Tape Library service representative.
Cartridge Magazine is missing	01C0	<ol style="list-style-type: none"> 1. Open the library front door. See “Opening the Tape Library Front Door” on page 77. 2. Make sure tape cartridge magazines are installed and fully seated in the magazine mounting plates. 3. Close the library front door and continue operations. If the error still reports, call the 8mm Tape Library service representative.
No valid cleaning tape cartridge in library	01D2	<ol style="list-style-type: none"> 1. Open the library front door. See “Opening the Tape Library Front Door” on page 77. 2. If a good cleaning cartridge is in the library, make sure the cartridge is in the correct location and the cleaning cartridge bar code mask matches the bar code label on the cleaning cartridge. See “Setting the Tape Drive Cleaning Schedule” on page 56 for viewing and setting the bar code mask. 3. If no cleaning cartridge is in the library or the installed cleaning cartridge is no longer usable, insert a new cleaning cartridge in the library. See “Inserting and Removing a Tape Cartridge in the 2-Slot Tape Cartridge Holder” on page 85 4. Close the library front door and repeat the cleaning procedure. If the error still reports, call the 8mm Tape Library service representative.
Accessor locked	01D0	<ol style="list-style-type: none"> 1. Open the library front door. See “Opening the Tape Library Front Door” on page 77. 2. Unlock the accessor lock (mechanical lock). 3. Close the library front door and continue operations. If the error still reports, call the 8mm Tape Library service representative.
Invalid split source element	0200	An invalid command has been received. The 8mm Tape Library will log the sense data, notify the operator, and stop current job or process. Refer to “Split Library Configuration” on page 6 for more information.
Invalid split destination element	0201	An invalid command has been received. The 8mm Tape Library will log the sense data, notify the operator, and stop current job or process. Refer to “Split Library Configuration” on page 6 for more information.
Inaccessible split element	0202	An element has been selected that is inaccessible because it is part of a split set. Refer to “Split Library Configuration” on page 6 for more information.
Manual mode in split configuration	0203	An invalid command has been received. The 8mm Tape Library will log the sense data, notify the operator, and stop current job or process. Refer to “Split Library Configuration” on page 6 for more information.

Table 7. 8mm Tape Library Error Conditions and Operator Corrective Actions (continued)







Error Condition	Unit Error Code	Corrective Action
SCSI ID overlap error	0230	<ol style="list-style-type: none"> 1. The current SCSI IDs are not valid. Change the SCSI IDs using “Selecting the SCSI ID” on page 67. 2. Refer to the 7331 and 3449 8mm Tape Library, Model 3xx Installation Guide for information about external cabling problems. 3. If the error still reports, call the 8mm Tape Library service representative.
Cartridge in picker	-	<ol style="list-style-type: none"> 1. Use the move command to move the tape cartridge into an empty slot. 2. If the tape cartridge will not move out of the picker, call the 8mm Tape Library service representative. 3. If the tape cartridge moves out of the picker, continue library operations.
Control panel display does not show the correct library configuration. For example, only one drive is displayed and the library has two drives installed.	-	<ol style="list-style-type: none"> 1. Open the control panel access cover the press the control panel power switch () to turn the library power Off. Wait 10 seconds for the power supply to reset, then press the control panel power switch () to turn the library power On. 2. If the control panel display still does not show the correct library configuration, call the 8mm Tape Library service representative. 3. If the control panel display is correct this was an intermittent problem, resume library operations.
Displayed UEC error description	All UECs not previously listed	<ol style="list-style-type: none"> 1. Open the control panel access cover the press the control panel power switch () to turn the library power Off. Wait 10 seconds for the power supply to reset, then press the control panel power switch () to turn the library power On. 2. If the library completes POST with no error conditions and control panel display is correct this was an intermittent problem, resume library operations. 3. If the error condition reoccurs, call the 8mm Tape Library service representative.

Table 7. 8mm Tape Library Error Conditions and Operator Corrective Actions (continued)

Error Condition	Unit Error Code	Corrective Action
<p>The cleaning operation continues for an extended time beyond that specified in “Manually Cleaning the Tape Path: Cleaning Cartridge Present” on page 50 or the cleaning cartridge does not eject at the end of the cleaning operation.</p>	<p>A UEC may or may not be shown</p>	<p>Note: If this is the second occurrence of this condition while in the process of cleaning, call the 8mm Tape Library service representative.</p> <ol style="list-style-type: none"> 1. Press the Cancel () button. The control panel display shows the message, Operator canceled the move. 2. Press the Cancel () button. The Mode Menu is shown on the control panel display. 3. Open the library front door. See “Opening the Tape Library Front Door” on page 77. 4. Using the move buttons on the inside of the front door, move the picker from in front of the tape drive. 5. Press the tape drive unload button. 6. If the tape drive does not eject the tape cartridge, call the 8mm Tape Library service representative. If the tape cartridge ejects, continue with next step. 7. Remove the ejected tape cartridge. 8. Insert a new cleaning cartridge in the library. Do not insert the cleaning cartridge in the tape drive. See “Inserting and Removing a Tape Cartridge in the 2-Slot Tape Cartridge Holder” on page 85. 9. Close the library front door and repeat the cleaning. Go to “Manually Cleaning the Tape Path: Cleaning Cartridge Present” on page 50.
<p>Note:</p> <ol style="list-style-type: none"> 1. The description under Error Condition does not necessarily match the messages displayed on the control panel display. 2. For all 8mm Tape Library errors not listed in this table call the service representative. 		

Appendix A. Bar Code Label Vendor List

Bar Code Labels

Bar code labels for use on the tape cartridges used in the 8mm Tape Library may be purchased from the following sources:

BARCODE Systems Inc.
15315 Minnetonka Industrial Rd.
Minneapolis, MN 55345-2216
(612) 945-9333
FAX (612) 945-9419

or

SCREENPRINT/DOW
271 Ballardvale St.
P.O. Box 1332
Wilmington, MA 01887-0932
(617) 935-6395

Appendix B. Statement of Limited Warranty

The warranties provided by IBM in this Statement of Limited Warranty apply only to Machines you originally purchase for your use, and not for resale, from IBM or your reseller. The term "Machine" means an IBM machine, its features, conversions, upgrades, elements, or accessories, or any combination of them. Unless IBM specifies otherwise, the following warranties apply only in the country where you acquire the Machine. If you have any questions, contact IBM or your reseller.

Machine: 7331 and 3449 8mm Tape Library, Model 3xx Operator Guide
Warranty Period*: One Year

**Contact your place of purchase for warranty service information.*

Production Status

Each Machine is manufactured from new parts, or new and used parts. In some cases, the Machine may not be new and may have been previously installed. Regardless of the Machine's production status, IBM's warranty terms apply.

The IBM Warranty for Machines

IBM warrants that each Machine 1) is free from defects in materials and workmanship and 2) conforms to IBM's Official Published Specifications. The warranty period for a Machine is a specified, fixed period commencing on its Date of Installation. The date on your receipt is the Date of Installation, unless IBM or your reseller informs you otherwise.

During the warranty period IBM or your reseller, if authorized by IBM, will provide warranty service under the type of service designated for the Machine and will manage and install engineering changes that apply to the Machine.

For IBM or your reseller to provide warranty service for a feature, conversion, or upgrade, IBM or your reseller may require that the Machine on which it is installed be 1) for certain Machines, the designated, serial-numbered Machine and 2) at an engineering-change level compatible with the feature, conversion, or upgrade. Many of these transactions involve the removal of parts and their return to IBM. You represent that all removed parts are genuine and unaltered. A part that replaces a removed part will assume the warranty service status of the replaced part.

If a Machine does not function as warranted during the warranty period, IBM or your reseller will repair it or replace it with one that is at least functionally equivalent, without charge. The replacement may not be new, but will be in good working order. If IBM or your reseller is unable to repair or replace the Machine, you may return it to your place of purchase and your money will be refunded.

If you transfer a Machine to another user, warranty service is available to that user for the remainder of the warranty period. You should give your proof of purchase and this Statement to that user. However, for Machines which have a life-time warranty, this warranty is not transferable.

Warranty Service

To obtain warranty service for the Machine, you should contact your reseller or call IBM. In the United States, call IBM at **1-800-IBM-SERV (426-7378)**. In Canada, call IBM at **1-800-465-6666**. You may be required to present proof of purchase.

IBM or your reseller will provide certain types of repair and exchange service, either at your location or at IBM's or your reseller's service center, to restore a Machine to good working order.

When a type of service involves the exchange of a Machine or part, the item IBM or your reseller replaces becomes its property and the replacement becomes yours. You represent that all removed items are genuine and unaltered. The replacement may not be new, but will be in good working order and at least functionally equivalent to the item replaced. The replacement assumes the warranty service status of the replaced item. Before IBM or your reseller exchanges a Machine or part, you agree to remove all features, parts, options, alterations, and attachments not under warranty service. You also agree to ensure that the Machine is free of any legal obligations or restrictions that prevent its exchange. You agree to:

1. Obtain authorization from the owner to have IBM or your reseller service a Machine that you do not own; and
2. Where applicable, before service is provided —
 - a. Follow the problem determination, problem analysis, and service request procedures that IBM or your reseller provide,
 - b. Secure all programs, data, and funds contained in a Machine, and
 - c. Inform IBM or your reseller of changes in a Machine's location.

IBM is responsible for loss of, or damage to, your Machine while it is 1) in IBM's possession or 2) in transit in those cases where IBM is responsible for the transportation charges.

Extent of Warranty

IBM does not warrant uninterrupted or error-free operation of a Machine.

The warranties may be voided by misuse, accident, modification, unsuitable physical or operating environment, improper maintenance by you, removal or alteration of Machine or parts identification labels, or failure caused by a product for which IBM is not responsible.

THESE WARRANTIES REPLACE ALL OTHER WARRANTIES OR CONDITIONS, EXPRESS OR IMPLIED, INCLUDING, BUT NOT LIMITED TO, THE IMPLIED WARRANTIES OR CONDITIONS OF MERCHANTABILITY AND FITNESS FOR A PARTICULAR PURPOSE. THESE WARRANTIES GIVE YOU SPECIFIC LEGAL RIGHTS AND YOU MAY ALSO HAVE OTHER RIGHTS WHICH VARY FROM JURISDICTION TO JURISDICTION. SOME JURISDICTIONS DO NOT ALLOW THE EXCLUSION OR LIMITATION OF EXPRESS OR IMPLIED WARRANTIES, SO THE ABOVE EXCLUSION OR LIMITATION MAY NOT APPLY TO YOU. IN THAT EVENT SUCH WARRANTIES ARE LIMITED IN DURATION TO THE WARRANTY PERIOD. NO WARRANTIES APPLY AFTER THAT PERIOD.

Limitation of Liability

Circumstances may arise where, because of a default on IBM's part or other liability you are entitled to recover damages from IBM. In each such instance, regardless of the basis on which you are entitled to claim damages from IBM (including fundamental breach, negligence, misrepresentation, or other contract or tort claim), IBM is liable only for:

1. Damages for bodily injury (including death) and damage to real property and tangible personal property; and
2. The amount of any other actual direct damages or loss, up to the greater of U.S. \$100,000 or the charges (if recurring, 12 months' charges apply) for the Machine that is the subject of the claim.

UNDER NO CIRCUMSTANCES IS IBM LIABLE FOR ANY OF THE FOLLOWING: 1) THIRD-PARTY CLAIMS AGAINST YOU FOR LOSSES OR DAMAGES (OTHER THAN THOSE UNDER THE FIRST ITEM LISTED ABOVE); 2) LOSS OF, OR DAMAGE TO, YOUR RECORDS OR DATA; OR 3) SPECIAL, INCIDENTAL, OR INDIRECT DAMAGES OR FOR ANY ECONOMIC CONSEQUENTIAL DAMAGES (INCLUDING LOST PROFITS OR SAVINGS), EVEN IF IBM OR YOUR RESELLER IS INFORMED OF THEIR POSSIBILITY. SOME JURISDICTIONS DO NOT ALLOW THE EXCLUSION OR LIMITATION OF INCIDENTAL OR CONSEQUENTIAL DAMAGES, SO THE ABOVE EXCLUSION OR LIMITATION MAY NOT APPLY TO YOU.

International Business Machines Corporation

Armonk, New York 10504, U.S.A.

Index

Numerics

- 7331 Tape Library
 - cleaning 9
 - configurations 4
 - description 1
 - SCSI Bus configuration 3

A

- automatic cleaning 10
- automatic cleaning, disable 58

B

- backup
 - write-protect switch 93
- bar code
 - applying labels 81
 - label mask 66
 - label specifications 90
 - labels 99
- base configuration 4, 53
- beeps, power on 20
- bonus slots 2, 85
- brightness setup 73

C

- cabling, split configuration 7
- Cancel button 18
- canceling cleaning 58
- changing
 - brightness 73
 - configuration 53, 54
 - contrast 73
 - language 75
 - tape location 48
- cleaning
 - automatic 10
 - cartridge 89
 - cartridge label 66
 - daily 61
 - disabling 58
 - drive status 59
 - manual 50, 80
 - requirements 9
 - scheduling 56
 - weekly 63
- clock setup 70
- configuration
 - base 4, 53
 - description 4
 - SCSI Bus 3
 - setting 53
 - split 6, 54
- contrast setup 73
- control panel
 - description 11

- control panel (*continued*)
 - display 14
 - language 75
 - operating 18
- correcting errors 95

D

- daily cleaning 61
- danger notices ix
- default
 - mode 4
 - mode, manual 4, 7
- display, LCD 14
- display setup 73
- displaying, main menu 24
- door, open 77
- Down button 18
- drive status, checking 15
- drive status cleaning 59
- drives
 - loading 86
 - status lights 87
 - tape status 17
- dual drive/dual host configuration 4

E

- environments 90
- environments, operating 92
- erasing tapes 91
- error codes 95
- errors
 - correcting 95
 - moving 50
 - power on 20
 - random mode 27
 - sequential mode 35

F

- features, description 1
- fixing errors 95
- front door, opening 77

G

- general information 1

I

- IDs, SCSI 67
- indicator
 - door lock 12
 - power on 12
 - tape drive status 17
- installing magazines 83

K

- keylock 13

L

- labels
 - applying 81
 - cleaning cartridge 66
 - specifications 90
- language, selecting 75
- LCD 14
- limited warranty 101
- loading drives 86
- lock, front door 77

M

- magazine
 - insertion 83
 - removal 83
 - status 15
 - tape insertion 82
 - tape removal 82
- manual cleaning 50, 80
- manual mode
 - description 4
 - split configuration 7
- media 89
- menu
 - clock set-up 70
 - displaying main 24
 - displaying mode 25
 - Set-up 56
 - structure 24
- modes
 - description 4
 - Manual 4
 - manual in split 7
 - menu display 25
 - random 26
 - random in base 5
 - random in split 8
 - random/sequential 9, 39
 - sequential 5, 29
 - sequential in split 7
 - sequential/random 9, 42
- move error 50
- moving tapes 48
 - Move Tape 48

O

- offline (manual) mode 4, 7
 - operation, split 8
 - Sequential mode 8
- operating environments 92
- operating modes 4
- operation setup 56

P

- POST 12
- power
 - switch 12, 18
 - turning off 22

- power (*continued*)
 - turning on 19
- power on self test (POST) 12
- Power On Self Test (POST)
 - warning beeps 21
- printer
 - bar code label 99
- protection, data loss 93

R

- random mode
 - base configuration 5
 - ending 28
 - errors 27
 - selecting 26
 - split configuration 8
- random/sequential mode
 - description 9
 - selecting 39

S

- Safety notices ix
- SCSI
 - configuration 3
 - setting IDs 67
- Select button 18
- sequential mode 5
 - base operation 5
 - ending 37
 - errors 35
 - selecting 29
 - split configuration 7
- sequential/random mode
 - description 9
 - selecting 42
- set-up
 - cleaning schedule 56
 - clock 70
 - daily cleaning 61
 - display screen 73
 - operations 56
 - SCSI ID 67
 - weekly cleaning 63
- single host configuration 3
- split
 - cabling requirements 7
 - configuration 54
- split configuration 6
- status
 - drive 15
 - drive lights 87
 - tape drive lights 17
- storage environments 91

T

- tape cartridge
 - description 89
 - environments 90

tape cartridge *(continued)*
erasing 91
insertion 85
labels 90
loading 86
removal 85
types 89
tape cartridge labels 81
tape drive unload 17
tape magazines 82
tape path cleaning 50, 80

U

unloading, tape drives 17
unloading drives 86
unlocking door 77
Up button 18
user menu 15

W

warranty, limited 101
weekly cleaning 63
write-protect switch 93

Readers' Comments — We'd Like to Hear from You

7331 and 3449 8mm Tape Library
Model 3xx
Operator Guide

Publication No. GA32-0376-00

Overall, how satisfied are you with the information in this book?

	Very Satisfied	Satisfied	Neutral	Dissatisfied	Very Dissatisfied
Overall satisfaction	<input type="checkbox"/>	<input type="checkbox"/>	<input type="checkbox"/>	<input type="checkbox"/>	<input type="checkbox"/>

How satisfied are you that the information in this book is:

	Very Satisfied	Satisfied	Neutral	Dissatisfied	Very Dissatisfied
Accurate	<input type="checkbox"/>	<input type="checkbox"/>	<input type="checkbox"/>	<input type="checkbox"/>	<input type="checkbox"/>
Complete	<input type="checkbox"/>	<input type="checkbox"/>	<input type="checkbox"/>	<input type="checkbox"/>	<input type="checkbox"/>
Easy to find	<input type="checkbox"/>	<input type="checkbox"/>	<input type="checkbox"/>	<input type="checkbox"/>	<input type="checkbox"/>
Easy to understand	<input type="checkbox"/>	<input type="checkbox"/>	<input type="checkbox"/>	<input type="checkbox"/>	<input type="checkbox"/>
Well organized	<input type="checkbox"/>	<input type="checkbox"/>	<input type="checkbox"/>	<input type="checkbox"/>	<input type="checkbox"/>
Applicable to your tasks	<input type="checkbox"/>	<input type="checkbox"/>	<input type="checkbox"/>	<input type="checkbox"/>	<input type="checkbox"/>

Please tell us how we can improve this book:

Thank you for your responses. May we contact you? Yes No

When you send comments to IBM, you grant IBM a nonexclusive right to use or distribute your comments in any way it believes appropriate without incurring any obligation to you.

Name

Address

Company or Organization

Phone No.



Fold and Tape

Please do not staple

Fold and Tape



NO POSTAGE
NECESSARY
IF MAILED IN THE
UNITED STATES

BUSINESS REPLY MAIL

FIRST-CLASS MAIL PERMIT NO. 40 ARMONK, NEW YORK

POSTAGE WILL BE PAID BY ADDRESSEE

International Business Machine Corporation
Department 61C
9000 South Rita Road
Tucson, AZ 85741-0001, U.S.A.

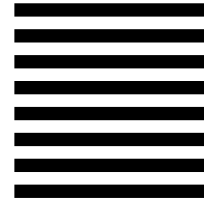

Fold and Tape

Please do not staple

Fold and Tape



Printed in the United States of America
on recycled paper containing 10%
recovered post-consumer fiber.

GA32-0376-00

