

7331 and 3449 8mm Tape Library

IBM

Model 3xx

Service Guide

7331 and 3449 8mm Tape Library

IBM

Model 3xx

Service Guide

Note!

Before using this information and the product it supports, be sure to read the general information under "Notices" on page ix.

First Edition (October 1997)

The following paragraph does not apply to any country where such provisions are inconsistent with local law.

INTERNATIONAL BUSINESS MACHINES CORPORATION PROVIDES THIS PUBLICATION "AS IS" WITHOUT WARRANTY OF ANY KIND, EITHER EXPRESS OR IMPLIED, INCLUDING BUT NOT LIMITED TO THE IMPLIED WARRANTIES OF MERCHANTABILITY OR FITNESS FOR A PARTICULAR PURPOSE.

Some states do not allow disclaimer of express or implied warranties in certain transactions; therefore, this statement may not apply to you.

Order publications through your IBM representative or the IBM branch office serving your locality. Publications are not stocked at the address given below.

A reader's comment form is provided at the back of this publication. Either mail the completed form or fax it to (520) 799-2906. If the form has been removed, address your comments about this book to:

IBM Corporation, Department 61C, 9000 South Rita Road, Tucson, AZ 85744-0001, U.S.A.

When you send information to IBM, you grant IBM a nonexclusive right to use or distribute the information in any way it believes appropriate without incurring any obligation to you.

Copyright International Business Machines Corporation 1997. All rights reserved.

Note to U.S. Government Users — Documentation related to restricted rights — Use, duplication or disclosure is subject to restrictions set forth in GSA ADP Schedule Contract with IBM Corp.

Contents

Notices	ix
About This Guide	xvii
Chapter 1. Reference Information	1
Specifications	1
Operator Control Panel	2
UEC and FRU Code Displays	10
Chapter 2. Service Operations	11
Operator Controls	11
Menu Displays	13
Chapter 3. Removal and Installation Procedures	43
Handling Static-Sensitive Devices	43
Library Cover Set Removal and Installation	44
Front Door Assembly Removal and Installation	48
Control Panel Assembly Removal and Installation	51
Control Panel Cable Removal and Installation	54
Tape Cartridge Magazine Removal and Installation	57
Magazine Mounting Plates Removal and Installation	59
2-Slot Cartridge Holder Removal and Installation	62
Fan Assembly Removal and Installation	64
Tape Drive Removal and Installation	67
Power Supply Removal and Installation	71
Controller Card Removal and Installation	74
Internal SCSI Cable Group Removal and Installation	78
Tape SCSI ID Cable Removal and Installation	81
Picker (Assembly & Umbilical Cable) Removal and Installation	83
Bar Code Reader Removal and Installation	88
Accessor Assembly Removal and Installation	91
Aligning the Picker Assembly with the Drive	94
Sensor Group Removal and Installation	96
Manually Removing a Tape Cartridge	100
Removing a Tape Cartridge Stuck in the Picker	104
Chapter 4. Problem Analysis Procedures (PAPs)	107
Analysis Starting Point	107
PAP 1, Inoperative Control Panel LCD or Power-On Indicator	111
PAP 2, Power Switch does not Power-Off the Library	116
PAP 3, Processing a Unit Error Code (UEC)	120
PAP 4, Power System Check	137
PAP 5, Control Panel Nonfunctional	144
Power-Switch Override Jumper Installation and Removal	150
Power Supply Voltage Measurement	152
Controller Card Voltage Measurement	153
Appendix A. Error Codes and Related Service Actions	155
Unit Error Codes (UECs)	155
Error codes sorted by UEC	155

FRU Group Codes	161
Failing Items and Related Service Actions	163
Appendix B. Accessing the System Error Log for RS/6000 (7331 Model 305 only)	167
Error Log Analysis	167
SMIT	167
TCTL Analysis	167
ERRPT	168
Running Tapeutil	171
Drive Fault Symptom Description	176
Drive Error Recovery Procedures	185
Appendix C. Parts Diagram and Parts List	187
How To Use This Parts Listing	187
Assemblies	188
Appendix D. Power Cables for Model 305	203
Appendix E. Statement of Limited Warranty	207
Index	211

Figures

1.	AC Grounding Diagram (50 Hz and 60 Hz)	xi
2.	Physical Specifications for the Tape Library	1
3.	Power Specifications for the Tape Library	1
4.	Recommended Environment for the Tape Library	1
5.	Operator Control Panel	2
6.	Control Panel Display	4
7.	Operation Modes Display	5
8.	Magazine and Tape Drive Status Displays	6
9.	Tape Cartridge Display Icons	6
10.	Tape Drive Status Lights and Unload Button	7
11.	Status Lights on the Tape Drive	8
12.	UEC and FRU Code Display	10
13.	Control Panel	11
14.	Main Menu/Service Menu Display	13
15.	Service Menu/Log Display	14
16.	Log Display	14
17.	Log/Errors Display	15
18.	SCSI Errors (type 00) Display	16
19.	Motion Errors type (01) Display	16
20.	Source and Destination Locations for Move Commands	17
21.	Library Motion Error Codes	17
22.	Other Errors type (02) Display	18
23.	Log/History Display	19
24.	SCSI History Display	19
25.	Front Panel and Automatic History Display	20
26.	Log/STATS Display	21
27.	STATS Menu Display	21
28.	Library Statistics Display	22
29.	Tape Drive Statistics Display	23
30.	Log/Sensors Display	24
31.	Sensors Display	25
32.	Sensor Group 1	25
33.	Sensor Group 2	26
34.	Sensor Group 3	26
35.	Service/Selftest Menu Display	27
36.	Move Tape Display	27
37.	Move Tape Display	28
38.	Tape Cartridge Placement for 5-Tape Calibration	29
39.	Service/Calibrate Menu Display	30
40.	MustHave/Calibrate Menu Display	30
41.	Number Drives in Library Display	30
42.	Error Types in Library Display	31
43.	Power On/Selftest in Progress Display	32
44.	Power On/Selftest Complete Display	32
45.	Service/Blank Line Display	33
46.	Serial Number Display	33
47.	Serial Number Selection Display	34
48.	Serial Number Selected Display	34
49.	Service/Blank Line Display	36
50.	Tuning Display	36

51.	Tuning Parameters Display	37
52.	Move Error Display	37
53.	Service/Blank Line Display	38
54.	Clear Logs Display	38
55.	Service/Blank Line Display	39
56.	Reset NVRAM Display	39
57.	Service/Blank Line Display	40
58.	CodeLoad Display	40
59.	Drive Error Message Display	41
60.	Reading Header Display	41
61.	Reading Image Display	41
62.	Available Code Images Display	42
63.	Reading Code Image Display	42
64.	Library Cover Set	44
65.	Front Door Assembly	48
66.	Control Panel Assembly	51
67.	Control Panel Cable	54
68.	Control Panel Cable Routing	56
69.	10-Slot Tape Cartridge Magazine	57
70.	Magazine Mounting Plates	59
71.	2-Slot Cartridge Holder	62
72.	Fan Assembly	64
73.	Tape Drive and Tray	67
74.	Tape Drive	68
75.	Tape Drive Connections	69
76.	Drive In Tray With Spacing	70
77.	Power Supply	71
78.	Library Controller card	74
79.	Controller Card	76
80.	Internal SCSI Signal Cable	78
81.	Internal SCSI Cable Configuration	80
82.	Tape SCSI ID Cable	81
83.	Picker Assembly	83
84.	Umbilical Cable Installation	85
85.	Bar Code Reader	88
86.	Accessor Assembly	91
87.	Aligning the Picker Assembly with the Drive	94
88.	Sensor Group	96
89.	Drive Top Cover Removal	100
90.	Moving Trolleys	101
91.	Moving the Supply Reel Motor. The drive is turned topside down.	102
92.	Unloading a Tape Cartridge	103
93.	Picker Assembly and Cover	105
94.	Start Here for Library Problem Analysis	107
95.	Control Panel	111
96.	Controller Card LEDs and Power-Switch Override Jumper	113
97.	Controller Card LEDs and Power-Sense Connector	116
98.	Control Panel	117
99.	Service Action Codes and Service Actions	120
100.	Controller Card LEDs and SCSI Port Term Power Jumpers	126
101.	SCSI ID Address Cable Connections	126
102.	Tape Drive Status Lights and Unload Button	135
103.	Controller Card LEDs	139
104.	SCSI ID Address Cable Connections	145

105. Controller Card LEDs and SCSI Port Term Power Jumpers	148
106. Controller Card Power-Switch Override Jumper	150
107. Controller Card Voltage Test Points	153
108. Controller Card Voltages	154
109. Error codes sorted by UEC	155
110. 8mm Tape Library FRU Group Codes with Failing FRU Probabilities	161
111. Failing Items and Related Service Actions	163
112. ERRPT pg Command Error Example	168
113. Hex to ASCII Conversion	168
114. AIX SMIT and ERRPT Command Tape Error Log Example	169
115. Sense Data for Tape Error Log Example	169
116. AIX SMIT and ERRPT Command SCSI Error Log Example	170
117. Sense Data for SCSI Error Log Example	170
118. Tape Util Error Sample	171
119. Hex to ASCII Conversion	171
120. Device Driver to AIX ERRNO Translation	172
121. Message Code Descriptions	173
122. Exception Message Descriptions	174
123. Fault Symptom Code and Error Recovery Procedures	176
124. ERP # (Recommended error recovery procedures)	185
125. Indenture Example	187
126. Power Cable Information	204
127. Types of Receptacles	205

Notices

References in this publication to IBM products, programs, or services do not imply that IBM intends to make these available in all countries in which IBM operates.

Any reference to an IBM program or other IBM product in this publication is not intended to state or imply that only IBM's program or other product may be used. Any functionally equivalent program that does not infringe any of IBM's intellectual property rights may be used instead of the IBM product. Evaluation and verification of operation in conjunction with other products, except those expressly designated by IBM, is the user's responsibility.

IBM may have patents or pending patent applications covering subject matter in this document. The furnishing of this document does not give you any license to these patents. You can send license inquiries, in writing, to the IBM Director of Licensing, IBM Corporation, 500 Columbus Avenue, Thornwood, NY 10594, U.S.A.

Safety Notices

Listed below are the safety requirements for operating this product.

Each danger and caution notice contains a reference number (RSFTxxxx). Use the reference number to check the translation in *External Devices Translated Safety Notices*, SA26-7192.

Danger Notices

A danger notice calls attention to a situation that is potentially lethal or extremely hazardous to people.

The following danger notices appear in this publication:

DANGER

To prevent a possible electrical shock from touching two surfaces with different electrical grounds, use one hand, when possible, to connect or disconnect signal cables. (RSFTD004)

DANGER

An electrical outlet that is not correctly wired could place hazardous voltage on metal parts of the system or the products that attach to the system. It is the customer's responsibility to ensure that the outlet is correctly wired and grounded to prevent an electrical shock. (RSFTD201)

DANGER

To prevent a possible electrical shock when adding or removing any devices to or from the system, ensure that the power cords for those devices are unplugged before the signal cables are connected or disconnected. If possible, disconnect all power cords from the existing system before you add or remove a device.

DANGER

To prevent a possible electrical shock when installing the device, ensure that the power cord for that device is unplugged before installing signal cables. (RSFTD204)

Caution Notices

A caution notice calls attention to a situation that is potentially hazardous to people because of some existing condition.



The general caution symbol identifies conditions where caution must be used.



The electrical caution symbol identifies electrical hazards where extreme caution must be used.



The weight caution symbol indicates that the 7331 Tape Library weighs 42 kilograms (92.5 pounds). It takes three persons to safely lift the unit.



The laser caution symbol indicates a laser device is present. Handling laser devices requires trained and knowledgeable personnel. Extreme caution is required.

Laser Safety Cautions

The following laser safety cautions appear in this document:

CAUTION:

The bar-code reader contains a Class II laser component. Only trained service personnel may repair the bar-code reader. (RSFTC237)

CAUTION:

Do not place a highly reflective surface between either the picker assembly and the tape cartridge magazines or between the picker assembly and the tape drives. This may cause damage to your eyes. (RSFTC238)

CAUTION:

If the automatic lock on the front door is not functioning and the door is open, do not look directly at the laser beam. Staring at the beam may cause damage to your eyes. (RSFTC239)

Attention Notices

An attention notice indicates the possibility of damage to a program, device, system, or data.

Safety Inspection Procedures

Perform the following safety inspection prior to the normal maintenance agreement inspection. **Suspect the 8mm Tape Library is unsafe until verified it is safe.** If unsafe conditions are present, decide how serious the hazard is and whether you can continue without correcting the problem. Possible safety hazards are:

Electrical An electrically charged frame can cause serious or lethal electrical shock.

Mechanical Hazards, such as a missing safety cover, are potentially harmful to people.

Chemical Do not use solvents, cleaners, or other chemicals not approved for use on the product.

Use Figure 1 to perform the following safety procedures. Before starting the procedures, ensure the existing room and electrical conditions are safe.

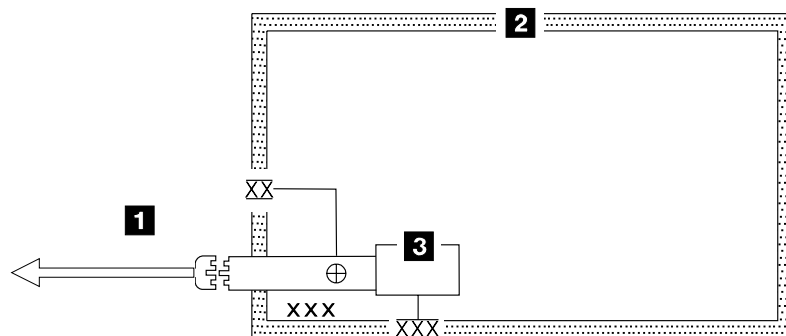

Legend:

XX External tooth lock washer

Green/yellow ground wire terminated to chassis or ground

⊕

Green/yellow ground wire terminated with slip-on spade terminal

XXX Redundant ground path to frame

XX External tooth lock washer

A34M0139

Figure 1. AC Grounding Diagram (50 Hz and 60 Hz)

1. Power off the 8mm Tape Library.
2. Disconnect the channel cables.
3. Disconnect the power cord 1 from its source.
4. Check that no voltage exists between the housing on the power source and the building ground.
5. Verify that resistance is less than 0.1 ohm from the building ground to the power supply enclosure 3 .
6. Inspect the power cable 1 for visible cracks, wear, or damage.
7. Check that resistance between the power cable ground and the Tape Libraryframe 2 is less than 0.1 ohm.

8. Inspect the power supply enclosure covers 3 to ensure that all screws are installed and are tight.

Environmental Notices

The following is environmental information pertaining to the Tape Library

Product Recycling

This unit contains recyclable materials. The materials should be recycled where facilities are available and according to local regulations. In some areas, IBM will provide a product take-back program that ensures proper handling of the product. Contact your IBM representative for more information.

Product Disposal

This unit may contain batteries. The batteries must be removed and discarded, or recycled according to local regulations and where facilities exist. Specific information per battery type will be referenced throughout the manual where applicable.

Environmental Design

The environmental efforts that have gone into the design of this unit signifies IBM's commitment to improve the quality of its products and processes. Some of these activities include elimination of the use of CFCs, development of reusable or recyclable packaging, and reductions in manufacturing wastes.

Trademarks

The following terms are trademarks of the IBM Corporation in the United States or other countries or both:

IBM

AIX

IBMLINK

RS/6000

AIX System Backup and Recovery/6000

The following terms are trademarks of other companies:

CSA Canadian Standards Association

UL Underwriter's Laboratories

IBM Agreement for Licensed Internal Code

You accept the terms of this Agreement by your initial use of a machine that contains IBM Licensed Internal Code (called "Code").

These terms apply to Code used by certain machines IBM or your reseller specifies (called "Specific Machines"). International Business Machines Corporation or one of its subsidiaries ("IBM") owns copyrights in Code or has the right to license Code. IBM or a third party owns all copies of Code, including all copies made from them.

If you are the rightful possessor of a Specific Machine, IBM grants you a license to use the Code (or any replacement IBM provides) on, or in conjunction with, only the Specific Machine for which the Code is provided. IBM licenses the Code to only one rightful possessor at a time.

Under each license, IBM authorizes you to do only the following:

1. Execute the Code to enable the Specific Machine to function according to its Official Published Specifications (called "Specifications");
2. Make a backup or archival copy of the Code (unless IBM makes one available for your use), provided you reproduce the copyright notice and any other legend of ownership on the copy. You may use the copy only to replace the original, when necessary; and
3. Execute and display the Code as necessary to maintain the Specific Machine.

You agree to acquire any replacement for, or additional copy of, Code directly from IBM in accordance with IBM's standard policies and practices. You also agree to use that Code under these terms.

You may transfer possession of the Code to another party only with the transfer of the Specific Machine. If you do so, you must 1) destroy all your copies of the Code that were not provided by IBM, 2) either give the other party all your IBM-provided copies of the Code or destroy them, and 3) notify the other party of these terms. IBM licenses the other party when it accepts these terms. These terms apply to all Code you acquire from any source.

Your license terminates when you no longer rightfully possess the Specific Machine.

Actions You May Not Take

You agree to use the Code only as authorized above. You may not do, for example, any of the following:

1. Otherwise copy, display, transfer, adapt, modify, or distribute the Code (electronically or otherwise), except as IBM may authorize in the Specific Machine's Specifications or in writing to you;
2. Reverse assemble, reverse compile, or otherwise translate the Code unless expressly permitted by applicable law without the possibility of contractual waiver;
3. Sublicense or assign the license for the Code; or
4. Lease the Code or any copy of it.

Electronic Emission Notices

The following statement applies to this IBM product. The statement for other IBM products intended for use with this product will appear in their accompanying manuals.

Federal Communications Commission (FCC) Statement

Note: This equipment has been tested and found to comply with the limits for a Class B digital device, pursuant to Part 15 of the FCC Rules. These limits are designed to provide reasonable protection against harmful interference in a residential installation. This equipment generates, uses, and can radiate radio frequency energy and, if not installed and used in accordance with the instructions, may cause harmful interference to radio communications. However, there is no guarantee that interference will not occur in a particular installation. If this equipment does cause harmful interference to radio or television reception, which can be determined by turning the equipment off and on, the user is encouraged to try to correct the interference by one or more of the following measures:

- Reorient or relocate the receiving antenna.
- Increase the separation between the equipment and receiver.
- Connect the equipment into an outlet on a circuit different from that to which the receiver is connected.
- Consult an IBM authorized dealer or service representative for help.

Properly shielded and grounded cables and connectors must be used in order to meet FCC emission limits. Proper cables and connectors are available from IBM authorized dealers. IBM is not responsible for any radio or television interference caused by using other than recommended cables and connectors or by unauthorized changes or modifications to this equipment. Unauthorized changes or modifications could void the user's authority to operate the equipment.

This device complies with Part 15 of the FCC Rules. Operation is subject to the following two conditions: (1) this device may not cause harmful interference, and (2) this device must accept any interference received, including interference that may cause undesired operation.

Industry Canada Compliance Statement

This Class A digital apparatus meets all requirements of the Canadian Interference-Causing Equipment Regulations.

Avis de conformité à la réglementation d'Industrie Canada

Cet appareil numérique de la classe A respecte toutes les exigences du Règlement sur le matériel brouilleur du Canada.

European Community Compliance Statement

This product is in conformity with the protection requirements of EC Council Directive 89/336/EEC on the approximation of the laws of the Member States relating to electromagnetic compatibility. IBM cannot accept responsibility for any failure to satisfy the protection requirements resulting from a non-recommended modification of the product, including the fitting of non-IBM option cards.

This product has been tested and found to comply with the limits for Class B Information Technology Equipment according to CISPR 22 / European Standard EN 55022. The limits for Class B equipment were derived for typical residential environments to provide reasonable protection against interference with licensed communication devices.

Properly shielded and grounded cables and connectors (IBM part number 21H1955 or its equivalent) must be used in order to reduce the potential for causing interference to radio and TV communications and to other electrical or electronic equipment. Such cables and connectors are available from IBM authorized dealers. IBM cannot accept responsibility for an interference caused by using other than recommended cables and connectors.

Germany Only: This product is in conformity with the EN55022 class B emission limits.

Japanese Voluntary Control Council for Interference (VCCI) Statement

この装置は、情報処理装置等電波障害自主規制協議会（VCCI）の基準に基づく第一種情報技術装置です。この装置を家庭環境で使用すると電波妨害を引き起こすことがあります。この場合には使用者が適切な対策を講ずるよう要求されることがあります。

Korean Government Ministry of Communication (MOC) Statement

Please note that this device has been approved for non-business purposes and may be used in any environment including residential areas.

About This Guide

This Service Guide provides information on how to service the 8mm Tape Library. Store this book with your system unit maintenance manuals.

Note: Figures of the operator panels display **7331–3xx**. These are for reference only. Panels on the actual product will display **7331–305**, **3449–355**, or **3449–356**.

It contains the following information:

Chapter 1, Reference Information , highlights physical and power specifications; the recommended environment; and an overview of the operator control panel; and an introduction to UEC displays.

Chapter 2, Service Operations , describes the control panel operation for service and diagnostic procedures.

Chapter 3, Removal and Installation Procedures , describes the removal and installation procedures required to service 8mm Tape Library assemblies.

Chapter 4, Problem Analysis Procedures (PAPs) , lists the problem analysis procedures (PAPs) required to service the 8mm Tape Library.

Appendix A, Error Codes and Related Service Actions , lists the library Unit Error Codes, FRU Group codes, and failing part number items with related service action.

Appendix B, Accessing the System Error Log for RS/6000 (7331 Model 305 only) , gives direction to view the error log in the following formats: SMIT, TCTL, ERRPT, and TAPEUTIL.

Appendix C, Parts Diagram and Parts List , provides a parts diagram and parts list required to service the 8mm Tape Library.

Appendix D, Power Cables for Model 305 , provides power cable information for different countries.

Appendix E, Statement of Limited Warranty , is the 7331 and 3449 8mm Tape Library Model 3xx Service Guide warranty.

Related Publications

External Devices Translated Safety Notices, SA26-7192 provides translations of danger and caution notices.

7331 and 3449 8mm Model 3xx Installation Guide provides installation information for the Tape Library.

7331 and 3449 8mm Tape Library Model 3xx Operator Guide provides information about operating the Tape Library.

Related Webpage Sources

[HTTP://WWW.US.PC.IBM.COM\Server](http://www.us.pc.ibm.com/Server) for information regarding the current IBM PC Company Compatible Systems and Applications for 3449 Models 355 and 356.

Chapter 1. Reference Information

This chapter provides information about the specifications, indicator lights, and operator controls for the Tape Library.

Specifications

Figure 2. Physical Specifications for the Tape Library

Width:	323mm (12.7 inches)
Depth:	723mm (28.5 inches)
Height:	637mm (25.1 inches)
Weight:	42kgm (92.5 pounds)

Figure 3. Power Specifications for the Tape Library

Kv A:	0.34
Vac:	100 to 127, or 200 to 240
Hertz:	50 to 60
Btu maximum:	580
Watts:	320
Power Factor:	0.95
Maximum Altitude:	2135m (7000 feet)
Maximum In-rush Current:	60 amps

Figure 4. Recommended Environment for the Tape Library

	Operating	Storage	Shipping
Temperature	16 to 32°C (60 to 90°F)	1°C to 60°C (34° to 140°F)	-40 to 60°C (-40 to 140°F)
Relative Humidity	20 to 80%	10 to 80%	10 to 90%
Maximum Wet Bulb	23°C (73°F)	29°C (84°F)	29°C (84°F)

Note: The operating limits include media. The storage and shipping limits do not include media. For media storage and shipping limits, refer to the *7331 and 3449 8mm Tape Library Model 3xx Operator Guide GA32-0376*

Operator Control Panel

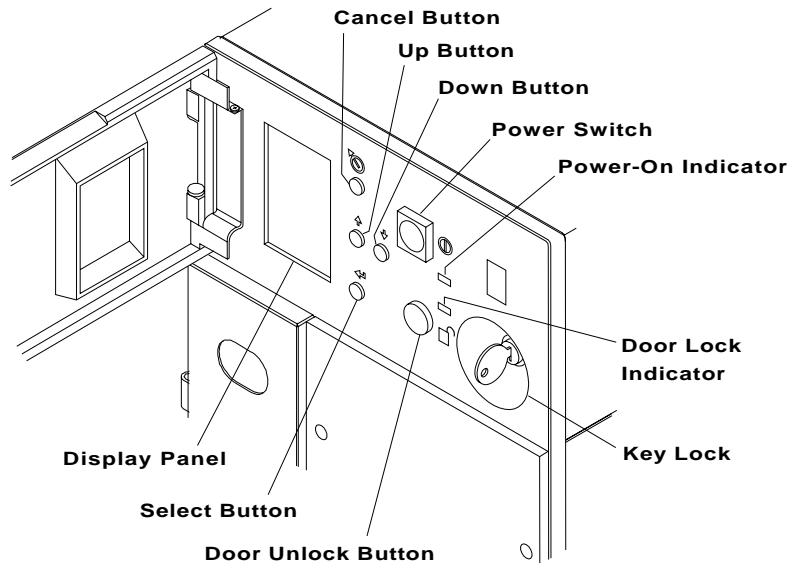

ASOPISX-00

Figure 5. Operator Control Panel

The Tape Library operator control panel (see Figure 5) is located behind the small access door on the front of the library and has the following features:

- Power switch and power-on indicator
- Door unlock button and door lock indicator
- Key lock
- Control buttons
- Liquid crystal display (LCD)

Power Switch and Power-On Indicator



The power switch (Ⓢ), located on the control panel, controls power to the tape drives and library. The power switch is a mechanical switch that retains its state when power is cycled. The switch does not provide a visual indication of its On or Off state. When the switch is On the library cooling fan operates and DC power is distributed to the components in the library.

The power-on indicator is a green LED located on the control panel adjacent to the power switch. The power-on indicator is software controlled. During initial power-on, the power-on indicator lights indicating the start of Power-On Self Test (POST). If no errors are detected during POST, the power-on indicator remains lit continuously. If an error is detected during POST, the power-on blinks one of four sequences that indicate a specific error. The only time other than POST when the power-on indicator blinks is following an unsuccessful microcode download command.

Note: The power-on indicator blink rate is twice per second with 1 second off between repetitions of the specific error sequence.

Door Unlock Button

The library provides a software controlled door lock and door lock indicator. When the library power is off, the door lock is unlocked to allow the operator access to the library contents. When initially powering on the library and during POST, the door remains unlocked. At the completion of POST, if the door sensor indicates the door is closed, the door is locked. If the sensor indicates the door is open, the door is not locked until it is closed.

Pressing the door unlock () button on the control panel signals the library that the operator wants to open the library front door. When the unlock () button is pressed, the control panel display shows the message, UNLOCK DOOR PRESSED, indicating that the button was pressed. If there is no system unit command to prevent media removal when the button is pressed, the library completes any move operation in progress and then parks the picker. When the picker is parked the library displays the message, DOOR UNLOCKED The door may now be opened.

Whenever the library door is opened, software assumes that the contents of the library have been altered and clears the current inventory. If the unlock button was inadvertently pressed, pressing the cancel button without opening the library door relocks the library and retains the current library inventory.

Library access can be prevented with a software controlled lock from the system unit or by the operator manually locking the door with the key lock. If the unlock () button is pressed when a system unit software controlled lock is present the library displays the message, UNLOCK NOT ALLOWED BY HOST Press any button.

The library does not accept any move commands from either the system unit or the library control panel while the door is open. The tape drives in the library can operate independent of other library operations and can be accessed directly by the system unit for running a manually inserted tape such as a diagnostics tape. When the door is open and library power is on, the picker can be moved using the Move Picker buttons located on the inside of the front door.

The library door automatically locks when the door is closed. After the door locks, move commands from either the system unit or the control panel will then be accepted by the library.

Door Lock Indicator

The door lock indicator is a green LED located on the control panel adjacent to the door unlock button. The door lock indicator is software controlled. During initial power-on, the door lock indicator may or may not light. After POST completes the door lock indicator lights if the door is locked. During library operation the software controls the state of the door lock indicator so that it matches the state of the door lock.

Key Lock

The key lock, located on the right side of the control panel, is a mechanical lock to prevent unauthorized access to the library. The key lock must be unlocked and the control panel unlock () button pressed to gain access to the library.

Control Buttons

There are four control buttons on the control panel to the right of the control panel display; two scroll buttons (Up and Down), a Select button, and a Cancel button. These buttons are functional after the completion of POST. When a button is pressed, an audible beep sounds. The beep is an audio confirmation for the operator that the button was pressed.

The scroll buttons (Up (↑) and Down (↓)) are used to move through the displayed menu list and highlight a menu item for selection or to advance to additional selections not currently displayed.

The Select (↵) button is used to choose the highlighted menu item.

The Cancel (⏪) button moves the highlight back one menu item, returns the control panel display to the previous menu, or cancels the operation.

Note: Canceling an operation in progress, may cause an error that displays a UEC. Also, a tape cartridge may be left in a tape drive or the picker.

Control Panel Liquid Crystal Display (LCD)

The control panel LCD is the primary method of displaying information for the operator. The control panel display brightness and contrast are software controlled. Using the control panel, the operator can adjust the brightness and contrast.

The control panel display (see Figure 6) shows status information, menu options, and operator prompts. The upper portion of the control display shows the current **library state** (item 1). When the library is performing a function, such as a host initiated tape cartridge move command, the upper portion of the display changes to indicate the new state. The lower portion of the display shows **drive status** or **user menus** (item 2). The right side of the display graphically depicts the **status of the magazines** (item 4) and **tape drives** (items 5 and 6) as shown in “Magazine and Tape Drive Status Displays” on page 6.

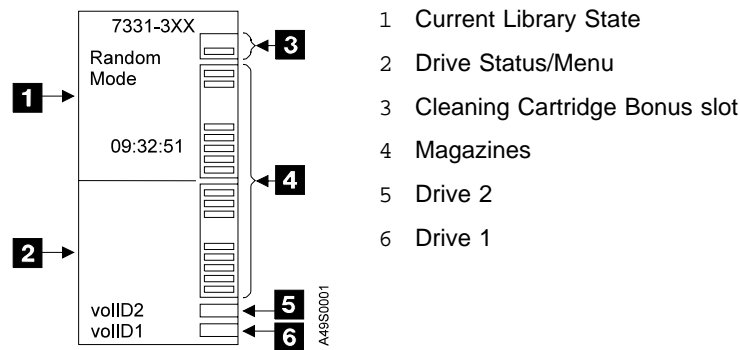

Figure 6. Control Panel Display

Library State

The library state display (see Figure 7) is determined by the current operation mode (**random**, **sequential**, or **manual**) and the operation in progress.

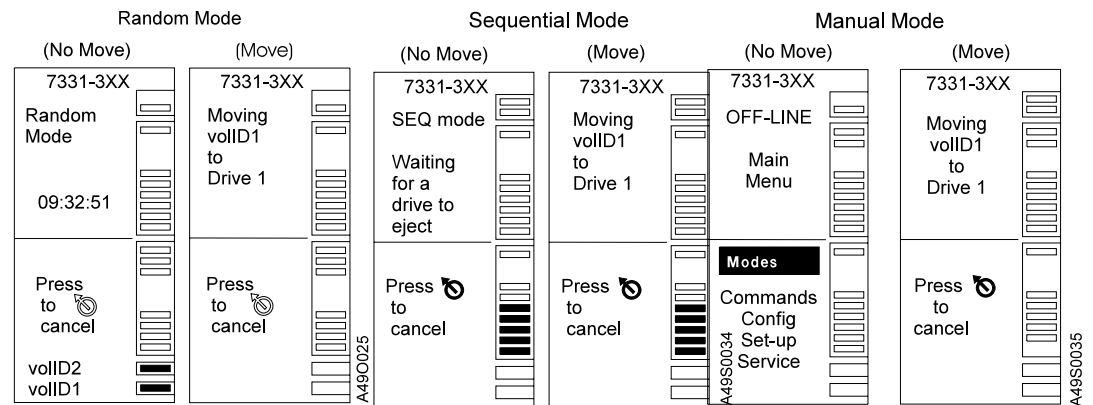

Figure 7. Operation Modes Display

When a manual mode operation is initiated, the library state section may display initialization messages to inform the operator that an operation is starting or that a programmed delay is occurring. During the processing of an operation, the control panel display shows messages that provide information about the current operation. If an error occurs during an operation, the error messages are shown on the display.

Drive Status or User Menu

The drive status or user menu display shows the current status of the tape drives and information about the tape cartridges in the tape drive.

When a menu is displayed, the drive status or user menu section shows the menu items available.

Examples of tape drive status displays and user menus can be seen in any of the procedures under “Service Menu Display” on page 13.

Magazine and Tape Drive Status

The “Magazine and Tape Drive Status” display illustrates the drives, magazines, and magazine slots (see Figure 8 on page 6).

Although columns 1, 2, and 3 represent different modes, they are identical in their physical make up.

Item 4 represents two bonus slots which, as with the magazines, uses a symbol to indicate the presence of a tape cartridge in each slot location where a tape cartridge is located.

The items 5 and 6 represent the tape cartridge magazines. These magazines use a symbol to indicate the presence of a tape cartridge in each slot location where a tape cartridge is located.

Items 7 and 8 represent the drives. A symbol is shown in the rectangle if a tape cartridge is loaded in the tape drive.

Magazine and Tape Drive Status Displays

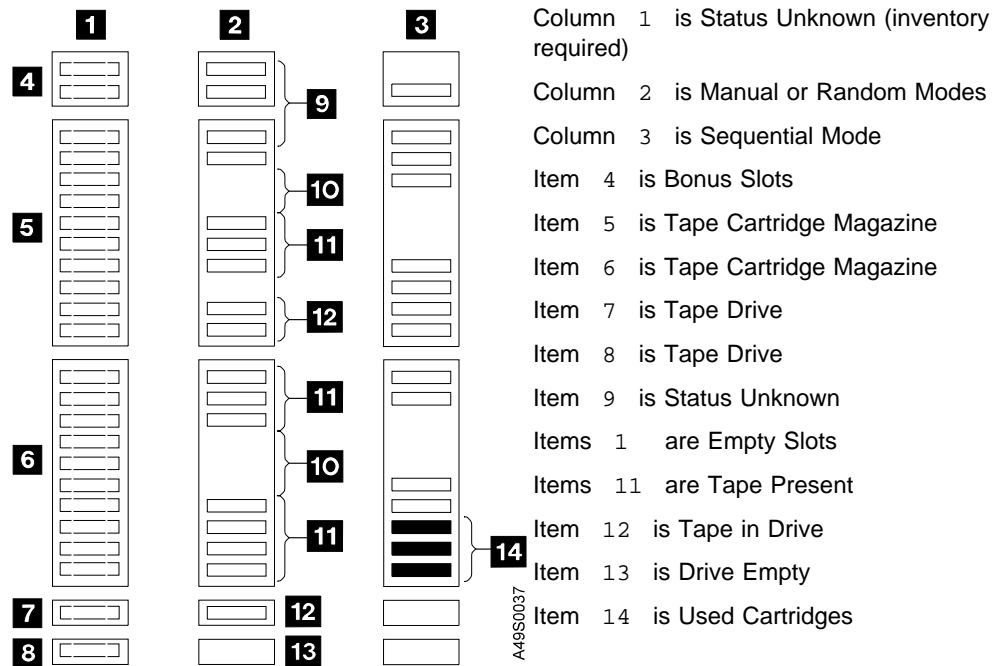
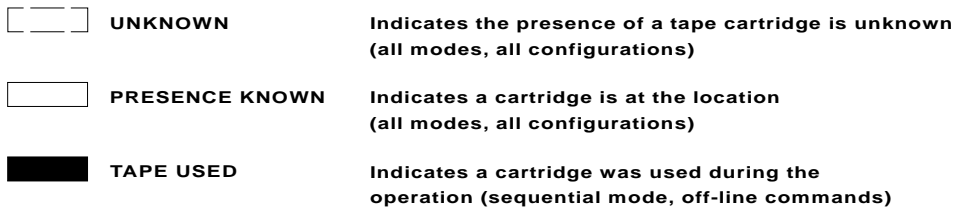

Figure 8. Magazine and Tape Drive Status Displays

Note: The dashed slots or drives in column 1 represent an unknown status. Column 2 illustrates a known status. The sequential mode column, item 3, illustrate used tape cartridges in a solid graphic. The column representations are illustrated in Figure 9.



ASICON-01

Figure 9. Tape Cartridge Display Icons

Tape Drive Status Lights and Unload Button

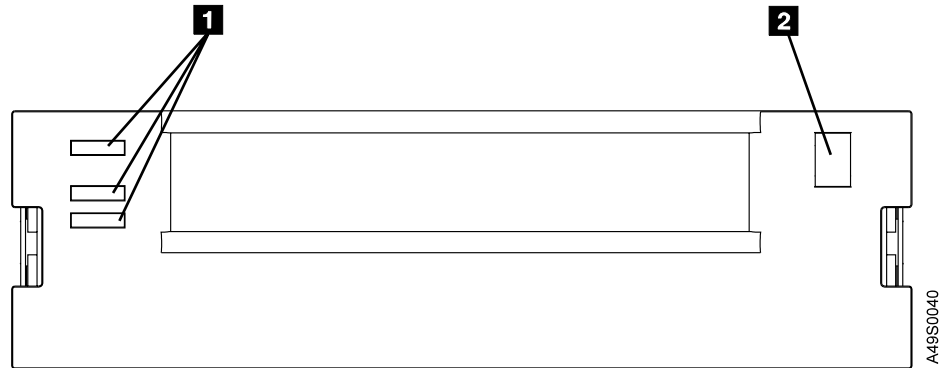

Figure 10. Tape Drive Status Lights and Unload Button

In Figure 10, Item 1 is the column of status lights made up of (top to bottom) DISTURBANCE, READY, and READ-WRITE indicators, and

Item 2 is the UNLOAD BUTTON.

Status Lights

There are three status lights on the tape drive: two green and one amber. These status lights are turned on and off in various combinations to indicate the status of the tape drive.

The symbols located next to the status lights are International Organization for Standardization (ISO) symbols that define the general function of the status lights as follows:

⌋ Disturbance	The amber status light flashes whenever the tape drive encounters an unrecoverable fault. It is on solid whenever the tape drive requires cleaning.
○ Ready	The green status light is on solid whenever the tape drive is ready to receive tape backup commands.
⬮ Read-Write	The green status light flashes whenever the tape drive is moving tape.













































The various on/off combinations of the status lights are shown in Figure 11.

Unload Button

Pressing the unload button unloads and ejects any tape cartridge loaded in the tape drive.

The unload button operates only when power is applied to the tape drive.

Figure 11. Status Lights on the Tape Drive

Status Lights	State	Status
     	<p>On</p> <p>On</p> <p>On</p>	<p>The Power-on Self Test (POST) is running or the system has issued a reset to the drive.</p> <p>Note: The POST condition can occur either when the power is first applied or after use of the diagnostic cartridge.</p>
     	<p>Off</p> <p>Off</p> <p>Off</p>	<p>The POST has completed successfully, but no tape cartridge has been inserted.</p>
     	<p>Off</p> <p>Off</p> <p>Flashing</p>	<p>A tape cartridge has been inserted and the tape drive is performing a tape load/unload operation.</p>
     	<p>Off</p> <p>On</p> <p>Off</p>	<p>The tape load operation has completed and the tape drive is ready to receive commands from the system.</p>
     	<p>Off</p> <p>On</p> <p>Flashing</p>	<p>The tape is in motion and the tape drive is busy running a device operation.</p>
     	<p>Flashing</p> <p>Off</p> <p>Off</p>	<p>The tape drive has detected an internal fault that requires corrective action. The flash rate will be fast (4 flashes per second) for any media using the diagnostic cartridge. The flash rate will be slow (1 flash per second) for any other type of failure. Refer to your service guide or system diagnostics.</p>
    or    or 	<p>On</p> <p>Off or On</p> <p>Off or Flashing</p>	<p>The tape path requires cleaning.</p>

Definition of Power-Off and Power-On

If **any** of the following indications are present, then the library is considered to be powered on. If **all** of the following indications are not present, then the library is considered to be powered off.

Items requiring an operational power supply:

- Power supply fan

Items requiring an operational power supply and minimal controller card functions:

- Library cooling fan
- Controller card power good LED (green)

Items requiring an operational power supply and most controller card functions:

- Controller card service LED (yellow), continuous or blinking
- Controller card speaker

Items requiring an operational power supply, most controller card functions, the control panel cable, and the control panel:

- Power-On Indicator (green) (duplicates the controller card power good LED (green))
- Control panel display
- Control panel speaker beeps at least once (duplicates the controller card speaker)
- Door lock indicator (green)

The tape drive lights indicate various encoded states, one of which is the all off state. Therefore, drive lights are not a valid indication of the absence of power to the tape drive. Since the tape drives receive power directly from the power supply and other library components receive their power through the controller card, power to the tape drives is not evidence that power is being distributed to the rest of the library.

Power Distribution

The power supply cooling fan operates and a power supply sense cable provides a low voltage to the controller card anytime the library power cord is plugged into a grounded power outlet. The output of the power supply to the tape drives and the controller card in the library is controlled by a power switch on the control panel and circuitry on the controller card. Additional, circuitry on the controller card senses when the control panel power switch is closed and signals the control circuit in the power supply to output power to the tape drives and the controller card in the library.

A power-switch override jumper on the controller card can override the control panel power switch and activate the library power supply.

Power is distributed from the power supply to both tape drives and the controller card. All library components, other than the tape drives, receive power from cables attached to the controller card. Except for the cooling fan, all power distributed from the controller card is through current limiting resistors which prevent damage in the case of a short in a cable or peripheral component. The cooling fan power is fused on the controller card.

UEC and FRU Code Displays

When an error condition is encountered during operation of the library the control panel display (see Figure 12) shows the errors, error codes, or condition of the library. the Unit Error Codes (UEC) and Field Replaceable Unit (FRU) codes are displayed as shown in the following figure.

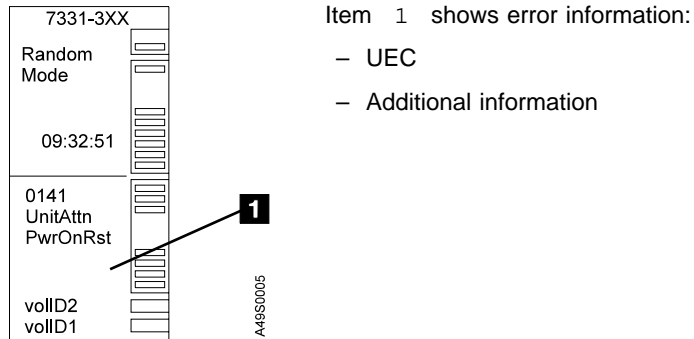

Figure 12. UEC and FRU Code Display

Chapter 2. Service Operations

This chapter describes how to use the 8mm Tape Library control panel to perform service and diagnostic procedures

Operator Controls

The service and diagnostic procedures described in this chapter are performed through the 8mm Tape Library control panel. The control panel (see Figure 13) consists of a display (Liquid Crystal Display) panel and a key pad.

Key Pad

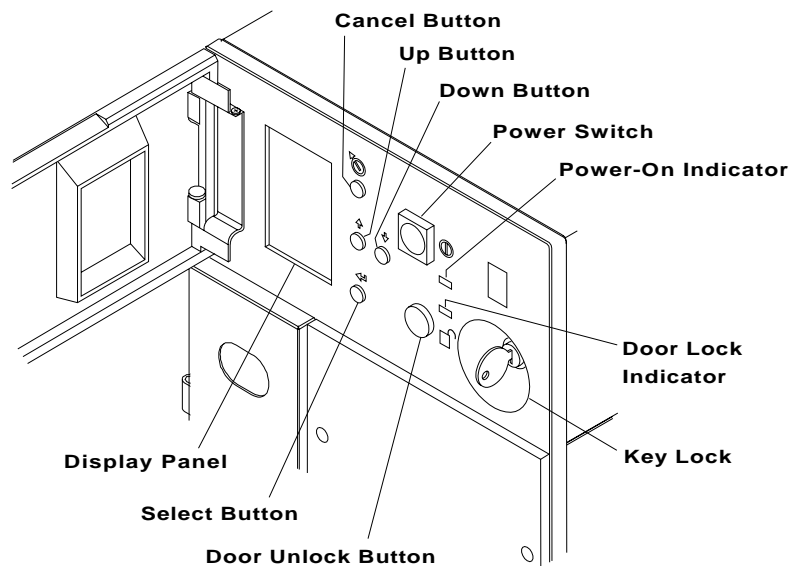

Figure 13. Control Panel

There are four control buttons on the control panel to the right of the control panel display; two scroll buttons (Up and Down), a Select button, and a Cancel button. These buttons are functional after the completion of POST. When a button is pressed, a beep sounds. The beep is an audio confirmation for the operator that the button was pressed.

The scroll buttons (Up (↑) and Down (↓)) are used to move through the displayed menu list and highlight a menu item for selection or to advance to additional selections not currently displayed.

The Select (↵) button is used to choose the highlighted menu item.

The Cancel (⏹) button moves the highlight back one menu item, returns the control panel display to the previous menu, or cancels the operation.

For a more detailed description of the operator controls see “Operator Control Panel” on page 2.

Menu Structure for Library Service Operations

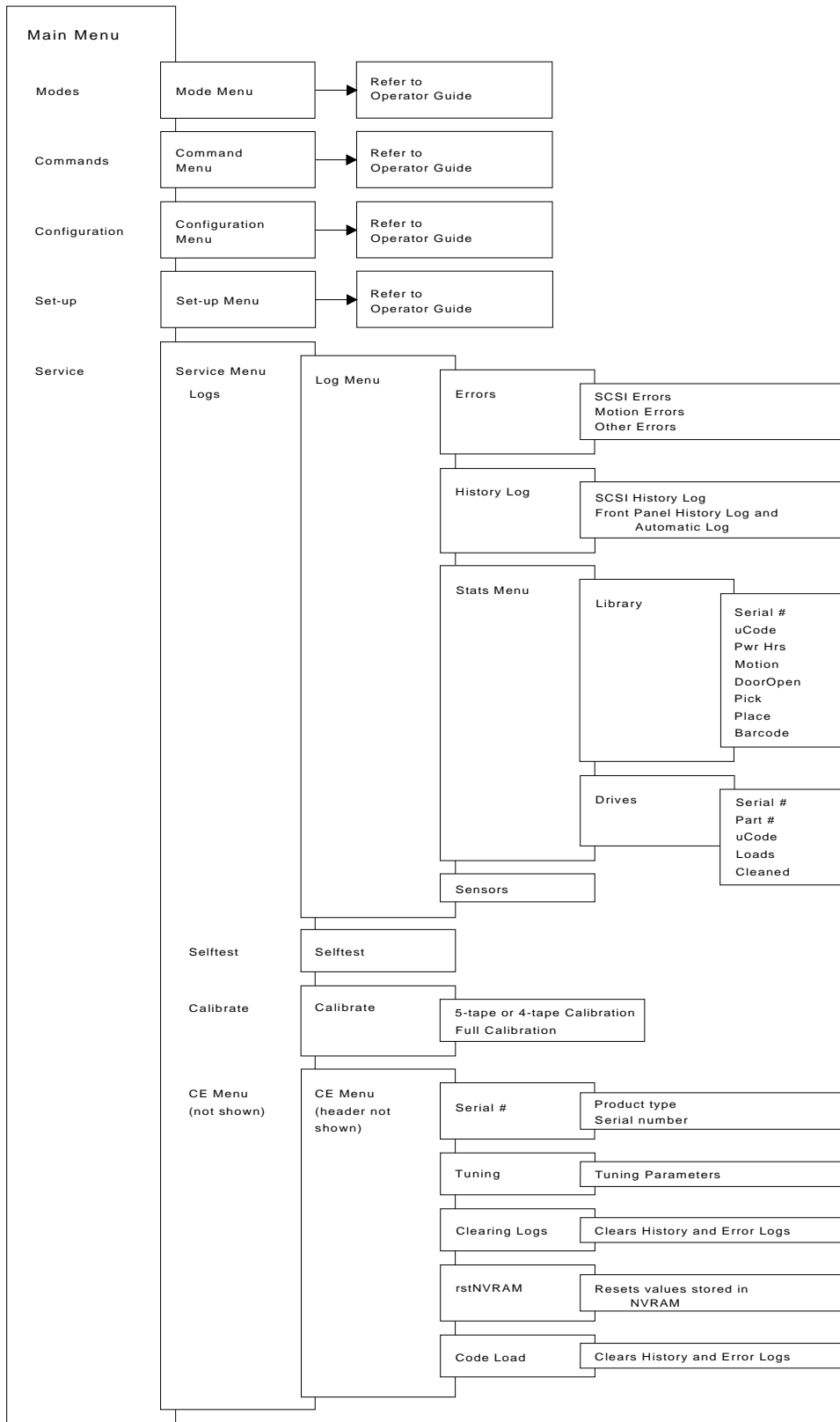

A34M01.41



Menu Displays

Service Menu Display

Service and diagnostics utilities are accessed by selecting *Service* from the Main Menu. Refer to “Menu Structure for Library Service Operations” on page 12 for a detailed flow of the Service Menu structure and Figure 14 for the display. Utilities available from the Service Menu are:

- Logs
- Selftest
- Calibrate

To display the Service Menu, do the following:

1. Open the control panel access door on the front of the tape library.
2. Using the Up () and Down () buttons, highlight:

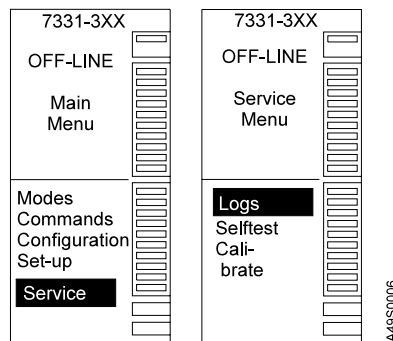

Service on the Main Menu.

Press the Select () button to display the Service Menu.



Figure 14. Main Menu/Service Menu Display

Log Menu Display

The **Logs** option on the service menu is used to view the following:

- Errors** A record of SCSI errors and motion errors.
- History** A record of all SCSI commands, front panel move commands, and automatic operations.
- Statistics** A record of tape drive and library statistics.
- Sensors** A record of library sensor settings.

To display the Log Menu (see Figure 15), use the following procedure:

1. Display the Service Menu. See “Service Menu Display” on page 13.
2. Using the Up () and Down () buttons, highlight:

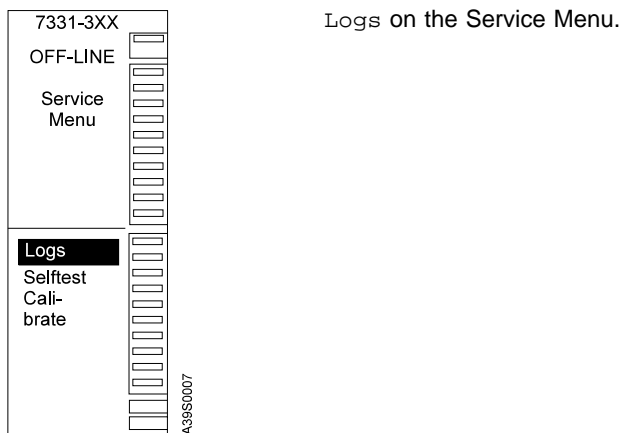

Figure 15. Service Menu/Log Display

3. Press the Select () button (see Figure 16) to display:

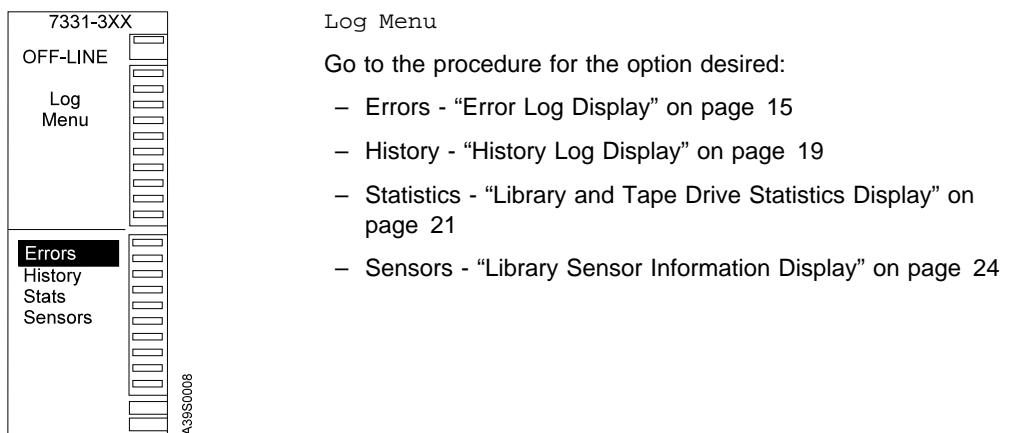

Figure 16. Log Display

4. Pressing the Cancel () button returns the display to the Set-up Menu.

Error Log Display

Errors detected during the library operation are logged in error logs. All logged errors contain the following basic information:

- Time the error occurred (24-hour clock format)
- Date the error occurred
- Unit Error Code (UEC) (see Figure 109 on page 155)
- Error log type

The **Errors** selection on the Log Menu is used to view the following:

- SCSI Errors (type 00)** Errors that occur during SCSI commands and contain the base sense information returned to the system unit.
- Motion Errors (type 01)** Errors that occur during motion commands and contain specific information about the type of motion in progress and the failure.
- Other Errors (type 02)** Errors that do not fall into one of the above categories.

To display the errors, refer to Figure 17 and use the following procedure:

1. Display the Log Menu. See “Log Menu Display” on page 14.
2. Using the Up (\uparrow) and Down (\downarrow) buttons, highlight:

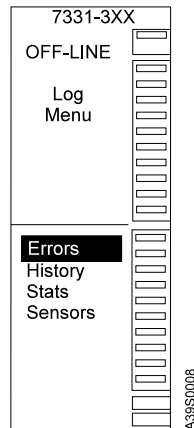

Errors on the Log Menu.

Press the Select (\leftarrow) button to display the first error in the error log.

Figure 17. Log/Errors Display

3. Errors are displayed in the following formats (see Figure 18).

SCSI Errors (type 00)

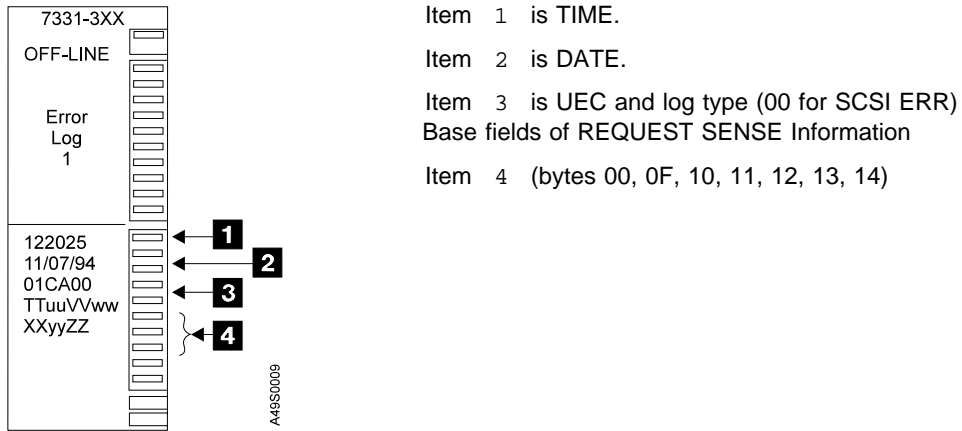

Figure 18. SCSI Errors (type 00) Display

Errors that occur during the communication between the system unit and the library are logged as SCSI errors. The error log also contains the information required to build the request sense information that is returned to the system unit when the error occurred.

The request sense information returned is largely based on the UEC. The information that is not contained in the UEC is stored in the log in the form of the returned request sense bytes (bytes 00, 0F, 10, 11, 12, 13, and 14 of the request sense information).

Motion Errors (type 01)

Refer to Figure 19.

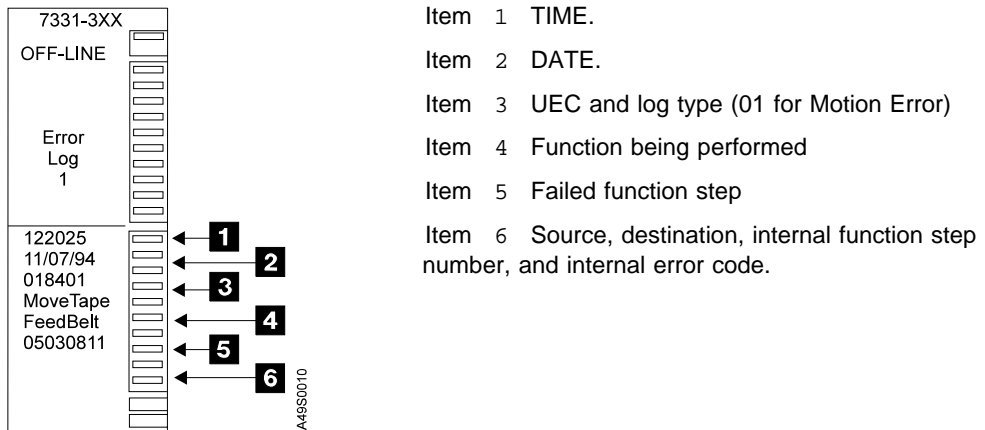

Figure 19. Motion Errors type (01) Display

When an error occurs during a motion process, the process information and specific error information is logged in an eight digit error code. This motion error code is shown in the bottom line of the above motion error display. The error code information is displayed in hexadecimal format (base 16).

The first four digits of the motion error code represent the source and destination of the move as shown in Figure 20

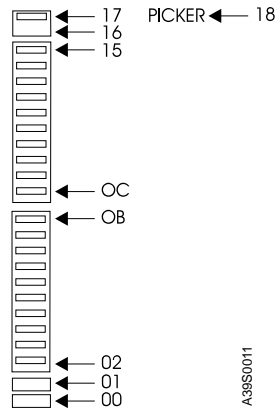

Figure 20. Source and Destination Locations for Move Commands

The next two digits of the error code are an internal process step number. The last two digits of the error code indicate the motion error code as listed in Figure 21.

Figure 21 (Page 1 of 2). Library Motion Error Codes

Error Description	Error Code
ABORT	
Cancel pressed	00
Door unlock pressed	01
Reset	02
Abort message	03
TIMEOUT	
Accessor motor	10
Feedbelt motor	11
Pinch motor	12
OVERCURRENT	
Accessor motor	20
Feedbelt motor	21
Pinch motor	22
UNEXPECTED SENSOR	
Generic	30
Accessor top limit	33
Accessor bottom limit	34
Accessor blocked	35
Feedbelt rear travel limit	39
Feedbelt tach count limit	3A
Pincher	3C
Door open	3E

Figure 21 (Page 2 of 2). Library Motion Error Codes	
Error Description	Error Code
ERROR DETECTED IN MOTION	
Detected in SCSI routine	40
Detected in motion routine	41

Other Errors (type 02)

Refer to Figure 22.

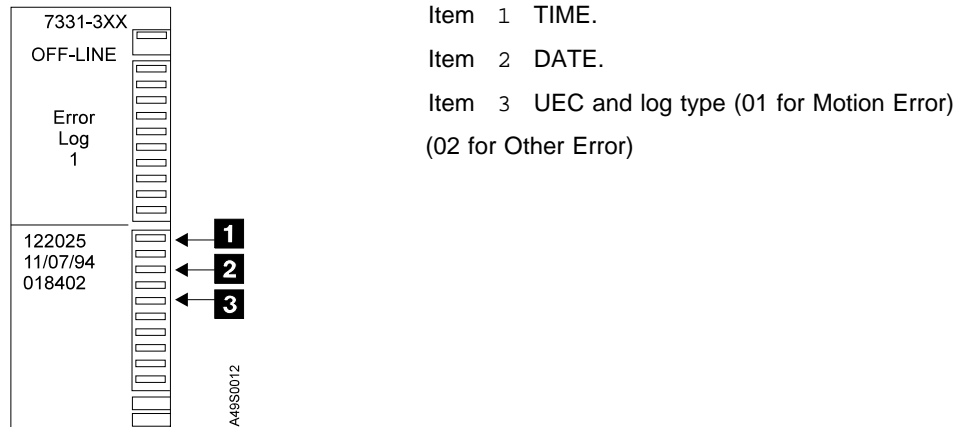





Figure 22. Other Errors type (02) Display

Note: New errors are added to the beginning of the log (error log 1 is the most recent error that occurred). When the error log reaches its maximum capacity the oldest errors logged are discarded as new errors are logged.

4. Press the Up () and Down () buttons to step through the error log from the most recent error log to the oldest error.
5. Press the Cancel () button at anytime to return to the Log Menu.

History Log Display

All SCSI commands, control panel move operations and automatic operations are logged in the History Log. There are three types of history log entries: SCSI history logs, control panel history logs, and automatic history logs.

To display the History Log, refer to Figure 23 and use the following procedure:

1. Display the Log Menu. See “Log Menu Display” on page 14.
2. Using the Up (\uparrow) and Down (\downarrow) buttons, highlight:

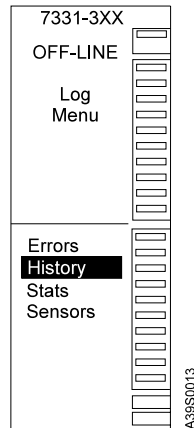

History on the Log Menu.

Press the Select (\leftarrow) button to display the first history entry.

Figure 23. Log/History Display

3. The history entries are displayed in the following formats.

SCSI History Log

See Figure 24.

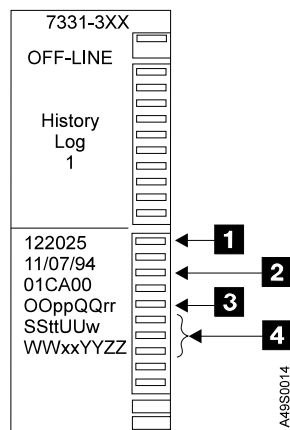

Item 1 TIME.

Item 2 DATE.

Item 3 UEC (or 'good' if no error) and log type (00 for SCSI)

Item 4 Command Descriptor Block (CDB)

Figure 24. SCSI History Display

Front Panel History Log and Automatic History Log

Refer to Figure 25.

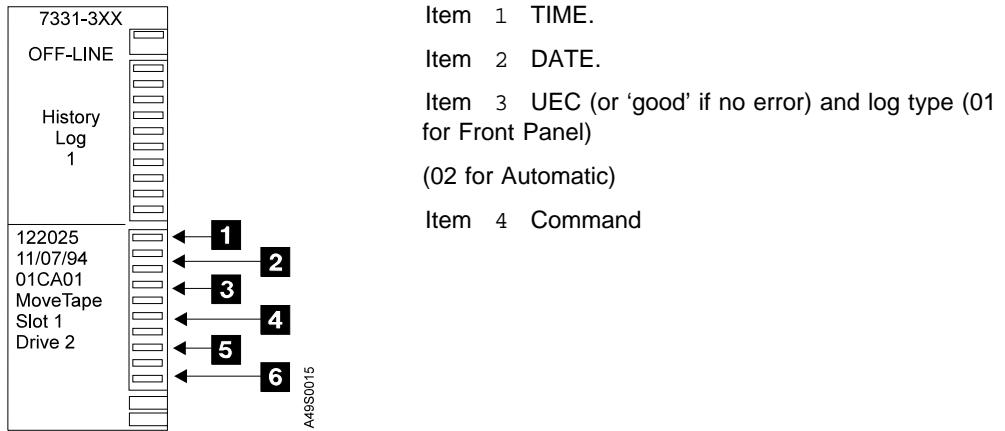





Figure 25. Front Panel and Automatic History Display

Note: New history entries are added to the beginning of the history log (history log 1 is the most recent operation that occurred). When the history log reaches its maximum capacity the oldest operations logged are discarded as new operations are logged.

4. Press the Up () and Down () buttons to step through the history log from the most recent operation logged to the oldest operation logged.
5. Press the Cancel () button at anytime to return to the Log Menu.

Library and Tape Drive Statistics Display

Library statistics are available for viewing from the Log Menu. There are two categories of statistics available: library statistics and drive statistics.

To display the library or tape drive statistics, use the following procedure:

1. Display the Log Menu. See “Log Menu Display” on page 14 and refer to Figure 26.
2. Using the Up (\uparrow) and Down (\downarrow) buttons, highlight:

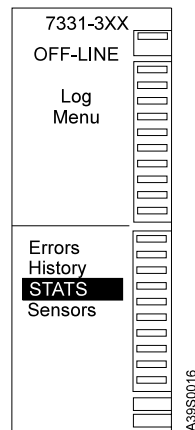

Stats on the Log Menu.

Press the Select (\leftarrow) button to display the Stats Menu.

Figure 26. Log/STATS Display

3. Using the Up (\uparrow) and Down (\downarrow) buttons, highlight the desired statistics for viewing.
4. Press the Select (\leftarrow) button to display the first statistics display for the selection chosen in the previous step (see Figure 27).

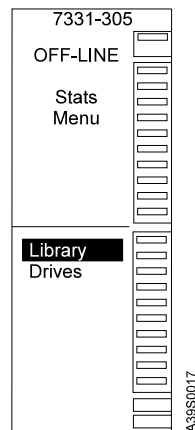

Figure 27. STATS Menu Display

5. Press the Up (\uparrow) and Down (\downarrow) buttons to step through the statistics log.

6. The statistics are displayed in the following formats (refer to Figure 28 and Figure 29 on page 23).

Library Statistics:

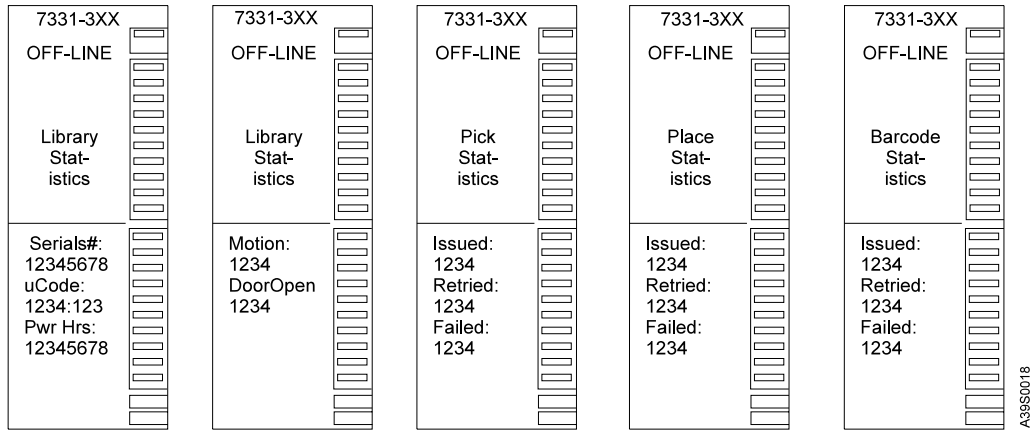

Figure 28. Library Statistics Display

Serial Number	Library serial number
uCode	Library uCode currently loaded
Power Hours	Total power on hours for the library
Motion	Number of move tape, inventory, calibrate, and accessor park operations
DoorOpen	Number of times the door has been opened and closed
Pick	issued: Number of pick operations started retried: Number of pick operations retried failed: Number of pick operations not completed
Place	issued: Number of place operations started retried: Number of place operations retried failed: Number of place operations not completed
Barcode	issued: Number of scans started retried: Number of scans retried failed: Number of scans not completed

Tape Drive Statistics:

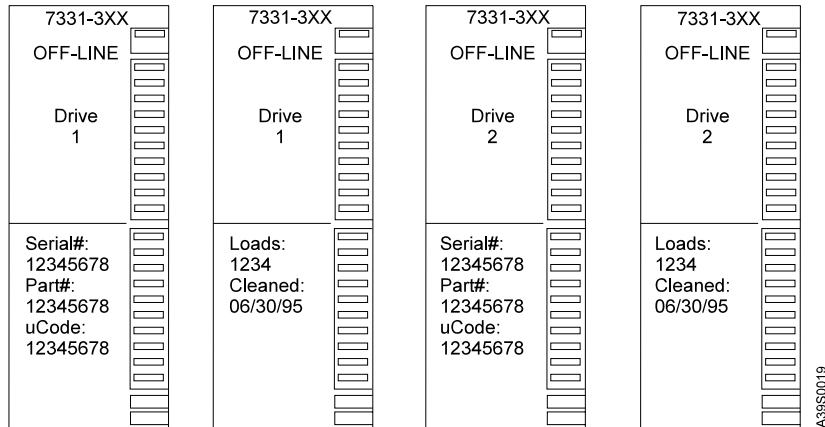

Figure 29. Tape Drive Statistics Display

All tape drives will be unknown if no statistics are available.



- Serial Number** Serial number for drive number shown in top section of display
- Part Number** Part number for drive number shown in top section of display
- uCode** Library card uCode currently loaded
- Loads** The number of load operations to the tape drive
- Cleaned** The date the drive was last cleaned using either the control panel or an automatic scheduled cleaning

Library Sensor Information Display

The library sensor information for the following sensors is available through the Log Menu.

Sensor	Location
Accessor Down Button	inside front door
Accessor Up Button	inside front door
Door Unlock Button	control panel
Cancel Button	control panel
Select Button	control panel
Down Button	control panel
Up Button	control panel
Accessor Locked sensor	top of accessor
Cartridge Present in Drive/Magazine sensor	on picker
Door Open sensor	on the library door
Accessor Obstructed Sensor	on frame, top & bottom
Pinch Cam Position Sensor	on the picker
Cartridge in Picker sensor/Cartridge Travel Warning Sensor	on the picker
Feed Belt Warning sensor	on the picker
Accessor Bottom Travel Limit Sensor	on the accessor assembly
Accessor Top Travel Limit Sensor	on the accessor assembly

To display the library sensor information, use the following procedure:

1. Display the Log Menu. See “Log Menu Display” on page 14 and refer to Figure 30.
2. Using the Up () and Down () buttons, highlight:

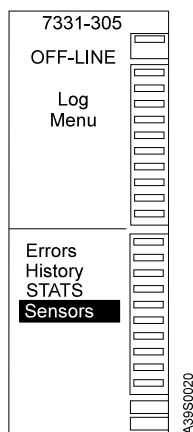

Sensors on the Log Menu.

Press the Select () button to display the library sensor information.

Figure 30. Log/Sensors Display

3. The sensor information (see Figure 31) displayed is in hexadecimal format (base 16). Use Figure 32, Figure 33 on page 26, and Figure 34 on page 26 to determine the specifics of the displayed sensor information.

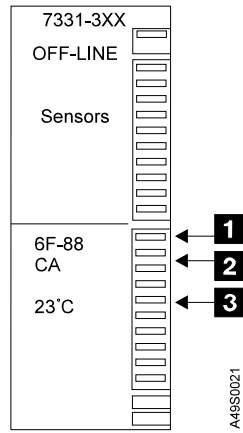

The information shown is a snapshot of the current sensor status. Each time the select button is pressed the information is updated.

- 1 Sensor group 1 setting and sensor group 2 setting
- 2 Sensor group 3 setting
- 3 Temperature

Figure 31. Sensors Display

4. Press the Cancel () button to display the Log Menu.

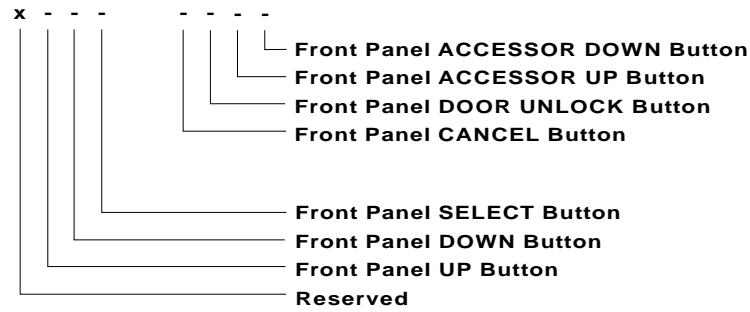

Polarity [-] = bit is 0 when button is pressed (- polarity)
 [+] = bit is 1 when button is pressed (+ polarity)

AS040

Figure 32. Sensor Group 1

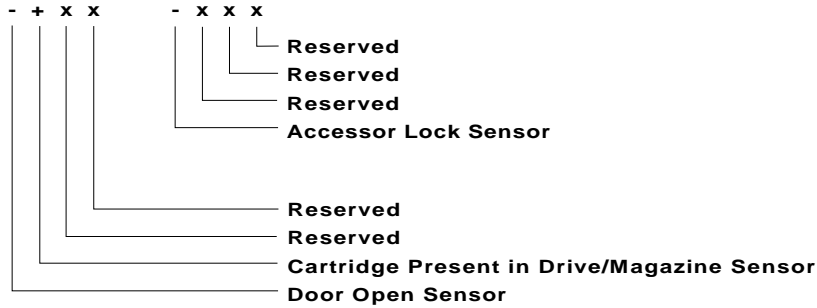

Polarity [-] = bit is 0 when the sensor is active (- polarity)
 [+] = bit is 1 when the sensor is active (+ polarity)
 [x] = no polarity

AS040A-00

Figure 33. Sensor Group 2



Polarity [-] = bit is 0 when the sensor is active (- polarity)
 [+] = bit is 1 when the sensor is active (+ polarity)
 [x] = no polarity

AS040B

Figure 34. Sensor Group 3

Perform a Library Selftest

The Selftest is a diagnostic tool to exercise the library by randomly moving tape cartridges from slot to slot. The tape cartridges are moved to and from the library tape drives during the Selftest. Any number of tape cartridges can be used providing that one slot remains empty.

To perform Selftest (see Figure 35 on page 27 and Figure 36 on page 27), use the following procedure:

1. Display the Service Menu. See "Service Menu Display" on page 13.
2. Using the Up (\uparrow) and Down (\downarrow) buttons, highlight:

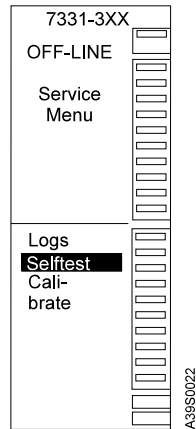

Selftest on the Service Menu.

The library picks and places tape cartridges in the library tape drive during the Selftest. It is the operators responsibility to ensure the system unit does not use a library tape drive while the Selftest is being performed.

Press the Select () button to run Selftest.

Figure 35. Service/Selftest Menu Display

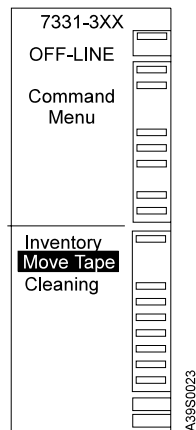



Figure 36. Move Tape Display

3. The Selftest runs continuously until one of the following conditions occur:

An error occurs. The Selftest stops when an error occurs and posts a UEC code on the control panel display.

If an error occurs, record the UEC and go to “Analysis Starting Point” on page 107.

Note: When an error occurs during Selftest, the error information is displayed and logged in the error log.

- The operator presses the Cancel () button to stop the Selftest, see Figure 37.

Note: Canceling an operation in progress, may cause an error that displays a UEC. Also, a tape cartridge may be left in a tape drive or the picker.

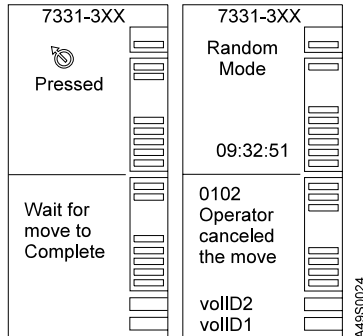





Figure 37. Move Tape Display

- The operator presses the door Unlock () button. After the library finishes current operation the library door is unlocked, the door lock indicator goes Off, and the control panel display shows the message, The door may now be opened.
- To stop the Selftest (recommended way) press the door Unlock () button. After the library finishes current operation the library door is unlocked, the door lock indicator goes Off, and the control panel display shows the message, The door may now be opened.
- Press the Cancel () button to relock the door and display the Service Menu.

Library Calibration

The `calibrate` option on the Service Menu is used to perform library calibration. The library determines where each element and drive location is during calibration. Calibration should be performed when the calibration required UEC (01CE) is displayed. Additionally, calibration is run when any of the following assemblies are replaced:

- Accessor assembly
- Magazine mounting plate assembly
- 2-slot cartridge holder
- Controller card
- Tape drive assembly
- Picker assembly

5-Tape Calibration

The library is calibrated using only five tape cartridges (four, if only one tape drive is installed).

The tape cartridges for a 5-tape calibration (see Figure 38 on page 29) are placed in the following locations:

- Tape drive 1 (in the unload position)
- Tape drive 2 (if installed, in the unload position)

- Slot 1 (bottom slot of bottom magazine)
- Slot 11 (bottom slot of top magazine)
- Bonus slot 1 (bottom bonus slot)

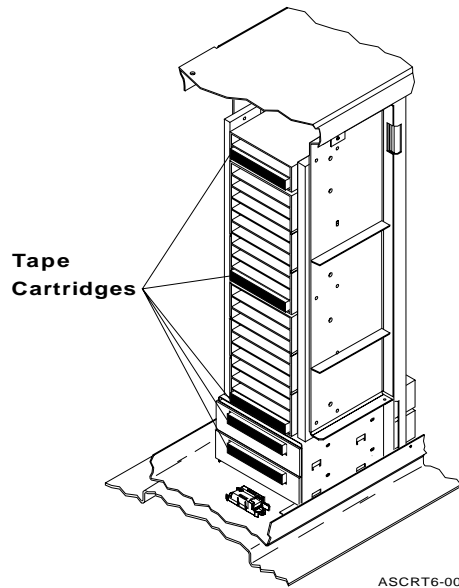

Figure 38. Tape Cartridge Placement for 5-Tape Calibration

During the 5-tape calibration the picker is moved in front of the tape cartridges and the calibration values for the library are calculated from the location of the tapes cartridges. **Full Calibration**

Note: A full calibration is only required if the 5-tape calibration is unsuccessful.

For a full calibration the operator places a tape cartridge in every location in the library. Twenty-four tape cartridges are required when both tape drives are installed in the library (one in each bonus slot, 20 in the two magazines, and, in the unload position, one in each tape drive). Only 23 tape cartridges are required when just one tape drive is installed in the library.

During a full calibrate the picker is moved in front of the tape cartridges and the location of each tape cartridge is recorded as the calibrate value.

To perform calibration, use the following procedure:

1. Display the Service Menu. See “Service Menu Display” on page 13 and refer to Figure 39 on page 30.
2. Using the Up (\uparrow) and Down (\downarrow) buttons, highlight:

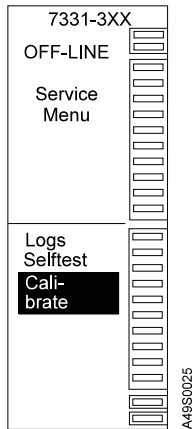

Calibrate on the Service Menu.

Figure 39. Service/Calibrate Menu Display

3. The control panel display (see Figure 40) shows the message:

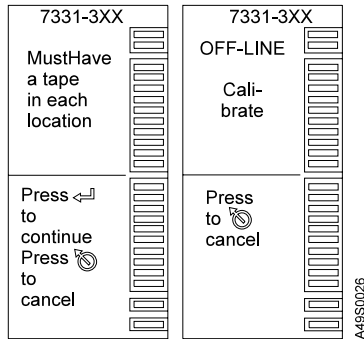

MustHave a tape in each location.

Ensure tape cartridges required for the calibrate desired (5-tape calibrate or full calibrate) are in the required positions. Ensure, also, tape cartridges in tape drives locations are in the eject position (sticking out of the drive).

Press the Select () button to perform calibrate.

Figure 40. MustHave/Calibrate Menu Display

Note: During calibration the library moves the picker across all the tape cartridge positions. The magazine present sensors on the picker determine the location of each element. During the calibrate process, the library also determines the number of tape drives configured in the library

4. After calibrate is complete the control panel display shows a completion message (see Figure 41) that states the number of drives detected in the library.

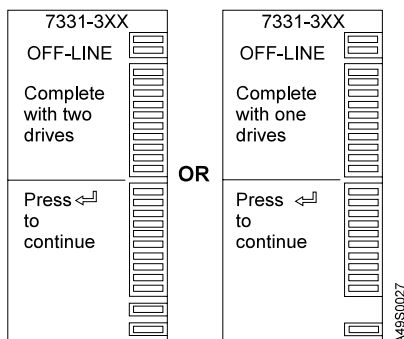

Figure 41. Number Drives in Library Display

- An error message will be displayed (see Figure 42 on page 31) if the library did not detect the correct number of tape cartridges, or if the locations do not match expected values.

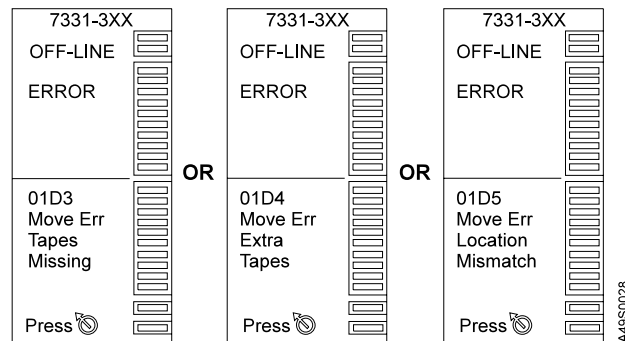



Figure 42. Error Types in Library Display



- If an error message is displayed, press the Cancel () button to cancel calibrate.
 - When the error is corrected, calibrate can be run.
- Press the Select () button to continue and display the Service Menu.
 - Return to the library service procedure that sent you here.

Enable the CE Menu

The CE Menu is only available when enabled during the power-on sequence and is used by the Customer Engineer (CE) to perform the following:

- Selecting the product type and serial number
- Setting the tuning parameters
- Clearing the history and error logs
- Resetting NVRAM
- Loading library internal code from a Code Load Tape

To enable the CE Menu, use the following procedure:

- Make sure the library power is Off.
- Press and hold the Up () and Down () buttons on the library control panel. Hold these buttons until instructed to release them in step 5 on page 32.
- Press the power switch () on the control panel to power on the library.

4. Continue to hold the Up (↑) and Down (↓) buttons, and refer to Figure 43 as the library performs the: (POST).

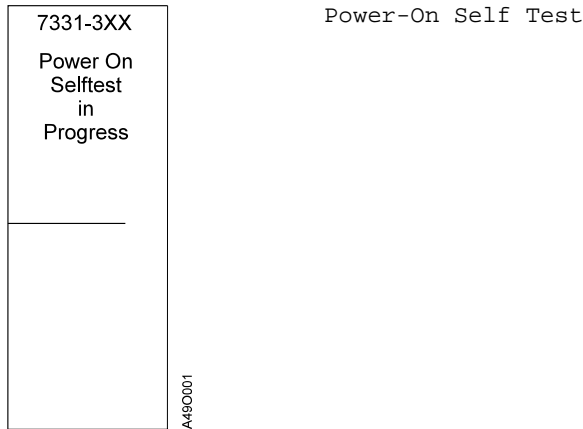

Figure 43. Power On/Selftest in Progress Display

5. When the control panel display (refer to Figure 44) shows the message:

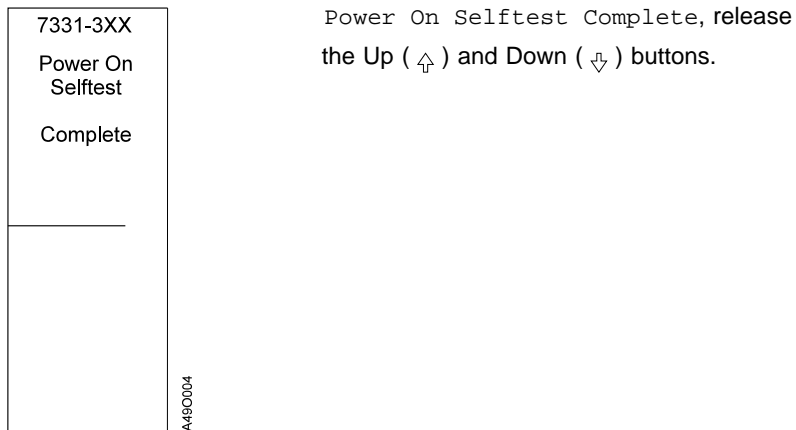

Figure 44. Power On/Selftest Complete Display

6. The CE Menu is now active and can be accessed through the Service Menu.

Set the Library Product Type and Serial Number

The library product type and serial number must be set in the library memory when the controller card is replaced or when the library memory is erased.

To initially set the library product type and serial number in the library memory, use the following procedure:

1. With the CE Menu enabled as described in “Enable the CE Menu” on page 31, display the Service Menu. See “Service Menu Display” on page 13.
2. Using the Up (\uparrow) and Down (\downarrow) buttons on the library control panel (refer to Figure 45) and highlight the:

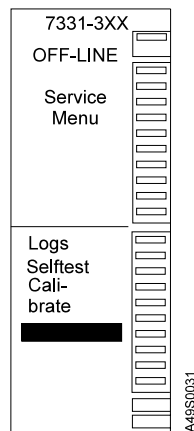

Blank Line under Calibrate on the Service Menu.

Press the Select (\leftarrow) button to display the CE Menu.

Figure 45. Service/Blank Line Display

3. Using the Up (\uparrow) and Down (\downarrow) buttons (refer to Figure 46) and highlight:

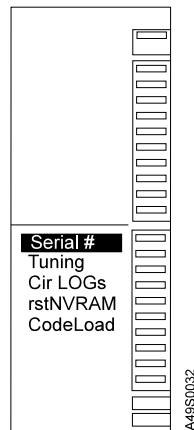

Serial # on the CE Menu.

Figure 46. Serial Number Display

- Press the Select () button and the product type (refer to Figure 47) and the serial number selection display is shown.

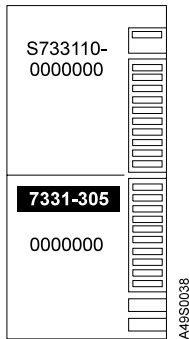



The product types available for selection is a list of all valid product types (7331-305, 3449-355, 3449-356) for the library.

Figure 47. Serial Number Selection Display

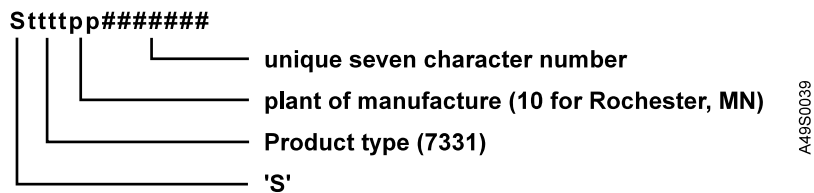
The format of the serial number is:



- Using the Up () and Down () buttons, sequence through the available product types until the product type shown matches your library.
- Press the Select () button to choose your product type. The product type selected is shown on the top line of the display during normal operation and in the information returned by the INQUIRY command.
- The first digit of the library serial number (refer to Figure 48) is now highlighted.

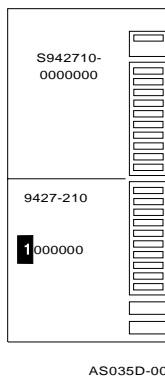

When installing a new controller card, the serial number shown is all zeros. During this procedure the serial number digits are set one at a time, starting with the first digit on the left.



Use the Up () and Down () buttons to display the first number of the serial number, then press the Select () button to select that digit and advance to the next digit. Repeat this step until all digits of the serial number are selected. When the last digit is selected, the CE Menu is displayed and the product type and serial number are stored in the library.

Figure 48. Serial Number Selected Display

- Return to the library service procedure that sent you here.

Set Library Tuning Parameters

Library tuning parameters are used to adjust the picker vertical position or the picker feed belts for differences in library pickers, magazines, tape drives, and bar code readers. The adjusted parameters are used when the library places tape cartridges into or picks tape cartridges from tape drives or magazine slots, or when the bar code reader reads bar code labels.

The following definitions apply to the library tuning parameters.

- PS** The picker (PS) tuning value is used to correct for differences in picker sensor positions. While setting the PS value, the picker is positioned at slot 9 to allow the operator to observe how changes to the PS value affect the picker position.
- The PS sets the position where the picker is located when picking a tape cartridge from a magazine slot. The PS should be set so that the tape cartridge is centered vertically between the ends of the picker.
- SS** The slot (SS) tuning value is used to correct for differences in magazines.
- The SS determines where the picker is located when placing a tape cartridge into a magazine slot.
- BS** The bar code (BS) tuning value is used to correct for differences in the location of the bar code scanners.
- The BS determines where the picker is located when reading the tape cartridge bar code label. The BS should be set so the bar code scan beam hits the center of the tape cartridge.
- FS** The feed-to-slot (FS) tuning value is used to correct for differences in the distance between the picker and the magazine slots. This value is used when the picker is picking a tape cartridge from a slot.
- PD** The pick-from-drive (PD) tuning value is used to correct for differences in the distance between the picker and the tape drives. This value is used when the picker is picking a tape cartridge from a tape drive.
- FD** The feed-to-drive (FD) tuning value is used to correct for differences in the distance between the picker and the tape drives. This value is used when the picker is placing a tape cartridge into a tape drive.
- Attention:** These values are set when the unit is manufactured. They should only be adjusted after all other service routines have been performed and the next level support has been called.

To set the library tuning parameters, use the following procedure:

1. With the CE Menu enabled as described in “Enable the CE Menu” on page 31, display the Service Menu. See “Service Menu Display” on page 13 and Figure 49.

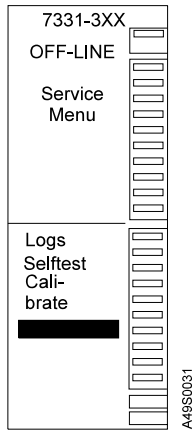



Blank Line under Calibrate on the Service Menu.
Press the Select () button to display the CE Menu.

Figure 49. Service/Blank Line Display

2. Using the Up () and Down () buttons (refer to Figure 50), highlight:

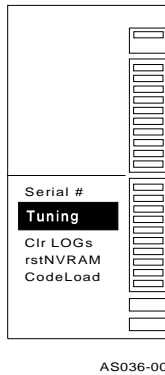

Tuning on the CE Menu.

Figure 50. Tuning Display

- Press the Select () button to display the list (refer to Figure 51), of tuning parameters.

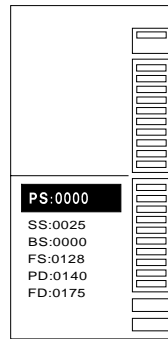

AS036A-00







Pressing the Cancel () button while in a menu moves the highlight back one menu item or if on the first item it will return the display to the previous menu.

Figure 51. Tuning Parameters Display

- Using the Up () and Down () buttons, change the tuning parameter to the desired setting.

Note: When the last tuning parameter is selected the display will return to the CE Menu.

To ensure parameter changes are saved, use the Select () button to advance through all tuning parameters when exiting the tuning parameter menu.

- Press the Select () button to advance to the next tuning parameter or press the Cancel () button to move back to the previous parameter.
- When a parameter is changed, the library places the picker or the feed belts at the location specified in the changed parameter.
- If an error occurs during positioning (for example, the accessor is obstructed), refer to Figure 52 illustrating a displayed message:

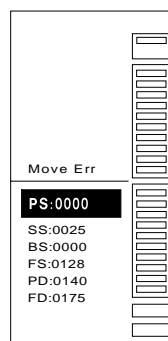

AS036B-00

Move Err. The error message indicates the picker or feedbelt is not positioned at the new parameter location.

Figure 52. Move Error Display

Clear History and Error Logs

To clear the history and error logs, use the following procedure:

1. With the CE Menu enabled as described in “Enable the CE Menu” on page 31, display the Service Menu. See “Service Menu Display” on page 13 and refer to Figure 53.

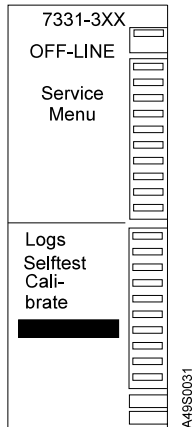



Blank Line under Calibrate on the Service Menu.
Press the Select () button to display the CE Menu.

Figure 53. Service/Blank Line Display

2. Using the Up () and Down () buttons see Figure 54 and highlight:

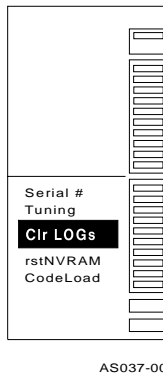

Clr LOGs on the CE Menu.
Press the Select () button to clear the library History and Error Logs. The library responds with a long beep to indicate the logs have been cleared.

Figure 54. Clear Logs Display

3. Press the Cancel () button to display the Service Menu.

Clear the Library NVRAM

Attention: Clearing the library non-volatile memory (NVRAM) should only be done if absolutely required. The library stores calibration values in NVRAM and these values are reset when selecting `rstNVRAM` on the CE Menu. Calibration must be performed after clearing NVRAM. Other library operations may also be affected, since values such as the tuning values are reset during NVRAM clearing.

To clear the library NVRAM, use the following procedure:

Note: The product data, such as the product type and serial number, are not reset during NVRAM clearing.

1. With the CE Menu enabled as described in “Enable the CE Menu” on page 31, display the Service Menu. See “Service Menu Display” on page 13.
2. Using the Up (\uparrow) and Down (\downarrow) buttons on the library control panel (see Figure 55), highlight:

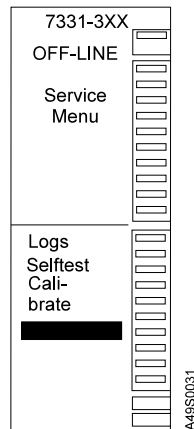

Blank Line under Calibrate on the Service Menu.
Press the Select (\leftarrow) button to display the CE Menu.

Figure 55. Service/Blank Line Display

3. Using the Up (\uparrow) and Down (\downarrow) buttons (see Figure 56), highlight:

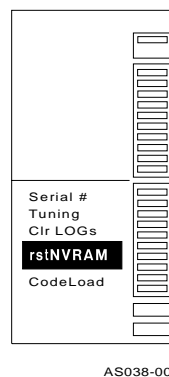

`rstNVRAM` on the CE Menu.
Press the Select (\leftarrow) button to clear the library NVRAM. The library responds with a long beep to indicate the NVRAM has been reset.
After the NVRAM is reset, the library must be powered down then powered on to use the reset values.

Figure 56. Reset NVRAM Display

4. Perform calibration. Go to “Library Calibration” on page 28.
5. Set any tuning parameters that were lost when the NVRAM was reset. Go to “Set Library Tuning Parameters” on page 35.

Load Library Internal Code from a Code Load Tape

The library internal code is loaded whenever there is a code update or the library memory is erased.

To load library internal code from a code load tape, use the following procedure:

1. Load the code load tape into Tape Drive 1. Go to the *7331 and 3449 8mm Tape Library Model 3xx Operator Guide* for instructions on loading a tape cartridge into a tape drive.

Note: If the code load tape is not in the drive when CodeLoad is selected in step 3, an error message displays indicating that the tape drive did not correctly load the code load tape.

2. With the CE Menu enabled as described in “Enable the CE Menu” on page 31, display the Service Menu. See “Service Menu Display” on page 13.

3. Using the Up (\uparrow) and Down (\downarrow) buttons (see Figure 57), highlight:

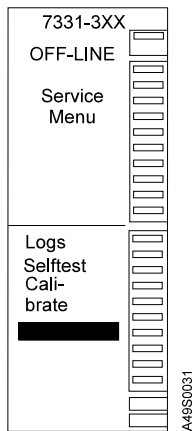

Blank Line under Calibrate on the Service Menu.

Press the Select (\leftarrow) button to display the CE Menu.

Figure 57. Service/Blank Line Display

4. Using the Up (\uparrow) and Down (\downarrow) buttons (see Figure 58), highlight:

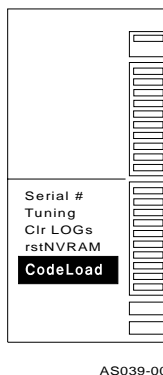

Highlight CodeLoad on the CE Menu.

Press the Select (\leftarrow) button to start the code load.

Figure 58. CodeLoad Display

- If the code load tape is not in the tape drive (see Figure 59) when CodeLoad is selected, an:

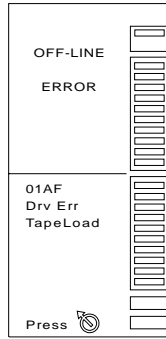

AS039A-00

Error message is displayed indicating the tape drive did not correctly load the code load tape. If this error condition occurs, make sure a code load tape is loaded in the tape drive and repeat the step necessary to load the code.

Figure 59. Drive Error Message Display

- The library begins to read the error (see Figure 60).

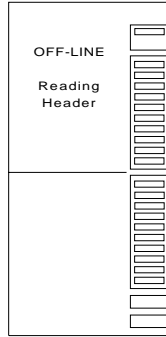

AS039B-00

Reading Header information at the start of the tape.

Figure 60. Reading Header Display

- If there is only one code load on the tape (see Figure 61), the library automatically displays:

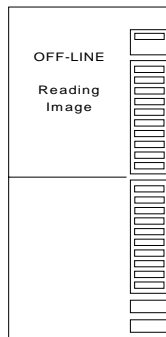

AS039C-00

Reading Image. The library reads the image and loads it into memory. Go to 11 on page 42.

Figure 61. Reading Image Display

8. If multiple code load images are on the tape, the library (see Figure 62) automatically displays:

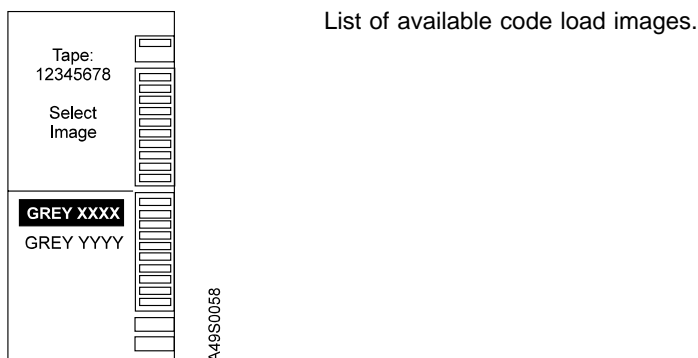

Figure 62. Available Code Images Display

9. Using the Up (\uparrow) and Down (\downarrow) buttons, highlight the code load image to be loaded.
10. Press the Select (\leftarrow) button (see Figure 63) to load the highlighted code load image.

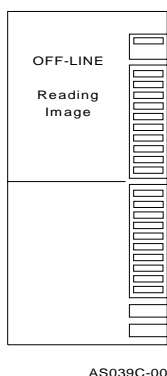

Figure 63. Reading Code Image Display

11. Once the code load image is read, the library verifies the image is correct, transfers the image to the code load area, and resets the library to perform a power-on selftest and start using the new code image. The tape is then unloaded from the tape drive.
12. When the power-on selftest is complete:
 - a. Open the library door.

Note: If the picker is located in front of the tape drive, the picker can be moved with the Move Picker buttons on the inside of the front door.
 - b. Remove the tape from the tape drive.
13. Verify the code load was successful by checking the uCode level in the library statistics. Go to “Library and Tape Drive Statistics Display” on page 21 to verify the library statistics.
14. Return the library to normal operations.

Chapter 3. Removal and Installation Procedures

This chapter describes the procedures you should follow when removing and installing the following 8mm Tape Library assemblies.

Handling Static-Sensitive Devices

Attention: The following Tape Library assemblies are sensitive to static electricity discharge.

- Control panel
- Tape drives
- Controller card
- Picker assembly
- Bar code reader (optional assembly)

During installation of these assemblies, assure they are handled as outlined below. When removed from the Tape Library, they must be placed in an antistatic bag.

Take the following precautions:

Do not remove the assemblies from their antistatic protective bag until they are to be installed.

With the assembly still in its antistatic bag, touch it to the metal frame of the Tape Library.

Handle the assembly carefully in order to prevent permanent damage.

Library Cover Set Removal and Installation

Removal and installation of the cover set (refer to Figure 64) or specific covers is done when the covers are damaged or to obtain access to internal assemblies during maintenance procedures.

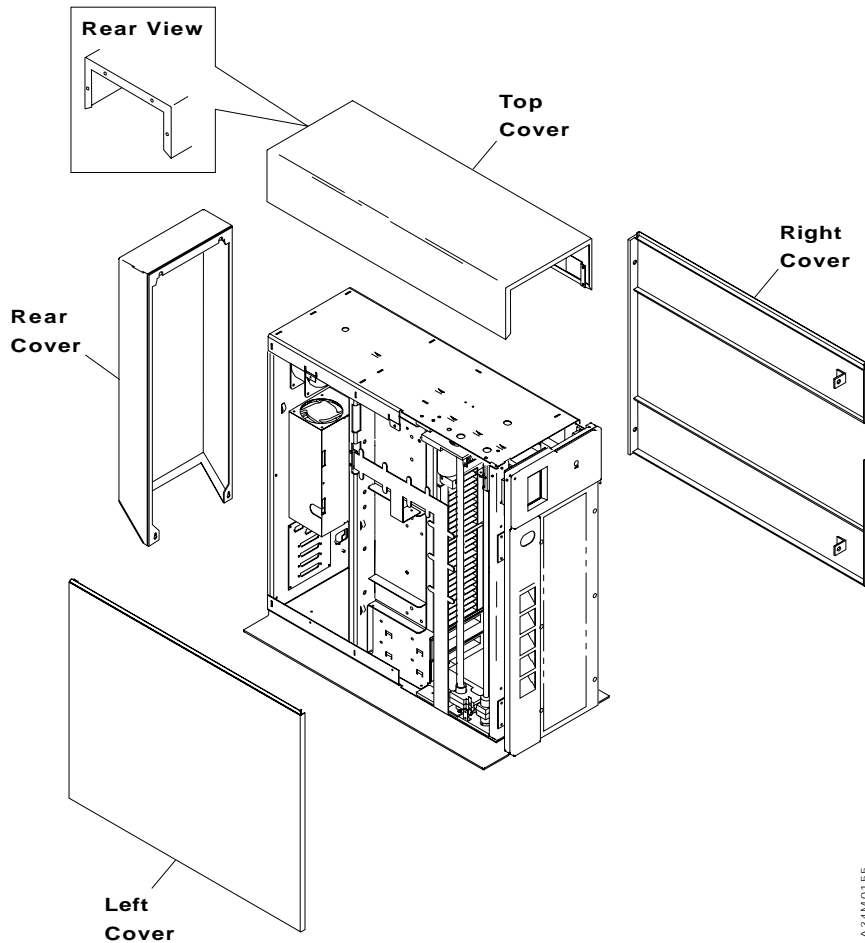

Figure 64. Library Cover Set



Note: The above symbols indicate appropriate cautions to address in this “Library Cover Set Removal and Installation” section of the manual.

Removal

DANGER

To prevent a possible electrical shock when installing the device, ensure that the power cord for that device is unplugged before installing signal cables. (RSFTD204)

DANGER

To prevent a possible electrical shock from touching two surfaces with different electrical grounds, use one hand, when possible, to connect or disconnect signal cables. (RSFTD004)

DANGER

To prevent a possible electrical shock when adding or removing any devices to or from the system, ensure that the power cords for those devices are unplugged before the signal cables are connected or disconnected. If possible, disconnect all power cords from the existing system before you add or remove a device.

CAUTION:

The weight of this part or unit is between 32 and 55 kilograms (70.5 and 121.2 pounds). It takes three persons to safely lift this part of unit. (RSFTC205)

CAUTION:

Do not place a highly reflective surface between either the picker assembly and the tape cartridge magazines or between the picker assembly and the tape drives. This may cause damage to your eyes. (RSFTC238)

CAUTION:

If the automatic lock on the front door is not functioning and the door is open, do not look directly at the laser beam. Staring at the beam may cause damage to your eyes. (RSFTC239)

Rear Cover

To remove, use the following procedure:

1. If the Tape Library is currently performing an operation, wait until the operation is complete before continuing.
2. If not already done, do a controlled system shutdown.
3. Open the control panel access cover and press the library power switch to turn the library power Off.
4. Unplug the library power cable from the power outlet.

Note: The rear cover is attached with M3X6 panhead screws.

5. Loosen 2 screws at the bottom of the rear cover and lift the cover to remove it from library.
6. Store the cover where it will not get damaged during further maintenance.

Top Cover

To remove, use the following procedure:

1. If the Tape Library is currently performing an operation, wait until the operation is complete before continuing.
2. If not already done, do a controlled system shutdown.
3. Open the control panel access cover and press the library power switch to turn the library power Off.

4. Unplug the library power cable from the power outlet.
5. Remove the library rear cover. See steps on rear cover removal at the beginning of this removal section.
6. Remove the library front door. See “Front Door Assembly Removal and Installation” on page 48.
Note: The top cover is attached with M3X6 panhead screws. The two screws at the top location on the back have spacers on the screw to provide clearance for mounting the rear cover.
7. Remove 2 screws at the front and 4 screws at the back of the top cover. Make sure the spacers removed with the 2 screws at the back are retained for installation.
8. Remove the top cover from the library.
9. Store the cover and screws where they will not get damaged during further maintenance.

Side Covers

To remove, use the following procedure:

1. If the 8mm Tape Library is currently performing an operation, wait until the operation is complete before continuing.
2. If not already done, do a controlled system shutdown.
3. Open the control panel access cover and press the library power switch to turn the library power Off.
4. Unplug the library power cable from the power outlet.
5. Remove the library rear cover. See steps on rear cover removal at the beginning of this removal section.
6. Open the library front door. If the left cover is being removed, remove the library front door. See “Front Door Assembly Removal and Installation” on page 48.

Notes:

- a. In the following step, Do Not remove the screw at the bottom on the back of the library that the rear cover mounts on. The hole in the side cover is sized to slide over the rear cover mounting screw.
- b. The side covers are attached with M3X4 panhead screws.
7. Remove 2 screws from the front and 2 screws from the back for the side cover requiring removal. Remove the cover from the library.
8. If both of the side covers require removal, repeat steps 6 - 7 to remove the other side cover.
9. Store the covers and screws where they will not get damaged during further maintenance.

Installation

DANGER

To prevent a possible electrical shock when installing the device, ensure that the power cord for that device is unplugged before installing signal cables. (RSFTD204)

DANGER

To prevent a possible electrical shock from touching two surfaces with different electrical grounds, use one hand, when possible, to connect or disconnect signal cables. (RSFTD004)

DANGER

To prevent a possible electrical shock when adding or removing any devices to or from the system, ensure that the power cords for those devices are unplugged before the signal cables are connected or disconnected. If possible, disconnect all power cords from the existing system before you add or remove a device.

CAUTION:

The weight of this part or unit is between 32 and 55 kilograms (70.5 and 121.2 pounds). It takes three persons to safely lift this part of unit. (RSFTC205)

CAUTION:

Do not place a highly reflective surface between either the picker assembly and the tape cartridge magazines or between the picker assembly and the tape drives. This may cause damage to your eyes. (RSFTC238)

CAUTION:

If the automatic lock on the front door is not functioning and the door is open, do not look directly at the laser beam. Staring at the beam may cause damage to your eyes. (RSFTC239)

To install the covers, use the following procedure:

1. Make sure the library power is Off and the library power cable is unplugged from the power source.
2. Obtain the covers to be installed.

Note: In the following step, install the top and side covers before installing the rear cover.

3. Position the covers on the library.

Note: Make sure the spacers are installed with the 2 screws at the top location at the back of the library when installing the top cover.

4. Install the screws required to the secure covers in position.
5. Make sure the library front door is installed.
6. Return to the library service procedure that sent you here.

Front Door Assembly Removal and Installation

Removal and installation of the front door assembly is done when the door assembly is damaged or when performing other maintenance procedures.

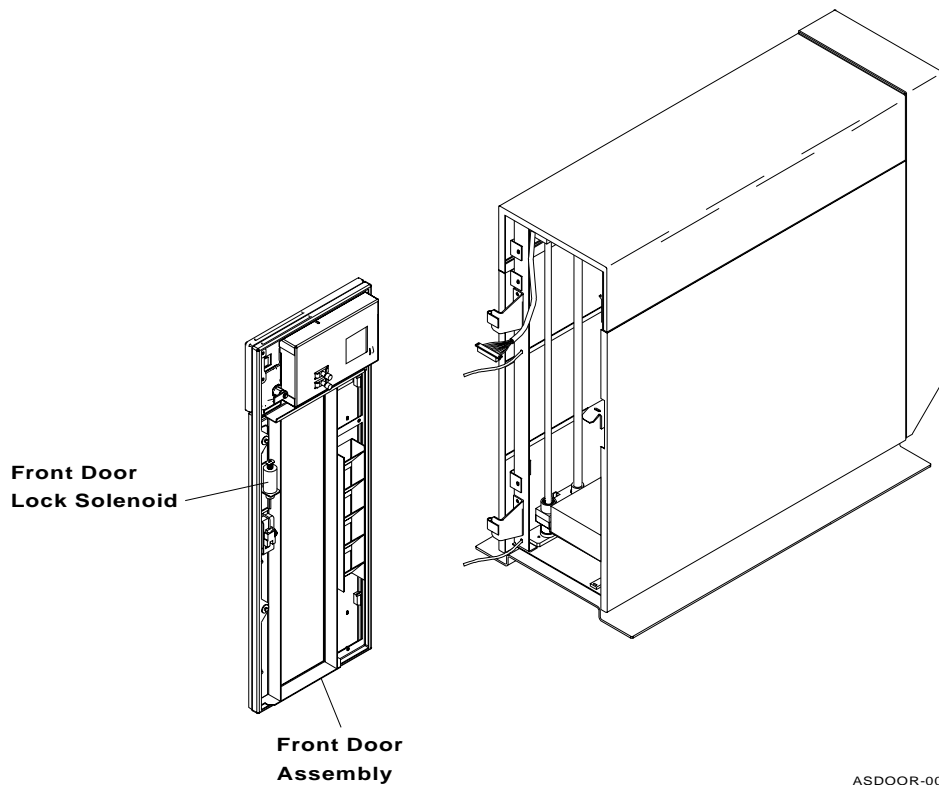

Figure 65. Front Door Assembly



Note: The above symbols indicate appropriate cautions to address in this “Front Door Assembly Removal and Installation” section of the manual.

Removal

To remove the front door assembly, use the following procedure:

DANGER

To prevent a possible electrical shock when installing the device, ensure that the power cord for that device is unplugged before installing signal cables. (RSFTD204)

DANGER

To prevent a possible electrical shock from touching two surfaces with different electrical grounds, use one hand, when possible, to connect or disconnect signal cables. (RSFTD004)

CAUTION:

Do not place a highly reflective surface between either the picker assembly and the tape cartridge magazines or between the picker assembly and the tape drives. This may cause damage to your eyes. (RSFTC238)

CAUTION:

If the automatic lock on the front door is not functioning and the door is open, do not look directly at the laser beam. Staring at the beam may cause damage to your eyes. (RSFTC239)

1. If the Tape Library is currently performing an operation, wait until the operation is complete before continuing.
2. If not already done, do a controlled system shutdown.
3. Open the control panel access cover and press the library power switch to turn the library power Off.
4. Unplug the library power cable from the power source.
5. Open the library front door.
6. Remove the cable restraint securing the control panel cable to the safety cover.
7. Disconnect the control panel signal cable from the control panel.
8. On the inside of the front door, remove the screw securing each frame-to-door ground strap. There are two ground straps. See Figure 65 on page 48.
9. Grasp the front door assembly and lift it off the hinges.
10. If door assembly is being removed because it is defective, remove the control panel assembly for installation on the new door assembly. See "Control Panel Assembly Removal and Installation" on page 51.

Installation

DANGER

To prevent a possible electrical shock when installing the device, ensure that the power cord for that device is unplugged before installing signal cables. (RSFTD204)

DANGER

To prevent a possible electrical shock from touching two surfaces with different electrical grounds, use one hand, when possible, to connect or disconnect signal cables. (RSFTD004)

CAUTION:

Do not place a highly reflective surface between either the picker assembly and the tape cartridge magazines or between the picker assembly and the tape drives. This may cause damage to your eyes. (RSFTC238)

CAUTION:

If the automatic lock on the front door is not functioning and the door is open, do not look directly at the laser beam. Staring at the beam may cause damage to your eyes. (RSFTC239)

To install the front door assembly, use the following procedure:

1. Make sure the library power is Off and the library power cable is unplugged from the power source.
2. Obtain the front door assembly to be installed.
3. If required, install the control panel on the door assembly. See “Control Panel Assembly Removal and Installation” on page 51.
4. Align the door assembly hinge pins with the library hinges and lower the door assembly into position.
5. Attach each frame-to-door ground strap to the inside of the front door with a screw. See Figure 65 on page 48.
6. Connect the control panel signal cable to the control panel.
7. Install a cable restraint to secure the control panel cable to the safety cover.
Note: The door does not lock in the following step. The library door solenoid locks the door when library power is turned On.
8. Close the library front door. Make sure it operates correctly.
9. Return to the library service procedure that sent you here.

Control Panel Assembly Removal and Installation

Removal and installation of the control panel assembly (see Figure 66) is done when the control panel has failed or when replacing the front door assembly.

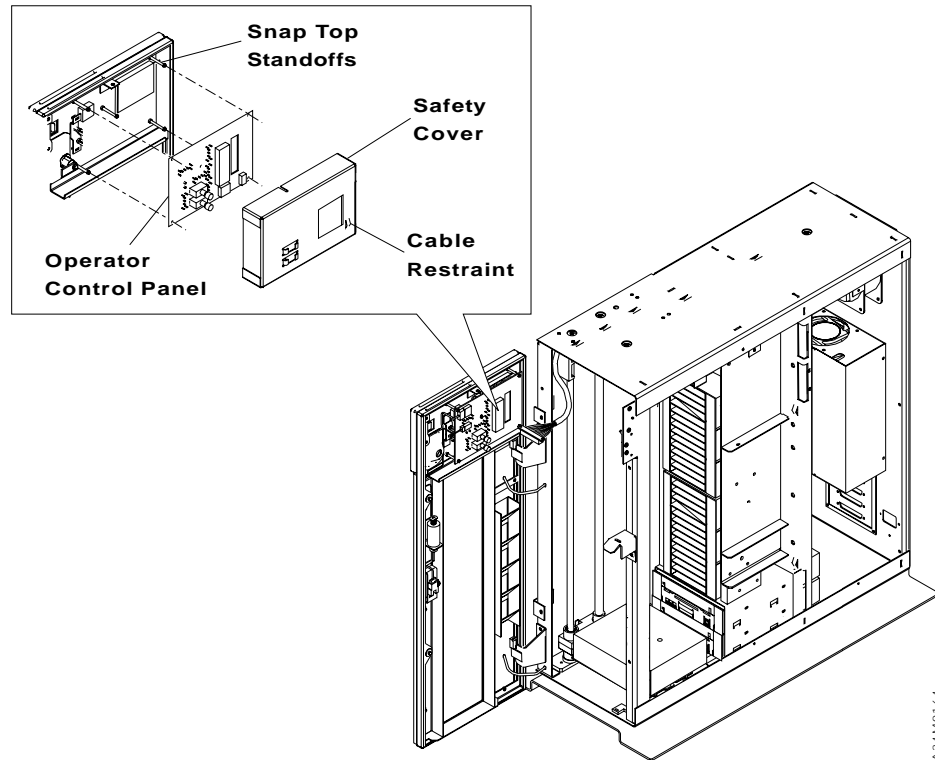

Figure 66. Control Panel Assembly



Note: The above symbol indicates appropriate cautions to address in this “Control Panel Assembly Removal and Installation” section of the manual.

Removal

To remove the control panel assembly, use the following procedure:

1. If the Tape Library is currently performing an operation, wait until the operation is complete before continuing.
2. If not already done, do a controlled system shutdown.
3. Open the control panel access cover and press the library power switch to turn the library power Off.

DANGER

To prevent a possible electrical shock when installing the device, ensure that the power cord for that device is unplugged before installing signal cables. (RSFTD204)

DANGER

To prevent a possible electrical shock from touching two surfaces with different electrical grounds, use one hand, when possible, to connect or disconnect signal cables. (RSFTD004)

4. Unplug the library power cable from the power outlet.
5. Open the library front door.
 - Attention:** The control panel assembly is sensitive to static electricity discharge. During the following steps, make sure it is handled as outlined in “Handling Static-Sensitive Devices” on page 43 and placed in an antistatic bag when removed from the Tape Library.
6. Remove the cable restraint securing the control panel cable to the safety cover.
7. Disconnect the control panel signal cable from the control panel.
8. Loosen or remove the screw at the top of the safety cover and remove the safety cover.
9. Disconnect the door lock solenoid cable and the door lock sensor cable from the bottom of the control panel circuit card.
 - Note:** When removing the control panel assembly card in the following step, pull where the mounting holes are located on the card. Pulling at other locations may flex the card and damage the card circuits.
10. Carefully remove the control panel by pulling at the edges where the snap-top standoffs (6) are located.

Installation

To install the control panel assembly, use the following procedure.

1. Make sure the library power is Off and the library power cable is unplugged from the power source.

Attention: The control panel assembly is sensitive to static electricity discharge. During the following steps, make sure it is handled as outlined in “Handling Static-Sensitive Devices” on page 43 and not removed from the antistatic bag until ready for installation in the 7331 Tape Library.

DANGER

To prevent a possible electrical shock when installing the device, ensure that the power cord for that device is unplugged before installing signal cables. (RSFTD204)

DANGER

To prevent a possible electrical shock from touching two surfaces with different electrical grounds, use one hand, when possible, to connect or disconnect signal cables. (RSFTD004)

2. Obtain the control panel assembly to be installed. Make sure antistatic precautions are observed when handling the control panel assembly.

Note: When installing the control panel assembly card in the following step, press where the mounting holes are located on the card. Pressing at the center of the card or at other locations on the card may flex the card and damage the card circuits.

3. Remove the control panel from the antistatic bag and position it on the library door with the card mounting holes over the snap-top standoffs. Carefully push at mounting locations to snap panel into place.
4. Connect the door lock solenoid cable and the door lock sensor cable to the bottom of the control panel circuit card.
5. Position the safety cover over the control panel and install or tighten screw at top to secure the cover in place.
6. Connect the control panel signal cable to the control panel.
7. Install a cable restraint to secure the control panel cable to the safety cover.
Note: The door does not lock in the following step. The library door solenoid locks the door when library power is turned On.
8. Close the library front door.
9. Return to the library service procedure that sent you here.

Control Panel Cable Removal and Installation

Removal and installation of the control panel cable (see Figure 67) is done when the cable has failed or when replacing the front door assembly.

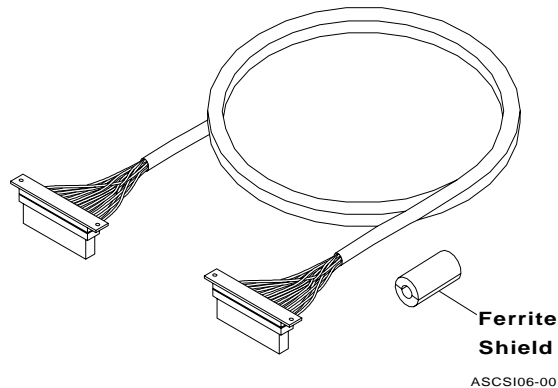

Figure 67. Control Panel Cable



Note: The above symbol indicates appropriate cautions to address in this “Control Panel Cable Removal and Installation” section of the manual.

Removal

To remove the control panel cable, use the following procedure:

1. If the Tape Library is currently performing an operation, wait until the operation is complete before continuing.
2. If not already done, do a controlled system shutdown.
3. Open the control panel access cover and press the library power switch to turn the library power Off.

DANGER

To prevent a possible electrical shock when installing the device, ensure that the power cord for that device is unplugged before installing signal cables. (RSFTD204)

DANGER

To prevent a possible electrical shock from touching two surfaces with different electrical grounds, use one hand, when possible, to connect or disconnect signal cables. (RSFTD004)

4. Unplug the library power cable from the power outlet.
5. Remove the library rear, top, and left side covers. See “Library Cover Set Removal and Installation” on page 44.
6. If not already open, open library front door.

Attention: The control panel assembly is sensitive to static electricity discharge. Make sure antistatic precautions are observed as outlined in “Handling Static-Sensitive Devices” on page 43 during the following removal steps.

7. Remove the cable restraint securing the control panel cable to the safety cover.
8. Disconnect the control panel signal cable from the control panel.
9. Measure and record the length of cable extending out of the front of the library.
10. Disconnect the control panel signal cable from P6 on the controller card.
11. Remove cable ties securing control panel cable inside the library frame. Note routing of cable.

Note: In the following step, use care so the control panel cable is not damaged when pulling the cable through the slot in the middle stiffener plate.

12. Carefully remove cable from library.
13. Retain cable and do not remove the ferrite shield from the cable until ready to transfer it to the new cable during installation.

Installation

To install the control panel cable, use the following procedure:

1. Make sure the library power is Off and the library power cable is unplugged from the power source.
2. Obtain the control panel cable to be installed.

Attention: The control panel assembly is sensitive to static electricity discharge. Make sure antistatic precautions are observed as outlined in “Handling Static-Sensitive Devices” on page 43 during the following installation steps.

3. Position the removed control panel cable and the new cable next to each other. Remove the ferrite shield from the removed cable and install it on the new cable in the same position as it was installed on the removed cable.

Note: In the following step, use care so the control panel cable is not damaged when routing the cable through the slot in the middle stiffener plate.

DANGER

To prevent a possible electrical shock when installing the device, ensure that the power cord for that device is unplugged before installing signal cables. (RSFTD204)

DANGER

To prevent a possible electrical shock from touching two surfaces with different electrical grounds, use one hand, when possible, to connect or disconnect signal cables. (RSFTD004)

4. Position the control panel cable in the library for connection to the controller card and the control panel.
5. Route the cable as follows (see Figure 68):

From the front of the frame along underside of the top to the location indicated in the figure,

Then to the left side and down a short distance,

Then towards the rear of the library through the upper slot in the middle frame panel to the controller card.

Note: Make sure the control panel end of the cable extends out of the front of the library the same distance as the removed cable did. Do not allow it to extend out farther than the removed cable did. Excess cable interferes with the picker operation when the door is closed.

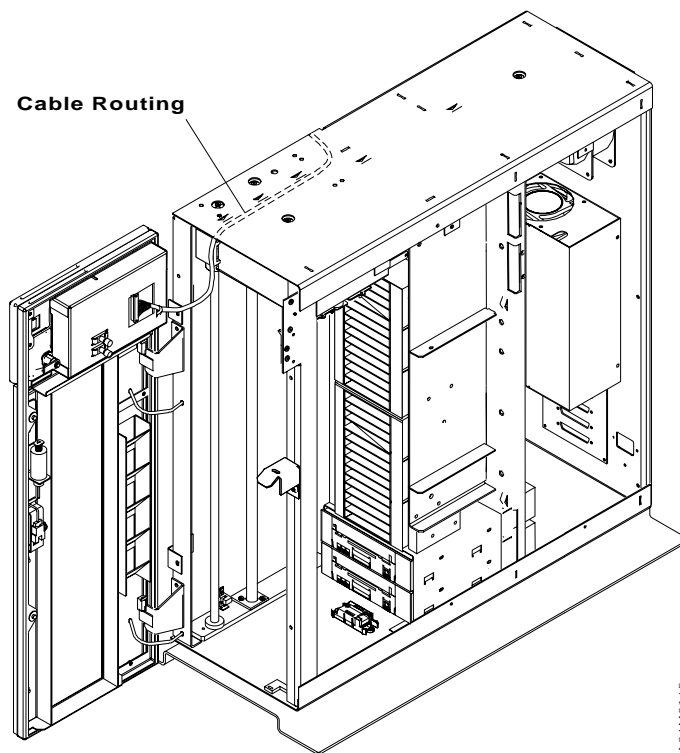

Figure 68. Control Panel Cable Routing

6. Secure the cable in position with cable ties.
7. Connect the control panel cable to the controller card. See Figure 79 on page 76 for location of connector.
8. Connect the control panel cable to the control panel.
9. Install a cable restraint to secure the control panel cable to the safety cover.
10. Close the library front door.
11. Return to the library service procedure that sent you here.

Tape Cartridge Magazine Removal and Installation

Both tape cartridge magazines can be removed from the Tape Library (see Figure 69). If neither magazine is installed, the library operates with one of the slots in the 2-slot cartridge holder.

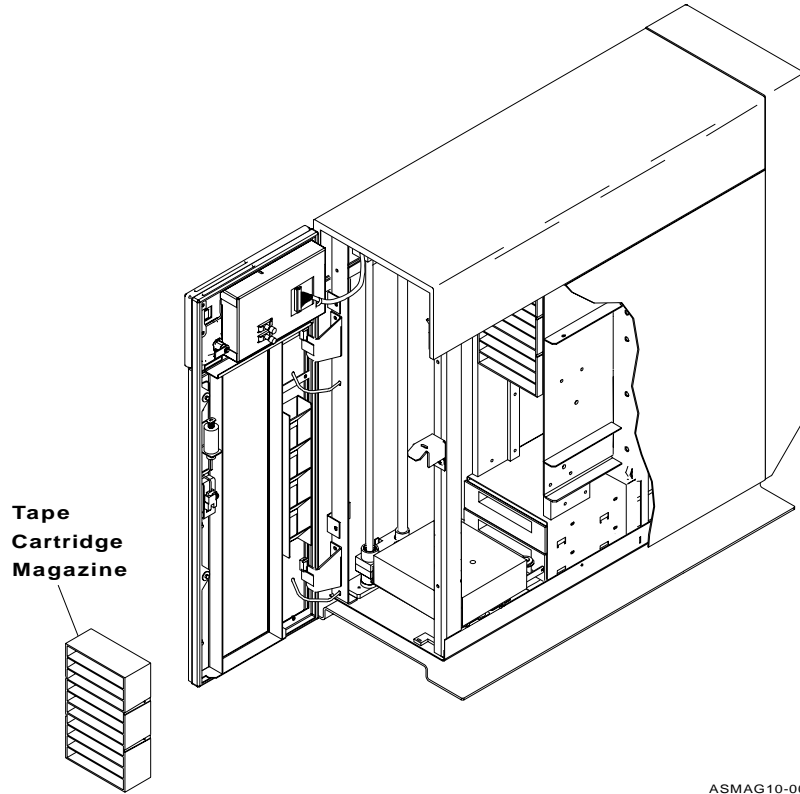

Figure 69. 10-Slot Tape Cartridge Magazine

Removal

To remove a tape cartridge magazine, use the following procedure:

1. If the Tape Library is currently performing an operation, wait until the operation is complete before continuing.
2. Open the library front door. See the *7331 and 3449 8mm Tape Library Model 3xx Operator Guide*.

Note: As long as power is applied to the library, the move buttons located inside the library front door on the back of the control panel card can be used to move the picker assembly up and down.

3. Either magazine can be removed at this time. If the picker is in front of the tape cartridge magazine to be removed, use the Move Picker buttons to relocate the picker.
4. Grasp the magazine by the sides and pull straight out to remove it from the library. If both magazines are to be removed, repeat this step.
5. If the magazine is to be stored with the cartridges installed, place a dust cover on the magazine.

6. If the tape cartridge magazine will not be installed at this time, close the library front door.

Installation

To install a magazine, use the following procedure:

1. If required, open library front door. See the *7331 and 3449 8mm Tape Library Model 3xx Operator Guide*.

Note: As long as power is applied to the library, the move buttons located inside the library front door on the back of the control panel card can be used to move the picker assembly up and down.

2. Make sure there is an empty location for installing the tape cartridge magazine. If the picker is in front of the location where the magazine is to be installed, use the Move Picker buttons to relocate the picker.
3. Obtain the tape cartridge magazine to be installed.
4. Remove and store the magazine dust cover.
5. Holding the tape cartridge magazine by the sides, position the magazine on the mounting plates and push firmly until the magazine seats on the mounting plates.
6. Make sure all of the tape cartridges are fully inserted into the magazine.
7. Close the library front door.
8. Return to the library service procedure that sent you here.

Magazine Mounting Plates Removal and Installation

Magazine mounting plates can be replaced as individual items or as a pair. Two sensors are positioned on the right mounting plate to detect whether a magazine is or is not installed. The sensors and the right mounting plate are an assembly and are removed as a unit.

Note: The right and left magazine mounting plates are not interchangeable.

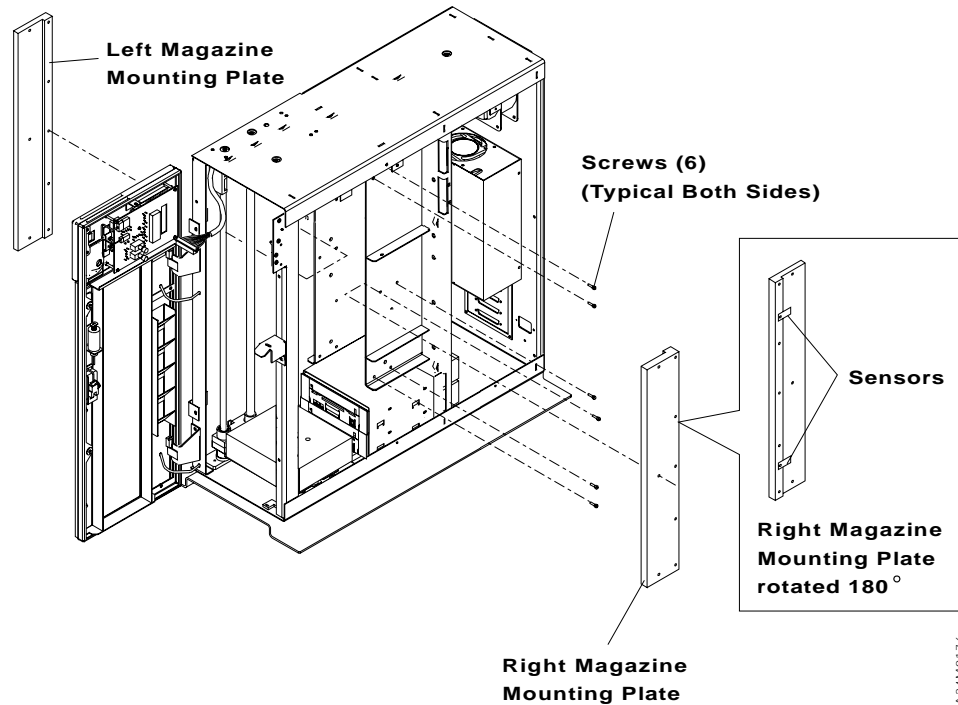

Figure 70. Magazine Mounting Plates



Note: The above symbol indicates appropriate cautions to address in this 10 on page 60 section of the manual.

Removal

To remove the magazine mounting plates, use the following procedure:

1. If the Tape Library is currently performing an operation, wait until the operation is complete before continuing.
2. If not already done, do a controlled system shutdown.
3. Open the control panel access cover and press the library power switch to turn the library power Off.

DANGER

To prevent a possible electrical shock when installing the device, ensure that the power cord for that device is unplugged before installing signal cables. (RSFTD204)

DANGER

To prevent a possible electrical shock from touching two surfaces with different electrical grounds, use one hand, when possible, to connect or disconnect signal cables. (RSFTD004)

4. Unplug the library power cable from the power outlet.
5. Open the library front door.
6. Remove all library covers. See “Library Cover Set Removal and Installation” on page 44.
7. Remove any installed tape magazines. See “Tape Cartridge Magazine Removal and Installation” on page 57.
8. Remove the 2-slot cartridge holder. See “2-Slot Cartridge Holder Removal and Installation” on page 62.
9. Disconnect the sensor signal cables at the sensors on the right mounting plate. There are two connectors on each sensor.
10. Remove 6 screws securing each mounting plate to the library frame and carefully remove the mounting plate from the library.
11. Repeat step 10 to remove the other mounting plate.

Installation

To install magazine mounting plates, use the following procedure:

1. Make sure the library power is Off and the library power cable is unplugged from the power source.

2. Obtain the magazine mounting plates to be installed.

Note: The mounting plates have pins that align with holes in the library frame when positioning the magazine mounting plates.

3. Position the mounting plate in the library and secure in position with 6 screws. Do not overtighten the screws.

DANGER

To prevent a possible electrical shock when installing the device, ensure that the power cord for that device is unplugged before installing signal cables. (RSFTD204)

DANGER

To prevent a possible electrical shock from touching two surfaces with different electrical grounds, use one hand, when possible, to connect or disconnect signal cables. (RSFTD004)

4. Connect the sensor signal cables to the sensors on the right mounting plate. There are two connectors on each sensor.
5. Install the 2-slot cartridge holder. See “2-Slot Cartridge Holder Removal and Installation” on page 62.
6. Install the tape cartridge magazines. See “Tape Cartridge Magazine Removal and Installation” on page 57.
7. Calibrate the Tape Library. See “Library Calibration” on page 28.
8. Install the library covers. See “Library Cover Set Removal and Installation” on page 44.
9. Make sure the library front door is closed.
10. Return to the library service procedure that sent you here.

2-Slot Cartridge Holder Removal and Installation

The 2-slot cartridge holder (see Figure 71) is removed because of failure or when performing other maintenance procedures.

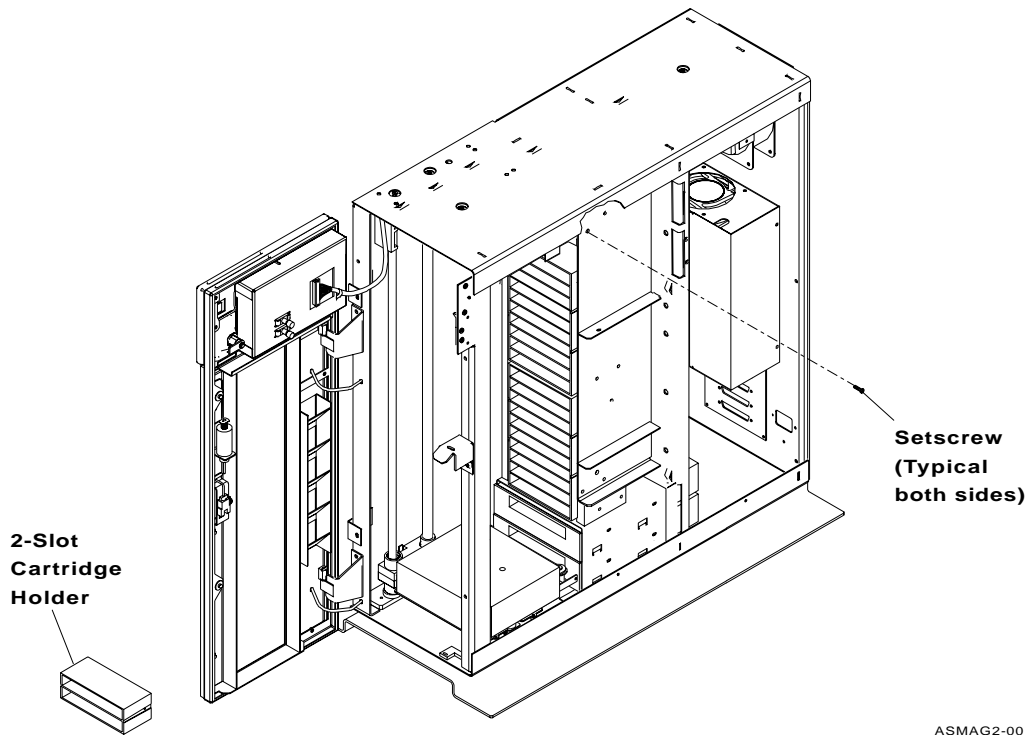

Figure 71. 2-Slot Cartridge Holder



Note: The above symbol indicates appropriate cautions to address in this “2-Slot Cartridge Holder Removal and Installation” section of the manual.

Removal

To remove the 2-slot cartridge holder, use the following procedure:

1. If the Tape Library is currently performing an operation, wait until the operation is complete before continuing.
2. If not already done, do a controlled system shutdown.
3. Open the control panel access cover and press the library power switch to turn the library power Off.
4. Open the library front door and remove all tape cartridges from the 2-slot cartridge holder.

DANGER

To prevent a possible electrical shock when installing the device, ensure that the power cord for that device is unplugged before installing signal cables. (RSFTD204)

DANGER

To prevent a possible electrical shock from touching two surfaces with different electrical grounds, use one hand, when possible, to connect or disconnect signal cables. (RSFTD004)

5. Unplug the library power cable from the power outlet.
6. Remove all library covers. See “Library Cover Set Removal and Installation” on page 44.
7. Loosen the setscrew on each side of the library that secures the cartridge holder in place. Remove the cartridge holder.

Installation

To install the 2-slot cartridge holder, use the following procedure:

1. Make sure the library power is Off and the library power cable is unplugged from the power source.
2. Obtain the 2-slot cartridge holder to be installed.

Attention: Do **Not** overtighten the setscrews in the following step. Overtightening the screws will cause the magazine supports to bow out.

3. Position the 2-slot cartridge holder in the library and tighten the setscrew on each side to secure in place. Do not overtighten setscrews.
4. Install the tape cartridges, that were removed above, in the 2-slot cartridge holder.
5. Calibrate the Tape Library. See “Library Calibration” on page 28.
6. Install the library covers. See “Library Cover Set Removal and Installation” on page 44.
7. Close the library front door.
8. Return to the library service procedure that sent you here.

Fan Assembly Removal and Installation

The Tape Library has a cooling fan (see Figure 72) in addition to the power supply fan. The cooling fan is replaced due to failure. The fan does not normally need to be removed when performing other maintenance procedures.

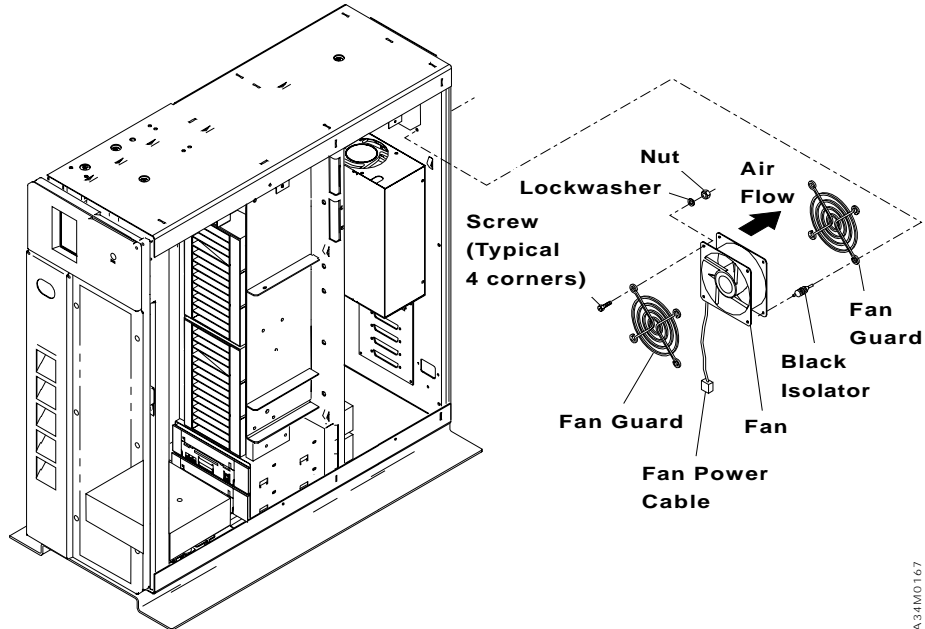

Figure 72. Fan Assembly



Note: The above symbol indicates appropriate cautions to address in this “Fan Assembly Removal and Installation” section of the manual.

Removal

To remove the fan assembly, use the following procedure:

1. If the Tape Library is currently performing an operation, wait until the operation is complete before continuing.
2. If not already done, do a controlled system shutdown.
3. Open the control panel access cover and press the library power switch to turn the library power Off.

DANGER

To prevent a possible electrical shock when installing the device, ensure that the power cord for that device is unplugged before installing signal cables. (RSFTD204)

DANGER

To prevent a possible electrical shock from touching two surfaces with different electrical grounds, use one hand, when possible, to connect or disconnect signal cables. (RSFTD004)

4. Unplug the library power cable from the power outlet.
5. Remove all library covers. See “Library Cover Set Removal and Installation” on page 44.
6. Disconnect the fan power cable from the controller card.
Note: The fan is mounted to the library backpanel with black isolators. The isolator is pulled to stretch it so it passes through the mounting hole, then it's released to hold the component in place.
7. To remove the fan the black isolators need to be released one at a time. Pull on the end of the isolator while pulling that corner of the fan away from the library backpanel. When all isolators are released remove the fan.
8. If replacement fan does not have black isolators in the corner mounting holes, remove them from this fan and install them in the replacement fan.
9. If replacement fan does not have a guard mounted on both sides, remove the guards from this fan and install them on the replacement fan.

Installation

To install the fan assembly, use the following procedure:

1. Make sure the library power is Off and the library power cable is unplugged from the power source.
2. Obtain the fan assembly to be installed. If the fan does not have black isolators in the corner mounting holes, remove them from the fan previously removed and install them on the new fan.
Note: In the following step the inside face of the fan is the side of the fan that the air is drawn into.
3. If the fan does not have a guard mounted on the inside face, remove the guard from the fan previously removed and secure it to the inside face of the new fan with 4 screws.
4. If the fan does not have a guard mounted on the outside face, remove the guard from the fan previously removed.
5. Position the fan guard on the outside face of the fan so black isolators go through the guard mounting holes and pull on each black isolator to secure the guard to the fan.
Note: When installing the fan, make sure the fan is positioned on the backpanel so air flows out of the library.
6. Position the fan in the library on the backpanel so black isolators go through mounting holes in backpanel and pull on each black isolator to secure fan in place.

DANGER

To prevent a possible electrical shock when installing the device, ensure that the power cord for that device is unplugged before installing signal cables. (RSFTD204)

DANGER

To prevent a possible electrical shock from touching two surfaces with different electrical grounds, use one hand, when possible, to connect or disconnect signal cables. (RSFTD004)

7. Connect the fan cable to the controller card. See Figure 79 on page 76 for location of connector.
8. Install the library covers. See “Library Cover Set Removal and Installation” on page 44.
9. Close the library front door.
10. Return to the library service procedure that sent you here.

Tape Drive Removal and Installation

The tape drives are replaced (see Figure 73) because of a tape drive failure or when performing other maintenance procedures.

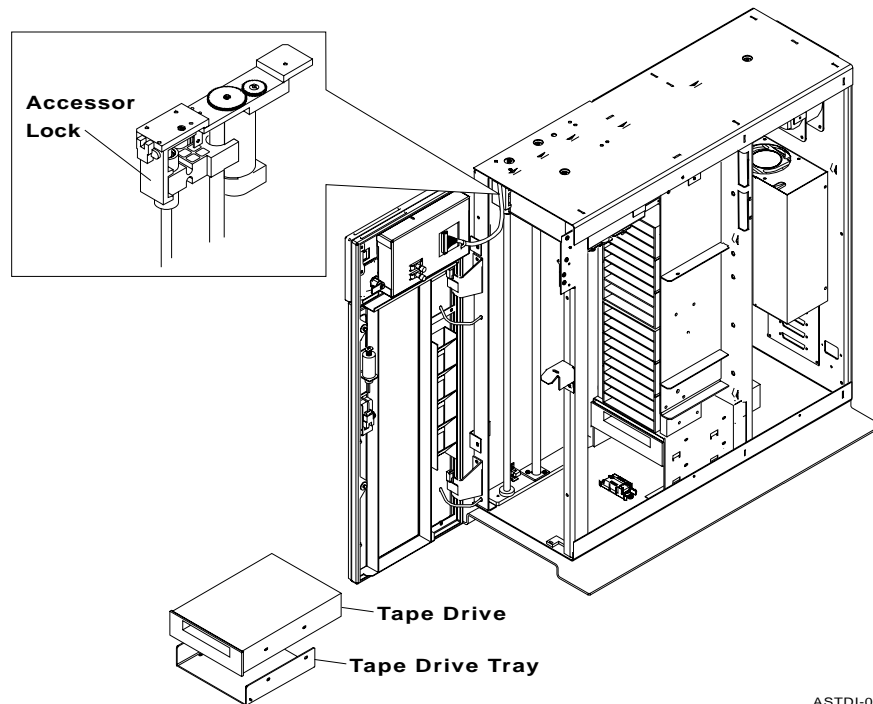

Figure 73. Tape Drive and Tray



Note: The above symbol indicates appropriate cautions to address in this “Tape Drive Removal and Installation” section of the manual.

Removal

To remove a tape drive (see Figure 74 on page 68) use the following procedure:

1. If the Tape Library is currently performing an operation, wait until the operation is complete before continuing.
2. If not already done, do a controlled system shutdown.
3. Open the control panel access cover and press the library power switch to turn the library power Off.

DANGER

To prevent a possible electrical shock when installing the device, ensure that the power cord for that device is unplugged before installing signal cables. (RSFTD204)

Figure 74. Tape Drive

DANGER

To prevent a possible electrical shock from touching two surfaces with different electrical grounds, use one hand, when possible, to connect or disconnect signal cables. (RSFTD004)

4. Unplug the library power cable from the power outlet.
5. Remove the library rear, right side, and left side covers. See “Library Cover Set Removal and Installation” on page 44.
6. Using your hand, move the picker to the top of the Accessor Assembly and lock in place with the accessor lock (mechanical lock). See Figure 73 on page 67.

Attention: The tape drives are sensitive to static electricity discharge. During the following steps, make sure tape drives are handled as outlined in “Handling Static-Sensitive Devices” on page 43 and placed in an antistatic bag when removed from the 7331 Tape Library.

7. Disconnect the following cables from the tape drive being removed:
 - 4-pin power connector
 - SCSI ID address cable
 - SCSI signal cable
8. Remove 4 screws securing the tape drive in the tape drive mounting sleeve.
9. Lift front of tape drive and slide the tape drive and tray out of the tape drive mounting sleeve.
10. Remove 4 screws from the bottom of the tray that secure the tray to the tape drive and remove tray.
11. Place the tape drive in an antistatic bag.

Installation

To install a tape drive, use the following procedure:

1. Make sure the library power is Off and the library power cable is unplugged from the power source.

Attention: The tape drives are sensitive to static electricity discharge. During the following steps, make sure tape drives are handled as outlined in “Handling Static-Sensitive Devices” on page 43 and not removed from the antistatic bag until ready for installation.
2. Obtain the tape drive to be installed. Make sure antistatic cautions are observed when installing the tape drive.
3. Remove the drive from the antistatic bag.
4. Place drive in tray and insert 4 screws through bottom of tray into drive. Align the drive as shown in Figure 76 on page 70.
5. Slide tape drive and drive tray into drive mounting sleeve. Tray self aligns with sleeve.

6. Secure tape drive in position with 2 screws through the right side and 2 screws through the left side of the tape drive mounting sleeve.
7. Support the picker with one hand while unlocking the accessor lock (mechanical lock) then lower picker to bottom of library.
8. Assure there is clearance between the front of the tape drive and the picker.

DANGER

To prevent a possible electrical shock when installing the device, ensure that the power cord for that device is unplugged before installing signal cables. (RSFTD204)

DANGER

To prevent a possible electrical shock from touching two surfaces with different electrical grounds, use one hand, when possible, to connect or disconnect signal cables. (RSFTD004)

9. Refer to Figure 75 and connect the following cables to the tape drive:
 - Item 1 - SCSI signal cable
 - Item 2 - SCSI ID address cable (longest cable goes to Tape Drive 1 and install cable with alignment tab in the up position)
 - Item 3 - 4-pin power connector

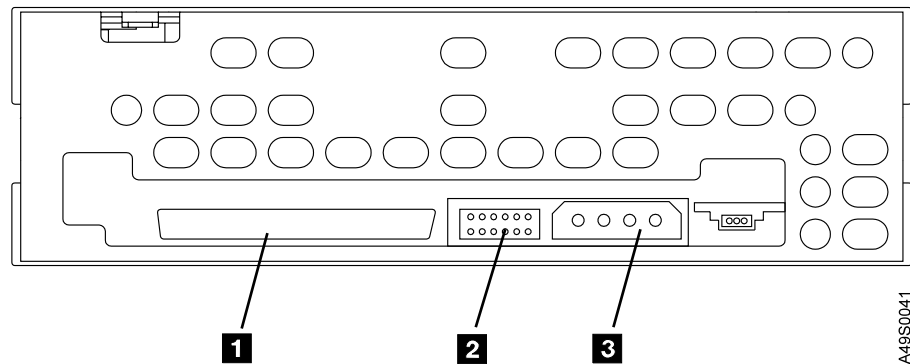
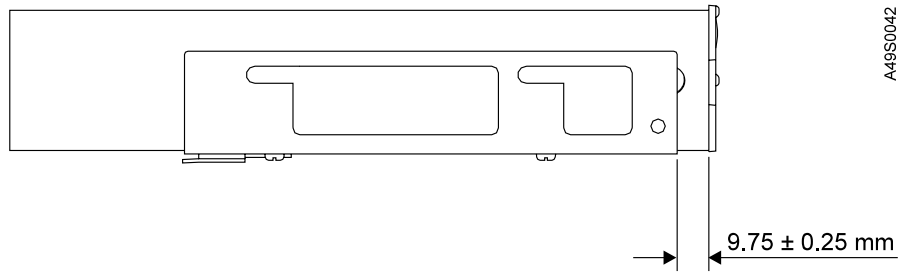

Figure 75. Tape Drive Connections

10. Calibrate the Tape Library. See “Library Calibration” on page 28.
11. Install the library covers. See “Library Cover Set Removal and Installation” on page 44.
12. Close the library front door.
13. Return to the library service procedure that sent you here.



A49S0042

Figure 76. Drive In Tray With Spacing

Power Supply Removal and Installation

The power supply is replaced (see Figure 77) because of failure or when performing other maintenance procedures.

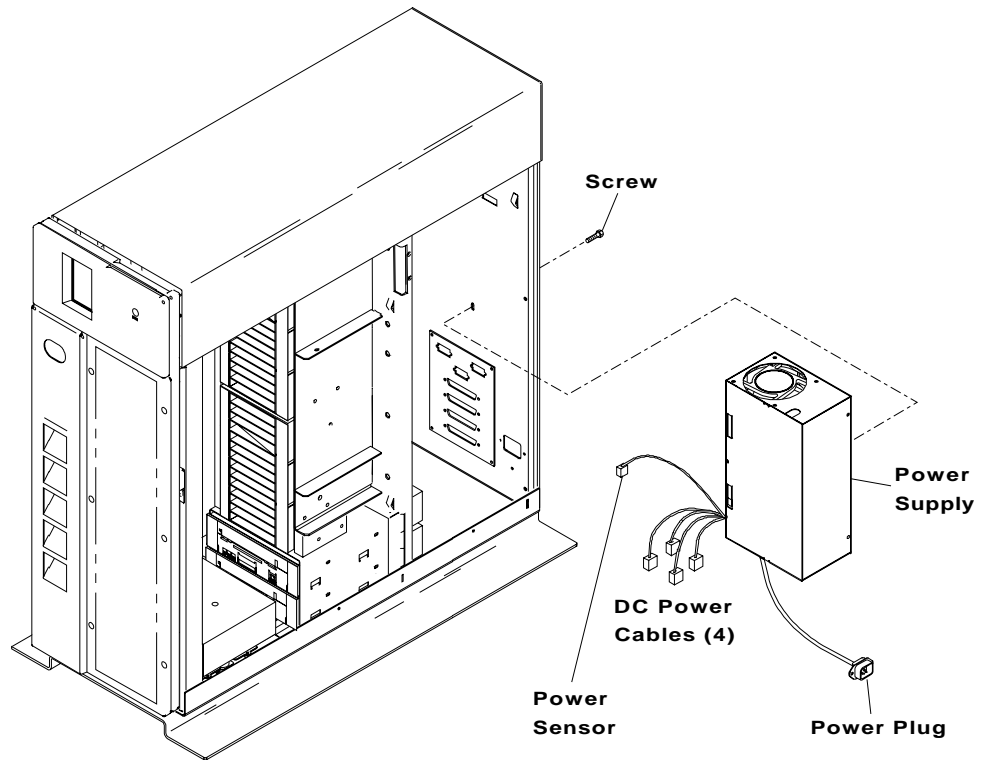

Figure 77. Power Supply



Note: The above symbol indicates appropriate cautions to address in this “Power Supply Removal and Installation” section of the manual.

Removal

To remove the power supply, use the following procedure:

1. If the 8mm Tape Library is currently performing an operation, wait until the operation is complete before continuing.
2. If not already done, do a controlled system shutdown.
3. Open the control panel access cover and press the library power switch to turn the library power Off.

Attention: Many assemblies in the library are sensitive to static electricity discharge. During the following steps, make sure all antistatic precautions are observed as outlined in “Handling Static-Sensitive Devices” on page 43.

DANGER

To prevent a possible electrical shock when installing the device, ensure that the power cord for that device is unplugged before installing signal cables. (RSFTD204)

DANGER

To prevent a possible electrical shock from touching two surfaces with different electrical grounds, use one hand, when possible, to connect or disconnect signal cables. (RSFTD004)

4. Unplug the library power cable from the power outlet.
5. Remove the library rear and right side covers. See “Library Cover Set Removal and Installation” on page 44.
6. Disconnect the following power supply cables:
 - Tape drive power cables
 - Power cable at P1 on the controller card
 - Power sense cable at P2 on the controller card
7. Remove nut and lockwasher securing the power supply input ground wire below the power supply input connector and remove ground wire.
8. Remove 2 nuts and lockwashers securing the power supply input connector to the threaded studs on the backpanel and remove the connector.
9. Remove the screw securing the power supply to the backpanel.
10. Lift the power supply until tab on back of the power supply is out of slots in the backpanel, then remove the power supply from the library.

Installation

To install the power supply, use the following procedure:

1. Make sure the library power is Off and the library power cable is unplugged from the power source.
2. Obtain the power supply to be installed.
 - Attention:** Many assemblies in the library are sensitive to static electricity discharge. During the following steps, make sure all antistatic precautions are observed as outlined in “Handling Static-Sensitive Devices” on page 43.
3. Position the power supply so tab on the back of power supply slips into slots in the library backpanel.
4. Install a screw through the backpanel to secure the power supply in place.
5. Position the power supply input connector over the threaded studs at the opening in the backpanel and secure with 2 lockwashers and nuts.
6. Place the power supply input ground wire over the threaded stud below the power supply input connector and secure with a lockwasher and nut.

DANGER

To prevent a possible electrical shock when installing the device, ensure that the power cord for that device is unplugged before installing signal cables. (RSFTD204)

DANGER

To prevent a possible electrical shock from touching two surfaces with different electrical grounds, use one hand, when possible, to connect or disconnect signal cables. (RSFTD004)

7. Connect the following power supply cables:
 - Tape drive power cables
 - Power cable to P1 on the controller card
 - Power sense cable to P2 on the controller card
8. Install the library covers. See “Library Cover Set Removal and Installation” on page 44.
9. Close the library front door.
10. Return to the library service procedure that sent you here.

Controller Card Removal and Installation

The controller card (see Figure 78) is replaced because of failure or when performing other maintenance procedures.

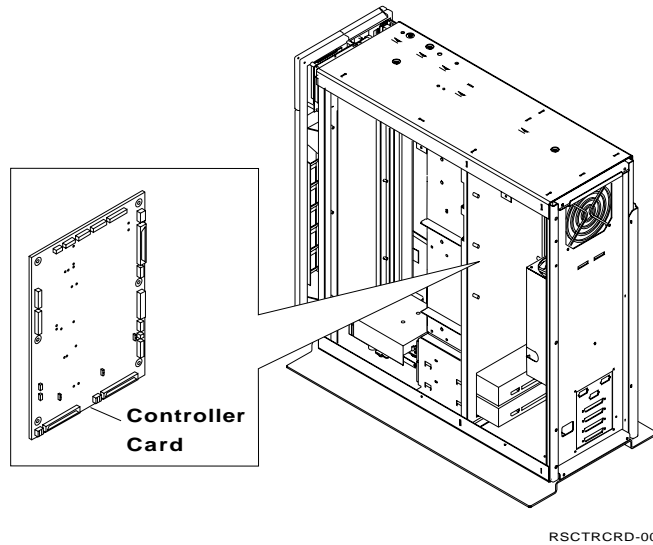

Figure 78. Library Controller card



Note: The above symbol indicates appropriate cautions to address in this “Controller Card Removal and Installation” section of the manual.

Removal

To remove the controller card, use the following procedure:

CAUTION:

The controller card contains a lithium battery. To avoid possible explosion, do not burn, exchange, or charge the battery. Discard the controller card as instructed by local regulations for lithium batteries. (RSFTC228)

1. If the Tape Library is currently performing an operation, wait until the operation is complete before continuing.
2. If not already done, do a controlled system shutdown.
3. Open the control panel access cover and press the library power switch to turn the library power Off.

Attention: The controller card is ESD sensitive.

DANGER

To prevent a possible electrical shock when installing the device, ensure that the power cord for that device is unplugged before installing signal cables. (RSFTD204)

DANGER

To prevent a possible electrical shock from touching two surfaces with different electrical grounds, use one hand, when possible, to connect or disconnect signal cables. (RSFTD004)

4. Unplug the library power cable from the power outlet.
5. Remove the library rear, top, and right covers. See “Library Cover Set Removal and Installation” on page 44.
6. Disconnect the following cables from the controller card.
 - DC power cable (P1)
 - DC sense cable (P2)
 - Fan cable (P3)
 - Picker umbilical cable (P4)
 - Accessor cable (P5)
 - Control panel cable (P6)
 - Accessor motor tach cable (P7)
 - Top travel limit and picker locked cable (P8)
 - Primary SCSI cable (P9)
 - Bottom travel limit (P10)
 - Magazine present switches cable (P11)
 - Accessor obstructed receiver cable (P12)
 - Accessor obstructed emitter cable (P13)
 - Secondary SCSI cable (P14)
 - Tape drive SCSI ID cable (P15)

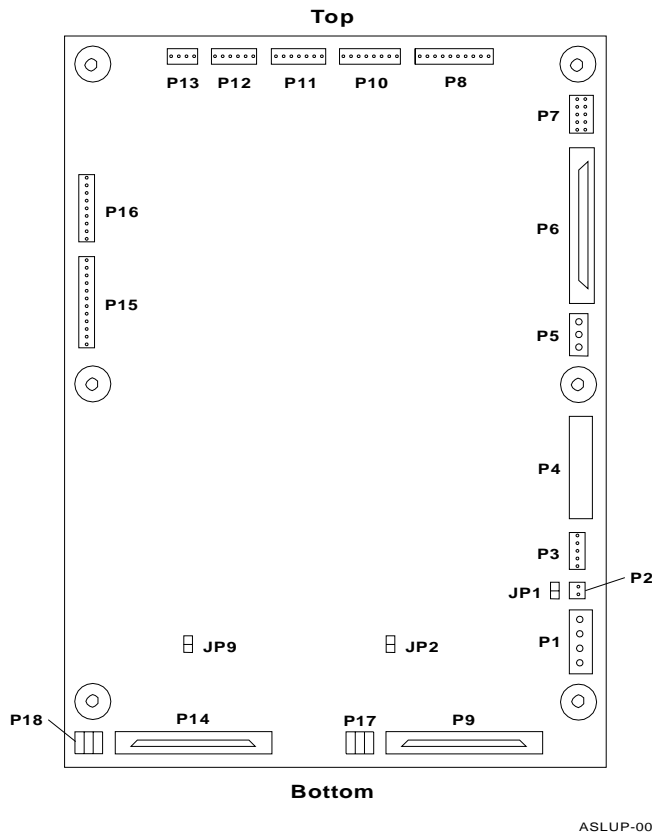

Figure 79. Controller Card

7. Remove 6 screws securing controller card to the standoffs on the library middle stiffener plate.
8. Remove the controller card from the library and place in an antistatic bag.

Installation

To install the controller card, use the following procedure:

CAUTION:

The controller card contains a lithium battery. To avoid possible explosion, do not burn, exchange, or charge the battery. Discard the controller card as instructed by local regulations for lithium batteries. (RSFTC228)

1. Make sure the library power is Off and the library power cable is unplugged from the power source.

Attention: The controller card is sensitive to static electricity discharge. During the following steps, make sure it is handled as outlined in “Handling Static-Sensitive Devices” on page 43 and not removed from the antistatic bag until ready to be installed in the Tape Library.

2. Obtain the controller card to be installed. Make sure antistatic precautions are observed when installing the card.
3. Remove the controller card from the antistatic bag and position on the standoffs inside library. Secure the card in position with 6 (M4X8 PH) screws.

DANGER

To prevent a possible electrical shock when installing the device, ensure that the power cord for that device is unplugged before installing signal cables. (RSFTD204)

DANGER

To prevent a possible electrical shock from touching two surfaces with different electrical grounds, use one hand, when possible, to connect or disconnect signal cables. (RSFTD004)

4. Connect the following connectors to the controller card. See Figure 79 on page 76 for location of connectors.
 - DC power cable (P1)
 - DC sense cable (P2)
 - Fan cable (P3)
 - Picker umbilical cable (P4)
 - Accessor cable (P5)
 - Control panel display cable (P6)
 - Accessor motor tach cable (P7)
 - Top travel limit and picker locked cable (P8)
 - Primary SCSI cable (P9)
 - Bottom travel limit (P10)
 - Magazine present switches cable (P11)
 - Accessor obstructed receiver cable (P12)
 - Accessor obstructed emitter cable (P13)
 - Secondary SCSI cable (P14)
 - Tape drive SCSI ID cable (P15)
5. Calibrate the Tape Library. See “Library Calibration” on page 28.
6. Install the library covers. See “Library Cover Set Removal and Installation” on page 44.
7. Close the library front door.
8. Locate and record the library serial number and product type. This information is on a label fastened to the right front corner of the library floor inside the library.
9. Close the library front door.
10. Go to “Set the Library Product Type and Serial Number” on page 33
11. Return to the library service procedure that sent you here.

Internal SCSI Cable Group Removal and Installation

The internal SCSI signal cable group (see Figure 80) is replaced because of failure or when performing other maintenance procedures.

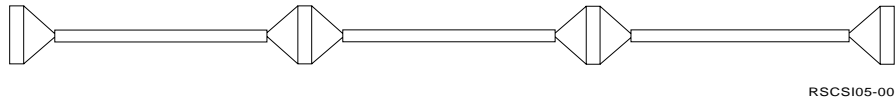

Figure 80. Internal SCSI Signal Cable



Note: The above symbol indicates appropriate cautions to address in this “Internal SCSI Cable Group Removal and Installation” section of the manual.

Removal

To remove the internal SCSI signal cable group, use the following procedure:

1. If the Tape Library is currently performing an operation, wait until the operation is complete before continuing.
2. If not already done, do a controlled system shutdown.
3. Open the control panel access cover and press the library power switch to turn the library power Off.

Attention: Many assemblies in the library are sensitive to static electricity discharge. During the following steps, make sure all antistatic precautions are observed as outlined in “Handling Static-Sensitive Devices” on page 43.

DANGER

To prevent a possible electrical shock when installing the device, ensure that the power cord for that device is unplugged before installing signal cables. (RSFTD204)

DANGER

To prevent a possible electrical shock from touching two surfaces with different electrical grounds, use one hand, when possible, to connect or disconnect signal cables. (RSFTD004)

4. Unplug the library power cable from the power outlet.
5. Remove the library rear and right side covers. See “Library Cover Set Removal and Installation” on page 44.
6. Disconnect the internal SCSI cables from P9 and P14 on the controller card.
7. Disconnect the internal SCSI signal cables from both tape drives.
8. Remove 2 screws securing each SCSI cable end connector to backpanel and remove SCSI cables from the library.

Installation

To install the internal SCSI cables, use the following procedure:

1. Make sure the library power is Off and the library power cable is unplugged from the power source.
2. Obtain the SCSI cables to be installed.

Attention: Many assemblies in the library are sensitive to static electricity discharge. During the following steps, make sure all antistatic precautions are observed as outlined in “Handling Static-Sensitive Devices” on page 43.

Note: Refer to Figure 81 on page 80 when positioning and connecting the internal SCSI cables in the following steps. To prevent possible incorrect cable connections, it is recommended that you do steps 3 - 6 to install one internal SCSI cable, then repeat steps 3 - 6 to install the other internal SCSI cable.

Figure 81 on page 80 shows the internal SCSI cable connections for a Tape Library.

DANGER

To prevent a possible electrical shock when installing the device, ensure that the power cord for that device is unplugged before installing signal cables. (RSFTD204)

DANGER

To prevent a possible electrical shock from touching two surfaces with different electrical grounds, use one hand, when possible, to connect or disconnect signal cables. (RSFTD004)

3. Position the SCSI cable inside the library.

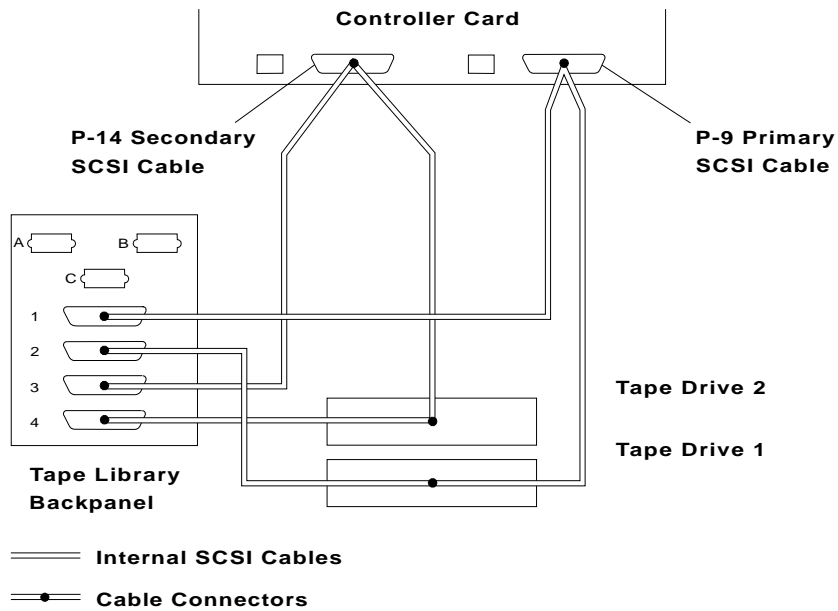

Note: If Tape Drive 2 is not present, the cabling will still be present, but not connected at Tape Drive 2.

RSSCSI1A-00

Figure 81. Internal SCSI Cable Configuration

4. Referring to Figure 81 for the internal SCSI connections, position the SCSI cable end connectors on inside of the backpanel and secure each connector in place with 2 screws.
5. Referring to Figure 81 connect the appropriate internal SCSI cable connector to the tape drive.
6. Connect the primary internal SCSI cable to P9 on the controller card and the secondary SCSI cable to P14 on the controller card.
7. Install the library covers. See "Library Cover Set Removal and Installation" on page 44.
8. Close the library front door.
9. Return to the library service procedure that sent you here.

Tape SCSI ID Cable Removal and Installation

The tape SCSI ID cable (see Figure 82) is replaced because of failure or when performing other maintenance procedures.

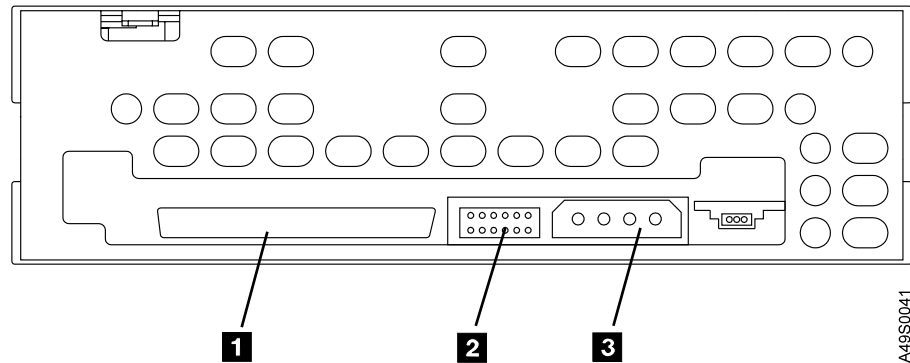

Figure 82. Tape SCSI ID Cable



Note: The above symbol indicates appropriate cautions to address in this “Tape SCSI ID Cable Removal and Installation” section of the manual.

The items in Figure 82 are:

- Item 1 - SCSI signal cable.
- Item 2 - SCSI ID address cable.
- Item 3 - 4-pin power connector.

Removal

To remove the tape SCSI ID cable, use the following procedure:

1. If the Tape Library is currently performing an operation, wait until the operation is complete before continuing.
2. If not already done, do a controlled system shutdown.
3. Open the control panel access cover and press the library power switch to turn the library power Off.

Attention: Many assemblies in the library are sensitive to static electricity discharge. During the following steps, make sure all antistatic precautions are observed as outlined in “Handling Static-Sensitive Devices” on page 43.

DANGER

To prevent a possible electrical shock when installing the device, ensure that the power cord for that device is unplugged before installing signal cables. (RSFTD204)

DANGER

To prevent a possible electrical shock from touching two surfaces with different electrical grounds, use one hand, when possible, to connect or disconnect signal cables. (RSFTD004)

4. Unplug the library power cable from the power outlet.
5. Remove the library rear and right side covers. See “Library Cover Set Removal and Installation” on page 44.
6. Disconnect the tape SCSI ID cable from both tape drives.
7. Disconnect the SCSI ID address cable from the controller card connector P15.

Installation

To install the tape SCSI ID cable, use the following procedure:

1. Make sure the library power is Off and the library power cable is unplugged from the power source.
2. Obtain the tape SCSI ID cable to be installed.

Attention: Many assemblies in the library are sensitive to static electricity discharge. During the following steps, make sure all antistatic precautions are observed as outlined in “Handling Static-Sensitive Devices” on page 43.

DANGER

To prevent a possible electrical shock when installing the device, ensure that the power cord for that device is unplugged before installing signal cables. (RSFTD204)

DANGER

To prevent a possible electrical shock from touching two surfaces with different electrical grounds, use one hand, when possible, to connect or disconnect signal cables. (RSFTD004)

3. Position the tape SCSI ID cable inside the library and connect the end of the SCSI ID address cable with a single connector to the controller card connector P15.
4. Referring to Figure 82 on page 81 connect the tape SCSI ID cable to each the tape drive. The longest SCSI ID address cable connects to Tape Drive 1. The cable is connected to the tape drive with the alignment tab in the up position.
5. Install the library covers. See “Library Cover Set Removal and Installation” on page 44.
6. Close the library front door.
7. Return to the library service procedure that sent you here.

Picker (Assembly & Umbilical Cable) Removal and Installation

The picker assembly and the picker umbilical cable (see Figure 83) are replaced because of failure or when performing other maintenance procedures.

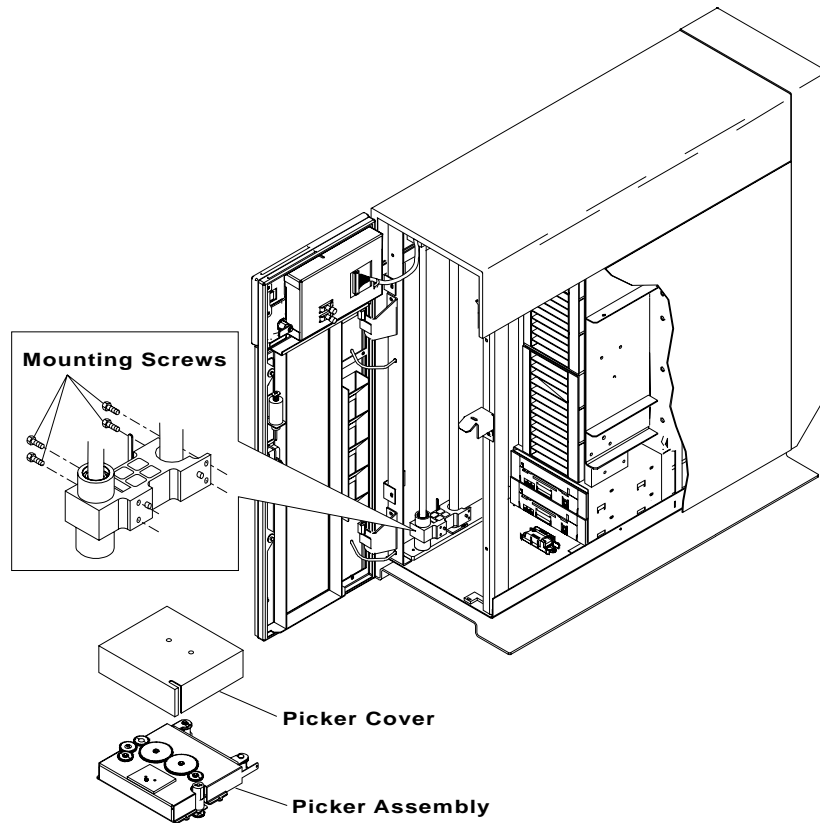

Figure 83. Picker Assembly



Note: The above symbols indicate appropriate cautions to address in this “Picker (Assembly & Umbilical Cable) Removal and Installation” section of the manual.

Removal

To remove the picker assembly and picker umbilical cable, use the following procedure:

CAUTION:

Do not place a highly reflective surface between either the picker assembly and the tape cartridge magazines or between the picker assembly and the tape drives. This may cause damage to your eyes. (RSFTC238)

CAUTION:

If the automatic lock on the front door is not functioning and the door is open, do not look directly at the laser beam. Staring at the beam may cause damage to your eyes. (RSFTC239)

1. If the Tape Library is currently performing an operation, wait until the operation is complete before continuing.
2. If not already done, do a controlled system shutdown.
3. Open the control panel access cover and press the library power switch to turn the library power Off.

Attention: Many assemblies in the library are sensitive to static electricity discharge. During the following steps, make sure all antistatic precautions are observed as outlined in “Handling Static-Sensitive Devices” on page 43.

DANGER

To prevent a possible electrical shock from touching two surfaces with different electrical grounds, use one hand, when possible, to connect or disconnect signal cables. (RSFTD004)

4. Unplug the library power cable from the power outlet.
5. Remove the library rear, top, and left side covers. See “Library Cover Set Removal and Installation” on page 44.
6. Remove the picker assembly cover. The cover snaps off the picker assembly. If the new picker cover does not have a **laser caution label** on it, retain the removed cover for installation on the new picker.
7. Remove 4 screws securing the picker assembly to the accessor assembly.
8. Move the picker away from the accessor, tilt right side of picker up and disconnect the picker umbilical cable from the picker.
9. Remove the picker assembly from the library.
10. If this library is configured with a bar code reader, remove the bar code reader from the picker assembly for installation on the new picker assembly. See “Bar Code Reader Removal and Installation” on page 88.
11. Place the picker assembly in an antistatic bag.
12. If a bar code reader was removed and will not be installed on the new picker assembly at this time, place it in an antistatic bag.
13. Disconnect the picker umbilical cable from P4 on the controller card.
14. Note the routing and the position of the colored stripe of the picker umbilical cable.
15. Remove 4 screws securing picker umbilical cable tray in place.

Note: In the following step, use care so the picker umbilical cable is not damaged when removing the cable from under picker and when pulling the cable through the slot in the middle stiffener plate.
16. Carefully remove the cable tray and cable from library.
17. Using a pliers, bend umbilical cable tray tabs out and remove umbilical cable from the tray.
18. Retain the cable and do not remove the ferrite shield from the umbilical cable until ready to transfer it to the new cable during installation.

Installation

To install the picker assembly and the picker umbilical cable, use the following procedure:

CAUTION:

Do not place a highly reflective surface between either the picker assembly and the tape cartridge magazines or between the picker assembly and the tape drives. This may cause damage to your eyes. (RSFTC238)

CAUTION:

If the automatic lock on the front door is not functioning and the door is open, do not look directly at the laser beam. Staring at the beam may cause damage to your eyes. (RSFTC239)

1. Make sure the library power is Off and the library power cable is unplugged from the power source.

Attention: Many assemblies in the library are sensitive to static electricity discharge. During the following steps, make sure all antistatic precautions are observed as outlined in "Handling Static-Sensitive Devices" on page 43.

2. Obtain the picker umbilical cable to be installed.
3. If not already installed, use 4 screws to install cable tray in library. Make sure top end of tray is positioned inside the middle stiffener slot.

Note: In the following step the colored stripe on the new umbilical cable must be orientated the same as the removed cable to ensure proper cable connection and picker operation.

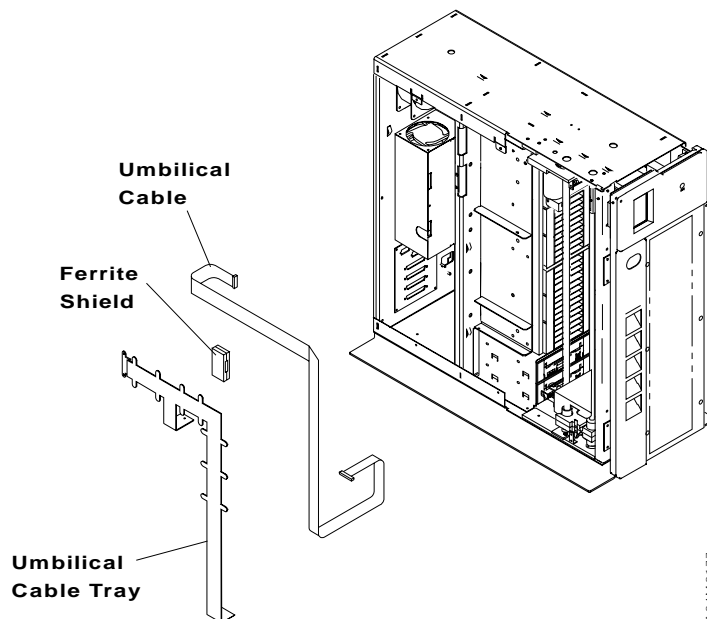

Figure 84. Umbilical Cable Installation

4. Position the new umbilical cable next to the removed cable and make 90° bend in new cable at same location as in removed cable. Make sure the colored stripe on the cables are placed in the same orientation. See Figure 84.

5. Remove the ferrite shield from the removed cable and install it on the new cable in the same location and orientation as it was installed on the removed cable. See Figure 84.

6. Position the picker umbilical cable in cable tray.

Note: Use care when bending tabs in following step so cable is not damaged.

7. Make sure the cable is positioned in the cable tray with the bend at the correct location and with the colored stripe correctly orientated, then carefully bend tabs on cable tray in to secure cable in position. See Figure 84 on page 85.

DANGER

To prevent a possible electrical shock when installing the device, ensure that the power cord for that device is unplugged before installing signal cables. (RSFTD204)

DANGER

To prevent a possible electrical shock from touching two surfaces with different electrical grounds, use one hand, when possible, to connect or disconnect signal cables. (RSFTD004)

8. Connect the picker umbilical cable to P4 on the controller card. See Figure 79 on page 76 for location of connector.

9. Obtain the picker assembly to be installed. Make sure antistatic precautions are observed when handling the picker assembly.

10. Remove the picker assembly from the antistatic bag.

11. If this library is configured with a bar code reader and the picker does not have a bar code reader installed, install the bar code reader removed from the defective picker. See “Bar Code Reader Removal and Installation” on page 88.

Note: The umbilical cable is routed under the picker in the following step.

12. Position picker inside the library and connect the picker umbilical cable to the picker.

Note: In the following step, **do not** tighten screws when they are first installed.

13. Align the picker mounting block with alignment pins on the accessor mounting block and loosely install 4 screws. See Figure 83 on page 83.

14. When viewing from the left side of the library, tighten the screws in the following sequence:

- a. Top rear screw
- b. Top front screw
- c. Bottom rear screw
- d. Bottom front screw

15. Install the picker assembly cover. The cover snaps on the picker assembly. If the new picker cover does not have a **laser caution label** on it, install the cover removed from the failed picker.

16. Align drives to picker assembly. See “Aligning the Picker Assembly with the Drive” on page 94.
17. Calibrate the Tape Library. See “Library Calibration” on page 28.
18. Install the library covers. See “Library Cover Set Removal and Installation” on page 44.
19. Close the library front door.
20. Return to the library service procedure that sent you here.

Bar Code Reader Removal and Installation

The bar code reader (see Figure 85) is an optional item for the Tape Library. It is replaced because of failure or when performing other maintenance procedures.

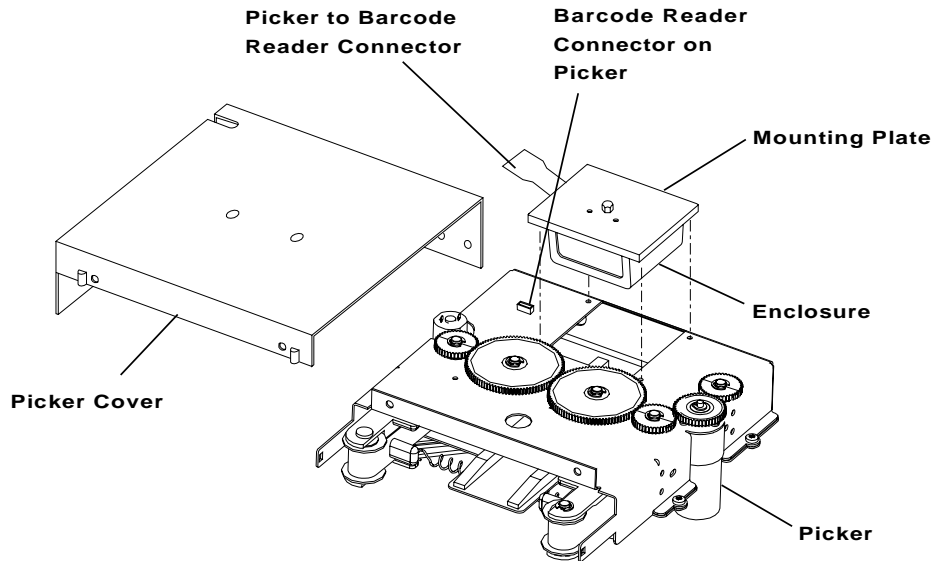

Figure 85. Bar Code Reader



Note: The above symbols indicate appropriate cautions to address in this “Bar Code Reader Removal and Installation” section of the manual.

Removal

To remove the bar code reader, use the following procedure:

CAUTION:

The bar-code reader contains a Class II laser component. Only trained service personnel may repair the bar-code reader. (RSFTC237)

CAUTION:

Do not place a highly reflective surface between either the picker assembly and the tape cartridge magazines or between the picker assembly and the tape drives. This may cause damage to your eyes. (RSFTC238)

CAUTION:

If the automatic lock on the front door is not functioning and the door is open, do not look directly at the laser beam. Staring at the beam may cause damage to your eyes. (RSFTC239)

1. If the Tape Library is currently performing an operation, wait until the operation is complete before continuing.
2. If not already done, do a controlled system shutdown.

3. Open the control panel access cover and press the library power switch to turn the library power Off.

DANGER

To prevent a possible electrical shock when installing the device, ensure that the power cord for that device is unplugged before installing signal cables. (RSFTD204)

DANGER

To prevent a possible electrical shock from touching two surfaces with different electrical grounds, use one hand, when possible, to connect or disconnect signal cables. (RSFTD004)

4. Unplug the library power cable from the power outlet.
5. Open the library front door.
Attention: The picker assembly and the bar code reader are sensitive to static electricity discharge. During the following steps, make sure they are handled as outlined in "Handling Static-Sensitive Devices" on page 43 and placed in an antistatic bag when removed from the Tape Library.
6. Remove the picker assembly cover. The cover snaps off the picker assembly.
7. Remove the bar code reader assembly by doing the following:
 - a. Using a flat-head screwdriver, gently pry the pigtail connector off the picker flex cable. This action disconnects the Bar Code Reader from the picker assembly.
 - b. Gently pry the par code reader assembly from the picker.
8. Place the bar code reader assembly in an antistatic bag.

Installation

To install the bar code reader, use the following procedure:

CAUTION:

The bar-code reader contains a Class II laser component. Only trained service personnel may repair the bar-code reader. (RSFTC237)

CAUTION:

Do not place a highly reflective surface between either the picker assembly and the tape cartridge magazines or between the picker assembly and the tape drives. This may cause damage to your eyes. (RSFTC238)

CAUTION:

If the automatic lock on the front door is not functioning and the door is open, do not look directly at the laser beam. Staring at the beam may cause damage to your eyes. (RSFTC239)

1. Make sure the library power switch is Off and the library power cable is unplugged from the power source.

Attention: The picker assembly and the bar code reader are sensitive to static electricity discharge. During the following steps, make sure they are handled as outlined in “Handling Static-Sensitive Devices” on page 43 and not be removed from the antistatic bag until ready to be installed in the Tape Library.

DANGER

To prevent a possible electrical shock when installing the device, ensure that the power cord for that device is unplugged before installing signal cables. (RSFTD204)

DANGER

To prevent a possible electrical shock from touching two surfaces with different electrical grounds, use one hand, when possible, to connect or disconnect signal cables. (RSFTD004)

2. Obtain the bar code reader assembly to be installed. Make sure antistatic precautions are observed when handling the bar code reader.
3. Remove the bar code reader assembly from the antistatic bag.
4. Place the bar code reader assembly into the opening of the picker. Assure that:
 - a. The enclosure is oriented with the window to the front of the picker.
 - b. The stakes on the bar code reader assembly fit into the holes on the picker. The picker should be supported with your hand while pressing the bar code reader assembly in place.

The assembly should fit level to the top of the picker shell.

Note: When upgrading the Tape Library to contain a bar code reader, the bar code mounting plate must be removed from the picker opening. To remove the mounting plate, use a flat-blade screwdriver and gently pry it from the picker.

5. Press the pigtail connector onto the picker flex cable.
6. Install the picker assembly cover. The cover snaps on the picker assembly.
7. Close the library front door.
8. To ensure the assembly was installed correctly, power the unit on and perform an inventory.

Note: If the inventory fails, recheck the bar code reader installation.

9. Return to the library service procedure that sent you here.

Accessor Assembly Removal and Installation

The accessor assembly (see Figure 86) is replaced because of failure or when performing other maintenance procedures.

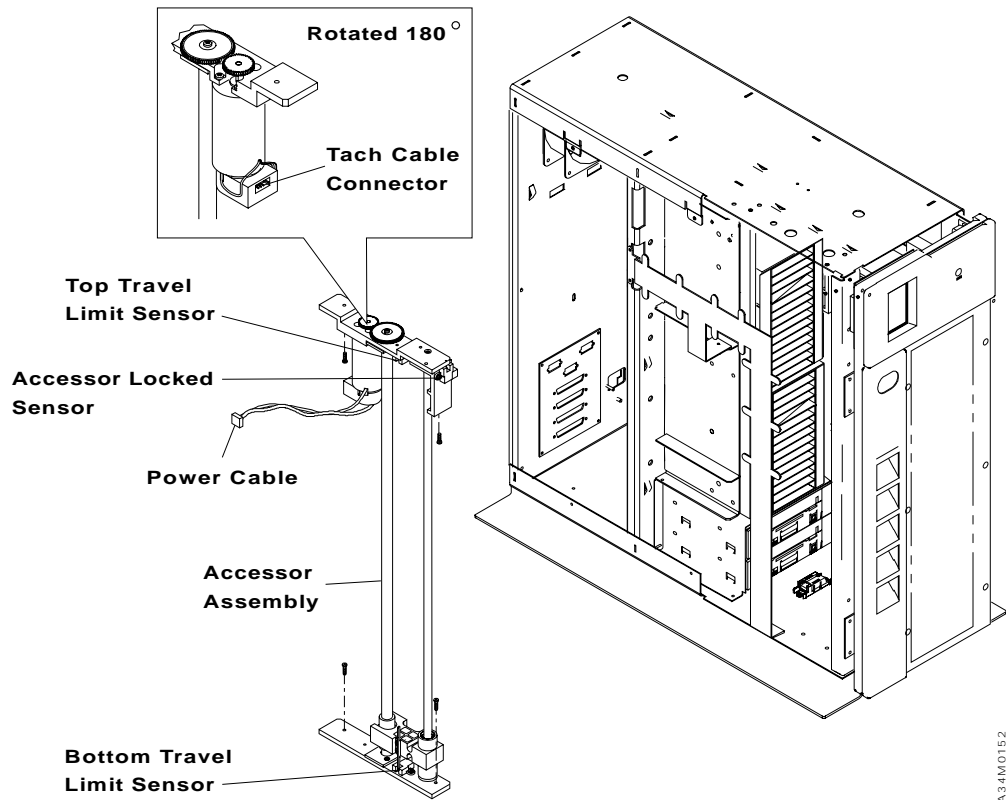

Figure 86. Accessor Assembly



Note: The above symbol indicates appropriate cautions to address in this “Accessor Assembly Removal and Installation” section of the manual.

Removal

To remove the accessor assembly, use the following procedure:

1. If the Tape Library is currently performing an operation, wait until the operation is complete before continuing.
2. If not already done, do a controlled system shutdown.
3. Open the control panel access cover and press the library power switch to turn the library power Off.

DANGER

To prevent a possible electrical shock when installing the device, ensure that the power cord for that device is unplugged before installing signal cables. (RSFTD204)

DANGER

To prevent a possible electrical shock from touching two surfaces with different electrical grounds, use one hand, when possible, to connect or disconnect signal cables. (RSFTD004)

4. Unplug the library power cable from the power outlet.
5. Remove the library rear, top, left side, and right side covers. See “Library Cover Set Removal and Installation” on page 44.
6. Remove the picker assembly. Do not leave picker assembly inside the library. See “Picker (Assembly & Umbilical Cable) Removal and Installation” on page 83.
7. Disconnect the accessor motor tach cable from accessor motor. Cable connector is not keyed, note orientation of cable connector for installation.
8. Disconnect the accessor power cable from P5 on the controller card.
9. Disconnect the top travel limit and accessor locked sensor connector, and the bottom travel limit sensor connector from the accessor.
10. Remove screw securing umbilical tray to bottom of accessor assembly. **Do not** remove other umbilical cable tray screws.
11. Remove 4 screws that secure accessor assembly to the library frame and remove accessor assembly from library frame.

Installation

To install the accessor assembly, use the following procedure:

1. Make sure the library power is Off and the library power cable is unplugged from the power source.
2. Obtain the accessor assembly to be installed.
3. Position the accessor in the library. Make sure accessor top and bottom mounting plates are firmly seated against alignment pins on library frame.
4. Install 2 screws through the accessor bottom mounting plate into the frame and tighten screws, then install 2 screws through the accessor top mounting plate into the frame and tighten screws.

DANGER

To prevent a possible electrical shock when installing the device, ensure that the power cord for that device is unplugged before installing signal cables. (RSFTD204)

DANGER

To prevent a possible electrical shock from touching two surfaces with different electrical grounds, use one hand, when possible, to connect or disconnect signal cables. (RSFTD004)

5. Connect the top travel limit and accessor locked sensor connector, and the bottom travel limit sensor connector to the accessor.
6. Connect the accessor motor tach cable to accessor motor. Cable connector is not keyed, make sure connector orientation is same as noted during accessor removal.
7. Connect the accessor power cable to P5 on the controller card. See Figure 79 on page 76 for location of connector.
8. Install the picker assembly. See "Picker (Assembly & Umbilical Cable) Removal and Installation" on page 83.
9. Align drives to picker assembly. See "Aligning the Picker Assembly with the Drive" on page 94.
10. Calibrate the Tape Library. See "Library Calibration" on page 28.
11. Install the library covers. See "Library Cover Set Removal and Installation" on page 44.
12. Close the library front door.
13. Return to the library service procedure that sent you here.

Aligning the Picker Assembly with the Drive

Align the picker assembly (see Figure 87) with the drive whenever picker or accessor assemblies are replaced.

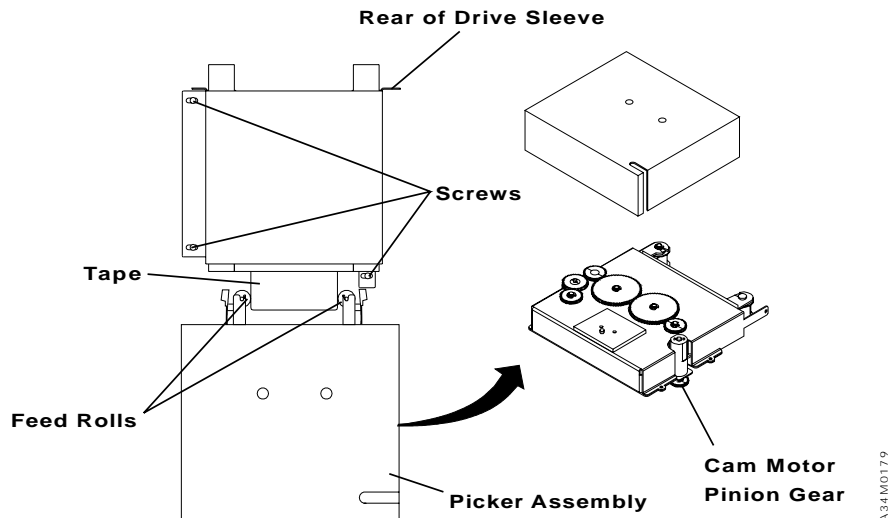

Figure 87. Aligning the Picker Assembly with the Drive



Note: The above symbol indicates appropriate cautions to address in this “Aligning the Picker Assembly with the Drive” section of the manual.

Attention: Before aligning the picker with the drive:

- Remove the 2 tape cartridge magazines.
- Remove any tapes from the 2-slot cartridge holder.

To align the picker with the drive, use the following procedure:

1. If the Tape Library is currently performing an operation, wait until the operation is complete before continuing.
2. If not already done, do a controlled system shutdown.
3. Open the control panel access and press the library power switch to turn the library power off.

DANGER

To prevent a possible electrical shock when installing the device, ensure that the power cord for that device is unplugged before installing signal cables. (RSFTD204)

DANGER

To prevent a possible electrical shock from touching two surfaces with different electrical grounds, use one hand, when possible, to connect or disconnect signal cables. (RSFTD004)

4. Unplug the library power cable from the power outlet.
5. Remove the library rear, right side, and left side covers. See “Library Cover Set Removal and Installation” on page 44.
6. Using your hand, move the picker assembly to the top of the accessor assembly and lock it in place with the accessor (mechanical) lock. Refer to Figure 73 on page 67.
7. Place a tape in the ejected position in the drive.
8. Remove the bezel from drive 1 (the lower drive).
9. Loosen the 3 screws holding the drive sleeve so the sleeve can be gently moved from side to side (reference Figure 87 on page 94). Assure the rear of the drive sleeve is positioned against the mid-point of the library frame.
10. Release the picker assembly and lower it to align with the tape in the drive.
11. Rotate the picker assembly’s cam motor pinion gear so the feed rolls open to the width of the tape cartridge.
12. Move the drive from right to left until the drive is centered with the picker assembly.
13. Manually raise and lower the picker assembly to assure it freely passes the tape cartridge.
14. Manually raise the picker assembly, then tighten the 3 screws holding the drive sleeve.
15. Install the bezel onto drive 1.
16. Manually raise and lower the picker assembly to verify the tape cartridge is still centered between the feed rolls.
17. Calibrate the tape library. See “Library Calibration” on page 28.
18. Install the library covers. See “Library Cover Set Removal and Installation” on page 44.
19. Close the library front door.
20. Return to the library service procedure that sent you here.

Sensor Group Removal and Installation

Removal and Installation

The sensor group includes the following:

- Accessor obstructed sensors (emitter and receiver)
- Accessor bottom travel limit cable
- Accessor top travel limit and lock cable
- Accessor motor tach cable
- Upper/lower magazine sensor cable

Note: This procedure is written for removing and installing the accessor obstructed sensors (emitter and receiver) and all sensor group cables listed above (see Figure 88). If only some of the sensor group are being replaced make sure all preparatory steps and all closing steps are performed.

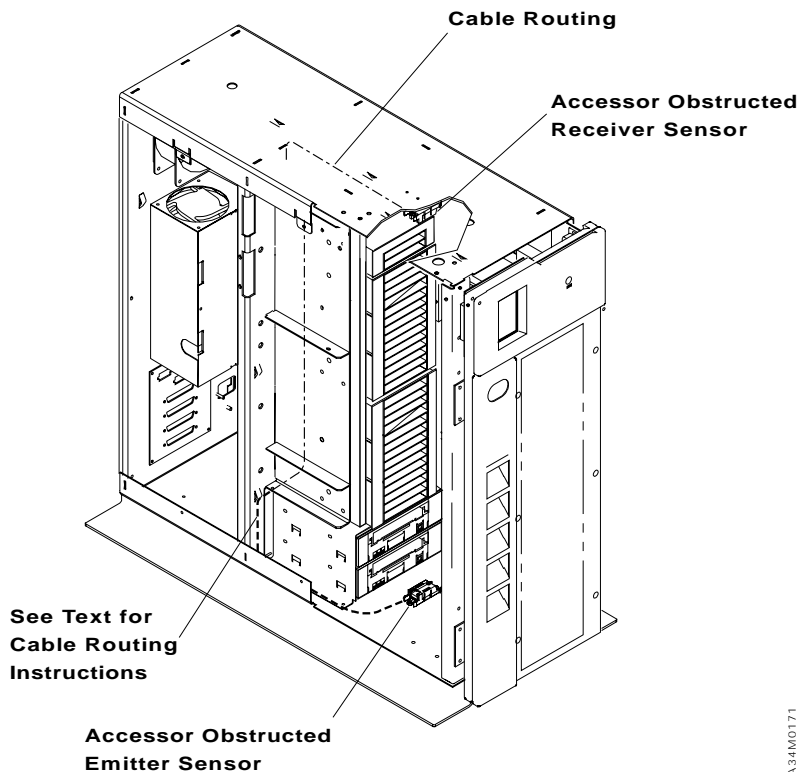

Figure 88. Sensor Group

Removal

To remove the sensor group, use the following procedure:

1. If the Tape Library is currently performing an operation, wait until the operation is complete before continuing.
2. If not already done, do a controlled system shutdown.
3. Open the control panel access cover and press the library power switch to turn the library power Off.

4. Unplug the library power cable from the power outlet.
5. Remove the library rear, top, and left side covers. See “Library Cover Set Removal and Installation” on page 44.
6. Remove the tape cartridge magazines. Go to “Tape Cartridge Magazine Removal and Installation” on page 57.

Removing the Accessor Obstructed Sensors and Cables

7. Disconnect the accessor obstructed receiver sensor cable from the accessor obstructed receiver sensor located inside of the library at the top.
8. Remove 2 screws from the sensor and remove the sensor.
9. Using your hand, move the picker to the top of the accessor and lock in position with the accessor lock (mechanical lock).
10. Disconnect the obstructed emitter sensor cable from the accessor obstructed emitter sensor located inside the library at the bottom.
11. Remove 2 screws from the sensor and remove the sensor.
12. Note the routing of the sensor cables, then remove cable ties from the sensor cables.
13. Disconnect the accessor obstructed emitter sensor cable from P13 on the controller card and the accessor obstructed receiver sensor cable from P12 on the controller card.
14. Carefully remove the sensor cables from the library.

Removing the Accessor Motor Tach Cable

15. Disconnect the accessor motor tach cable from accessor. Connector is not keyed, note orientation of connector for installation.
16. Note the routing of the tach cable, then remove cable ties from the tach cable.
17. Disconnect the tach cable from P7 on the controller card.
18. Carefully remove the tach cable from the library.

Removing the Magazine Sensors Cable

19. Disconnect the magazine present sensor cables from the magazine sensors.
20. Note the routing of the sensor cable, then remove cable ties from the sensor cable.
21. Disconnect the sensor cable from P11 on the controller card.
22. Carefully remove the sensor cables from the library.

Removing the Bottom Travel Limit Sensor Cable

23. Disconnect the bottom travel limit sensor cable from the accessor assembly.
24. Note the routing of the sensor cable, then remove cable ties from the sensor cable.
25. Disconnect the sensor cable from P10 on the controller card.
26. Carefully remove the sensor cable from the library.

Removing the Top Travel Limit and Accessor Locked sensor cable

27. Disconnect the top travel limit and accessor locked sensor cable from the accessor assembly.
28. Note the routing of the sensor cable, then remove cable ties from the sensor cable.
29. Disconnect the sensor cable from P8 on the controller card.
30. Carefully remove the sensor cable from the library.

Installation

To install the sensor group, use the following procedure:

1. Make sure the library power is Off and the library power cable is unplugged from the power source.
2. Obtain the sensors and sensor cables to be installed.
3. Make sure the tape cartridge magazines are removed.

Installing the Accessor Obstructed Sensors and Cables

4. If not already done, move the picker to the top of the accessor and lock in position with the accessor lock (mechanical).
5. Position the accessor obstructed emitter sensor in the bottom of the library and secure in position with 2 screws.
Note: In the following steps, use care so sensor cables are not damaged when they are routed through the slots in the middle stiffener plate.
6. Connect the accessor obstructed emitter sensor cable to the sensor.
7. Route the sensor cable as shown in Figure 88 on page 96 to the controller card and connect sensor cable to P13 on the controller card. See Figure 79 on page 76 for location of connector.
8. Support the picker with one hand while unlocking the accessor lock (mechanical lock) then lower picker to bottom of library.
9. Position the accessor obstructed receiver sensor inside the library at the top and secure in position with 2 screws.
10. Connect the accessor obstructed receiver sensor cable to the sensor.
11. Route cable as shown in Figure 88 on page 96 to the controller card and connect sensor cable to P12 on the controller card. See Figure 79 on page 76 for location of connector.

Installing the Accessor Motor Tach Cable

12. Connect the accessor motor tach cable to the accessor motor. See Figure 86 on page 91. Cable connector is not keyed, make sure connector orientation is same as noted during accessor removal.
13. Route the tach cable, route from the accessor motor through upper slot in middle frame panel to controller card.
14. Attach required cable ties to secure sensor cable to library frame.
15. Connect the tach cable to P7 on the controller card.

Installing the Magazine Sensors Cable

16. Position the magazine present sensor cable in the
17. Position the magazine present sensor cable in the library and connect the sensor cables to the magazine sensors. The longer sensor cable connects to the bottom sensor.
18. Route the sensor cable, up the center of the middle frame panel. The sensor cable controller card connector (single connector) is routed through the slot at the top of the middle frame panel.
19. Attach required cable ties to secure sensor cable to library frame.
20. Connect the sensor cable to P11 on the controller card.

Installing the Bottom Travel Limit Sensor Cable

21. Position the bottom travel limit sensor cable in the library and connect to the accessor assembly connector at the bottom of the accessor assembly.
22. Route the sensor cable as follows:
 - Along the bottom left side of the frame to the middle frame panel and up as far as the top of the tape drive sleeve,
 - Pass the cable through the opening between the sleeve and the magazine mounting plate side panels to the center of the middle frame panel,
 - Up the middle frame panel and through the opening at the top of the frame panel.
23. Attach required cable ties to secure sensor cable to library frame.
24. Connect the sensor cable to P10 on the controller card.

Installing the Top Travel Limit and Accessor Locked Sensor cable

25. Position the top travel limit and accessor locked sensor cable in the library and connect the sensor cable to the accessor assembly.
26. Route the sensor cable along the inside top of the library and through the opening at the top of the middle frame panel.
27. Attach required cable ties to secure sensor cable to library frame.
28. Connect the sensor cable to P8 on the controller card.
29. If required, install the library covers. See "Library Cover Set Removal and Installation" on page 44.
30. Close the library front door.
31. Return to the library service procedure and continue.

Manually Removing a Tape Cartridge

If a power failure or a drive failure prevents the tape cartridge from ejecting, the cartridge can be removed manually.

Before manually removing a tape cartridge:

- Remove power from the 8mm Tape Drive,
- Apply power, again, to clear potential error conditions, then
- Press the unload.

If the tape does not eject, proceed with a manual removal.

Attention: The procedure that follows may result in damage to a tape cartridge.

Remove The Tape Cartridge:

1. Perform the cover removal procedure. Refer to “Library Cover Set Removal and Installation” on page 44.
2. Perform the drive removal procedure. Refer to “Tape Drive Removal and Installation” on page 67.
3. Remove the three (3) T-6 screws that secure the top cover of the drive (see Figure 89); one (1) each on the rear and two (2) sides of the drive. See Figure 89.

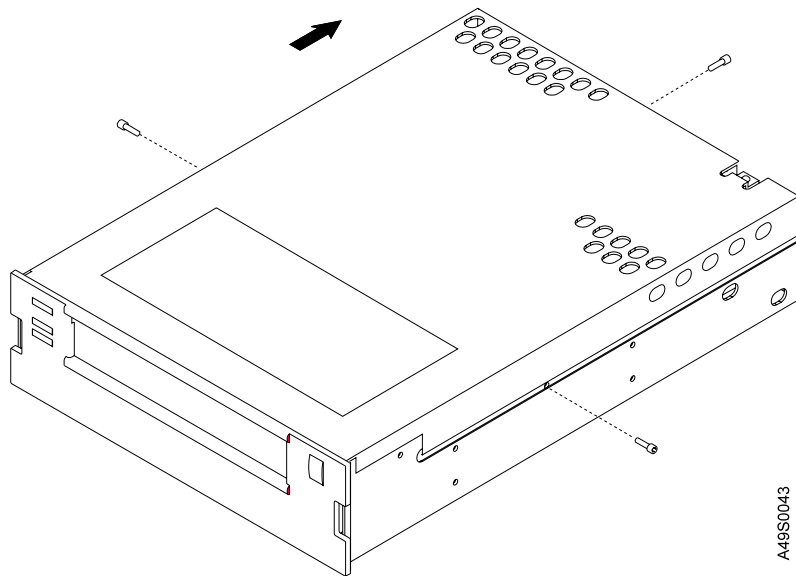

Figure 89. Drive Top Cover Removal

4. Slide cover to the rear of the drive and remove it.
5. If it is obvious the tape must be destroyed before it can be removed, perform the following procedure. Otherwise, continue with step 6 on page 101.

Attention: This procedure will destroy the tape cartridge and its data.

Use the following procedure only if the loaded tape is known to be damaged or cannot be unloaded by another method.

- a. Cut the tape at a convenient location.

- b. Manually unload the tape cartridge (see “Unload the tape cartridge:” on page 102).
6. Position the drive with the front facing the technician.
7. Take up slack in the tape by using the following instructions to move the drive’s trolleys and the supply reel motor.

Attention: To avoid damaging the tape, do not touch it.

Move the Trolleys:

1. On the left side panel of the drive (toward the rear), locate the hole marked UNLOAD 1 (Figure 90).
2. Insert a 2.5-mm allen wrench approximately 43 mm (2 in.) into the UNLOAD hole and position it so it seats securely into the inner socket.
3. Turn the wrench in the direction marked on the drive (clockwise).
4. Rotate the wrench until the trolleys 2 stop moving.

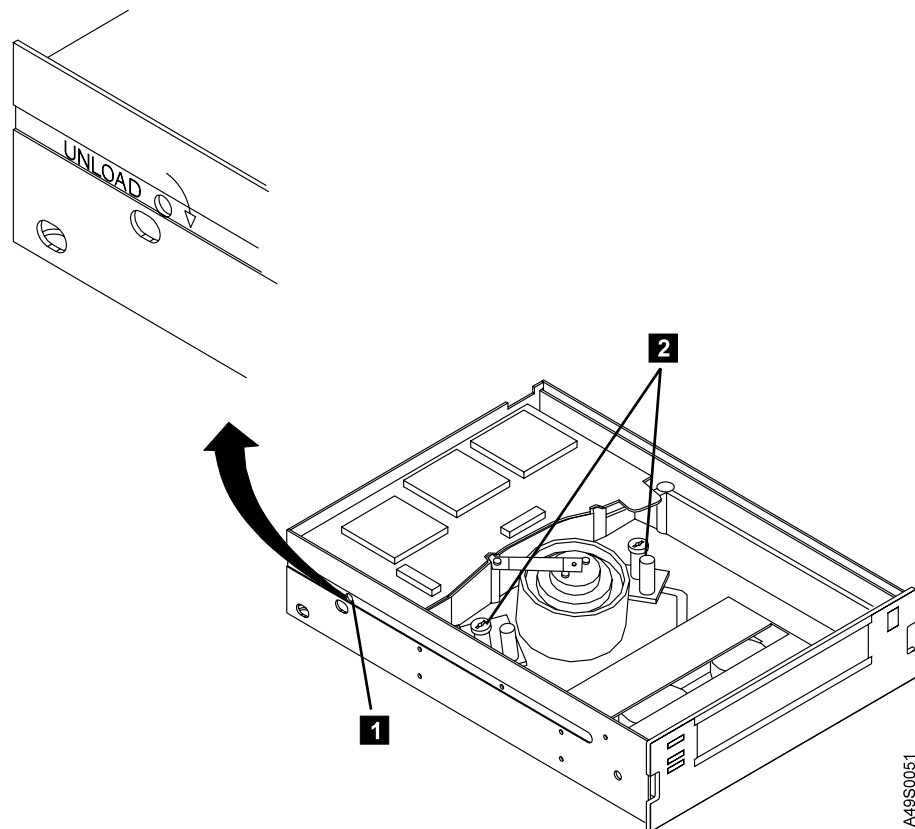

Figure 90. Moving Trolleys

Move the Supply Reel Motor:

1. Locate the hole marked UNLOAD 1 on the bottom of the drive (Figure 91 on page 102).
2. Insert a non-metallic probe (such as the wooden end of a swab) approximately 0.64 cm (0.25 in.) into the UNLOAD hole and position it so it rests on the inner flange 2 .

3. Gently push the flange with the probe in the direction marked on the drive (clockwise).
4. Repeat the preceding step until there is no slack in the tape.
5. Ensure the tape is fully retracted into the cartridge

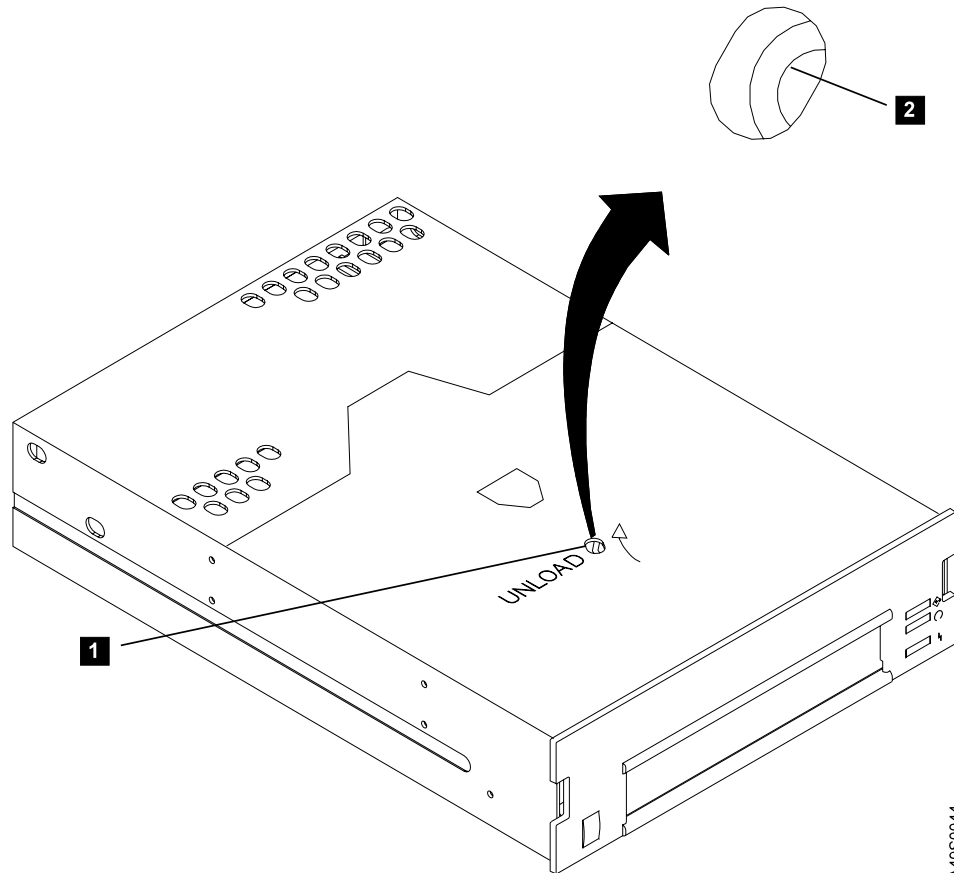

Figure 91. Moving the Supply Reel Motor. The drive is turned topside down.

Unload the tape cartridge:

1. Insert a 2.5-mm allen wrench into the hole marked UNLOAD 1 at the left front of the drive (see Figure 92 on page 103).
2. Turn the wrench in the direction marked on the drive (counterclockwise) until the tape ejects.

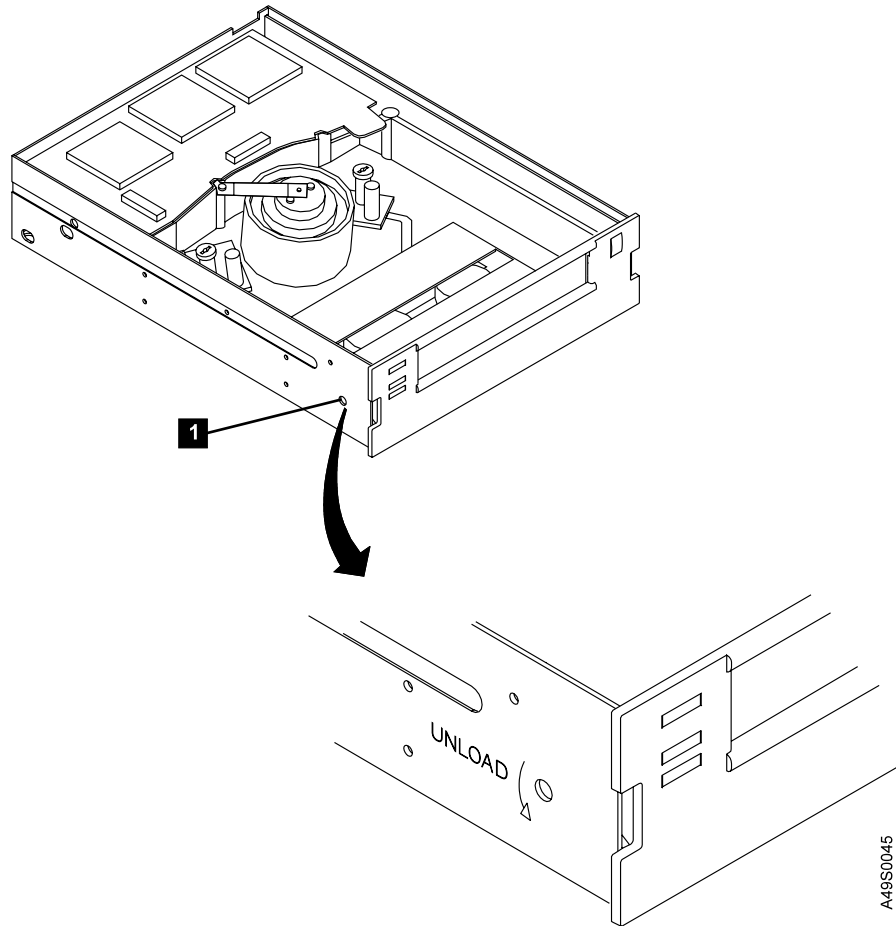

Figure 92. Unloading a Tape Cartridge

Install a New Drive:

1. Reverse the removal procedure.
2. Replace the drive cover on the old drive and return the drive according to instructions that came with the new drive.

Removing a Tape Cartridge Stuck in the Picker



Note: The above symbols indicate appropriate cautions to address in this “Removing a Tape Cartridge Stuck in the Picker” section of the manual.

Removal

Note: This procedure assumes the tape cartridge is stuck in the picker and the tape is not extended into the tape drive.

To remove a tape cartridge that is stuck in a picker, use the following procedure:

CAUTION:

Do not place a highly reflective surface between either the picker assembly and the tape cartridge magazines or between the picker assembly and the tape drives. This may cause damage to your eyes. (RSFTC238)

CAUTION:

If the automatic lock on the front door is not functioning and the door is open, do not look directly at the laser beam. Staring at the beam may cause damage to your eyes. (RSFTC239)

1. If the Tape Library is currently performing an operation, wait until the operation is complete before continuing.
2. If not already done, do a controlled system shutdown.
3. Open the control panel access cover and press the library power switch to turn the library power Off.

DANGER

To prevent a possible electrical shock when installing the device, ensure that the power cord for that device is unplugged before installing signal cables. (RSFTD204)

DANGER

To prevent a possible electrical shock from touching two surfaces with different electrical grounds, use one hand, when possible, to connect or disconnect signal cables. (RSFTD004)

4. Unplug the library power cable from the power outlet.
5. Open the library front door.
6. Remove the picker assembly cover. The cover snaps off the picker assembly.
7. Using your hand, lift the picker to allow access to the gears on the bottom of the picker.

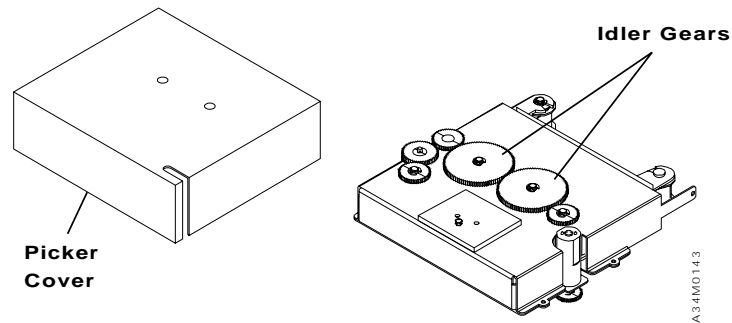

Figure 93. Picker Assembly and Cover

8. Using your other hand turn the large idler gear on the bottom of the picker to fully open the picker arms.
9. Align the tape cartridge in the picker with an empty magazine slot.
10. Rotate the idler gears to move the cartridge out of the picker assembly and into the empty magazine slot.
11. Lower the picker to the bottom of the library.
12. Examine the picker and the tape cartridge for damage or the presence of a foreign substance. If required, clean or replace picker. See "Picker (Assembly & Umbilical Cable) Removal and Installation" on page 83.
13. Install the picker assembly cover. The cover snaps on the picker assembly.
14. Close the library front door.
15. Return to the library service procedure that sent you here.

Chapter 4. Problem Analysis Procedures (PAPs)

Problem Analysis Procedures (PAPs) are used to isolate 8mm Tape Library failures and to provide repair actions for those failures. Listed in the following table are problem conditions with corresponding processes to identify PAPs. PAPs protocols follow the table.

Analysis Starting Point

Begin all problem analysis for the 8mm Tape Library with Figure 94. Locate the first condition in the left column of the table that most closely describes the library problem and perform the corresponding action in the right column.

<i>Figure 94 (Page 1 of 4). Start Here for Library Problem Analysis</i>	
If You Observe this Condition	Take this Action
The library power switch does not power-on the library. See "Definition of Power-Off and Power-On" on page 9.	Do the following: <ol style="list-style-type: none"> 1. Go to "PAP 1, Inoperative Control Panel LCD or Power-On Indicator" on page 111. 2. Make sure all the library covers are installed. 3. If not already done, power-on the library. See the <i>7331 and 3449 8mm Tape Library Model 3xx Operator Guide GA32-0376</i>. 4. Return the library to the operational mode it was in before the error condition.
The library power-on indicator does not light when library power is On. See "Definition of Power-Off and Power-On" on page 9.	Do the following: <ol style="list-style-type: none"> 1. Go to "PAP 1, Inoperative Control Panel LCD or Power-On Indicator" on page 111. 2. Make sure all the library covers are installed. 3. If not already done, power-on the library. See the <i>7331 and 3449 8mm Tape Library Model 3xx Operator Guide, GA32-0376</i>. 4. Return the library to the operational mode it was in before the error condition.
The library continuously beeps and the power-on indicator continuously blinks one of four sequences indicating an error occurred during the Power-On Self Test (POST).	Do the following: <ol style="list-style-type: none"> 1. If a UEC is displayed, continue problem analysis with "PAP 3, Processing a Unit Error Code (UEC)" on page 120. 2. If calibration failed and a UEC is not displayed, continue problem analysis using the condition listed in this table that best describes the failure condition. 3. Make sure all the library covers are installed. 4. If not already done, power-on the library. See the <i>7331 and 3449 8mm Tape Library Model 3xx Operator Guide, GA32-0376</i>. 5. Return the library to the operational mode it was in before the error condition.

Figure 94 (Page 2 of 4). Start Here for Library Problem Analysis

If You Observe this Condition	Take this Action
<p>The control panel display is blank.</p>	<p>Do the following:</p> <ol style="list-style-type: none"> 1. Go to "PAP 1, Inoperative Control Panel LCD or Power-On Indicator" on page 111. 2. Make sure all the library covers are installed. 3. If not already done, power-on the library. See the <i>7331 and 3449 8mm Tape Library Model 3xx Operator Guide</i>, GA32-0376. 4. Return the library to the operational mode it was in before the error condition.
<p>Control panel display does not show the correct library configuration. For example, only one drive is displayed and the library has two drives installed.</p>	<p>Do the following:</p> <ol style="list-style-type: none"> 1. If a library power reset has not been attempted, perform step 2. Otherwise go to step 5. 2. Press the control panel power switch (Ⓚ) to turn the library power Off. Wait 10 seconds for the power supply to reset, then press the power switch (Ⓚ) to turn the library power On. 3. If the control panel display still does not show the correct library configuration, go to step 5. 4. If the control panel display is correct, this was an intermittent problem. Resume library operations. 5. Perform calibration. Go to "Library Calibration" on page 28. <ol style="list-style-type: none"> a. If calibration passed and the display is correct, resume library operations. b. If calibration failed and a UEC is displayed, continue problem analysis with "PAP 3, Processing a Unit Error Code (UEC)" on page 120. c. If calibration failed and a UEC is not displayed, continue problem analysis using the condition listed in this table that best describes the failure condition. 6. Make sure all the library covers are installed. 7. If not already done, power-on the library. See the <i>7331 and 3449 8mm Tape Library Model 3xx Operator Guide</i> 8. Return the library to the operational mode it was in before the error condition.
<p>The library power switch does not power-off the library. See "Definition of Power-Off and Power-On" on page 9.</p>	<p>Do the following:</p> <ol style="list-style-type: none"> 1. Go to "PAP 2, Power Switch does not Power-Off the Library" on page 116. 2. Make sure all the library covers are installed. 3. If not already done, power-on the library. See the <i>7331 and 3449 8mm Tape Library Model 3xx Operator Guide</i> 4. Return the library to the operational mode it was in before the error condition.

Figure 94 (Page 3 of 4). Start Here for Library Problem Analysis

If You Observe this Condition	Take this Action
<p>The control panel display shows a Unit Error Code or the unit fails during system diagnostics. See "UEC and FRU Code Displays" on page 10.</p>	<p>Do the following:</p> <ol style="list-style-type: none"> 1. Go to "PAP 3, Processing a Unit Error Code (UEC)" on page 120. 2. Make sure all the library covers are installed. 3. If not already done, power-on the library. See the <i>7331 and 3449 8mm Tape Library Model 3xx Operator Guide</i> 4. Return the library to the operational mode it was in before the error condition.
<p>System unit cannot read bar code label. Unknown tape error.</p>	<p>Do the following:</p> <ol style="list-style-type: none"> 1. Perform "Step 10, SAC 08" on page 129. If problem analysis is required beyond this SAC, use a FRU group of 0A. 2. Make sure all the library covers are installed. 3. If not already done, power-on the library. See the <i>7331 and 3449 8mm Tape Library Model 3xx Operator Guide</i> 4. Return the library to the operational mode it was in before the error condition.
<p>The library control panel is nonfunctional.</p>	<p>Do the following:</p> <ol style="list-style-type: none"> 1. Perform "PAP 5, Control Panel Nonfunctional" on page 144. 2. Make sure all the library covers are installed. 3. If not already done, power-on the library. See the <i>7331 and 3449 8mm Tape Library Model 3xx Operator Guide</i> 4. Return the library to the operational mode it was in before the error condition.
<p>A Door Open message is displayed continuously.</p>	<p>Do the following:</p> <ol style="list-style-type: none"> 1. Perform "Step 11, SAC 09" on page 129. If problem analysis is required beyond this SAC, use a FRU group of 08. 2. Make sure all the library covers are installed. 3. If not already done, power-on the library. See the <i>7331 and 3449 8mm Tape Library Model 3xx Operator Guide</i> 4. Return the library to the operational mode it was in before the error condition.
<p>Control panel display does not show an installed magazine.</p>	<p>Do the following:</p> <ol style="list-style-type: none"> 1. Perform "Step 12, SAC 10" on page 130. If problem analysis is required beyond this SAC, use a FRU group of 0C. 2. Make sure all the library covers are installed. 3. If not already done, power-on the library. See the <i>7331 and 3449 8mm Tape Library Model 3xx Operator Guide</i> 4. Return the library to the operational mode it was in before the error condition.

Figure 94 (Page 4 of 4). Start Here for Library Problem Analysis

If You Observe this Condition	Take this Action
A tape cartridge is stuck in a tape drive.	Do the following: <ol style="list-style-type: none">1. Perform "Manually Removing a Tape Cartridge" on page 100.2. Make sure all the library covers are installed.3. If not already done, power-on the library. See the <i>7331 and 3449 8mm Tape Library Model 3xx Operator Guide</i>4. Return the library to the operational mode it was in before the error condition.
A tape cartridge is stuck in the picker.	Do the following: <ol style="list-style-type: none">1. Perform "Removing a Tape Cartridge Stuck in the Picker" on page 104.2. Make sure all the library covers are installed.3. If not already done, power-on the library. See the <i>7331 and 3449 8mm Tape Library Model 3xx Operator Guide</i>4. Return the library to the operational mode it was in before the error condition.

PAP 1, Inoperative Control Panel LCD or Power-On Indicator



Note: The above symbol indicates appropriate caution to address in this “PAP 1, Inoperative Control Panel LCD or Power-On Indicator” section of the manual.

This procedure is performed if **either** of the following conditions exist:

- Blank control panel display (LCD)
- Power-On indicator (POI) continuously off

Note: At power-on the library software sets valid display brightness and contrast values and writes status messages to the display (see Figure 95). The software also turns the power-on indicator On.

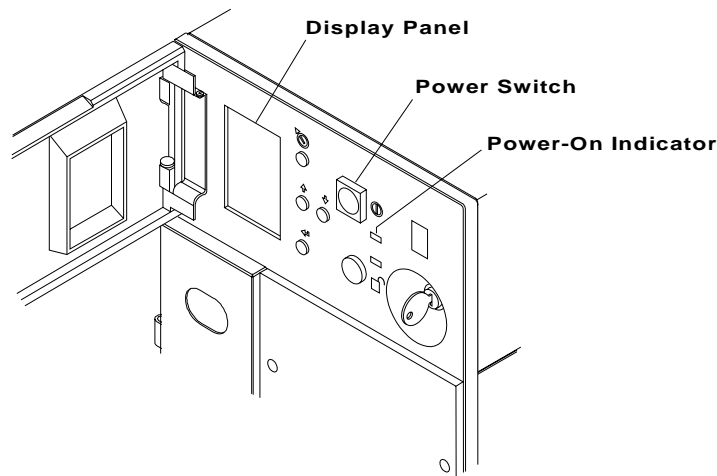

ASOP03-00

Figure 95. Control Panel

Step 1

1. Do a controlled system shutdown.
2. Unplug the library power cord from the power outlet and wait at least 10 seconds before continuing (this allows the power supply to reset).
3. Plug the library power cord into the power outlet.

Are BOTH the power-on indicator and the control panel display On?

YES Go to “Step 9” on page 115.

NO Do the following:

1. Press the control panel power switch **once**.
2. If both the power-on indicator and the control panel display are On, go to “Step 9” on page 115.
3. If either the power-on indicator or the control panel display are Off, go to “Step 2” on page 112.

Step 2

1. Unplug the library power cord from the power outlet.
2. Remove all library covers. Go to “Library Cover Set Removal and Installation” on page 44.

DANGER

To prevent a possible electrical shock when installing the device, ensure that the power cord for that device is unplugged before installing signal cables. (RSFTD204)

DANGER

To prevent a possible electrical shock from touching two surfaces with different electrical grounds, use one hand, when possible, to connect or disconnect signal cables. (RSFTD004)

3. Disconnect, inspect, repair or replace, and reconnect the following cables and connectors:

Note: Inspect the connectors for bent, broken, or missing pins; corrosion or other damage that could prevent a good connection.

Connectors at both ends of control panel cable

Power-sense cable connector at P2 on the controller card

Power supply cable connector at P1 on the controller card

4. Make sure all of the cables disconnected in the previous step are reconnected, then plug the library power cord into the power outlet.

Are BOTH the power-on indicator and the control panel display On? (Refer to Figure 96 on page 113.)

YES Go to “Step 9” on page 115.

NO Do the following:

1. Press the control panel power switch **once**.
2. If both the power-on indicator and the control panel display are On, go to “Step 9” on page 115.
3. If either the power-on indicator or the control panel display are Off, go to “Step 3” on page 113.

Step 3

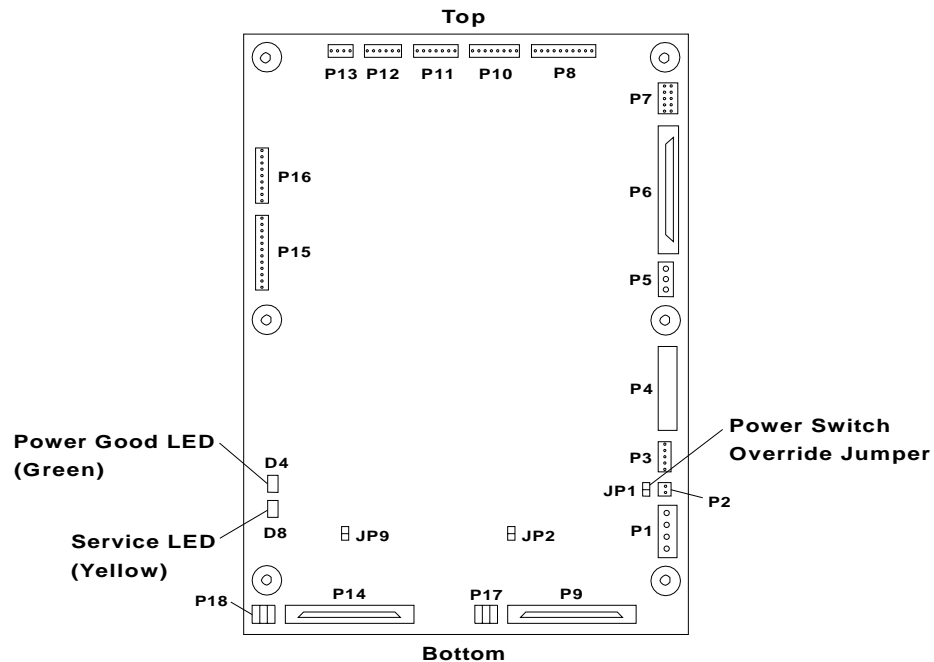

ASLUP1-00

Figure 96. Controller Card LEDs and Power-Switch Override Jumper

Is the Controller Card Power Good LED (green) Off?

Note: The control card power good LED (green) On condition indicates that an undervoltage condition does not exist on the control card.

- YES** Do the following:
1. Install a jumper at JP1 (power-switch override) on the controller card. Go to "Power-Switch Override Jumper Installation and Removal" on page 150.
 2. Go to "Step 4."
- NO** Go to "Step 5" on page 114.

Step 4

Is the Controller Card Power Good LED (green) Off?

- YES** Do the following:
1. Go to "PAP 4, Power System Check" on page 137.
 2. If power system check passed or corrected the problem, return to the library service procedure that sent you here.
 3. If power system check did not isolate a problem, go to "Step 8" on page 114.
- NO** Go to "Step 5" on page 114.

Step 5

Is the Controller Card Service LED (yellow) Off?

Note: The control card service LED (yellow) indicator is a redundant indicator for the library front panel power indicator.

YES Go to "Step 6."

NO Go to "Step 7."

Step 6

1. Replace the controller card. Go to "Controller Card Removal and Installation" on page 74.
2. Power-on the library. See the *7331 and 3449 8mm Tape Library Model 3xx Operator Guide*

Are BOTH the power-on indicator and the control panel display On?

YES This procedure is complete. Return to the library service procedure that sent you here.

NO Go to "Step 6."

Step 7

1. Replace the control panel assembly and control Panel cable. Go to "Control Panel Assembly Removal and Installation" on page 51 and "Control Panel Cable Removal and Installation" on page 54.
2. Power-on the library. See the *7331 and 3449 8mm Tape Library Model 3xx Operator Guide*

Are BOTH the power-on indicator and the control panel display On?

YES Do the following:

1. Make sure all cables are connected and library covers are installed.
2. Return to the library service procedure that sent you here.

NO Go to "Step 8."

Step 8

1. Call the 8mm Tape Library service representative or the next level of support.
2. The problem was resolved with technical support assistance.
3. Make sure all cables are connected and all the library covers are installed.
4. Return to the library service procedure that sent you here or prepare library for operational use.

Step 9

Both the power-on indicator and the control panel display are now functioning, an intermittent problem is no longer present, and the cause of the problem cannot be determined at this time.

1. If the library covers are off, install the covers. Go to “Library Cover Set Removal and Installation” on page 44.
2. This procedure is complete, return to the library service procedure that sent you here.

PAP 2, Power Switch does not Power-Off the Library

This Problem Analysis Procedure (PAP) is performed if the 8mm Tape Library does not power-off when the control panel power switch is pressed. For information on power distribution within the library, refer to “Power Distribution” on page 9.

Note: If the library power is On, proceed with this PAP. For a definition of power-on, refer to “Definition of Power-Off and Power-On” on page 9.



Note: The above symbol indicates appropriate caution to address in this “PAP 2, Power Switch does not Power-Off the Library” section of the manual.

Step 1

1. If you have not already done so, do a controlled system shutdown.
2. Remove all library covers. Go to “Library Cover Set Removal and Installation” on page 44.

Is a jumper installed at JP1 (power-switch override) on the controller card?
(Refer to Figure 97.)

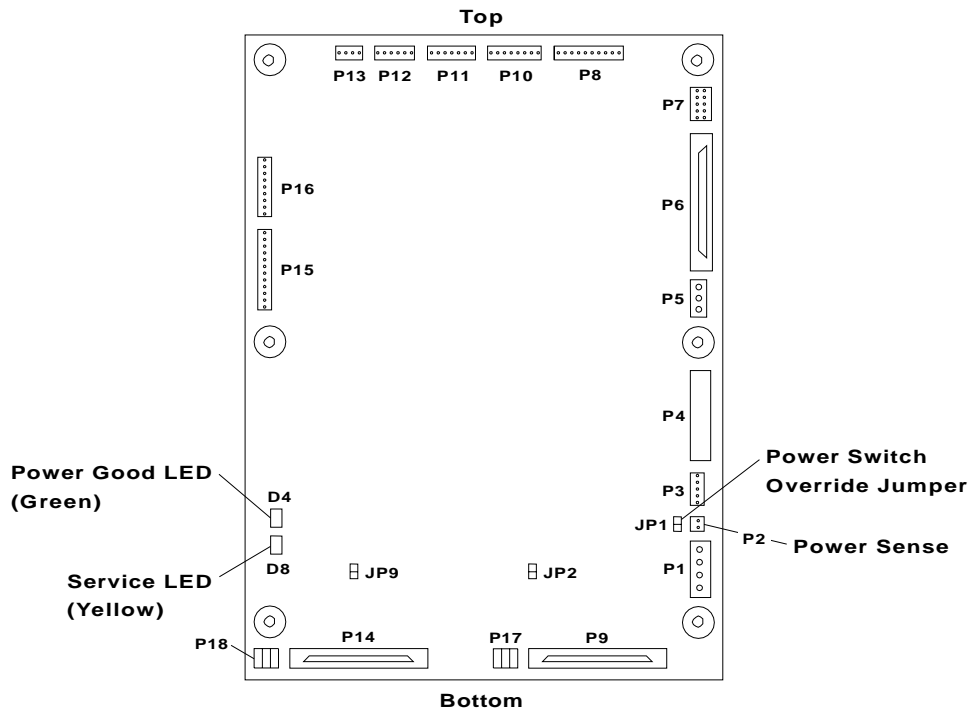

ASLUP3-00

Figure 97. Controller Card LEDs and Power-Sense Connector

YES Do the following:

1. Remove the jumper from JP1 (power-switch override) on the controller card. Go to “Power-Switch Override Jumper Installation and Removal” on page 150.

2. Go to "Step 2" on page 117.

NO Go to "Step 3."

Step 2

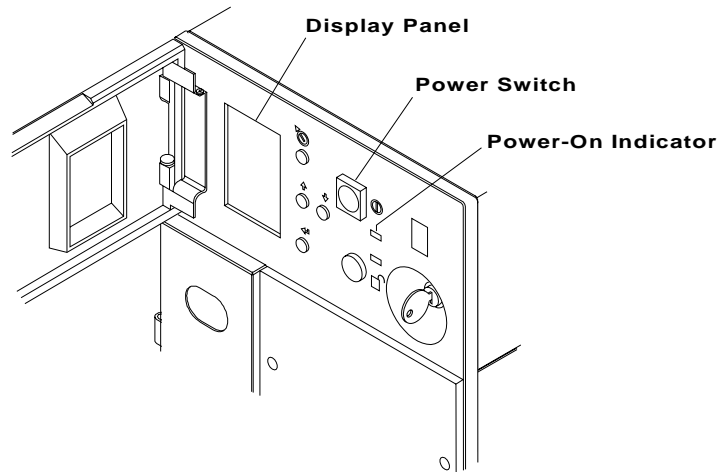

ASOP03-00

Figure 98. Control Panel

Is the library power still On? (Refer to Figure 98.)

YES Do the following:

1. Press the control panel power switch **one** time.
2. If the library power is still On, go to "Step 3."
3. If the library power is Off, install the covers. Go to "Library Cover Set Removal and Installation" on page 44.
4. This procedure is complete, return to the library service procedure that sent you here.

NO Go to "Step 3."

Step 3

DANGER

To prevent a possible electrical shock when installing the device, ensure that the power cord for that device is unplugged before installing signal cables. (RSFTD204)

DANGER

To prevent a possible electrical shock from touching two surfaces with different electrical grounds, use one hand, when possible, to connect or disconnect signal cables. (RSFTD004)

Disconnect the control panel cable from the control panel card.

Is the library power Off?

- YES** Do the following:
1. Replace the control panel. Go to “Control Panel Assembly Removal and Installation” on page 51.
 2. Power-on the library. See the *7331 and 3449 8mm Tape Library Model 3xx Operator Guide*
 3. Press the control panel power switch **one** time.
 4. If the library power is still On, go to “Step 4.”
 5. If the library power is Off, install the covers. Go to “Library Cover Set Removal and Installation” on page 44.
 6. This procedure is complete, return to the library service procedure that sent you here.
- NO** Go to “Step 4.”

Step 4

Disconnect the control panel cable from P6 on the controller card. See Figure 97 on page 116.

Is the library power Off?

- YES** Do the following:
1. Replace the control panel cable. Go to “Control Panel Cable Removal and Installation” on page 54.
 2. Power-on the library. See the *7331 and 3449 8mm Tape Library Model 3xx Operator Guide*
 3. Press the control panel power switch **one** time.
 4. If the library power is still On, go to “Step 5.”
 5. If the library power is Off, install the covers. Go to “Library Cover Set Removal and Installation” on page 44.
 6. This procedure is complete, return to the library service procedure that sent you here.
- NO** Go to “Step 5.”

Step 5

1. Connect the control panel cable to the control panel.
2. Disconnect the power-sense cable from P2 on the controller card.

Is the library power Off?

- YES** Do the following:
1. Replace the controller card. Go to “Controller Card Removal and Installation” on page 74.
 2. Power-on the library. See the *7331 and 3449 8mm Tape Library Model 3xx Operator Guide*
 3. Perform calibration. Go to “Library Calibration” on page 28.

4. If calibration failed, go to “Step 6” on page 119.
5. If calibration passed, install the covers. Go to “Library Cover Set Removal and Installation” on page 44.
6. This procedure is complete. Return to the library service procedure that sent you here.

NO Go to “Step 6.”

Step 6

1. Connect the control panel cable to P6 on the controller card. See Figure 97 on page 116.
2. If not already connected, connect the power-sense cable to P2 on the controller card.
3. Replace the power supply. Go to “Power Supply Removal and Installation” on page 71.
4. Power-on the library. See the *7331 and 3449 8mm Tape Library Model 3xx Operator Guide*

Are **BOTH** the control panel display and the power-on indicator On?

YES Do the following:

1. Install the covers. Go to “Library Cover Set Removal and Installation” on page 44.
2. Return to the library service procedure that sent you here.

NO Do the following:

1. Call the 8mm Tape Library service representative or the next level of support.
2. The problem was resolved with technical support assistance.
3. Make sure all cables are connected and all the library covers are installed.
4. Return to the library service procedure that sent you here or prepare library for operational use.

PAP 3, Processing a Unit Error Code (UEC)

This procedure is performed if a Unit Error Code (UEC) is available through the front panel display or through the system unit Sense data.



Note: The above symbol indicates appropriate caution to address in this “PAP 3, Processing a Unit Error Code (UEC)” section of the manual.

Step 1

1. Find the UEC code in Figure 109 on page 155.
2. Record the Service Action Code (SAC) and the FRU group for the UEC.
3. Locate the SAC in Figure 99 and perform the service actions indicated for the SAC value.

Figure 99. Service Action Codes and Service Actions

SAC	Service Action
00	Go to “Step 2, SAC 00.”
01	Go to “Step 3, SAC 01” on page 121.
02	Go to “Step 4, SAC 02” on page 121.
03	Go to “Step 5, SAC 03” on page 124.
04	Go to “Step 6, SAC 04” on page 124.
05	Go to “Step 7, SAC 05” on page 125.
06	Go to “Step 8, SAC 06” on page 127.
07	Go to “Step 9, SAC 07” on page 128.
08	Go to “Step 10, SAC 08” on page 129.
09	Go to “Step 11, SAC 09” on page 129.
10	Go to “Step 12, SAC 10” on page 130.
11	Go to “Step 13, SAC 11” on page 131.
12	Go to “Step 14, SAC 12” on page 132.
13	Go to “Step 15, SAC 13” on page 133.
14	Go to “Step 16, SAC 14” on page 133.
15	Go to “Step 17, SAC 15” on page 134.

Step 2, SAC 00

FRU Group 00 is for information only.

1. No service action required, return to the library service procedure that sent you here.

Step 3, SAC 01

1. Find the FRU Group number in Figure 110 on page 161.
2. For each FRU of the FRU Group in Figure 110 on page 161, do the following:
 - a. Locate the service action for the FRU in Figure 111 on page 163.
 - b. Perform the FRU service action.
 - c. If the service action repaired the problem, this procedure is complete. Return to the library service procedure that sent you here.
 - d. If the service action did not correct the problem, repeat step 2a - 2d for the next FRU listed in the FRU Group until the problem is corrected or all service actions are complete.
3. If you have completed the service actions for all the FRUs in the FRU Group and the problem still exists, call the 7331 Tape Library service representative or the next level of support.
4. The problem was resolved with technical support assistance.
5. Make sure all cables are connected and all the library covers are installed.
6. Return to the library service procedure that sent you here or prepare library for operational use.

Step 4, SAC 02

Possible mechanical interference problems preventing smooth picking and placing of cartridges.

1. CAUTION:

Do not place a highly reflective surface between either the picker assembly and the tape cartridge magazines or between the picker assembly and the tape drives. This may cause damage to your eyes. (RSFTC238)

CAUTION:

If the automatic lock on the front door is not functioning and the door is open, do not look directly at the laser beam. Staring at the beam may cause damage to your eyes. (RSFTC239)

2. Open the library front door. See the *7331 and 3449 8mm Tape Library Model 3xx Operator Guide*

Note: As long as power is applied to the library, the move buttons located inside the library front door on the back of the control panel card can be used to move the picker assembly up and down.

Are all tape cartridges fully seated in magazine slots and the tape cartridge magazines properly seated in the magazine mounting plates?

YES Go to "Step 4a" on page 122.

NO Go to "Step 4b" on page 122.

Step 4a

Is a tape cartridge stuck in the picker assembly?

- YES** Do the following:
1. Go to "Removing a Tape Cartridge Stuck in the Picker" on page 104.
 2. Make sure all cartridges are fully seated and the library is operational.
 3. Power-on the library. See the *7331 and 3449 8mm Tape Library Model 3xx Operator Guide*
 4. If the error cleared, return to the library service procedure that sent you here.
 5. If the error did not clear, go to "Step 4c."
- NO** Go to "Step 4c."

Step 4b

1. Make sure all tape cartridges are fully seated.
2. Make sure the tape cartridge magazines are fully seated.
3. Close the library door.

Does the error clear?

- YES** If the error cleared, return to the library service procedure that sent you here.
- NO** Go to "Step 4a."

Step 4c

Go to "History Log Display" on page 19 and verify the source and destination of the move.

Is the destination a tape drive?

- YES** Do the following:
1. Use the move command to move a tape cartridge to the destination tape drive. See the *7331 and 3449 8mm Tape Library Model 3xx Operator Guide* for instructions on moving a tape cartridge.
 2. If the error reoccurs, go to "Step 4d" on page 123.
 3. If the error cleared and does not reoccur, return to the library service procedure that sent you here.
- NO** Go to "Step 3, SAC 01" on page 121.

Step 4d

Is a second drive installed in the library?

YES Go to "Step 4e."

NO Do the following:

1. Replace the tape drive. Go to "Tape Drive Removal and Installation" on page 67.
2. Make sure all cables are connected to the tape drive.
3. Plug the library power cable into a grounded outlet.
4. Press the control panel power switch () to turn the library power On.
5. Use the move command to move a tape cartridge to the tape drive. See the *7331 and 3449 8mm Tape Library Model 3xx Operator Guide* for instructions on moving a tape cartridge.
6. If the error reoccurs, go to "Step 3, SAC 01" on page 121.
7. If the error cleared and does not reoccur, return to the library service procedure that sent you here.

Step 4e

Use the move command to move a tape cartridge to the other tape drive. See the *7331 and 3449 8mm Tape Library Model 3xx Operator Guide* for instructions on moving a tape cartridge.

Does the tape cartridge load into the other tape drive without producing an error?

YES Do the following:

1. Replace the first tape drive. Go to "Tape Drive Removal and Installation" on page 67.
2. Make sure all cables are connected to the tape drive.
3. Plug the library power cable into a grounded outlet.
4. Press the control panel power switch () to turn the library power On.
5. Use the move command to move a tape cartridge to the tape drive that was just installed. See the *7331 and 3449 8mm Tape Library Model 3xx Operator Guide* for instructions on moving a tape cartridge.
6. If the error reoccurs, go to "Step 3, SAC 01" on page 121.
7. If the error cleared and does not reoccur, return to the library service procedure that sent you here.

NO Go to "Step 3, SAC 01" on page 121.

Step 5, SAC 03

Possible mechanical interference problems preventing smooth operation of the accessor mechanism.

1. If not already done, do a controlled system shutdown.
2. Open the control panel access cover and press the library power switch to turn the library power Off.
3. Unplug the library power cable from the power outlet.
4. Using your hand, move the picker assembly from the lower to the upper limit and back to check for any obvious binding.
5. Make sure the accessor lock (blue plastic at top of accessor) is fully retracted and not preventing the accessor from reaching the upper limit.

Were any mechanical interference problems found?

- YES** Do the following:
1. Perform the necessary service actions to correct the problem.
 2. Go to "Step 5a."
- NO** Go to "Step 3, SAC 01" on page 121.

Step 5a

Did the service actions correct the problems?

- YES** Return to the library service procedure that sent you here.
- NO** Go to "Step 3, SAC 01" on page 121.

Step 6, SAC 04

1. Power-down the library. See the *7331 and 3449 8mm Tape Library Model 3xx Operator Guide*
2. Remove the library right side cover. Go to "Library Cover Set Removal and Installation" on page 44.

DANGER

To prevent a possible electrical shock when installing the device, ensure that the power cord for that device is unplugged before installing signal cables. (RSFTD204)

DANGER

To prevent a possible electrical shock from touching two surfaces with different electrical grounds, use one hand, when possible, to connect or disconnect signal cables. (RSFTD004)

3. Make sure the 2 cables connecting the accessor motor and tachometer to the controller card are connected at both ends.
4. Connect any connectors that are not connected.

Were there any loose connectors that were connected?

- YES** Do the following:
1. Install the library right side cover. Go to “Library Cover Set Removal and Installation” on page 44.
 2. Power-on the library. See the *7331 and 3449 8mm Tape Library Model 3xx Operator Guide*
 3. Go to “Step 6a.”
- NO** Go to “Step 3, SAC 01” on page 121.

Step 6a

Did the service actions correct the problems?

- YES** Return to the library service procedure that sent you here.
- NO** Go to “Step 3, SAC 01” on page 121.

Step 7, SAC 05

SCSI communication problems.

1. Make sure the 7331 Tape Library and library tape drives are set to the correct SCSI IDs. See the *7331 and 3449 8mm Tape Library Model 3xx Operator Guide*
2. Power-down the library. See the *7331 and 3449 8mm Tape Library Model 3xx Operator Guide*
3. Remove the library right side cover. Go to “Library Cover Set Removal and Installation” on page 44.

DANGER

To prevent a possible electrical shock when installing the device, ensure that the power cord for that device is unplugged before installing signal cables. (RSFTD204)

DANGER

To prevent a possible electrical shock from touching two surfaces with different electrical grounds, use one hand, when possible, to connect or disconnect signal cables. (RSFTD004)

4. Make sure the library internal SCSI bus cables are connected and properly terminated. See “Internal SCSI Cable Group Removal and Installation” on page 78 for internal SCSI cable configuration and *7331 and 3449 8mm Model 3xx Installation Guide* for the proper termination for your library configuration.

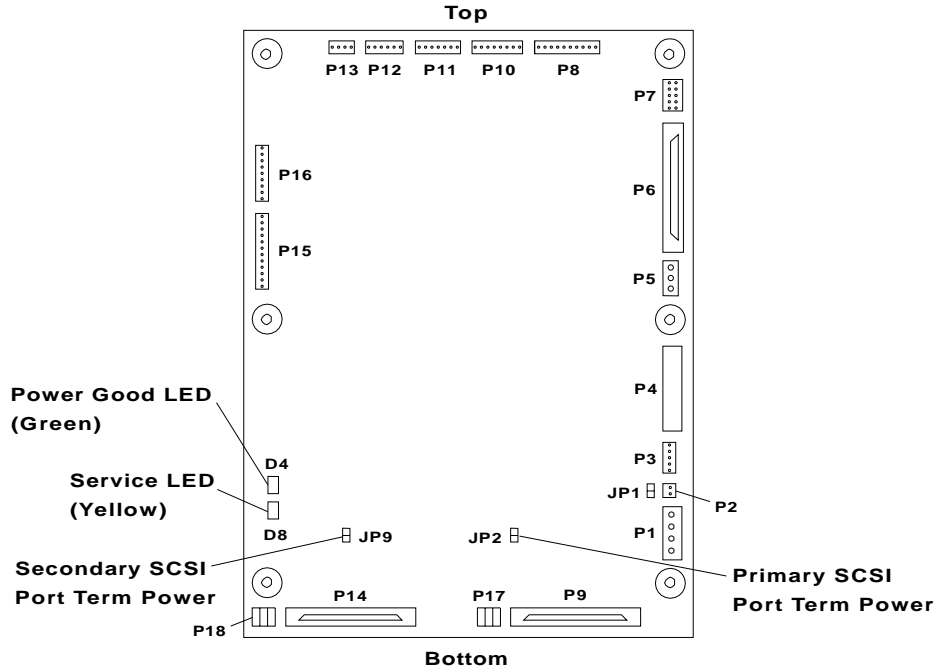

ASLUP4-00

Figure 100. Controller Card LEDs and SCSI Port Term Power Jumpers

5. If the library is not connected to a host computer system and the SCSI terminators are installed, make sure the jumpers are installed at JP2 and JP9 (Primary and Secondary SCSI Port Term Power) on the controller card. See Figure 100.
6. Make sure the SCSI ID Address cable is connected to each tape drive and the controller card P15. The longest SCSI ID address cable connects to Tape Drive 1. The cable is connected to the tape drive with the alignment tap in the up position.

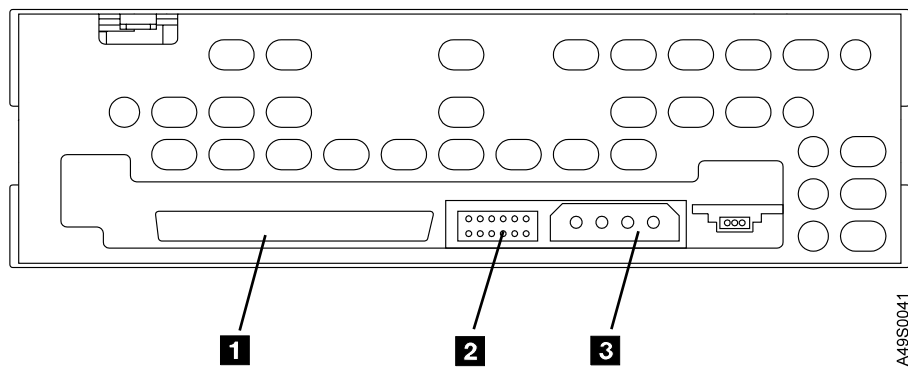

A49S0041

Figure 101. SCSI ID Address Cable Connections

The items in Figure 101 are:

- Item 1 - SCSI Signal Cable.
- Item 2 - SCSI ID Address Cable.
- Item 3 - 4-pin Power Connector.

7. Connect any connectors that are not connected.

Were there any loose connectors that were connected?

- YES** Do the following:
1. Power-on the library. See the *7331 and 3449 8mm Tape Library Model 3xx Operator Guide*
 2. Go to “Step 7a.”
- NO** Go to “Step 3, SAC 01” on page 121.

Step 7a

Did the service actions correct the problems?

- YES** Return to the library service procedure that sent you here.
- NO** Go to “Step 3, SAC 01” on page 121.

Step 8, SAC 06

The SCSI bus reset (RST) line is stuck active.

1. Power-down the library. See the *7331 and 3449 8mm Tape Library Model 3xx Operator Guide*
2. Remove the library right side cover. Go to “Library Cover Set Removal and Installation” on page 44.

DANGER

To prevent a possible electrical shock when installing the device, ensure that the power cord for that device is unplugged before installing signal cables. (RSFTD204)

DANGER

To prevent a possible electrical shock from touching two surfaces with different electrical grounds, use one hand, when possible, to connect or disconnect signal cables. (RSFTD004)

3. If the library is not connected to a host computer system and the SCSI terminators are installed, make sure the jumpers are installed at JP2 and JP9 (SCSI Port Term Power) on the controller card. See Figure 100 on page 126.

Were any cables, terminators, or jumpers connected or installed in the previous step?

- YES** Do the following:
1. Power-on the library. See the *7331 and 3449 8mm Tape Library Model 3xx Operator Guide*
 2. Go to “Step 8a” on page 128.
- NO** Go to “Step 3, SAC 01” on page 121.

Step 8a

Did the service actions correct the problems?

YES Return to the library service procedure that sent you here.

NO Go to "Step 3, SAC 01" on page 121.

Step 9, SAC 07

Calibration problem. The location of the tape cartridges during calibration is not within the acceptable range.

1. Open the library front door. See the *7331 and 3449 8mm Tape Library Model 3xx Operator Guide*

Note: As long as power is applied to the library, the move buttons located inside the library front door on the back of the control panel card can be used to move the picker assembly up and down.

CAUTION:

Do not place a highly reflective surface between either the picker assembly and the tape cartridge magazines or between the picker assembly and the tape drives. This may cause damage to your eyes. (RSFTC238)

CAUTION:

If the automatic lock on the front door is not functioning and the door is open, do not look directly at the laser beam. Staring at the beam may cause damage to your eyes. (RSFTC239)

2. Make sure the tape cartridges, tape cartridge magazines, and tape drives are properly installed.

Were the tape cartridges, tape cartridge magazines, and tape drives all properly installed?

YES Go to "Step 3, SAC 01" on page 121.

NO Do the following:

1. Perform the necessary service actions to correct the problem.
2. Perform calibration. Go to "Library Calibration" on page 28.
3. Go to "Step 9a."

Step 9a

Did calibration pass?

YES Return to the library service procedure that sent you here.

NO Go to "Step 3, SAC 01" on page 121.

Step 10, SAC 08

Bar code reader error.

1. Open the library front door. See the *7331 and 3449 8mm Tape Library Model 3xx Operator Guide*

Note: As long as power is applied to the library, the move buttons located inside the library front door on the back of the control panel card can be used to move the picker assembly up and down.

CAUTION:

Do not place a highly reflective surface between either the picker assembly and the tape cartridge magazines or between the picker assembly and the tape drives. This may cause damage to your eyes. (RSFTC238)

CAUTION:

If the automatic lock on the front door is not functioning and the door is open, do not look directly at the laser beam. Staring at the beam may cause damage to your eyes. (RSFTC239)

2. Make sure the bar code labels are of the correct type, properly applied, and have no visible print quality problems that prevent the label from being scanned correctly. See the *7331 and 3449 8mm Tape Library Model 3xx Operator Guide* for bar code specifications.

Were the bar code labels of the correct type, properly applied, and in good condition?

YES Go to “Step 3, SAC 01” on page 121 and use FRU Group 0A if a FRU Group was not previously assigned.

NO Do the following:

1. Perform the necessary actions to correct the problem.
2. Perform calibration. Go to “Library Calibration” on page 28.
3. Go to “Step 10a.”

Step 10a

Did calibration pass?

YES Return to the library service procedure that sent you here.

NO Go to “Step 3, SAC 01” on page 121 and use FRU Group 0A if a FRU Group was not previously assigned.

Step 11, SAC 09

A door open condition is detected. The library front door open sensor is indicating that the door is open.

1. Make sure the library front door is closed. If the door appears to be closed, open and close the door.

Did closing the door properly correct the problem?

YES Return to the library service procedure that sent you here.

NO Go to “Step 3, SAC 01” on page 121.

Step 12, SAC 10

The library detects a tape cartridge magazine is missing. The presence of the tape cartridge magazine is sensed by a microswitch located behind the magazine.

1. Open the library front door. See the *7331 and 3449 8mm Tape Library Model 3xx Operator Guide*

Note: As long as power is applied to the library, the move buttons located inside the library front door on the back of the control panel card can be used to move the picker assembly up and down.

CAUTION:

Do not place a highly reflective surface between either the picker assembly and the tape cartridge magazines or between the picker assembly and the tape drives. This may cause damage to your eyes. (RSFTC238)

CAUTION:

If the automatic lock on the front door is not functioning and the door is open, do not look directly at the laser beam. Staring at the beam may cause damage to your eyes. (RSFTC239)

2. Make sure the tape cartridge magazines are present and properly seated in the magazine mounting plates.

Did installing missing magazines or properly seating magazines correct the problem?

YES Return to the library service procedure that sent you here.

NO Go to “Step 12a.”

Step 12a

1. Power-down the library. See the *7331 and 3449 8mm Tape Library Model 3xx Operator Guide*
2. Remove the library right side cover. Go to “Library Cover Set Removal and Installation” on page 44.
3. Remove the tape cartridge magazines. Go to “Tape Cartridge Magazine Removal and Installation” on page 57.

DANGER

To prevent a possible electrical shock when installing the device, ensure that the power cord for that device is unplugged before installing signal cables. (RSFTD204)

DANGER

To prevent a possible electrical shock from touching two surfaces with different electrical grounds, use one hand, when possible, to connect or disconnect signal cables. (RSFTD004)

4. Inspect the magazine sensor switches and the sensor cables connecting the sensors to the controller card (P11) for damage and loose connections.
5. Connect any connectors that are not connected or replace any damaged components.

Were there any loose connectors that were connected or any components replaced?

- YES** Do the following:
1. Power-on the library. See the *7331 and 3449 8mm Tape Library Model 3xx Operator Guide*
 2. Go to "Step 12b."
- NO** Go to "Step 3, SAC 01" on page 121.

Step 12b

Did the service actions correct the problem?

- YES** Install the library covers and return to the library service procedure that sent you here.
- NO** Go to "Step 3, SAC 01" on page 121.

Step 13, SAC 11

An over temperature condition has been detected.

Is the library cooling fan operating?

- YES** Go to "Step 13b."
- NO** Go to "Step 3, SAC 01" on page 121.

Step 13b

Is the library cooling fan air flow blocked?

- YES** Do the following:
1. Power-down the library. See the *7331 and 3449 8mm Tape Library Model 3xx Operator Guide*
 2. Remove the obstruction.
 3. Power-on the library. See the *7331 and 3449 8mm Tape Library Model 3xx Operator Guide*
 4. If the error is cleared, this procedure is complete. Return to the library service procedure that sent you here.
 5. If the error has not cleared, go to "Step 13c" on page 132.
- NO** Go to "Step 13c" on page 132.

Step 13c

Is the ambient temperature too high (5 to 40°C or 41 to 104°F)?

- YES** Do the following:
1. Lower the ambient temperature.
 2. When the ambient temperature is at the correct level, power-on the library. See the *7331 and 3449 8mm Tape Library Model 3xx Operator Guide*.
 3. If the error is cleared, this procedure is complete. Return to the library service procedure that sent you here.
 4. If the error has not cleared, go to “Step 3, SAC 01” on page 121.
- NO** Go to “Step 3, SAC 01” on page 121.

Step 14, SAC 12

An accessor locked condition has been detected.

1. Open the library front door. See the *7331 and 3449 8mm Tape Library Model 3xx Operator Guide*

CAUTION:

Do not place a highly reflective surface between either the picker assembly and the tape cartridge magazines or between the picker assembly and the tape drives. This may cause damage to your eyes. (RSFTC238)

CAUTION:

If the automatic lock on the front door is not functioning and the door is open, do not look directly at the laser beam. Staring at the beam may cause damage to your eyes. (RSFTC239)

2. Verify the accessor lock (blue plastic at top of accessor) is fully retracted.

Is accessor lock fully retracted?

- YES** Go to “Step 3, SAC 01” on page 121.
- NO** Do the following:
1. Retract and secure the accessor lock.
 2. Make sure the accessor lock sensor cable is fully connected.
 3. Close the library door.
 4. If the service actions corrected the problem, return to the library service procedure that sent you here.
 5. If the service actions did not correct the problem, go to “Step 3, SAC 01” on page 121.

Step 15, SAC 13

Go to “History Log Display” on page 19 and verify the source and destination of the move.

Is the destination full?

- YES** Do the following:
1. Return to the operation.
 2. Choose an empty destination and continue the operation.
 3. If the error reoccurs, go to “Step 15a.”
- NO** Go to “Step 15a.”

Step 15a

Perform calibration. Go to “Library Calibration” on page 28.

Does the problem still exist?

- YES** Go to “Step 3, SAC 01” on page 121 and use a FRU Group of 03.
- NO** Return to the library service procedure that sent you here.

Step 16, SAC 14

1. Open the library front door. See the *7331 and 3449 8mm Tape Library Model 3xx Operator Guide*

Note: As long as power is applied to the library, the move buttons located inside the library front door on the back of the control panel card can be used to move the picker assembly up and down.

CAUTION:

Do not place a highly reflective surface between either the picker assembly and the tape cartridge magazines or between the picker assembly and the tape drives. This may cause damage to your eyes. (RSFTC238)

CAUTION:

If the automatic lock on the front door is not functioning and the door is open, do not look directly at the laser beam. Staring at the beam may cause damage to your eyes. (RSFTC239)

2. Check for tape cartridge magazines that are not fully seated and tape cartridges that are not fully seated in magazine slots.

Are all tape cartridge magazines and all tape cartridges fully seated?

- YES** Go to “Step 16a” on page 134.
- NO** Go to “Step 16b” on page 134.

Step 16a

Is there a tape cartridge stuck in the picker assembly?

- YES** Do the following:
1. Go to "Removing a Tape Cartridge Stuck in the Picker" on page 104.
 2. Make sure all cartridges are fully seated and the library is operational.
 3. Power-on the library. See the *7331 and 3449 8mm Tape Library Model 3xx Operator Guide*
 4. If the error cleared, return to the library service procedure that sent you here.
 5. If the error did not clear, go to "Step 3, SAC 01" on page 121.
- NO** Go to "Step 5, SAC 03" on page 124.

Step 16b

1. Make sure all tape cartridge magazines and all tape cartridges are fully seated.
2. Close the library door.

Does the error clear?

- YES** If the error cleared, return to the library service procedure that sent you here.
- NO** Go to "Step 16a."

Step 17, SAC 15

1. Open the library front door. See the *7331 and 3449 8mm Tape Library Model 3xx Operator Guide*

Note: As long as power is applied to the library, the move buttons located inside the library front door on the back of the control panel card can be used to move the picker assembly up and down.

CAUTION:

Do not place a highly reflective surface between either the picker assembly and the tape cartridge magazines or between the picker assembly and the tape drives. This may cause damage to your eyes. (RSFTC238)

CAUTION:

If the automatic lock on the front door is not functioning and the door is open, do not look directly at the laser beam. Staring at the beam may cause damage to your eyes. (RSFTC239)

2. If the picker is positioned in front of the tape drive, use the move buttons to reposition the picker away from the tape drives.
3. Press the tape drive unload button.

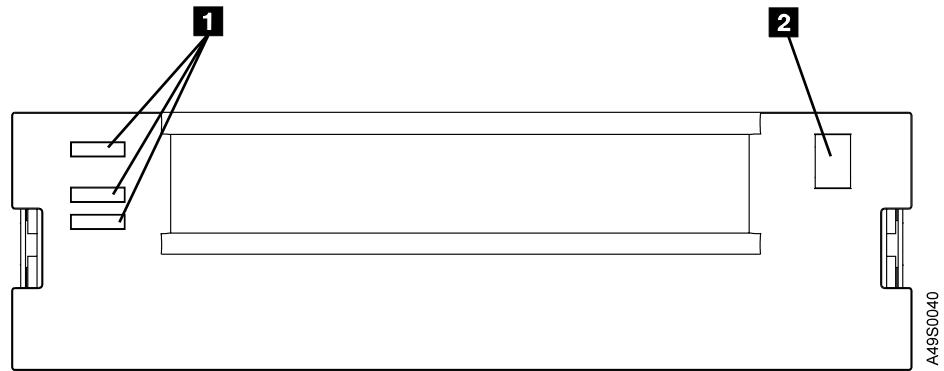

Figure 102. Tape Drive Status Lights and Unload Button

In Figure 102, Item 1 is the column of status lights made up of (top to bottom) DISTURBANCE, READY, and READ-WRITE indicators, and Item 2 is the UNLOAD BUTTON.

Did the tape drive eject a tape cartridge?

YES

Do the following:

1. Close the library door.
2. Use the move command to move a tape cartridge to the problem tape drive. See the *7331 and 3449 8mm Tape Library Model 3xx Operator Guide* for instructions on moving a tape cartridge.
3. Use the move command to move the tape cartridge from the problem tape drive to an empty slot.
4. If the error reoccurs, go to “Step 3, SAC 01” on page 121.
5. If the error cleared and does not reoccur, return to the library service procedure that sent you here.

NO

Go to “Step 17a.”

Step 17a

Open the tape drive door and check for a tape cartridge stuck in the drive.

Is a tape cartridge stuck in the tape drive?

YES

Perform the following:

1. Go to “Manually Removing a Tape Cartridge” on page 100.
2. Perform calibration. Go to “Library Calibration” on page 28.
3. If calibration failed, go to “Step 3, SAC 01” on page 121, except do not replace the tape drive if a new one was just installed.
4. If calibration passed, use the move command to move a tape cartridge to the tape drive then to an empty slot.
5. If the error reoccurs, go to “Step 3, SAC 01” on page 121, except do not replace the tape drive if a new one was just installed.

6. If the error cleared and does not reoccur, return to the library service procedure that sent you here.

NO

Go to "Step 3, SAC 01" on page 121.

PAP 4, Power System Check

This Problem Analysis Procedure verifies the integrity of the 7331 Tape Library power system. For information on power distribution within the library, refer to “Power Distribution” on page 9.



Note: The above symbol indicates appropriate caution to address in this “PAP 4, Power System Check” section of the manual.

Step 1

1. If not already done, perform the following operations:
 - a. Do a controlled system shutdown.
 - b. Remove all library covers. Go to “Library Cover Set Removal and Installation” on page 44.

DANGER

To prevent a possible electrical shock when installing the device, ensure that the power cord for that device is unplugged before installing signal cables. (RSFTD204)

DANGER

To prevent a possible electrical shock from touching two surfaces with different electrical grounds, use one hand, when possible, to connect or disconnect signal cables. (RSFTD004)

- c. Install a jumper at JP1 (power-switch override) on the controller card. Go to “Power-Switch Override Jumper Installation and Removal” on page 150.
 - d. Unplug the library power cable from the power outlet.
2. If not already done, disconnect the following power cables:
 - Power cable to the controller card
 - Tape drive power cable to Tape Drive 1
 - Tape drive power cable to Tape Drive 2
3. Make sure the power supply power-sense cable is connected to P2 on the controller card.
4. Plug the library power cable into a grounded outlet.

Is the power supply fan is Off? (Refer to Figure 103 on page 139.)

YES Go to “Step 2” on page 138.

NO Go to “Step 5” on page 138.

Step 2

Is this the first time to this step in this procedure?

- YES** Do the following:
1. Replace the power supply. Go to “Power Supply Removal and Installation” on page 71.
 2. Go to “Step 1” on page 137.
- NO** Go to “Step 3.”

Step 3

Is this the first time to this step in this procedure?

- YES** Do the following:
1. Replace the controller card. Go to “Controller Card Removal and Installation” on page 74.
 2. Go to “Step 1” on page 137.
- NO** Go to “Step 4.”

Step 4

1. Call the 8mm Tape Library service representative or the next level of support.
2. The problem was resolved with technical support assistance.
3. Make sure all cables are connected and all the library covers are installed.
4. Return to the library service procedure that sent you here or prepare library for operational use.

Step 5

1. Unplug the library power cable from the power outlet.
2. Connect the power cable from the power supply to the controller card.
3. Make sure the power supply power-sense cable is connected to P2 on the controller card.
4. If the tape drive power cables to Tape Drive 1 and Tape Drive 2 are connected, disconnect them.
5. Plug the library power cable into a grounded outlet.

Is the controller card Power Good LED (green) On? (Refer to Figure 103 on page 139.)

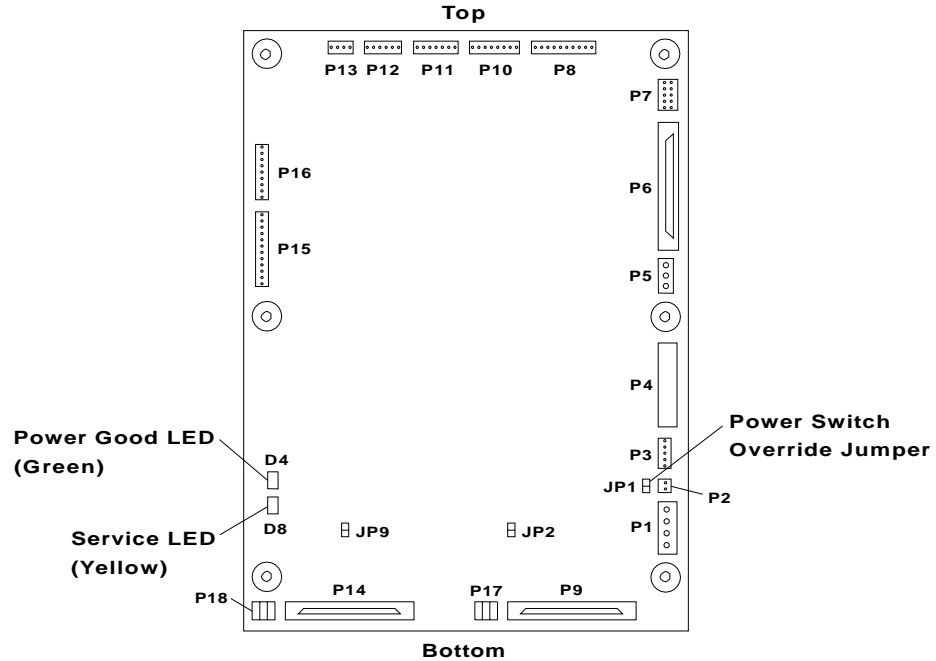

ASLUP1-00

Figure 103. Controller Card LEDs

- YES** Go to “Step 12” on page 140.
- NO** Go to “Step 6.”

Step 6

Do you have a voltmeter?

- YES** Go to “Step 7.”
- NO** Go to “Step 9” on page 140.

Step 7

Measure the voltages on the controller card. Go to “Controller Card Voltage Measurement” on page 153.

Are the voltages within tolerance?

- YES** Do the following:
1. Replace the controller card. Go to “Controller Card Removal and Installation” on page 74.
 2. Go to “Step 5” on page 138
- NO** Go to “Step 8.”

Step 8

1. Unplug the library power cable from the power outlet.
2. Disconnect the power cable to the controller card.
3. Measure the voltage on all of the power cables coming from the power supply. Go to “Power Supply Voltage Measurement” on page 152.

Are the voltages within tolerance?

YES Go to "Step 12."

NO Do the following:

1. Replace the power supply. Go to "Power Supply Removal and Installation" on page 71.
2. Go to "Step 5" on page 138.

Step 9

Is this the first time to this step in this procedure?

YES Do the following:

1. Replace the power supply. Go to "Power Supply Removal and Installation" on page 71.
2. Go to "Step 5" on page 138.

NO Go to "Step 10."

Step 10

Is this the first time to this step in this procedure?

YES Do the following:

1. Replace the controller card. Go to "Controller Card Removal and Installation" on page 74.
2. Go to "Step 5" on page 138.

NO Go to "Step 11."

Step 11

1. Call the 8mm Tape Library service representative or the next level of support.
2. The problem was resolved with technical support assistance.
3. Make sure all cables are connected and all the library covers are installed.
4. Return to the library service procedure that sent you here or prepare library for operational use.

Step 12

1. Unplug the library power cable from the power outlet.
2. Connect the tape drive power cable 1 to Tape Drive 1.
3. Plug the library power cable into a grounded outlet.

Is the Controller Card Power Good LED (green) On?

YES Go to "Step 16" on page 142.

NO Go to "Step 13" on page 141.

Step 13

1. Unplug the library power cable from the power outlet.
2. Disconnect the tape drive power cable 1 from Tape Drive 1.
3. Connect the tape drive power cable 2 to Tape Drive 2.
4. Plug the library power cable into a grounded outlet.

Is the Controller Card Power Good LED (green) On?

YES Go to "Step 14."

NO Do the following:

1. Replace the power supply. Go to "Power Supply Removal and Installation" on page 71.
2. Disconnect the tape drive power cables from Tape Drive 1 and Tape Drive 2.
3. Go to "Step 12" on page 140.

Step 14

1. Unplug the library power cable from the power outlet.
2. Disconnect the tape drive power cable 2 from Tape Drive 2.
3. Connect the tape drive power cable 2 to Tape Drive 1.
4. Plug the library power cable into a grounded outlet.

Is the Controller Card Power Good LED (green) On?

YES Do the following:

1. Replace the power supply. Go to "Power Supply Removal and Installation" on page 71.
2. Disconnect the tape drive power cables from Tape Drive 1 and Tape drive 2.
3. Go to "Step 12" on page 140.

NO Go to "Step 15."

Step 15

Is this the first time to this step in this procedure?

YES Do the following:

1. Replace Tape Drive 1. Go to "Tape Drive Removal and Installation" on page 67.
2. Go to "Step 12" on page 140.

NO Do the following:

1. Call the 8mm Tape Library service representative or the next level of support.
2. The problem was resolved with technical support assistance.
3. Make sure all cables are connected and all the library covers are installed.

4. Return to the library service procedure that sent you here or prepare library for operational use.

Step 16

1. Unplug the library power cable from the power outlet.
2. If not already done, connect the tape drive power cable 1 to Tape Drive 1.
3. Connect the tape drive power cable 2 to Tape Drive 2.
4. Plug the library power cable into a grounded outlet.

Is the Controller Card Power Good LED (green) On?

YES Go to "Step 20" on page 143.

NO Go to "Step 17."

Step 17

1. Unplug the library power cable from the power outlet.
2. Disconnect the tape drive power cable 1 from Tape Drive 1.
3. Plug the library power cable into a grounded outlet.

Is the Controller Card Power Good LED (green) On?

YES Do the following:

1. Replace the power supply. Go to "Power Supply Removal and Installation" on page 71.
2. Disconnect the tape drive power cables from Tape Drive 1 and Tape Drive 2.
3. Go to "Step 16."

NO Go to "Step 18."

Step 18

1. Unplug the library power cable from the power outlet.
2. Disconnect the tape drive power cable 2 from Tape Drive 2.
3. Connect the tape drive power cable 1 to Tape Drive 2.
4. Plug the library power cable into a grounded outlet.

Is the Controller Card Power Good LED (green) On?

YES Do the following:

1. Replace the power supply. Go to "Power Supply Removal and Installation" on page 71.
2. Disconnect the tape drive power cables from Tape Drive 1 and Tape Drive 2.
3. Go to "Step 16."

NO Go to "Step 19" on page 143.

Step 19

Is this the first time to this step in this procedure?

YES

Do the following:

1. Replace Tape Drive 2. Go to "Tape Drive Removal and Installation" on page 67.
2. Go to "Step 12" on page 140.

NO

Do the following:

1. Call the 8mm Tape Library service representative or the next level of support.
2. The problem was resolved with technical support assistance.
3. Make sure all cables are connected and all the library covers are installed.
4. Return to the library service procedure that sent you here or prepare library for operational use.

Step 20

1. Remove the jumper from JP1 (power-switch override) on the controller card. Go to "Power-Switch Override Jumper Installation and Removal" on page 150.
2. Unplug the library power cable from the power outlet.
3. Replace any library covers removed during the power problem analysis procedure. Go to "Library Cover Set Removal and Installation" on page 44.
4. Plug the library power cable into a grounded outlet.
5. This procedure is complete, return to the library service procedure that sent you here.

PAP 5, Control Panel Nonfunctional

This procedure is used to analyze a library that is not responding to any control panel input.



Note: The above symbol indicates appropriate caution to address in this “PAP 5, Control Panel Nonfunctional” section of the manual.

Step 1

1. If you have not already done so, do a controlled system shutdown.
2. Open the control panel access cover and press the control panel power switch (Ⓢ) to turn the library power Off.
3. Unplug the library power cord from the power outlet and wait 10 seconds. (Ensures a power supply reset.)
4. Plug the library power cord into a grounded power outlet.
5. Press the control panel power switch (Ⓢ) to turn the library power On.
6. Press the control panel Up (⬆) or Down (⬇) button.

Did the control panel respond when the buttons were pressed?

YES

Do the following:

1. The non-response condition is no longer present, and the cause of the problem cannot be determined at this time.
2. If the library covers are off, install the covers. Go to “Library Cover Set Removal and Installation” on page 44.
3. This procedure is complete, return to the library service procedure that sent you here.

NO

Go to “Step 2.”

Step 2

1. Open the control panel access cover and press the control panel power switch (Ⓢ) to turn the library power Off.
2. Remove all library covers. Go to “Library Cover Set Removal and Installation” on page 44.
3. If the library is not connected to a host computer system and the SCSI terminators are installed, make sure the jumpers are installed at JP2 and JP9 (Primary and Secondary SCSI Port Term Power) on the controller card.

DANGER

To prevent a possible electrical shock when installing the device, ensure that the power cord for that device is unplugged before installing signal cables. (RSFTD204)

DANGER

To prevent a possible electrical shock from touching two surfaces with different electrical grounds, use one hand, when possible, to connect or disconnect signal cables. (RSFTD004)

4. Make sure the library internal SCSI bus cables are connected and properly terminated. See "Internal SCSI Cable Group Removal and Installation" on page 78 for internal SCSI cable configuration and the *7331 and 3449 8mm Model 3xx Installation Guide* for the proper termination for your library configuration.
5. Make sure the SCSI ID Address cable is connected to each tape drive and the controller card P15. The longest SCSI ID address cable connects to Tape Drive 1. The cable is connected to the tape drive with the alignment dot in the up position.

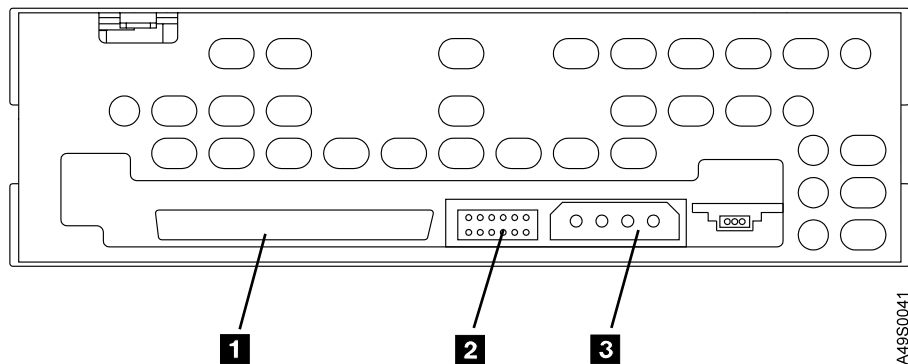

Figure 104. SCSI ID Address Cable Connections

The items identified in Figure 104 are as follows:

- Item 1 - SCSI Signal Cable.
- Item 2 - SCSI ID Address Cable.
- Item 3 - 4-pin Power Connector.

Were any cables connected in this step?

YES



Do the following:

1. Open the control panel access cover and press the control panel power switch (Ⓜ) to turn the library power On.
2. Press the control panel Up (⬆) or Down (⬇) button.
3. If control panel responds, go to "Step 3" on page 146.
4. If control panel does not respond, go to "Step 4" on page 146.





NO

Go to "Step 4" on page 146.

Step 3

1. Press the control panel power switch () to turn the library power Off.
2. Install the library covers. Go to “Library Cover Set Removal and Installation” on page 44.
3. Press the control panel power switch () to turn the library power On.
4. This procedure is complete, return to the library service procedure that sent you here.



Step 4

1. If the library power is not Off, press the control panel power switch () to turn the library power Off.
2. Disconnect the SCSI signal cable from Tape Drive 1.
3. Press the control panel power switch () to turn the library power On.
4. Press the control panel Up () or Down () button.

Did the control panel respond when the buttons were pressed?

YES

Do the following:





1. Replace Tape Drive 1. Go to “Tape Drive Removal and Installation” on page 67.
2. Make sure all cables are connected to Tape Drive 1.
3. Press the control panel power switch () to turn the library power On.
4. Press the control panel Up () or Down () button.
5. If control panel responds, go to “Step 3.”
6. If control panel does not respond, go to “Step 5.”

NO

Do the following:

1. Press the control panel power switch () to turn the library power Off.
2. Reconnect the SCSI signal cable to Tape Drive 1.
3. Go to “Step 5.”

Step 5

1. If the library power is not Off, press the control panel power switch () to turn the library power Off.
2. Disconnect the SCSI signal cable from Tape Drive 2.
3. Press the control panel power switch () to turn the library power On.
4. Press the control panel Up () or Down () button.

Did the control panel respond when the buttons were pressed?

YES

Do the following:

1. Replace Tape Drive 2. Go to “Tape Drive Removal and Installation” on page 67.
2. Make sure all cables are connected to Tape Drive 2.

3. Press the control panel power switch (Ⓞ) to turn the library power On.
4. Press the control panel Up (⬆) or Down (⬇) button.
5. If control panel responds, go to “Step 3” on page 146.
6. If control panel does not respond, go to “Step 6.”

NO

Do the following:

1. Press the control panel power switch (Ⓞ) to turn the library power Off.
2. Reconnect the SCSI signal cable to Tape Drive 2.
3. Go to “Step 6.”

Step 6

1. If the library power is not Off, press the control panel power switch (Ⓞ) to turn the library power Off.
2. Disconnect the internal SCSI cables from P9 and P14 on the controller card.
3. Press the control panel power switch (Ⓞ) to turn the library power On.
4. Press the control panel Up (⬆) or Down (⬇) button.

Did the control panel respond when the buttons were pressed?

YES

Do the following:

1. Replace the controller card. Go to “Controller Card Removal and Installation” on page 74.
2. Make sure all cables are connected to controller card.
3. Press the control panel power switch (Ⓞ) to turn the library power On.
4. Press the control panel Up (⬆) or Down (⬇) button.
5. If control panel responds:
 - a. Perform library calibration, go to “Library Calibration” on page 28.
 - b. Go to “Step 3” on page 146.
6. If control panel does not respond, go to “Step 7” on page 148.

NO

Do the following:

1. Press the control panel power switch (Ⓞ) to turn the library power Off.
2. Connect the primary internal SCSI cable to P9 on the controller card and the secondary SCSI cable to P14 on the controller card. See “Internal SCSI Cable Group Removal and Installation” on page 78 for internal SCSI cable configuration.
3. Go to “Step 7” on page 148.

Step 7

1. If the library power is not Off, press the control panel power switch (Ⓢ) to turn the library power Off.
2. Disconnect the external SCSI cables at the back of the library.
3. Install jumpers at JP2 and JP9 (SCSI port term power) on the controller card. See Figure 105.

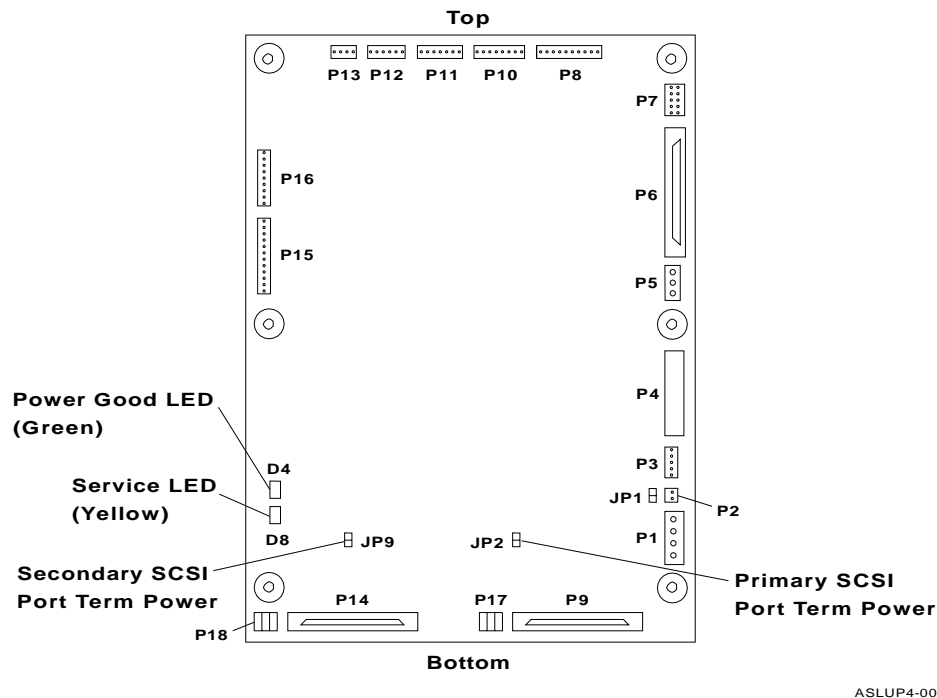

Figure 105. Controller Card LEDs and SCSI Port Term Power Jumpers

4. Press the control panel power switch (Ⓢ) to turn the library power On.
5. Press the control panel Up (⬆) or Down (⬇) button.

Did the control panel respond when the buttons were pressed?

YES

Do the following:

1. Replace the internal SCSI cables. Go to "Internal SCSI Cable Group Removal and Installation" on page 78.
2. Make sure all internal and external SCSI cables are connected.
3. Remove the jumpers from JP2 and JP9 (SCSI port term power) on the controller card. See Figure 105.
4. Press the control panel power switch (Ⓢ) to turn the library power On.
5. Press the control panel Up (⬆) or Down (⬇) button.
6. If control panel responds, go to "Step 3" on page 146.
7. If control panel does not respond, go to "Step 8" on page 149.

NO

Do the following:

1. Press the control panel power switch () to turn the library power Off.
2. Connect the external SCSI cables at the back of the library.
3. Remove the jumpers from JP2 and JP9 (SCSI port term power) on the controller card. See Figure 105 on page 148
4. Go to "Step 8."

Step 8

1. If you have completed the service actions for all the FRUs in the FRU Group and the problem still exists, call the 8mm Tape Library service representative or the next level of support.
2. The problem was resolved with technical support assistance.
3. Make sure all cables are connected and all the library covers are installed.
4. Return to the library service procedure that sent you here or return the library to the operational mode it was in before the error condition.

Power-Switch Override Jumper Installation and Removal

Attention: Do not enter the manual here unless you have been directed to do so by another procedure in this book.



Note: The above symbol indicates appropriate caution to address in this “Power-Switch Override Jumper Installation and Removal” section of the manual.

An installed controller card power-switch override jumper overrides the library power switch and turns on the library power supply when the library power cord is plugged into an outlet. The jumper should not be installed during normal operation.

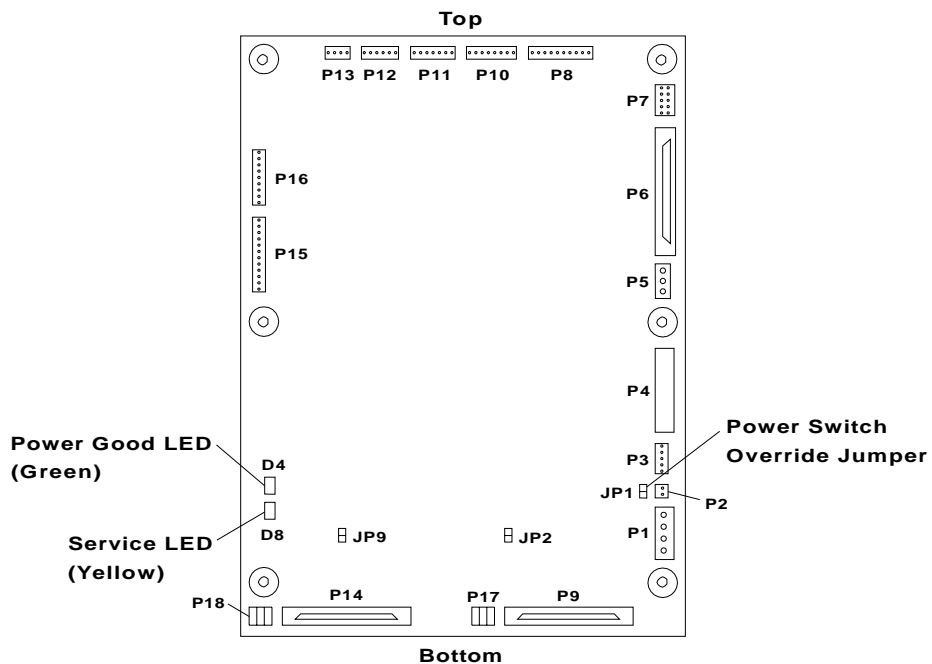

ASLUP1-00

Figure 106. Controller Card Power-Switch Override Jumper

To install or remove the controller card power-switch override jumper (see Figure 106 on page 150), do the following:

1. Unplug the library power cord.

DANGER

To prevent a possible electrical shock when installing the device, ensure that the power cord for that device is unplugged before installing signal cables. (RSFTD204)

DANGER

To prevent a possible electrical shock from touching two surfaces with different electrical grounds, use one hand, when possible, to connect or disconnect signal cables. (RSFTD004)

2. Carefully, remove or install the jumper at JP1 (power-switch override) on the controller card.
3. Plug the library power cord into a grounded outlet.

Power Supply Voltage Measurement



Note: The above symbol indicates appropriate caution to address in this “Power Supply Voltage Measurement” section of the manual.

DANGER

To prevent a possible electrical shock when installing the device, ensure that the power cord for that device is unplugged before installing signal cables. (RSFTD204)

DANGER

To prevent a possible electrical shock from touching two surfaces with different electrical grounds, use one hand, when possible, to connect or disconnect signal cables. (RSFTD004)

Attention: Do not enter the manual here unless you have been directed to do so by another procedure in this book.

1. Make sure the following cables are disconnected:

Power cable to the controller card

Tape drive power cable to Tape Drive 1

Tape drive power cable to Tape Drive 2

2. Make sure the power supply power-sense cable is connected to P2 on the controller card.
3. Install the jumper at JP1 (power-switch override) on the controller card. Go to “Power-Switch Override Jumper Installation and Removal” on page 150.
4. Plug the library power cable into a grounded electrical outlet.
5. Using a voltmeter, carefully measure and record the following voltages on the power supply connectors. (See illustration below.)

Measure the +12 volt position for +11.4 to +12.6 volts.

Measure the +5 volt position for +4.75 to +5.25 volts.

Power Supply Connector

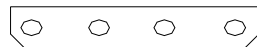

+5v Gnd Gnd +12v

SC2F1-00

6. Remove the jumper from JP1 (power-switch override) on the controller card. Go to “Power-Switch Override Jumper Installation and Removal” on page 150.
7. Return to the library service procedure that sent you here.

Controller Card Voltage Measurement

Attention: Do not enter the manual here unless you have been directed to do so by another procedure in this book.



Note: The above symbol indicates appropriate caution to address in this “Controller Card Voltage Measurement” section of the manual.

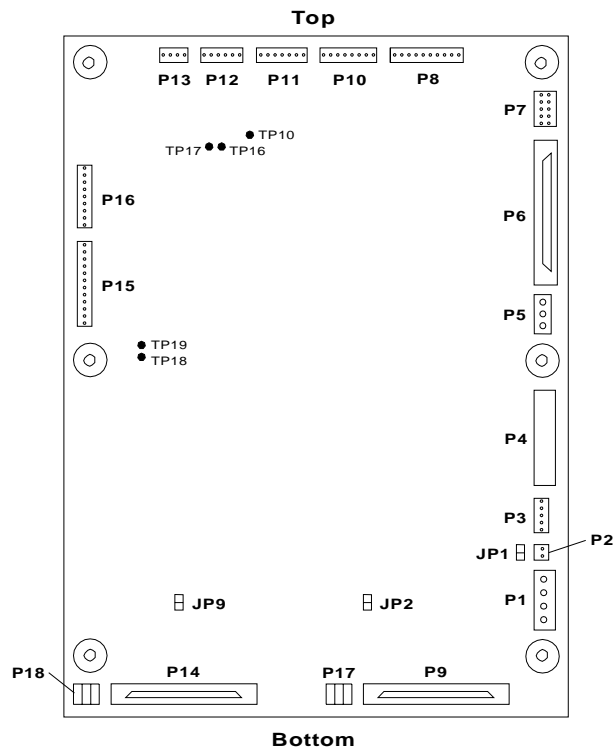

ASLUP2-00

Figure 107. Controller Card Voltage Test Points

1. DANGER

To prevent a possible electrical shock when installing the device, ensure that the power cord for that device is unplugged before installing signal cables. (RSFTD204)

DANGER

To prevent a possible electrical shock from touching two surfaces with different electrical grounds, use one hand, when possible, to connect or disconnect signal cables. (RSFTD004)

2. Make sure the power supply power-sense cable (see Figure 107 on page 153) is connected to P2 on the controller card.
3. Install a jumper at JP1 (power-switch override) on the controller card. Go to "Power-Switch Override Jumper Installation and Removal" on page 150.
4. Plug the library power cable into a grounded electrical outlet.
5. Using a voltmeter, carefully measure and record the voltages as indicated in "Controller Card Voltage Measurement" on page 153.

Figure 108. Controller Card Voltages

Test Point	Signal Name	Voltage Range	Description
TP 10	+12V	+11.4 to +12.6V	Power supply voltage monitor
TP 16	-15V	-13.5 to -16.5V	Local inverter output monitor
TP 17	-12V	-11.75 to -12.25V	Local regulator output monitor
TP 18	+5V	+4.75 to +5.25V	Power supply voltage monitor
TP 19	GND		Signal ground

6. Remove the jumper from JP1 on (power-switch override) on the controller card. Go to "Power-Switch Override Jumper Installation and Removal" on page 150.
7. Return to the procedure that sent you here.

Appendix A. Error Codes and Related Service Actions

Unit Error Codes (UECs)

Figure 109 lists UEC codes generated by the 8mm Tape Library. Most of these UEC codes are returned in the SCSI Request Sense data and also displayed on the front panel. The table includes the FRU Group for each UEC.

Attention: Do not start 8mm Tape Library problem analysis with Figure 109. This table is used in support of other service tables and procedures, and is only used when it is referenced by those service procedures and tables.

Error codes sorted by UEC

<i>Figure 109 (Page 1 of 7). Error codes sorted by UEC</i>						
UEC	SAC	UEC Description	Sense Key Byte 2, Bits 3-0	ASC/ASCQ Bytes 12/13	RAC/BRAC Bytes 21/22	FRU Group Byte 14
0102	00	Operation cancelled at control panel	6	2A/01	02/01	00
0103	01	Logical unit is in process of becoming ready	2	04/01	06/01	05
0104	11	Over temperature sensed on controller card	2	04/92	15/01	0D
0105	05	Synchronous data transfer error	B	1B/00	02/01	04
0106	01	Cartridge present in magazine sensor error	4	40/89	01/01	02
0114	01	Degraded mode / RAM microcode not loaded	4	4C/00	01/01	05
0115	01	Degraded mode / RAM microcode incomplete	4	40/85	01/01	05
011D	00	SCSI message error	B	43/00	02/01	00
011E	00	SCSI message error	B	43/00	02/01	00
0122	01	Degraded mode / bringup successful	4	40/80	01/01	05
012C	01	SBIC internal parity error	4	44/00	01/01	05
012D	01	Cannot resume function	B	44/00	02/01	05
0130	00	Invalid command operation code	5	20/00	09/01	00
0132	00	Invalid field in CDB	5	24/00	09/01	00
0133	00	Logical unit not supported	5	25/00	09/01	00
0134	00	Invalid field in parameter list	5	26/00	09/01	00
0135	00	Parameter list length error	5	1A/00	09/01	00
0136	00	Load ID mismatch	5	26/00	09/01	00
0137	00	Invalid field in CDB	5	24/00	09/01	00
0138	00	Invalid field in parameter list	5	26/00	09/01	00
013A	00	Invalid field in CDB	5	24/00	09/01	00

Figure 109 (Page 2 of 7). Error codes sorted by UEC

UEC	SAC	UEC Description	Sense Key Byte 2, Bits 3-0	ASC/ASCQ Bytes 12/13	RAC/BRAC Bytes 21/22	FRU Group Byte 14
013B	00	Downloaded microcode checksum failed	5	26/02	09/01	00
0141	00	Power On, Reset, or Bus device reset occurred	6	29/00	05/01	00
0142	00	Unit attention - Mode parameters changed	6	2A/01	02/01	00
0144	00	Commands cleared by another initiator	6	2F/00	02/01	00
0145	00	Power on, Reset, or Bus device reset occurred	6	29/00	05/01	00
0146	00	Inquiry data has changed	6	3F/03	02/01	00
0148	00	Inventory changed by operator or another initiator	6	28/80	02/01	00
0149	00	Unit attention - Log changed	6	2A/02	02/01	00
014A	00	Unit Attention - Mode changed	6	2A/01	02/01	00
014B	01	Generic microprocessor error	4	40/81	01/01	05
014C	01	Microprocessor PCM register error	4	40/81	01/01	05
014D	01	Microprocessor timer error	4	40/81	01/01	05
014E	01	Microprocessor stack error	4	40/81	01/01	05
014F	01	ROS microcode checksum error	4	40/81	01/01	05
0150	01	Control store RAM error	4	40/80	01/01	05
0151	01	NVRAM clock error	4	40/82	01/01	05
0152	01	NVRAM error	4	40/88	17/01	05
0153	01	SCSI port #1 BIST never finished	4	40/83	01/01	05
0154	01	SCSE port #2 BIST never finished	4	40/84	01/01	05
0155	01	SCSI port #1 BIST error	4	40/83	01/01	05
0156	01	SCSI port #2 BIST error	4	40/84	01/01	05
0157	01	SCSI port #1 BIST flag error	4	40/83	01/01	05
0158	01	SCSI port #2 BIST flag error	4	40/84	01/01	05
0159	01	SCSI port #1 dual port RAM error	4	40/83	01/01	05
015A	01	SCSI port #2 dual port RAM error	4	40/84	01/01	05
015B	01	FPGA DONE Not Active Error	4	40/8C	01/01	05
015C	01	Accessor motor controller R/W register test error	4	40/86	01/01	05
015D	01	UART error	4	40/8D	01/01	05
015E	06	Barcode scanner error	4	40/87	01/01	0A
015F	00	SCSE RESET deassertion timeout	4	00/00	01/01	00
0160	00	Initiator detected error message received	B	48/00	09/01	00
0161	00	SCSI parity error (cmd or data)	B	47/00	02/01	00
0162	00	Overlapped commands attempted	B	4E/00	09/01	00
0163	01	LCD error	4	40/88	01/01	09

Figure 109 (Page 3 of 7). Error codes sorted by UEC

UEC	SAC	UEC Description	Sense Key Byte 2, Bits 3-0	ASC/ASCQ Bytes 12/13	RAC/BRAC Bytes 21/22	FRU Group Byte 14
0164	01	Upper-Lower limit sensor conflict	4	40/89	01/01	0B
0165	01	Generic sensor error	4	40/89	01/01	0B
0166	03	Acsr motor overcurrents detected	4	40/8B	01/01	01
0167	04	Uncontrollable accessor	4	40/8B	01/01	01
0168	01	Incompatible hardware	4	40/8C	01/01	05
0169	02	Feed motor overcurrents detected	4	40/8A	01/01	02
016A	02	Pick motor overcurrents detected	4	40/8A	01/01	02
016B	04	Acsr motor out of control detect	4	40/8B	01/01	01
016C	01	Feed motor out of control detect	4	40/8A	01/01	02
016D	01	Internal target failure - Unexpected bus free	4	44/00	01/01	05
016E	01	Pick motor out of control detect	4	40/8A	01/01	02
016F	01	Bar scanner not present error	4	40/87	01/01	0A
0170	00	Abnormal termination, Abort message received	n/a	00/00	00/00	00
0171	00	Different LUN addressed (ID Message) from first selected	B	25/00	09/01	00
0172	00	SCSI Message error	B	43/00	02/01	00
0173	00	Select or Reselect failure	B	45/00	01/01	00
0174	00	SCSI parity error (msg out)	B	47/00	02/01	00
0175	00	Initiator detected error	B	48/00	09/01	00
0176	00	Invalid message error	B	49/00	09/01	00
0177	00	SCSI message error	B	43/00	02/01	00
0178	00	SCSI message error	B	43/00	02/01	00
0179	00	Reserved bits in identify message not 0	5	3D/00	09/01	00
017A	00	SCSI parity error detected by initiator	B	47/00	02/01	00
017B	05	Internal target failure - SCSI interrupt invalid	4	44/00	01/01	05
017C	00	Abort tag message received	n/a	00/00	05/01	00
017D	00	Clear queue tag message received	n/a	00/00	05/01	00
017E	01	NVRAM watch dog timer error	4	40/82	01/01	05
017F	01	NVRAM battery error	4	40/82	01/01	05
0180	01	GA ram error	4	40/8C	01/01	05
0181	04	Acsr motor error	4	40/8B	01/01	01
0182	01	Feed motor error	4	40/8A	01/01	02
0183	01	Pick motor error	4	40/8A	01/01	02
0184	01	Cool fan error	4	40/8E	01/01	0D
0185	01	Upper travel limit error	4	40/89	01/01	0B
0186	01	Lower travel limit error	4	40/89	01/01	0B
0187	01	Accessor overcurrent sensor error	4	40/8B	01/01	01

Figure 109 (Page 4 of 7). Error codes sorted by UEC

UEC	SAC	UEC Description	Sense Key Byte 2, Bits 3-0	ASC/ASCQ Bytes 12/13	RAC/BRAC Bytes 21/22	FRU Group Byte 14
0188	01	Accessor motor move error	4	40/8B	01/01	01
0189	01	Feed belt warning sensor	4	40/8A	01/01	02
018A	02	Feed belt overcurrent sensor	4	40/8A	01/01	02
018B	02	Feed belt move error	4	40/8A	01/01	02
018C	01	Pinch cam position sensor error	4	40/8A	01/01	02
018D	01	OP Panel presence error	4	40/88	01/01	09
018E	00	No empty slots in the library (manual move)	5	3B/0D	0D/01	00
018F	00	No tapes in the library	5	3B/0E	0D/01	00
0190	01	Invalid SCSI opcode (internal)	4	40/B0	01/01	05
0191	01	Accessor obstructed sensor error	4	40/93	01/01	0B
0192	01	Feed belt tach error	4	40/94	01/01	02
0197	01	No task available	4	40/B0	01/01	05
0199	01	Diagnostic failure SCSI port reset unsuccessful	4	40/B0	01/01	05
019A	01	Diagnostic failure stack has overflowed	4	40/B0	01/01	05
019B	01	Diagnostic failure divide by zero Interrupt	4	40/B0	01/01	05
019C	01	Diagnostic failure invalid program counter	4	40/B0	01/01	05
019D	01	Illegal CPU instruction error	4	40/B0	01/01	05
019F	01	SCSI invalid queue operation	4	40/B0	01/01	05
01A0	14	Accessor path not clear	2	04/8F	0F/01	00
01A1	00	Changed operating definition	6	3F/02	02/01	00
01A2	00	Command phase error	B	4A/00	02/01	00
01A3	00	Command sequence error	5	2C/00	09/01	00
01A4	00	Data phase error	B	4B/00	02/01	00
01A6	00	Invalid bits in identify message	B	3D/00	09/01	00
01A7	00	Invalid element address	5	21/01	09/01	00
01A8	00	I/O process terminated	B	00/06	09/01	00
01A9	00	Log counter at maximum	6	5B/02	08/05	00
01AA	00	Log list codes exhausted	5	5B/03	09/01	00
01AB	01	Logical unit failed self-configuration	4	4C/00	01/01	05
01AC	00	Logical unit not ready, cause not reportable	2	04/00	06/01	00
01AD	00	Logical unit not ready, manual intervention required	2	04/03	06/01	00
01AE	01	Mechanical positioning error	4	15/01	01/01	01
01AF	15	media load or eject failed	4	53/00	06/01	0E
01B0	15	Media load or eject failed	2	53/00	06/01	0E
01B1	13	Medium destination element full	5	3B/0D	0A/01	00

Figure 109 (Page 5 of 7). Error codes sorted by UEC

UEC	SAC	UEC Description	Sense Key Byte 2, Bits 3-0	ASC/ASCQ Bytes 12/13	RAC/BRAC Bytes 21/22	FRU Group Byte 14
01B1	00	Medium not present				00
01B3	00	Medium removal prevented	5	53/02	09/01	00
01B4	04	Medium source element empty	5	3B/0E	0A/01	00
01B7	00	Not ready to ready transition, medium may have changed	6	28/00	02/01	00
01B9	00	parameter not supported	5	26/01	09/01	00
01BA	00	Parameter value invalid	5	26/02	09/01	00
01BB	00	Rounded parameter	1	37/00	05/01	00
01BC	00	Saving parameters not supported	5	39/00	09/01	00
01BD	00	Threshold condition met	6	5B/01	08/05	00
01BE	00	Threshold parameters not supported	5	26/03	09/01	00
01BF	09	Open door	2	04/85	10/01	08
01C0	10	Cartridge holder is missing	2	04/86	11/01	0C
01C1	00	In manual mode	2	04/8D	06/01	00
01C2	00	In sequential mode	2	04/8E	06/01	00
01C3	02	Pick error	4	81/12	01/01	02
01C4	02	Place error	4	82/22	01/01	02
01C5	05	SCSI error communicating to tape drive	4	90/00	01/01	0E
01C6	00	Error log overflow	6	0A/00	08/05	00
01C7	00	Medium in picker (unable to scan barcodes)	2	04/90	0A/01	00
01C8	03	Move error	4	85/50	01/01	02
01C9	00	Medium in drive	5	3B/0D	0E/01	00
01CA	00	Element reserved by another initiator	n/a	80/00	00/00	00
01CB	00	Element status unknown - Initialize element status required	n/a	81/00	0B/01	00
01CC	00	Drive not present	n/a	82/00	00/00	00
01CD	00	Medium loaded in drive (unable to access)	2	83/00	0E/01	00
01CE	00	Need to calibrate tape locations	2	06/00	13/01	00
01CF	08	Barcode read error	n/a	11/00	16/01	0A
01D0	12	Accessor is locked	2	04/91	14/01	0B
01D1	02	Medium in picker	5	3B/80	01/01	00
01D2	00	No usable cleaning tape in library	n/a	00/00	12/01	00
01D3	00	Calibrate failed (missing cartridges)	n/a	00/00	0D/01	00
01D4	00	Calibrate failed (miscalculation)	n/a	00/00	0D/01	00
01D5	07	Calibrate failed (did not match table)	n/a	00/00	01/01	0C
01D6	01	Generic drive communication problem	4	90/00	01/01	0E
01D7	01	Drive comm. Invalid SCSI opcode	4	90/00	01/01	05

Figure 109 (Page 6 of 7). Error codes sorted by UEC

UEC	SAC	UEC Description	Sense Key Byte 2, Bits 3-0	ASC/ASCQ Bytes 12/13	RAC/BRAC Bytes 21/22	FRU Group Byte 14
01D8	01	Drive comm. Unexpected SCSI port number	4	90/00	01/01	05
01D9	05	Drive comm. Unexpected SCSI bus phase	4	90/00	01/01	0E
01DA	01	Drive comm. SBIC rejected start	4	90/00	01/01	05
01DB	01	Drive comm. Sequence address other than expected	4	90/00	01/01	05
01DC	05	Drive comm. Selection timeout	4	90/00	01/01	0E
01DD	05	Drive comm. Unexpected bit in stopu register	4	90/00	01/01	0E
01DE	05	Drive comm. Unexpected bit in uei register	4	90/00	01/01	05
01DF	00	Drive comm. Target mode interrupt pending	4	90/00	01/01	00
01E0	01	Cartridge travel warning sensor	4	04/8A	01/01	02
01E1	05	Drive 1 error	4	90/00	18/01	0E
01E2	05	Drive 1 present error	4	90/00	18/01	0E
01E3	05	Drive 1 third error	4	90/00	18/01	0E
01E4	05	Drive 2 error	4	90/00	18/01	0E
01E5	05	Drive 2 present error	4	90/00	18/01	0E
01E6	05	Drive 2 third error	4	90/00	18/01	0E
01E7	00	High SRAM error	4	40/81	01/01	05
01E8	00	Invalid packet from scanner	4	40/87	01/01	0A
01E9	00	No transmit ready from UART	4	40/87	01/01	05
01EA	00	Scanner - no CMDACK for CAPREQUEST	4	40/87	01/01	0A
01EB	00	Scanner - Timeout waiting for RTS	4	40/87	01/01	0A
01EC	00	Scanner - Timeout waiting for packet	4	40/87	01/01	0A
01ED	00	Scanner - Packet receive error (bad UART status)	4	40/87	01/01	0A
01EE	00	Scanner - Error sending IDREPLY	4	40/87	01/01	0A
01EF	00	Scanner - Error sending CMDACK	4	40/87	01/01	0A
01F0	00	Scanner - Error sending ATN	4	40/87	01/01	0A
01F1	01	Scanner - Error sending STORECAP	4	40/87	01/01	0A
01F2	01	Scanner - Error sending CAPREQUEST	4	40/87	01/01	0A
01F3	01	Scanner - no CMDACK received for ATN packet	4	40/87	01/01	0A
01F4	01	Scanner - Expected IDREQUEST not received	4	40/87	01/01	0A
01F5	01	Scanner - No CMDACK for IDREPLY packet	4	40/87	01/01	0A
01F6	01	Scanner - No CMDACK for STORECAP packet	4	40/87	01/01	0A

Figure 109 (Page 7 of 7). Error codes sorted by UEC

UEC	SAC	UEC Description	Sense Key Byte 2, Bits 3-0	ASC/ASCQ Bytes 12/13	RAC/BRAC Bytes 21/22	FRU Group Byte 14
01F7	01	Scanner - No CAPREPLY packet received	4	40/87	01/01	0A
01F8	01	Scanner - Expected CAPREQUEST not received	4	40/87	01/01	0A
01F9	01	RTS active at entry to xmit	4	40/87	01/01	0A
01FA	00	Codeload - No valid code load tape				0A
0200	00	Invalid Split source element	5	24/82	09/01	00
0201	00	Invalid Split destination element	5	24/83	09/01	00
0202	00	Inaccessible Split element	n/a	80/02	00/00	00
0203	00	Manual mode in Split configuration	5	24/85	09/01	00
0210	00	SCSI ID overlay error	n/a	90/00	20/01	00
Note: <ol style="list-style-type: none"> The unit error code (UEC) is described in this table. The service action code (SAC) cross references to Figure 99 on page 120 for a specific service actions required for the reported UEC. The field replacement unit (FRU) group code cross references to Figure 110 on page 161 for failing FRUs associated with the reported UEC. 						

FRU Group Codes

Figure 110 lists the library field replaceable unit (FRU) Group codes that are reported to the system unit in SCSI Request Sense data when a library assembly fails. The possible failing FRUs for the FRU Group are listed with their probability of correcting the problem.

Attention: Do not start 8mm Tape Library problem analysis with Figure 110. This table is used in support of other service tables and procedures, and is only used when it is referenced by those service procedures and tables.

Figure 110 (Page 1 of 2). 8mm Tape Library FRU Group Codes with Failing FRU Probabilities

FRU Group	Failing FRU	IBM P/N	Probability (%)
00	Reserved		
01	Accessor Assembly	86G9258	75
	Sensor Group	86G9260	10
	Controller Card	59H3410	10
	Other	-	5
02	Picker Assembly w/ umbilical cable	59H3409	75
	Accessor Assembly	86G9258	20
	Controller Card	59H3410	5

Figure 110 (Page 2 of 2). 8mm Tape Library FRU Group Codes with Failing FRU Probabilities

FRU Group	Failing FRU	IBM P/N	Probability (%)
03	Picker Assembly w/ umbilical cable	59H3409	75
	Accessor Assembly	86G9258	20
	Controller Card	59H3410	5
04	Controller Card	59H3410	95
	Internal SCSI Cable Group	86G9255	5
05	Controller Card	59H3410	100
06	Picker Assembly w/ umbilical cable	59H3409	55
	Accessor Assembly	86G9258	35
	Sensor Group	86G9260	10
	Other	-	5
07	Reserved		
08	Control Panel Assembly	87G1531	40
	Control Panel Cable	87G1554	40
	Front Door Assembly	59H3408	20
09	Control Panel Assembly	87G1531	55
	Control Panel Cable	87G1554	40
	Controller Card	59H3410	5
0A	Bar Code Reader	44H3620	70
	Picker Assembly w/ umbilical cable	59H3409	20
	Controller Card	59H3410	10
0B	Sensor Group	86G9260	95
	Controller Card	59H3410	5
0C	Magazine Mounting Plate	86G9299	70
	Magazine	86G9310	25
	Controller Card	59H3410	5
0D	Fan Assembly	86G9326	95
	Controller Card	59H3410	5
0E	Tape Drive	59H2842	60
	Internal SCSI Cable Group	87G1885	35
	Controller Card	59H3410	5
10-FF	Reserved		
Note:			
1. IBM part number cross references to Figure 111 on page 163 for a description of the Failing Item and any required service actions.			

Failing Items and Related Service Actions

Attention: Do not start 8mm Tape Library problem analysis with Figure 111. This table is used in support of other service tables and procedures, and is only used when it is referenced by those service procedures and tables.

Figure 111 (Page 1 of 4). Failing Items and Related Service Actions

Failing Item	Description	Service Action
A0B00E0	Licensed Internal Code for the programmable tape drive	Service Functions; APAR or LICTR
AJSLC01	I/O processor Licensed Internal Code	Service Functions; APAR or LICTR
FI01140	External SCSI Cable	Do the following: <ol style="list-style-type: none"> 1. Replace the cable. 2. Return to the service procedure that sent you here.
LIBDEV	Library Device	Do the following: <ol style="list-style-type: none"> 1. Go to "Analysis Starting Point" on page 107. 2. Return to the service procedure that sent you here.
59H2678	Defective tape	Do the following: <ol style="list-style-type: none"> 1. Replace the tape. 2. Return to the service procedure that sent you here.
ULYWAIT	Wait to next IPL or perform TU-PIP4	Problem Analysis
17G9134	Terminating plug	Do the following: <ol style="list-style-type: none"> 1. Replace the SCSI bus terminator. 2. Return to the service procedure that sent you here.
86G1554	Control Panel Cable	Do the following: <ol style="list-style-type: none"> 1. Go to "Control Panel Cable Removal and Installation" on page 54. 2. Return to the service procedure that sent you here.
59H2842	Tape Drive Assembly	Do the following: <ol style="list-style-type: none"> 1. Go to "Tape Drive Removal and Installation" on page 67. 2. Return to the service procedure that sent you here.

Figure 111 (Page 2 of 4). Failing Items and Related Service Actions

Failing Item IBM P/N	Description	Service Action
59H3409	Picker Assembly w/ umbilical cable	Do the following: 1. Go to "Picker (Assembly & Umbilical Cable) Removal and Installation" on page 83. 2. Return to the service procedure that sent you here.
59H3410	Controller Card	Do the following: 1. Go to "Controller Card Removal and Installation" on page 74. 2. Return to the service procedure that sent you here.
86G9255	Internal SCSI Cable Group	Do the following: 1. Go to "Internal SCSI Cable Group Removal and Installation" on page 78. 2. Return to the service procedure that sent you here.
86G9258	Accessor Assembly	Do the following: 1. Go to "Accessor Assembly Removal and Installation" on page 91. 2. Return to the service procedure that sent you here.
	Power Cord	Do the following: 1. Refer to Figure 127 on page 205.
86G9260	Sensor Group (Accessor Obstructed, Accessor Travel Limit, Accessor Lock with Cables)	Do the following: 1. Go to "Sensor Group Removal and Installation" on page 96. 2. Return to the service procedure that sent you here.
86G9274	Power supply	Do the following: 1. Go to "Power Supply Removal and Installation" on page 71. 2. Return to the service procedure that sent you here.
86G9299	Magazine Mount Plate Assembly (includes Sensors and Cables)	Do the following: 1. Go to 10 on page 60. 2. Return to the service procedure that sent you here.

Figure 111 (Page 3 of 4). Failing Items and Related Service Actions

Failing Item IBM P/N	Description	Service Action
86G9310	Magazine	Do the following: <ol style="list-style-type: none"> 1. Go to "Tape Cartridge Magazine Removal and Installation" on page 57. 2. Return to the service procedure that sent you here.
86G9312	2 Slot Cartridge Holder	Do the following: <ol style="list-style-type: none"> 1. Go to "2-Slot Cartridge Holder Removal and Installation" on page 62. 2. Return to the service procedure that sent you here.
86G9326	Fan Assembly	Do the following: <ol style="list-style-type: none"> 1. Go to "Fan Assembly Removal and Installation" on page 64. 2. Return to the service procedure that sent you here.
44H3620	Bar Code Reader Assembly	Do the following: <ol style="list-style-type: none"> 1. Go to "Bar Code Reader Removal and Installation" on page 88. 2. Return to the service procedure that sent you here.
87G1531	Control Panel Assembly	Do the following: <ol style="list-style-type: none"> 1. Go to "Control Panel Assembly Removal and Installation" on page 51. 2. Return to the service procedure that sent you here.
87G1601	SCSI Jumper	Do the following: <ol style="list-style-type: none"> 1. Replace the SCSI jumper. 2. Return to the service procedure that sent you here.
59H3408	Front Door Assembly, White (Includes Lock Solenoid and Sensor)	Do the following: <ol style="list-style-type: none"> 1. Go to "Front Door Assembly Removal and Installation" on page 48. 2. Return to the service procedure that sent you here.

Figure 111 (Page 4 of 4). Failing Items and Related Service Actions

Failing Item	Description	Service Action
IBM P/N 87G5109	Cover Set, White (Sides, Top and Back)	Do the following: <ol style="list-style-type: none">1. Go to "Library Cover Set Removal and Installation" on page 44.2. Return to the service procedure that sent you here.

Appendix B. Accessing the System Error Log for RS/6000 (7331 Model 305 only)

Error Log Analysis

The AIX Tape and Medium Changer Device Driver for the 7331 Tape Library provides logging to the system error log for a variety of errors. You can view the error log in various formats by using one of the following AIX commands:

smit command, see page “SMIT.”

TCTL command, see page “TCTL Analysis.”

errpt command, see page “ERRPT” on page 168.

tapeutil command, see page “Running Tapeutil” on page 171.

Use the Hex to ASCII conversion in Figure 119 on page 171. Examples of the different error log formats are shown following this text.

SMIT

The **smit** command has various ways to format the error log. To use the **smit** command:

1. Type **smit** at the AIX command line.
2. Select **Problem Determination** from the System Management menu.
3. Select **Error Log** from the Problem Determination menu.
4. Select **Generate Error Report** from the Error Log menu.
5. Select **filename**, then select **no** from the Single Select list.
6. From the Generate Error Report menu you can select the type of reports you want to view, then press the **Do** icon.
7. You can scroll through the log by using the up or down icons on the menu.

TCTL Analysis

TCTL is used to perform operations on a device. This is especially useful for those types of devices that are NOT accessible from Tapeutil (ex: 7331, 7336, etc.).

An example follows:

tctl -f/dev/rmt3 rewoff1 Rewind/Unload of a tape drive.

An alternate form of using TCTL is with line commands as shown below.

1. **Usage:** TCTL (-Bnv) (-b num) (-p device) (subcommand (count))
2. Valid Subcommands are:

weof	fsf	fsr	rewind	repffl
eof	bsf	bsr	offline	

ERRPT

To use the **errpt** command:

1. Select **errpt |pg** at the AIX command line. The summary report will be displayed.
2. Scroll through the log by pressing the Enter key for the next page.
3. Type **q** to quit the error log at any time.

Figure 112 is information for the 'errpt |pg' command.

IDENTIFIER	TIMESTAMP	T	C	RESOURCE_NAME	DESCRIPTION
2E2EFDDE	2 5 83897	U	H	rmt	UNDETERMINED ERROR
4865FA9B	2 5 83897	P	H	rmt	TAPE OPERATION ERROR
476B351D	2 5 83497	P	H	rmt	TAPE DRIVE FAILURE
2E2EFDDE	2 5 83497	U	H	rmt	UNDETERMINED ERROR
4865FA9B	2 5 82997	P	H	rmt2	TAPE OPERATION ERROR
5537AC5F	2 5 82697	P	H	rmt	TAPE DRIVE FAILURE
5537AC5F	2 5 82697	P	H	rmt	TAPE DRIVE FAILURE
5537AC5F	2 5 82697	P	H	rmt	TAPE DRIVE FAILURE
4865FA9B	2 5 82497	P	H	rmt	TAPE OPERATION ERROR
4865FA9B	2 5 81897	P	H	rmt	TAPE OPERATION ERROR
4865FA9B	2 5 81197	P	H	rmt1	TAPE OPERATION ERROR
4865FA9B	2 5 8 897	P	H	rmt1	TAPE OPERATION ERROR
4865FA9B	2 5 8 697	P	H	rmt1	TAPE OPERATION ERROR
4865FA9B	2 5 8 597	P	H	rmt1	TAPE OPERATION ERROR

Figure 112. ERRPT |pg Command Error Example

Attention: For errors indicating system problems, enter the appropriate maintenance package.

The following table is for quick reference.

Figure 113. Hex to ASCII Conversion

Hex	ASCII	Hex	ASCII	Hex	ASCII	Hex	ASCII	Hex	ASCII
00	Null	30	0	41	A	4A	J	54	T
20	Space	31	1	42	B	4B	K	55	U
		32	2	43	C	4C	L	56	V
		33	3	44	D	4D	M	57	W
		34	4	45	E	4E	N	58	X
		35	5	46	F	4F	O	59	Y
		36	6	47	G	50	P	5A	Z
		37	7	48	H	51	Q	5F	-
		38	8	49	I	52	R		
		39	9			53	S		

Note: All codes are not shown.

1. Type **errpt -a |pg** at the AIX command line; the detailed report will be displayed.
2. Press the Enter key to scroll through the log.
3. Type **Q** to quit the error log at any time.

ERROR LABEL: TAPE_ERR2
ERROR ID: 476B351D

Date/Time: Tue Dec 17 07:58:40
Sequence Number: 55588
Machine Id: 000029843500
Node Id: raptor
Error Class: H
Error Type: PERM
Resource Name: smc0
Resource Class: tape
Resource Type: 7331
Location: 00-02-01-50
VPD:

Error Description
TAPE DRIVE FAILURE

Probable Causes
TAPE DRIVE

Failure Causes
TAPE
TAPE DRIVE

Recommended Actions
PERFORM PROBLEM DETERMINATION PROCEDURES

Detail Data

SENSE DATA

```
0C05 0000 A500 0000 000A 0017 0000 0000 0102 0000 7000 0400 0000 0018 0000 0000
4089 0B00 0000 0050 0B01 0100 0186 0000 0000 0000 0000 0000 0000 0000 0000 0000
0000 0000 0000 0000 0000 0000 0000 0000 0000 0000 0000 0000 0000 0000 0000 0000
0000 0000 0000 0000 0000 0000 0000 0000 0000 0000 0000 0000 0000 0000 0000 0000
0000 0000 0000 0000 0000 0000 0000 0000 0000 0000 0000 0000 0000 0000 0000 0000
```

A49S0056

Figure 114. AIX SMIT and ERRPT Command Tape Error Log Example

HEX	Description
4	Sense key
4 89	ASC/ASCQ (additional sense code/additional sense code qualifier)
186	UEC (Unit Error Code)

Figure 115. Sense Data for Tape Error Log Example

ERROR LABEL: TAPE_ERR4
ERROR ID: 5537AC5F

Date/Time: FRI Dec 13 12:53:02
Sequence Number: 55545
Machine Id: 000029843500
Node Id: raptor
Error Class: H
Error Type: PERM
Resource Name: rmt3
Resource Class: tape
Resource Type: ost
Location: 00-02-01-10
VPD:

Error Description
TAPE DRIVE FAILURE

Probable Causes
ADAPTER
TAPE DRIVE

Failure Causes
ADAPTER
TAPE DRIVE

Recommended Actions
PERFORM PROBLEM DETERMINATION PROCEDURES

Detail Data

SENSE DATA

```
0601 0000 0000 0000 0000 0000 0000 0000 0200 0800 0000 xx00 0000 0000 0000 0000
yyyy 0000 0000 0000 0000 0000 0000 0000 zz00 0000 0000 0000 0000 0000 0000 0000
0000 0000 0000 0000 0000 0000 0000 0000 0000 0000 0000 0000 0000 0000 0000
0000 0000 0000 0000 0000 0000 0000 0000 0000 0000 0000 0000 0000 0000 0000
0000 0000 0000 0000 0000 0000 0000 0000 0000 0000 0000 0000 0000 0000
```

A49S0057

Figure 116. AIX SMIT and ERRPT Command SCSI Error Log Example

HEX	Description
xx	Sense key
yyyy	ASC/ASCQ (additional sense code/additional sense code qualifier)
zz	FSC (Fault Symptom Code)

Figure 117. Sense Data for SCSI Error Log Example

Running Tapeutil

If **tapeutil** is running and an error condition is detected, an error message is displayed. The error sense data has the format seen in Figure 118. The **errno**, or error number, is explained in Figure 120 on page 172.

```

Read/Write test terminated, total bytes written
Operation failed with errno 5: I/O error
Residual count: 2 48

Error Sense Data, Length 8

  1 2 3 4 5 6 7 8 9 1 12 14 A B C D E F
7   4           18           4 89 B           5 B 1

1   186

HEX  DESCRIPTION
    4  Sense Key
  4 89  ASC/ASCQ (additional sense code/additional sense code
        qualifier)
   186  UEC (Unit Error Code)

```

Figure 118. Tape Util Error Sample

The following table is for quick reference.

Figure 119. Hex to ASCII Conversion

Hex	ASCII	Hex	ASCII	Hex	ASCII	Hex	ASCII	Hex	ASCII
00	Null	30	0	41	A	4A	J	54	T
20	Space	31	1	42	B	4B	K	55	U
		32	2	43	C	4C	L	56	V
		33	3	44	D	4D	M	57	W
		34	4	45	E	4E	N	58	X
		35	5	46	F	4F	O	59	Y
		36	6	47	G	50	P	5A	Z
		37	7	48	H	51	Q	5F	-
		38	8	49	I	52	R		
		39	9			53	S		

Note: All codes are not shown.

Figure 120 shows only the **errno** values pertaining to tape devices. The complete list of **errno** values can be found in the AIX `/usr/include/sys/errno.h` header file.

<i>Figure 120 (Page 1 of 2). Device Driver to AIX ERRNO Translation</i>		
AIX errno	Device Driver Error Code	Description
1	EPERM	General: The process does not have adequate permission to perform the desired function.
5	EIO	Open: An I/O error occurred that indicates a failure to operate the device. Write: The physical end of medium was detected, or it is a general error state indicating a failure to write to device. IOCTL: An I/O error occurred during the operation. Close: An I/O error occurred during the operation.
6	ENXIO	General: The device has not been configured and is not receiving requests. Write: A write operation was attempted after the device had reached end of medium.
9	EBADF	General: A bad file descriptor was passed. Write: A write operation was attempted on a device that was opened for read only.
11	EAGAIN	Read: The device is already opened.
12	ENOMEM	General: Insufficient memory available for some internal memory operation. Read: The number of bytes requested in a read of a variable block record was less than the size of the block. This is referred to as an over-length condition.
14	EFAULT	General: A memory failure occurred due to an invalid pointer or address.
16	EBUSY	General: An excessive busy state was encountered. Open: The device is reserved by another initiator or an excessive busy state was encountered.
22	EINVAL	Open: The operation requested had invalid parameters or an invalid combination of parameters. Write: The operation requested had invalid parameters or an invalid combination of parameters, or the number of bytes requested in the write was not a multiple of the block size for a fixed block transfer, or the number of bytes requested in the write was greater than the maximum block size allowed by the device for variable block transfers.
28	ENOSPC	Write: A write operation failed because it had reached the early warning mark while running in label processing mode. This return code is only returned once at the moment early warning is reached.
46	ENOTREADY	General: The device is not ready for operation or a tape is not in the drive. Open: If not opened with the <code>O_NONBLOCK</code> or <code>O_NDELAY</code> , the drive is not ready for operation or there is no tape in drive. If the non-blocking flags are used, the drive is not ready for operation.

Figure 120 (Page 2 of 2). Device Driver to AIX ERRNO Translation

AIX errno	Device Driver Error Code	Description
47	EWRPROTECT	<p>Open:An open operation with the O_RDWR or O_WRONLY flag was attempted on a write-protected tape.</p> <p>Write:A write operation was attempted on a write-protected tape.</p> <p>IOCTRL:An operation that would modify the media was attempted on a write-protected tape or a device that was opened for O_RDONLY.</p>
78	ETIMEDOUT	General: A command has timed out.
110	EMEDIA	General: An unrecoverable media error was detected.

Message Codes

Figure 121. Message Code Descriptions

Message Code Hex	Message Code ASCII	Description
3030	00	No Message: This is the default message indicating that the device does not have an error to report.
3430	40	Operator Intervention Required: An operator action is required at the device. For example, a magazine is full and needs to be replaced or emptied. Check the device error log for possible repair action.
3431	41	Device Degraded: The device is performing in a degraded state, but can be used. A FID is displayed with the error message. Check the device error log for possible repair action.
3432	42	Device Hardware Failure: The device can not be used. A FID is displayed with the error message. Check the device error log for possible repair action.
3433	43	Service Circuits Failed, Operations not Affected: This error does not affect the performance of the device. The failure only affects circuits used for non-operational testing. A FID is displayed with the error message. Check the device error log for possible repair action.
3535	55	Clean Device: Load a cleaning cartridge in the device. The drive returns the cleaning cartridge following the cleaning procedure. This message is not posted if attached to a 3494 tape library.
3537	57	Device has been cleaned: The drive has been cleaned by a cleaning cartridge.
3630	60	Bad Media, Read Only Permitted: MIM message.
3631	61	Rewrite Media if Possible: MIM message.
3634	64	Bad Media, Cannot Read or Write: MIM message.
3732	72	Replace Cleaner Cartridge: MIM message.

Exception Messages

Figure 122. Exception Message Descriptions

Exception Message Hex	Exception Message ASCII	Description
32	2	Data Degraded:
34	4	Medium Degraded:
36	6	Block 0 Error:
37	7	Medium Exception:

TAPEUTIL Analysis

Tapeutil is a tool that allows the exercise of libraries and devices that attach to the Atape Driver. To use Tapeutil, simply type **Tapeutil** at the prompt. The following screen appears.

```

-----
General Commands:
  1. Open a Device           5. Inquiry                 9. Log Sense Page
  2. Close a Device         6. Test Unit Ready       1 . Mode Sense Page
  3. Device Info           7. Reserve Device       11. Release Device
  4. Tape Drive Service Aids 8. Request Sense        Q. Quit Program
Medium Changer Commands:
 12. Element Information    16. Move Medium
 13. Position To Element   17. Load/Unload Medium
 14. Element Inventory     18. Initialize Element Status
 15. Prevent Medium Removal 19. Allow Medium Removal
Tape Commands:
 2 . Query/Set Parameters   3 . Read and Write Tests
21. Load Tape              31. Unload Tape
22. Rewind                 32. Erase
23. Erase Gap              33. Write Filemarks
24. Forward Space Filemarks 34. Backward Space Filemarks
25. Forward Space Records  35. Backward Space Records
26. Space to End of Data   36. Query/Set Tape Position
27. Log Sense              37. Library Sequence Number
28. Display Message       38. Read or Write Files
29. Synchronize Buffers   39. Recover Buffer Data
Enter Selection:
-----

```

To open a device, perform the following:

```

-----
Enter Selection: 1 <enter>
Enter device special file name: name <enter>
(example: /dev/rmt ): /dev/rmt3)
Select mode: name <enter>
(example: 1=Read/Write, 2=Read Only, 3=Write only, 4=Append)
Opening Device. . .
Hit <enter> to continue. . . <enter>
-----

```

When the screen appears again, make any selection required to verify library and/or drive operation.

USING TAPEUTIL LINE COMMANDS

An alternate form of using Tapeutil is with line commands. Examples follow:

1. **tapeutil -f/dev/rmt3 move -s11 -24** (Move medium from a cell location to a drive.)
2. **tapeutil -f/dev/rmt3 inventory** (Perform an inventory.)
3. **Usage: Tapeutil (-f Device) (Subcommand (Subcommand))**

General Subcommands:

devinfo	inquiry	print "Text"	vpd	reset
reserve	release	reqsense	tur	

Medium Changer Subcommands:

audit	mount (Slot)	unmount (Slot)
inventory	allow	move -s Source -d Destination
elementinfo	prevent	position -d Destination

Tape Subcommands:

append	bsf (Count)	bsr (Count)
autoload	eof (Count)	weof (Count)
compress	fsf (Count)	fsr (Count)
nocompress	erg	valid "Name"
load	erase	display "Message"
mtdevice	rewind	read -d Destination
qrypos	retension	write -s Source
setpos	status	rtest (-b Blocksize) (-c Count) (-r Repetition)
offline	parms	wtest (-b Blocksize) (-c Count) (-r Repetition)
rewoffl	sync	rwtest (-b Blocksize) (-c Count) (-r Repetition)
unload	logsense	

Service Aid Subcommands:

dump	fmrtape	resetdrive	ucode "Name"
------	---------	------------	--------------

Drive Fault Symptom Description

Drive Fault Symptom Code

This byte provides an alternate means of obtaining fault information from the drive. This information can be used individually or in conjunction with the Sense Key and ASC/ASCQ to understand each specific error condition. The following table describes the supported FSC error codes and their relationship with the other error indicators.

Note: For the CAUSE column, T=Tape and D=Drive.

Figure 123 (Page 1 of 9). Fault Symptom Code and Error Recovery Procedures

SKEY	ASC	ASCQ	FSC	DESCRIPTION	SCSI ERROR	ERP #	CAUSE
					DESCRIPTION		
05	50	01	02	Invalid position for WRITE	No Log, Return "Illegal Request"	2	-
07	27	00	03	Tape is write protected for WRITE	No Log, "Disable Write Protect"	5	-
00	00	02	04	LEOT encountered on current WRITE	No Log, Notify User	10	-
0B	00	00	05	Operation has aborted (as requested)	Log, Aborted Command	11	-
00	00	02	06	LEOT encountered on the last WRITE	No Log, Notify User	10	-
0B	10	00	08	Compression data integrity check failed	Log, Hardware Error	12	D=100%
00	00	02	09	Detected LEOT during READ	No Log, Notify User	10	-
00	00	00	0A	Length mismatch on READ	No Log, Notify User	15	-
03	11	01	0B	Uncorrectable block on READ	Log Medium Error	8,6	T=90% D=10%
08	00	05	0C	EOD encountered on READ	No Log, Notify User	13	-
00	00	01	0D	Filemark encountered during a READ	No Log, Notify User	10	-
05	00	05	0E	Illegal condition for READ	No Log, Return "Illegal Request"	2	-
08	00	05	0F	READ issued at blank tape	No Log, Notify User	4	-

Figure 123 (Page 2 of 9). Fault Symptom Code and Error Recovery Procedures

SKEY	ASC	ASCQ	FSC	DESCRIPTION	SCSI ERROR	ERP #	CAUSE
					DESCRIPTION		
0B	00	00	10	READ operation has aborted (as requested)	Log, Aborted Command	11	-
03	11	03	11	Too many permanent READ errors, cannot sync	Log Medium Error	8,6	T=90% D=10%
03	00	02	14	PEOT or PEOP encountered on READ or VERIFY	Log Medium Error	2,8,6	-
09	15	02	15	Bad Filemark encountered during a READ	Log, Notify User	8,6	T=100%
03	14	00	16	Medium error detected during a READ	Log Medium Error	8,6	T=90% D=10%
04	11	00	17	Hardware error during a READ	Log Hardware Error	12	D=100%
04	11	00	18	READ decompression failed--HW error	Log Hardware Error	12	D=100%
04	11	02	19	READ decompression CRC failed	Log Hardware Error	12	D=100%
03	30	01	1C	Unknown or incompatible format	Display "Tape Format Bad"	14	T=100%
00	00	03	1D	Hit setmark on read	No Log, Notify User	10	-
05	50	01	26	Not at legal place to WFM	No Log, Return "Illegal Request"	2	-
07	27	00	27	Tape is write protected for WFM	No Log, "Disable Write Protect"	5	-
00	00	02	28	LEOT encountered during WFM	No Log, Notify User	10	-
00	00	03	31	Setmark detected on Space/Locate	No Log, Notify User	10	-
00	00	01	32	Filemark detected during SPACE/LOCATE	No Log, Notify User	10	-

Figure 123 (Page 3 of 9). Fault Symptom Code and Error Recovery Procedures

SKEY	ASC	ASCQFSC	DESCRIPTION	SCSI ERROR	ERP #	CAUSE	
				DESCRIPTION			
05	00	05	33	EOD encountered on SPACE/LOCATE	No Log, Notify User	10	-
03	00	02	34	PEOT encountered on SPACE/LOCATE	Log Medium Error	8,6,2	-
00	00	04	35	PBOT encountered on SPACE/LOCATE	No Log, Notify User	2	-
03	31	00	36	Format error during SPACE/LOCATE	Log Medium Error	8,6	T=80% D=20%
03	11	00	37	Uncorrectable block during a SPACE/LOCATE	Log Medium Error	8,6	T=90% D=10%
03	14	00	38	Medium error during SPACE/LOCATE	Log Medium Error	8,6	T=80% D=20%
09	15	02	3A	Wrong file number in filemark during SPACE (2.3 GB mode only)	Log, Notify User	3	T=100%
0B	00	00	3B	SPACE/LOCATE has aborted (as requested)	Log, Aborted Command	11	-
03	15	00	3D	Lost in Space	Log Medium Error	8,6	T=80% D=20%
03	30	00	47	Incompatible Medium Rejected after Loading	No Log, Notify User	14	-
05	50	01	4B	Illegal position for ERASE	No Log, Return "Illegal Request"	2	-
07	27	00	4C	Tape is write protected for ERASE	No Log, "Disable Write Protect"	5	-
0B	00	00	4E	ERASE has aborted (as requested)	Log, Aborted Command	11	-
04	00	00	58	Hardware error during SEND DIAGNOSTIC	Log, Hardware Error	12	D=100%
05	26	02	61	Header in wrong format when loading ucode	Display "Software Bad"	8,6	T=100%

Figure 123 (Page 4 of 9). Fault Symptom Code and Error Recovery Procedures

SKEY	ASC	ASCQ	FSC	DESCRIPTION	SCSI ERROR	ERP #	CAUSE
					DESCRIPTION		
05	26	02	63	Control load image not valid	Display "Software Bad"	8,6	T=100%
05	26	02	65	EEPROM load image not valid	Display "Software Bad"	8,6	T=100%
05	26	01	66	Boot code old	Display "Software Bad"	8,6	T=100%
04	00	00	67	Cannot program one of the memories	Log Hardware Error	12	D=100%
03	26	02	69	CRC in load image was not correct	Display "Software Bad"	8,6	T=100%
04	00	00	6D	Read buffer command failed	Log Hardware Error	12	D=100%
05	50	01	71	Illegal position to format partition.		2	
0D	00	02	72	Partitions are too big for tape		2	
03	31	01	74	Partition format of tape failed	No Log, Notify User	8,6	-
0B	00	00	75	Partition format aborted		8,6	
03	31	00	79	Failed position to a new partition		8,6	
0B	00	00	7A	Partition switch aborted		8,6	
04	44	00	8C	Software hang, we are very confused	Log Hardware Error	12	D=100%
04	40	80	8D	Software detects a hardware problem	Log Hardware Error	12	D=100%
0D	00	02	93	Detect PEOP		10	
03	03	02	94	Write Setmark failure	No Log, Notify User	6	-
03	50	01	95	WRITE failure after retry limit exceeded	Log Medium Error	8,6	T=70% D=30%
03	03	02	96	WFM failure after retry limit exceeded	Log Medium Error	8,6	T=70% D=30%

Figure 123 (Page 5 of 9). Fault Symptom Code and Error Recovery Procedures

SKEY	ASC	ASCQ	FSC	DESCRIPTION	SCSI ERROR	ERP #	CAUSE
					DESCRIPTION		
03	03	02	97	Write EOD failure after retry limit exceeded	Log Medium Error	8,6	T=70% D=30%
04	44	00	98	Fill error, invalid BRT	Log Hardware Error	12	D=100%
04	44	00	99	Fill error, buffer empty	Log Hardware Error	12	D=100%
04	08	01	9A	Deformatter Intrap timeout on search	Log Hardware Error	12	D=100%
03	03	02	9B	Overwrite (bad readback check block type)	Log Medium Error	8,6	T=50% D=50%
04	08	01	9C	Formatter Intrap timeout on WRITE	Log Hardware Error	12	D=100%
03	03	02	9D	Permanent write error, write recovery fail	Log Medium Error	8,6	T=70% D=30%
03	03	02	9E	Permanent write error, rewrite threshold	Log Medium Error	8,6	T=70% D=30%
03	03	02	9F	Servo zone readback check failure	Log Medium Error	8,6	T=70% D=30%
04	0C	00	A1	Head sync error during WRITE	Log Hardware Error	8,6	D=90% T=10%
04	44	00	A2	Underrun error during WRITE	Log Hardware Error	12	D=100%
0B	08	02	A3	IPOINT write buffer parity error	Log Hardware Error	12	D=100%
04	08	02	A4	DPOINT WRITE parity error	Log Hardware Error	12	D=100%
04	08	02	A5	PPOINT WRITE parity error	Log Hardware Error	12	D=100%
0B	08	02	A6	IPOINT READ parity error	Log Hardware Error	12	D=100%
04	08	02	A7	DPOINT READ parity error	Log Hardware Error	12	D=100%
04	08	02	A8	PPOINT READ parity error	Log Hardware Error	12	D=100%

Figure 123 (Page 6 of 9). Fault Symptom Code and Error Recovery Procedures

SKEY	ASC	ASCQFSC	DESCRIPTION	SCSI ERROR	ERP #	CAUSE	
				DESCRIPTION			
04	44	00	AC	Servo software error	Log Hardware Error	12	D=100%
04	15	01	AD	Servo hardware error	Log Hardware Error	8,6	D=90% T=10%
03	09	00	AE	Not tracking	Log Medium Error	8,6	T=60% D=40%
0D	00	02	AF	EOT encountered during a motion command		2	-
03	09	00	B0	Not tracking--loss of PLL	Log Medium Error	8,6	T=60% D=40%
03	03	02	B3	LBOT WRITE failure	Log Medium Error	8,6	T=70% D=30%
03	0C	00	B4	LBOT ATM write failure	Log Medium Error	8,6	T=70% D=30%
03	11	00	B5	Read manager could not read LBOT	Log Medium error	8,6	T=70% D=30%
0D	00	02	B6	EOT encountered during buffer flush		2	-
06	29	00	C0	Power-on reset occurred	No Log, Reissue Failing Command	3	-
06	28	00	C1	Tape may have been changed	No Log, Reissue Failing Command	3	-
06	2A	01	C2	Mode Select parameters have changed	No Log, Reissue Failing Command	3	-
06	3F	01	C3	New ucode was loaded	No Log, Reissue Failing Command	3	-
06	5A	01	C4	Operator requested media removal	No Log, Reissue Failing Command	11	-
06	30	00	C5	Incompatible media was rejected	No Log, Notify User	14	-
02	04	00	C6	Not ready, cause not known	No Log, Return "Not Ready"	7,3	-

Figure 123 (Page 7 of 9). Fault Symptom Code and Error Recovery Procedures

SKEY	ASC	ASCQFSC	DESCRIPTION	SCSI ERROR	ERP #	CAUSE	
				DESCRIPTION			
02	04	01	C7	Not ready, in process of becoming ready	No Log, Return "Not Ready"	3	-
02	04	00	C8	A backup positioning command is required	No Log, Issue a Backup Command	2	-
02	3A	00	C9	Command requires a tape and none is loaded	No Log, Return "Not Ready"	7,3	-
06	5B	01	CA	Log Threshold met	No Log, Reissue Failing Command	3	
06	2A	02	CB	Log Parameter changed	No Log, Reissue Failing Command	3	
05	1A	00	CC	Parameter List Length error in CDB	No Log, Return "Illegal Request"	2	-
05	20	00	CD	Illegal Operation Code	No Log, Return "Illegal Request"	2	-
05	24	00	CE	Invalid field or reserved bits set in CDB	No Log, Return "Illegal Request"	2	-
05	25	00	CF	This LUN is not supported	No Log, Return "Illegal Request"	2	-
05	26	00	D0	Invalid field in Parameter List (Mode Data)	No Log, Return "Illegal Request"	2	-
05	25	00	D1	Illegal bit set in Identify Message	No Log, Return "Illegal Request"	2	-
05	53	02	D2	Media removal is prevented	No Log, Return "Illegal Request"	2	-
05	81	00	D3	Command has mode mismatch (variable/fixed)	No Log, Return "Illegal Request"	2	-
05	1A	00	D4	Illegal Transfer Length in CDB	No Log, Return "Illegal Request"	2	-

Figure 123 (Page 8 of 9). Fault Symptom Code and Error Recovery Procedures

SKEY	ASC	ASCQ	FSC	DESCRIPTION	SCSI ERROR	ERP #	CAUSE
					DESCRIPTION		
05	84	00	D6	Tried to change Mode Parm's and not at LBOT	No Log, Return "Illegal Request"	2	-
05	30	02	D7	Can't read medium, incompatible format	No Log, Return "Illegal Request"	14	-
05	4E	00	D8	Overlapped commands attempted, bad ITL nexus	No Log, Return "Illegal Request"	2	-
05	3D	00	DA	Illegal bits set in ID message	No Log, Return "Illegal Request"	2	-
05	30	00	DB	Cannot write to tape; not AME	No Log, Return "Illegal Request"	14	T=100%
01	37	00	DC	Rounding has occurred	No log, return "Illegal Request"	10	
02	04	00	DD	Not ready--head sync tape	No log, return "Illegal Request"	7	
05	30	05	DE	Density not supported	No Log, Return "Illegal Request"	2	-
0B	43	00	E0	Aborted in CDB phase, parity or other error	Log, Aborted Command	12	-
0B	43	00	E1	Aborted prior to Data phase, bad message	Log, Aborted Command	12	-
0B	48	00	E2	Aborted in data phase, init detected error	Log, Aborted Command	12	-
0B	43	00	E3	Aborted in Data phase, bad message	Log, Aborted Command	12	-
0B	43	00	E4	Aborted after data phase, bad message	Log, Aborted Command	12	-
0B	43	00	E5	Aborted after Data phase, other error	Log, Aborted Command	12	-
0B	47	00	E6	ABORT caused by SCSI Bus Parity Error	Log, Aborted Command	12	-

Figure 123 (Page 9 of 9). Fault Symptom Code and Error Recovery Procedures

SKEY	ASC	ASCQFSC	DESCRIPTION	SCSI ERROR		ERP #	CAUSE
				DESCRIPTION			
0B	00	00	E7	ABORT sent by initiator has been completed	Log, Aborted Command	12	-
01	00	17	E8	Drive needs cleaning	Clean Log, Notify User	1	-
05	26	00	EA	Invalid mode (2.3 GB) for data compression	No Log, Return "Illegal Request"	2	-
0B	00	00	EB	download in progress	Log, Aborted Command	3	-
01	5B	02	EC	Log parameter overflow (recovered error)		10	
00	5D	00	EE	Service required	Log Hardware Error	12	D=70% T=30%
04	00	00	FA	Serial number invalid or blank	Reprogram EEPROM	12	D=100%
04	00	00	FC	Head sync value in EEPROM out of range	Reprogram EEPROM	12	D=100%
04	00	00	FD	EEPROM contains meaningless information	Reprogram EEPROM	12	D=100%

Drive Error Recovery Procedures

If two or more ERP codes are listed for the Fault Symptom Code, perform the action for the first code, then perform the action for the second code, and so on.

Figure 124. ERP # (Recommended error recovery procedures)

ERP	Recommended Error Recovery Procedure
1	Warning Message, clean drive
2	Application program error or user error using application. Retry operation. If this problem continues, notify application provider.
3	Reissue the failed command or command sequence.
4	Application attempted to read a blank tape. Either write to the tape or replace the tape with a tape containing data.
5	Tape is write protected and a write or erase was attempted. Either write enable the tape or insert a write enabled tape.
6	Perform the following until the operation can be completed. <ol style="list-style-type: none"> 1. Clean the drive 2. Retry operation 3. Clean the drive 4. Replace the tape cartridge 5. If the error still persists and there is an error in the system error log, call your maintenance provider.
7	Insert a data cartridge into the tape drive.
8	Perform one of the following actions: Reset the tape drive by holding down the unload button until the "RESET" message appears in the drive LCD display; then release the button. Send a SCSI bus reset ("hard" reset).
9	Clean the tape drive and repeat the operation.
10	No action is necessary.
11	User has pushed the eject button. No action is required, tape drive performed the requested operation.
12	The tape drive requires maintenance.
13	Tape drive has encountered the end of the media on a Read or Write. Mount the next tape and continue the tape operation.
14	Media type is not supported. Clean the drive and retry the operation with supported media.
15	Blocksize requested on Read operation does not match blocksize the tape was written at. Change blocksize the application is attempting to read at.

Appendix C. Parts Diagram and Parts List

This chapter provides a parts diagram and parts list required to service the 8mm Tape Library.

How To Use This Parts Listing

- Similar Assemblies** If two assemblies contain a majority of identical parts, they are broken down on the same list. Common parts are shown by one index number. Parts unique to one of the assemblies are listed separately and identified by description.
- AR** (As Required) in the *Units* column indicates that the quantity is not the same for all machines.
- NP** (Non-Procurable) in the *Part Number* column indicates that the part is non-procurable and that the individual parts or the next higher assembly should be ordered.
- NR** (Not Recommended) in the *Units* column indicates that the part is procurable but not recommended for field replacement, and that the next higher assembly should be ordered.
- NS** (Not Shown) in the *Asm- Index* column indicates that the part is either not shown or not referenced in the illustration.
- R** (Restricted) in the *Units* column indicates that the part has a restricted availability.
- Indenture** The indenture is marked by a series of dots located before the parts description. The indenture indicates the relationship of a part to the next higher assembly. For example:

Indenture	Relationship of Parts
(No dot)	MAIN ASSEMBLY
(One dot)	Detail parts of a main assembly
(One dot)	Sub assembly of the main assembly
(Two dots)	Detail part of a one-dot sub assembly
(Two dots)	Sub assembly of a one-dot sub assembly
(Three dots)	Detail part of a two-dot sub assembly

Example of Parts Listing

Asm-Index	Part Number	Units	Description
3-	2512667	1	Cover Asm, Rear, Red
	2513714	1	Cover Asm, Rear, White
			For Next Higher Asm, see Assembly 1-2.
-1	5373637	1	Seal, Top
-2	5356429	2	Clip, Retaining
-3	1847630	1	Finger Stock Asm
-4	1847602	NR	Channel, Finger Stock
-5	5373639	AR	Seal, Bottom
-6	5356429	2	Clip, Retaining
-7	NP	1	Cover, Rear, Without Paint
-5	0416629	R	Screw, Panel

Assemblies

Assemblies with their component parts lists follow.

1. "Assembly 1: External Library, Model 305 - Stand Alone Tower" on page 190
2. "Assembly 2: Internal Library, Model 305" on page 192
3. "Assembly 3: Tape Library Cables and Miscellaneous, Model 305" on page 194
4. "Assembly 4: Library Model 355 - Stand Alone — External" on page 196
5. "Assembly 5: Library Model 356 - Rack Mount— External" on page 198
6. "Assembly 6: Library Models 355 and 356" on page 200

Assembly 1: External Library, Model 305 - Stand Alone Tower

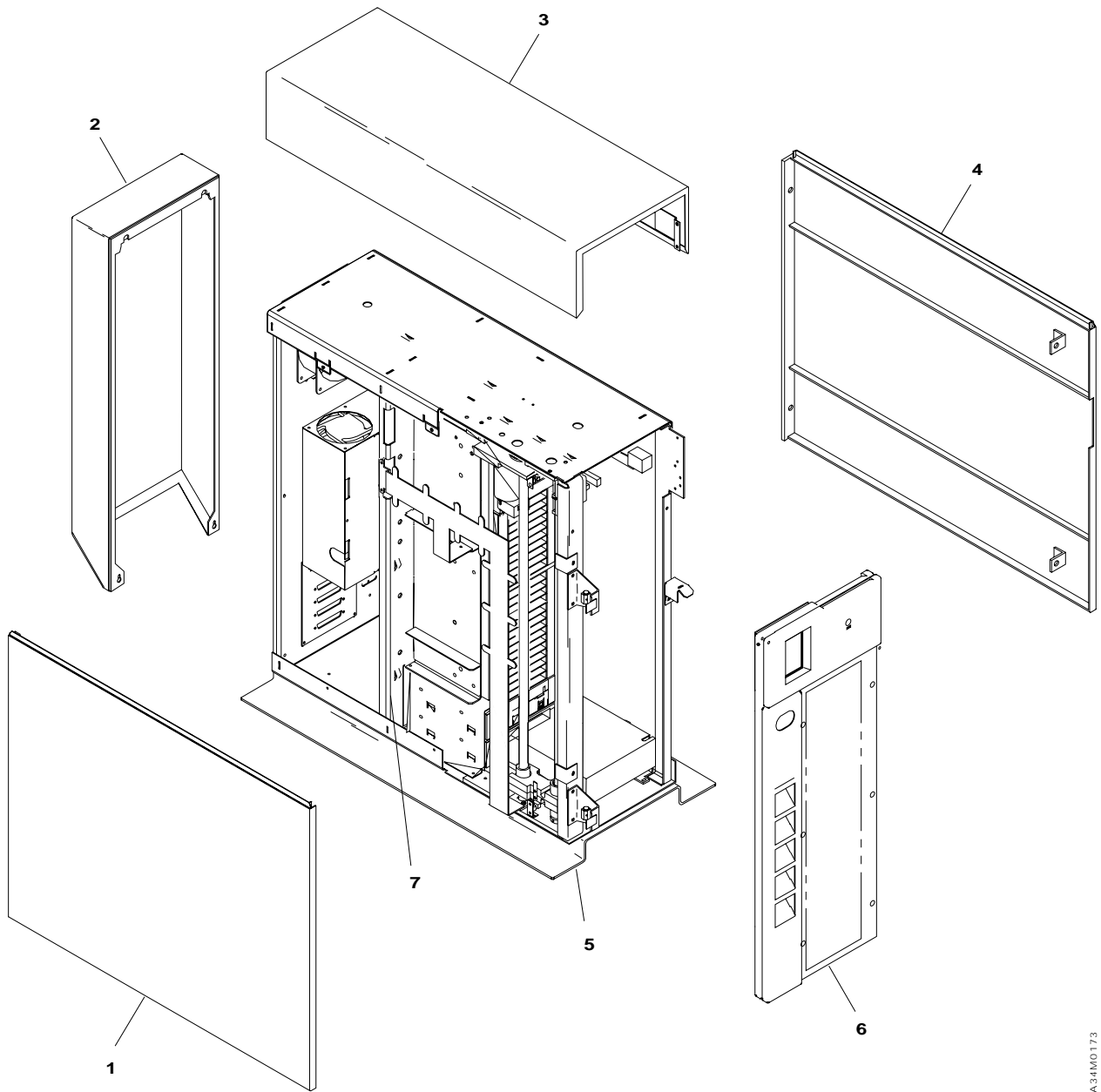

A34MD173

Asm- Index	Part Number	Units	Description
			Stand-Alone Cover Assembly
1-	87G5109	1	Stand Alone Cover Assembly - White
-1	NP	1	Cover (Left)
-2	NP	1	Cover (Rear)
-3	NP	1	Cover (Top)
-4	NP	1	Cover (Right)
-5	NP	1	Pedestal, Shale Grey
-6	59H3408	1	Front Door Assembly - White
-	87G1517	2	Clevis (Door Hinge Pin)
-	87G1518	1	Access Door Latch
-	87G1519	1	Door Lock (Key)
-	87G1520	1	Solenoid (Door Lock)
-	87G1525	1	Catch (Access Door)
-	87G1527	1	Bracket (Strike)
-7	NP	1	Frame Assembly
			Fasteners required for the Stand-Alone Library External Assemblies
-	87G1874	2	M3X6 PH Screw with washer (Rear of Top Cover)
-	87G1874	8	M3X4 PH Screw (Top and Rear Cover)
-	87G1874	8	M3X6 PH Screw (Side Covers)
-	87G1874	4	M4X8 PH Screw (Pedestal Mount)
-	87G1874	2	M3X6 PH Screw (Strike Bracket)
-	87G1874	4	M3X4 PH Screw (SCSI Panel)
			Part number 87G1874 consists of a package containing four of each kind of screw in the 7331 Tape Library.

Assembly 2: Internal Library, Model 305

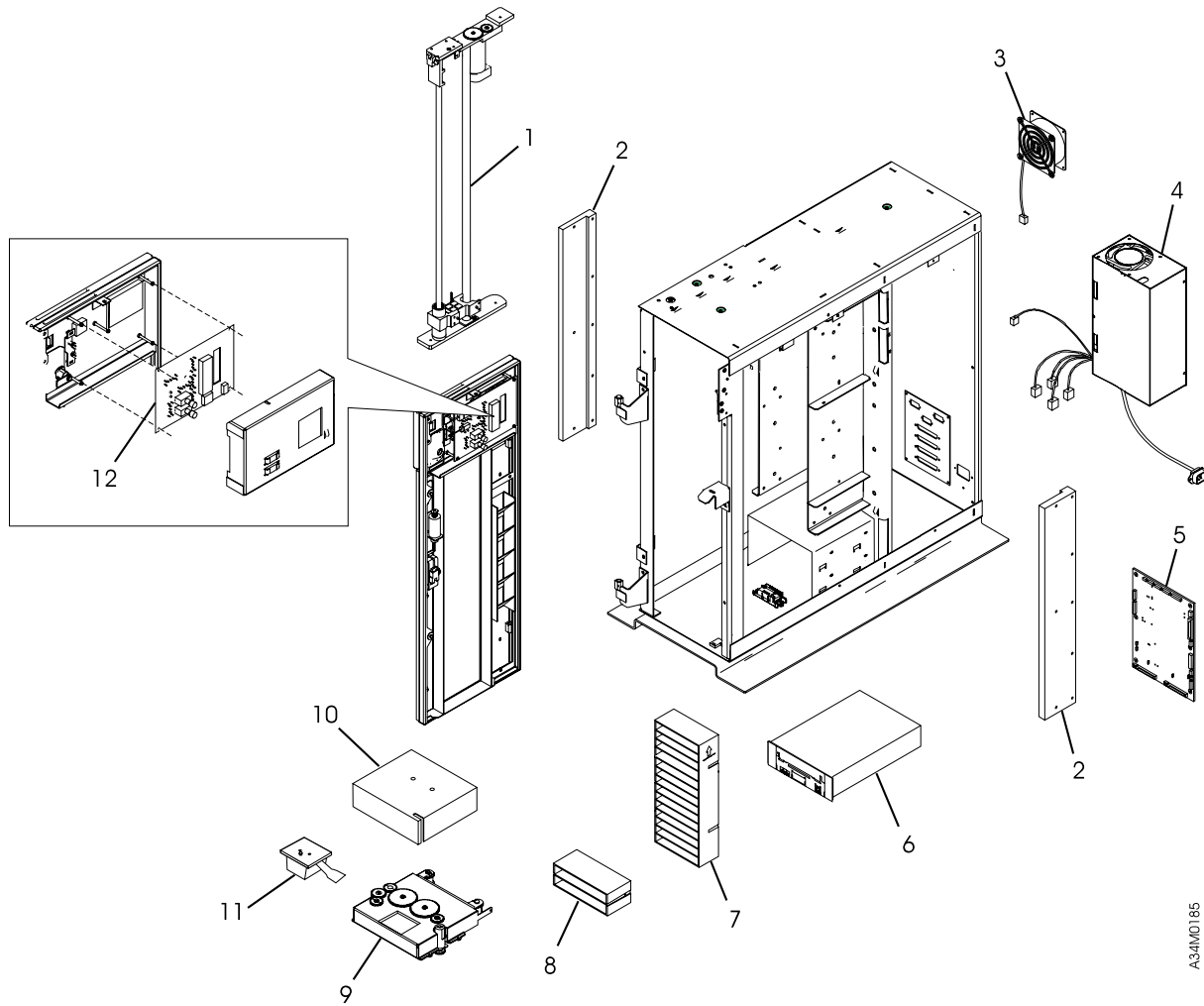

A34M0185

Asm- Index	Part Number	Units	Description
2-1	86G9258	1	Accessor Assembly
-	NP	2	Accessor Travel Limit sensor (Bottom & Top)
-	NP	1	Accessor Sensor
-	86G9299	1	Magazine Mounting Plate Assembly
-2	NP	2	Magazine Mounting Plates (Right & Left)
-	NP	2	Magazine Mounting Plate Sensors
-	86G9260	1	Sensor Group
-	NP	1	Upper/Lower Magazine Sensor Cable
-	NP	1	Accessor Bottom Travel Limit Cable
-	NP	1	Accessor Top Travel Limit and Lock Cable
-	NP	1	Accessor Motor Tach Cable
-	NP	1	Accessor Obstructed Sensors (Emitter & Receiver)
-3	86G9326	1	Fan Assembly
-	81F7977	4	Rubber Isolator Mount (Fan)
-4	86G9274	1	Power Supply
-5	59H3410	1	Controller Logic Card
-6	59H2842	2	Tape Drive Assembly, 206GB
-	87G1885	1	Internal SCSI Cable Group
-	NP	2	Drive Cables
-	87G1558	1	SCSI Jumper Cable
-7	86G9310	2	Magazine Assembly, 10-Slot
-8	86G9312	1	2-Slot Magazine
-9	59H3409	1	Picker Assembly without Bar Code Reader
-10	87G1835	1	Picker Cover
-	NP	1	Picker Umbilical Cable
-11	44H3620	1	Bar Code Reader with Flex Cable Assembly
-12	87G1531	1	Control Panel Assembly
-	6272886	1	Sensor (Door)
			Fasteners required for the Library Internal Assemblies
-	87G1874	1	M3X4 PH Screw (Power Supply Mount)
-	87G1874	4	M3X6 PH Screw (Accessor Mount)
-	87G1874	12	M4X8 PH Screw (Magazine Mount)
-	87G1874	4	M4X8 PH Screw (Controller Card Mount)
-	87G1874	2	M4X10 PH Screw (Controller Card Mount)
-	87G1874	8	M3X4 PH Screw (Drive to Tray)
-	87G1874	4	M3X4 PH Screw (Tray to Sleeve)
-	87G1874	2	Screw (2-Slot Magazine Mount)
-	87G1874	2	M3X6 PH Screw (Picker Panel)
-	87G1874	2	M3X12 PH Screw (Picker Panel)
			Part number 87G1874 consists of a package containing four of each kind of screw in the 7331 Tape Library.
			The 7331 Tape Library can be configured with one or two tape drives.

Assembly 3: Tape Library Cables and Miscellaneous, Model 305

Asm- Index	Part Number	Units	Description
3-	52G4337	1	System-to-Device Cable, External (1.5 M)
-	52G4291	1	Device-to-Device Cable, External (0.6 M)
-	52G4233	1	Device-to-Device Cable, External (2.5 M)
-	67G1263	1	System-to-Device Cable, External (14.0 M)
-	87G1554	1	Door Open/Close Sensor Cable, Internal
-	59H3038	1	SCSI ID Cable, Internal
-	87G1544	1	Control Panel Cable, Internal
-	1675209	1	Jumper, Internal (Tape Drive, Controller Card)
-	61G8324	1	Terminator
-	59H2678	1	Cartridge, Data - 170m
-	59H2898	1	Cartridge, Cleaning
-	59H2677	1	Cartridge, Test - 22m

Assembly 4: Library Model 355 - Stand Alone — External

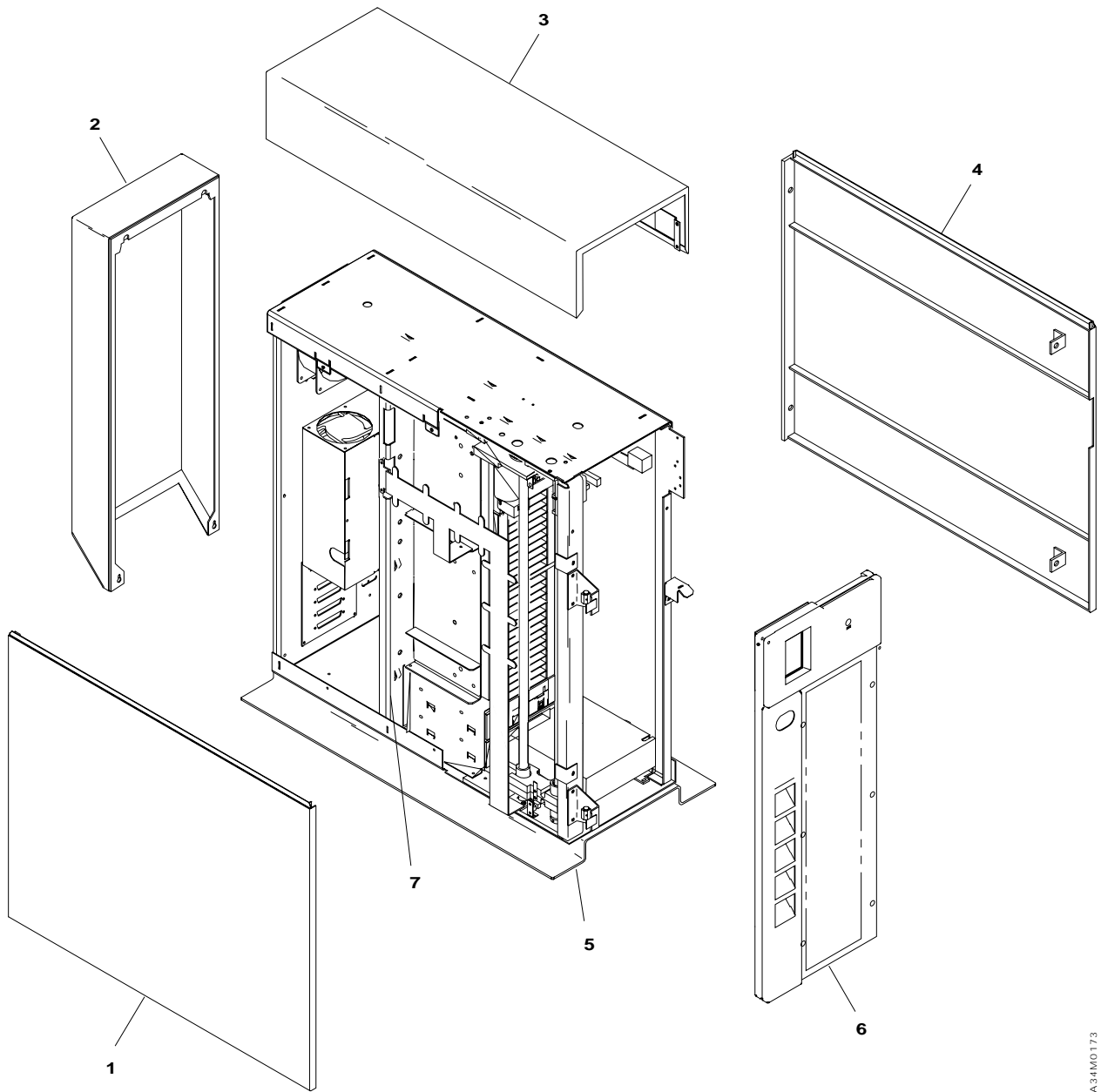

A34MD173

Asm- Index	Part Number	Units	Description
4-	87G1589	1	Top & Side Cover Assembly, Black (includes Rear, Top, Left, and Right covers)
-1	NP	1	Cover (Left)
-2	NP	1	Cover (Rear)
-3	NP	1	Cover (Top)
-4	NP	1	Cover (Right)
-5	NP	1	Pedestal, Black
-	87G1874	2	M3x6 PH Screw with washer (Rear of Top Cover)
-	87G1874	8	M3x4 PH Screw (Top and Rear Cover)
-	87G1874	8	M3x6 PH Screw (Side Covers)
-	87G1874	4	M3x8 PH Screw (Pedestal Mount)
-	59H3915	1	Front Door Assembly, Black with Logo (includes lock, solenoid, and sensor)
-	87G1517	2	Clevis (Door Hinge Pin)
-	87G1518	1	Access Door Latch
-	87G1519	1	Door Lock (Key)
-	87G1520	1	Solenoid (Door Lock)
-	87G1525	1	Catch (Access Door)
-	87G1527	1	Bracket (Strike)
-	87G1874	2	M3x6 PH Screw (Strike Bracket)
-7	NP	1	Frame Assembly
-	NP	1	SCSI Panel
-	87G1874	4	M3x4 PH Screw (SCSI Panel)
-	87G1558	1	SCSI Jumper, External (Controller Card)
-	61G8324	1	Terminator
-	59H2678	1	Cartridge, Data, 170M
-	59H2898	1	Cartridge, Cleaning
-	59H2677	1	Cartridge, Test, 22M

A dash (-) in the Index Number column indicates the part is either not shown or not called out.
NP in the Part Number column indicates the part is nonprocurable.
P/N 87G1874 contains 4 each of all required screws.

Assembly 5: Library Model 356 - Rack Mount— External

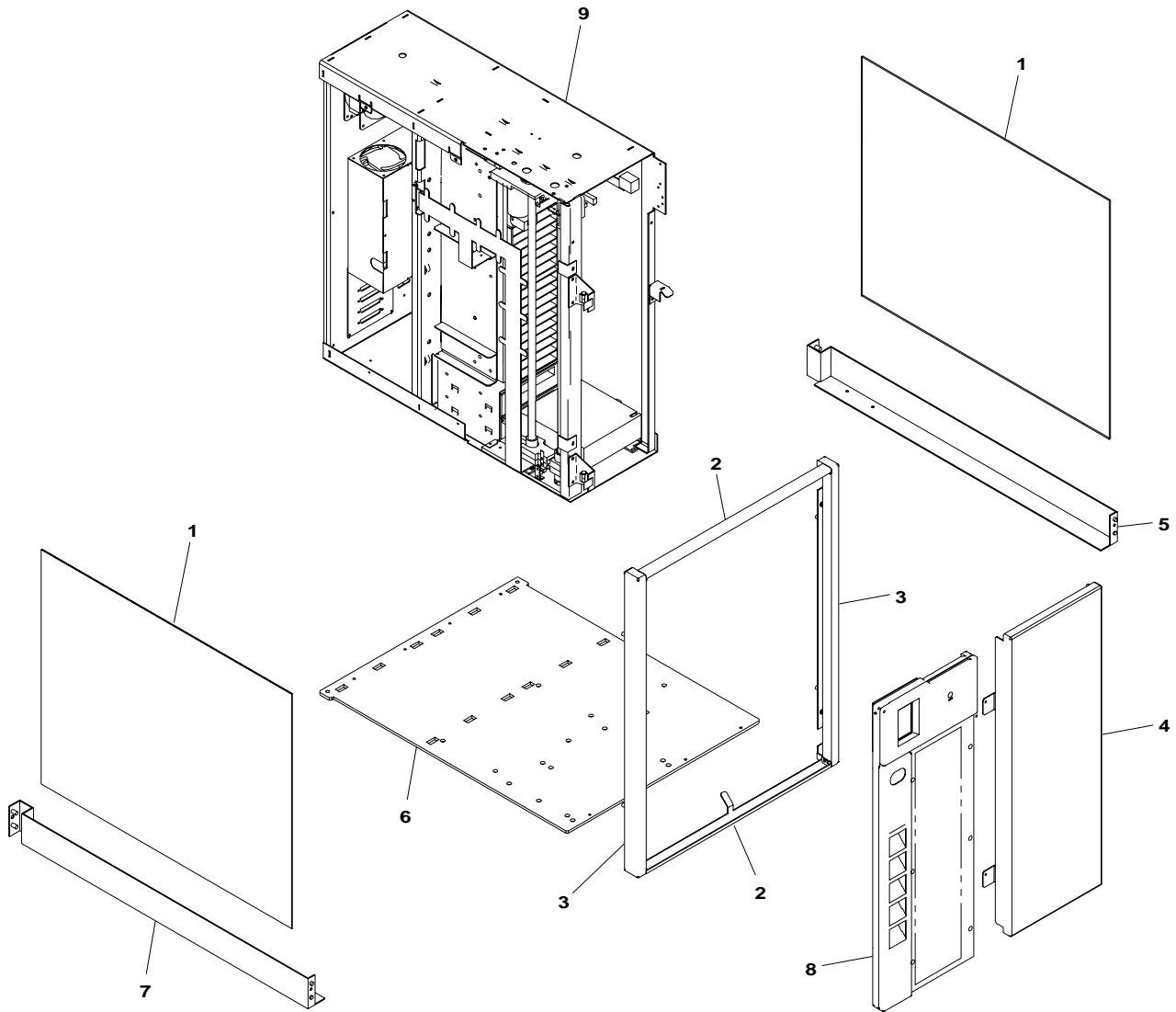

ASPART3-00

Asm- Index	Part Number	Units	Description
5-1	87G1534	2	Left & Right Internal Covers
-	87G1874	4	M3x8 PH Screw (Library — to — Base)
-	87G1874	8	M3x6 PH Screw (Left and Right Internal Side Covers)
-		1	Rack Mount Assembly (includes the following)
-	59H3896	1	Filler Strip
-	59H3839	1	Rack, Bezel
-	59H3897	1	Filler Panel
-	59H3838	1	Rail (Right)
-	87G1533	1	Rack, Plate
-	59H3837	1	Rail (Left)
-	1624779	2	M5 Fastener
-	1255289	2	M6 Fastener
-	59H3915	4	M3x8 PH Screw (Rack Mount)
-7		1	Front Door Assembly with Logo (includes lock, solenoid, and sensor)
-	87G1517	2	Clevis (Door Hinge Pin)
-	87G1518	1	Access Door Latch
-	87G1519	1	Door Lock (Key)
-	87G1520	1	Solenoid (Door Lock)
-	87G1525	1	Catch (Access Door)
-	87G1527	1	Bracket (Strike)
-	87G1874	2	M3x6 PH Screw (Strike Bracket)
-8	NP	1	Frame Assembly
-	NP	1	SCSI Panel
-	87G1874	4	M3x4 PH Screw (SCSI Panel)
-	67G1263	1	System to Device SCSI Cable (14m)
-	61G8324	1	Terminator
-	59H2678	1	Cartridge, Data, 170m
-	59H2898	1	Cartridge, Cleaning
-	59H2677	1	Cartridge, Test, 22m
-	59H3900	1	IBM Fastwide SCSI Adapter

A dash (-) in the Index Number column indicates the part is either not shown or not called out.
NP in the Part Number column indicates the part is nonprocurable.
P/N 87G1874 contains 4 each of all required screws.

Assembly 6: Library Models 355 and 356

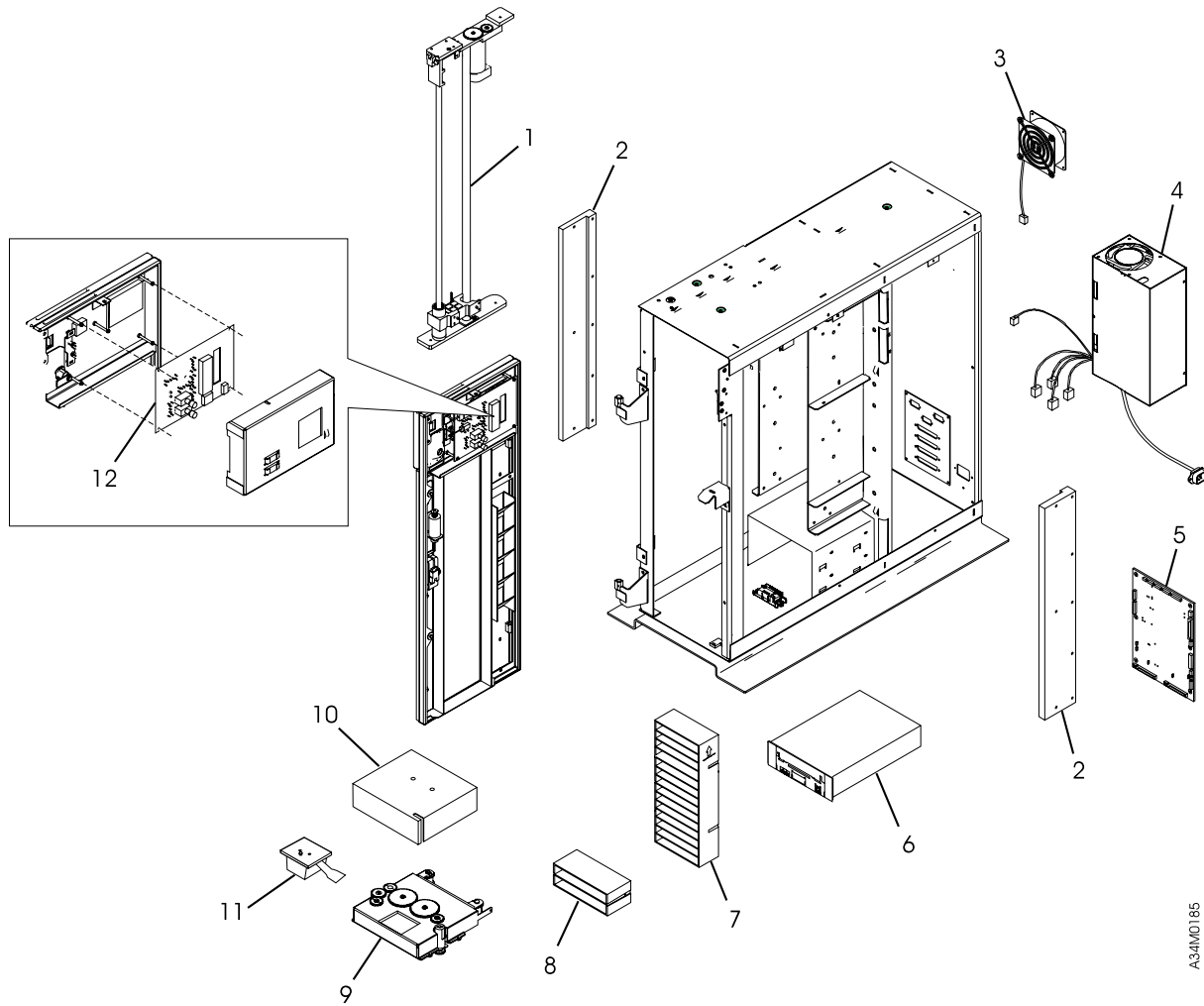

A34M0185

Asm- Index	Part Number	Units	Description
6-1	86G9258	1	Accessor Assembly (includes Top and Bottom Travel Limit and Accessor Sensors)
-	87G1874	4	M3X6 PH Screw (Accessor Mount)
-2	86G9299	1	Magazine Mounting Plate Assembly (included Left and Right Mounting Plates and Sensors)
-	87G1874	12	M4X8 PH Screw (Magazine Mount)
-	86G9260	1	Sensor Group (includes Accessor Obstructed Sensors, Accessor Bottom Travel Limit Cable, Accessor Top Travel Limit and Lock Cable, Accessor Motor Tach Cable, Upper and Lower Magazine Sensor Cable)
-3	86G9326	1	Fan Assembly
-	81F7977	4	Rubber Isolator Mount (Fan)
-4	86G9274	1	Power Supply
-	87G1874	1	M3X4 PH Screw (Power Supply Mount)
-5	59H3410	1	Controller Logic Card
-	87G1874	4	M4X8 PH Screw (Controller Card Mount)
-	87G1874	2	M4X10 PH Screw (Controller Card Mount)
-6	59H2842	2	Tape Drive Assembly, 20GB
-	86G9255	1	Internal SCSI Cable Group (includes Drive 1 and Drive 2 cables)
-	59H3038	1	Cable, Tape Drive SCSI ID
-	NP	2	Tray (Tape Drive)
-	87G1874	8	M3X4 PH Screw (Drive to Tray, 4 each drive)
-	NP	1	Sleeve (Tape Drive)
-	87G1874	4	M3X4 PH Screw (Tray to Sleeve)
-7	86G9310	2	Magazine Assembly, 10-Slot (includes Magazine and Cover)
-8	86G9312	1	2-Slot Magazine
-	87G1874	2	Screw (2-Slot Magazine Mount)
-9	59H3409	1	Picker Assembly without Bar Code Reader (includes Umbilical Cable)
-	87G1874	2	M3X6 PH Screw (Picker Mount)
-	87G1874	2	M3X12 PH Screw (Picker Mount)
-10	44H3620	1	Bar Code Reader with Flex Cable Assembly
-	87G1874	4	Screw (Bar Code Reader)
-11	87G1531	1	Operator Panel Assembly
-	87G1544	1	Operator Panel Cable
-	6272886	1	Sensor (Door)
-	87G1544	1	Door Open or Close Sensor Cable

A dash (-) in the Index Number column indicates the part is either not shown or not called out.
NP in the Part Number column indicates the part is nonprocurable.
P/N 87G1874 contains 4 each of all required screws.
The 8mm Tape Library can be configured with one or two tape drives.

Assembly 6: (continued)

The library can be configured with
1 or 2 tape drives.

Appendix D. Power Cables for Model 305

To avoid electrical shock, a power cable with a grounded attachment plug has been provided. Use only properly grounded outlets.

Power cables used in the United States and Canada are listed by Underwriter's Laboratories (UL**) and certified by the Canadian Standards Association (CSA**) These power cables consist of:

Electrical cables, type SVT or SJT.

Attachment plugs complying with National Electrical Manufacturers Association (NEMA) 5-15P. That is,

"For 115 V operation use a UL Listed Cable Set consisting of a minimum 18 AWG, Type SVT or SJT three conductor cable a maximum of 15 feet in length and a parallel blade, grounding type attachment plug rated at 15 A, 125 V."

"For 230 V operation in the United States use a UL Listed Cable Set consisting of a minimum 18 AWG, Type SVT or SJT three conductor cable a maximum of 15 feet in length, and a tandem blade, grounding type attachment plug rated at 15 A, 250 V."

Appliance couplers complying with International Electrotechnical Commission (IEC) Standard 320, Sheet C13.

Power cables used in other countries consist of:

Electrical cables, type HD21.

Attachment plugs approved by the appropriate testing organization for the specific countries where they are used.

"For units set at 230 V (outside of U. S.): Use a Cable Set consisting of a minimum 18 AWG cable and grounding type attachment plug rated 15 A, 250 V. The Cable Set should have the appropriate safety approvals for the country in which the equipment will be installed and marked 'HAR'."

Figure 126 lists the power cable part number, the country where the power cable can be used, and an index number to be matched with the receptacle illustrations shown in Figure 127 on page 205. Please contact your local dealer if your 7331 power cable does not match this information.

Figure 126. Power Cable Information

Part Number	Country	Index
1838574 US/Canada	Bahamas, Barbados, Bolivia, Brazil, Canada, Costa Rica, Dominican Republic, Ecuador, El Salvador, Guatemala, Guyana, Haiti, Honduras, Jamaica, Japan, Netherlands Antilles, Panama, Peru, Philippines, Taiwan, Thailand, Tobago, Trinidad, U.S.A. (except Chicago), Venezuela	1
6952300 US/Canada	Bahamas, Barbados, Bermuda, Bolivia, Brazil, Canada, Cayman Islands, Colombia, Costa Rica, Dominican Republic, Ecuador, El Salvador, Guatemala, Guyana, Haiti, Honduras, Jamaica, Japan, Korea (South), Mexico, Netherlands Antilles, Nicaragua, Panama, Peru, Philippines, Puerto Rico, Saudi Arabia, Suriname, Taiwan, Trinidad, U.S.A. (except Chicago), Venezuela	2
6952301 6 ft Chicago	Chicago, U.S.A.	2
13F9940 Australia	Argentina, Australia, New Zealand	3
13F9979 France	Abu Dhabi, Austria, Belgium, Bosnia, Botswana, Bulgaria, Croatia, Egypt, Finland, France, Germany, Greece, Iceland, Indonesia, Korea (South), Lebanon, Luxembourg, Macau, Macedonia, Netherlands, Norway, Portugal, Saudi Arabia, Serbia, Slovenia, Spain, Sudan, Sweden, Turkey	4
13F9997 Denmark	Denmark	5
14F0015 South Africa	Bangladesh, Burma, Pakistan, South Africa, Sri Lanka	6
14F0033 United Kingdom	Bahrain, Bermuda, Brunei, Channel Islands, Cyprus, Ghana, Hong Kong, India, Iraq, Ireland, Jordan, Kenya, Kuwait, Malawi, Malaysia, Nigeria, Oman, People's Republic of China, Qatar, Sierra Leone, Singapore, Tanzania, Uganda, United Arab Emirates (Dubai), United Kingdom, Zambia	7
14F0051 Switzerland	Liechtenstein, Switzerland	8
14F0069 Italy	Chile, Ethiopia, Italy	9
14F0087 Israel	Israel	10
6952291 Colombia	Colombia, Paraguay, Uruguay	11

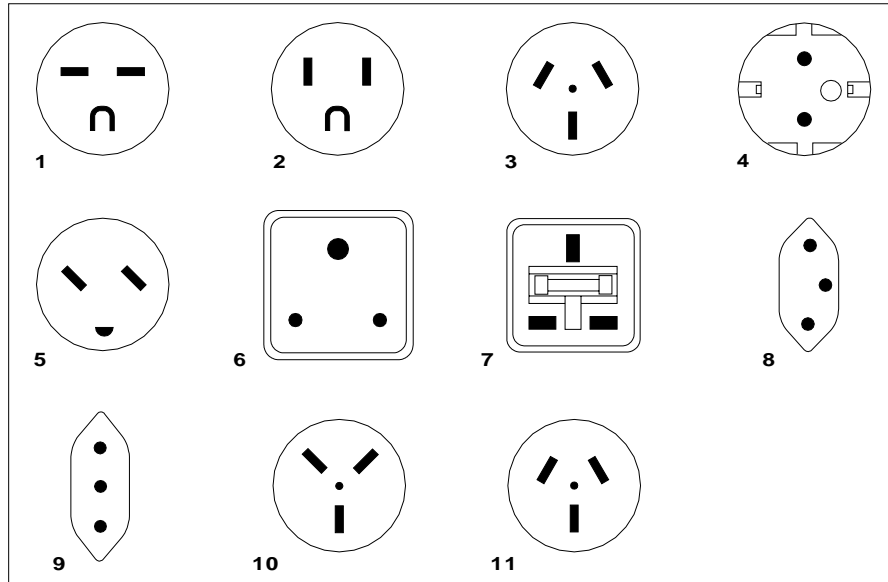

Figure 127. Types of Receptacles

Appendix E. Statement of Limited Warranty

The warranties provided by IBM in this Statement of Limited Warranty apply only to Machines you originally purchase for your use, and not for resale, from IBM or your reseller. The term "Machine" means an IBM machine, its features, conversions, upgrades, elements, or accessories, or any combination of them. Unless IBM specifies otherwise, the following warranties apply only in the country where you acquire the Machine. If you have any questions, contact IBM or your reseller.

Machine: 7331 and 3449 8mm Tape Library Model 3xx Service Guide
Warranty Period*: One year

**Contact your place of purchase for warranty service information.*

Production Status

Each Machine is manufactured from new parts, or new and used parts. In some cases, the Machine may not be new and may have been previously installed. Regardless of the Machine's production status, IBM's warranty terms apply.

The IBM Warranty for Machines

IBM warrants that each Machine 1) is free from defects in materials and workmanship and 2) conforms to IBM's Official Published Specifications. The warranty period for a Machine is a specified, fixed period commencing on its Date of Installation. The date on your receipt is the Date of Installation, unless IBM or your reseller informs you otherwise.

During the warranty period IBM or your reseller, if authorized by IBM, will provide warranty service under the type of service designated for the Machine and will manage and install engineering changes that apply to the Machine.

For IBM or your reseller to provide warranty service for a feature, conversion, or upgrade, IBM or your reseller may require that the Machine on which it is installed be 1) for certain Machines, the designated, serial-numbered Machine and 2) at an engineering-change level compatible with the feature, conversion, or upgrade. Many of these transactions involve the removal of parts and their return to IBM. You represent that all removed parts are genuine and unaltered. A part that replaces a removed part will assume the warranty service status of the replaced part.

If a Machine does not function as warranted during the warranty period, IBM or your reseller will repair it or replace it with one that is at least functionally equivalent, without charge. The replacement may not be new, but will be in good working order. If IBM or your reseller is unable to repair or replace the Machine, you may return it to your place of purchase and your money will be refunded.

If you transfer a Machine to another user, warranty service is available to that user for the remainder of the warranty period. You should give your proof of purchase and this Statement to that user. However, for Machines which have a life-time warranty, this warranty is not transferable.

Warranty Service

To obtain warranty service for the Machine, you should contact your reseller or call IBM. In the United States, call IBM at **1-800-IBM-SERV (426-7378)**. In Canada, call IBM at **1-800-465-6666**. You may be required to present proof of purchase.

IBM or your reseller will provide certain types of repair and exchange service, either at your location or at IBM's or your reseller's service center, to restore a Machine to good working order.

When a type of service involves the exchange of a Machine or part, the item IBM or your reseller replaces becomes its property and the replacement becomes yours. You represent that all removed items are genuine and unaltered. The replacement may not be new, but will be in good working order and at least functionally equivalent to the item replaced. The replacement assumes the warranty service status of the replaced item. Before IBM or your reseller exchanges a Machine or part, you agree to remove all features, parts, options, alterations, and attachments not under warranty service. You also agree to ensure that the Machine is free of any legal obligations or restrictions that prevent its exchange. You agree to:

1. Obtain authorization from the owner to have IBM or your reseller service a Machine that you do not own; and
2. Where applicable, before service is provided —
 - a. Follow the problem determination, problem analysis, and service request procedures that IBM or your reseller provide,
 - b. Secure all programs, data, and funds contained in a Machine, and
 - c. Inform IBM or your reseller of changes in a Machine's location.

IBM is responsible for loss of, or damage to, your Machine while it is 1) in IBM's possession or 2) in transit in those cases where IBM is responsible for the transportation charges.

Extent of Warranty

IBM does not warrant uninterrupted or error-free operation of a Machine.

The warranties may be voided by misuse, accident, modification, unsuitable physical or operating environment, improper maintenance by you, removal or alteration of Machine or parts identification labels, or failure caused by a product for which IBM is not responsible.

OR IMPLIED, INCLUDING, BUT NOT LIMITED TO, THE IMPLIED WARRANTIES OR CONDITIONS OF MERCHANTABILITY AND FITNESS FOR A PARTICULAR PURPOSE. THESE WARRANTIES GIVE YOU SPECIFIC LEGAL RIGHTS AND YOU MAY ALSO HAVE OTHER RIGHTS WHICH VARY FROM JURISDICTION TO JURISDICTION. SOME JURISDICTIONS DO NOT ALLOW THE EXCLUSION OR LIMITATION OF EXPRESS OR IMPLIED WARRANTIES, SO THE ABOVE EXCLUSION OR LIMITATION MAY NOT APPLY TO YOU. IN THAT EVENT SUCH WARRANTIES ARE LIMITED IN DURATION TO THE WARRANTY PERIOD. NO WARRANTIES APPLY AFTER THAT PERIOD.

Limitation of Liability

Circumstances may arise where, because of a default on IBM's part or other liability you are entitled to recover damages from IBM. In each such instance, regardless of the basis on which you are entitled to claim damages from IBM (including fundamental breach, negligence, misrepresentation, or other contract or tort claim), IBM is liable only for:

1. Damages for bodily injury (including death) and damage to real property and tangible personal property; and
2. The amount of any other actual direct damages or loss, up to the greater of U.S. \$100,000 or the charges (if recurring, 12 months' charges apply) for the Machine that is the subject of the claim.

1) THIRD-PARTY CLAIMS AGAINST YOU FOR LOSSES OR DAMAGES (OTHER THAN THOSE UNDER THE FIRST ITEM LISTED ABOVE); 2) LOSS OF, OR DAMAGE TO, YOUR RECORDS OR DATA; OR 3) SPECIAL, INCIDENTAL, OR INDIRECT DAMAGES OR FOR ANY ECONOMIC CONSEQUENTIAL DAMAGES (INCLUDING LOST PROFITS OR SAVINGS), EVEN IF IBM OR YOUR RESELLER IS INFORMED OF THEIR POSSIBILITY. SOME JURISDICTIONS DO NOT ALLOW THE EXCLUSION OR LIMITATION OF INCIDENTAL OR CONSEQUENTIAL DAMAGES, SO THE ABOVE EXCLUSION OR LIMITATION MAY NOT APPLY TO YOU.

International Business Machines Corporation

Armonk, New York 10504, U.S.A.

Index

A

- Accessor
 - Installing 92
 - Removing 91
- Assembly Diagrams
 - Model 305 - Stand Alone Tower (External) 196, 198
 - Model 3xx - Stand Alone Tower (External) 190
 - Model 3xx (Internal) 192, 200

B

- Bar Code Reader
 - Installing 89
 - Removing 88

C

- Cables
 - Control Panel, Removing and Installing Cable 54
 - Parts List 194
 - Power Cable Requirements 203
 - Removing and Installing Picker Umbilical Cable 83
- Calibration, Library
 - 5-Tape Calibration 28
 - Full Calibration 29
- Cartridge Holder, 2-Slot
 - Installing 63
 - Removing 62
- CE Menu
 - Code Loading (Library) 40
 - Enabling 31
 - Error Log, Clearing 38
 - History Log, Clearing 38
 - Library NVRAM, Clearing 39
 - Product Type, Setting in the Library 33
 - Serial Number, Setting in the Library 33
 - Tuning Parameters, Setting Library 35
- Code Loading (Library) 40
- Control Panel
 - Description of Key Pad 11
 - Features (Descriptions) 2
 - Control Panel Buttons 4
 - Control Panel Liquid Crystal Display (LCD) 4
 - Door Lock Indicator 3
 - Door Unlock Button 3
 - Key Lock 3
 - Power Switch and Power-On Indicator 2
 - Inoperative Display or Power-On Indicator 111
 - Installing 52
 - Nonfunctional 144
 - Power Switch does not Power-Off the Library 116
 - Removing 51

- Control Panel Cable
 - Installing 55
 - Removing 54
- Control Panel Operations
 - See Service Operations
- Controller Card
 - Installing 76
 - Measuring Voltages 153
 - Power-Switch Override Jumper, Installing or Removing 150
 - Removing 74
- Cover Set, Library
 - Installing 47
 - Removing 44

D

- danger notices ix
- Data Cartridge 194
- Door Lock Indicator, description 3
- Door Unlock Button, description 3
- Door, Front
 - See Front Door
- drive status, checking 5

E

- Error Codes and Related Service Actions 155
- Error Codes and Related Services 155
- Error Log
 - Clearing 38
 - Displaying 15

F

- Failure Analysis Procedures
 - See Problem Analysis Procedures
- Fan
 - Installing 65
 - Removing 64
- Field Replaceable Unit (FRU) Code
 - Description of FRUs and Related Service Actions 163
 - Display (figure) 10
 - Group Codes 161
- Front Door
 - Installing 49
 - Removing 48

H

- Handling Static-Sensitive Devices 43
 - Power-Switch Override Jumper, Installing or Removing 150

History Log
Clearing 38
Displaying 19

I

Installation Procedures
2-Slot Cartridge Holder 63
Accessor 92
Bar Code Reader 89
Control Panel 52
Control Panel Cable 55
Controller Card 76
Cover Set, Library 47
Fan 65
Front Door 49
Magazine Mounting Plates 60
Picker and Picker Umbilical Cable 85
Power Supply 72
SCSI Cable Group, Internal 79
Sensor Group 98
Tape Cartridge Magazine 58
Tape Drive 68
Tape SCSI ID Cable 82
Internal Code Loading (Library) 40

K

Key Lock, description 3

L

Library Statistics, Displaying 21
limited warranty 207
Log Menu, Displaying 14

M

Magazine Mounting Plates
Installing 60
Removing 59
Magazine, Tape Cartridge
Installing 58
Removing 57
Maintenance Analysis Procedures
See Problem Analysis Procedures
Menu Structure (Service Operations) 12

N

NVRAM (Library), Clearing 39

P

Parts Diagram and Parts List 187
Assembly (External), Model 3xx - Stand Alone
Tower 190, 196, 198

Parts Diagram and Parts List (*continued*)
Assembly (Internal), Model 3xx 192, 200
How to Use 187
Media Kit 194
Parts List (External), Model 3xx - Stand Alone
Tower 191, 197, 199
Parts List (Internal), Model 3xx 193, 201
Parts List, Cables and Miscellaneous 194
Picker and Picker Umbilical Cable
Installing 85
Removing 83
Tape Cartridge Stuck, Removing 104
Power Cable Requirements 203
Power Distribution
Description 9
Measuring Power Supply Voltages 152
Power System Checkout 137
Power-Switch Override Jumper, Installing or
Removing 150
Power Supply
Installing 72
Measuring Voltages 152
Removing 71
Power Switch and Power-On Indicator description 2
Power-Off
Definition 9
Power-On
Definition 9
Indicator Inoperative 111
Switch does not Power-Off the Library 116
Problem Analysis Procedures
Error Codes and Related Service Actions 155
List of 7331 Tape Library FRU Group Codes 161
List of 7331 Tape Library Unit Error Codes 155
Starting Point for 107
Product Type, Setting in the Library 33

R

Reference Information
Control Panel Features 2
Specifications, Library 1
Removal Procedures
2-Slot Cartridge Holder 62
Accessor 91
Bar Code Reader 88
Control Panel 51
Control Panel Cable 54
Controller Card 74
Cover Set, Library 44
Fan 64
Front Door 48
Magazine Mounting Plates 59
Picker and Picker Umbilical Cable 83
Power Supply 71
SCSI Cable Group, Internal 78

Removal Procedures *(continued)*

- Sensor Group 96
- Tape Cartridge Magazine 57
- Tape Cartridge Stuck in the Picker 104
- Tape Drive 67
- Tape SCSI ID Cable 81

S

- Safety Notices
 - danger ix
- SCSI Cable Group, Internal
 - Installing 79
 - Removing 78
- SCSI ID Cable, Tape
 - Installing 82
 - Removing 81
- Selftest (Library), Performing 26
- Sensor Group
 - Accessor Bottom Travel Limit Cable
 - Installing 99
 - Removing 97
 - Accessor Motor Tach Cable
 - Installing 98
 - Removing 97
 - Accessor Obstructed Sensors (Emitter and Receiver)
 - Installing 98
 - Removing 97
 - Accessor Top Travel Limit and Lock Cable
 - Installing 99
 - Removing 98
 - Upper/Lower Magazine Sensor Cable
 - Installing 99
 - Removing 97
- Sensor Information (Library), Displaying 24
- Serial Number, Setting in the Library 33
- Service Menu, Displaying 13
- Service Operations
 - Calibrating the Library 28
 - CE Menu, Enabling 31
 - Code Loading (Library) 40
 - Control Panel Features 2
 - Control Panel Operations 11
 - Error Log, Clearing 38
 - Error Log, Displaying 15
 - History Log, Clearing 38
 - History Log, Displaying 19
 - Library NVRAM, Clearing 39
 - Library Statistics, Displaying 21
 - Log Menu, Displaying 14
 - Menu Structure 12
 - Product Type, Setting in the Library 33
 - Selftest 26
 - Sensor Information (Library), Displaying 24
 - Serial Number, Setting in the Library 33
 - Service Menu, Displaying 13

Service Operations *(continued)*

- Tape Drive Statistics, Displaying 21
- Tuning Parameters, Setting Library 35
- Specifications, Library 1
- Static-Sensitive Devices, Handling 43

T

- Tape Cartridge
 - Cleaning 194
 - Data 194
 - Installing Tape Cartridge Magazine 58
 - Removing a Tape Cartridge Magazine 57
 - Stuck in the Picker, Removing 104
 - Test 194
- Tape Cartridge Magazine
 - Installing 58
 - Removing 57
- Tape Drive
 - Installing 68
 - Removing 67
 - Status Lights, description 7
 - Unload Button, description 7
- Tape Drive Statistics, Displaying 21
- Tuning Parameters, Setting Library 35

U

- Unit Error Code (UEC) Code
 - 7331 Tape Library (listing) 155
 - Display (figure) 10
 - Problem Analysis using a UEC 120
- user menu 5

W

- warranty, limited 207

Readers' Comments — We'd Like to Hear from You

7331 and 3449 8mm Tape Library
Model 3xx
Service Guide
Publication No. GA32-0377-00

Overall, how satisfied are you with the information in this book?

Very Satisfied Satisfied Neutral Dissatisfied Very Dissatisfied

Overall satisfaction

How satisfied are you that the information in this book is:

Very Satisfied Satisfied Neutral Dissatisfied Very Dissatisfied

Accurate
Complete
Easy to find
Easy to understand
Well organized
Applicable to your tasks

Please tell us how we can improve this book:

Thank you for your responses. May we contact you? Yes No

When you send comments to IBM, you grant IBM a nonexclusive right to use or distribute your comments in any way it believes appropriate without incurring any obligation to you.

Name

Address

Company or Organization

Phone No.

IBM

Cut or Fold
Along Line

Fold and Tape

Please do not staple

Fold and Tape

PLACE
POSTAGE
STAMP
HERE

International Business Machine Corporation
Department 61C
9000 South Rita Road
Tucson, AZ 85741-0001, U.S.A.

Fold and Tape

Please do not staple

Fold and Tape

Cut or Fold
Along Line

IBM

Part Number: 59H3447



Printed in the United States of America
on recycled paper containing 10%
recovered post-consumer fiber.

GA32- 377-

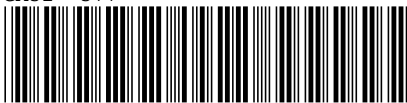

PN59H3447



Spine information:

IBM 7331 and 3449 8mm Tape Library Model 3xx

Service Guide

DSMKPO654E INVALID POSTSCRIPT FILE.
DSMMOM395I '.EDFPO' LINE 70: .po @E@P@S
DSMMOM397I '.EDFPO' WAS IMBEDDED AT LINE 910 OF '.EDFAWRK'
DSMMOM397I '.EDFAWRK' WAS IMBEDDED AT LINE 130 OF '.EDFARTA'
DSMMOM397I '.EDFARTA' WAS IMBEDDED AT LINE 3769 OF 'A49S0MST'
DSMBEG323I STARTING PASS 2 OF 4.
DSMKPO654E INVALID POSTSCRIPT FILE.
DSMMOM395I '.EDFPO' LINE 70: .po @E@P@S
DSMMOM397I '.EDFPO' WAS IMBEDDED AT LINE 910 OF '.EDFAWRK'
DSMMOM397I '.EDFAWRK' WAS IMBEDDED AT LINE 130 OF '.EDFARTA'
DSMMOM397I '.EDFARTA' WAS IMBEDDED AT LINE 3769 OF 'A49S0MST'
DSMBEG323I STARTING PASS 3 OF 4.
DSMKPO654E INVALID POSTSCRIPT FILE.
DSMMOM395I '.EDFPO' LINE 70: .po @E@P@S
DSMMOM397I '.EDFPO' WAS IMBEDDED AT LINE 910 OF '.EDFAWRK'
DSMMOM397I '.EDFAWRK' WAS IMBEDDED AT LINE 130 OF '.EDFARTA'
DSMMOM397I '.EDFARTA' WAS IMBEDDED AT LINE 3769 OF 'A49S0MST'
DSMBEG323I STARTING PASS 4 OF 4.
DSMKPO654E INVALID POSTSCRIPT FILE.
DSMMOM395I '.EDFPO' LINE 70: .po @E@P@S
DSMMOM397I '.EDFPO' WAS IMBEDDED AT LINE 910 OF '.EDFAWRK'
DSMMOM397I '.EDFAWRK' WAS IMBEDDED AT LINE 130 OF '.EDFARTA'
DSMMOM397I '.EDFARTA' WAS IMBEDDED AT LINE 3769 OF 'A49S0MST'