

**IBM**

**@server**

xSeries 235

Type 8671

# User's Guide





IBM xSeries 235 Type 8671



# User's Guide

**Note:**

Before using this information and the product it supports, be sure to read the general information in Appendix B, "Warranty information", on page 31, and Appendix C, "Notices", on page 43.

**Second Edition (January 2003)**

**© Copyright International Business Machines Corporation 2002. All rights reserved.**

US Government Users Restricted Rights – Use, duplication or disclosure restricted by GSA ADP Schedule Contract with IBM Corp.

---

# Contents

<b>Safety</b>	v
<b>Chapter 1. Introducing the IBM xSeries 235 Type 8671 server.</b>	1
Related Publications	1
Notices and statements used in this book	2
Features and specifications	3
What your server offers	4
Reliability, availability, and serviceability	5
IBM Director	6
The UpdateXpress program	7
Server controls and indicators	8
Front view	8
Rear view	10
Operator information panel	11
Server power features	12
Turning on the server	12
Turning off the server	13
Standby mode	14
<b>Chapter 2. Configuring your server</b>	15
Using the Configuration/Setup Utility program	16
Starting the Configuration/Setup Utility program	16
Choices available from the Configuration/Setup main menu	16
Using passwords	20
Using the LSI Logic Configuration Utility program	21
Starting the LSI Logic Configuration Utility program	22
Formatting a SCSI hard disk drive	22
Using the ServerGuide Setup and Installation CD	22
ServerGuide features	23
Setup and configuration overview	23
System Partition	24
Typical operating-system installation	25
Setting up or updating multiple servers	25
Installing your operating system without ServerGuide	25
Using ServeRAID Manager	26
Configuring the Gigabit Ethernet controller	27
High-performance Ethernet modes	27
Ethernet port connector	27
Updating the integrated system management firmware	28
<b>Appendix A. Getting help and technical assistance</b>	29
Before you call	29
Using the documentation	29
Getting help and information from the World Wide Web	29
Software service and support	30
Hardware service and support	30
<b>Appendix B. Warranty information</b>	31
Warranty period	31
Problem determination	31
Warranty service and support	32
International Warranty Service	33
Purchasing additional services	33

IBM Statement of Limited Warranty Z125-4753-06 8/2000 . . . . .	34
Part 1 - General Terms . . . . .	34
Part 2 - Country-unique Terms . . . . .	36
<b>Appendix C. Notices . . . . .</b>	<b>43</b>
Edition notice . . . . .	43
Trademarks . . . . .	44
Important notes. . . . .	44
Electronic emission notices . . . . .	45
Federal Communications Commission (FCC) statement . . . . .	45
Industry Canada Class A emission compliance statement . . . . .	46
Australia and New Zealand Class A statement . . . . .	46
United Kingdom telecommunications safety requirement. . . . .	46
European Union EMC Directive conformance statement. . . . .	46
Taiwan electrical emission statement . . . . .	46
Japanese Voluntary Control Council for Interference (VCCI) statement . . . . .	47
Power cords . . . . .	47
<b>Index . . . . .</b>	<b>49</b>

## Safety

Before installing this product, read the Safety Information.

قبل تركيب هذا المنتج، يجب قراءة الملاحظات الأمنية

Antes de instalar este produto, leia as Informações de Segurança.

在安装本产品之前，请仔细阅读 **Safety Information** (安全信息)。

安裝本產品之前，請先閱讀「安全資訊」。

Prije instalacije ovog produkta obavezno pročitajte Sigurnosne Upute.

Před instalací tohoto produktu si přečtěte příručku bezpečnostních instrukcí.

Læs sikkerhedsforskrifterne, før du installerer dette produkt.

Lees voordat u dit product installeert eerst de veiligheidsvoorschriften.

Ennen kuin asennat tämän tuotteen, lue turvaohjeet kohdasta Safety Information.

Avant d'installer ce produit, lisez les consignes de sécurité.

Vor der Installation dieses Produkts die Sicherheitshinweise lesen.

Πριν εγκαταστήσετε το προϊόν αυτό, διαβάστε τις πληροφορίες ασφαλείας (safety information).

לפני שתתקינו מוצר זה, קראו את הוראות הבטיחות.

A termék telepítése előtt olvassa el a Biztonsági előírásokat!

Prima di installare questo prodotto, leggere le Informazioni sulla Sicurezza.

製品の設置の前に、安全情報をお読みください。

본 제품을 설치하기 전에 안전 정보를 읽으십시오.

Пред да се инсталира овој продукт, прочитајте информацијата за безбедност.

Les sikkerhetsinformasjonen (Safety Information) før du installerer dette produktet.

Przed zainstalowaniem tego produktu, należy zapoznać się z książką "Informacje dotyczące bezpieczeństwa" (Safety Information).

Antes de instalar este produto, leia as Informações sobre Segurança.

Перед установкой продукта прочтите инструкции по технике безопасности.

Pred inštaláciou tohto zariadenia si pečítajte Bezpečnostné predpisy.

Pred namestitvijo tega proizvoda preberite Varnostne informacije.

Antes de instalar este producto lea la información de seguridad.

Läs säkerhetsinformationen innan du installerar den här produkten.

#### Statement 1



#### Danger

Electrical current from power, telephone, and communication cables is hazardous.

#### To avoid a shock hazard:

- Do not connect or disconnect any cables or perform installation, maintenance, or reconfiguration of this product during an electrical storm.
- Connect all power cords to a properly wired and grounded electrical outlet.
- Connect to properly wired outlets any equipment that will be attached to this product.
- When possible, use one hand only to connect or disconnect signal cables.
- Never turn on any equipment when there is evidence of fire, water, or structural damage.
- Disconnect the attached power cords, telecommunications systems, networks, and modems before you open the device covers, unless instructed otherwise in the installation and configuration procedures.
- Connect and disconnect cables as described in the following table when installing, moving, or opening covers on this product or attached devices.

#### To connect:

1. Turn everything OFF.
2. First, attach all cables to devices.
3. Attach signal cables to connectors.
4. Attach power cords to outlet.
5. Turn device ON.

#### To disconnect:

1. Turn everything OFF.
2. First, remove power cords from outlet.
3. Remove signal cables from connectors.
4. Remove all cables from devices.

#### Statement 2



#### CAUTION:

When replacing the lithium battery, use only IBM Part Number 33F8354 or an equivalent type battery recommended by the manufacturer. If your system has a module containing a lithium battery, replace it only with the same module type made by the same manufacturer. The battery contains lithium and can explode if not properly used, handled, or disposed of.

#### Do not:

- Throw or immerse into water.
- Heat to more than 100°C (212°F)
- Repair or disassemble

Dispose of the battery as required by local ordinances or regulations.



Statement 3



**CAUTION:**

When laser products (such as CD-ROMs, DVD drives, fiber optic devices, or transmitters) are installed, note the following:

- Do not remove the covers. Removing the covers of the laser product could result in exposure to hazardous laser radiation. There are no serviceable parts inside the device.
- Use of controls or adjustments or performance of procedures other than those specified herein might result in hazardous radiation exposure.



**Danger**

Some laser products contain an embedded Class 3A or Class 3B laser diode. Note the following. Laser radiation when open. Do not stare into the beam, do not view directly with optical instruments, and avoid direct exposure to the beam.

Statement 4

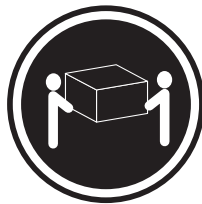

≥18 kg (39.7 lb)



≥32 kg (70.5 lb)



≥55 kg (121.2 lb)

**CAUTION:**

Use safe practices when lifting.

Statement 5



**CAUTION:**

The power-control button on the device and the power switch on the power supply do not turn off the electrical current supplied to the device. The device also might have more than one power cord. To remove all electrical current from the device, ensure that all power cords are disconnected from the power source.

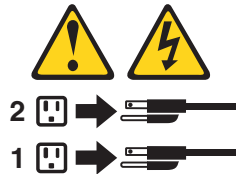

Statement 8



**CAUTION:**

Never remove the cover on a power supply or any part that has the following label attached.



Hazardous voltage, current, and energy levels are present inside any component that has this label attached. There are no serviceable parts inside these components. If you suspect a problem with one of these parts, contact a service technician.

Statement 10



**CAUTION:**

Do not place any object weighing more than 82 kg (180 lb) on top of rack-mounted devices.



>82 kg (180 lb)

Statement 13



**DANGER:**

Overloading a branch circuit is potentially a fire hazard and a shock hazard under certain conditions. To avoid these hazards, ensure that your system electrical requirements do not exceed the branch circuit protection requirements. Refer to the information that is provided with your IBM device for electrical specifications.

Statement 14



**CAUTION:**

Hazardous voltage, current, and energy levels might be present. Only a qualified service technician is authorized to remove the covers where the following label is attached.



Statement 15



**CAUTION:**

Make sure that the rack is secured properly to avoid tipping when the server unit is extended.

Statement 16



**CAUTION:**

Some accessory or option board outputs exceed Class 2 or limited power source limits and must be installed with appropriate interconnecting cabling in accordance with the national electric code.

**Statement 17**



**CAUTION:**

The following label indicates moving parts nearby.



---

## Chapter 1. Introducing the IBM xSeries 235 Type 8671 server

The IBM® @server xSeries™ 235 Type 8671 is a high-performance server. It can be upgraded to a symmetric multiprocessing (SMP) server through a microprocessor upgrade. It is ideally suited for networking environments that require superior microprocessor performance, efficient memory management, flexibility, and large amounts of reliable data storage.

Performance, ease of use, reliability, and expansion capabilities were key considerations in the design of your server. These design features make it possible for you to customize the system hardware to meet your needs today and provide flexible expansion capabilities for the future.

Your server contains IBM Enterprise X-Architecture™ technologies, which help increase performance and reliability. For more information, see “What your server offers” on page 4 and “Reliability, availability, and serviceability” on page 5.

You can obtain up-to-date information about your server and other IBM server products at <http://www.ibm.com/eserver/xseries/> on the World Wide Web.

Your server serial number and model number are located on labels on the bottom of the server and on the front, visible through the bezel. You will need these numbers when you register your server with IBM. The information label containing the serial number, machine type, model number, and agency marks for your server is located as follows:

- **Tower Model:** On the bottom of the server
- **Rack Configuration:** On the side of the server

**Note:** The illustrations in this document might differ slightly from your hardware.

---

### Related Publications

This *User's Guide* provides general information about your server, including information about features, how to configure your server, how to use the *ServerGuide™ Setup and Installation* CD, and how to get help.

In addition to this *User's Guide*, the following xSeries 235 Type 8671 documentation is provided with your server:

- *Installation Guide*  
This printed publication contains setup and installation instructions.
- *Rack Installation Instructions*  
This publication is provided in Portable Document Format (PDF) on the IBM *xSeries Documentation* CD. It contains the instructions to install your server in a rack.
- *Safety Information Book*  
This multilingual publication is provided in PDF on the IBM *xSeries Documentation* CD. It contains translated versions of the caution and danger statements that appear in the documentation for your server. Each caution and danger statement has an assigned number, which you can use to locate the corresponding statement in your native language.

- *Hardware Maintenance Manual and Troubleshooting Guide*  
This publication is provided in PDF on the IBM *xSeries Documentation* CD. It contains information to help you solve the problem yourself or to provide helpful information to a service technician.
- *Option Installation Guide*  
This publication is provided in PDF on the IBM *xSeries Documentation* CD. It contains instructions to install, remove, and connect optional devices supported by your server.

Depending on your server model, additional publications might be included on the IBM *xSeries Documentation* CD.

---

## Notices and statements used in this book

The caution and danger statements used in this book also appear in the multilingual *Safety Information* book provided on the IBM *xSeries Documentation* CD. Each caution and danger statement is numbered for easy reference to the corresponding statements in the safety book.

The following types of notices and statements are used in this book:

- **Note:** These notices provide important tips, guidance, or advice.
- **Important:** These notices provide information or advice that might help you avoid inconvenient or problem situations.
- **Attention:** These notices indicate possible damage to programs, devices, or data. An attention notice is placed just before the instruction or situation in which damage could occur.
- **Caution:** These statements indicate situations that can be potentially hazardous to you. A caution statement is placed just before the description of a potentially hazardous procedure step or situation.
- **Danger:** These statements indicate situations that can be potentially lethal or extremely hazardous to you. A danger statement is placed just before the description of a potentially lethal or extremely hazardous procedure step or situation.

## Features and specifications

The Table 1 provides a summary of the features and specifications for your server.

Table 1. Features and specifications

<p><b>Microprocessor:</b></p> <ul style="list-style-type: none"> <li>Intel Xeon™, 1.8 GHz or higher depending on server model</li> <li>512 KB (minimum) Level-2 cache</li> <li>400 MHz or 533 MHz front-side bus (FSB) depending on server model</li> <li>Support for up to two microprocessors</li> </ul> <p><b>Note:</b> You can use the Configuration/Setup program in your server to determine the specific type of microprocessor on your system board.</p> <p><b>Memory:</b></p> <ul style="list-style-type: none"> <li>Standard: 256 MB or 512 MB, depending on server model, expandable to 6 GB</li> <li>Type: 133 MHz/266 MHz, registered, ECC, double data rate, SDRAM</li> <li>Sizes: 128 MB, 256 MB, 512 MB, or 1 GB, in pairs</li> <li>Connectors: two-way interleaved, six dual inline memory module (DIMM) connectors</li> <li>Maximum: Three pairs of DIMMs</li> </ul> <p><b>Drives standard:</b></p> <ul style="list-style-type: none"> <li>Diskette: 1.44 MB</li> <li>CD-ROM: IDE</li> </ul> <p><b>Expansion bays:</b></p> <ul style="list-style-type: none"> <li>Six open hot-swap, slim-high, 3.5-inch drive bays</li> <li>Three 5.25-inch bays (CD-ROM drive installed in one bay)</li> <li>One 3.5-inch removable-media drive bay (diskette drive installed)</li> </ul> <p><b>PCI expansion slots:</b></p> <ul style="list-style-type: none"> <li>Two Active PCI-X™ (hot-plug) 133 MHz/64-bit</li> <li>Three PCI-X non-hot-plug 100 MHz/64-bit</li> <li>One PCI non-hot-plug, 33 MHz/32-bit</li> </ul> <p><b>Upgradeable microcode:</b> BIOS, diagnostics, and IBM integrated system management upgrades (when available) can update EEPROMs on the system board</p>	<p><b>Predictive Failure Analysis® (PFA) alerts:</b></p> <ul style="list-style-type: none"> <li>Power supplies</li> <li>Fans</li> <li>Memory</li> <li>Hard disk drives</li> <li>Microprocessors</li> <li>Voltage regulator modules (VRMs)</li> </ul> <p><b>Integrated functions:</b></p> <ul style="list-style-type: none"> <li>IBM integrated system management processor (ISMP) <ul style="list-style-type: none"> <li>Service processor with Light Path Diagnostics™</li> <li>RS-485 (ASM interconnect)</li> <li>Support for IBM Remote Supervisor Adapter</li> </ul> </li> <li>Broadcom 5703 10/100/1000 Ethernet controller (one port, controller on system board)</li> <li>One serial port</li> <li>One parallel port</li> <li>Two internal Ultra320 SCSI ports (dual-channel integrated SCSI controller with RAID capabilities on the system board)</li> <li>Three Universal Serial Bus (USB) v1.1 ports (one on the front and two on the rear of the enclosure)</li> <li>Keyboard port</li> <li>Mouse port</li> <li>ATI Rage XL video (controller on system board) <ul style="list-style-type: none"> <li>Compatible with SVGA and VGA</li> <li>8 MB video memory</li> </ul> </li> </ul> <p><b>Security features:</b></p> <ul style="list-style-type: none"> <li>Door and side cover lock</li> <li>Power-on and administrator passwords</li> <li>Remote-control security settings</li> <li>Selectable drive startup</li> <li>Keyboard password</li> <li>System-management security <ul style="list-style-type: none"> <li>User login password</li> <li>Read-only or read/write access</li> <li>Dial-in call-back</li> </ul> </li> </ul> <p><b>Power supplies:</b></p> <ul style="list-style-type: none"> <li>Hot-swap (some models) <ul style="list-style-type: none"> <li>Standard: Two 560 watts (115-230 V ac) for redundancy</li> <li>Redundant/nonredundant indicator on diagnostic LED panel</li> </ul> </li> <li>Non-hot-swap (some models) <ul style="list-style-type: none"> <li>Standard: One 560 watts (115-230 V ac)</li> <li>Upgradeable to two hot-swap power supplies</li> </ul> </li> </ul>	<p><b>Acoustical noise emissions:</b></p> <ul style="list-style-type: none"> <li>Sound power, idle: 6.5 bel</li> <li>Sound power, operating: 6.5 bel</li> <li>Bystander sound pressure, idle: 49 dBa</li> <li>Bystander sound pressure, operating: 49 dBa</li> </ul> <p><b>Redundant cooling:</b> Six hot-swap fans</p> <p><b>Electrical input:</b></p> <ul style="list-style-type: none"> <li>Sine-wave input (50-60 Hz) required</li> <li>Input voltage range automatically selected</li> <li>Input voltage low range: <ul style="list-style-type: none"> <li>Minimum: 100 V ac</li> <li>Maximum: 127 V ac</li> </ul> </li> <li>Input voltage high range: <ul style="list-style-type: none"> <li>Minimum: 200 V ac</li> <li>Maximum: 240 V ac</li> </ul> </li> <li>Input kilovolt-amperes (kVA) approximately: <ul style="list-style-type: none"> <li>Minimum: 0.1 kVA</li> <li>Maximum: 0.8 kVA</li> </ul> </li> </ul> <p><b>Power available for drives:</b></p> <ul style="list-style-type: none"> <li>+5 V dc</li> <li>+12 V dc</li> </ul> <p><b>Heat output:</b> Approximate heat output in British thermal units (Btu) per hour</p> <ul style="list-style-type: none"> <li>Minimum configuration: 341 Btu (100 watts/hour)</li> <li>Maximum configuration: 2600 Btu (760 watts/hour)</li> </ul> <p><b>Environment:</b></p> <ul style="list-style-type: none"> <li>Air temperature: <ul style="list-style-type: none"> <li>Server on: 10° to 35°C (50° to 95°F)</li> <li>Altitude: 0 to 2134 m (7000 ft)</li> <li>Server off: -40° to +60°C (-40° to 140°F)</li> <li>Maximum altitude: 2133 m (7000 ft)</li> </ul> </li> <li>Humidity: <ul style="list-style-type: none"> <li>Server on: 8% to 80%</li> <li>Server off: 8% to 80%</li> </ul> </li> </ul> <p><b>Size (tower model):</b></p> <ul style="list-style-type: none"> <li>Height: 440 mm (17.3 in.)</li> <li>Depth: 700 mm (27.5 in.)</li> <li>Width: 221 mm (8.7 in.)</li> <li>Weight: 33.5 kg (74 lb) to 45.8 kg (101 lb) depending upon configuration</li> </ul> <p><b>Size (5 U) (rack configuration):</b></p> <ul style="list-style-type: none"> <li>Height: 216 mm (8.5 in.)</li> <li>Depth: 674 mm (26.5 in.)</li> <li>Width: 440 mm (17.3 in.)</li> <li>Weight: 33.5 kg (74 lb) to 45.8 kg (101 lb) depending upon configuration</li> </ul>
------------------------------------------------------------------------------------------------------------------------------------------------------------------------------------------------------------------------------------------------------------------------------------------------------------------------------------------------------------------------------------------------------------------------------------------------------------------------------------------------------------------------------------------------------------------------------------------------------------------------------------------------------------------------------------------------------------------------------------------------------------------------------------------------------------------------------------------------------------------------------------------------------------------------------------------------------------------------------------------------------------------------------------------------------------------------------------------------------------------------------------------------------------------------------------------------------------------------------------------------------------------------------------------------------------------------------------------------------------------------------------------------------------------------------------------------------------------------------------------------------------------------------------------------------------------------------------------------------------------------------------------------------------------------------------------------	---------------------------------------------------------------------------------------------------------------------------------------------------------------------------------------------------------------------------------------------------------------------------------------------------------------------------------------------------------------------------------------------------------------------------------------------------------------------------------------------------------------------------------------------------------------------------------------------------------------------------------------------------------------------------------------------------------------------------------------------------------------------------------------------------------------------------------------------------------------------------------------------------------------------------------------------------------------------------------------------------------------------------------------------------------------------------------------------------------------------------------------------------------------------------------------------------------------------------------------------------------------------------------------------------------------------------------------------------------------------------------------------------------------------------------------------------------------------------------------------------------------------------------------------------------------------------------------------------------------------------------------------------------------------------------------------------------------------------------------------------------------------------------------------------------------------------------------------------------------------------------------------------------------------------------------------------------------------------------------------------------------------------------------------------------------------------------------------------------------------	---------------------------------------------------------------------------------------------------------------------------------------------------------------------------------------------------------------------------------------------------------------------------------------------------------------------------------------------------------------------------------------------------------------------------------------------------------------------------------------------------------------------------------------------------------------------------------------------------------------------------------------------------------------------------------------------------------------------------------------------------------------------------------------------------------------------------------------------------------------------------------------------------------------------------------------------------------------------------------------------------------------------------------------------------------------------------------------------------------------------------------------------------------------------------------------------------------------------------------------------------------------------------------------------------------------------------------------------------------------------------------------------------------------------------------------------------------------------------------------------------------------------------------------------------------------------------------------------------------------------------------------------------------------------------------------------------------------------------------------------------------------------------------------------------------------------------------------------------------------------------------------------------------------------------------------------------------------------------------------------------------------------------------------------------------------------------------------------------------------------------------------------------------------------------------------------------------------------------------------------------------------------------------------------------------------------------

---

## What your server offers

The design of your server takes advantage of advancements in symmetric multiprocessing (SMP), data storage, disk-array technologies, and memory management. Your server combines:

- **IBM X-Architecture technology**

IBM X-Architecture features leverage proven innovative IBM technologies to build the most powerful, scalable, reliable Intel-processor-based servers in the world. X-Architecture features include Light Path Diagnostics, Chipkill™ memory, Predictive Failure Analysis (PFA), and the Advanced System Management processor.

- **Impressive performance using SMP**

Your server supports up to two Intel Xeon microprocessors. Your server comes with at least one microprocessor installed; if it comes with one microprocessor, you can install an additional microprocessor to enhance performance and provide SMP capability.

- **Large data-storage and hot-swap capabilities**

All models of the server support up to six 25.4 mm (1-inch) slim-high, 3.5-inch hot-swap hard disk drives in the hot-swap bays. This *hot-swap* feature enables you to add, remove, or replace hard disk drives without turning off the server.

- **Active PCI (hot-plug) adapter capabilities**

Your server has two *hot-plug* slots for peripheral component interconnect (PCI) adapters. With operating system support, you can replace failing hot-plug PCI adapters without turning off the server. You can also add PCI adapters in these slots without turning off the server, *if the operating system and the adapter support the hot-add feature.*

- **Redundant cooling and power capabilities**

The redundant cooling and hot-swap capabilities of the fans in your server enable continued operation if one of the fans fails. You can also replace a failing fan without turning off the server.

Some models of the server come with two hot-swap 560-watt power supplies. The two hot-swap power supplies provide redundant power for many server configurations. If a problem occurs with one of the power supplies, the other power supply can handle the load. The NONREDUNDANT light-emitting diode (LED) on the diagnostic LED panel is lit when a problem is detected with one of the redundant hot-swap power supplies. For models that come with one fixed 560-watt power supply, a hot-swap power-supply option containing two hot-swap 560-watt power supplies is available; you can replace the fixed power supply with the hot-swap power-supply option to provide redundancy. (See the *Option Installation Guide* on the IBM xSeries Documentation CD for instructions.)

- **Large system memory**

Your server supports up to 6 GB of system memory. The memory controller provides error correcting code (ECC) support for up to six industry-standard, 133 MHz/266 MHz, 2.5 V, 184-pin, double-data-rate (DDR), PC2100 registered, synchronous dynamic random-access memory (SDRAM) dual inline memory modules (DIMMs). The memory controller also provides Chipkill Memory protection if all DIMMs are of the type x4. Chipkill Memory protection is a technology that protects the server from a single chip failure on a DIMM.

- **System-management capabilities**

Your server comes with an integrated system management processor (ISMP) and support for the Remote Supervisor Adapter. The ISMP, in conjunction with the



system-management software that is provided with your server, enables you to manage the functions of the server locally and remotely. The ISMP also provides system monitoring and event recording.

**Note:** The ISMP is sometimes referred to as the service processor.

The optional IBM Remote Supervisor Adapter works with the integrated service processor to give you a World Wide Web interface to the system-management functions. You can manage your server over the Internet or intranet.

See the documentation provided with your system-management software for more information. To order an optional Remote Supervisor Adapter, contact your IBM marketing representative or authorized reseller.

- **Integrated network environment support**

Your server comes with an integrated Broadcom Gigabit Ethernet controller on the system board. This Ethernet controller has an interface for connecting to 10/100/1000-Mbps networks. The server automatically selects between 10BASE-T and 100/1000BASE-TX environments. The controller provides full-duplex (FDX) capability, which enables simultaneous transmission and reception of data on the Ethernet local area network (LAN). This controller supports Wake on LAN<sup>®</sup> technology.

- **Redundant connection**

The addition of an optional network-interface card (NIC) provides a failover capability to a redundant Ethernet connection. If a problem occurs with the primary Ethernet connection, all Ethernet traffic associated with this primary connection is automatically switched to the redundant NIC. If the appropriate device drivers are installed, this switching occurs without data loss and without user intervention.

- **IBM ServerGuide Setup and Installation CD**

The *ServerGuide Setup and Installation* CD that comes with your server provides programs to help you set up your server and install the operating system. The ServerGuide program detects installed hardware options and provides the correct configuration programs and device drivers. For more information about the *ServerGuide Setup and Installation* CD, see “Using the ServerGuide Setup and Installation CD” on page 22.

- **IBM Director**

IBM Director is a workgroup-hardware-management tool that you can use to centrally manage xSeries servers. For more information about IBM Director, see the *IBM Director User's Guide* on the *IBM xSeries Documentation* CD.

---

## Reliability, availability, and serviceability

Three of the most important features in server design are reliability, availability, and serviceability (RAS). These factors help to ensure the integrity of the data stored on your server; that your server is available when you want to use it; and that should a failure occur, you can easily diagnose and repair the failure with minimal inconvenience.

The following is an abbreviated list of the RAS features that your server supports:

- Active PCI<sup>™</sup> (hot-plug) adapter slots
- Automatic error retry and recovery
- Automatic restart after a power failure
- Backup basic input/output system (BIOS) switching under the control of the service processor

- Built-in, menu-driven electrically erasable programmable ROM (EEPROM) based setup, system configuration, redundant array of independent disks (RAID) configuration, and diagnostic programs
- Built-in monitoring for fan, power, temperature, voltage, and power-supply redundancy
- Cable-presence detection on most connectors
- Chipkill memory protection
- Error codes and messages
- Error correcting code (ECC) L2 cache and system memory
- Fault-resistant startup
- Universal Serial Bus (USB) keyboard and mouse
- Hot-swap hard disk drives
- Integrated System Management Processor (ISMP)
- Information and Light Path Diagnostics LED panels
- Integrated service processor subsystem for remote system management
- Key lock support for physical security (tower model)
- Memory scrubbing and Predictive Failure Analysis (PFA) (background and real time)
- Availability of microcode and diagnostic levels
- Parity checking on the small computer system interface (SCSI) bus and PCI buses
- Power managed and Advanced Configuration and Power Interface (ACPI) compliant
- Power-on self-test (POST)
- Predictive Failure Analysis (PFA) alerts
- Redundant Ethernet capabilities (requires optional Ethernet adapter) with failover support
- Redundant hot-swap capability
  - Cooling fans with speed-sensing capability
  - Power supplies (some models)
- Remind button to temporarily flash the Attention LED
- Remote system problem-determination support
- Standby voltage for system-management features and monitoring
- Startup (boot) from LAN using Preboot Execution Environment (PXE) protocol
- System auto-configuring from the configuration menu
- System error logging (POST and service processor)
- Upgradeable microcode for POST, BIOS, diagnostics, service processor, and read-only memory (ROM) resident code, locally or over the LAN
- Vital product data (VPD) on microprocessors, system board, power supplies, and SCSI (hot-swap-drive) backplane
- Wake on LAN capability
- IBM Director workgroup-hardware-management tool
- xSeries Server Management

---

## IBM Director

With IBM Director, a network administrator can:

- View the hardware configuration of remote systems, in detail
- Monitor the usage and performance of critical components, such as microprocessors, disks, and memory
- Centrally manage individual or large groups of IBM and non-IBM Intel-based servers, desktop computers, workstations, and mobile computers on a variety of platforms

IBM Director provides a comprehensive entry-level workgroup hardware manager. Key features include:

- Advanced self-management capabilities for maximum system availability
- Multiple operating-system platform support, including Microsoft® Windows® 98, Windows NT®, Windows 2000, Windows XP Professional, Novell NetWare, IBM OS/2®, SCO UnixWare, Linux®, and Caldera OpenUNIX®
- Support for IBM and non-IBM servers, desktop computers, workstations, and mobile computers
- Support for systems-management industry standards
- Integration into leading workgroup and enterprise systems-management environments
- Ease of use, training, and setup

IBM Director also provides an extensible platform that supports advanced server tools that are designed to reduce the total cost of managing and supporting networked systems. By deploying IBM Director, you can achieve reductions in ownership costs through:

- Reduced downtime
- Increased productivity of IT personnel and users
- Reduced service and support costs

For more information about IBM Director, see the *IBM Director* CD that comes with your server, the IBM Director publications on the CD, and the following Web pages:

**Systems Management - Director Package**

<http://www.ibm.com/pc/qtechinfo/MIGR-40738.html>

This Web page includes links to software downloads and publications for the latest release of IBM Director.

**IBM xSeries Systems Management page**

[http://www.ibm.com/pc/ww/eserver/xseries/systems\\_management/index.html](http://www.ibm.com/pc/ww/eserver/xseries/systems_management/index.html)

This Web page presents an overview of IBM Systems Management and IBM Director.

**IBM Universal Manageability page**

<http://www.ibm.com/pc/us/pc/um/index.html>

This Web page links to an IBM portfolio of advanced management tools that help reduce costs and increase availability throughout the life cycle of a product.

---

## The UpdateXpress program

The UpdateXpress program is available for most xSeries servers and server options. It detects supported and installed device drivers and firmware in your server and installs available updates. You can download the UpdateXpress program from the Web at no additional cost, or you can purchase it on a CD. To download the program or purchase the CD, go to

<http://www.ibm.com/pc/ww/eserver/xseries/serverguide/xpress.html>.

# Server controls and indicators

This section identifies the controls and indicators on the front and rear of your server.

**Note:** The illustrations in this document might differ slightly from your hardware.

## Front view

### Tower model

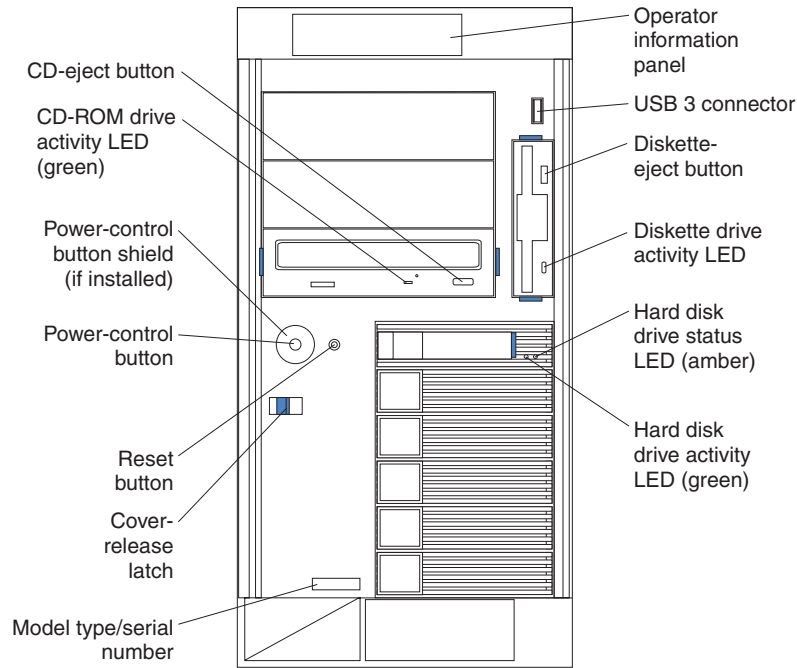

### Rack configuration

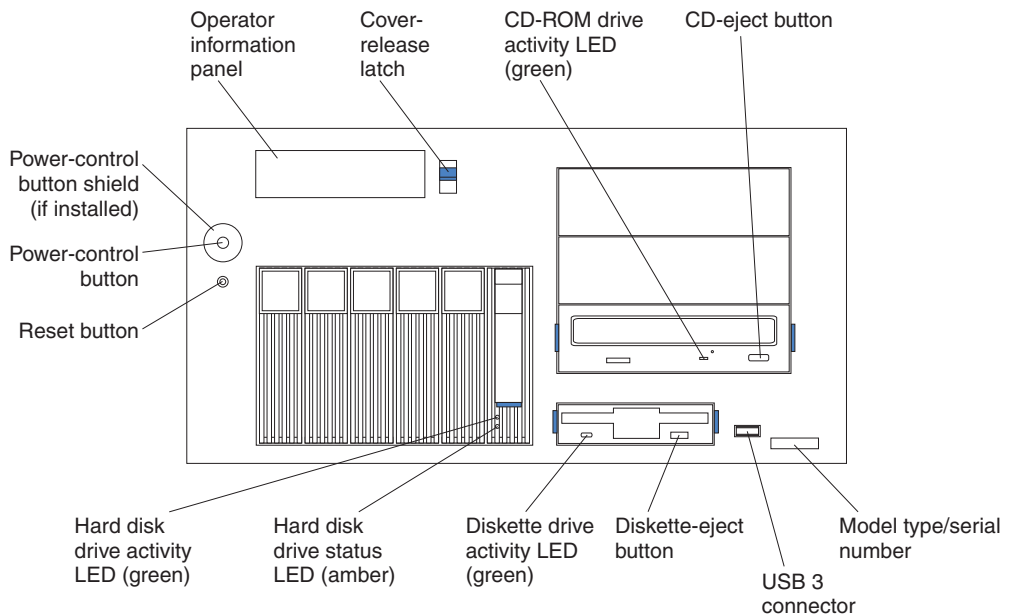

**Operator information panel:** The LEDs on this panel give status information for your server. See “Operator information panel” on page 11 for more information.

**USB 3 connector:** This is the front USB connector. Two additional USB connectors are on the rear of the server.

**Diskette-eject button:** Press this button to release a diskette from the drive.

**Diskette-drive activity LED:** When this LED is on, it indicates that the diskette drive is in use.

**Hard disk drive status LED:** Each hot-swap drive has a hard disk drive status LED. When this amber LED is on continuously, the drive has failed. If an optional IBM ServeRAID™ controller is installed in the server, when the LED flashes slowly (one flash per second), the drive is being rebuilt. When the LED flashes rapidly (three flashes per second), the controller is identifying the drive.

**Hard disk drive activity LED:** Each hot-swap drive has a hard disk drive activity LED. When this green LED is flashing, the drive is being accessed.

**Model type/serial number:** The model type identifies your server model. The serial number uniquely identifies your server.

**Cover-release latch:** Slide this latch to release the cover.

**Reset button:** Press this button to reset the server and run POST.

**Power-control button:** Press this button to manually turn on the server or put the server in Standby mode (see “Server power features” on page 12).

**Power-control button shield:** You can install this circular disk over the power-control button to prevent accidental manual power-off. This disk is provided with your server.

**CD-ROM drive activity LED:** When this LED is on, it indicates that the CD-ROM drive is in use.

**CD-eject button:** Press this button to release a CD from the drive.

## Rear view

This section identifies the indicators on the rear of your server. The following illustrations contain most of these indicators. The remaining indicators are illustrated in the “Working with adapters” section in the *Option Installation Guide* on the IBM xSeries Documentation CD.

### Server with fixed power supply

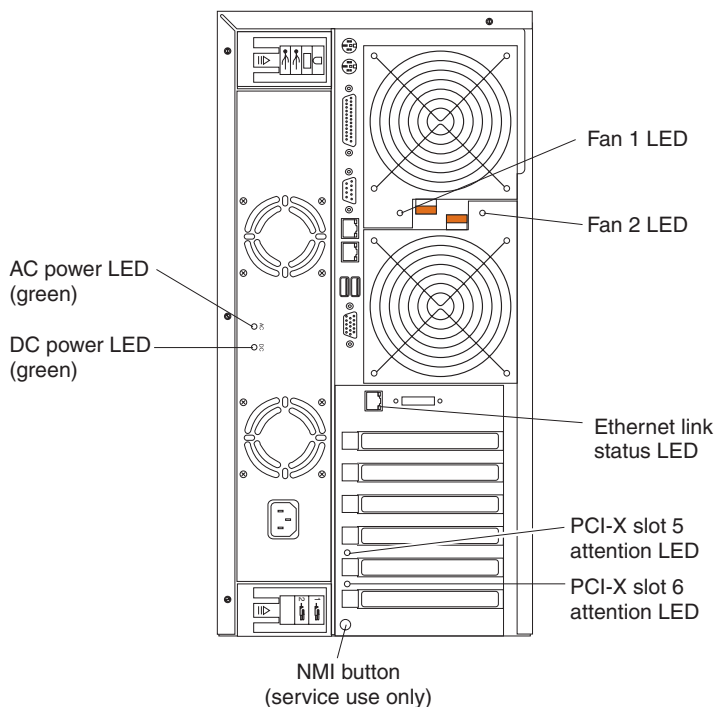

### Server with hot-swap power supplies

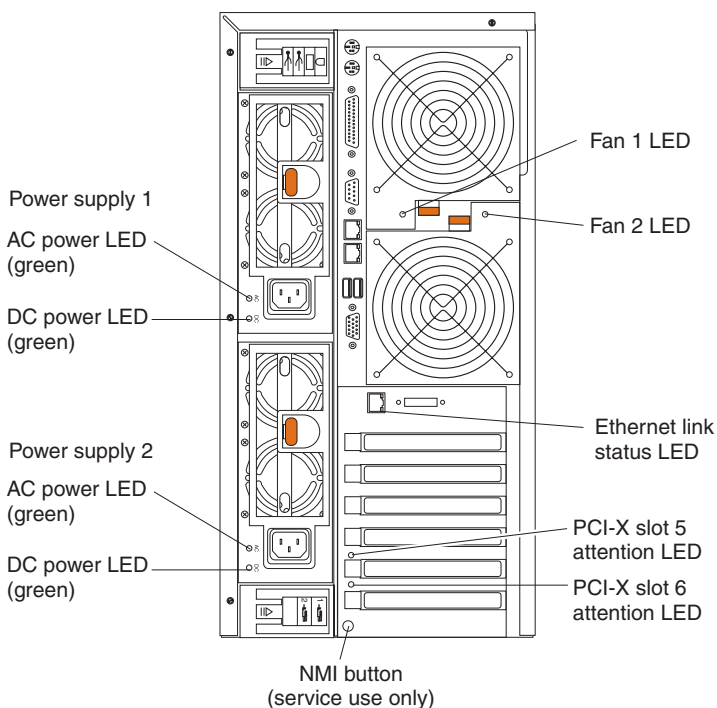

**Fans 1 and 2 LEDs:** These LEDs provide status information about rear fans 1 and 2. For additional information, see the section about the Light Path Diagnostics feature in the *Hardware Maintenance Manual and Troubleshooting Guide* on the IBM *xSeries Documentation CD*.

**Ethernet link status LED:** This LED is on the Ethernet connector. When this LED is on, there is an active connection on the Ethernet port.

**PCI-X slot attention LED:** This green LED flashes approximately once per second when it is on. This LED is visible from the rear of the server and from inside the server. The meaning of the attention LED is defined by your operating system. For an illustration showing this LED on the system board, see the *Option Installation Guide* on the IBM *xSeries Documentation CD*. For additional information, see the “LEDs for Active PCI slots” in the *Hardware Maintenance Manual and Troubleshooting Guide* on the IBM *xSeries Documentation CD*.

**NMI button:** The Non-Maskable Interrupt (NMI) button is for service use only.

**DC power LED:** This green LED provides status information about the power supply. During typical operation, both the ac and dc power LEDs are on. For any other combination of LEDs, see the *Hardware Maintenance Manual and Troubleshooting Guide* on the IBM *xSeries Documentation CD*.

**AC power LED:** This green LED provides status information about the power supply. During typical operation, both the ac and dc power LEDs are on. For any other combination of LEDs, see the *Hardware Maintenance Manual and Troubleshooting Guide* on the IBM *xSeries Documentation CD*.

## Operator information panel

The following illustration shows the status LEDs on the operator information panel on the front of the server.

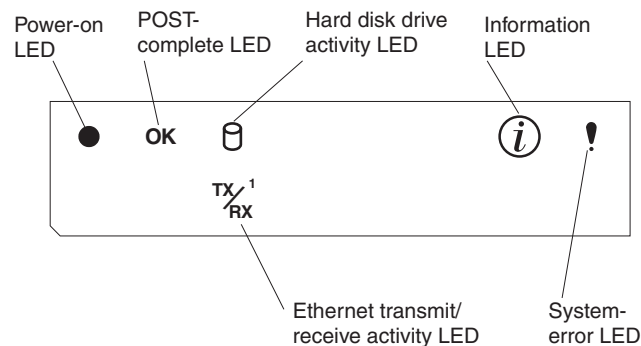

**Important:** If the power-on LED is off, it does not mean there is no electrical current present in the server. The LED might be burned out. To remove all electrical current from the server, you must unplug the server power cords from the electrical outlets or from the uninterruptible power device.

**Power-on LED:** When this green LED is on, power is present in the server. When this LED flashes, the server is in Standby mode (the system operating system is turned off and ac current is present). When this LED is off, the power subsystem, the ac power, or an LED has failed.

**POST-complete LED:** This green LED is on when POST is completed without any errors.

**Hard disk drive activity LED:** This green LED flickers when there is activity on a hard disk drive.

**Information LED:** When this amber LED is on, the server power supplies are nonredundant, or some other noncritical event has occurred. The event is recorded in the Error log. See “Choices available from the Configuration/Setup main menu” on page 16 for instructions for viewing the Error log. Check the diagnostic LED panel for more detailed information (see the *Hardware Maintenance Manual and Troubleshooting Guide* on the IBM xSeries Documentation CD).

**System-error LED:** This amber LED is on when a system error occurs. An LED on the diagnostic LED panel will also be on to further isolate the error. (For more information, see the *Hardware Maintenance Manual and Troubleshooting Guide* on the IBM xSeries Documentation CD.)

**Ethernet transmit/receive activity LED:** When this green LED is on, there is activity between the server and the network.

---

## Server power features

This section contains information about how to properly turn your server on and off.

### Turning on the server

Turning on the server refers to the act of plugging the power cords of your server into the power source and starting the operating system.

You can turn on the server in any of the following ways:

- If the power cords are connected to a power source, you can press the power-control button on the front of the server.

**Notes:**

1. You can install a circular disk over the power-control button to prevent accidental manual power-off. This disk, known as the power-control button shield, comes with your server.
  2. After you plug the power cords of your server into the electrical outlets, wait approximately 20 seconds before pressing the power-control button. During this time, the system-management adapter is initializing; therefore, the power-control button does not respond.
- If the server is turned on and a power failure occurs, the server will restart automatically when power is restored.
  - If ac power is present, the server is in Standby mode, and the server is connected to an ASM interconnect network that contains at least one system with an optional Remote Supervisor Adapter installed, the server can be turned on from the Remote Supervisor Adapter user interface.
  - If ac power is present, the server is in Standby mode, and an optional Remote Supervisor Adapter is installed in the server, the server can be turned on from the Remote Supervisor Adapter user interface.
  - When you plug in your server for the first time, Wake on LAN can turn on the server.
  - If your server was previously turned on, it must be properly placed in Standby mode for the Wake on LAN feature to turn on the server.



Complete the following steps to manually turn on the server:

1. Review the information in “Safety” on page v.
2. Turn on all external devices, such as the monitor.
3. Plug the server power cords into the power source.
4. Press the power-control button on the front of the server.

**Note:** While the server is powering up, the power-on LED on the front of the server is lit.

## Turning off the server

Turning off the server refers to the act of disconnecting the server from the power source.

Complete the following steps to manually turn off the server:

1. Review the information in “Safety” on page v.
2. See your operating system documentation for the proper procedure to shut down the operating system.

### Statement 5

---



#### CAUTION:

The power-control button on the device and the power switch on the power supply do not turn off the electrical current supplied to the device. The device also might have more than one power cord. To remove all electrical current from the device, ensure that all power cords are disconnected from the power source.

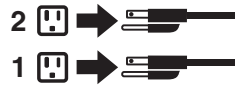

3. Press the power-control button on the front of the server. This will put the server in Standby mode.

**Note:** You might need to press and hold the power-control button for more than 4 seconds to cause an immediate shutdown of the server and to force it into Standby mode. You can use this feature if the operating system stops functioning.

4. Disconnect the server from the power source.

**Note:** After disconnecting all the power cords, wait approximately 15 seconds for your system to stop running. Watch for the power-on LED on the front of the server to stop flashing.

## Standby mode

Standby mode refers to the condition in which the server is connected to an ac power source but the server operating system is not running and all core logic is shut down except for the service processor. In Standby mode, the server can respond to service processor requests, such as a remote request to turn on the server. When the server is in Standby mode, the power-on LED on the front of the server flashes (when the server is running, the power-on LED stays on and does not flash).

You can put the server in Standby mode in any of the following ways:

- You can press the power-control button on the server. This starts an orderly shutdown of the operating system, if this feature is supported by your operating system.
- If the server is connected to an ASM interconnect network that contains at least one system with an optional Remote Supervisor Adapter installed, the server can be placed in Standby mode from the Remote Supervisor Adapter user interface.
- If an optional Remote Supervisor Adapter is installed in the server, the server can be placed in Standby mode from the Remote Supervisor Adapter user interface.

**Attention:** You must disconnect all the server power cords from the electrical outlets to remove all power from the server.

Complete the following steps to put the server into Standby mode:

1. See the operating system documentation for the proper procedure to shut down the operating system.

**Note:** Each operating system is different. Read all the documentation about shutting down the operating system before continuing.

2. Press the power-control button on the front of the server.

**Notes:**

- a. After you place the server in Standby mode, wait at least 5 seconds before you turn on the server again.
- b. You might need to press and hold the power-control button for more than 4 seconds to cause an immediate shutdown of the operating system and to force it into Standby mode. You can use this feature if the operating system stops functioning.

The ISMP can put the server in Standby mode as an automatic response to a critical system failure. You can also put the server into Standby mode remotely by means of an optional Remote Supervisor Adapter or through connection to an ASM interconnect network.

---

## Chapter 2. Configuring your server

The following configuration programs are provided with your server:

- **Configuration/Setup Utility**

This program is part of the basic input/output system (BIOS) code that comes with your server. You can use this program to configure serial and parallel port assignments, change interrupt request (IRQ) settings, change the drive startup sequence, set the date and time, and set passwords. You also can use this program to view the system configuration settings, for example, the number and type of installed microprocessors, the amount of installed memory, or the BIOS diagnostics version level. See “Using the Configuration/Setup Utility program” on page 16 for more information.

- **LSI Logic Configuration Utility**

With the built-in LSI Logic Configuration Utility program, you can configure the integrated SCSI controller and the devices that are attached to it. See “Using the LSI Logic Configuration Utility program” on page 21.

- **ServeRAID Manager**

The ServeRAID programs come with your server. If your server has a ServeRAID controller installed, or if you are using the integrated SCSI controller with RAID capabilities as a RAID controller, you must use the ServeRAID Manager program to define and configure your disk-array subsystem *before* you install your operating system. See “Using ServeRAID Manager” on page 26 for more information.

- **IBM ServerGuide Setup and Installation CD**

This provides software-setup tools and installation tools that are designed for your server. Use this CD during the installation of your server to configure basic hardware features, such as an integrated SCSI controller with RAID capabilities, and to simplify the installation of your operating system. For information about using this CD, see “Using the ServerGuide Setup and Installation CD” on page 22.

- **Ethernet controller configuration process**

To configure the integrated Ethernet controller, see “Configuring the Gigabit Ethernet controller” on page 27.

- **Integrated System Management update and configuration**

To update the integrated system management (ISM) firmware, see “Updating the integrated system management firmware” on page 28.

---

## Using the Configuration/Setup Utility program

This section provides instructions to start the Configuration/Setup Utility program and descriptions of the available menu choices.

### Starting the Configuration/Setup Utility program

To start the Configuration/Setup Utility program:

1. Turn on the server and watch the monitor screen.
2. When the message Press F1 for Configuration/Setup appears, press F1.

**Note:** If you have set both levels of passwords (power-on and administrator), you must type the administrator password to access the full Configuration/Setup Utility menu. Without the administrator password, limited Configuration/Setup Utility program functions are available.

3. Follow the instructions that appear on the screen.

### Choices available from the Configuration/Setup main menu

From the Configuration/Setup Utility main menu, you can select settings that you want to view or change. The Configuration/Setup Utility main menu is similar to the following.

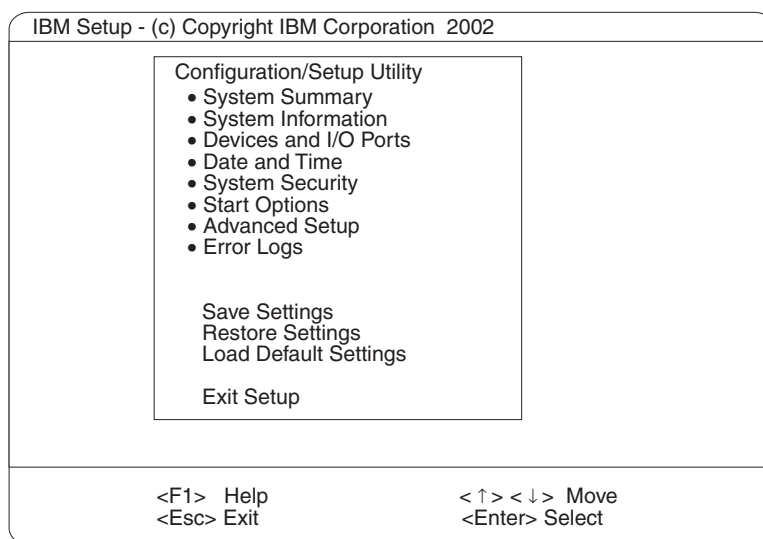

#### Notes:

1. You can press F1 to display help information for a selected menu item.
2. The choices on some menus might differ slightly, depending on the BIOS version in your server.

Descriptions of the choices available from the main menu are:

- **System Summary**

Select this choice to display configuration information. This includes the type, speed, and cache sizes of the microprocessors and the amount of memory installed.

Changes that you make to configuration settings appear on this summary screen. You cannot edit the fields.

This choice appears on both the full and limited Configuration/Setup Utility menus.

- **System Information**

Select this choice to display information about your server. Changes that you make on other menus might appear on this summary screen. You cannot edit any fields. The **System Information** choice appears only on the full Configuration/Setup Utility main menu.

- **Product Data**

Select this choice to view system information, such as the machine type and model, the server serial number, and the revision level or issue date of the BIOS and diagnostics code stored in the electrically erasable programmable ROM (EEPROM).

- **Devices and I/O Ports**

Select this choice to view or change the assignments for devices and input/output (I/O) ports. This choice appears only on the full Configuration/Setup Utility main menu.

You can use this choice also to enable or disable the integrated SCSI controller with RAID capabilities and Ethernet controllers, and standard ports (serial, parallel, and so on).

- The default setting is **Enabled** for all the controllers you can control from this menu. If you select **Disabled**, the system will not configure the disabled device and the operating system will not detect the device. (This is equivalent to unplugging the device.)
  - If the integrated SCSI controller with RAID capabilities is disabled and no SCSI adapter is installed, the server will have no SCSI capability.
  - If the on-board Ethernet controller is disabled and no Ethernet adapter is installed, the server will have no Ethernet capability.

- **Date and Time**

Select this choice to set the system date and time. This choice appears only on the full Configuration/Setup Utility main menu.

The system time is in a 24-hour format (hour:minute:second).

- **System Security**

Select this choice to set passwords or the Remote Control Security settings. This choice appears only on the full Configuration/Setup Utility main menu.

You can implement two levels of password protection:

- **Power-on Password**

Select this choice to set or change a power-on password. See “Using passwords” on page 20 for more information.

- **Administrator Password**

**Attention:** If an administrator password is set and then forgotten, it cannot be overridden or removed. You must replace the system board.

**Note:** This choice is available on the Configuration/Setup Utility menu only if the optional IBM Remote Supervisor Adapter is installed in your server.

Select this choice to set or change an administrator password.

The administrator password provides access to all choices on the Configuration/Setup Utility main menu. You can set, change, or delete both the administrator and power-on passwords and allow a power-on password to be changed by the user.

See “Using passwords” on page 20 for more information.

- **Start Options**

Select this choice to view or change the start options. This choice appears only on the full Configuration/Setup Utility main menu. Start options take effect when you start your server.

You can select keyboard operating characteristics, such as the keyboard speed. You also can specify whether the keyboard number lock starts on or off. You also can enable the server to issue error messages when it is run without a diskette drive, monitor, or keyboard.

The server uses a startup sequence to determine the device from which the operating system is loaded. For example, you can define a startup sequence that checks for a startable diskette in the diskette drive, then checks the hard disk drive in bay 0, and then checks a network adapter.

If your server contains Wake on LAN hardware and software and your operating system supports Wake on LAN functions, you can also define a startup sequence for the Wake on LAN functions.

If the **Boot Fail Count** choice is enabled, you can restore the BIOS system defaults after three consecutive boot failures. If this choice is disabled, the BIOS system defaults can be loaded only from the Configuration/Setup Utility main menu.

You also can select whether the integrated SCSI controller with RAID capabilities or a PCI SCSI adapter is given boot precedence. Select **Planar SCSI** to give the integrated SCSI controller with RAID capabilities boot precedence. If a PCI SCSI adapter is to be given boot precedence, select the slot number where this adapter is installed.

You can enable a virus-detection test that checks for changes in the master boot record at startup.

- **Advanced Setup**

Select this choice to change values for advanced hardware features, such as cache control, and PCI configuration. This choice appears only on the full Configuration/Setup Utility main menu.

A warning message appears above the choices on this menu to alert you that the system might malfunction if these options are configured incorrectly. Follow the instructions on the screen carefully.

- **System Partition Visibility**

Select this choice to indicate whether the System Partition is visible. To make the System Partition visible, set this choice to **Visible**. To make the System Partition invisible, set this choice to **Hidden**. See “Using the ServerGuide Setup and Installation CD” on page 22 for additional information about the System Partition.

- **Memory Settings**

Select this choice to manually enable a pair of memory connectors.

If a memory error is detected during POST or memory configuration, the server will automatically disable the failing pair of memory connectors and continue operating with reduced memory capacity. If this occurs, you must manually enable the set of memory connectors after the problem is corrected. Select **Memory Settings** from the **Advanced Setup** menu, and use the arrow keys to highlight the pair of memory connectors that you want to enable; then, use the arrow keys to select **Enable**.

- **CPU Options**  
Select this choice to indicate whether the microprocessor serial number in the microprocessor is readable or to set the microprocessor cache mode to disabled, write-back, or write-through. Selecting write-back mode will provide better system performance.
- **PCI Bus Control**  
Select this choice to view and set interrupts for PCI devices and to configure the master latency timer value for the server.
- **Integrated System Management Processor Settings**  
You can view and enable or disable the **Reboot on System NMI** setting on this menu. If this setting is enabled, the server will automatically restart 60 seconds after the service processor issues a Non-maskable interrupt (NMI) to the server. If this setting is disabled, the server will not restart. The default value is **Enable**.
- **Error Logs**  
Select this choice to view or clear error logs.
  - Select **POST Error Log** to view the three most recent error codes and messages that the system generated during POST.  
Select **Clear event/error logs** from the **POST Error Log** menu to clear the POST Error Log.
  - Select **System Event/Error Log** to view the System Event/Error Log. The System Event/Error Log contains all the system error and warning messages that the system has generated. You can use the arrow keys to move between pages in the System Event/Error Log.  
Select **Clear event/error logs** from the **System Event/Error Log** menu to clear the System Event/Error Log.
- **Save Settings**  
Select this choice to save your customized settings.
- **Restore Settings**  
Select this choice to delete your changes.
- **Load Default Settings**  
Select this choice to cancel your changes.
- **Exit Setup**  
If you have made any changes and not saved them, the program will prompt you to save the changes or exit without saving the changes.

### **Additional Configuration/Setup Utility menu choices**

When you install an IBM Remote Supervisor Adapter in your server, you can view additional menu choices in the Configuration/Setup Utility program, such as:

- **System Card Data**  
Select this choice to display information about your server.
- **PCI Slot/Device Information**  
Select this choice to view the properties of adapters installed in PCI slots.
- **Administrator Password**  
Select this choice to set or change the administrator password.

- **Remote Control Security Settings**

Select this choice to set a remote-control password. When you set a remote-control password, you can also set the number of failed attempts to enter the correct remote-control password, and the duration before another attempt is allowed.

For a list of supported options for your server, go to <http://www.ibm.com/pc/us/compat/> on the World Wide Web. To order an optional Remote Supervisor Adapter, contact your IBM marketing representative or authorized reseller.

## Using passwords

The **System Security** choice appears only on the full Configuration/Setup Utility menu. After you select this choice, you can implement two levels of password protection: power-on password and administrator password. The administrator password is available only if the optional IBM Remote Supervisor Adapter is installed in your server.

### Power-on password

After you set a power-on password, you can enable the Unattended Start mode. This locks the keyboard and mouse but enables the operating system to start. The keyboard and mouse remain locked until you type the correct password.

You can use any combination of up to seven characters (A–Z, a–z, and 0–9) for your power-on password. Keep a record of your password in a secure place. When a power-on password is set, POST is not completed until you type the password. If you forget the power-on password, you can regain access to the server through one of the following methods:

- If an administrator password is set, type the administrator password at the power-on prompt. (If necessary, see “Administrator password” on page 21 for details.) Start the Configuration/Setup Utility program and change the power-on password.
- Remove the battery and then reinstall the battery (see the *Option Installation Guide* on the IBM xSeries Documentation CD for instructions).
- Change the position of the power-on password override switch (switch 6 on switch block 1) as described below to bypass the power-on password check. You can then start the Configuration/Setup Utility program and change the power-on password.

#### Notes:

1. Before changing any switch settings or moving any jumpers, turn off the server; then, disconnect all power cords and external cables. (Review the information in “Safety” on page v and “Turning off the server” on page 13.)
2. Any system-board switch or jumper blocks that are not shown in the illustrations in this book are reserved.

#### Power-on password override (switch 6)

Changing the position of this switch bypasses the power-on password check the next time the server is powered on. You do not need to move the switch back after the password is overridden. The default position is Off. To bypass the power-on password check, move the switch to the opposite position. Changing the position of this switch does not affect the administrator password check if an administrator password is set.



## Administrator password

Select this choice to set an administrator password. The administrator password provides access to all choices on the Configuration/Setup Utility main menu. You can set, change, or delete both the administrator and power-on passwords and allow a power-on password to be changed by the user. You can use any combination of up to seven characters (A–Z, a–z, and 0–9) for your administrator password. Keep a record of your password in a secure place. The administrator password is available only if the optional IBM Remote Supervisor Adapter is installed in your server.

**Attention:** If an administrator password is set and then forgotten, it cannot be overridden or removed. You must replace the system board.

The following table provides a summary of the password features.

*Table 2. Power-on and administrator password features*

Type of password	Features
Power-on password	<ul style="list-style-type: none"><li>Type the password to complete the system startup.</li><li>All choices are available on the Configuration/Setup Utility main menu.</li></ul>
Administrator password	<ul style="list-style-type: none"><li>No password is required to complete the system startup.</li><li>Type the password to access the Configuration/Setup Utility program.</li><li>All choices are available on the Configuration/Setup Utility main menu.</li></ul>
Administrator <i>and</i> power-on password	<ul style="list-style-type: none"><li>You can type either password to complete the system startup.</li><li>The administrator password provides access to all choices on the Configuration/Setup Utility main menu. You can set, change, or delete both the administrator and power-on passwords and allow a power-on password to be changed by the user.</li><li>The power-on password provides access to a limited set of choices on the Configuration/Setup Utility main menu. This limited access might include changing or deleting the power-on password.</li></ul>

---

## Using the LSI Logic Configuration Utility program

LSI Logic Configuration is a built-in, menu-driven configuration utility program that you can use to:

- Perform a low-level format of a SCSI hard disk drive
- Set a SCSI device scan order
- Set a SCSI ID for a controller

### Notes:

- The integrated SCSI controller with RAID capabilities in your server supports only RAID level-1 and RAID level-1 Enhanced (RAID level-1E). Installing an optional ServeRAID-5i controller provides additional RAID levels. See “Using ServeRAID Manager” on page 26 for information about configuring your server for RAID operation.
- If you install a different type of RAID adapter in your server, use the configuration method supplied with the RAID adapter to view or change SCSI settings for attached devices.

The following sections provide the instructions needed to start the LSI Logic Configuration Utility program and to format a SCSI hard disk drive.

## Starting the LSI Logic Configuration Utility program

Complete the following steps to start the LSI Logic Configuration Utility program:

1. Turn on the server.
2. When the <<< Press <CTRL><C> to start LSI Logic Configuration Utility >>> prompt appears, press Ctrl+C.

**Note:** If an administrator password has been set, you are prompted to type the password to start the LSI Logic Configuration Utility program.

3. Use the arrow keys to select a controller (channel) from the list of adapters; then, press Enter.
4. Follow the instructions on the resulting screen to change the settings of the selected items; then, press Enter. The **Device Properties** and **Mirroring Properties** choices produce additional screens of parameters to review or change.

## Formatting a SCSI hard disk drive

You can use the LSI Logic Configuration Utility program to perform a low-level format on a SCSI hard disk drive. Complete the following steps to format a drive:

1. Select the controller channel for the drive to format from the list of adapters.
2. Select **Device Properties** from the resulting screen.
3. Use the arrow keys (↑ or ↓) to highlight the drive to format.

**Attention:** Low-level formatting removes all data from the hard disk drive. If there is data you want to save, backup the hard disk drive before continuing this procedure.

4. Use the arrow keys (← or →) or the End key to scroll to the right.
5. Highlight the **Format** item; then, press Enter to begin the low-level formatting operation.

---

## Using the ServerGuide Setup and Installation CD

The *ServerGuide Setup and Installation CD* includes an easy-to-use setup and installation program that is designed for your IBM server. The ServerGuide program detects the server model and hardware options that are installed and uses that information during setup to configure the hardware. The ServerGuide program simplifies operating-system installations by providing updated device drivers and, in some cases, installing them automatically.

If a later version of the ServerGuide program is available, you can download a free image of the *ServerGuide Setup and Installation CD*, or you can purchase the CD. To download the image, go to the IBM ServerGuide Web page at <http://www.ibm.com/pc/qtechinfo/MIGR-4ZKPPT.html>. To purchase the latest *ServerGuide Setup and Installation CD*, go to the ServerGuide fulfillment Web site at <http://www.ibm.com/pc/coupon/>.

The ServerGuide program has the following features to make setup easier:

- An easy-to-use interface with online help
- Diskette-free setup, and configuration programs that are based on detected hardware

- ServeRAID Manager program, which configures your ServeRAID adapter or integrated SCSI controller with RAID capabilities
- A system BIOS code update program, which updates the BIOS code directly from the CD
- Device drivers that are provided for your server model and detected hardware
- Operating-system partition size and file-system type that are selectable during setup

## ServerGuide features

Features and functions can vary slightly with different versions of the ServerGuide program. To learn more about the version that you have, start the *ServerGuide Setup and Installation* CD and view the online overview. Not all features are supported on all server models.

The ServerGuide program requires a supported IBM server with an enabled startable (bootable) CD-ROM drive. In addition to the *ServerGuide Setup and Installation* CD, you must have your operating-system CD to install your operating system.

The ServerGuide program has the following features:

- Sets system date and time.
- Detects the SCSI RAID adapter, controller, or integrated SCSI controller with RAID capabilities and runs the SCSI RAID configuration program.
- Updates the licensed internal code (firmware) level without diskettes.
- Checks the system BIOS code and microcode (firmware) levels of supported options to determine whether a later level is available from the CD. You can perform updates without using diskettes.
- Creates a System Partition on the default drive. You can run server-specific utility programs after setup.
- Detects installed hardware options and provides updated device drivers for most adapters and devices.
- Creates a setup-replication diskette for replicating setup selections for other servers of the same model.
- Provides diskette-free installation for supported operating systems.
- Provides a replicated installation path for multiple installations of supported operating systems.
- Includes an online README file with links to tips for your hardware and operating-system installation.

## Setup and configuration overview

When you use the *ServerGuide Setup and Installation* CD, you do not need setup diskettes. You can use the CD to configure any supported IBM server model. The ServerGuide program checks your system BIOS, service processors, and other system hardware to determine if system updates are available. The setup program provides a list of tasks that are required to set up your server model. On a server with a ServeRAID adapter or integrated SCSI controller with RAID capabilities, you can run the SCSI RAID configuration program to create logical drives.

**Note:** Features and functions can vary slightly with different versions of the ServerGuide program.

When you start the *ServerGuide Setup and Installation* CD, the program performs the following tasks:

- The ServerGuide program prompts you for your language, country, and keyboard layout. (This information is stored and later passed to the operating-system installation program.)
- The ServerGuide program displays choices for running the configuration programs. For example:
  - The Express Configuration method runs the required programs for your server, based on the hardware that is detected.
  - The Custom Configuration method displays all programs that are available for your server, and you decide which programs to run.
  - The Replicated Configuration method provides the option of duplicating your setup selections to other servers that are the same model.
- If you select the Custom Configuration method, the following features are optional. If you select the Express Configuration method, some or all of these features are run, depending on the hardware that is detected:
  - The Set Date and Time feature is provided so that you do not have to use the Configuration/Setup Utility program to access these settings.
  - The Clear Hard Disks feature is provided so you can delete all partitions on all hard disk drives.
  - The ServerGuide program checks the server BIOS code and microcode (firmware) levels for supported options and then checks the CD for a newer level. The CD content might be newer than the BIOS code and firmware level. The ServerGuide program can perform a flash update of the BIOS code and supported microcode (firmware) options without using diskettes.
  - The SCSI RAID configuration program starts, leading you through the entire configuration process.
  - The ServerGuide program creates a System Partition on the default drive.
- The ServerGuide program displays a confirmation summary, so that you will know when you have completed all the required tasks. Then, you are ready to install your operating system.

**Notes:**

1. Plug and Play adapters are configured automatically. Non-Plug and Play adapters or non-IBM adapters might require switch settings, additional device drivers, and installation after the operating system is installed. See the documentation that comes with the adapter.
2. Diagnostics for your server come in BIOS code or on a separate diagnostics CD.

## System Partition

The ServerGuide program creates a 50 MB System Partition on the default drive. The System Partition contains server-specific utility programs such as service-processor disk operating system (DOS) utilities, system diagnostics, flash BIOS updates, and other programs. Programs in the System Partition vary by server model, and not all server models run utility programs from the System Partition. To determine which ones do, start the *ServerGuide Setup and Installation* CD and view the online overview.

After setup is complete, you can access programs in the System Partition by restarting the server and pressing Alt+F1 when the prompt is displayed. The **System Partition** menu displays the programs that are available on your server model.

## Typical operating-system installation

You can use the ServerGuide program to shorten your installation time. The ServerGuide program provides the device drivers that are required for your hardware and for the operating system that you are installing. This section describes a typical ServerGuide operating-system installation.

**Note:** Features and functions can vary slightly with different versions of the ServerGuide program.

1. After you have completed the setup process, the operating-system installation program starts. (You will need your operating-system CD to complete the installation.)
2. The ServerGuide program stores information about the server model, service processor, hard disk drive controllers, and network adapters. Then, the program checks the CD for newer device drivers. This information is stored and then passed to the operating-system installation program.
3. With some operating-system installations, you can create an operating-system replication diskette for setting up additional servers. This diskette contains the Internet protocol (IP) address, server name, and other selections.
4. The ServerGuide program presents operating-system partition options that are based on your operating-system selection and the installed hard disk drives.
5. If you are installing the operating system from diskettes, the ServerGuide program lists the diskettes that you must create and the optional device-driver diskettes (for installed adapters or controllers) that you might want to create.
6. The ServerGuide program prompts you to insert your operating-system CD and restart the server. At this point, the installation program for the operating system takes control to complete the installation.

## Setting up or updating multiple servers

You can use the ServerGuide program to create diskettes that help you set up or update multiple servers. You can modify information on the diskettes as you use them to set up or update other servers.

**Note:** Availability and function can vary by server model and by the hardware that is installed.

You can create a setup-replication diskette, which contains your hardware configuration selections. Use this diskette to replicate selections to other servers that are of the same model.

You can create an operating-system replication diskette, which contains information that you need to complete multiple installations. Not all operating systems support operating-system replication diskettes.

## Installing your operating system without ServerGuide

If you have already configured the server hardware and you decide not to use the ServerGuide program to install your operating system, complete the following steps to download the latest operating-system installation instructions from the IBM Support Web page:

1. Go to <http://www.ibm.com/pc/support/>.
2. Under **Browse**, click **Servers**.
3. From the **Family** drop-down list, select your server model.

4. If operating-system installation instructions are available for your server model, **OS installation** is in the list in the upper-left corner of the Web page. Click **OS installation** and select the instructions for your operating system.

---

## Using ServeRAID Manager

You can use the ServeRAID Manager program, provided on the *IBM ServeRAID Support CD*, to:

- Configure a redundant array of independent disks (RAID)
- Restore a SCSI hard disk to factory-default settings, erasing all data
- View your RAID configuration and associated devices
- Monitor operation of your RAID controllers

The ServeRAID Manager program operates in two ways:

- Startable-CD mode
- As an installed software program

See the ServeRAID documentation on the *IBM ServeRAID Support CD* for additional information about RAID technology and instructions for using ServeRAID Manager. The *Installation Guide* for your server also contains instructions for using ServeRAID Manager to configure your integrated SCSI controller with RAID capabilities.

### Notes:

1. The integrated SCSI controller with RAID capabilities in your server supports only RAID level-1 and RAID level-1E. Installing an optional ServeRAID-5i controller provides additional RAID levels.
2. If you install a different type of RAID adapter in your server, use the configuration method supplied with the RAID adapter to view or change SCSI settings for attached devices.

Before you install your operating system, you must configure the controller that is attached to the hard disk drives. You must use the configuration program on the *IBM ServeRAID Support CD* to configure the integrated SCSI controller with RAID capabilities or to configure an optional IBM ServeRAID controller.

### Notes:

1. You cannot use the *ServerGuide Setup and Installation CD* to configure the optional controllers.
2. To update the firmware and BIOS for an optional ServeRAID controller, you must use the *IBM ServeRAID Support CD* that comes with the ServeRAID option.

---

## Configuring the Gigabit Ethernet controller

The Ethernet controller is integrated on the system board. This controller provides an interface for connecting to 10-Mbps, 100-Mbps, or 1000-Mbps networks and provides full duplex (FDX) capability, which enables simultaneous transmission and reception of data on the Ethernet local area network (LAN). You do not need to set any jumpers or configure the controller for your operating system before you use the Ethernet controller. However, you must install a device driver to enable your operating system to address the Ethernet controller. The device drivers are provided on the *ServerGuide Setup and Installation CD*.

When you connect your server to the network, the Ethernet controller automatically detects the data-transfer rate (10-Mbps, 100-Mbps, or 1000-Mbps) on the network and then sets the controller to operate at the appropriate rate. In addition, if the Ethernet ports that your server is connected to support auto-negotiation, the Gigabit Ethernet controller will set the appropriate duplex state. That is, the Ethernet controller will adjust to the network data rate, whether the data rate is standard Ethernet (10BASE-T), Fast Ethernet (100BASE-TX/1000BASE-T), half duplex (HDX), or full duplex (FDX). The controller supports half-duplex (HDX) and full-duplex (FDX) modes at both speeds.

For information about configuring your Ethernet controller, see the *Broadcom NetXtreme Gigabit Ethernet Software CD* that comes with your server. For updated information about configuring your Ethernet controller, go to the IBM Support Web site at <http://www.ibm.com/pc/support> and navigate to the area for your specific server type. From this area you can download documentation, the most current device drivers for your server, and software that supports advanced networking functions. After downloading, run the downloaded program *launch.exe*.

## High-performance Ethernet modes

Your Ethernet controller supports optional modes, such as teaming, priority packets, load balancing, fault tolerance, and virtual LANs, which provide higher performance, security, and throughput for your server. These modes apply to the integrated Ethernet controller and to the controllers on supported Ethernet adapters.

## Ethernet port connector

The following illustration shows the pin-number assignments for the RJ-45 connector. These assignments apply to both 10BASE-T and 100/1000BASE-TX devices.

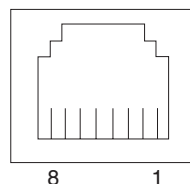

---

## Updating the integrated system management firmware

To update the integrated system management (ISM) firmware for the integrated system management processor (ISMP), download the Integrated System Management Firmware Update Utility program for your server from the IBM Support Web site at <http://www.ibm.com/pc/support/>. Then run the Integrated System Management Firmware Update Utility program to create a diskette to use to update the ISM firmware. This diskette updates the ISM firmware only and does not affect any device drivers.

Complete the following steps to update the ISM firmware:

1. Turn off your server. (Review the information in “Safety” on page v and “Turning off the server” on page 13.)
2. Insert the diskette into the diskette drive.
3. Turn on your server. If your server does not start from the diskette drive, use the Configuration/Setup Utility program to configure the diskette drive as a startup device. See “Using the Configuration/Setup Utility program” on page 16. Then, start again at step 1.
4. From the main menu, select **Update System Management Firmware** and press Enter.
5. Follow the on-screen instructions to complete the update.

If there is an error in updating the ISM firmware, try installing it again.



---

## Appendix A. Getting help and technical assistance

If you need help, service, or technical assistance or just want more information about IBM products, you will find a wide variety of sources available from IBM to assist you. This appendix contains information about where to go for additional information about IBM and IBM products, what to do if you experience a problem with your xSeries or IntelliStation<sup>®</sup> system, and whom to call for service, if it is necessary.

---

### Before you call

Before you call, make sure that you have taken these steps to try to solve the problem yourself:

- Check all cables to make sure that they are connected.
- Check the power switches to make sure that the system is turned on.
- Use the troubleshooting information in your system documentation, and use the diagnostic tools that come with your system.
- Go to the IBM Support Web site at <http://www.ibm.com/pc/support/> to check for technical information, hints, tips, and new device drivers.
- Use an IBM discussion forum on the IBM Web site to ask questions.

You can solve many problems without outside assistance by following the troubleshooting procedures that IBM provides in the online help or in the publications that are provided with your system and software. The information that comes with your system also describes the diagnostic tests that you can perform. Most xSeries and IntelliStation systems, operating systems, and programs come with information that contains troubleshooting procedures and explanations of error messages and error codes. If you suspect a software problem, see the information for the operating system or program.

---

### Using the documentation

Information about your IBM xSeries or IntelliStation system and preinstalled software, if any, is available in the documentation that comes with your system. That documentation includes printed books, online books, README files, and help files. See the troubleshooting information in your system documentation for instructions for using the diagnostic programs. The troubleshooting information or the diagnostic programs might tell you that you need additional or updated device drivers or other software. IBM maintains pages on the World Wide Web where you can get the latest technical information and download device drivers and updates. To access these pages, go to <http://www.ibm.com/pc/support/> and follow the instructions. Also, you can order publications through the IBM Publications Ordering System at <http://www.elink.ibm.com/public/applications/publications/cgibin/pbi.cgi>.

---

### Getting help and information from the World Wide Web

On the World Wide Web, the IBM Web site has up-to-date information about IBM xSeries and IntelliStation products, services, and support. The address for IBM xSeries information is <http://www.ibm.com/eserver/xseries/>. The address for IBM IntelliStation information is <http://www.ibm.com/pc/intellistation/>.

You can find service information for your IBM products, including supported options, at <http://www.ibm.com/pc/support/>. If you click **Profile** from the support page, you can create a customized support page. The support page has many sources of information and ways for you to solve problems, including:

- Diagnosing problems, using the IBM Online Assistant
- Downloading the latest device drivers and updates for your products
- Viewing Frequently Asked Questions (FAQ)
- Viewing hints and tips to help you solve problems
- Participating in IBM discussion forums
- Setting up e-mail notification of technical updates about your products

---

## Software service and support

Through IBM Support Line, you can get telephone assistance, for a fee, with usage, configuration, and software problems with xSeries servers, IntelliStation workstations, and appliances. For information about which products are supported by Support Line in your country or region, go to <http://www.ibm.com/services/sl/products/>.

For more information about Support Line and other IBM services, go to <http://www.ibm.com/services/>, or go to <http://www.ibm.com/planetwide/> for support telephone numbers.

---

## Hardware service and support

You can receive hardware service through IBM Integrated Technology Services or through your IBM reseller, if your reseller is authorized by IBM to provide warranty service. Go to <http://www.ibm.com/planetwide/> for support telephone numbers.

In the U.S. and Canada, hardware service and support is available 24 hours a day, 7 days a week. In the U.K., these services are available Monday through Friday, from 9 a.m. to 6 p.m.

---

## Appendix B. Warranty information

This section contains information about your warranty period and the service and support that are provided by your warranty.

---

### Warranty period

The warranty period varies by machine type and country or region.

Contact your place of purchase for warranty service information. Some IBM Machines are eligible for on-site warranty service depending on the country or region where service is performed.

**Prior to on-site warranty service, you are required to go through problem determination with an IBM service specialist call center technician.**

A warranty period of 3 years on parts and 1 year on labor means that IBM will provide warranty service without charge for:

1. parts and labor during the first year of the warranty period
2. parts only, on an exchange basis, in the second and third years of the warranty period. IBM will charge you for any labor it provides in performance of the repair or replacement.

The IBM Machine Warranties Web site at [http://www.ibm.com/servers/support/machine\\_warranties/](http://www.ibm.com/servers/support/machine_warranties/) contains a worldwide overview of the IBM Statement of Limited Warranty for IBM Machines, a glossary of terms used in the Statement of Limited Warranty, Frequently Asked Questions (FAQ), and links to Product Support Web pages. The IBM Statement of Limited Warranty is available from this Web site in 29 languages in Portable Document Format (PDF).

**Machine** - IBM @server xSeries 235 Type 8671

Country or region	Warranty period	Service delivery method
Japan	Parts - 3 years, labor - 1 year	On-site
Worldwide	3 years	On-site

### Problem determination

Prior to on-site warranty service, you are required to go through problem determination with an IBM service specialist call center technician. The service specialist will run diagnostic tests on the hardware and check the software.

#### Running diagnostics

The IBM service specialist will help you determine whether your equipment is functioning as specified. It might be necessary to isolate the failing xSeries, Netfinity®, or IntelliStation system; IBM component; or both from any active production environment to run diagnostics and perform defect-isolation programs. You are responsible for making the system, IBM component, or both available for running diagnostics and defect-isolation programs.

## Checking software

The IBM service specialist will help you ensure that the correct BIOS code, firmware, device drivers, and other supporting IBM software are installed and correctly configured. It might be necessary to manually gather information about the relevant software levels or run IBM-approved utility programs to gather this information. It might be necessary to isolate the failing system from any active production environment to gather this information. You are responsible, with assistance from the service specialist, for gathering this information. The IBM Statement of Limited Warranty does not include on-site assistance with this activity.

## Warranty service and support

With the original purchase of an IBM xSeries or IntelliStation system, you have access to extensive service and support. During the IBM Machine warranty period, you may call IBM or your reseller for problem-determination assistance under the terms of the IBM Statement of Limited Warranty.

The following services are available during the warranty period:

- **Problem determination** - Trained personnel are available to assist you with determining if you have a hardware problem and deciding what action is necessary to fix the problem.
- **IBM hardware repair** - If the problem is determined to be caused by IBM hardware under warranty, trained service personnel are available to provide the applicable level of service, either on-site or at an IBM service center as determined by IBM.
- **Engineering Change management** - Occasionally, there might be changes that are required after a product has been shipped from IBM. In those instances, IBM will make Engineering Changes (ECs) available that apply to your hardware.
- **Customer replaceable units (CRUs)** - Some parts of IBM servers are designated as customer replaceable units. IBM ships CRUs to you for replacement by you. CRUs include keyboards, monitors, memory, diskette drives, hard disk drives, and mice (this list is not inclusive of all CRUs).

The following items are not covered under warranty service:

- Replacement or use of non-IBM parts. All IBM parts contain a 7-character identification in the format IBM FRU XXXXXXXX.
- Identification of software problem sources.
- Installation of customer replaceable units (CRUs).
- Installation and configuration of BIOS code, firmware, or device drivers that are designated as customer installable.

See the IBM Statement of Limited Warranty for a full explanation of IBM warranty terms. Be sure to retain your proof of purchase to obtain warranty service.

Please have the following information ready when you call:

- The machine type and model of your IBM hardware product (if available)
- Serial numbers of your IBM hardware products
- A description of the problem
- The exact wording of any error messages
- Hardware and software configuration information

## International Warranty Service

If you travel with your xSeries or IntelliStation system or relocate it to a country where your system is sold and serviced by IBM or IBM resellers authorized to perform warranty service, International Warranty Service (IWS) is available during the warranty period. Eligible IBM systems are identified by their four-digit machine types.

You can obtain IWS through the service delivery method (such as depot, carry-in, or on-site) provided in the servicing country. Service methods and procedures vary by country, and some service or parts might not be available in all countries. Service centers in certain countries might not be able to service all models of a particular machine type. In addition, some countries might have fees and restrictions that apply at the time of service.

To determine whether your system is eligible for IWS, go to <http://www.ibm.com/pc/support/> and click **Warranty lookup**.

## Purchasing additional services

During and after the warranty period, you can purchase additional services, such as support for IBM and non-IBM hardware, operating systems, and application programs; network setup and configuration; upgraded or extended hardware repair services; and custom installations. Service availability and service name might vary by country or region.

For more information about these services, contact your IBM marketing representative.

---

# IBM Statement of Limited Warranty Z125-4753-06 8/2000

## Part 1 - General Terms

This Statement of Limited Warranty includes Part 1 - General Terms and Part 2 - Country-unique Terms. The terms of Part 2 replace or modify those of Part 1. The warranties provided by IBM in this Statement of Limited Warranty apply only to Machines you purchase for your use, and not for resale, from IBM or your reseller. The term "Machine" means an IBM machine, its features, conversions, upgrades, elements, or accessories, or any combination of them. The term "Machine" does not include any software programs, whether pre-loaded with the Machine, installed subsequently or otherwise. Unless IBM specifies otherwise, the following warranties apply only in the country where you acquire the Machine. Nothing in this Statement of Limited Warranty affects any statutory rights of consumers that cannot be waived or limited by contract. If you have any questions, contact IBM or your reseller.

**The IBM Warranty for Machines:** IBM warrants that each Machine 1) is free from defects in materials and workmanship and 2) conforms to IBM's Official Published Specifications ("Specifications"). The warranty period for a Machine is a specified, fixed period commencing on its Date of Installation. The date on your sales receipt is the Date of Installation unless IBM or your reseller informs you otherwise.

If a Machine does not function as warranted during the warranty period, and IBM or your reseller are unable to either 1) make it do so or 2) replace it with one that is at least functionally equivalent, you may return it to your place of purchase and your money will be refunded.

**Extent of Warranty:** The warranty does not cover the repair or exchange of a Machine resulting from misuse, accident, modification, unsuitable physical or operating environment, improper maintenance by you, or failure caused by a product for which IBM is not responsible. The warranty is voided by removal or alteration of Machine or parts identification labels.

**THESE WARRANTIES ARE YOUR EXCLUSIVE WARRANTIES AND REPLACE ALL OTHER WARRANTIES OR CONDITIONS, EXPRESS OR IMPLIED, INCLUDING, BUT NOT LIMITED TO, THE IMPLIED WARRANTIES OR CONDITIONS OF MERCHANTABILITY AND FITNESS FOR A PARTICULAR PURPOSE. THESE WARRANTIES GIVE YOU SPECIFIC LEGAL RIGHTS AND YOU MAY ALSO HAVE OTHER RIGHTS WHICH VARY FROM JURISDICTION TO JURISDICTION. SOME JURISDICTIONS DO NOT ALLOW THE EXCLUSION OR LIMITATION OF EXPRESS OR IMPLIED WARRANTIES, SO THE ABOVE EXCLUSION OR LIMITATION MAY NOT APPLY TO YOU. IN THAT EVENT, SUCH WARRANTIES ARE LIMITED IN DURATION TO THE WARRANTY PERIOD. NO WARRANTIES APPLY AFTER THAT PERIOD.**

**Items Not Covered by Warranty:** IBM does not warrant uninterrupted or error-free operation of a Machine. Any technical or other support provided for a Machine under warranty, such as assistance via telephone with "how-to" questions and those regarding Machine set-up and installation, will be provided **WITHOUT WARRANTIES OF ANY KIND.**

**Warranty Service:** To obtain warranty service for a Machine, contact IBM or your reseller. If you do not register your Machine with IBM, you may be required to present proof of purchase.

During the warranty period, IBM or your reseller, if approved by IBM to provide warranty service, provides without charge certain types of repair and exchange service to keep Machines in, or restore them to, conformance with their Specifications. IBM or your reseller will inform you of the available types of service for a Machine based on its country of installation. At its discretion, IBM or your reseller will 1) either repair or exchange the failing Machine and 2) provide the service either at your location or a service center. IBM or your reseller will also manage and install selected engineering changes that apply to the Machine.

Some parts of IBM Machines are designated as Customer Replaceable Units (called "CRUs"), e.g., keyboards, memory, or hard disk drives. IBM ships CRUs to you for replacement by you. You must return all defective CRUs to IBM within 30 days of your receipt of the replacement CRU. You are responsible for downloading designated Machine Code and Licensed Internal Code updates from an IBM Internet Web site or from other electronic media, and following the instructions that IBM provides.

When warranty service involves the exchange of a Machine or part, the item IBM or your reseller replaces becomes its property and the replacement becomes yours. You represent that all removed items are genuine and unaltered. The replacement may not be new, but will be in good working order and at least functionally equivalent to the item replaced. The replacement assumes the warranty service status of the replaced item. Many features, conversions, or upgrades involve the removal of parts and their return to IBM. A part that replaces a removed part will assume the warranty service status of the removed part.

Before IBM or your reseller exchanges a Machine or part, you agree to remove all features, parts, options, alterations, and attachments not under warranty service.

You also agree to

1. ensure that the Machine is free of any legal obligations or restrictions that prevent its exchange;
2. obtain authorization from the owner to have IBM or your reseller service a Machine that you do not own; and
3. where applicable, before service is provided:
  - a. follow the problem determination, problem analysis, and service request procedures that IBM or your reseller provides;
  - b. secure all programs, data, and funds contained in a Machine;
  - c. provide IBM or your reseller with sufficient, free, and safe access to your facilities to permit them to fulfill their obligations; and
  - d. inform IBM or your reseller of changes in a Machine's location.

IBM is responsible for loss of, or damage to, your Machine while it is 1) in IBM's possession or 2) in transit in those cases where IBM is responsible for the transportation charges.

Neither IBM nor your reseller is responsible for any of your confidential, proprietary or personal information contained in a Machine which you return to IBM or your reseller for any reason. You should remove all such information from the Machine prior to its return.

**Limitation of Liability:** Circumstances may arise where, because of a default on IBM's part or other liability, you are entitled to recover damages from IBM. In each such instance, regardless of the basis on which you are entitled to claim damages from IBM (including fundamental breach, negligence, misrepresentation, or other

contract or tort claim), except for any liability that cannot be waived or limited by applicable laws, IBM is liable for no more than

1. damages for bodily injury (including death) and damage to real property and tangible personal property; and
2. the amount of any other actual direct damages, up to the charges (if recurring, 12 months' charges apply) for the Machine that is subject of the claim. For purposes of this item, the term "Machine" includes Machine Code and Licensed Internal Code.

This limit also applies to IBM's suppliers and your reseller. It is the maximum for which IBM, its suppliers, and your reseller are collectively responsible.

**UNDER NO CIRCUMSTANCES IS IBM LIABLE FOR ANY OF THE FOLLOWING: 1) THIRD-PARTY CLAIMS AGAINST YOU FOR DAMAGES (OTHER THAN THOSE UNDER THE FIRST ITEM LISTED ABOVE); 2) LOSS OF, OR DAMAGE TO, YOUR RECORDS OR DATA; OR 3) SPECIAL, INCIDENTAL, OR INDIRECT DAMAGES OR FOR ANY ECONOMIC CONSEQUENTIAL DAMAGES, LOST PROFITS OR LOST SAVINGS, EVEN IF IBM, ITS SUPPLIERS OR YOUR RESELLER IS INFORMED OF THEIR POSSIBILITY. SOME JURISDICTIONS DO NOT ALLOW THE EXCLUSION OR LIMITATION OF INCIDENTAL OR CONSEQUENTIAL DAMAGES, SO THE ABOVE LIMITATION OR EXCLUSION MAY NOT APPLY TO YOU.**

**Governing Law:** Both you and IBM consent to the application of the laws of the country in which you acquired the Machine to govern, interpret, and enforce all of your and IBM's rights, duties, and obligations arising from, or relating in any manner to, the subject matter of this Agreement, without regard to conflict of law principles.

## Part 2 - Country-unique Terms

### AMERICAS

#### BRAZIL

**Governing Law:** *The following is added after the first sentence:* Any litigation arising from this Agreement will be settled exclusively by the court of Rio de Janeiro.

#### NORTH AMERICA

**Warranty Service:** *The following is added to this Section:* To obtain warranty service from IBM in Canada or the United States, call 1-800-IBM-SERV (426-7378).

#### CANADA

**Governing Law:** *The following replaces "laws of the country in which you acquired the Machine" in the first sentence:* laws in the Province of Ontario.

#### UNITED STATES

**Governing Law:** *The following replaces "laws of the country in which you acquired the Machine" in the first sentence:* laws of the State of New York.

### ASIA PACIFIC

#### AUSTRALIA



**The IBM Warranty for Machines:** *The following paragraph is added to this Section:* The warranties specified in this Section are in addition to any rights you may have under the Trade Practices Act 1974 or other similar legislation and are only limited to the extent permitted by the applicable legislation.

**Limitation of Liability:** *The following is added to this Section:* Where IBM is in breach of a condition or warranty implied by the Trade Practices Act 1974 or other similar legislation, IBM's liability is limited to the repair or replacement of the goods or the supply of equivalent goods. Where that condition or warranty relates to right to sell, quiet possession or clear title, or the goods are of a kind ordinarily acquired for personal, domestic or household use or consumption, then none of the limitations in this paragraph apply.

**Governing Law:** *The following replaces "laws of the country in which you acquired the Machine" in the first sentence:* laws of the State or Territory.

### **CAMBODIA, LAOS, AND VIETNAM**

**Governing Law:** *The following replaces "laws of the country in which you acquired the Machine" in the first sentence:* laws of the State of New York.

*The following is added to this Section:* Disputes and differences arising out of or in connection with this Agreement shall be finally settled by arbitration which shall be held in Singapore in accordance with the rules of the International Chamber of Commerce (ICC). The arbitrator or arbitrators designated in conformity with those rules shall have the power to rule on their own competence and on the validity of the Agreement to submit to arbitration. The arbitration award shall be final and binding for the parties without appeal and the arbitral award shall be in writing and set forth the findings of fact and the conclusions of law.

All proceedings shall be conducted, including all documents presented in such proceedings, in the English language. The number of arbitrators shall be three, with each side to the dispute being entitled to appoint one arbitrator.

The two arbitrators appointed by the parties shall appoint a third arbitrator before proceeding upon the reference. The third arbitrator shall act as chairman of the proceedings. Vacancies in the post of chairman shall be filled by the president of the ICC. Other vacancies shall be filled by the respective nominating party. Proceedings shall continue from the stage they were at when the vacancy occurred.

If one of the parties refuses or otherwise fails to appoint an arbitrator within 30 days of the date the other party appoints its, the first appointed arbitrator shall be the sole arbitrator, provided that the arbitrator was validly and properly appointed.

The English language version of this Agreement prevails over any other language version.

### **HONG KONG AND MACAU**

**Governing Law:** *The following replaces "laws of the country in which you acquired the Machine" in the first sentence:* laws of Hong Kong Special Administrative Region.

### **INDIA**

**Limitation of Liability:** *The following replaces items 1 and 2 of this Section:*

1. liability for bodily injury (including death) or damage to real property and tangible personal property will be limited to that caused by IBM's negligence;
2. as to any other actual damage arising in any situation involving nonperformance by IBM pursuant to, or in any way related to the subject of this Statement of Limited Warranty, IBM's liability will be limited to the charge paid by you for the individual Machine that is the subject of the claim.

## **JAPAN**

**Governing Law:** *The following sentence is added to this Section:* Any doubts concerning this Agreement will be initially resolved between us in good faith and in accordance with the principle of mutual trust.

## **NEW ZEALAND**

**The IBM Warranty for Machines:** *The following paragraph is added to this Section:* The warranties specified in this Section are in addition to any rights you may have under the Consumer Guarantees Act 1993 or other legislation which cannot be excluded or limited. The Consumer Guarantees Act 1993 will not apply in respect of any goods which IBM provides, if you require the goods for the purposes of a business as defined in that Act.

**Limitation of Liability:** *The following is added to this Section:* Where Machines are not acquired for the purposes of a business as defined in the Consumer Guarantees Act 1993, the limitations in this Section are subject to the limitations in that Act.

## **PEOPLE'S REPUBLIC OF CHINA (PRC)**

**Governing Law:** *The following replaces this Section:* Both you and IBM consent to the application of the laws of the State of New York (except when local law requires otherwise) to govern, interpret, and enforce all your and IBM's rights, duties, and obligations arising from, or relating in any manner to, the subject matter of this Agreement, without regard to conflict of law principles.

Any disputes arising from or in connection with this Agreement will first be resolved by friendly negotiations, failing which either of us has the right to submit the dispute to the China International Economic and Trade Arbitration Commission in Beijing, the PRC, for arbitration in accordance with its arbitration rules in force at the time. The arbitration tribunal will consist of three arbitrators. The language to be used therein will be English and Chinese. An arbitral award will be final and binding on all the parties, and will be enforceable under the Convention on the Recognition and Enforcement of Foreign Arbitral Awards (1958).

The arbitration fee will be borne by the losing party unless otherwise determined by the arbitral award.

During the course of arbitration, this Agreement will continue to be performed except for the part which the parties are disputing and which is undergoing arbitration.

## **EUROPE, MIDDLE EAST, AFRICA (EMEA)**

**THE FOLLOWING TERMS APPLY TO ALL EMEA COUNTRIES:** The terms of this Statement of Limited Warranty apply to Machines purchased from IBM or an IBM reseller.

**Warranty Service:** If you purchase an IBM Machine in Austria, Belgium, Denmark, Estonia, Finland, France, Germany, Greece, Iceland, Ireland, Italy, Latvia, Lithuania, Luxembourg, Netherlands, Norway, Portugal, Spain, Sweden, Switzerland or United Kingdom, you may obtain warranty service for that Machine in any of those countries from either (1) an IBM reseller approved to perform warranty service or (2) from IBM. If you purchase an IBM Personal Computer Machine in Albania, Armenia, Belarus, Bosnia and Herzegovina, Bulgaria, Croatia, Czech Republic, Georgia, Hungary, Kazakhstan, Kirghizia, Federal Republic of Yugoslavia, Former Yugoslav Republic of Macedonia (FYROM), Moldova, Poland, Romania, Russia, Slovak Republic, Slovenia, or Ukraine, you may obtain warranty service for that Machine in any of those countries from either (1) an IBM reseller approved to perform warranty service or (2) from IBM.

If you purchase an IBM Machine in a Middle Eastern or African country, you may obtain warranty service for that Machine from the IBM entity within the country of purchase, if that IBM entity provides warranty service in that country, or from an IBM reseller, approved by IBM to perform warranty service on that Machine in that country. Warranty service in Africa is available within 50 kilometers of an IBM authorized service provider. You are responsible for transportation costs for Machines located outside 50 kilometers of an IBM authorized service provider.

**Governing Law:** The applicable laws that govern, interpret and enforce rights, duties, and obligations of each of us arising from, or relating in any manner to, the subject matter of this Statement, without regard to conflict of laws principles, as well as Country-unique terms and competent court for this Statement are those of the country in which the warranty service is being provided, except that in 1) Albania, Bosnia-Herzegovina, Bulgaria, Croatia, Hungary, Former Yugoslav Republic of Macedonia, Romania, Slovakia, Slovenia, Armenia, Azerbaijan, Belarus, Georgia, Kazakhstan, Kyrgyzstan, Moldova, Russia, Tajikistan, Turkmenistan, Ukraine, and Uzbekistan, the laws of Austria apply; 2) Estonia, Latvia, and Lithuania, the laws of Finland apply; 3) Algeria, Benin, Burkina Faso, Cameroon, Cape Verde, Central African Republic, Chad, Congo, Djibouti, Democratic Republic of Congo, Equatorial Guinea, France, Gabon, Gambia, Guinea, Guinea-Bissau, Ivory Coast, Lebanon, Mali, Mauritania, Morocco, Niger, Senegal, Togo, and Tunisia, this Agreement will be construed and the legal relations between the parties will be determined in accordance with the French laws and all disputes arising out of this Agreement or related to its violation or execution, including summary proceedings, will be settled exclusively by the Commercial Court of Paris; 4) Angola, Bahrain, Botswana, Burundi, Egypt, Eritrea, Ethiopia, Ghana, Jordan, Kenya, Kuwait, Liberia, Malawi, Malta, Mozambique, Nigeria, Oman, Pakistan, Qatar, Rwanda, Sao Tome, Saudi Arabia, Sierra Leone, Somalia, Tanzania, Uganda, United Arab Emirates, United Kingdom, West Bank/Gaza, Yemen, Zambia, and Zimbabwe, this Agreement will be governed by English Law and disputes relating to it will be submitted to the exclusive jurisdiction of the English courts; and 5) in Greece, Israel, Italy, Portugal, and Spain any legal claim arising out of this Statement will be brought before, and finally settled by, the competent court of Athens, Tel Aviv, Milan, Lisbon, and Madrid, respectively.

**THE FOLLOWING TERMS APPLY TO THE COUNTRY SPECIFIED:**

**AUSTRIA AND GERMANY**

**The IBM Warranty for Machines:** *The following replaces the first sentence of the first paragraph of this Section:* The warranty for an IBM Machine covers the functionality of the Machine for its normal use and the Machine's conformity to its Specifications.

*The following paragraphs are added to this Section:*

The minimum warranty period for Machines is six months. In case IBM or your reseller is unable to repair an IBM Machine, you can alternatively ask for a partial refund as far as justified by the reduced value of the unrepaired Machine or ask for a cancellation of the respective agreement for such Machine and get your money refunded.

**Extent of Warranty:** *The second paragraph does not apply.*

**Warranty Service:** *The following is added to this Section:* During the warranty period, transportation for delivery of the failing Machine to IBM will be at IBM's expense.

**Limitation of Liability:** *The following paragraph is added to this Section:* The limitations and exclusions specified in the Statement of Limited Warranty will not apply to damages caused by IBM with fraud or gross negligence and for express warranty.

*The following sentence is added to the end of item 2:* IBM's liability under this item is limited to the violation of essential contractual terms in cases of ordinary negligence.

## **EGYPT**

**Limitation of Liability:** *The following replaces item 2 in this Section:* as to any other actual direct damages, IBM's liability will be limited to the total amount you paid for the Machine that is the subject of the claim. For purposes of this item, the term "Machine" includes Machine Code and Licensed Internal Code.

*Applicability of suppliers and resellers (unchanged).*

## **FRANCE**

**Limitation of Liability:** *The following replaces the second sentence of the first paragraph of this Section:*In such instances, regardless of the basis on which you are entitled to claim damages from IBM, IBM is liable for no more than: *(items 1 and 2 unchanged).*

## **IRELAND**

**Extent of Warranty:** *The following is added to this Section:* Except as expressly provided in these terms and conditions, all statutory conditions, including all warranties implied, but without prejudice to the generality of the foregoing all warranties implied by the Sale of Goods Act 1893 or the Sale of Goods and Supply of Services Act 1980 are hereby excluded.

**Limitation of Liability:** *The following replaces items one and two of the first paragraph of this Section:*1. death or personal injury or physical damage to your real property solely caused by IBM's negligence; and 2. the amount of any other actual direct damages, up to 125 percent of the charges (if recurring, the 12 months' charges apply) for the Machine that is the subject of the claim or which otherwise gives rise to the claim.

*Applicability of suppliers and resellers (unchanged).*

*The following paragraph is added at the end of this Section: IBM's entire liability and your sole remedy, whether in contract or in tort, in respect of any default shall be limited to damages.*

## **ITALY**

**Limitation of Liability:** *The following replaces the second sentence in the first paragraph: In each such instance unless otherwise provided by mandatory law, IBM is liable for no more than: 1. (unchanged) 2. as to any other actual damage arising in all situations involving nonperformance by IBM pursuant to, or in any way related to the subject matter of this Statement of Warranty, IBM's liability, will be limited to the total amount you paid for the Machine that is the subject of the claim. Applicability of suppliers and resellers (unchanged).*

*The following replaces the third paragraph of this Section: Unless otherwise provided by mandatory law, IBM and your reseller are not liable for any of the following: (items 1 and 2 unchanged) 3) indirect damages, even if IBM or your reseller is informed of their possibility.*

## **SOUTH AFRICA, NAMIBIA, BOTSWANA, LESOTHO AND SWAZILAND**

**Limitation of Liability:** *The following is added to this Section: IBM's entire liability to you for actual damages arising in all situations involving nonperformance by IBM in respect of the subject matter of this Statement of Warranty will be limited to the charge paid by you for the individual Machine that is the subject of your claim from IBM.*

## **UNITED KINGDOM**

**Limitation of Liability:** *The following replaces items 1 and 2 of the first paragraph of this Section:*

1. death or personal injury or physical damage to your real property solely caused by IBM's negligence;
2. the amount of any other actual direct damages or loss, up to 125 percent of the charges (if recurring, the 12 months' charges apply) for the Machine that is the subject of the claim or which otherwise gives rise to the claim;

*The following item is added to this paragraph: 3. breach of IBM's obligations implied by Section 12 of the Sale of Goods Act 1979 or Section 2 of the Supply of Goods and Services Act 1982.*

*Applicability of suppliers and resellers (unchanged).*

*The following is added to the end of this Section: IBM's entire liability and your sole remedy, whether in contract or in tort, in respect of any default shall be limited to damages.*



---

## Appendix C. Notices

This publication was developed for products and services offered in the U.S.A.

IBM may not offer the products, services, or features discussed in this document in other countries. Consult your local IBM representative for information on the products and services currently available in your area. Any reference to an IBM product, program, or service is not intended to state or imply that only that IBM product, program, or service may be used. Any functionally equivalent product, program, or service that does not infringe any IBM intellectual property right may be used instead. However, it is the user's responsibility to evaluate and verify the operation of any non-IBM product, program, or service.

IBM may have patents or pending patent applications covering subject matter described in this document. The furnishing of this document does not give you any license to these patents. You can send license inquiries, in writing, to:

*IBM Director of Licensing  
IBM Corporation  
North Castle Drive  
Armonk, NY 10504-1785  
U.S.A.*

INTERNATIONAL BUSINESS MACHINES CORPORATION PROVIDES THIS PUBLICATION "AS IS" WITHOUT WARRANTY OF ANY KIND, EITHER EXPRESS OR IMPLIED, INCLUDING, BUT NOT LIMITED TO, THE IMPLIED WARRANTIES OF NON-INFRINGEMENT, MERCHANTABILITY OR FITNESS FOR A PARTICULAR PURPOSE. Some jurisdictions do not allow disclaimer of express or implied warranties in certain transactions, therefore, this statement may not apply to you.

This information could include technical inaccuracies or typographical errors. Changes are periodically made to the information herein; these changes will be incorporated in new editions of the publication. IBM may make improvements and/or changes in the product(s) and/or the program(s) described in this publication at any time without notice.

Any references in this publication to non-IBM Web sites are provided for convenience only and do not in any manner serve as an endorsement of those Web sites. The materials at those Web sites are not part of the materials for this IBM product, and use of those Web sites is at your own risk.

IBM may use or distribute any of the information you supply in any way it believes appropriate without incurring any obligation to you.

---

### Edition notice

**© COPYRIGHT INTERNATIONAL BUSINESS MACHINES CORPORATION, 2003.  
All rights reserved.**

Note to U.S. Government Users — Documentation related to restricted rights — Use, duplication or disclosure is subject to restrictions set forth in GSA ADP Schedule Contract with IBM Corp.

---

## Trademarks

The following terms are trademarks of International Business Machines Corporation in the United States, other countries, or both:

Active Memory	Predictive Failure Analysis
Active PCI	PS/2
Active PCI-X	ServeRAID
Alert on LAN	ServerGuide
C2T Interconnect	ServerProven
Chipkill	TechConnect
EtherJet	Tivoli
e-business logo	Tivoli Enterprise
FlashCopy	Update Connector
HelpWare	Wake on LAN
IBM	XA-32
Light Path Diagnostics	XA-64
NetBAY	X-Architecture
Netfinity	XcelL4
NetView	XpandOnDemand
NetVista	xSeries
OS/2 WARP	

Lotus, Lotus Notes, and Domino are trademarks of Lotus Development Corporation and/or IBM Corporation in the United States, other countries, or both.

Intel, Celeron, MMX, LANDesk, Pentium, Pentium II Xeon, Pentium III Xeon, and Xeon are trademarks of Intel Corporation in the United States, other countries, or both.

Microsoft, Windows, and Windows NT are trademarks of Microsoft Corporation in the United States, other countries, or both.

UNIX is a registered trademark of The Open Group in the United States and other countries.

Java and all Java-based trademarks and logos are trademarks or registered trademarks of Sun Microsystems, Inc. in the United States, other countries, or both.

Linux is a registered trademark of Linus Torvalds.

Other company, product, or service names may be the trademarks or service marks of others.

---

## Important notes

Processor speeds indicate the internal clock speed of the microprocessor; other factors also affect application performance.

CD-ROM drive speeds list the variable read rate. Actual speeds vary and are often less than the maximum possible.



When referring to processor storage, real and virtual storage, or channel volume, KB stands for approximately 1000 bytes, MB stands for approximately 1 000 000 bytes, and GB stands for approximately 1 000 000 000 bytes.

When referring to hard disk drive capacity or communications volume, MB stands for 1 000 000 bytes, and GB stands for 1 000 000 000 bytes. Total user-accessible capacity may vary depending on operating environments.

Maximum internal hard disk drive capacities assume the replacement of any standard hard disk drives and population of all hard disk drive bays with the largest currently supported drives available from IBM.

Maximum memory may require replacement of the standard memory with an optional memory module.

IBM makes no representation or warranties regarding non-IBM products and services that are ServerProven<sup>®</sup>, including but not limited to the implied warranties of merchantability and fitness for a particular purpose. These products are offered and warranted solely by third parties.

IBM makes no representations or warranties with respect to non-IBM products. Support (if any) for the non-IBM products is provided by the third party, not IBM.

Some software may differ from its retail version (if available), and may not include user manuals or all program functionality.

---

## Electronic emission notices

### Federal Communications Commission (FCC) statement

**Note:** This equipment has been tested and found to comply with the limits for a Class A digital device, pursuant to Part 15 of the FCC Rules. These limits are designed to provide reasonable protection against harmful interference when the equipment is operated in a commercial environment. This equipment generates, uses, and can radiate radio frequency energy and, if not installed and used in accordance with the instruction manual, may cause harmful interference to radio communications. Operation of this equipment in a residential area is likely to cause harmful interference, in which case the user will be required to correct the interference at his own expense.

Properly shielded and grounded cables and connectors must be used in order to meet FCC emission limits. Properly shielded and grounded cables and connectors must be used in order to meet FCC emission limits. IBM is not responsible for any radio or television interference caused by using other than recommended cables and connectors or by using other than recommended cables and connectors or by unauthorized changes or modifications to this equipment. Unauthorized changes or modifications could void the user's authority to operate the equipment.

This device complies with Part 15 of the FCC Rules. Operation is subject to the following two conditions: (1) this device may not cause harmful interference, and (2) this device must accept any interference received, including interference that may cause undesired operation.

## Industry Canada Class A emission compliance statement

This Class A digital apparatus complies with Canadian ICES-003.

### Avis de conformité à la réglementation d'Industrie Canada

Cet appareil numérique de la classe A est conforme à la norme NMB-003 du Canada.

## Australia and New Zealand Class A statement

**Attention:** This is a Class A product. In a domestic environment this product may cause radio interference in which case the user may be required to take adequate measures.

## United Kingdom telecommunications safety requirement

### Notice to Customers

This apparatus is approved under approval number NS/G/1234/J/100003 for indirect connection to public telecommunication systems in the United Kingdom.

## European Union EMC Directive conformance statement

This product is in conformity with the protection requirements of EU Council Directive 89/336/EEC on the approximation of the laws of the Member States relating to electromagnetic compatibility. IBM cannot accept responsibility for any failure to satisfy the protection requirements resulting from a nonrecommended modification of the product, including the fitting of non-IBM option cards.

This product has been tested and found to comply with the limits for Class A Information Technology Equipment according to CISPR 22/European Standard EN 55022. The limits for Class A equipment were derived for commercial and industrial environments to provide reasonable protection against interference with licensed communication equipment.

**Attention:** This is a Class A product. In a domestic environment this product may cause radio interference in which case the user may be required to take adequate measures.

## Taiwan electrical emission statement

警告使用者：  
這是甲類的資訊產品，在  
居住的環境中使用時，可  
能會造成射頻干擾，在這  
種情況下，使用者會被要  
求採取某些適當的對策。

## Japanese Voluntary Control Council for Interference (VCCI) statement

この装置は、情報処理装置等電波障害自主規制協議会（VCCI）の基準に基づくクラスA情報技術装置です。この装置を家庭環境で使用すると電波妨害を引き起こすことがあります。この場合には使用者が適切な対策を講ずるよう要求されることがあります。

---

### Power cords

For your safety, IBM provides a power cord with a grounded attachment plug to use with this IBM product. To avoid electrical shock, always use the power cord and plug with a properly grounded outlet.

IBM power cords used in the United States and Canada are listed by Underwriter's Laboratories (UL) and certified by the Canadian Standards Association (CSA).

For units intended to be operated at 115 volts: Use a UL-listed and CSA-certified cord set consisting of a minimum 18 AWG, Type SVT or SJT, three-conductor cord, a maximum of 15 feet in length and a parallel blade, grounding-type attachment plug rated 15 amperes, 125 volts.

For units intended to be operated at 230 volts (U.S. use): Use a UL-listed and CSA-certified cord set consisting of a minimum 18 AWG, Type SVT or SJT, three-conductor cord, a maximum of 15 feet in length and a tandem blade, grounding-type attachment plug rated 15 amperes, 250 volts.

For units intended to be operated at 230 volts (outside the U.S.): Use a cord set with a grounding-type attachment plug. The cord set should have the appropriate safety approvals for the country in which the equipment will be installed.

IBM power cords for a specific country or region are usually available only in that country or region.

IBM power cord part number	Used in these countries and regions
13F9940	Argentina, Australia, China (PRC), New Zealand, Papua New Guinea, Paraguay, Uruguay, Western Samoa
13F9979	Afghanistan, Algeria, Andorra, Angola, Austria, Belgium, Benin, Bulgaria, Burkina Faso, Burundi, Cameroon, Central African Rep., Chad, China (Macau S.A.R.), Czech Republic, Egypt, Finland, France, French Guiana, Germany, Greece, Guinea, Hungary, Iceland, Indonesia, Iran, Ivory Coast, Jordan, Lebanon, Luxembourg, Malagasy, Mali, Martinique, Mauritania, Mauritius, Monaco, Morocco, Mozambique, Netherlands, New Caledonia, Niger, Norway, Poland, Portugal, Romania, Senegal, Slovakia, Spain, Sudan, Sweden, Syria, Togo, Tunisia, Turkey, former USSR, Vietnam, former Yugoslavia, Zaire, Zimbabwe
13F9997	Denmark
14F0015	Bangladesh, Burma, Pakistan, South Africa, Sri Lanka

IBM power cord part number	Used in these countries and regions
14F0033	Antigua, Bahrain, Brunei, Channel Islands, China (Hong Kong S.A.R.), Cyprus, Dubai, Fiji, Ghana, India, Iraq, Ireland, Kenya, Kuwait, Malawi, Malaysia, Malta, Nepal, Nigeria, Polynesia, Qatar, Sierra Leone, Singapore, Tanzania, Uganda, United Kingdom, Yemen, Zambia
14F0051	Liechtenstein, Switzerland
14F0069	Chile, Ethiopia, Italy, Libya, Somalia
14F0087	Israel
1838574	Thailand
6952301	Bahamas, Barbados, Bermuda, Bolivia, Brazil, Canada, Cayman Islands, Colombia, Costa Rica, Dominican Republic, Ecuador, El Salvador, Guatemala, Guyana, Haiti, Honduras, Jamaica, Japan, Korea (South), Liberia, Mexico, Netherlands Antilles, Nicaragua, Panama, Peru, Philippines, Saudi Arabia, Suriname, Taiwan, Trinidad (West Indies), United States of America, Venezuela

---

# Index

## A

- acoustical noise emissions 3
- Active PCI (hot-plug) components 4
- activity LEDs
  - CD-ROM drive 9
  - diskette drive 9
- adapter
  - specifications 3
- administrator password 21
- availability features 5

## B

- bypassing an unknown power-on password 20

## C

- CD-ROM drive
  - activity LED 9
  - eject button 9
  - specifications 3
- Class A electronic emission notice 45
- configuration
  - Configuration/Setup Utility 15
  - Ethernet 27
  - LSI Logic Configuration Utility 15
  - ServeRAID programs 15
  - ServerGuide Setup and Installation CD 15
  - with ServerGuide 23
- Configuration/Setup Utility program 15, 16
- connectors, Ethernet 27
- controls 8
- cooling 3

## D

- data rate, Ethernet 27
- diskette
  - eject button 9
- diskette drive
  - activity LED 9
  - specifications 3

## E

- eject button
  - CD 9
  - diskette 9
- electrical input 3
- electrical safety information viii
- electronic emission Class A notice 45
- environment 3
- Ethernet
  - configuring 27
  - connector pin-number assignments 27
  - high performance modes 27

- Ethernet (*continued*)
  - integrated on system board 27
  - modes 27
  - pin-number assignment 27
  - port 27
  - teaming 27
- Ethernet activity LED 12
- Ethernet controller, configuring 27
- Ethernet-link status LED 11

## F

- fan 1 LED 11
- fan 2 LED 11
- Fast Ethernet 27
- FCC Class A notice 45
- features
  - reliability, availability, and serviceability 5
  - server 3, 4
  - ServerGuide 23
- forgotten power-on password, bypassing 20
- formatting a hard disk
  - using LSI Logic Configuration 22

## H

- hard disk drive
  - activity LED 9, 12
  - status LED 9
- heat output 3
- hot-swap drive specifications 3

## I

- indicators 8
- information label 1
- information LED 11
- information light 12
- information panel 8, 11
- integrated system management, update and configuration 15

## J

- jumper, power-on password override 20

## L

- LEDs
  - CD-ROM drive activity 9
  - diskette drive activity 9
  - Ethernet activity 12
  - Ethernet-link status 11
  - fan 1 11
  - fan 2 11
  - front of server 11
  - front view 8

LEDs (*continued*)  
  hard disk drive 11  
  hard disk drive activity 9, 12  
  hard disk drive status 9  
  Information 12  
  operator panel 11  
  POST-complete 12  
  power-on 11  
  rear view 10  
  system error 12  
  system-management adapter 11  
LSI Logic Configuration Utility  
  description 21  
  formatting a hard disk 22  
  starting 22  
LSI Logic Configuration Utility program 15

## M

memory module  
  specifications 3  
memory, specifications 3  
microprocessor specifications 3  
modes, Ethernet 27

## N

NOS installation  
  with ServerGuide 25  
  without ServerGuide 25  
notes, important 44  
notices  
  electronic emission 45  
  FCC, Class A 45  
  used in this book 2

## O

operator panel 11

## P

password  
  administrator 21  
  override jumper 20  
  power-on 20  
PCI expansion slots 3  
pin-number assignments, Ethernet 27  
port, Ethernet 27  
POST-complete LED 12  
power cords 47  
power supply specifications 3  
power-control button 9  
power-control button shield 9, 12  
power-on LED 11  
power-on password 20

## R

RAS  
  reliability, availability, and serviceability 5  
  reliability features 5  
Remote Supervisor Adapter, configuration 15  
reset button 9

## S

safety information  
  electrical vi, viii  
  laser vii  
  lifting vii  
ServeRAID Manager  
  description 26  
  overview 26  
  startable-CD mode 26  
ServeRAID programs 15  
ServerGuide  
  CDs 15  
  features 23  
  NOS installation 25  
  setting up multiple servers 25  
  Setup and Installation CD 15  
  using 22  
serviceability features 5  
setting password override jumper 20  
setting up  
  multiple servers 25  
setup  
  with ServerGuide 23  
shield, power-control button 9, 12  
size 3  
SMP 1  
specifications 3  
startable-CD mode 26  
starting  
  LSI Logic Configuration Utility 22  
  the server 12  
status LEDs 8, 10, 11  
symmetric multiprocessing 1  
system error LED 12

## T

temperature 3  
trademarks 44  
turning on the server 12

## U

United States electronic emission Class A notice 45  
United States FCC Class A notice 45  
utility  
  Configuration/Setup 16  
  LSI Logic Configuration 21  
  ServeRAID Manager 26

## **V**

video 3  
video controller 3

## **W**

Web site  
    IBM server products 1

Web site *(continued)*  
    ServerGuide 22  
weight 3  
World Wide Web 1









Part Number: 59P6536

Printed in the United States of America.

59P6536

