

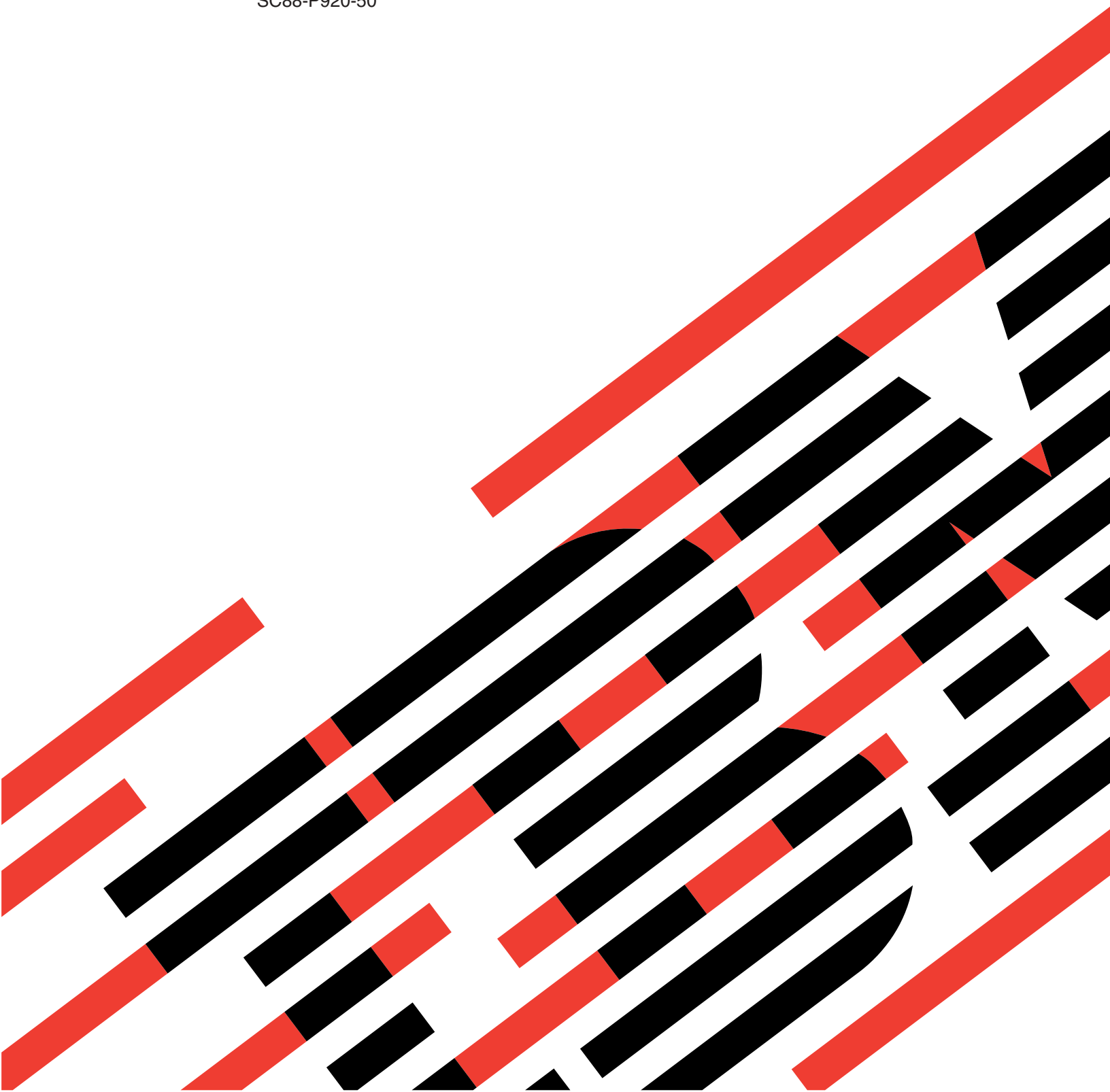

IBM xSeries 255
Type 8685

Option Installation Guide

SC88-P920-50





@server

IBM xSeries 255
Type 8685

Option Installation Guide

SC88-P920-50

Note:

Before using this information and the product it supports, read the general information in “Notices”, on page 83.

Second Edition (June 2003)

© Copyright International Business Machines Corporation 2003. All rights reserved.

US Government Users Restricted Rights – Use, duplication or disclosure restricted by GSA ADP Schedule Contract with IBM Corp.

Contents

Safety	v
Chapter 1. Introduction	1
Notices and statements used in this book	1
Major components view of the xSeries 255 Type 8685 server	2
Component locations	4
System-board option connectors	4
System-board internal cable connectors	5
System-board external port connectors	6
System-board switches and jumpers	7
System-board LED locations	9
Light Path Diagnostics panel	10
LEDs	10
Remind button	11
Memory-board component locations	12
Chapter 2. Installing options	13
Before you begin	13
System reliability considerations	13
Working inside the server with the power on	13
Handling static-sensitive devices	14
Removing the top cover and bezel.	15
Removing the top cover (all models)	15
Removing the bezel (rack model)	16
Removing the bezel (tower model).	16
Working with adapters	17
Adapter considerations	18
Installing an adapter	19
Cabling a RAID or SCSI adapter	22
Cabling a single SCSI channel using the standard hot-swap drive SCSI backplane	22
Working with the optional xSeries 6-Pack Hot-Swap Hard Drive Expansion Kit	28
Installing the optional 6-Pack hot-swap drive backplane	29
Installing internal drives.	37
Internal drive bays	37
Installing a hot-swap hard disk drive	38
Installing a 5.25-inch removable-media drive	39
Installing memory modules	46
Installing an additional microprocessor	54
Installing a hot-swap power supply	63
Replacing a hot-swap fan	66
Replacing an internal fan	66
Replacing an external fan	67
Completing the installation.	68
Installing the top cover and bezel	68
Installing the top cover (all models)	68
Installing the bezel (tower model)	69
Installing the bezel (rack model)	69
Updating your server configuration.	70
Connecting external options	70
SCSI cabling requirements	71
Replacing the battery	71

Chapter 3. Input/output ports and connectors	75
Video port	76
Keyboard port	76
Auxiliary-device (pointing device) port	76
Ultra160 SCSI connectors	77
Setting SCSI IDs	77
SCSI port connectors	78
Serial ports	79
Viewing or changing the serial-port assignments	79
Serial-port connectors	79
Universal Serial Bus ports	79
USB cables and hubs	80
USB-port connectors	80
Gigabit Ethernet port	80
Configuring the Gigabit Ethernet controller	80
High-performance Ethernet modes	81
Ethernet port connector	81
Integrated system management processor (ISMP) interconnect ports	81
Cabling the server	82
Appendix. Notices	83
Edition notice	83
Trademarks	84
Important notes	84
Electronic emission notices	85
Federal Communications Commission (FCC) statement	85
Industry Canada Class A emission compliance statement	85
Australia and New Zealand Class A statement	86
United Kingdom telecommunications safety requirement	86
European Union EMC Directive conformance statement	86
Taiwanese Class A warning statement	86
Japanese Voluntary Control Council for Interference (VCCI) statement	86
Power cords	87
Index	89

Safety

Before installing this product, read the Safety Information.

قبل تركيب هذا المنتج، يجب قراءة الملاحظات الأمنية

Antes de instalar este produto, leia as Informações de Segurança.

在安装本产品之前，请仔细阅读 **Safety Information** (安全信息)。

安裝本產品之前，請先閱讀「安全資訊」。

Prije instalacije ovog produkta obavezno pročitajte Sigurnosne Upute.

Před instalací tohoto produktu si přečtěte příručku bezpečnostních instrukcí.

Læs sikkerhedsforskrifterne, før du installerer dette produkt.

Lees voordat u dit product installeert eerst de veiligheidsvoorschriften.

Ennen kuin asennat tämän tuotteen, lue turvaohjeet kohdasta Safety Information.

Avant d'installer ce produit, lisez les consignes de sécurité.

Vor der Installation dieses Produkts die Sicherheitshinweise lesen.

Πριν εγκαταστήσετε το προϊόν αυτό, διαβάστε τις πληροφορίες ασφάλειας (safety information).

לפני שתתקינו מוצר זה, קראו את הוראות הבטיחות.

A termék telepítése előtt olvassa el a Biztonsági előírásokat!

Prima di installare questo prodotto, leggere le Informazioni sulla Sicurezza.

製品の設置の前に、安全情報をお読みください。

본 제품을 설치하기 전에 안전 정보를 읽으십시오.

Пред да се инсталира овој продукт, прочитајте информацијата за безбедност.

Les sikkerhetsinformasjonen (Safety Information) før du installerer dette produktet.

Przed zainstalowaniem tego produktu, należy zapoznać się z książką "Informacje dotyczące bezpieczeństwa" (Safety Information).

Antes de instalar este produto, leia as Informações sobre Segurança.

Перед установкой продукта прочтите инструкции по технике безопасности.

Pred inštaláciou tohto zariadenia si pečítajte Bezpečnostné predpisy.

Pred namestitvijo tega proizvoda preberite Varnostne informacije.

Antes de instalar este producto, lea la información de seguridad.

Läs säkerhetsinformationen innan du installerar den här produkten.

Statement 1:



DANGER

Electrical current from power, telephone, and communication cables is hazardous.

To avoid a shock hazard:

- **Do not connect or disconnect any cables or perform installation, maintenance, or reconfiguration of this product during an electrical storm.**
- **Connect all power cords to a properly wired and grounded electrical outlet.**
- **Connect to properly wired outlets any equipment that will be attached to this product.**
- **When possible, use one hand only to connect or disconnect signal cables.**
- **Never turn on any equipment when there is evidence of fire, water, or structural damage.**
- **Disconnect the attached power cords, telecommunications systems, networks, and modems before you open the device covers, unless instructed otherwise in the installation and configuration procedures.**
- **Connect and disconnect cables as described in the following table when installing, moving, or opening covers on this product or attached devices.**

To Connect:	To Disconnect:
1. Turn everything OFF.	1. Turn everything OFF.
2. First, attach all cables to devices.	2. First, remove power cords from outlet.
3. Attach signal cables to connectors.	3. Remove signal cables from connectors.
4. Attach power cords to outlet.	4. Remove all cables from devices.
5. Turn device ON.	

Statement 2:



CAUTION:

When replacing the lithium battery, use only IBM Part Number 33F8354 or an equivalent type battery recommended by the manufacturer. If your system has a module containing a lithium battery, replace it only with the same module type made by the same manufacturer. The battery contains lithium and can explode if not properly used, handled, or disposed of.

Do not:

- Throw or immerse into water
- Heat to more than 100°C (212°F)
- Repair or disassemble

Dispose of the battery as required by local ordinances or regulations.

Statement 3:



CAUTION:

When laser products (such as CD-ROMs, DVD drives, fiber optic devices, or transmitters) are installed, note the following:

- Do not remove the covers. Removing the covers of the laser product could result in exposure to hazardous laser radiation. There are no serviceable parts inside the device.
- Use of controls or adjustments or performance of procedures other than those specified herein might result in hazardous radiation exposure.



DANGER

Some laser products contain an embedded Class 3A or Class 3B laser diode. Note the following.

Laser radiation when open. Do not stare into the beam, do not view directly with optical instruments, and avoid direct exposure to the beam.

Statement 4:

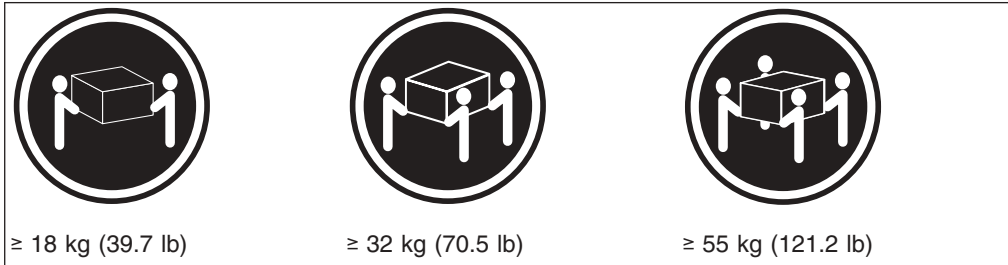

CAUTION:

Use safe practices when lifting.

Statement 5:



CAUTION:

The power control button on the device and the power switch on the power supply do not turn off the electrical current supplied to the device. The device also might have more than one power cord. To remove all electrical current from the device, ensure that all power cords are disconnected from the power source.

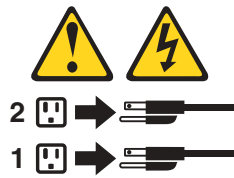

Statement 6:



CAUTION:

If you install a strain-relief bracket option over the end of the power cord that is connected to the device, you must connect the other end of the power cord to an easily accessible power source.

Statement 8:



CAUTION:

Never remove the cover on a power supply or any part that has the following label attached.



Hazardous voltage, current, and energy levels are present inside any component that has this label attached. There are no serviceable parts inside these components. If you suspect a problem with one of these parts, contact a service technician.

Statement 13:



DANGER

Overloading a branch circuit is potentially a fire hazard and a shock hazard under certain conditions. To avoid these hazards, ensure that your system electrical requirements do not exceed branch circuit protection requirements. Refer to the information that is provided with your device for electrical specifications.

Statement 14:



CAUTION:

Hazardous voltage, current, and energy levels might be present. Only a qualified service technician is authorized to remove the covers where the following label is attached.



Chapter 1. Introduction

Your server supports many optional devices. This *Option Installation Guide* provides instructions to install, remove, and connect the optional devices that your server supports.

In addition to this *Option Installation Guide*, the following IBM® @server xSeries™ 255 Type 8685 documentation is provided with your server:

- *Installation Guide*
This printed publication contains setup and installation instructions.
- *Rack Installation Instructions*
This printed publication contains instructions to install your server in a rack.
- *Safety Book*
This multilingual publication is provided in Portable Document Format (PDF) on the *IBM xSeries Documentation CD*. It contains translated versions of the caution and danger statements that appear in the documentation for your server. Each caution and danger statement has an assigned number, which you can use to locate the corresponding statement in your native language.
- *User's Guide*
This publication is provided in PDF on the *IBM xSeries Documentation CD*. It contains general information about your server.
- *Hardware Maintenance Manual and Troubleshooting Guide*
This publication is provided in PDF on the *IBM xSeries Documentation CD*. It contains information to help you solve problems yourself or to provide helpful information to a service technician.

Depending on your server model, additional publications might be included on the *IBM xSeries Documentation CD*.

Notices and statements used in this book

The caution and danger statements used in this book also appear in the multilingual *Safety Information* book provided on the *IBM xSeries Documentation CD*. Each caution and danger statement is numbered for easy reference to the corresponding statements in the safety book.

The following types of notices and statements are used in this book:

- **Note:** These notices provide important tips, guidance, or advice.
- **Important:** These notices provide information or advice that might help you avoid inconvenient or problem situations.
- **Attention:** These notices indicate possible damage to programs, devices, or data. An attention notice is placed just before the instruction or situation in which damage could occur.
- **Caution:** These statements indicate situations that can be potentially hazardous to you. A caution statement is placed just before the description of a potentially hazardous procedure step or situation.
- **Danger:** These statements indicate situations that can be potentially lethal or extremely hazardous to you. A danger statement is placed just before the description of a potentially lethal or extremely hazardous procedure step or situation.

Major components view of the xSeries 255 Type 8685 server

The orange color on components and labels in your server identifies hot-swap or hot-plug components. You can install or remove these components while the system is running, provided that your system is configured to support this function. For complete information about installing or removing a hot-swap or hot-plug component, see the detailed information in Chapter 2, “Installing options”, on page 13.

The blue color on components and labels indicates touch points where a component can be gripped, a latch moved, and so on.

If you have access to the World Wide Web, you can obtain up-to-date information about your server model and other IBM server products at <http://www.ibm.com/eserver/xseries/> on the World Wide Web.

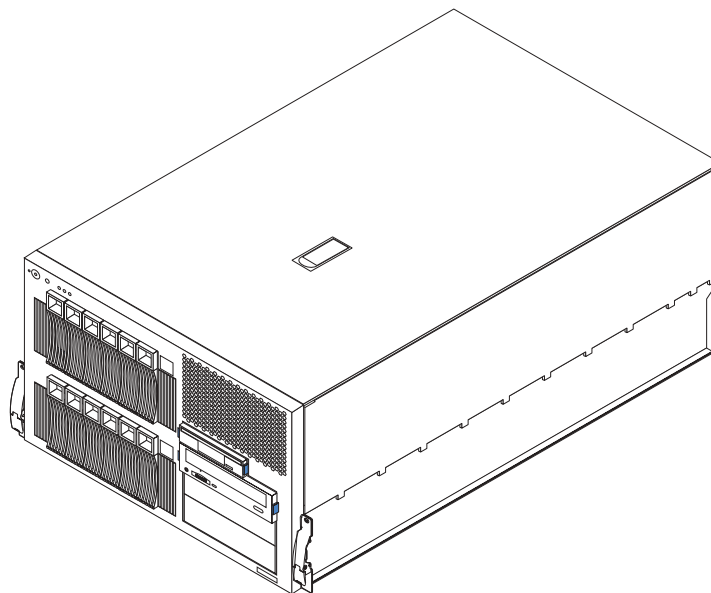

The following illustration shows the major components of a rack model server.

Notes:

1. The illustrations in this document might differ slightly from your hardware.
2. The xSeries 255 server is also available as a floor-standing tower model that contains the same components as the rack model. The tower model also includes a door with a key lock on the front of the server and wheels on the bottom of the server for easier mobility.

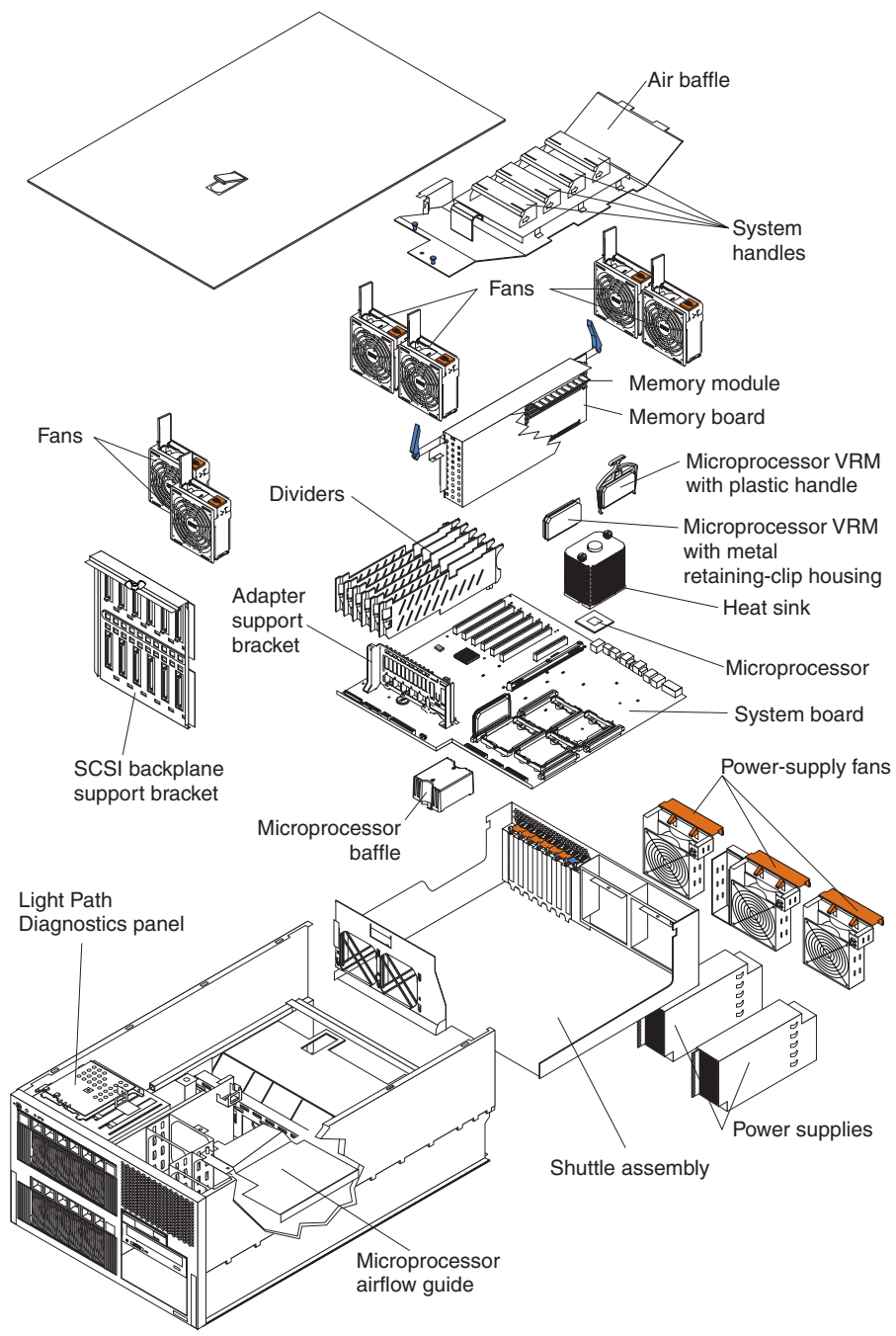

Component locations

This section provides illustrations of the component locations on the system board, Light Path Diagnostics panel, and memory board.

System-board option connectors

The following illustration shows the location of the system-board connectors for user-installable options.

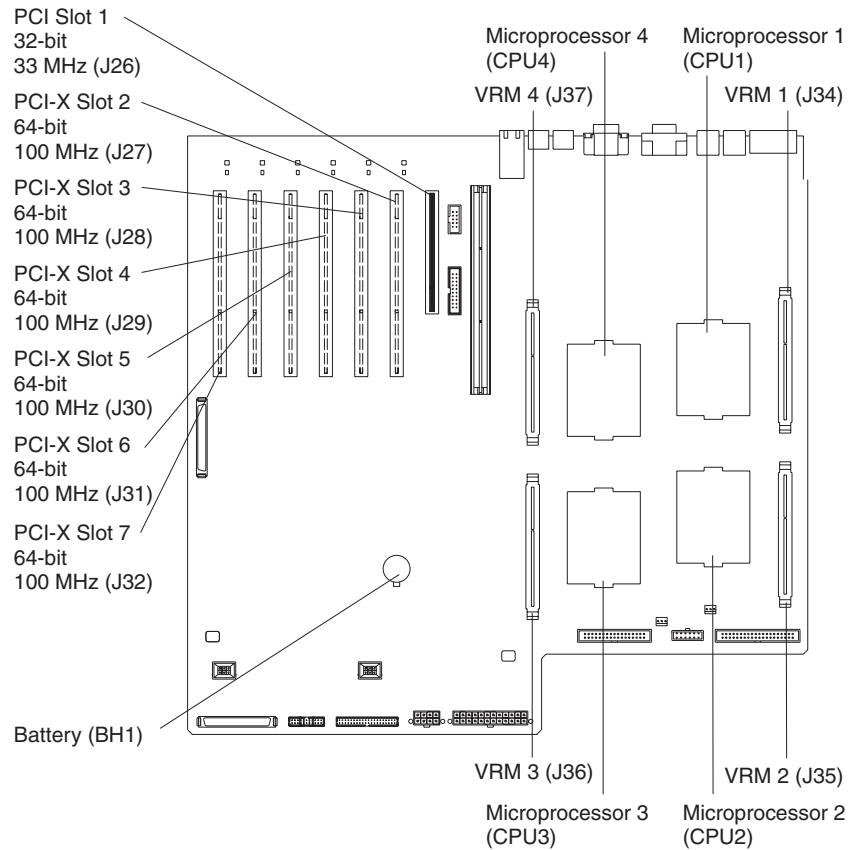

System-board internal cable connectors

The following illustration shows the internal cable connectors on the system board.

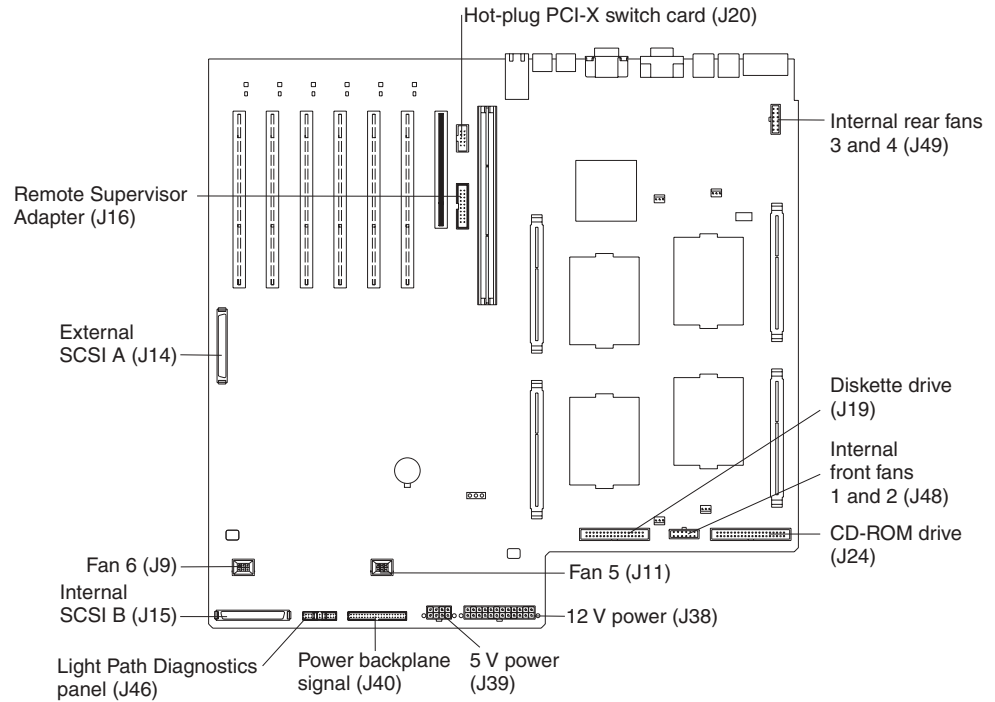

Notes:

1. The internal center fans are connected directly into the system-board connectors. Cable connectors are not required.
2. A cable is attached to the hot-plug PCI-X switch card connector (J20) on the system board so that the hot-plug function will work properly for PCI-X slots 2 through 7. Do not disconnect this cable.

System-board external port connectors

The following illustration shows the location of the input/output external port connectors on the system board.

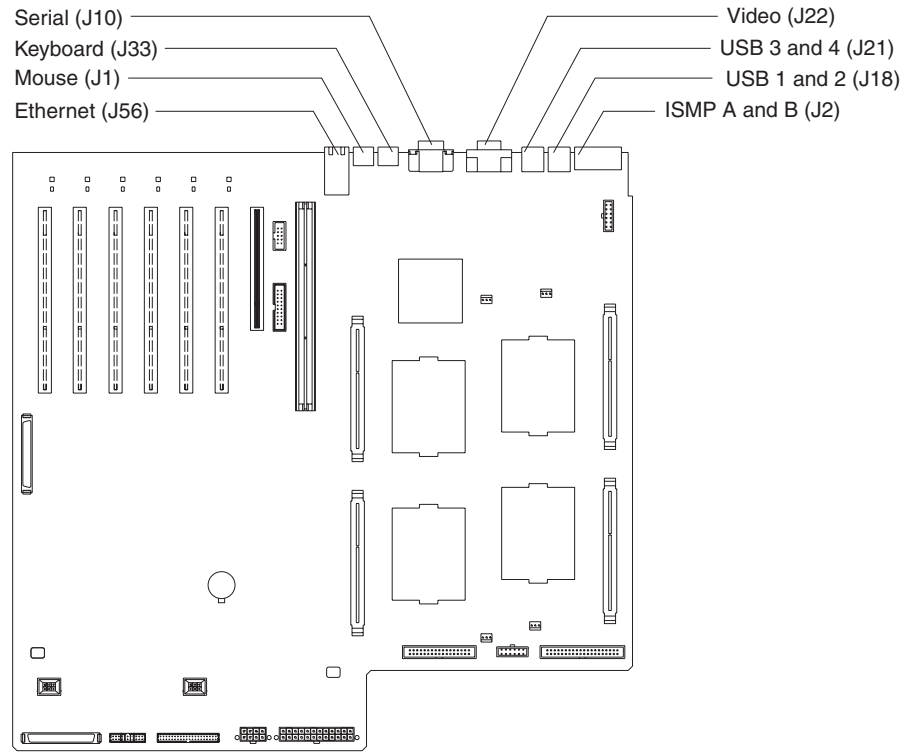

Note: ISMP ports (ISMP A and B) are used for the RS-485 interconnect network communications. These ports become inactive if you install an optional IBM Remote Supervisor Adapter in this server. If you install an optional IBM Remote Supervisor Adapter in this server, you must use the RJ-45 connector on the adapter for interconnect network communications.

System-board switches and jumpers

The following illustration shows the location of the switch block (SW2) on the system board.

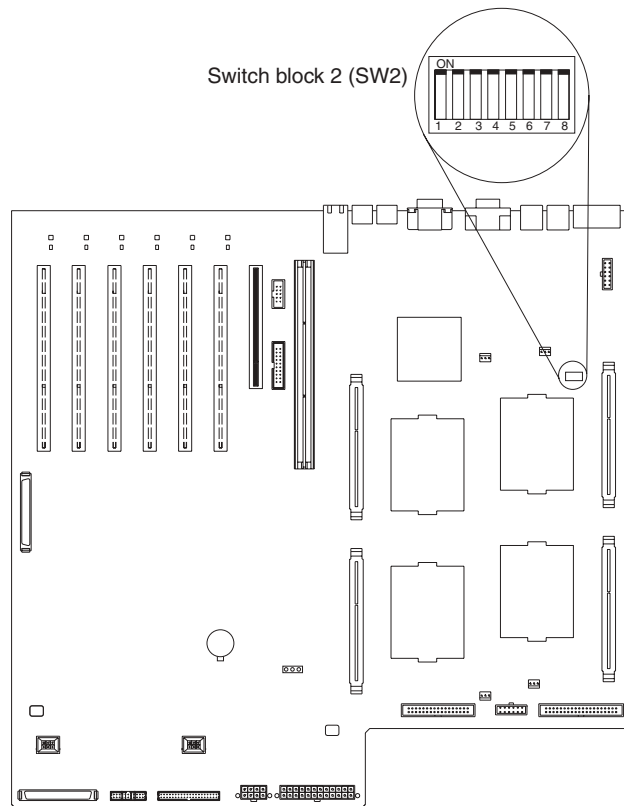

The following illustration shows the switches on the switch block (SW2).

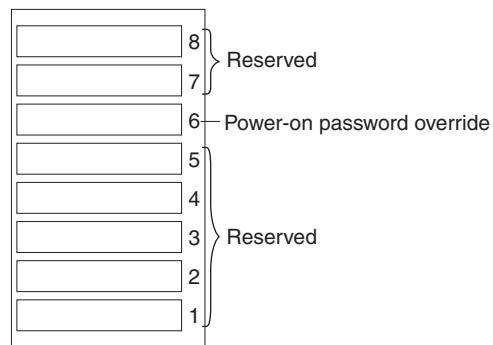
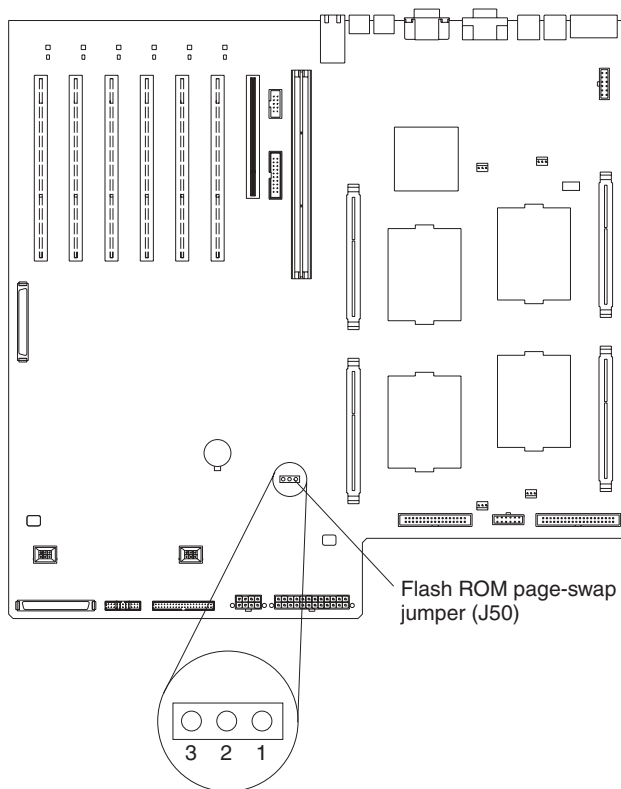

Table 1 describes the function of each switch on the switch block.

Table 1. Switches 1-8

Switch number	Default value	Switch description
7 to 8	Off	Reserved.
6	Off	<p>Power-on password override. Changing the position of this switch bypasses the power-on password check if the switch setting has been changed since the server was last powered on. You do not need to move the switch back to the default position after the password is overridden.</p> <p>Changing the position of this switch does not affect the administrator password check if an administrator password is set.</p> <p>See the <i>User's Guide</i> on the <i>IBM xSeries Documentation CD</i> for additional information about the power-on password.</p>
1 to 5	Off	Reserved.

The following illustration shows the location of the flash ROM page-swap jumper (J50) on the system board. When this jumper is moved to the non-default position, it recovers the server BIOS code. The default position is pins 1 and 2. See the *Hardware Maintenance Manual and Troubleshooting Guide* on the *IBM xSeries Documentation CD* for complete details.



Notes:

1. Before changing any switch settings or moving any jumpers, turn off the server; then, disconnect all power cords and external cables.
2. Any system-board switch or jumper blocks that are not shown in the illustrations in this book are reserved.

System-board LED locations

The following illustration shows the location of the LEDs on the system board. You might need to refer to this illustration when solving problems with the server.

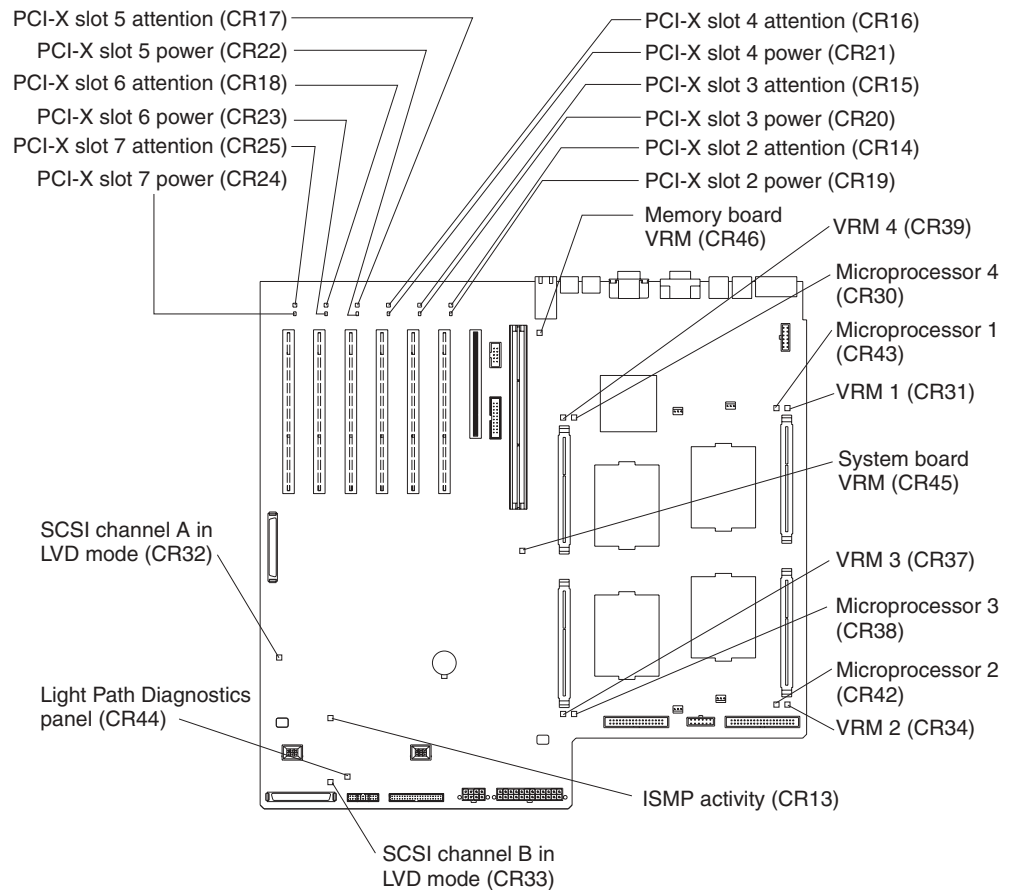

Note: See the *Hardware Maintenance Manual and Troubleshooting Guide* on the *IBM xSeries Documentation CD* for a detailed description of these LEDs.

Important: The amber CR44 LED also illuminates if the cable interface from the system board to the Light Path Diagnostics panel is missing or incorrectly connected. Therefore, verify that the required cable is present and correctly connected before you call for service for the Light Path Diagnostics panel.

Light Path Diagnostics panel

The following illustration shows the location of the error LEDs and the Remind button on the Light Path Diagnostics panel. To access the Light Path Diagnostics panel, you must remove the top cover.

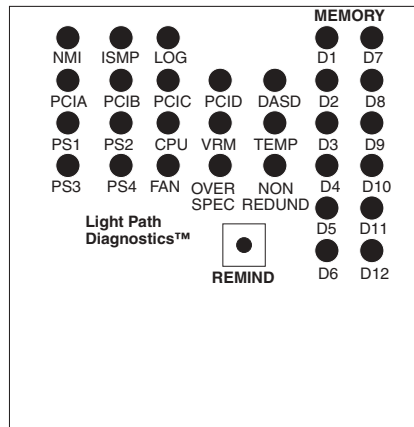

Notes:

1. The Light Path Diagnostics panel is also called the LED card or diagnostics LED panel.
2. See the *Hardware Maintenance Manual and Troubleshooting Guide* on the *IBM xSeries Documentation CD* for additional information about these LEDs.

LEDs

The Light Path Diagnostics panel LEDs are described in the following table.

Table 2. Light Path Diagnostics panel LEDs

Light Path Diagnostics panel LED	Description
NMI	Nonmaskable interrupt occurred (for service personnel only).
ISMP	Integrated system management processor (ISMP) failure.
LOG	See the System Error Log in the Configuration/Setup Utility program, or the error log is full.
PCIA	Error occurred on an adapter in PCI bus A (slot 1) or integrated SCSI or video controller on the system board.
PCIB	Error occurred on an adapter in PCI bus B (slots 2 and 3) or integrated Ethernet controller on the system board.
PCIC	Error occurred on an adapter in PCI bus C (slots 4 and 5) on the system board.
PCID	Error occurred on an adapter in PCI bus D (slots 6 and 7) on the system board.
DASD	A SCSI backplane or a device connected to a SCSI bus failed. This LED also illuminates if there is a DASD failure in the SCSI controller.
PS1	The power supply in bay 1 failed.
PS2	The power supply in bay 2 failed.
CPU	One or more microprocessors failed, a microprocessor has been installed in the incorrect order, or the wrong type of microprocessor has been installed in a socket.
VRM	Error on microprocessor voltage regulator module (VRM), on integrated system board VRM, or on integrated memory board VRM.

Table 2. Light Path Diagnostics panel LEDs (continued)

Light Path Diagnostics panel LED	Description
TEMP	System temperature exceeded maximum rating.
PS3	The power supply in bay 3 failed.
PS4	The power supply in bay 4 failed.
FAN	A fan (1, 2, 3, 4, 5, 6, 7, 8, or 9) failed or is operating slowly.
NONREDUND	Server power supplies are no longer redundant.
OVER SPEC	Server power requirements exceed the maximum rating of the power supplies.
D1 through D12	Memory failure. One or more dual inline memory modules (DIMMs) failed. These LEDs are arranged in two adjacent columns on the upper right side of the Light Path Diagnostics panel.

Remind button

You can use the Remind button to place the system-error LED into the Remind mode. By pressing the button, you acknowledge the failure but indicate that you will not take immediate action. If a new failure occurs, the system-error LED will become solid.

In the Remind mode, the system-error LED located on the front of the server, flashes every 2 seconds. The system-error LED remains in the Remind mode until one of the following situations occurs:

- All known problems are resolved
- The system is restarted
- A new problem occurs

You can use the Remind button to delay server maintenance until a later time. Also, resetting the system-error LED enables the LED to react to another error.

Memory-board component locations

The following illustration shows the location of the dual inline memory module (DIMM) connectors on the memory board.

Note: The DIMM error LEDs (D1 through D12) are located on the Light Path Diagnostics panel (see “Light Path Diagnostics panel” on page 10). Therefore, the DIMM LEDs are not included in this illustration.

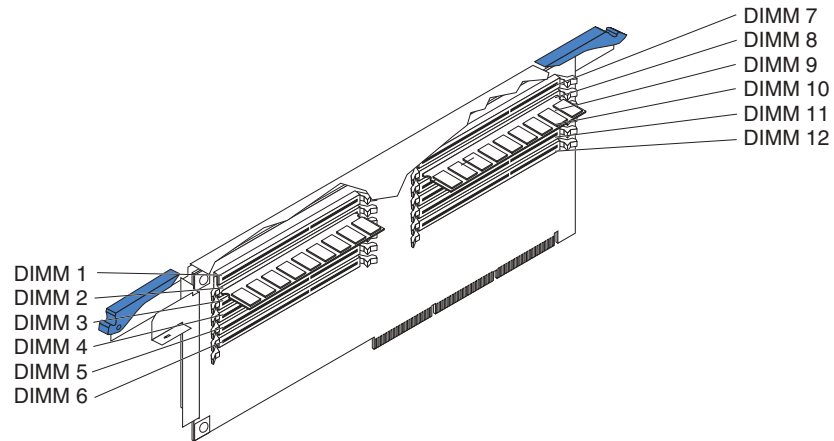

Chapter 2. Installing options

This chapter provides instructions for adding options to your server.

Before you begin

Before you begin to install options in your server, read the following information:

- Become familiar with the safety and handling guidelines specified under “Handling static-sensitive devices” on page 14, and read the safety statements in “Safety” on page v. These guidelines will help you work safely with your server or options.
- You do not need to turn off the server to install or replace hot-swap power supplies, hot-swap drives, hot-swap fans, Active™ PCI and Active™ PCI-X (hot-plug) adapters, or hot-plug Universal Serial Bus (USB) devices.
- The orange color on components and labels in your server identifies hot-swap or hot-plug components. You can install or remove these components while the system is running, provided that your system is configured to support this function.
- The blue color on components and labels identifies touch points where you can grip a component, move a latch, and so on.
- Make sure that you have an adequate number of properly grounded electrical outlets for your server, monitor, and any other options that you intend to install.
- Back up all important data before you make changes to disk drives.
- For a list of supported options for your server, go to <http://www.ibm.com/pc/us/compat/> on the World Wide Web.

System reliability considerations

To help ensure proper cooling and system reliability, make sure that:

- Each of the drive bays has either a drive or a filler panel installed.
- Each of the fan bays has a fan installed.
- The first two power-supply bays have a power supply installed.
- There is at least 50 mm (2 inches) of ventilated space at the sides of the server and 150 mm (6 inches) at the rear of the server.
- The server cover is in place during normal operation.
- The server cover is removed for no longer than 30 minutes while the server is operating.
- A removed hot-swap drive is replaced within 2 minutes of removal.
- Cables for optional adapters are routed according to the instructions provided with the adapters.
- A failed fan is replaced as soon as possible.
- The air baffle is always installed in the server except when you are:
 - Checking the LEDs that are located under the air baffle
 - Installing, removing, disconnecting, or reconnecting the components that are located under the air baffle

Working inside the server with the power on

Your server supports hot-plug, hot-add, and hot-swap devices and is designed to operate safely while turned on with the cover removed. Follow these guidelines when you work inside a server that is turned on:

- Avoid loose-fitting clothing on your forearms. Button long-sleeved shirts before working inside the server; do not wear cuff links while you are working inside the server.
- Do not allow your necktie or scarf to hang inside the server.
- Remove jewelry, such as bracelets, necklaces, rings, and loose-fitting wrist watches.
- Remove items from your shirt pocket (such as pens or pencils) that could fall into the server as you lean over it.
- Avoid dropping any metallic objects, such as paper clips, hair pins, or screws, into the server.

Handling static-sensitive devices

Attention: Static electricity can damage electronic devices and your system. To avoid damage, keep static-sensitive devices in their static-protective packages until you are ready to install them.

To reduce the possibility of electrostatic discharge, observe the following precautions:

- Limit your movement. Movement can cause static electricity to build up around you.
- Handle the device carefully, holding it by its edges or its frame.
- Do not touch solder joints, pins, or exposed printed circuitry.
- Do not leave the device where others can handle and possibly damage the device.
- While the device is still in its static-protective package, touch it to an unpainted metal part of the system unit for at least 2 seconds. (This drains static electricity from the package and from your body.)
- Remove the device from its package and install it directly into your server without setting it down. If it is necessary to set the device down, place it in its static-protective package. Do not place the device on your server cover or on a metal table.
- Take additional care when handling devices during cold weather because heating reduces indoor humidity and increases static electricity.

Removing the top cover and bezel

Before you remove the server top cover and bezel, review the information beginning with “Before you begin” on page 13 through “Handling static-sensitive devices” on page 14.

Removing the top cover (all models)

Complete the following steps to remove the server top cover.

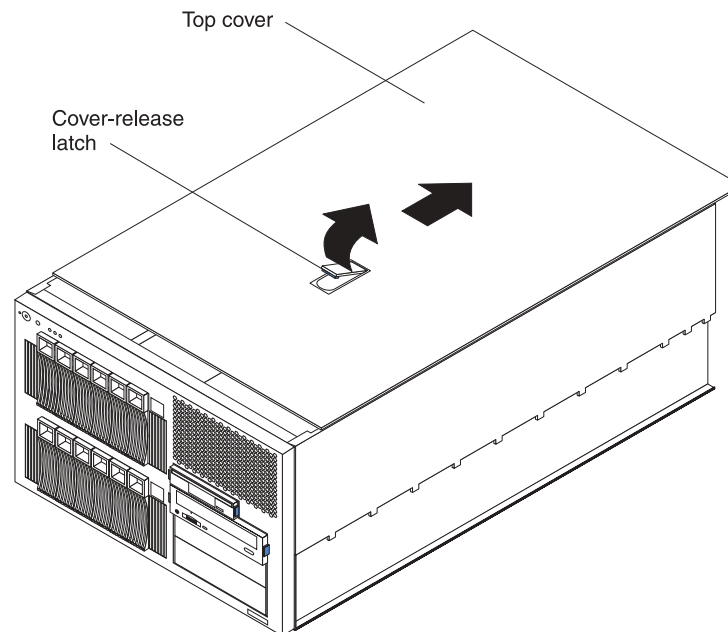

1. Lift the plastic cover-release latch near the edge of the top cover.
2. Slide the top cover slightly toward the rear of the server; the cover will stop after moving approximately 25 mm (1 inch). Lift the cover off the server, and set the cover aside.

Attention: To maintain proper cooling and airflow, install the server cover before turning on the server. Operating the server for extended periods of time (over 30 minutes) with the server cover removed might damage server components.

Removing the bezel (rack model)

Before you can install any removable-media drives in a rack model server, you must first remove the bezel.

Complete the following steps to remove the rack model bezel.

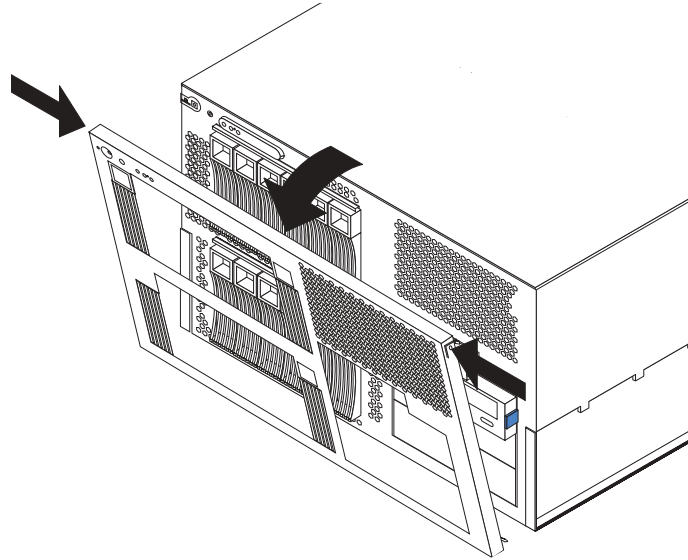

1. Press on the two release latches at the top edge of the bezel, and pull the top of the bezel slightly away from the server.
2. Lift the bezel to release the two tabs at the bottom edge of the bezel.
3. Store the bezel in a safe place.

Removing the bezel (tower model)

Before you can access the controls on the front of a tower model server or install any internal drives in a tower model server, you must first remove the bezel.

Complete the following steps to remove the tower model bezel.

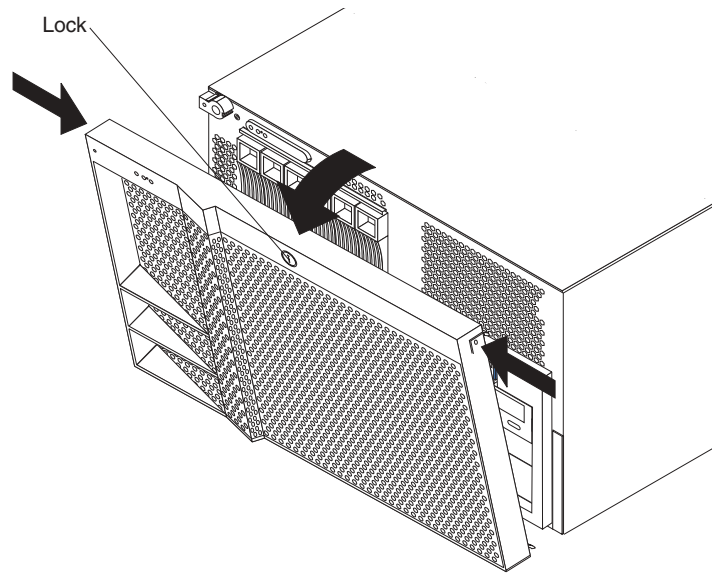

1. Unlock the bezel, if it has not already been unlocked.
2. Press on the two release latches at the top edge of the bezel, and pull the top of the bezel slightly away from the server.
3. Lift the bezel to release the two tabs at the bottom edge of the bezel.
4. Store the bezel in a safe place.

Working with adapters

This section describes how to install hot-plug and non-hot-plug PCI and PCI-X adapters. Before you continue with the adapter-installation procedures, review “Adapter considerations” on page 18.

The following illustration shows the location of the PCI and PCI-X adapter expansion slots on the system board. Slots 2 through 7 are Active PCI-X slots. Active PCI and Active PCI-X slots are also called hot-plug PCI and PCI-X slots.

Notes:

1. A cable is attached to the hot-plug PCI-X switch card connector (J20) on the system board so that the hot-plug function will work properly for PCI-X slots 2 through 7. Do not disconnect this cable.
2. See the *Hardware Maintenance Manual and Troubleshooting Guide* for additional information about identifying problems through LEDs.

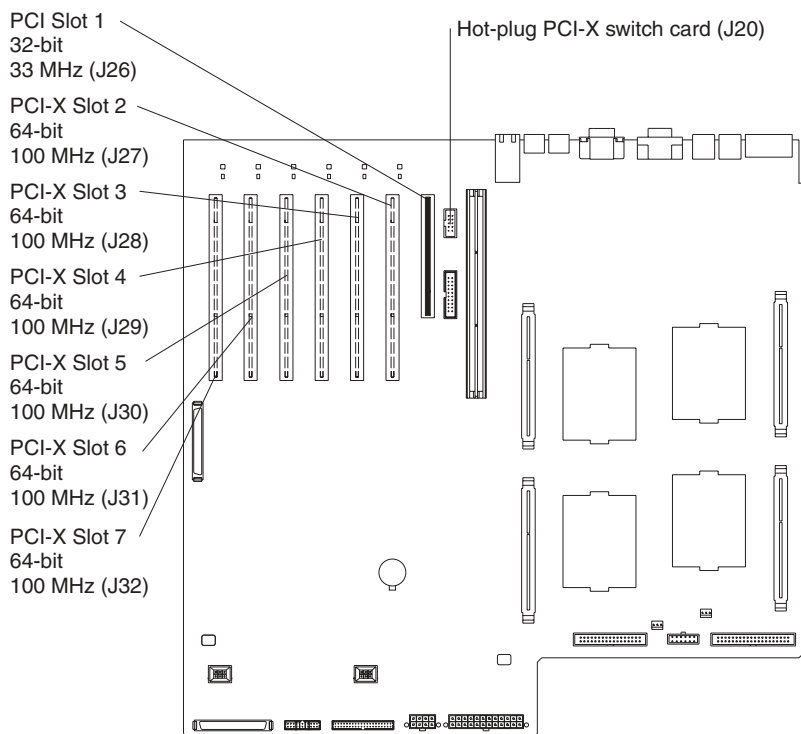

Adapter considerations

Before you install an adapter, review the following:

- Read the documentation that comes with your operating system.
- Locate the documentation that comes with the adapter and follow those instructions in addition to the instructions in this chapter. If you need to change the switch or jumper settings on your adapter, follow the instructions that come with the adapter.
- You can install full-length adapters and non-hot-plug adapters in any expansion slot.
- The 32-bit slot supports 5.0 V and universal PCI and PCI-X adapters; this slot does not support 3.3 V adapters.
- The 64-bit slots support 3.3 V and universal PCI and PCI-X adapters; they do not support 5.0 V adapters.
- If you install an optional IBM Remote Supervisor Adapter in this server, you must install the adapter in PCI slot 1. However, you can install other compatible adapters in this slot.

If you install an optional IBM Remote Supervisor Adapter in the server, use the ribbon cable that comes with the adapter to connect the adapter to the system-management connector (J16) on the system board. The external power adapter that comes with the IBM Remote Supervisor Adapter is not required with this server.

- If you install an optional Integrated xSeries Adapter (IXA) in this server, you must install the adapter in PCI-X slot 2 and move the jumper on J57 to pins 2 and 3 (J57 is located between PCI slots 1 and 2). IXAs are wide and require two adjacent slots; therefore, if you install an IXA in the server, you cannot install an adapter in PCI-X slot 3. In addition, you must remove the divider between PCI-X slots 2 and 3 before you can install an IXA in the server. Go to <http://www.ibm.com/pc/us/compat/> on the World Wide Web for information about

the IXAs that this server supports. See the documentation that comes with your IXA for additional information about IXAs.

Attention: Although an optional IXA can be installed only in slots 2 through 3, it is not a hot-plug adapter. See “Installing an adapter” for instructions for installing a non-hot-plug adapter.

- The server might require additional power supplies if you install adapters that have electrical current requirements that exceed the installed power-supply capabilities.
- The PCI bus configuration is:
 - Non-hot-plug, 32-bit PCI slot 1 (on PCI bus A, 33 MHz, 5.0 V)
PCI bus A also includes the video controller.
 - Hot-plug, 64-bit PCI-X slots 2 and 3 (on PCI bus B, 100 MHz, 3.3 V)
PCI bus B also includes the Ethernet controller.
 - Hot-plug, 64-bit PCI-X slots 4 and 5 (on PCI bus C, 100 MHz, 3.3 V)
 - Hot-plug, 64-bit PCI-X slots 6 and 7 (on PCI bus D, 100 MHz, 3.3 V)
 - SCSI controller (on a separate PCI bus operating at 66 MHz).

If there is a PCI bus failure on the SCSI controller, the PCI-A error LED lights.

Note: The SCSI controller is on PCI bus 1; PCI bus B is often referred to as bus 2; PCI bus C is often referred to as bus 3; and PCI bus D is often referred to as bus 4. However, the bus numbers vary according to the adapters that are installed.

- If you install an adapter with a speed of less than 100 MHz, the speed of that PCI bus will be reduced to the speed of the slowest device on that bus.
To maintain an optimum speed for the Ethernet controller on PCI bus B (PCI-X slots 2 and 3), install the following types of adapters in PCI-X slots 4 through 7:
 - Redundant array of independent disks (RAID) adapters
 - 33 MHz or 66 MHz speed adapters
 - PCI adapters
- To assign system resources, the system scans the PCI and PCI-X devices in the following order: PCI slot 1, PCI-X slots 4 through 7, system board SCSI devices, and then PCI-X slots 2 and 3. Then, the system starts (boots) the PCI and PCI-X devices in this order, if you have not changed the default boot precedence.

Note: To change the boot precedence for PCI and PCI-X devices, you must disable the devices through the Configuration/Setup Utility program. Start the Configuration/Setup Utility program, and select **Start Options** from the main menu. See the *User's Guide* on the *IBM xSeries Documentation* CD for details about using the Configuration/Setup Utility program.

Installing an adapter

This section contains the procedure for installing a hot-plug or non-hot-plug PCI or PCI-X adapter. If your operating system supports hot-plug PCI or PCI-X adapters, you can replace a failing hot-plug PCI or PCI-X adapter with a new hot-plug PCI or PCI-X adapter of the same type without turning off power to the server. If your operating system and adapter also support the hot-add feature, you can install a new adapter without turning off the power to the server.

Note: You do not have to turn off the server to install hot-plug adapters in the hot-plug slots. However, you must turn off the server when performing any steps that involve installing or removing cables.

Important: Do not remove a hot-plug PCI or PCI-X adapter before performing the operating-system-defined procedure for disabling the Active PCI-X (hot-plug) slot that contains the adapter. Failure to do so might cause your system to lock up. See your operating-system documentation.

The following illustration shows how to install a hot-plug PCI or PCI-X adapter.

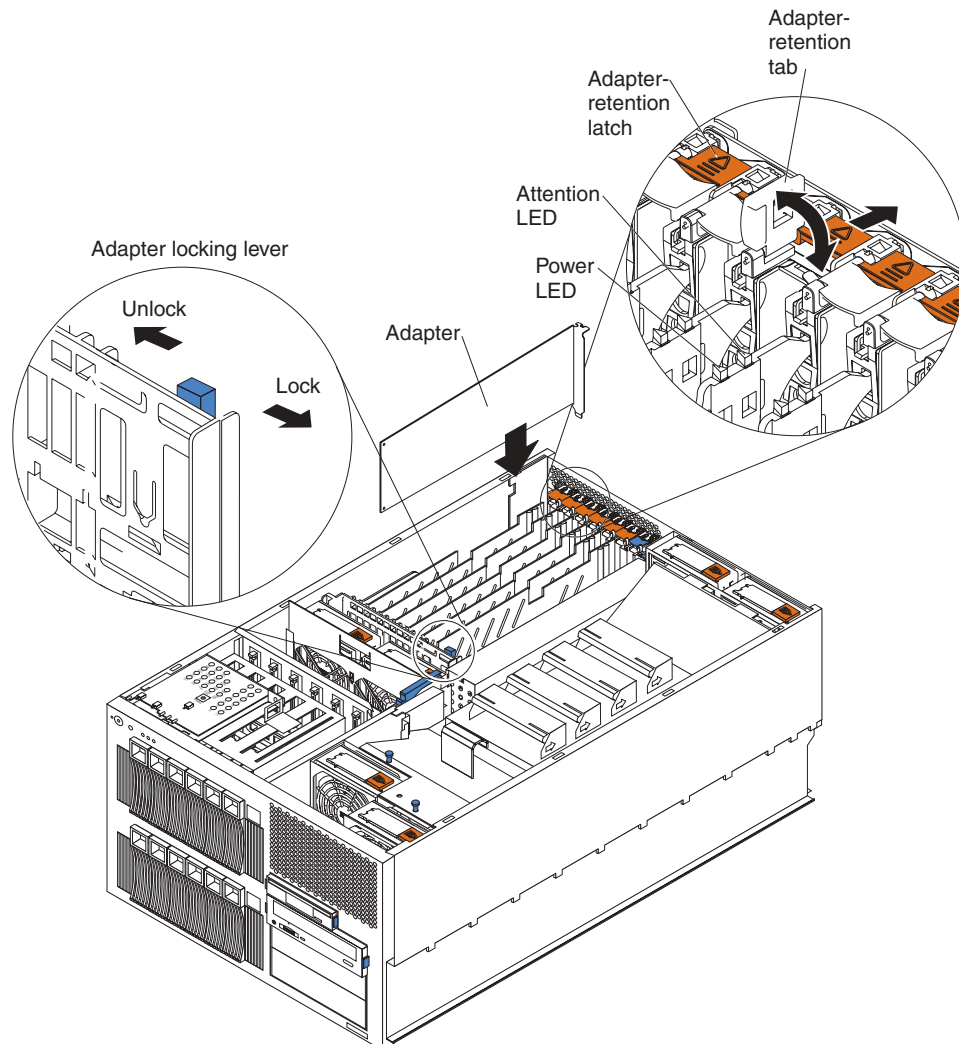

Complete the following steps to install an adapter.

Attention: When you handle static-sensitive devices, take precautions to avoid damage from static electricity. For details about handling these devices, see “Handling static-sensitive devices” on page 14.

1. Review the information beginning with “Before you begin” on page 13 through “Handling static-sensitive devices” on page 14.
2. If you are installing a hot-plug adapter, continue with the next step.
If you are installing a non-hot-plug adapter, you must turn off the server and peripheral devices and disconnect all power cords and external cables.
3. Remove the server cover (see “Removing the top cover (all models)” on page 15).
4. Select the slot in which you want to install the adapter.

Note: PCI-X slots 2 through 7 support hot-plug PCI and PCI-X adapters. If you are using the hot-add feature to install an adapter in PCI-X slot 2 or 3, you must install an adapter with a speed of 100 MHz or higher. This maintains an optimum speed for the Ethernet controller on PCI bus B (PCI-X slots 2 and 3).

5. If you are installing a non-hot-plug adapter, continue with the next step.

If you are installing a hot-plug adapter or using the hot-add feature, disable the selected PCI-X slot from your operating system. (See the documentation that comes with your operating system for information about disabling a hot-plug PCI-X slot.) Disabling the PCI-X slot turns off the power-on LED for that PCI-X slot.

Attention: Make sure that the power-on LED for the hot-plug PCI slot is off before you continue with the next step.

6. Remove the expansion-slot cover:

- a. Press the adapter-retention latch as indicated by the arrow to move the latch to the unlocked (open) position.
- b. Lift the adapter-retention tab on the top of the expansion-slot cover; then, remove the expansion-slot cover from the server. Store it in a safe place for future use.

Attention: Expansion-slot covers must be installed on all empty slots. This maintains the electronic emissions characteristics of the system and ensures proper cooling of system components.

7. If you are installing a full-length adapter, move the adapter locking lever to the unlocked (open) position on the adapter-support bracket as indicated by the arrows. Otherwise, continue with the next step.

8. See the documentation that comes with your adapter for any cabling instructions. It might be easier for you to route cables before you install the adapter.

9. Touch the static-protective package that contains the adapter to any unpainted metal surface on the server; then, remove the adapter from the package.

Attention: Avoid touching the components and gold-edge connectors on the adapter. If you need to place the adapter down before installing it, place the adapter component side up, on a flat, static-protective surface.

10. Set any jumpers or switches on the adapter according to the documentation that comes with the adapter.

11. Install the adapter:

- a. Carefully grasp the adapter by its top edge or upper corners, and align it with the expansion slot on the system board.
- b. Press the adapter *firmly* into the expansion slot.

Attention: When you install an adapter in the server, be sure that it is completely and correctly seated in the system-board connector. Incomplete insertion might cause damage to the system board or the adapter.

- c. Lower the adapter-retention tab over the top corner of the adapter. When the adapter-retention tab is completely closed, the adapter-retention latch snaps (locks) into place.

12. If you installed a full-length adapter, move the adapter locking lever to the locked (closed) position on the adapter-support bracket as indicated by the arrows.

13. Connect any needed cables to the adapter.

14. If you installed a non-hot-plug adapter, continue with the next step.

If you installed a hot-plug adapter or used the hot-add feature, enable the PCI-X slot from your operating system. (See the documentation that comes with your operating system for information about enabling a hot-plug PCI-X slot.) Make sure that the power-on LED for the hot-plug PCI-X slot comes on. If the power-on LED does not come on, see the *Hardware Maintenance Manual and Troubleshooting Guide* on the *IBM xSeries Documentation CD* for additional information.

15. If you have other options to install or remove, do so now; otherwise, go to “Completing the installation” on page 68.

Cabling a RAID or SCSI adapter

You can install an optional RAID or SCSI adapter in your server to control the internal hot-swap hard disk drives, for example, so that you can configure the internal hot-swap hard disk drives into disk arrays. The illustrations in this section show the cabling for internal hot-swap hard disk drives. You can also cable a RAID or SCSI adapter to external hard disk drives. See your RAID or SCSI adapter option documentation for complete instructions about installing a RAID or SCSI adapter in your server and for additional information about RAID or SCSI adapters.

Your server comes with one SCSI cable. One end of this cable is attached to the connector on the standard SCSI backplane, and the other end is attached to the internal SCSI channel connector (J15) on the system board.

The following procedures describe the single-channel cable routing that is necessary when you install a RAID or SCSI adapter. The illustrations in this section are examples. The cabling that you use for your server depends on your system configuration.

Notes:

1. For details on connecting two SCSI channels, see “Working with the optional xSeries 6-Pack Hot-Swap Hard Drive Expansion Kit” on page 28.
2. See the documentation that comes with your adapter for any cabling instructions.
3. Cable identifiers are printed on the cables that come with your server and options. Use these identifiers to connect the cables to the correct connectors. For example, the hard disk drive cables are labeled “HDD option.”

Cabling a single SCSI channel using the standard hot-swap drive SCSI backplane

Complete the following steps to cable a single SCSI channel on a RAID or SCSI adapter using the standard hot-swap drive SCSI backplane:

1. Review the information beginning with “Before you begin” on page 13 through “Handling static-sensitive devices” on page 14.
2. Turn off the server and peripheral devices and disconnect all power cords and external cables.
3. If your server is a tower model, continue with the next step.
If your server is a rack model and you have already installed the server in a rack enclosure, you must disconnect the cable-management-arm bracket from the server.
 - a. Disconnect the cable-management-arm bracket from the server.

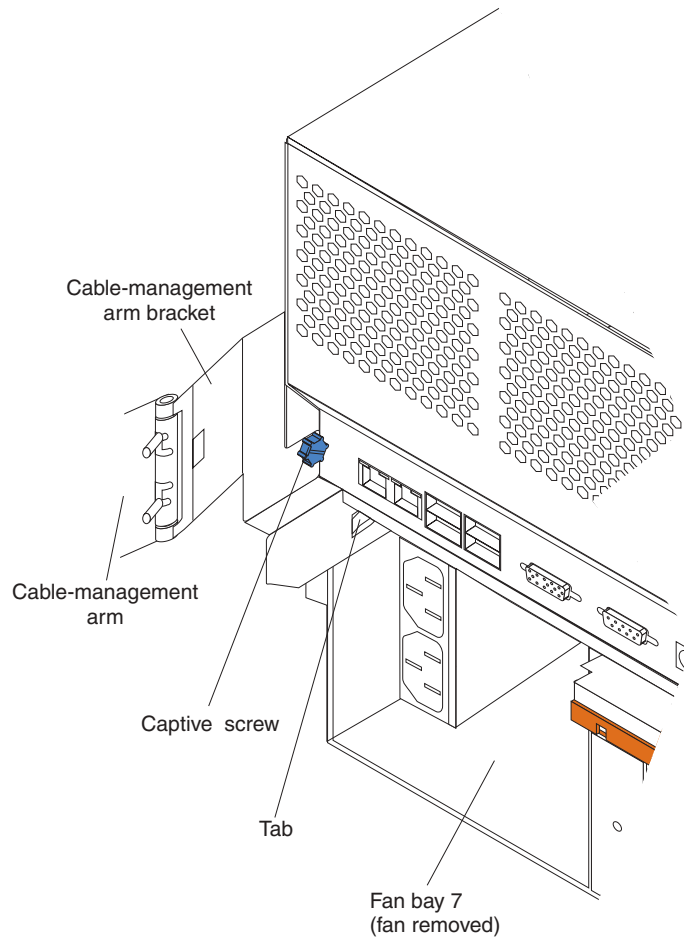

- 1) Loosen the captive screw on the cable-management-arm bracket.
- 2) Slide the tab on the cable-management-arm bracket out of the slot on the server; then, remove the bracket from the server.
 - b. Slide the server out of the rack enclosure until it locks into place.
4. Remove the top cover (see “Removing the top cover (all models)” on page 15).
5. Remove the air baffle:
 - a. Pull out the two plastic fasteners on the front of the air baffle.

Note: Do not remove the fasteners from the air baffle.

 - b. Grasp the handle on the air baffle; then, lift the air baffle from the server.

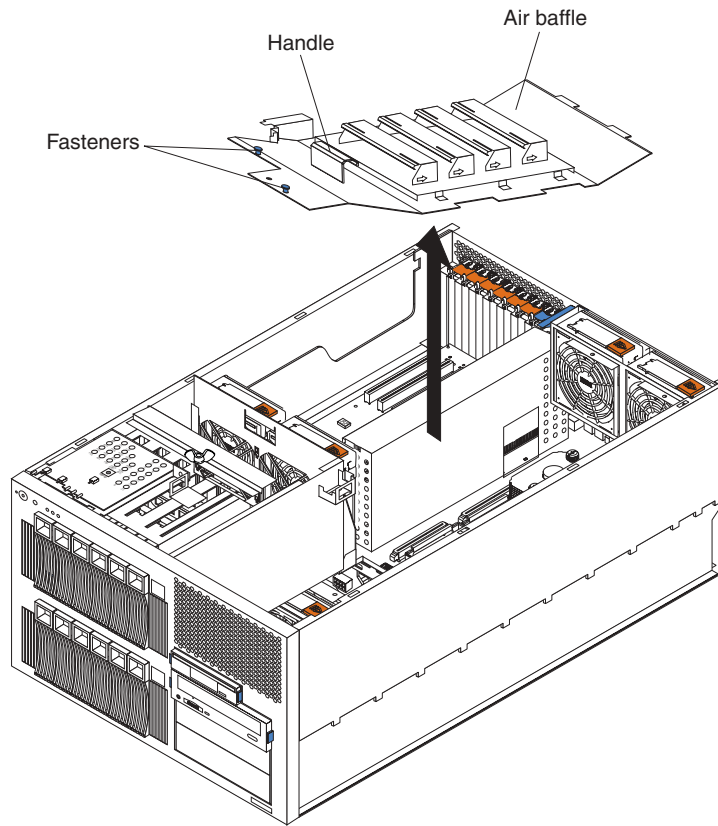

6. Open the microprocessor airflow guide located between the front fans and the microprocessors.

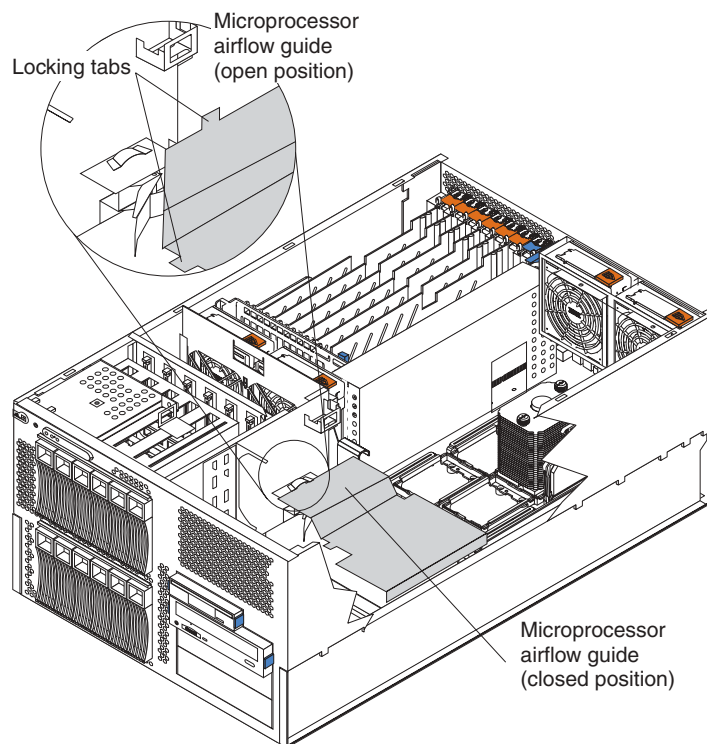

- Unlock the metal-hinge latch that secures the shuttle assembly in place. Then, slide the shuttle assembly toward the rear of the server, approximately 10 cm (4 in.).

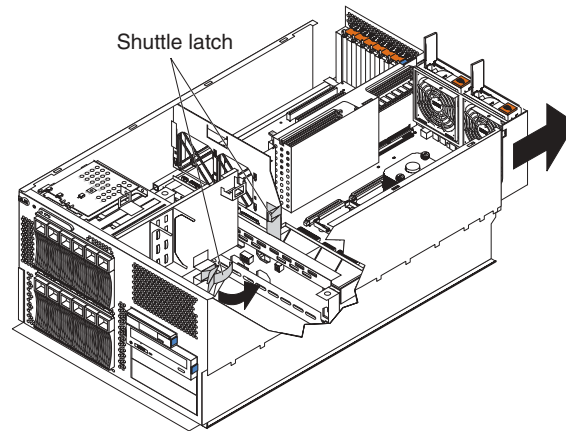

- Disconnect the internal integrated drive electronics (IDE) signal cable from the IDE system-board connector. Disconnect the diskette-drive signal cable and front-fan signal cable from the corresponding system-board connectors. See “System-board internal cable connectors” on page 5 for cable locations.
- If you have not yet installed a RAID or SCSI adapter, install it now. Otherwise, continue with the next step. See “Installing an adapter” on page 19 and the option documentation for additional information about installing a RAID or SCSI adapter in your server.
- Disconnect the SCSI signal cable from the internal SCSI connector (J15) on the system board.

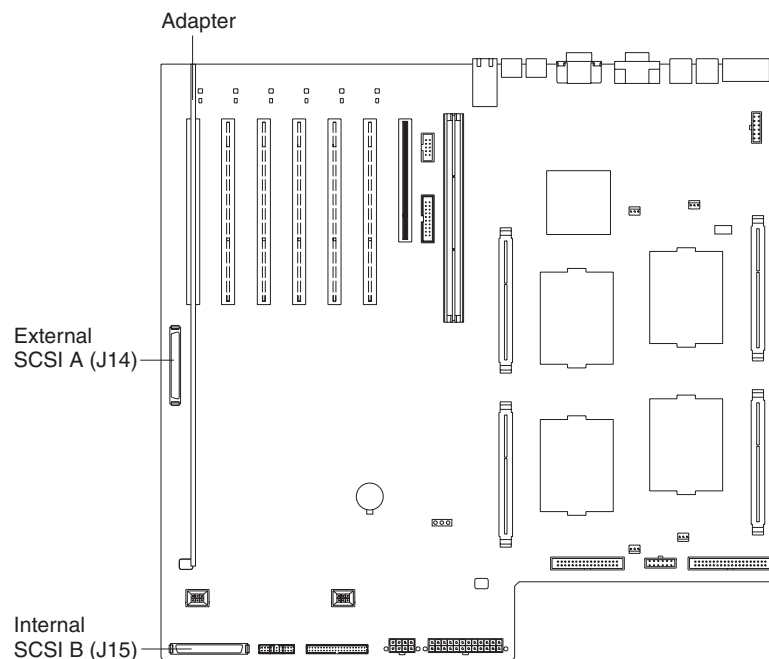

Attention: Do not block the ventilated space in front of the fan assembly.

- Slide the shuttle assembly back into place and secure it by locking the metal-hinge latch.

12. Route the SCSI cable from the standard SCSI backplane through the opening in the adapter-support bracket to the internal channel connector on the RAID or SCSI adapter.

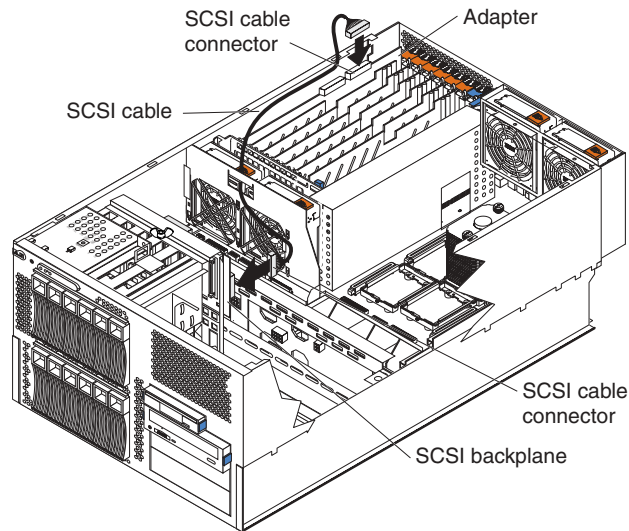

13. Reconnect the internal IDE signal cable to the IDE system-board connector. Reconnect the diskette-drive signal cable and front-fan signal cable to the corresponding system-board connectors. See “System-board internal cable connectors” on page 5 for cable locations.
14. Close the microprocessor airflow guide located between the front fans and the microprocessors. Insert the tabs into the corresponding slots.
15. Reinstall the air baffle:
 - a. Align and insert the two tabs on the rear of the air baffle into the corresponding slots on the rear of the server.
 - b. Align the hole on the front of the air baffle over the corresponding alignment pin on the chassis; then, lower the air baffle into place.

Note: The alignment pin is located near the plastic fastener behind fan 1.

 - c. Press firmly on the two plastic fasteners until they snap into place on the front of the air baffle. This secures the air baffle in the server.
16. If your server is a tower model, continue with the next step.
If your server is a rack model and you have already installed the server in a rack enclosure, you must reconnect the cable-management-arm bracket to the server.
 - a. Slide the server into the rack.
 - b. Reattach the cable-management-arm bracket to the server.

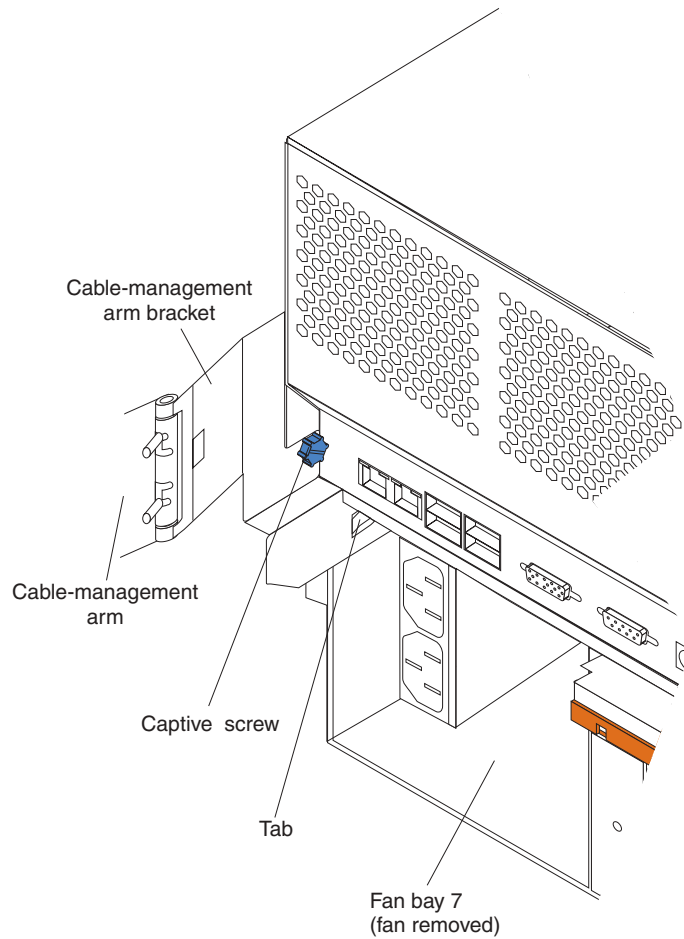

- 1) Remove the fan from fan bay 7.
 - 2) Insert the tab on the cable-management-arm bracket into the corresponding slot on the server.
 - 3) Tighten the captive screw on the cable-management-arm bracket to the server.
 - 4) Reinstall the fan in fan bay 7.
17. If you have other options to install or remove, do so now; otherwise, go to “Completing the installation” on page 68.

Working with the optional xSeries 6-Pack Hot-Swap Hard Drive Expansion Kit

Your server contains hardware that enables you to replace a failed hard disk drive without turning off the server. Therefore, you have the advantage of continuing to operate your system while a hard disk drive is removed or installed. These drives are known as *hot-swap* drives. The hot-swap drives are attached to a hot-swap hard disk drive *backplane*. The backplane is a printed circuit board behind the drive bays. For more information about drive bays and drive installation, see “Installing internal drives” on page 37. The low voltage differential (LVD) SCSI hot-swap hard disk drive backplane supports a maximum of six slim-high, hot-swap hard disk drives.

If you install the optional 6-Pack hot-swap drive backplane, you can attach up to six additional drives. The optional xSeries 6-Pack Hot-Swap Hard Drive Expansion Kit contains a hot-swap hard disk drive backplane that you install below the standard hot-swap hard disk drive backplane. Your server supports a maximum of two hot-swap drive backplanes.

You can configure the channels on the two SCSI backplanes as follows:

- You can configure each SCSI channel (bus) independently. This is the only available (typical) backplane configuration. In this configuration:
 - The hard disk drives (bays 1 through 6) that are connected to the standard SCSI backplane are attached to channel B through the internal SCSI connector (J15) on the system board. This is the standard configuration. You can also attach the drives in bays 1 through 6 to an optional RAID or SCSI adapter, as described in this section.
 - The hard disk drives (bays 7 through 12) that are connected to the optional 6-Pack hot-swap drive backplane are attached to an optional RAID or SCSI adapter.

Notes:

1. To use the optional xSeries 6-Pack Hot-Swap Hard Drive Expansion Kit, you must install a RAID or SCSI adapter in your server. For more information about installing an adapter, see “Installing an adapter” on page 19.
2. The standard SCSI backplane is also known as the hot-swap hard disk drive backplane.
3. The SCSI backplane that comes with the optional xSeries 6-Pack Hot-Swap Hard Drive Expansion Kit is also known as the 6-Pack backplane.
4. When you install hard disk drives, they must have the same speed. If you install drives with different speeds, the server will operate at the slower speed. For a list of supported options for your server, go to <http://www.ibm.com/pc/us/compat/> on the World Wide Web.
5. Table 5 on page 78 lists the SCSI identifiers (IDs) for the standard SCSI backplane and hard disk drives. Table 6 on page 78 lists the SCSI IDs for the 6-Pack backplane and hard disk drives.
6. Cable identifiers are printed on the cables that come with your server and options. Use these identifiers to connect the cables to the correct connectors. For example, the hard disk drive cables are labeled “HDD option.”

Installing the optional 6-Pack hot-swap drive backplane

Note: The optional xSeries 6-Pack Hot-Swap Hard Drive Expansion Kit might contain some components that you will not need for this procedure. For information about the contents of this option kit, see the documentation that comes with the option kit.

Complete the following steps to install the optional 6-Pack hot-swap drive backplane.

Note: The server does not support an optional SCSI repeater card or a single-channel configuration for the hard disk drives.

Attention: When you handle static-sensitive devices, take precautions to avoid damage from static electricity. For details about handling these devices, see “Handling static-sensitive devices” on page 14.

1. Review the information beginning with “Before you begin” on page 13 through “Handling static-sensitive devices” on page 14.
2. Turn off the server and peripheral devices and disconnect all power cords and external cables.
3. Disconnect all the hot-swap hard disk drives from the standard SCSI backplane; then, slide the drives forward, approximately 7.6 cm (3 in.).

Note: It is not necessary to remove the drives from the server.

4. If your server is a tower model, continue with the next step.
If your server is a rack model and you have already installed the server in a rack enclosure, you must disconnect the cable-management-arm bracket from the server.
 - a. Disconnect the cable-management-arm bracket from the server.

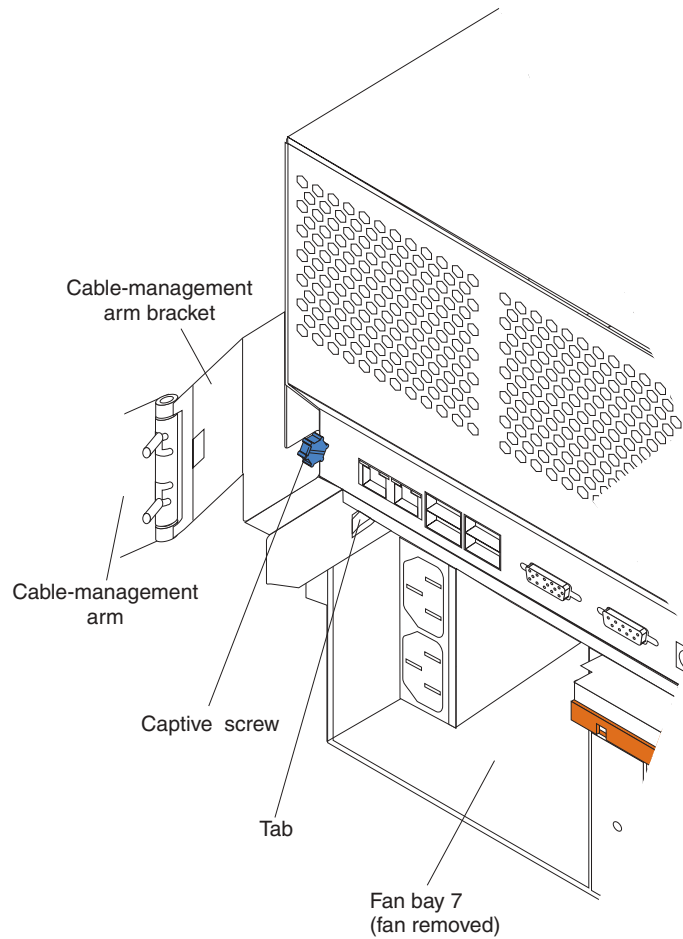

- 1) Loosen the captive screw on the cable-management-arm bracket.
- 2) Slide the tab on the cable-management-arm bracket out of the slot on the server; then, remove the bracket from the server.
 - b. Slide the server out of the rack enclosure until it locks into place.
5. Remove the top cover (see “Removing the top cover (all models)” on page 15).
6. Remove the air baffle:
 - a. Pull out the two plastic fasteners on the front of the air baffle.

Note: Do not remove the fasteners from the air baffle.
 - b. Grasp the handle on the air baffle; then, lift the air baffle from the server.

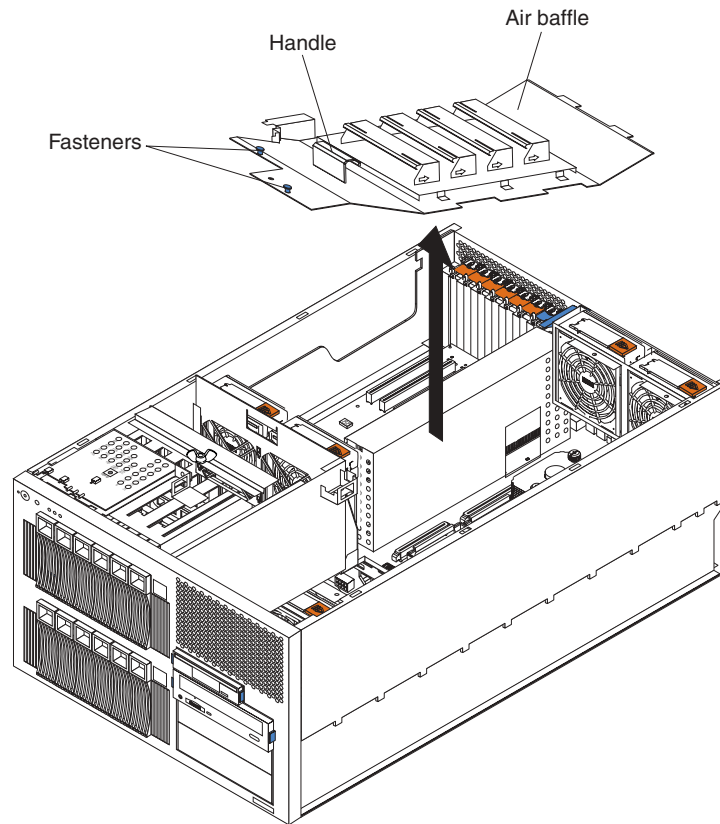

7. Open the microprocessor airflow guide located between the front fans and the microprocessors.

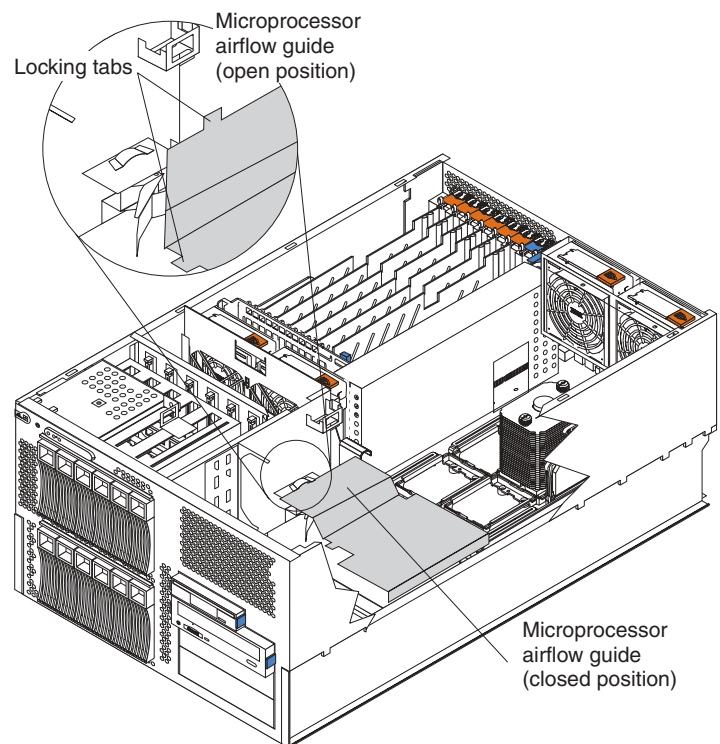

8. Unlock the metal-hinge latch that secures the shuttle assembly in place. Then, slide the shuttle assembly toward the rear of the server, approximately 10 cm (4 in.).

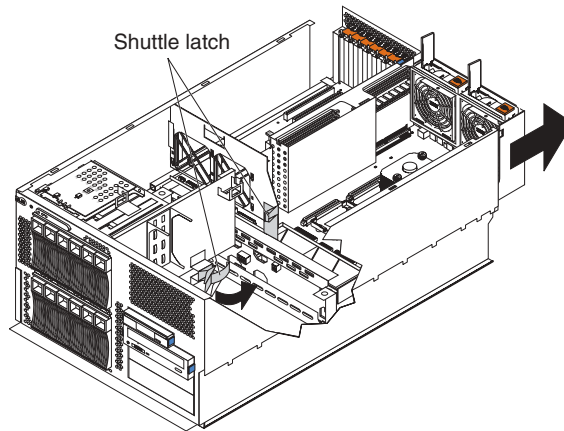

9. Disconnect the internal IDE signal cable from the IDE system-board connector. Disconnect the diskette-drive signal cable and front-fan signal cable from the corresponding system-board connectors. See "System-board internal cable connectors" on page 5 for cable locations.
10. Disconnect the internal cables from the front of the system board, near the center fans. See "System-board internal cable connectors" on page 5 for cable locations.
11. If you have not yet installed a RAID or SCSI adapter, install it now. Otherwise, continue with the next step. See "Installing an adapter" on page 19 and your RAID or SCSI adapter option documentation for additional information about installing a RAID or SCSI adapter in your server and connecting the SCSI cables to a RAID or SCSI adapter.
12. Disconnect the signal and power cables that are attached to the standard SCSI backplane.

13. Loosen the captive screw on top of the metal backplane support bracket by turning the screw counterclockwise. Lift the metal backplane support bracket from the server.

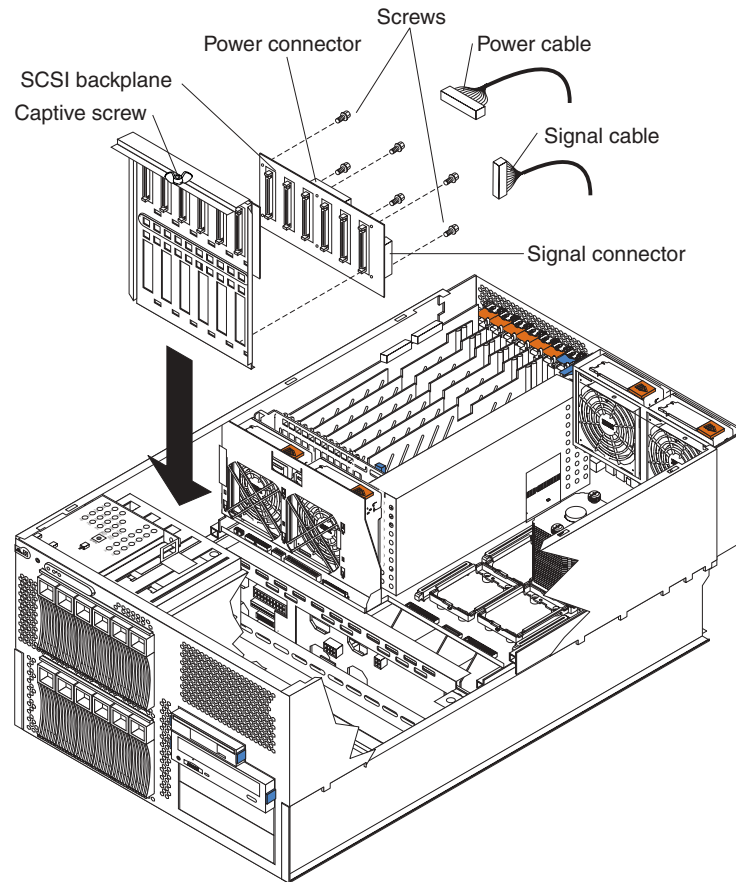

14. Touch the static-protective package that contains the optional SCSI backplane to any unpainted metal surface on the server; then, remove the SCSI backplane from the package and place it on a static-protective surface.
15. Locate the two alignment pins on the metal backplane support bracket. Attach the optional SCSI backplane to the lower drive cage slots on the backplane support bracket by matching the two alignment pins on the rear of the bracket with the corresponding holes on the SCSI backplane. Use the six screws that come with the option kit to secure the SCSI backplane to the backplane support bracket.
16. Reinstall the backplane support bracket in the server. Tighten the captive screw on top of the metal backplane support bracket by turning the screw clockwise until it snaps into place. This secures the backplane support bracket in the server.

Note: Make sure that no cables are under the backplane support bracket.

17. Locate the SCSI signal cable that comes with this option kit.
 - a. Connect the end of the cable that is labeled “HDD backplane” to the new 6-Pack hot-swap drive backplane.
 - b. Route the SCSI signal cable through the opening in the adapter-support bracket. Do not connect the cable to the adapter at this time.

Attention: Do not block the ventilated space in front of the fan assembly.

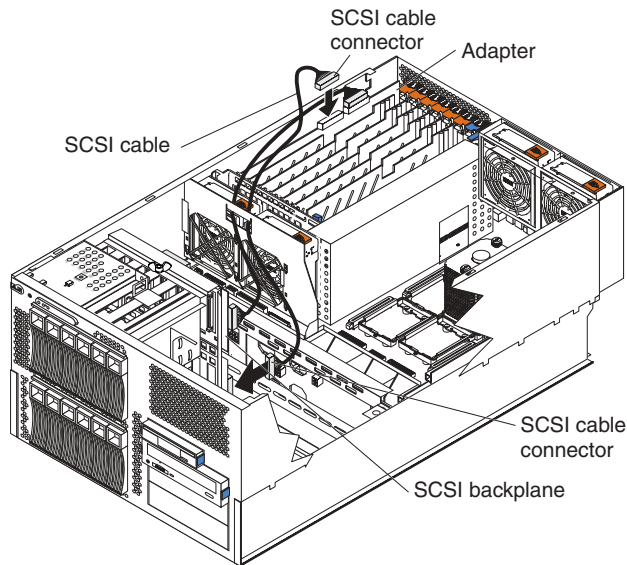

18. Locate the power cable that comes with this option kit.
 - a. Remove the protective cover from the end of the cable and connect one end of the cable to the lower power backplane connector.

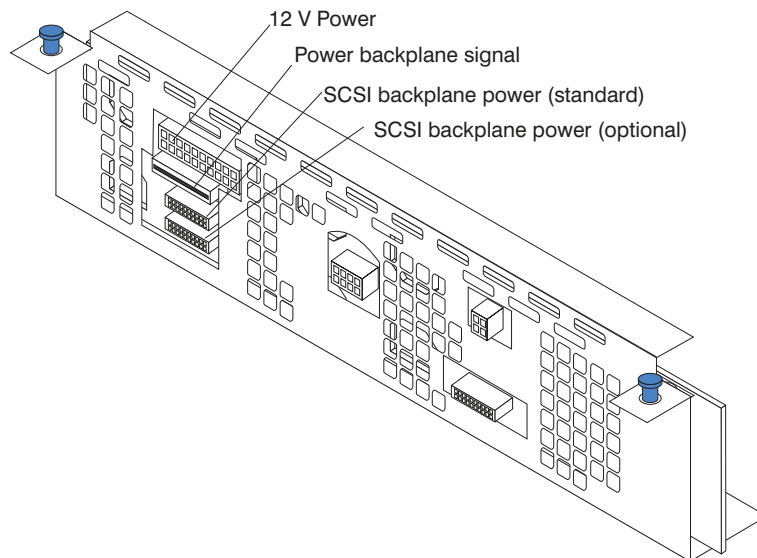

- b. Connect the other end of the cable (labeled “HDD2”) to the new 6-Pack hot-swap drive backplane.

19. Reconnect the SCSI signal cable and power cable to the standard SCSI backplane:
 - a. Make sure that one end of the power cable is still connected to the upper power backplane connector.
 - b. Connect the other end of the power cable (labeled “HDD1”) to the standard SCSI backplane.
 - c. Connect the end of the SCSI signal cable that is labeled “HDD backplane” to the standard SCSI backplane.
 - d. If you want to attach the upper drive cage (bays 1 through 6) to a RAID or SCSI adapter, route the SCSI signal cable through the opening in the adapter-support bracket. Do not connect the cable to the adapter at this time.

Attention: Do not block the ventilated space in front of the fan assembly. If you do not plan to attach the upper drive cage (bays 1 through 6) to a RAID or SCSI adapter, reconnect the SCSI signal cable to the internal SCSI connector (J15) on the system board.
20. Reconnect the internal cables, except for the IDE signal cable, diskette-drive signal cable, front-fan signal cable, and the cable that you disconnected from the internal SCSI connector (J15) on the system board.
21. Slide the shuttle assembly back into place and secure it by locking the metal-hinge latch.
22. Reconnect the internal IDE signal cable to the IDE system-board connector. Reconnect the diskette-drive signal cable and front-fan signal cable to the corresponding system-board connectors. See “System-board internal cable connectors” on page 5 for cable locations.
23. Close the microprocessor airflow guide located between the front fans and the microprocessors. Insert the tabs into the corresponding slots.
24. Reinstall the air baffle:
 - a. Align and insert the two tabs on the rear of the air baffle into the corresponding slots on the rear of the server.
 - b. Align the hole on the front of the air baffle over the corresponding alignment pin on the chassis; then, lower the air baffle into place.

Note: The alignment pin is located near the plastic fastener behind fan 1.
 - c. Press firmly on the two plastic fasteners until they snap into place on the front of the air baffle. This secures the air baffle in the server.
25. In step 17 on page 34, you connected one end of the optional SCSI signal cable to the new 6-Pack hot-swap drive backplane and routed the cable through the opening in the adapter-support bracket. Now complete the procedure by routing the optional SCSI signal cable to a dual-channel RAID or SCSI adapter and connecting the unattached end of the cable to an internal channel connector on the adapter (see “Cabling a RAID or SCSI adapter” on page 22).

Attention: Do not block the ventilated space in front of the fan assembly.
26. If you decided to attach the upper drive cage (bays 1 through 6) to a RAID or SCSI adapter in step 19, you must disconnect the SCSI signal cable from the internal SCSI connector (J15) on the system board (see “System-board internal cable connectors” on page 5 for the system-board connector locations). In step 19, you connected one end of the standard SCSI signal cable to the standard SCSI backplane and routed the cable through the opening in the adapter-support bracket. Now complete the procedure by routing the standard

SCSI signal cable to the RAID or SCSI adapter and connecting the unattached end of the cable to an internal channel connector on the adapter (see “Cabling a RAID or SCSI adapter” on page 22).

Attention: Do not block the ventilated space in front of the fan assembly.

27. Slide the hot-swap hard disk drives back into bays 1 through 6 to reconnect the drives to the standard SCSI backplane.
28. Install additional internal hot-swap hard disk drives in bays 7 through 12 to connect the drives to the optional 6-Pack hot-swap drive backplane (see “Installing a hot-swap hard disk drive” on page 38).

Note: The optional 6-Pack hot-swap drive backplane sets the SCSI IDs for these hot-swap hard disk drives. See “Setting SCSI IDs” on page 77 for additional information.

29. If your server is a tower model, continue with the next step.
If your server is a rack model and you have already installed the server in a rack enclosure, you must reconnect the cable-management-arm bracket to the server.
 - a. Slide the server into the rack.
 - b. Reattach the cable-management-arm bracket to the server.

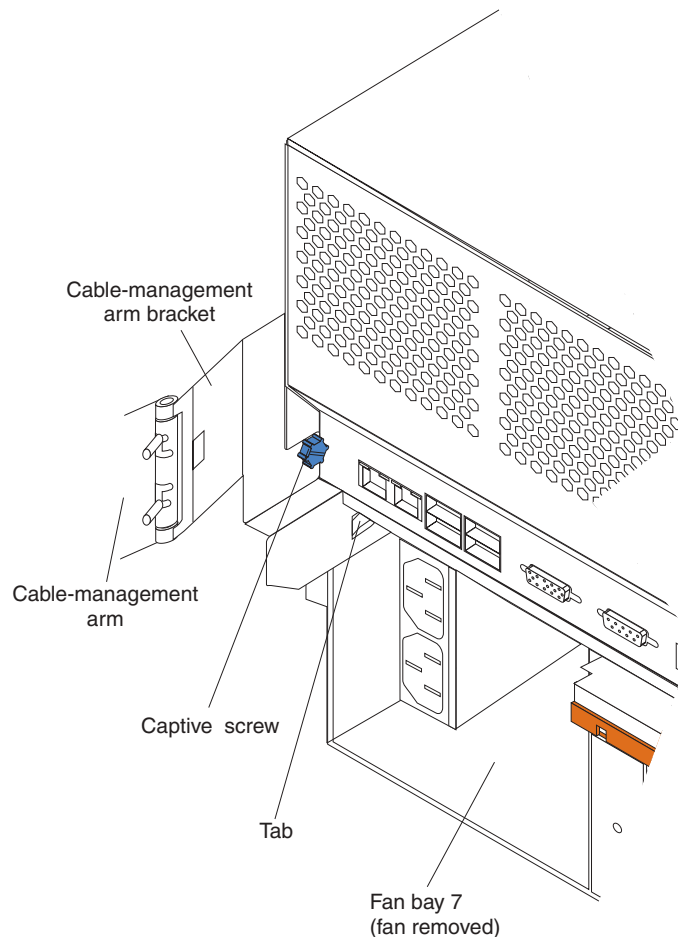

- 1) Remove the fan from fan bay 7.
- 2) Insert the tab on the cable-management-arm bracket into the corresponding slot on the server.

- 3) Tighten the captive screw on the cable-management-arm bracket to the server.
 - 4) Reinstall the fan in fan bay 7.
30. If you have other options to install or remove, do so now; otherwise, go to “Completing the installation” on page 68.

Installing internal drives

If you add different types of drives, your system can read multiple types of media and store more data. Several types of drives are available, such as:

- Diskette
- Hard disk
- CD-ROM
- Tape, including digital linear tape (DLT), super digital linear tape (SDLT), and linear tape-open (LTO)

Note: The server supports both internal and external tape drives.

Your server contains hardware that enables you to replace a failed hard disk drive without turning off the server. Therefore, you have the advantage of continuing to operate your system while a hard disk drive is removed or installed. These drives are known as *hot-swap* drives.

Each hot-swap drive has two indicator lights (see the *User's Guide on the xSeries Documentation CD*). If the amber hard disk drive status light for a drive is lit continuously, that individual drive is faulty and requires replacement. When the hard disk drive status light indicates a drive fault, you can replace a hot-swap drive without turning off the server.

Each hot-swap drive that you plan to install must be mounted in a hot-swap-drive tray. The drive must have a single connector attachment (SCA) connector. Hot-swap-drive trays come with hot-swap drives.

Internal drive bays

Internal drives are installed in *bays*. The following illustration identifies the bays for the tower and rack models.

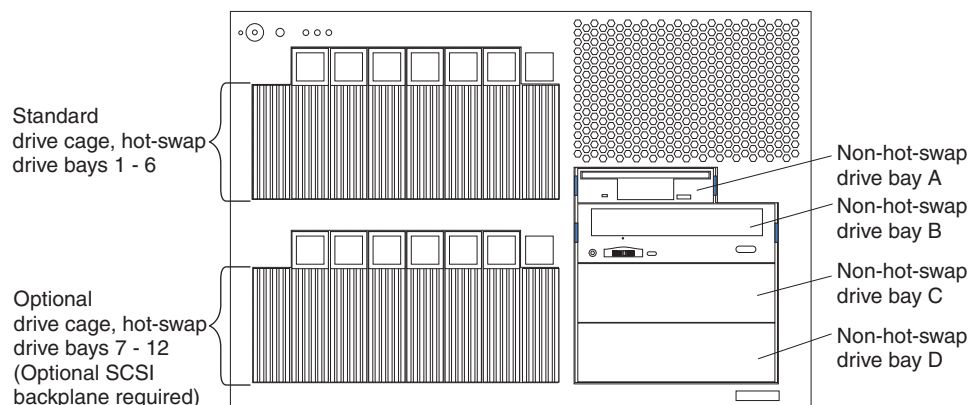

- Your server comes with one integrated drive electronics (IDE) CD-ROM drive and one 3.5-inch, 1.44 MB diskette drive.
- The CD-ROM drive bay (bay B, right front) supports 5.25-inch, half-high, removable-media drives. A CD-ROM drive comes preinstalled in the server.

- You cannot install hot-swap hard disk drives or non-hot-swap hard disk drives in the right-front bays (bays A through D). You can install hot-swap hard disk drives only in the hot-swap hard disk drive bays on the left-front side of the server.
- Your server supports a maximum of six standard 26 mm (1-inch) slim-high, 3.5-inch, hot-swap hard disk drives in the hot-swap bays. The standard hot-swap bays are bays 1 through 6, located in the standard (upper) drive cage.
- You can install six additional hot-swap hard disk drives in the server after you install the optional 6-Pack hot-swap backplane in the optional (lower) drive cage. The optional hot-swap bays are bays 7 through 12, located in the optional (lower) drive cage.
- The SCSI IDs for the hot-swap drives are printed on the bezel, immediately adjacent to the hot-swap drive bays. The IDs are:
 - 0 through 5 for bays 1 through 6
 - 10 through 15 for bays 7 through 12
- The server does not support half-high hot-swap drives.
- To minimize the possibility of damage to the hard disk drives when you are installing a hard disk drive in a rack model, install the rack model in the rack enclosure before installing the hard disk drives.
- You do not have to turn off the server to install hot-swap drives in the hot-swap drive bays. However, you must turn off the server when performing any steps that involve installing or removing cables.
- Before you install any internal drives in a tower model server, you must first remove the bezel (see “Removing the bezel (tower model)” on page 16). Before you install 5.25-inch removable-media drives in a rack model server, you must first remove the bezel (see “Removing the bezel (rack model)” on page 16).
- Your server supports one IDE device. You must first disconnect the IDE cable from the CD-ROM drive that comes with your server and remove the CD-ROM drive before you install another IDE device.

Note: Attach the black connector end of the IDE cable to the IDE device; attach the blue connector end of the IDE cable to the system board.

- For a list of supported IDE and SCSI options for your server, go to <http://www.ibm.com/pc/us/compat/> on the World Wide Web.

Installing a hot-swap hard disk drive

Complete the following steps to install a drive in a hot-swap bay.

Attention: When you handle static-sensitive devices, take precautions to avoid damage from static electricity. For details about handling these devices, see “Handling static-sensitive devices” on page 14.

1. Review the information beginning with “Before you begin” on page 13 through “Handling static-sensitive devices” on page 14.
2. If you are installing drives in a tower model, remove the bezel (see “Removing the bezel (tower model)” on page 16).
3. Touch the static-protective package that contains the drive to any unpainted metal surface on the server; then, remove the drive from the package and place it on a static-protective surface.
4. Determine the bay into which you will install the drive.

Note: If you are installing a hard disk drive in one of the bays 7 through 12 (lower drive cage), you must first install an optional hot-swap SCSI backplane and a SCSI or RAID adapter. See “Working with the optional

xSeries 6-Pack Hot-Swap Hard Drive Expansion Kit” on page 28 for complete detailed installation instructions.

5. Remove the filler panel from one of the empty hot-swap bays by inserting your finger into the depression at the left side of the filler panel and pulling the panel away from the server.

Attention: To maintain proper system cooling, do not operate the server for more than 10 minutes without either a drive or a filler panel installed in each bay.

6. Install the hard disk drive in the hot-swap bay:
 - a. Ensure that the tray handle is open (that is, perpendicular to the drive).
 - b. Align the drive assembly with the guide rails in the bay.
 - c. Gently push the drive assembly into the bay until the drive stops.
 - d. Push the tray handle to the closed (locked) position.

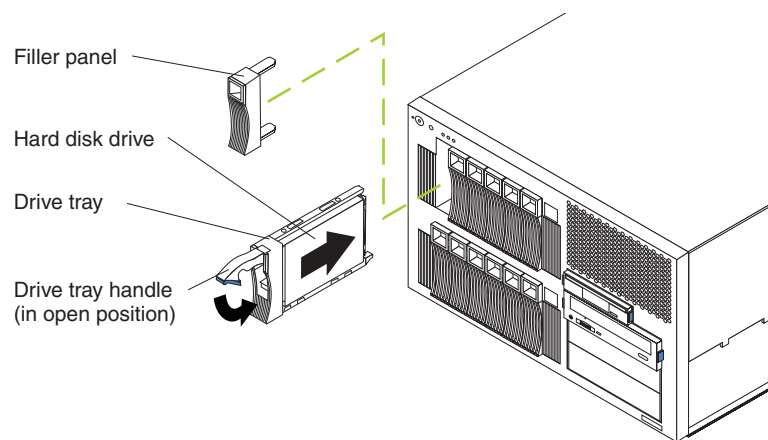

- e. Check the hard disk drive status LED on the front of the drive to verify that the hard disk drive is operating properly.

If the amber hard disk drive status LED for a drive is lit continuously, that individual drive is faulty and needs to be replaced. If the green hard disk drive activity LED is flashing, the drive is being accessed.

Note: If your server has a RAID controller or adapter installed, you might need to reconfigure your disk arrays after installing hard disk drives. See your RAID adapter option documentation for complete instructions for installing a RAID adapter in your server and for additional information about RAID adapters.

7. Reinstall the bezel:
 - If you installed drives in a tower model, see “Installing the bezel (tower model)” on page 69.
 - If you installed drives in a rack model, see “Installing the bezel (rack model)” on page 69.

Installing a 5.25-inch removable-media drive

Your server also comes with one integrated drive electronics (IDE) CD-ROM drive. The CD-ROM drive bay (bay B) supports a 5.25-inch, half-high, removable-media drive. Your server supports one IDE device.

You can install two additional 5.25-inch, half-high, removable-media drives or one additional 5.25-inch, full-high, removable-media drive in the removable-media drive bays (C and D).

A three-drop power cable and a one-drop IDE signal cable come with your server. Use these cables to connect the removable-media drives. If you plan to install SCSI devices in the removable-media drive bays, you must purchase a SCSI cable or use the cable that comes with your option. Consult your IBM marketing representative or reseller for additional information about the number and types of cables that your server configuration requires.

Before you install a SCSI device, such as a tape drive, you must install a RAID or SCSI adapter in your server and connect the standard hot-swap drive backplane to the RAID or SCSI adapter. Then, you can use a SCSI cable to connect the SCSI device to the internal SCSI connector (J15) on the system board. See “Installing an adapter” on page 19 for additional information.

Check the instructions that come with the drive to see if you need to set any switches or jumpers on the drive.

Complete the following steps to install a removable-media drive in bay C or D (see “Internal drive bays” on page 37 for the locations of the drive bays).

Attention: When you handle static-sensitive devices, take precautions to avoid damage from static electricity. For details about handling these devices, see “Handling static-sensitive devices” on page 14.

1. Review the information beginning with “Before you begin” on page 13 through “Handling static-sensitive devices” on page 14.
2. Turn off the server and peripheral devices and disconnect all power cords and external cables.
3. If your server is a tower model, continue with the next step.
If your server is a rack model and you have already installed the server in a rack enclosure, you must disconnect the cable-management-arm bracket from the server.
 - a. Disconnect the cable-management-arm bracket from the server.

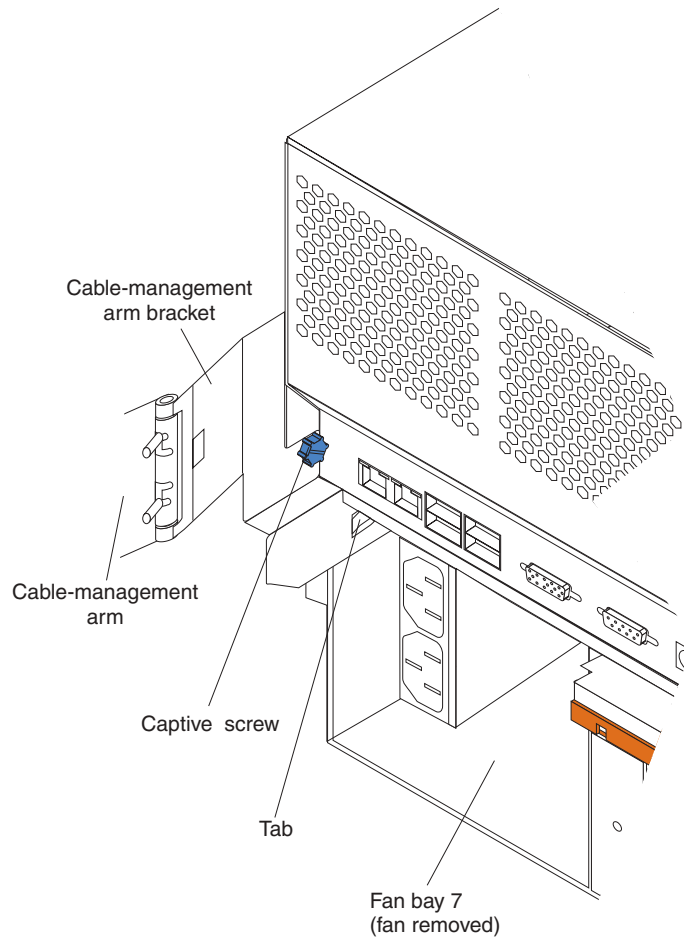

- 1) Loosen the captive screw on the cable-management-arm bracket.
- 2) Slide the tab on the cable-management-arm bracket out of the slot on the server; then, remove the bracket from the server.
 - b. Slide the server out of the rack enclosure until it locks into place.
4. Remove the top cover and bezel (see “Removing the top cover and bezel” on page 15).
5. Remove the air baffle:
 - a. Pull out the two plastic fasteners on the front of the air baffle.

Note: Do not remove the fasteners from the air baffle.

 - b. Grasp the handle on the air baffle; then, lift the air baffle from the server.

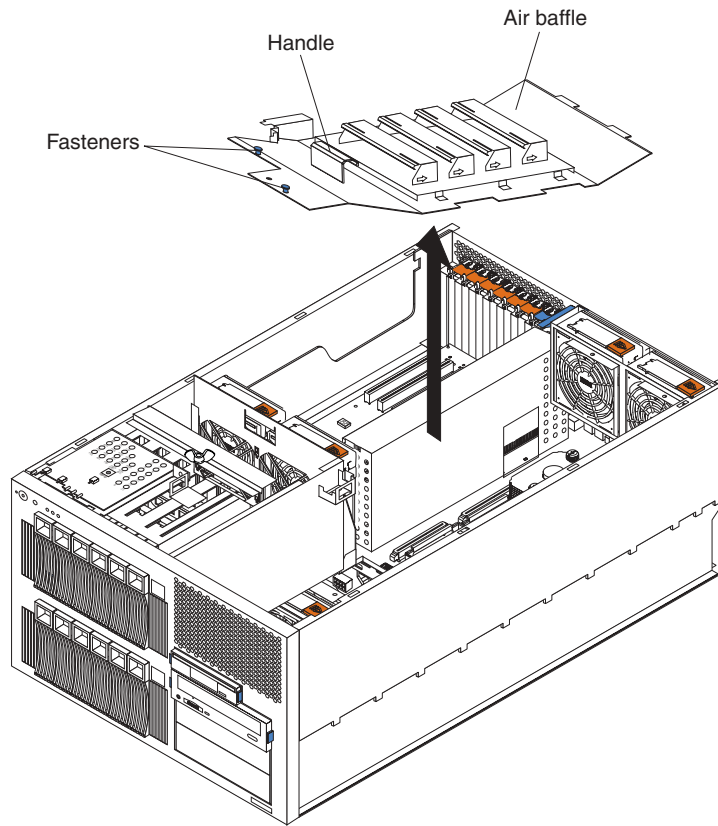

6. Open the microprocessor airflow guide located between the front fans and the microprocessors.

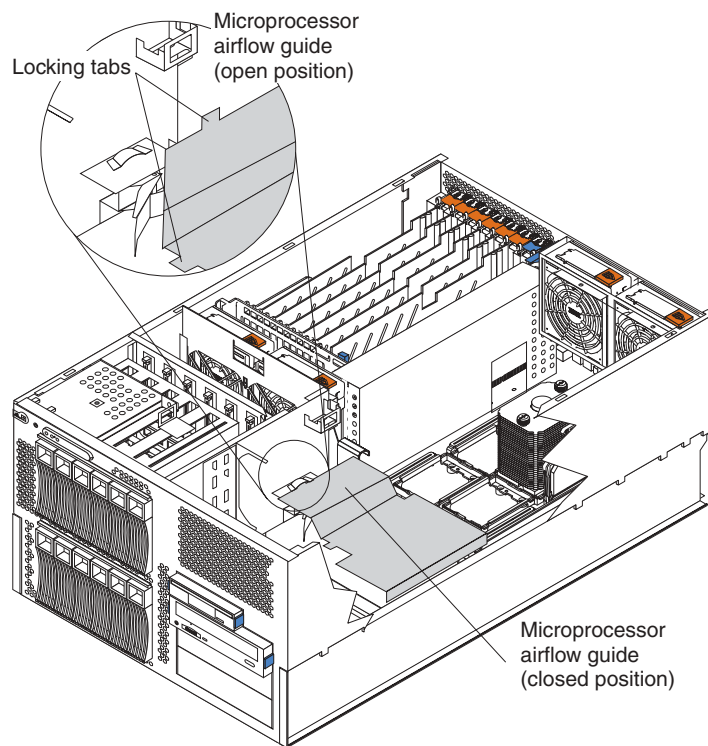

7. Unlock the metal-hinge latch that secures the shuttle assembly in place. Then, slide the shuttle assembly toward the rear of the server, approximately 10 cm (4 in.).

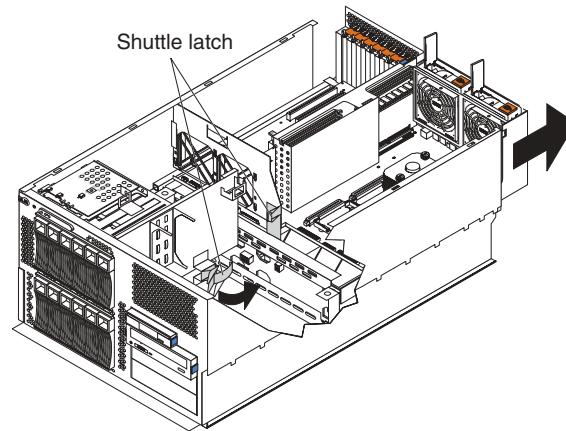

8. Disconnect the internal IDE signal cable from the IDE system-board connector. Disconnect the diskette-drive signal cable and front-fan signal cable from the corresponding system-board connectors. See “System-board internal cable connectors” on page 5 for cable locations.
9. If you have not yet installed a RAID or SCSI adapter, install it now. Otherwise, continue with the next step. See “Installing an adapter” on page 19 and your RAID or SCSI adapter option documentation for additional information about installing a RAID or SCSI adapter in your server and connecting the SCSI cables to a RAID or SCSI adapter.
10. Disconnect the SCSI signal cable from the internal SCSI connector (J15) on the system board.

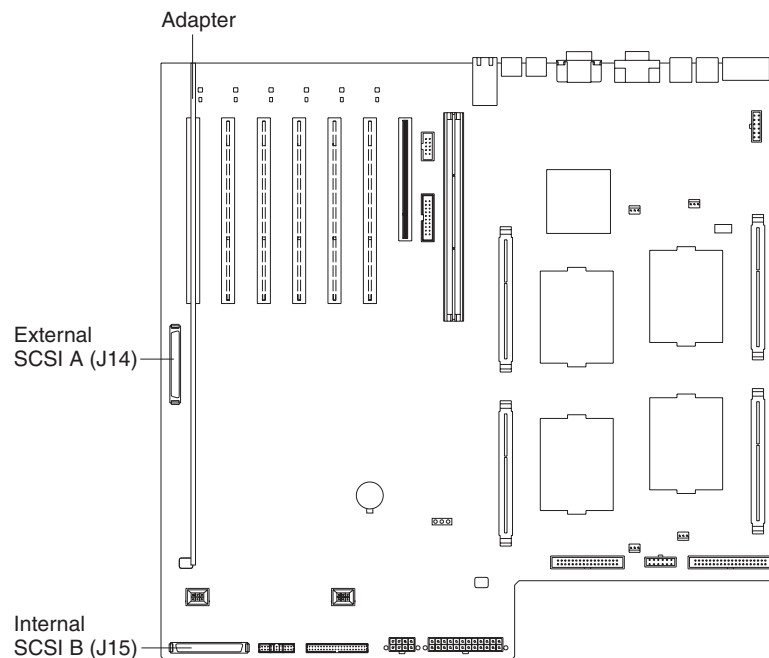

Attention: Do not block the ventilated space in front of the fan assembly.

11. Choose the bay in which you want to install the drive.
12. Remove the filler panel from the removable-media bay opening.

Note: The server electromagnetic interference (EMI) integrity and cooling are both protected by having the bays covered or occupied. When you install a drive, save the filler panel from the bay, in case you later remove the drive and do not replace it with another.

13. Touch the static-protective package that contains the drive to any unpainted metal surface on the server; then, remove the drive from the package and place it on a static-protective surface.
14. Set any jumpers or switches on the drive according to the documentation that comes with the drive.
15. Install the drive:
See the following illustration when installing a 5.25-inch removable-media drive.

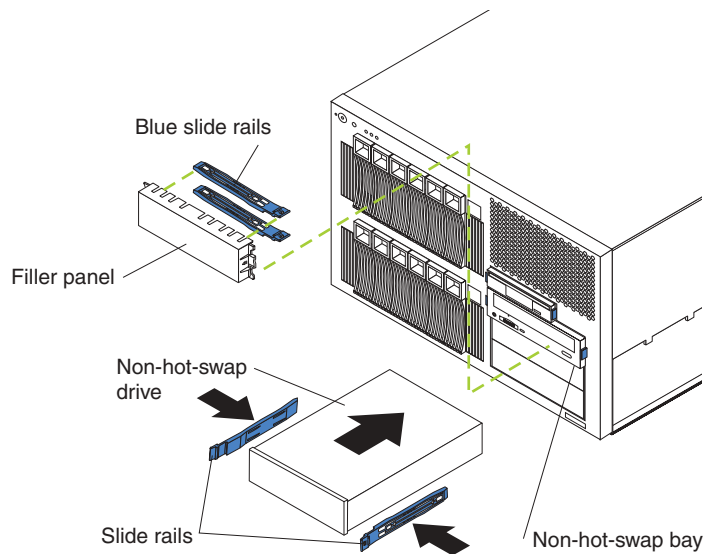

- Use the blue plastic slide rails that come with the server as described in this step, unless the drive comes with custom metal slide rails.
- If you are installing an SDLT drive, use the custom metal slide rails and screws that come with the option package. Follow the installation instructions that come with the option package; then, continue with step 15c.
- If you are installing a full-high DLT drive, use the custom metal slide rails and screws that are located inside the server, under the microprocessor airflow guide. See the illustration in step 6 on page 42 for the location of the microprocessor airflow guide.

Follow the installation instructions that come with the option package; then, continue with step 15c.

- a. Remove the blue snap-on slide rails from inside the filler panel.
 - b. Clip the slide rails onto the sides of the drive.
 - c. Store the filler panel for later use.
 - d. Align the slide rails on the drive with the guide rails in the bay; then, slide the drive into the bay until it snaps into place.
16. Connect a compatible signal cable to the device that you just installed (see “System-board internal cable connectors” on page 5 for cable locations):
 - If you installed an IDE device, connect the black end of the IDE signal cable to the rear of the IDE device. Make sure that the blue end of the IDE signal cable is still connected to the system board.

- If you installed a SCSI device, install a SCSI signal cable by attaching one end of the cable to the rear of the SCSI device that you installed. Attach the other end of the cable to the internal SCSI connector (J15) on the system board.

Important: At this time, you must connect a RAID or SCSI adapter to the hard disk drives in the upper drive cage (see “Cabling a RAID or SCSI adapter” on page 22 for additional information).

17. Connect a power cable to the rear of the drive. A three-drop power cable for removable-media drives comes installed in your server. It is attached to the standard CD-ROM drive. The connectors are keyed and can be inserted only one way.
18. Reconnect the remaining internal cables (if any), except for the IDE signal cable, diskette-drive signal cable, front-fan signal cable, and the cable that you disconnected from the internal SCSI connector (J15) on the system board.
19. Slide the shuttle assembly back into place and secure it by locking the metal-hinge latch.
20. Route the standard SCSI signal cable from the standard SCSI backplane through the opening in the adapter-support bracket to the RAID or SCSI adapter. Connect the unattached end of the cable to an internal channel connector on the adapter (see “Cabling a RAID or SCSI adapter” on page 22).

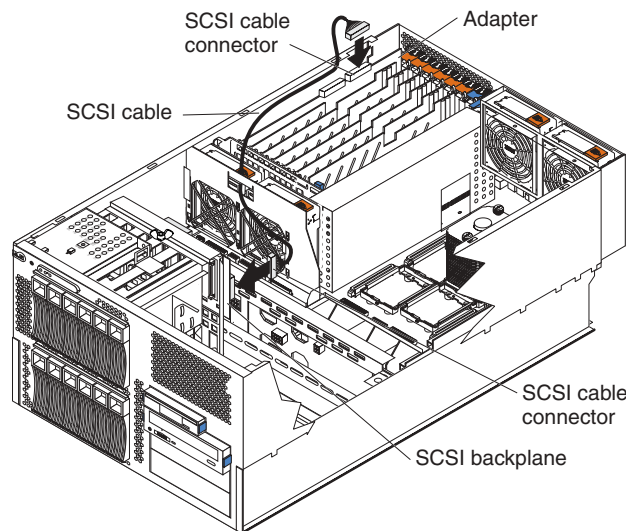

21. Reconnect the internal IDE signal cable to the IDE system-board connector. Reconnect the diskette-drive signal cable and front-fan signal cable to the corresponding system-board connectors. See “System-board internal cable connectors” on page 5 for cable locations.
22. Close the microprocessor airflow guide located between the front fans and the microprocessors. Insert the tabs into the corresponding slots.
23. Reinstall the air baffle:
 - a. Align and insert the two tabs on the rear of the air baffle into the corresponding slots on the rear of the server.
 - b. Align the hole on the front of the air baffle over the corresponding alignment pin on the chassis; then, lower the air baffle into place.

Note: The alignment pin is located near the plastic fastener behind fan 1.

- c. Press firmly on the two plastic fasteners until they snap into place on the front of the air baffle. This secures the air baffle in the server.

24. If your server is a tower model, continue with the next step.
If your server is a rack model and you have already installed the server in a rack enclosure, you must reconnect the cable-management-arm bracket to the server.
- a. Slide the server into the rack.
 - b. Reattach the cable-management-arm bracket to the server.

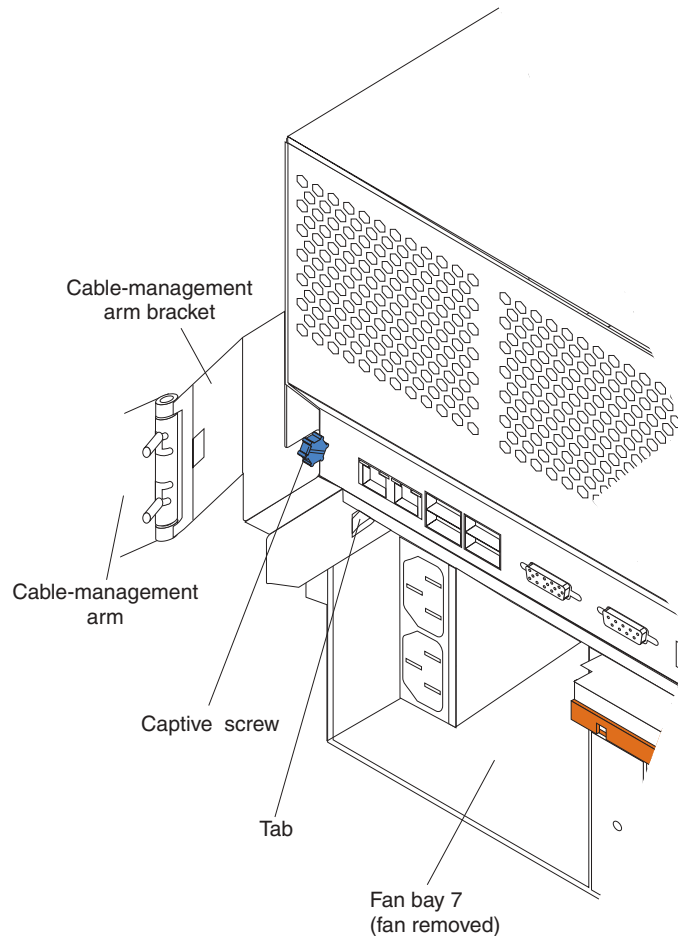

- 1) Remove the fan from fan bay 7.
 - 2) Insert the tab on the cable-management-arm bracket into the corresponding slot on the server.
 - 3) Tighten the captive screw on the cable-management-arm bracket to the server.
 - 4) Reinstall the fan in fan bay 7.
25. If you have other options to install or remove, do so now; otherwise, go to “Completing the installation” on page 68.

Installing memory modules

Adding memory to your server is an easy way to make programs run faster. You can increase the amount of memory in your server by installing memory-module options. When you install memory, you must install a set of two or four matched dual inline memory modules (DIMMs).

Before you install memory, review the following:

Notes:

1. The DIMM options available for your server are 256 MB, 512 MB, and 1 GB. Your server supports a minimum of 512 MB and a maximum of 12 GB of system memory.
2. The amount of usable memory will be reduced depending on the system configuration. A certain amount of memory must be reserved below the amount of installed memory for system resources. The BIOS will display the amount of installed memory.
3. Your server comes with a minimum of two 256 MB DIMMs (for a total of 512 MB memory) installed in the DIMM 2 and DIMM 8 memory connectors (D2 and D8, respectively). You must have DIMMs installed in these connectors at all times.
4. When you install additional DIMMs, be sure to install them in pairs or quads and follow the DIMM installation sequence in the illustration in this section. A pair or quad is also known as a memory bank. See Table 3 on page 48 for the DIMM connectors in each pair or quad.
5. All the DIMMs in a single pair or quad must be the same size, speed, and type.
6. Multiple pairs or quads of DIMMs do not have to contain DIMMs of the same size, speed, and type, unless the Hot Spare Memory feature is enabled.
7. The memory board contains 12 DIMM connectors and supports two-way and four-way memory interleaving.

To use the four-way memory interleaving technology in your server, you must install DIMMs in all four connectors in each populated set.

8. Install only 2.5 V, 184-pin, 72-bit, 100 MHz, double-data-rate (DDR), PC1600, registered synchronous dynamic random-access memory (SDRAM) dual inline memory modules (DIMMs) with error correcting code (ECC). Only 100 MHz, 72-bit, registered, synchronous memory is supported for the 256 MB, 512 MB, and 1 GB DIMMs. These DIMMs must be compatible with the latest PC1600 SDRAM Registered DIMM specification. For a list of supported options for your server, go to <http://www.ibm.com/us/compat/> on the World Wide Web.
9. Installing or removing DIMMs changes the configuration information in the server. The Configuration/Setup Utility program automatically saves the new configuration information. When you restart the server, the system displays a message indicating that the memory configuration has changed. See the *User's Guide* on the *IBM xSeries Documentation* CD for more information about the Configuration/Setup Utility program.
10. Your server supports the Hot Spare Memory feature in the event of an active memory pair or quad of DIMM failure. This feature, when enabled, disables the failed memory from the system configuration and activates a Hot Spare Memory pair or quad of DIMMs to replace the failed pair or quad of DIMMs. Before you can enable this feature, you must also install at least one additional pair or quad of DIMMs as described in this book. To ensure proper server operation and to avoid disabling the Hot Spare Memory feature, all additional pairs or quads of DIMMs must be the same size, speed, and type as the failed pair or quad of DIMMs.

You can enable the Hot Spare Memory feature through the Configuration/Setup Utility program. After you enable the Hot Spare Memory feature, the Configuration/Setup Utility program assigns the Hot Spare Memory bank according to your server configuration. If your server has a two-way interleaved configuration, the Hot Spare Memory bank becomes the DIMMs in connectors D2 and D8. If your server has a four-way interleaved configuration, the Hot Spare Memory bank becomes the DIMMs in connectors D1, D2, D7, and D8.

See the *User's Guide* on the *IBM xSeries Documentation CD* for further details about enabling the Hot Spare Memory feature.

When you install DIMMs, install them in the order listed in Table 3.

Table 3. DIMM installation order

Interleaving	Number of DIMMs	Install DIMMs in these connectors
Two-way	2	D2, D8 (standard)
Two-way	4	D2, D8 (standard) (Hot Spare memory bank for two-way interleaving) D4, D10
Two-way	6	D2, D8 (standard) (Hot Spare memory bank for two-way interleaving) D4, D10 D6, D12
Four-way	4	D2, D8, D1, D7
Four-way	8	D2, D8, D1, D7 (Hot Spare memory bank for four-way interleaving) D4, D10, D3, D9
Four-way	12	D2, D8, D1, D7 (Hot Spare memory bank for four-way interleaving) D4, D10, D3, D9 D6, D12, D5, D11

Complete the following steps to install a DIMM.

Attention: When you handle static-sensitive devices, take precautions to avoid damage from static electricity. For details about handling these devices, see “Handling static-sensitive devices” on page 14.

1. Review the information beginning with “Before you begin” on page 13 through “Handling static-sensitive devices” on page 14.
2. Turn off the server and disconnect all power cords and external cables; then, remove the server cover (see “Removing the top cover and bezel” on page 15).
3. Remove the air baffle:
 - a. Pull out the two plastic fasteners on the front of the air baffle.

- Note:** Do not remove the fasteners from the air baffle.
- b. Grasp the handle on the air baffle; then, lift the air baffle from the server.

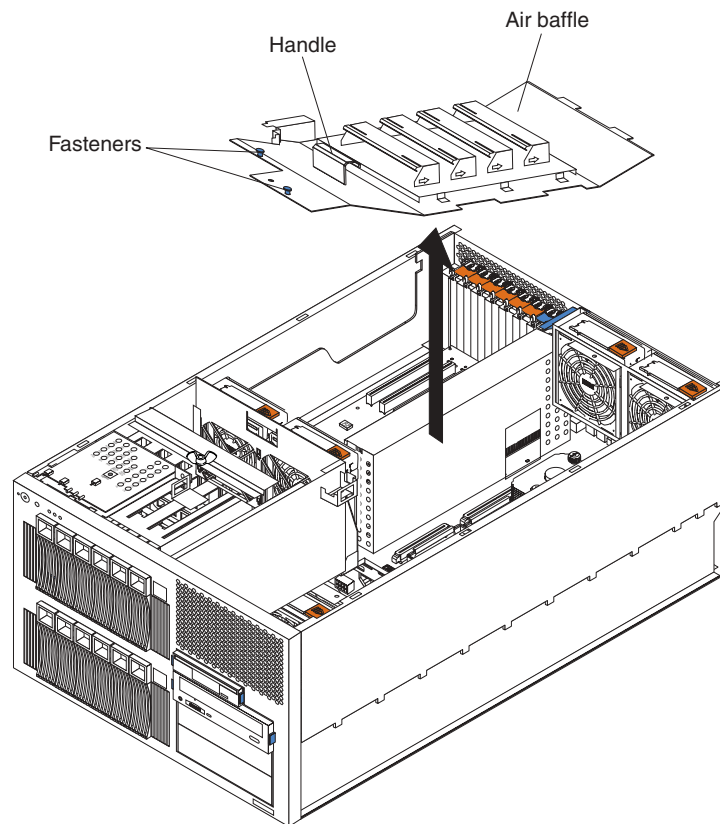

4. Remove the memory-board assembly:
 - a. Open the release latches located on both ends of the memory-board assembly.
 - b. Lift up on the memory-board assembly and remove it from the server.

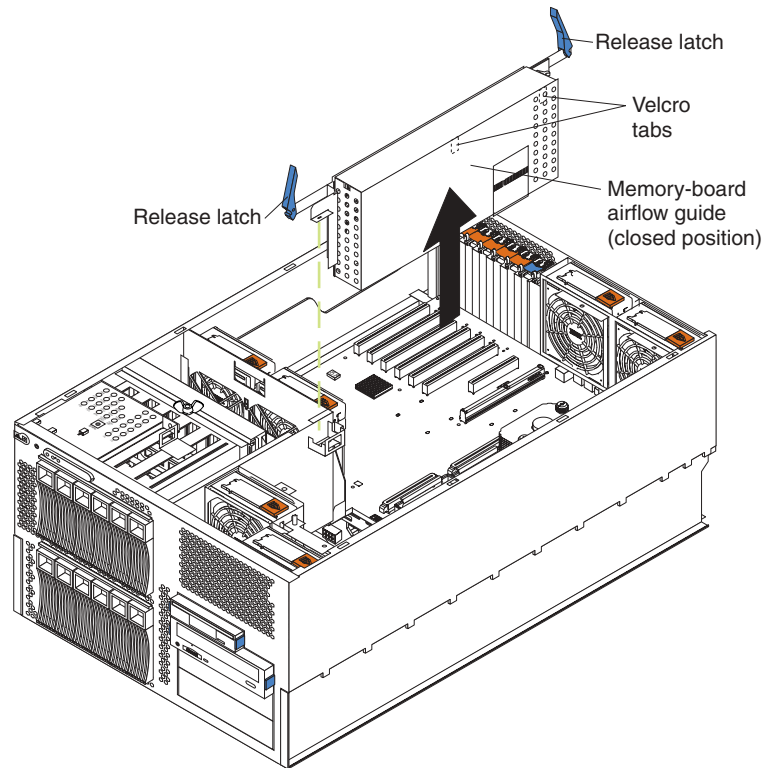

- c. Place the memory-board assembly on a static-protective surface.

5. Open (to the unlocked position) the memory-board airflow guide away from the memory-board assembly.

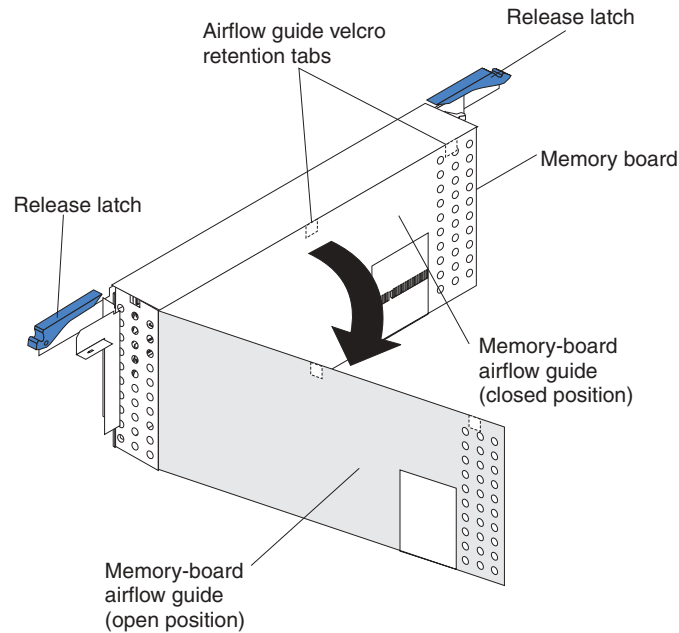

6. Locate the DIMM connectors on the memory board. Determine the DIMM connectors into which you will install the DIMMs. For more information, see the notes at the beginning of this procedure.

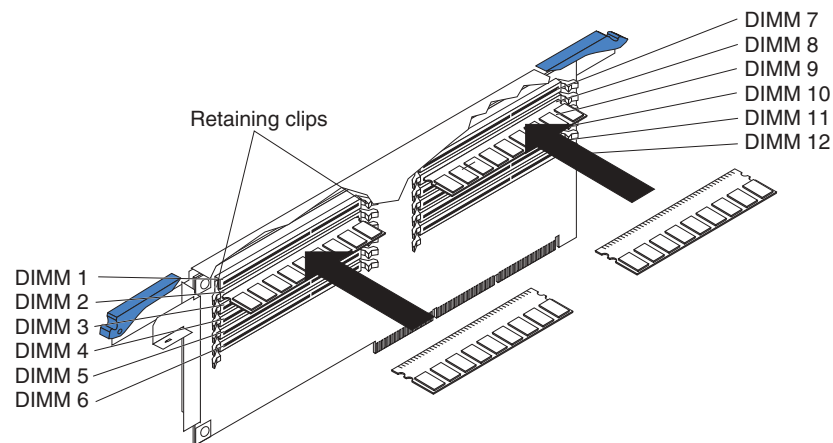

7. Open the retaining clips located on the ends of the DIMM connector, if necessary.
Attention: To avoid breaking the retaining clips or damaging the DIMM connectors, handle the clips gently.
8. Touch the static-protective package that contains the DIMM option to any unpainted metal surface on the server. Then, remove the DIMM from the package.
9. Turn the DIMM so that the DIMM keys align correctly with the connector. The DIMM can be inserted only one way.
10. Insert the DIMM by pressing the DIMM straight into the connector. Be sure that the retaining clips snap into the closed positions.

11. Make sure that the retaining clips are in the closed position. If a gap exists between the DIMM and the retaining clips, the DIMM has not been properly installed. In this case, open the retaining clips and remove the DIMM; then, reinsert the DIMM.
12. Repeat steps 6 through 11 for each additional DIMM that you install.
13. Close the memory-board airflow guide and press the Velcro tabs together to secure the airflow guide to the memory-board assembly.

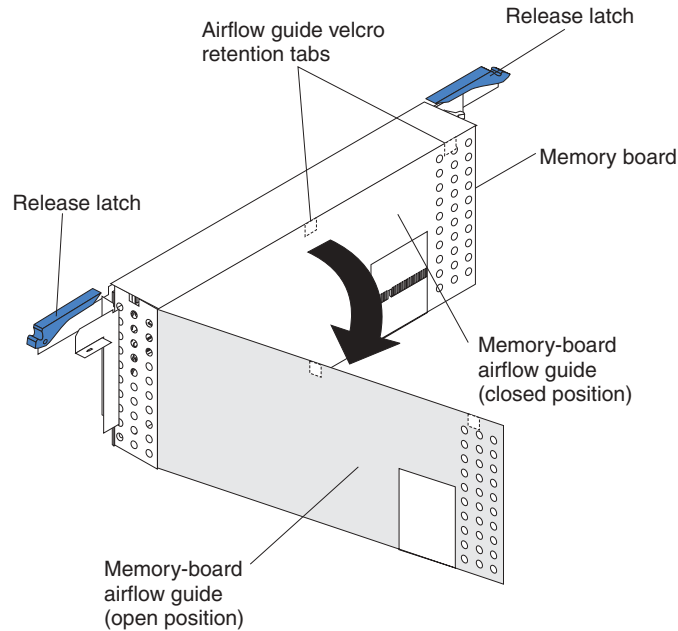

14. Reinstall the memory-board assembly:
 - a. Make sure that the release latches are in the open position before you install the memory-board assembly in the server.
 - b. Align the memory-board assembly into the card guides and over the memory-board connector.
 - c. Align the holes on each side of the memory-board bracket over the corresponding alignment pins on the chassis; then, slide the memory-board bracket over the alignment pins.

Note: The alignment pins are located near the release latches. The left alignment pin is located between the air baffle and the center internal fans. The right alignment pin is located between the air baffle and the rear internal fans and the adapter slots.
 - d. Close (to the locked position) the release latches to seat the memory board in the connector.

Note: To ensure proper server operation, make sure that the memory-board airflow guide is in the closed position.
 - e. Firmly press the memory-board assembly down into the connector until it snaps into place. This secures the memory board in the server.
15. Reinstall the air baffle:
 - a. Align and insert the two tabs on the rear of the air baffle into the corresponding slots on the rear of the server.
 - b. Align the hole on the front of the air baffle over the corresponding alignment pin on the chassis; then, lower the air baffle into place.

- Note:** The alignment pin is located near the plastic fastener behind fan 1.
- c. Press firmly on the two plastic fasteners until they snap into place on the front of the air baffle. This secures the air baffle in the server.
16. If you have other options to install or remove, do so now; otherwise, go to “Completing the installation” on page 68.

Note: When you restart the server, the system displays a message indicating that the memory configuration has changed.

- If you installed additional memory, the Configuration/Setup Utility program automatically saves the new configuration information.
- If you just replaced a failed DIMM, you must start the Configuration/Setup Utility program, select **Advanced Setup**, select **Memory Settings**, highlight the DIMM or pair or quad of DIMMs that you want to enable, and then select **Enable**. See the *User's Guide* on the *IBM xSeries Documentation* CD for more information about the Configuration/Setup Utility program.
- In some memory configurations, the 3-3-3 beep code might sound during POST followed by a blank display screen. If this occurs and the Boot Fail Count feature in the **Start Options** menu of the Configuration/Setup Utility program is set to **Enabled** (its default setting), you must restart the server three times to force the system BIOS to reset the DIMM or pair or quad of DIMMs from **Disabled** to **Enabled**.

If this procedure does not enable the DIMMs, either the memory board or at least one DIMM is improperly seated, or a memory component has failed. Verify that the memory board and all the DIMMs are properly seated. If the memory board or a DIMM is improperly seated, remove and correctly reinstall it. If all of these components are properly seated, check the memory-board VRM LED on the system board (see “System-board LED locations” on page 9 for the LED location). If the memory-board VRM LED is on or the problem remains, call for service.

Installing an additional microprocessor

Your server comes with one microprocessor installed on the system board. Your server supports up to four microprocessors. If you install at least one additional microprocessor, your server can operate as a symmetric multiprocessing (SMP) server. With SMP, certain operating systems and application programs can distribute the processing load among the microprocessors.

Before you begin:

- Review the information beginning with “Before you begin” on page 13 through “Handling static-sensitive devices” on page 14.
- Thoroughly review the documentation that comes with the microprocessor, so that you can determine whether you need to update the server BIOS code. The latest level of BIOS code for your server is available through the World Wide Web. See the *User’s Guide* on the *IBM xSeries Documentation* CD for the World Wide Web addresses.
- (Optional) Obtain an SMP-capable operating system. For a list of supported operating systems, go to <http://www.ibm.com/pc/us/compat/> on the World Wide Web.

Attention: To avoid damage and ensure proper server operation when you install an additional microprocessor, use microprocessors that have the same cache size and type, and the same clock speed. Microprocessor internal and external clock frequencies must be identical.

Notes:

1. To order additional microprocessor options, contact your IBM reseller or IBM marketing representative.
2. When you install an additional microprocessor, you must also install the voltage regulator module (VRM) that comes with the microprocessor in the corresponding VRM connector.
A VRM metal retaining-clip housing comes installed in the empty microprocessor VRM connectors for microprocessors 3 and 4. When you install a VRM in connector 3 or 4, you must first remove the VRM metal retaining-clip housing from the appropriate VRM connector. You must also remove the metal retaining clip from the VRM metal retaining-clip housing when installing a VRM.
3. Your server comes with one microprocessor installed in microprocessor socket 1 (labeled CPU1) on the system board. The microprocessor in socket 1 is the startup (boot) microprocessor. If more than one microprocessor is installed, the microprocessor installed in the highest-numbered socket is the microprocessor from which the server will start. Therefore, the microprocessors installed in the lowest-numbered sockets are used as application microprocessors.
4. The microprocessor sockets in this server contain built-in termination for the microprocessor bus; therefore, terminator cards are not required for empty microprocessor sockets. However, each empty microprocessor socket contains a protective, flat plastic cover that you must remove before you install a microprocessor in these sockets.
5. To ensure proper server operation, microprocessor socket 4 contains a plastic microprocessor baffle that resembles a heat sink. You must remove the microprocessor baffle when you install a microprocessor in socket 4. Otherwise, the microprocessor baffle must remain in place to ensure proper airflow in your server.

If you need to install additional microprocessors and VRMs, install them in the order listed in Table 4. The corresponding VRM connector is located adjacent to the microprocessor socket.

Important: If you do not install the microprocessors in the correct order, the server will not operate properly.

Table 4. Microprocessor and VRM installation order

Microprocessor number	Microprocessor socket label	VRM connector
1 (standard)	CPU1	J34 (standard, plastic retaining clip provided on VRM housing)
2	CPU2	J35 (plastic retaining clip provided on VRM housing)
3	CPU3	J36 (standard, metal retaining clip provided on VRM housing)
4	CPU4	J37 (standard, metal retaining clip provided on VRM housing)

The following illustration is a layout of the microprocessor socket locations and other microprocessor-related components on the system board.

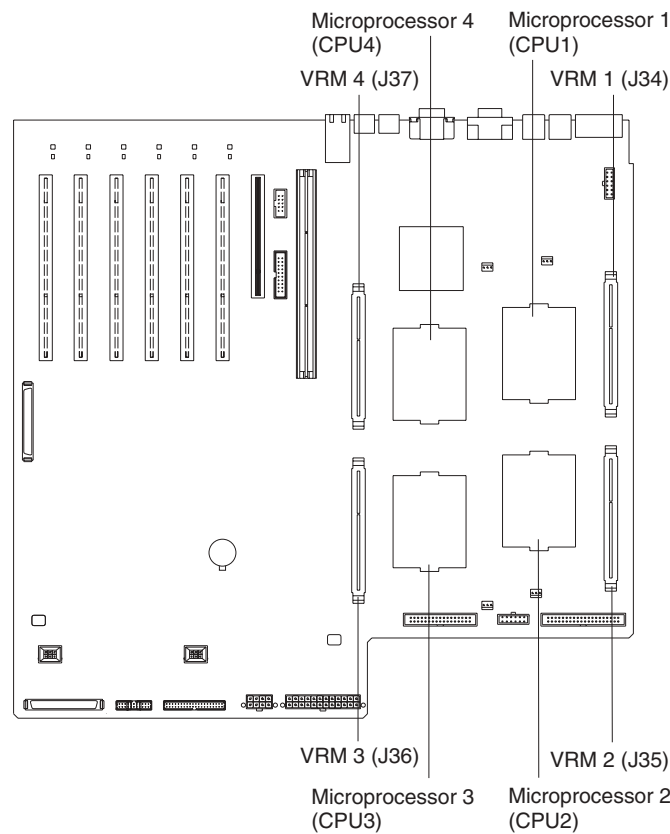

Note: For additional illustrations of the system-board components, see “System-board option connectors” on page 4.

The following illustration shows how to install an additional microprocessor on the system board.

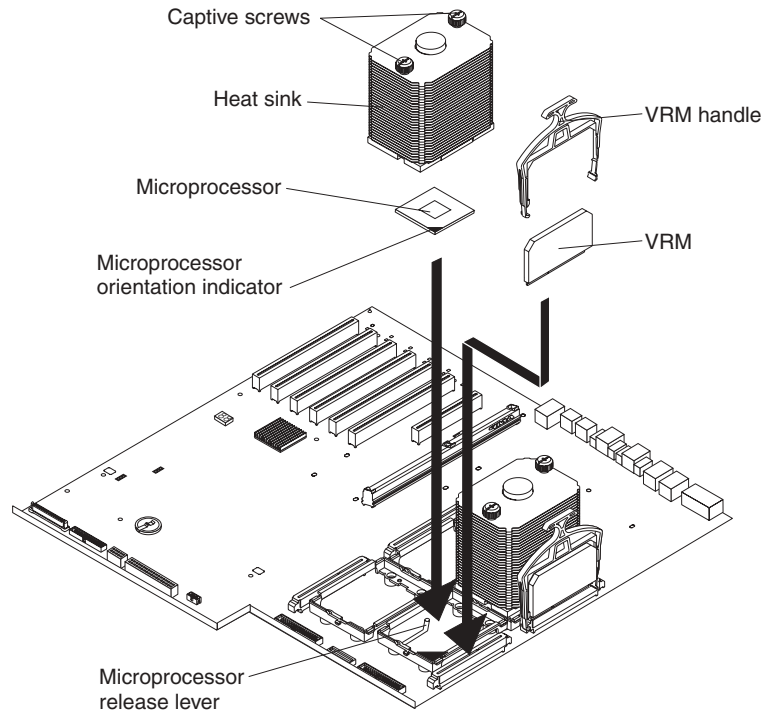

Complete the following steps to install an additional microprocessor.

Attention: When you handle static-sensitive devices, take precautions to avoid damage from static electricity. For details about handling these devices, see “Handling static-sensitive devices” on page 14.

1. Review the information beginning with “Before you begin” on page 13 through “Handling static-sensitive devices” on page 14.
2. Turn off the server and disconnect all power cords and external cables; then, remove the server cover (see “Removing the top cover and bezel” on page 15).

3. Remove the air baffle:
 - a. Pull out the two plastic fasteners on the front of the air baffle.

Note: Do not remove the fasteners from the air baffle.

 - b. Grasp the handle on the air baffle; then, lift the air baffle from the server.

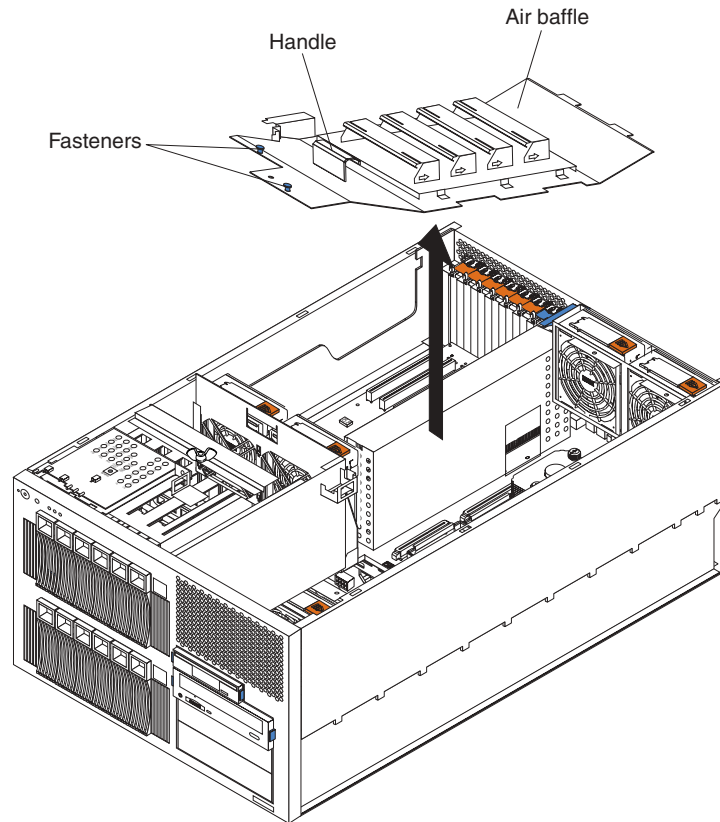

4. Determine the socket where the microprocessor is to be installed.
5. Install a VRM in the corresponding VRM connector (see Table 4 on page 55 for locations):
 - a. If you are installing a VRM for microprocessor 3 or 4, remove the memory-board assembly:
 - 1) Open the release latches located on both ends of the memory-board assembly.
 - 2) Lift up on the memory-board assembly and remove it from the server.

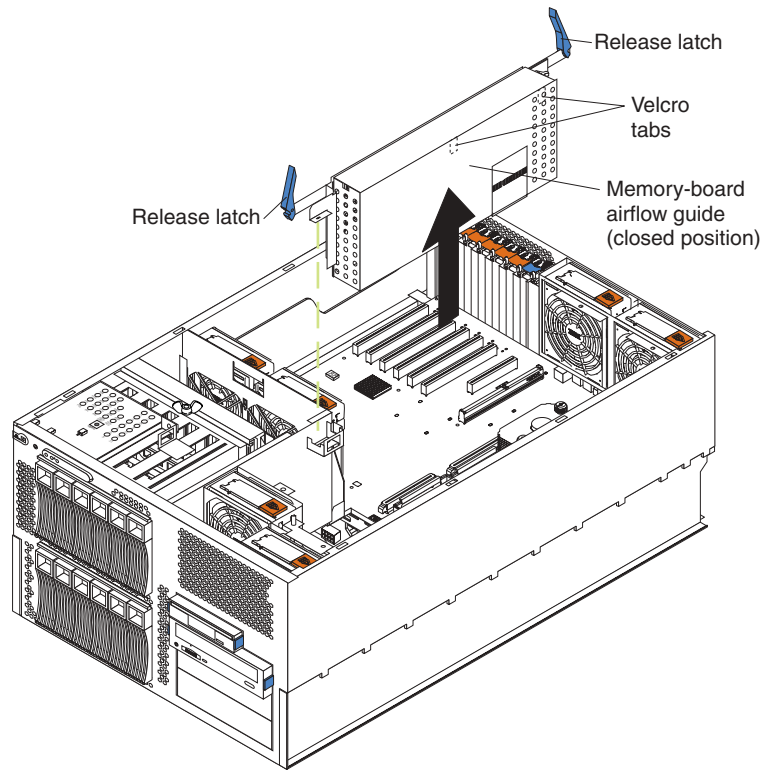

- 3) Place the memory-board assembly on a static-protective surface.
 - b. Touch the static-protective package containing the new VRM to any *unpainted* metal surface on the server; then, remove the VRM from the package.
 - c. Attach the retainer clip to the VRM:
 - If you are installing a VRM for microprocessor 1 or 2, remove the plastic retainer clip from the package; then, attach the top of the plastic retainer clip to the top of the VRM.

Note: Do not attach the plastic retainer clip to the VRM for microprocessor 3 or 4.

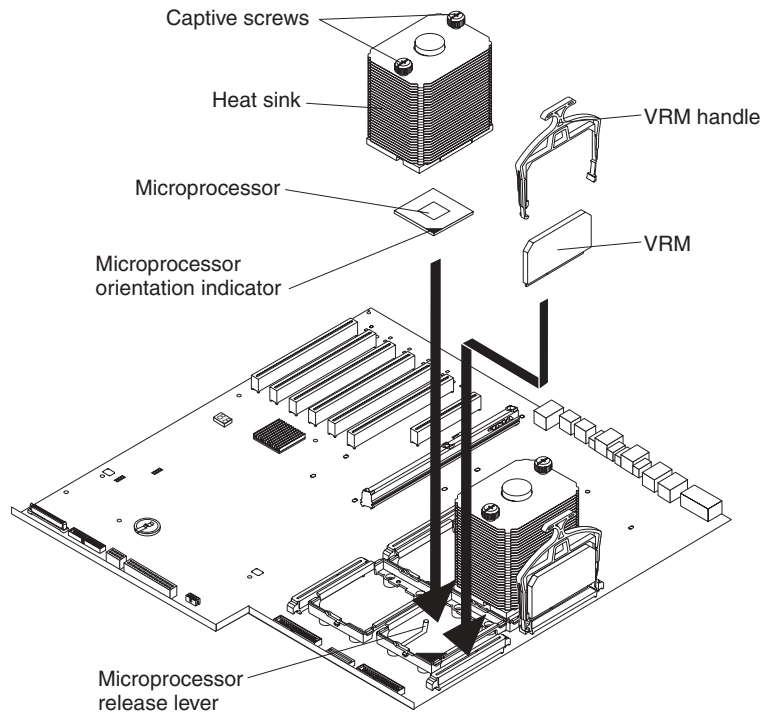

- If you are installing a VRM for microprocessor 3 or 4, remove the metal retainer clip from the corresponding VRM baffle. Then, remove the plastic VRM baffle from the appropriate VRM connector. Attach the top of the metal retainer clip to the top of the VRM.

Note: The locations of the microprocessor-release lever and microprocessor orientation indicator might vary depending on the location of the microprocessor socket.

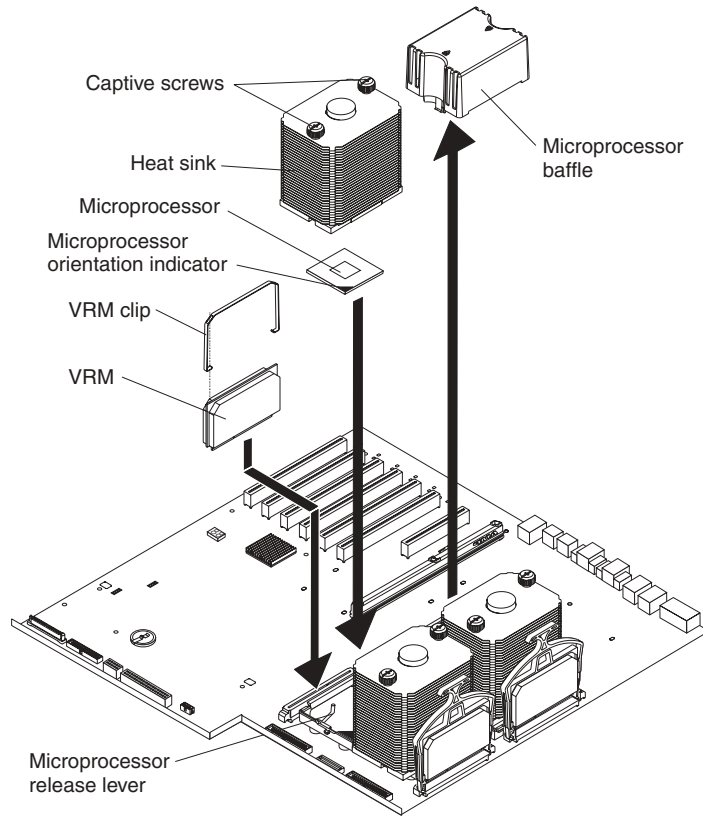

- d. Center the VRM over the connector. Make sure that the VRM is oriented and aligned correctly. The bottom edge of the VRM is keyed and can be inserted only one way.
 - e. Carefully but firmly push down the VRM to seat the VRM in the connector. Be sure that the bottom sides of the retainer clip snap into place on the sides of the connector.
6. Remove the flat, plastic cover from the empty microprocessor socket.
If you are installing a microprocessor in socket 4, remove the plastic microprocessor baffle from socket 4. Store the plastic microprocessor baffle in a safe place. If you remove the microprocessor and heat sink from socket 4, you must reinstall the microprocessor baffle in that socket.
7. Install the microprocessor:
 - a. Touch the static-protective package containing the new microprocessor to any *unpainted* metal surface on the server; then, remove the microprocessor from the package.
 - b. Pull out and lift up on the microprocessor-release lever to unlock the microprocessor socket.

Note: The locations of the microprocessor-release lever and microprocessor orientation indicator might vary depending on the location of the microprocessor socket.

 - c. Center the microprocessor over the microprocessor socket. Carefully press the microprocessor into the socket.

Attention:

- Do not use excessive force when pressing the microprocessor into the socket.
 - Make sure that the microprocessor is oriented and aligned correctly with pin number 1 in the socket before you try to close the lever.
- d. Carefully close the lever to secure the microprocessor in the socket.
8. If you installed a VRM for microprocessor 3 or 4, reinstall the memory-board assembly:

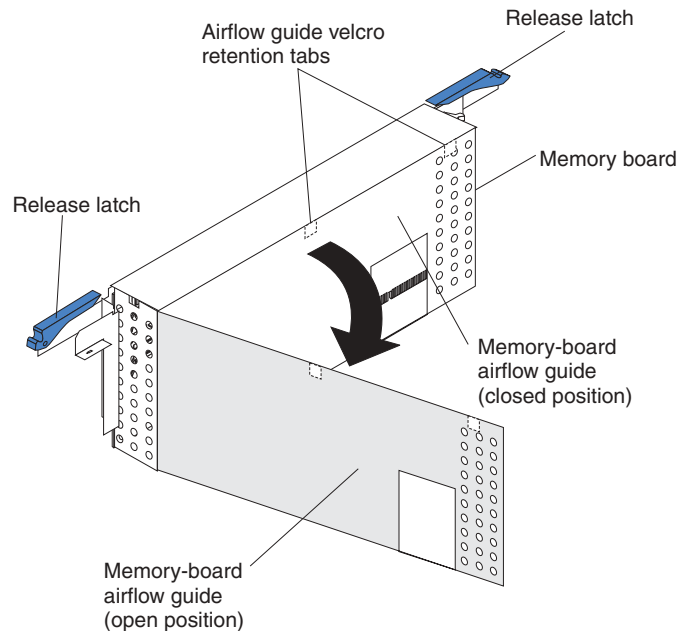

- a. Align the memory-board assembly into the card guides and over the memory-board connector.
- b. Align the holes on each side of the memory-board bracket over the corresponding alignment pins on the chassis; then, slide the memory-board bracket over the alignment pins.

Note: The alignment pins are located near the release latches. The left alignment pin is located between the air baffle and the center internal fans. The right alignment pin is located between the air baffle and the rear internal fans and the adapter slots.

- c. Close (to the locked position) the release latches to seat the memory board in the connector.

Note: To ensure proper server operation, make sure that the memory-board airflow guide is in the closed position.

- d. Firmly press the memory-board assembly down into the connector until it snaps into place. This secures the memory board in the server.
9. Install a heat sink on the microprocessor:
- a. Remove the plastic protective cover from the bottom of the heat sink. Do not touch the bottom of the heat sink or set the heat sink down after you remove the plastic cover. Make sure that the square of thermal material is still on the bottom of the heat sink; if not, the heat sink must be replaced.
- b. Align and place the heat sink on top of the microprocessor in the retention bracket. Press firmly on the heat sink.

- c. Secure the heat sink to the microprocessor. Alternate between the two captive screws in the heat sink while tightening them.

Attention: If you do not alternate the tightening the two captive screws, you might damage the microprocessor. Ensure that the screws are completely tightened; otherwise, the server will not function properly.

10. Reinstall the air baffle:

- a. Align and insert the two tabs on the rear of the air baffle into the corresponding slots on the rear of the server.
- b. Align the hole on the front of the air baffle over the corresponding alignment pin on the chassis; then, lower the air baffle into place.

Note: The alignment pin is located near the plastic fastener behind fan 1.

- c. Press firmly on the two plastic fasteners until they snap into place on the front of the air baffle. This secures the air baffle in the server.
11. If you have other options to install or remove, do so now; otherwise, go to “Completing the installation” on page 68.

Installing a hot-swap power supply

Your server comes with two hot-swap power supplies. These power supplies are located in power-supply bays 1 and 2. You can install two additional power supplies. Your server supports N+N line cords for power redundancy. For example, to ensure power redundancy for a full configuration, four power supplies must be installed in the server, and power cords must be connected to both power-cord connectors.

Note: To show the location of the power-supply bays, the hot-swap fans are not included in this illustration.

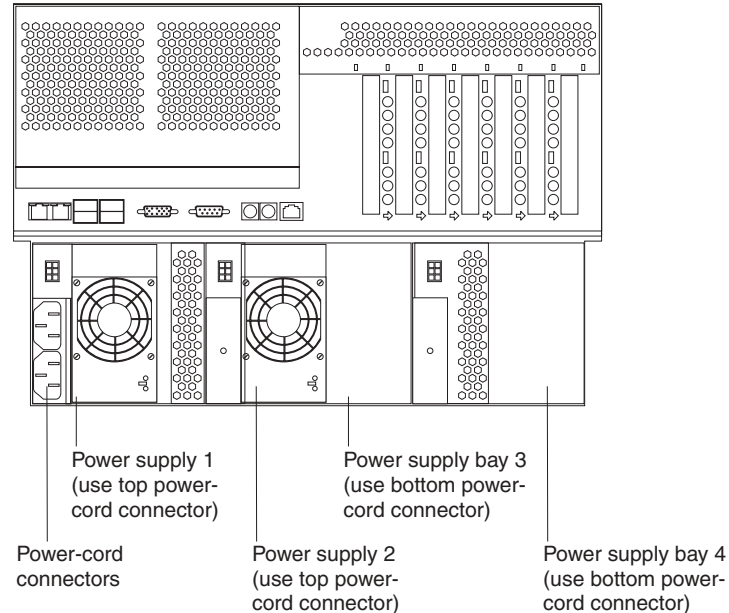

Since the server comes with hot-swap power supplies in power-supply bays 1 and 2, you must plug a power cord into the top power-cord connector. If you install additional power supplies in power-supply bays 3 and 4, you must also plug a power cord into the bottom power-cord connector. Depending on the number of power supplies installed in your server, plug one or two power cords into the corresponding connectors on the back of the server; then, plug the other end of the power cords into properly grounded electrical outlets.

Before you continue with the power-supply installation procedure, review the following precautions:

Notes:

1. To ensure proper cooling and server operation, power-supply bays 1 and 2 must have a power supply installed at all times.
2. The external fans (fans 7 through 9) are located in front of the power supplies. During normal operation, each fan bay must have a fan installed for proper cooling. See “Replacing an external fan” on page 67 for an illustration of the external fan bays.

Statement 8:



CAUTION:

Never remove the cover on a power supply or any part that has the following label attached.



Hazardous voltage, current, and energy levels are present inside any component that has this label attached. There are no serviceable parts inside these components. If you suspect a problem with one of these parts, contact a service technician.

Statement 6:



CAUTION:

If you install a strain-relief bracket option over the end of the power cord that is connected to the device, you must connect the other end of the power cord to an easily accessible power source.

Complete the following steps to install an additional power supply:

1. Review the information beginning with “Before you begin” on page 13 through “Handling static-sensitive devices” on page 14.
2. Select the power-supply bay in which you want to install the power supply.
3. Remove the fan assembly that covers the power-supply bay (see “Replacing a hot-swap fan” on page 66).
4. Move the handle on the power supply to the up (open) position.
5. Slide the power supply into the chassis, and lower (close) the handle.

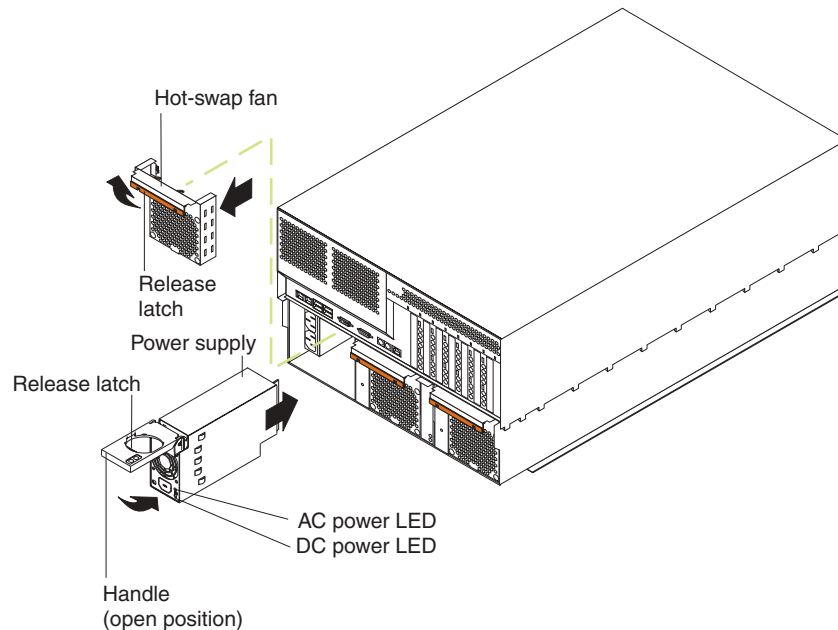

6. Depending on the number of power supplies installed in your server, plug one or two power cords into the corresponding connectors on the back of the server; then, plug the other end of the power cords into properly grounded electrical outlets. Power supplies 1 and 2 (PS1 and PS2, respectively) are connected to the top power-cord connector. Power supplies 3 and 4 (PS3 and PS4, respectively) are connected to the bottom power-cord connector.
7. If the server is not on, turn on the server.
8. Verify that the dc power LED and the ac power LED on the power supply are lit, indicating that the power supply is operating properly.
9. Reinstall the fan assembly in front of the power-supply bay.

Replacing a hot-swap fan

Your server comes with nine hot-swap fans: six internal and three external. The internal fans consist of the front, center, and top rear fans. The front fans (1 and 2) are located inside the server in front of the air baffle, the top rear fans (fans 3 and 4) are located inside the server at the rear of the air baffle, and the center fans (fans 5 and 6) are located inside the server near the adapters. The external fans (fans 7 through 9) are located on the outside of the server in front of the power supplies. When a fan has failed or is operating slowly, the amber LED illuminates on that fan. You do not need to turn off the power to the server to replace a hot-swap fan.

Attention: During normal operation, each fan bay must have a fan installed for proper cooling. If a fan fails, replace it as soon as possible to maintain and ensure proper cooling.

Complete the following steps to replace a hot-swap fan. The internal fans (front, center, and top rear) are installed differently from the external fans (bottom rear). This section contains separate instructions for each group of fans.

Replacing an internal fan

If you are replacing one of the internal fans (fans 1 through 6):

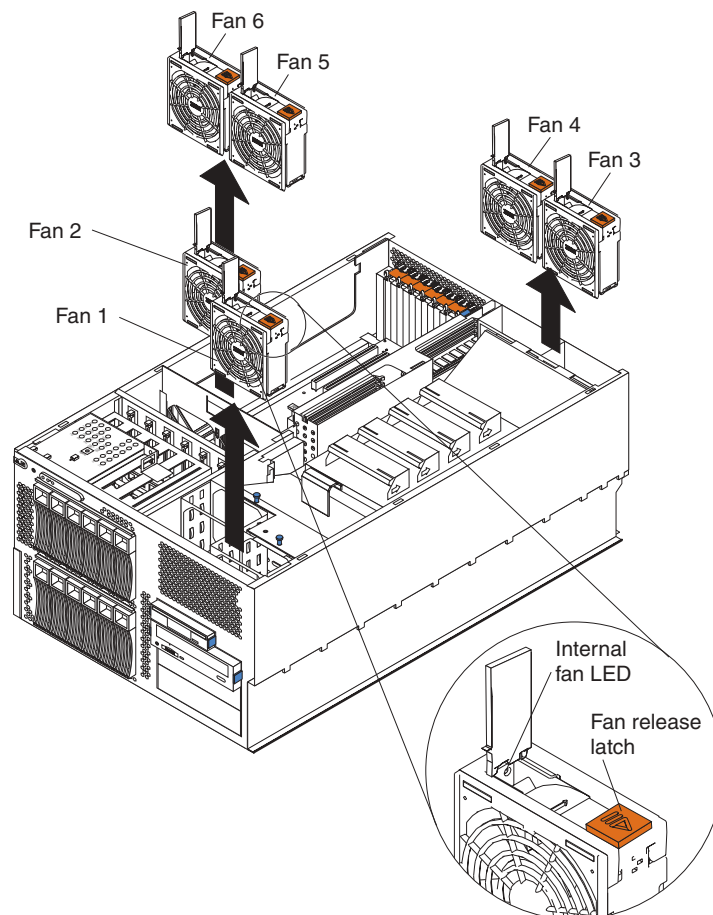

1. Remove the server cover (see “Removing the top cover and bezel” on page 15).
Attention: To ensure proper system cooling, do not leave the top cover off the server for more than 30 minutes.
2. Press the fan-release latch in the direction indicated by the arrow on the latch. This moves the fan handle to the open position.
3. Grasp the fan handle and lift the fan out of the server.
4. Slide the replacement fan into the fan connector until it snaps into place.
5. Press the fan handle down until it snaps into place.
6. Reinstall the server cover (see “Installing the top cover and bezel” on page 68).

Replacing an external fan

If you are replacing one of the three external fans (fans 7 through 9):

Attention: Fan bay 8 is a different size from fan bays 7 and 9; therefore, the fan assembly in bay 8 is not interchangeable with the fan assemblies in bays 7 and 9. Be sure to install the correct replacement fan assembly into the corresponding fan bay.

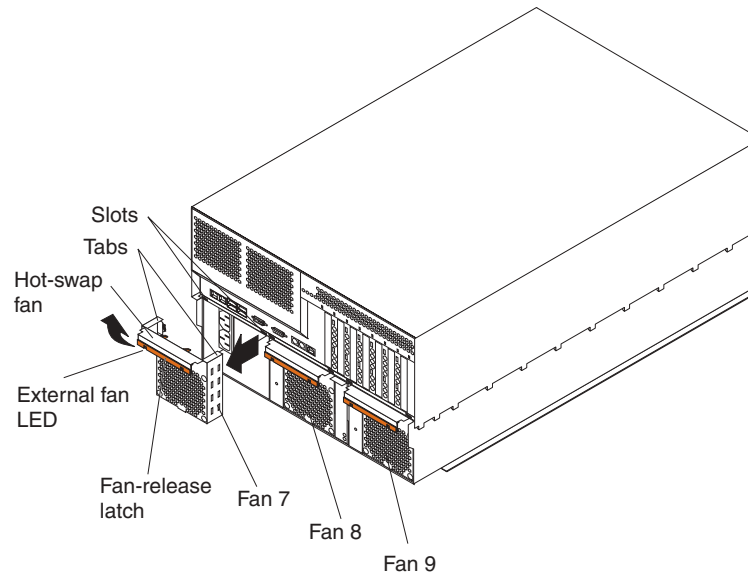

1. Firmly grasp the fan-release latch; then, press and hold the fan-release latch while pulling the fan assembly out of the server.
2. Align the tabs on the replacement fan assembly with the corresponding slots on the fan bay; then, slide the tabs into the slots.

Completing the installation

To complete your installation, you must reinstall the server cover, reinstall the bezel, reconnect all the cables that you disconnected earlier and, for certain options, run the Configuration/Setup Utility program. Follow the instructions in this section.

Attention: To maintain proper cooling and airflow, install the server cover before turning on the server. Operating the server for extended periods of time (over 30 minutes) with the server cover removed might damage server components.

Note: If you have just plugged the power cords of your server into an electrical outlet, you will have to wait approximately 20 seconds before pressing the power-control button.

Installing the top cover and bezel

Installing the top cover (all models)

Complete the following steps to install the server top cover:

1. Check that all cables, adapters, and other components are installed and seated correctly and that you have not left loose tools or parts inside the server.

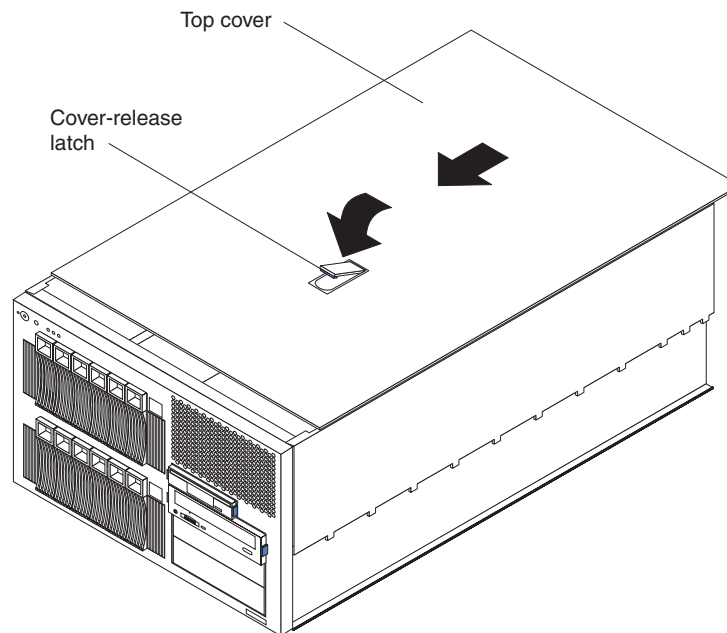

2. Move the cover-release latch to the open (up) position.
3. Insert the bottom tabs of the cover into the matching slots in the server chassis.
4. Close the cover-release latch to pull the cover forward and lock the cover in place.
5. If you disconnected any cables from the back of the server, reconnect the cables; then, plug the power cords into properly grounded electrical outlets.

Note: If necessary, see Chapter 3, “Input/output ports and connectors”, on page 75 for connector locations.

Installing the bezel (tower model)

Complete the following steps to install the tower model bezel:

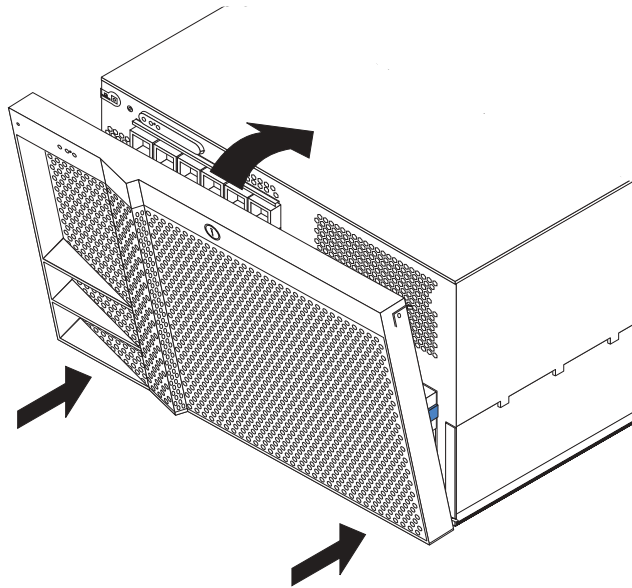

1. Insert the two tabs on the bottom of the bezel into the matching holes on the server chassis.
2. Push the top of the bezel toward the server until the two release latches at the top of the bezel snap into place.
3. Lock the bezel.

Installing the bezel (rack model)

Complete the following steps to install the rack model bezel:

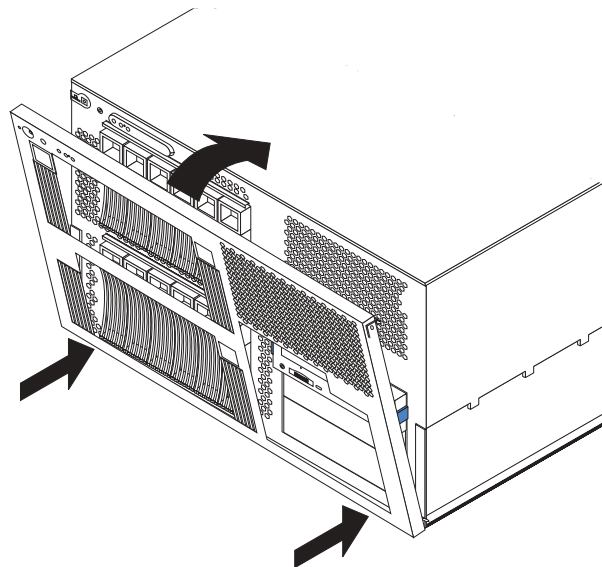

1. Insert the two tabs on the bottom of the bezel into the matching holes on the server chassis.
2. Push the top of the bezel toward the server until the two release latches at the top of the bezel snap into place.

Updating your server configuration

When you start your server for the first time after you add or remove an internal option or an external SCSI device, you might see a message telling you that the configuration has changed. The Configuration/Setup Utility program automatically saves the new configuration information. See the *User's Guide* on the *IBM xSeries Documentation* CD for information about the Configuration/Setup Utility program.

Some options have device drivers that you need to install. See the documentation that comes with your option for information about installing any required device drivers.

Your server comes with at least one microprocessor installed on the system board. If you have installed one or more additional microprocessors, your server can now operate as an SMP server. Therefore, you might need to upgrade your operating system to support SMP. See the *User's Guide* on the *IBM xSeries Documentation* CD and your operating-system documentation for additional information.

If your server has a RAID adapter installed and you have installed or removed a hard disk drive, see the documentation that comes with your RAID adapter for information about reconfiguring your disk arrays.

Connecting external options

If you attach an external SCSI cable to the external SCSI connector (J14) on the system board, you can attach additional external options to the rear of your server. You can also use a SCSI storage expansion enclosure to attach additional external devices to your server. For a list of supported options for your server, go to <http://www.ibm.com/pc/us/compat/> on the World Wide Web.

If you plan to attach external SCSI devices, you must order additional SCSI cables. To select and order the correct cables for use with external devices, contact your IBM reseller or IBM marketing representative.

Complete the following steps to attach an external device:

1. Review the information beginning with "Before you begin" on page 13 through "Handling static-sensitive devices" on page 14, and read the documentation that comes with your options.
2. Turn off the server and all attached devices; then, disconnect all power cords and external cables.
Attention: To ensure proper system cooling, do not leave the top cover off the server for more than 30 minutes.
3. Remove the server cover (see "Removing the top cover and bezel" on page 15).
4. Remove the knockout on the rear of the server (see Chapter 3, "Input/output ports and connectors", on page 75 for the location of the knockout connector).
5. Follow the instructions that come with the option to prepare it for installation and to connect it to the server.
6. Route one end of the optional external SCSI cable to the external SCSI A connector (J14) on the system board. Attach the other end of the cable to the knockout device connector.
7. Reinstall the server cover (see "Installing the top cover and bezel" on page 68).
8. Reconnect all the devices, cables, and power cords that you disconnected; then, turn on the server and all attached devices.

SCSI cabling requirements

For information about the maximum length of SCSI cable, see the American National Standards Institute (ANSI) SCSI standards on the ANSI Web site at <http://www.ansi.org/> on the World Wide Web. Adhering to these standards will help to ensure that your server operates properly.

When you attach a SCSI device to the external SCSI connector, you must set a unique ID for the device. See the information that is provided with the device for instructions to set its SCSI ID. See “Setting SCSI IDs” on page 77 for additional information about SCSI IDs.

Replacing the battery

IBM has designed this product with your safety in mind. The lithium battery must be handled correctly to avoid possible danger. If you replace the battery, you must adhere to the following instructions.

Note: In the U. S., call 1-800-IBM-4333 for information about battery disposal.

If you replace the original lithium battery with a heavy-metal battery or a battery with heavy-metal components, be aware of the following environmental consideration. Batteries and accumulators that contain heavy metals must not be disposed of with normal domestic waste. They will be taken back free of charge by the manufacturer, distributor, or representative, to be recycled or disposed of in a proper manner.

To order replacement batteries, call 1-800-772-2227 within the United States, and 1-800-465-7999 or 1-800-465-6666 within Canada. Outside the U.S. and Canada, call your IBM reseller or IBM marketing representative.

Note: After you replace the battery, you must reconfigure your server and reset the system date and time.

Statement 2:



CAUTION:

When replacing the lithium battery, use only IBM Part Number 33F8354 or an equivalent type battery recommended by the manufacturer. If your system has a module containing a lithium battery, replace it only with the same module type made by the same manufacturer. The battery contains lithium and can explode if not properly used, handled, or disposed of.

Do not:

- **Throw or immerse into water**
- **Heat to more than 100°C (212°F)**
- **Repair or disassemble**

Dispose of the battery as required by local ordinances or regulations.

Complete the following steps to replace the battery:

1. Review the information beginning with “Before you begin” on page 13 through “Handling static-sensitive devices” on page 14.
2. Follow any special handling and installation instructions supplied with the battery.
3. Turn off the server and all attached devices and disconnect all power cords and external cables; then, remove the server cover (see “Removing the top cover and bezel” on page 15).
4. Disconnect any internal cables as necessary, so that you can access the battery.
5. If the server does not contain any full-length adapters, continue with the next step.

If the server contains a full-length adapter in PCI-X slot 2 or 3, you must remove it. Move the adapter locking lever to the unlocked (open) position on the adapter-support bracket as indicated by the arrows. Then, remove the adapters. See “Working with adapters” on page 17 for additional information about adapters.

6. Locate the battery (connector BH1) on the system board.

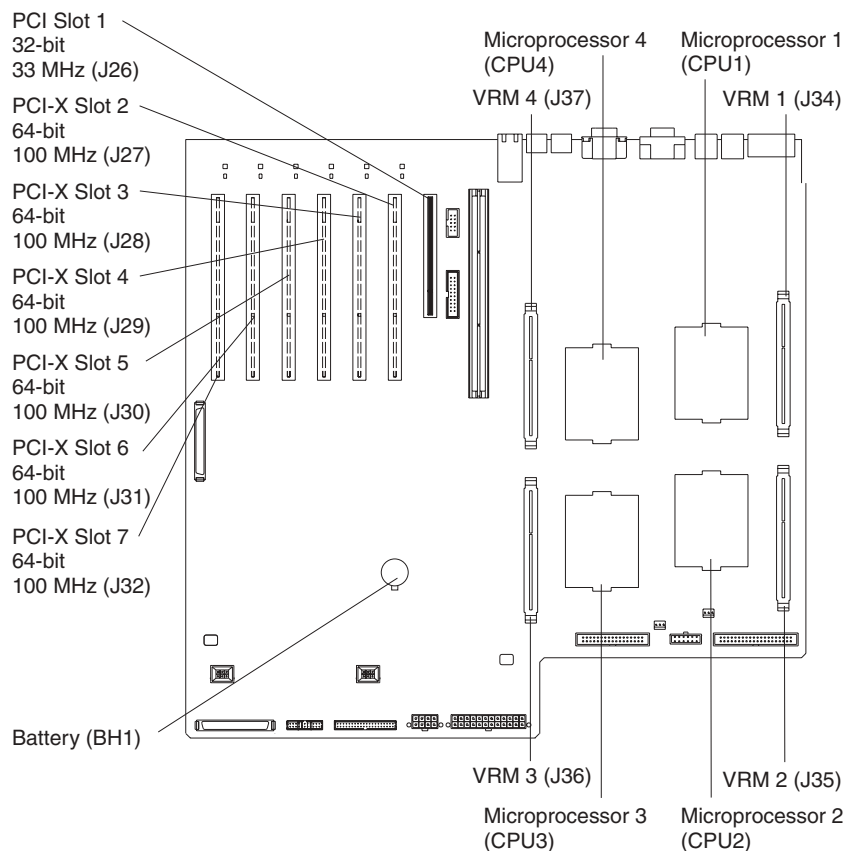

7. Remove the battery:
 - a. Use one finger to slightly slide the battery toward the rear of the server away from the back of the server. The spring mechanism behind the battery will push it out toward you as you slide it toward the rear.
 - b. Use your thumb and index finger to pull the battery from under the battery clip.
 - c. Ensure that the battery clip is touching the base of the battery socket by pressing gently on the clip.

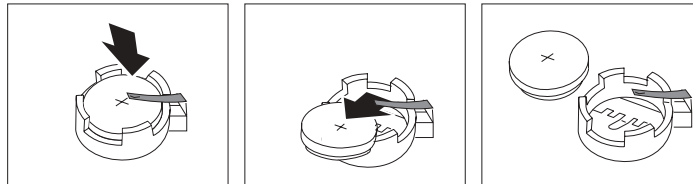

8. Insert the new battery:
 - a. Tilt the battery so that you can insert it into the front of the socket, under the battery clip.
 - b. As you slide it under the battery clip, press the battery down into the socket.

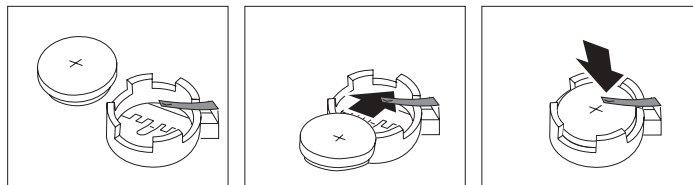

9. If you did not remove any full-length adapters, continue with the next step. If you removed any full-length adapters, you must reinstall the adapters. Move the adapter locking lever to the locked (closed) position on the adapter-support bracket. See “Working with adapters” on page 17 for additional information about adapters.
 10. Reconnect the internal cables that you disconnected.
 11. Reinstall the server cover (see “Installing the top cover and bezel” on page 68).
- Note:** You must wait approximately 20 seconds after you plug the power cord of your server into an electrical outlet before the power-control button becomes active.
12. Reconnect all external cables and power cords that you disconnected; then, turn on the server and all attached devices.
 13. Start the Configuration/Setup Utility program and set configuration parameters as needed. See the *User's Guide* for information about the Configuration/Setup Utility program.

Chapter 3. Input/output ports and connectors

This section provides information about the input/output (I/O) connectors on the rear of your server. These connectors include the following:

- One video port
- One keyboard port
- One auxiliary-device (pointing device) port
- One serial port
- Four Universal Serial Bus (USB) ports
- One Ethernet port
- Two ISMP (RS-485) ports

The server system board contains two Ultra160 SCSI connectors. See “System-board internal cable connectors” on page 5 for the SCSI connector locations.

The following illustration shows the I/O ports on the rear of your server.

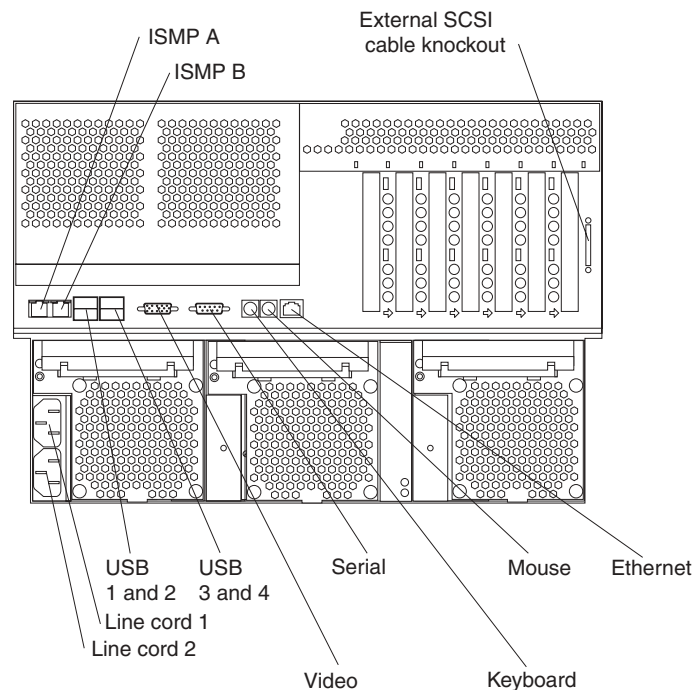

Notes:

1. The ISMP ports (ISMP A and B) are dedicated for use by the system-management subsystem. The ISMP ports are used for the RS-485 interconnect network communications. These ports become inactive if you install an optional IBM Remote Supervisor Adapter in this server. If you install an optional IBM Remote Supervisor Adapter in this server, you must use the RJ-45 connector on the adapter for interconnect network communications.
2. For more information about line cords and power supplies, see “Installing a hot-swap power supply” on page 63.

Video port

Your server comes with an integrated super video graphics array (SVGA) video controller. This controller is not removable, but you can disable it by installing a PCI video adapter.

Note: If you install a PCI video adapter, the server BIOS will automatically disable the integrated video controller.

The integrated video controller is located on PCI bus A (slot 1) on the system board. See “Adapter considerations” on page 18 for detailed information about the PCI buses in your server.

The following illustration shows the pin-number assignments for the 15-pin analog video connector on the rear of your server.

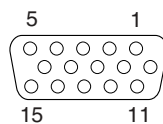

Keyboard port

There is one keyboard port on the rear of your server.

Note: If you attach a standard (non-USB) keyboard to the keyboard port, the USB ports and devices will be disabled during the power-on self-test (POST). You might need to use the Configuration/Setup Utility to Enable keyboardless operation and prevent the POST error message 301 from being displayed during startup. For detailed information about this option and how to connect it to your server, refer to the documentation that comes with the option.

The following illustration shows the pin-number assignments for the keyboard port on the rear of your server.

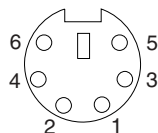

Auxiliary-device (pointing device) port

The system board has one auxiliary-device port that supports a mouse or other pointing device.

The following illustration shows the pin-number assignments for the auxiliary-device port on the rear of your server.

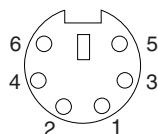

Ultra160 SCSI connectors

Your server has an integrated dual-channel Ultra160 small computer system interface (SCSI) controller. This controller supports two independent Ultra 160/m SCSI channels: one internal and one external. Each channel supports up to 16 SCSI devices. In addition, this controller uses:

- Double-transition clocking to achieve high transfer rates
- Domain-name validation to negotiate compatible data-transfer speeds with each device
- Cyclic redundancy checking (CRC), instead of parity checking, to significantly improve data reliability
- An active terminator on the system board for SCSI bus termination

The integrated SCSI controller is located on PCI bus A (slot 1) on the system board. See “Adapter considerations” on page 18 for detailed information about the PCI buses in your server.

The server comes with one SCSI cable. This cable connects the internal SCSI channel connector (J15) to the standard hot-swap-drive backplane. If you want to use the external SCSI channel connector (J14) to connect external SCSI devices to the server, you must remove the knockout on the rear of the server and install an optional external SCSI cable.

Note: If you install a PCI RAID adapter to configure and manage the internal hot-swap drives, you must move the SCSI cable from the system-board SCSI connector to an internal channel connector on the RAID adapter. See “Cabling a RAID or SCSI adapter” on page 22 for additional information.

Setting SCSI IDs

Each SCSI device that is connected to a SCSI controller must have a unique SCSI ID. This ID enables the SCSI controller to identify the device and ensure that different devices on the same SCSI channel do not attempt to transfer data simultaneously. SCSI devices that are connected to different SCSI channels can have duplicate SCSI IDs. SCSI IDs 6 and 7 are reserved for SCSI controllers. The default ID for the SCSI controller is 7. The hot-swap-drive backplane controls the SCSI IDs for the internal hot-swap drive bays. See “Working with the optional xSeries 6-Pack Hot-Swap Hard Drive Expansion Kit” on page 28 for instructions for installing the 6-Pack option, and “Installing internal drives” on page 37 for instructions for installing hard disk drives.

Table 5 on page 78 lists the SCSI IDs for the standard backplane and the hard disk drives in bays 1 through 6; these devices are connected to the same SCSI channel. In the typical server configuration, the standard backplane and the hard disk drives in bays 1 through 6 are connected to channel B (internal SCSI connector J15 on the system board). Table 6 on page 78 lists the SCSI IDs for the optional backplane and the hard disk drives in bays 7 through 12; these devices are connected to the same SCSI channel. The optional backplane and the hard disk drives in bays 7 through 12 are connected to a channel on a RAID adapter (see “Cabling a RAID or SCSI adapter” on page 22). Note that in Table 5 on page 78 and Table 6 on page 78, the hot-swap hard disk drive bay numbers are from left to right.

Table 5. SCSI IDs for standard backplane, SCSI controller, and hot-swap drives in bays 1 through 6

Device	SCSI ID
Drive bay 1	0
Drive bay 2	1
Drive bay 3	2
Drive bay 4	3
Drive bay 5	4
Drive bay 6	5
SCSI controller	6 or 7 (default)
Backplane	8

Table 6. SCSI IDs for optional backplane, SCSI controller, and hot-swap drives in bays 7 through 12

Device	SCSI ID
SCSI controller	6 or 7 (default)
Backplane	9
Drive bay 7	10
Drive bay 8	11
Drive bay 9	12
Drive bay 10	13
Drive bay 11	14
Drive bay 12	15

SCSI port connectors

The following illustration shows the pin-number assignments for the 68-pin SCSI connectors.

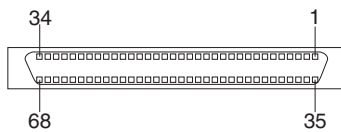

Serial ports

Your server has one standard serial port: serial port A. The operating system and the ISMP cannot use or share serial port A.

Some application programs require specific ports, and some modems function properly only at certain communication port addresses. You might need to use the Configuration/Setup Utility program to change communication port address assignments to prevent or resolve address conflicts.

Viewing or changing the serial-port assignments

To view or change the serial-port assignments:

1. Restart the server and watch the monitor screen.
2. When the message Press F1 for Configuration/Setup appears, press F1.
3. From the main menu, select **Devices and I/O Ports**; then, press Enter.

Note: The **Devices and I/O Ports** choice appears only on the full configuration menu. If you set two levels of passwords, you must type the administrator password to access the full configuration menu.

4. Select the serial port; then, use the arrow keys to advance through the available settings.
5. Select **Save Settings**; then, select **Exit Setup** to exit from the Configuration/Setup Utility main menu.

Serial-port connectors

The following illustration shows the pin-number assignments for the 9-pin, male D-shell serial-port connector on the rear of your server. These pin-number assignments conform to the industry standard.

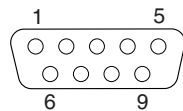

Universal Serial Bus ports

Your server has four Universal Serial Bus (USB) ports, which are configured automatically. USB is a serial interface standard for telephony and multimedia devices. It uses Plug and Play technology to determine the type of device that is attached to the connector.

Notes:

1. If you attach a standard (non-USB) keyboard to the keyboard connector, the USB ports and devices will be disabled during the power-on self-test (POST).
2. If you install a USB keyboard that has a mouse port, the USB keyboard emulates a mouse, and you will not be able to disable the mouse settings in the Configuration/Setup Utility program.
3. Check to make sure that your NOS supports USB devices.
4. For additional information about USB devices, go to <http://www.usb.org/>.

USB cables and hubs

You need a 4-pin cable to connect devices to USB 1, or USB 2, USB3, or USB4. If you plan to attach more than four USB devices, you must use a hub to connect the devices. The hub provides multiple connectors for attaching additional external USB devices.

USB technology provides up to 12 MBps speed with a maximum of 127 external devices and a maximum signal distance of five meters (16 ft) per segment.

USB-port connectors

Each USB port has an external connector on the rear of the server for attaching USB compatible devices.

The following illustration shows the pin-number assignments for the USB ports on the rear of your server.

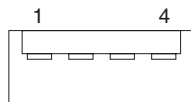

Gigabit Ethernet port

Your server comes with an integrated Gigabit Ethernet controller. This controller provides an interface for connecting to 10-Mbps, 100-Mbps, or 1000-Mbps networks and provides full-duplex (FDX) capability, which enables simultaneous transmission and reception of data on the Ethernet local area network (LAN).

The integrated Ethernet controller is located on PCI bus B (slots 2 and 3) on the system board. See “Adapter considerations” on page 18 for detailed information about the PCI buses in your server.

To access the Ethernet port, connect a Category 3, 4, or 5 unshielded twisted-pair (UTP) cable to the RJ-45 connector on the rear of your server.

Note: The 100BASE-TX/1000BASE-T Fast Ethernet standard requires that the cabling in the network be Category 5 or higher.

The Ethernet (RJ-45) connector has two LEDs. The Ethernet link LED is on the right. When this green LED is on, there is an active connection on the Ethernet port. The Ethernet activity LED is on the left. When this amber LED is on, there is activity between the server and the network. These LEDs have the same functions as the Ethernet link LED and the Ethernet activity LED on the rear of the server (see the *User's Guide* on the *IBM xSeries Documentation* CD for information about the Configuration/Setup Utility program).

Configuring the Gigabit Ethernet controller

The Ethernet controller is integrated on the system board. This controller provides an interface for connecting to 10-Mbps, 100-Mbps, or 1000-Mbps networks and provides full duplex (FDX) capability, which enables simultaneous transmission and reception of data on the Ethernet local area network (LAN). You do not need to set any jumpers or configure the controller for your operating system before you use the Ethernet controller. However, you must install a device driver to enable your

operating system to address the Ethernet controller. The device drivers are provided on the ServerGuide™ *Setup and Installation* CD.

When you connect your server to the network, the Ethernet controller automatically detects the data-transfer rate (10 Mbps, 100 Mbps, or 1000 Mbps) on the network and then sets the controller to operate at the appropriate rate. In addition, if the Ethernet ports that your server is connected to support auto-negotiation, the Gigabit Ethernet controller will set the appropriate duplex state. That is, the Ethernet controller will adjust to the network data rate, whether the data rate is standard Ethernet (10BASE-T), Fast Ethernet (100BASE-TX/1000BASE-T), half duplex (HDX), or full duplex (FDX). The controller supports half-duplex (HDX) and full-duplex (FDX) modes at both speeds.

For information on configuring your Ethernet controller, see the *Broadcom NetXtreme Gigabit Ethernet Software CD* that comes with your server. For updated information about configuring your Ethernet controller, go to the IBM Support Web site at <http://www.ibm.com/pc/support> and navigate to the area for your specific server type. From this area you can download documentation, the most current device drivers for your server, and software that supports advanced networking functions. After downloading, run the downloaded program *launch.exe*.

High-performance Ethernet modes

Your Ethernet controller supports optional modes, such as teaming, priority packets, load balancing, fault tolerance, and virtual LANs, which provide higher performance, security, and throughput for your server. These modes apply to the integrated Ethernet controller and to the controllers on supported Ethernet adapters.

Ethernet port connector

The following illustration shows the pin-number assignments for the RJ-45 port. These assignments apply to the 10BASE-T, 100BASE-TX, and 1000BASE-T devices.

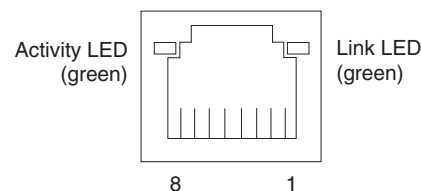

Integrated system management processor (ISMP) interconnect ports

The integrated system management processor (ISMP) ports (ISMP A and B) use a dual RJ-45 connector to interconnect ISMPs of several servers through an optional Remote Supervisor Adapter.

Note: ISMP ports (ISMP A and B) are used for the RS-485 interconnect network communications. These ports become inactive if you install an optional IBM Remote Supervisor Adapter in this server. If you install an optional IBM Remote Supervisor Adapter in this server, you must use the RJ-45 connector on the adapter for interconnect network communications.

Cabling the server

Notes:

1. You must turn off the server before connecting any cables to or disconnecting any cables from the server.
2. See the documentation that comes with your options for additional cabling instructions. It might be easier for you to route cables before you install certain options.
3. Cable identifiers are printed on the cables that come with your server and options. Use these identifiers to connect the cables to the correct connectors. For example, the hard disk drive cables are labeled "HDD option."

The following illustration shows the external cable connectors on the server. Detailed cabling instructions are in the *Rack Installation Instructions* documentation that comes with your server.

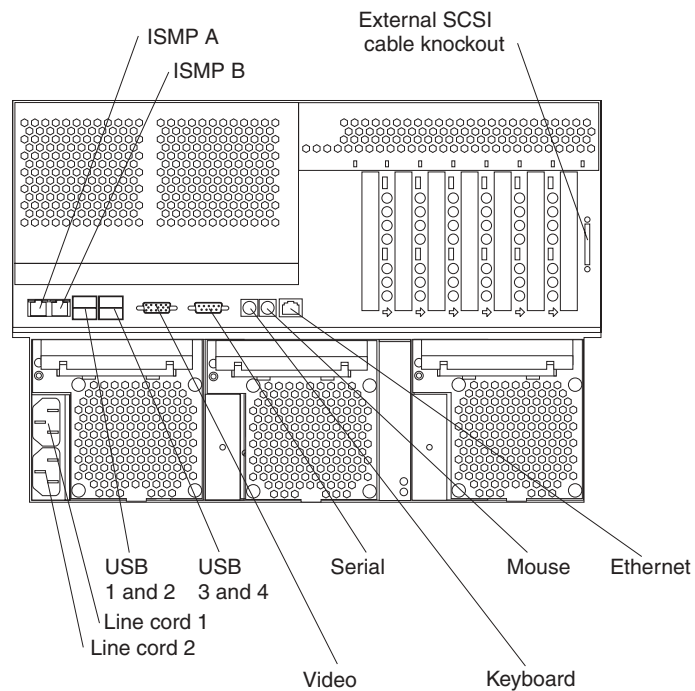

Appendix. Notices

This publication was developed for products and services offered in the U.S.A.

IBM may not offer the products, services, or features discussed in this document in other countries. Consult your local IBM representative for information on the products and services currently available in your area. Any reference to an IBM product, program, or service is not intended to state or imply that only that IBM product, program, or service may be used. Any functionally equivalent product, program, or service that does not infringe any IBM intellectual property right may be used instead. However, it is the user's responsibility to evaluate and verify the operation of any non-IBM product, program, or service.

IBM may have patents or pending patent applications covering subject matter described in this document. The furnishing of this document does not give you any license to these patents. You can send license inquiries, in writing, to:

*IBM Director of Licensing
IBM Corporation
North Castle Drive
Armonk, NY 10504-1785
U.S.A.*

INTERNATIONAL BUSINESS MACHINES CORPORATION PROVIDES THIS PUBLICATION "AS IS" WITHOUT WARRANTY OF ANY KIND, EITHER EXPRESS OR IMPLIED, INCLUDING, BUT NOT LIMITED TO, THE IMPLIED WARRANTIES OF NON-INFRINGEMENT, MERCHANTABILITY OR FITNESS FOR A PARTICULAR PURPOSE. Some jurisdictions do not allow disclaimer of express or implied warranties in certain transactions, therefore, this statement may not apply to you.

This information could include technical inaccuracies or typographical errors. Changes are periodically made to the information herein; these changes will be incorporated in new editions of the publication. IBM may make improvements and/or changes in the product(s) and/or the program(s) described in this publication at any time without notice.

Any references in this publication to non-IBM Web sites are provided for convenience only and do not in any manner serve as an endorsement of those Web sites. The materials at those Web sites are not part of the materials for this IBM product, and use of those Web sites is at your own risk.

IBM may use or distribute any of the information you supply in any way it believes appropriate without incurring any obligation to you.

Edition notice

**© COPYRIGHT INTERNATIONAL BUSINESS MACHINES CORPORATION, 2003.
All rights reserved.**

Note to U.S. Government Users — Documentation related to restricted rights — Use, duplication or disclosure is subject to restrictions set forth in GSA ADP Schedule Contract with IBM Corp.

Trademarks

The following terms are trademarks of International Business Machines Corporation in the United States, other countries, or both:

Active Memory	PS/2
Active PCI	ServeRAID
Active PCI-X	ServerGuide
Alert on LAN	ServerProven
C2T Interconnect	TechConnect
Chipkill	Tivoli
EtherJet	Tivoli Enterprise
e-business logo	Update Connector
FlashCopy	Wake on LAN
IBM	XA-32
Light Path Diagnostics	XA-64
NetBAY	X-Architecture
Netfinity	XcelL4
NetView	XpandOnDemand
OS/2 WARP	xSeries
Predictive Failure Analysis	

Lotus, Lotus Notes, and Domino are trademarks of Lotus Development Corporation and/or IBM Corporation in the United States, other countries, or both.

Intel, Celeron, LANDesk, MMX, NetBurst, Pentium, Pentium II Xeon, Pentium III Xeon, and Xeon are trademarks of Intel Corporation in the United States, other countries, or both.

Microsoft, Windows, and Windows NT are trademarks of Microsoft Corporation in the United States, other countries, or both.

UNIX is a registered trademark of The Open Group in the United States and other countries.

Java and all Java-based trademarks and logos are trademarks or registered trademarks of Sun Microsystems, Inc. in the United States, other countries, or both.

Linux is a registered trademark of Linus Torvalds.

Other company, product, or service names may be the trademarks or service marks of others.

Important notes

Processor speeds indicate the internal clock speed of the microprocessor; other factors also affect application performance.

CD-ROM drive speeds list the variable read rate. Actual speeds vary and are often less than the maximum possible.

When referring to processor storage, real and virtual storage, or channel volume, KB stands for approximately 1000 bytes, MB stands for approximately 1 000 000 bytes, and GB stands for approximately 1 000 000 000 bytes.

When referring to hard disk drive capacity or communications volume, MB stands for 1 000 000 bytes, and GB stands for 1 000 000 000 bytes. Total user-accessible capacity may vary depending on operating environments.

Maximum internal hard disk drive capacities assume the replacement of any standard hard disk drives and population of all hard disk drive bays with the largest currently supported drives available from IBM.

Maximum memory may require replacement of the standard memory with an optional memory module.

IBM makes no representation or warranties regarding non-IBM products and services that are ServerProven[®], including but not limited to the implied warranties of merchantability and fitness for a particular purpose. These products are offered and warranted solely by third parties.

IBM makes no representations or warranties with respect to non-IBM products. Support (if any) for the non-IBM products is provided by the third party, not IBM.

Some software may differ from its retail version (if available), and may not include user manuals or all program functionality.

Electronic emission notices

Federal Communications Commission (FCC) statement

Note: This equipment has been tested and found to comply with the limits for a Class A digital device, pursuant to Part 15 of the FCC Rules. These limits are designed to provide reasonable protection against harmful interference when the equipment is operated in a commercial environment. This equipment generates, uses, and can radiate radio frequency energy and, if not installed and used in accordance with the instruction manual, may cause harmful interference to radio communications. Operation of this equipment in a residential area is likely to cause harmful interference, in which case the user will be required to correct the interference at his own expense.

Properly shielded and grounded cables and connectors must be used in order to meet FCC emission limits. Properly shielded and grounded cables and connectors must be used in order to meet FCC emission limits. IBM is not responsible for any radio or television interference caused by using other than recommended cables and connectors or by using other than recommended cables and connectors or by unauthorized changes or modifications to this equipment. Unauthorized changes or modifications could void the user's authority to operate the equipment.

This device complies with Part 15 of the FCC Rules. Operation is subject to the following two conditions: (1) this device may not cause harmful interference, and (2) this device must accept any interference received, including interference that may cause undesired operation.

Industry Canada Class A emission compliance statement

This Class A digital apparatus complies with Canadian ICES-003.

Avis de conformité à la réglementation d'Industrie Canada

Cet appareil numérique de la classe A est conforme à la norme NMB-003 du Canada.

Australia and New Zealand Class A statement

Attention: This is a Class A product. In a domestic environment this product may cause radio interference in which case the user may be required to take adequate measures.

United Kingdom telecommunications safety requirement

Notice to Customers

This apparatus is approved under approval number NS/G/1234/J/100003 for indirect connection to public telecommunication systems in the United Kingdom.

European Union EMC Directive conformance statement

This product is in conformity with the protection requirements of EU Council Directive 89/336/EEC on the approximation of the laws of the Member States relating to electromagnetic compatibility. IBM cannot accept responsibility for any failure to satisfy the protection requirements resulting from a nonrecommended modification of the product, including the fitting of non-IBM option cards.

This product has been tested and found to comply with the limits for Class A Information Technology Equipment according to CISPR 22/European Standard EN 55022. The limits for Class A equipment were derived for commercial and industrial environments to provide reasonable protection against interference with licensed communication equipment.

Attention: This is a Class A product. In a domestic environment this product may cause radio interference in which case the user may be required to take adequate measures.

Taiwanese Class A warning statement

警告使用者：
這是甲類的資訊產品，在
居住的環境中使用時，可
能會造成射頻干擾，在這種
情況下，使用者會被要求
採取某些適當的對策。

Japanese Voluntary Control Council for Interference (VCCI) statement

この装置は、情報処理装置等電波障害自主規制協議会（VCCI）の基準に基づくクラスA情報技術装置です。この装置を家庭環境で使用すると電波妨害を引き起こすことがあります。この場合には使用者が適切な対策を講ずるよう要求されることがあります。

Power cords

For your safety, IBM provides a power cord with a grounded attachment plug to use with this IBM product. To avoid electrical shock, always use the power cord and plug with a properly grounded outlet.

IBM power cords used in the United States and Canada are listed by Underwriter's Laboratories (UL) and certified by the Canadian Standards Association (CSA).

For units intended to be operated at 115 volts: Use a UL-listed and CSA-certified cord set consisting of a minimum 18 AWG, Type SVT or SJT, three-conductor cord, a maximum of 15 feet in length and a parallel blade, grounding-type attachment plug rated 15 amperes, 125 volts.

For units intended to be operated at 230 volts (U.S. use): Use a UL-listed and CSA-certified cord set consisting of a minimum 18 AWG, Type SVT or SJT, three-conductor cord, a maximum of 15 feet in length and a tandem blade, grounding-type attachment plug rated 15 amperes, 250 volts.

For units intended to be operated at 230 volts (outside the U.S.): Use a cord set with a grounding-type attachment plug. The cord set should have the appropriate safety approvals for the country in which the equipment will be installed.

IBM power cords for a specific country or region are usually available only in that country or region.

IBM power cord part number	Used in these countries and regions
13F9940	Argentina, Australia, China (PRC), New Zealand, Papua New Guinea, Paraguay, Uruguay, Western Samoa
13F9979	Afghanistan, Algeria, Andorra, Angola, Austria, Belgium, Benin, Bulgaria, Burkina Faso, Burundi, Cameroon, Central African Rep., Chad, China (Macau S.A.R.), Czech Republic, Egypt, Finland, France, French Guiana, Germany, Greece, Guinea, Hungary, Iceland, Indonesia, Iran, Ivory Coast, Jordan, Lebanon, Luxembourg, Malagasy, Mali, Martinique, Mauritania, Mauritius, Monaco, Morocco, Mozambique, Netherlands, New Caledonia, Niger, Norway, Poland, Portugal, Romania, Senegal, Slovakia, Spain, Sudan, Sweden, Syria, Togo, Tunisia, Turkey, former USSR, Vietnam, former Yugoslavia, Zaire, Zimbabwe
13F9997	Denmark
14F0015	Bangladesh, Burma, Pakistan, South Africa, Sri Lanka
14F0033	Antigua, Bahrain, Brunei, Channel Islands, China (Hong Kong S.A.R.), Cyprus, Dubai, Fiji, Ghana, India, Iraq, Ireland, Kenya, Kuwait, Malawi, Malaysia, Malta, Nepal, Nigeria, Polynesia, Qatar, Sierra Leone, Singapore, Tanzania, Uganda, United Kingdom, Yemen, Zambia
14F0051	Liechtenstein, Switzerland
14F0069	Chile, Ethiopia, Italy, Libya, Somalia
14F0087	Israel
1838574	Thailand

IBM power cord part number	Used in these countries and regions
6952301	Bahamas, Barbados, Bermuda, Bolivia, Brazil, Canada, Cayman Islands, Colombia, Costa Rica, Dominican Republic, Ecuador, El Salvador, Guatemala, Guyana, Haiti, Honduras, Jamaica, Japan, Korea (South), Liberia, Mexico, Netherlands Antilles, Nicaragua, Panama, Peru, Philippines, Saudi Arabia, Suriname, Taiwan, Trinidad (West Indies), United States of America, Venezuela

Index

A

- adapter
 - boot option 19
 - cabling 26, 34, 45
 - considerations 18
 - expansion slot locations 17
 - hot-plug devices 19
 - installing
 - hot-plug 19
 - IXA (option) 19
 - PCI bus, identification 19
 - RAID 22, 34, 45
 - SCSI 26, 34, 45
 - SCSI connectors 26, 34, 45
- Advanced System Management ports 81
- air baffle
 - installing 26, 52, 62
 - removing 23, 49, 57
- airflow guide
 - memory board 51
 - microprocessor 24
- auxiliary-device port 76

B

- backplane, SCSI 26, 34, 45
- baffle
 - air 23
 - microprocessor 60
 - VRM 59
- battery
 - connector 4
 - replacing 71
- bay identification
 - hot-swap drive 37
 - removable-media drive 37
- bezel
 - installing 69
 - removing 15, 16, 17
- BIOS code recovery jumper 8

C

- cable
 - connectors 5, 6
 - routing 26, 82
 - SCSI 26, 34, 45
 - standards 71
- cable-management-arm bracket
 - installing 26, 36, 46
 - removing 22, 29, 40
- cabling
 - adapters 26, 34, 45
 - external 71, 82
 - internal 44
 - RAID adapter 22
 - removable-media drive 44

- cabling (*continued*)
 - SCSI requirements 70
 - system-board external connectors 5, 6
 - system-board internal connectors 5
 - the server 82
- Class A electronic emission notice 85
- components
 - Light Path Diagnostics panel 10
 - major 2
 - memory board 12
 - optional xSeries 6-Pack Hot-Swap Expansion Kit 29
 - system board 4
- configuration
 - hardware, cabling for 82
 - updating 70
- configuring Ethernet controller 80
- connecting
 - xSeries 6-Pack Hot-Swap Expansion Kit to SCSI backplane 33
- connectors
 - adapter 4, 17
 - battery 4
 - cable 5
 - external port 6
 - internal cable 5
 - memory 4
 - microprocessor 4
 - port 6
 - system board 4
 - system-board switch block 7
 - VRM 4
- controls 11
- cover
 - installing 68
 - removing 15

D

- data rate, Ethernet 80
- device scanning order 19
- DIMM.
 - See memory module
- documentation CD 1
- drive
 - bays 28, 37
 - hot-swap
 - bay identification 37
 - installing 38
 - support 38
 - internal 37
 - non-hot-swap 39
 - removable-media 39

E

- electronic emission Class A notice 85

- Ethernet controller
 - configuring 80, 81
 - high performance modes 81
 - integrated on system board 80
 - modes 81
 - operating speed requirements 19
 - teaming 81
- Ethernet port 80
 - external
 - cabling 82
 - devices, connecting 70

F

- fan
 - power supply 63
 - replacing 66
- Fast Ethernet 81
- FCC Class A notice 85
- filler panel
 - removable-media drive bay 43
- flash ROM page-swap jumper 8

H

- Hot Spare Memory feature 47
- hot-plug adapter.
 - See adapter
- hot-swap and hot-plug devices
 - adapters 19
 - drives 38
 - fans 66
 - power supplies 63, 65
- hot-swap drive
 - backplane
 - components 29
 - description 28
 - illustration 33
 - bay identification 37
 - description 28
 - installing 38
- hot-swap power supply
 - installing 63, 65
- hub 80

I

- indicators 10
- installation order
 - memory modules 48
 - microprocessors 55
 - VRMs 55
- installing
 - air baffle 26, 52, 62
 - bezel 69
 - cable-management-arm bracket 26, 36, 46
 - cover 68
 - hot-plug adapter 19
 - hot-swap drive 38
 - hot-swap power supply 63, 65
 - memory board 52

- installing (*continued*)
 - microprocessor 60
 - non-hot-swap drive 39
 - options 13
 - removable-media drive 39
 - VRM 57
 - xSeries 6-Pack Hot-Swap Expansion Kit 28

J

- jumper
 - flash ROM page-swap 8

K

- keyboard port 76

L

- LED card 10
- LEDs
 - CPU 10
 - D1 11
 - D10 11
 - D11 11
 - D12 11
 - D2 11
 - D3 11
 - D4 11
 - D5 11
 - D6 11
 - D7 11
 - D8 11
 - D9 11
 - DASD 10
 - DIMM error 12
 - FAN 11
 - ISMP 10
 - Light Path Diagnostics panel 10
 - LOG 10
 - NMI 10
 - NONREDUND 11
 - OVER SPEC 11
 - PCIA 10
 - PCIB 10
 - PCIC 10
 - PCID 10
 - PS1 10
 - PS2 10
 - PS3 11
 - PS4 11
 - system board 9
 - TEMP 11
 - VRM 10
- Light Path Diagnostics panel
 - LEDs 10
 - REMIND button 11

M

- major components 2
- memory
 - installing 46
- memory board
 - airflow guide 51
 - component locations 12
 - installing 52
 - removing 50
- memory module
 - installing 46
 - order of installation 48
 - supported 47
- microprocessor
 - airflow guide 24
 - baffle 60
 - heat sink 61
 - installing 54, 60
 - order of installation 55
 - socket cover 60
 - VRM 57
- modes, Ethernet 81

N

- non-hot-swap drive
 - installing 39
- notes, important 84
- notices
 - electronic emission 85
 - FCC, Class A 85
 - used in this book 1

O

- options
 - external
 - cabling requirements 70, 71
 - connecting 70
 - installing 70
- order of installation
 - memory modules 48
 - microprocessors 55
 - VRMs 55

P

- PCI and PCI-X devices
 - considerations 18
 - installing 19
 - scanning order 19
 - slot locations 17
 - startup order 19
- PCI bus
 - identification 19
 - speeds 19
- pointing device port 76
- port
 - Advanced System Management 81
 - auxiliary-device 76

- port (*continued*)
 - connectors 6
 - Ethernet 80
 - input/output 75
 - keyboard 76
 - parallel 76
 - pointing device 76
 - serial 79
 - Ultra160 SCSI 77
 - Universal Serial Bus 79
- power supply
 - installing 63
 - operating requirements 63
- power-on password override switch 8

R

- rack, installing server in 82
- RAID adapter
 - cabling 22, 34, 45
- REMIND button 11
- removable-media drive
 - bay identification 37
 - installing 39, 44
- removing
 - air baffle 23, 49, 57
 - bezel 16, 17
 - cable-management arm bracket 22, 29, 40
 - cover 15
 - memory board 50

S

- scanning order for PCI and PCI-X devices 19
- SCSI
 - backplane
 - attaching to xSeries 6-Pack Hot-Swap Expansion Kit 33
 - configuration 28
 - cable 70
 - connecting to backplane 34
 - external devices 71
 - maximum length 71
 - removable-media drive 44
 - IDs 77
- SCSI adapter
 - boot option 19
 - cabling 26, 34, 45
- SCSI connectors
 - adapter 26, 34, 45
 - location 5
 - system board 25, 43
- SCSI port
 - description 77
 - pin assignments 78
- serial port 79
- shuttle assembly
 - unlocking 25, 32, 43
- static-sensitive devices, handling 14, 20
- switch
 - power-on password override 8

- switch block 7
- system board
 - connectors
 - cable 5
 - external port 6
 - internal cable 5
 - SCSI 5
 - user-installable options 4
 - jumpers 8
 - LEDs 9
 - switch block 7
 - switches 8
- system reliability 13

T

- top cover
 - installing 68
 - removing 15
- trademarks 84

U

- Ultra160 SCSI port 77
- United States electronic emission Class A notice 85
- United States FCC Class A notice 85
- Universal Serial Bus port 79
- unlocking
 - shuttle assembly 25, 32, 43

V

- video port 76
- voltage regulator module
 - baffle 59
 - installation order 55
 - installing 57
- VRM
 - See voltage regulator module

W

- Web site
 - product information 2
 - SCSI standards 71
- working inside server with power on 13

X

- xSeries 6-Pack Hot-Swap Expansion Kit option 28



Part Number: 88P9205

Printed in U.S.A.

SC88-P920-50



(1P) P/N: 88P9205

