

# ICF-7600D

## SERVICE MANUAL

AEP Model  
UK Model  
E Model

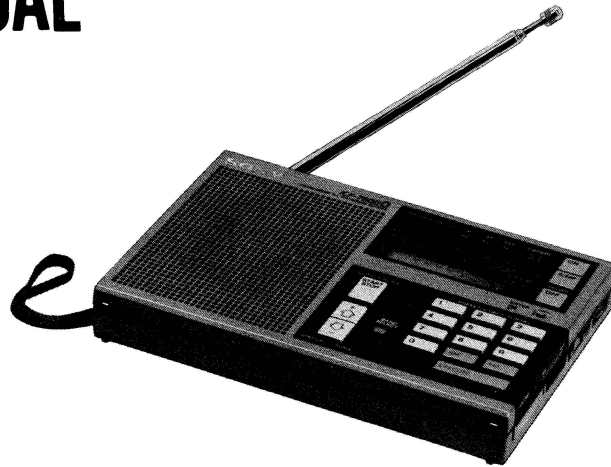

### SPECIFICATIONS

Circuit system	FM: Superheterodyne AM: Dual conversion superheterodyne	Battery life	Radio: approx. 12 hours of listening for four hours at a normal volume, using Sony SUM-3(NS) New Super batteries Computer back up/clock: approx. 1 year of continuous operation with Sony SUM-3 (NS) New Super batteries
Frequency range	FM: 87.6 – 108.0 MHz (FM Narrow) 76.0 – 108.0 MHz (FM Wide) MW: 522 – 1611 kHz SW: 1615 – 29995 kHz (AM Wide) 1615 – 26100 kHz (AM Narrow) LW: 153 – 519 kHz SSB/CW: 153 – 29995 kHz	Dimensions	Approx. 184.5×118.5×32mm (w/h/d) (7 <sup>3</sup> / <sub>8</sub> ×4 <sup>3</sup> / <sub>4</sub> ×1 <sup>5</sup> / <sub>16</sub> inches) including projecting parts and controls
Antennas	Telescopic antenna (FM/SW) Built-in ferrite bar antenna (MW/LW) External antenna terminal (FM/LW/MW/SW)	Weight	Approx. 640 g (1.4 lb) including batteries
Speaker	Approx. 7.7 cm (3 <sup>1</sup> / <sub>8</sub> inches) diameter		
Power output	200 mW (at 10% harmonic distortion, for UK Model) 400 mW (at 10% harmonic distortion, for AEP, E Model)		
Outputs	Recording output jack (minijack) output level 0.775 mV (-60 dB) output impedance 1 kilohm Earphone jack (minijack) for 8ohm earphone Radio: 6 V dc		
Power requirements	Four IEC designation R6 batteries (size AA) Supplied AC-240 ac power adaptor (110, 120, 220 or 240 V ac adjustable, 50/60 Hz) Optional DCC-127A or DCC-240 car battery cord for use with 12 V or 24 V car battery, respectively Computer back up/clock: 3 V dc, two IEC designation R6 batteries (size AA)		

#### SAFETY-RELATED COMPONENT WARNING!!

COMPONENTS IDENTIFIED BY SHADING AND MARK  ON THE SCHEMATIC DIAGRAMS AND IN THE PARTS LIST ARE CRITICAL TO SAFE OPERATION. REPLACE THESE COMPONENTS WITH SONY PARTS WHOSE PART NUMBERS APPEAR AS SHOWN IN THIS MANUAL OR IN SUPPLEMENTS PUBLISHED BY SONY.

FM/LW/MW/SW  
PLL SYNTHESIZED RECEIVER  
**SONY**<sup>®</sup>



● Identification Of Each Model



Indication of Frequency Range

- AEP model : FM 76-108 MHz
- UK model : LW/MW/SW 153-29,995 KHz
- E model
  
- ME model : FM 87.6-108 MHz
- G-AEP model : LW/MW/SW 153-26,100 KHz
  
- French model : FM 87.6-108 MHz
- LW/MW/SW 153-29,995 KHz

**EXT ANT**

Not provided for G-AEP model.

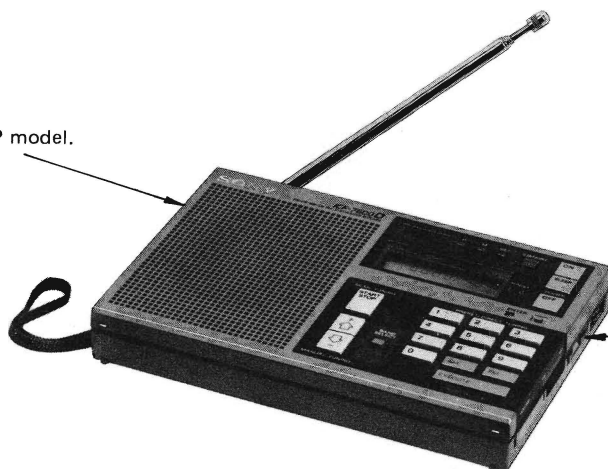

**SSB**

Not provided for ME model.

SERVICING NOTES

1. FREQUENCY RANGE ADJUSTMENT

When replacing switch board, adjust frequency range by solder-bridging or opening adjustment patterns according to original patterns.

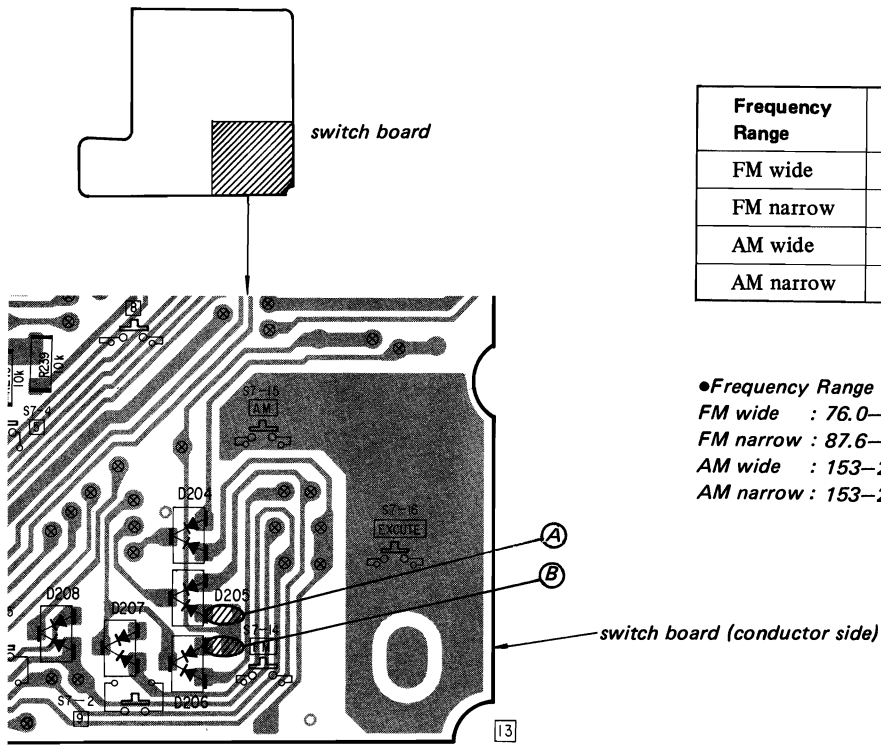

Frequency Range	Bridge (A)	Bridge (B)
FM wide	open	_____
FM narrow	bridge	_____
AM wide	_____	open
AM narrow	_____	bridge

●Frequency Range  
 FM wide : 76.0-108.0 MHz  
 FM narrow : 87.6-108.0 MHz  
 AM wide : 153-29,995 kHz  
 AM narrow : 153-26,100 kHz

2. BUTTONS REPLACEMENT

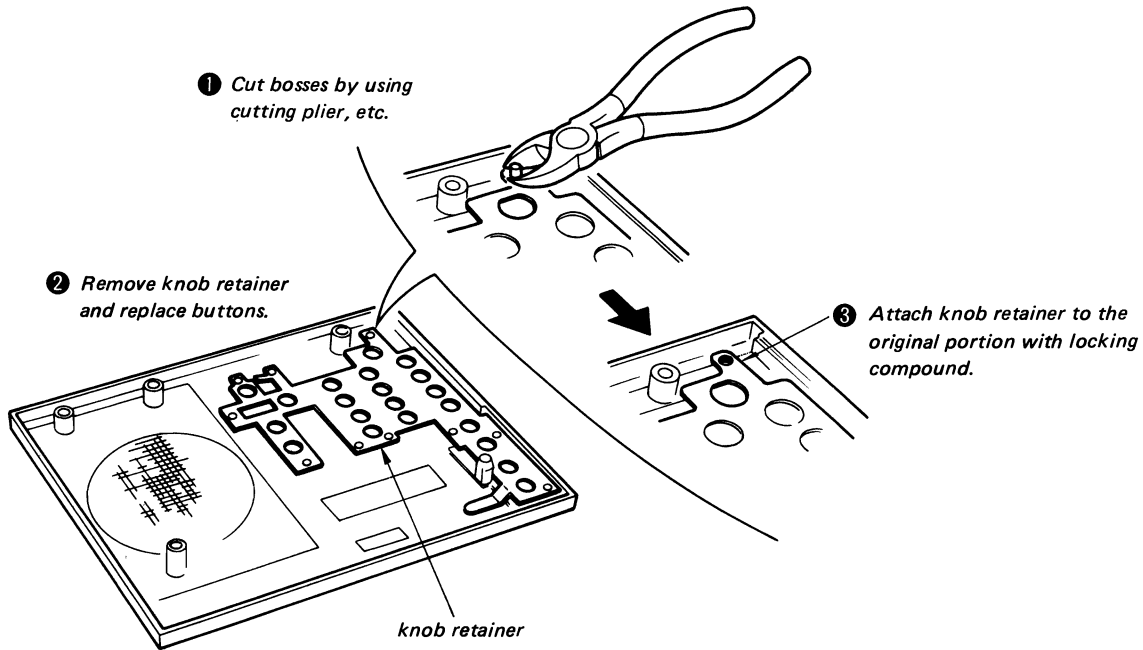

3. MELF (Metal Electrodes Face-Bonding) Components

**Warning**

If MELF components are forcibly removed from the printed circuit board with pincers or pliers, the circuit board pattern is likely to peel away. Always remove MELF components according to the procedure described on the next page. Replace MELF components with the lead type components.

MELF components are soldered directly to the surface of the printed circuit board.

MELF resistors and capacitors have the same dimensions and are distinguished by their background colors: light brown for resistors, and pink or light green for capacitors.

The MELF resistor color coding is the same as for conventional resistors, and MELF capacitor color coding is the same as for tube-type ceramic capacitors.

Components larger than resistors and without a color code are cross conductors, which are used instead of jumper wires.

1. Structure

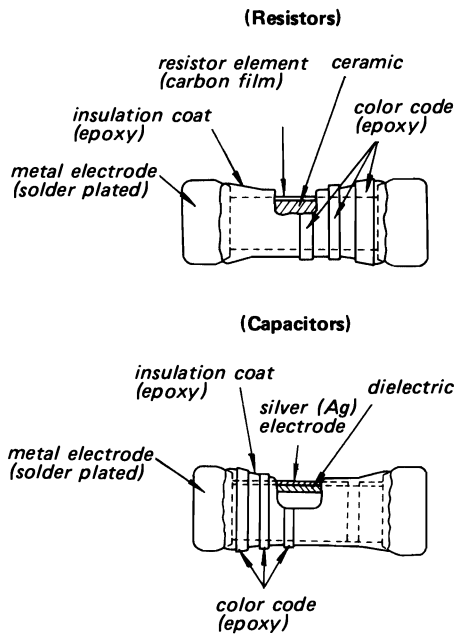
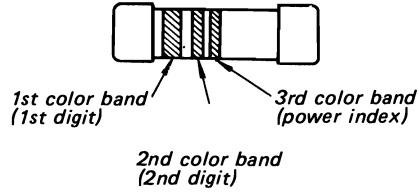
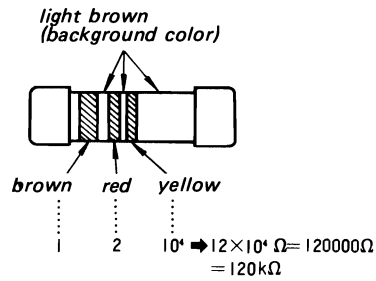

Fig. 1

2. Color Code Reading



(Example of Resistor)



(Example of Capacitor)

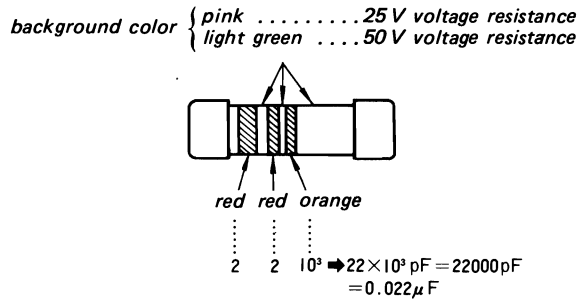

Fig. 2

### 3. How to Remove MELF Components and Mount Replacements

Use a soldering iron of at least 40W with an iron tip 4 mm in diameter and file the tip down to the angle shown in the diagram.

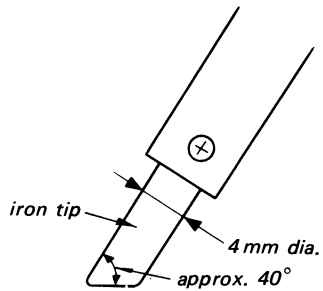

Fig. 3

- Use lead type resistors to replace the MELF components. This replacement may be mounted with short leads (see Fig. 5).

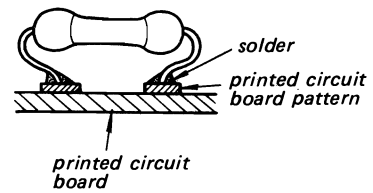

Fig. 5

- Bring the flat surface of the soldering iron in equal contact with both soldered ends of the component.
- The solder should melt in about 4 seconds. (The solder will melt more readily if a small amount of solder is attached to the iron tip and the iron tip is placed against the component.)
- Once the solder has melted, tap the component aside with the tip of the soldering iron, and remove it from the board.

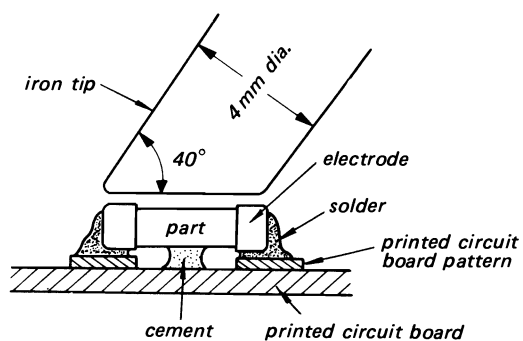

Fig. 4

Note: Use 3216 type chip components to replace the MELF capacitor components.  
See page 6 for mounting of chip components.

## 4. Chip components

Chip components include resistors, capacitors, transistors, diodes, coil and adjustable resistors.

In this section, the types of resistors, ceramic capacitors, transistors and diodes which are used most frequently will be described.

Dimension of transistors and capacitors

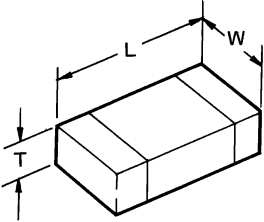

(Unit: mm)

Type	L	W	T
3216	3.2	1.6	0.45 ~ 0.6
2125	2.0	1.25	0.35 ~ 0.5

## Identification

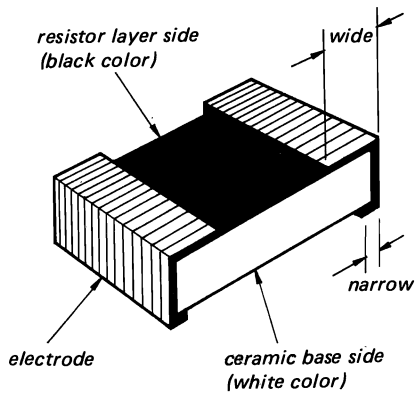

**Resistor**

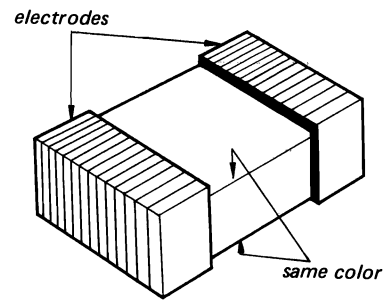

**Laminated Ceramic Capacitor**

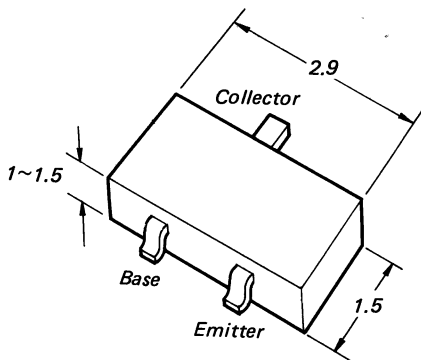

**Transistor**

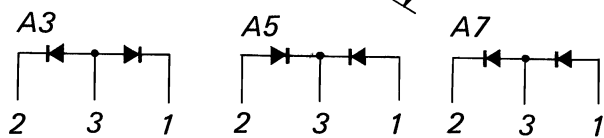
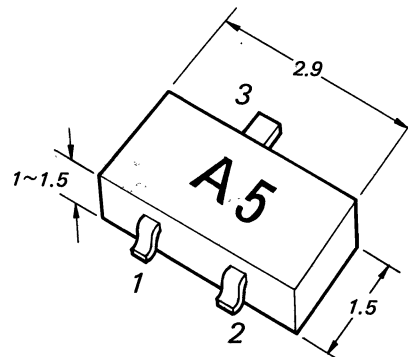

**Diode**

**Replacing chip components**

All chip components should be connected and disconnected, using a tapered soldering iron [temperature of the iron tip: less than 280°C (536°F)], a pair of tweezers and braided wire.

**Precautions for replacement**

1. Do not disconnect the chip component forcefully. Otherwise, the pattern may peel off.
2. Never re-use a disconnected chip component. Dispose of all old chip components.
3. To protect the chip component, heating time for attaching the component should be within 3 seconds.

○ **Removing chip components**

(1) **Removing solder at electrode**

Remove the solder at the electrode, using a thin braided wire. Do not remove the solder of the part (chip component) attached adjacent to the electrode.

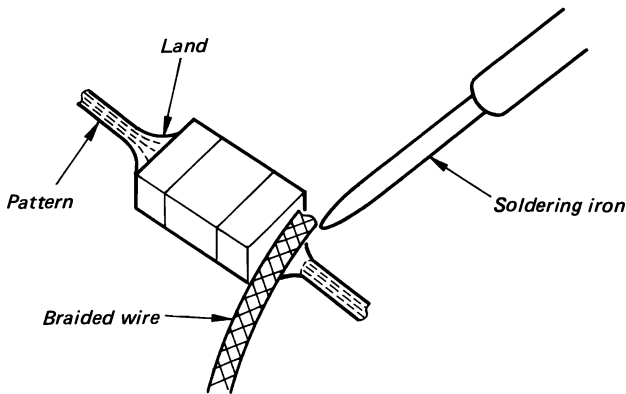

(2) **Disconnecting chip components**

Turn the tweezers with the soldering iron alternately applied to both electrodes, and the chip component will be disconnected. Take careful precautions while disconnecting, because if the chip component is forcefully removed the land may peel off. Never re-use a disconnected chip component.

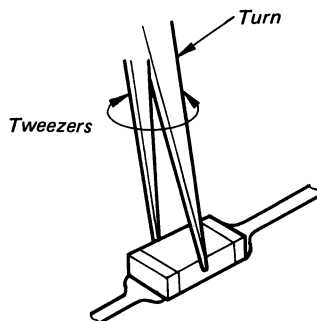

(3) **Smoothing the soldered surface**

After disconnecting the chip component, remove the solder by using a braided wire to smooth the land surface.

○ **Connecting chip components**

The value of chip components is not displayed on the main body. Take due precautions to avoid mixing new chip components with other ones.

(1) **Applying solder to land on one side**

Apply a thin layer of solder to the land on one side where the chip component is to be connected. Too much solder may cause bridging.



(2) **Speedy soldering**

Hold the chip component at the desired position, using tweezers, and apply the soldering iron in the arrow-marked direction. To protect the chip component, heating time should be within 3 seconds.

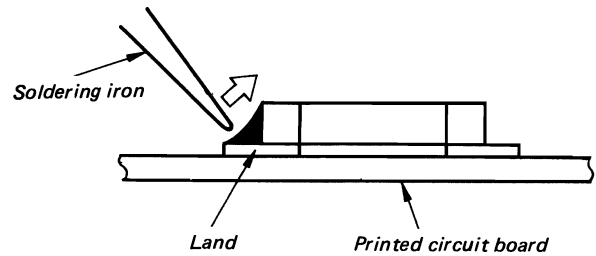

(3) **Speedy soldering of electrode on the other side**

Solder the electrode on the other side in the same way as in (2) above.

## LOCATION AND FUNCTION OF CONTROLS

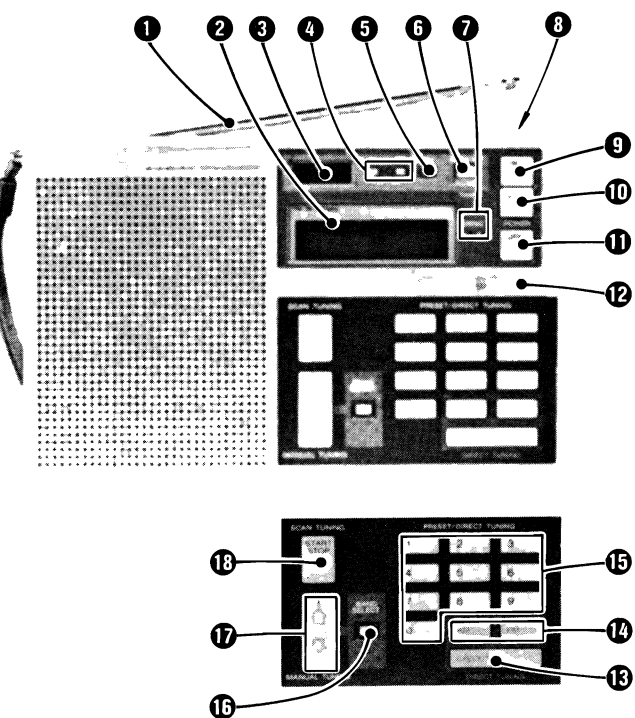

**1 Telescopic antenna**  
Used for both FM and SW reception.

**2 Frequency display**  
Displayed as follows:

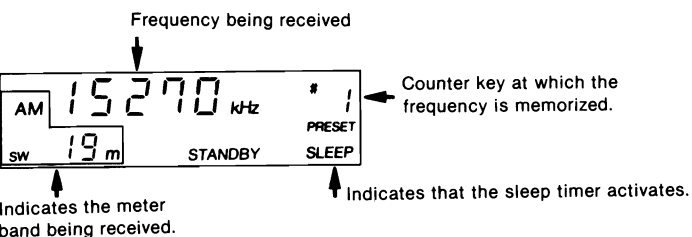

**3 Time display**  
Displayed by 24 hours.  
The timer-setting time will be displayed when the SET button is pressed.

**4 Time adjust button**  
Press the H (hour) button and M (minute) button while pressing the TIME SET button to adjust the clock to the current time.

**5 SET (timer setting) button**  
Press the H button and M button while pressing the SET button to set the timer.

**6 STANDBY (timer standby) button**  
Press this button after setting the timer.

**7 TUNING indicator**  
The indicator illuminates when a signal is received.

**8 MAIN POWER switch**  
Set this switch to ON before pressing the ON button to turn on the radio.  
Set it to OFF when carrying the radio.  
With this switch at OFF, the power will not be turned on even if the ON button is pressed accidentally.

**9 ON button**  
Press this button to turn the radio on.

**10 SLEEP timer button**  
Press this button to set the sleep timer.

**11 OFF button**  
Press this button to turn the radio off.

**12 ENTER key**  
Used to input a station to one of the counter keys for preset tuning.

**13 EXECUTE key**  
After inputting your desired band and frequency, press this key to complete your tuning.

**14 FM/AM key**  
Used to input a frequency for direct tuning.

**15 Counter keys**  
Used to input a frequency. If you punch in a frequency with the numbered keys, the frequency will appear in the frequency display.

**16 BAND SELECT key**  
Used with  $\uparrow$  (plus) key or  $\downarrow$  (minus) key to continuously search a broadcast band such as FM, LW, MW and SW, or to search the meter bands of SW.

**17  $\uparrow$  (plus) /  $\downarrow$  (minus) key**  
Used with the BAND SELECT key to search the desired broadcast band and tune the frequency in correctly for manual tuning.  
If you press  $\downarrow$  key or  $\uparrow$  once, the tuned frequency will be increased or decreased by the following intervals:  
FM: 0.1 MHz    MW: 10 kHz  
LW: 3 kHz      SW: 5 kHz

If you keep the key depressed, the frequency changes continuously.  
The MW interval of 9 kHz is preset at the factory but you can change to the interval of 10 kHz to match the MW frequency allocation system of the country where you will use the unit.

**18 START/STOP key**  
If you press this key, the radio begins searching for a station, scanning the broadcast band of the frequency inputted by direct tuning or searched for by manual tuning. Scanning stops automatically for 1.5 seconds when a station is received. Press the START/STOP key again to stop the scanning.



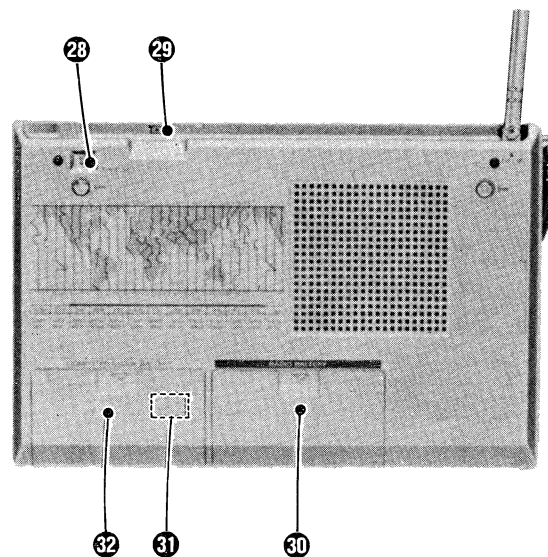
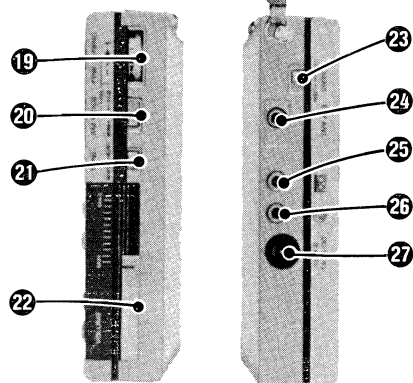

**19 FINE TUNING control**

Adjust this control for better reception of LW, MW or SW.

**20 AM MODE selector**

**NORM:** Normally set the selector to this position.

**FINE:** Set to this position for better reception of LW, MW and SW and adjust the tuning with the FINE TUNING control.

**SSB:** For SSB/CW reception, set to this position and adjust the tuning with the FINE TUNING control.

**21 TONE control**

**NEWS:** For listening to news.

**MUSIC:** For listening to music.

**22 VOLUME control**

**23 SENS (FM/AM sensitivity) selector**

Normally set this selector to HIGH. Set it to LOW when the sound is distorted due to strong signals or when there is interference.

**24 EXT ANT (external antenna) jack**

Connect the supplied external antenna connector.

**25  Recording output jack**

For recording radio programs with a tape recorder, connect the optional RK-69A connecting cord.

**26  Earphone jack**

For private listening with an earphone. When the earphone is plugged in, the speaker is automatically disconnected.

**27 DC IN 6 V (external power input) jack**

For operation from an external power source.

**28 TIME SET button**

Used with H and M button at the front to adjust the current time.

**29 12/24 hour selector**

You can choose either 12 hour indication or 24 hour indication by switching this selector.

**30 Radio battery compartment**

**31 9 kHz/10 kHz selector (in the computer back up/clock battery compartment)**

Set this selector according to the MW frequency allocation system of your country.

**32 Computer back up/clock battery compartment**

SECTION 1  
OUTLINE

1-1. BLOCK DIAGRAM

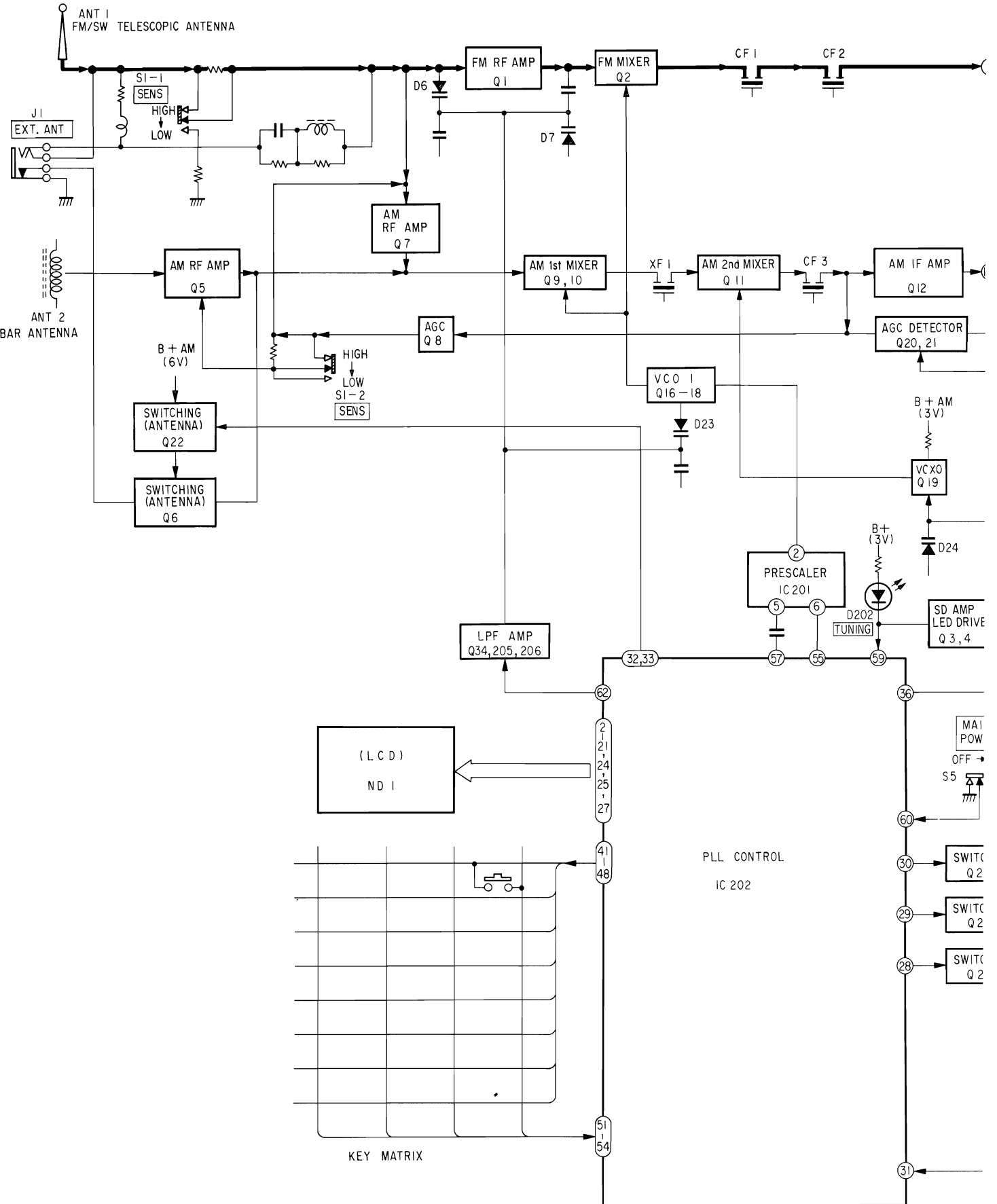

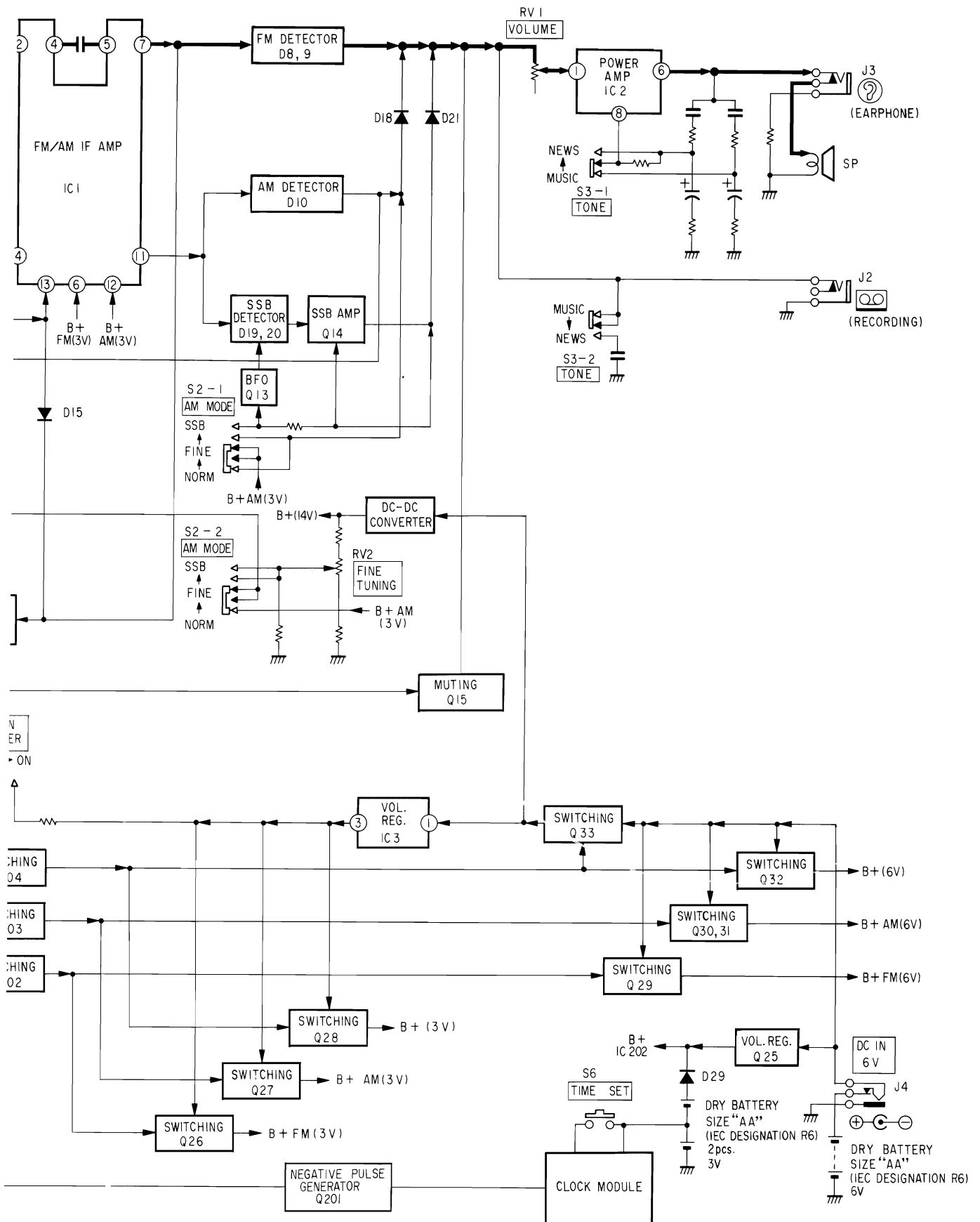



●IC201's (PLL CONTROL IC μPD1706G-511) TERMINAL FUNCTIONS

Terminal No.	Terminal Name	Function	Terminal No.	Terminal Name	Function
1	—	This terminal is not used on this set.	32	LW	Signal output for antenna switching. LW mode: L otherwise: H
2	8a	Signal output for LCD segment.	33	MW	Signal output for antenna switching. MW mode: L otherwise: H
3	7c		34, 35	—	These terminals are not used on this set.
4	7a		36	MUTE	Signal output for sound muting. mute:H otherwise:L
5	6a		37-40	—	These terminals are not used on this set.
6	5c		41	KS0	Signal output for key matrix scanning.
7	5b		42	KS1	
8	5a		43	KS2	
9	3b		44	KS3	
10	4c		45	KS4	
11	4b		46	KS5	
12	4a	47	KS6		
13	3a	48	KS7		
14	2c	49	XI	Clock pulse oscillating terminal.	
15	2b	50	XO		
16	2a	51	K3	Signal input for key matrix scanning.	
17	1c	52	K2		
18	1b	53	K1		
19	1a	54	K0	Signal output for prescaler control. This terminal is not used on this set.	
20	7b	55	PSC		
21	9a	56	—	Signal input for swallow pulse. Power supply terminal. (3V)	
22	VL	57	FM in		
23	VH	58	VDD	Signal input for station detector. tuned: L detuned: H	
24	COM2	59	SD		
25	COM1	60	CE	Signal input for chip enable.	
26	VDD	61	—	This terminal is not used on this set.	
27	COM0	62	ER	Signal output for PLL error	
28	FM	63	—	This terminal is not used on this set.	
29	AM	64	GND	Ground terminal.	
30	POWER OUT				
31	POWER IN	Power turns on when negative pulse is applied to this terminal at the STANDBY mode.			

● KEY MATRIX

input output	⑤1 K3	⑤2 K2	⑤3 K1	⑤4 K0
④1 KS0	—	—	—	9 kHz 10 kHz step frequency switch
④2 KS1	ENTER	BAND SELECT	—	—
④3 KS2	0 (10 key)	1 (10 key)	2 (10 key)	3 (10 key)
④4 KS3	—	FM	AM	EXECUTE
④5 KS4	—	↓ (down)	↑ (up)	SCAN TUNING
④6 KS5	STANDBY	SLEEP	ON	OFF
④7 KS6	4 (10 key)	5 (10 key)	6 (10 key)	7 (10 key)
④8 KS7	8 (10 key)	9 (10 key)	—	—

## SECTION 2 DISASSEMBLY

- Follow the disassembly procedure in the numerical order given.

### REAR CABINET

*Note: Be careful not to break the lead wire of telescopic antenna when removing the rear cabinet.*

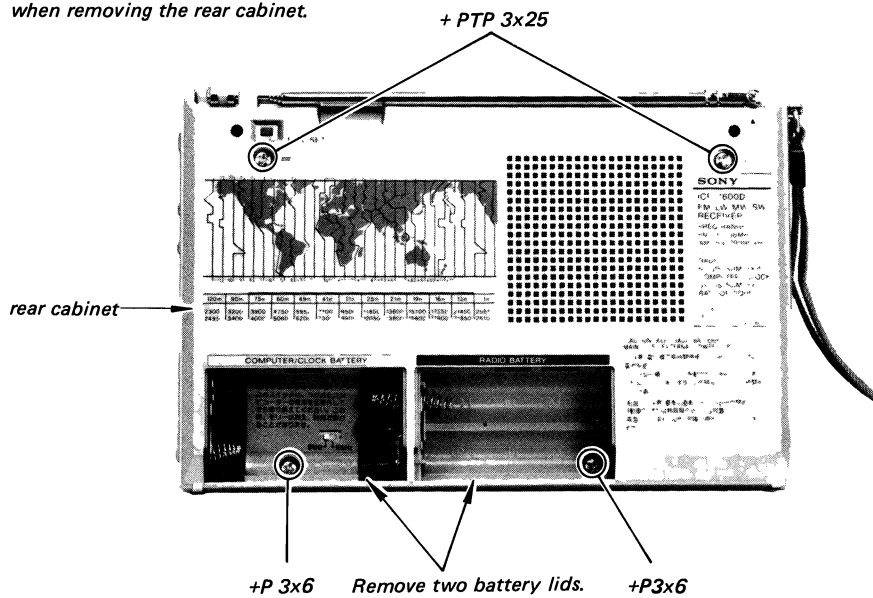

### FRONT CABINET/ANTENNA BOARD/JACK BOARD

*Note: Jack board should be removed after the front cabinet is removed.*

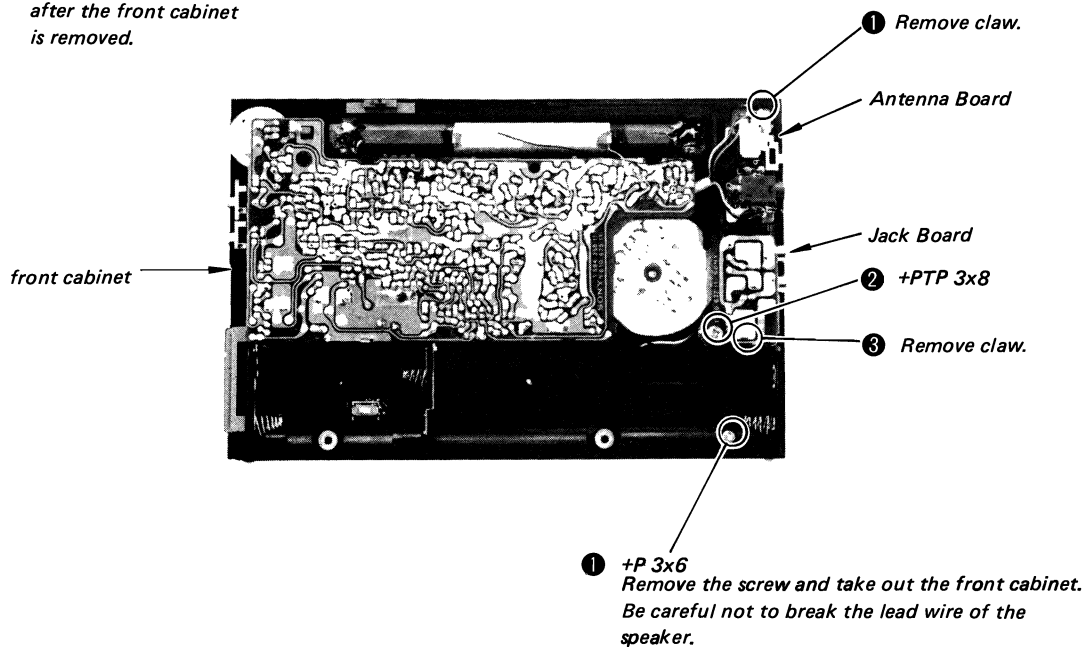

**SWITCH BOARD**

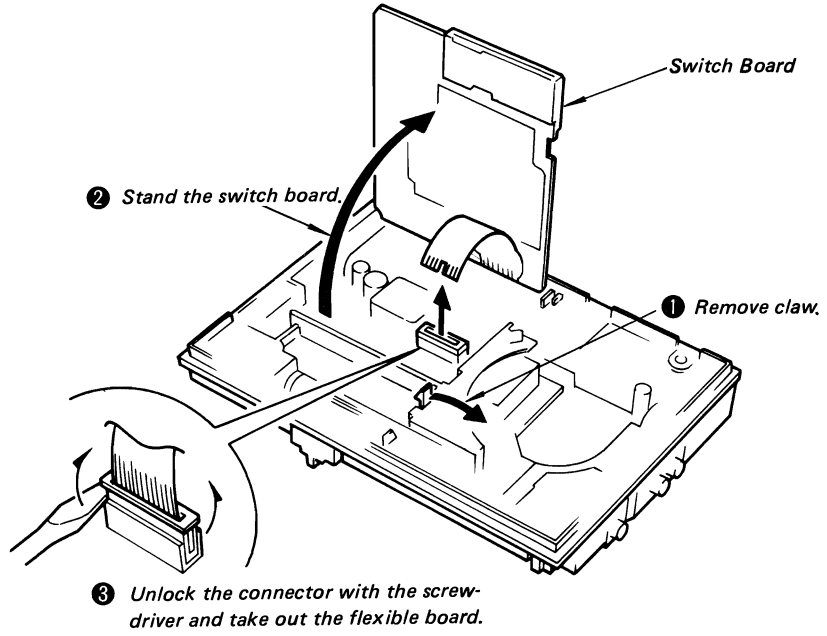

**MAIN BOARD**

*Note: Be careful not to break the lead wire when removing the main board.*

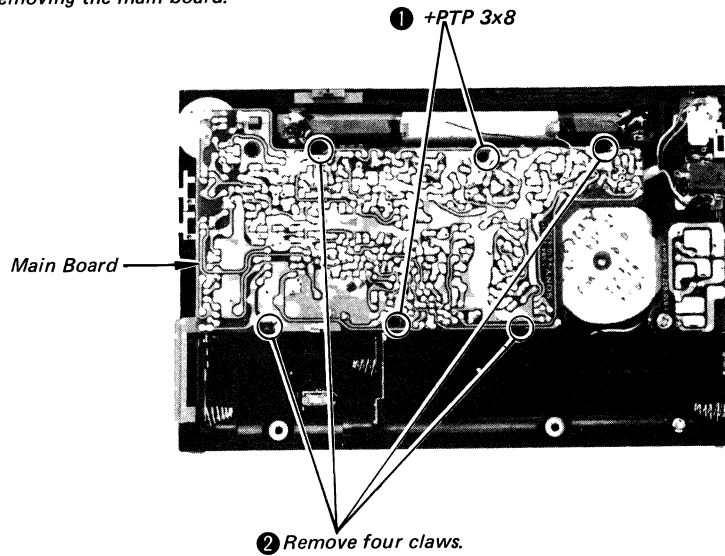





**AM IF ALIGNMENT**

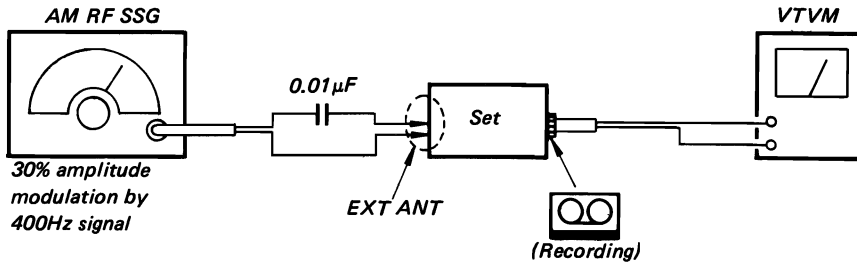

**AM 1st IF ALIGNMENT**  
 Adjust for a maximum reading on VTVM.

T8	L19
----	-----

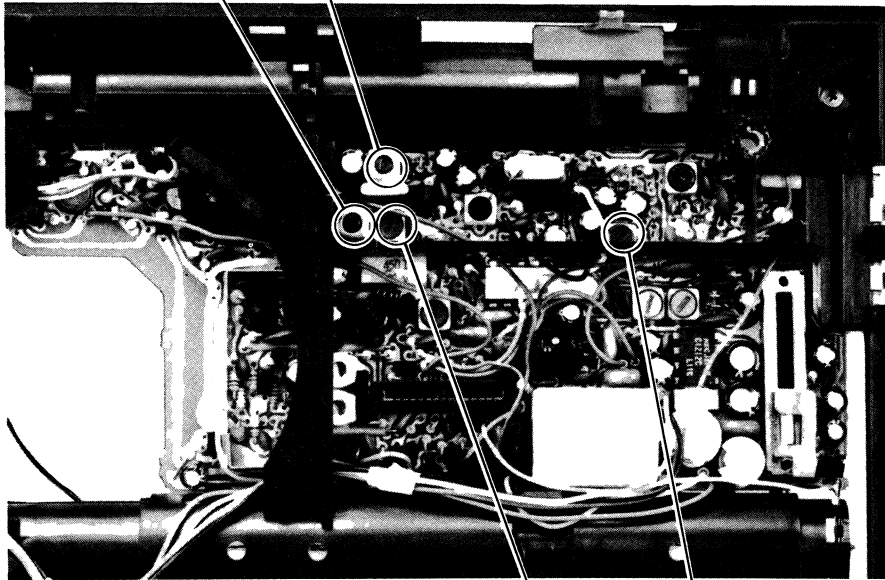

T9	T6
Adjust for a maximum reading on VTVM.	
<b>AM 2nd IF ALIGNMENT</b>	

**AM 2nd IF VCXO ADJUSTMENT**

Adjust T11 for 55,395MHz reading on the frequency counter.

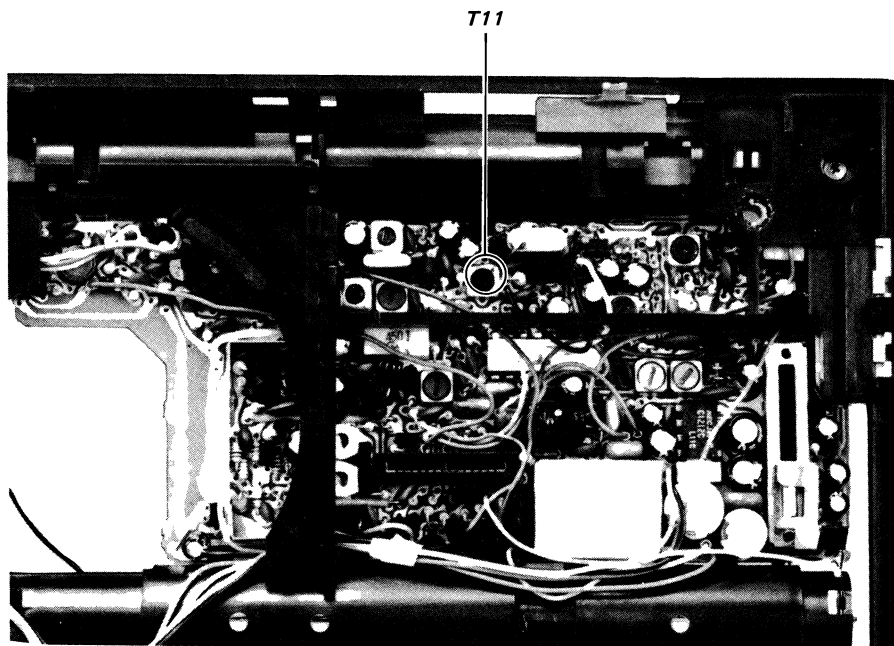
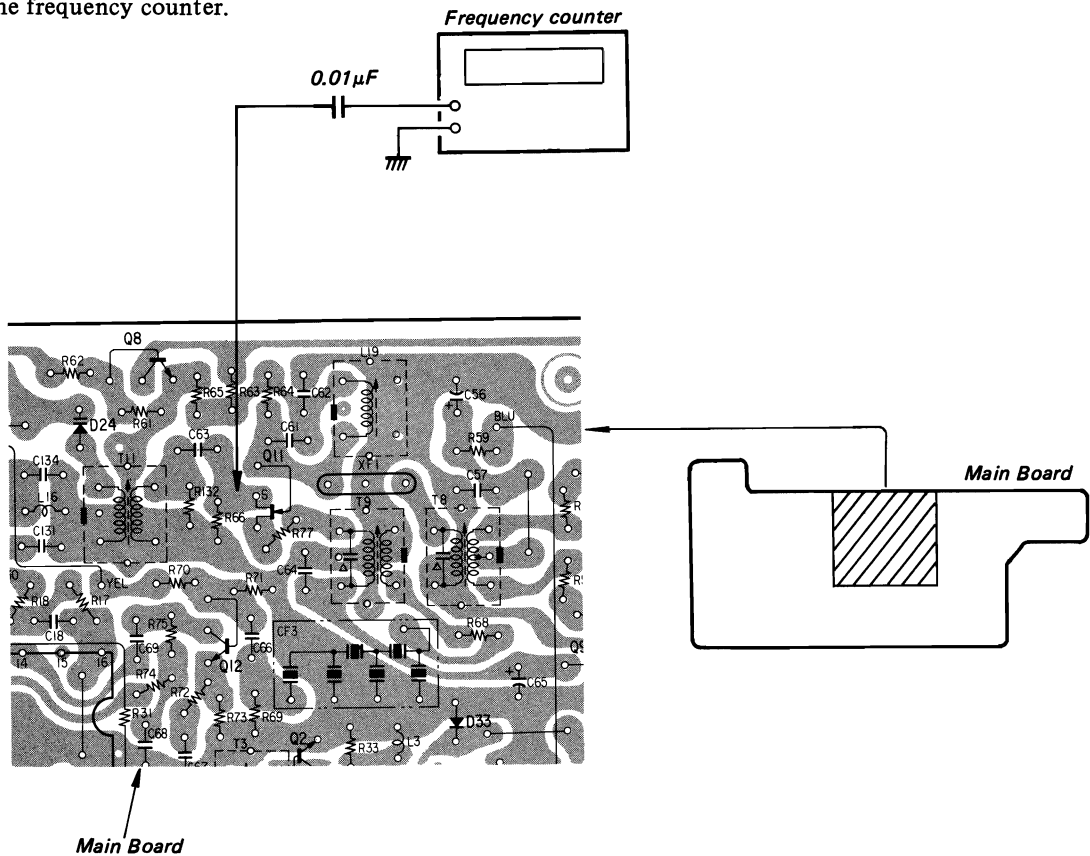

**FM IF ALIGNMENT**

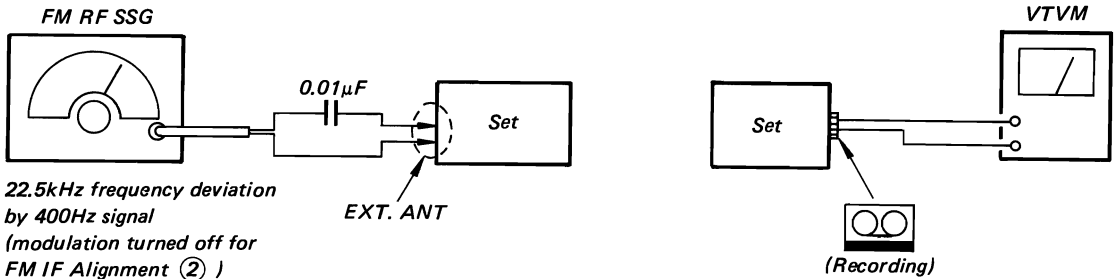

22.5kHz frequency deviation  
by 400Hz signal  
(modulation turned off for  
FM IF Alignment ② )

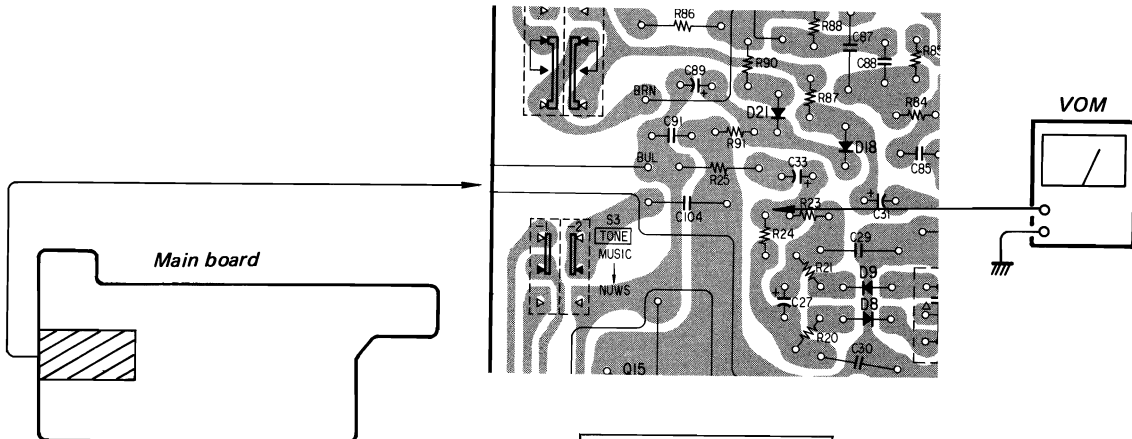

**FM IF ALIGNMENT ①**  
Adjust for a maximum  
reading on VTVM.

T3	T4
----	----

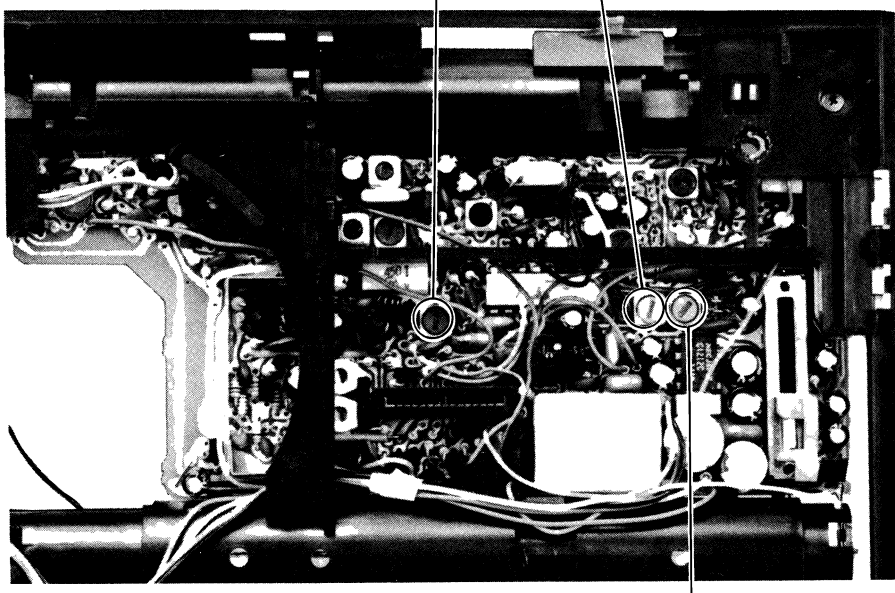

T5  
Adjust for a 0V DC.  
reading on VOM.

**FM IF ALIGNMENT ②**

**FM TRACKING ADJUSTMENT**

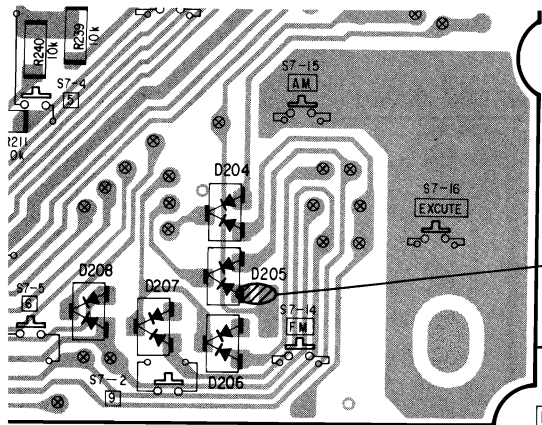

• Note for FM narrow band set  
 When FM narrow band set is adjusted,  
 unsolder the bridge (A).  
 After adjustment, solder the bridge (A).

(A)  
 switch board  
 (conductor side)

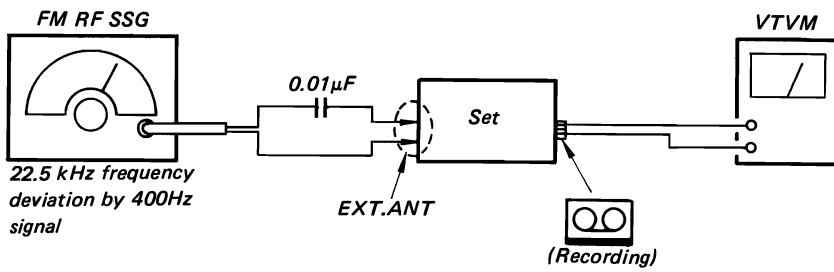

FM TRACKING ADJUSTMENT	
Adjust for a maximum reading on VTVM.	
102 MHz	
CT1	CT2

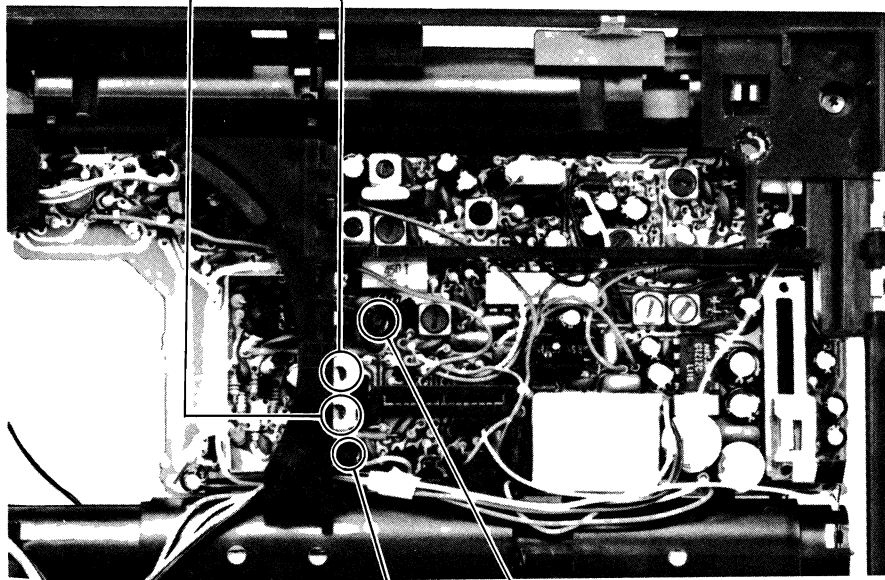

T1	L20
81 MHz	
Adjust for a maximum reading on VTVM.	
FM TRACKING ADJUSTMENT	

4-1. MOUNTING DIAGRAM

— Conductor Side —

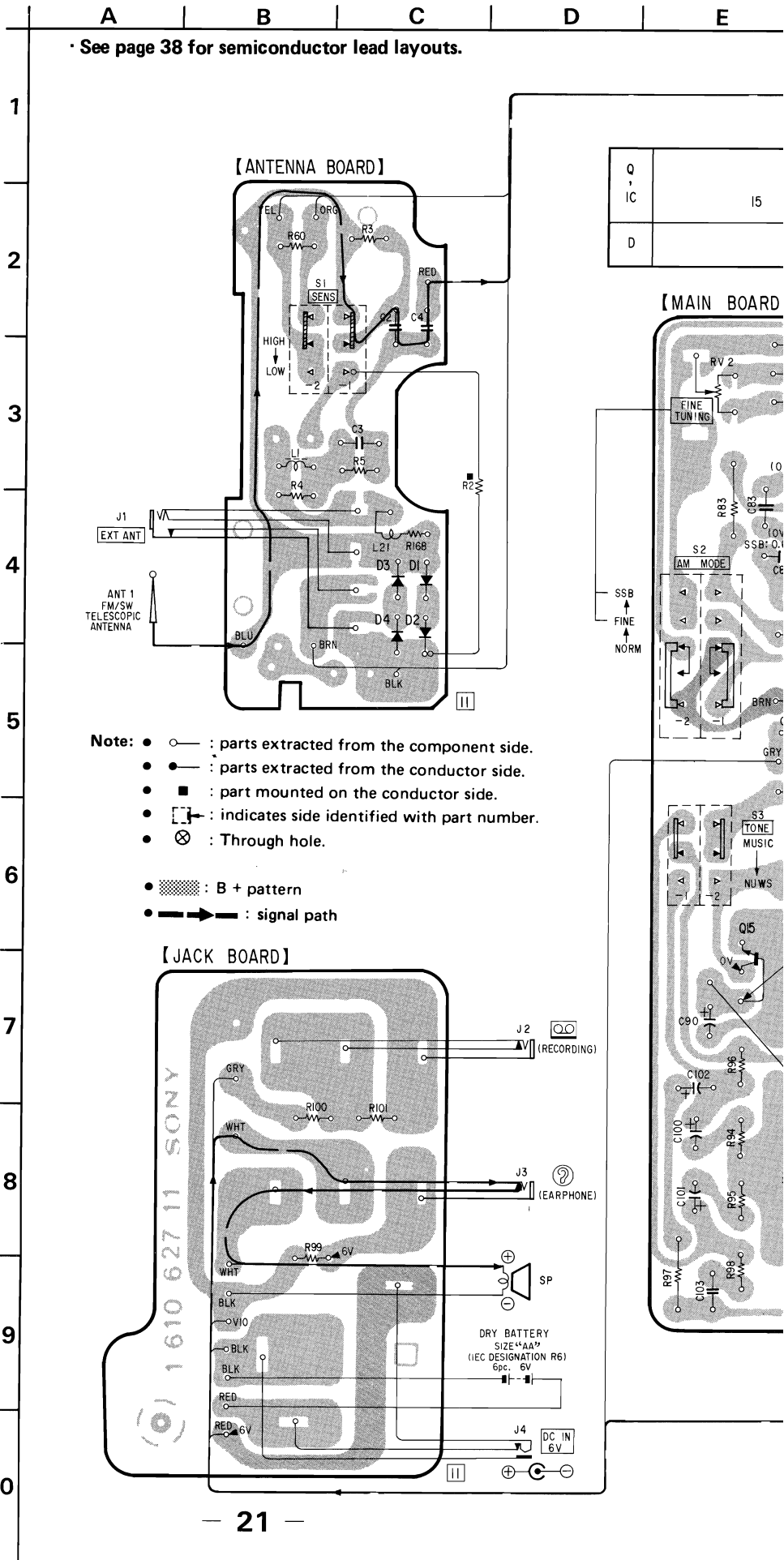

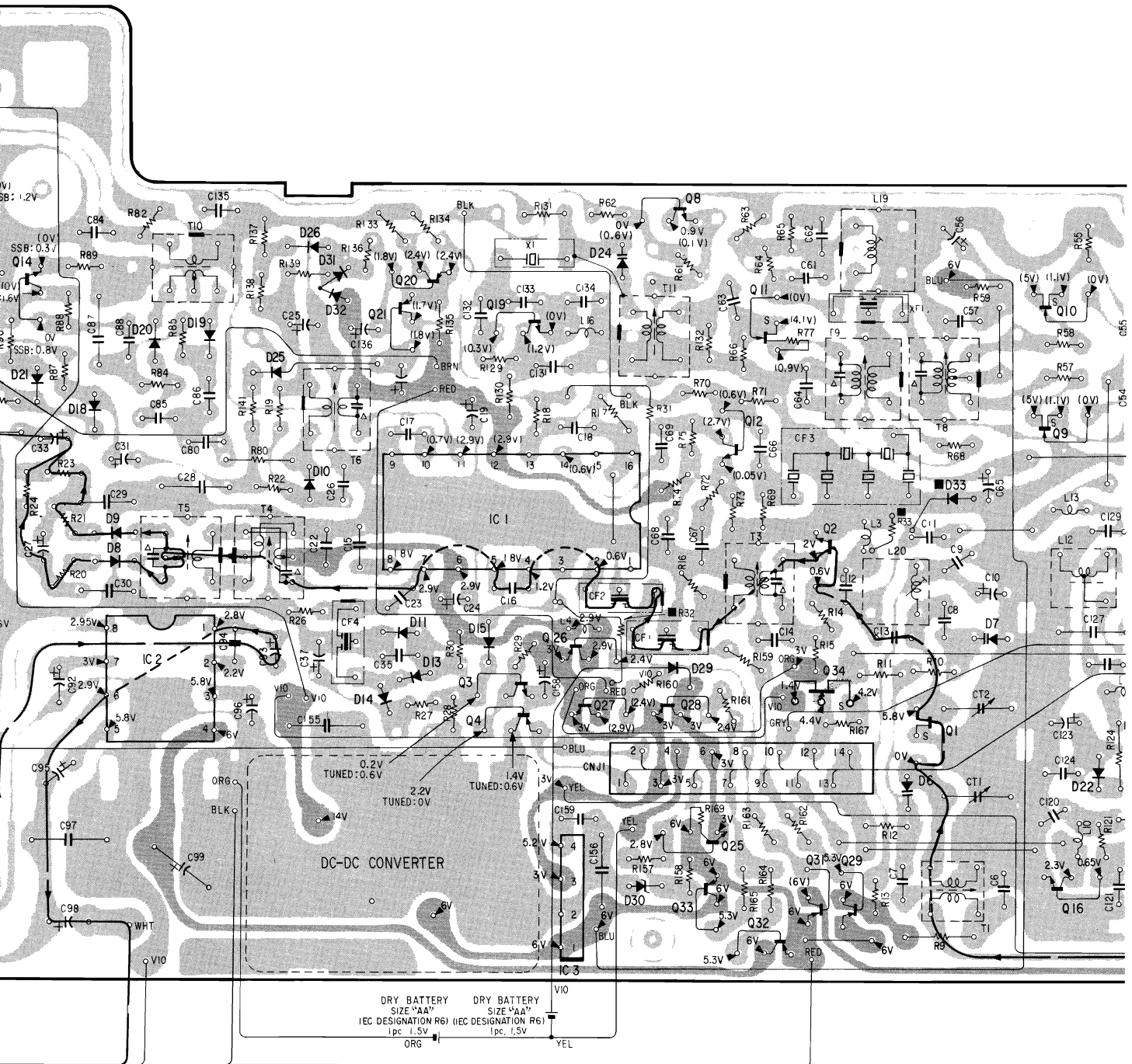
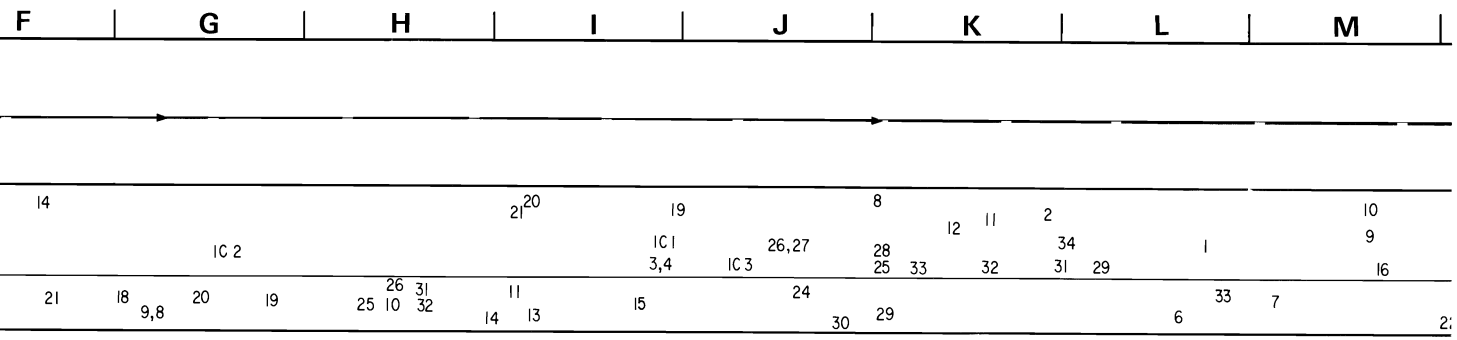

N O P Q R S T U

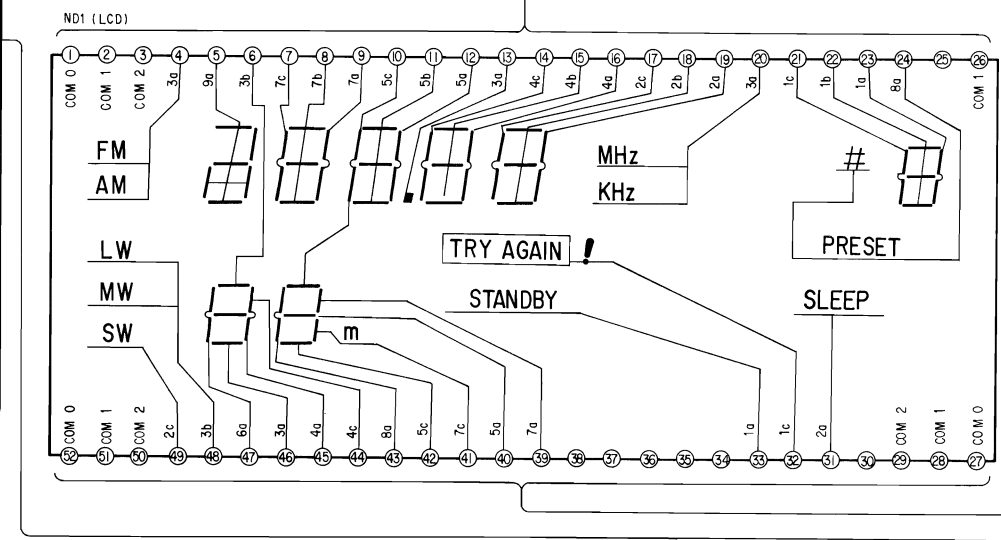
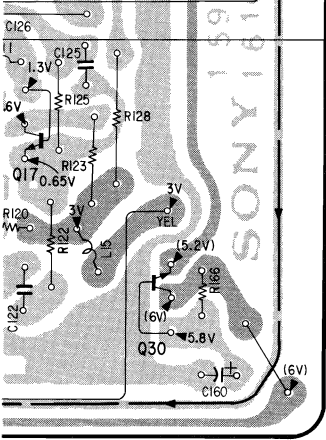
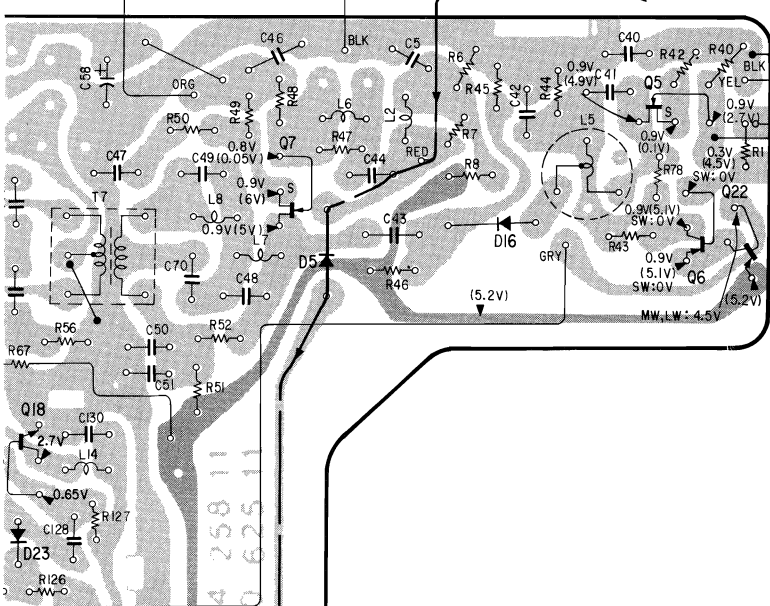
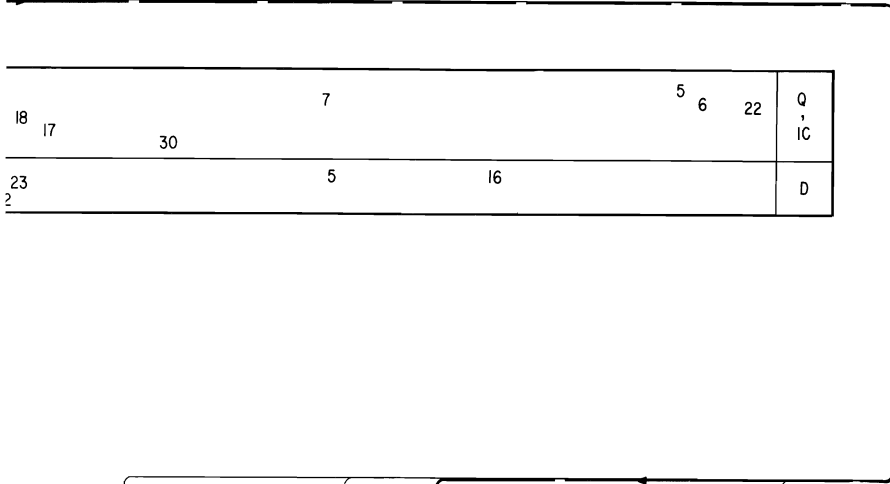

Q	IC
D	

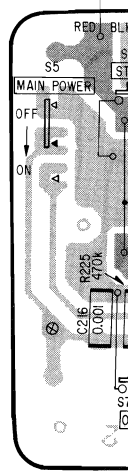
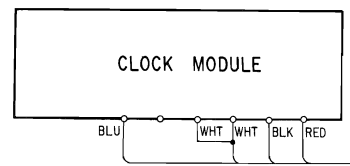

V | W | X | Y | Z | A1 | B1 | C1

Diego Luis Uribe J.

201	205	206	IC201	204	Q
	203	IC202		203	IC
202				204	
201			208	205	D
			207	206	

[SWITCH BOARD]

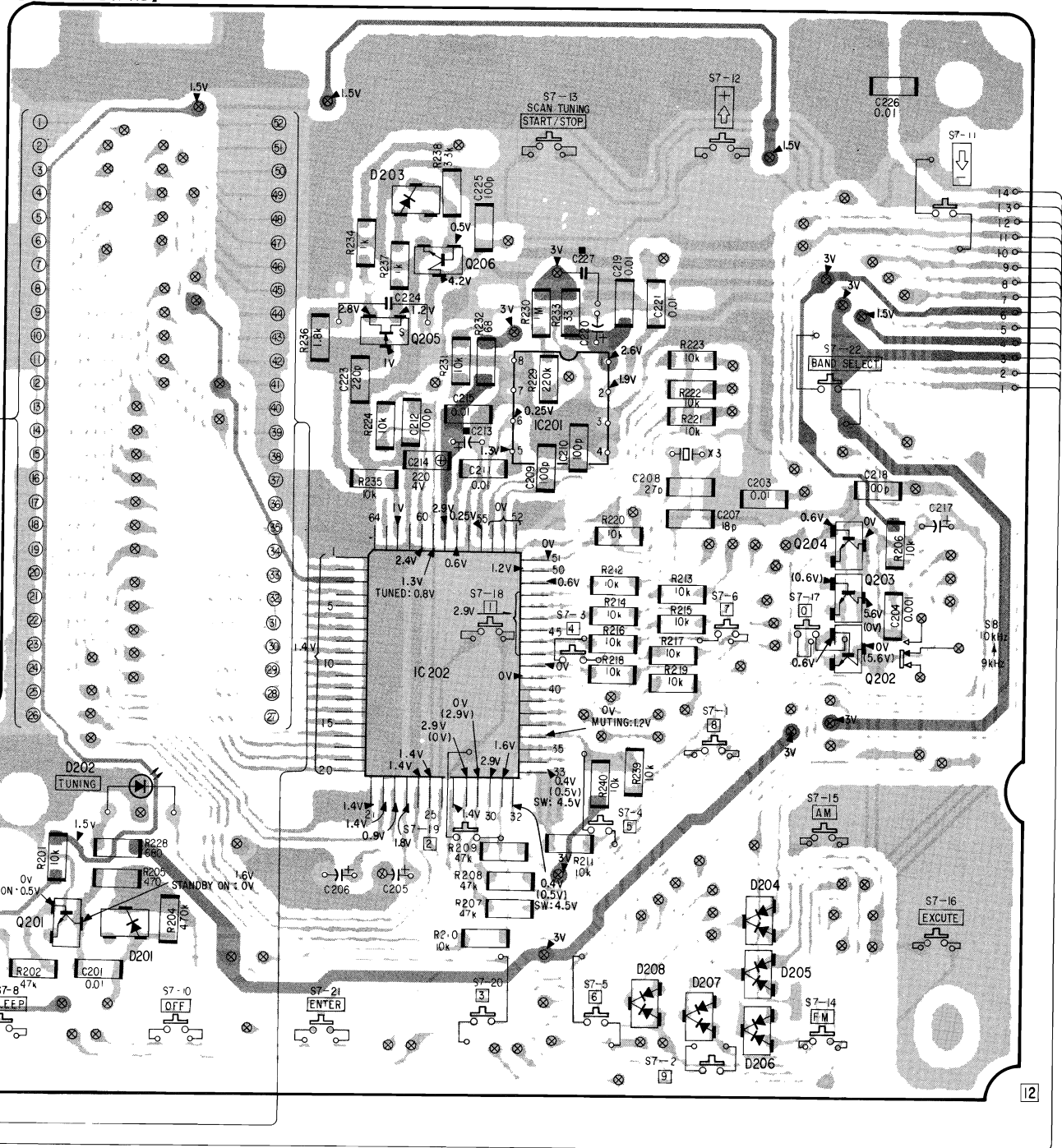



4-2. SCHEMATIC DIAGRAM

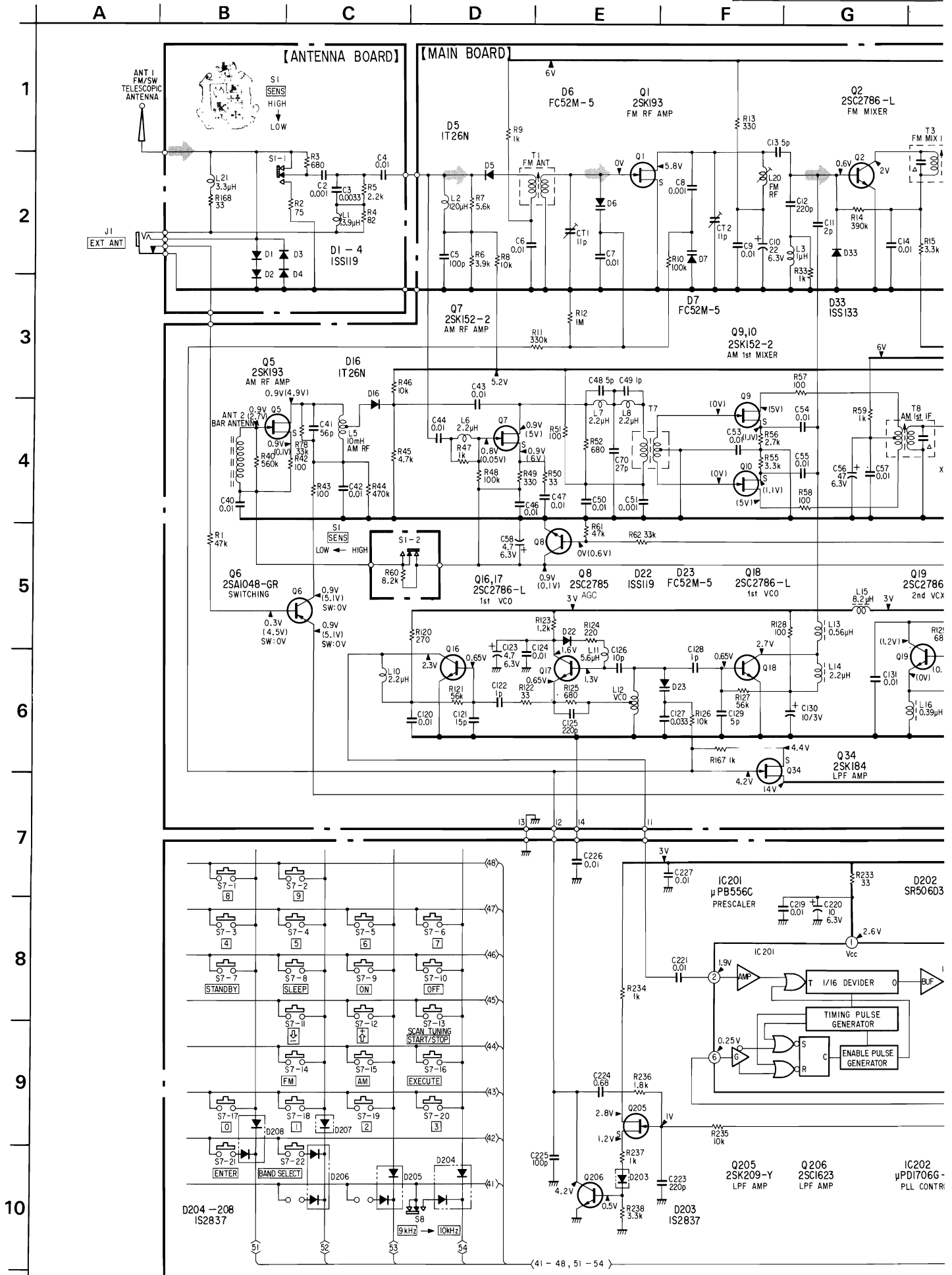



P Q R S T U V W

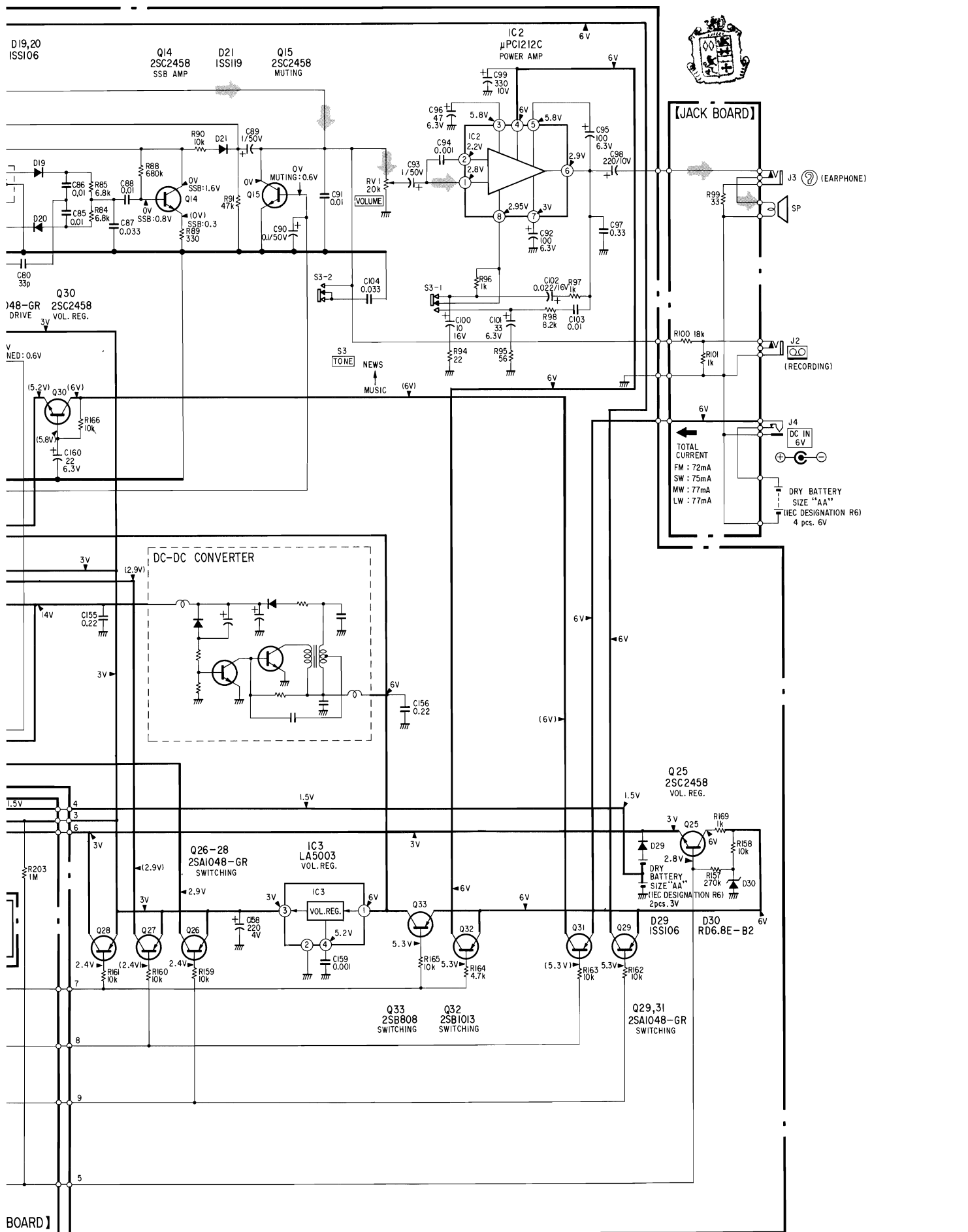

## NOTE FOR SCHEMATIC DIAGRAM

- Note:**
- All capacitors are in  $\mu\text{F}$  unless otherwise noted.  $\text{pF} : \mu\mu\text{F}$   
50WV or less are not indicated except for electrolytics and tantalums.
  - All resistors are in ohms, 1/6W unless otherwise noted.  
 $\text{k}\Omega : 1000 \Omega, \text{M}\Omega : 1000 \text{k}\Omega$
  - $\triangle$  : internal component.
  - : panel designation.
  - : B+ bus.
  - Readings are taken under no-signal (detuned) conditions with a VOM (50  $\text{k}\Omega/\text{V}$ ).  
no mark : FM  
( ) : AM
  - Switch

Ref. No.	Switch	Position
S1	SENS	HIGH
S2	AM MODE	NORM
S3	TONE	MUSIC
S5	MAIN POWER	OFF
S6	TIME SET	OFF
S7- 1	8 (10 key)	OFF
S7- 2	9 (10 key)	OFF
S7- 3	4 (10 key)	OFF
S7- 4	5 (10 key)	OFF
S7- 5	6 (10 key)	OFF
S7- 6	7 (10 key)	OFF
S7- 7	STANDBY	OFF
S7- 8	SLEEP	OFF
S7- 9	ON	OFF
S7-10	OFF	OFF
S7-11	UP	OFF
S7-12	DOWN	OFF
S7-13	START/STOP	OFF
S7-14	FM	OFF
S7-15	AM	OFF
S7-16	EXECUTE	OFF
S7-17	0 (10 key)	OFF
S7-18	1 (10 key)	OFF
S7-19	2 (10 key)	OFF
S7-20	3 (10 key)	OFF
S7-21	ENTER	OFF
S7-22	BAND SELECT	OFF
S8	9kHz-10kHz	9kHz

-  : signal path



H I J K L M N

21	20	19	26	8	11		10		
		3	27	28	12	2	9	18	17
		4							
IC2		IC1	IC3	25	32	34	1	16	7
				33	31	29			30
20	19	26	32	11			6	33	7
		25	31	14	13		22	23	36
					24	30			37
									16
									5

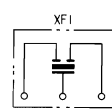

See page 36 for G-AEP model.

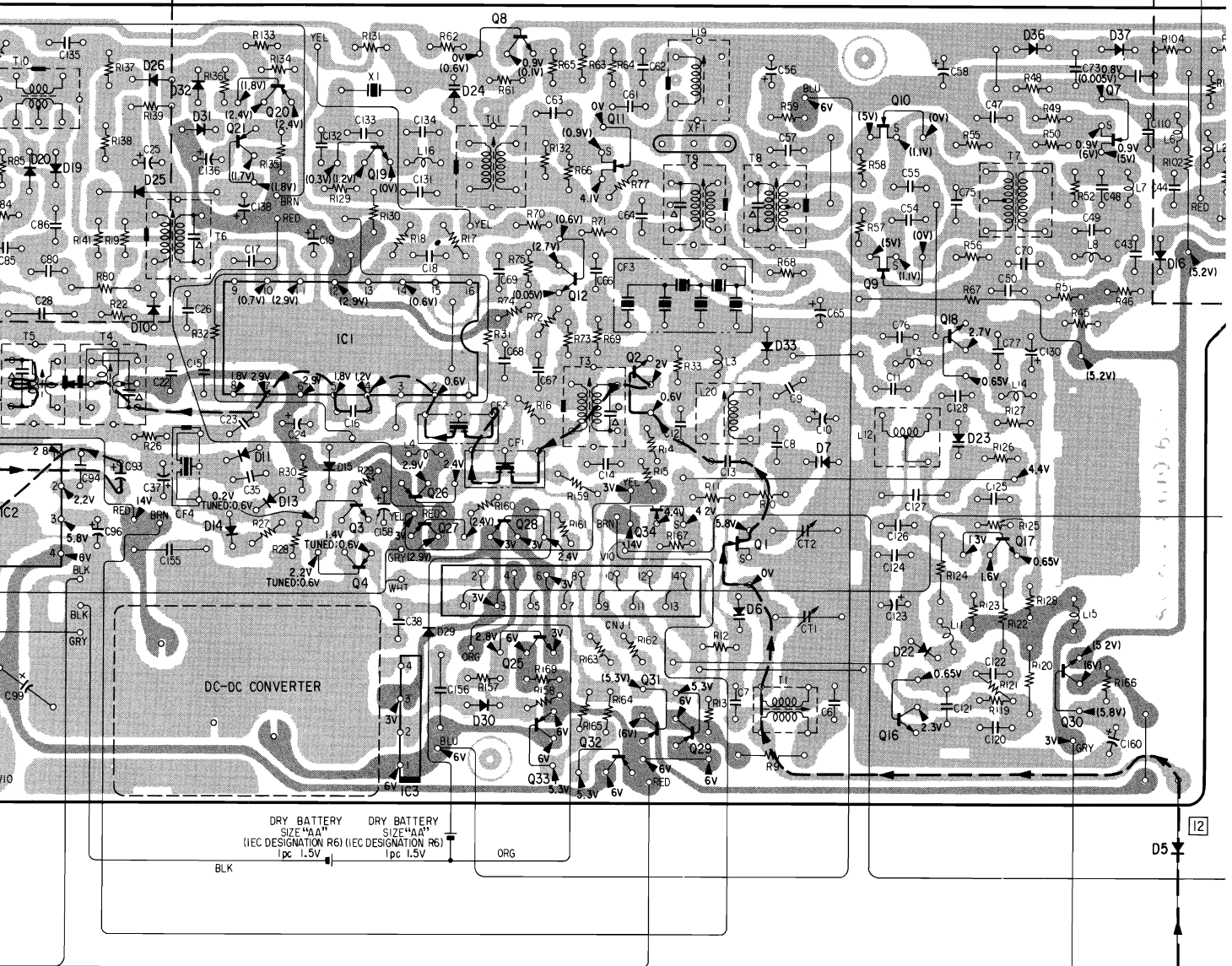

DC-DC CONVERTER

DRY BATTERY SIZE "AAA" (REC DESIGNATION R6) (pc 1.5V)

DRY BATTERY SIZE "AAA" (REC DESIGNATION R6) (pc 1.5V)

BLK

ORG

D5



W X Y Z A1 B1 C1 D1

	205	206 IC202	IC201		204 205 202	Q IC	
	201	203		208	207	204 205 206	D

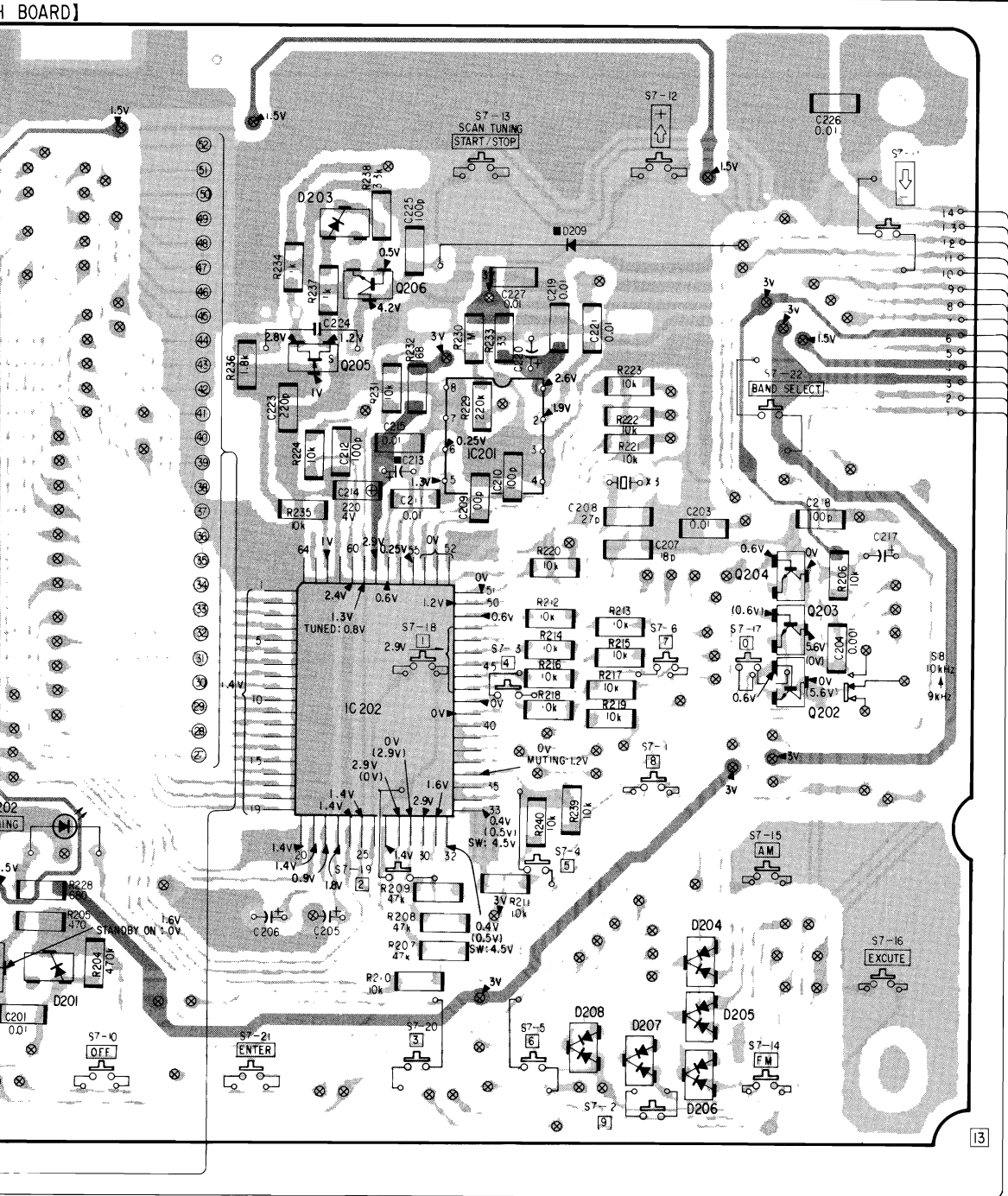





See page 37 for ME model.

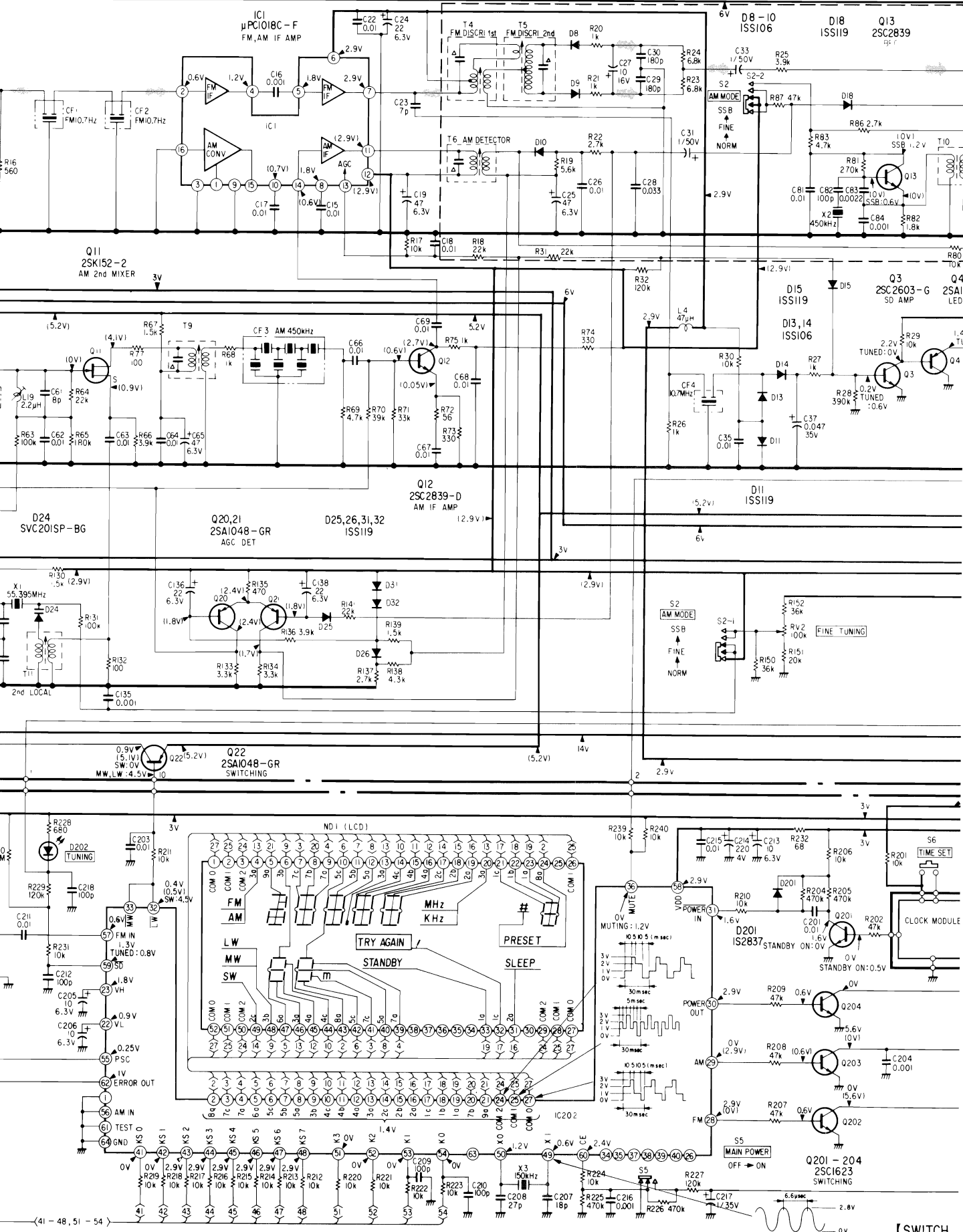

<41 - 48, 51 - 54

[ SWITCH

P Q R S T U V

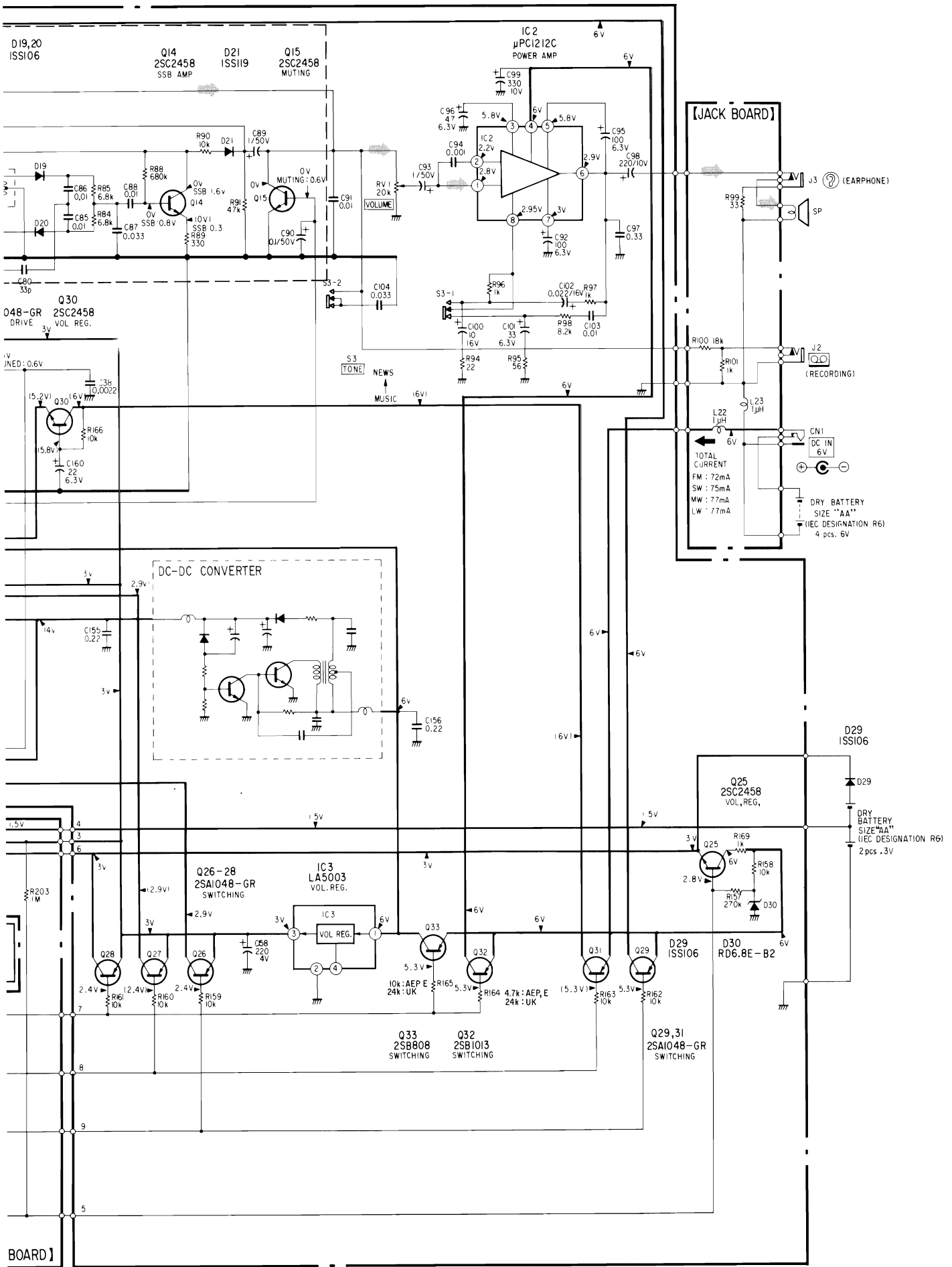

BOARD ]

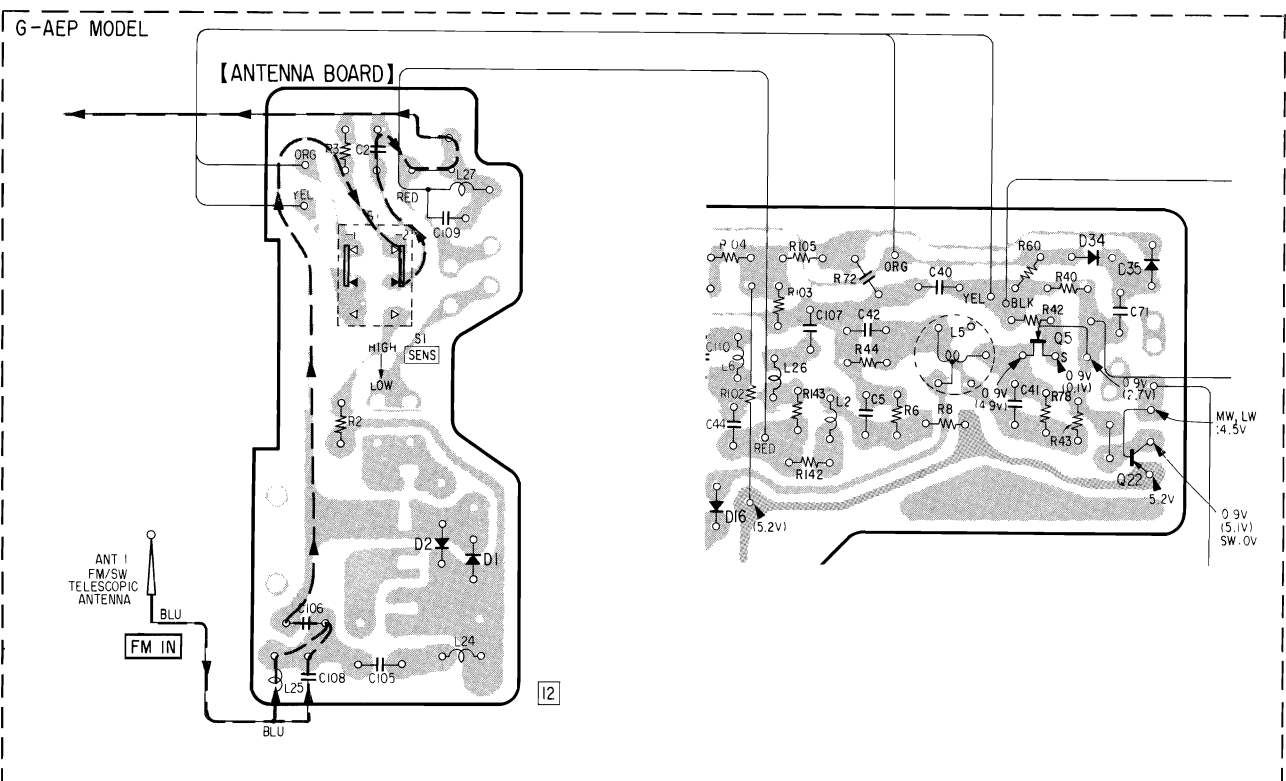
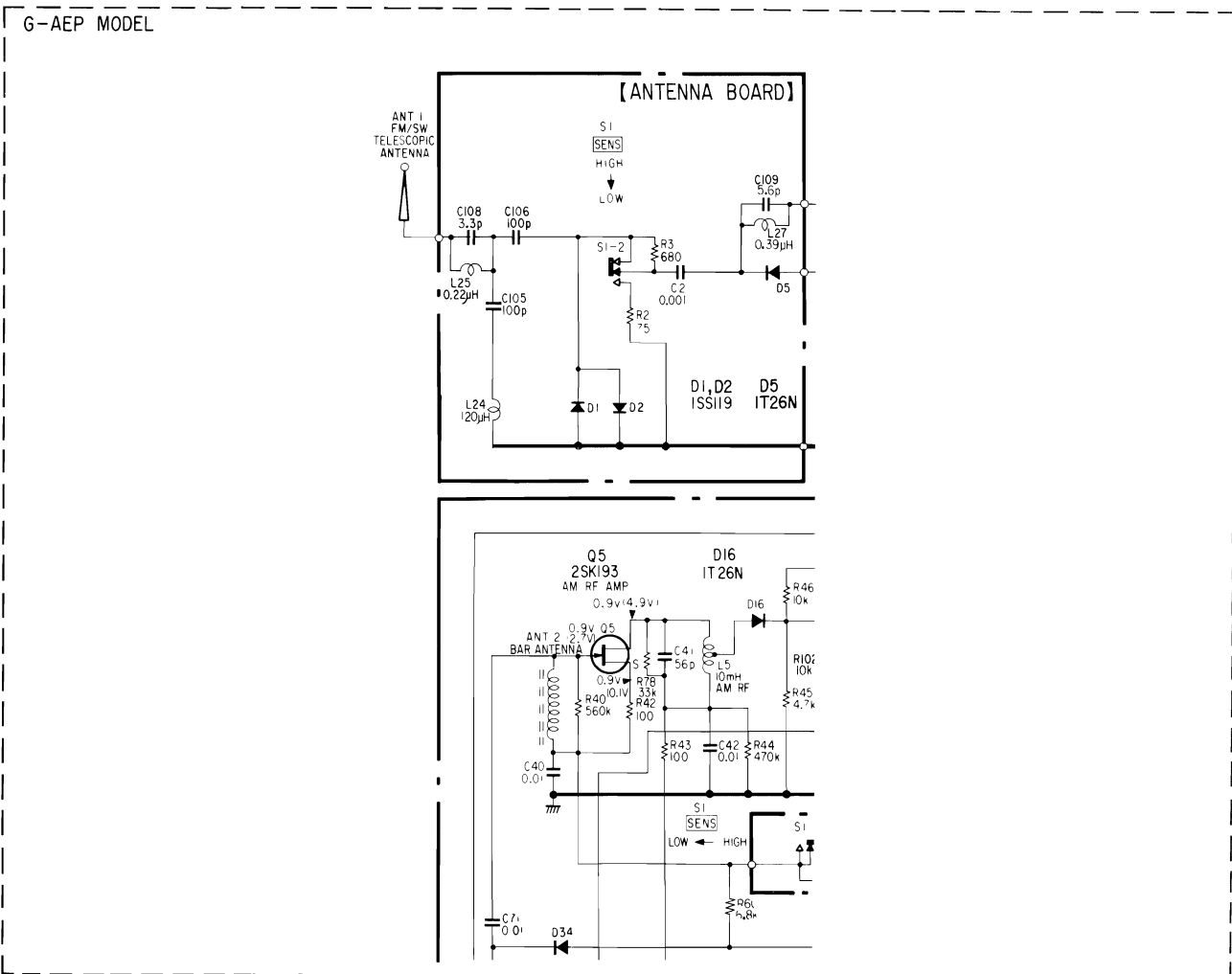

A B C D E F G

1  
2  
3  
4  
5  
6  
7  
8  
9  
0  
11

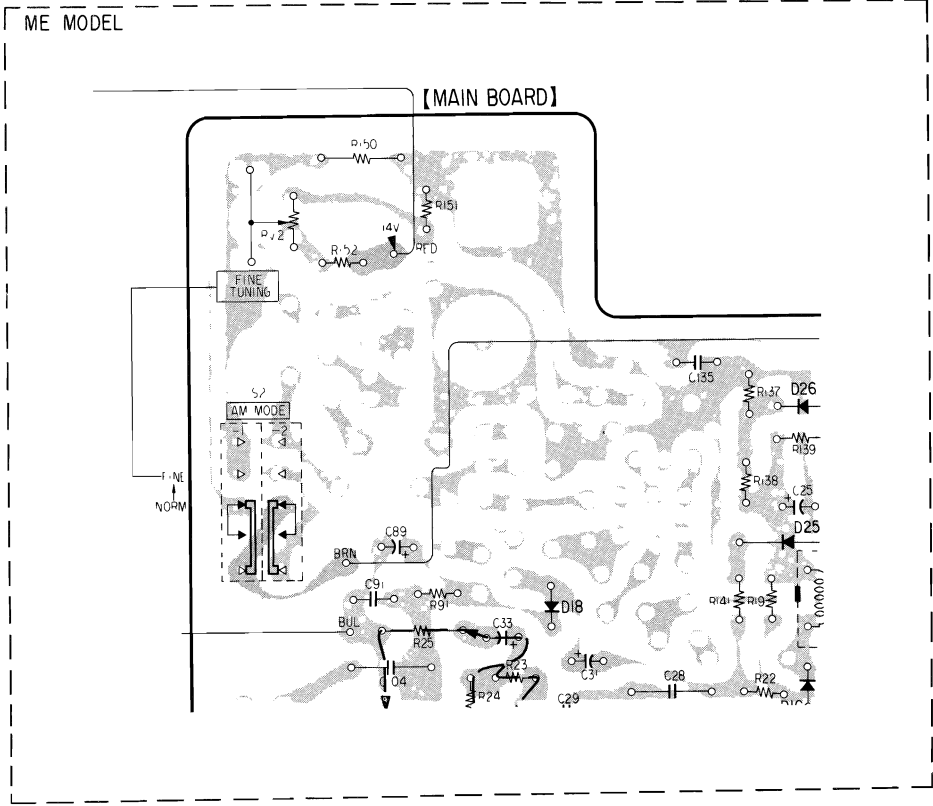
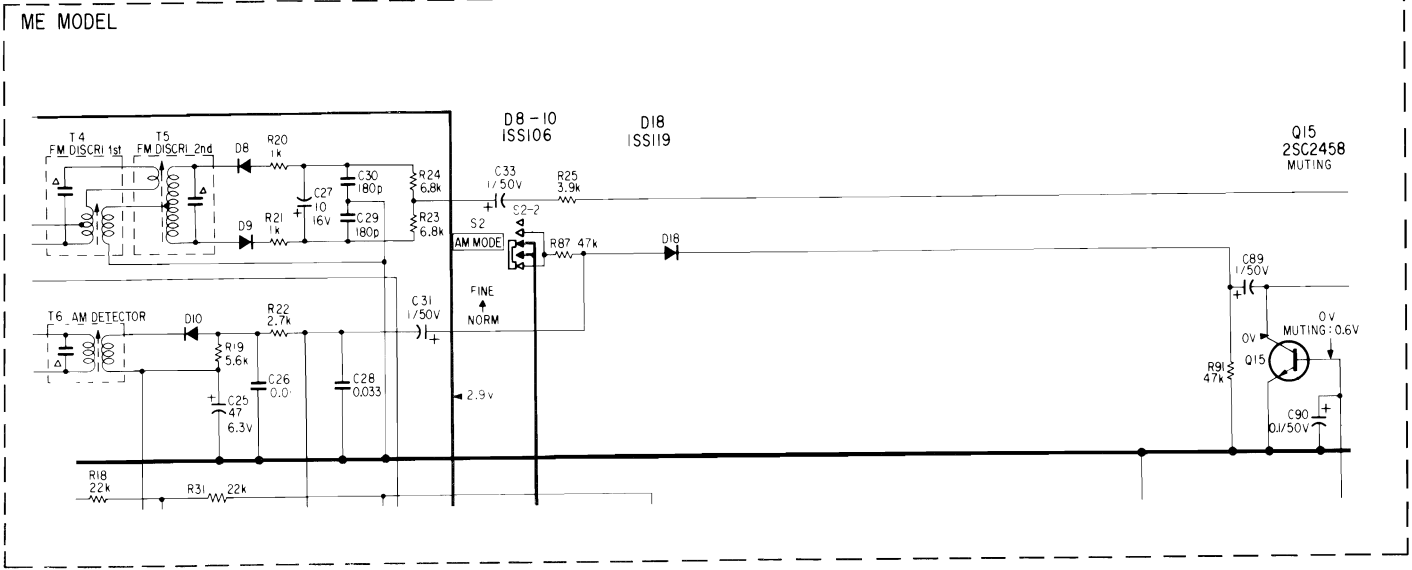

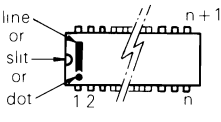
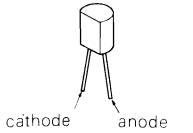
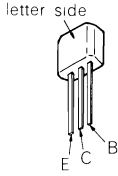
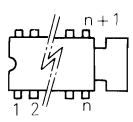
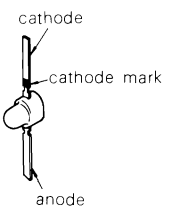
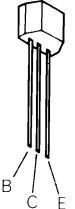
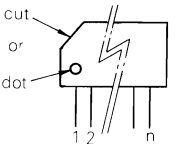
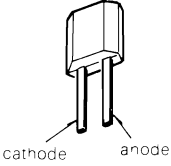
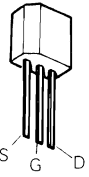
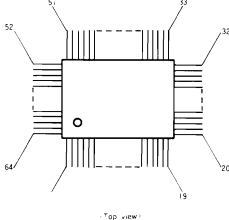
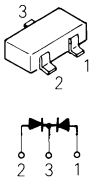
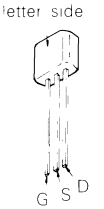
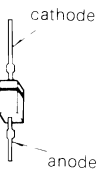

## Semiconductor Lead Layouts

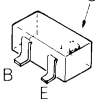
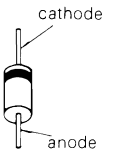
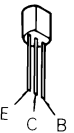
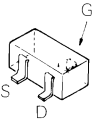
<p><b><math>\mu</math>PB556C</b> <b><math>\mu</math>PC1018C-F</b></p>  <p>(Top view)</p>	<p><b>FC52M-5</b></p> 	<p><b>2SC2603-F</b> <b>2SC2785</b> <b>2SC2786-K</b> <b>2SC2786-L</b></p> 
<p><b><math>\mu</math>PC1212C</b></p>  <p>(Top view)</p>	<p><b>SR506D3</b></p> 	<p><b>2SA1048-GR</b> <b>2SB808</b> <b>2SC2458</b> <b>2SC2839-D</b></p> 
<p><b>LA5003</b></p> 	<p><b>SVC201SP-BG</b></p> 	<p><b>2SK184</b></p> 
<p><b><math>\mu</math>PD1706G-511</b></p>  <p>(Top view)</p>	<p><b>1S2837</b></p> 	<p><b>2SK193-Y</b></p> 
<p><b>1T26N</b></p> 	<p><b>2SK152-2</b></p> 	<p><b>2SC1623</b></p> 
<p><b>1SS106</b> <b>1SS119</b> <b>1SS133</b> <b>RD6.8EB2</b></p> 	<p><b>2SB1013</b></p> 	<p><b>2SK209-Y</b></p> 

SECTION 5  
EXPLODED VIEWS AND PARTS LIST

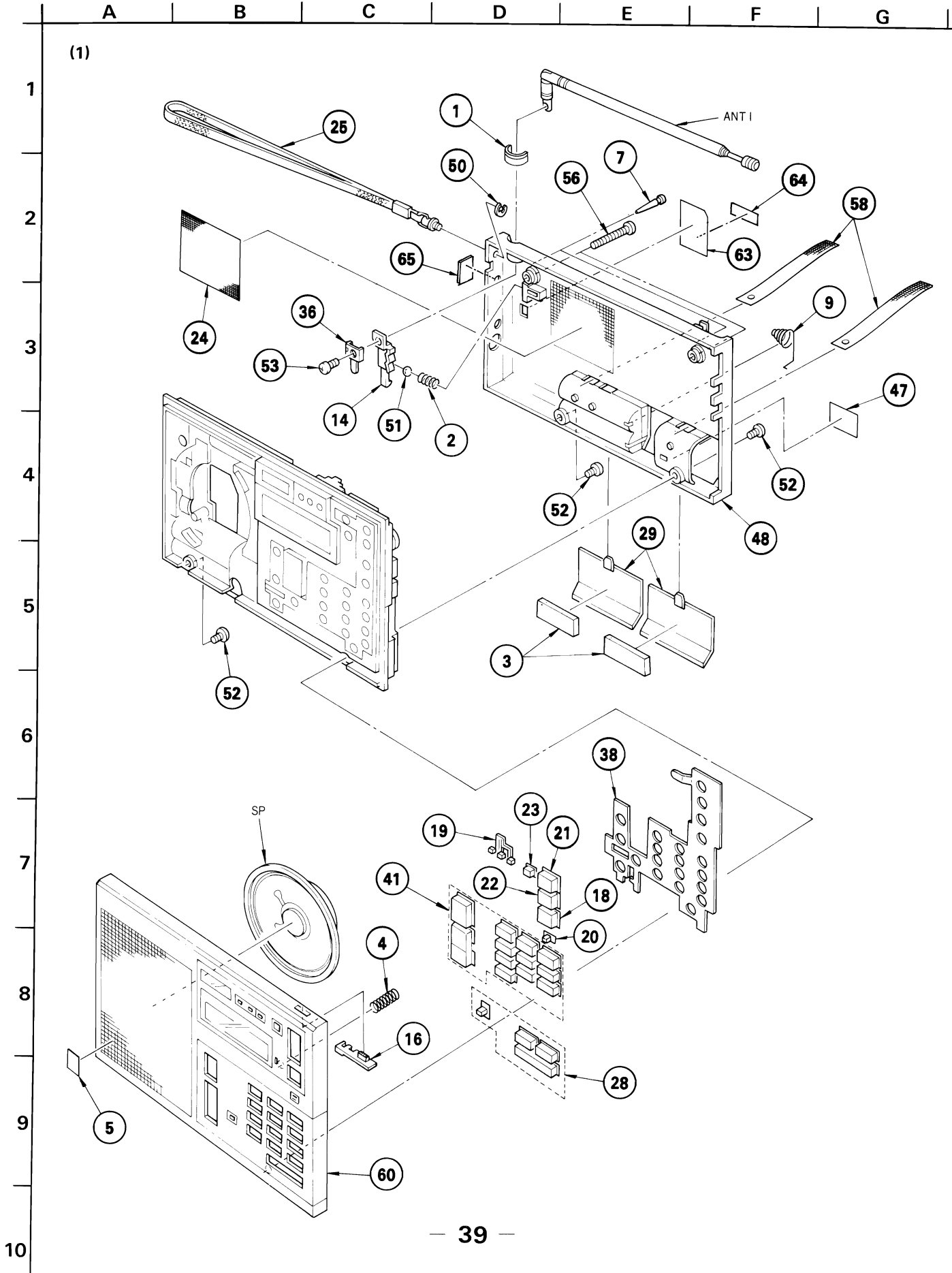

A B C D E F G

(2)

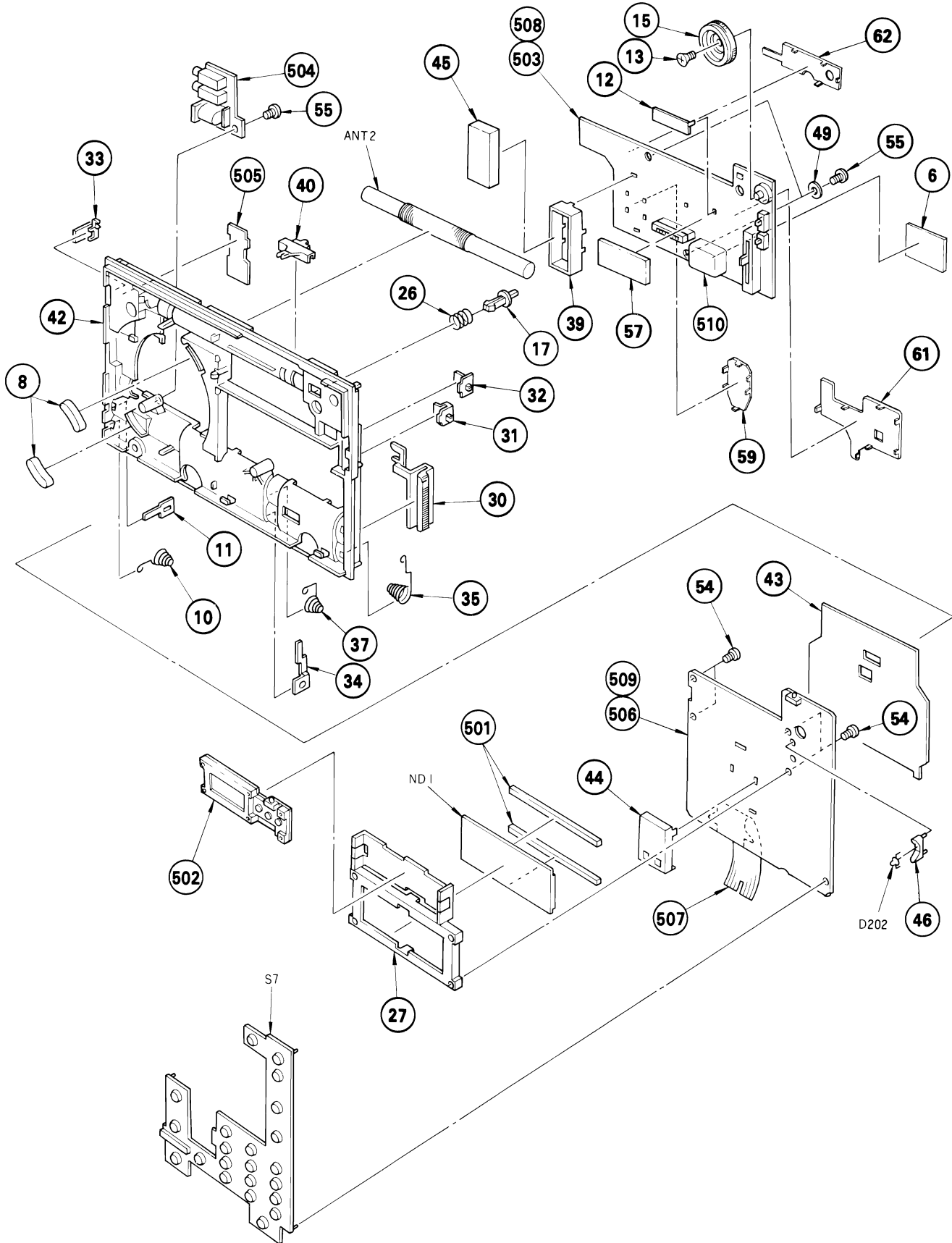



GENERAL SECTION

GENERAL SECTION

No.	Part No.	Description
1	3-891-847-01	GUARD, ANTENNA
2	3-140-063-00	SPRING, COMPRESSION
3	3-485-341-11	CUSHION
4	3-554-017-00	SPRING, COMPRESSION
5	3-703-709-00	STICKER, SONY SYMBOL (15)
6	3-831-441-XX	CUSHION
7	3-880-917-00	STOPPER
8	3-881-931-00	CUSHION, SPEAKER
9	3-883-423-00	SPRING
10	3-883-424-00	SPRING
11	3-883-428-00	PLATE, TERMINAL (POSITIVE)
12	●;3-884-935-00	PLATE (A), SHIELD
13	3-888-156-00	SCREW
14	3-891-802-00	SLIDER (ANTENNA, TELESCOPIC)
15	3-891-803-00	KNOB (FINE)
16	3-891-804-00	KNOB (LOCK)
17	3-891-805-00	BUTTON (TIME SET)
18	3-891-806-00	BUTTON (C)
19	3-891-807-00	BUTTON (D)
20	3-891-808-00	BUTTON (E)
21	3-891-809-01	BUTTON (F)
22	3-891-809-11	BUTTON (F)
23	3-891-810-00	BUTTON (G)
24	3-891-812-00	NET, DUST PROTECTION
25	3-891-813-00	STRAP, HAND
26	3-891-814-00	SPRING, COMPRESSION
27	3-891-815-00	HOLDER
28	3-891-816-00	BUTTON (B)
29	3-891-817-00	LID, BATTERY CASE
30	3-891-818-00	KNOB (VOL)
31	3-891-819-00	KNOB (TONE)
32	3-891-820-00	(AEP,UK,E)...KNOB (MODE)
32	3-891-877-00	(ME)...KNOB (MODE)
33	3-891-821-00	KNOB (SENS)
34	3-891-822-00	TERMINAL, BATTERY
35	3-891-823-00	SPRING (PLUS MINUS)
36	3-891-829-00	TERMINAL BOARD, ANTENNA
37	3-891-830-00	SPRING
38	3-891-834-00	RETAINER, KNOB
39	●;3-891-835-00	CASE (C), SHIELD
40	3-891-837-00	KNOB (SELECT)
41	3-891-839-00	BUTTON (A)
42	3-891-843-00	CHASSIS
43	●;3-891-853-00	PLATE (D), SHIELD
44	●;3-891-854-00	CASE (E), SHIELD
45	●;3-891-863-00	CASE, SHIELD (H)

No.	Part No.	Description
46	3-891-872-00	HOLDER, LED
47	3-891-873-00	LABEL (C)
48	3-891-874-00	LID, REAR, CABINET
49	7-623-954-41	WASHER 3, FIBER
50	7-624-104-04	STOP RING 2.0, TYPE -E
51	7-671-115-01	BALL, STEEL
52	7-682-147-13	SCREW +P 3X6
53	7-682-159-01	SCREW +P 4X5
54	7-685-103-11	SCREW +P 2X5 TYPE2 NON-SLIT
55	7-685-146-11	SCREW +P 3X8 TYPE2 NON-SLIT
56	7-685-152-14	SCREW +P 3X25 TYPE2 NON-SLIT
57	9-911-815-01	CUSHION
58	9-911-816-02	CLOTH, BATTERY DRAWER
59	●;X-3891-806-0	PLATE (G) ASSY, SHIELD
60	X-3891-807-1	(AEP,UK,E).....FRONT PANEL ASSY
60	X-3891-814-1	(SOSA FRANCE)...FRONT PANEL ASSY
60	X-3891-815-1	(G-AEP).....FRONT PANEL ASSY
60	X-3891-816-1	(ME).....FRONT PANEL ASSY
61	X-3891-817-0	PLATE (J) ASSY, SHIELD
62	X-3891-818-0	PLATE (K) ASSY, SHIELD
63	3-890-156-00	LABEL, MODEL NUMBER (JE)
64	●;3-703-593-01	(G-AEP)...LABEL, FTZ
65	3-891-878-00	(G-AEP)...PLATE, BLIND

NOTE:

- Items with no part number and no description are not stocked because they are seldom required for routine service.
- Items marked " ● " are not stocked since they are seldom required for routine service. Some delay should be anticipated when ordering these items.
- Due to standardization, parts with part numbers (Δ-ΔΔΔ-ΔΔΔ-XX or Δ-ΔΔΔΔ-ΔΔΔ-X) may be different from those used in the set.

CAPACITORS:

MF:μF, PF:μμF.

RESISTORS

- All resistors are in ohms.
- F : nonflammable

COILS

- MMH : mH, UH : μH

SEMICONDUCTORS

In each case, U : μ, for example:  
 UA...: μA...; UPA...: μPA...; UPC...: μPC,  
 UPD...: μPD...

## ACCESSORY & PACKING MATERIAL

No.	Part No.	Description
101	▲ 1-463-454-00	ADAPTOR, AC (AC-240)
102	1-501-283-00	ANTENNA, WIRE (AM)
103	1-504-059-11	MAGNETIC EARPHONE (ME-20H)
104	1-506-443-00	ADAPTOR, PLUG
105	3-701-616-00	BAG, POLYETHYLENE
106	3-701-617-00	BAG, POLYETHYLENE
107	3-701-620-00	BAG, POLYETHYLENE
108	3-703-539-01	(G-AEP)...INSTRUCTION, FTZ
109	3-887-285-01	BOOK, RADIO GUIDE
110	3-890-830-00	BAG, POLYETHYLENE
111	3-891-848-00	CASE, CARRYING
112	3-891-849-00	CASE, ACCESSORY
113	3-891-850-00	INDIVIDUAL CARTON
114	3-891-851-00	CUSHION
115	3-891-883-00	(G-AEP)...FRAME, INNER, ACCESSORY
116	3-995-966-11	(AEP,E)...MANUAL, INSTRUCTION
117	3-995-966-41	(G-AEP)...MANUAL, INSTRUCTION
118	3-995-966-51	(UK).....MANUAL, INSTRUCTION
119	3-995-966-61	(AEP,E)...MANUAL, INSTRUCTION
120	3-995-966-71	(ME).....MANUAL, INSTRUCTION
121	X-3891-802-0	ANTENNA ASSY, WIRE, AM
122	3-891-892-01	(UK)....LABEL (UK)

## ELECTRICAL PARTS

Ref.No.	Part No.	Description
501	1-535-468-00	CONDUCTOR, CONNECTOR
502	1-548-136-00	CLOCK MODULE
503	●;1-610-625-00	PC BOARD, MAIN
504	●;1-610-627-00	PC BOARD, JACK
505	●;1-610-628-00	PC BOARD, ANTENNA
506	●;1-610-629-00	PC BOARD, SWITCH
507	1-610-740-00	PC BOARD, JOINT
508	●;A-3660-443-A	(AEP,E)...MOUNTED PCB, MAIN
508	●;A-3660-461-A	(G-AEP)...MOUNTED PCB, MAIN
508	●;A-3660-462-A	(ME).....MOUNTED PCB, MAIN
508	●;A-3660-464-A	(UK).....MOUNTED PCB, MAIN
508	●;A-3661-177-A	(E Former Type)...MOUNTED PCB, MAIN
509	●;A-3681-177-A	(AEP,E)...MOUNTED PCB, SWITCH
505	●;A-3681-181-A	(AEP,E)...MOUNTED PCB, SWITCH
510	A-3689-039-A	(AEP,E)...DC-DC CONVERTER
510	A-3689-045-A	(UK).....DC-DC CONVERTER
ANT1	1-501-255-00	ANTENNA, TELESCOPIC
ANT2	1-402-022-12	ANTENNA, FERRITE-ROD (LW/MW)
C2	1-161-026-00	CERAMIC 0.001MF 20% 25V
C3	1-161-029-00	(G-AEP:NOT USED)...CERAMIC 0.0033MF 20% 25V
C4	1-161-032-00	(G-AEP:NOT USED)...CERAMIC 0.01MF 20% 25V
C5	1-161-039-00	CERAMIC 0.001MF 20% 50V
C6	1-161-032-00	CERAMIC 0.01MF 20% 25V
C7	1-161-032-00	CERAMIC 0.01MF 20% 25V
C8	1-161-043-00	CERAMIC 0.0022MF 20% 50V
C9	1-161-032-00	CERAMIC 0.01MF 20% 25V
C10	1-123-618-00	ELECT 22MF 20% 6.3V
C11	1-102-935-00	CERAMIC 2PF 0.25PF 50V
C12	1-102-110-00	CERAMIC 220PF 10% 50V
C13	1-102-942-00	CERAMIC 5PF 0.5PF 50V
C14	1-161-032-00	CERAMIC 0.01MF 20% 25V
C15	1-161-032-00	CERAMIC 0.01MF 20% 25V
C16	1-101-001-00	CERAMIC 0.001MF 50V
C17	1-161-032-00	CERAMIC 0.01MF 20% 25V
C18	1-161-032-00	CERAMIC 0.01MF 20% 25V
C19	1-123-647-00	ELECT 47MF 20% 6.3V
C22	1-161-032-00	CERAMIC 0.01MF 20% 25V
C23	1-102-944-00	CERAMIC 7PF 0.5PF 50V
C24	1-123-618-00	ELECT 22MF 20% 6.3V
C25	1-123-647-00	ELECT 47MF 20% 6.3V
C26	1-161-032-00	CERAMIC 0.01MF 20% 25V
C27	1-123-617-00	ELECT 10MF 20% 16V

### NOTE:

- Items with no part number and no description are not stocked because they are seldom required for routine service.
- Items marked "●" are not stocked since they are seldom required for routine service. Some delay should be anticipated when ordering these items.
- Due to standardization, parts with part numbers (Δ-ΔΔΔ-ΔΔΔ-XX or Δ-ΔΔΔΔ-ΔΔΔ-X) may be different from those used in the set.
- If there are two or more same circuits in a set such as a stereophonic machine, only typical circuit parts may be indicated and capacitors and resistors in other same circuits may be omitted.

### CAPACITORS:

MF:μF, PF:μμF.

### RESISTORS

- All resistors are in ohms.
- F : nonflammable

### COILS

- MMH : mH, UH : μH

### SEMICONDUCTORS

In each case, U : μ, for example:  
 UA...: μA..., UPA...: μPA..., UPC...: μPC,  
 UPD...: μPD...

The components identified by shading and mark ▲ are critical for safety. Replace only with part number specified.

## ELECTRICAL PARTS

Ref.No.	Part No.	Description			
C28	1-161-035-00	CERAMIC	0.033MF	20%	25V
C29	1-102-976-00	CERAMIC	180PF	10%	50V
C30	1-102-976-00	CERAMIC	180PF	10%	50V
C31	1-123-611-00	ELECT	1MF	20%	50V
C33	1-123-611-00	ELECT	1MF	20%	50V
C35	1-161-032-00	CERAMIC	0.01MF	20%	25V
C37	1-131-400-00	TANTALUM	0.047MF	20%	35V
C38	1-161-043-00	CERAMIC	0.0022MF	20%	25V
C40	1-161-032-00	CERAMIC	0.01MF	20%	25V
C41	1-101-884-00	CERAMIC	56PF	10%	50V
C42	1-161-032-00	CERAMIC	0.01MF	20%	25V
C43	1-161-032-00	CERAMIC	0.01MF	20%	25V
C44	1-161-032-00	CERAMIC	0.01MF	20%	25V
C47	1-161-032-00	CERAMIC	0.01MF	20%	25V
C48	1-102-942-00	CERAMIC	5PF	0.5PF	50V
C49	1-102-934-00	CERAMIC	1PF	0.25PF	50V
C50	1-161-032-00	CERAMIC	0.01MF	20%	25V
C54	1-161-032-00	CERAMIC	0.01MF	20%	25V
C55	1-161-032-00	CERAMIC	0.01MF	20%	25V
C56	1-123-647-00	ELECT	47MF	20%	6.3V
C57	1-161-032-00	CERAMIC	0.01MF	20%	25V
C58	1-123-647-00	ELECT	47MF	20%	6.3V
C61	1-102-945-00	CERAMIC	8PF	0.5PF	50V
C62	1-161-032-00	CERAMIC	0.01MF	20%	25V
C63	1-161-032-00	CERAMIC	0.01MF	20%	25V
C64	1-161-032-00	CERAMIC	0.01MF	20%	25V
C65	1-123-647-00	ELECT	47MF	20%	6.3V
C66	1-161-032-00	CERAMIC	0.01MF	20%	25V
C67	1-161-032-00	CERAMIC	0.01MF	20%	25V
C68	1-161-032-00	CERAMIC	0.01MF	20%	25V
C69	1-161-032-00	CERAMIC	0.01MF	20%	25V
C70	1-102-961-00	CERAMIC	27PF	5%	50V
C71	1-161-051-00	CERAMIC	0.01MF	10%	50V
C72	1-161-051-00	CERAMIC	0.01MF	10%	50V
C73	1-161-051-00	CERAMIC	0.01MF	10%	50V
C74	1-161-051-00	CERAMIC	0.01MF	10%	50V
C75	1-102-947-00	CERAMIC	10PF	5%	50V
C76	1-102-953-00	CERAMIC	18PF	5%	50V
C77	1-102-959-00	CERAMIC	18PF	5%	50V
C80	1-102-963-00	(ME:NOT USED)..CERAMIC	33PF	5%	50V
C81	1-161-032-00	(ME:NOT USED)..CERAMIC	0.01MF	20%	25V
C82	1-102-973-00	(ME:NOT USED)..CERAMIC	100PF	5%	50V
C83	1-161-028-00	(ME:NOT USED)..CERAMIC	0.0022MF	20%	25V
C84	1-161-026-00	(ME:NOT USED)..CERAMIC	0.001MF	20%	25V
C85	1-161-032-00	(ME:NOT USED)..CERAMIC	0.01MF	20%	25V

## ELECTRICAL PARTS

Ref.No.	Part No.	Description			
C86	1-161-032-00	(ME:NOT USED)..CERAMIC	0.01MF	20%	25V
C87	1-161-035-00	(ME:NOT USED)..CERAMIC	0.033MF	20%	25V
C88	1-161-032-00	(ME:NOT USED)..CERAMIC	0.01MF	20%	25V
C89	1-123-611-00	ELECT	1MF	20%	50V
C90	1-123-607-00	ELECT	0.1MF	20%	50V
C91	1-161-032-00	CERAMIC	0.01MF	20%	25V
C92	1-123-661-00	ELECT	100MF	20%	6.3V
C93	1-123-611-00	ELECT	1MF	20%	50V
C94	1-101-001-00	CERAMIC	0.001MF		50V
C95	1-123-661-00	ELECT	100MF	20%	6.3V
C96	1-123-647-00	ELECT	47MF	20%	6.3V
C97	1-130-774-00	FILM	0.33MF	10%	63V
C98	1-123-308-00	ELECT	220MF	20%	10V
C99	1-123-309-00	ELECT	330MF	20%	10V
C100	1-123-617-00	ELECT	10MF	20%	16V
C101	1-123-646-00	ELECT	33MF	20%	6.3V
C102	1-131-398-00	TANTALUM	0.022MF	20%	35V
C103	1-161-032-00	CERAMIC	0.01MF	20%	25V
C104	1-161-035-00	CERAMIC	0.033MF	20%	25V
C105	1-102-106-00	CERAMIC	100PF	10%	50V
C106	1-102-106-00	CERAMIC	100PF	10%	50V
C107	1-102-113-00	CERAMIC	390PF	10%	50V
C108	1-162-007-00	CERAMIC	3.3PF	10%	50V
C109	1-162-010-00	CERAMIC	5.6PF	10%	50V
C110	1-102-937-00	CERAMIC	4PF	0.25PF	50V
C120	1-161-032-00	CERAMIC	0.01MF	20%	25V
C121	1-102-951-00	CERAMIC	15PF	5%	50V
C122	1-102-934-00	CERAMIC	1PF	0.25PF	50V
C123	1-123-647-00	ELECT	47MF	20%	6.3V
C124	1-161-032-00	CERAMIC	0.01MF	20%	25V
C125	1-102-110-00	CERAMIC	220PF	10%	50V
C126	1-102-947-00	CERAMIC	10PF	5%	50V
C127	1-161-035-00	CERAMIC	0.033MF	20%	25V
C128	1-102-934-00	CERAMIC	1PF	0.25PF	50V
C130	1-131-389-00	TANTALUM	10MF	20%	3.15V
C131	1-161-032-00	CERAMIC	0.01MF	20%	25V
C132	1-101-884-00	CERAMIC	56PF	10%	50V
C133	1-101-880-00	CERAMIC	47PF	10%	50V
C134	1-101-884-00	CERAMIC	56PF	10%	50V
C135	1-161-026-00	CERAMIC	0.001MF	20%	25V
C136	1-123-618-00	ELECT	22MF	20%	6.3V
C138	1-123-618-00	ELECT	22MF	20%	6.3V

**NOTE:**

- Items with no part number and no description are not stocked because they are seldom required for routine service.
- Items marked "●" are not stocked since they are seldom required for routine service. Some delay should be anticipated when ordering these items.
- Due to standardization, parts with part numbers (Δ-ΔΔΔ-ΔΔΔ-XX or Δ-ΔΔΔΔ-ΔΔΔ-X) may be different from those used in the set.
- If there are two or more same circuits in a set such as a stereophonic machine, only typical circuit parts may be indicated and capacitors and resistors in other same circuits may be omitted.

**CAPACITORS:**

MF:μF, PF:μμF.

**RESISTORS**

- All resistors are in ohms.
- F : nonflammable

**COILS**

- MMH : mH, UH : μH

**SEMICONDUCTORS**

In each case, U : μ, for example:  
 UA...: μA..., UPA...: μPA..., UPC...: μPC,  
 UPD...: μPD...

ELECTRICAL PARTS

Ref.No.	Part No.	Description			
C155	1-130-772-00	FILM	0.22MF	10%	63V
C156	1-130-772-00	FILM	0.22MF	10%	63V
C158	1-123-827-00	ELECT	220MF	20%	4V
C159	1-101-001-00	CERAMIC	0.001MF		50V
C160	1-123-618-00	ELECT	22MF	20%	6.3V
C201	1-163-059-00	CERAMIC CHIP	0.01MF	10%	50V
C203	1-163-059-00	CERAMIC CHIP	0.01MF	10%	50V
C204	1-163-047-00	CERAMIC CHIP	0.001MF	10%	50V
C205	1-124-435-00	ELECT	10MF	20%	6.3V
C206	1-124-435-00	ELECT	10MF	20%	6.3V
C207	1-163-163-00	CERAMIC CHIP	18PF	5%	50V
C208	1-163-167-00	CERAMIC CHIP	27PF	5%	50V
C209	1-163-181-00	CERAMIC CHIP	100PF	5%	50V
C210	1-163-181-00	CERAMIC CHIP	100PF	5%	50V
C211	1-163-059-00	CERAMIC CHIP	0.01MF	10%	50V
C212	1-163-181-00	CERAMIC CHIP	100PF	5%	50V
C213	1-131-383-00	TANTALUM	10MF	20%	6.3V
C214	1-123-827-00	ELECT	220MF	20%	4V
C215	1-163-059-00	CERAMIC CHIP	0.01MF	10%	50V
C216	1-163-047-00	CERAMIC CHIP	0.001MF	10%	50V
C217	1-124-438-00	ELECT	1MF	20%	50V
C218	1-163-181-00	CERAMIC CHIP	100PF	5%	50V
C219	1-163-059-00	CERAMIC CHIP	0.01MF	10%	50V
C220	1-131-383-00	TANTALUM	10MF	20%	6.3V
C221	1-163-059-00	CERAMIC CHIP	0.01MF	10%	50V
C223	1-163-189-00	CERAMIC CHIP	220PF	5%	50V
C224	1-130-832-00	FILM	0.68MF	10%	63V
C225	1-163-181-00	CERAMIC CHIP	100PF	5%	50V
C226	1-163-047-00	CERAMIC CHIP	0.001MF	5%	50V
C227	1-163-059-00	CERAMIC	0.01MF	10%	50V
CF1	1-527-795-71	FILTER, CERAMIC			
CF2	1-527-795-71	FILTER, CERAMIC			
CF3	1-567-106-00	FILTER, CERAMIC			
CF4	1-567-107-00	FILTER, CERAMIC			
CNJ1	1-562-283-00	SOCKET, CONNECTOR	14P		
CT1	1-141-232-00	CAP, TRIMAR	11PF		
CT2	1-141-232-00	CAP, TRIMAR	11PF		
D1	8-719-911-19	DIODE	1SS119		
D2	8-719-911-19	DIODE	1SS119		
D5	8-719-104-15	DIODE	1T26N		
D6	8-719-907-19	DIODE	FC52M-5		
D7	8-719-907-19	DIODE	FC52M-5		
D8	8-719-911-06	DIODE	1SS106		

ELECTRICAL PARTS

Ref.No.	Part No.	Description
D9	8-719-911-06	DIODE 1SS106
D10	8-719-911-06	DIODE 1SS106
D11	8-719-911-19	DIODE 1SS119
D13	8-719-911-06	DIODE 1SS106
D14	8-719-911-06	DIODE 1SS106
D15	8-719-911-19	DIODE 1SS119
D16	8-719-104-15	DIODE 1T26N
D18	8-719-911-19	DIODE 1SS119
D19	8-719-911-06	(ME:NOT USED)...DIODE 1SS106
D20	8-719-911-06	(ME:NOT USED)...DIODE 1SS106
D21	8-719-911-19	(ME:NOT USED)...DIODE 1SS119
D22	8-719-911-19	DIODE 1SS119
D23	8-719-907-19	DIODE FC52M-5
D24	8-719-912-03	DIODE SVC201SP-BG
D25	8-719-911-19	DIODE 1SS119
D26	8-719-911-19	DIODE 1SS119
D29	8-719-911-06	DIODE 1SS106
D30	8-719-100-41	DIODE RD6.8EB2
D31	8-719-911-19	DIODE 1SS119
D32	8-719-911-19	DIODE 1SS119
D33	8-719-901-33	DIODE 1SS133
D34	8-719-911-19	DIODE 1SS119
D35	8-719-911-19	DIODE 1SS119
D36	8-719-911-19	DIODE 1SS119
D37	8-719-911-19	DIODE 1SS119
D201	8-719-100-05	DIODE 1S2837
D202	8-719-104-37	DIODE SR506D
D203	8-719-100-05	DIODE 1S2837
D204	8-719-100-05	DIODE 1S2837
D205	8-719-100-05	DIODE 1S2837
D206	8-719-100-05	DIODE 1S2837
D207	8-719-100-05	DIODE 1S2837
D208	8-719-100-05	DIODE 1S2837
D209	8-719-911-19	DIODE 1SS119
IC1	8-759-110-17	IC UPC1018C-F
IC2	8-759-100-17	IC UPC1212C
IC3	8-759-800-27	IC LA5003
IC201	8-759-100-63	IC UPB556C
IC202	8-759-101-11	IC UPD1706G-511
J1	1-507-853-00	(G-AEP:NOT USED)...JACK (EXT.ANT)
J2	1-507-527-00	JACK, EARPHONE (REC OUT)
J3	1-507-527-00	JACK, EARPHONE (EARPHONE)
J4	1-507-459-00	JACK (DC IN 6V)
L1	1-408-558-00	(G-AEP:NOT USED)...MICRO INDUCTOR 3.9UH
L2	1-408-563-00	MICRO INDUCTOR 10UH
L3	1-407-882-00	COIL

NOTE:

- Items with no part number and no description are not stocked because they are seldom required for routine service.
- Items marked "●" are not stocked since they are seldom required for routine service. Some delay should be anticipated when ordering these items.
- Due to standardization, parts with part numbers (Δ-ΔΔΔ-ΔΔΔ-XX or Δ-ΔΔΔΔ-ΔΔΔ-X) may be different from those used in the set.

CAPACITORS:

MF:μF, PF:μμF.

RESISTORS

- All resistors are in ohms.
- F : nonflammable

COILS

- MMH : mH, UH : μH

SEMICONDUCTORS

In each case, U : μ, for example:  
 UA...: μA..., UPA...: μPA..., UPC...: μPC,  
 UPD...: μPD...

ELECTRICAL PARTS

ELECTRICAL PARTS

Ref.No.	Part No.	Description
L4	1-408-571-00	MICRO INDUCTOR 47UH
L5	1-426-137-00	TRANSFORMER, HF
L6	1-408-900-11	MICRO INDUCTOR 0.82UH
L7	1-408-555-00	MICRO INDUCTOR 2.2UH
L8	1-408-555-00	MICRO INDUCTOR 2.2UH
L11	1-408-560-00	MICRO INDUCTOR 5.6UH
L12	1-422-135-00	COIL, AIR-CORE (RF)
L13	1-408-800-11	MICRO INDUCTOR 0.27UH
L14	1-408-901-11	MICRO INDUCTOR 0.56UH
L15	1-408-562-00	MICRO INDUCTOR 8.2UH
L16	1-408-903-11	MICRO INDUCTOR 0.39UH
L19	1-426-158-00	COIL (RF)
L20	1-459-475-00	COIL (WITH CORE)
L21	1-408-557-00	(G-AEP:NOT USED)...MICRO INDUCTOR 3.3UH
L22	1-407-882-00	INDUCTOR 1UH
L23	1-407-882-00	INDUCTOR 1UH
L24	1-408-576-00	MICRO INDUCTOR 120UH
L25	1-408-801-11	MICRO INDUCTOR 0.22UH
L26	1-408-574-00	MICRO INDUCTOR 82UH
L27	1-408-903-11	MICRO INDUCTOR 0.39UH
ND1	1-806-646-00	DISPLAY PANEL, LIQUID CRYSTAL
Q1	8-729-119-32	TRANSISTOR 2SK193
Q2	8-729-178-62	TRANSISTOR 2SC2786-L
Q3	8-729-606-33	TRANSISTOR 2SC2603-F
Q4	8-729-204-83	TRANSISTOR 2SA1048-GR
Q5	8-729-119-32	TRANSISTOR 2SK193
Q6	8-729-204-83	(G-AEP:NOT USED)..TRANSISTOR 2SA1048-GR
Q7	8-729-162-00	TRANSISTOR 2SK152-2
Q8	8-729-178-54	TRANSISTOR 2SC2785-F
Q9	8-729-162-00	TRANSISTOR 2SK152-2
Q10	8-729-162-00	TRANSISTOR 2SK152-2
Q11	8-729-162-00	TRANSISTOR 2SK152-2
Q12	8-729-883-91	TRANSISTOR 2SC2839-D
Q13	8-729-883-92	(ME:NOT USED)...TRANSISTOR 2SC2839
Q14	8-729-245-83	(ME:NOT USED)...TRANSISTOR 2SC2458
Q15	8-729-245-83	TRANSISTOR 2SC2458
Q16	8-729-178-62	TRANSISTOR 2SC2786-L
Q17	8-729-178-62	TRANSISTOR 2SC2786-L
Q18	8-729-178-62	TRANSISTOR 2SC2786-L
Q19	8-729-178-63	TRANSISTOR 2SC2786-K
Q20	8-729-204-83	TRANSISTOR 2SA1048-GR
Q21	8-729-204-83	TRANSISTOR 2SA1048-GR
Q22	8-729-204-83	TRANSISTOR 2SA1048-GR
Q25	8-729-245-83	TRANSISTOR 2SC2458
Q26	8-729-204-83	TRANSISTOR 2SA1048-GR

Ref.No.	Part No.	Description
Q27	8-729-204-83	TRANSISTOR 2SA1048-GR
Q28	8-729-204-83	TRANSISTOR 2SA1048-GR
Q29	8-729-204-83	TRANSISTOR 2SA1048-GR
Q30	8-729-245-83	TRANSISTOR 2SC2458
Q31	8-729-204-83	TRANSISTOR 2SA1048-GR
Q32	8-729-801-83	TRANSISTOR 2SB1013
Q33	8-729-800-83	TRANSISTOR 2SB808
Q34	8-729-218-42	TRANSISTOR 2SK184
Q201	8-729-100-66	TRANSISTOR 2SC1623
Q202	8-729-100-66	TRANSISTOR 2SC1623
Q203	8-729-100-66	TRANSISTOR 2SC1623
Q204	8-729-100-66	TRANSISTOR 2SC1623
Q205	8-729-220-93	TRANSISTOR 2SK209-Y
Q206	8-729-100-66	TRANSISTOR 2SC1623
R1	1-247-871-00	(G-AEP:NOT USED)...CARBON 47K 5% 1/6W
R2	1-247-804-00	CARBON 75 5% 1/6W
R3	1-247-827-00	CARBON 680 5% 1/6W
R4	1-247-805-00	(G-AEP:NOT USED)...CARBON 82 5% 1/6W
R5	1-247-839-00	(G-AEP:NOT USED)...CARBON 2.2K 5% 1/6W
R6	1-247-845-00	CARBON 3.9K 5% 1/6W
R8	1-247-855-00	CARBON 10K 5% 1/6W
R9	1-247-831-00	CARBON 1K 5% 1/6W
R10	1-247-879-00	CARBON 100K 5% 1/6W
R11	1-247-891-00	CARBON 330K 5% 1/6W
R12	1-247-903-00	CARBON 1M 5% 1/6W
R13	1-247-819-00	CARBON 330 5% 1/6W
R14	1-247-893-00	CARBON 390K 5% 1/6W
R15	1-247-843-00	CARBON 3.3K 5% 1/6W
R16	1-247-825-00	CARBON 560 5% 1/6W
R17	1-247-855-00	CARBON 10K 5% 1/6W
R18	1-247-863-00	CARBON 22K 5% 1/6W
R19	1-247-849-00	CARBON 5.6K 5% 1/6W
R20	1-247-831-00	CARBON 1K 5% 1/6W
R21	1-247-831-00	CARBON 1K 5% 1/6W
R22	1-247-841-00	CARBON 2.7K 5% 1/6W
R23	1-247-851-00	CARBON 6.8K 5% 1/6W
R24	1-247-851-00	CARBON 6.8K 5% 1/6W
R25	1-247-845-00	CARBON 3.9K 5% 1/6W
R26	1-247-831-00	CARBON 1K 5% 1/6W
R27	1-247-831-00	CARBON 1K 5% 1/6W
R28	1-247-893-00	CARBON 390K 5% 1/6W
R29	1-247-855-00	CARBON 10K 5% 1/6W
R30	1-247-855-00	CARBON 10K 5% 1/6W
R31	1-247-863-00	CARBON 22K 5% 1/6W

NOTE:

- Items with no part number and no description are not stocked because they are seldom required for routine service.
- Items marked "●" are not stocked since they are seldom required for routine service. Some delay should be anticipated when ordering these items.
- Due to standardization, parts with part numbers (Δ-ΔΔΔ-ΔΔΔ-XX or Δ-ΔΔΔΔ-ΔΔΔ-X) may be different from those used in the set.

CAPACITORS:

MF:μF, PF:μμF.

RESISTORS

- All resistors are in ohms.
- F : nonflammable

COILS

- MMH : mH, UH : μH

SEMICONDUCTORS

In each case, U : μ, for example:  
 UA...: μA..., UPA...: μPA..., UPC...: μPC,  
 UPD...: μPD...

## ELECTRICAL PARTS

Ref.No.	Part No.	Description			
R32	1-247-881-00	CARBON	120K	5%	1/6W
R33	1-247-831-00	CARBON	1K	5%	1/6W
R40	1-247-897-00	CARBON	560K	5%	1/6W
R42	1-247-807-00	CARBON	100	5%	1/6W
R43	1-247-807-00	CARBON	100	5%	1/6W
R44	1-247-895-00	CARBON	470K	5%	1/6W
R45	1-247-847-00	CARBON	4.7K	5%	1/6W
R46	1-247-855-00	CARBON	10K	5%	1/6W
R47	1-247-831-00	CARBON	1K	5%	1/6W
R48	1-247-879-00	CARBON	100K	5%	1/6W
R49	1-247-819-00	CARBON	330	5%	1/6W
R50	1-247-795-00	CARBON	33	5%	1/6W
R51	1-247-807-00	CARBON	100	5%	1/6W
R52	1-247-827-00	CARBON	680	5%	1/6W
R55	1-247-841-00	CARBON	2.7K	5%	1/6W
R56	1-247-843-00	CARBON	3.3K	5%	1/6W
R57	1-247-807-00	CARBON	100	5%	1/6W
R58	1-247-807-00	CARBON	100	5%	1/6W
R59	1-247-831-00	CARBON	1K	5%	1/6W
R60	1-247-851-00	CARBON	6.8K	5%	1/6W
R61	1-247-871-00	CARBON	47K	5%	1/6W
R62	1-247-867-00	CARBON	33K	5%	1/6W
R63	1-247-879-00	CARBON	100K	5%	1/6W
R64	1-247-863-00	CARBON	22K	5%	1/6W
R65	1-247-885-00	CARBON	180K	5%	1/6W
R66	1-247-845-00	CARBON	3.9K	5%	1/6W
R67	1-247-835-00	CARBON	1.5K	5%	1/6W
R68	1-247-831-00	CARBON	1K	5%	1/6W
R69	1-247-847-00	CARBON	4.7K	5%	1/6W
R70	1-247-869-00	CARBON	39K	5%	1/6W
R71	1-247-867-00	CARBON	33K	5%	1/6W
R72	1-247-801-00	CARBON	56	5%	1/6W
R73	1-247-819-00	CARBON	330	5%	1/6W
R74	1-247-819-00	CARBON	330	5%	1/6W
R75	1-247-831-00	CARBON	1K	5%	1/6W
R77	1-247-807-00	CARBON	100	5%	1/6W
R78	1-247-867-00	CARBON	33K	5%	1/6W
R80	1-247-855-00	(ME:NOT USED)...CARBON	10K	5%	1/6W
R81	1-247-889-00	(ME:NOT USED)...CARBON	270K	5%	1/6W
R82	1-247-837-00	(ME:NOT USED)...CARBON	1.8K	5%	1/6W
R83	1-247-847-00	(ME:NOT USED)...CARBON	4.7K	5%	1/6W
R84	1-247-851-00	(ME:NOT USED)...CARBON	6.8K	5%	1/6W
R85	1-247-851-00	(ME:NOT USED)...CARBON	6.8K	5%	1/6W
R86	1-247-841-00	(ME:NOT USED)...CARBON	2.7K	5%	1/6W

## ELECTRICAL PARTS

Ref.No.	Part No.	Description			
R87	1-247-871-00	CARBON	47K	5%	1/6W
R88	1-247-899-00	(ME:NOT USED)...CARBON	680K	5%	1/6W
R89	1-247-819-00	(ME:NOT USED)...CARBON	330	5%	1/6W
R90	1-247-855-00	(ME:NOT USED)...CARBON	10K	5%	1/6W
R91	1-247-871-00	CARBON	47K	5%	1/6W
R94	1-247-791-00	CARBON	22	5%	1/6W
R95	1-247-801-00	CARBON	56	5%	1/6W
R96	1-247-831-00	CARBON	1K	5%	1/6W
R97	1-247-831-00	CARBON	1K	5%	1/6W
R98	1-247-853-00	CARBON	8.2K	5%	1/6W
R99	1-247-795-00	CARBON	33	5%	1/6W
R100	1-247-861-00	CARBON	18K	5%	1/6W
R101	1-247-831-00	CARBON	1K	5%	1/6W
R102	1-247-855-00	CARBON	10K	5%	1/6W
R103	1-247-843-00	CARBON	3.3K	5%	1/6W
R104	1-247-831-00	CARBON	1K	5%	1/6W
R105	1-247-855-00	CARBON	10K	5%	1/6W
R119	1-247-815-00	CARBON	220	5%	1/6W
R120	1-247-817-00	CARBON	270	5%	1/6W
R121	1-247-873-00	CARBON	56K	5%	1/6W
R122	1-247-795-00	CARBON	33	5%	1/6W
R123	1-247-833-00	CARBON	1.2K	5%	1/6W
R124	1-247-815-00	CARBON	220	5%	1/6W
R125	1-247-827-00	CARBON	680	5%	1/6W
R126	1-247-855-00	CARBON	10K	5%	1/6W
R127	1-247-873-00	CARBON	56K	5%	1/6W
R128	1-247-807-00	CARBON	100	5%	1/6W
R129	1-247-875-00	CARBON	68K	5%	1/6W
R130	1-247-835-00	CARBON	1.5K	5%	1/6W
R131	1-247-879-00	CARBON	100K	5%	1/6W
R132	1-247-807-00	CARBON	100	5%	1/6W
R133	1-247-843-00	CARBON	3.3K	5%	1/6W
R134	1-247-843-00	CARBON	3.3K	5%	1/6W
R135	1-247-823-00	CARBON	470	5%	1/6W
R136	1-247-845-00	CARBON	3.9K	5%	1/6W
R137	1-247-841-00	CARBON	2.7K	5%	1/6W
R138	1-247-846-00	CARBON	4.3K	5%	1/6W
R139	1-247-835-00	CARBON	1.5K	5%	1/6W
R141	1-247-863-00	CARBON	22K	5%	1/6W
R142	1-247-835-00	CARBON	1.5K	5%	1/6W
R143	1-247-815-00	CARBON	220	5%	1/6W
R150	1-247-868-00	CARBON	36K	5%	1/6W
R151	1-247-862-00	CARBON	20K	5%	1/6W
R152	1-247-868-00	CARBON	36K	5%	1/6W

## NOTE:

- Items with no part number and no description are not stocked because they are seldom required for routine service.
- Items marked "●" are not stocked since they are seldom required for routine service. Some delay should be anticipated when ordering these items.
- Due to standardization, parts with part numbers ( $\Delta$ - $\Delta\Delta\Delta$ - $\Delta\Delta\Delta$ -XX or  $\Delta$ - $\Delta\Delta\Delta$ - $\Delta\Delta\Delta$ -X) may be different from those used in the set.
- If there are two or more same circuits in a set such as a stereophonic machine, only typical circuit parts may be indicated and capacitors and resistors in other same circuits may be omitted.

## CAPACITORS:

MF:  $\mu$ F, PF:  $\mu$  $\mu$ F.

## RESISTORS

- All resistors are in ohms.
- F : nonflammable

## COILS

MMH : mH, UH :  $\mu$ H

## SEMICONDUCTORS

In each case, U :  $\mu$ , for example:UA...:  $\mu$ A..., UPA...:  $\mu$ PA..., UPC...:  $\mu$ PC,UPD...:  $\mu$ PD...

## ELECTRICAL PARTS

Ref.No.	Part No.	Description				
R157	1-247-889-00	CARBON	270K	5%	1/6W	
R158	1-247-855-00	CARBON	10K	5%	1/6W	
R159	1-247-855-00	CARBON	10K	5%	1/6W	
R160	1-247-855-00	CARBON	10K	5%	1/6W	
R161	1-247-855-00	CARBON	10K	5%	1/6W	
R162	1-247-855-00	CARBON	10K	5%	1/6W	
R163	1-247-855-00	CARBON	10K	5%	1/6W	
R164	1-247-847-00	CARBON	4.7K	5%	1/6W	
R164	1-247-864-00	(UK)...CARBON	24K	5%	1/6W	
R165	1-247-855-00	CARBON	10K	5%	1/6W	
R165	1-247-864-00	(UK)...CARBON	24K	5%	1/6W	
R166	1-247-855-00	CARBON	10K	5%	1/6W	
R167	1-247-831-00	CARBON	1K	5%	1/6W	
R168	1-247-795-00	(G-AEP: NOT USED)...CARBON	33	5%	1/6W	
R169	1-247-831-00	CARBON	1K	5%	1/6W	
R201	1-247-855-00	CARBON	10K	5%	1/6W	
R202	1-247-871-00	CARBON	47K	5%	1/6W	
R203	1-247-903-00	CARBON	1M	5%	1/6W	
R204	1-247-895-00	CARBON	470K	5%	1/6W	
R205	1-247-895-00	CARBON	470K	5%	1/6W	
R206	1-247-855-00	CARBON	10K	5%	1/6W	
R207	1-247-871-00	CARBON	47K	5%	1/6W	
R208	1-247-871-00	CARBON	47K	5%	1/6W	
R209	1-247-871-00	CARBON	47K	5%	1/6W	
R210	1-247-855-00	CARBON	10K	5%	1/6W	
R211	1-247-855-00	CARBON	10K	5%	1/6W	
R212	1-247-855-00	CARBON	10K	5%	1/6W	
R213	1-247-855-00	CARBON	10K	5%	1/6W	
R214	1-247-855-00	CARBON	10K	5%	1/6W	
R215	1-247-855-00	CARBON	10K	5%	1/6W	
R216	1-247-855-00	CARBON	10K	5%	1/6W	
R217	1-247-855-00	CARBON	10K	5%	1/6W	
R218	1-247-855-00	CARBON	10K	5%	1/6W	
R219	1-247-855-00	CARBON	10K	5%	1/6W	
R220	1-247-855-00	CARBON	10K	5%	1/6W	
R221	1-247-855-00	CARBON	10K	5%	1/6W	
R222	1-247-855-00	CARBON	10K	5%	1/6W	
R223	1-247-855-00	CARBON	10K	5%	1/6W	
R224	1-247-855-00	CARBON	10K	5%	1/6W	
R225	1-247-895-00	CARBON	470K	5%	1/6W	
R226	1-247-895-00	CARBON	470K	5%	1/6W	
R227	1-247-881-00	CARBON	120K	5%	1/6W	
R228	1-247-827-00	CARBON	680	5%	1/6W	
R229	1-247-881-00	CARBON	120K	5%	1/6W	

## ELECTRICAL PARTS

Ref.No.	Part No.	Description				
R230	1-247-903-00	CARBON	1M	5%	1/6W	
R231	1-247-855-00	CARBON	10K	5%	1/6W	
R232	1-247-803-00	CARBON	68	5%	1/6W	
R234	1-247-831-00	CARBON	1K	5%	1/6W	
R233	1-247-795-00	CARBON	33	5%	1/6W	
R235	1-247-855-00	CARBON	10K	5%	1/6W	
R236	1-247-837-00	CARBON	1.8K	5%	1/6W	
R237	1-247-831-00	CARBON	1K	5%	1/6W	
R238	1-247-843-00	CARBON	3.3K	5%	1/6W	
R239	1-247-855-00	CARBON	10K	5%	1/6W	
R240	1-247-855-00	CARBON	10K	5%	1/6W	
RV1	1-230-042-00	RES, VAR, SLIDE 20K (VOLUME)				
RV2	1-230-065-00	RES, VAR, CARBON 100K (FINE TUNING)				
S1	1-554-462-00	SWITCH, SLIDE (SENS)				
S2	1-553-989-00	SWITCH, SLIDE (AM MODE)				
S3	1-554-078-00	SWITCH, SLIDE (TONE)				
S5	1-553-510-00	SWITCH, SLIDE (MAIN POWER)				
S6	1-554-371-00	SWITCH, TACT (TIME SET)				
S7	1-554-604-00	SWITCH, RUBBER KEY (COUNTER KEYS)				
S8	1-553-977-00	SWITCH, SLIDE (9KHz-10KHz)				
SP	1-502-631-00	SPEAKER				
T1	1-459-458-00	COIL (WITH CORE)				
T3	1-404-126-00	IFT (SMALL TYPE)				
T4	1-404-130-00	TRANSFORMER, DISCRI				
T5	1-404-131-00	TRANSFORMER, DISCRI				
T6	1-404-127-00	IFT (SMALL TYPE)				
T7	1-426-136-00	TRANSFORMER, HF				
T8	1-404-448-00	TRANSFORMER, IF				
T9	1-404-191-00	TRANSFORMER, IF				
T10	1-404-447-00	(ME:NOT USED)...TRANSFORMER, IF				
T11	1-406-052-00	COIL (OSC)				
X1	1-567-108-00	VIBRATOR, CRYSTAL				
X2	1-567-105-00	(ME:NOT USED)...OSCILLATOR, CERAMIC				
X3	1-567-109-00	VIBRATOR, CRYSTAL				
XF1	1-527-372-00	FILTER, CRYSTAL				

## NOTE:

- Items with no part number and no description are not stocked because they are seldom required for routine service.
- Items marked "●" are not stocked since they are seldom required for routine service. Some delay should be anticipated when ordering these items.
- Due to standardization, parts with part numbers (Δ-ΔΔΔ-ΔΔΔ-XX or Δ-ΔΔΔΔ-ΔΔΔ-X) may be different from those used in the set.
- If there are two or more same circuits in a set such as a stereophonic machine, only typical circuit parts may be indicated and capacitors and resistors in other same circuits may be omitted.

## CAPACITORS:

MF:μF, PF:μμF.

## RESISTORS

- All resistors are in ohms.
- F : nonflammable

## COILS

- MMH : mH, UH : μH

## SEMICONDUCTORS

In each case, U : μ, for example:

UA...: μA..., UPA...: μPA..., UPC...: μPC,

UPD...: μPD...

