

ICOM

INSTRUCTION MANUAL

DUAL BAND
FM TRANSCEIVER

IC-2400A

IC-2400E

IC-2500A

IC-2500E

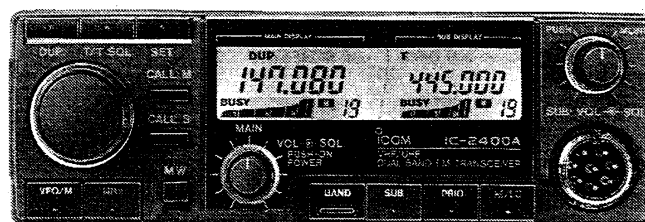

Icom Inc.

CAUTIONS

Before using the transceiver, read all the instructions carefully and completely.

SAVE THIS INSTRUCTION MANUAL – This instruction manual contains important safety and operating instructions for the IC-2400A/E and IC-2500A/E.

NEVER connect the transceiver to an AC outlet. This will ruin the transceiver.

NEVER connect more than 16 V DC power to the transceiver. Check the source voltage before connecting the power cable.

NEVER allow children to touch the transceiver during operation.

NEVER expose the transceiver to rain, snow or any liquids.

AVOID using or storing the transceiver in places with temperatures below -10°C ($+14^{\circ}\text{F}$) or over $+60^{\circ}\text{C}$ ($+140^{\circ}\text{F}$).

DO NOT place the transceiver in excessively humid environments.

AVOID placing the transceiver in direct sunlight, such as on the dashboard.

AVOID placing the transceiver in excessively dusty environments.

BE CAREFUL! The heatsink may become hot when operating the transceiver for long periods.

TABLE OF CONTENTS

CAUTIONS	i	6 RELATED FUNCTIONS.....	20
TABLE OF CONTENTS.....	ii	6-1 RIT AND VXO	
FOREWORD	iii	OPERATIONS	20
UNPACKING.....	iii	6-2 MEMORY OPERATION	22
1 FEATURES.....	1	6-3 CALL CHANNEL	
2 PANEL DESCRIPTION.....	2	OPERATION	24
2-1 FRONT PANEL	2	6-4 SCAN FUNCTIONS.....	26
2-2 FUNCTION DISPLAY	4	6-5 PRIORITY WATCH.....	30
2-3 REAR PANEL.....	5	6-6 DIMMER CONTROL	32
2-4 MICROPHONE	5	6-7 BEEP ON/OFF.....	32
3 INSTALLATION	6	6-8 SUB BAND BEEP AND SUB	
4 MODE CONSTRUCTION	10	BAND MUTE.....	33
5 BASIC OPERATIONS.....	12	7 POCKET BEEP AND TONE	
5-1 FREQUENCY SETTING	12	SQUELCH.....	34
5-2 LOCK FUNCTION.....	13	7-1 UT-40 INSTALLATION	34
5-3 SUB BAND ACCESS	14	7-2 HIGH/LOW BAND	
5-4 SUB BAND OFF	14	SELECTION.....	34
5-5 RECEIVING.....	15	7-3 POCKET BEEP FUNCTION..	35
5-6 TRANSMITTING.....	16	7-4 TONE SQUELCH	
5-7 REPEATER OPERATION	18	FUNCTION	36
		8 MAINTENANCE.....	37
		8-1 TROUBLESHOOTING.....	37
		8-2 CPU RESETTING	38
		8-3 MISCELLANEOUS	
		MAINTENANCE	39
		9 INSIDE VIEWS	40
		9-1 IC-2400A/E INSIDE	
		VIEWS.....	40
		9-2 IC-2500A/E INSIDE	
		VIEWS.....	41
		10 SPECIFICATIONS	42
		11 OPTIONS	43
		SCHEMATIC DIAGRAM. . SEPARATE	

FOREWORD

Thank you for purchasing the **IC-2400A/E** or **IC-2500A/E** **DUAL BAND FM TRANSCEIVER** from Icom.

Please read this instruction manual thoroughly before operating your new **IC-2400A/E** or **IC-2500A/E**. For further information, please feel free to contact your nearest Icom Dealer or Service Center.

UNPACKING

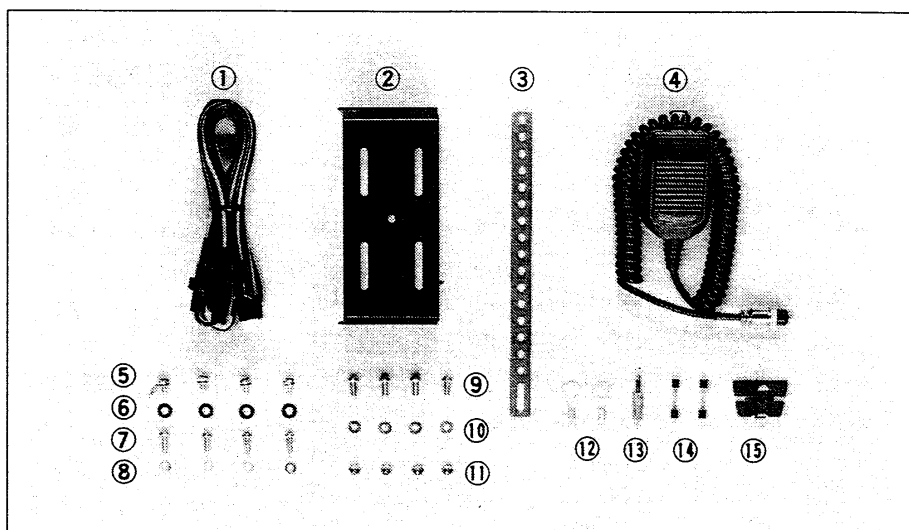

Accessories included	Qty.
① DC power cable (OPC-044B)	1
② Mobile mounting bracket	1
③ Support bracket.	1
④ Microphone*	1
⑤ Set screws (A) 4 x 8	4
⑥ Flat washers (M5).	4
⑦ Self-tapping screws (A0 5 x 16).	4
⑧ Spring washers (M5)	4
⑨ Screws (M5 x 12)	4
⑩ Flat washers (M4).	4
⑪ Nuts (M5)	4
⑫ Cable lugs	2
⑬ External speaker plug.	1
⑭ Fuses (15 A).	2
⑮ Microphone hanger	1

* HM-14 for U.S.A. version
 HM-12 for Australia version
 HM-15 for Europe version

DUAL BAND CAPABILITY

The transceiver receives on both the MAIN and SUB bands simultaneously. While operating on one band, you can watch for scheduled QSO calls on another band.

DUAL BAND READOUT, SEPARATE CONTROLS

The advanced -function display simultaneously shows you the MAIN and SUB band operating frequencies. And each band can be independently controlled with separate volume and squelch controls.

SUB BAND ACCESS FUNCTION

This function gives you immediate access to the SUB band at any time. Set the operating frequency and other operating conditions on the SUB band, leaving your MAIN band free for other operations.

AFC FUNCTION (IC-2500A/E 1200 MHz band only)

Icom's advanced AFC* system automatically and immediately tunes the receive frequency to the frequency of the transmitting station when the transmitting station is off frequency.

* Automatic Frequency Control.

40 MEMORY CHANNELS

The transceiver has 20 memory channels and 1 call channel for each band. Memory channels and the call channel store all information for repeater operation.

SCAN FUNCTIONS AND PRIORITY WATCH

Both the scan function and priority watch operate independently on the MAIN and SUB bands.

POCKET BEEP FUNCTION

A 30 sec. alarm is generated when a subaudible tone identical to the pre-programmed tone is received. This function can be set separately on the MAIN and SUB bands to limit reception to stations you want to hear.

* An optional UT-40 TONE SQUELCH UNIT is necessary.

2-1 FRONT PANEL

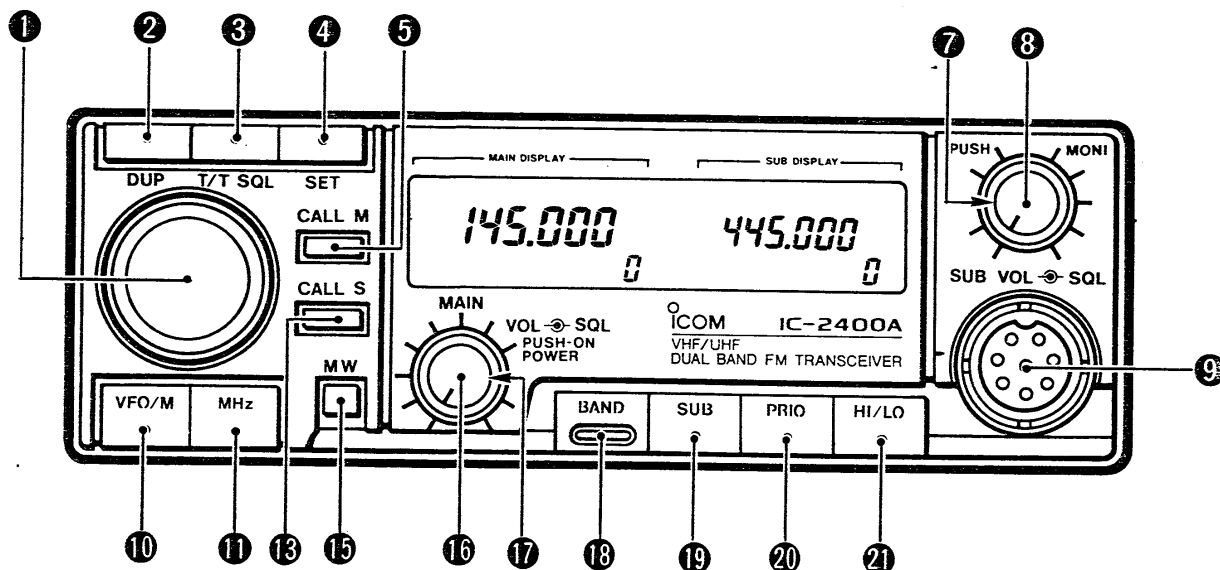

The illustration above shows the IC-2400A.

① TUNING CONTROL

- Changes the operating frequency. (p. 12)
- Changes the memory channel. (p. 22)
- Changes contents of the SET mode display. (p. 10)

② DUPLEX SWITCH [DUP]

Selects simplex, -duplex or +duplex. (p. 18)

③ TONE SWITCH [T/T SQL]

- Turns ON and OFF the subaudible tone encoder. (p. 18)
- Selects the optional UT-40 functions. (pgs. 35, 36)

④ SET SWITCH [SET]

Selects SET mode and advances the SET mode displays. (p. 10)

⑤ MAIN BAND CALL CHANNEL SWITCH [CALL M] (IC-2400A/E)

Selects a MAIN band call channel. (p. 24)

⑥ AFC SWITCH [AFC] (IC-2500A/E)

Selects the AFC-RIT (VXO) or manual-RIT (VXO) function. (p. 21)

⑦ SUB BAND SQUELCH CONTROL [SUB SQL]

Adjusts the SUB band squelch threshold level. (p. 15)

⑧ SUB BAND VOLUME [SUB VOL]

- Adjusts the SUB band audio level. (p. 15)
- Opens the MAIN band squelch while being pushed. (p. 15)

⑨ MICROPHONE CONNECTOR

Connects the supplied microphone or another suitable microphone. (p. 5)

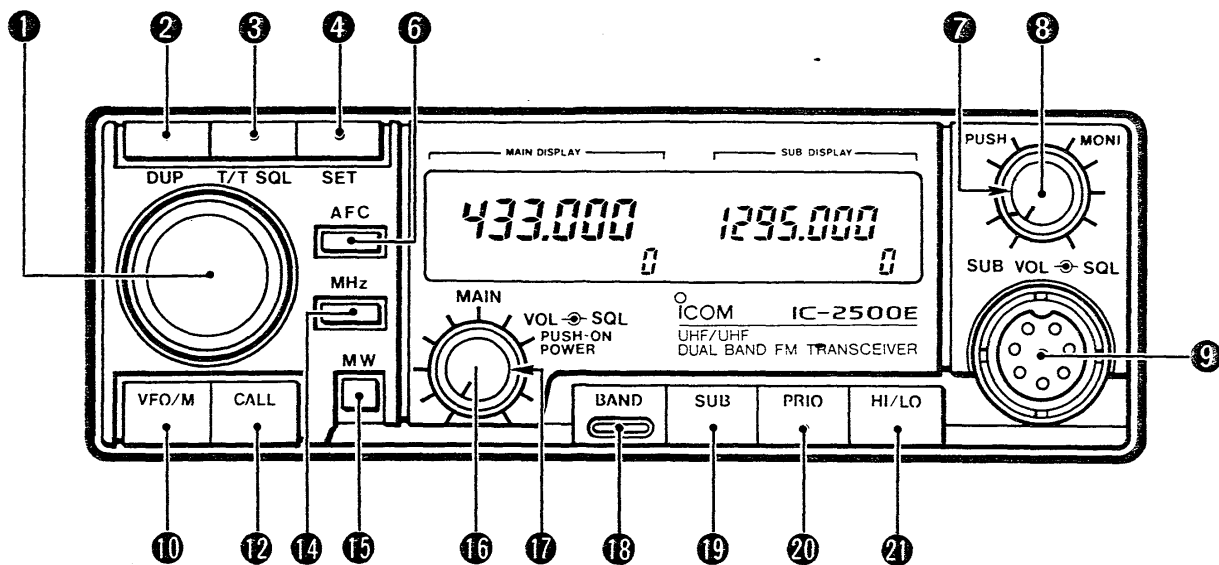

The illustration above shows the IC-2500E.

- 10 VFO/MEMORY SWITCH [VFO/M]**
Selects VFO or MEMORY mode.
(pgs. 12, 22)
- 11 MHz SWITCH [MHz] (IC-2400A/E)**
Selects a 1 MHz tuning step increment.
(p. 12)
- 12 CALL CHANNEL SWITCH [CALL] (IC-2500A/E)**
Selects a call channel. (p. 24)
- 13 SUB BAND CALL CHANNEL SWITCH [CALL S] (IC-2400A/E)**
Selects a SUB band call channel. (p. 24)
- 14 MHz SWITCH [MHz] (IC-2500A/E)**
Selects a 1 MHz tuning step increment.
(p. 12)
- 15 MEMORY WRITE SWITCH [MW]**
 - Writes a memory channel. (p. 23)
 - Transfers the contents of a memory channel to the VFO. (p. 23)
 - Programs a call channel. (p. 25)
- 16 POWER SWITCH/MAIN BAND VOLUME CONTROL [MAIN VOL]**
 - Turns the power ON and OFF. (p. 12)
 - Adjusts the MAIN band audio level.
(p. 15)
- 17 MAIN BAND SQUELCH CONTROL [MAIN SQL]**
Adjusts the MAIN band squelch threshold level. (p. 15)
- 18 BAND SWITCH [BAND]**
Exchanges MAIN and SUB bands. (p. 12)
- 19 SUB BAND SWITCH [SUB]**
 - Selects the SUB band access function.
(p. 14)
 - Deactivates the TUNING CONTROL and some switches. (p. 13)
- 20 PRIORITY SWITCH [PRIO]**
Turns priority watch ON and OFF. (p. 30)
- 21 TRANSMIT POWER SWITCH [HI/LO]**
Selects HIGH or LOW transmit output power. (p. 16)

2 PANEL DESCRIPTION

2-2 FUNCTION DISPLAY

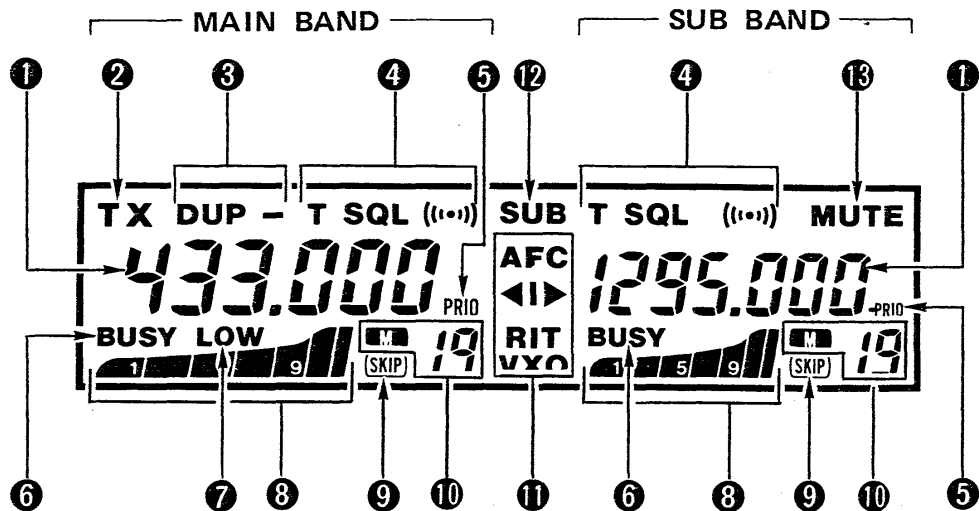

The illustration above shows the IC-2500E FUNCTION DISPLAY.

① FREQUENCY READOUTS

Display the operating frequencies except in SET mode.

② TRANSMIT INDICATOR

Appears during transmission. (p. 16)

③ DUPLEX INDICATORS

Indicate duplex direction. (p. 18)

④ TONE INDICATORS

Indicate subaudible tone encoder or optional UT-40 operating conditions. (pgs. 18, 35, 36)

⑤ PRIORITY INDICATORS

Appear during priority watch. (p. 30)

⑥ RECEIVE INDICATORS

Appear when a squelch opens. (p. 15)

⑦ LOW POWER INDICATOR

Appears when LOW output power is selected. (p. 16)

⑧ S/Rf INDICATORS

- Show signal strengths while receiving. (p. 15)
- Show relative output power selection while transmitting. (p. 16)

⑨ SKIP CHANNEL INDICATORS

Appear when a memory channel is programmed as a skip channel. (p. 29)

⑩ MEMORY INDICATORS AND MEMORY CHANNEL READOUTS

- "M" appears when MEMORY mode is selected. (p. 22)
- Display the memory channel numbers. (p. 22)
- "C" appears when a call channel is selected. (p. 24)

⑪ AFC/RIT/VXO AND CENTER INDICATORS (IC-2500A/E 1200 MHz band only)

Indicate RIT or VXO operating conditions. (p. 21)

⑫ SUB BAND INDICATOR

Appears when the SUB band access function is used. (p. 14)

⑬ SUB BAND MUTE INDICATOR

Appears when the SUB band audio level is automatically reduced. (p. 33)

2-3 REAR PANEL

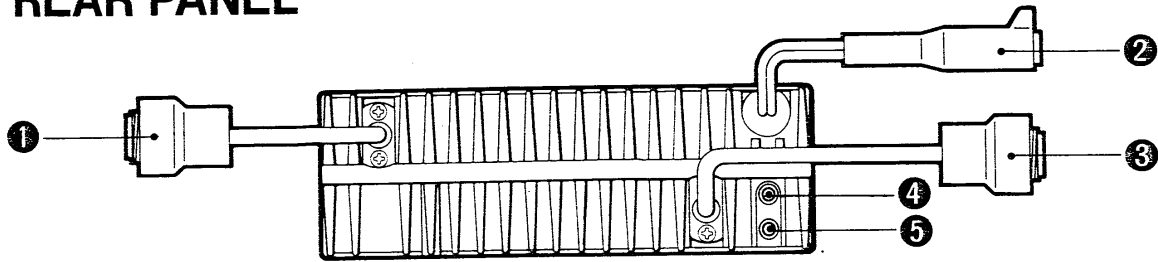

1 ANTENNA CONNECTOR 1

Connects a 144 MHz band antenna connector (IC-2400A/E) or a 1200 MHz band antenna connector (IC-2500A/E). (p. 8)

2 POWER CONNECTOR

Connects 13.8 V DC using the supplied DC power cable. (p. 7)

3 ANTENNA CONNECTOR 2

Connects a 430 or 440 MHz band antenna connector. (p. 8)

4 SUB BAND SPEAKER JACK [SUB SP]

5 MAIN BAND SPEAKER JACK [MAIN SP]

Connect 4 ~ 8 Ω speakers, when required. (p. 8)

2-4 MICROPHONE

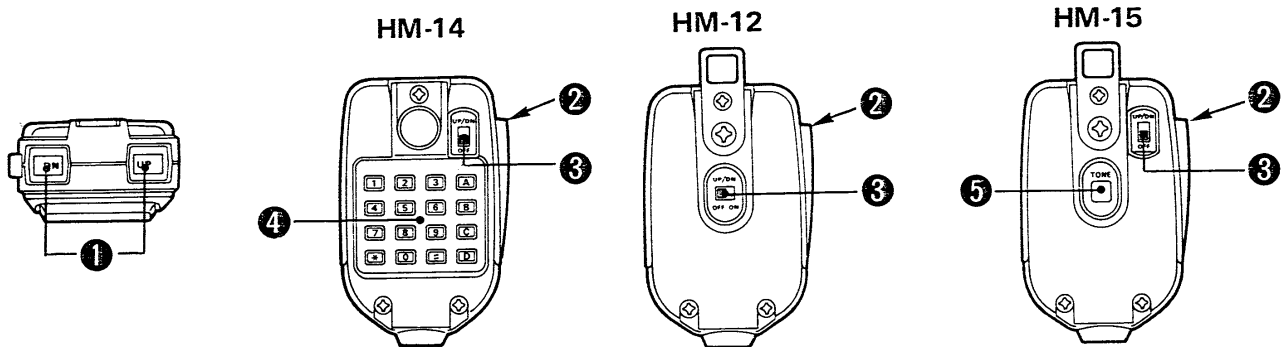

1 UP/DOWN SWITCHES

Push either of these switches to change the operating frequency or memory channel.

Push and hold either of these switches to start scanning.

2 PTT SWITCH

Push to transmit.

3 UP/DOWN ON/OFF SWITCH

Prevents accidental frequency changes with the [UP] and [DN] switches.

4 DTMF KEYBOARD

Produces DTMF signals while transmitting. (HM-14)

5 TONE CALL SWITCH

Transmits a 1750 Hz tone signal. (HM-15)

• MICROPHONE CONNECTOR (Front panel view)

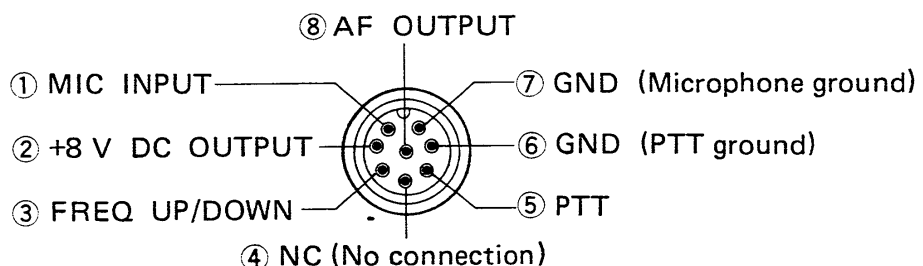

3

INSTALLATION

(1) LOCATION

Select a location for the transceiver that does not interfere with driving in any way. We recommend the locations shown in the figure below.

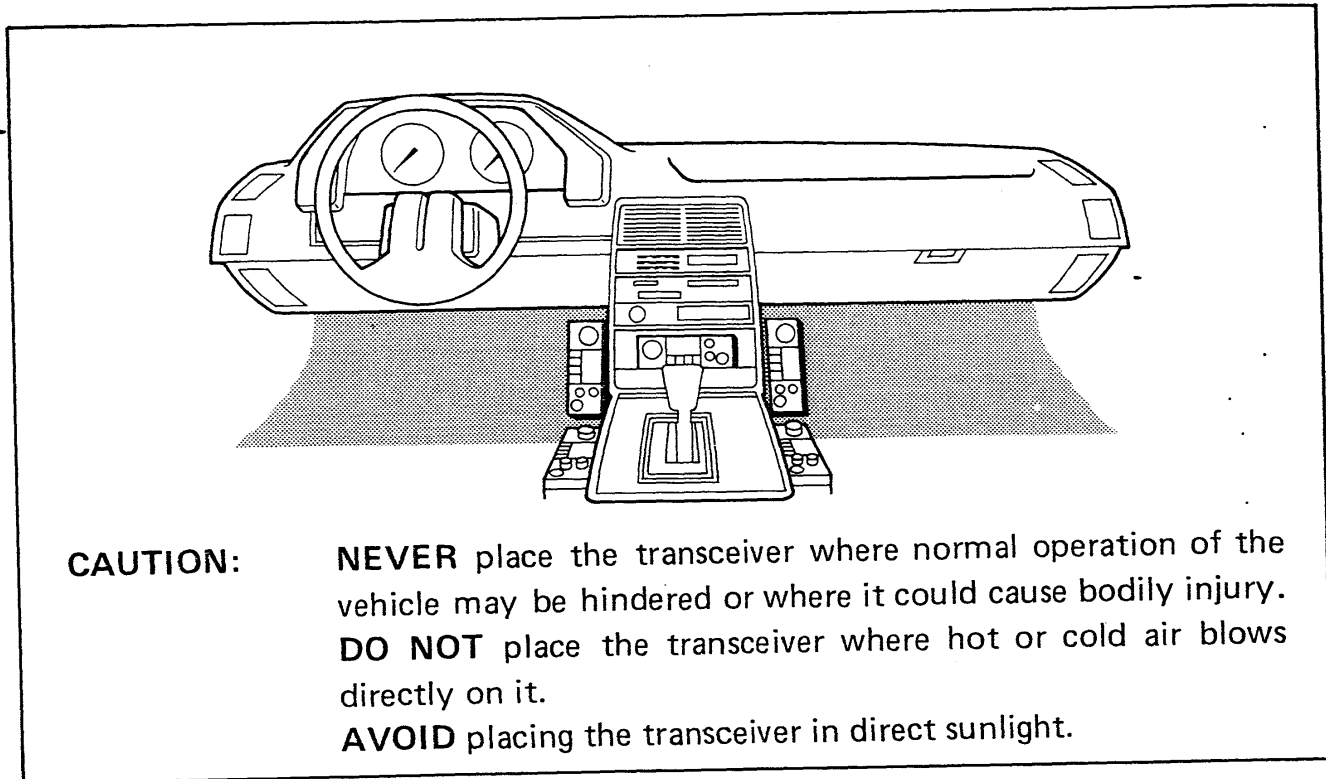

CAUTION: NEVER place the transceiver where normal operation of the vehicle may be hindered or where it could cause bodily injury. DO NOT place the transceiver where hot or cold air blows directly on it. AVOID placing the transceiver in direct sunlight.

(2) MOUNTING

After mounting the transceiver, be sure all screws have been tightened.

• MOUNTING THE TRANSCEIVER

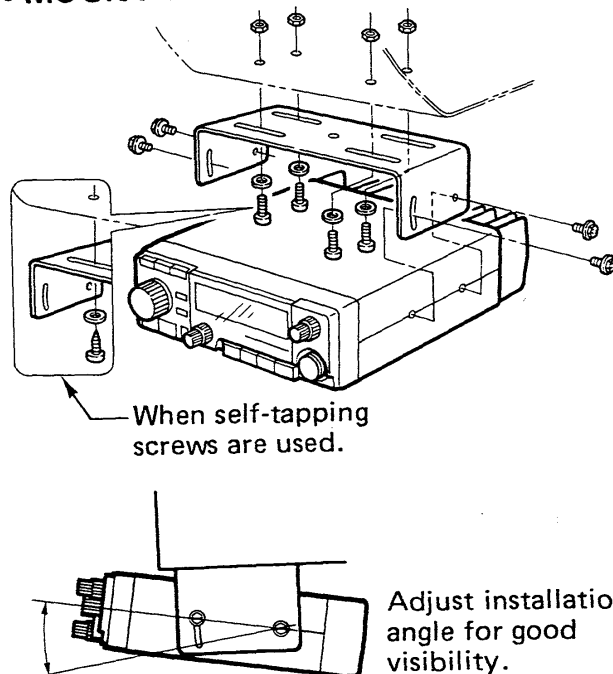

1) Drill holes where the mounting bracket is to be installed.

• Hole size:

approx. 5.5 ~ 6 mm for nuts.

approx. 2 ~ 3 mm for self-tapping screws.

2) Insert the supplied screws, nuts and washers through the mounting bracket and tighten.

3) If the mounting location is not flat, use the supplied support bracket.

4) Adjust the angle for the clearest view of the FUNCTION DISPLAY.

(1 mm \doteq 1/32 in)

(3) BATTERY CONNECTION

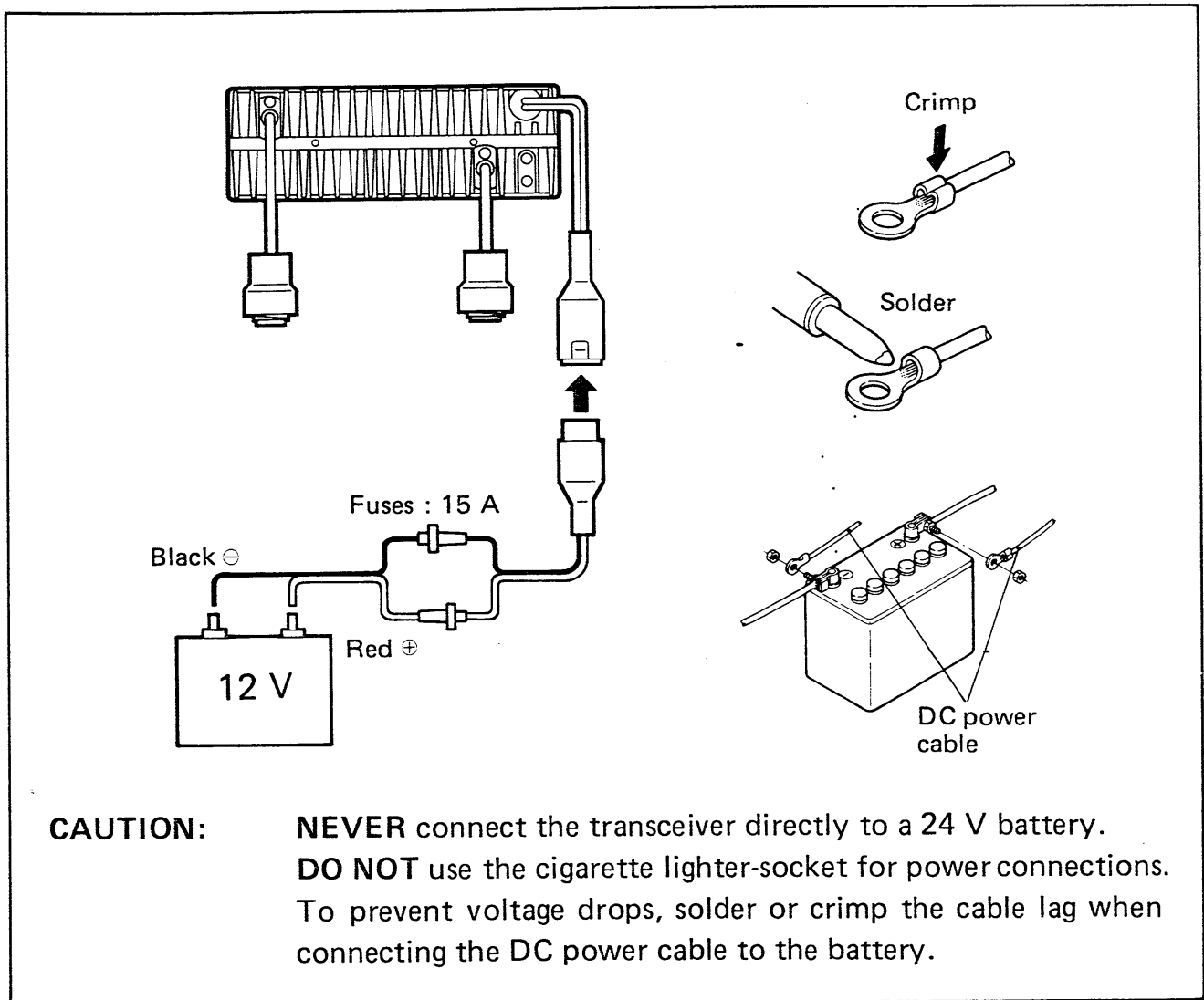

CAUTION: NEVER connect the transceiver directly to a 24 V battery. DO NOT use the cigarette lighter-socket for power connections. To prevent voltage drops, solder or crimp the cable lag when connecting the DC power cable to the battery.

(4) EXTERNAL POWER SUPPLY

Use a 13.8 V DC power source with more than 12 A capability. The optional IC-PS30 AC POWER SUPPLY is suitable for base station operation.

When using the transceiver as a base station, make sure a ground terminal of the power supply is grounded. Use the heaviest gauge wire or strap available and make the connection as short as possible.

3 INSTALLATION

(5) EXTERNAL SPEAKER CONNECTIONS

Connect 4 ~ 8 Ω external speakers when necessary. Speakers operate as follows:

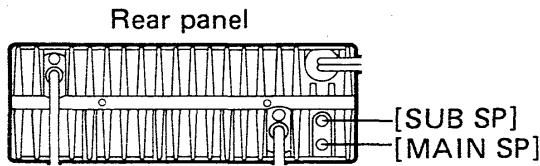

SPEAKER JACKS		SPEAKERS	
[MAIN SP]	[SUB SP]	MAIN BAND AUDIO	SUB BAND AUDIO
NC	NC	Internal (MAIN and SUB band audio is mixed.)	
NC	In use	Internal	External
In use	NC	External (MAIN and SUB band audio is mixed.)	
In use	In use	External	External

NC : No connection

(6) ANTENNA LOCATION

To obtain maximum performance from the transceiver, select a high-quality antenna and a good location.

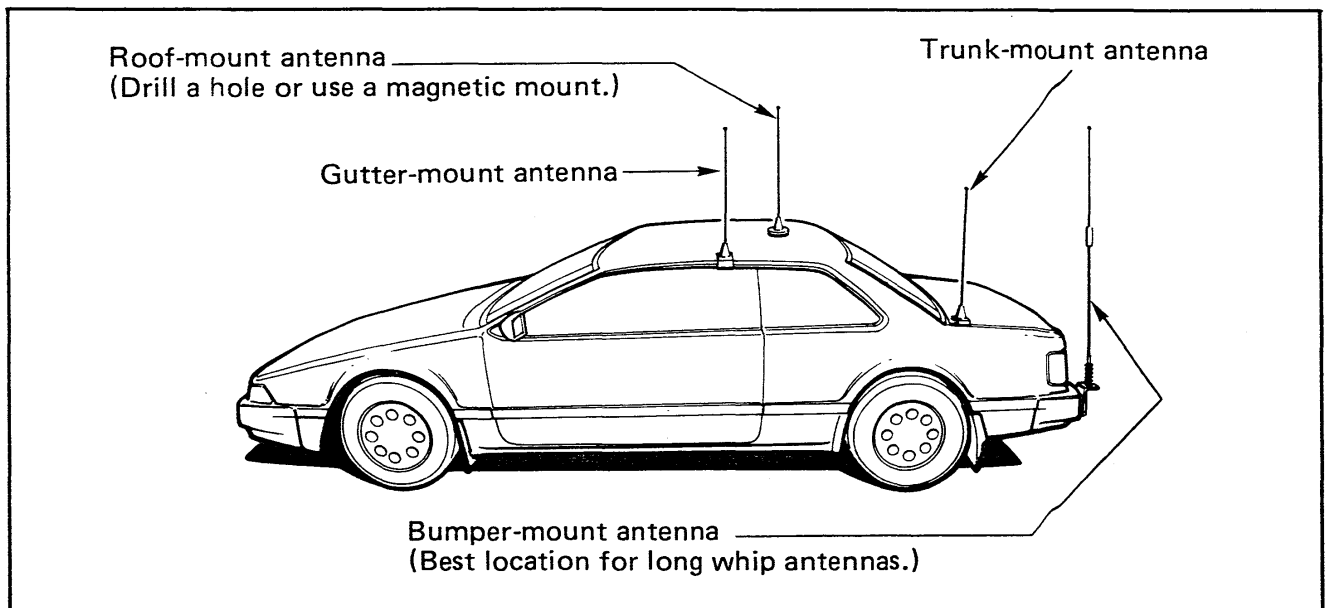

(7) DUPLEXER

When using a dual-band antenna (i.e., 144/430 MHz or 430/1200 MHz), a duplexer must be used.

• Mono-band antennas connections

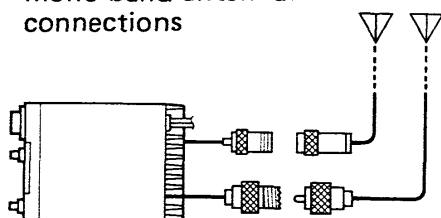

• Dual-band antenna connections

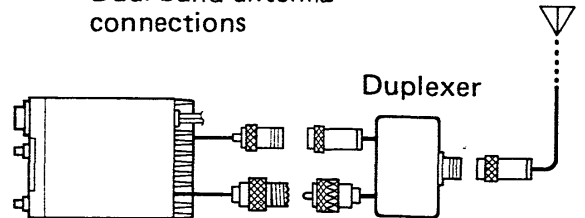

A duplexer must be purchased separately.

(8) ANTENNA CONNECTOR

A PL-259 antenna connector is used for the 144 MHz band:

- 1) Slide the coupling ring over the coaxial cable. Strip only the cable jacket, but keep the jacket in place for soft soldering.
- 2) Soft solder the shield conductor.
- 3) Strip the cable as shown in the figure, and soft solder the center conductor.
- 4) Slide the connector body onto the coaxial cable and solder.
- 5) Screw the coupling ring onto the connector body.

A Type-N antenna connector or connectors used for the 430 or 440 MHz and 1200 MHz bands.

- 1) Slide the nut, washer, and rubber gasket over the coaxial cable and cut the end of the cable evenly.
- 2) Cut and remove 15 mm of the outer vinyl jacket, and fold the braid back over the clamp. The clamp end should be flush with the end of the vinyl jacket. Evenly trim the braid ends.

Cut and remove 6 mm of the dielectric (the center conductor insulation).
- 3) Soft solder the center conductor. Install a center conductor pin and solder it.
- 4) Carefully slide the plug into place aligning the center conductor pin on the cable with the hole in the insulator inside the connector body.
- 5) Complete the assembly by screwing the nut into the connector body.

4

MODE CONSTRUCTION

(1) 4 DIFFERENT MODES

■ VFO MODE

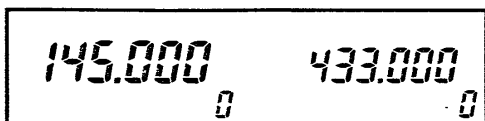

■ MEMORY MODE

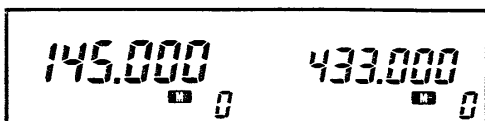

■ CALL CHANNEL MODE

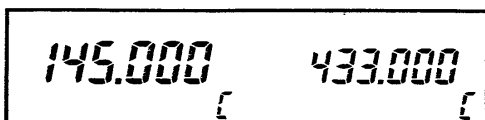

■ SET MODE

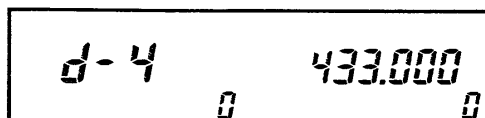

(2) SET MODE SELECTION

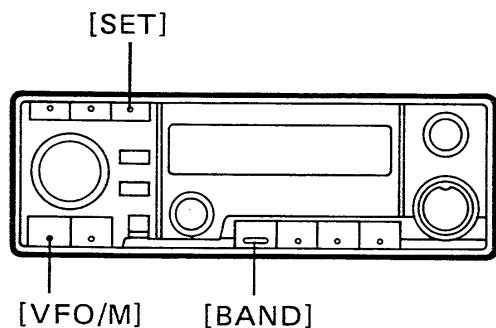

The transceiver has 4 different modes for versatile multi-function operations.

This mode is used for normal operations over the entire band.

This mode is used for operating the transceiver using memory channel contents. You can use 20 memory channels for each band.

This mode provides 1 call channel for each band. You can program your most often-used frequencies into these channels.

This mode is used to program data.

- 1) Push the [BAND] switch to select the operating band on the MAIN band display.
- 2) Push the [VFO/M] switch to select VFO or MEMORY mode.
 - A different display appears depending on the selected mode. (p. 11)
- 3) Push the [SET] switch to select SET mode.
 - Refer to the SET mode construction charts. (p. 11)
- 4) Push the [SET] switch to advance SET mode.
- 5) Push the [VFO/M] switch to exit SET mode.
- 6) To access SET mode in the SUB band, push the [SUB] switch then follow steps from 2 above.

(3) SET MODE CONSTRUCTION CHARTS

A different display appears depending on the selected mode. The following charts show setting examples for the IC-2500A.

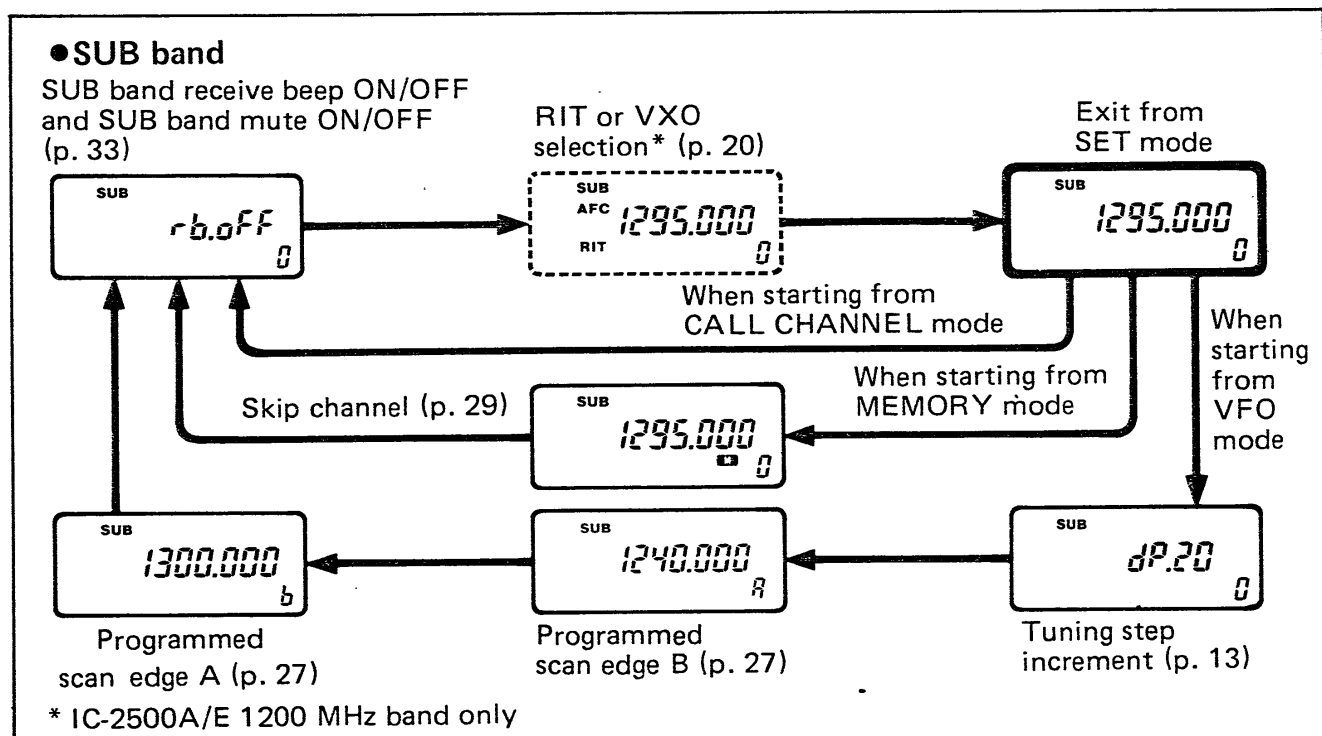
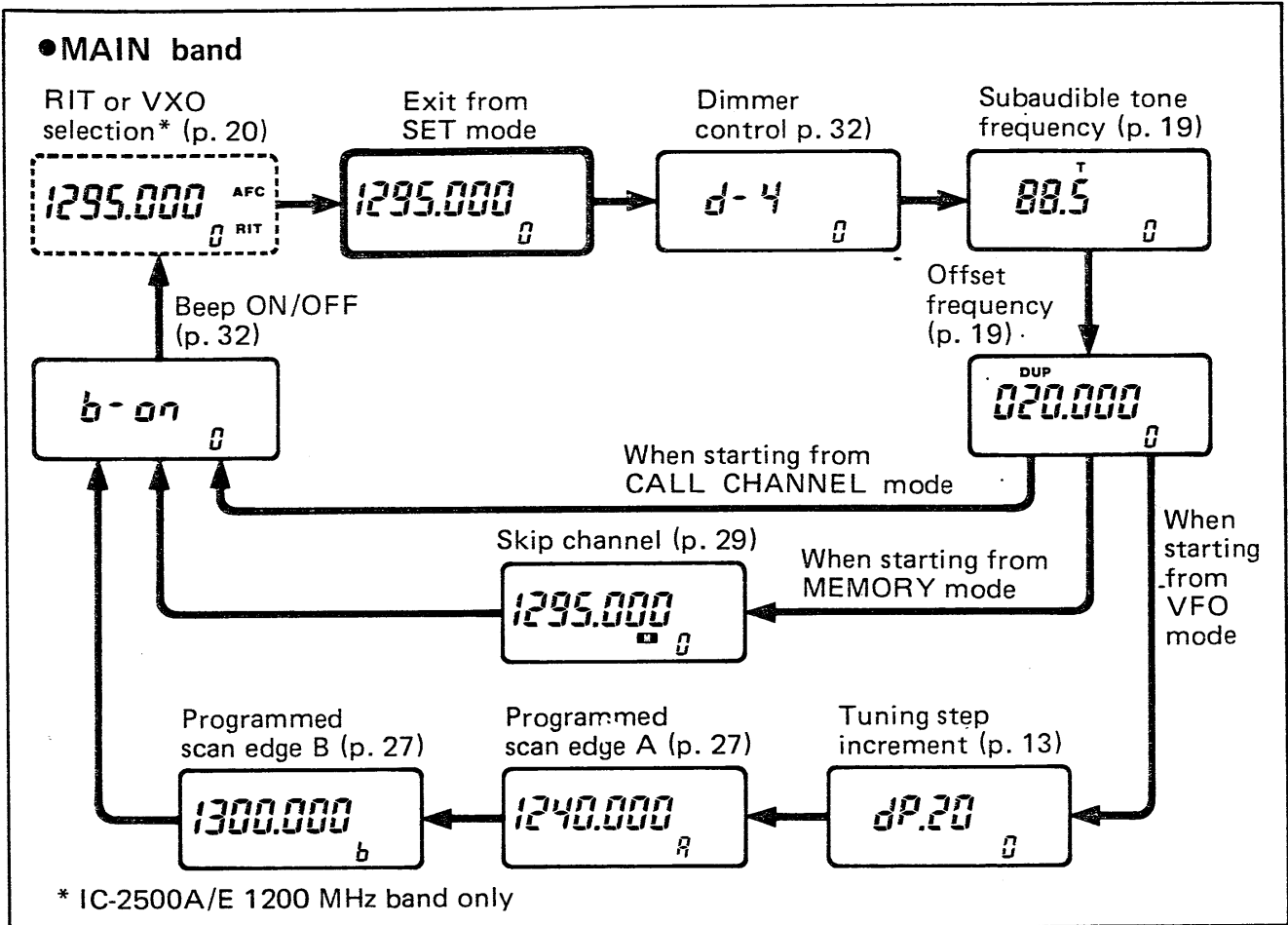

5-1 FREQUENCY SETTING

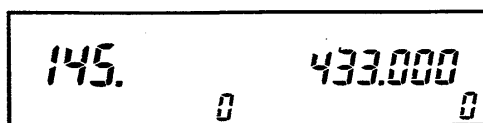
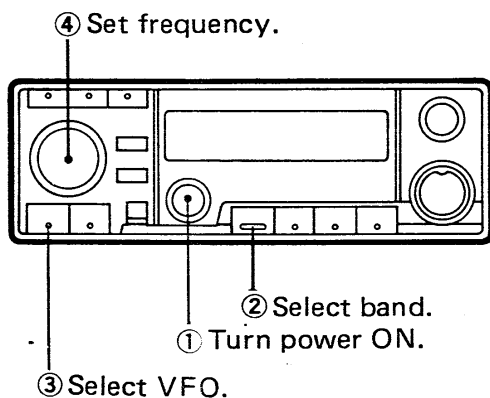
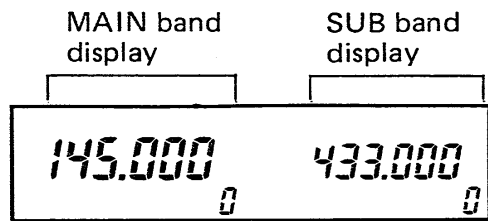

The display shows that a 1 MHz step is selected on the MAIN band.

Both the MAIN and SUB band operating frequencies can be set with the TUNING CONTROL or the [UP] or [DN] switch on the microphone.

- 1) Push the [MAIN VOL] control to turn ON power.
- 2) Push the [BAND] switch to select the desired operating band on the MAIN band display.
 - When "L" appears on both the MAIN and SUB band displays, push the [SUB] switch once to unlock the TUNING CONTROL and switches. (p. 13)
- 3) When "M" or "C" appears on the band you wish to set the frequency, push the [VFO/M] switch to select VFO mode.
- 4) Rotate the TUNING CONTROL or push the [UP] or [DN] switch on the microphone to change the operating frequency.
 - Select a tuning step increment in SET mode when necessary. (p. 13)
 - When the manual-RIT or manual-VXO is activated (IC-2500A/E only) the TUNING CONTROL does not change the operating frequency. (p. 21)
- 5) To select 1 MHz tuning steps, push the [MHz] switch.
 - The TUNING CONTROL changes the frequency in 1 MHz steps.
 - The [UP] or [DN] switch on the microphone does not change the frequency in 1 MHz steps.
 - Push the [MHz] switch again to return to the previous tuning steps.
- 6) To set the SUB band operating frequency, push the [SUB] switch then follow steps from 1 above.

USING SET MODE

■ **SETTING A TUNING STEP INCREMENT**

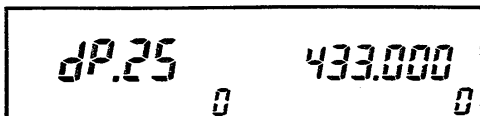

The display shows that the tuning step increment on the MAIN band is 25 kHz.

- 1) Push the [VFO/M] switch to select VFO mode.
- 2) Push the [SET] switch several times until "dP." appears.
- 3) Rotate the TUNING CONTROL for the desired tuning step increment. The following tuning steps are available depending on the band and version.

VERSION	144, 430 or 440 MHz	1200 MHz
U.S.A.	5, 10, 15,	10 or 20 kHz
Australia	20 or 25 kHz	
Europe	12.5 or 25 kHz	12.5 or 25 kHz

- Minimum tuning steps can be changed. (p. 38)

- 4) Push the [VFO/M] switch to exit SET mode.
 - Programmed tuning step increments are preserved in the operating band even when pushing the [BAND] switch.
- 5) To set the tuning step increment on the SUB band, push the [SUB] switch then follow steps from 1 above.

5-2 LOCK FUNCTION

This function deactivates the TUNING CONTROL and switches to prevent accidental changes.

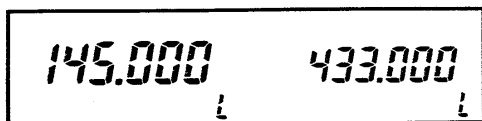

The display shows that the lock function is activated.

- 1) Push the [SUB] switch until "L" appears on both the MAIN and SUB band displays.
 - The [MAIN VOL], [MAIN SQL], [SUB VOL], [SUB SQL] controls and PTT switch are not locked.
- 2) Push the [SUB] switch once to unlock.

5 BASIC OPERATIONS

5-3 SUB BAND ACCESS

It is easy to access the SUB band and return to the MAIN band with the [SUB] switch.

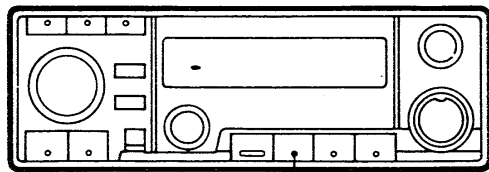

[SUB]

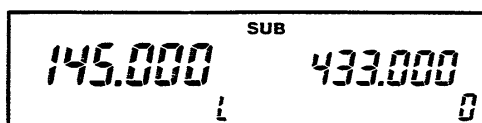

The display shows that the SUB band access is selected.

- 1) Push the [SUB] switch to access the SUB band.
 - "SUB" appears.
 - "L" appears on the MAIN band display.
 - The MAIN band still functions for receiving and transmitting.
- 2) Set the desired SUB band operating frequency with the TUNING CONTROL or the [UP] or [DN] switch on the microphone.
 - A SUB band memory channel can also be changed. (p. 22)
- 3) To exit the SUB band, push the [SUB] switch until "L" disappears both on the MAIN and SUB band displays.
 - "SUB" disappears.

5-4 SUB BAND OFF

SUB band operations can be turned OFF using this function. The function is convenient when you prefer single band operation using only the MAIN band.

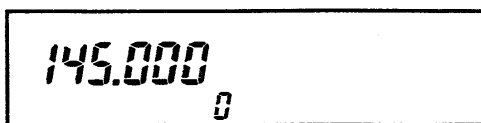

The display shows that the SUB band is turned OFF.

- 1) Turn OFF power.
- 2) Push and hold the [SUB] switch.
- 3) Continue holding the switch, then turn ON power.
 - The SUB band display does not appear.
- 4) Push the [BAND] switch to exchange the bands.
- 5) To use both the MAIN and SUB bands again, repeat procedures 1 ~ 3 above.

5-5 RECEIVING

The transceiver receives both the MAIN and SUB bands simultaneously.

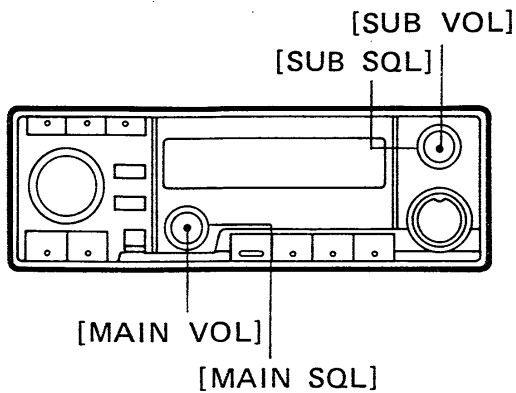

The display shows that a signal is received on the MAIN band.

- 1) Push the [MAIN VOL] control to turn power ON and rotate both the MAIN and SUB SQUELCH controls maximum counterclockwise.
 - "BUSY" appears on each band display.
- 2) Rotate both the MAIN and SUB VOLUME controls to the desired band audio levels.
- 3) Rotate both the MAIN and SUB SQUELCH controls to the squelch threshold points.
- 4) Set the desired operating frequencies with the TUNING CONTROL or the [UP] or [DN] switch on the microphone.
 - Use SUB band access to set the SUB band frequency. (p. 14)
 - When a signal is received, the speaker emits audio and the S/R F INDICATOR shows the relative signal strength.
- 5) When a weak signal cannot open the MAIN band squelch completely, push and hold the [SUB VOL] control.
 - The MAIN band squelch opens while the [SUB VOL] control is pushed.
- 6) For 1200 MHz band operation, use the RIT or VXO function, when necessary. (IC-2500A/E only) (p. 20)

5 BASIC OPERATIONS

5-6 TRANSMITTING

The transceiver can only transmit on the MAIN band.

CAUTION: Transmitting without an antenna may damage the transceiver.

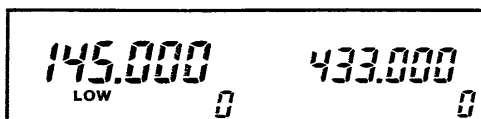
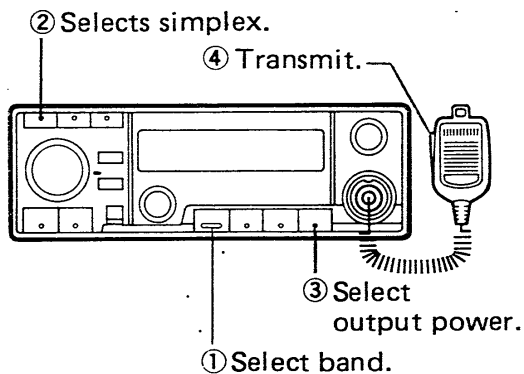

The display shows that LOW output power is selected.

- 1) Push the [BAND] switch to select the desired operating band on the MAIN band display.
 - Even when the SUB band is accessed, a signal is transmitted on the MAIN band.
- 2) When "DUP—" or "DUP" appears, push the [DUP] switch until the indicator disappears to select a simplex mode.
 - See p. 18 when you require duplex operation (repeater operation).
- 3) Push the [HI/LO] switch to select output power.
 - "LOW" appears when LOW power is selected. There is no HIGH power indicator.
 - Output power is as follows:

	144 MHz	430 or 440 MHz	1200 MHz
HIGH	45 W	35 W	10 W
LOW	5 W	5 W	1 W
- 4) Push and hold the PTT switch on the microphone to transmit.
 - "TX" appears and the S/RF INDICATOR shows relative output power selection.
- 5) Speak into the microphone using your normal voice level.
 - Do not hold the microphone too closely to your mouth or speak too loudly. This may distort the signal.
- 6) Release the PTT switch to return to receiving.

■ FULL DUPLEX OPERATION

The transceiver receives SUB band audio during transmission on the MAIN band.

Using this capability, full duplex operation is possible. No special setting is necessary for full duplex operation.

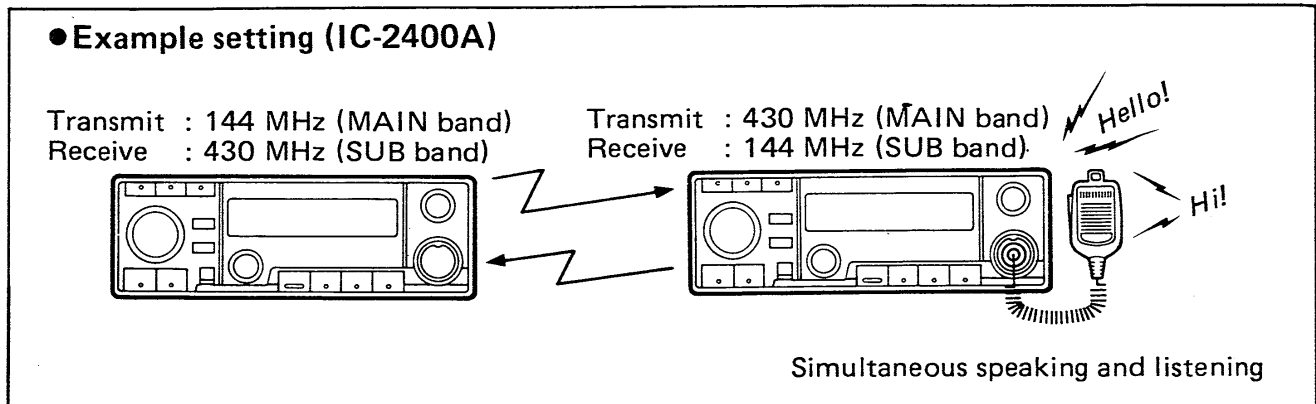

- 1) Set the desired transmit and receive frequencies on the MAIN and SUB bands respectively in your transceiver.
- 2) Set the same frequencies in reverse on the MAIN and SUB bands in the other transceiver. (See the diagram above.)
- 3) Push and hold the PTT switch on the microphone to transmit and speak into the microphone.
 - Transmitting and receiving activate simultaneously.

NOTE: To prevent howling, **AVOID** setting the higher band frequency near the 3rd multiple of the lower band frequency. For example, **AVOID** these settings:

IC-2400A/E :

145.000 MHz and 435.000 MHz

IC-2500A/E :

432.000 MHz and 1296.000 MHz

5 BASIC OPERATIONS

5-7 REPEATER OPERATION

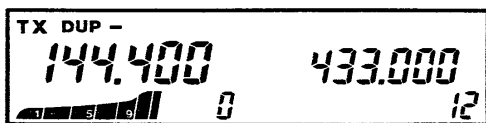
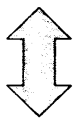
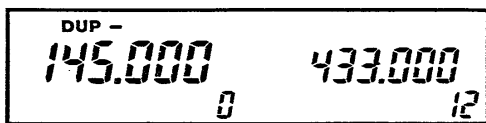
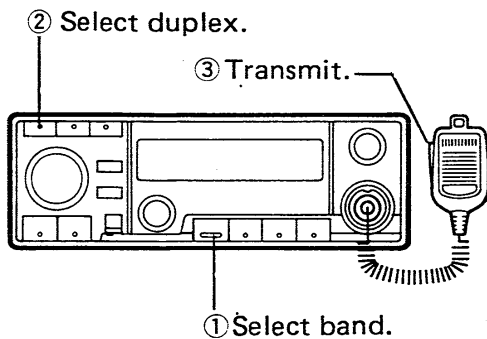

Above displays show the duplex operation with 600 kHz offset.

Select duplex mode when operating with a station through a repeater. To access a repeater which requires a tone or tones see below.

- 1) Push the [BAND] switch to select the desired operating band on the MAIN band display.
- 2) Push the [DUP] switch once to set -duplex or push again to set +duplex.
 - "DUP-" or "DUP" appears.

"DUP-"	: Transmit freq.=
	Receive freq. - Offset freq.
"DUP"	: Transmit freq.=
	Receive freq. + Offset freq.

- 3) Push and hold the PTT switch to transmit on the repeater input frequency.
- 4) To check transmit frequency (repeater input frequency), push the [SUB VOL] control.
 - MAIN band squelch opens.
 - This allows checking of the signal strength of your contacted station directly without going through a repeater.
- 5) To return to simplex, push the [DUP] switch until "DUP" or "DUP-" disappears.

• SUBAUDIBLE TONE

Push the [T/T SQL] switch to turn the subaudible tone encoder ON and OFF.

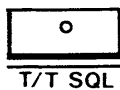

"T" appears.

• DTMF TONES

Push and hold the PTT switch and then push the keyboard numbers on the microphone rear panel.

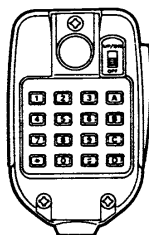

(U.S.A. versions)

• 1750 Hz TONE CALL

Push and hold the [TONE] switch on the microphone for approx. 1 ~ 3 sec. to transmit 1750 Hz tone call signals.

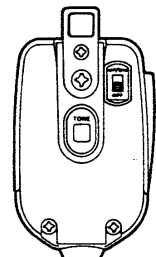

(Europe versions)

USING SET MODE

■ **SETTING A
SUBAUDIBLE TONE
FREQUENCY**



The display shows the subaudible tone frequency set at 88.5 Hz.

This setting can only be programmed on the MAIN band.

Select a subaudible tone frequency to access a repeater requiring a subaudible tone. Subaudible tones can be set on both bands separately.

- 1) Push the [BAND] switch to select the desired operating band on the MAIN band display.
- 2) Push the [SET] switch several times until "T" flashes.
- 3) Rotate the TUNING CONTROL to select the desired subaudible tone frequency.
- 4) Push the [VFO/M] switch to exit SET mode.
 - Programmed subaudible frequencies are preserved in the operating band even when pushing the [BAND] switch.

USING SET MODE

■ **SETTING AN
OFFSET FREQUENCY**

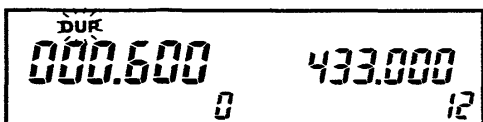

The display shows the offset frequency set at 600 kHz.

This setting can only be programmed on the MAIN band.

An offset frequency can be set on both bands separately.

- 1) Push the [BAND] switch to select the desired operating band on the MAIN band display.
- 2) Push the [SET] switch until "DUP" flashes.
- 3) Rotate the TUNING CONTROL to select the desired offset frequency.
 - To select 1 MHz tuning step increments, push the [MHz] switch. (p. 12)
- 4) Push the [VFO/M] switch to exit SET mode.
 - Programmed offset frequencies are preserved in the operating band even when pushing the [BAND] switch.

6-1 RIT AND VXO OPERATIONS

These functions operate only on the IC-2500A/E 1200 MHz band.

To compensate for off frequency of the transmitting station, the IC-2500A/E is equipped with a total of 4 different RIT and VXO functions for the 1200 MHz band.

(1) PRESETTING

The following RIT and VXO functions can be selected:

■ AFC-RIT FUNCTION

Automatically fine tunes the receive frequency to the frequency of the transmitting station. Use this function when the transmitting station also uses the AFC function.

■ MANUAL-RIT FUNCTION

Manually fine tunes the receive frequency.

■ AFC-VXO FUNCTION

Automatically fine tunes both transmit and receive frequencies to the frequency of the transmitting station. Use this function when the transmitting station does not use the AFC function.

■ MANUAL-VXO FUNCTION

Manually fine tunes both transmit and receive frequencies.

USING SET MODE

■ SELECTING THE RIT OR VXO FUNCTION

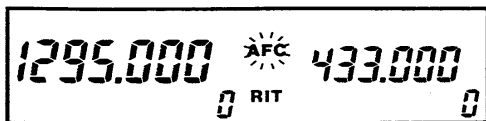

The display shows that the RIT function is selected.

This setting can only be programmed on the 1200 MHz band.

- 1) Push the [BAND] or [SUB] switch to select the 1200 MHz band.
- 2) Push the [SET] switch several times until "AFC" flashes.
- 3) Rotate the TUNING CONTROL to select the RIT or VXO function.
- 4) Push the [VFO/M] switch to set the condition and exit SET mode.

(2) AFC OPERATION

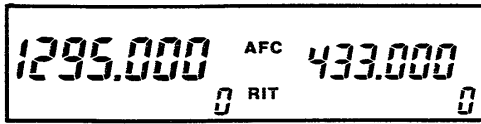

The display shows that the AFC-RIT function is activated.

- 1) Push the [BAND] or [SUB] switch to select the 1200 MHz band.
- 2) Push the [AFC] switch to activate the AFC function.
 - "AFC" appears.
 - AFC-RIT or AFC-VXO can be changed using SET mode. (p. 20)
 - When an off frequency signal (within approx. ± 5.5 kHz) is received, "◀" or "▶" flashes until the transceiver tunes the operating frequency to the receiving frequency.
- 3) Push the [AFC] switch twice to cancel the function.

(3) MANUAL FINE TUNING OPERATION

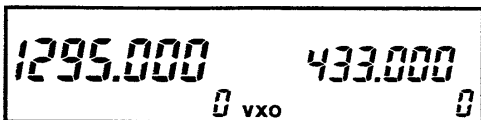

The display shows that the manual-VXO function is activated.

- 1) Push the [BAND] or [SUB] switch to select the 1200 MHz band.
- 2) Push the [AFC] switch twice to activate the manual-RIT or manual-VXO function.
 - "RIT" or "VXO" appears. ("AFC" does not appear).
 - Manual-RIT or manual-VXO can be changed using SET mode. (p. 20)
- 3) Rotate the TUNING CONTROL for fine tuning.
 - "◀" or "▶" shows the fine tuning direction.
 - RIT or VXO operates in a range of approx. ± 5.5 kHz of the operating frequency.
 - "◀" or "▶" flashes when RIT or VXO exceeds an operation range of approx. ± 5.5 kHz.
- 4) Push the [AFC] switch once to cancel the function.

6 RELATED FUNCTIONS

6-2 MEMORY OPERATION

The transceiver has 20 memory channels for each band. Each memory channel independently stores an operating frequency, offset frequency, subaudible tone frequency and memory skip function.

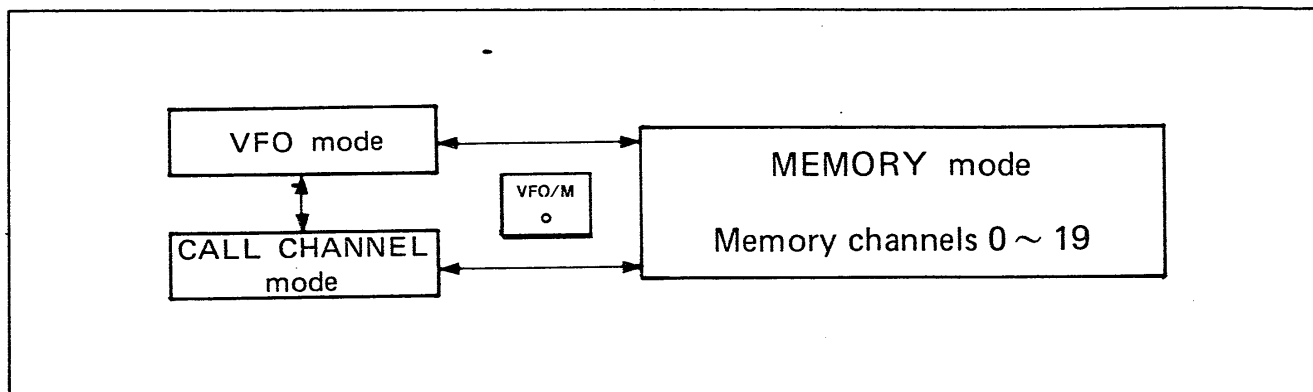

(1) MEMORY READING

- 1) Push the [VFO/M] switch to select MEMORY mode.
 - "M" appears.

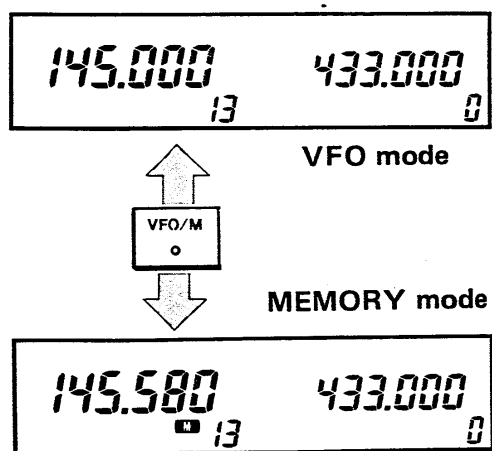

- 2) Rotate the TUNING CONTROL to select the desired memory channel.
 - The [UP] or [DN] switch on the microphone also changes the memory channel.
- 3) Push the [VFO/M] switch again to return to VFO mode.
- 4) To select a SUB band memory channel, push the [SUB] switch then follow steps from 1 above.

(2) MEMORY WRITING

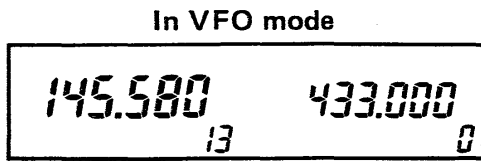

Push and hold while in VFO mode.

- 1) Push the [VFO/M] switch to select MEMORY mode.
 - "M" appears.
- 2) Rotate the TUNING CONTROL to select the desired memory channel.
- 3) Push the [VFO/M] switch to select VFO mode.
 - "M" disappears.
- 4) Select the desired frequency to store. (p. 12)
 - Repeater or other information contents can be programmed. (pgs. 18, 35, 36)
- 5) Push and hold the [MW] switch until the speaker emits 3 beep tones.
 - The information is now programmed.
- 6) To program a SUB band memory channel, push the [SUB] switch then follow steps from 1 above.

(3) MEMORY TRANSFERRING

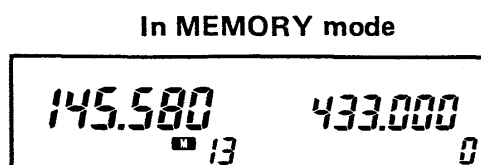

Push and hold while in MEMORY mode.

Copy and transfer the displayed memory contents into the VFO. This function is useful for searching for signals around the memory channel frequency. Memory channel contents are not erased.

- 1) Push the [VFO/M] switch to select MEMORY mode.
 - "M" appears.
- 2) Rotate the TUNING CONTROL to select the desired memory channel.
- 3) Push and hold the [MW] switch until the speaker emits 3 beep tones.
 - The memory contents have been transferred into the VFO.
 - The transceiver returns to VFO mode.
- 4) To select a SUB band memory channel, push the [SUB] switch then follow steps from 1 above.

6 RELATED FUNCTIONS

6-3 CALL CHANNEL OPERATION

The transceiver has an independent call channel for each band to easily select your most-used frequencies. A call channel can be selected from VFO and MEMORY modes.

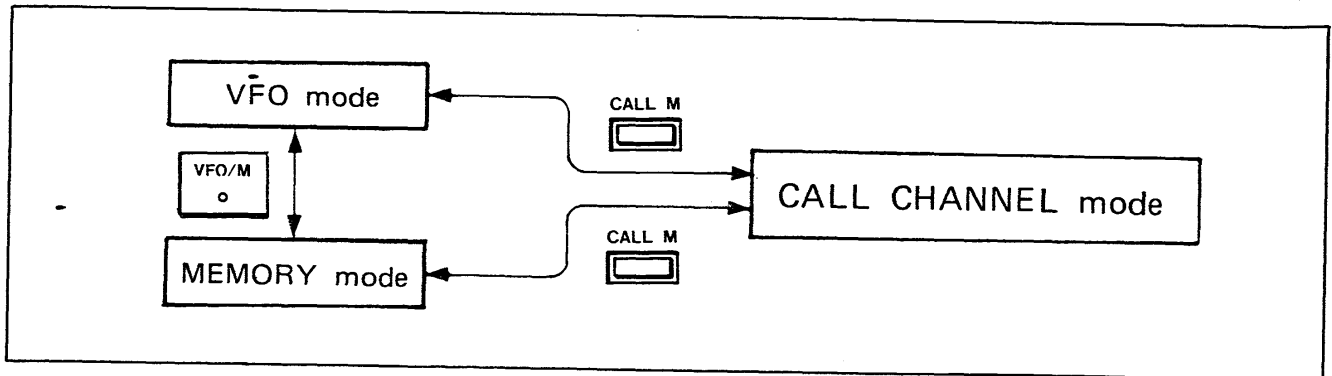

(1) RECALLING A CALL CHANNEL

■ IC-2400A/E



- 1) Push the [CALL M] or [CALL S] switch to select a call channel.
 - [CALL M] : MAIN band call channel
 - [CALL S] : SUB band call channel
 - "C" appears.
 - The TUNING CONTROL is deactivated.

- 2) Push the previously pushed CALL switch again to cancel the call channel.
 - Pushing the [VFO/M] switch also cancels the call channel.

■ IC-2500A/E

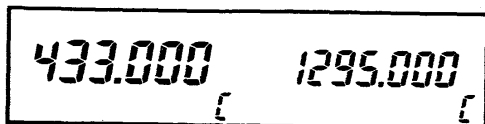

- 1) Push the [CALL] switch to select a call channel.
 - "C" appears.
 - The TUNING CONTROL is deactivated.

- 2) Push the [CALL] switch again to cancel the call channel.
 - Pushing the [VFO/M] switch also cancels the call channel.

- 3) To select a SUB band call channel, push the [SUB] switch then follow steps from 1 above.

(2) PROGRAMMING A CALL CHANNEL

■ IC-2400A/E

In call channel

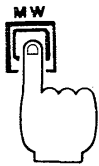

Push and hold while in call channel.

- 1) Push the [VFO/M] switch to select VFO mode.
- 2) Select the frequency as a call channel.
 - Repeater or other information can be programmed. (pgs. 18, 35, 36)
- 3) Push the [CALL M] or [CALL S] switch to select the call channel.
 - MAIN band: [CALL M]
 - SUB band : [CALL S]
 - (with the SUB band is accessed)
- 4) Push and hold the [MW] switch until the speaker emits 3 beep tones.
 - The selected frequency is programmed into the call channel.
- 5) To program a SUB band call channel, push the [SUB] switch then follow steps from 1 above.

■ IC-2500A/E

In call channel

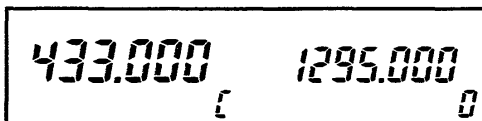

Push and hold while in call channel.

- 1) Push the [VFO/M] switch to select VFO mode.
- 2) Select the frequency as a call channel.
 - Repeater or other information can be programmed. (pgs. 18, 35, 36)
- 3) Push the [CALL] switch to select the call channel.
- 4) Push and hold the [MW] switch until the speaker emits 3 beep tones.
 - The selected frequency is programmed into the call channel.
- 5) To program a SUB band call channel, push the [SUB] switch then follow steps from 1 above.

6 RELATED FUNCTIONS

6-4 SCAN FUNCTIONS

There are 2 scan functions: programmed scan and memory scan. The memory skip function can be used with memory scan.

(1) PROGRAMMED SCAN

Programmed scan repeatedly scans between 2 programmed frequencies.

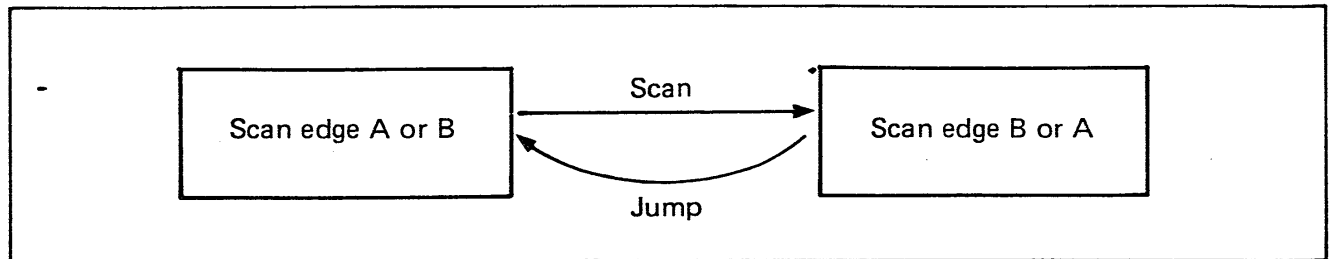

Push and hold while
in VFO mode.

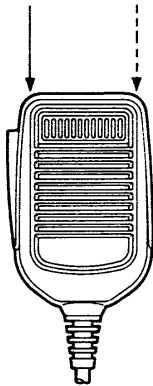

The decimal point flashes while scanning.

NOTE: Programmed scan does not function when:

- Priority watch is activated. (p. 30)
- Scan edge A and B are equal. (p. 27)

- 1) Push the [VFO/M] switch to select VFO mode.
- 2) Set scan edge frequencies using SET mode. (p. 27)
- 3) Rotate the SQUELCH controls to the squelch threshold points.
 - MAIN band : [MAIN SQL]
 - SUB band : [SUB SQL]
 - "BUSY" disappears.
- 4) Push and hold the [UP] or [DN] switch on the microphone for approx. 1 sec. to start the scan.
 - [UP] : upwards scan
 - [DN] : downwards scan
 - The decimal point flashes while scanning.
- 5) When receiving a signal, the scan pauses for approx. 15 sec on the frequency.
 - When the signal disappears, the scan resumes after approx. 2 sec.

- 6) To cancel the scan, push the [UP] or [DN] switch on the microphone.
 - The TUNING CONTROL and some other switches also cancel the scan.
- 7) To scan the SUB band, push the [SUB] switch then follow steps from 1 above.

USING SET MODE

■ SETTING SCAN EDGES

These settings can only be programmed in VFO mode.

Scan edges can be set in the MAIN and SUB bands separately.



The display shows programmed scan edge frequency A on the MAIN band.

1) Push the [VFO/M] switch to select VFO mode.

2) Push the [SET] switch several times until "A" flashes.

3) Rotate the TUNING CONTROL to set a desired scan edge frequency.

- To select 1 MHz tuning step increments, push the [MHz] switch. (p. 12)



The display shows programmed scan edge frequency B on the MAIN band.

4) Push the [SET] switch once.

- "b" flashes.

5) Rotate the TUNING CONTROL to set the other scan edge frequency.

6) Push the [VFO/M] switch to set scan edges and exit SET mode.

7) To set the SUB band scan edges, push the [SUB] switch then follow steps from 1 above.

6 RELATED FUNCTIONS

(2) MEMORY SCAN

Memory scan repeatedly scans all memory channels in succession.

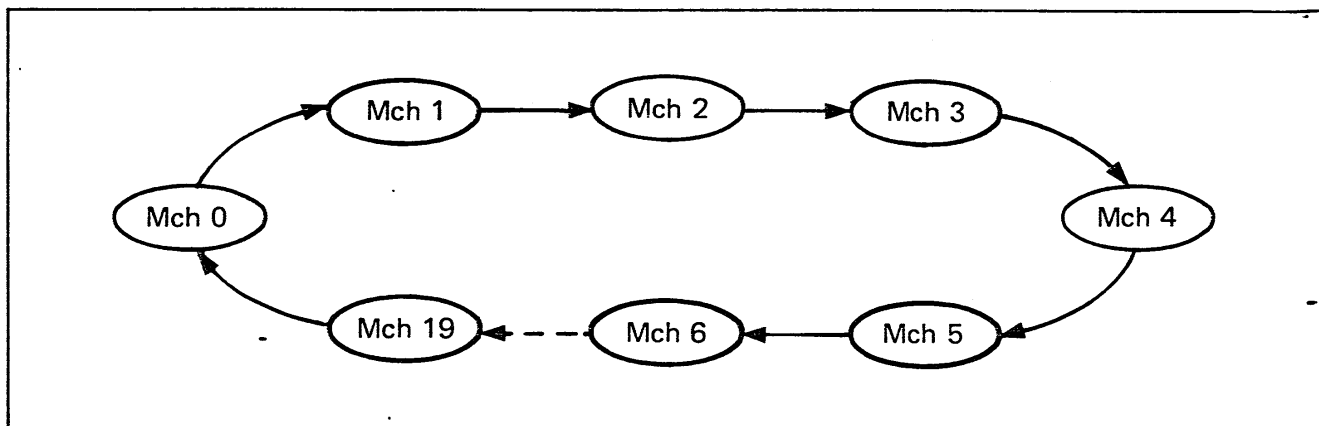

1) Push the [VFO/M] switch to select MEMORY mode. (p. 22)

- "M" appears.

2) Rotate the SQUELCH control to the squelch threshold point.

- MAIN band : [MAIN SQL]
SUB band : [SUB SQL]
- "BUSY" disappears.

3) Push and hold the [UP] or [DN] switch on the microphone for approx. 1 sec. to start the scan.

- [UP] : upwards scan
[DN] : downwards scan

4) When receiving a signal, scan pauses for approx. 15 sec. on the frequency.

- When the signal disappears the scan resumes after approx. 2 sec.

5) To cancel the scan, push the [UP] or [DN] switch on the microphone.

- The TUNING CONTROL and some other switches also cancel the scan.

6) To scan SUB band memory channels, push the [SUB] switch then follow steps from 1 above.

Push and hold while in MEMORY mode.

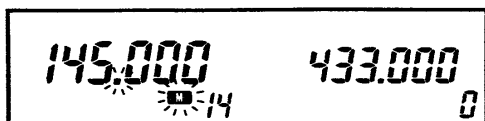
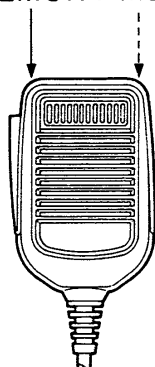

Both "M" and the decimal point flash.

(3) MEMORY SKIP FUNCTION

This function is used for skipping memory channels you do not wish to scan during memory scan operation. The memory skip function can also be used for priority watch (VFO ↔ memory channels). (p. 31)

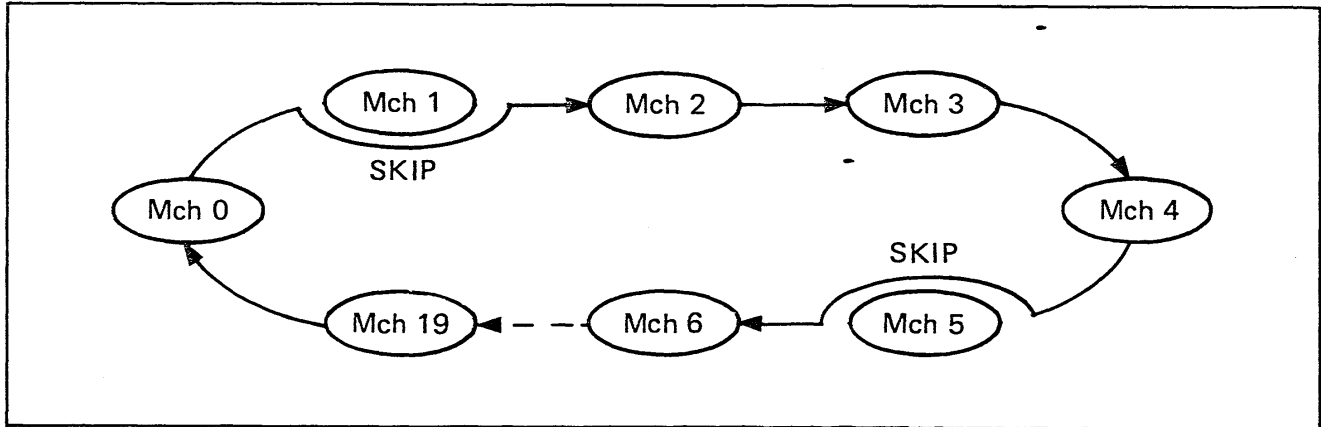

USING SET MODE FROM MEMORY MODE

- 1) Push the [VFO/M] switch to select MEMORY mode.
 - "M" appears.
- 2) Select the memory channel to be skipped with the TUNING CONTROL.
- 3) Push the [SET] switch several times until the memory channel number flashes.
- 4) Rotate the TUNING CONTROL to program the memory channel as a skip or non-skip channel.
 - "SKIP" appears when the memory channel is programmed as a skip channel.
- 5) Push the [VFO/M] switch to exit SET mode.
- 6) Repeat steps 1 ~ 5 to program another memory channel as a skip channel.
- 7) To select a SUB band memory channel, push the [SUB] switch then follow steps from 1 above.



The display shows that memory channel 18 on the MAIN band and 15 on SUB band are programmed as skip channels.

6 RELATED FUNCTIONS

6-5 PRIORITY WATCH

(1) VFO ↔ MEMORY OR CALL CHANNEL

Approx. every 5 sec. priority watch monitors a programmed frequency while you operate on a VFO frequency. Priority watch functions in the MAIN and SUB bands separately.

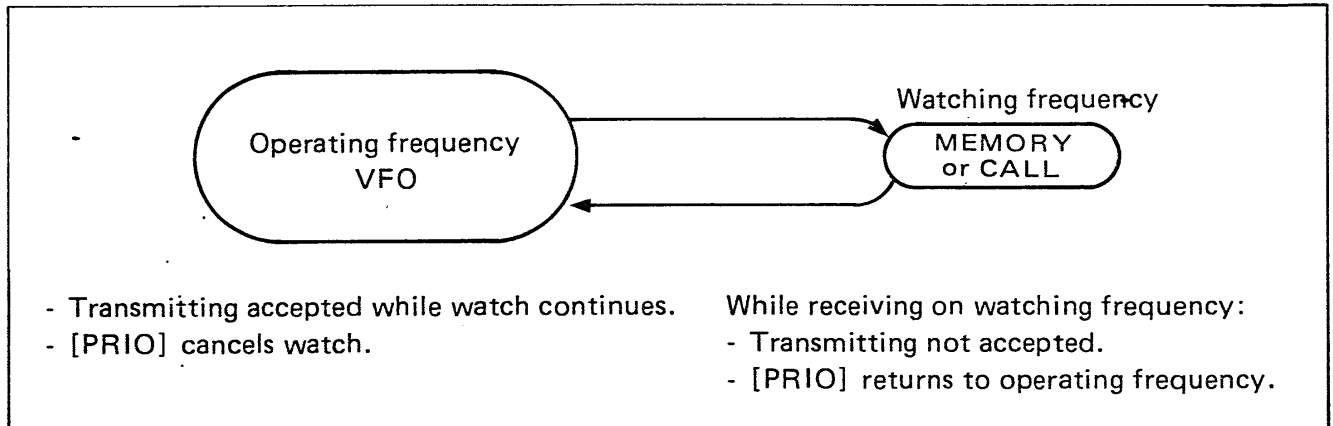

1) Set the desired operating frequency in VFO mode. (p. 12)

2) Select a memory channel in MEMORY mode or the call channel to be watched. (pgs. 22, 24)

3) Push the [PRIO] switch to start priority watch.
• "PRIO" appears.

4) When a signal is received on the priority frequency, priority watch pauses for approx. 15 sec. on the frequency.

• "PRIO" flashes.

• When the signal disappears, priority watch resumes after approx. 2 sec.

5) To cancel priority watch, push the [PRIO] switch when the operating frequency is displayed.

6) To watch a SUB band memory or call channel, push the [SUB] switch then follow steps from 1 above.

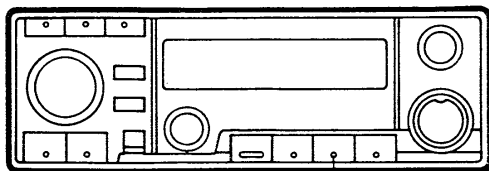

Push [PRIO].

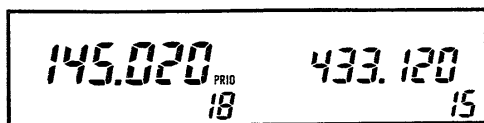

VFO frequency

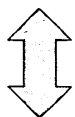

MEMORY channel

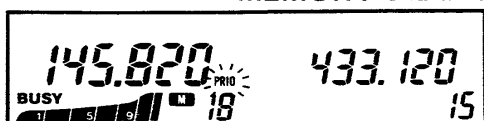

"PRIO" flashes when receiving a signal.

(2) VFO ↔ MEMORY CHANNELS

Priority watch can also watch each memory channel in approx. 5 sec. consecutive intervals.

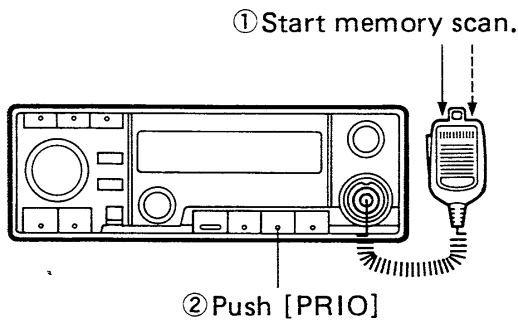
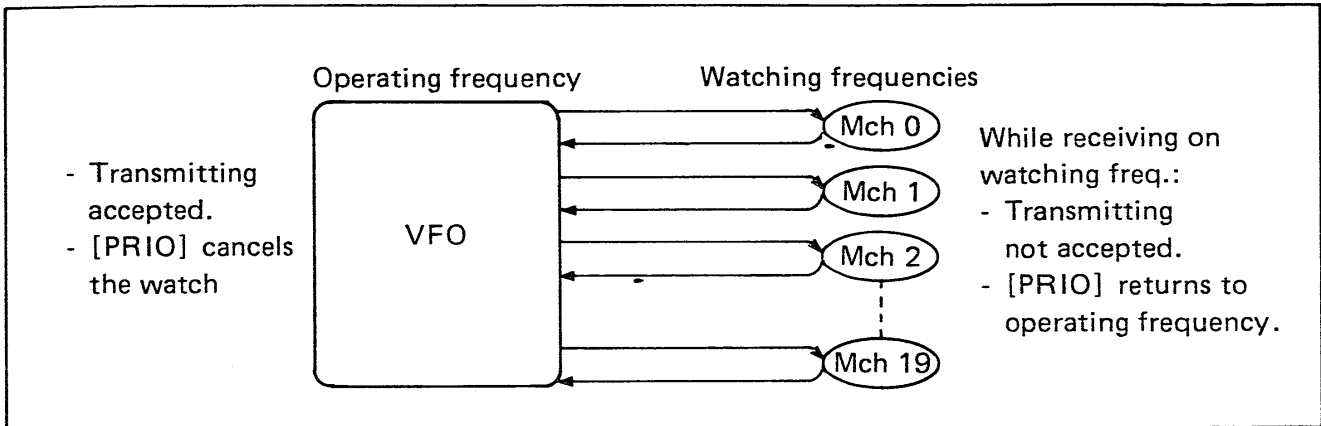

1) Set the desired operating frequency in VFO mode.

2) Push the [VFO/M] switch to select MEMORY mode.

- The memory skip function can be used. (p. 29)

3) Push and hold the [UP] or [DN] switch on the microphone for approx. 1 sec. to start memory scan. (p. 28)

4) Push the [PRIO] switch to start priority watch.

- "PRIO" appears.
- Memory channels advance approx. every 5 sec.

5) When a signal is received on a priority frequency, priority watch pauses for approx. 15 sec. on the frequency.

- "PRIO" flashes.
- When the signal disappears, priority watch resumes after approx. 2 sec.

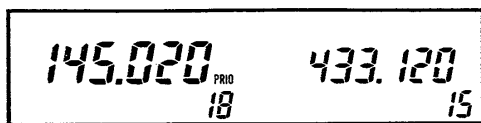

VFO frequency

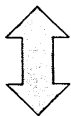

MEMORY channel



Changes each memory channel.

6) To cancel priority watch, push the [PRIO] switch when the VFO frequency is displayed.

7) To watch SUB band memory channels, push the [SUB] switch then follow steps from 1 above.

6 RELATED FUNCTIONS

6-6 DIMMER CONTROL

USING SET MODE ON THE MAIN BAND

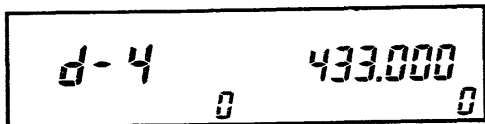

The display shows the brightest intensity.

This function can only be programmed on the MAIN band.

The intensity of the FUNCTION DISPLAY back-light is adjustable as follows:

- 1) When "SUB" appears, push the [SUB] switch several times to exit the SUB band.
- 2) Push the [SET] switch several times until "d-1", "d-2", "d-3" or "d-4" appears.
- 3) Rotate the TUNING CONTROL for the desired lighting intensity.
- 4) Push the [VFO/M] switch to set the intensity and exit SET mode.

6-7 BEEP ON/OFF

USING SET MODE ON THE MAIN BAND

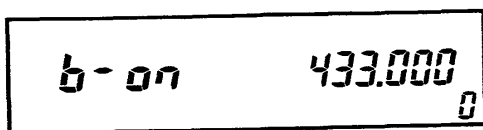

The display shows that beep is ON.

This function can only be programmed on the MAIN band.

The speaker emits a beep tone each time a switch is pushed. Turn ON or OFF beep tones as follows:

- 1) When "SUB" appears, push the [SUB] switch several times to exit the SUB band.
- 2) Push the [SET] switch until "b-on" or "b-off" appears.
- 3) Rotate the TUNING CONTROL to select beep ON and OFF.
- 4) Push the [VFO/M] switch to set the condition and exit SET mode.

6-8 SUB BAND BEEP AND SUB BAND MUTE

USING SET MODE ON THE SUB BAND

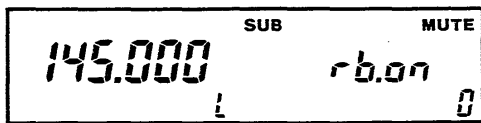

The display shows that both SUB band mute and SUB band beep functions are ON.

These settings can only be programmed on the SUB band.

To distinguish between the MAIN and SUB band audio, the SUB band beep function emits a beep tone when the SUB band squelch closes.

The SUB band mute function reduces the SUB band audio level and indicates "MUTE" when both the MAIN band and SUB band squelches open simultaneously. This function provides clear MAIN band audio.

Turn ON or OFF these functions as follows:

- 1) Push the [SUB] switch to access the SUB band.
 - "SUB" appears.
- 2) Push the [SET] switch several times until "rb.on" or "rb.oFF" appears.
- 3) Rotate the TUNING CONTROL to select functions as follows:

DISPLAY	FUNCTIONS	
	SUB BAND BEEP	SUB BAND MUTE
"rb.oFF"	OFF	OFF
"rb.on"	ON	OFF
"rb.oFF" "MUTE"	OFF	ON
"rb.on", "MUTE"	ON	ON

- 4) Push the [VFO/M] switch to set the condition and exit SET mode.
- 5) Push the [SUB] switch to exit the SUB band.

7-1 UT-40 INSTALLATION

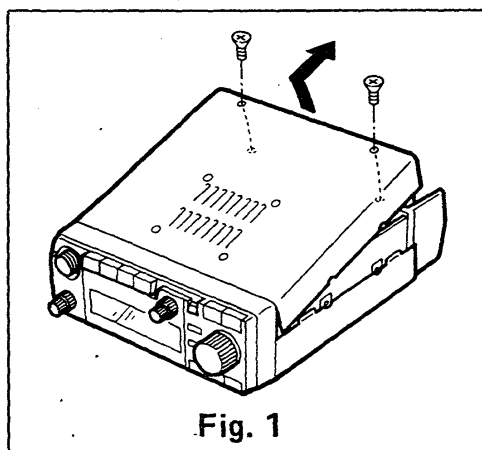

Fig. 1

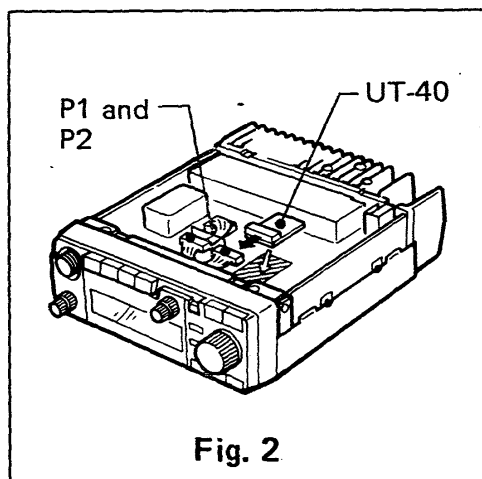

Fig. 2

Install an optional UT-40 TONE SQUELCH UNIT for pocket beep and tone squelch functions. Up to 2 UT-40s can be installed.

CAUTION: Turn OFF power and disconnect the DC power cable before removing covers from the transceiver.

- 1) Remove 2 screws from the bottom cover and remove the cover. (Fig. 1)
- 2) Connect the P1 or P2 plug (10-pin plug) from the transceiver MAIN-A UNIT to the UT-40 connector. (Fig. 2)
 - When 2 UT-40s are installed, stack 1 UT-40 on the other.
 - Use either P1 or P2 when only 1 UT-40 is installed.
- 3) Peel off the white sheet from the back of the UT-40.
- 4) Install the UT-40 in the proper position. (Fig. 2)
- 5) Replace the bottom cover and screws.

7-2 HIGH/LOW BAND SELECTION

This function can only be programmed on the MAIN band.

When only 1 UT-40 is installed in the transceiver, select a higher or lower band for UT-40 operation.

USING SET MODE WITH UT-40

- 1) When "SUB" appears, push the [SUB] switch several times to exit the SUB band.
- 2) Push the [SET] switch several times until "OP.Hb" or "OP.Lb" appears.
 - These indicators appear only when 1 UT-40 is installed.

POCKET BEEP AND TONE SQUELCH 7

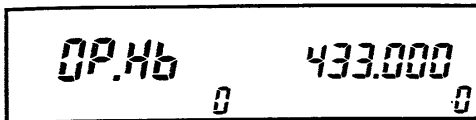

The display shows that the UT-40 operates on the higher band.

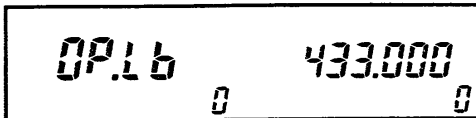

The display shows that the UT-40 operates on the lower band.

- 3) Rotate the TUNING CONTROL to select a higher or lower band.

	Lower band "OP.Lb"	Higher band "OP.Hb"
IC-2400A/E	144 MHz	430 or 440 MHz
IC-2500A/E	430 or 440 MHz	1200 MHz

- 4) Push the [VFO/M] switch to set the desired band and exit SET mode.

7-3 POCKET BEEP FUNCTION

The pocket beep function alerts you with approx. 30 sec. beep tones and a flashing "(((•)))" indicator when a signal with the same subaudible tone as pre-programmed is received. An optional UT-40 is necessary.

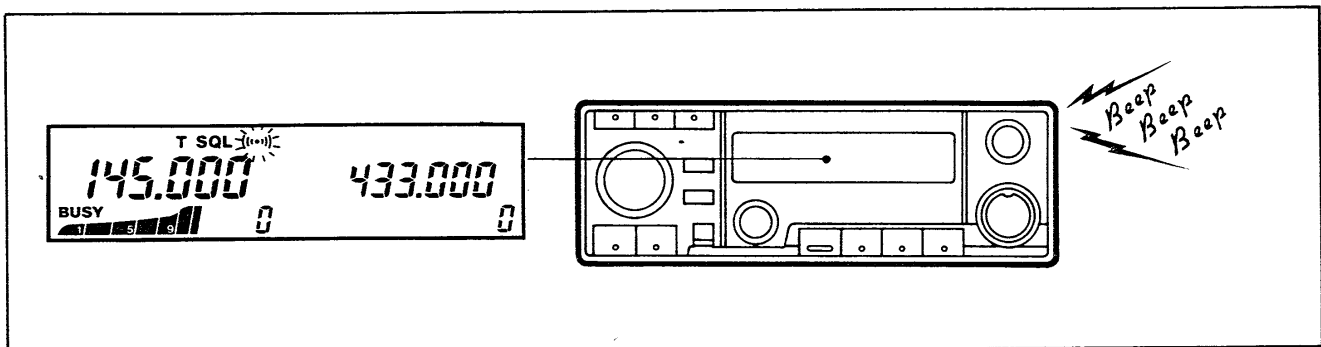

- 1) When only 1 UT-40 is installed, select the desired band. (p. 34)
- 2) Set a desired subaudible tone frequency. (p. 19)
- 3) Push the [T/T SQL] switch several times until "T SQL (((•)))" appears.
- 4) When the same subaudible tone as that pre-programmed is received, beep tones are emitted from the speaker.
 - "(((•)))" flashes.
- 5) Push any switch on the front panel or the PTT switch on the microphone to stop beep tones.
 - The tone squelch function is automatically activated. (p. 36)

7 POCKET BEEP AND TONE SQUELCH

7-4 TONE SQUELCH FUNCTION

When a signal with the same subaudible tone as that pre-programmed is received, the squelch opens. An optional UT-40 is necessary.

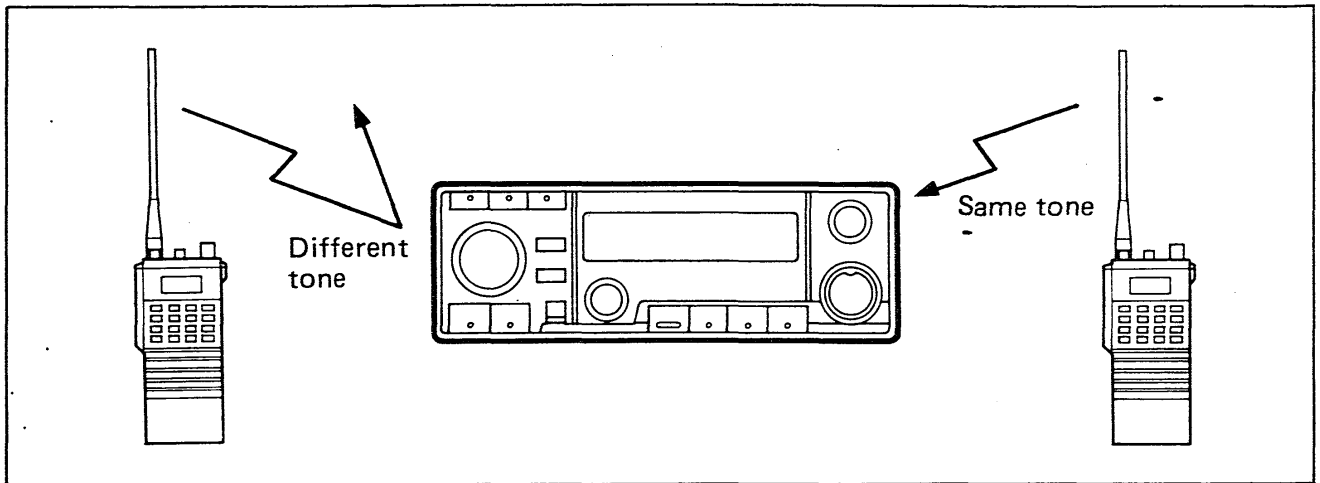

NOTE: Some repeaters are equipped with filters that filter out subaudible tones. Using the pocket beep or tone squelch function when contacting other stations may not always be possible.

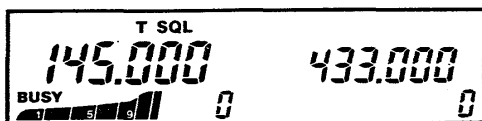

- 1) When only 1 UT-40 is installed, select the desired band. (p. 34)
- 2) Set the desired subaudible tone frequency. (p. 19)
- 3) Push the [T/T SQL] switch several times until "T SQL" appears.
- 4) When the same subaudible tone as that pre-programmed is received, the squelch opens.
 - Push the [SUB VOL] control to open the MAIN band squelch when necessary.

8-1 TROUBLESHOOTING

PROBLEM	POSSIBLE CAUSE	SOLUTION	REF.
1. Power does not come ON.	<ul style="list-style-type: none"> • Polarity of the power connection is reversed. • Blown fuse. 	<ul style="list-style-type: none"> • Reconnect the power cable observing the proper polarity. • Check the cause, then replace the fuse. 	<p>p. 7</p> <p>p. 39</p>
2. No sound comes from the speaker.	<ul style="list-style-type: none"> • The [MAIN SQL] or [SUB SQL] control is turned too far clockwise. • The optional tone squelch is turned ON when the UT-40 is installed. 	<ul style="list-style-type: none"> • Set the [MAIN SQL] or [SUB SQL] control at the threshold point. • Turn OFF the tone squelch function. 	<p>p. 15</p> <p>p. 36</p>
3. No contact possible with another station.	<ul style="list-style-type: none"> • The transceiver is set to duplex. 	<ul style="list-style-type: none"> • Set to simplex. 	<p>p. 16</p>
4. Repeater cannot be accessed.	<ul style="list-style-type: none"> • Wrong offset frequency is programmed. • Wrong subaudible tone frequency is programmed. 	<ul style="list-style-type: none"> • Correct the offset frequency. • Correct the subaudible tone frequency. <p>Be sure the offset and subaudible tone frequencies are independently programmed on each memory channel.</p>	<p>p. 19</p> <p>p. 19</p>
5. Frequency cannot be set.	<ul style="list-style-type: none"> • The lock function is activated. • CALL CHANNEL mode is selected. • Manual-RIT or manual-VXO function is activated. 	<ul style="list-style-type: none"> • Push the [SUB] switch several times until "L" disappears. • Push the [VFO/M] switch to leave CALL CHANNEL mode. • Push the [AFC] switch. 	<p>p. 13</p> <p>p. 12</p> <p>p. 21</p>
6. Scan does not operate.	<ul style="list-style-type: none"> • Squelch is open. • Scan edge A equals B. • All memory channels are programmed as the skip channel. 	<ul style="list-style-type: none"> • Set the squelch threshold point. • Reset scan edges. • Cancel the memory skip function in the desired channel. 	<p>p. 15</p> <p>p. 27</p> <p>p. 29</p>
7. All programmed memories have been erased.	<ul style="list-style-type: none"> • Data error occurred in the CPU RAM because of the following problems: <ul style="list-style-type: none"> - The backup battery is empty. - The CPU has been damaged by static. 	<ul style="list-style-type: none"> • Replace the backup battery. <p>Reset the CPU.</p>	<p>p. 39</p> <p>p. 38</p>

8 MAINTENANCE

8-2 CPU RESETTING

(1) AUTOMATIC RESETTING

The CPU is automatically reset when power is ON under the following conditions:

- The backup battery is empty.
- Static or magnetic field has caused a data error in the CPU RAM.

(2) MANUAL RESETTING

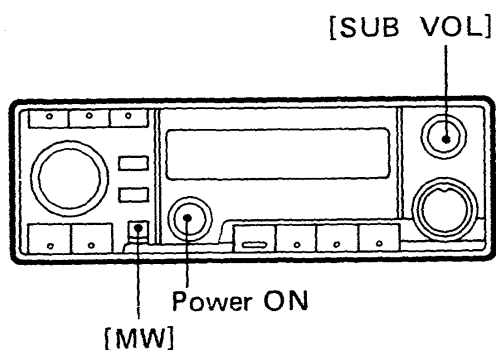

NOTE: Resetting the CPU erases all programmed information.

- 1) Turn OFF power.
- 2) Push and hold the [SUB VOL] control and [MW] switch.
- 3) Turn ON power, then release the switches.
 - The CPU is reset.

(3) CHANGING THE MINIMUM TUNING STEP INCREMENT

The minimum tuning step can be changed as follows:

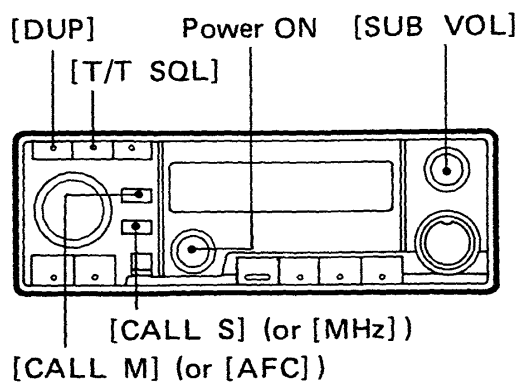

- 1) Turn OFF power.
- 2) Push and hold the [SUB VOL] control and one of the following switches:

144 MHz band

- 5 kHz → 12.5 kHz : [CALL S]
- 12.5 kHz → 5 kHz : [CALL M]

430 or 440 MHz band

- 5 kHz → 12.5 kHz : [T/T SQL]
- 12.5 kHz → 5 kHz : [DUP]

1200 MHz band

- 10 kHz → 12.5 kHz : [MHz]
- 12.5 kHz → 10 kHz : [AFC]

- 3) Turn ON power, then release the switches.
 - Use SET mode to select desired tuning step increment.

8-3 MISCELLANEOUS MAINTENANCE

■ FUSE REPLACEMENT

Locate the problem if possible before replacing a blown fuse.

- DC line fuses : 15 A

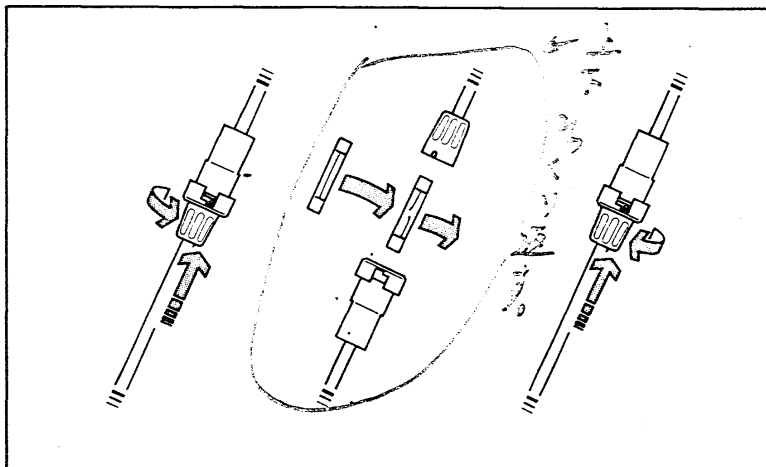

■ BACKUP BATTERY

The IC-2400A/E and IC-2500A/E have a lithium backup battery for retaining memory information.

The usual life of the backup battery is approx. 5 years. When the battery is exhausted, the transceiver transmits and receives normally but the transceiver cannot retain memory information.

NOTE: Battery replacement must be done by an authorized Icom Dealer or Service Center.

■ CLEANING



When the transceiver becomes dusty or dirty, wipe it clean with a dry, soft cloth. Avoid the use of chemical agents such as benzine or alcohol as they may damage the surfaces of the transceiver.

■ ADJUSTMENT CAUTION

Your IC-2400A/E and IC-2500A/E have been thoroughly adjusted and checked at the factory before being shipped. Your transceiver warranty does not cover problems caused by unauthorized internal adjustments.

9-1 IC-2400A/E INSIDE VIEWS

■ TOP VIEW (MAIN-B UNIT)

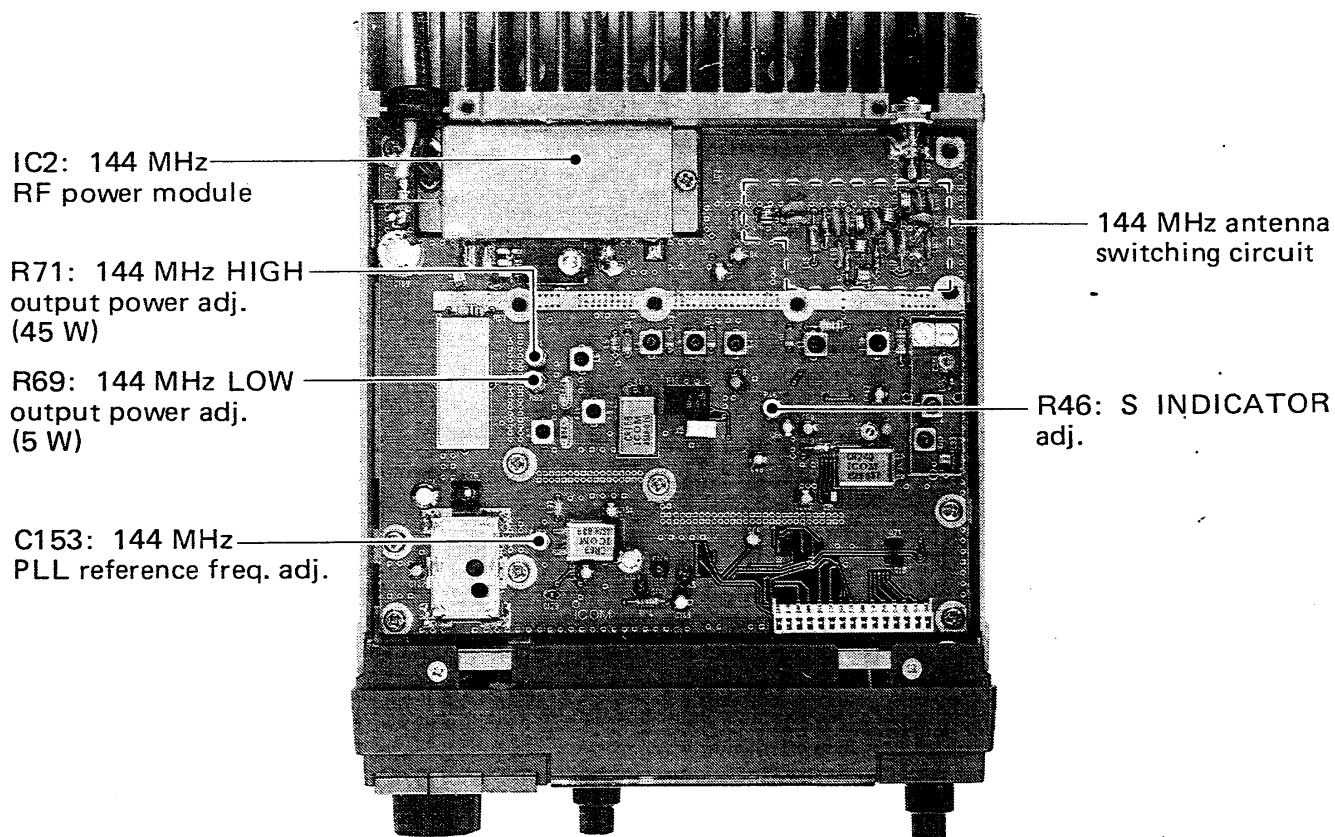

■ BOTTOM VIEW (MAIN-A UNIT)

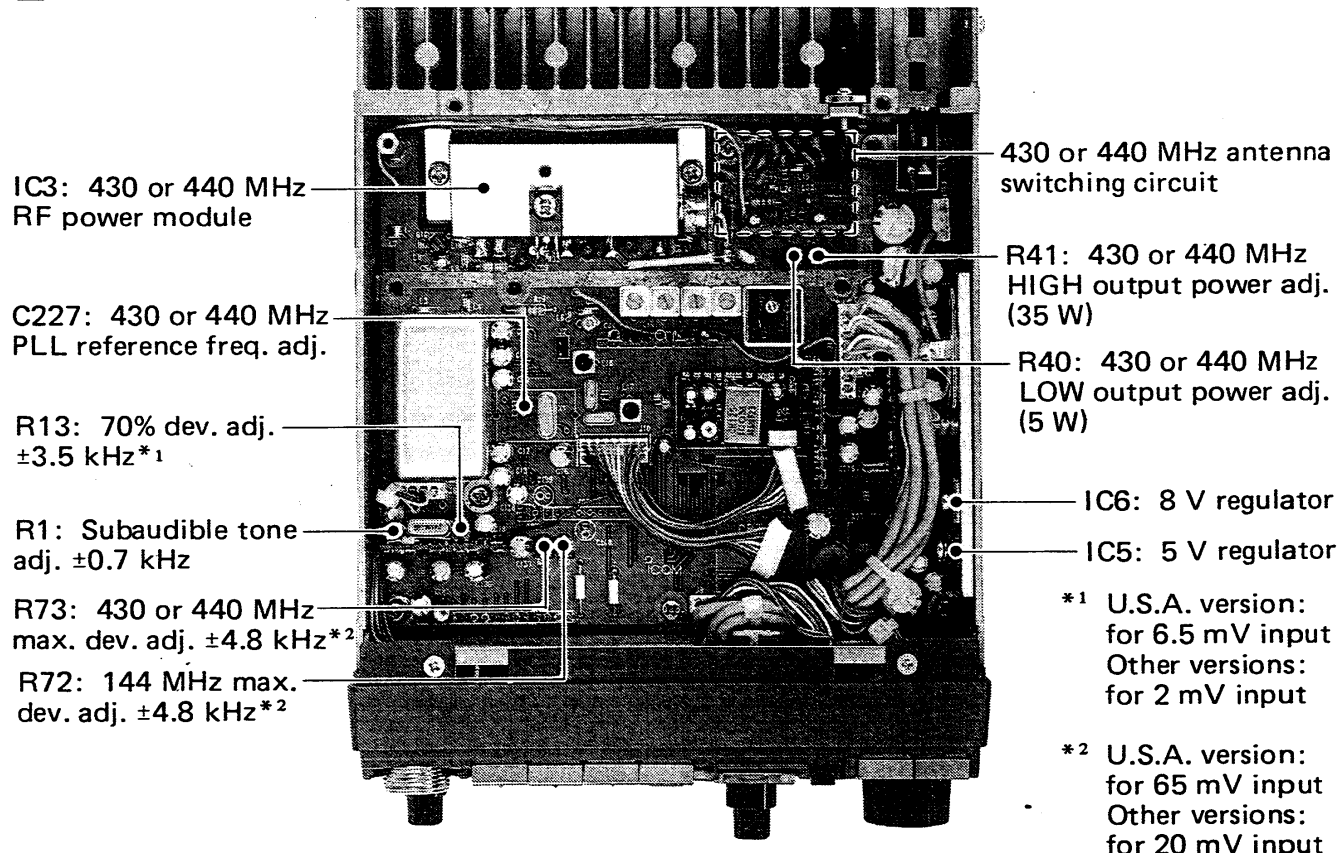

9-2 IC-2500A/E INSIDE VIEWS

■ TOP VIEW (MAIN-B UNIT)

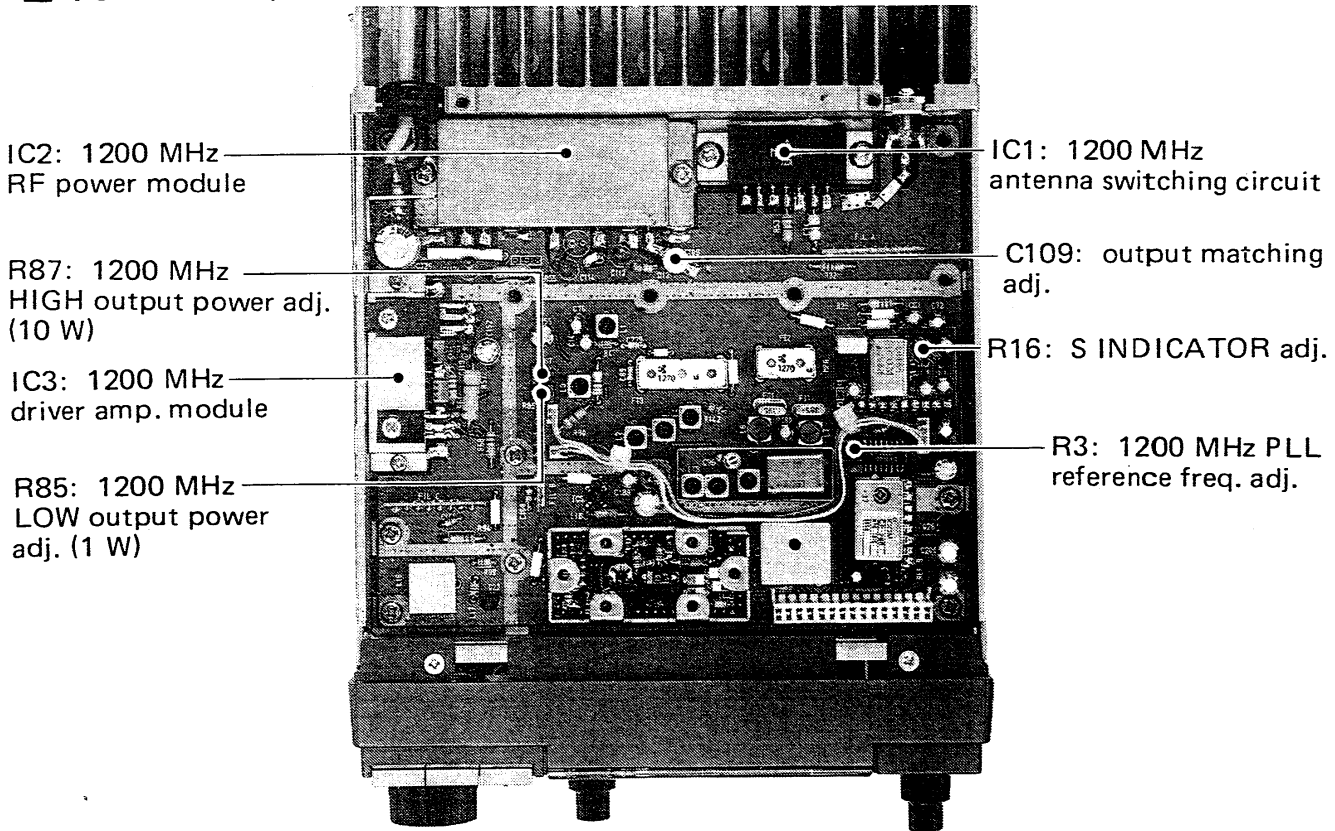

■ BOTTOM VIEW (MAIN-A UNIT)

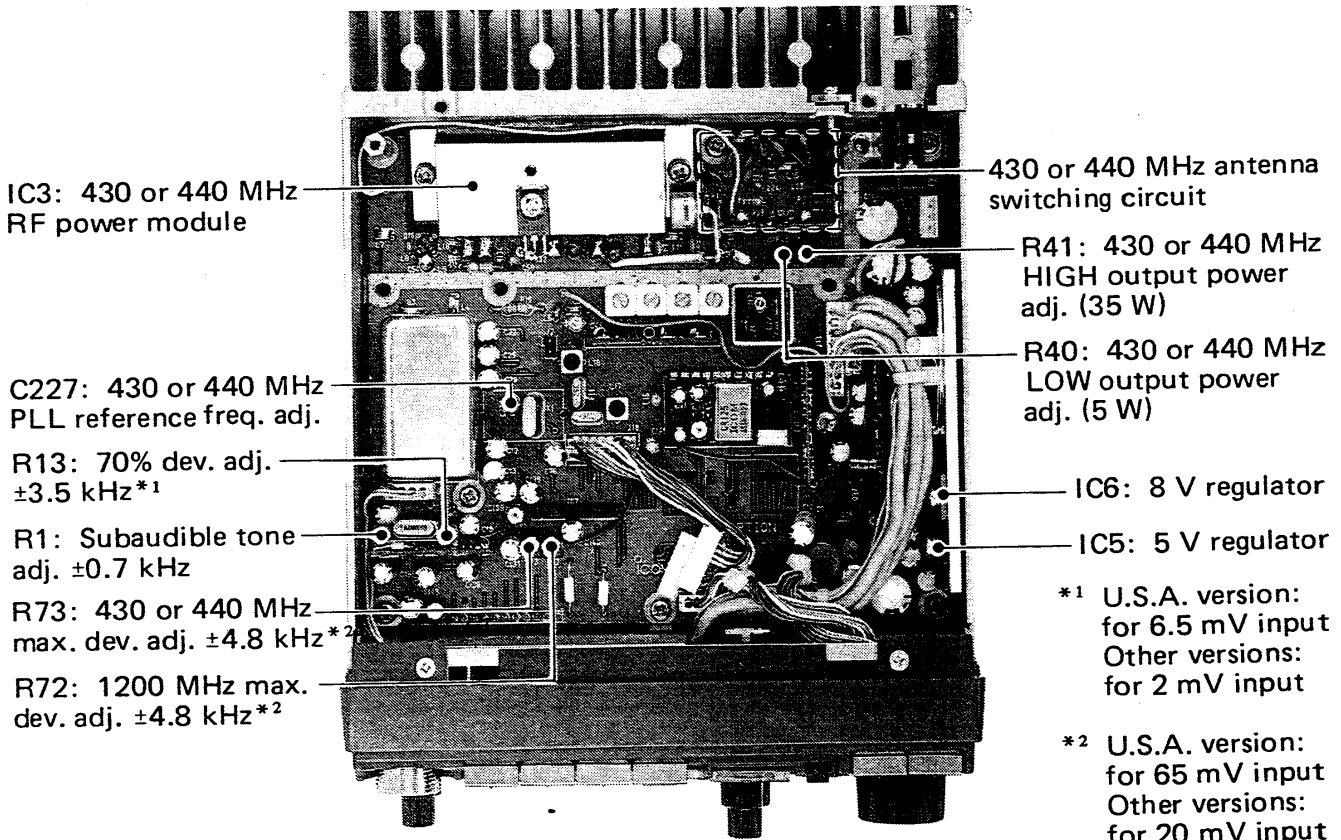

The above pictures show the transceiver without shield covers.

MODEL			IC-2400A/E		IC-2500A/E	
BAND			144 MHz	430 or 440 MHz	430 or 440 MHz	1200 MHz
Frequency coverage	U.S.A.	(Rx)	138~174*	440~450	440~450	1240~1300
		(Tx)	140~150*	440~450	440~450	1240~1300
	Australia		144~148	430~440	430~440	1240~1300
	Europe		144~146	430~440	430~440	1240~1300
(Unit : MHz)			*Specifications guaranteed 144 ~ 148 MHz.			
Tuning step increment			See p. 13			
Memory channels			40 and 2 call channels			
Mode			FM (F3)			
Antenna impedance			50 Ω (unbalanced)			
Power supply requirement			13.8 V DC \pm 15% (negative ground)			
Current drain						
Transmit	HIGH		10.5 A	10.5 A	10.5 A	6.6 A
	LOW		4.5 A	5.0 A	5.0 A	4.0 A
Receive	Squelched		1.0 A	1.0 A	1.0 A	1.0 A
	Max. audio output		1.4 A	1.4 A	1.4 A	1.4 A
Usable temperature range			-10°C ~ +60°C (+14°F ~ +140°F)			
Dimensions (projections not included)			150(W) x 50(H) x 195(D) mm 5.9(W) x 2.0(H) x 7.7(D) in			
Weight			1.7 kg (3.7 lb)		1.8 kg (4.0 lb)	
Output power	HIGH		45 W	35 W	35 W	10 W
	LOW		5 W	5 W	5 W	1 W
Spurious emissions (less than)			-60 dB	-60 dB	-60 dB	-50 dB (at 10 W) -40 dB (at 1 W)
Microphone impedance			600 Ω			
Intermediate frequencies	1st		17.2 MHz	30.875 MHz	30.875 MHz	136.6 MHz
	2nd		455 kHz	455 kHz	455 kHz	17.2 MHz
	3rd		—	—	—	455 kHz
Sensitivity (for 12 dB SINAD)			0.18 μ V	0.18 μ V	0.18 μ V	0.22 μ V
			Sensitivities are less than the above values.			
Spurious response rejection			Less than -60dB (except 1/2 IF on 1200 MHz)			
Audio output power			More than 2.4 W at 10 % distortion with an 8 Ω load			
Audio output impedance			4 ~ 8 Ω			

All stated specifications are subject to change without notice or obligation.

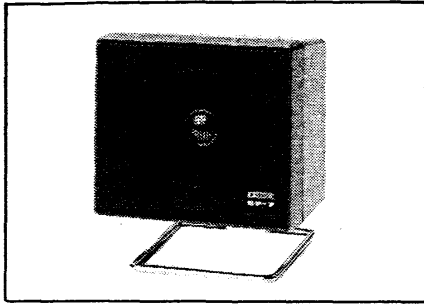

SP-7
EXTERNAL SPEAKER

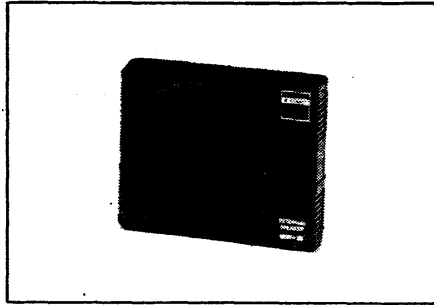

SP-8
EXTERNAL SPEAKER

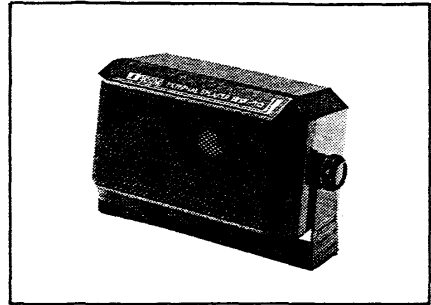

SP-10
EXTERNAL SPEAKER

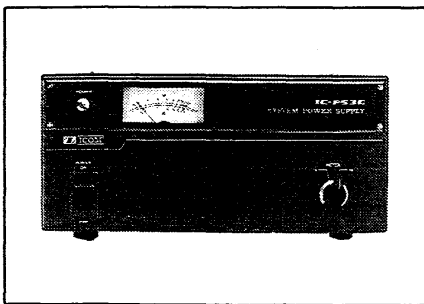

IC-PS30
AC POWER SUPPLY
(13.8 V DC, 25 A)

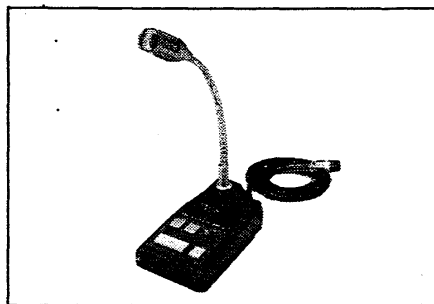

SM-8
DESK MICROPHONE

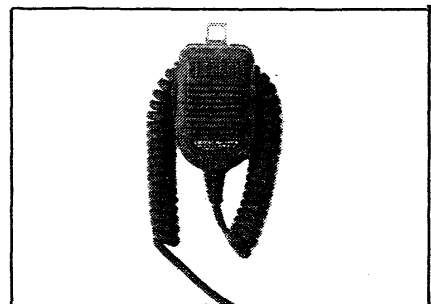

HM-14
DTMF MICROPHONE
(Same type supplied with the
U.S.A. versions.)

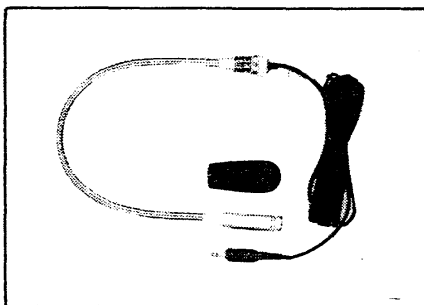

HS-15
FLEXIBLE MOBILE
MICROPHONE

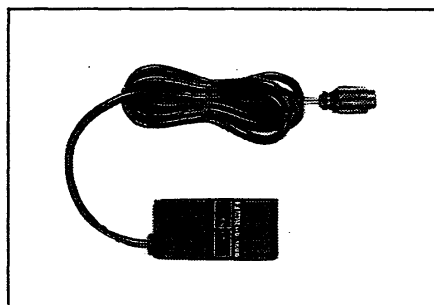

HS-15SB
SWITCHBOX
(for the HS-15)

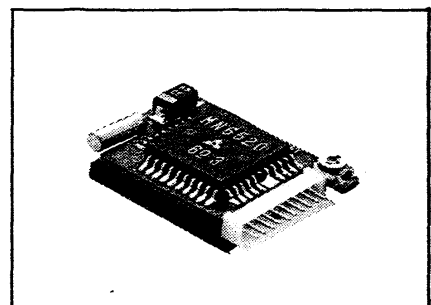

UT-40
TONE SQUELCH UNIT

AH-1200	1200 MHz MOBILE ANTENNA
AHB-1200	TRUNK MOUNT (For attaching the AH-1200 to your vehicle trunk.)

Count on us!



A-5051-1EX ①
Printed in Japan
Copyright © 1989 by Icom Inc.

Icom Inc.
6-9-16, Kamihigashi, Hirano-ku, Osaka 547, Japan
