

ICOM

INSTRUCTION MANUAL

144 MHz FM TRANSCEIVER

IC-T21A

IC-T21E

UHF FM TRANSCEIVER

IC-T41A

IC-T41E

This device complies with Part 15 of the FCC Rules. Operation is subject to the following two conditions: (1) This device may not cause harmful interference, and (2) this device must accept any interference received, including interference that may cause undesired operation.

Icom Inc.



IMPORTANT

READ ALL INSTRUCTIONS carefully and completely before using the transceiver.

SAVE THIS INSTRUCTION MANUAL — This instruction manual contains important safety and operating instructions for the IC-T21A/E and IC-T41A/E.

This instruction manual uses the IC-T21A/E for most of the example displays. Please note that only the frequency differs from the IC-T41A/E.

EXPLICIT DEFINITIONS

CAUTION : Equipment damage may occur.

NOTE : If disregarded, inconvenience only. No risk of personal injury, fire or electric shock.

WHEN FIRST APPLYING POWER

◇ Battery pack charging

- ① Insert the battery pack into the transceiver.
- ② Connect the wall charger to the [DC13.5V] jack to charge the battery pack.
 - Charging period of the BP-151 and BP-152 is approx. 15 hrs.

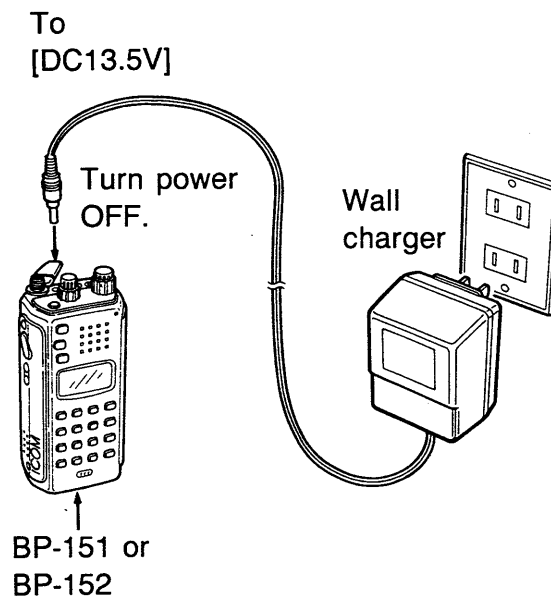

◇ Installing batteries into the battery case

- ① Remove the battery case from the transceiver as shown below. (Fig. 1)
- ② Install four dry cell batteries as shown below. (Fig. 2)
 - Pay attention to the polarities.
- ③ Insert the battery case into the transceiver until hearing a click.

(Fig. 1)

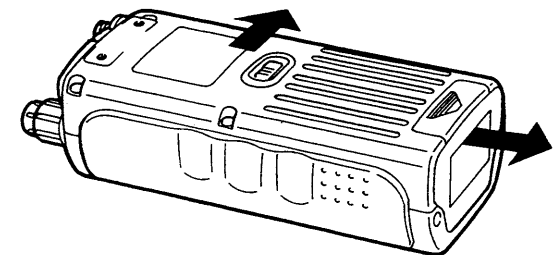

(Fig. 2)

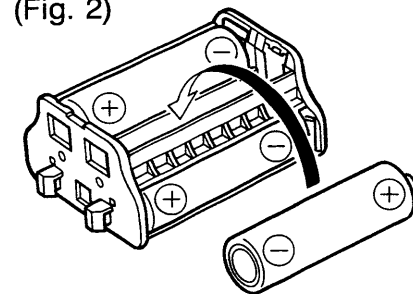

◇ Power ON

Push and hold [POWER] on the top panel for 1 sec. to turn power ON.

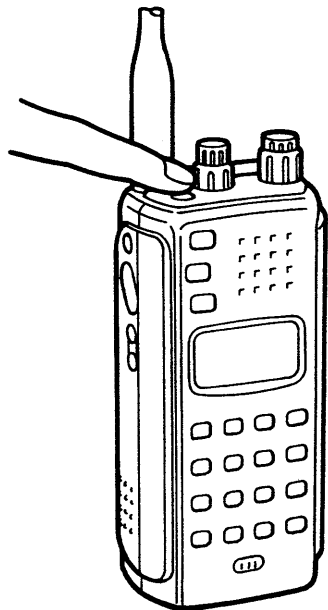

Push and hold [POWER] for 1 sec. again to turn power OFF.

◇ Resetting the transceiver

Reset the transceiver before operating for the first time, or when the internal CPU malfunctions.

- ① Turn power OFF.
- ② While pushing [FUNC], [A CLR] and [* ▽], push and hold [POWER] for 1 sec. to reset the CPU.

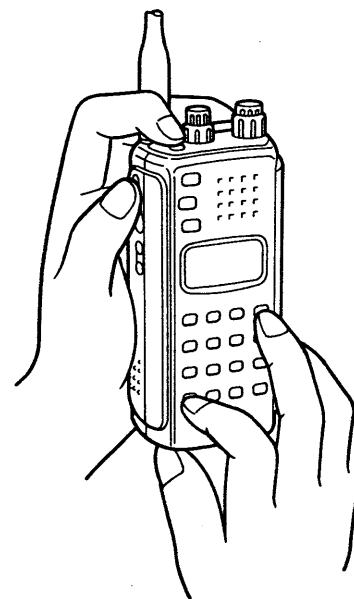

Partial resetting is alternatively available. See p. 48. for details.

CAUTIONS

NEVER connect the transceiver to an AC outlet or to a power source of more than 16 V DC.

NEVER connect the transceiver to a power source using reverse polarity. This connection will ruin the transceiver.

NEVER allow children to touch the transceiver.

AVOID using or placing the transceiver in direct sunlight or in areas with temperatures below -10°C ($+14^{\circ}\text{F}$) or above $+60^{\circ}\text{C}$ ($+140^{\circ}\text{F}$).

BE CAREFUL! When transmitting for a long time with high output power, the rear panel will become hot.

The use of non-Icom battery packs/chargers may impair transceiver performance and invalidate the warranty.

Even when the transceiver power is OFF, a slight current still flows in the circuits. Remove the battery pack or case from the transceiver when not using the transceiver for a long time. Otherwise, the battery pack or installed dry cell batteries in the battery case will become exhausted.

UNPACKING

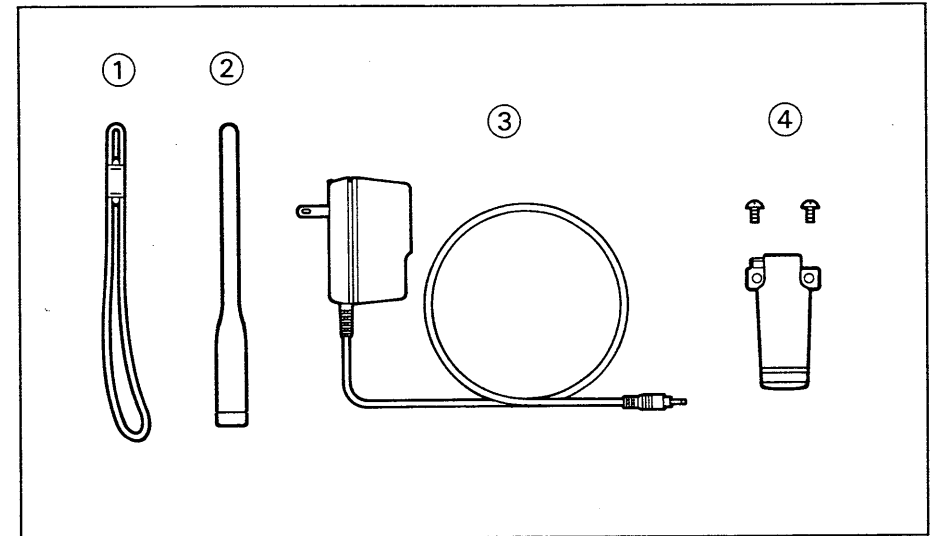

Accessories included with the transceiver:	Qty.
① Handstrap	1
② Antenna (FA-S270A)	1
③ Wall charger*	1
④ Belt clip and screws	1 set
Battery pack (BP-151) or battery case (BP-159) (attached to the transceiver)	1

*Not included with versions which include a battery case.

TABLE OF CONTENTS

IMPORTANT	i	■ Offset frequency	18	12 CLOCK AND TIMERS	35 – 38
EXPLICIT DEFINITIONS	i	■ Repeater memory	19	■ Clock operation	35
WHEN FIRST APPLYING POWER	i–ii	■ Auto repeater power control	19	■ Timer mode	36
CAUTIONS	iii	■ Auto repeater function	20	■ Auto power-off	36
UNPACKING	iii	■ Tone scan	20	■ Power-on timer	37
TABLE OF CONTENTS	iv			■ Power-off timer	38
1 PANEL DESCRIPTION	1–6	7 MEMORY OPERATION	21–24	13 PAGER AND CODE SQUELCH	39–42
■ Front and side panels	1	■ General description	21	■ General description	39
■ Top panel	2	■ Memory channel selection	21	■ Code programming	40
■ Keyboard	3	■ Programming a memory channel	22	■ Pager operation	41
■ Function display	5	■ Transferring memory contents	23	■ Code squelch operation	42
2 BATTERY PACK CHARGING	7–8	■ Masking a memory	23	14 POCKET BEEP AND	
■ Battery pack charging	7	■ Memory select channels	24	TONE SQUELCH	43–44
■ Charging precautions	7	■ Programming a memory select		■ Optional UT-81 installation	43
■ About the battery pack	7	channel	24	■ Pocket beep operation	44
■ Charging connections	8	8 CALL CHANNEL OPERATION	25	■ Tone squelch operation	44
3 ACCESSORY ATTACHMENT	9	■ Calling up a call channel	25	15 WHISPER FUNCTION	45
4 SETTING A FREQUENCY	10–13	■ Transferring call channel's contents	25	■ General operation	45
■ VFO and memory modes	10	■ Programming a call channel	25	■ Time-out timer setting	45
■ Main and sub bands	10	9 SCAN OPERATION	26–31	16 OTHER FUNCTIONS	46–48
■ Setting via the keyboard	11	■ Scan types	26	■ Power saver	46
■ Lock function	11	■ Full scan	27	■ Battery voltage indication	46
■ Presetting for the tuning dial	12	■ Programmed scan	27	■ PTT lock function	47
■ Setting via Δ/∇ keys	13	■ Crossband scan	27	■ Beep tone on/off	47
■ Using the tuning dial	13	■ Programming scan edges	28	■ Receive indicator on/off	47
■ LCD lighting	13	■ Frequency skip function	29	■ LCD contrast	47
5 BASIC OPERATION	14–16	■ Memory scan	30	■ DTMF speed	48
■ Receiving	14	■ Memory skip scan	30	■ Partial resetting	48
■ Transmitting	14	■ Skip channel setting	31	■ Optional HM-75A functions	48
■ Crossband full duplex	16	■ Scan resume condition	31	17 MODE CONSTRUCTION CHART	49–50
6 REPEATER OPERATION	17–20	10 DTMF MEMORY	32	18 TROUBLESHOOTING	51
■ Operation	17	■ Programming a DTMF code	32	19 SPECIFICATIONS	52
■ Tone information	17	■ Transmitting a DTMF code	32	20 OPTIONS	53–54
■ Subaudible tone	18	11 PRIORITY WATCH	33–34		
		■ Priority watch types	33		
		■ Priority watch operation	34		

■ Front and side panels

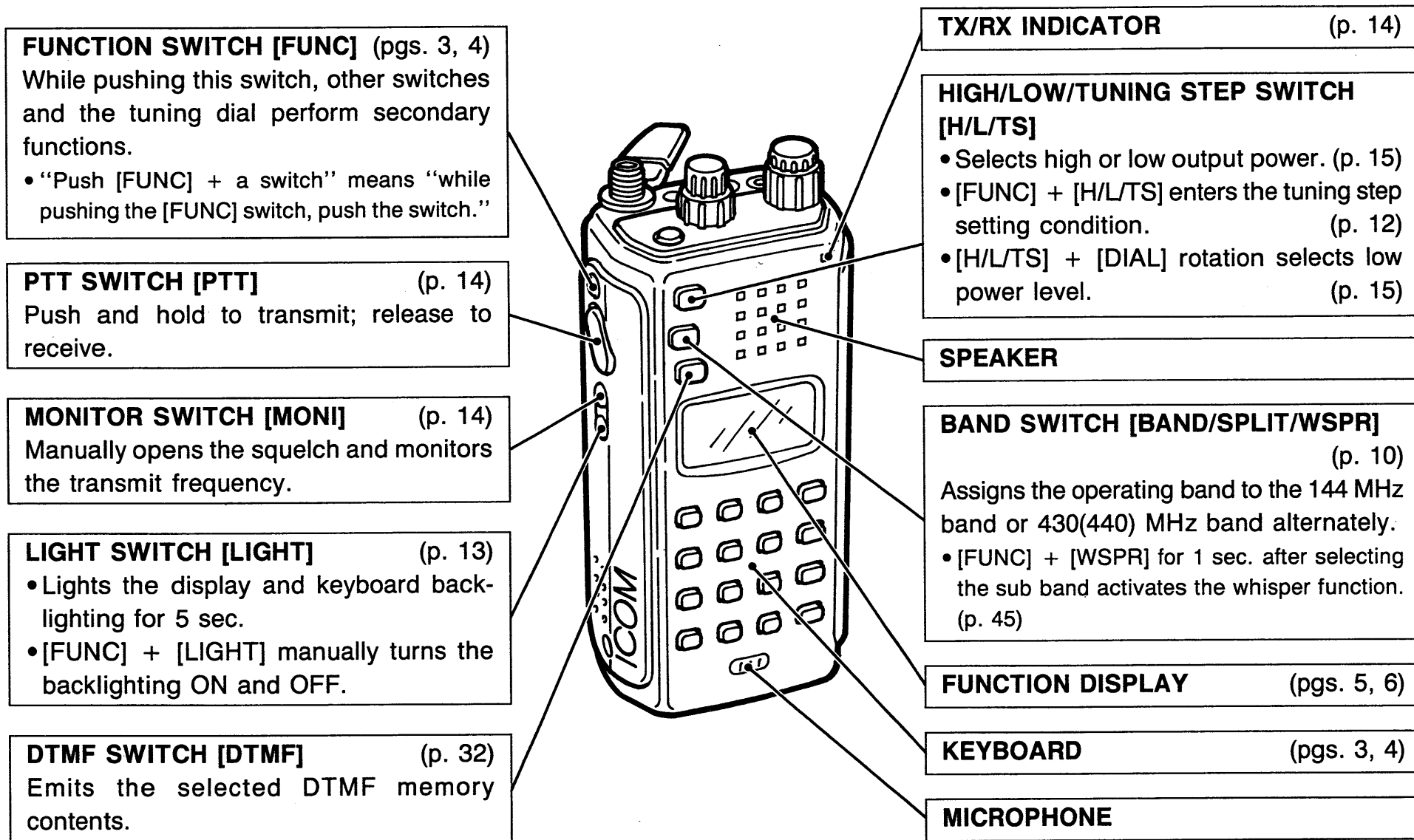

■ Top panel

EXTERNAL DC POWER JACK [DC13.5V] (p. 53)
 Allows operation with a 13.5 V DC power source using the optional cables, CP-12 or OPC-254.

CAUTION: Operation with an external DC power source simultaneously charges batteries inside the battery case or the battery pack. This may cause battery leakage and damage the transceiver or cause battery overcharging and shorten the life of the battery pack, respectively.

ANTENNA CONNECTOR (p. 9)
 Connects the supplied antenna.

POWER SWITCH [POWER] (p. ii)
 Turns the power ON and OFF when pushed for 1 sec.

SQUELCH CONTROL [SQL] (p. 14)
 Varies the squelch threshold point for noise mute.

BATTERY PACK RELEASE BUTTON (p. i)

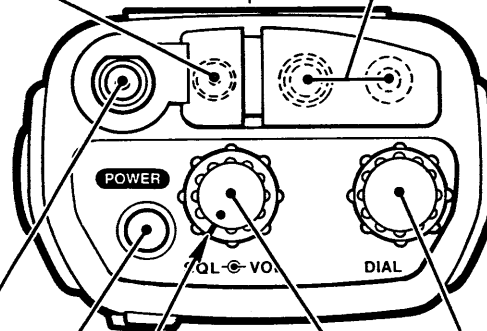

EXTERNAL SPEAKER AND MICROPHONE JACKS [SP]/[MIC]
 Connect an optional speaker-microphone or headset, if desired. The internal microphone will not function when either is connected. The HM-9 cannot be used. (p. 54)

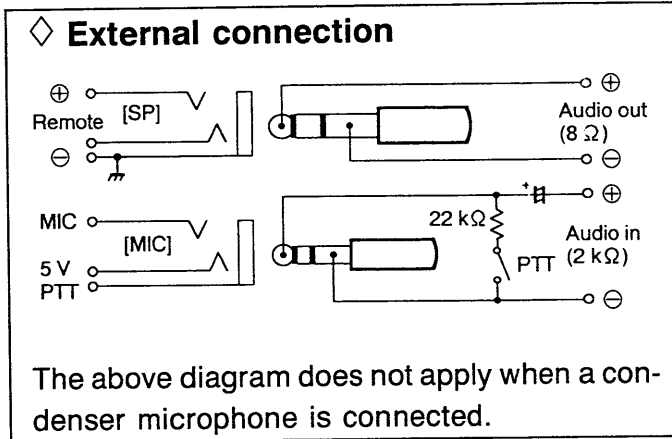

TUNING DIAL [DIAL]
 Sets operating frequency, memory channel and set mode contents.

VOLUME CONTROL [VOL] (p. 14)
 Adjusts the audio level.









1 PANEL DESCRIPTION

Keyboard

T/TSQL ①	PGR/C SQL ②	SKIP ③	CLR/M▶V A
DUP ④	CODE ⑤	MASK ⑥	MR/MW B
PRIO ⑦	SET ⑧	TIMER ⑨	RPT-M C
▽/SCAN X	D SEL 0	△/SCAN CALL/LOCK #	D

KEY	FUNCTION	SECONDARY FUNCTION (+ [FUNC])
T/TSQL ①	<ul style="list-style-type: none"> • Input the appropriate digit while in VFO and memory modes. (pgs. 11, 21) • Transmit the appropriate DTMF code while transmitting. 	Activates the following optional* functions in this sequence: subaudible tone encoder → pocket beep → tone squelch → non-tone operation. (pgs. 17, 44)
PGR/C SQL ②		Activates the following functions in this sequence: pager → code squelch → non-selective calling. (pgs. 41, 42)
SKIP ③		Sets the selected memory channel as a skip memory channel in memory mode. (p. 31)
DUP ④		Selects the duplex direction in this sequence: – duplex → + duplex → simplex. (p. 17)
CODE ⑤		Programs the code channel for pager and code squelch operation. (p. 40)
MASK ⑥		Hides and displays the selected memory channel in memory mode. Memory channel 0 cannot be hidden. (p. 23)
PRIO ⑦		Starts the priority watch. (p. 34)
SET ⑧		Enters set mode. (Various pages)
TIMER ⑨		Enters timer mode. (p. 36)
D SEL 0		Selects the dial select step. (p. 12)

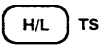
*Built-in to the U.S.A. version.

KEY	FUNCTION	SECONDARY FUNCTION (+ [FUNC])
CLR/M▶V 	<ul style="list-style-type: none"> • Clears frequency input before entry. (p. 11) • Selects VFO mode. (p. 10) 	When selecting memory mode, repeater memory or a call channel: transfers the contents into the VFO when pushed and held. (pgs. 23, 25)
MR/MW 	<ul style="list-style-type: none"> • Selects memory mode from VFO mode. (p. 21) • Selects memory mode or memory select mode when the memory select channels are set up. (pgs. 21, 24) 	Writes the VFO contents into the memory channel or call channel when pushed and held. (pgs. 22, 25) Programs the memory channel as a memory select channel when pushed and held. (p. 24)
RPT-M 	<ul style="list-style-type: none"> • Calls up the repeater memory. (p. 19) 	Starts tone scan while an optional* ² tone squelch is in use. (p. 20)
CALL/LOCK 	Calls up the call channel. (p. 25)	Turns the lock function ON and OFF. (p. 11)
▼/SCAN  ▲/SCAN 	<ul style="list-style-type: none"> • Changes the frequency in VFO mode. (p. 13) • Selects the memory channel in memory mode. (p. 21) • Starts the full scan or memory scan when pushed and held. (pgs. 27, 30) 	Selects one of 3 programmed scan edges and starts the programmed scan in VFO mode. (p. 27) Starts the memory skip scan in memory mode. (p. 30)
	<ul style="list-style-type: none"> • Selects high or low output power. (p. 15) • The tuning dial selects a low output power level while pushing this switch. (p. 15) • Generates a 1750 Hz tone*¹ while transmitting. (p. 17) 	The tuning dial selects the tuning step increments in VFO mode. (p. 12)
	<ul style="list-style-type: none"> • Assigns the operating band to the 144 MHz band or 430(440) MHz band alternately. (p. 10) • Generates a 1750 Hz tone*¹ while transmitting. (p. 17) • Starts crossband scan while full scan or programmed scan is activated. (p. 27) 	Turns the whisper function ON when pushed and held while receiving the sub band. (p. 45)
	Emits the selected DTMF memory contents. (p. 32)	Selects DTMF memory mode. (p. 32)

*¹ Europe, Italy and Denmark versions only.

*² Built-in to the U.S.A. version.

1 PANEL DESCRIPTION

■ Function display

FUNCTION INDICATOR

Appears while the [FUNC] switch is pushed.

LOCK INDICATOR

(p. 11)

Appears while the keyboard is electronically locked.

SUB BAND INDICATOR

(p. 10)

Appears while operating on the sub band (receiver band).

BATTERY VOLTAGE INDICATOR

(p. 46)

Graphically indicates the attached battery pack's voltage.

WHISPER FUNCTION INDICATOR

(p. 45)

Appears while the whisper function (telephone-style operation) is in use.

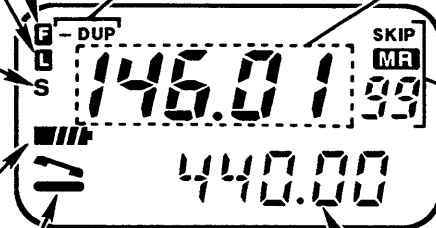

DUPLEX INDICATOR

(p. 17)

• “-DUP” or “DUP” appears during semi-duplex operation (repeater operation).

FREQUENCY READOUT

Shows the operating frequency, set mode contents, etc.

• The decimal point of the frequency flashes while scanning. (pgs. 26 – 31)

MEMORY CHANNEL INDICATOR

(p. 21)

Shows the selected memory channel number.

• “MR” appears when memory mode is selected.
• “SKIP” appears when the selected memory channel is set as a skip channel. (p. 31)
• “” appears when a call channel is selected. (p. 25)

SUB FREQUENCY READOUT

(p. 10)

Shows the current time or the secondary band's operating frequency during split operation.

TONE INDICATOR

Appears while an optional* tone squelch unit is in use.

- “T” appears while the subaudible tone encoder is in use. (p. 17)
- “T SQL” appears while the tone squelch is in use. (p. 44)
- “T SQL ((•))” appears while the pocket beep function is in use. (p. 44)

*Built-in to the U.S.A. version.

LOW POWER INDICATOR

- “LOW” appears while low output power is selected. (p. 15)
- “LOW” blinks while auto repeater power control is in use. (p. 19)
- “E LOW” appears while the economical low power (15 mW) is assigned to low output power and low power is selected. (p. 15)

AUTO POWER-OFF INDICATOR

(p. 36)

Appears while the auto power-off function is in use.

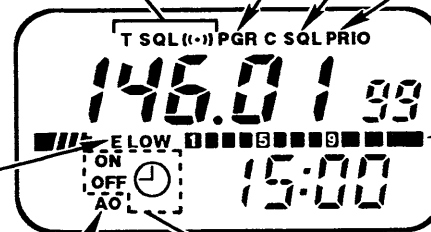

PAGER INDICATOR

(p. 41)

Appears while the pager function is in use.

CODE SQUELCH INDICATOR

(p. 42)

Appears while the code squelch is in use.

PRIORITY INDICATOR

(p. 34)

Appears while the priority watch is activated; flashes while the watch is paused.

S/R/F INDICATOR

- Shows the relative signal strength while receiving signals. (p. 14)
- Shows the output power selection while transmitting. (p. 15)

TIMER INDICATOR

(pgs. 37, 38)

- “⌚” appears while the power-on or power-off timer is in use.
- “ON” appears while the power-on timer is in use.
- “OFF” appears while the power-off timer is in use.

■ Battery pack charging

The supplied* BP-151 BATTERY PACK includes rechargeable Ni-Cd batteries and can be charged approx. 300 times. Charge the battery pack before first operating the transceiver or when the battery pack becomes exhausted. (p. 8)

* Optional for versions which come with the BP-159 BATTERY CASE.

If you want to be able to charge the battery pack more than 300 times, the following points should be observed:

1. Avoid overcharging. The charging period should be less than 48 hours.
2. Use the battery until it becomes almost completely exhausted under normal conditions. We recommend battery charging after transmitting becomes impossible.

■ Charging precautions

NEVER attempt to charge dry cell batteries. This will cause internal liquid leakage and damage the battery case or transceiver.

NEVER connect two or more chargers at the same time.

Charging may not occur in extreme cold (under 0°C; +32°F) or extreme heat (over +40°C; +104°F).

■ About the battery pack

◇ Operating period

Depending on the attached battery pack, the operating period of the transceiver varies. Refer to the table below.

Battery pack	Battery capacity	Approx. operating period			
		IC-T21A/E		IC-T41A/E	
		Cond. 1	Cond. 2	Cond. 1	Cond. 2
BP-151	800 mAh	5 h 40 m	1 h 55 m	6 h 00 m	2 h 00 m
BP-152	1100 mAh	7 h 45 m	2 h 40 m	8 h 15 m	2 h 50 m
BP-153	600 mAh	3 h 15 m	1 h 5 m	2 h 45 m	1 h 00 m

Condition 1: Tx (High) : Rx : Standby (power saved) = 1:1:8 (min.)

Condition 2: Tx (High) : Rx = 1:3 (min.) Operating periods are estimated values and vary depending on output power, temperature, etc.

◇ Battery pack life

When the operating period becomes extremely short even after charging the battery pack fully, a new battery pack is needed.

◇ When the battery is exhausted:

- Transmitting is interrupted while holding the [PTT] switch.
- The economical low power is automatically selected by the automatic power down function. (p. 15)
- The [POWER] switch cannot turn the power OFF. (At this time, remove the battery pack from the transceiver.)

■ Charging connections

◆ Regular charging

Connect the supplied* wall charger as shown below when a battery pack is attached to the transceiver.

* Optional for versions which include a battery case.

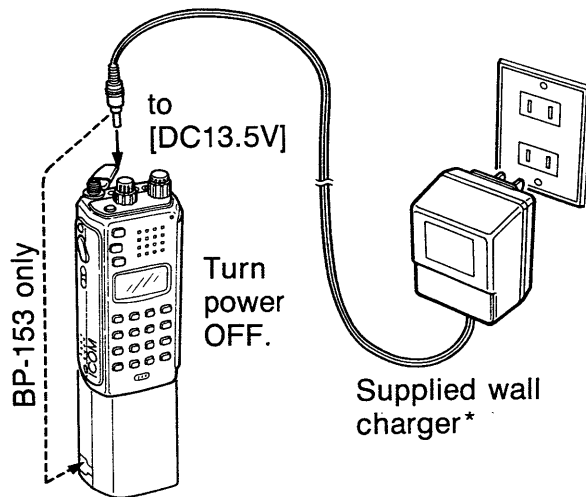

- The optional CP-12/L or OPC-254/L with a 12 – 16 V DC power source can be used for charging.
- Connect a charger directly to the battery pack for charging the BP-153.
- **Charging period: Approx. 15 hrs.**

◆ Rapid charging

- ① Insert the optional AD-44A BATTERY PACK ADAPTER into the charging slot of the BC-79 DESKTOP CHARGER.
- ② Firmly insert a battery pack into the AD-44A.

- Attach the AD-44B when charging the BP-151 or BP-152 alone.

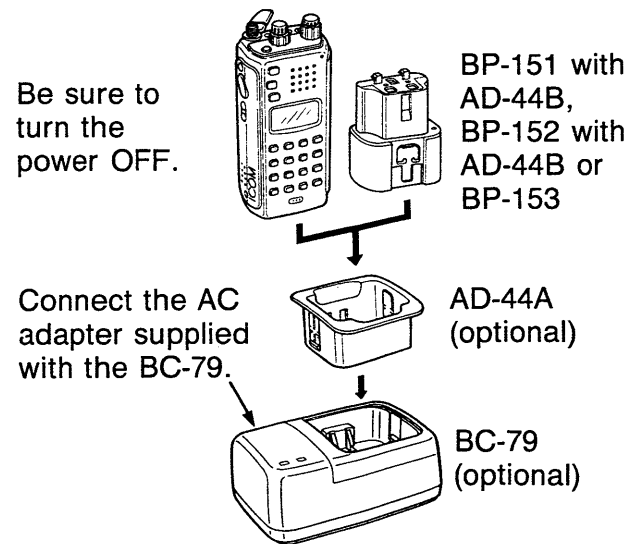

BATTERY PACK	BP-151	BP-152	BP-153
APPROX. CHARGING PERIOD	75 min.	70 min.	80 min

◆ Charging during external DC operation

CP-12/L (optional)

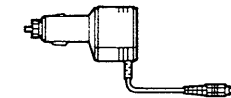

To cigarette lighter socket

OPC-254/L (optional)

White ⊕

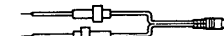

Black ⊖

To 12 – 16 V DC power source

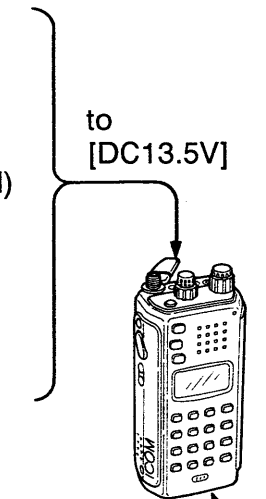

- When the BP-153 is attached, the battery pack is not charged.
- **NEVER** connect the above options when the BP-159 is attached.
- **Charging period: Approx. 15 hrs.**

3

ACCESSORY ATTACHMENT

◇ Antenna

Insert the supplied antenna into the antenna connector and screw down the antenna as shown in the diagram below. The transceiver uses an SMA-type antenna connector.

KEEP the jack cover attached when jacks are not in use to avoid bad contacts.

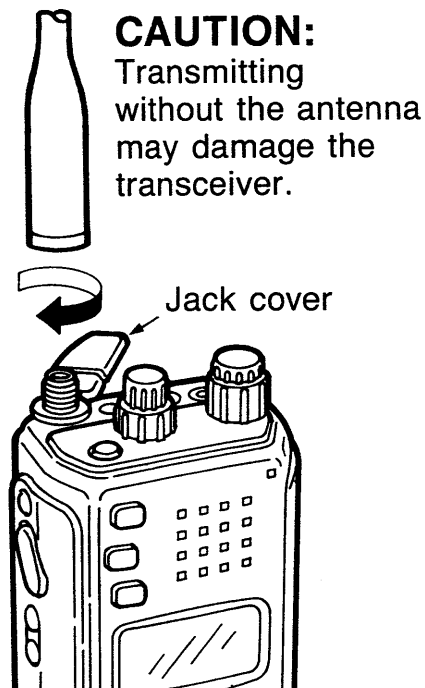

◇ Handstrap

Install the handstrap to the supplied belt clip as shown in the figure below. Attach the belt clip to the transceiver as described at right.

The handstrap facilitates carrying.

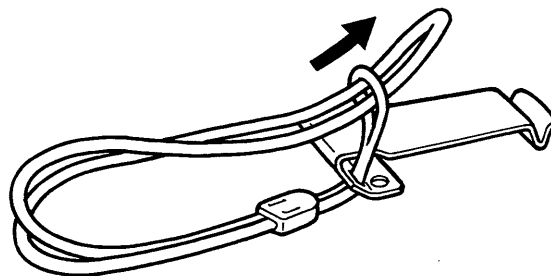

◇ Belt clip

Remove the plastic screws, then attach the belt clip with the supplied metal screws. Conveniently attaches to your belt.

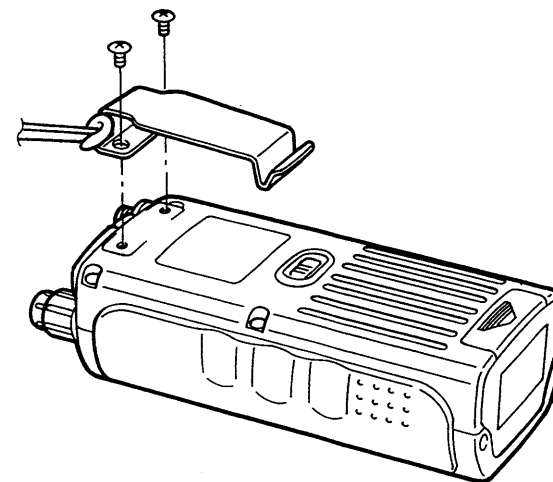

■ VFO and memory modes

This transceiver has 2 normal operating modes: VFO mode and memory mode. Pushing [A CLR] one or more times selects VFO mode. (pgs. 49, 50)

VFO mode (for setting a frequency):

This mode is used for setting a desired frequency within the band range.



Memory mode:

This mode is used for operation of memory channels which have programmed frequencies. 100 memory channels are available to store 100 different frequencies.



What is VFO?

VFO is an abbreviation of Variable Frequency Oscillator. Frequencies for transmitting and receiving are generated and controlled by the VFO.

■ Main and sub bands

The transceiver can receive another ham band frequency on the sub band.

- ① Push [A CLR] to select VFO mode.
- ② Push [BAND] to select the sub band.
 - The clock indication changes to the main band frequency.
- ③ Push [BAND] again to exit the sub band.



NOTE:

- Receiver performance on the sub band is reduced from a conventional transceiver. (p. 52)
- The memory channels can store both 144 MHz and 430(440) MHz band frequencies with selection of the sub band.
- The following functions are not available for the sub band:
 - Tone encoder (Optional for non-U.S.A. versions.)
 - Duplex setting
 - Call channel
 - Repeater memory



4 SETTING A FREQUENCY

■ Setting via the keyboard

- ① Push [A CLR] to select VFO mode.
- ② Select the desired band with [BAND].
- ③ Push 4 appropriate digit keys to input a frequency starting from the 1 MHz digit.
 - When a digit is mistakenly input, push [A CLR] to clear the input, then start again.
 - “0,” “2,” “5,” or “7” are acceptable for the 1 kHz digits (depending on the 10 kHz digit).

■ Lock function

The lock function prevents accidental frequency changes and accidental function activation.

- ① Push [FUNC] + [D LOCK] to turn the function ON.
 - “” appears.
- ② To turn the function OFF, repeat step ① above.
 - “” disappears.

NOTE: Output power can be selected between high and one of low powers even if the lock function is in use.

[EXAMPLE]: Setting the frequency to 145.26 MHz.

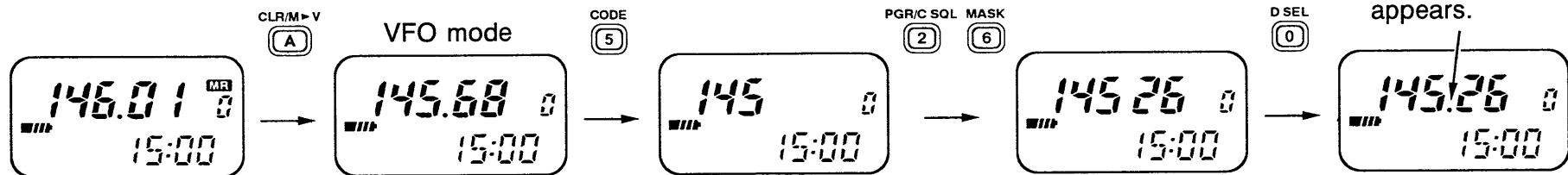

[EXAMPLE]: Setting the frequency to 446.375 MHz.

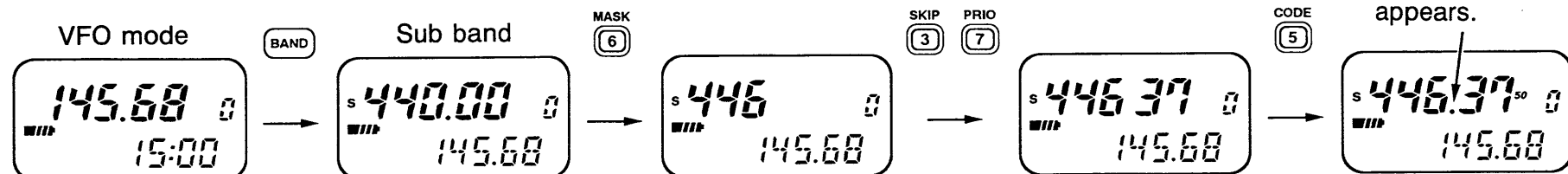

■ Presetting for the tuning dial

◇ Tuning step selection

A desired tuning step can be selected for each band. This transceiver has 8 tuning steps as follows:

- 5 kHz
- 10 kHz
- 12.5 kHz
- 15 kHz
- 20 kHz
- 25 kHz
- 30 kHz
- 50 kHz

- ① Push [A CLR] to select VFO mode.
- ② Select the desired band with [BAND].
- ③ Push [FUNC] + [H/L/TS] to enter the tuning step setting condition.
 - Previously selected tuning step appears.
- ④ Rotate the tuning dial to select the desired tuning step.
- ⑤ Push [H/L/TS] or [A CLR] to set the selected tuning step.

NOTE: For convenience, select a tuning step that matches the frequency intervals of repeaters in your area.

[DISPLAY EXAMPLE]

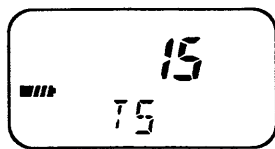

15 kHz tuning step

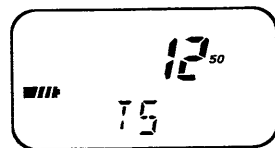

12.5 kHz tuning step

◇ Setting a dial select step

In VFO mode, rotating the tuning dial while pushing [FUNC] changes the frequency in 100 kHz or 1 MHz steps, or the memory channel number.

This function is useful for quick tuning or memory channel selection in VFO mode such as when programming 2 or more memory channels.

- ① Push [A CLR] to select VFO mode.
- ② While pushing [FUNC], push [D SEL] some times to set the dial select step.
 - While pushing [FUNC], the selected digit (100 kHz or 1 MHz) or memory channel number blinks.
 - Common setting for each band.
- ③ While pushing [FUNC], rotate the tuning dial to change the frequency or memory channel using the dial select tuning.

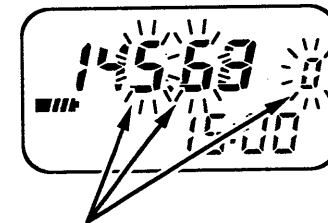

Selected digit (100 kHz or 1 MHz) or memory channel number blinks while setting the dial select step.

4 SETTING A FREQUENCY

■ Setting via Δ/∇ key

- ① Push [Δ CLR] to select VFO mode.
- ② Select the desired band with [BAND].
- ③ Push [$\#$ Δ] or [\ast ∇] to change the frequency.
 - The frequency changes according to the tuning step. (p. 12)
 - Pushing the key for more than 0.5 sec. will activate full scan.
 - If scan starts, push [$\#$ Δ] or [\ast ∇] again to stop it.

■ Using the tuning dial

- ① Push [Δ CLR] to select VFO mode.
- ② Select the desired band with [BAND].
- ③ Rotate the tuning dial to set the frequency.
- ④ To change the frequency quickly, rotate the tuning dial while pushing [FUNC].
 - See p. 12 for setting a dial select step.

■ LCD lighting

For easy operation at nighttime, the transceiver has an LCD (Liquid Crystal Display) and keyboard lighting function with a 5 sec. timer.

◇ 5 sec. timer

- ① Push [LIGHT] to turn the lighting ON.
- ② The lighting will automatically turn OFF when no switches or the tuning dial have been operated for 5 sec.
- ③ To turn OFF the lighting manually, push [LIGHT] again.

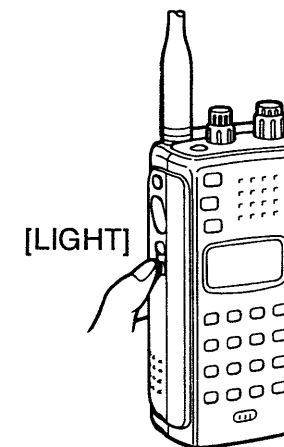

◇ Continuous lighting

Push [FUNC] + [LIGHT] for continuous lighting.

- Push [LIGHT] to turn the lighting OFF.

NOTE: Continuous lighting remains activated even when the power is turned OFF and ON again.

■ Receiving

- ① Turn power ON.
- ② Set the audio level.
 - Rotate [SQL] maximum counterclockwise.
 - Rotate [VOL] to adjust the desired audio output level.
 - Rotate [SQL] clockwise until noise is muted.
- ③ Set the desired frequency with the tuning dial. (pgs. 10–13)

When a signal is received:

- The TX/RX indicator lights up in green.
- Squelch opens and audio is emitted from the speaker.
- The S/RF indicator shows the relative signal strength.

When the [SQL] control is set too “tight” (extremely clockwise), squelch may not open for weak signals. To receive weak signals, set the squelch to a “loose” (less clockwise) position or use the monitor function.

◇ Monitor function

This function is used to listen to weak signals without disturbing the squelch setting or to open the main band squelch manually even when the pager, etc. is in use.

Push and hold [MONI] to open the squelch.

- While duplex is ON for repeater operation, the transmit frequency can be monitored with [MONI].

■ Transmitting

CAUTION: Transmitting without an antenna may damage the transceiver.

- ① Set the operating frequency. (pgs. 10–13)
 - If the sub band has been selected, select the main band in advance.
- ② Push and hold [PTT] to transmit.
 - The TX/RX indicator lights up in red.
 - The S/RF indicator shows the output power selection. (p. 15)
 - The sub band can receive while transmitting. See p. 16 “full duplex” for details.
 - If the PTT lock function is activated, transmission is impossible. Cancel the function, in advance. (p. 47)
- ③ Speak into the microphone using your normal voice level. The microphone is located below the keyboard.
 - DO NOT hold the transceiver too close to your mouth or speak too loudly. This may distort the signal.
- ④ Release [PTT] to return to receive.

5 BASIC OPERATION

◇ Output power selection

SELECTING HIGH OR LOW

Push [H/L] to select high or low output power.

- “LOW” or “E LOW” appears while a low power is selected.

SETTING A LOW OUTPUT POWER LEVEL

- ① Push and hold [H/L].
- ② While continuing to push [H/L], rotate the tuning dial to select the desired low power level.
 - The S/RF indicator shows the selected level as below.
 - Maximum output power at 6.0 V DC is approx. 1.5 W (typical).
 - “E LOW” appears while the economical low (15 mW) output power is selected.

POWER SELECTION	S/RF INDICATOR	OUTPUT POWER (typical; at 13.5 V)	
		IC-T21A/E	IC-T41A/E
HIGH	■■■■■□■■■■■□■■■■■	6.0 W	6.0 W
LOW 3	LOW ■■■■□■■■■□	4.0 W	4.0 W
LOW 2	LOW ■■■■□	1.4 W	3.0 W
LOW 1	LOW ■	1.0 W	2.0 W
E LOW	E LOW ■	15 mW	15 mW

NOTE: When the auto repeater power control is functioning, the “LOW” indicator blinks and the output power cannot be selected. (p. 19)

◇ Automatic power down function

The automatic power down function automatically selects “E LOW” as the output power just before the battery becomes exhausted. When this function activates, the battery will be immediately exhausted.

- When using dry cell batteries with the BP-159, you can still transmit for a short time at “E LOW (15 mW).”

The function can be turned OFF if desired.

USING SET MODE

SETTING THE AUTOMATIC POWER DOWN FUNCTION ON/OFF

- ① Push [FUNC] + [Ⓢ SET] to enter set mode.
- ② Push [⊛ ▽] or [⊛ Δ] until “ELOW” appears as shown in the display.
- ③ Rotate the tuning dial to turn the automatic power down function ON or OFF.
- ④ Push [ⓐ CLR] to set the condition and to exit set mode.

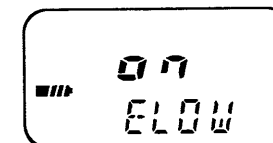

The automatic power down function is ON.

■ Crossband full duplex

The transceiver can receive the sub band frequency while transmitting on the main band. Using this capability, crossband full duplex operation is possible.

To prevent howling, use an optional HS-51 HEADSET or select the semi-duplex as described at right.

- ① Set the transmit frequency.
 - Push [A CLR] to select VFO mode.
 - Select the main band if the sub band has been selected.
 - Rotate the tuning dial to set the transmit frequency.
- ② Set the receive frequency.
 - Push [BAND] to select the sub band.
 - Rotate the tuning dial to set the receive frequency.
- ③ Set the same frequencies, but select your receiving band as the main (transmit) band for the other transceiver.
- ④ Push and hold [PTT] to operate in full duplex.
 - Transmitting and receiving activate simultaneously.

NOTE: This function cannot be used with 2 IC-T21A/E's or 2 IC-T41A/E's. If your transceiver is the IC-T21A/E, the other station's transceiver must be able to transmit/receive on 430(440) MHz and receive on 144 MHz. (e.g. IC-T41A/E, IC-W21AT/ET)

◇ Crossband full duplex and semi-duplex

The crossband full duplex can be turned OFF in set mode. In this case, semi-duplex operation is selected. (Transmitting on the main band and receiving on the sub band alternately.)

USING SET MODE

SELECTING THE CROSSBAND FULL DUPLEX OR SEMI-DUPLEX

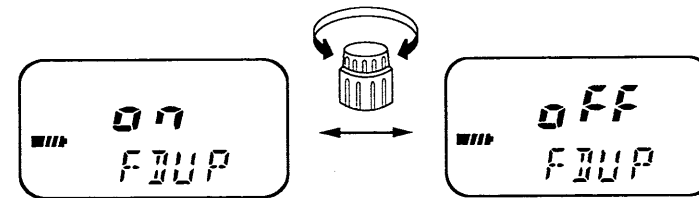

The crossband full duplex is ON.

The crossband full duplex is OFF (semi-duplex is ON).

- ① Push [FUNC] + [8 SET] to enter set mode.
- ② Push [* ▽] or [# △] until "FDUP" (Full Duplex) appears as shown in the display.
- ③ Rotate the tuning dial to select the crossband full duplex ("on") or semi-duplex ("off").
- ④ Push [A CLR] to set the condition and to exit set mode.

■ Operation

A repeater amplifies received signals and retransmits them at a different frequency. When using a repeater, the transmit frequency is shifted from the receive frequency by the offset frequency. (p. 18) It is convenient to program repeater information into a memory channel. (p. 22)

- ① Select the main band VFO mode.
- ② Set the receive frequency (repeater output frequency). (pgs. 10 – 13)
- ③ Push [FUNC] + [④ DUP] to select – duplex or push it again for + duplex.
 - “– DUP” or “DUP” appears to indicate the transmit frequency for minus shift or plus shift, respectively.
 - When the auto repeater power control is in use, “LOW” blinks and the output power is automatically selected. (p. 19)
 - The U.S.A. version has an auto repeater function. (p. 20)
- ④ Push and hold [PTT] to transmit.
 - The displayed frequency automatically changes to the transmit frequency (repeater input frequency).
 - When the repeater requires a tone, see section at right.
 - The operating condition is automatically programmed into a repeater memory. See p. 19 for details.
 - If “o.FF” appears, confirm the offset frequency. (p. 18)
- ⑤ Release [PTT] to receive.
- ⑥ Push and hold [MONI] to check whether the other station’s transmit signal can be directly received or not.

■ Tone information

SUBAUDIBLE TONE

(An optional UT-81 is necessary for non-U.S.A. versions.)

- ① Push [FUNC] + [① T/TSQL] several times until only “T” appears to turn ON the subaudible tone encoder.
 - To set the subaudible tone frequency, see “Subaudible tone” on the page at right.
 - For the U.S.A. version, an auto repeater function is available. When the auto repeater function type-2 (“rPT2”) is selected, the subaudible tone encoder is automatically turned ON or OFF when the operating frequency is adjusted to inside or outside of the general repeater input frequency range, respectively. (p. 20)
- ② Push [FUNC] + [① T/TSQL] several times until “T” disappears to turn OFF the subaudible tone encoder.

DTMF TONES

While pushing [PTT], push the desired digit key to transmit DTMF tones.

- The transceiver has 5 DTMF memory channels. See p. 32 for details.

1750 Hz TONE

(Europe, Italy and Denmark versions only)

While pushing [PTT], push and hold [H/L] or [BAND] for 1 – 2 sec. to transmit a 1750 Hz tone call signal.

■ Subaudible tone USING SET MODE

(An optional UT-81 is necessary for non-U.S.A. versions.)



The display shows an 88.5 Hz subaudible tone frequency.

■ Offset frequency USING SET MODE

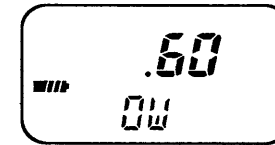

The display shows a 0.6 MHz (600 kHz) offset frequency.

- ① Push [A CLR] to select VFO mode.
- ② Push [FUNC] + [8 SET] to enter set mode.
- ③ Push [*▽] or [#△] until "TONE" appears as shown in the display.
- ④ Rotate the tuning dial to select the desired frequency.
 - Common setting for each band.
- ⑤ Push [A CLR] to set the value and to exit set mode.

• Subaudible tone frequency list

67.0	85.4	103.5	127.3	156.7	192.8	241.8
71.9	88.5	107.2	131.8	162.2	203.5	250.3
74.4	91.5	110.9	136.5	167.9	210.7	
77.0	94.8	114.8	141.3	173.8	218.1	
79.7	97.4	118.8	146.2	179.9	225.7	
82.5	100.0	123.0	151.4	186.2	233.6	

(Unit: Hz)

- ① Push [A CLR] to select VFO mode.
- ② Select the main band if the sub band has been selected.
- ③ Push [FUNC] + [8 SET] to enter set mode.
- ④ Push [*▽] or [#△] until "OW" appears as shown in the display.
- ⑤ Rotate the tuning dial to set the desired frequency.
 - Selectable step increment is the same as the preset tuning step. (p. 12)
 - Rotating the tuning dial while pushing [FUNC] changes the frequency in 100 kHz steps.
- ⑥ Push [A CLR] to set the value and to exit set mode.

6 REPEATER OPERATION

■ Repeater memory

This transceiver has a repeater memory to store repeater information separately from regular memory channels and the call channel.

When transmitting with duplex ON, the following information is automatically programmed into the repeater memory.

- Repeater output frequency (your receive frequency).
- “-DUP” or “DUP” setting and offset frequency.
- “T” setting and subaudible tone frequency (when used).

After you operate the transceiver in simplex, you can easily select the repeater memory.

- ① Push [C] RPT·M] to select the repeater memory.
 - Programmed repeater information and “rP” appear.
 - Push [A CLR] when the call channel is selected in advance.
 - When first applying power or after CPU resetting, the repeater memory is blanked and cannot be accessed.
- ② To return to the previous operating mode (VFO or memory mode), push [C] RPT·M] again.

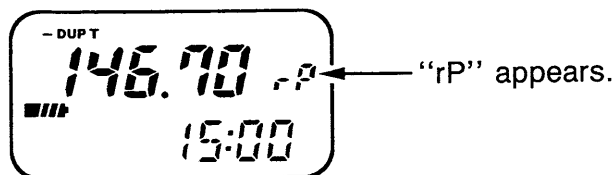

■ Auto repeater power control

This transceiver automatically selects the output power while in duplex operation. When receiving with duplex ON, the transceiver monitors the signal strength every 0.5 sec. and determines an output power between high, low 1 – low 3. This function automatically conserves the battery power during repeater communication.

- While the function is in use and duplex is selected, the “LOW” indicator blinks and [H/L] cannot select the output power.

Sometimes an appropriate output power may not be selected because of the repeater location, propagation conditions, etc.

USING SET MODE

SETTING THE AUTO REPEATER POWER CONTROL FUNCTION ON/OFF

- ① Push [FUNC] + [8]SET] to enter set mode.
- ② Push [*∇] or [#Δ] until “rPTPW” appears as shown in the display.
- ③ Rotate the tuning dial to turn the auto repeater power control function ON or OFF.
- ④ Push [A CLR] to set the condition and to exit set mode.

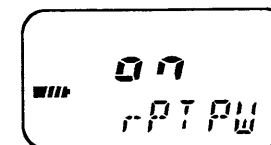

■ Auto repeater function

(U.S.A. version only)

The U.S.A. version automatically activates or deactivates the repeater settings (duplex ON/OFF, duplex direction, tone encoder ON/OFF) when the main band operating frequency falls within or outside of the general repeater output frequency range, respectively. The offset frequency and subaudible tone frequency are not changed by the auto repeater function, reset these frequencies, if desired.

USING SET MODE

SETTING THE AUTO REPEATER FUNCTION ON/OFF

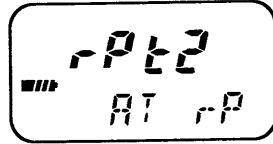
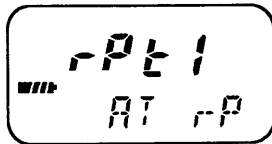

Duplex setting: Automatic
Tone encoder: Automatic OFF

Automatic
Automatic ON

- ① Push [FUNC] + [Ⓢ SET] to enter set mode.
- ② Push [⌘ ▽] or [⌘ △] until "AT rP" appears as shown in the display.
- ③ Rotate the tuning dial to turn the auto repeater function ON ("rPt1" and "rPt2") or OFF.
- ④ Push [Ⓐ CLR] to set the condition and to exit set mode.

■ Tone scan

The transceiver can detect the subaudible tone frequency in a received signal. By monitoring a signal that is being transmitted on a repeater input frequency, you can determine the tone frequency of the repeater.

An optional UT-81 is necessary for non-U.S.A. versions.

- ① Push [Ⓐ CLR] to select VFO mode.
- ② Select the desired band with [BAND].
- ③ Set the desired frequency to be checked for a tone frequency.
- ④ Push [FUNC] + [① T/TSQ] one or more times until "T SQL" appears in the function display.
- ⑤ Push [FUNC] + [Ⓒ RPT·M] to start the tone scan.
 - To change the scanning direction, rotate the tuning dial.
 - Be sure the pager or code squelch is deactivated in advance. (pgs. 41, 42)
- ⑥ When the tone frequency is matched, the squelch opens and the tone frequency is programmed into the VFO.
 - The tone frequency setting is common for each band.
 - The scan resumes in the selected scan resume condition.
- ⑦ Push [Ⓐ CLR] to stop the scan.

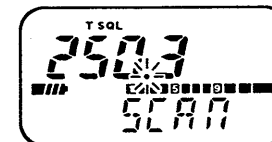

■ General description

The transceiver has 100 memory channels (plus 6 scan edge memory channels for each band) for storage of often-used frequencies. You can program the following data into each memory channel separately. In addition, memory select channels are available to speedup the selection of often-used memory channels.

- Operating frequency (pgs. 11 – 13)
- Sub band frequency and sub band selection (p. 10)
- Duplex direction (DUP or –DUP) (p. 17)
- Offset frequency (p. 18)
- Subaudible tone frequency*¹ (p. 18)
- Subaudible tone encoder ON/OFF*¹ (p. 17)
- Tone squelch ON/OFF*¹ (p. 44)
- Skip information*² (p. 31)

*¹ An optional UT-81 TONE SQUELCH UNIT is necessary for non-U.S.A. versions.

*² Except for the scan edge memory channels.

MEMORY CHANNEL ARRANGEMENT

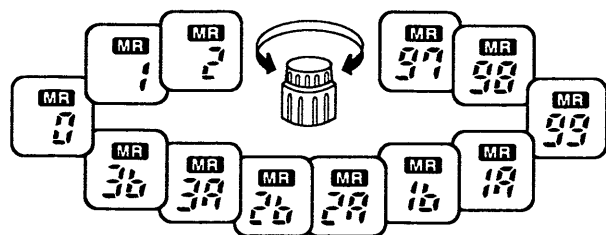

■ Memory channel selection

- ① Push [Ⓑ MR] to select memory mode.
 - “MR” appears.
 - To select scan edge channels (“1A” – “3A,” “1b” – “3b”), push [BAND] to select the desired band in advance.
 - If the call channel or repeater memory has been selected, push [Ⓐ CLR] to exit.
 - If a memory select channel is selected, push [Ⓑ MR] again to select memory mode. (p. 24)

- ② Select the desired memory channel.

Using the tuning dial:

Rotate the tuning dial to select the desired memory channel.

- To select a masked channel, rotate the tuning dial while pushing [FUNC].

Using the keyboard:

Push 2 appropriate digit keys to select the desired memory channel.

- To select scan edge channels “1A” – “3A” or “1b” – “3b” push [1]–[3], then, push [⊛ ∇] or [⊚ Δ], respectively.

Using the Δ/∇ keys:

Push [⊚ Δ] or [⊛ ∇] to change the memory channel.

- Masked channels cannot be selected. (p. 23)
- Pushing [⊚ Δ] or [⊛ ∇] for more than 0.5 sec. will activate memory scan. If scan starts, push [⊚ Δ] or [⊛ ∇] again to stop the scan.

- ③ To return to VFO mode, push [Ⓐ CLR].

■ Programming a memory channel

VFO mode settings, including the set mode contents such as subaudible tone frequency, etc., can be programmed into a memory channel.

① Select the memory channel to be programmed:

- Push [B MR] to select memory mode. (“MR” appears.)
- Rotate the tuning dial to select the memory channel.
- To select a masked channel, rotate the tuning dial while pushing [FUNC].
- If a memory select channel is selected, push [B MR] again to select memory mode. (p. 24)

② Set the desired frequency in VFO mode:

- Push [A CLR] to select VFO mode.
- Set the desired frequency using the keyboard or tuning dial.
- Set other data (e.g. offset frequency, duplex direction, subaudible tone encoder ON/OFF and its frequency), if required.
- Push [BAND]; then, set the sub band frequency, etc., if desired.

③ Push [FUNC] + [B MW] for 1 sec. to program.

- 3 beeps may sound and the VFO contents (including the subaudible tone frequency, etc.) are programmed.

[EXAMPLE]: Programming 145.875 MHz into memory channel 20.

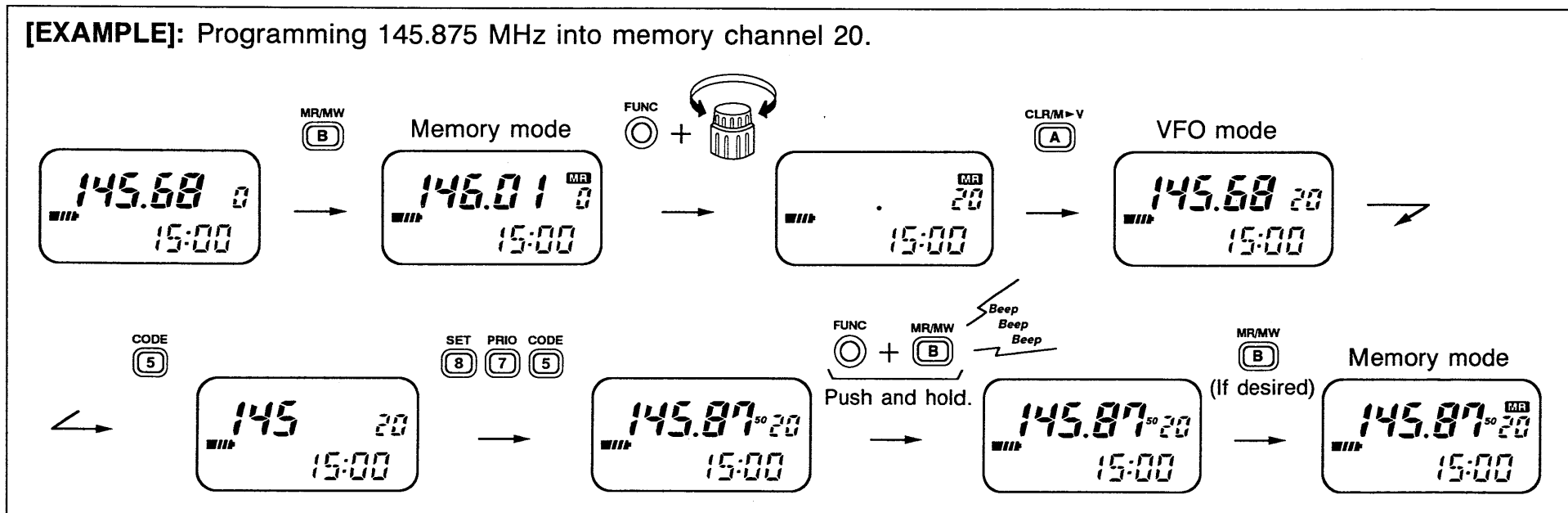

■ Transferring memory contents

This function transfers a memory channel's contents into a VFO. This is useful when searching for signals around a memory channel's frequency and for recalling the offset frequency, subaudible tone frequency, etc.

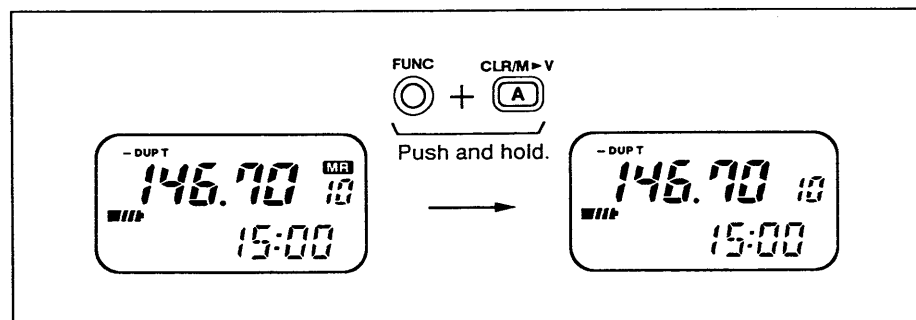

- ① Select the the memory channel or memory select channel to be transferred:
 - Push [Ⓑ MR] to select memory mode. ("MR" appears.)
 - When memory select channel(s) are set, push [Ⓑ MR] once or twice to enter memory mode or memory select mode.
 - Rotate the tuning dial to select the memory channel.
- ② Push [FUNC] + [Ⓐ M▶V] for 1 sec.
 - "MR" disappears as VFO mode is automatically selected.
 - 3 beeps may sound and the memory contents (including the subaudible tone frequency, etc.) are transferred.

■ Masking a memory

Unwanted memory channels can be masked (hidden). A masked memory channel cannot be selected for normal use. The contents of the masked memory, however, can be recalled by the following procedure.

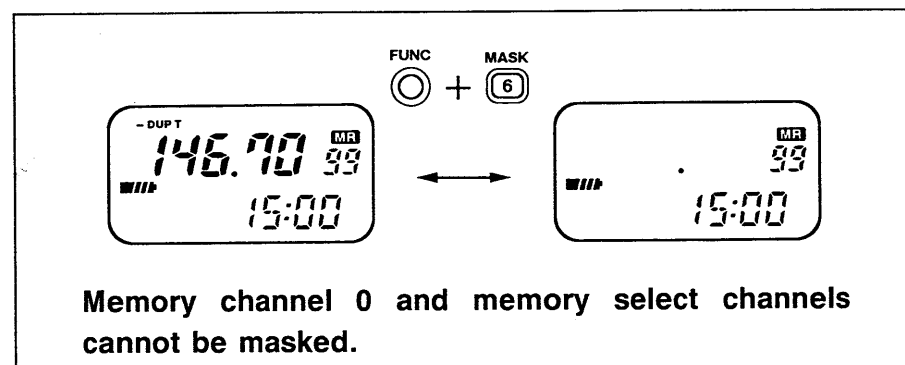

- ① Select the memory channel to be masked:
 - Push [Ⓑ MR] to select memory mode. ("MR" appears.)
 - When memory select channel(s) are set, push [Ⓑ MR] once or twice to enter memory mode. Memory select channels cannot be masked.
 - Rotate the tuning dial to select the memory channel.
- ② Push [FUNC] + [Ⓒ MASK] to mask the memory channel.
 - Memory channel 0 cannot be masked.

To recall the masked memory contents, select the desired memory channel; then, repeat step ②.

■ Memory select channels

The transceiver can memorize up to 100 memory channels. To select the desired memory channel quickly or to speed-up the memory scan, often-used memory channels can be placed into up to 30 memory select channels. The skip information is not valid for the memory select channel. (p. 31)

When first applying power or after resetting the CPU, memory select channels are not set up. The memory select channel numbers can be set from 1 to 30 in set mode.

USING SET MODE

SETTING THE MEMORY SELECT CHANNEL NUMBERS

- ① Push [FUNC] + [⑧ SET] to enter set mode.
- ② Push [⊛ ▽] or [⊙ △] until "SELMr" appears as shown in the display.
- ③ Rotate the tuning dial to set the memory select channel numbers or turn the function OFF.
- ④ Push [Ⓐ CLR] to set the condition and to exit set mode.

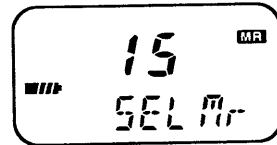

15 memory select channels are set.

■ Programming a memory select channel

- ① Set the desired memory select channel numbers as described at left.
- ② Select the memory channel to be programmed:
 - Push [Ⓑ MR] once or twice to enter memory mode.
 - Rotate the tuning dial to select the memory channel.
- ③ Push [Ⓑ MR] to enter memory select mode.
- ④ Rotate the tuning dial to select the desired memory select channel.
 - Pushing [FUNC] displays previously selected memory channel number in the memory channel indicator.
- ⑤ Push [FUNC] + [Ⓑ MW] for 1 sec. to program.

NOTE: The memory select channels memorize only the number of the memory channel. When the programmed memory channel is changed, the memory select channel's contents are automatically changed also.

◇ Selecting a memory select channel



- ① Push [Ⓑ MR] once or twice to enter memory select mode.
 - " _ , " " _ - " or " _ = " appears at the 2nd digit of the memory channel indicator.
- ② Select the desired memory select channel with the tuning dial or Δ/▽ keys.

■ Calling up a call channel

The transceiver has a one-touch-access call channel to store a most-often-used frequency for quick recall.

- ① Push [D CALL] to select the call channel.
 - “” appears.
- ② To return to the previous mode, push [D CALL].

■ Transferring call channel's contents

- ① Push [D CALL] to select the call channel.
 - “” appears.
- ② Push [FUNC] + [A M▶V] for 1 sec.
 - “” disappears as VFO mode is automatically selected.
 - 3 beeps may emit and the call channel contents (including the subaudible tone frequency, etc.) are transferred.

■ Programming a call channel

In addition to an operating frequency, duplex information and subaudible tone* information (tone encoder or tone squelch ON/OFF and its frequency) can be programmed into the call channel.

* Optional for non-U.S.A. versions.

The sub band information cannot be programmed into the call channel.

- ① Push [A CLR] to select VFO mode.
- ② Select the main band if the sub band has been selected.
- ③ Set the desired frequency using the keyboard or tuning dial.
 - Set other data (e.g. offset frequency, duplex direction, subaudible tone encoder ON/OFF and its frequency), if required.
- ④ Push [D CALL] to select the call channel.
 - “” appears.
- ⑤ Push [FUNC] + [B MW] for 1 sec. to program.
 - The frequency display changes to the programmed VFO contents.
 - 3 beeps may sound and the VFO contents (including the subaudible tone frequency, etc.) are programmed.

■ Scan types

The transceiver has 5 scan types with skip functions and 4 resume conditions to suit your needs.

FULL SCAN (p. 27)

Repeatedly scans all frequencies over the entire band. Used as the simplest scan without any presetting.

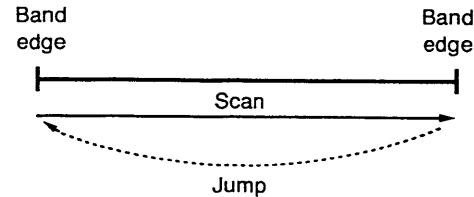

PROGRAMMED SCAN (p. 27)

Repeatedly scans between two user-programmed frequencies. Used for checking for frequencies within a specified range such as repeater output frequencies, etc. 3 pairs of scan edges are selectable.

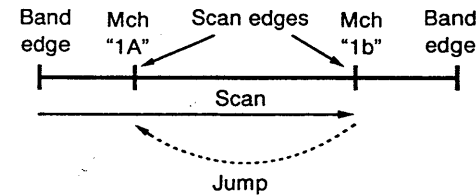

MEMORY SCAN (p. 30)

Repeatedly scans all memory channels, except masked channels, in sequence. Memory select channel scan speeds up the memory scan.

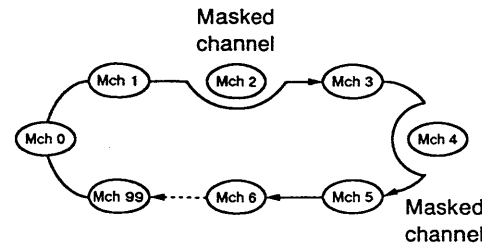

MEMORY SKIP SCAN (p. 30)

Repeatedly scans memory channels except skip and masked channels. Used for checking often-used channels and bypassing usually busy channels such as repeater frequencies.

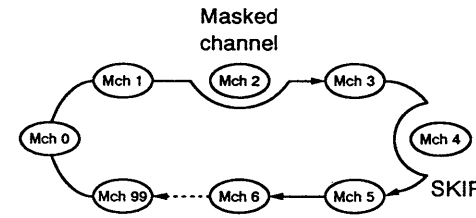

FREQUENCY SKIP FUNCTION (p. 29)

Skips unwanted frequencies that inconveniently stop scanning. This function can be turned ON or OFF in set mode.

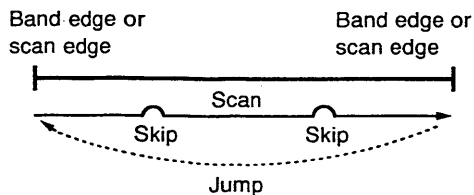

CROSSBAND SCAN (p. 27)

Repeatedly scans both the 144 MHz and 430(440) MHz bands alternately every 1 sec. while operating the full or programmed scan.

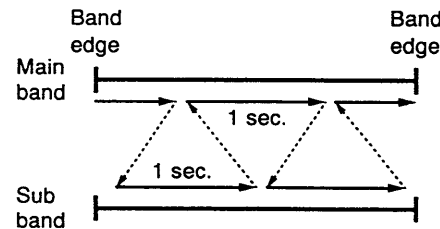

9 SCAN OPERATION

■ Full scan

- ① Push [A CLR] to select VFO mode.
- ② Select the desired band with [BAND].
- ③ Set [SQL] to the point where noise is muted.
- ④ Push [*▽/SCAN] or [#△/SCAN] for 1 sec. to start the scan.
 - To change the scanning direction, rotate the tuning dial.
- ⑤ To stop the scan, push [*▽/SCAN] or [#△/SCAN].

When the pager or code squelch is in use, scan does not function. Cancel it in advance. (pgs. 41, 42)

◇ Scan resume condition:

- When receiving a signal, scan resumes in one of the following ways:
 - after pausing 15 sec.
 - after pausing 10 sec.
 - after pausing 5 sec.
 - after the signal disappears.
- The scan resume condition can be selected in set mode. (p. 31)
- While scanning, rotating the tuning dial changes the scanning direction or skips a paused frequency.

■ Programmed scan

Scan edge frequencies should be programmed into the scan edge channels "1A" – "3A" and "1b" – "3b" in advance. (p. 28)

- ① Push [A CLR] to select VFO mode.
- ② Select the desired band with [BAND].
- ③ Set [SQL] to the point where noise is muted.
- ④ Push [FUNC] + [*▽/SCAN] or [#△/SCAN] one or more times to select scan edge channels.
 - "P1," "P2" or "P3" appears on the memory channel readout.
 - "P1" shows scan edge channels "1A" and "1b" are selected.
- ⑤ Release [FUNC] to start the programmed scan.
 - To change the scanning direction, rotate the tuning dial.
 - Rotating the tuning dial while pushing [FUNC] changes the scanning band edges.
- ⑥ To stop the scan, push [*▽/SCAN] or [#△/SCAN].

■ Crossband scan

The transceiver scans both the 144 MHz and 430(440) MHz band frequencies alternately every 1 sec. The programmed scan edge pairs can be selected separately for each band.

While operating the full or programmed scan, push [BAND] to activate the crossband scan.

■ Programming scan edges

Scan edges can be programmed in the same way as memory channels. Memory channels “1A” – “3A” and “1b” – “3b” are available for programming scan edges.

- ① Push [A CLR] to select VFO mode.
- ② Select the desired band with [BAND].
- ③ Select scan edge memory channel “1A,” “2A” or “3A”:
 - Push [B MR] to select memory mode.
 - Push [1] – [3] and [⊛ ▽], or rotate the tuning dial to select memory channel “1A,” “2A” or “3A.”

- ④ Set the desired frequency in VFO mode:
 - Push [A CLR] to select VFO mode.
 - Rotate the tuning dial to set the desired frequency.
- ⑤ Push [FUNC] + [B MW] for 1 sec.
 - If the beep tone is ON, 3 beeps alert you that the contents are programmed.
- ⑥ To program a frequency for the other scan edge memory channel, “1b,” “2b” or “3b,” repeat steps ② – ⑤.
 - If the same frequency is programmed into a pair of scan edges, the pair cannot be selected as scan edges.
 - If the same frequency is programmed into all of the scan edges, programmed scan will not function.

[EXAMPLE]: Programming 145.20 MHz and 145.80 MHz for the 144 MHz band scan edges.

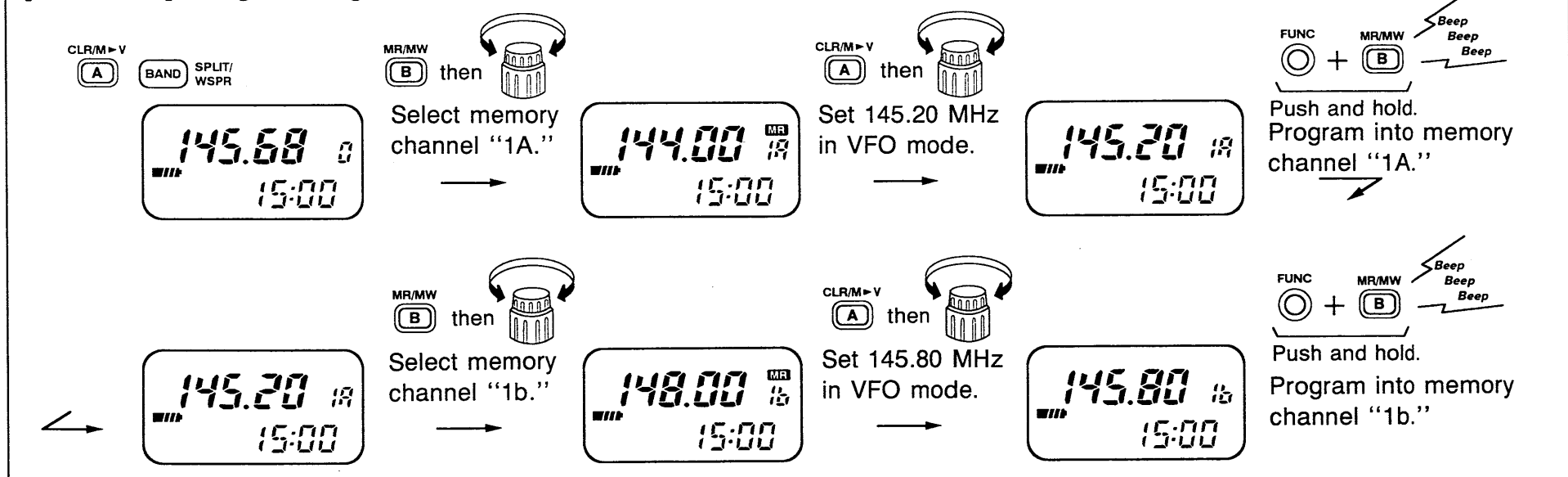

■ Frequency skip function

◇ Programming a skip frequency

Unwanted frequencies can be skipped and programmed as skip channels when full or programmed scan is pausing.

- ① Turn ON the frequency skip function as described at right.
- ② Start full scan or programmed scan. (p. 27)
- ③ Push [FUNC] + [B MW] for 1 sec. to program the received frequency as a skip frequency.
 - The transceiver emits 3 beeps and the scan resumes.
 - Masked memory channels 99 – 10 are used in reverse sequence.
 - To scan the skip frequency after programming, cancel the skip information or mask the memory channel. (pgs. 23, 31)

◇ Programming a paused frequency

A paused frequency can be programmed into the selected memory channel when full or programmed scan is pausing.

- ① Turn OFF the frequency skip function as described at right.
- ② Start full scan or programmed scan. (p. 27)
- ③ Push [FUNC] + [B MW] for 1 sec. to program the received frequency into the selected memory channel.
 - The transceiver emits 3 beeps and the scan resumes according to the selected resume condition.

◇ Frequency skip function ON/OFF

The frequency skip function can be turned OFF in set mode. In this case, the frequencies will not be skipped even if skip information is programmed and “SKIP” will not blink during full scan or programmed scan.

USING SET MODE

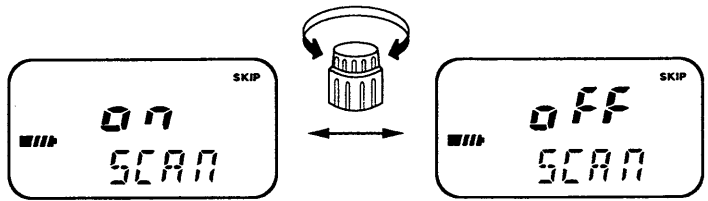

The frequency skip function is ON.

The frequency skip function is OFF.

- ① Push [FUNC] + [8 SET] to enter set mode.
- ② Push [* ▽] or [# △] one or more times until “SCAN” and “SKIP” appear as shown in the display.
- ③ Rotate the tuning dial to turn the frequency skip function “on” or “off.”
 - When selecting “on,” the frequency skip function for full scan and programmed scan is turned ON.
- ④ Push [A CLR] to set the condition and to exit set mode.

■ Memory scan

Memory scan repeatedly scans all memory channels, except masked channels, in sequence. To speed up the memory scan, program often-used memory channels as memory select channels. (p. 24)

- ① Push [**B** MR] to select memory mode or memory select mode.
 - “**MR**” appears.
 - If the call channel or repeater memory has been selected, push [**A** CLR] to exit.
- ② Set [SQL] to the point where noise is muted.
- ③ Push [***** ∇/SCAN] or [**#** △/SCAN] for 1 sec. to start the scan.
 - To change the scanning direction, rotate the tuning dial.
- ④ To stop the scan, push [***** ∇/SCAN] or [**#** △/SCAN].

/// When the pager or code squelch is in use, scan does not function. Cancel it in advance. (pgs. 41, 42)

■ Memory skip scan

Memory skip scan repeatedly scans memory channels except skip and masked channels. Program the desired channel(s) as a skip channel(s) in advance. (p. 31)

- ① Push [**B** MR] to select memory mode.
 - “**MR**” appears.
 - If the call channel or repeater memory has been selected, push [**A** CLR] to exit.
- ② Set [SQL] to the point where noise is muted.
- ③ Push [FUNC] + [***** ∇/SCAN] or [**#** △/SCAN] to start the scan.
 - To change the scanning direction, rotate the tuning dial.
- ④ To stop the scan, push [***** ∇/SCAN] or [**#** △/SCAN].

◇ Scan resume condition:

- When receiving a signal, scan resumes in one of the following ways:
 - after pausing 15 sec.
 - after pausing 10 sec.
 - after pausing 5 sec.
 - after the signal disappears.

- The scan resume condition can be selected in set mode. (p. 31)
- While scanning, rotating the tuning dial changes the scanning direction or skips a paused frequency.

9 SCAN OPERATION

■ Skip channel setting

Memory channels can be specified to be skipped for memory skip scan. This is useful to speedup the memory skip scan interval. These skip channels are also skipped during priority watch (memory skip scan watch). When the frequency skip function is ON, skip frequencies are skipped during full scan or programmed scan. (p. 27)

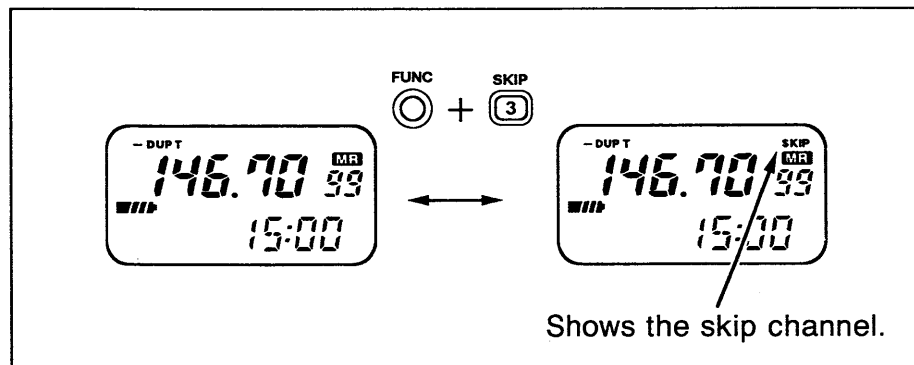

- ① Select the memory channel to be programmed as a skip channel:
 - Push [B MR] to select memory mode.
 - Rotate the tuning dial or push [* ▽] or [# △] to select the desired memory channel.
 - Memory select channels cannot be set as skip channels.
- ② Push [FUNC] + [3 SKIP] to set the memory channel as a skip channel.
 - “SKIP” appears.
- ③ Repeat step ② to cancel a skip channel.

■ Scan resume condition

USING SET MODE

The scan resume condition can be selected as a pause or timer scan. The resume condition is also used for priority watch. (p. 33)

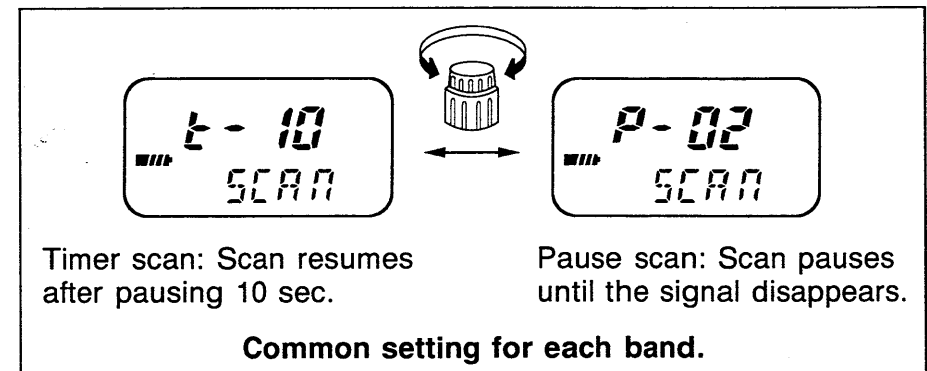

- ① Push [FUNC] + [8 SET] to enter set mode.
- ② Push [* ▽] or [# △] one or more times until “SCAN” and “t-” or “P-” appear as shown in the display.
- ③ Rotate the tuning dial to select the desired condition.
 - “t-15” : Scan pauses 15 sec. while receiving a signal.
 - “t-10” : Scan pauses 10 sec. while receiving a signal.
 - “t-05” : Scan pauses 5 sec. while receiving a signal.
 - “P-02” : Scan pauses until the signal disappears and then resumes 2 sec. after that.
- ④ Push [A CLR] to exit set mode.

■ Programming a DTMF code

DTMF codes are used for autopatching, accessing repeaters, controlling other equipment, etc. The transceiver has 5 DTMF memory channels (t1 – t5) for storage of often-used DTMF codes of up to 32 digits.

- ① Push [FUNC] + [DTMF] to select DTMF memory mode.
- ② Rotate the tuning dial to select the desired channel.
- ③ Push [FUNC] + [8] SET; then push the desired keys.
 - “E” stands for “*” and “F” stands for “#.”
 - Pushing [BAND] deletes the last entered digit.
 - Push [DTMF] and repeat this step when making a mistake.
 - “-” indicates no digits are programmed.
- ④ Push [DTMF] to store the entered digits.
 - If 32 digits are input, this is not necessary.
- ⑤ Push [A CLR] or [PTT] to exit DTMF memory mode.

■ Transmitting a DTMF code

◇ Using a DTMF memory channel

- ① Push [FUNC] + [DTMF] to select DTMF memory mode.
- ② Rotate the tuning dial to select the desired channel.
- ③ Push [PTT] to exit DTMF memory mode.
 - Pushing [A CLR] also exits DTMF memory mode.
- ④ While pushing [PTT], push [DTMF] to transmit the selected DTMF code.
 - The function display shows the DTMF digits sent.

NOTE: The DTMF code transmission speed is adjustable in set mode. See p. 48 for details.

◇ Transmitting a DTMF code manually

While pushing [PTT], push the key of the desired DTMF digit.

- 1–0, A–D, *(E) and #(F) are available.

[EXAMPLE]: Programming “21ABC38” into DTMF memory channel “t5.”

The diagram illustrates the following steps:

1. Initial display: 145.68, 15:00. Buttons: [FUNC] + [DTMF].
2. Tuning dial rotated to channel t5. Display: --- -- t5, DTMF. Button: [DTMF].
3. Pressing [SET]. Display: --- -- t5, SET. Buttons: [FUNC] + [8] SET.
4. Pressing [2]. Display: 2 --- -- t5, SET. Buttons: [2], [1], [A], [B], [C], [3], [8].
5. Pressing [1]. Display: 21 --- -- t5, SET. Buttons: [DTMF].
6. Pressing [A]. Display: 21A --- -- t5, SET. Buttons: [DTMF].
7. Pressing [B]. Display: 21AB --- -- t5, SET. Buttons: [DTMF].
8. Pressing [C]. Display: 21ABC --- -- t5, SET. Buttons: [DTMF].
9. Pressing [8]. Display: 21ABC3 --- -- t5, SET. Buttons: [DTMF].
10. Pressing [8]. Display: 21ABC38 --- -- t5, SET. Buttons: [DTMF].
11. Pressing [A]. Display: 21ABC38 t5, DTMF. Buttons: [CLR/M-V] [A].

11 PRIORITY WATCH

Priority watch types

The priority watch checks for signals on a memory or call channel every 5 sec. while operating on a VFO frequency. The transceiver has 6 priority watch types to suit your needs. You can transmit on the main band VFO frequency while the priority watch operates.

When receiving a signal, priority watch resumes according to the selected scan resume condition. (p. 31)

MEMORY CHANNEL WATCH While operating on a VFO frequency, priority watch checks a selected memory channel every 5 sec.

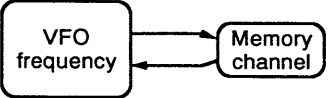

CALL CHANNEL WATCH While operating on a VFO frequency, priority watch checks the call channel every 5 sec.

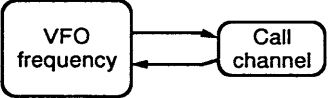

MEMORY SCAN WATCH While operating on a VFO frequency, priority watch checks each memory channel except masked channels every 5 sec.

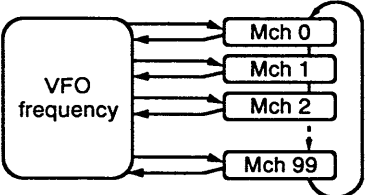

NOTE:

- Priority watch does not operate when:
 - The selected memory channels is a masked channel. (p. 23)
 - Pager or code squelch function is activated. (pgs. 41, 42)
- If the pocket beep function is activated, the transceiver automatically selects the tone squelch function when priority watch starts.
- A memory channel with skip information can be watched.

MEMORY SKIP SCAN WATCH While operating on a VFO frequency, priority watch checks each memory channel except skip and masked channels every 5 sec.

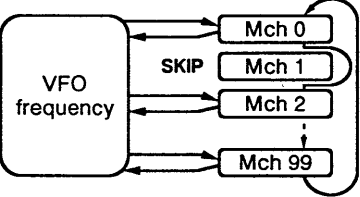

SUB BAND WATCH While operating on a VFO frequency, priority watch checks sub band frequency every 5 sec.

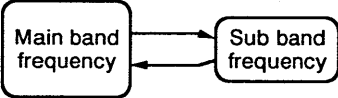

MAIN BAND WATCH While receiving on a sub band frequency, priority watch checks main band frequency every 5 sec.

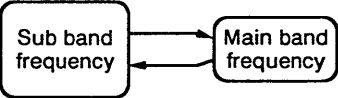

■ Priority watch operation

◇ Memory channel and call channel watch

- ① Push [A CLR] to select VFO mode.
- ② Select the desired band with [BAND].
- ③ Set the operating frequency.
- ④ Set the watching channel(s).

For memory channel watch:

Select memory or memory select mode; then, select the desired memory channel.

For memory scan watch:

Select memory or memory select mode; then, push [* ∇/SCAN] or [# Δ/SCAN] for 1 sec. to start the memory scan.

For memory skip scan watch:

Select memory mode; then, push [FUNC] + [* ∇/SCAN] or [# Δ/SCAN] to start the memory skip scan.

- No memory skip scan is available in memory select mode.

For call channel watch:

Push [D CALL] to select the call channel.

- ⑤ Push [FUNC] + [7 PRIO] to start the watch.
 - The transceiver receives the memory or call channel frequency every 5 sec.
 - While the watch is pausing, pushing [A CLR] resumes the watch manually.
- ⑥ Push [A CLR] while the display shows the VFO frequency to stop the watch.

◇ Sub band watch

- ① Push [A CLR] to select VFO mode.
- ② Set the main band operating frequency and sub band watching frequency.
- ③ Push [BAND] to select the main band.
- ④ Push [FUNC] + [7 PRIO] to start the watch.
 - The transceiver receives the sub band frequency every 5 sec.
 - While the watch is pausing, pushing [A CLR] resumes the watch manually.
- ⑤ Push [A CLR] while the display shows the main band frequency to stop the watch.

◇ Main band watch

- ① Push [A CLR] to select VFO mode.
- ② Set the main band and sub band receive frequencies.
- ③ Push [BAND] to select the sub band.
- ④ Push [FUNC] + [7 PRIO] to start the watch.
 - The transceiver receives the main band frequency every 5 sec.
 - While the watch is pausing, pushing [A CLR] resumes the watch manually.
 - While the watch is operating, crossband full or semi-duplex can be used.
- ⑤ Push [A CLR] while the display shows the sub band frequency to stop the watch.

12 CLOCK AND TIMERS

■ Clock operation

The transceiver has a built-in 24-hour clock with auto power-off, power-on timer and power-off timer functions. This is useful when logging QSO's and so on. The clock indication is always displayed except when selecting set mode, sub band, etc.

TIME ERROR: ± 1 min./week

NOTE: CPU resetting clears the clock time. Set the time again in this case.

◆ Setting the clock

- ① Push [FUNC] + [9] TIMER to select timer mode.
- ② Push [* ▽] or [# △] until only the clock appears.
- ③ Push [FUNC] + [8] SET to enter the time setting condition.
 - The hour digit blinks.
- ④ Rotate the tuning dial to set the hour. (24-hour system)
- ⑤ Push [* ▽] or [# △]; then rotate the tuning dial to set the minutes.
 - The clock starts from 0 sec. and “:” blinks.
 - To cancel time setting and exit the time setting condition, push [PTT].
- ⑦ Push [A CLR] or [PTT] to exit timer mode.

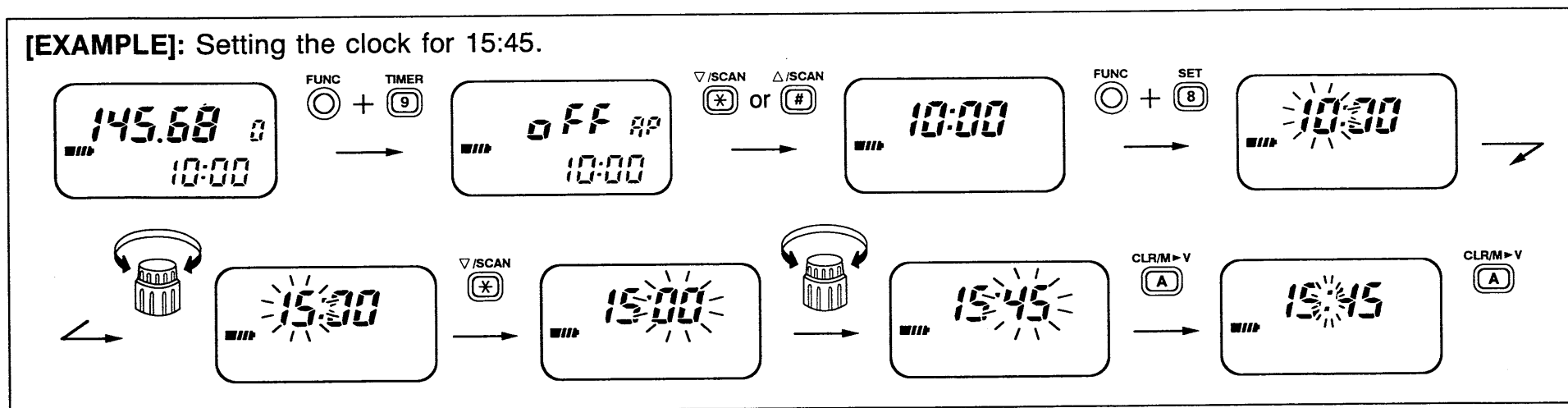

■ Timer mode

The following chart shows the timer mode arrangement.

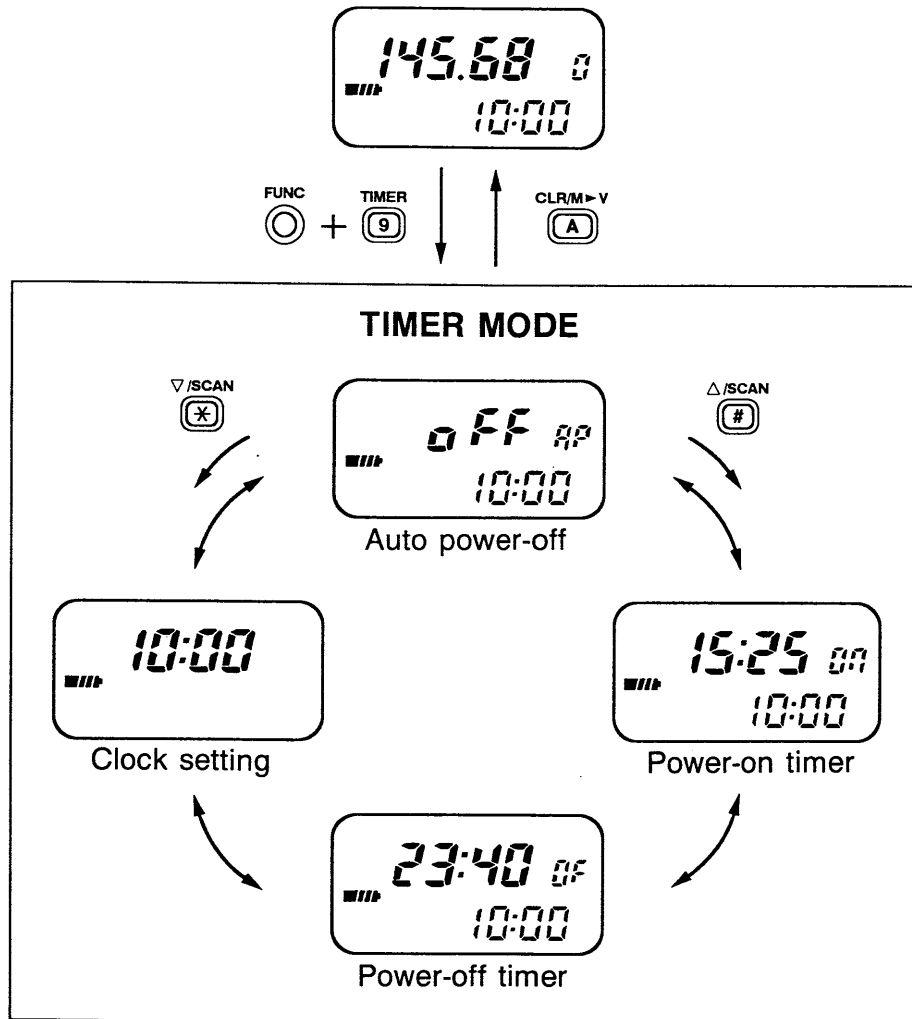

■ Auto power-off

The transceiver automatically turns OFF after a selected period in which no switch is pushed. This is useful if you forget to turn the power OFF.

60 min., 40 min., 20 min. and OFF can be selected. The selected period is retained even when the transceiver is turned OFF by the auto power-off function. To cancel the function, select “oFF” in step ③ below.

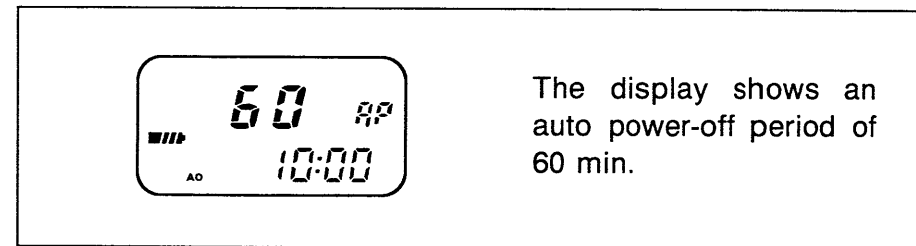

- ① Push [FUNC] + [9] TIMER to select timer mode.
- ② Push [* ▽] or [# △] until “AP” appears to select the auto power-off display as shown above.
- ③ Rotate the tuning dial to select the auto power-off period or turn the function OFF.
- ④ Push [A CLR] or [PTT] to exit timer mode.
 - When the set period passes, the power is automatically turned OFF with 5 beeps.
 - A melody can be selected instead of the 5 beeps in set mode. (p. 47)
 - “AO” appears while the auto power-off function is in use.

12 CLOCK AND TIMERS

■ Power-on timer

Use the power-on timer to suit your schedule and to save battery power.

- ① Set the frequency and audio level as desired at power ON.
- ② Push [FUNC] + [⑨ TIMER] to select timer mode.
- ③ Push [* ▽] or [# △] until "On" appears to select the power-on display.
- ④ Rotate the tuning dial clockwise to turn the power-on timer ON.
 - "ON ☺" appears.
- ⑤ Set the power-on time:
 - Push [FUNC] + [⑧ SET]; then rotate the tuning dial to set the hour.
 - Push [* ▽] or [# △]; then rotate the tuning dial to set the minutes.
 - Push [A CLR] to enter the time.

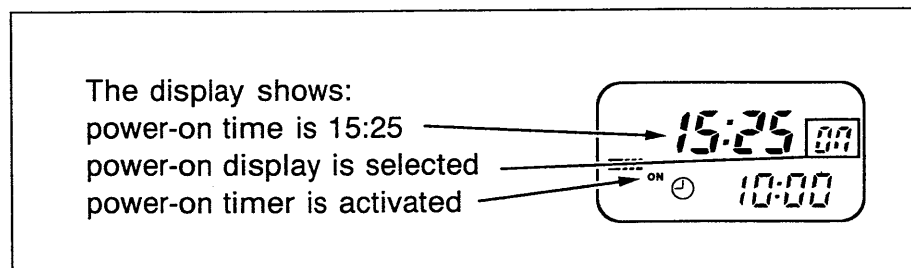

- ⑥ Push [POWER] for 1 sec. to turn the power OFF.
 - When the set time arrives, the power is automatically turned ON with 5 beeps and the power-on timer ON/OFF setting is set to OFF.
 - A melody can be selected instead of the 5 beeps in set mode. (p. 47)

Cancel the power-on timer:

- ① Push [FUNC] + [⑨ TIMER] to select timer mode.
- ② Push [* ▽] or [# △] until "On" appears to select the power-on display.
- ③ Rotate the tuning dial counterclockwise to turn the power-on timer OFF.
 - "ON ☺" disappears.

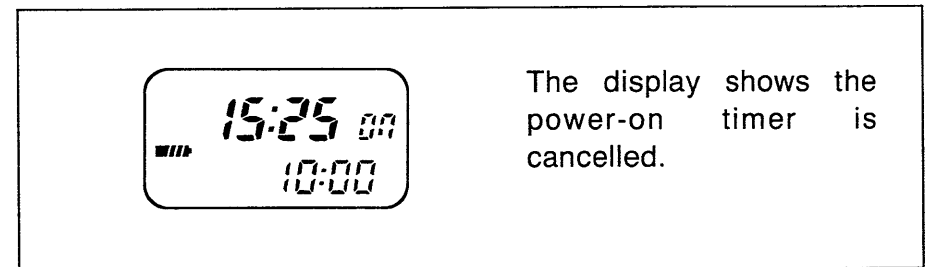

- ④ Push [A CLR] or [PTT] to exit timer mode.

■ Power-off timer

Like the power-on timer, the power-off timer can be set to suit your schedule and conserve battery power. When the timer is activated, the timer indicator appears in the function display and the transceiver operates normally until the pre-set time at which it will turn OFF.

- ① Push [FUNC] + [⑨ TIMER] to select timer mode.
- ② Push [* ▽] or [# △] until "OF" appears to select the power-off display.
- ③ Rotate the tuning dial clockwise to turn the power-off timer ON.
 - "OFF ☹" appears.
- ④ Set the power-off time:
 - Push [FUNC] + [⑧ SET]; then rotate the tuning dial to set the hour.
 - Push [* ▽] or [# △]; then rotate the tuning dial to set the minutes.
 - Push [A CLR] to enter the time.

The display shows:

- power-off time is 23:40
- power-off display is selected
- power-off timer is activated

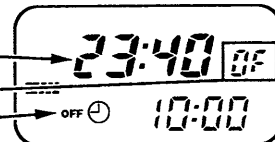

- ⑤ Push [A CLR] or [PTT] to exit timer mode.
 - "OFF ☹" appears while the power-off timer is in use.
 - When the set time arrives, the power is automatically turned OFF with 5 beeps and the power-off timer ON/OFF setting is set to OFF.
 - A melody can be selected instead of the 5 beeps in set mode. (p. 47)

Cancel the power-off timer:

- ① Push [FUNC] + [⑨ TIMER] to select timer mode.
- ② Push [* ▽] or [# △] until "OF" appears to select the power-off display.
- ③ Rotate the tuning dial counterclockwise to turn the power-off timer OFF.
 - "OFF ☹" disappears.

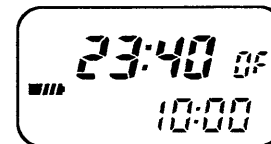

The display shows the power-off timer is cancelled.

- ④ Push [A CLR] or [PTT] to exit timer mode.

13 PAGER AND CODE SQUELCH

■ General description

• Pager function

This function uses DTMF codes for paging and can be used as a “message pager” to inform you of a caller’s identity even if you leave the transceiver temporarily unattended.

Personal calls and group calls are available with the pager function. Personal calls use the receiving parties’ ID code for calling. The receiving parties’ display shows your ID code and other stations in the party know that you called. You can also call all stations in your group using the group call.

To use the pager function in your group, all stations need the pager function.

• Code squelch

The code squelch allows you communication with silent standby since you will only receive calls from stations which know your ID or group code.

The code squelch transmits a 3-digit code prior to voice transmission in order to open the receiving station’s code squelch.

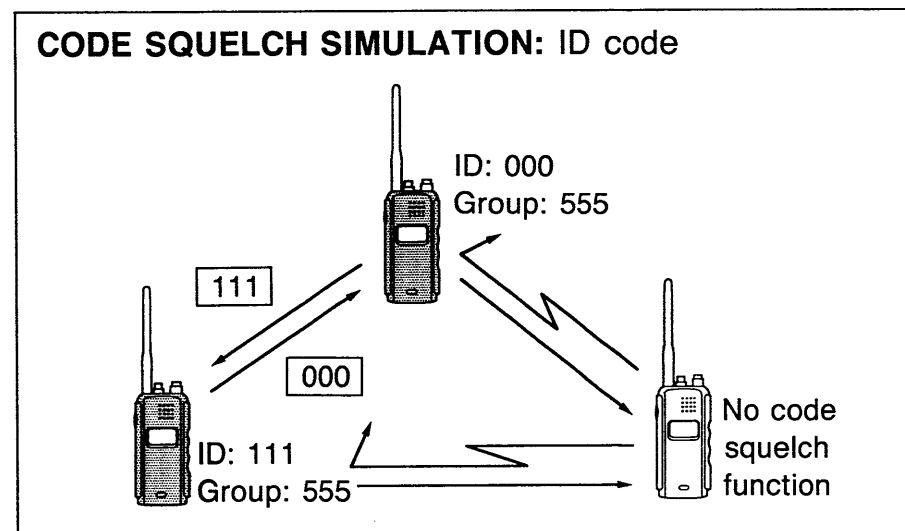
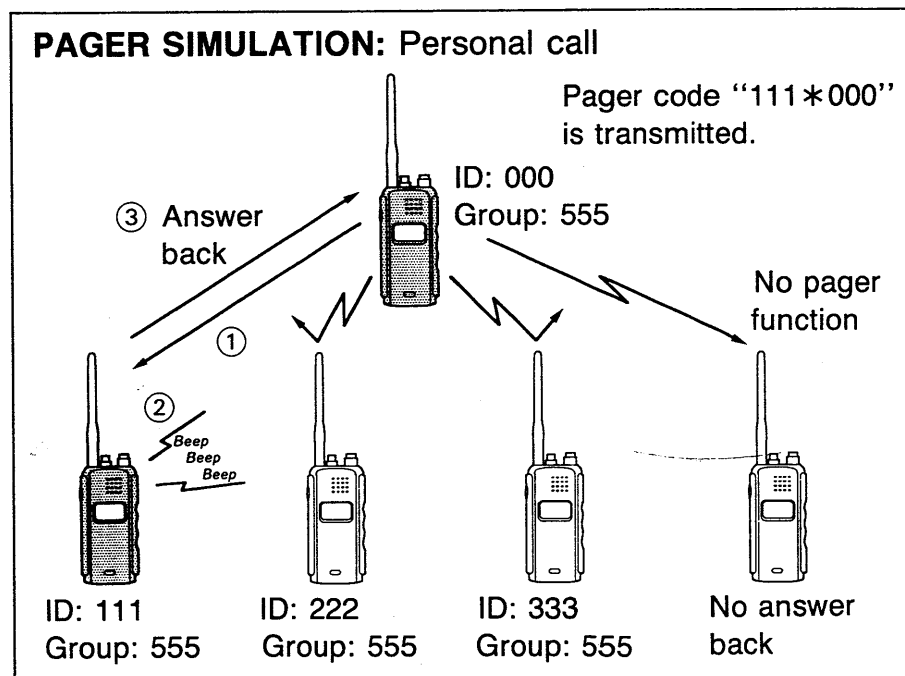

■ Code programming

• Before programming

The pager and code squelch functions require ID codes and a group code. These codes are 3-digit DTMF codes and must be written in the code channels before operation.

• Code channel assignment

ID OR GROUP CODE	CODE CHANNEL NUMBER	“RECEIVE ACCEPT” OR “RECEIVE INHIBIT”
Your ID code	C0	“Receive accept” only.
Other parties' ID code	C1 – C5	“Receive inhibit” should be programmed in each channel.
Group code	One of C1 – C5	“Receive accept” must be programmed.
Memory space*	CP	“Receive inhibit” only.

* Code channel CP automatically memorizes an ID code when receiving a pager call. The contents in channel CP cannot be changed manually.

RECEIVE ACCEPT AND INHIBIT

Code channels C1 – C5 can store the transmit codes for personal calls with other parties and the group codes for group calls.

The group codes should be programmed as “receive accept” to receive all calls from your parties' members.

• Programming

- ① Push [FUNC] + [⑤ CODE] to select the code channel setting display.
 - Common settings for each band.
- ② Rotate the tuning dial to select the desired code channel, C0 – C5.
 - Code channel CP cannot be used for programming.
- ③ Push the numeral keys to enter the desired 3-digit code.
 - Digits are automatically stored once the 3rd digit has been entered.
 - When an unwanted digit is entered, push [Ⓐ CLR] and enter the desired code from the beginning.
- ④ Push [FUNC] + [③ SKIP] to set the channel for “receive inhibit” or “receive accept.”
 - When “receive inhibit” is set, “SKIP” appears.
 - Code channel C0 cannot be set as “receive inhibit.”
- ⑤ Push [PTT] to exit the setting display.
 - Pushing [Ⓐ CLR] also exits the setting display.

If transmit codes are not programmed as “receive inhibit,” the transceiver accepts calls directed to other parties and your answer back may confuse to your parties' member – it is not a selective calling system. Therefore, transmit codes should be programmed as “receive inhibit” so the transceiver rejects calls directed to other parties.

■ Pager operation

◇ Calling a specific station

- ① Set the frequency for using pager call.
- ② Push [FUNC] + [② PGR/C SQL] to turn the pager function ON.
 - “PGR” appears in the display.
 - An optional tone squelch can be used together with the pager function. (p. 44)
- ③ Select the desired code channel:
 - Push [FUNC] + [⑤ CODE].
 - Rotate the tuning dial to select the channel.
 - Push [PTT] or [A CLR] to exit the setting display.
- ④ Push [PTT] to transmit the pager code.
- ⑤ Wait for an answer back.
 - When the transceiver receives an answer back code, the function display shows the other party’s ID or group code.
- ⑥ After confirming a connection, push [A CLR] to display the operating frequency.
 - **DO NOT** push numeral keys while code channels C0 – C5 are indicated, or code channel contents are changed.
- ⑦ Push [FUNC] + [② PGR/C SQL] once to select the code squelch or twice to select the non-selective calling system.

◇ Waiting for a call from a specific station

- ① Set the frequency for waiting for a pager call.
 - The sub band can be used only for waiting for a call.
- ② Push [FUNC] + [② PGR/C SQL] to turn the pager function ON.
 - “PGR” appears in the display.
 - An optional tone squelch can be used together with the pager function. (p. 44)
- ③ Wait for a call.
 - When receiving a call, other party’s ID or group code appears and the receiving time blinks as shown at right.
 - **DO NOT** push numeral keys while code channels C0 – C5 are indicated, or code channel contents are changed.
- ④ Push [PTT] to send an answer back call and display the operating frequency.
 - While waiting for a call on the sub band, the answer back call is transmitted on the main band.
- ⑤ Push [FUNC] + [② PGR/C SQL] once to select the code squelch or twice to select the non-selective calling system.

During pager operation, the power saver duty cycle becomes 1:1 if the power saver is activated.

PERSONAL CALL

This display appears when you are called with your ID code and the calling station's ID code is 374.

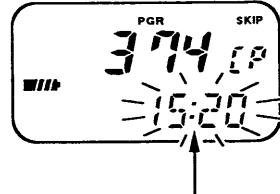

Receiving time blinks.

GROUP CALL

This display appears when you are called with the group code, 123, and 123 has been programmed into code channel C5.

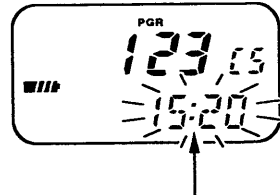

Receiving time blinks.

ERROR INFORMATION

When the transceiver receives an incomplete signal, "E" appears.

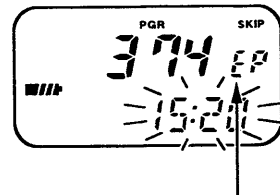

"E" appears.

Code squelch operation

- ① Set the operating frequency for using the code squelch.
 - If selecting the sub band, crossband code squelch will be used.
- ② Push [FUNC] + [② PGR/C SQL] twice to turn the code squelch ON.
 - "C SQL" appears in the display.
 - An optional tone squelch can be used together with the pager function. (p. 44)
- ③ Select the desired code channel:
 - Push [FUNC] + [⑤ CODE].
 - Rotate the tuning dial to select the channel.
 - Push [PTT] or [A CLR] to exit the setting display.
- ④ Operate the transceiver in the normal way (push [PTT] to transmit; release [PTT] to receive).
 - Prior to voice transmission, a 3-digit transmit code is sent each time [PTT] is pushed in order to open the receiving station's code squelch.
- ⑤ To cancel the code squelch, push [FUNC] + [② PGR/C SQL].
 - "C SQL" disappears.

During code squelch operation, the power saver duty cycle becomes 1:1 if the power saver is activated.

14 POCKET BEEP AND TONE SQUELCH

■ Optional UT-81 installation

An optional UT-81 TONE SQUELCH UNIT is available for this transceiver. The UT-81 provides pocket beep, tone squelch and programmable tone encoder functions. The U.S.A. version already includes an equivalent unit.

- ① Turn power OFF, then remove the battery pack and/or DC power cable.
- ② Unscrew the 6 screws as shown below.

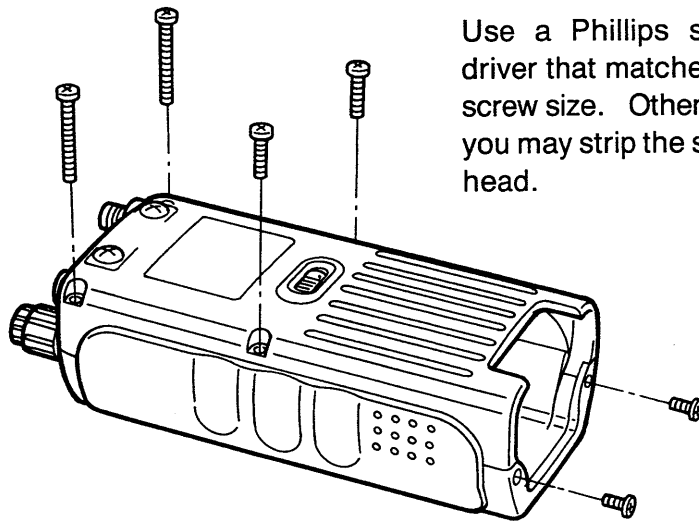

CAUTION:

Use a Phillips screw driver that matches the screw size. Otherwise, you may strip the screw head.

- ③ Carefully separate the front and rear panels as shown below.

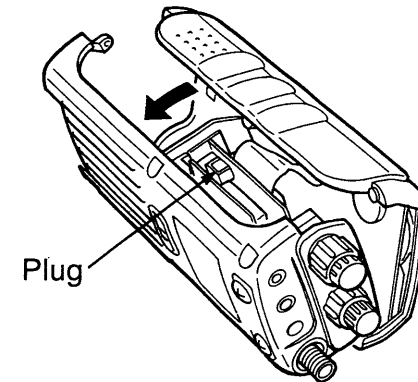

- ④ Plug in the UT-81 as shown below.
- ⑤ Reassemble the front and rear panels; then, replace the 6 screws removed in step ②.
 - DO NOT pinch the speaker cables.

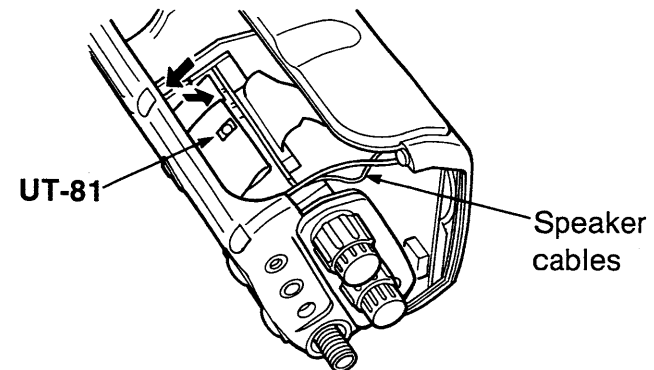

■ Pocket beep operation

This function uses subaudible tones for calling and can be used as a “common pager” to inform you that someone has called while you were away from the transceiver.

◇ Waiting for a call from a specific station

- ① Set the frequency for waiting for a call.
 - The sub band can be used only for waiting for a call.
- ② Program the subaudible tone frequency in set mode.
 - See p. 18 for programming details.
- ③ Push [FUNC] + [① T/TSQL] several times until “T SQL ((•))” appears in the function display.
 - Turn OFF the pager or code squelch to activate the pocket beep. (pgs. 41, 42) The pocket beep cannot be used in combination with the pager or code squelch.
- ④ When a signal with the correct tone is received, the transceiver emits beep tones for 30 sec. and flashes “((•)).”
- ⑤ Push [PTT] to answer or push [A CLR] to stop the beeps and flashing.
 - Tone squelch is automatically selected.

◇ Calling a waiting station using pocket beep

A subaudible tone matched with the station’s tone frequency is necessary. Use the tone squelch at right or a subaudible tone encoder (p. 17, optional for non-U.S.A. versions).

■ Tone squelch operation

The tone squelch opens only when receiving a signal with the same pre-programmed subaudible tone. You can silently wait for a call from group members using the same tone. This function can be activated on the sub band with the crossband full or semi-duplex.

- ① Set the frequency for using the tone squelch.
- ② Program the subaudible tone frequency in set mode.
 - See p. 18 for programming details.
- ③ Push [FUNC] + [① T/TSQL] several times until “T SQL” appears in the function display.
 - The tone squelch is separately set for each band. Activate the tone squelch on both bands to use it in crossband.
 - The code squelch can be used together with the tone squelch. (p. 42)
- ④ When the received signal includes the correct tone, the squelch opens and the signal can be heard.
 - When the received signal includes an incorrect tone, the squelch does not open. Only the green indicator lights up.
 - To open the main band squelch manually, push and hold [MONI].
- ⑤ Operate the transceiver in the normal way (push [PTT] to transmit; release [PTT] to receive).
- ⑥ To cancel the tone squelch, push [FUNC] + [① T/TSQL].
 - “T SQL” disappears.

15 WHISPER FUNCTION

■ General operation

The whisper function automatically attenuates the audio level to a telephone-like level while in crossband full duplex communication. You can operate the transceiver like a telephone. It is not necessary to push the [PTT] while in whisper operation.

- ① Set the main and sub band frequencies as transmit and receive frequencies, respectively.
 - Use the [BAND] switch and tuning dial for VFO mode.
 - Memory mode is useful for whisper frequencies programming.
- ② Push [FUNC] + [BAND/SPLIT/WSPR] for 1 sec. to activate the function.
 - “” appears.
 - The transceiver automatically starts transmitting without pushing [PTT] and the TX indicator lights up in red.
- ③ Hold the transceiver as you would a telephone handset, then, speak into the microphone.
 - Received signals are emitted from the speaker at an attenuated level.
 - The whisper function will be cancelled after a specified period when the time-out timer is set. See section at right for details.
 - The tuning dial and switches cannot be used.
- ④ To cancel the function, push [BAND/SPLIT/WSPR].

■ Time-out timer setting

To prevent prolonged, continuous transmission with the whisper function, the transceiver has a time-out timer. This timer turns the whisper function OFF 5, 15 or 30 min. after the function starts. This timer can be cancelled.

10 sec. before the time-out time passes, the transceiver emits a beep tone and counts down from TEL 9 to TEL 0. Pushing [BAND/SPLIT/WSPR] while counting down restarts the time-out timer.

USING SET MODE

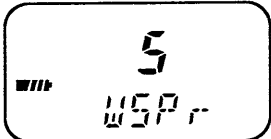

The display shows 5 min. timer is selected.

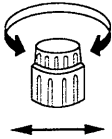



The display shows the time-out timer is cancelled.

- ① Push [FUNC] + [⑧ SET] to enter set mode.
- ② Push [* ▽] or [# △] one or more times until “WSPr” appears as shown in the display.
- ③ Rotate the tuning dial to select the desired time-out time from 5, 15, 30 min. or turn the timer OFF.
- ④ Push [A CLR] to exit set mode.

■ Power saver

USING SET MODE

The power saver function reduces the current drain to conserve battery power while waiting on a frequency. The power-saver duty cycle can be set to 1:1, 1:12, 1:40 or OFF. Setting it to 1:40 conserves the most power. For packet operation, the power saver should be turned OFF to receive reliable packet data.

Standby 50 msec. Circuit off 50 msec.	50 msec. 600 msec.	50 msec. 2 sec.	Power saver is turned OFF.

- ① Push [FUNC] + [8] SET] to enter set mode.
- ② Push [* ▽] or [# △] one or more times until “PSD” appears in the display.
- ③ Rotate the tuning dial to select the desired duty cycle or to turn the function OFF.
- ④ Push [A CLR] to exit set mode.

NOTE: When the duty cycle is set to 1:40, signals may be clipped up to a 2 sec. max.

■ Battery voltage indication

The transceiver has a battery capacity indicator that shows the connected battery voltage graphically. This indicator is designed to show dry cell battery consumption in the BP-159* BATTERY CASE. When using the BP-151 – BP-153, the indicator appears; however, it is not useful. This is because once the voltage goes down, it will decrease rapidly as a result of the Ni-Cd battery characteristics.

* Optional for versions which include the BP-151.

◇ Resetting the indicator

When placing new dry cell batteries in the battery case, the indicator should be reset. When the indicator shows 1 segment (□■■■), the dry cell batteries in the BP-159 cannot activate the transmitter circuitry.

- ① Turn power OFF.
- ② While pushing [FUNC], push and hold [POWER] for 1 sec. to reset the reference voltage.
 - The indicator shows “■■■■” (100% voltage).

• Relationship between indication and approx. voltage

Indication	4 seg.	3 seg.	2 seg.	1 seg.
6.0 V ref. voltage	5.4 V or above (89 – 100%)	4.7 – 5.4 V (78 – 89%)	4.1 – 4.7 V (67 – 78%)	4.1 V or below (67% or below)

■ PTT lock function USING SET MODE

The PTT lock function locks the PTT switch electronically to prevent accidental transmission. The whisper function can be used even when the PTT lock function is in use.

- ① Push [FUNC] + [8] SET] to enter set mode.
- ② Push [* ▽] or [# △] one or more times until “PTTLK” appears in the display.
- ③ Rotate the tuning dial to turn the PTT lock function “on” or “oFF.”
- ④ Push [A CLR] to exit set mode.

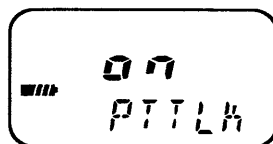

■ Beep tone on/off USING SET MODE

The confirmation beep can be turned ON or OFF, as desired. When “BEEP 2” is selected, a melody is emitted instead of the 5 beeps when the power-on/off timers or auto power-off is activated. These 5 beeps for timers cannot be turned OFF even when “BEEP oFF” is selected.

- ① Push [FUNC] + [8] SET] to enter set mode.
- ② Push [* ▽] or [# △] one or more times until “BEEP” appears in the display.
- ③ Rotate the tuning dial to select the beep tone ON (1 or 2) or “oFF.”
- ④ Push [A CLR] to exit set mode.

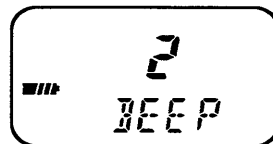

■ Receive indicator on/off USING SET MODE

The receive (busy) indicator can be turned ON or OFF. Turn it OFF when you want to conserve battery power.

- ① Push [FUNC] + [8] SET] to enter set mode.
- ② Push [* ▽] or [# △] one or more times until “BUSy” appears in the display.
- ③ Rotate the tuning dial to select the receive indicator “on” or “oFF.”
- ④ Push [A CLR] to exit set mode.

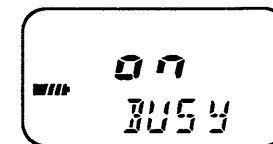

■ LCD contrast USING SET MODE

The LCD (Liquid Crystal Display) contrast can be selected from 4 levels (1 – 4) for your preference. Select a suitable level depending on the ambient light.

- ① Push [FUNC] + [8] SET] to enter set mode.
- ② Push [* ▽] or [# △] one or more times until “LCD” appears in the display.
- ③ Rotate the tuning dial to select the desired contrast.
 - Level 4 is the highest contrast.
- ④ Push [A CLR] to exit set mode.

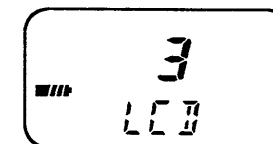

■ DTMF speed

USING SET MODE

The sending speed of the DTMF memory can be selected from 4 speeds to suit your needs. This setting does not affect pager and code squelch operation.

- ① Push [FUNC] + [8] SET] to enter set mode.
- ② Push [* ▽] or [# △] one or more times until "DTMF" appears in the display.
- ③ Rotate the tuning dial to select the desired speed.
 - 100 msec. (5 cps), 200 msec. (2.5 cps), 300 msec. (1.6 cps) and 500 msec. (1 cps) are available. (cps = characters/sec.)
- ④ Push [A CLR] to exit set mode.

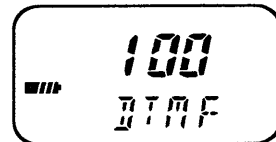

■ Partial resetting

If you want to initialize the operating condition (VFO frequency, VFO settings, set mode contents) without clearing the memory contents, repeater memories, clock or timer, a partial resetting function is available for the transceiver.

- ① Turn power OFF.
- ② While pushing [A CLR], push and hold [POWER] for 1 sec. to partially reset the transceiver.

■ Optional HM-75A functions

When using an optional HM-75A with the transceiver, the switches on the HM-75A function as follows:

① A SWITCH

- Changes the operating band between the 144 MHz and 430(440) MHz bands.
- Starts the crossband scan while full scan or programmed scan is activated.
- Generates a 1750 Hz tone* while transmitting.

② B SWITCH

Changes mode between VFO, memory and select memory (when used).

③ Δ/▽ SWITCHES

- Change the frequency in the selected tuning steps in VFO mode.
- Change memory channel in memory mode.
- Start the previously selected programmed scan or memory skip scan when pushed for 1 sec.
- Change the frequency or memory channel using dial select tuning while pushing [FUNC].

*Europe, Italy and Denmark versions only.

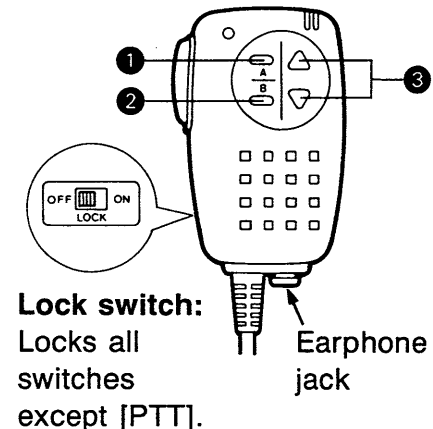

17 MODE CONSTRUCTION CHART

Although the following chart refers only to the IC-T21A/E, the IC-T41A/E has the same mode arrangement.

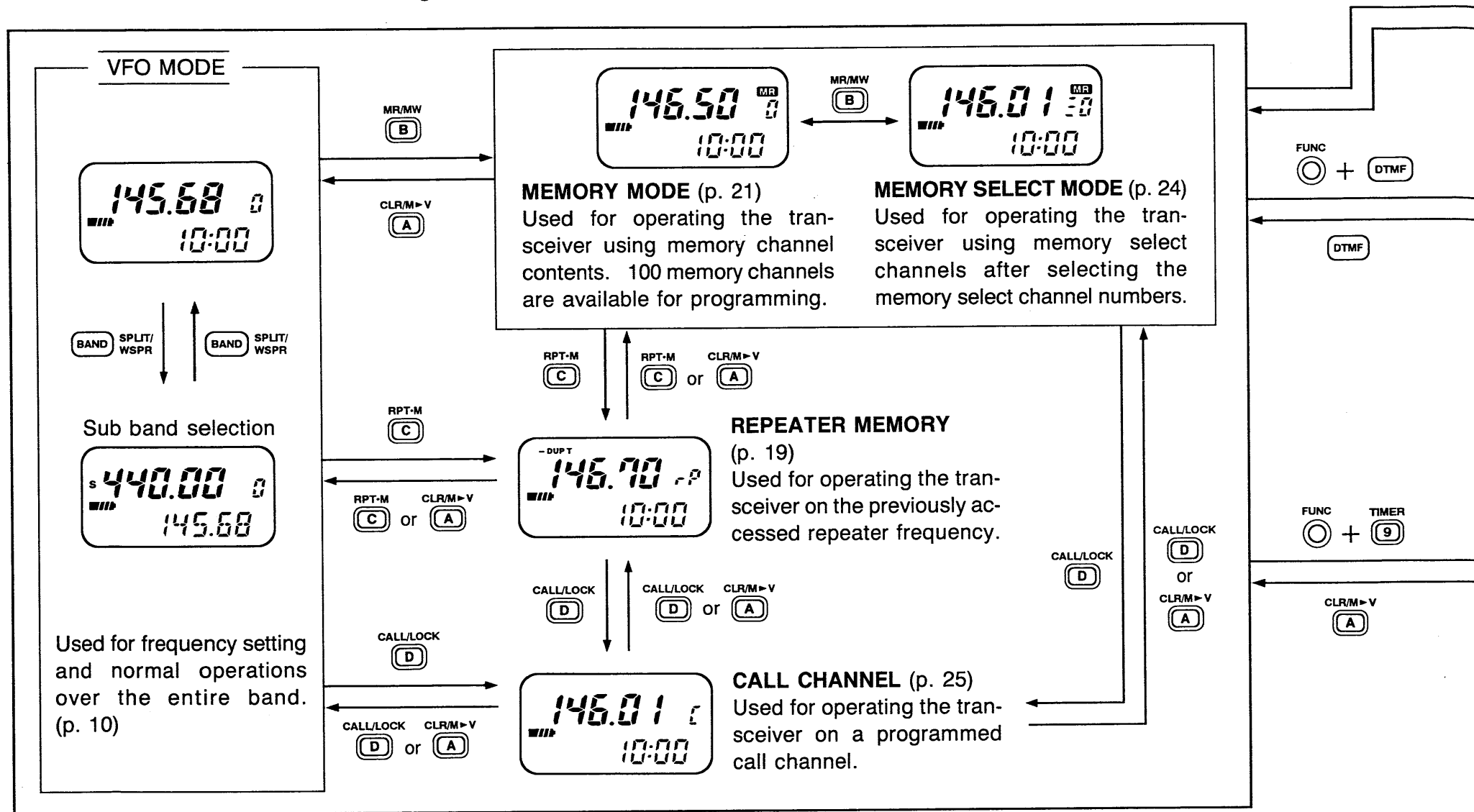

FUNC + SET (8)

CLR/M-V (A)

DTMF MEMORY MODE

2196E 25
DTMF

See p. 32 for details.

TIMER MODE

▽/SCAN (*)

OFF AP
10:00

△/SCAN (#)

Auto power-off (p. 36)

10:00

Clock setting display (p. 35)

0:00 ON
10:00

Power-on timer (p. 37)

0:00 OF
10:00

Power-off timer (p. 38)

SET MODE

Subaudible tone frequency*1 (p. 18)

88.5
TONE

Offset frequency*2 (p. 18)

.60
OFF

PTT lock (p. 47)

OFF
PTTLK

Whisper time-out timer (p. 45)

5
WSPR

Beep tone (p. 47)

1
BEEP

Full duplex setting (p. 16)

ON
FDUP

▽/SCAN (*)

△/SCAN (#)

Power saver duty cycle (p. 46)

1:12
P53

DTMF speed (p. 48)

100
DTMF

*1 Appears when an optional UT-81 is installed, except for the U.S.A. version, and when entering set mode from VFO mode.

Receive indicator (p. 47)

ON
BUSY

*2 Appears when entering set mode from the main band VFO mode.

Memory select channel (p. 24)

OFF MR
SEL MR

*3 Appears for the U.S.A. version only.

NOTE: These displays show the default settings except for the offset frequency setting.

LCD contrast (p. 47)

3
LCD

Auto repeater*3 (p. 20)

OFF
AT RP

Auto repeater power control (p. 19)

OFF
RPTPW

Automatic power down function (p. 15)

ON
ELOW

Scan resume condition (p. 31)

t-10
SCAN

Frequency skip function (p. 29)

ON
SCAN

18 TROUBLESHOOTING

If your transceiver seems to be malfunctioning, please check the following points before sending it to a service center.

PROBLEM	POSSIBLE CAUSE	SOLUTION	REF.
<ul style="list-style-type: none"> No power comes on. 	<ul style="list-style-type: none"> The battery is exhausted. (A slight current flows in the circuits even when the power is OFF.) Poor plug connection to the external DC power cable. 	<ul style="list-style-type: none"> Charge the battery pack or place new dry cell batteries in the battery case. (Remove the battery pack if you will not be using the transceiver for a long time.) Check the connector or remove and replace the cable. 	<p>pgs. i, 8</p> <p>—</p>
<ul style="list-style-type: none"> Power cannot be turned OFF. 	<ul style="list-style-type: none"> The battery became exhausted during operation. 	<ul style="list-style-type: none"> Charge the battery pack or place new dry cell batteries in the battery case, then, turn the power OFF. 	<p>pgs. i, 8</p>
<ul style="list-style-type: none"> No sound comes from the speaker. 	<ul style="list-style-type: none"> [SQL] is turned too far clockwise. An external speaker or earphone is connected. Pager or code squelch is activated. Optional pocket beep or tone squelch is activated. 	<ul style="list-style-type: none"> Rotate [SQL] counterclockwise. Unplug the speaker or earphone. Push [FUNC] + [② PGR/C SQL] once or twice to turn the function OFF. Push [FUNC] + [① T/TSQL] once or twice to turn the function OFF. 	<p>p. 14</p> <p>—</p> <p>pgs. 41, 42</p> <p>p. 44</p>
<ul style="list-style-type: none"> Transmitting is impossible. 	<ul style="list-style-type: none"> The PTT lock function is activated. 	<ul style="list-style-type: none"> Cancel the PTT lock function using set mode. 	<p>p. 47</p>
<ul style="list-style-type: none"> Frequency cannot be set. 	<ul style="list-style-type: none"> Memory mode, call channel or repeater memory is selected. The lock function is activated. 	<ul style="list-style-type: none"> Push [A CLR] one or more times to select VFO mode. Push [FUNC] + [D LOCK] to deactivate the lock function. 	<p>p. 10</p> <p>p. 11</p>
<ul style="list-style-type: none"> Scan cannot be activated. 	<ul style="list-style-type: none"> The squelch is open. 	<ul style="list-style-type: none"> Rotate the [SQL] control clockwise until noise disappears. 	<p>pgs. 27, 30</p>
<ul style="list-style-type: none"> The VFO contents and set mode settings are initialized. 	<ul style="list-style-type: none"> The internal memory backup battery is exhausted because no charging has been performed for a long time. 	<ul style="list-style-type: none"> Charge the battery pack or place new dry cell batteries in the battery case. The memory backup battery is simultaneously charged. 	<p>pgs. i, 8</p>

SPECIFICATIONS 19

		IC-T21A/E	IC-T41A/E
		Frequency coverage (Guaranteed range of VHF is 144 – 148 MHz.)	U.S.A.
Asia, Italy	Tx: 144 – 148 MHz Rx: 138 – 174 MHz 430 – 440 MHz		Tx: 430 – 440 MHz Rx: 430 – 440 MHz 138 – 174 MHz
Australia	Tx: 144 – 148 MHz Rx: 144 – 148 MHz 430 – 440 MHz		Tx: 430 – 440 MHz Rx: 430 – 440 MHz 144 – 148 MHz
Europe	Tx: 144 – 146 MHz Rx: 144 – 146 MHz 430 – 440 MHz		Tx: 430 – 440 MHz Rx: 430 – 440 MHz 144 – 146 MHz
Denmark	Tx: 144 – 146 MHz Rx: 144 – 146 MHz 432 – 438 MHz		Tx: 432 – 438 MHz Rx: 432 – 438 MHz 144 – 146 MHz
Taiwan	Tx: 145 – 146 MHz Rx: 145 – 146 MHz 430 – 432 MHz		Tx: 430 – 432 MHz Rx: 430 – 432 MHz 145 – 146 MHz
Mode	FM (F3E)		
Frequency stability	± 10 ppm (0°C to +50°C)		
Tuning steps	5, 10, 12.5, 15, 20, 25, 30 or 50 kHz		
Antenna impedance	50 Ω (nominal)		
External DC power	4 – 16 V DC (negative ground)		
Current drain (at 13.5 V, typical)	Tx	High	1.8 A
		Low 1	1.0 A
		E LOW	90 mA
	Rx	Rated audio	160 mA
		Power saved	8 mA (average)
Usable temperature range	– 10°C to +60°C; +14°F to +140°F		
Dimensions (with BP-151) (projections not included)	54(W) × 111(H) × 35.5(D) mm; 2.1(W) × 4.4(H) × 1.4(D) in		
Weight (with BP-151)	315 g; 11.1 oz		

		IC-T21A/E	IC-T41A/E	
		TRANSMITTER	Selectable output power* (at 13.5 V)	6.0 W, 4.0 W, 1.4 W 1.0 W, 15 mW
Modulation system	Variable reactance frequency modulation			
Max. frequency deviation*	± 5 kHz			
Spurious emissions*	Less than – 60 dB (at high power) Less than – 40 dB (at E LOW)			
Microphone impedance	2 kΩ			
RECEIVER	Receive system	Double-conversion superheterodyne		
	Intermediate frequencies	1st	30.85 MHz	35.8 MHz
		2nd	455 kHz	
	Sensitivity* (for 12 dB SINAD)	VHF	Less than 0.16 μV	Less than 0.22 μV
		UHF	Less than 0.22 μV	Less than 0.16 μV
	Squelch sensitivity	Less than 0.13 μV (at threshold)		
	Selectivity	More than 15 kHz/– 6 dB Less than 30 kHz/– 60 dB		
	Spurious and image rejection ratio*	More than 60 dB (Except half of image frequency)		
	Audio output power* (at 13.5 V)	More than 300 mW (at 10% distortion with an 8 Ω load)		
Audio output impedance	8 Ω			

*Specifications guaranteed at a transceiver temperature of +25°C (+77°F).

All stated specifications are subject to change without notice or obligation.

◇ Battery packs and chargers

BATTERY MODEL	HEIGHT (with handset)	VOLTAGE	CAPACITY	CARRYING CASE
BP-109	111 mm; 4.4 in	6.0 V	800 mAh	LC-109
BP-111	126.8 mm; 5.0 in	6.0 V	1100 mAh	LC-111
BP-110	174.7 mm; 6.9 in	12.0 V	600 mAh	LC-110
BP-153	111 mm; 4.4 in	Battery case R6 (AA) size × 4		LC-109

CP-12/L

CIGARETTE LIGHTER CABLE WITH NOISE FILTER
For operation and charging with a 12 V cigarette lighter socket.

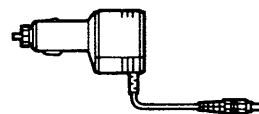

OPC-254/L

DC POWER CABLE
For operation and charging with an external power supply.

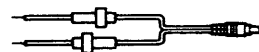

BC-74A/E/D/V

WALL CHARGER
Regularly charges a battery pack.

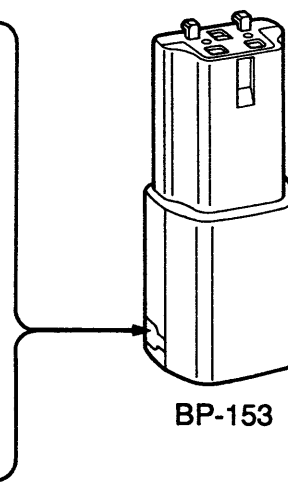
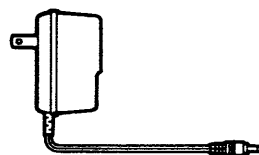

BP-153

- The BC-73E/D cannot be used as the charging power source.

BC-79 DESKTOP CHARGER + AD-44 BATTERY PACK ADAPTER

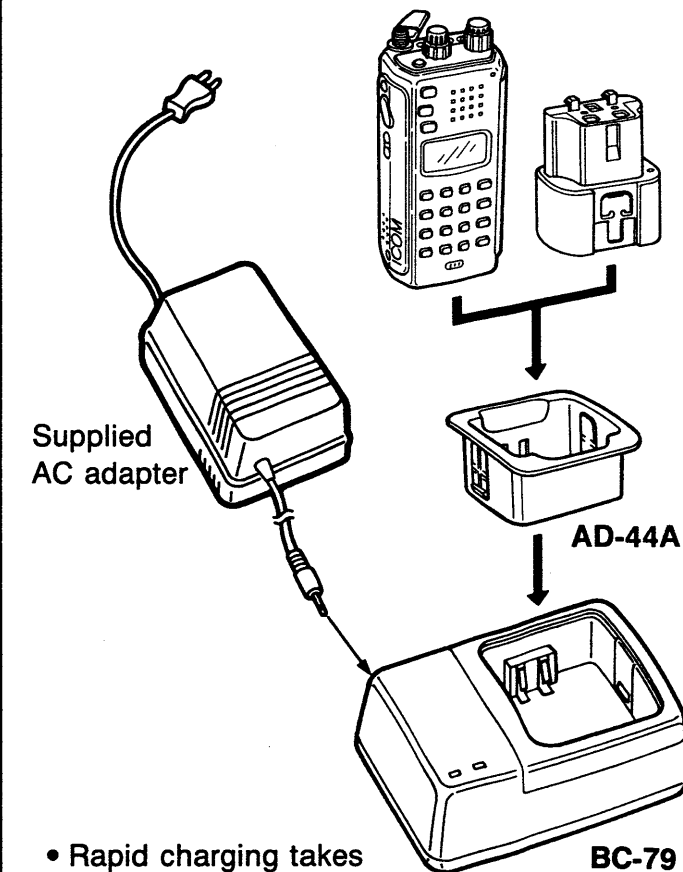

- Rapid charging takes 70–80 min.
- An AC adapter is packed with the BC-79.
- The CP-13/L or OPC-288/L can be used instead of the supplied AC adapter.

◆ Speaker-microphones

HM-46

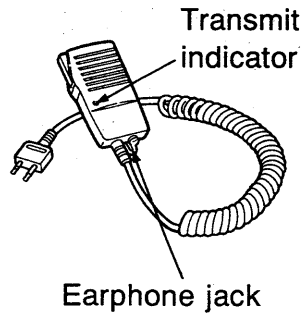

HM-54

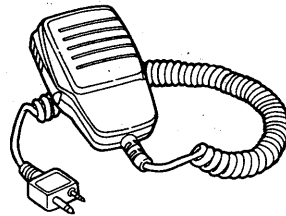

MB-30 MOUNTING BRACKET

When using the bracket hanger

When using no bracket hanger

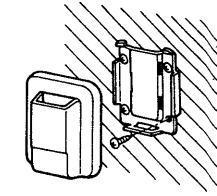
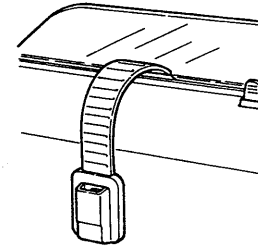

HM-55/A

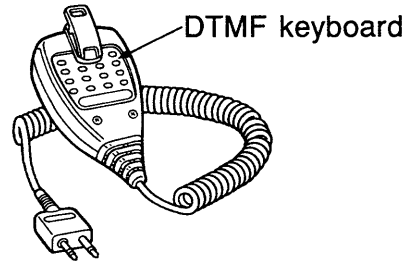

HM-75A

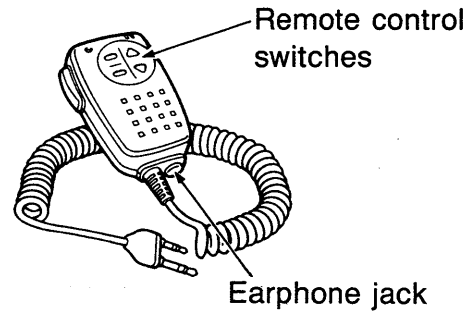

HS-51 HEADSET

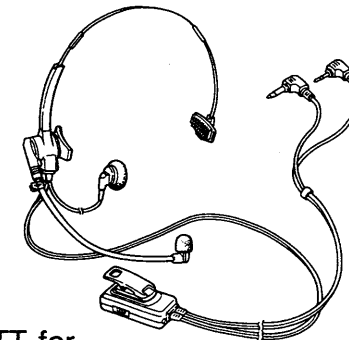

- PTT switch
- VOX
- One-touch PTT for hands-free operation

SP-13 EARPHONE

Provides clear receive audio in noisy environments.

UT-81 TONE SQUELCH UNIT

Already installed in the U.S.A. version. Provides a "personalized" tone squelch system with other stations and tone scan function. Also functions as a programmable tone encoder.

Count on us!

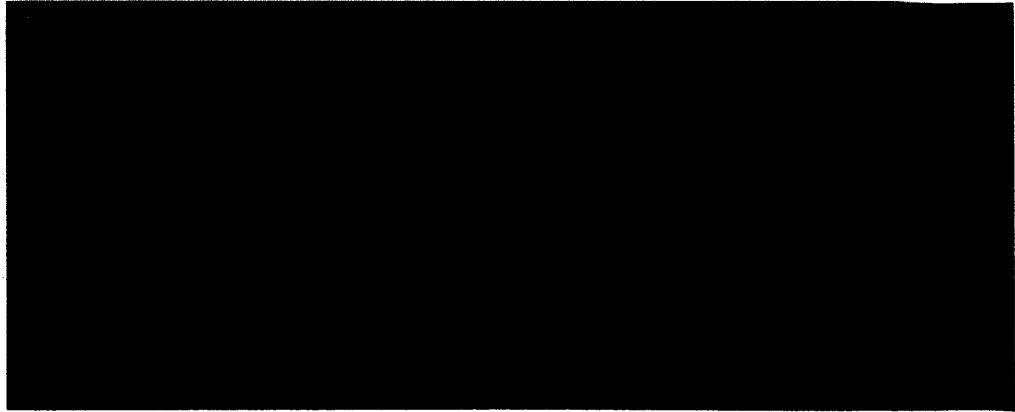

A-5264S-1EX
Printed in Japan
Copyright © 1993 by Icom Inc.

Icom Inc.
6-9-16, Kamihigashi, Hirano-ku, Osaka 547, Japan