

ICOM

INSTRUCTION MANUAL

144 MHz FM TRANSCEIVER

IC-T22A

IC-T22E

UHF FM TRANSCEIVER

IC-T42A

IC-T42E

This device complies with Part 15 of the FCC rules. Operation is subject to the following two conditions: (1) This device may not cause harmful interference, and (2) this device must accept any interference received, including interference that may cause undesired operation.

Downloaded by
RadioAmateur.EU

icom Inc.

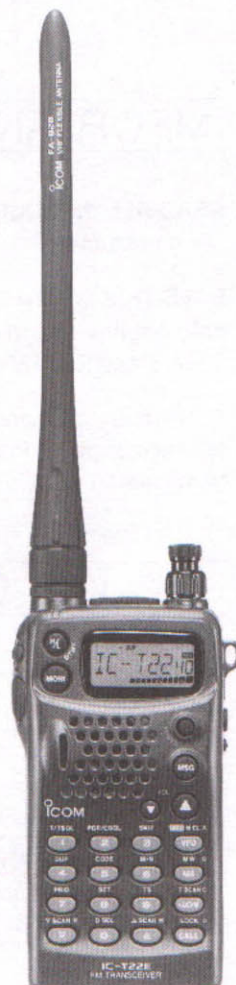

IMPORTANT

READ ALL INSTRUCTIONS carefully and completely before using the transceiver.

SAVE THIS INSTRUCTION MANUAL—This instruction manual contains important operating instructions for the IC-T22A/E and IC-T42A/E.

This instruction manual uses the IC-T22A/E for most of the example displays. Please note that only the frequency differs from the IC-T42A/E.

EXPLICIT DEFINITIONS

The explicit definitions described below apply to this instruction manual.

WORD	DEFINITION
⚠ WARNING	Personal injury, fire hazard or electric shock may occur.
CAUTION	Equipment damage may occur.
NOTE	If disregarded, inconvenience only. No risk of personal injury, fire or electric shock.

CAUTIONS

⚠ WARNING! NEVER hold the transceiver so that the antenna is very close to, or touching exposed parts of the body, especially the face or eyes, while transmitting. The transceiver will perform best if the microphone is 5 to 10 cm (2 to 4 in) away from the lips and the transceiver is vertical.

⚠ WARNING! NEVER operate the transceiver with a headset or other audio accessories at high volume levels. Hearing experts advise against continuous high volume operation. If you experience a ringing in your ears, reduce the volume level or discontinue use.

NEVER connect the transceiver to an AC outlet or to a power source of more than 16 V DC. Such a connection will damage the transceiver.

NEVER connect the transceiver to a power source using reverse polarity without a fuse (or with a more than 5 A fuse). This connection will ruin the transceiver.

NEVER attempt to charge alkaline or dry cell batteries. Beware that external DC power connections will charge batteries inside the battery case. This will damage not only the battery case but also the transceiver.

DO NOT push the PTT when not actually desiring to transmit.

DO NOT allow children to play with any radio equipment containing a transmitter.

DO NOT operate the transceiver near unshielded electrical blasting caps or in an explosive atmosphere.

AVOID using or placing the transceiver in direct sunlight or in areas with temperatures below -10°C ($+14^{\circ}\text{F}$) or above $+60^{\circ}\text{C}$ ($+140^{\circ}\text{F}$).

BE CAREFUL! When transmitting for a long time at high output power, the rear panel will become hot.

The use of non-Icom battery packs/chargers may impair transceiver performance and invalidate the warranty.

Even when the transceiver power is OFF, a slight current still flows in the circuits. Remove the battery pack or case from the transceiver when not using it for a long time. Otherwise, the battery pack or installed dry cell batteries will become exhausted.

UNPACKING

Accessories included with the transceiver:

	Qty.
① Antenna	1
② Handstrap	1
③ Battery pack (BP-171 or BP-180) or battery case (BP-170) attached to the transceiver	1
④ Belt clip	1
⑤ Wall charger*	1

*Not supplied with battery case versions.

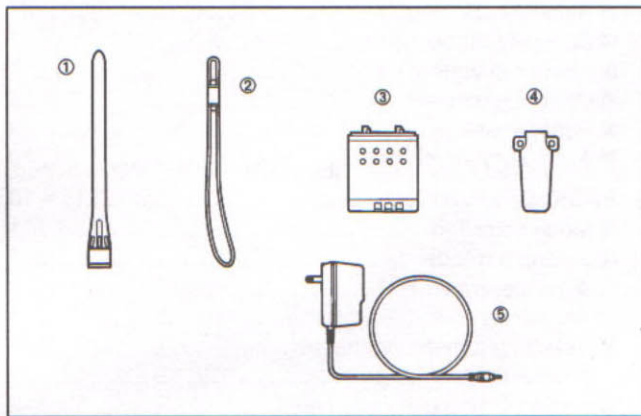

TABLE OF CONTENTS

IMPORTANT	i	■ Lock function	13
EXPLICIT DEFINITIONS	i	■ PTT lock function	13
CAUTIONS	i	■ LCD backlighting	13
UNPACKING	ii	■ Receive and transmit	14
TABLE OF CONTENTS	iii	◇ Volume switches	14
		◇ Output power selection	14
1 PANEL DESCRIPTION	1 – 6	■ Repeater operation	15
■ Switches, controls, keys and connectors	1	◇ General	15
■ Function display	6	◇ Tone information	15
2 BATTERY PACKS AND ACCESSORIES.....	7 – 10	◇ Setting subaudible tones	15
■ Battery pack charging	7	◇ Setting an offset frequency	16
■ Charging precautions	7	◇ Auto repeater function	16
■ About the battery pack	7		
■ Charging connections	8	4 ADVANCED FUNCTIONS.....	17 – 32
■ Battery case	9	■ Memory/call channels	17
■ Accessory attachment.....	10	◇ Available memory channels	17
		◇ Programming during selection	17
3 BASIC OPERATION.....	11 – 16	◇ Programming after selection	18
■ Mode selection	11	◇ Memory/call ⇒ VFO	18
■ Setting a frequency	11	◇ Memory/call ⇒ call/memory	18
◇ Via the keypad	11	◇ Memory clear	18
◇ Other methods	11	◇ Memory name function	19
■ Selecting a memory channel.....	12	◇ Programming memory names	19
◇ Other methods	12	■ DTMF memory operation	20
■ Setting tuning dial increments	12	◇ Programming a DTMF code	20
◇ Tuning step selection	12	◇ Transmitting a DTMF code	20
◇ Setting a dial select step	13	◇ DTMF transmit speed	20

■ Scan operation.....	21	◇ Pocket beep operation	31
◇ Scan types	21	◇ Calling a waiting station using pocket beep	31
◇ Full/programmed scan	22	■ Installing the optional UT-94 TONE SQUELCH UNIT	32
◇ Memory (skip) scan	22	5 OTHER FUNCTIONS	33 – 37
◇ Setting a skip channel.....	22	■ Beep tones ON/OFF	33
◇ Frequency skip function.....	23	■ Initial set mode	33
◇ Frequency skip function ON/OFF	23	◇ Entering initial set mode	33
◇ Scan resume condition	23	◇ Opening text	33
■ Priority watch	24	◇ Microphone simple mode.....	34
◇ Operation	24	◇ Auto power OFF.....	34
■ Pager function	25	◇ Power saver duty cycle	34
■ Code programming	25	◇ External power condition	35
◇ Before programming	25	◇ Busy LED ON/OFF	35
◇ Code channel assignment	25	◇ Function display backlighting ON/OFF	35
◇ Programming	26	◇ LCD contrast.....	35
■ Pager operation.....	27	■ CPU resetting.....	36
◇ Calling a specific station	27	◇ Partial reset.....	36
◇ Waiting for a call from a specific station.....	27	◇ Full reset	36
■ Code squelch	28	■ Optional HM-75A functions	36
■ Message function	29	6 TROUBLESHOOTING	37
◇ Message standby (receive).....	29	7 OPTIONS	38
◇ Clearing received messages	29	8 TABLES AND DIAGRAMS	39
◇ Programming for transmit messages	29	9 SPECIFICATIONS.....	40
◇ Transmitting a message	30	10 MODE ARRANGEMENT.....	41 – 42
■ Subaudible tone operation	30		
◇ Tone squelch operation.....	30		
◇ Tone scan	31		

PANEL DESCRIPTION

■ Switches, controls, keys and connectors

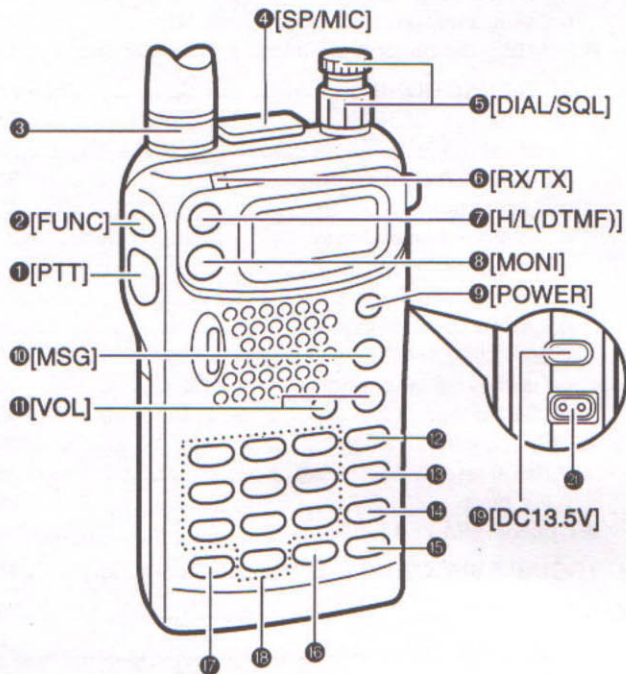

1 PTT SWITCH [PTT] (p. 14)

Push and hold to transmit; release to receive.

2 FUNCTION KEY [FUNC]

While pushing [FUNC], push other keys to activate their secondary functions.

3 ANTENNA CONNECTOR (p. 10)

Connects the supplied antenna.

4 EXTERNAL SPEAKER AND MICROPHONE JACKS [SP/MIC]

Connect an optional speaker-microphone or headset, if desired. The internal microphone and speaker will not function when either is connected. (See p. 38 for options.)

5 TUNING DIAL [DIAL] AND SQUELCH CONTROL [SQL]

➤ Rotate [DIAL] to set an operating frequency, select a memory channel, select set mode contents, change scan direction, etc.

➤ Rotate [DIAL] while pushing [MONI] to adjust the audio level (p. 14).

➤ Rotate [SQL] clockwise to close and counterclockwise to open the squelch.

6 RX/TX INDICATOR [RX/TX] (p. 14)

Lights green while receiving a signal or when the squelch is open; lights red while transmitting.

• The green RX indicator can be turned OFF in set mode to conserve battery power.

7 OUTPUT POWER SWITCH [H/L(DTMF)]

➤ Push to toggle between low and high output power (p. 14).

➤ While pushing [FUNC] push this key to call up a DTMF memory (p. 20).

➤ While pushing [PTT] push this key to transmit a DTMF memory (p. 20).

8 MONITOR KEY [MONI] (p. 14)

➤ Push this key to open the squelch without changing the [SQL] setting.

➤ Sets the dial function to volume control when pushing this key.

9 POWER SWITCH [POWER]

Push for 1 sec. to toggle power ON and OFF.

10 MESSAGE KEY [MSG]

➤ Push this key to call up receive and transmit message memories (p. 29).

• Rotate [DIAL] to select the desired message memory.

➤ While pushing [FUNC] push this key to enter message receive mode (p. 29).

• "[MSG]" appears.

• Pager or code squelch must be activated to receive a message.

➤ During transmit, push this key then a message

1 PANEL DESCRIPTION

memory number to transmit the corresponding message (p. 30).

① VOLUME SWITCHES [VOL] (p. 14)

VOL Push these switches to adjust the volume to the desired level.



• "VOL" and the volume level indicators appear.

② VFO MODE KEY [VFO(CLR)(M CLR)(A)]

CLR M CLA ➔ Push this key to cancel most functions, then push again to select VFO mode (p. 11).



• When making a mistake during input, push this key to cancel and start from the beginning.

➔ In memory mode, while pushing [FUNC] push this key to clear the selected memory (p. 18).

➔ While pushing [PTT], this key sends a DTMF "A."

③ MEMORY MODE KEY [MR(MW)(B)]

MW B ➔ Push this key to select memory mode (p. 11).



➔ While pushing [FUNC] push this key to enter memory writing mode (p. 17).

• Writing operation is: while pushing [FUNC], [MR(MW)], [DIAL] then push and hold [MR(MW)].

➔ While pushing [PTT], this key sends a DTMF "B."

④ LOG MEMORY KEY [LOG•M(T SCAN)(C)]

T SCAN C ➔ Push this key to select a log memory or repeater memory (p. 11).



➔ While pushing [FUNC] push this key to start tone scan when an optional* tone squelch is in use (p. 31).

➔ While pushing [PTT], this key sends a DTMF "C."

⑤ CALL MODE KEY [CALL(LOCK)(D)]

LOCK D ➔ Push this key to select the call channel (p. 11).



➔ Push [FUNC] then this key to toggle the lock function ON and OFF (p. 13).

• "L" appears while the lock function is activated.

• [PTT], [POWER], [VOL], [MONI], [SQL], [H/L] and [FUNC] can still be accessed while the lock function is on.

➔ While pushing [PTT], this key sends a DTMF "D."

⑥ UP KEY [Δ(Δ SCAN)]

Δ SCAN # ➔ In VFO mode, push this key to increment the frequency according to the selected tuning steps, in memory mode, push this key to increment the memory channel (pgs. 11, 12).



➔ Push this key for 1 sec. to start full or memory scan in the "up" direction (p. 22).

➔ While pushing [FUNC] push this key to start programmed or memory skip scan in the "up" direction (p. 22).

➔ While pushing [PTT], this key sends a DTMF "F."

7 DOWN KEY [▽(▽ SCAN)]

- ▽SCAN*** ➔ In VFO mode, push this key to decrement the frequency according to the selected tuning steps, in memory mode, push this key to decrement the memory channel (pgs. 11, 12).
- ➔ Push this key for 1 sec. to start full or memory scan in the "down" direction (p. 22).
- ➔ While pushing [FUNC] push this key to start programmed or memory skip scan in the "down" direction (p. 22).
- ➔ While pushing [PTT], this key sends a DTMF "E."

8 DIGIT KEYS

- ➔ Input the specified digit during frequency input, memory channel selection, etc.
- ➔ Transmit the DTMF code of the specified digit while pushing [PTT].
- ➔ In addition, each key has one or more secondary functions while pushing [FUNC] as follows:

- T/SQL** ➔ While pushing [FUNC] push this key to activate the subaudible tone encoder (optional for Europe and Italy versions).
- ➔ When installing an optional* UT-94 TONE SQUELCH UNIT, while pushing [FUNC] push this key to activate the subaudible tone encoder, pocket beep, tone squelch, or normal operation, in that order

(pgs. 30, 31).

- "T" appears during tone operation; "T SQL ((·))" appears during pocket beep operation and "T SQL" appears during tone squelch operation.

PGR/CSQL**2**

- ➔ While pushing [FUNC] push this key to activate the pager or code squelch function or to turn them OFF (pgs. 27, 28).
- "P" appears in place of the 100 MHz digit during pager operation; "C" appears in place of the 100 MHz digit during code squelch operation.

SKIP**3**

- ➔ In memory mode, while pushing [FUNC] push this key to toggle the channel's skip setting ON/OFF for memory skip scan (p. 22).
- ➔ During pager or code squelch operation, the skip setting is used to set a code for "receive inhibit" (p. 26).

DUP**4**

- ➔ While pushing [FUNC] push this key to select semi-duplex or simplex operation (p. 15).
- "- DUP" appears during minus duplex operation, "DUP" appears during plus duplex operation and no indicator appears during simplex operation.

CODE**5**

- ➔ While pushing [FUNC] push this key to enter code setting mode for pager or code squelch use. (p. 26).

1 PANEL DESCRIPTION

M-N
6

- ➔ In memory mode, while pushing [FUNC] push this key to toggle between frequency and memory name indication (p. 19).
- ➔ In memory mode, while pushing [FUNC] push this key for longer than 1 sec. to enter memory name writing mode (p. 19).

PRIO
7

- ➔ While pushing [FUNC] push this key to start priority watch (p. 24).
 - While in VFO mode priority watch becomes memory channel watch; when the call channel is indicated, priority watch becomes call channel watch.

SET
8

- ➔ In VFO mode, while pushing [FUNC] push this key to enter set mode.
 - [Δ]/[▽] select set mode items and [DIAL] selects a set mode condition while in set mode.

TS
9

- ➔ While pushing [FUNC] push this key then rotate [DIAL] to select a tuning step (p. 12).

D SEL
0

- ➔ In VFO mode, while pushing [FUNC] push this key to toggle the dial select step (p. 13).

⑩ EXTERNAL DC POWER JACK [DC13.5V]

Allows operation with a 13.5 V DC power source using the optional cables, CP-12L or OPC-254L.

CAUTION: Operation with an external DC power source simultaneously charges batteries inside the battery case or the battery pack. When using dry cell batteries this may cause battery leakage and damage the transceiver; when using a Ni-Cd battery pack this may cause battery overcharging and shorten the life of the battery pack.

⑪ BATTERY PACK RELEASE (p. 9)

Push to open the latch for battery pack removal.

■ Function display

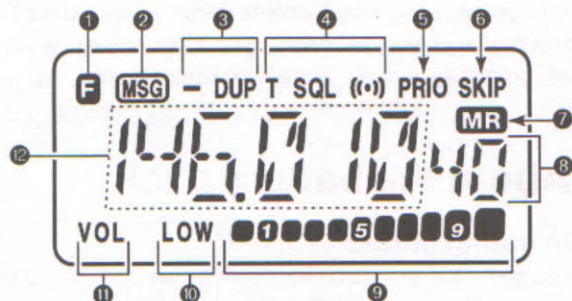

1 FUNCTION INDICATOR

Shows that the secondary functions of switches can be accessed.

2 MESSAGE INDICATOR (p. 29)

Appears when the message function is activated.

3 DUPLEX INDICATOR (p. 15)

Appears during semi-duplex operation.

4 TONE INDICATOR

- "T" appears when the subaudible tone encoder is in use.
- Additionally, "T SQL" and "T SQL (·)" appear in sequence when the optional* UT-94 TONE SQUELCH UNIT is activated. (pgs. 30, 31)

5 PRIORITY INDICATOR (p. 24)

Appears when the priority watch is activated.

6 SKIP INDICATOR (pgs. 22, 26)

Appears when a selected memory channel is set as a skip channel or when a code channel is set for "receive inhibit" during pager or code squelch operation.

7 MEMORY MODE INDICATOR

Appears while in memory mode.

8 MEMORY CHANNEL INDICATOR

Indicates the selected memory channel and other items such as the key lock indicator, etc.

9 VOLUME LEVEL AND S/R/F INDICATORS

- Show the volume level while setting volume (p. 14).
- Show the relative signal strength while receiving and the output power selection while transmitting. (p. 14)

10 LOW POWER INDICATOR

Appears when low output power is selected (p. 14).

11 VOLUME INDICATOR

Appears while adjusting the volume (p. 14).

12 ALPHANUMERIC READOUTS

Show the selected frequency, set mode contents, etc. Also, memory names can be indicated instead of the frequency.

■ Battery pack charging

The supplied* BP-171 or BP-180 BATTERY PACK includes rechargeable Ni-Cd batteries and can be charged approx. 300 times. Charge the battery pack before first operating the transceiver or when the battery pack becomes exhausted.

*Optional for versions which come with the BP-170 BATTERY CASE.

If you want to be able to charge the battery pack more than 300 times, the following points should be observed:

1. Avoid overcharging. The charging period should be less than 48 hours.
2. Use the battery until it becomes almost completely exhausted under normal conditions. We recommend battery charging just after transmitting becomes impossible.

■ Charging precautions

NEVER attempt to charge dry cell batteries. This will cause internal liquid leakage and damage the battery case and transceiver.

NEVER connect two or more chargers at the same time.

Charging may not occur under temperatures of 10°C (50°F) or over temperatures of 40°C (104°F).

DO NOT attempt to charge a fully charged battery pack.

Full charge capacity may become lower when repeatedly recharging after only partial discharging. In this case, discharge almost completely through normal use before recharging.

■ About the battery pack

◇ Operating period

Depending on the attached battery pack, the operating period of the transceiver varies. Refer to the addendum.

◇ Battery pack life

When the operating period becomes extremely short even after charging the battery pack fully, a new battery pack is needed.

Recycling information (U.S.A. only)



The product that you have purchased contains a rechargeable battery. The battery is recyclable. At the end of its useful life, under various state and local laws, it may be illegal to dispose of this battery into the municipal waste stream. Call 1-800-8-BATTERY for battery recycling options in your area or contact your dealer.

■ Charging connections

◇ Regular charging

Attach the supplied* or optional battery pack; then, connect the supplied* wall charger via an AC outlet as shown below.

*Optional for versions which include a battery case.

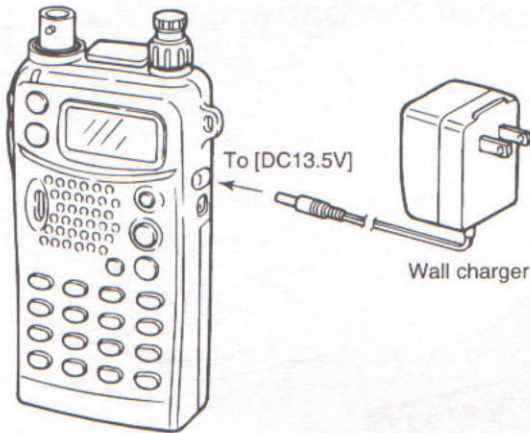

Charging periods:

15 hours (w/BP-171, BP-173 or BP-180)
20 hours (w/BP-172)

◇ Rapid charging with the BC-119

- ① Insert the AD-56A into the charging slot of the BC-119.
- ② Insert the AD-56B into the groove in the AD-56A (front-facing side of the AD-56A).
- ③ Insert the battery pack, either by itself or attached to the transceiver, into the AD-56B.

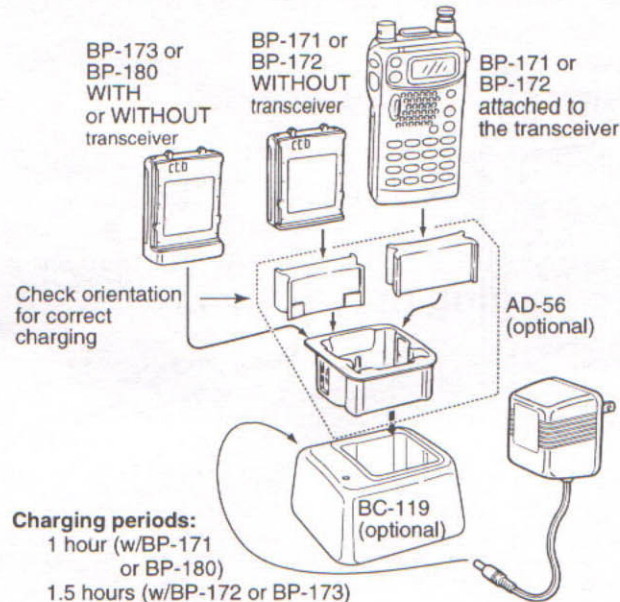

2 BATTERY PACKS AND ACCESSORIES

◇ Operation with an optional cable

Connect an optional charger or cable to the transceiver as illustrated below. Be careful of battery overcharging as the connected battery is charged simultaneously.

CAUTION: Remove dry cell batteries from the BP-170 BATTERY CASE when it is not in use.

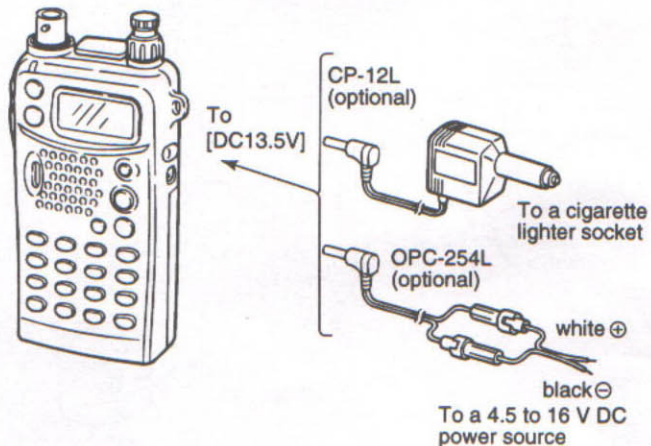

■ Battery case

When using a battery case attached to the transceiver, install 4 AA(R6) size alkaline batteries as illustrated below.

Remove the case from the transceiver.

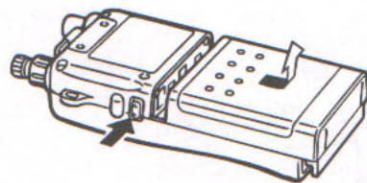

Open the case.

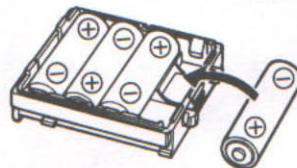
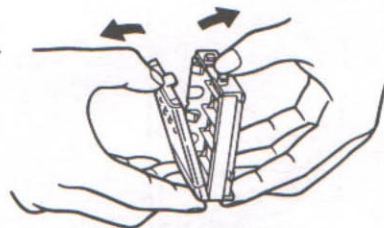

Install 4 AA(R6) size dry cell batteries into the battery case.

■ Accessory attachment

◇ Antenna

Insert the supplied antenna into the antenna connector and rotate the antenna as shown in the diagram below.

Keep the jack cover attached when jacks are not in use to avoid bad contacts.



CAUTION:

Transmitting without the antenna may damage the transceiver.

◇ Belt clip

Remove screws, then attach the belt clip using the same screws. Conveniently attaches to your belt.

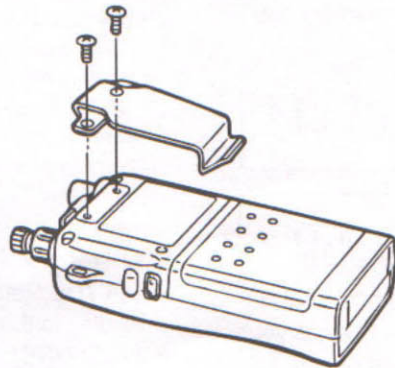

◇ Handstrap

Attach the handstrap as shown in the diagram below. Facilitates carrying.

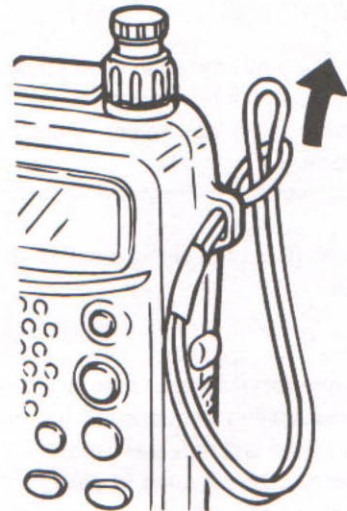

Mode selection

VFO mode is used for setting a desired frequency within the band range.

➔ Push [VFO] to select VFO mode.

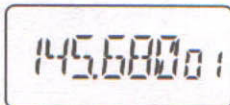

Memory (call) mode is used for operation of memory (call) channels which have programmed frequencies.

➔ Push [MR] to select memory mode.

• To program a memory, refer to p. 17.

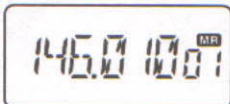

➔ Push [CALL] to select a call channel.

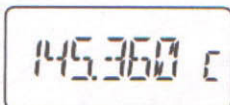

Log memory/repeater memory mode is used to recall your last-transmitted frequency or the frequency and duplex settings for the last repeater used.

➔ Push [LOG•M] once to select the log memory and again to select the repeater memory.

• Subsequent pushes toggle between the 2 modes.

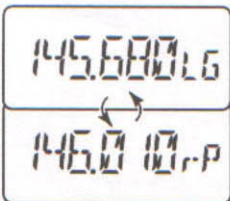

Setting a frequency

◆ Via the keypad

① Push [VFO] to select VFO mode.

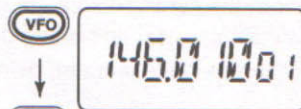

② Push 4 digit keys, starting from the 1 MHz digit, to input a frequency.

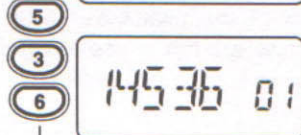

• When a digit is mistakenly input, push [(VFO)CLR] and input from the beginning.

• "0," "2," "5" and "7" are acceptable for the 1 kHz digits (depending on the 10 kHz digit).

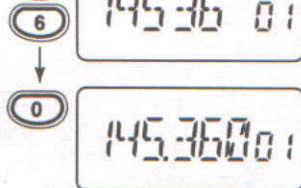

◆ Other methods

➔ **VIA THE DIAL:** Rotate [DIAL] to change the frequency according to the set tuning steps.

➔ **VIA [FUNC] + THE DIAL:** While pushing [FUNC] rotate [DIAL] to change the frequency according to the set dial select step.

➔ **VIA THE [Δ]/[▽] KEYS:** Push [Δ]/[▽] to increment/decrement the frequency according to the set tuning steps.

▨ **NOTE:** Pushing [Δ]/[▽] for more than 1 sec. activates a scan — push [Δ] or [▽] again momentarily to stop it.

■ Selecting a memory channel

① Push [MR] to select memory mode.



② Push 2 digit keys to select the desired memory channel.



- The first nine memory channels are preceded by a "0."

- To select scan edges 1A to 3B, use [*] for "A" and [#] for "B."

- Only programmed memory channels can be selected.

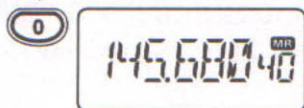

◇ Other methods

- **VIA THE DIAL:** Rotate [DIAL] to change the memory channel.
- **VIA [FUNC] + THE DIAL:** Rotate [DIAL] while pushing [FUNC] to select the scan edge memories, 1A to 3B.
- **VIA THE [Δ]/[▽] KEYS:** Push [Δ]/[▽] to increment/decrement the memory channel.

■ Setting tuning dial increments

◇ Tuning step selection

This transceiver has 8 tuning steps as follows:

- 5 kHz
- 10 kHz
- 12.5 kHz
- 15 kHz
- 20 kHz
- 25 kHz
- 30 kHz
- 50 kHz

① Push [FUNC] + [ⓈTS] to enter the tuning step setting condition.

- Previously selected tuning step appears.

② Rotate [DIAL] to select the desired tuning step.

③ Push [(VFO)CLR] to set the selected tuning step.

For convenience, select a tuning step that matches the frequency intervals of repeaters in your area.

[DISPLAY EXAMPLE]

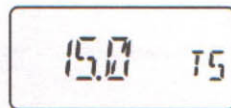

15 kHz tuning step

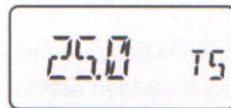

25 kHz tuning step

3 BASIC OPERATION

◆ Setting a dial select step

In VFO mode, rotating [DIAL] while pushing [FUNC], ("□" appears), changes the frequency in 100 kHz or 1 MHz steps.

This function is useful for quick tuning.

- ① Push [VFO] to select VFO mode.
- ② Push [FUNC] + [D SEL] once or twice to set the dial select step.
 - The selected step (100 kHz or 1 MHz) flashes.
- ③ While pushing [FUNC] rotate [DIAL] to change the frequency using the dial select step.

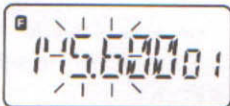

■ Lock function

The lock function prevents accidental frequency changes and accidental function activation.

- Push [FUNC] + [(CALL)LOCK] to toggle the lock function ON and OFF.
 - "L" appears while the lock function is activated.
 - [PTT], [POWER], [VOL], [SQL], [MONI], [H/L] and [FUNC] are not affected.

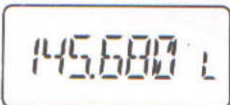

■ PTT lock function

USING SET MODE

The PTT lock function locks the PTT switch electronically to prevent accidental transmission.

- ① Push [FUNC] + [SET] to enter set mode.
- ② Push [Δ] or [▽] one or more times until "PT" appears.
- ③ Rotate [DIAL] to set the PTT lock function ON or OFF.
- ④ Push [(VFO)CLR] to exit set mode.



■ LCD backlighting

- The transceiver has an backlight function which automatically turns on the function display backlighting for 5 sec. when a key or switch is pushed. This function can be turned OFF (p. 35).
- If desired, use the initial set mode item, external power condition, to set the transceiver so that the function display backlighting stays on continuously while operating with external power (p. 35).

Receive and transmit

CAUTION: Transmitting without an antenna may damage the transceiver.

- ① Push [POWER] for 2 sec. to turn power ON.
- ② While pushing [MONI] rotate [DIAL] to set the audio output level.
- ③ Rotate [SQL] to set the point where audio noise is just muted.
- ④ Set an operating frequency.
When a signal is received:
 - Squelch opens and audio is emitted from the speaker.
 - The S/RF indicator shows the relative signal strength.
- ⑤ Push and hold [PTT] to transmit; then speak into the mic.
 - Do not hold the microphone too close to your mouth or speak too loudly. This may distort the signal.
 - The TX/RX indicator lights red.
 - The S/RF indicator shows the output power selection.
- ⑥ Release [PTT] to return to receive.

✓ CONVENIENT

Monitor function: Push and hold [MONI] to listen to weak signals without disturbing the squelch setting.

RX indicator: The green LED lights when receiving a signal (or when squelch opens). However, it can be turned OFF to conserve battery power (p. 35).

◇ Volume switches

The [VOL] switches can be used to adjust the audio output at any time. The audio output can be adjusted over 17 discrete levels — push the [VOL] switches momentarily to increment or decrement to volume in single steps; or, push and hold the [VOL] switches to continuously change the volume.

- “VOL” and the audio output bar appear while pushing one of the [VOL] switches.

Push VOL  to increase the volume.

Max. audio: VOL 

Push  VOL to decrease the volume.

Audio muted: VOL (no segments appear)



✓ CONVENIENT

Using the [DIAL]: While pushing [MONI], audio can be adjusted with [DIAL].

◇ Output power selection

Push [H/L] to toggle the output power level between high and low.

- “LOW” appears when low output power is selected.

POWER SELECTION	S/RF INDICATOR	OUTPUT POWER (typical; at 13.5 V)
HIGH		5.0 W
LOW	LOW 	500 mW

3 BASIC OPERATION

■ Repeater operation

◇ General

When using a repeater, the transmit frequency is shifted from the receive frequency by the offset frequency. It is convenient to program repeater information into memory channels (p. 17).

- ① Set the receive frequency (repeater output frequency).
- ② Push [FUNC] + [④DUP] once to select – DUP or twice to select DUP.
 - “– DUP” or “DUP” appears to indicate the transmit frequency for minus shift or plus shift, respectively.
 - When the auto repeater function is in use (U.S.A. version only) this selection and step ③ are not necessary (p. 16).
- ③ Push [FUNC] + [①T/TSQL] to activate the subaudible tone encoder, according to repeater requirements.
 - Optional for Europe, U.K. and Italy versions.
 - Refer to the addendum for a list of available tone frequencies.
- ④ Push and hold [PTT] to transmit.
 - The displayed frequency automatically changes to the transmit frequency (repeater input frequency).
 - The operating condition is automatically programmed into the repeater memory (p. 11).
 - If “OFF” appears, check the offset frequency (p. 16).
- ⑤ Release [PTT] to receive.
- ⑥ Push and hold [MONI] to check whether the other station's transmit signal can be directly received or not.

◇ Tone information

Some repeaters require a tone to be accessed. In this case, precede step ④ at left with the required tone.

DTMF TONES

While pushing [PTT], push the desired digit key(s) to transmit DTMF tones

- The transceiver has 5 DTMF memory channels. See p. 20 for details.

1750 Hz TONE (Europe and Italy versions only)

While pushing [PTT], push and hold [MONI] for 1 to 2 sec. to transmit a 1750 Hz tone signal.

◇ Setting subaudible tones

USING SET MODE

Some repeaters require subaudible tones to be accessed. Subaudible tones are superimposed over your normal signal and must be set in advance. This setting is an option for Europe and Italy versions.

- ① Push [VFO] to select VFO mode.
- ② Push [FUNC] + [③SET] to enter set mode.
- ③ Push [Δ] or [▽] until “TO” appears.
- ④ Rotate [DIAL] to select the desired subaudible tone.
- ⑤ Push [(VFO)CLR] to set the condition and to exit set mode.

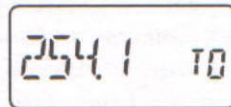
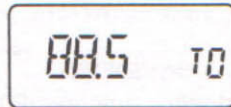

◆ Setting an offset frequency

When communicating through a repeater, the transmit frequency is shifted from the receive frequency by an amount determined by the offset frequency.

- ① Push [VFO] to select VFO mode.
- ② Push [FUNC] + [®SET] to enter set mode.
- ③ Push [Δ] or [▽] until "OW" appears.
- ④ Rotate [DIAL] to select the offset frequency.
 - [FUNC] + [DIAL] allows 100 kHz selection.
- ⑤ Push [(vfo)CLR] to set the condition and to exit set mode.

USING SET MODE



◆ Auto repeater function

(U.S.A. only)

The U.S.A. version automatically activates the repeater settings (duplex ON/OFF, duplex direction, tone encoder ON/OFF) when the operating frequency falls within or outside of the general repeater output frequency range, respectively. The offset frequency and subaudible tone frequency are not changed by the auto repeater function, reset these, if necessary.

USING SET MODE

- ① Push [VFO] to select VFO mode.
- ② Push [FUNC] + [®SET] to enter set mode.
- ③ Push [Δ] or [▽] until "Ar" appears.
- ④ Rotate [DIAL] to select the desired auto repeater condition as at right.
- ⑤ Push [(vfo)CLR] to set the condition and to exit set mode.

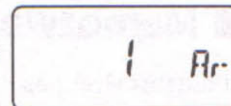

Activates for duplex only.

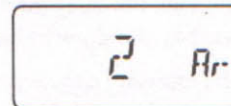

Activates for duplex and tone.

Downloaded by
RadioAmateur.EU

Memory/call channels

The transceiver has 40 memory channels (plus 3 pairs of scan edge channels) and 1 call channel for storage of often-used frequencies. Memory names can be assigned to each channel, however, when you don't need memory names, the number of memory channels can be increased to 80.

The following can be programmed into memory/call channels:

- Operating frequency
- Duplex direction and offset frequency (pgs. 15, 16)
- Subaudible tone encoder*¹ (or optional*² tone squelch) ON/OFF and its frequency (pgs. 15, 30)

- Skip information
- Memory name

*¹Optional for Eur. and Italy versions; *²Standard for U.S.A. version.

Available memory channels

at POWER ON

The number of memory channels available can be toggled between 40 and 80 (not including scan edge pairs and the call channel).

CAUTION: Selecting the number of memory channels clears all memory contents and set mode settings.

- Push [FUNC] + [Δ] + [VFO] + [POWER] to set available memory channels to 80 (memory names cannot be used).
- Push [FUNC] + [▽] + [VFO] + [POWER] to set available memory channels to 40 (memory name function available).

Programming during selection

NOTE: Perform steps ③ and ④ below within 2 sec., otherwise programming will not be successful.

- ① Push [VFO] to select VFO mode.
- ② Set the desired frequency:
 - Set other data, such as repeater information, etc. if required.



- ③ While pushing and holding [FUNC] (until step ④), push [(MR)MW] momentarily to indicate memory channels.



- "MR" flashes.
- Do not hold [MW] for more than 0.5 sec., otherwise the memory channel will overwrite the displayed number.



- ④ Rotate [DIAL] to select the desired channel.

- Call channel and scan edge channels, as well as regular memory channels, can be programmed in this way.



- ⑤ While continuing to push [FUNC], push [(MR)MW] for 0.5 sec. to program.
 - "MR" stops flashing.

◇ Programming after selection

- ① Select the memory channel to be programmed:
 - Push [MR] to select memory mode.
 - Rotate [DIAL] (or use the keypad) to select the memory channel.
- ② Set the desired frequency in VFO mode:
 - Push [VFO] to select VFO mode.
 - Set the desired frequency using the keypad or [DIAL].
 - Set other data, if desired.
- ③ Push [FUNC] + [(MR)MW] for 0.5 sec. to program.

◇ Memory/call ⇒ VFO

- ① Select the memory/call channel to be transferred:
 - Push [MR] (or [CALL]) to select memory (call) mode.
 - Rotate [DIAL] (or use the keypad) to select the memory channel.
- ② Push [FUNC] + [(MR)MW] for 0.5 sec. to transfer.
 - "VF" appears briefly and VFO mode is selected.

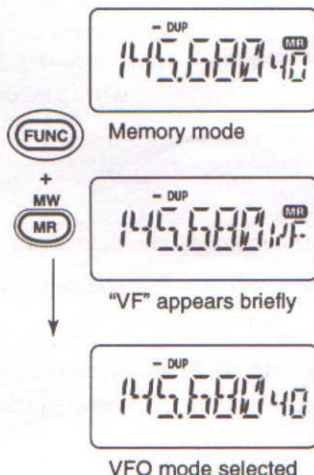

◇ Memory/call ⇒ call/memory

- ① Select the memory/call channel to be transferred:
 - Push [MR] (or [CALL]) to select memory (call) mode.
 - Rotate [DIAL] (or use the keypad) to select the memory channel.
- ② While pushing and holding [FUNC] (until step ④), push [(MR)MW] momentarily to indicate memory channels.
 - "VF" appears and "MR" flashes.
 - Do not hold [MW] for more than 0.5 sec., otherwise the memory channel will overwrite the displayed number.
- ③ Rotate [DIAL] to select a memory channel to transfer the data.
- ④ While continuing to push [FUNC], push [(MR)MW] for 0.5 sec. to program.
 - "MR" stops flashing.

◇ Memory clear

- ① Push [MR] to select memory mode.
- ② Select the memory channel to be cleared.
- ③ Push [FUNC] + [(VFO)M CL] for 0.5 sec.
 - "-----" appears briefly in place of the frequency, the memory is cleared and the next programmed memory is automatically selected.
 - Scan edges and memory channel 1 cannot be cleared.

NOTE: Be careful — the contents of cleared memories CANNOT be recalled.

4 ADVANCED FUNCTIONS

◇ Memory name function

Each memory can be programmed with an alphanumeric name such as a repeater name, club name, etc.

- This function can be selected for each memory channel independently.
- This function is not available when the number of memory channels is expanded to 80.

① Push [MR] to select memory mode.

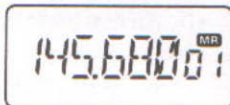

② Select a memory channel for name indication.

③ Push [FUNC] + [◻M•N].

- The default name for a memory is "CH" followed by the channel number, e.g. the default name indication for memory channel 01 is "CH01."

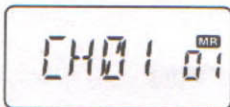

/// **NOTE:** While using the monitor function, the display shows the frequency even when memory name indication is selected.

◇ Programming memory names

① Select the memory channel to be programmed:

- ➡ Push [MR] to select memory mode.
- ➡ Rotate [DIAL] (or use the keypad) to select a memory channel.

② Push [FUNC] + [◻M•N] for 1 sec. to enter memory name writing mode.

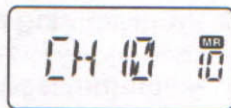

- The character (or cursor) at the far left begins to flash.

③ Rotate [DIAL] to select the desired character; or push [Δ] to move to the next position.

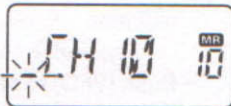

- Push [▽] to move to the previous position.

④ Repeat step ③ until the desired memory name is input.

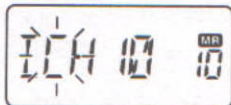

- Up to 6 characters can be programmed into a memory name.

⑤ Push [FUNC] + [◻M•N] to exit memory name writing mode.

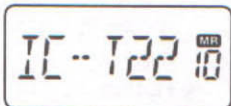

The following characters can be used in names:

- ➡ 0 to 9, A to Z (capitals only), (space, <, >, +, -, =, *, /, Δ, μ, and Σ.

/// **NOTE:** The programmed memory name is cleared when overwriting a memory channel.

■ DTMF memory operation

◇ Programming a DTMF code

The transceiver has 5 DTMF memory channels (D1 to D6) for storage of often-used DTMF codes of up to 30 digits.

- ① Push [FUNC] + [(H/L)DTMF] to enter DTMF memory mode.
- ② Rotate [DIAL] to select the desired channel.
- ③ Push [FUNC] + [@SET] to enter DTMF programming mode.
 - "_____" appears.
 - Programmed memories can be cleared in this way.
- ④ Push digit keys to enter the desired DTMF code.
 - A maximum of 30 digits can be input.
 - If a digit is mistakenly input, push [MR] then repeat from step ③.
- ⑤ Push [(H/L)DTMF] to input the digits.
- ⑥ Push [(VFO)CLR] to exit DTMF programming mode.

◇ Transmitting a DTMF code

- ① Select the DTMF channel to be transmitted:
 - Push [FUNC] + [(H/L)DTMF] to select DTMF memory mode.
 - Rotate [DIAL] to select the desired DTMF channel.
- ② Push [(VFO)CLR] to exit.
- ③ While pushing [PTT] push [(H/L)DTMF] to transmit the previously selected DTMF channel's contents.

✓ CONVENIENT

Monitoring a DTMF code: While in DTMF memory mode, push [(H/L)DTMF] to monitor the selected DTMF channel without transmitting it.

Confirming a DTMF code's contents: While in DTMF memory mode, push the [Δ]/[∇] keys to scroll the displayed digits 6 characters to the right or left, respectively.

◇ DTMF transmit speed

AT POWER ON

When slow DTMF transmission speeds are required (such as for some repeaters) the transceiver's rate of DTMF transmission can be adjusted.

- ① While pushing [@SET] push [POWER] for 0.5 sec. to enter initial set mode.
- ② Push [Δ] or [∇] until "DT" appears in the display.
- ③ Rotate [DIAL] to select the desired transmission speed.
 - 4 speeds are available: "100" being the fastest and "500" being the slowest.
- ④ Push [(VFO)CLR] to set the condition and exit initial set mode.



fastest



slowest

4 ADVANCED FUNCTIONS

■ Scan operation

◇ Scan types

FULL SCAN (p. 22)

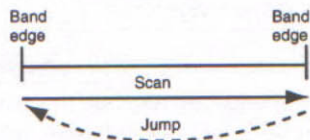

Repeatedly scans all frequencies over the entire band.

PROGRAMMED SCAN (p. 22)

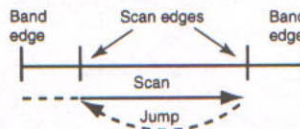

Repeatedly scans between two user-programmed frequencies. Used for checking for frequencies within a specified range such as repeater output frequencies, etc. 3 pairs of scan edges are available.

MEMORY SCAN (p. 22)

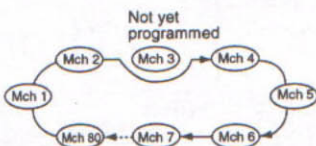

Repeatedly scans all memory channels in sequence.

MEMORY SKIP SCAN (p. 22)

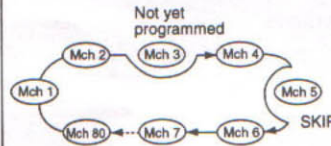

Repeatedly scans memory channels except skip channels. Used for checking often-called channels and bypassing usually busy channels such as repeater frequencies.

SCAN RESUME CONDITION (p. 23)

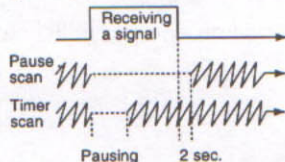

4 resume conditions are available: pause scan and 3 timer scans. When receiving a signal, pause scan pauses until the signal disappears; timer scans pause for 5, 10 or 15 sec.

FREQUENCY SKIP FUNCTION (p. 23)

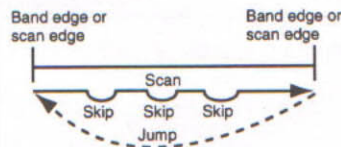

Skips unwanted frequencies that inconveniently stop scanning during full or programmed scan.

◇ Full/programmed scan

- ① Push [VFO] to select VFO mode.
- ② Set [SQL] to the point where noise is muted.
- ③ Start the desired scan.
 - ➔ For full scan: Push [Δ /SCAN] or [∇ /SCAN] for 1 sec.
 - ➔ For programmed scan: Push [FUNC] + [Δ /SCAN] or [∇ /SCAN] to start programmed scan.
 - "P1," "P2" or "P3" appears to indicate which pair of scan edges is being scanned.
- ④ Push [①], [②] or [③] to select the desired scan range or push [④] to select full scan.
- ⑤ To stop the scan, push [Δ /SCAN] or [∇ /SCAN].

NOTE: For programmed scan, scan edges must be programmed in advance. Program scan edges in the same manner as regular memory channels (p. 17)

If the same frequencies are programmed into a pair of scan edges, programmed scan edge appears, such as "P1," but programmed scan does not proceed.

✓ CONVENIENT:

The frequency skip function is utilised to skip undesired signals which pause a scan (p. 24).

◇ Memory (skip) scan

- ① Push [MR] to select memory mode.
- ② Set the [SQL] to the point where noise is muted.
- ③ Start the desired scan.
 - ➔ For memory scan: Push [Δ /SCAN] or [∇ /SCAN] for 1 sec.
 - ➔ For memory skip scan: Push [FUNC] + [Δ /SCAN] or [∇ /SCAN].
- ④ To stop the scan, push [Δ /SCAN] or [∇ /SCAN].

◇ Setting a skip channel

Memory channels can be set to be skipped for memory skip scan. This is useful to speedup the memory skip scan interval.

- ① Select the memory channel to be programmed as a skip channel:
 - ➔ Push [MR] to select memory mode.
 - ➔ Rotate [DIAL] (or use the keypad) to select a memory channel.
- ② Push [FUNC] + [③SKIP] to set the memory channel as a skip channel.
 - "SKIP" appears.
- ③ Repeat step ② to cancel a skip channel.
 - "SKIP" disappears.

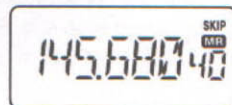

4 ADVANCED FUNCTIONS

◇ Frequency skip function

When you want to skip undesired signals that inconveniently pause full or programmed scan, the frequency skip function is available.

Push [FUNC] + [(MR)MW] while scan is paused on an undesired signal. The frequency is programmed into the highest non-programmed memory channel as a skip frequency. Skip frequencies are subsequently "skipped" during scanning.

NOTE: When the frequency skip function is turned OFF, pushing [FUNC] + [(MR)MW] while scan is paused on a signal overwrites the frequency as a regular memory channel.

◇ Frequency skip function ON/OFF USING SET MODE

- ① Push [FUNC] + [®SET] to enter set mode.
- ② Push [▽] or [Δ] one or more times until "PS" appears.
 - "SKIP" also appears.
- ③ Rotate [DIAL] to turn programmed skip scan ON or OFF.
 - When selecting "ON," programmed skip scan is activated for full or programmed scan and "SKIP" appears and flashes during scanning.
- ④ Push [(vFo)CLR] to set the condition and to exit set mode.



◇ Scan resume condition USING SET MODE

The resume condition can be selected as a pause or timer scan. The resume condition is used for scan and priority watch (p. 24).

- ① Push [FUNC] + [®SET] to enter set mode.
- ② Push [▽] or [Δ] one or more times until "SC" appears.
- ③ Rotate [DIAL] to select the desired scan resume condition.
 - "T-15": scan pauses for 15 sec. on a received signal.
 - "T-10": scan pauses for 10 sec. on a received signal.
 - "T-05": scan pauses for 5 sec. on a received signal.
 - "P-02": scan pauses on a received signal until it disappears.
- ④ Push [(vFo)CLR] to set the condition and to exit set mode.

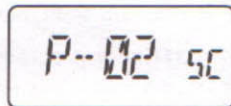
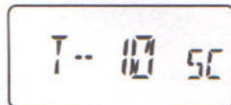

■ Priority watch

The priority watch checks for signals on a memory or call channel every 5 sec. while operating on a VFO frequency. The transceiver has 2 priority watch types to suit your needs. You can transmit on the VFO frequency while the priority watch operates.

When receiving a signal, priority watch pauses according to the set scan resume condition.

Memory channel watch

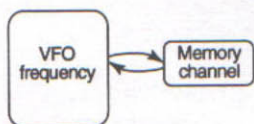

Call channel watch

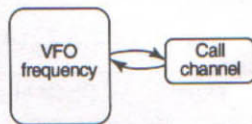

NOTE:

- Priority watch does not operate when the pager or code squelch function is activated (pgs. 27, 28).
- If the optional* pocket beep function is activated, the transceiver automatically selects the tone squelch function when priority watch starts.

◇ Operation

- ① Select VFO; then, set a frequency.
- ② Set the desired memory or call channel as the watching channel.
 - ➔ Push [MR] then rotate [DIAL] for a memory channel.
 - ➔ Push [CALL] for the call channel.
- ③ Push [FUNC] + [⊙PRIO] to start the watch.
 - The transceiver checks the memory or call channel frequency every 5 sec.
 - While the watch is pausing, pushing [(VFO)CLR] resumes the watch manually.
- ④ Push [(VFO)CLR] while the display shows the VFO frequency to stop the watch.



While pausing on a memory channel, "PRIO" flashes.

4 ADVANCED FUNCTIONS

■ Pager function

This function uses DTMF codes for paging and can be used as a "message pager" to inform you of a caller's identity even when you leave the transceiver temporarily unattended.

Personal calls and group calls are available with the pager function. Personal calls use the receiving member's ID code for calling. The receiving member's display shows your ID code and other members in the group know you called. You can also call all members in your group using the group call.

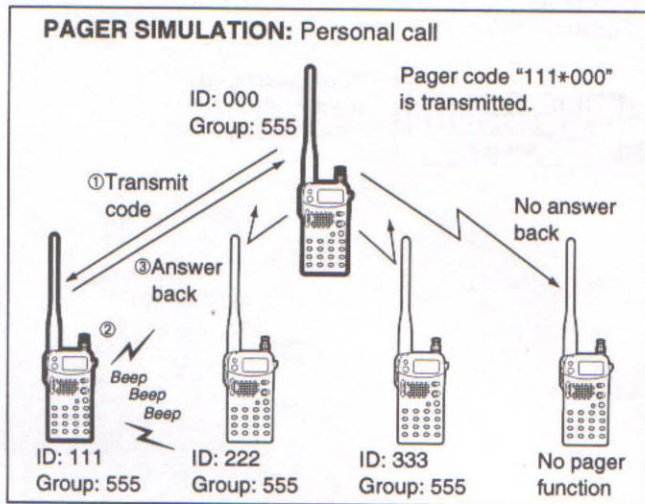

■ Code programming

◇ Before programming

The pager and code squelch functions require ID codes and a group code. These codes are 3-digit DTMF codes and must be written into the code channels before operation.

- ① Decide the ID code of each transceiver and a group code for your group.
- ② Decide whether you want to return to normal operation or code squelch operation after a connection is made.
- ③ Program the ID code, group code and transmit codes (other station's ID codes) as below.

◇ Code channel assignment

ID or group code	Code channel number	"Receive accept" or "Receive inhibit"
Your ID code	C0	"Receive accept" only.
Other members ID codes	C1-C5	"Receive inhibit" should be programmed in each channel.
Group code	One of C1-C5	"Receive accept" must be programmed.
Memory space*	CP	"Receive inhibit" only.

*Channel CP automatically memorises an ID code when receiving a pager call. The contents in channel CP cannot be changed manually.

◇ Programming

① Push [FUNC] + [⑤CODE] to select the code channel setting display.

② Rotate [DIAL] to select the desired code channel, C0–C5.

- Code channel C0 cannot be used for programming.

③ Push the numeral keys to input the desired 3-digit code.

- Digit keys are automatically stored once the 3rd digit has been entered.
- When a digit key is mistakenly input, push [(VFO)CLR] and enter the desired code from the beginning.

④ Push [FUNC] + [③SKIP] to set the channel for “receive inhibit” or “receive accept.”

- When “receive inhibit” is set, “SKIP” appears.
- Code channel C0 cannot be set as “receive inhibit.”
- See below for “receive accept” and “receive inhibit” details.

⑤ Push [(VFO)CLR] to exit the setting display.



even when the transceiver receives a code the same as that in the code channel. Transmit codes should therefore be programmed for “receive inhibit,” otherwise the transceiver will not reject unnecessary calls.

⚡ During code squelch operation, the power saver duty cycle becomes 1 : 1 if the power saver is activated.

• Receive accept/receive inhibit

- ➡ “Receive accept” (“SKIP” indicator does not appear) accepts pager calls when the transceiver receives a signal with a code the same as that in the code channel.
- ➡ “Receive inhibit” (“SKIP” indicator appears) rejects calls

■ Pager operation

◇ Calling a specific station

- ① Program the needed code channel in advance.
- ② Set the operating frequency.
- ③ Push [FUNC] + [2PGR/CSQL] once or twice to turn the pager function ON.
 - "P" appears in place of the 100 MHz digit.
 - An optional* tone squelch can be used in conjunction with the pager function.
- ④ Select the desired transmit code channel:
 - ➔ Push [FUNC] + [5CODE].
 - ➔ Rotate [DIAL] to select the channel.
- ⑤ Push [PTT] to transmit the pager code.
- ⑥ Wait for an answer back.
 - When the transceiver receives an answer back code, the function display shows the other members' ID or group code.
- ⑦ After confirming a connection push [(VFO)CLR] to display the operating frequency.
 - **DO NOT** push any digit keys while code channels C0 to C5 are displayed, or code channel contents are changed.
- ⑧ Push [FUNC] + [2PGR/CSQL] once to select the code squelch or twice to select the non-selective calling system.

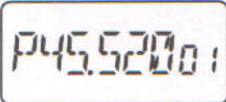

◇ Waiting for a call from a specific station

- ① Set the operating frequency.
- ② Push [FUNC] + [2PGR/CSQL] once or twice to turn the pager function ON.
 - "P" appears in place of the 100 MHz digit.
 - An optional* tone squelch can be used in conjunction with the pager function.
- ③ Wait for a call.
 - When receiving a call, the callers' ID or group code appears as shown at right.
 - **DO NOT** push any digit keys while code channels C0 to C5 are displayed, or code channel contents are changed.
- ④ Push [PTT] to send an answer back call and display the operating frequency.
- ⑤ Push [FUNC] + [2PGR/CSQL] once to select the code squelch or twice to select the non-selective calling system.

PERSONAL CALL

This display appears when you are called with your ID code and the calling station's ID code is 386.



"(••)" flashes

GROUP CALL

This display appears when you are called with the group code, 123, 123 has been programmed into code channel C5.



Code channel

ERROR INFORMATION

When the transceiver receives an incomplete signal, "E" appears.



"E" appears

Code squelch

Code squelch provides communications with quiet standby since you will only receive calls from stations which know your ID or group code. Each push of [PTT] sends a 3-digit code in order to open the receiving station's code squelch prior to voice transmission.

- ① Set the operating frequency.
- ② Push [FUNC] + [②PGR/CSQL] once or twice to turn the code squelch ON.
 - "C" appears in place of the 100 MHz digit.
 - An optional tone squelch can be used in conjunction with the code squelch (p. 30).
- ③ Select the desired transmit code channel:
 - ➔ Push [FUNC] + [⑤CODE].
 - ➔ Rotate [DIAL] to select the channel.
 - ➔ Push [PTT] to exit the setting display.
- ④ Operate the transceiver in the normal way (push [PTT] to transmit; release [PTT] to receive).
- ⑤ To cancel the code squelch, push [FUNC] + [②PGR/CSQL].
 - "C" disappears and the 100 MHz digit returns to the display.

4 ADVANCED FUNCTIONS

■ Message function

6-digit alphanumeric "messages" can be transmitted or received together with the pager or code squelch functions. The transceiver has 6 message memories each for receive and transmit, to memorise and send messages, respectively. There are 2 methods to transmit a message: manually, or automatically with preprogrammed transmit memories.

◇ Message standby (receive)

- ① Set the transceiver for pager or code squelch operation.
 - Remember that pager code programming, etc., for each transceiver in the group is necessary.
- ② Push [FUNC] + [MSG].
 - "MSG" appears.
- ③ When receiving a signal with a message, the message is programmed into receive message channel "r0" and indicated.
 - Previous messages are shifted to the next higher memory.
- ④ To confirm a previous message, rotate [DIAL] to select the appropriate receive message memory.
- ⑤ Push [(VFO)CLR] to return to frequency indication.

◇ Clearing received messages

- ① Push [MSG] to select a receive message memory.
- ② Push [FUNC] + [(VFO)M CLR].
 - All receive messages, "r0" to "r5," are cleared.

◇ Programming for transmit messages

- ① Push [MSG] 2 times to select a transmit message memory.
 - One of "T0" to "T5" appears.
- ② Rotate [DIAL] to select the desired memory.
- ③ Push [FUNC] + [SET] to enter message writing mode.
 - The first character of the message (or "-") flashes.
- ④ Rotate [DIAL] to select the desired first character.
 - See the table on p. 39 for available characters.
- ⑤ Push [Δ#] to select the next digit for input; then rotate [DIAL] to select a character.
 - [▽*] selects the previous digit.
- ⑥ Repeat step ⑤ until the desired message is input.
 - 6 characters is the maximum for a message.
- ⑦ Push [MSG] to complete the programming.
- ⑧ Push [(VFO)CLR] to exit the message memory.

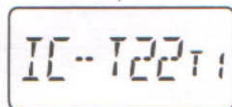
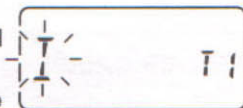
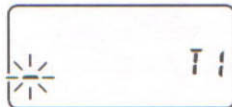
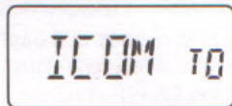

/// **NOTE:** Message memory channel "T0" is used for the opening message and "ICOM" is programmed as the default text. This can be changed in initial set mode, (p. 33).

◇ Transmitting a message

- ① Set the transceiver for pager or code squelch operation.
 - Remember that pager code programming, etc. for each transceiver in a group is necessary.

For memory transmission:

- ② Push [FUNC] + [MSG] to turn the message function ON.
 - "MSG" appears.
- ③ Push and hold [PTT].
 - The pager or code squelch code is transmitted.
- ④ While continuing to push [PTT], push the corresponding digit key for the transmit message memory.
 - "0" to "5" correspond to transmit message memories "T0" to "T5."

For manual transmission:

- ② Push [FUNC] + [MSG] to turn the message function OFF.
 - "MSG" disappears (when the message function is turned ON, memory contents are automatically transmitted).
- ③ Push and hold [PTT].
 - The pager or code squelch code is transmitted.
- ④ While continuing to push [PTT], push [Δ#], then push the corresponding digit keys for the desired message.
 - Refer to the table on page 39 for details.
- ⑤ When the desired message has been input, push [Δ#] to signal the end of the transmission.

[EXAMPLE]:

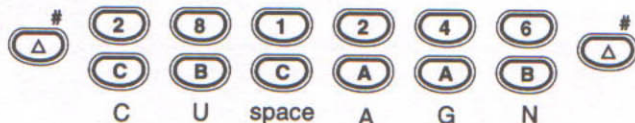

■ Subaudible tone operation

Some versions of this transceiver have a built-in subaudible tone encoder as standard. When an optional* UT-94 is installed, the tone decoder function becomes additionally available and allows you to operate the tone squelch, tone scan and pocket beep functions. Refer to p. 32 for unit installation.

◇ Tone squelch operation

The tone squelch opens only when receiving a signal containing a matching subaudible tone. You can silently wait for calls from group members using the same tone.

- ① Set the operating frequency.
- ② Set the desired subaudible tone in set mode.
 - See p. 39 for a list of tones available and p. 15 for programming.
- ③ Push [FUNC] + [①T/TSQL] until "TSQL" appears.
 - The code squelch can be used with the tone squelch (p. 28).
- ④ When the received signal includes a matching tone, squelch opens and the signal can be heard.
 - When the received signal's tone does not match, squelch does not open, however, the S-indicator shows signal strength.
 - To open the squelch manually, push and hold [MONI].
- ⑤ Operate the transceiver in the normal way.
- ⑥ To cancel the tone squelch, push [FUNC] + [①T/TSQL].

✓ CONVENIENT

Store subaudible tone frequencies and tone squelch ON/OFF settings in memories (call) for easy recall.

4 ADVANCED FUNCTIONS

◇ Tone scan

The transceiver can detect the subaudible tone frequency in a received signal. By monitoring a signal, such as that being transmitted on a repeater input frequency, you can determine the tone frequency required to access the repeater.

- ① Push [VFO] to select VFO mode.
 - Tone scan cannot be used in memory mode.
- ② Set the desired frequency to be checked for a tone frequency.
- ③ Push [FUNC] + [ⓁT/TSQL] until "TSQL" appears.
- ④ Push [FUNC] + [(LOG-M)T SCAN] to start the tone scan.
 - To change the scanning direction, rotate [DIAL].
 - Be sure the pager or code squelch is not activated in advance (pgs. 27, 28).
- ⑤ When the tone frequency is matched, the squelch opens and the tone frequency is programmed into the VFO.
- ⑥ Push [(VFO)CLR] to stop the scan.

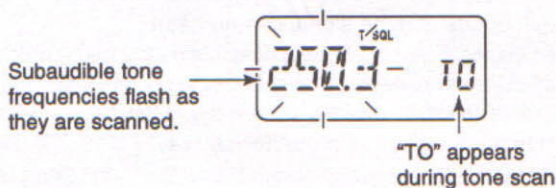

◇ Pocket beep operation

This function uses subaudible tones for calling and can be used as a "common pager" to inform you that someone has called while you were away from the transceiver.

- ① Set the operating frequency.
- ② Set the desired subaudible tone in set mode.
 - See p. 39 for a list of available tones and p. 15 for programming.
- ③ Push [FUNC] + [ⓁT/TSQL] until "TSQL (··)" appears.
 - The pocket beep function cannot be used in combination with the pager or code squelch (pg. 27, 28).
- ④ When a signal with a matched tone is received, the transceiver emits beep tones for 30 sec. and flashes "TSQL (··)".
- ⑤ Push [PTT] to answer or push [(VFO)CLR] to stop the beeps and flashing.
 - Tone squelch is automatically selected.

◇ Calling a waiting station using pocket beep

A subaudible tone matched with the station's tone frequency is necessary. Use the tone squelch on p. 30 or a subaudible tone encoder.

■ Installing the optional UT-94 TONE SQUELCH UNIT

An optional UT-94 TONE SQUELCH UNIT is available for this transceiver. The UT-94 provides tone scan, tone squelch and pocket beep functions.

- ① Turn power OFF, then remove the battery pack and/or DC power cable.
- ② Unscrew the 6 screws as shown below.

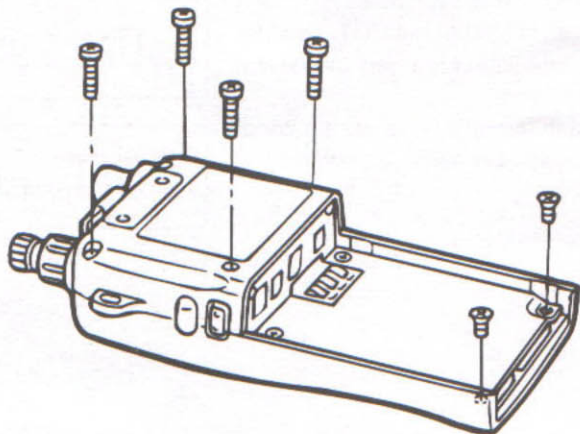

- ③ Carefully separate the front and rear panels as shown below.
- ④ Plug in the UT-94 as shown below.

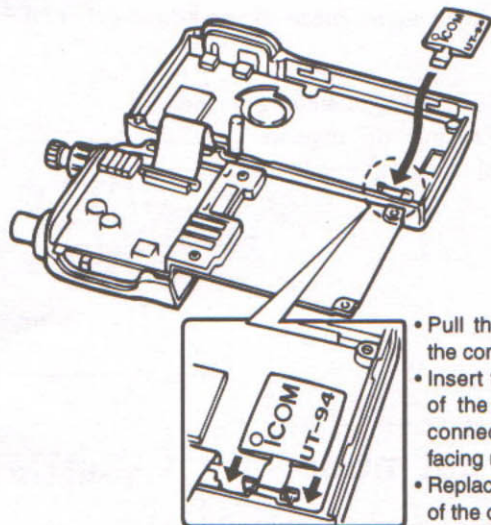

- Pull the brown part of the connector.
- Insert the ribbon cable of the UT-94 into the connector (silver end facing upwards).
- Replace the brown part of the connector.
- Gently tug on the UT-94 to confirm that it has been correctly installed.

- ⑤ Reassemble the front and rear panels; then, replace the 6 screws removed in step ②.

■ Beep tones ON/OFF

USING SET MODE

Beep tones sound when keys are pushed, when an operation is performed, such as programming a memory, etc., and to indicate invalid commands. These can be turned ON or OFF as you prefer.

- ① Push [FUNC] + [SET] to enter set mode.
- ② Push [▽] or [△] until "BE" appears.
- ③ Rotate [DIAL] to toggle beep tones ON or OFF.



■ Initial set mode

AT POWER ON

Initial set mode is accessed at power ON and allows you to set seldom-changed settings. In this way you can "customise" transceiver operation to suit your preferences and operating style.

◇ Entering initial set mode

While pushing [SET] push [POWER] to turn power ON.

- The transceiver enters initial set mode and the last-selected (or default) item is displayed.
- Push [(VFO)CLR] to exit initial set mode and select VFO operation.

◇ Opening text

This item turns the opening text ON or OFF. Opening text is the message that is displayed briefly when turning power ON. The opening text message is stored in transmit message memory T0 and can be changed if desired (p. 29). The default for the opening text is "ICOM."

- ① Select initial set mode.
- ② Push [▽] or [△] until "OT" appears.
- ③ Rotate [DIAL] to select the desired condition.
- ④ Push [(VFO)CLR] to set the condition and exit initial set mode.



◇ Microphone simple mode

This item turns the microphone simple mode ON or OFF. Microphone simple mode is used to change the function assignments for switches on the optional HM-75A REMOTE CONTROL MICROPHONE as follows:

Simple mode ON		Simple mode OFF	
Switch	Function	Switch	Function
[A]	Monitor ON/OFF	[A]	Monitor ON/OFF
[B]	Call	[B]	V/M
[▲]	Mch 1 (VOL-UP during monitor ON)	[▲]	UP (VOL-UP during monitor ON)
[▼]	Mch 2 (VOL-DOWN during monitor ON)	[▼]	DOWN (VOL-DOWN during monitor ON)

- ① Select initial set mode.
- ② Push [▼] or [▲] until "MS" appears.
- ③ Rotate [DIAL] to select the desired condition.
- ④ Push [(VFO)CLR] to set the condition and exit initial set mode.

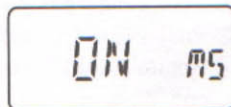
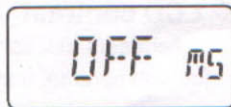

◇ Auto power OFF

This item allows you to set a time at which the transceiver will automatically turn OFF. The power OFF time can be set to 20, 40, 60 min. or turned OFF.

- ① Select initial set mode.
- ② Push [▼] or [▲] until "AO" appears.
- ③ Rotate [DIAL] to select the desired condition.
- ④ Push [(VFO)CLR] to set the condition and exit initial set mode.

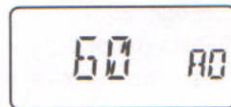

◇ Power saver duty cycle

This item sets the power saver duty cycle — the ratio of receive circuit ON to receive circuit OFF while standing by. The duty cycle can be set to 1:1, 1:12, 1:40 or OFF. Setting to 1:40 conserves the most battery power.

- ① Select initial set mode.
- ② Push [▼] or [▲] until "PD" appears.
- ③ Rotate [DIAL] to select the desired condition.
- ④ Push [(VFO)CLR] to set the condition and exit initial set mode.

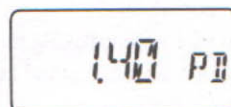

/// **NOTE:** When the duty cycle is set to 1:40, signals may be clipped a max. of up to 2 sec.

5 OTHER FUNCTIONS

◇ External power condition

When this item is set to "1" power saver duty cycle automatically turns OFF when connecting external power; when set to "2": same as "1" and in addition, display backlighting is turned ON continuously.

- ① Select initial set mode.
- ② Push [▽] or [Δ] until "EP" appears.
- ③ Rotate [DIAL] to select the desired condition.
- ④ Push [(VFO)CLR] to set the condition and exit initial set mode.

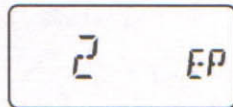

◇ Busy LED ON/OFF

This item sets the busy LED ON or OFF. When set to ON the RX indicator lights green when receiving signals (or when the squelch is open); when set to OFF the RX indicator does not light even when receiving signals.

- ① Select initial set mode.
- ② Push [▽] or [Δ] until "BL" appears.
- ③ Rotate [DIAL] to select the desired condition.
- ④ Push [(VFO)CLR] to set the condition and exit initial set mode.

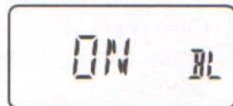

◇ Function display backlighting ON/OFF

When set to AUTO, display backlighting automatically turns on when a key is pushed; when set to OFF display backlighting cannot be turned ON.

- ① Select initial set mode.
- ② Push [▽] or [Δ] until "LI" appears.
- ③ Rotate [DIAL] to select the desired condition.
- ④ Push [(VFO)CLR] to set the condition and exit initial set mode.



◇ LCD contrast

This item sets function display contrast to one of 2 levels. "1" is for high contrast and "2" is for low contrast.

- ① Select initial set mode.
- ② Push [▽] or [Δ] until "LC" appears.
- ③ Rotate [DIAL] to select the desired condition.
- ④ Push [(VFO)CLR] to set the condition and exit initial set mode.

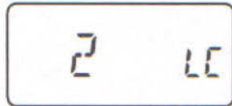
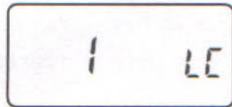

■ CPU resetting

at POWER ON

◇ Partial reset

If you want to initialise the operating conditions (VFO frequency, VFO settings, set mode contents) without clearing the memory contents, message memories, etc., a partial resetting function is available for the transceiver.

- While pushing [(VFO)CLR] turn power ON to partially reset the transceiver.

◇ Full reset

Reset the the CPU before operating the transceiver for the first time, or when the internal CPU malfunctions.

- While pushing [FUNC] + [▽] + [VFO] turn power ON to reset the transceiver.
 - Then number of memory channels is set to 40.

/// **CAUTION:** Resetting the CPU returns all programmed contents to their default settings.

■ Optional HM-75A functions

When using an optional HM-75A with the transceiver, the switches on the HM-75A function as follows:

① A SWITCH

Toggles the monitor function ON and OFF.

② B SWITCH

Change mode between VFO and memory.

③ Δ/▽ SWITCHES

- Change the frequency in the selected tuning steps in VFO mode.
- Change memory channel in memory mode.
- Start programmed scan or memory skip scan when pushed for 0.5 sec
- Adjust the audio level when the monitor function is ON.

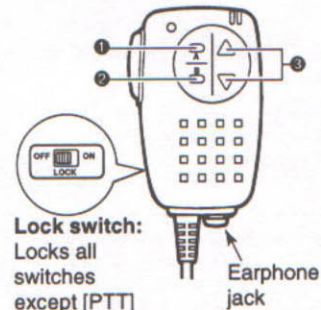

/// **NOTE:** Switches can be assigned different functions by using microphone simple mode (p. 34).

/// **CAUTION:** When connecting the HM-75A to the transceiver, make sure that power to the transceiver is turned OFF, otherwise the CPU may malfunction.

6

TROUBLESHOOTING

If your transceiver seems to be malfunctioning, please check the following points before sending it to a service center.

PROBLEM	POSSIBLE CAUSE	SOLUTION	REF.
<ul style="list-style-type: none"> No power comes on. 	<ul style="list-style-type: none"> The battery is exhausted. (A slight current flows in the circuits even when the power is OFF). Poor plug connection to the external DC power cable. 	<ul style="list-style-type: none"> Charge the battery pack or place new dry cell batteries in the battery case. (Remove the battery pack if you will not be using the transceiver for a long time.) Check the connector or remove and replace the cable. 	<p>pgs. 8, 9</p> <p>—</p>
<ul style="list-style-type: none"> No sound comes from the speaker. 	<ul style="list-style-type: none"> [SQL] is turned too far clockwise. Pager or code squelch is activated. 	<ul style="list-style-type: none"> Rotate [SQL] counterclockwise. Push [FUNC] + [PGR/CSQL] once or twice to turn the function OFF. 	<p>p. 14</p> <p>pgs. 27, 28</p>
<ul style="list-style-type: none"> Transmitting is impossible. 	<ul style="list-style-type: none"> The battery is exhausted. PTT lock function is activated. 	<ul style="list-style-type: none"> Charge the battery pack or place new dry cells in the battery case. Turn the function OFF. 	<p>pgs. 8, 9</p> <p>p. 13</p>
<ul style="list-style-type: none"> Frequency cannot be set. 	<ul style="list-style-type: none"> Memory mode, call channel or repeater memory is selected. The lock function is activated. 	<ul style="list-style-type: none"> Push [VFO] to select VFO mode. Push [FUNC] + [(CALL)LOCK] to deactivate the lock function. 	<p>p. 11</p> <p>p. 13</p>
<ul style="list-style-type: none"> Cannot receive "messages". 	<ul style="list-style-type: none"> Pager or code squelch is not activated and/or the message function is not activated. 	<ul style="list-style-type: none"> Activate pager or code squelch with [FUNC] + [PGR/CS] in advance. 	<p>pgs. 27, 28</p>
<ul style="list-style-type: none"> Scan cannot be activated. 	<ul style="list-style-type: none"> The squelch is open. 	<ul style="list-style-type: none"> Rotate [SQL] clockwise until noise disappears. 	<p>p. 14</p>
<ul style="list-style-type: none"> Receive indicator does not light even when receiving a signal. 	<ul style="list-style-type: none"> "Busy LED" is set to OFF in initial set mode. 	<ul style="list-style-type: none"> Set the "busy LED" to ON in initial set mode. 	<p>p. 35</p>
<ul style="list-style-type: none"> Display backlight does not turn OFF. 	<ul style="list-style-type: none"> External power condition is set to "2" and external DC power is connected. 	<ul style="list-style-type: none"> Set the external power condition to "1" or "OFF." 	<p>p. 35</p>

◇ Battery packs

BATTERY PACK	HEIGHT (mm/in)	VOLTAGE	CAPACITY	OUTPUT POWER	CARRYING CASE
BP-170	63.5/2.5	Battery case for R6(AA) x 4 alkaline cells		1.5 (1.5) W	LC-125
BP-171	63.5/2.5	4.8 V	700 mAh	1.5 (1.3) W	LC-125
BP-172	63.5/2.5	4.8 V	950 mAh	1.5 (1.3) W	LC-125
BP-173	75.5/3.0	9.6 V	650 mAh	5 (5) W	LC-126
BP-180	75.5/3.0	7.2 V	600 mAh	3.5 (3.5) W	LC-126

In the output power column, bracketed values refer to the IC-T42A/E.

◇ Chargers and cables

BC-110A/D, BC-74E WALL CHARGERS

Regularly charge battery packs attached to the transceiver.

BC-119 DESKTOP CHARGER + AD-56 BATTERY PACK ADAPTER

Rapidly charge battery packs in 1 to 1.5 hrs. depending on the battery pack. An AC adapter is packed with the BC-119. The AD-56 must be used with the BC-119 for charging the battery pack. The CP-17L or OPC-515L can be used instead of the supplied AC adapter.

CP-12L CIGARETTE LIGHTER CABLE WITH NOISE FILTER

For operation and charging via a 12 V cigarette lighter socket.

OPC-254L DC POWER CABLE

For operation and charging via an external power supply.

◇ Speaker-microphones

HM-46



HM-54



HM-75A



HS-85 HEADSET



- PTT switch
- VOX
- One-touch PTT for hands-free operation

◇ Others

MB-30 MOUNTING BRACKET

When using the bracket hanger

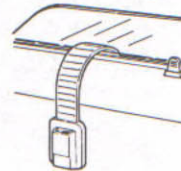

When using no bracket hanger

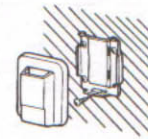

SP-13 EARPHONE

Provides clear receive audio in noisy environments.

UT-94 TONE SQUELCH UNIT

Provides a "personalised" tone squelch system, and calling system for pocket beep operation, with other stations. A tone scan is also available to decode subaudible tone frequencies.

◇ External connection

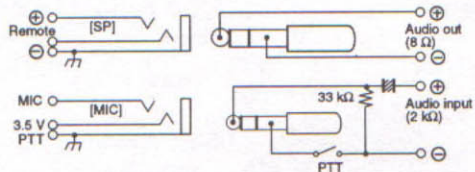

The above connection does not apply when a condenser microphone is connected.

◇ Operating period

BATTERY PACK	OUTPUT VOLTAGE	BATTERY CAPACITY	OUTPUT POWER & OPERATING PERIOD (approx.)	
			IC-T22A/E	IC-T42A/E
BP-171	4.8 V	700 mAh	1.5 W (6 h)	1.3 W (4.5 h)
BP-172	4.8 V	950 mAh	1.5 W (8 h)	1.3 W (6.2 h)
BP-173	9.6 V	650 mAh	5 W (3.3 h)	5 W (2.8 h)
BP-180	7.2 V	600 mAh	3.5 W (4 h)	3.5 W (3.5 h)

Condition: Tx (high) : Rx : Standby (power saved) = 1 : 1 : 8 (min.)

Downloaded by
RadioAmateur.EU

◇ Subaudible tone frequency list

(Unit: Hz)

67.0	79.7	94.8	110.9	131.8	156.7	171.3	186.2	203.5	229.1
69.3	82.5	97.4	114.8	136.5	159.8	173.8	189.9	206.5	233.6
71.9	85.4	100.0	118.8	141.3	162.2	177.3	192.8	210.7	241.8
74.4	88.5	103.5	123.0	146.2	165.5	179.9	196.6	218.1	250.3
77.0	91.5	107.2	127.3	151.4	167.9	183.5	199.5	225.7	254.1

◇ Message characters

0 : [0]	A : [2]+[8]	K : [5]+[9]	U : [8]+[9]	+ : [0]+[C]
1 : [1]	B : [2]+[9]	L : [5]+[C]	V : [8]+[C]	- : [1]+[0]
2 : [2]	C : [2]+[C]	M : [6]+[8]	W : [9]+[8]	= : [2]+[0]
3 : [3]	D : [3]+[8]	N : [6]+[9]	X : [9]+[9]	* : [3]+[0]
4 : [4]	E : [3]+[9]	O : [6]+[C]	Y : [9]+[C]	/ : [4]+[0]
5 : [5]	F : [3]+[C]	P : [7]+[8]	Z : [1]+[9]	Δ : [5]+[0]
6 : [6]	G : [4]+[8]	Q : [1]+[8]	(space)	μ : [6]+[0]
7 : [7]	H : [4]+[9]	R : [7]+[9]	: [1]+[C]	Σ : [7]+[0]
8 : [8]	I : [4]+[C]	S : [7]+[C]	< : [0]+[8]	:: [8]+[0]
9 : [9]	J : [5]+[8]	T : [8]+[8]	> : [0]+[9]	

		IC-T22A/E	IC-T42A/E
Frequency coverage (MHz)	U.S.A.	Tx: 144–148 Rx: 136–174* ¹	Tx: 440–450 Rx: 400–470* ²
	Europe	144–146	430–440
	Asia	Tx: 144–148 Rx: 140–150* ¹	430–440
	Italy	Tx: 144–148 Rx: 136–174* ¹	Tx: 430–440 Rx: 400–470* ³
	Guaranteed range: * ¹ 144–148 * ² 440–450 * ³ 430–440		
Mode		FM (F3E)	
Frequency stability (0°C to +50°C; +32°F to +122°F)		± 10 ppm	± 5 ppm
Tuning steps		5, 10, 12.5, 15, 20, 25, 30 or 50 kHz	
Antenna impedance		50 Ω (unbalanced)	
Usable battery pack/case		See options on page 38.	
External DC power		4.5 to 16 V DC (negative ground)	
Current drain (at 13.5 V, typical)	Tx	High	1.4 A
		Low	500 mA
	Rx	Rated audio	150 mA
		Power saved	15 mA (average)
Usable temperature range		–10°C to +60°C (+14°F to +140°F)	
Dimensions (with BP-171) (projections not included)		57(W) x 110(H) x 27(D) mm; 2¼(W) x 4⅝(H) x 1⅛(D) in	
Weight (with BP-171 and antenna)		310 g; 10.9 oz	300 g; 10.6 oz

		IC-T22A/E	IC-T42A/E
TRANSMITTER	Output power* (at 13.5 V)	5 W, 0.5 W (selectable)	
	Modulation system	Variable reactance frequency modulation	
	Max. freq. deviation*	±5.0 kHz	
	Microphone impedance	2 kΩ	
RECEIVER	Receive system	Double conversion superheterodyne	
	Intermediate frequencies	1st	30.85 MHz
		2nd	450 kHz
	Sensitivity* (12 SINAD)	Less than 0.16 μV (typical)	
	Squelch sensitivity	Less than 0.16 μV (at threshold)	
	Selectivity	More than 15 kHz/–6 dB Less than 30 kHz/–60 dB	
	Spurious and image rejection ratio*	More than 60 dB	More than 50 dB
		(More than 45 dB at ½ IF)	
	Audio output power* (at 13.5 V)	More than 200 mW (at 10% distortion with an 8 Ω load)	
Audio output impedance	8 Ω		

*Specifications guaranteed at a transceiver temperature of +25°C (+77°F).

All stated specifications are subject to change without notice or obligation.

10 MODE ARRANGEMENT

NOTE: Displays for set and initial set modes show the default settings — rotate [DIAL] to change the condition.

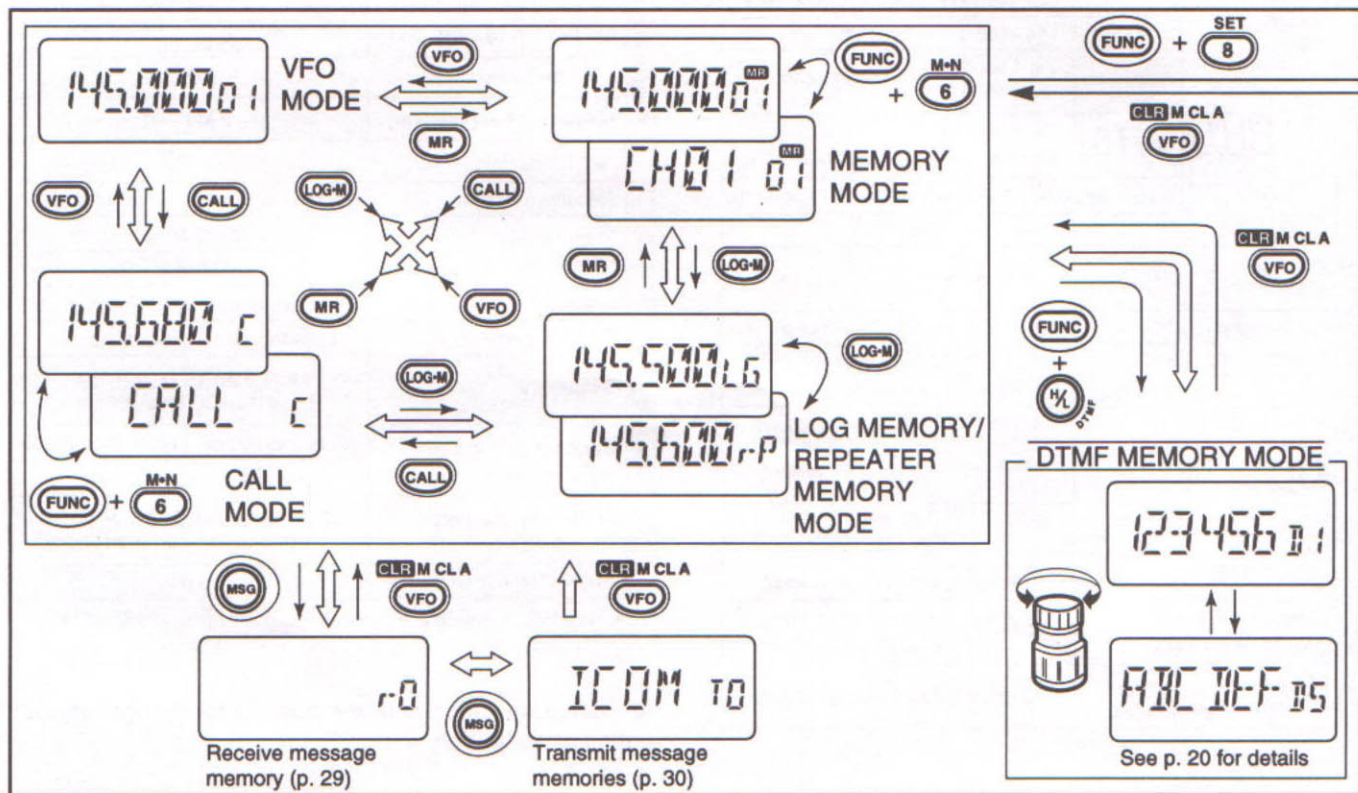

SET MODE

<p>▽SCAN * →</p> <p>Subaudible tones* (p. 15)</p> <p>005 TO</p> <p>△SCAN # →</p> <p>*Cannot select when set mode is selected from memory mode.</p>	<p>Scan resume condition (p. 23)</p> <p>T- 07 SC</p>	<p>Programmed skip scan (p. 23)</p> <p>ON PS^{SKIP}</p>	<p>Auto repeater (p. 16)</p> <p>OFF Ar</p>
	<p>Offset frequency* (p. 16)</p> <p>06000w</p> <p>(Default differs for IC-T42A/E)</p>	<p>PTT lock (p. 13)</p> <p>OFF PT</p>	<p>Beep tones (p. 33)</p> <p>ON BE</p>

INITIAL SET MODE

TO EXIT ← CLR M CLA VFO

POWER + SET 8 AT POWER ON

<p>▽SCAN * →</p> <p>Opening text (p. 33)</p> <p>ON OT</p> <p>△SCAN # →</p>	<p>DTMF speed (p. 20)</p> <p>100 DT</p>	<p>LCD contrast (p. 35)</p> <p>1 LC</p>	<p>LCD backlight (p. 35)</p> <p>AUT LI</p>	<p>Busy LED (p. 35)</p> <p>ON BL</p>
	<p>MIC simple mode (p. 34)</p> <p>OFF MS</p>	<p>Auto power OFF (p. 34)</p> <p>OFF AO</p>	<p>Power saver duty (p. 34)</p> <p>112 PD</p>	<p>External power (p. 35)</p> <p>1 EP</p>

Count on us!

A-5349KA-1EX-②
Printed in Japan
© 1998 Icom Inc.

**Downloaded by
RadioAmateur.EU**

Icom Inc.
6-9-16 Kamihigashi, Hirano-ku, Osaka 547-0002 Japan