

ICOM

INSTRUCTION MANUAL

DUAL BAND FM TRANSCEIVER

IC-W21AT IC-W21ET

This device complies with Part 15 of the FCC Rules. Operation is subject to the following two conditions: (1) This device may not cause harmful interference, and (2) this device must accept any interference received, including interference that may cause undesired operation.

Icom Inc.

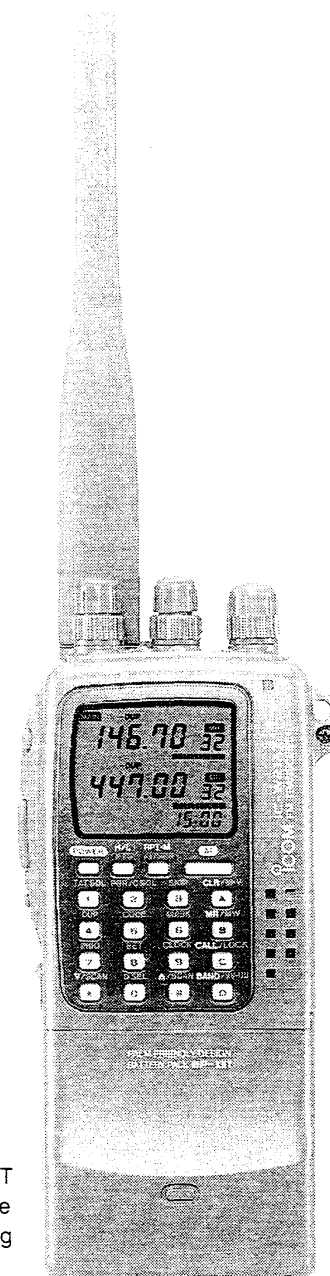

The photo shows IC-W21AT with optional BP-131. The battery pack differs according to versions.

IMPORTANT

READ ALL INSTRUCTIONS carefully and completely before using the transceiver.

SAVE THIS INSTRUCTION MANUAL — This instruction manual contains important safety and operating instructions for the IC-W21AT and IC-W21ET.

EXPLICIT DEFINITIONS

CAUTION: Equipment damage may occur.

NOTE: If disregarded, inconvenience only. No risk of personal injury, fire or electric shock.

WHEN FIRST APPLYING POWER

◆ Battery pack charging

- ① Attach the battery pack to the transceiver.
- ② Connect the wall charger to the [DC12.5V] jack to charge the battery pack.

• Charging period of the BP-157 and BP-131 is approx. 15 hrs.

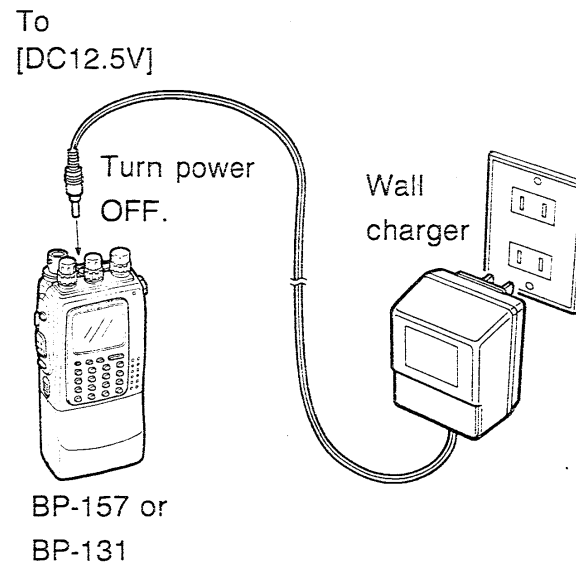

◆ Installing batteries into the battery case

Install six dry cell batteries as shown in the figures below.

• Pay attention to the polarities.

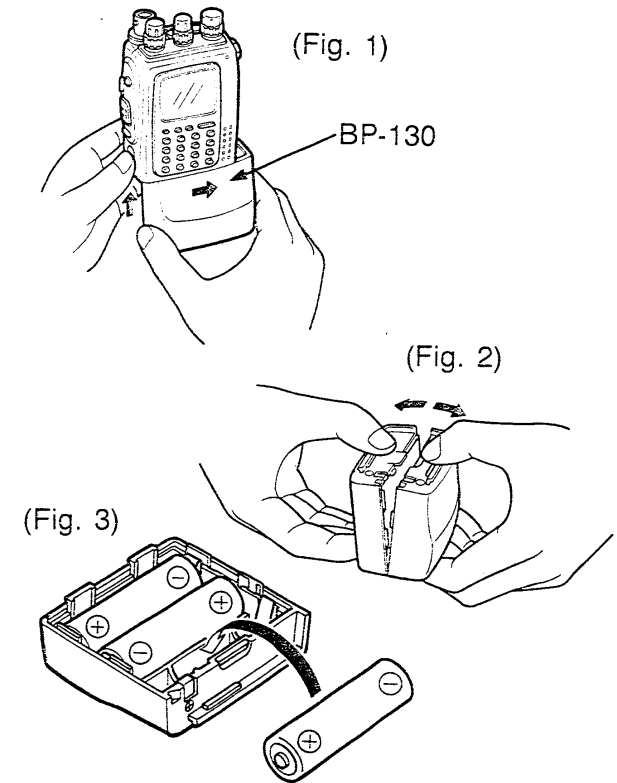

◆ Power ON

Push and hold [POWER] for 1 sec. to turn power ON.

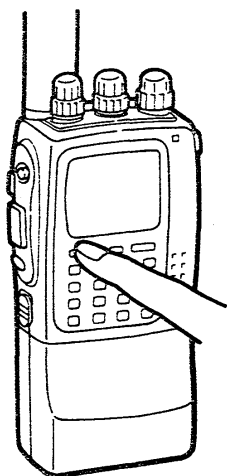

Push and hold [POWER] for 1 sec. again to turn power OFF.

The power key may not function when the transceiver has not been operated for 2 months or more as the internal memory backup battery (rechargeable) may have become empty. In this case, activate the CPU as described in the box at right.

• Activating the CPU

(when the power does not come on)

While pushing the [F] key, attach the charged battery pack. Then, turn power ON.

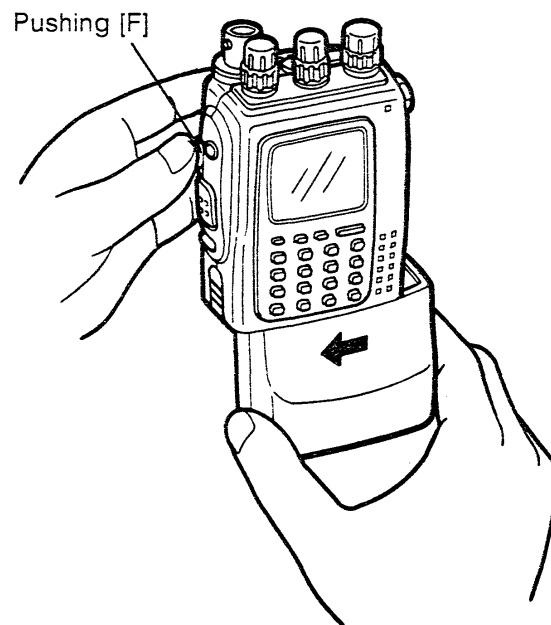

◆ Resetting the transceiver

Reset the transceiver before operating for the first time, or when the internal CPU malfunctions.

- ① Turn power OFF.
- ② While pushing [F], [▲ CLR] and [✳ ▽], push and hold [POWER] for 1 sec. to reset the CPU.

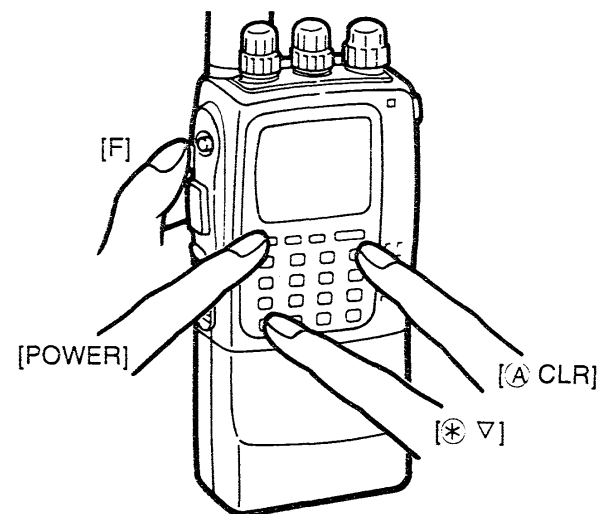

Partial resetting is alternatively available. See p. 48. for details.

CAUTIONS

NEVER connect the transceiver to an AC outlet or to a power source of more than 16 V DC.

NEVER connect the transceiver to a power source using reverse polarity. This connection will ruin the transceiver.

NEVER allow children to touch the transceiver.

AVOID using or placing the transceiver in direct sunlight or in areas with temperatures below -10°C ($+14^{\circ}\text{F}$) or above $+60^{\circ}\text{C}$ ($+140^{\circ}\text{F}$).

BE CAREFUL! When transmitting for a long time with high output power, the rear panel may become hot.

The use of non-Icom battery packs/chargers may impair transceiver performance and invalidate the warranty.

Even when the transceiver power is OFF, a slight current still flows in the circuits. Remove the battery pack or case from the transceiver when not using the transceiver for a long time. Otherwise, the battery pack or installed dry cell batteries in the battery case will become exhausted.

UNPACKING

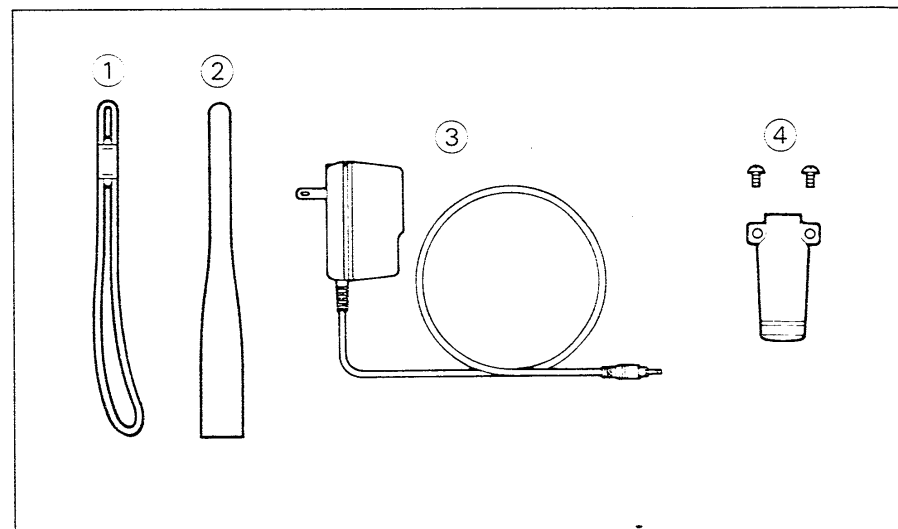

| Accessories included with the transceiver: | Qty. |
|---|-------|
| ① Handstrap | 1 |
| ② Antenna (FA-B270A) | 1 |
| ③ Wall charger* | 1 |
| ④ Belt clip and screws | 1 set |
| Battery pack (BP-157) or battery case (BP-130) (attached with the transceiver) | 1 |

*Not included with versions which include a battery case.

TABLE OF CONTENTS

| | | | | | |
|---------------------------------------|---------|--|---------|-----------------------------------|---------|
| IMPORTANT | i | Repeater memory | 19 | 14 CLOCK AND TIMERS | 35 - 38 |
| EXPLICIT DEFINITIONS | i | Auto repeater power control | 19 | Clock operation | 35 |
| WHEN FIRST APPLYING POWER | i - ii | 7 MEMORY OPERATION | 20 - 22 | Timer mode | 36 |
| CAUTIONS | iii | General description | 20 | Auto power-off | 36 |
| UNPACKING | iii | Memory channel selection | 20 | Power-on timer | 37 |
| TABLE OF CONTENTS | iv | Programming a memory channel | 21 | Power-off timer | 38 |
| 1 PANEL DESCRIPTION | 1 - 6 | Transferring memory contents | 22 | 15 PAGER AND CODE SQUELCH | 39 - 43 |
| Front and side panels | 1 | Masking a memory | 22 | Pager function | 39 |
| Top panel | 2 | 8 CALL CHANNEL OPERATION | 23 | Code channel | 40 |
| Keyboard | 3 | Calling up a call channel | 23 | Code programming | 41 |
| Function display | 5 | Transferring call channel contents | 23 | Pager operation | 41 |
| 2 BATTERY PACK CHARGING | 7 - 8 | Programming a call channel | 23 | Code squelch operation | 43 |
| Battery pack charging | 7 | 9 SCAN OPERATION | 24 - 29 | 16 POCKET BEEP AND | |
| Charging precautions | 7 | Scan types | 24 | TONE SQUELCH | 44 - 45 |
| About the battery pack | 7 | Full scan | 25 | Optional UT-63 installation | 44 |
| Charging connection | 8 | Programmed scan | 25 | Pocket beep operation | 45 |
| 3 ACCESSORY ATTACHMENT | 9 | Programming scan edges | 26 | Tone squelch operation | 45 |
| 4 SETTING A FREQUENCY | 10 - 13 | Frequency skip function | 27 | 17 OTHER FUNCTIONS | 46 - 48 |
| Main band | 10 | Memory scan | 28 | Power saver | 46 |
| VFO and memory modes | 10 | Memory skip scan | 28 | Battery voltage indication | 46 |
| Setting via the keyboard | 11 | Skip channel setting | 29 | PTT lock function | 47 |
| Lock function | 11 | Scan resume condition | 29 | Beep tone on/off | 47 |
| Presetting for the tuning dial | 12 | 10 PRIORITY WATCH | 30 | Receive indicator on/off | 47 |
| Setting via Δ/∇ key | 13 | Priority watch types | 30 | LCD contrast | 47 |
| Using the tuning dial | 13 | Priority watch operation | 30 | External speaker selection | 48 |
| LCD lighting | 13 | 11 DTMF MEMORY | 31 | Partial resetting | 48 |
| 5 BASIC OPERATION | 14 - 16 | Programming a DTMF code | 31 | Optional HM-75 functions | 48 |
| Receiving | 14 | Transmitting a DTMF code | 31 | 18 MODE ARRANGEMENT CHART | 49 - 50 |
| U by U and V by V functions | 15 | 12 OPTIONAL WHISPER FUNCTION | 32 | 19 TROUBLESHOOTING | 51 |
| Transmitting | 15 | General operation | 32 | 20 SPECIFICATIONS | 52 |
| 6 REPEATER OPERATION | 17 - 19 | Time-out timer setting | 32 | 21 OPTIONS | 53 - 54 |
| Operation | 17 | 13 AI FUNCTION | 33 - 34 | | |
| Tone information | 17 | What does AI in the transceiver do? | 33 | | |
| Subaudible tone | 18 | Learning function | 34 | | |
| Offset frequency | 18 | Learning function on/off | 34 | | |
| | | Manual assignment | 34 | | |

■ Front and side panels

MONITOR SWITCH [MONI] (p. 14)
Manually opens the main band's squelch and monitors the transmit frequency.

FUNCTION SWITCH [F] (pgs. 3, 4)
While pushing this switch, other switches and the tuning dial perform secondary functions.
• "Push [F] + a switch" means "while pushing the [F] switch, push the switch."

PTT SWITCH [PTT] (p. 15)
Push and hold to transmit; release to receive.

LIGHT SWITCH [LIGHT] (p. 13)
• Lights the display and keyboard back-lighting for 5 sec.
• [F] + [LIGHT] manually turns the back-lighting ON and OFF.

BATTERY PACK RELEASE BUTTON
Opens the latch for battery pack removal when pushed upwards.

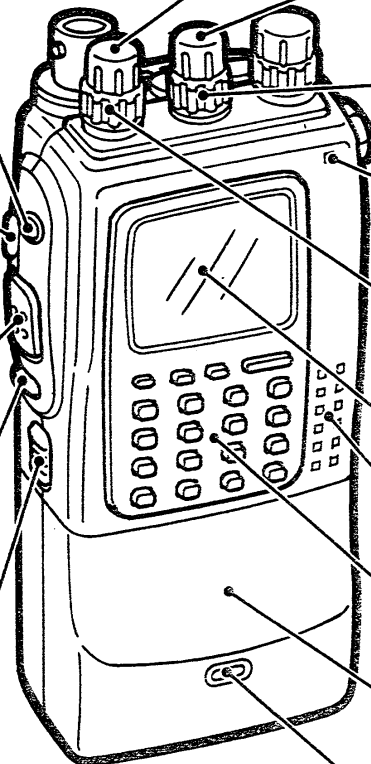

VHF VOLUME CONTROL [VOL] (p. 14)
Adjusts the VHF audio level.

UHF VOLUME CONTROL [VOL] (p. 14)
Adjusts the UHF audio level.

UHF SQUELCH CONTROL [SQL] (p. 14)
Varies the UHF squelch threshold point for noise mute.

TX/RX INDICATOR (pgs. 14, 15)

VHF SQUELCH CONTROL [SQL] (p. 14)
Varies the VHF squelch threshold point for noise mute.

FUNCTION DISPLAY (pgs. 5, 6)

SPEAKER/MICROPHONE

KEYBOARD (pgs. 3, 4)

BATTERY PACK/CASE (pgs. i, 7, 8)

OPTIONAL SUB MICROPHONE (p. 32)
Used for the optional whisper function.
(The BP-131 or BP-132 is required.)

■ Top panel

ANTENNA CONNECTOR (p. 9)
Connects the supplied antenna.

EXTERNAL DC POWER JACK [DC12.5V] (p. 53)
Allows operation with a 12.5 V DC power source using the optional cables, CP-13 or OPC-288.

CAUTION: Operation with an external DC power source simultaneously charges batteries inside the battery case or the battery pack. This may cause battery leakage and damage the transceiver or cause battery overcharging and shorten the life of the battery pack, respectively.

TUNING DIAL
Sets operating frequency, memory channel and set mode contents.

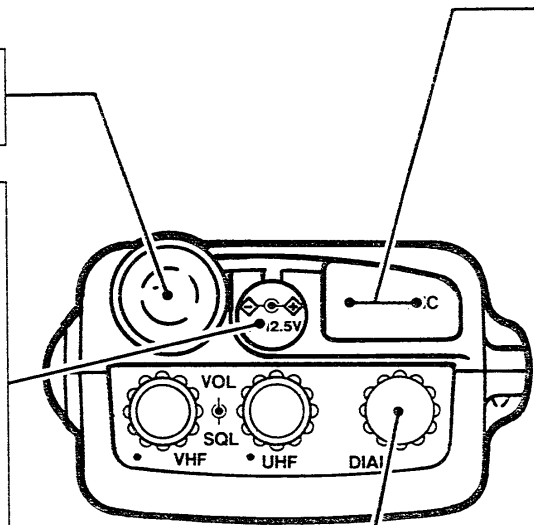

EXTERNAL SPEAKER AND MICROPHONE JACKS. [SP]/[MIC]
Connect an optional speaker-microphone or headset, if desired. The internal microphone will not function when either is connected. (See pgs. 53, 54 for options.)

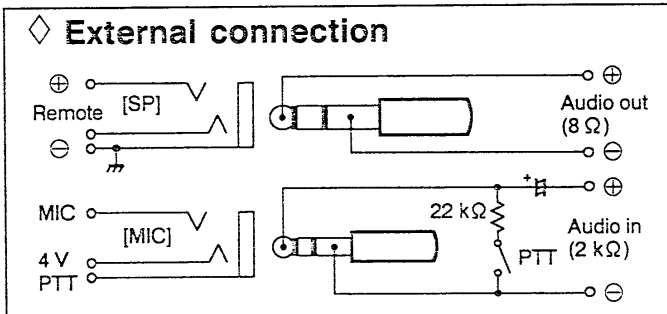

The above diagram does not apply when a condenser microphone is connected.

◇ **External audio output**
Audio output from the [SP] jack can be selected for VHF and/or UHF using set mode. When connecting a TNC, etc., set the undesired band audio to the internal speaker. (p. 48)





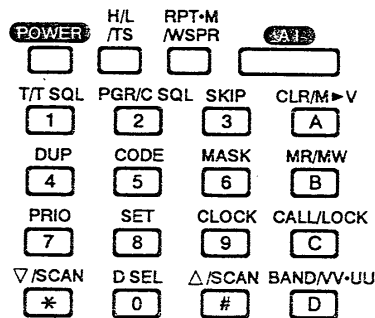





1 PANEL DESCRIPTION

Keyboard



| KEY | FUNCTION | SECONDARY FUNCTION (+ [F]) |
|----------------|--|--|
| T/T SQL 1 | | Activates the following optional* functions in this sequence: subaudible tone encoder → pocket beep → tone squelch → non-tone operation. (pgs. 17, 45) |
| PGR/C SQL 2 | | Activates the following functions in this sequence: pager → code squelch → non-selective calling. (pgs. 41 - 43) |
| SKIP 3 | • Input the appropriate digit while in VFO mode. (p. 11) | Sets the selected memory channel as a skip memory channel in memory mode. (p. 29) |
| DUP 4 | | Selects the duplex direction in this sequence: – duplex → + duplex → simplex. (p. 17) |
| CODE 5 | • Input the first digit while in memory mode. (p. 20) | Programs the code channel for pager and code squelch operation. (p. 41) |
| MASK 6 | • Transmit the appropriate DTMF code while transmitting. | Hides and displays the selected memory channel in memory mode. Memory channel 1 cannot be hidden. (p. 22) |
| PRIO 7 | | Starts the priority watch. (p. 30) |
| SET 8 | | Enters set mode. (Various pages) |
| CLOCK 9 | | • Indicates the clock display. (p. 35) • Sets clock time when pushed 2 times. (p. 35) |
| D SEL 0 | | Selects the dial select step. (p. 12) |

*Built-in to the U.S.A. version.

| KEY | FUNCTION | SECONDARY FUNCTION (+[F]) |
|--|---|---|
|  | Turns power ON and OFF when pushed for 1 sec. (p. ii) | The same as the primary function at left. (p. ii) |
|  | <ul style="list-style-type: none"> • Selects high or low output power. (p. 16) • The tuning dial selects a low output power level while pushing this switch. (p. 16) | The tuning dial selects the tuning step increments in VFO mode. (p. 12) |
|  | <ul style="list-style-type: none"> • Calls up the repeater memory. (p. 19) • Generates a 1750 Hz tone while transmitting. (IC-W21ET only) (p. 17) | Turns the optional whisper function ON and OFF. (p. 32) |
|  | <ul style="list-style-type: none"> • Activates the function indicated in the AI function indicator. (p. 34) • The tuning dial selects the AI functions while pushing this switch. (p. 34) | When the AI function indicator shows battery voltage: reset the reference voltage. (p. 46) |
|  | <ul style="list-style-type: none"> • Clears frequency input before entry. (p. 11) • Selects VFO mode. (p. 10) | When selecting memory mode or a call channel: transfers the contents into the VFO when pushed and held. (pgs. 22, 23) |
|  | <ul style="list-style-type: none"> • Selects memory mode from VFO mode. (p. 20) • Increments the memory channel number in units of 10 when memory mode has been selected. (p. 20) | Writes the VFO contents into the memory channel or call channel when pushed and held. (pgs. 21, 23) |
|  | Calls up a call channel. (p. 23) | Turns the lock function ON and OFF. (p. 11) |
|  | Assigns the main band to the VHF or UHF band alternately. (p. 10) | Selects the U by U and V by V functions. (p. 15) Turns the sub band display ON and OFF when pushed and held. (p. 14) |
|   | <ul style="list-style-type: none"> • Changes the frequency in VFO mode. (p. 13) • Starts the full scan or memory scan when pushed and held. (pgs. 25, 28) | Starts the programmed scan or memory skip scan. (pgs. 25, 28) |

1 PANEL DESCRIPTION

■ Function display

MAIN BAND INDICATORS (p. 10)

Appears in one of two positions to show the main band for transmitting and function control.

FREQUENCY READOUTS

Show the operating frequency, set mode contents, etc.

- The decimal point of the frequency flashes while scanning. (pgs. 24 - 29)
- "P" or "C" appears in place of the 100 MHz digit while pager or code squelch is in use, respectively. (pgs. 41 - 43)

PTT LOCK INDICATOR (p. 47)

Appears when the PTT switch is electronically locked.

WHISPER FUNCTION INDICATOR (p. 32)

Appears while the optional whisper function (telephone-style operation) is in use. Battery pack, BP-131 or BP-132 is required for operation.

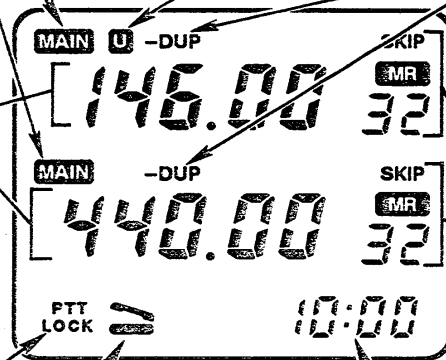

U BY U INDICATOR (p. 15)

Appears when the U by U or V by V function (two frequencies in one band) is in use.

DUPLEX INDICATORS (p. 17)

- "- DUP" or "DUP" appears when semi-duplex operation (repeater operation) is in use.

MEMORY CHANNEL INDICATOR (p. 20)

Shows the selected memory channel number.

- "MR" appears when memory mode is selected.
- "SKIP" appears when the selected memory channel is set as a skip channel. (p. 29)
- " [" appears when a call channel is selected. (p. 23)

AI FUNCTION INDICATOR (p. 33)

Shows an assignment function of the [AI] key, current time or percentage of the battery pack's voltage.

TONE INDICATOR

Appears when an optional* tone squelch unit is in use.

- “T” appears when the subaudible tone encoder is in use. (p. 17)
- “T SQL” appears when the tone squelch is in use. (p. 45)
- “T SQL ((•))” appears when the pocket beep function is in use. (p. 45)

*Built-in to the U.S.A. version.

LOW POWER INDICATOR

- “LOW” appears when low output power is selected. (p. 16)
- “LOW” blinks when auto repeater power control is in use. (p. 19)
- “E LOW” appears when the economical low power (15 mW) is assigned to low output power and low power is selected. (p. 16)

AUTO POWER-OFF INDICATOR

(p. 36)

Appears when the auto power-off function is in use.

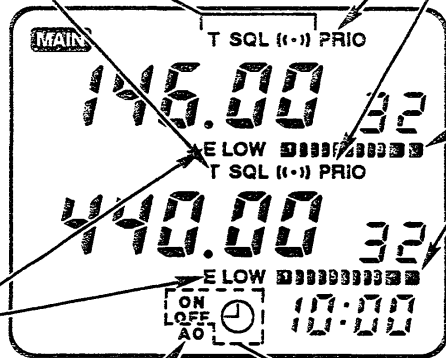

PRIORITY INDICATOR (p. 30)

Appears when the priority watch is activated; flashes when the watch is paused.

S/RF INDICATORS

- Show the relative signal strength while receiving signals. (p. 14)
- Show the output power selection while transmitting. (p. 16)

TIMER INDICATOR (pgs. 37, 38)

- “⊖” appears when the power-on or power-off timer is in use.
- “ON” appears when the power-on timer is in use.
- “OFF” appears when the power-off timer is in use.

■ Battery pack charging

The supplied* BP-157 BATTERY PACK includes rechargeable NiCd batteries and can be charged approx. 300 times. Charge the battery pack before first operating the transceiver or when the battery pack becomes exhausted. (p. 8)

* Optional for versions which come with the BP-130 BATTERY CASE.

If you want to be able to charge the battery pack more than 300 times, the following points should be observed:

1. Avoid overcharging. The charging period should be less than 48 hours.
2. Use the battery until it becomes almost completely exhausted under normal conditions. We recommend battery charging after transmitting is impossible.

■ Charging precautions

NEVER attempt to charge dry cell batteries. This will cause internal liquid leakage and damage the battery case or transceiver.

NEVER connect two or more chargers at the same time.

Charging may not occur in extreme cold (under 0°C; +32°F) or extreme heat (over +40°C; +104°F).

■ About the battery pack

◇ Operating period

Depending on the attached battery pack, the operating period of the transceiver varies. Refer to the table below.

| BATTERY PACK | OUTPUT VOLTAGE | BATTERY CAPACITY | OPERATING PERIOD (Approx.) | |
|----------------|----------------|------------------|----------------------------|----------|
| | | | VHF | UHF |
| BP-131, BP-157 | 7.2 V | 900 mAh | 6 h 40 m | 6 h 10 m |
| BP-132 | 12.0 V | 600 mAh | 4 h 30 m | 4 h 10 m |

Operating condition: Transmitting at high power for 1 min., receiving for 1 min. and standby (power saved) for 8 min. with the sub band OFF. Operating periods are estimated values and vary depending on output power, temperature, etc.

◇ Battery pack life

When the operating period becomes extremely short even after charging the battery pack fully, a new battery pack is needed.

◇ When the battery is exhausted:

- Transmitting is interrupted while holding the [PTT] switch.
- The economical low power is automatically selected by the automatic power down function. (p. 16)
- The transceiver emits a battery alarm sound.
- The [POWER] switch cannot turn the power OFF. (At this time, remove the battery pack from the transceiver.)

■ Charging connection

◇ Regular charging

Attach the supplied* battery pack or optional BP-131; then, connect the supplied* wall charger to the transceiver as shown below.

* Optional for versions which include a battery case.

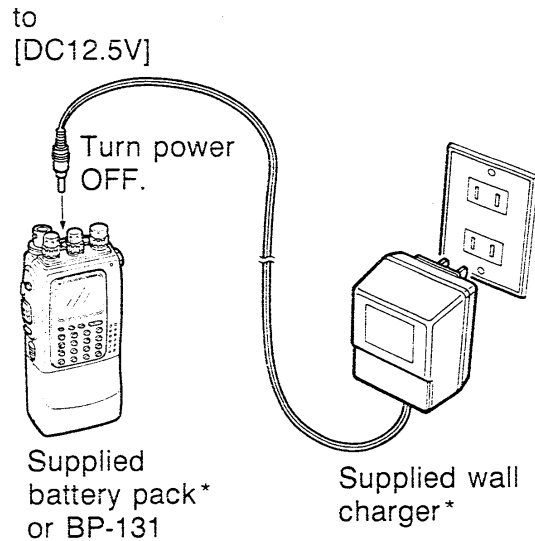

- The optional BP-132 cannot be charged via the transceiver.
- The optional CP-13/L or OPC-288/L with a 12 - 16 V DC can be used for the charging power source.
- Charging period: 15 hrs. (approx.)

◇ Rapid charging

- ① Insert the optional AD-28 BATTERY PACK ADAPTER into the charging slot of the BC-79 DESKTOP CHARGER.
- ② Firmly insert a battery pack into the AD-28.

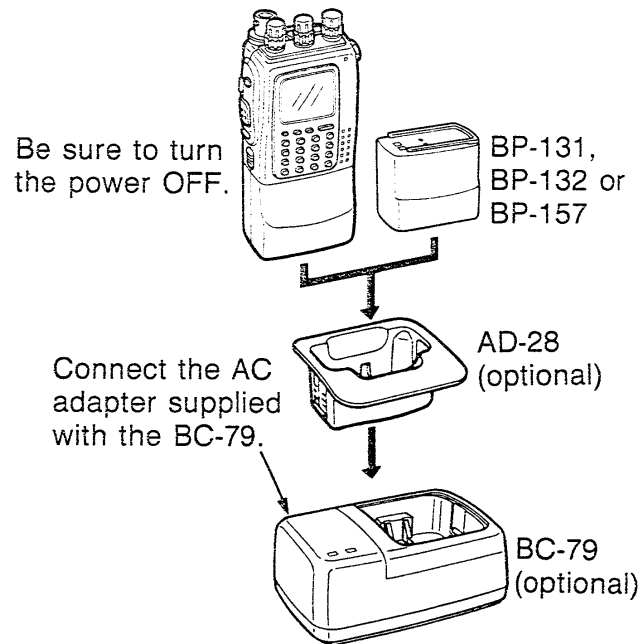

| | | |
|--------------------------------|----------------|----------|
| BATTERY PACK | BP-131, BP-157 | BP-132 |
| APPROX. CHARGING PERIOD | 1 hr. | 1.5 hrs. |

◇ Charging without transceiver

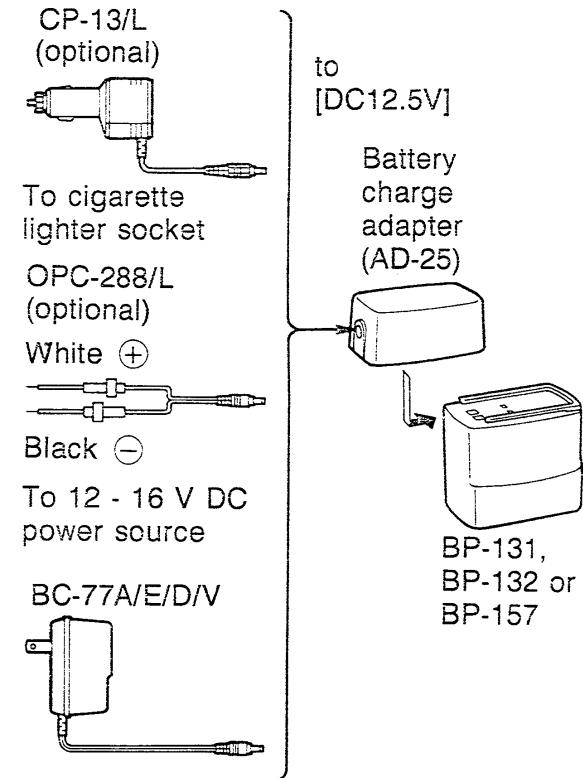

- NEVER connect the above options to the BP-130.

| | | |
|--------------------------------|----------------|---------|
| BATTERY PACK | BP-131, BP-157 | BP-132 |
| APPROX. CHARGING PERIOD | 15 hrs. | 20 hrs. |

3

ACCESSORY ATTACHMENT

◇ Antenna

Insert the supplied antenna into the antenna connector and rotate the antenna as shown in the diagram below.

KEEP the jack cover attached when jacks are not in use to avoid bad contacts.

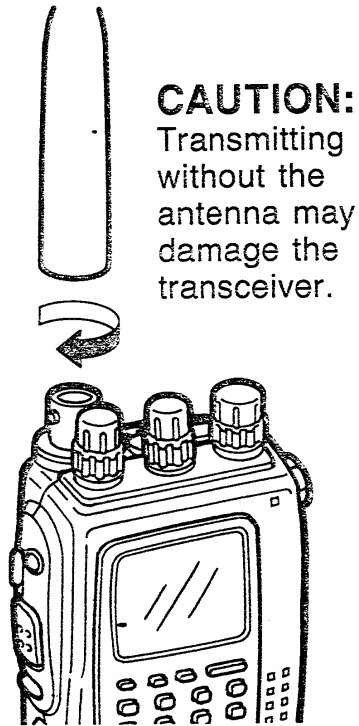

◇ Belt clip

Remove the plastic screws, then attach the belt clip with the supplied metal screws. Conveniently attaches to your belt.

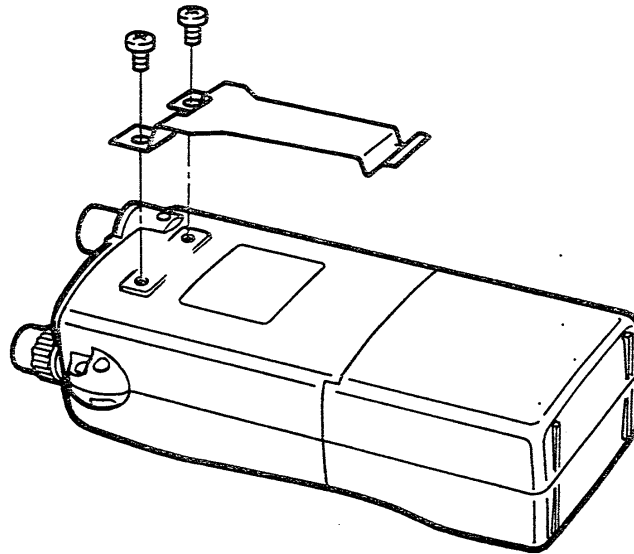

◇ Handstrap

Install the handstrap as shown in the figure below. Facilitates carrying.

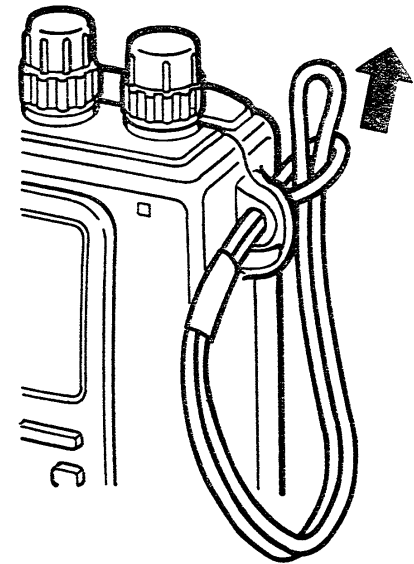

■ Main band

This transceiver can receive VHF and UHF signal simultaneously. To change frequency or to activate a function, you must designate the band, VHF or UHF, as a main band. All switches and the tuning dial affect only the main band.

The [ⓈBAND] switch changes the main band between VHF and UHF.

- “MAIN” indicator shows the selected band as the main band.

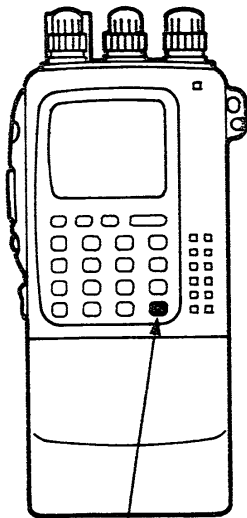

Band switch

Main band indicator

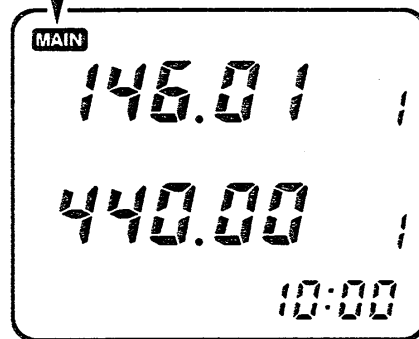

■ VFO and memory modes

This transceiver has 2 normal operating modes: VFO mode and memory mode. You can select VFO mode or memory mode independently on each band. Pushing [ⓈCLR] one or more times selects VFO mode. (pgs. 49 - 50)

VFO mode (for setting a frequency):

This mode is used for setting a desired frequency within the band range.

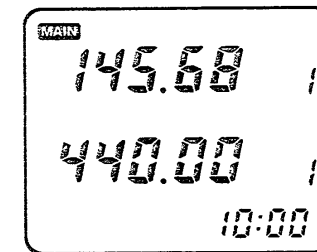

“MEM” is not indicated.

Memory mode:

This mode is used for operation of memory channels which have programmed frequencies. 32 memory channels are available on each band to store 32 different frequencies.

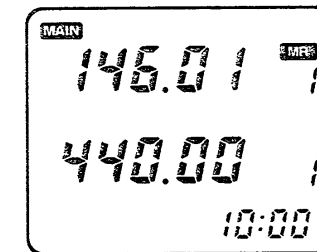

“MEM” is indicated.

What is VFO?

VFO is an abbreviation of Variable Frequency Oscillator. Frequencies for transmitting and receiving are generated and controlled by the VFO.

4 SETTING A FREQUENCY

■ Setting via the keyboard

- ① Select VHF or UHF with [D BAND].
- ② Select VFO mode if another mode has been selected.
 - Push [A CLR] one or more times to select VFO mode. See p. 10 for more about VFO mode.
- ③ Push 4 appropriate digit keys to input a frequency.
 - When a wrong digit is input, push [A CLR] to clear the input, then start again.
 - “0,” “2,” “5,” or “7” are acceptable for the 1 kHz digits (depending on the 10 kHz digit).

■ Lock function

The lock function prevents accidental frequency changes and accidental function activation.

- ① Push [F] + [C LOCK] to turn the function ON.
 - Two “ \perp ” ’s appear instead of the memory channel number.
- ② To turn the function OFF, repeat step ① above.
 - Two “ \perp ” ’s disappear.

NOTE: Output power can be selected between high and one of low powers even if the lock function is in use.

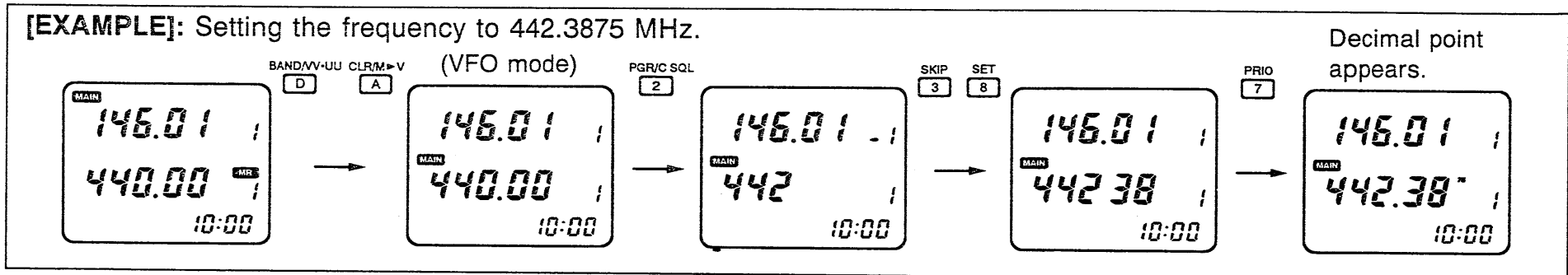
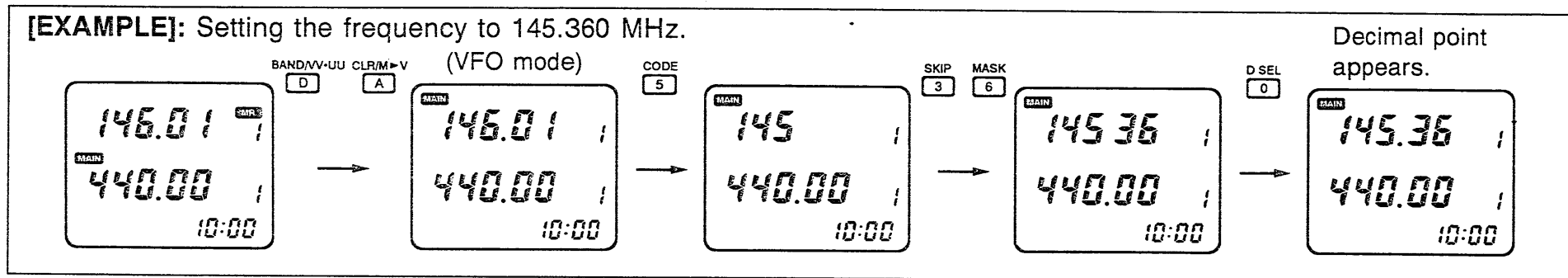

■ Presetting for the tuning dial

◇ Tuning step selection

A desired tuning step can be selected for each band. This transceiver has 8 tuning steps as follows:

- 5 kHz
- 10 kHz
- 12.5 kHz
- 15 kHz
- 20 kHz
- 25 kHz
- 30 kHz
- 50 kHz

- ① Select VHF or UHF with [D BAND].
- ② Select VFO mode if another mode has been selected.
- ③ Push [F] + [H/L/TS] to enter the tuning step setting condition.
 - Previously selected tuning step appears.
- ④ Rotate the tuning dial to select the desired tuning step.
- ⑤ Push [H/L/TS] to set the selected tuning step.

NOTE: For convenience, select a tuning step that matches the frequency intervals of repeaters in your area.

[DISPLAY EXAMPLE]

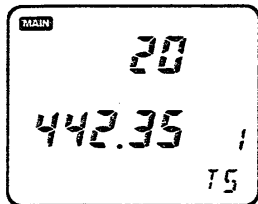

20 kHz tuning step in VHF

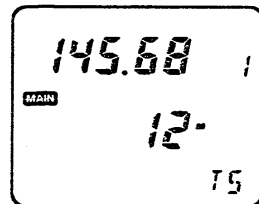

12.5 kHz tuning step in UHF

◇ Setting a dial select step

In VFO mode, rotating [DIAL] while pushing [F] changes the frequency in 100 kHz steps or 1 MHz steps, or the memory channel number.

- 10 MHz step may be available depending on version.

This function is useful for quick tuning or memory channel selection in VFO mode such as when programming 2 or more memory channels. A dial select step can be set in each band.

- ① Select VHF or UHF with [D BAND].
- ② Select VFO mode if another mode has been selected.
- ③ Push [F] + [D SEL] one or more times to set the dial select step.
 - The selected digit (100 kHz or 1 MHz) or memory channel number blinks.
- ④ While pushing [F], rotate [DIAL] to change the frequency or memory channel using the dial select tuning.

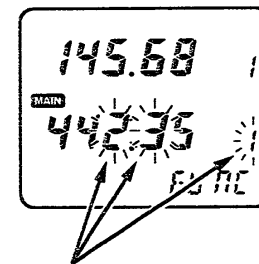

Selected digit (1 MHz or 100 kHz) or memory channel number blinks while setting the dial select step.

4 SETTING A FREQUENCY

■ Setting via ∇/Δ key

- ① Select VHF or UHF with [D BAND].
- ② Select VFO mode if another mode has been selected.
- ③ Push [# Δ] or [* ∇] to change the frequency.
 - The frequency changes according to the tuning step. (p. 12)
 - Pushing the key for more than 0.5 sec. will activate full scan.
 - If the scan is started, push [# Δ] or [* ∇] again to stop.

■ Using the tuning dial

- ① Select VHF or UHF with [D BAND].
- ② Select VFO mode if another mode has been selected.
- ③ Rotate the tuning dial to set the frequency.
- ④ To change the frequency quickly, rotate the tuning dial while pushing [F].
 - See p. 12 for setting a dial select step details.

■ LCD lighting

For easy operation at nighttime, the transceiver has an LCD (Liquid Crystal Display) and keyboard lighting function with a 5 sec. timer.

◇ 5 sec. timer

- ① Push [LIGHT] to turn the lighting ON.
- ② The lighting will automatically turn OFF when no switches or [DIAL] have been operated for 5 sec.
- ③ To turn OFF the lighting manually, push [LIGHT] again.

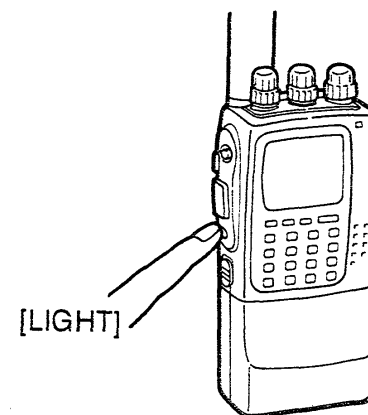

◇ Continuous lighting

- Push [F] + [LIGHT] for continuous lighting.
 - Push [LIGHT] to turn the lighting OFF.

NOTE: Continuous lighting remains activated even when the power is turned OFF and ON again.

■ Receiving

- ① Turn power ON.
- ② Set the VHF audio level.
 - Rotate VHF [SQL] maximum counterclockwise.
 - Rotate VHF [VOL] to adjust the desired audio output level.
 - Rotate VHF [SQL] clockwise until noise is muted.
- ③ Set the UHF audio level.
 - Rotate UHF [SQL] maximum counterclockwise.
 - Rotate UHF [VOL] to adjust the desired audio output level.
 - Rotate UHF [SQL] clockwise until noise is muted.
- ④ Set the VHF and UHF frequencies with [D BAND] and [DIAL]. (pgs. 10 - .13)

When a signal is received:

- The TX/RX indicator lights up in green.
- Squelch opens and audio is emitted from the speaker.
- The receiving band's S/RF indicator shows the relative signal strength.

NOTE1: When a [SQL] control is set too "tight" (extremely clockwise), squelch may not open for weak signals. To receive weak signals, set the squelch to a "loose" (less clockwise) position or use the monitor function.

NOTE2: The transceiver receives in the sub band even when transmitting in the main band. However, the receiver's sensitivity decreases during transmission.

◇ Monitor function

This function is used to listen to weak signals without disturbing the squelch setting.

When receiving a signal that is too weak to open the squelch completely, push and hold [MONI].

- This function is available only to the main band.
- While duplex is ON for repeater operation, the transmitting frequency can be monitored with [MONI].

◇ Single band function

This function turns the sub band circuit OFF and allows the transceiver to be used as a mono band transceiver. This function is useful to conserve battery power.

- ① Turn the U by U function OFF if it is in use. (p. 15)
- ② Push [F] + [D BAND] for 1 sec. to turn the sub band OFF.
 - The sub band frequency, etc. disappears.
 - The operating band can be changed with [D BAND].
- ③ To turn the sub band ON again, repeat step ② above.
 - The sub band frequency, etc. appears.



The display shows the UHF band circuit is turned OFF.

5 BASIC OPERATION

■ U by U and V by V functions

The transceiver can receive 2 frequencies simultaneously on either VHF or UHF band using the U by U function.

- ① Turn the single band function OFF if it is in use. (p. 14)
- ② Push [F] + [D]VV·UU once to turn the U by U function ON or twice to turn the V by V function ON.
 - “U” appears on the VHF band display.
 - Both band frequency displays show UHF frequencies or VHF frequencies while the function is in use.
- ③ Push [F] + [D]VV·UU once or twice to cancel.

NOTE:

- The frequency which would normally be in the other band is weaker, especially when the 2 frequencies are separated by more than 10 MHz.
- Memory channels and repeater memory are used for both frequency displays.
- The optional whisper function cannot be used.
- The upper frequency display cannot use 5 and 15 kHz tuning steps while in the U by U function.
- Repeater memory cannot be overwritten while it is indicated on the sub band frequency display.
- The receive frequency of the sub band display is muted during main band transmitting.

■ Transmitting

CAUTION: Transmitting without an antenna may damage the transceiver.

NOTE: To prevent howling, AVOID setting the UHF frequency near the 3rd multiple of the VHF frequency, e.g. setting for 145.00 MHz and 435.00 MHz.

- ① Select VHF or UHF as the main band for transmitting.
- ② Set the operating frequency. (pgs. 10 - 13)
- ③ Push and hold [PTT] to transmit.
 - The TX/RX indicator lights up in red.
 - The S/RF indicator shows the output power selection.
 - The sub band can receive while transmitting in the main band.
- ④ Speak into the microphone using your normal voice level.
 - DO NOT hold the transceiver too close to your mouth or speak too loudly. This may distort the signal.
- ⑤ Release [PTT] to return to receive.

◇ **Output power selection**

SELECTING HIGH OR LOW

Push [H/L/TS].

- “LOW” or “E LOW” appears when a low power is selected.

SETTING A LOW OUTPUT POWER LEVEL

① Push and hold [H/L/TS].

② While continuing to push [H/L/TS], rotate [DIAL] to select the desired low power level.

- The S/RF indicator shows the selected level as below.
- “E LOW” appears when the economical low (15 mW) output power is selected.

| POWER SELECTION | S/RF INDICATOR | OUTPUT POWER (typical; at 13.5 V) | |
|-----------------|----------------|-----------------------------------|--------|
| | | VHF | UHF |
| HIGH | | 5.0 W | 5.0 W |
| LOW 3 | LOW | 3.5 W | 3.5 W |
| LOW 2 | LOW | 1.5 W | 1.5 W |
| LOW 1 | LOW | 500 mW | 500 mW |
| E LOW | E LOW | 15 mW | 15 mW |

NOTE: When the auto repeater power control is functioning, the “LOW” indicator blinks and the output power cannot be selected. (p. 19)

◇ **Automatic power down function**

The automatic power down function automatically selects “E LOW (15 mW)” as the output power just before the battery becomes exhausted. When this function activates, the battery will be immediately exhausted.

- When using dry cell batteries with BP-130, you can still transmit for a short time at “E LOW.”

The function can be turned OFF if desired.

USING SET MODE

SETTING THE AUTOMATIC POWER DOWN FUNCTION ON/OFF

The automatic power down function is ON.

The automatic power down function is OFF.

- ① Push [F] + [Ⓑ SET] to enter set mode.
- ② Push [⌘ ▽] or [⌘ △] until “EL” appears as shown above.
- ③ Rotate the tuning dial to turn the automatic power down function ON or OFF.
- ④ Push [Ⓐ CLR] to set the condition and to exit set mode.

■ Operation

A repeater amplifies a received signal and transmits it at a different frequency. When using a repeater, the transmit frequency is shifted from the receive frequency by the offset frequency. (p. 18) It is convenient to program repeater information into a memory channel. (p. 21)

- ① Select VHF or UHF with [D BAND].
- ② Set the receive frequency (repeater output frequency). (pgs. 10 - 13)
- ③ Push [F] + [④ DUP] to select - duplex or push it again for + duplex.
 - “- DUP” or “DUP” appears to indicate the transmit frequency for minus shift or plus shift respectively.
 - When the auto repeater power control is in use, “LOW” blinks and the output power is automatically selected. (p. 19)
- ④ Push and hold [PTT] to transmit.
 - The displayed frequency automatically changes to the transmit frequency (repeater input frequency).
 - When the repeater requires a tone, see section at right.
 - The operating condition is automatically programmed into a repeater memory. See p. 19 for details.
 - If “o.FF” appears, confirm the offset frequency. (p. 18)
- ⑤ Release [PTT] to receive.
- ⑥ Push and hold [MONI] to check whether the other station's transmit signal can be directly received or not.

■ Tone information

SUBAUDIBLE TONE

(An optional UT-63 is necessary for non-U.S.A. versions.)

- ① Push [F] + [① T/T SQL] several times until only “T” appears to turn ON the subaudible tone encoder.
 - To set the subaudible tone frequency, see “Subaudible tone” on the page at right.
- ② Push [F] + [① T/T SQL] several times until “T” disappears to turn OFF the subaudible tone encoder.

DTMF TONES

While pushing [PTT], push the desired digit key to transmit DTMF tones.

- The transceiver has 4 DTMF memory channels. See p. 31 for details.

1750 Hz TONE (IC-W21ET only)

While pushing [PTT], push and hold [RPT·M] for 1 - 2 sec. to transmit a 1750 Hz tone call signal.

■ Subaudible tone USING SET MODE

(An optional UT-63 is necessary for non-U.S.A. versions.)

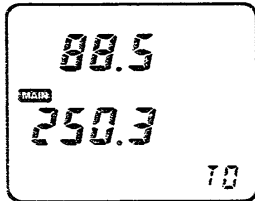

The display shows an 88.5 Hz subaudible tone frequency for the VHF band and a 250.3 Hz subaudible tone frequency for the UHF band.

Separate setting for each band.

■ Offset frequency USING SET MODE

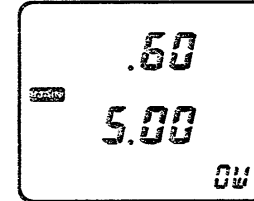

The display shows a 0.6 MHz (600 kHz) offset frequency for the VHF band and a 5.0 MHz offset frequency for the UHF band.

Separate setting for each band.

- ① Select the desired mode or channel you wish to set the subaudible tone frequency to, such as VFO mode, memory channel or call channel.
 - The subaudible tone frequency is independently programmed into each mode or channel.
- ② Push [F] + [ⓈSET] to enter set mode.
- ③ Push [*▽] or [#△] until "TO" appears as shown above.
- ④ Rotate the tuning dial to select the desired frequency.
- ⑤ Push [ⓁBAND] to change the band, if desired.
- ⑥ Push [ⒶCLR] to set the value and to exit set mode.

- ① Select the desired mode or channel you wish to set the offset frequency to, such as VFO mode, memory channel or call channel.
 - The offset frequency is independently programmed into each mode or channel.
- ② Push [F] + [ⓈSET] to enter set mode.
- ③ Push [*▽] or [#△] until "OW" appears as shown above.
- ④ Rotate the tuning dial to set the desired frequency.
 - Selectable step increment is the same as the preset tuning step. (p. 12)
 - Rotating the tuning dial while pushing [F] changes the frequency in 100 kHz steps.
- ⑤ Push [ⓁBAND] to change the band, if desired.
- ⑥ Push [ⒶCLR] to set the value and to exit set mode.

• Subaudible tone frequency list

| | | | | | | |
|------|-------|-------|-------|-------|-------|-------|
| 67.0 | 85.4 | 103.5 | 127.3 | 156.7 | 192.8 | 241.8 |
| 71.9 | 88.5 | 107.2 | 131.8 | 162.2 | 203.5 | 250.3 |
| 74.4 | 91.5 | 110.9 | 136.5 | 167.9 | 210.7 | |
| 77.0 | 94.8 | 114.8 | 141.3 | 173.8 | 218.1 | |
| 79.7 | 97.4 | 118.8 | 146.2 | 179.9 | 225.7 | |
| 82.5 | 100.0 | 123.0 | 151.4 | 186.2 | 233.6 | |

(Unit: Hz)

6 REPEATER OPERATION

■ Repeater memory

This transceiver has a repeater memory in each band to store repeater information separately from regular memory channels and the call channel.

When transmitting with duplex ON, the following information is automatically programmed into the repeater memory.

- Repeater output frequency (your receiving frequency).
- “-DUP” or “DUP” setting and offset frequency.
- “T” setting and subaudible tone frequency (when used).

After you operate the transceiver in simplex, you can easily call up the repeater memory.

- ① Push [RPT·M] to call up the repeater memory.
 - Programmed repeater information and “rP” appear.
 - Repeater memory is blanked after CPU resetting.
- ② To return to the normal operating mode (VFO or memory mode), push [RPT·M] again.

[REPEATER MEMORY]

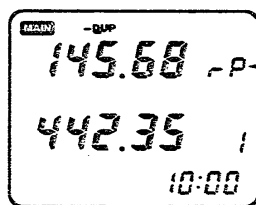

“rP” appears.

■ Auto repeater power control

This transceiver automatically selects the output power while in duplex operation. When receiving with duplex ON, the transceiver monitors the signal strength every 1 sec. and determines an output power between high, low 1 - low 3. This function automatically conserves the battery power during repeater communication.

- While the function is in use, the “LOW” indicator blinks and [H/L] cannot select the output power.

This function may not select an appropriate output power because of the repeater location, propagation conditions, etc.

USING SET MODE

SETTING THE AUTO REPEATER POWER CONTROL FUNCTION ON/OFF

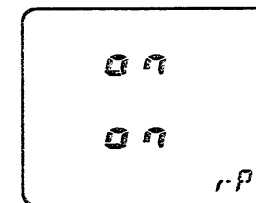

The auto
repeater
power control
function is ON.

- ① Push [F] + [ⓈSET] to enter set mode.
- ② Push [⊛▽] or [⊛△] until “rP” appears as shown above.
- ③ Rotate the tuning dial to turn the auto repeater power control function ON or OFF.
- ④ Push [ⒶCLR] to set the condition and to exit set mode.

■ General description

The transceiver has 32 memory channels (plus 2 scan edge memory channels) on each band for storage of often-used frequencies. You can program the following data into each memory channel separately.

- Operating frequency (pgs. 11 - 13)
- Duplex direction (DUP or -DUP) (p. 17)
- Offset frequency (p. 18)
- Subaudible tone frequency*¹ (p. 18)
- Subaudible tone encoder ON/OFF*¹ (p. 17)
- Tone squelch ON/OFF*¹ (p. 45)
- Skip information*² (p. 29)

*¹ An optional UT-63 TONE SQUELCH UNIT is necessary for non-U.S.A. versions.

*² Except for the scan edge memory channels.

MEMORY CHANNEL ARRANGEMENT

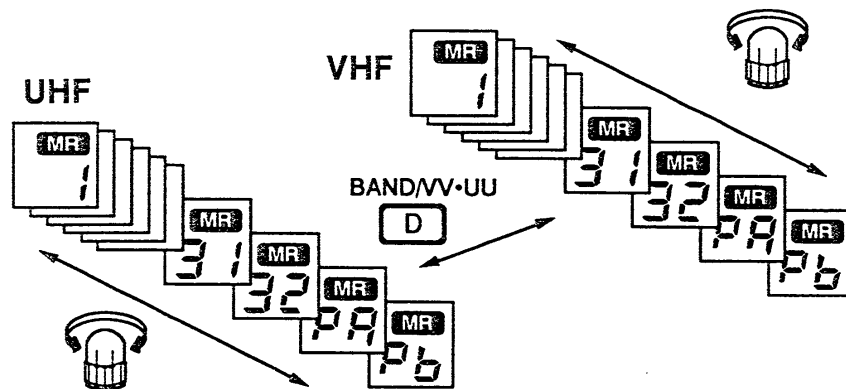

■ Memory channel selection

- ① Select VHF or UHF with [D BAND].
- ② Push [B MR] to select memory mode.
 - “MR” appears.
 - If the call channel or repeater memory has been selected, push [A CLR] to exit in advance.
- ③ Select the desired memory channel.

Using the tuning dial:

Rotate [DIAL] to select the desired memory channel.

- Memory channels “PA” and “Pb” are scan edge channels. (p. 26)
- To select a masked channel, rotate [DIAL] while pushing [F].

Using the keyboard:

- Push a numeral key to enter the first digit into the memory channel.
 - When “PA” or “Pb” has been selected, use another method to select the channel.
- Push [B MR] to change the memory channel in units of 10.
 - All memory channels except “PA” or “Pb” can be selected.

Using the Δ/∇ keys:

Push [* ∇] or [# Δ] to change the memory channel.

- Masked channels cannot be selected. (p. 22)
- Pushing [* ∇] or [# Δ] for more than 0.5 sec. will activate memory scan. If the scan is started, push [* ∇] or [# Δ] again to stop the scan.

- ④ To return to VFO mode, push [A CLR].

7 MEMORY OPERATION

■ Programming a memory channel

VFO mode settings, including the set mode contents such as subaudible tone frequency, etc., are programmed into a memory channel.

- ① Select VHF or UHF with [D BAND].
- ② Select the memory channel to be programmed:
 - Push [B MR] to select memory mode. ("MR" appears.)
 - Rotate [DIAL] to select the memory channel.
 - To select a masked channel, rotate [DIAL] while pushing [F].
- ③ Set the desired frequency in VFO mode:
 - Push [A CLR] to select VFO mode.
 - Set the desired frequency using the keyboard or [DIAL].
 - Set other data (e.g. offset frequency, duplex direction, subaudible tone encoder ON/OFF and its frequency), if required.
- ④ Push [F] + [B MW] for 1 sec. to program.
 - If the beep tone is ON, 3 beeps alert you that the VFO contents, including the duplex information, subaudible tone frequency, etc., are programmed.

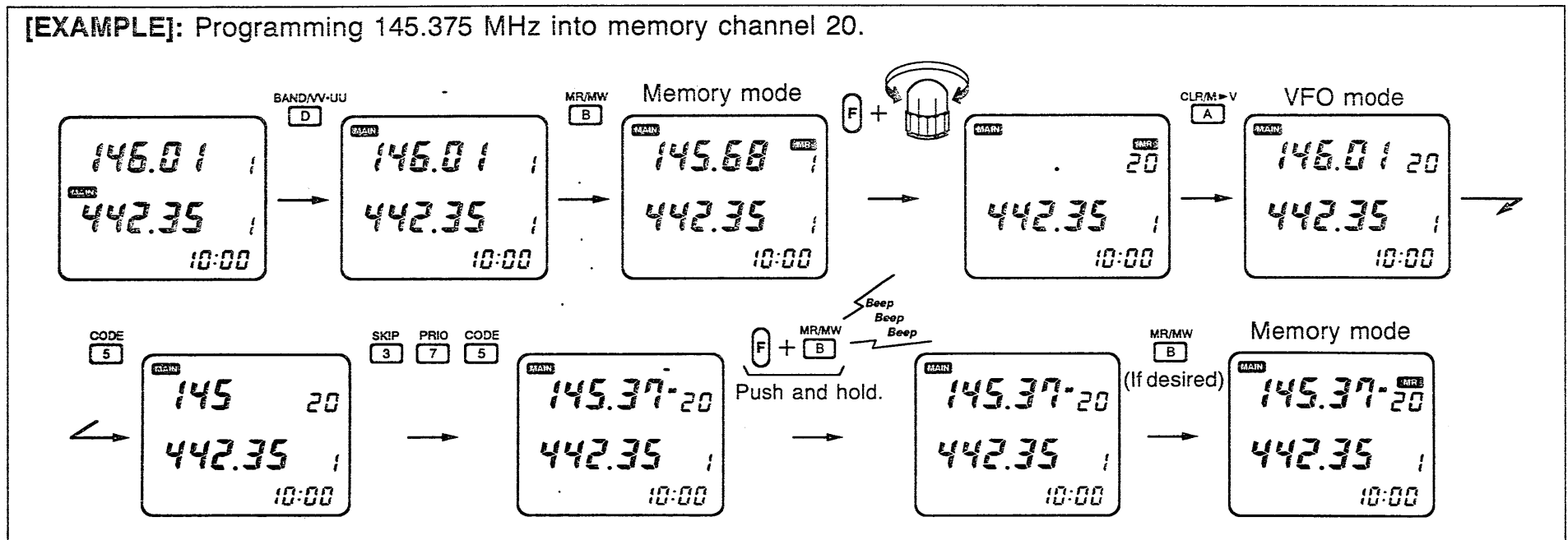

■ Transferring memory contents

This function transfers a memory channel's contents into a VFO. This is useful for searching for signals around a memory channel frequency and for recalling the offset frequency, subaudible tone frequency, etc.

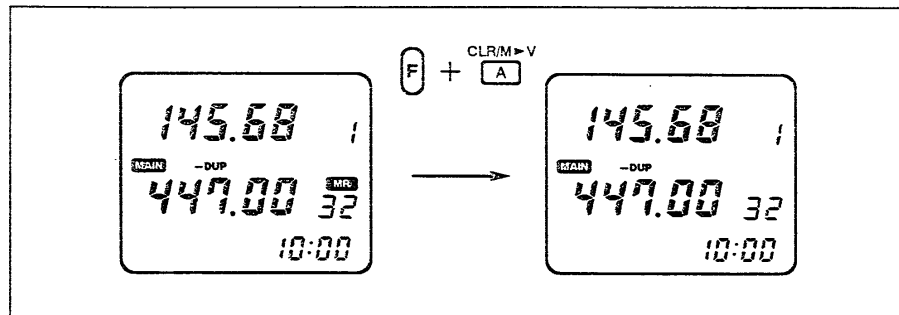

- ① Select VHF or UHF with [D BAND].
- ② Select the memory channel to be transferred:
 - Push [B MR] to select memory mode. ("MR" appears.)
 - Rotate the [DIAL] to select the memory channel.
- ③ Push [F] + [A M▶V] for 1 sec.
 - "MR" disappears as VFO mode is automatically selected.
 - If the beep tone is ON, 3 beeps alert you that the memory channel contents, including the duplex information, subaudible tone frequency, etc., are transferred.

■ Masking a memory

Unwanted memory channels can be masked (hidden). A masked memory channel cannot be selected for normal use. The contents of the masked memory, however, can be recalled by the following procedure.

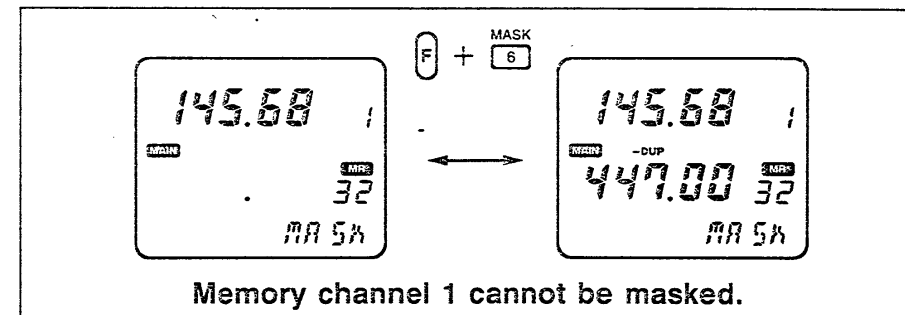

- ① Select VHF or UHF with [D BAND].
- ② Select the memory channel to be masked:
 - Push [B MR] to select memory mode. ("MR" appears.)
 - Rotate the [DIAL] to select the memory channel.
- ③ Push [F] + [6 MASK] to mask the memory channel.
 - Memory channel 1 cannot be masked.

To recall the masked memory contents, select the desired memory channel; then, repeat step ③.

■ Calling up a call channel

Each band has an independent call channel to store a most-often-used frequency for quick recall.

- ① Select VHF or UHF with [D BAND].
- ② Push [C CALL] to select the call channel.
 - “ [” appears.
 - If the repeater memory has been selected, push [A CLR] to exit in advance.
- ③ To return to the previous mode, push [C CALL].

■ Transferring call channel contents

- ① Select VHF or UHF with [D BAND].
- ② Push [C CALL] to select the call channel.
 - “ [” appears.
 - If the repeater memory has been selected, push [A CLR] to exit in advance.
- ③ Push [F] + [A M▶V] for 1 sec.
 - “ [” disappears as VFO mode is automatically selected.
 - If the beep tone is ON, 3 beeps alert you that the call channel contents, including the duplex information, subaudible tone frequency, etc., are transferred.

■ Programming a call channel

As well as an operating frequency, duplex information and subaudible tone* information (tone encoder or tone squelch ON/OFF and its frequency) can be programmed into the call channel.

* Optional for non-U.S.A. versions.

- ① Select VHF or UHF with [D BAND].
- ② Set the desired frequency in VFO mode:
 - Push [A CLR] to select VFO mode.
 - Set the desired frequency using the keyboard or [DIAL].
 - Set other data (e.g. offset frequency, duplex direction, subaudible tone encoder ON/OFF and its frequency), if required.
- ③ Push [C CALL] to select the call channel.
 - “ [” appears.
- ④ Push [F] + [B MW] for 1 sec. to program.
 - The frequency display changes to the programmed VFO contents.
 - If the beep tone is ON, 3 beeps alert you that the VFO contents, including the duplex information, subaudible tone frequency, etc., are programmed.

■ Scan types

Each band has 4 scan types with skip functions and 4 resume conditions to suit your needs. Scans on both bands can be operated separately or simultaneously.

FULL SCAN (p. 25) Repeatedly scans all frequencies over the entire selected band.

PROGRAMMED SCAN (p. 25) Repeatedly scans between two user-programmed frequencies. Used for checking for frequencies within a specified range such as repeater output frequencies, etc.

MEMORY SCAN (p. 28) Repeatedly scans all memory channels, except masked channels, in sequence.

MEMORY SKIP SCAN (p. 28) Repeatedly scans memory channels except skip and masked channels. Used for checking often-called channels and bypassing usually busy channels such as repeater frequencies.

FREQUENCY SKIP FUNCTION (p. 27) Skips unwanted frequencies that inconveniently stop scanning.

SCAN RESUME CONDITION (p. 29) 4 resume conditions are available: pause scan and 3 timer scans. When receiving a signal, pause scan pauses until the signal disappears; timer scans pause for 5, 10 or 15 sec.

9 SCAN OPERATION

■ Full scan

- ① Select VHF or UHF with [D BAND].
- ② Select VFO mode with [A CLR] if another mode has been selected on the selected band.
- ③ Turn the pager or code squelch function OFF when the function is in use. (pgs. 41 - 43)
- ④ Set the selected band's [SQL] to the point where noise is muted.
- ⑤ Push [* ∇/SCAN] or [# Δ/SCAN] for 1 sec. to start the scan.
 - To change the scanning direction, rotate [DIAL].
- ⑥ To stop the scan, push [* ∇/SCAN] or [# Δ/SCAN].

■ Programmed scan

Scan edge frequencies should be programmed into the scan edge channels "PA" and Pb" in advance. (p. 26)

- ① Select VHF or UHF with [D BAND].
- ② Select VFO mode with [A CLR] if another mode has been selected on the selected band.
- ③ Turn the pager or code squelch function OFF when the function is in use. (pgs. 41 - 43)
- ④ Set the selected band's [SQL] to the point where noise is muted.
- ⑤ Push [F] + [* ∇/SCAN] or [# Δ/SCAN] to start the scan.
 - To change the scanning direction, rotate [DIAL].
- ⑥ To stop the scan, push [* ∇/SCAN] or [# Δ/SCAN].

◇ Scan resume condition:

- When receiving a signal, scan resumes in one of the following ways:
 - after pausing 15 sec.
 - after pausing 10 sec.
 - after pausing 5 sec.
 - after the signal disappears.

- The scan resume condition can be selected in set mode. (p. 29)
- While scanning, rotating the tuning dial changes the scanning direction or skips a paused frequency.

■ Programming scan edges

Scan edges can be programmed in the same way as memory channels. Memory channels "PA" and "Pb" are available for programming scan edges.

- ① Select VHF or UHF with [D BAND].
- ② Select the scan edge memory channel "PA" or "Pb":
 - Push [B MR] to select memory mode. ("MR" appears.)
 - Rotate [DIAL] to select the memory channel "PA" or "Pb."
- ③ Set the desired frequency in VFO mode:
 - Push [A CLR] to select VFO mode.
 - Rotate [DIAL] to set the desired frequency.
- ④ Push [F] + [B MW] for 1 sec.
 - If the beep tone is ON, 3 beeps alert you that the contents are programmed.
- ⑤ To program a frequency for the other scan edge memory channel "Pb" or "PA," repeat steps ② - ④.
 - If the same frequency is programmed into "PA" and "Pb," programmed scan will not function.

[EXAMPLE]: Programming 145.50 MHz and 145.80 MHz for the VHF scan edges.

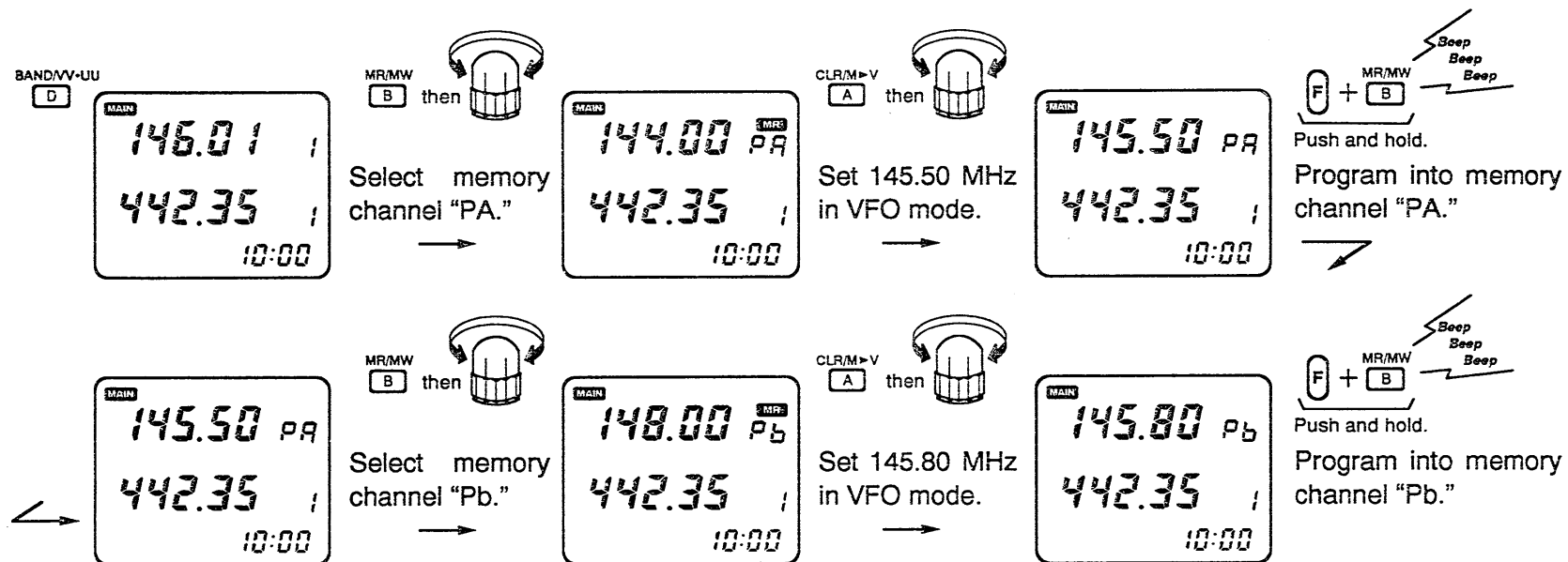

9 SCAN OPERATION

■ Frequency skip function

◇ Programming a skip frequency

Unwanted frequencies can be skipped and programmed as skip channels when full or programmed scan is pausing.

- ① Turn ON the frequency skip function of the desired band as described at right.
- ② Start full scan or programmed scan. (p. 25)
- ③ Push [F] + [B MW] for 1 sec. to program the received frequency as a skip frequency.
 - The transceiver emits 3 beeps and the scan resumes.
 - Masked memory channels 32 - 11 are used in reverse sequence.
 - To scan the skip frequency after programming, cancel the skip information or mask the memory channel. (pgs. 22, 29)

◇ Programming a paused frequency

A paused frequency can be programmed into the selected memory channel when full or programmed scan is pausing.

- ① Turn OFF the frequency skip function of the desired band as described at right.
- ② Start full scan or programmed scan. (p. 25)
- ③ Push [F] + [B MW] for 1 sec. to program the received frequency into the selected memory channel.
 - The transceiver emits 3 beeps and the scan resumes.

◇ Frequency skip function ON/OFF

The frequency skip function can be turned OFF in set mode. In this case, the frequencies will not be skipped even if skip information is programmed and "SKIP" will not blink while scanning.

USING SET MODE

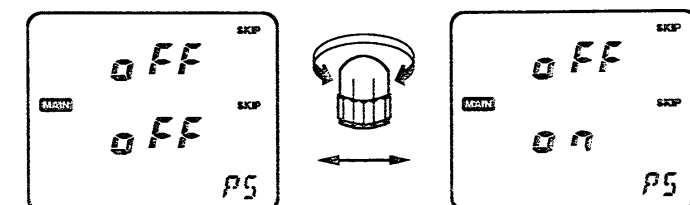

The frequency skip function of UHF is OFF.

The frequency skip function of UHF is ON.

- ① Push [F] + [8 SET] to enter set mode.
- ② Push [* ▽] or [# △] one or more times until "PS" appears in the display.
- ③ Rotate the tuning dial to turn the frequency skip function "on" or "off."
 - When selecting "on," the frequency skip function for full scan and programmed scan is turned ON.
- ④ Push [D BAND] to set the other band condition if desired.
- ⑤ Push [A CLR] to exit set mode.

■ Memory scan

- ① Select VHF or UHF with [D BAND].
- ② Push [B MR] to select memory mode.
 - “**MR**” appears.
 - If the call channel or repeater memory has been selected, push [A CLR] to exit.
- ③ Turn the pager or code squelch function OFF when the function is in use. (pgs. 41 - 43)
- ④ Set the selected band's [SQL] to the point where noise is muted.
- ⑤ Push [*▽/SCAN] or [#△/SCAN] for 1 sec. to start the scan.
 - To change the scanning direction, rotate [DIAL].
- ⑥ To stop the scan, push [*▽/SCAN] or [#△/SCAN].

■ Memory skip scan

Memory skip scan repeatedly scans memory channels except skip and masked channels. Program the desired channel as a skip channel in advance. (p. 29)

- ① Select VHF or UHF with [D BAND].
- ② Push [B MR] to select memory mode.
 - “**MR**” appears.
 - If the call channel or repeater memory has been selected, push [A CLR] to exit.
- ③ Turn the pager or code squelch function OFF when the function is in use. (pgs. 41 - 43)
- ④ Set the selected band's [SQL] to the point where noise is muted.
- ⑤ Push [F] + [*▽/SCAN] or [#△/SCAN] to start the scan.
 - To change the scanning direction, rotate [DIAL].
- ⑥ To stop the scan, push [*▽/SCAN] or [#△/SCAN].

◇ Scan resume condition:

- When receiving a signal, scan resumes in one of the following ways:
 - after pausing 15 sec.
 - after pausing 10 sec.
 - after pausing 5 sec.
 - after the signal disappears.

- The scan resume condition can be selected in set mode. (p. 29)
- While scanning, rotating the tuning dial changes the scanning direction or skips a paused frequency.

9 SCAN OPERATION

■ Skip channel setting

Memory channels can be specified to be skipped for memory skip scan. This is useful to speedup the memory skip scan interval. These skip channels are also skipped during priority watch (memory skip scan watch). When the frequency skip function is ON, the frequencies of the channels are skipped during full scan or programmed scan. (p. 27)

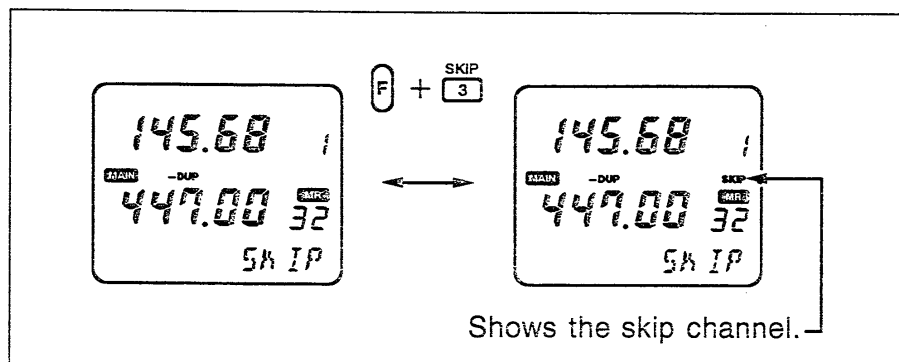

- ① Select the memory channel to be programmed as a skip channel:
 - Select VHF or UHF with [D BAND].
 - Push [B MR]; then rotate [DIAL] or push [*▽] or [#△] to select the desired memory channel.
- ② Push [F] + [3 SKIP] to set the memory channel to the skip channel.
 - "SKIP" appears.
- ③ Repeat step ② to cancel a skip channel.
 - "SKIP" disappears.

■ Scan resume condition

USING SET MODE

The resume condition can be selected as a pause or timer scan. The resume condition is only used for scan and does not affect priority watch. (p. 30)

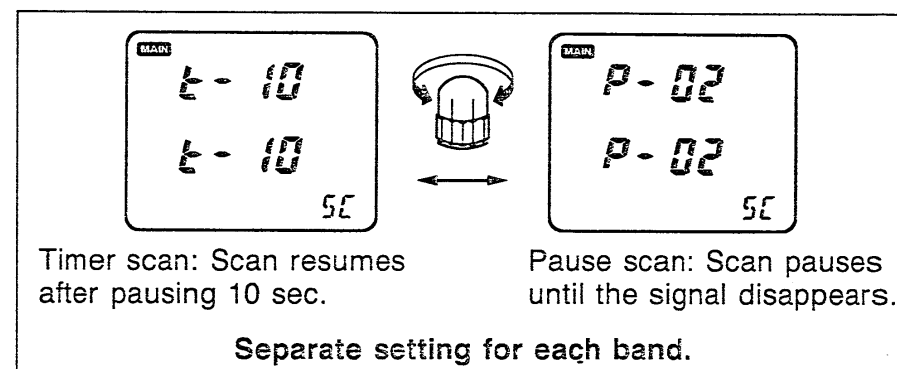

- ① Push [F] + [8 SET] to enter set mode.
- ② Push [*▽] or [#△] one or more times until "SC" appears in the display.
- ③ Rotate the tuning dial to set the desired timer.
 - "t-15" : Scan pauses 15 sec. while receiving a signal.
 - "t-10" : Scan pauses 10 sec. while receiving a signal.
 - "t-05" : Scan paused 5 sec. while receiving a signal.
 - "P-02" : Scan pauses until the signal disappears and then resumes 2 sec. after that.
- ④ Push [D BAND] to set the other band condition, if desired.
- ⑤ Push [A CLR] to exit set mode.

■ Priority watch types

The priority watch checks for signals on a memory or call channel every 5 sec. while operating on a VFO frequency. The transceiver has 4 priority watch types to suit your needs. You can transmit on the VFO frequency while the priority watch operates.

When receiving a signal, priority watch pauses for 5 sec. (if the signal disappears within 5 sec., the watch resumes).

NOTE:

- Priority watch does not operate when:
 - The selected memory channel is a masked channel. (p. 22)
 - Pager or code squelch function is activated. (pgs. 41 - 43)
 - If an optional* pocket beep function is activated, the transceiver automatically selects the tone squelch function when priority watch starts.
- * Built-in to the U.S.A. version.
- A memory channel with skip information can be watched.

Memory channel watch

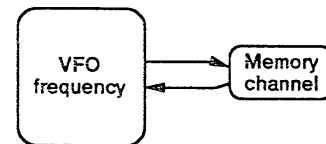

Memory scan watch

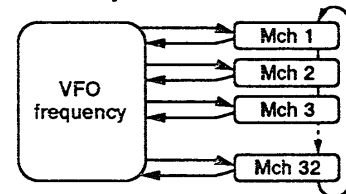

Memory skip scan watch

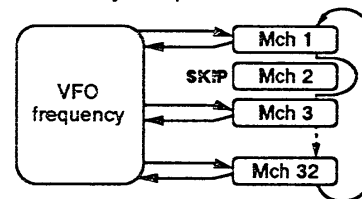

Call channel watch

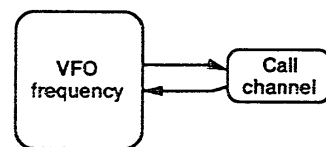

■ Priority watch operation

- ① Select VHF or UHF with [D BAND].
- ② Select VFO mode; then, set an operating frequency.
- ③ Set the watching channel(s).

For memory channel watch:

Select the desired memory channel.

For memory scan watch:

Select memory mode; then, push [*▽/SCAN] or [#△/SCAN] for 1 sec. to start the memory scan.

For memory skip scan watch:

Select memory mode; then, push [F] + [*▽/SCAN] or [#△/SCAN] to start the memory skip scan.

For call channel watch:

Push [C CALL] to select the call channel.

- ④ Push [F] + [7 PRIO] to start the watch.
 - The transceiver receives the memory or call channel frequency every 5 sec.
 - While the watch is pausing, pushing [A CLR] resumes the watch manually.
- ⑤ Push [A CLR] while the display shows the VFO frequency to stop the watch.

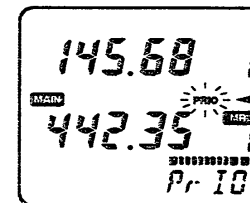

While pausing on a memory channel, "PRIO" blinks.

11 DTMF MEMORY

■ Programming a DTMF code

DTMF codes are used for autopatching, accessing repeaters, controlling other equipment, etc. The transceiver has 4 DTMF memory channels (t1 - t4) for storage of often-used DTMF codes of up to 15 digits. The memory channels are for common use on both bands.

- ① Push [AI] until the AI function indicator blinks; then, rotate [DIAL] while continuing to push [AI] to select "DTMF."
- ② Push [AI] momentarily to select DTMF memory mode.
- ③ Rotate [DIAL] to select the desired channel.
- ④ Push [F] + [Ⓢ SET]; then push the desired keys.
 - "E" stands for "*" and "F" stands for "#."
 - Push [AI] and repeat this step when making a mistake.
- ⑤ Push [AI] to store the entered digits.
 - If 15 digits are input, this is not necessary.
- ⑥ Push [AI] or [PTT] to exit DTMF memory mode.
 - When [AI] is pushed, the transceiver emits the programmed code.

■ Transmitting a DTMF code

◇ Using a DTMF memory channel

- ① Push [AI] until the AI function indicator blinks; then, rotate [DIAL] while continuing to push [AI] to select "DTMF."
- ② Push [AI] momentarily to select DTMF memory mode.
- ③ Rotate [DIAL] to select the desired channel.
- ④ Push [PTT] to exit DTMF memory mode.
 - Pushing [AI] also exits DTMF memory mode.
- ⑤ While pushing [PTT], push [AI] to transmit the selected DTMF code.
 - The function display shows the DTMF digits sent.

◇ Transmitting a DTMF code manually

- While pushing [PTT], push the key of the desired DTMF digit.
 - 1 - 0, A - D, * (E) and # (F) are available.

[EXAMPLE]: Programming "21ABC38" into DTMF memory channel "t4."

1. The display shows "145.68" and "442.35" with "DTMF" at the bottom. A button labeled "AI" is shown to the right. Text below says "Select 'DTMF' in advance."

2. The display shows "442.35" and "DTMF" at the bottom. A button labeled "AI" is shown to the right. Text below says "then SET F + B".

3. The display shows "442.35" and "DTMF" at the bottom. A button labeled "AI" is shown to the right. Text below shows a grid of buttons: 2, 1, A, B, C, 3, 8.

4. The display shows "38" and "442.35" with "DTMF" at the bottom. A button labeled "AI" is shown to the right. Text below says "then AI".

■ General operation

The whisper function provides crossband full duplex communication, like a telephone, using a sub microphone on the optional battery pack, BP-131 or BP-132.

NOTE: The whisper function can be activated, but your voice is not transmitted when the BP-130 or BP-157 is attached.

- ① Set the main band frequency as a transmit frequency.
- ② Set the sub band frequency as a receive frequency.
- ③ Push [F] + [RPT·M / WSPR] to activate the function.
 - “” appears.
 - The transceiver automatically starts transmitting without pushing [PTT] and the TX indicator lights up in red.
 - Be sure the U by U or single band function is deactivated in advance. (pgs. 14, 15)
- ④ Hold the transceiver as you would a telephone handset, then, speak into the microphone on the battery pack.
 - Received signals are emitted from the speaker at an attenuated level.
 - When the selected time-out time is passed after the whisper function starts, the whisper function is automatically cancelled by the time-out timer and returns to the normal operating condition. See section at right for details.
 - The tuning dial and switches cannot be used.
- ⑤ To cancel the function, push [RPT·M / WSPR].

■ Time-out time setting

To prevent continuous transmission with the whisper function, the transceiver has a time-out timer. This timer turns the whisper function OFF 5, 15 or 30 min. after the function starts.

10 sec. before the time-out time passes, the transceiver emits a beep tone and counts down from TEL9 to TEL0. Pushing [RPT·M / WSPR] while counting down restarts the time-out timer.

USING SET MODE

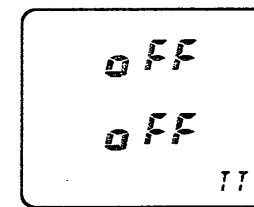
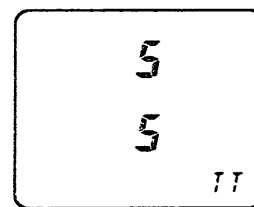

- ① Push [F] + [Ⓢ SET] to enter set mode.
- ② Push [Ⓢ▽] or [Ⓢ△] one or more times until “TT” appears in the display.
- ③ Rotate the tuning dial to select the desired time-out time from 5, 15, 30 min. or OFF.
- ④ Push [Ⓢ CLR] to exit set mode.

13 AI FUNCTION

■ What does AI in the transceiver do?

The AI in this transceiver has 2 important functions, "Learning Function" and "Automatic Order Selection."

• Learning function

The AI automatically assigns one of the transceiver functions, shown in the table at right, to the [AI] key after it is used. This function is then displayed in the function display and can be conveniently accessed by simply pushing the [AI] key. Because the transceiver 'learns' the last used function, this is called the "Learning Function."

In some cases, this automatic assignment of functions to the [AI] key may be inconvenient and for this reason the learning function can be turned OFF. The transceiver functions can then be manually assigned to the [AI] key.

• Automatic order selection

The AI changes the order in which functions can be selected via the [AI] key. To illustrate this, push and hold the [AI] key; then, rotate the tuning dial while continuing to push [AI]. Let's say you find the following order: [MASK], [SCAN], [PRIO], [DUP], etc. and you release the [AI] key when [PRIO] appears. The order changes to [PRIO], [MASK], [SCAN] and [DUP]. In other words, the AI keeps track of which function you use and when. It then orders them accordingly. This order is convenient when the learning function is OFF and you are manually assigning transceiver functions to the [AI] key.

| FUNCTION INDICATOR | FUNCTIONS |
|--------------------|---|
| 15:00 | Clock indication, timer functions |
| SC AN | Programmed scan, memory skip scan |
| TO NE* | Tone encoder, tone squelch, pocket beep |
| DUP | Duplex set |
| PG r | Pager, code squelch |
| CO DE | Code channel |
| Pr IO | Priority watch |
| SK IP | Skip channel setting |
| MA SK | Masking a channel |
| SE T | SET mode |
| BATT | Battery voltage indication |
| DT MF | DTMF memory channels |

* An optional UT-63 is necessary for non-U.S.A. versions.

■ Learning function

When the learning function is ON:

[Example - to use the [AI] key as [F] + [6] MASK.]

- ① Select VHF or UHF with [D] BAND].
- ② Select a memory channel to mask.
- ③ Push [F] + [6] MASK].
 - Confirm that “MASK” is indicated in the AI function indicator — this means the [MASK] is now assigned to the [AI] key.
- ④ Push [AI] again to recall the masked channel.
- ⑤ Select another memory channel to mask.
- ⑥ Push [AI] to mask the memory channel.

■ Learning function on/off

USING SET MODE

- ① Push [F] + [8] SET] to enter set mode.
- ② Push [*▽] or [#△] one or more times until “AI” appears in the display.
- ③ Rotate the tuning dial to turn the learning function “on” or “off.”
 - When selecting “on,” the learning function is turned ON.
- ④ Push [A CLR] to exit set mode.

■ Manual assignment

While the learning function is ON, the [AI] key will activate your most recently used function: [F] + [X]. To manually assign functions to the [AI] key, the learning function must be OFF.

- ① Push and hold [AI] until the AI function indicator flashes.
- ② While continuing to push [AI], rotate the tuning dial to select the desired function.
 - The function order can be observed in the display as you rotate the tuning dial.
- ③ Release [AI] to select a function.
- ④ To activate the function you have assigned to the [AI] key, push [AI].

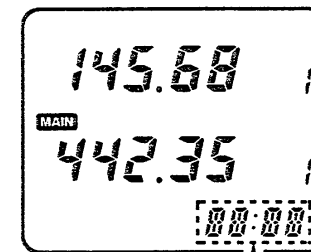

AI function indicator shows the assigned function.

NOTE: Pushing [F] + [9] CLOCK] assigns clock indication even when the learning function is OFF.

14 CLOCK AND TIMERS

■ Clock operation

◇ Setting the clock

- ① While pushing [F], push [9] CLOCK twice to enter the time setting condition.
 - The hour digit blinks.
- ② Rotate the tuning dial to set the hour. (24-hour system)
- ③ Push [*▽] or [#△]; then rotate the tuning dial to set the minutes.
- ④ To start the clock, push [A CLR].
 - The clock starts from 0 sec. and ":" blinks.
- ⑤ To cancel time setting and exit the time setting condition, push [PTT].

◇ Calling up the clock display

- Push [F] + [9] CLOCK to call up the clock display.

TIME ERROR: ±1 min./week

NOTE: CPU resetting clears the clock time. Set the time again in this case.

[EXAMPLE]: Setting the clock for 15:45.

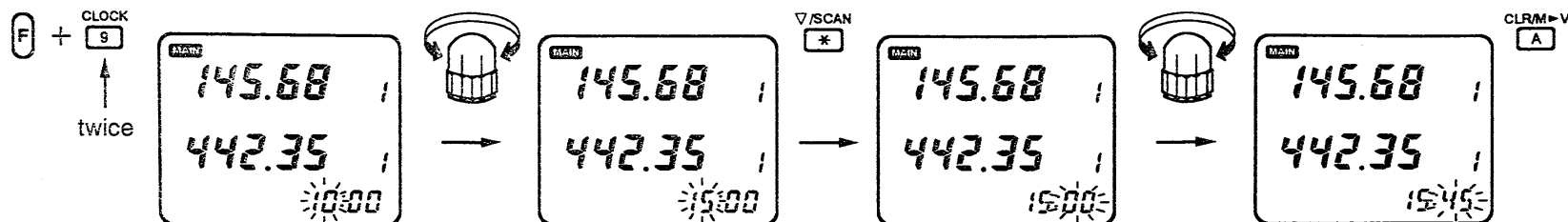

■ Timer mode

The transceiver has a built-in 24-hour clock with auto power-off, power-on timer and power-off timer functions.

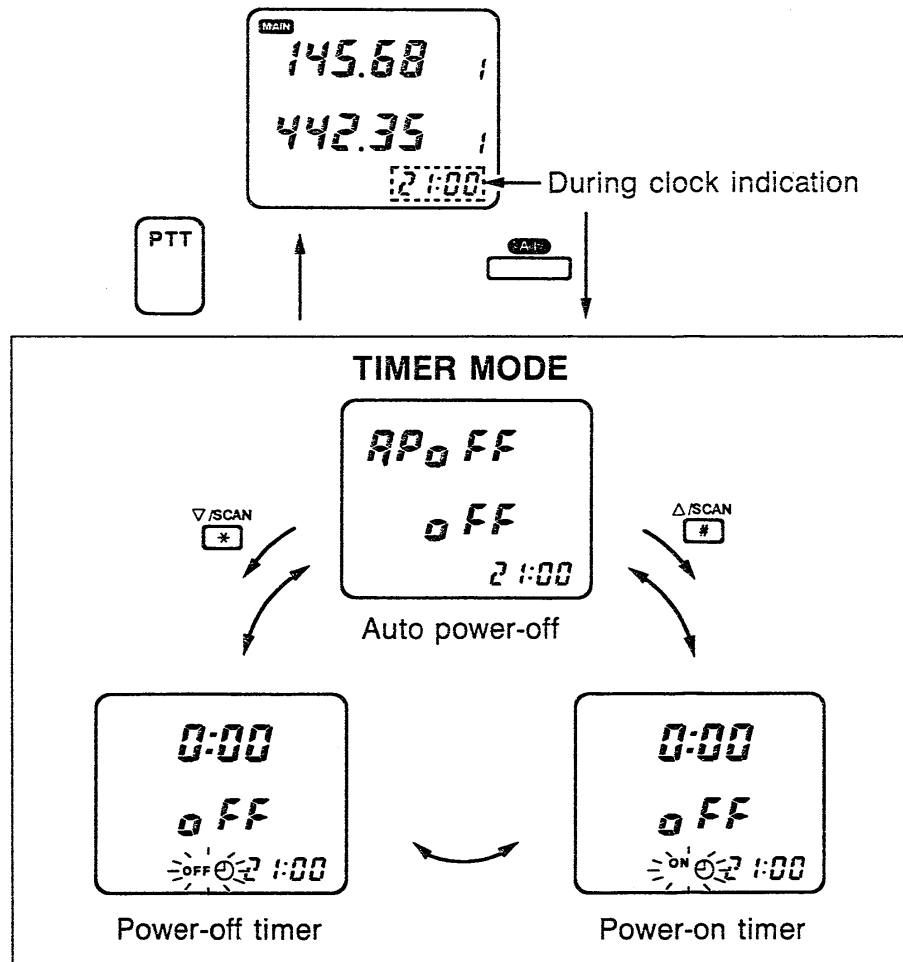

■ Auto power-off

The transceiver automatically turns OFF after a selected period in which no switch is pushed.

60 min., 40 min., 20 min. and OFF can be selected. The selected period is retained even when the transceiver is turned OFF by the auto power-off function. To cancel the function, select "oFF" in step ④ below.

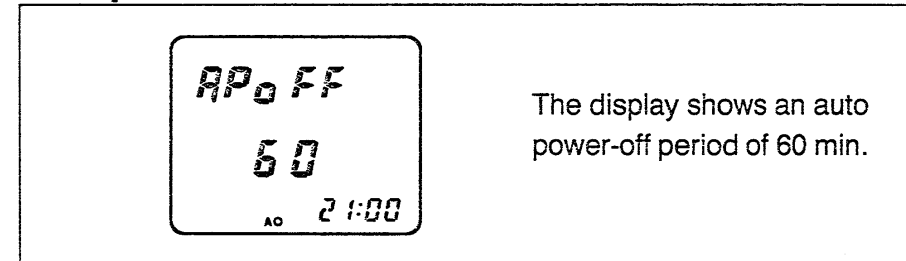

- ① Push [F] + [⑨ CLOCK] to call up the clock display.
- ② Push [AI] to select timer mode.
- ③ Push [*/▽] or [#△] until "APoFF" appears to select the auto power-off display.
- ④ Rotate the tuning dial to select the auto power-off period.
- ⑤ Push [PTT] to exit timer mode.
 - When the set period passes, the power is automatically turned OFF with 5 beeps.
 - "AO" appears when the auto power-off function is in use.

14 CLOCK AND TIMERS

■ Power-on timer

Use the power-on timer to suit your schedule and to save battery power.

- ① Select VHF or UHF with [D BAND].
- ② Push [A CLR] to select VFO mode; then rotate the tuning dial to set the operating frequency.
- ③ Adjust the selected band's [VOL] to the desired audio level.
- ④ Push [F] + [9 CLOCK] to call up the clock display.
- ⑤ Push [AI] to select timer mode.
- ⑥ Push [* ▽] or [# △] until "ON ⊖" blinks to select the power-on display.
- ⑦ Rotate the tuning dial clockwise to turn the power-on timer ON.
- ⑧ Set the power-on time:
 - Push [F] + [8 SET]; then rotate the tuning dial to set the hour.
 - Push [* ▽] or [# △]; then rotate the tuning dial to set the minutes.
 - Push [A CLR] to enter the time.

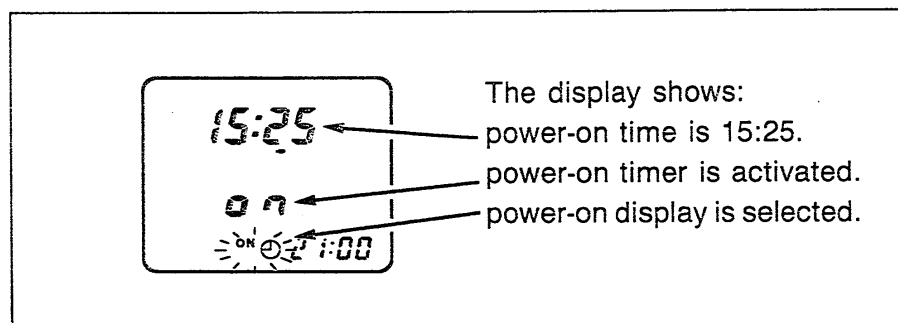

- ⑨ Push [POWER] for 1 sec. to turn the power OFF.
 - When the set time arrives, the power is automatically turned ON with 5 beeps and the power-on timer ON/OFF setting is set to OFF.

Cancel the power-on timer:

- ① Push [F] + [9 CLOCK] to call up the clock display.
- ② Push [AI] to select timer mode.
- ③ Push [* ▽] or [# △] until "ON ⊖" blinks to select the power-on display.
- ④ Rotate the tuning dial counterclockwise to turn the power-on timer OFF.

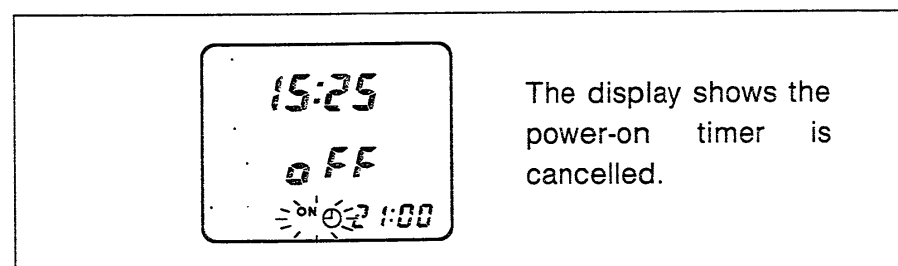

- ⑤ Push [PTT] to exit timer mode.

■ Power-off timer

Like the power-on timer, the power-off timer can be set to suit your schedule and conserve battery power. When the timer is activated, the timer indicator appears in the function display and the transceiver operates normally until the pre-set time at which it will turn OFF.

- ① Push [F] + [⑨ CLOCK] to call up the clock display.
- ② Push [A] to select timer mode.
- ③ Push [*▽] or [#△] until "OFF⊖" blinks to select the power-off display.
- ④ Rotate the tuning dial clockwise to turn the power-off timer ON.
- ⑤ Set the power-off time:
 - Push [F] + [⑧ SET]; then rotate the tuning dial to set the hour.
 - Push [*▽] or [#△]; then rotate the tuning dial to set the minutes.
 - Push [A CLR] to enter the time.

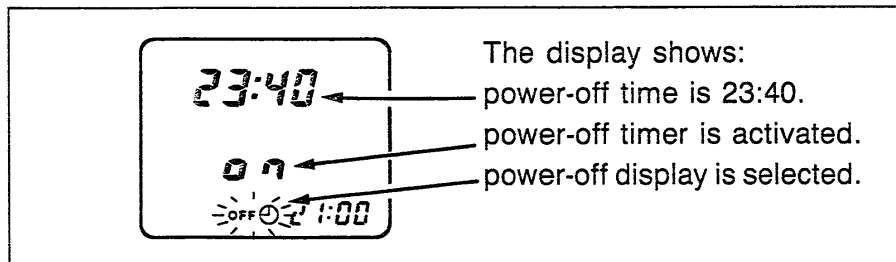

- ⑥ Push [PTT] to exit timer mode.
 - "OFF⊖" appears when the power-off timer is in use.
 - When the set time arrives, the power is automatically turned OFF with 5 beeps and the power-off timer ON/OFF setting is set to OFF.

Cancel the power-off timer:

- ① Push [F] + [⑨ CLOCK] to call up the clock display.
- ② Push [A] to select timer mode.
- ③ Push [*▽] or [#△] until "OFF⊖" blinks to select the power-off display.
- ④ Rotate the tuning dial counterclockwise to turn the power-off timer OFF.

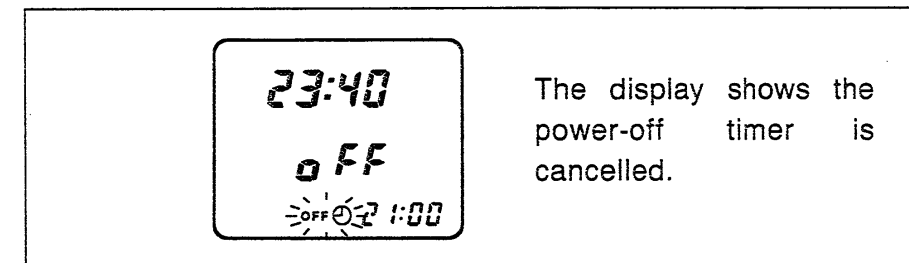

- ⑤ Push [PTT] to exit timer mode.

15 PAGER AND CODE SQUELCH

■ Pager function

This function uses DTMF codes for paging and can be used as a “message pager” to inform you of a caller’s identity even if you leave the transceiver temporarily unattended.

Personal calls and group calls are available with the pager function. Personal calls use the receiving parties’ ID code for calling. The receiving parties’ display shows your ID code and other stations in the party know that you called. You can also call all stations in your group using the group call.

To use the pager function in your group, all stations need the pager function.

During pager operation, the power saver duty cycle becomes 1:1 if the power saver is activated.

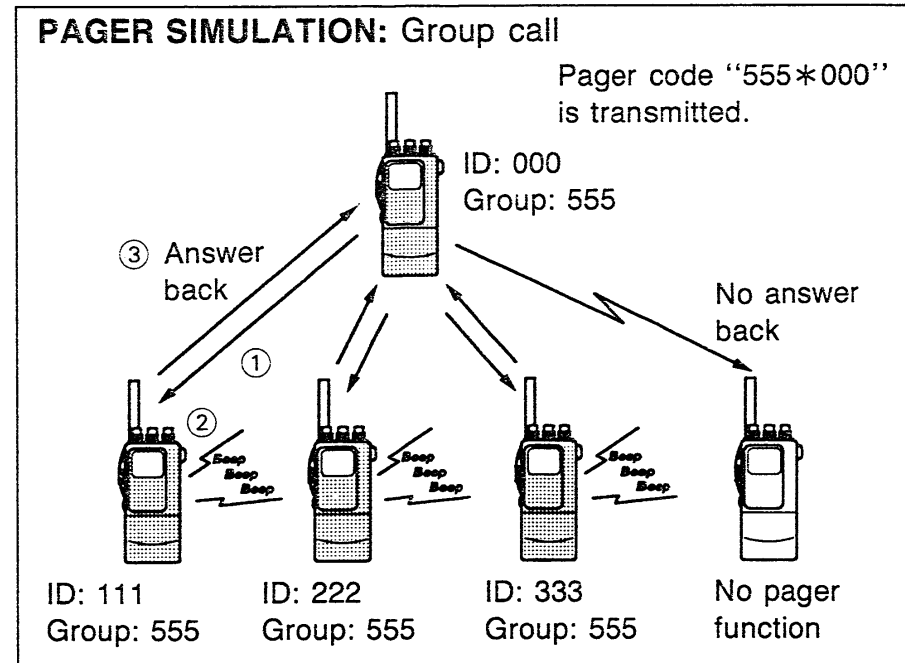
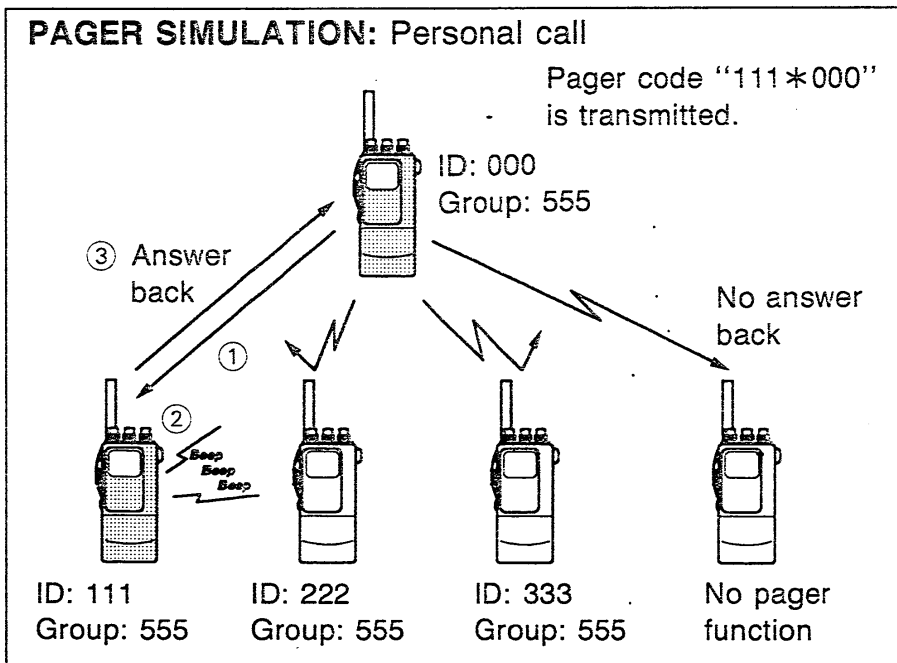

■ Code channel

• Before programming

The pager and code squelch functions require ID codes and a group code. These codes are 3-digit DTMF codes and must be written into the code channels before operation.

• Code channel assignment

| ID or group code | Code channel number | “Receive accept” or “Receive inhibit” |
|------------------------|---------------------|---|
| Your ID code | C0 | “Receive accept” only. |
| Other parties' ID code | C1 - C5 | “Receive inhibit” should be programmed in each channel. |
| Group code | One of C1 - C5 | “Receive accept” must be programmed. |
| Memory space* | CP | “Receive inhibit” only. |

* Channel CP automatically memorizes an ID code when receiving a pager call. The contents in channel CP cannot be changed manually.

“RECEIVE ACCEPT” OR “RECEIVE INHIBIT”

Code channels C1 - C5 should be effectively programmed as “Receive accept” or “Receive inhibit.”

- “Receive accept” (“SKIP” indicator is not illuminated) accepts pager calls when the transceiver receives a signal with a code the same as that in the code channel.
- “Receive inhibit” (“SKIP” indicator is illuminated) rejects calls even when the transceiver receives a signal with a code the same as that in the code channel.

For example, the code channel that stores the group code should be programmed as “Receive accept.” If the channel is programmed as “Receive inhibit,” you cannot receive group calls.

The code channels that store other parties' ID codes for a transmit code should be programmed as “Receive inhibit.” If the channels are programmed as “Receive accept,” personal calls for parties other than yours will be received.

■ Code programming

- ① Select VHF or UHF with [D BAND].
 - Each band has separate code channels.
- ② Push [F] + [5 CODE] to select the code channel setting display.
- ③ Rotate the tuning dial to select the desired code channel, C0 - C5.
 - Code channel CP cannot be used for programming.
- ④ Push the numeral keys to enter the desired 3-digit code.
 - Digits are automatically stored once the 3rd digit has been entered.
 - When an unwanted digit is entered, push [A CLR] and enter the desired code from the beginning.
- ⑤ Push [F] + [3 SKIP] to set the channel for “receive inhibit” or “receive accept.”
 - When “receive inhibit” is set, “SKIP” is illuminated.
 - Code channel C0 cannot be set as “receive inhibit.”
 - See the previous page for “receive inhibit” or “receive accept” details.
- ⑥ Push [PTT] to exit the setting display.

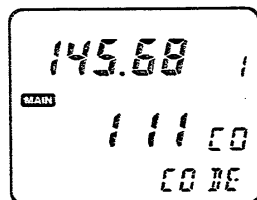

The display shows code channel C0 is programmed for 111.

■ Pager operation

◇ Calling a specific station

- ① Select VHF or UHF with [D BAND].
 - The pager function can be used on one band only.
- ② Set the operating frequency.
- ③ Push [F] + [2 PGR/C SQL] to turn the pager function ON.
 - “P” appears in place of the 100 MHz digit.
 - An optional tone squelch can be used together with the pager function. (p. 45)
- ④ Select the desired code channel:
 - Push [F] + [5 CODE].
 - Rotate the tuning dial to select the channel.
 - Push [PTT] to exit the setting display.
- ⑤ Push [PTT] to transmit the pager code.
- ⑥ Wait for an answer back.
 - When the transceiver receives an answer back code, the function display shows the other party’s ID or group code.
- ⑦ After confirming a connection, push [AI] to display the operating frequency.
 - **DO NOT** push numeral keys while code channels C0 - C5 are indicated, or code channel contents are changed.
- ⑧ Push [F] + [2 PGR/C SQL] once to select the code squelch or twice to select the non-selective calling system.

◇ Waiting for a call from a specific station

- ① Select VHF or UHF with [D BAND].
 - The pager function can be used on one band only.
- ② Set the operating frequency.
- ③ Push [F] + [② PGR/C SQL] to turn the pager function ON.
 - “P” appears in place of the 100 MHz digit.
 - An optional tone squelch can be used together with the pager function. (p. 45)
- ④ Wait for a call.
 - When receiving a call, your ID or group code appears and the receiving time blinks as shown at right.
 - **DO NOT** push numeral keys while code channels C0 - C5 are indicated, or code channel contents are changed.
- ⑤ Push [PTT] to send an answer back call and display the operating frequency.
- ⑥ Push [F] + [② PGR/C SQL] once to select the code squelch or twice to select the non-selective calling system.

PERSONAL CALL

This display appears when you are called with your ID code and the calling station's ID code is 386.

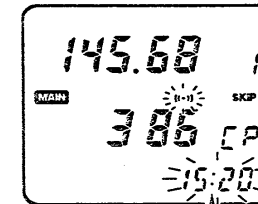

Receiving time blinks.

GROUP CALL

This display appears when you are called with the group code, 123, and 123 has been programmed into code channel C5.

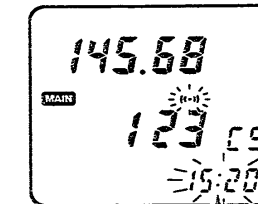

Receiving time blinks.

ERROR INFORMATION

When the transceiver receives an incomplete signal, “E” appears.

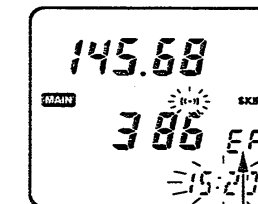

“E” appears.

15 PAGER AND CODE SQUELCH

■ Code squelch operation

The code squelch allows you communication with silent standby since you will only receive calls from stations which know your ID or group code.

The code squelch transmits a 3-digit code prior to voice transmission in order to open the receiving station's code squelch.

During code squelch operation, the power saver duty cycle becomes 1:1 if the power saver is activated.

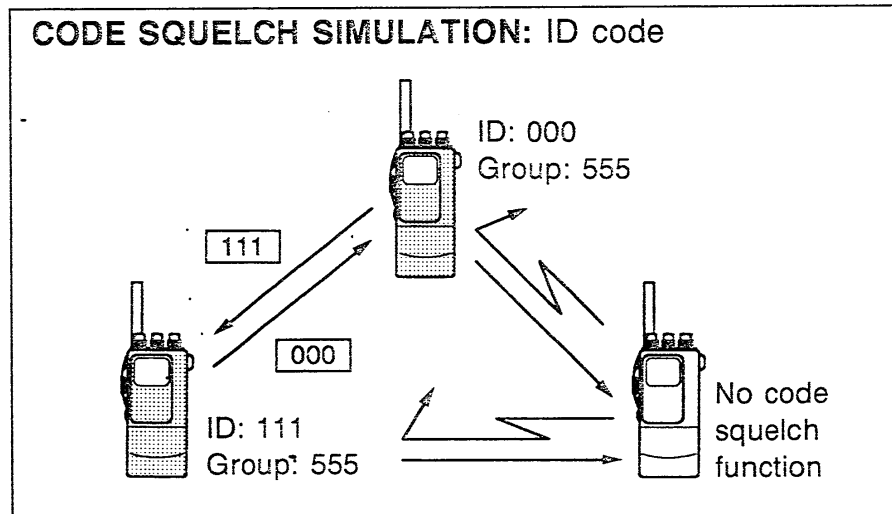

- ① Select VHF or UHF with [D BAND].
 - The code squelch can be used on one band only.
- ② Set the operating frequency.
- ③ Push [F] + [② PGR/C SQL] twice to turn the code squelch ON.
 - “C” appears in place of the 100 MHz digit.
 - An optional tone squelch can be used together with the code squelch. (p. 45)
- ④ Select the desired code channel:
 - Push [F] + [⑤ CODE].
 - Rotate the tuning dial to select the channel.
 - Push [PTT] to exit the setting display.
- ⑤ Operate the transceiver in the normal way (push [PTT] to transmit; release [PTT] to receive).
 - Prior to voice transmission, a 3-digit transmit code is sent each time [PTT] is pushed in order to open the receiving station's code squelch.
- ⑥ To cancel the code squelch, push [F] + [② PGR/C SQL].
 - “C” returns to indicate the 100 MHz digit.

■ Optional UT-63 installation

An optional UT-63 TONE SQUELCH UNIT is available for this transceiver. The UT-63 provides pocket beep, tone squelch and programmable tone encoder functions. The U.S.A. version already includes an equivalent unit.

- ① Turn power OFF, then remove the battery pack or DC power cable.
- ② Unscrew the 6 screws; then, remove the bottom plates as shown below.

CAUTION:

Use a Phillips screw driver that matches the screw size. Otherwise, you may strip the screw head.

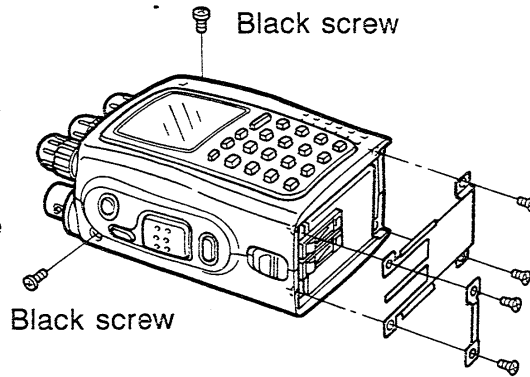

- ③ Carefully separate the front and rear panels as shown in the top right-hand corner of this page.
 - **BE CAREFUL** not to lose the battery pack release button.

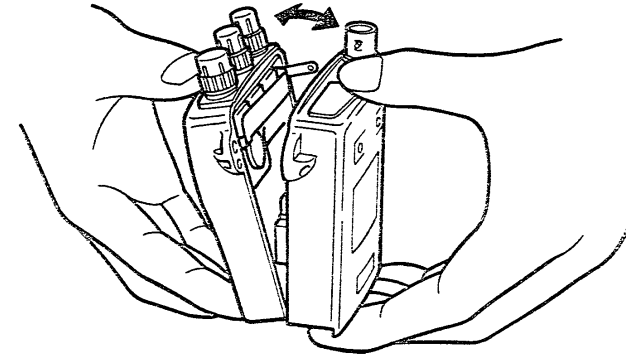

- ④ Plug in the UT-63 as shown below.
- ⑤ Reassemble the front and rear panels; then, tighten the 2 black screws as shown in step ②.
- ⑥ Push the connector board firmly to securely connect it to the inside connectors.
- ⑦ Slide the bottom plate back in place. Be sure the center prong of the plate is inserted into the ridge of the release button.
- ⑧ Attach the corner holder; then tighten the 4 remaining screws.

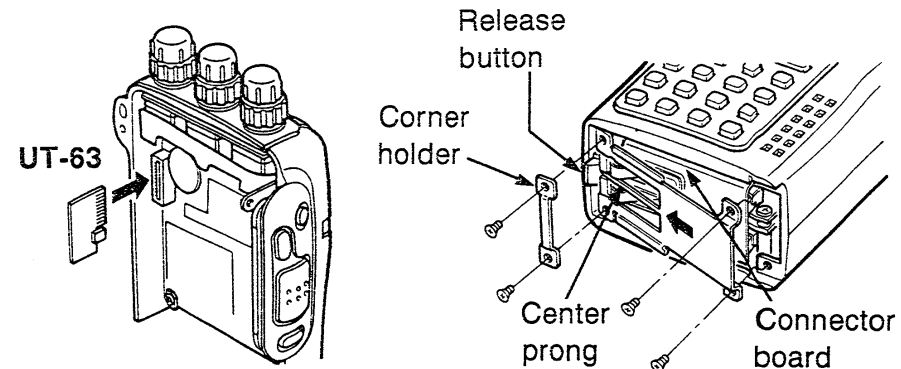

16 POCKET BEEP AND TONE SQUELCH

■ Pocket beep operation

This function uses subaudible tones for calling and can be used as a “common pager” to inform you that someone has called while you were away from the transceiver.

◇ Waiting for a call from a specific station

- ① Select VHF or UHF with [D BAND].
- ② Set the operating frequency.
- ③ Program the subaudible tone frequency in set mode.
 - See p. 18 for programming details.
- ④ Push [F] + [① T/T SQL] several times until “T SQL ((•))” appears on the function display.
 - Turn OFF the pager or code squelch to activate the pocket beep. (pgs. 41 - 43) The pocket beep cannot be used in combination with the pager or code squelch.
- ⑤ When a signal with the correct tone is received, the transceiver emits beep tones for 30 sec. and flashes “((•)).”
- ⑥ Push [PTT] to answer or push [A CLR] to stop the beeps and flashing.
 - Tone squelch is automatically selected.

◇ Calling a waiting station using pocket beep

A subaudible tone matched with the station’s tone frequency is necessary. Use the tone squelch at right or a subaudible tone encoder (p. 17, optional for non-U.S.A. versions).

■ Tone squelch operation

The tone squelch opens only when receiving a signal with the same pre-programmed subaudible tone. You can silently wait for a call from group members using the same tone.

- ① Select VHF or UHF with [D BAND].
- ② Set the operating frequency.
- ③ Program the subaudible tone frequency in set mode.
 - See p. 18 for programming details.
- ④ Push [F] + [① T/T SQL] several times until “T SQL” appears on the function display.
 - The code squelch can be used together with the tone squelch. (p. 43)
- ⑤ When the received signal includes the correct tone, the squelch opens and the signal can be heard.
 - When the received signal includes an incorrect tone, the squelch does not open. Only the green indicator lights up.
 - To open the main band squelch manually, push and hold [MONI].
- ⑥ Operate the transceiver in the normal way (push [PTT] to transmit; release [PTT] to receive).
- ⑦ To cancel the tone squelch, push [F] + [① T/T SQL] several times until “T” or “T SQL” disappears from the function display.

■ Power saver

USING SET MODE

The power saver function reduces the current drain to conserve battery power. The power saver duty cycle can be set to 1:4, 1:16 or OFF. Setting it to 1:16 conserves the most power. For packet operation, the power saver should be turned OFF to receive reliable packet data.

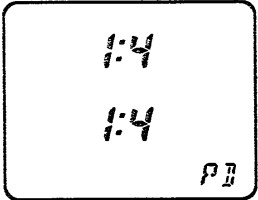
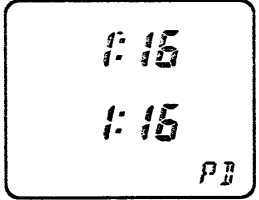
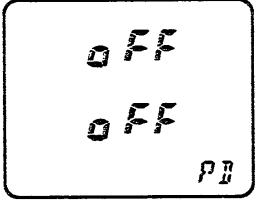
| | | |
|---|---|---|
|  |  |  |
| Standby 125 msec. | 125 msec. | Power saver is |
| Circuit off 500 msec. | 2 sec. | turned OFF. |

Common setting for both bands.

- ① Push [F] + [Ⓢ SET] to enter set mode.
- ② Push [Ⓢ▽] or [Ⓢ△] one or more times until "PD" appears in the display.
- ③ Rotate the tuning dial to select the desired duty cycle or to turn the function OFF.
- ④ Push [Ⓢ CLR] to exit set mode.

NOTE: When the duty cycle is set to 1:16, signals may be clipped up to a 2 sec. max.

■ Battery voltage indication

The transceiver has a battery capacity indicator that indicates the connected battery voltage as a %. This indicator is designed to show dry cell battery consumption in the BP-130* BATTERY CASE. When using the BP-131, BP-132 or BP-157, voltage is indicated; however, it is not useful. This is because once the voltage goes down, it will decrease rapidly as a result of the NiCd battery characteristics.

* Optional for versions which include the BP-157.

- ① While pushing [AI], rotate the tuning dial to select "BATT"; then, release [AI] to display the battery capacity indicator.
- ② The indicator shows the current voltage.
 - "B 100" means the same voltage as the starting voltage.
 - "B 80" means the voltage is at 80% of the starting voltage.
- ③ When the indicator shows "B 60" to "B 50," the dry cell batteries in the BP-130 cannot activate the transmitter circuitry.

◇ Resetting the indicator

When placing new dry cell batteries in the battery case, the indicator should be reset.

- ① Select the battery capacity indicator as above procedure.
- ② Push [F] + [AI] to reset the reference voltage.
 - The indicator shows "B 100" (100% voltage).

17 OTHER FUNCTIONS

■ PTT lock function USING SET MODE

The PTT lock function locks the PTT switch electronically to prevent accidental transmission. The whisper function can be used even when the PTT lock function is in use.

- ① Push [F] + [8] SET] to enter set mode.
- ② Push [*▽] or [#△] one or more times until "PT" appears in the display.
- ③ Rotate the tuning dial to turn the PTT lock function ON ("PL") or OFF ("P").
- ④ Push [A CLR] to exit set mode.

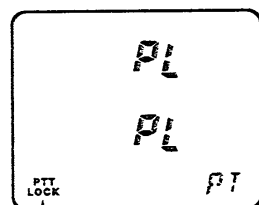

PTT lock indicator appears when the function is in use.

■ Beep tone on/off USING SET MODE

The beep tone which sounds each time a switch is pushed can be turned ON or OFF, as desired.

- ① Push [F] + [8] SET] to enter set mode.
- ② Push [*▽] or [#△] one or more times until "BE" appears in the display.
- ③ Rotate the tuning dial to select the beep tone "on" or "oFF."
- ④ Push [A CLR] to exit set mode.

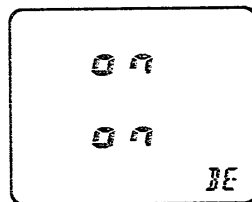

■ Receive indicator on/off USING SET MODE

The receive indicator can be turned ON or OFF. Turn it OFF when you want to conserve battery power.

- ① Push [F] + [8] SET] to enter set mode.
- ② Push [*▽] or [#△] one or more times until "BL" appears in the display.
- ③ Rotate the tuning dial to select the receive indicator "on" or "oFF."
- ④ Push [A CLR] to exit set mode.

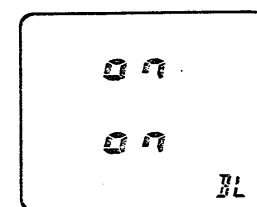

■ LCD contrast USING SET MODE

The LCD (Liquid Crystal Display) contrast can be selected from 2 levels (1 and 2) for your preference. Select a suitable level depending on the ambient light.

- ① Push [F] + [8] SET] to enter set mode.
- ② Push [*▽] or [#△] one or more times until "LC" appears in the display.
- ③ Rotate the tuning dial to select the desired contrast.
- ④ Push [A CLR] to exit set mode.

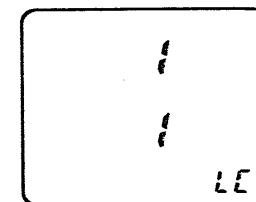

- Level 2 is higher contrast.

■ External speaker selection USING SET MODE

When an external speaker is connected, audio of each band can be selected to external equipment or the internal speaker.

- ① Push [F] + [8 SET] to enter set mode.
- ② Push [*▽] or [#△] one or more times until "SP" appears in the display.
- ③ Push [D BAND] to select the desired band.
- ④ Rotate the tuning dial to set the selected band audio for external equipment ("out") or internal speaker ("in").
 - Even if "out" is selected, audio is emitted via the internal speaker when the [SP] jack has no connection.
- ⑤ Push [A CLR] to exit set mode.

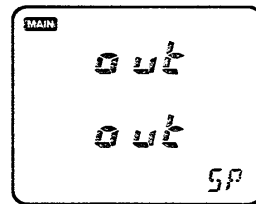

■ Optional HM-75 functions

When using an optional HM-75 with the transceiver, the switches on the HM-75 function as follows:

① A SWITCH

Changes the main band between VHF and UHF or activates a function assigned in the AI function indicator. (See below.)

② B SWITCH

Changes mode between VFO and memory.

③ ▽/△ SWITCHES

- Change the frequency in the selected tuning steps in VFO mode.
- Change memory channel in memory mode.
- Start programmed scan or memory skip scan when pushed for 1 sec.

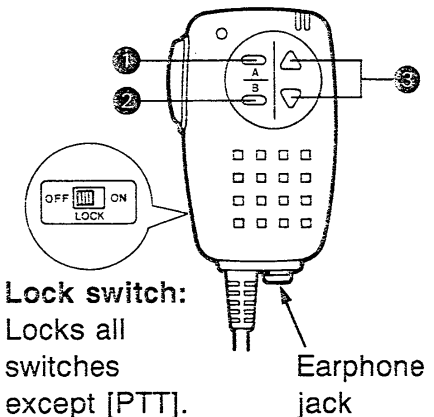

◇ Setting the [A] switch as [AI]

- ① Turn power OFF.
- ② While pushing [F] and [AI], turn power ON.

◇ Setting the [A] switch as [D BAND] (default setting)

- ① Turn power OFF.
- ② While pushing [F] and [D BAND], turn power ON.

■ Partial resetting

If you want to initialize the operating condition (VFO frequency, VFO settings, set mode contents) without clearing the memory contents, repeater memories, clock or timer, a partial resetting function is available for the transceiver.

- While pushing [A CLR], turn power ON to partially reset the transceiver.

18 MODE ARRANGEMENT CHART

Although the following chart refers only to the VHF band, the transceiver has the same mode arrangement in the UHF band.

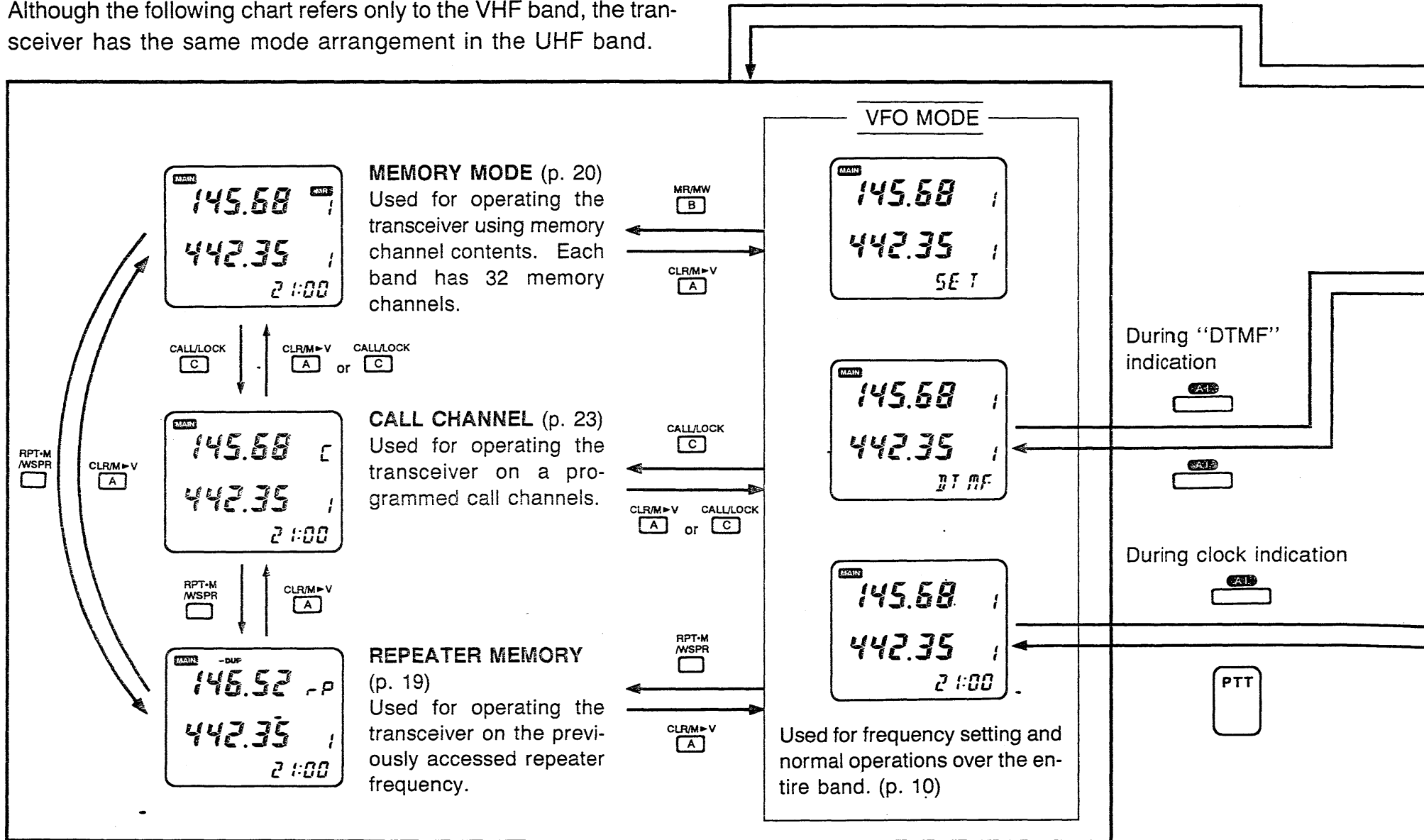

[F] + [SET 8]

CLR/M-V
[A]

DTMF MEMORY MODE

2 1A 6E t4
442.35
DT MF

See p. 31 for details.

TIMER MODE

AP OFF
OFF
2:00

Auto power-off
(p. 36)

0:00
OFF
OFF 1:00

Power-off timer
(p. 38)

0:00
OFF
ON 1:00

power-on timer
(p. 37)

SET MODE

Subaudible tone
frequency*1*2(p.18)

88.5
88.5
TQ

Offset frequency*2
(p. 18)

.50
5.00
OW

PTT lock (p. 47)

P
P
PT

Beep tone (p. 47)

07
07
BE

Frequency skip
function (p. 27)

07
07
PS

Auto repeater power
control (p. 19)

OFF
OFF
rP

Learning function
(p. 34)

07
07
RI

Whisper time-out
timer (p. 32)

5
5
TT

down function
(p. 16)

07
07
EL

External speaker
selection (p. 48)

out
out
SP

Scan resume
condition (p. 29)

t-10
t-10
SC

Power saver duty
cycle (p. 46)

1:4
1:4
PB

Receive indicator
(p. 47)

07
07
BL

LCD contrast
(p. 47)

1
1
LC

*1 Appears when an optional UT-63 is installed except for the U.S.A. version.

*2 The contents cannot be changed when entering set mode from a repeater memory.

NOTE: These displays show the default settings except for the offset frequency setting.

19 TROUBLESHOOTING

If your transceiver seems to be malfunctioning, please check the following points before sending it to a service center.

| PROBLEM | POSSIBLE CAUSE | SOLUTION | REF. |
|--|--|--|---|
| <ul style="list-style-type: none"> No power comes on. | <ul style="list-style-type: none"> The battery is exhausted. (A slight current flows in the circuits even when the power is OFF.) Poor plug connection to the external DC power cable. | <ul style="list-style-type: none"> Charge the battery pack or place new dry cell batteries in the battery case. (Remove the battery pack if you will not be using the transceiver for a long time.) Check the connector or remove and replace the cable. | <p>pgs. i, 8</p> <p>—</p> |
| <ul style="list-style-type: none"> Power cannot be turned OFF. | <ul style="list-style-type: none"> The battery became exhausted during operation. | <ul style="list-style-type: none"> Charge the battery pack or place new dry cell batteries in the battery case, then, turn the power OFF. | <p>pgs. i, 8</p> |
| <ul style="list-style-type: none"> No sound comes from the speaker. | <ul style="list-style-type: none"> [SQL] is turned too far clockwise. An external speaker or earphone is connected. Pager or code squelch is activated. | <ul style="list-style-type: none"> Rotate [SQL] counterclockwise. Unplug the speaker or earphone. Push [F] + [② PGR/C SQL] once or twice to turn the function OFF. | <p>p. 14</p> <p>—</p> <p>pgs. 41 - 43</p> |
| <ul style="list-style-type: none"> Transmitting is impossible. | <ul style="list-style-type: none"> The battery is exhausted. | <ul style="list-style-type: none"> Charge the battery pack or place new dry cell batteries in the battery case. | <p>pgs. i, 8</p> |
| <ul style="list-style-type: none"> Frequency cannot be set. | <ul style="list-style-type: none"> Memory mode, call channel or repeater memory is selected. The lock function is activated. | <ul style="list-style-type: none"> Push [A CLR] one or more times to select VFO mode. Push [F] + [C LOCK] to deactivate the lock function. | <p>p. 10</p> <p>p. 11</p> |
| <ul style="list-style-type: none"> Scan cannot be activated. | <ul style="list-style-type: none"> The squelch is open. | <ul style="list-style-type: none"> Rotate the [SQL] control clockwise until noise disappears. | <p>pgs. 25, 28</p> |
| <ul style="list-style-type: none"> The contents of the memories are erased. | <ul style="list-style-type: none"> The internal memory backup battery is exhausted because no charging has been performed for a long time. | <ul style="list-style-type: none"> Charge the battery pack or place new dry cell batteries in the battery case. The memory backup battery is simultaneously charged. | <p>pgs. i, 8</p> |

SPECIFICATIONS 20

| | | VHF | UHF | |
|--|--|-----------------|--|-----------------|
| GENERAL | Frequency coverage (Guaranteed range of VHF is 144 - 148 MHz) | U.S.A. | Tx: 144 - 148 MHz Rx: 138 - 174 MHz | 440 - 450 MHz |
| | | Asia | Tx: 144 - 148 MHz Rx: 138 - 174 MHz | 430 - 440 MHz |
| | | Australia | 144 - 148 MHz | 430 - 440 MHz |
| | | Europe, U.K. | 144 - 146 MHz | 430 - 440 MHz |
| | | Italy | Tx: 144 - 148 MHz Rx: 138 - 174 MHz | 430 - 440 MHz |
| | | Denmark | 144 - 146 MHz | 432 - 438 MHz |
| | Mode | FM (F3E) | | |
| Frequency stability | ± 5 ppm (0°C - +50°C; +32°F - +122°F) | | | |
| Tuning steps | 5, 10, 12.5, 15, 20, 25, 30 or 50 kHz | | | |
| Antenna impedance | 50 Ω (nominal) | | | |
| Usable battery pack/case | BP-130 - BP-132, BP-157 | | | |
| External DC power | 6 - 16 V DC (negative ground) | | | |
| Current drain (at 13.5 V, typical) | Tx | High | 1.3 A | 1.5 A |
| | | Low 1 | 500 mA | 600 mA |
| | 1 band Rx | Rated audio | 150 mA | 150 mA |
| | | Power saved | 15 mA (average) | 20 mA (average) |
| 2 bands Rx | Rated audio | 200 mA | | |
| | Power saved | 35 mA (average) | | |
| Usable temperature range | -10°C - +60°C; +14°F - +140°F | | | |
| Dimensions (with BP-157) (projections not included) | 57(W) × 125(H) × 35(D) mm; 2.2(W) × 4.9(H) × 1.4(D) in | | | |
| Weight (with BP-157 and FA-B270A) | 390 g; 13.8 oz | | | |

| | | VHF | UHF | |
|------------------------|-------------------------------------|--|----------|-----------|
| TRANSMITTER | Output power* (at 13.5 V) | 5 W, 3.5 W, 1.5 W, 500 mW, 15 mW (selectable) | | |
| | Modulation system | Variable reactance frequency modulation | | |
| | Max. freq. deviation* | ± 5 kHz | | |
| | Spurious emissions* | Less than -60 dB | | |
| | Microphone impedance | 2 kΩ | | |
| RECEIVER | Receive system | Double-conversion superheterodyne | | |
| | Intermediate frequencies | 1st | 43.1 MHz | 45.15 MHz |
| | | 2nd | 455 kHz | |
| | Sensitivity* (for 12 dB SINAD) | Less than 0.16 μV | | |
| | Squelch sensitivity | Less than 0.13 μV (at threshold) | | |
| | Selectivity | More than 15 kHz/ -6 dB Less than 30 kHz/ -60 dB | | |
| | Spurious and image rejection ratio* | More than 60 dB (More than 45 dB at IF/2) | | |
| | Audio output power* (at 13.5 V) | More than 200 mW (at 10% distortion with an 8 Ω load) | | |
| Audio output impedance | 8 Ω | | | |

*Specifications guaranteed at a transceiver temperature of +25°C (+77°F).

All stated specifications are subject to change without notice or obligation.

21 OPTIONS

Some versions cannot use all of the following options since electrical standards, etc. vary between countries. Ask your Icom Dealer which options are available.

| BATTERY PACK | HEIGHT | VOLTAGE | CAPACITY | CARRYING CASE | SUB MICROPHONE |
|--------------|-----------------|----------------------------------|----------|---------------|----------------|
| BP-130 | 50 mm, 2.0 in | Battery case R6 (AA) size × 6 | | LC-105 | Not included |
| BP-131 | 50 mm, 2.0 in | 7.2 V | 900 mAh | LC-105 | Included |
| BP-132 | 78.2 mm, 3.1 in | 12.0 V | 600 mAh | LC-106 | Included |
| BP-157 | 50 mm, 2.0 in | 7.2 V | 900 mAh | LC-105 | Not included |

CP-13/L
CIGARETTE LIGHTER
CABLE WITH NOISE FILTER
For operation and charging
with a 12 V cigarette lighter
socket.

OPC-288/L
DC POWER CABLE
For operation and charging
with an external power supply.

BC-77A/E/D/V
WALL CHARGER
Regularly charges a battery
pack.

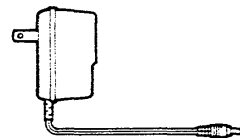
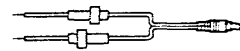
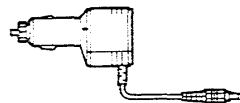

AD-25
BATTERY CHARGE
ADAPTER
Allows you to charge
the BP-131, BP-132
or BP-157.

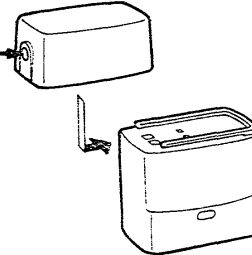

BP-131,
BP-132 or
BP-157

BC-79 DESKTOP CHARGER + AD-28 BATTERY PACK ADAPTER

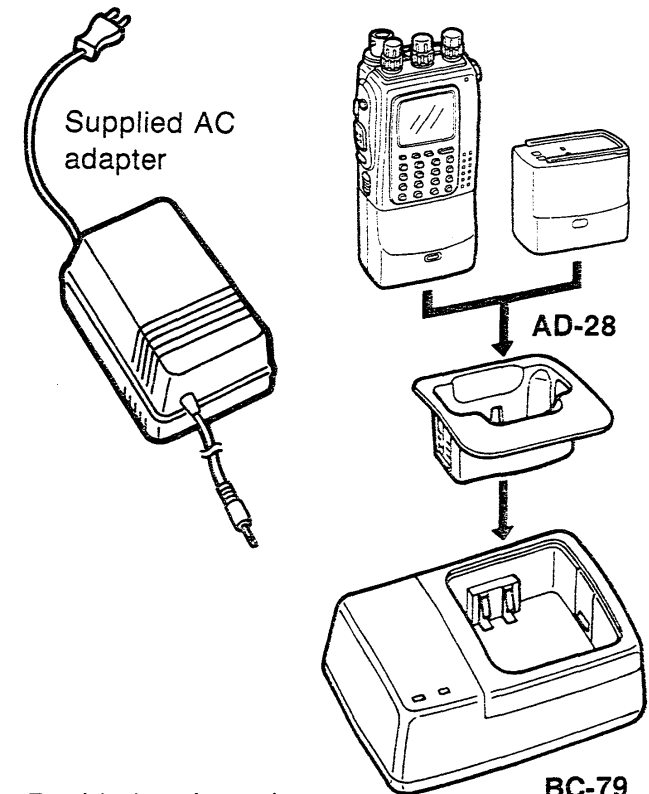

- Rapid charging takes 1 - 1.5 hrs.
- An AC adapter is packed with the BC-79.
- The CP-13/L or OPC-288/L can be used instead of the supplied AC adapter.

NOTE: Audio output from the [SP] jack can be selected in set mode. When external equipment is connected, only the selected band audio can be heard. See p. 48 for details.

◆ **Speaker-microphones**

HM-9

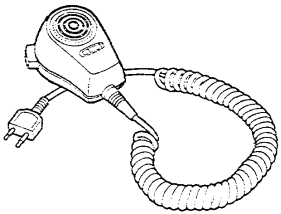

HM-46

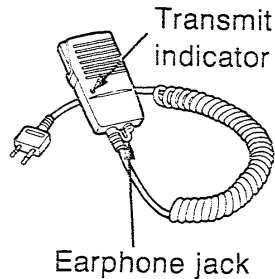

HM-54

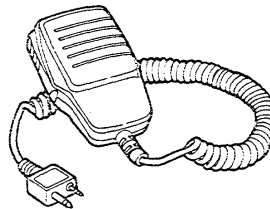

HM-55/A

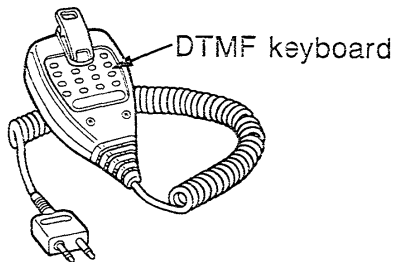

HM-75

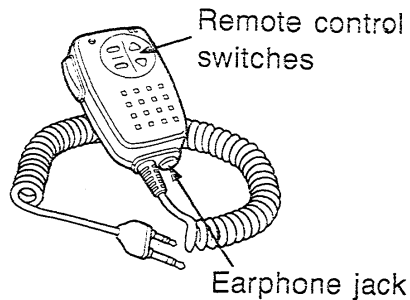

HM-30 MOUNTING BRACKET

When using the bracket hanger

When using the bracket hanger

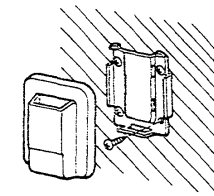
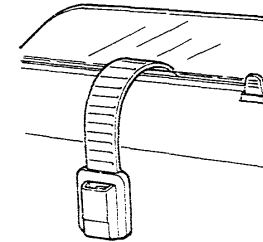

HS-51 HEADSET

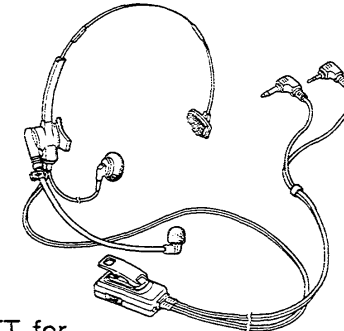

- PTT switch
- VOX
- One-touch PTT for hands-free operation

FA-B270A DUAL BAND FLEXIBLE ANTENNA

The same type as supplied with the transceiver.

SP-13 EARPHONE

Provides clear receive audio in noisy environments.

UT-63 TONE SQUELCH UNIT

Already installed in the U.S.A. version. Provides a "personalized" tone squelch system with other stations. Has simultaneous dual band capability with separate subaudible tone frequencies. Also functions as a programmable tone encoder.

Count on us!

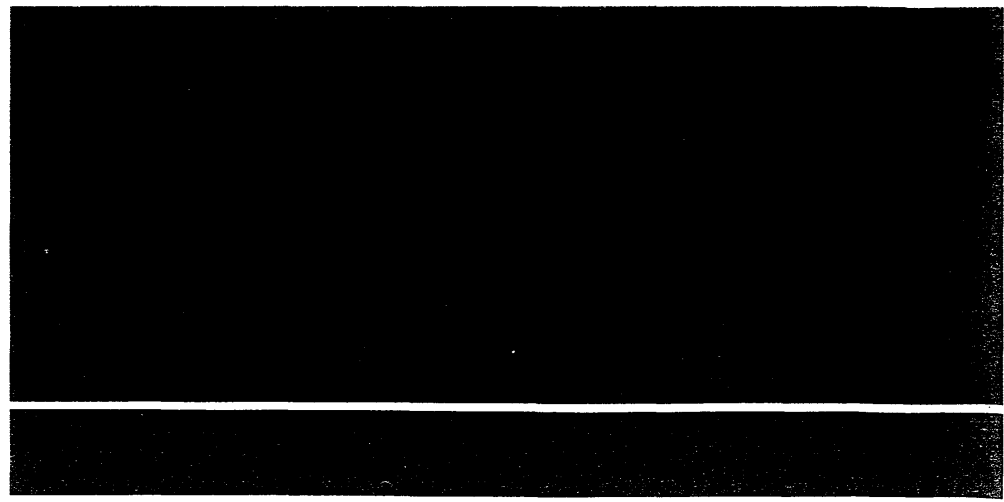

A-5239S-1EX-①
Printed in Japan
Copyright © 1993 by Icom Inc.

Icom Inc.
6-9-16, Kamihigashi, Hirano-ku, Osaka 547, Japan
