

RESTRICTED

THE INFORMATION GIVEN IN THIS DOCUMENT IS NOT TO BE
COMMUNICATED EITHER DIRECTLY OR INDIRECTLY TO THE
PRESS OR TO ANY PERSON NOT AUTHORIZED TO RECEIVE IT

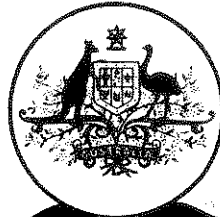

AUSTRALIAN MILITARY FORCES



USER HANDBOOK
ON
RECEIVER RADIO R5223

MILITARY BOARD

Army Headquarters
CANBERRA.

Issued by command of the Military Board.

AMENDMENTS

AAO's	Amendment No	Signature and date

**Act
at Once**

MOUTH-TO-MOUTH RESUSCITATION OF ELECTRIC SHOCK VICTIMS

*Every Second
Counts*

SWITCH OFF, IF NOT POSSIBLE PROTECT HANDS WITH DRY INSULATING MATERIAL AND PULL VICTIM CLEAR OF CONDUCTOR. LAY VICTIM ON HIS BACK. IF NOT EASY TO DO, WORK WHERE HE IS.

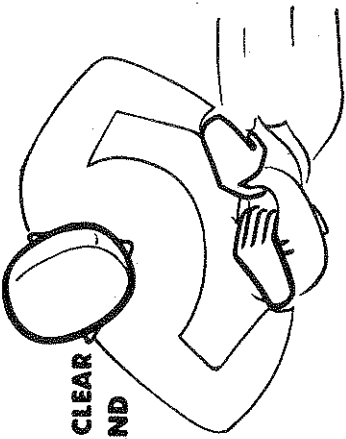
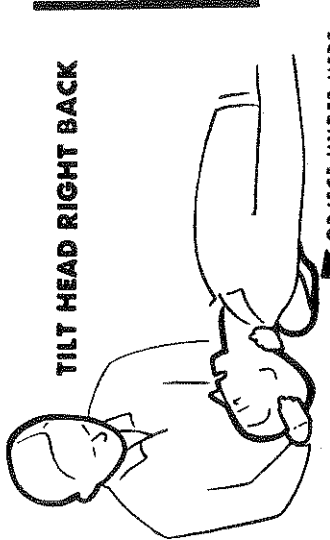
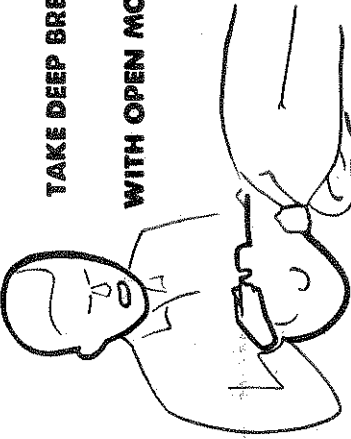
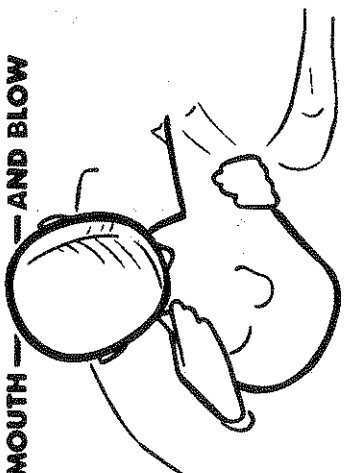
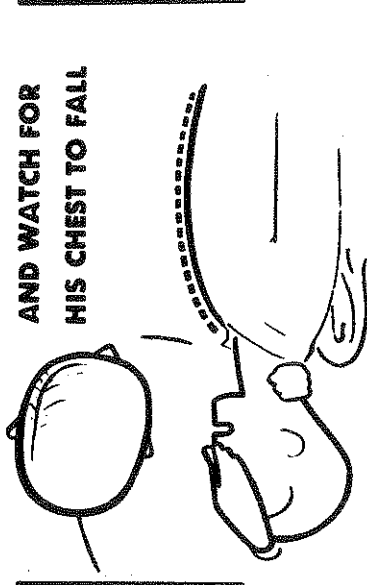
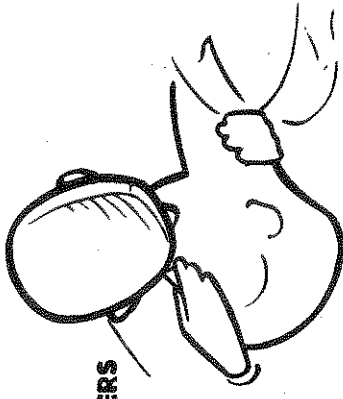
- 1** QUICKLY CLEAR MOUTH AND THROAT

- 2** TILT HEAD RIGHT BACK

- 3** PINCH NOSE WITH FINGERS, AND TAKE DEEP BREATH WITH OPEN MOUTH

- 4** SEAL HIS MOUTH WITH YOUR MOUTH — AND BLOW

- 5** WHEN HIS CHEST RISES TURN YOUR HEAD, LISTEN FOR ESCAPING AIR, AND WATCH FOR HIS CHEST TO FALL

- 6** INHALE THEN BLOW AGAIN AND CONTINUE CYCLE UNTIL VICTIM RECOVERS

*Do not leave
victim until
help arrives*

MAKE YOUR FIRST 10 BREATHS FAST, THEN ABOUT 10-15 A MINUTE

*If Help near
send for
Doctor*

THIS METHOD MAY ALSO BE USED FOR DROWNING, SUFFOCATION, STRANGULATION, DRUG OVERDOSE, AND HEART ATTACK

SYNOPSIS

The Receiver, Radio, R5223 provides facilities for the reception of CW, MCW, and VOICE emissions within the 1.5 to 30.5 Mc/s range. It may be used for general communication and interception purposes, including operation in aircraft. The sealed sub-unit principle is used in the receiver design, and mounting of the valves outside the seals facilitates replacement. The receiver is suitable for 19-inch rack mounting.

CONTENTS

CHAPTER ONE - GENERAL DESCRIPTION

<u>Section</u>		<u>Page</u>
1	Purpose and Facilities	1
2	Frequency Range	1
3	Power Supply - Sources	1
4	Performance - Inputs Audio Output IF Output Frequency Stability Characteristics Calibration Accuracy	3 3 3 3 3
5	Controls and Connecting Points	3
6	General Construction	9
7	Weight and Dimensions	10
8	Accessories	10

CHAPTER TWO - OPERATION

9	Preliminary Instructions - Action on Receipt of an Equipment Setting up R5223 Receiver Checking Valve Currents	11 11 13
10	Operating Instructions - Operation on Voice Operation on CW Diversity Reception Operating with a Transmitter	13 15 17 17

CHAPTER THREE - UNIT SERVICING AND ADJUSTMENTS

11	General	18
12	Replacements - Valves Fuses Lamps	18 19 19

ILLUSTRATIONS

<u>Fig No.</u>		<u>Pages</u>
1	Receiver, Radio, R5223	2
2	Receiver, Radio, R5223 - Controls and Connecting Points	4 and 6
3	Receiver, Radio, Block Schematic Diagram	8
4	Receiver, Radio, R5223 - Controls and Connecting Points	12, 14, and 16

CHAPTER ONE – GENERAL DESCRIPTION

SECTION 1 – PURPOSE AND FACILITIES

1. The Receiver, Radio, R5223 is a high grade HF receiver. It may also be used for general communication and interception purposes, including operation in aircraft.
2. The set employs the double superheterodyne principle, and facilities are provided for the reception of CW, MCW, and VOICE emissions.
3. Detachable brackets are provided for attachment to the ends of the receiver to enable it to be fitted into standard 19-inch rack mounting.
4. Operation in aircraft up to heights of 25,000 feet is possible, and the receiver will function satisfactorily at all atmospheric pressures encountered from sea level to that altitude. The equipment may be air-dropped using standard air-dropping equipment.
5. The receiver is hermetically sealed, and is therefore suitable for universal use.
6. It will function with any type of aerial.

SECTION 2 – FREQUENCY RANGE

7. The R5223 receiver has a frequency coverage of 1.5 Mc/s to 30.5 Mc/s in 29 bands of 1 Mc/s with sufficient overlap to ensure continuous frequency coverage.
8. The second intermediate frequency is at 500 kc/s. Variable frequency oscillator coverage is 2-3 Mc/s on all bands.

SECTION 3 – POWER SUPPLY

SOURCES

9. The receiver may be operated from the following power supplies:-

100 - 130 V ac	50 - 60 c/s
200 - 260 V ac	50 - 60 c/s
24 V dc	

SECTION 4 - PERFORMANCE

INPUTS

10. The input circuit of the receiver provides for:-
- (a) 70 ohms unbalanced - co-axial connector
 - (b) 70/600 ohms balanced

AUDIO OUTPUT

11. Two 75 ohm telephone sockets are fed against ground with a maximum level of 20 mW.
12. A balanced output for a 600 ohm cable is provided by terminals at which 20 mW are available.
13. An in-built 9 ohm speaker may be fed with up to 150 mW. The speaker may be switched out of circuit when not required.

IF OUTPUT

14. A 500 kc/s IF output of 50 mV RMS is provided at a 70 ohm co-axial socket fed from the detector cathode.

FREQUENCY STABILITY CHARACTERISTICS

15. After 30 minutes warm-up and initial re-tuning the frequency shift is sufficiently small that no re-tuning should be necessary over a period of four hours, even with an ambient temperature change of 11°C plus or minus.

CALIBRATION ACCURACY

16. When the receiver is set up by using the crystal calibrator, a calibration accuracy of plus or minus 2 kc/s may be achieved over the temperature range -30 to $+55^{\circ}\text{C}$. The scale accuracy is in the order of plus or minus 3 kc/s, and the re-setting accuracy plus or minus 1 kc/s.

SECTION 5 - CONTROLS AND CONNECTING POINTS

17. All controls and connecting points are located on the front panel of the receiver. They may be identified by reference to Fig 2 and Table 1.

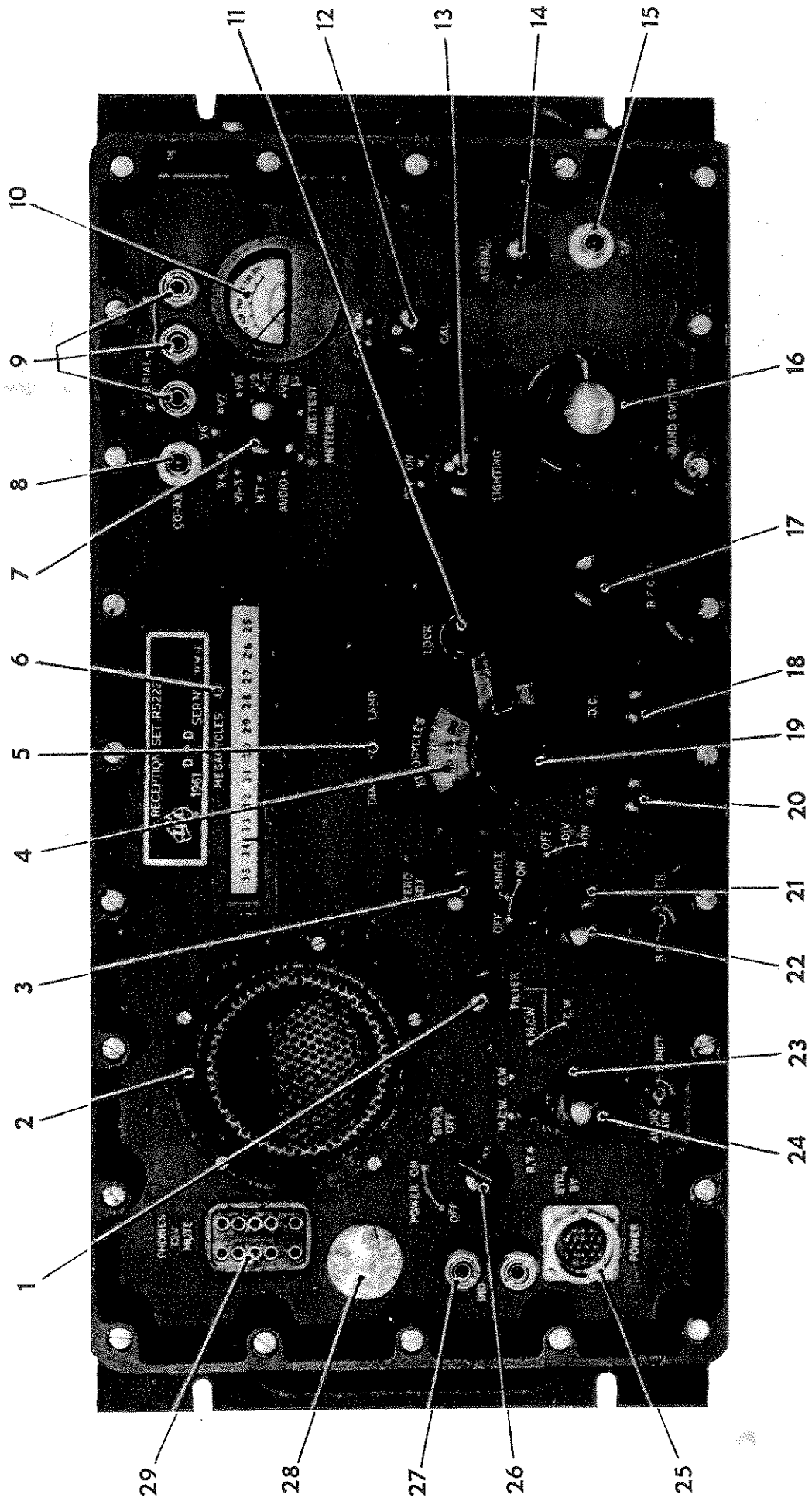

FIG 2 RECEIVER, RADIO, R5223 CONTROLS AND CONNECTING POINTS

TABLE 1
(See Fig 2)

CONTROLS AND FRONT PANEL - RECEIVER, RADIO, R5223

Item Reference Fig 2	Panel Marking	Purpose
1	FILTER	Cuts the higher audio frequencies. Tunes the centre frequency on CW. (See Item 23)
2	Speaker (No marking)	
3	ZERO ADJ.	To adjust the cursor to take up calibration inaccuracies.
4	KILOCYCLES	Direct reading in kc/s.
5	DIAL LAMP	Removable cover to allow access to the main dial lamp. This point is also used for seal testing.
6	MEGACYCLES	Changed by BAND SWITCH (16) to show frequency cover.
7	METERING	First position of switch provides an S meter reading, position 2 audio output, and position 3 an HT reading. Next 7 positions provide metering of valve currents. Last position is for wander leads for general metering purposes.
8	CO-AX	Aerial 70 ohm. Co-axial socket unbalanced for co-axial cable termination.
9	AERIAL E	Terminals for 600 ohm feeder either balanced or unbalanced. For the unbalanced application a link is placed between the RH terminal and Earth.
10	Meter (no marking)	Operates with METERING switch (7). Positions 4 to 10 on METERING switch should indicate 1/2 scale deflection on meter.
11	LOCK	Locks tuning (19).
12	CAL. OFF-ON	Switches 100 kc/s calibration oscillator.
13	LIGHTING OFF-ON	Switches dial lamps ON or OFF.
14	AERIAL	Tuning of aerial circuit for optimum performance.
15	IF	Co-axial 70 ohm output from IF for 500 kc/s ancillary equipment.

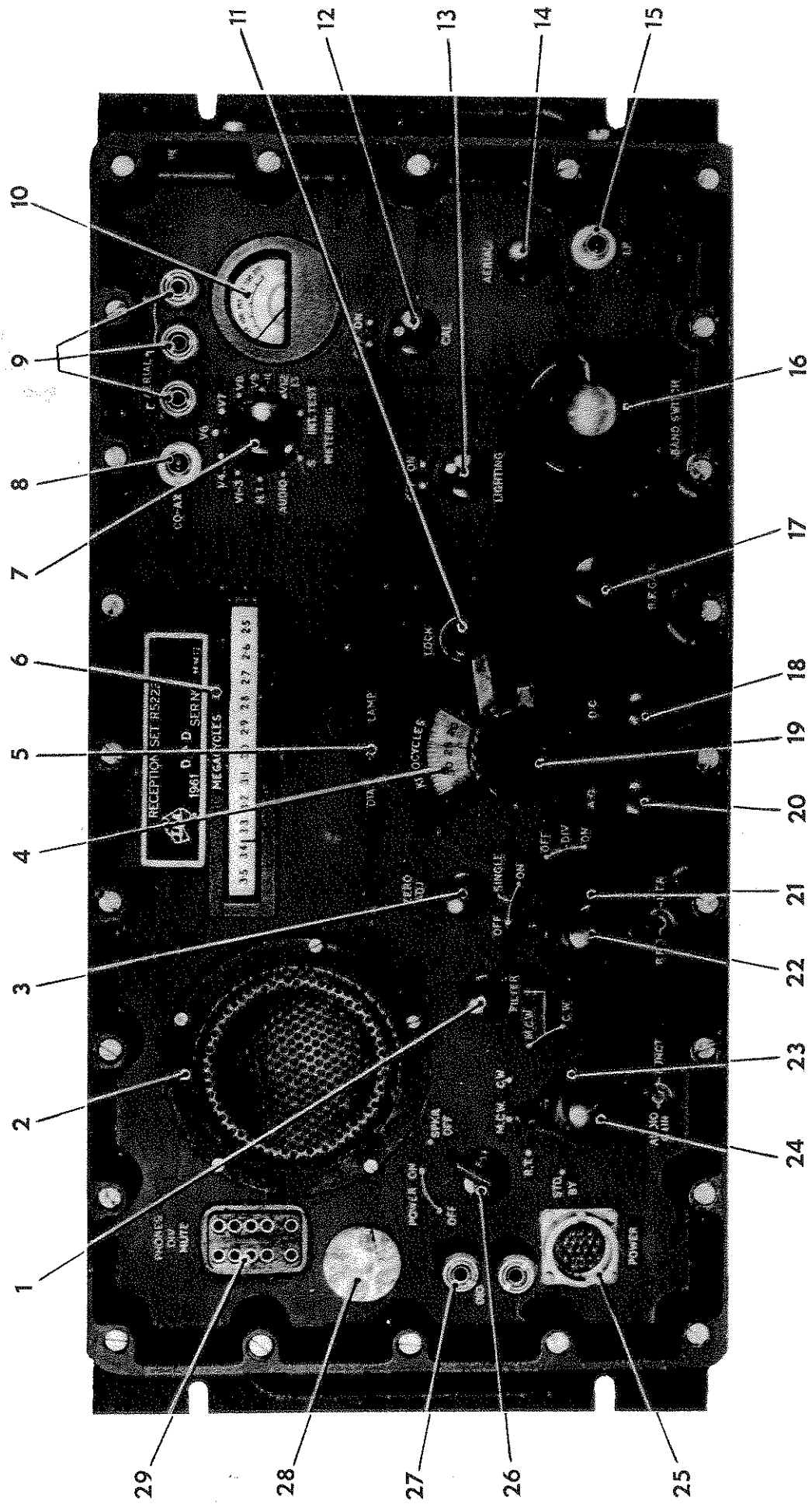

FIG 2 RECEIVER, RADIO, R5223 CONTROLS AND CONNECTING POINTS

TABLE 1 (CONT'D)

Item Reference Fig 2	Panel Marking	Purpose
16	BAND SWITCH	A 29 position switch to select the required frequency band.
17	RF GAIN	Manual control of RF and IF amplification.
18	DC	4 amp fuse in holder.
19	Tune (No marking)	Frequency selection.
20	AC	500 mA fuse in holder.
21	LTR	A four position switch for diversity ON-OFF under either condition of limiter in or out.
22	BFO	Varies the CW Note.
23	FUNCT.	<p>6 position function switch.</p> <p>STD BY (Filaments only) RT MCW CW MCW) CW) Audio Filter in</p> <p>In the positions without filter, the filter control acts as a tone control, ie, top cut filter. With filter in a 250 c/s pass band is tunable over the audio range.</p>
24	AUDIO GAIN	Manual control of output level.
25	POWER	20 point connector for ac or dc supply. Heater series parallel arrangement effected in the plug for 24 V operation. Polarity of battery connection is immaterial.
26	POWER ON-OFF SPKR OFF	Applies power to the power transformer primary; additional position switches speaker OFF.
27	D 10	600 ohm balanced line output. May also be used for remote speaker.
28	Supply volts selector (No marking)	Sets to the supply voltage.
29	PHONES DIV MUTE	Phone output 75 ohms. Two sockets in parallel, also carry the muting and diversity controls when two receivers are used in space diversity.

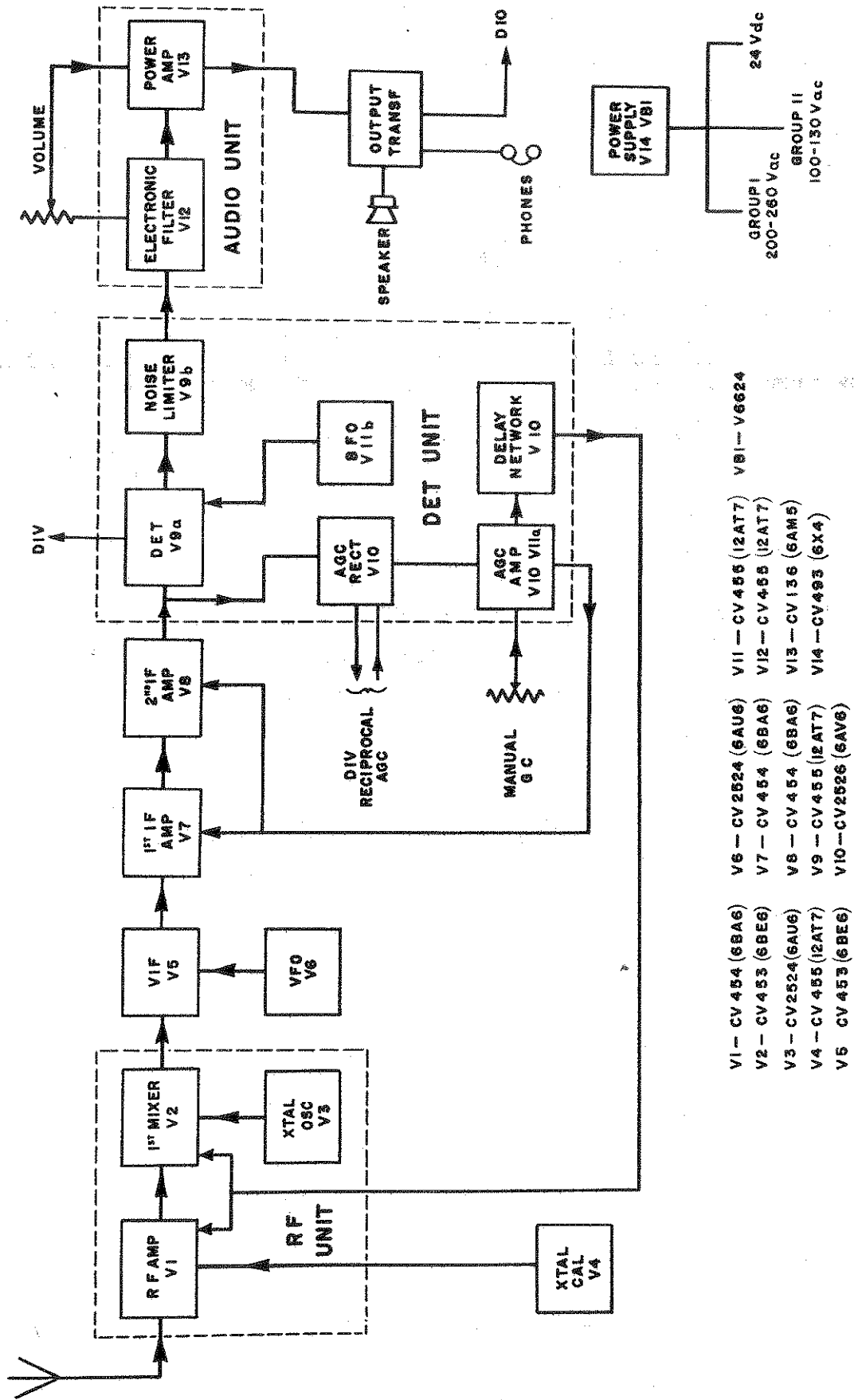

FIG 3 - RECEIVER, RADIO, R5223 - BLOCK SCHEMATIC DIAGRAM

SECTION 6 - GENERAL CONSTRUCTION

(See Fig 3)

18. The receiver is designed on the sealed sub-unit principle, with the valves placed outside the seal. This obviates breaking the seal to replace valves, and enables the isolation of faulty sub-units in case of break-down.

19. The individual sub-units are detailed below:-

- (a) Radio frequency (RF) unit containing -
 - Aerial tuned circuits
 - RF tuned circuits
 - 1st mixer
 - Crystal oscillator
- (b) Variable intermediate frequency (VIF) unit containing -
 - Tuned circuits covering two bands,
1.5 Mc/s - 2.5 Mc/s, and 2.5 Mc/s - 3.5 Mc/s;
 - 2nd Mixer.
- (c) Variable frequency oscillator (VFO) unit tunable from 2-3 Mc/s.
- (d) Intermediate frequency units (1st IF and 2nd IF) containing a pair of tuned circuits, and a valve amplifier.
- (e) Detector, BFO, AVC (DET.BFO.LTR) source and amplifier, and noise suppressor.
- (f) Audio amplifier and audio filter.
- (g) Calibration crystal oscillator (100 kc/s)
- (h) The main frame-work of the equipment which also carries the power supply and metering facilities.
- (j) Gear box and dial mechanism. This unit also carries potentiometers for gain controls and filter tuning.

20. Each sub-unit is screwed to the main frame, and has solder connections to the wiring loom. Detachable couplings are provided for spindles entering sub-units.

21. The receiver case is sealed by a neoprene gasket, and the front panel is attached to the case by 24 screws.

22. Scale and meter illumination are provided by separate pilot lamps, one mounted between the two scales, and the other below the meter inside the case.

SECTION 7 - WEIGHT AND DIMENSIONS

23. The weight and dimensions of the R5223 receiver are as follows:-

Weight - 42 pounds

Width - 19 inches

Height - $8\frac{3}{4}$ inches

Depth - $12\frac{1}{4}$ inches

SECTION 8 - ACCESSORIES

24.	5995-66-012-7878	Cable Assembly, Power Electric 24V	- 1
	5995-66-012-9999	Cable Assembly, Power Electric 125V	- 1
	5995-66-012-9052	Cable Assembly, Power Electric 250V	- 1
	Y1/YAA 2286	Receivers, Headgear, SI, Double No.1A	- 2

CHAPTER TWO – OPERATION

The ac voltages employed in this equipment are sufficiently high to endanger human life. Every reasonable precaution has been observed in the design to safeguard operating personnel.

A copy of the standard drill for the treatment of electric shock is printed in the front of this book. Learn it by heart, and practise it until perfect; the knowledge gained may save a life. As prevention is better than cure, do not tamper with supply leads, and switch off the power supply before removing connectors. All operators MUST know the location of the mains switches controlling ac power supply to the equipment.

SECTION 9 – PRELIMINARY INSTRUCTIONS

(See Fig 4)

ACTION ON RECEIPT OF AN EQUIPMENT

25. On receipt of a complete station, check it to see that it contains all the accessories detailed in the Complete Equipment Schedule, and is in sound mechanical condition. Any deficiencies or damage should be reported at once.
26. The equipment should function properly as soon as it has been correctly set up. If it does not respond to the operating instructions laid down in this chapter, the fact should be reported at once so that repair or exchange action may be taken without loss of time.
27. If the receiver is to be rack mounted, attach the mounting wings to it. Then place it in its operating position in the rack with scale windows at a convenient height for observation.

ENSURE THAT THE MOUNTING RACK IS EARTHED

SETTING UP R5223 RECEIVER

28. (a) See that POWER ON-OFF switch (26) is OFF and connect appropriate power cable to POWER point on set (25) and to source. When source is 24V dc polarity of connection does not matter, but where the battery is earthed the black lead MUST be connected to the earth side of the battery.
- (b) Set supply volts selector (28) to voltage nearest to actual supply voltage. To set carousel pull out until contacts disengage. Then

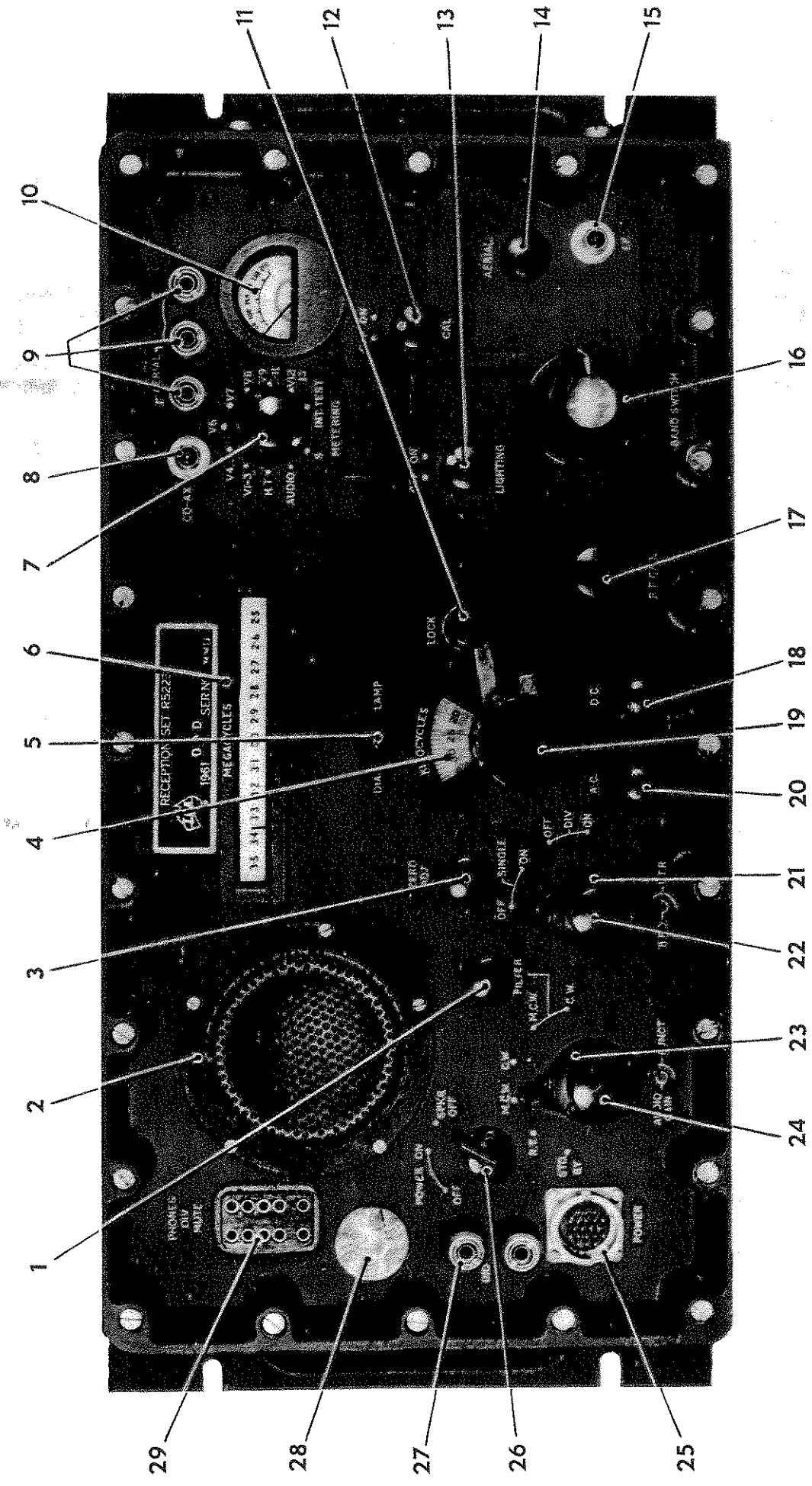

FIG 4 RECEIVER, RADIO, R5223 CONTROLS AND CONNECTING POINTS

rotate it until pointer on panel is opposite required voltage on supply volts selector.

- (c) Connect aerial feeder to AERIAL terminal(s) (9).
- (d) Ensure earth link is connected to E (9) when using unbalanced feeder, including co-axial feeder or single wire aerial.
- (e) Plug in headphones (29).
- (f) Connect D10 cable (27), if required.

CHECKING VALVE CURRENTS

- 29. (a) Switch on supply at source.
- (b) Turn POWER/SPKR switch (26) to ON.
- (c) Turn METERING switch (7) to each valve position in turn, starting with V 1-3 and finishing with V 12-13. For correct functioning the meter (10) should indicate half scale deflection.
- (d) Switch off at source.

SECTION 10 - OPERATING INSTRUCTIONS

OPERATION ON VOICE (RT on panel)

- 30. Referring to Fig 4 proceed as follows:-
 - (a) Switch on supply at source and put POWER/SPKR (26) switch to ON. If speaker not required turn switch to SPKR OFF.
 - (b) Switch LIGHTING switch (13) to ON if required.
 - (c) Switch CALIBRATOR (12) to ON.
 - (d) Set METERING switch (7) to S.
 - (e) Turn BAND SWITCH (16) to required band.
 - (f) Set FUNCTION switch (23) to RT.
 - (g) Set audio FILTER (1) to extreme clockwise position.
 - (h) Set AUDIO GAIN (24) to comfortable level.
 - (j) Set KILOCYCLES scale (4) to nearest 100 kc/s point to required frequency.

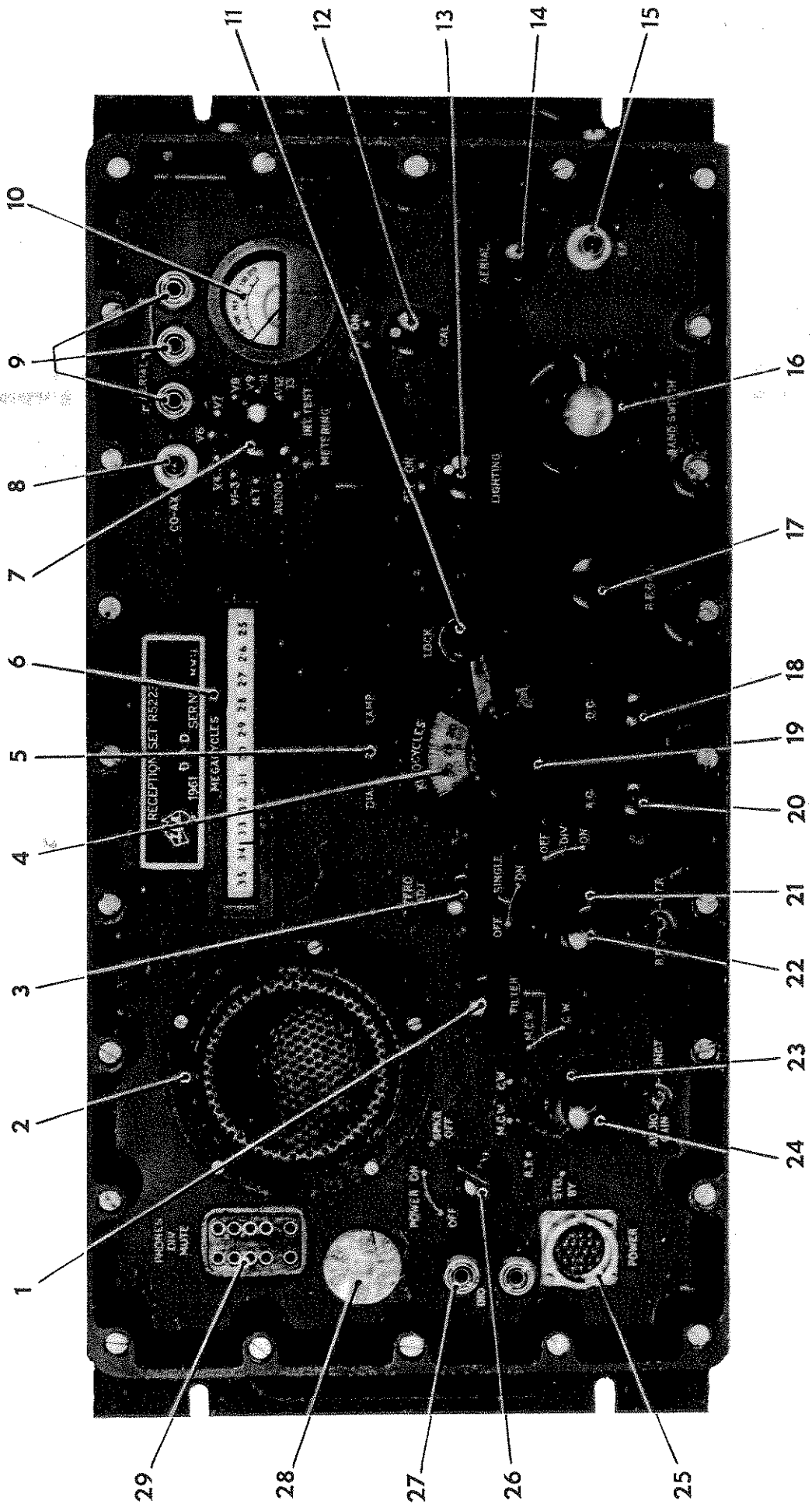

FIG 4 RECEIVER RADIO RS223 CONTROLS AND CONNECTING POINTS

- (k) Tune until maximum reading is shown on meter (10), or zero beat is reached.
- (l) Adjust ZERO ADJ (3) until kilocycles dial cursor reads zero.
- (m) Switch CALIBRATOR (12) to OFF.
- (n) Tune KILOCYCLES scale (4) to required frequency.
- (p) When signal is heard tune to maximum.
- (q) Tune AERIAL (14) for maximum signal.
- (r) Adjust AUDIO GAIN (24) to required level.
- (s) Tune FILTER control (1) for clearer signal, if necessary.
- (t) If reception still difficult, turn FUNCTION Switch (23) to MCW and again tune FILTER (1).
- (u) Adjust RF GAIN (17) to desired level.
- (v) If ignition noise, atmospherics, etc, experienced, switch LTR switch (21) to SINGLE ON.

OPERATION ON CW

31. Referring to Fig 4 proceed as follows:-
- (a) Put POWER/SPKR switch (26) to ON. If speaker not required, turn switch to SPKR OFF.
 - (b) Switch LIGHTING switch (13) to ON if required.
 - (c) Switch CALIBRATOR (12) to ON.
 - (d) Set METERING switch (7) to S.
 - (e) Turn BAND SWITCH (16) to required band.
 - (f) Turn FUNCTION switch (23) to RT.
 - (g) Set audio FILTER (1) to extreme clockwise position.
 - (h) Set AUDIO GAIN (24) to comfortable level.
 - (j) Set KILOCYCLES scale (4) to nearest 100 kc/s point to required frequency.
 - (k) Tune until maximum reading is shown on meter (10) or zero beat is reached.
 - (l) Adjust ZERO ADJ (3) until kilocycles dial cursor reads zero.
 - (m) Switch CALIBRATOR (12) to OFF and the FUNCTION switch (23) to CW.

- (n) Turn BFO control (22) to centre frequency, ie, point of maximum noise.
- (p) Turn LTR switch (21) to SINGLE OFF.
- (q) Tune KILOCYCLES scale (4) to required frequency where a note should be heard. Tune to zero beat.
- (r) Adjust BFO control (22) to give desired note.
- (s) If interference present in form of ignition noise or atmospherics, etc, set LTR switch (21) to SINGLE ON.
- (t) If interference persists turn FUNCTION switch (23) to FILTER CW.
- (u) Tune FILTER (1) and BFO (22) controls to select most readable signal.
- (v) If interference present in form of neighbouring signal, tune BFO (22) to the side of the wanted signal away from the unwanted signal to give greater separation of notes before using FILTER tune control (1).
- (w) Further improvement may be obtained by detuning receiver slightly (4).
- (x) BFO control (22) will require readjustment to give desired note again.

DIVERSITY RECEPTION (See Fig 4)

32. For space diversity reception two receivers may be paralleled by inter-connection of the spare phone sockets (29), thus:-

Pin 1 (top)	inter-connected
2	inter-connected
3	to Pin 4 of other set
4	to Pin 3 of other set
5 (bottom)	inter-connected if muting is required

33. The two IF outlet sockets (15) must also be inter-connected. In this state the two sets may be used singly or in dual diversity by selection with the diversity switch (21).

OPERATING WITH A TRANSMITTER

34. When using the R5223 receiver in conjunction with a transmitter, aerial change-over facilities must be provided by the transmitter. Muting of the receiver may be achieved by applying 24V dc between the MUTE terminals (see Fig 4 - Item 29) and earth.

CHAPTER THREE - USER SERVICING AND ADJUSTMENTS

SECTION 11 - GENERAL

35. No equipment or installation can be expected to work properly unless it is kept in first-class condition by regular maintenance, conscientiously carried out. This maintenance is the responsibility of the NCO or man who is in direct charge of the equipment and responsible for its operation.

36. The equipment should be kept in a clean and dry condition. It should be the first task of an operator to ensure this when he comes on watch. He should also check that all connections are secure, and that all controls work smoothly and firmly through their range of movement.

SECTION 12 - REPLACEMENTS

VALVES

37. To replace faulty valves, remove the chassis of the reception set from its case. To do this first remove the 24 screws securing the chassis to the case. The valves are of the following types:-

<u>Valve</u>	<u>Type</u>
V1, 7, 8	CV454 (6BA6)
V2, V5	CV453 (6BE6)
V4, 9, 11, 12	CV455 (12AT7) - ECC81
V3, 6	CV2524 (6AU6)
V10	CV2526 (6AV6)
V13	CV136 (6AM5) EL91
V14	CV493 (6X4)
VB1	V6624

DO NOT PUT FAULTY VALVES BACK
IN THE SPARE VALVES CASE.
EXCHANGE THEM FOR SOUND ONES
AS SOON AS POSSIBLE AND PUT
THE SOUND ONES IN THE CASE.

FUSES

38. The ac and dc fuses are located in the lower centre of the panel, (Fig 4, Items 20 and 18 respectively). The fuse-holder marked AC takes a 500 mA fuse and that marked DC takes a 4A fuse. Both fuses are of the normal cartridge type.

39. To replace a fuse, unscrew the moulded cap of the fuse-holder, and withdraw complete with fuse. Replace the spent fuse by a new one of the same rating, and screw the assembly back into position.

LAMPS

40. To remove a faulty scale lamp in the receiver, insert a coin in the slot of the lamp receptacle (centre of panel marked DIAL LAMP - Fig 4 Item 5), and turn anti-clockwise until free. The lamp will then pop out, and a sound one can then be inserted in its place.

41. Another lamp, which illuminates the meter, is contained inside the case. To replace this it will be necessary to remove the chassis from the case. This will seldom be necessary as it is a 6-Volt lamp operating from 4 volts.

NOTES