

Table of Contents

INTRODUCTION.....	1
COMPUTER INTERFACING.....	4
MFJ Starter Packs	4
Computer Interface with MFJ Starter Pack	5
Computer Interface without MFJ Starter Pack	5
SERIAL PORT SIGNALS	5
COMPUTER WITH SPECIFIC SERIAL INTERFACES	6
Apple Macintosh	6
Commodore C64, C128 and VIC-20.....	7
IBM PCjr.....	7
Radio Shack Color Computer	8
Color Computers	8
IBM PC/XT/AT/386/486 and compatibles Computer	8
Other Computers with Nonstandard Serial Ports.....	9
TERMINAL SOFTWARE REQUIREMENTS	10
Apple Macintosh	10
Apple II, II+, IIe, IIc	10
Commodore C64, C128 and VIC-20.....	11
IBM PCjr.....	11
IBM and Compatible Computers	11
Radio Shack Color Computer	12
Radio Shack Model 100/102 and NEC 8201	12
MFJ-1278B SERIAL PORT PIN FUNCTIONS.....	12
COMPUTER BAUD RATE	13
Autobaud.....	13
Changing Terminal Baud Rate	14
VERIFYING SERIAL PORT OPERATION.....	15
PARALLEL PRINTER PORT	16
Printer Port Connection.....	16
Printer Consideration	17
Printer Port Test.....	17
RADIO INTERFACING.....	18
MFJ-1278B Radio Ports	18
RADIO PORTS CONNECTION.....	19
HANDHELD RADIO CONNECTION	20
RADIO INTERFACING METHODS	21
Method 1: Direct Connection to Microphone and Speaker	21
Transmit Audio Level Adjustment for Method I Interface	21
Setting the Receiver Audio Input Level.....	22

FSK CONNECTION.....	29
GETTING STARTED	30
First Steps.....	30
Basic Commands	30
SERIAL PORT CONFIGURATION	31
Parity and Word Length.....	32
Echos.....	32
New Lines and Line Wrapping.....	33
THE MFJ-1278B MULTI-MODE MODEM.....	33
OPERATIONAL MODES	35
Verifying Operation Status.....	35
Mode Switching With the MODE Command.....	35
Radio Port Switching	36
MEMORY BUFFERS.....	36
Loading the Memory Buffers	37
Transmitting the Memory Buffers	37
Buffer Serial Numbering.....	37
Memory Repeat and Buffer Repeat Time.....	38
Chaining the Memory Buffers	38
TUNING INDICATOR.....	39
PACKET OPERATION.....	40
VHF Packet.....	40
A Connecting and Disconnecting Exercise	40
Digipeating	42
Unsuccessful Connections	43
Monitoring Channel Activity	43
Your First Packet QSO	45
Starting the QSO	45
Digipeating	46
Monitoring on the Air.....	47
Special Input Characters	47
BASIC HF PACKET OPERATION	49
HF Packet Operation Hints	50
PACTOR	51
What is Pactor?	51
PACTOR Operation.....	51
FEC Unproto operation.....	52
PACTOR ARQ	53
Changeover	53
Monitoring	53
Monitoring AMTOR ARQ requests.....	54
Exiting PACTOR Mode.....	54

CONNECT.....	56
SPEEDup/SPEEDdown	56
AUTOMATIC ON-LINE COMPRESSION	56
FLOW CONTROL.....	56
AMTOR while in PACTOR mode	56
Amtor Detection in Pactor.....	57
PACTOR STATUS INDICATORS.....	57
PACTOR MAILBOX	58
Setting Up your Pactor Mailbox.....	58
General Overview	60
Detailed Pactor Mailbox Overview	63
Mailbox Messages.....	67
CW OPERATION.....	68
Receiving CW	69
Transmitting CW.....	70
Transmitting from Memory Buffers.....	71
CW Weighting	71
Tuning your Radio	72
Random Code Generator.....	72
Setting Up the for Code Practice	73
CW CONTEST MEMORY KEYS OPERATION.....	74
Sending CW with External Key Paddle	74
MODULATED CW OPERATION.....	75
BAUDOT RTTY & ASCII OPERATION.....	76
Setting Up for ASCII and RTTY Operation	76
RTTY and ASCII Receiving	77
RTTY and ASCII Transmitting.....	77
BAUDOT RTTY OPERATION HINTS	78
Commercial RTTY Reception	79
AUTOMATIC SIGNAL ANALYSIS	80
ASA OPERATION	80
MARS OPERATION	82
Configuring for MARS	82
Operating MARS with MultiCom for IBM	83
The MARsmode Command	83
MARSMODE 1- QSO Mode	84
MARSMODE 3- Storage Mode	84
AMTOR OPERATION.....	85
Mode A "ARQ".....	85
Setting up for Mode A Operations.....	85
Operating Mode A	86
Monitoring Mode A "APQ".....	87

Summary of AMTOR Contact Sequence	90
NAVTEX OPERATION.....	91
Navtex Stations and Frequencies	91
Navtex Operation	91
FAX OPERATION	94
FAX Formats.....	95
FAX Frequency.....	96
FAX Installation.....	96
Printer Connection	96
Receiving FAX.....	97
Receiving FAX to the Printer	97
Display FAX Picture on Computer Screen & Save it to Disk.....	99
Two Level FAX Picture Format	99
Multi-level FAX Picture Raw Data Format.....	100
Transmitting FAX	101
Two Level FAX Transmitting.....	101
Multi-level FAX Transmitting	102
Creating FAX Pictures for Transmitting	104
SLOW SCAN TELEVISION OPERATION	105
SSTV Formats.....	106
SSTV Installation.....	106
Printer Connection.....	106
Receiving SSTV Pictures.....	107
SSTV Printing to the Printer.....	107
Printing SSTV Pictures to the Screen	110
Saving SSTV Pictures to Disk	111
Terminating SSTV Printing	111
Transmitting SSTV Pictures.....	111
Creating SSTV Pictures for Transmitting	112
ADVANCED PACKET OPERATION.....	114
SPECIAL CHARACTERS	114
PACKET OPERATING MODES.....	115
Command Mode.....	115
Entering Data-Transfer Modes.....	116
Converse Mode	117
Transparent Mode	118
FLOW CONTROL.....	119
XON/XOFF Flow Control	120
Hardware Flow Control.....	121
Type-in Flow Control.....	121
DETAILED VHF PACKET OPERATION	121
Station Identification	121

Packet Timing.....	125
Radio Baud Rate.....	126
Special Protocol Timing	127
Monitor Functions.....	127
Real-Time Clock and Time Stamping.....	128
Multi-Connect Guide.....	129
Setting the MFJ-1278B to Normal Operation.....	129
How do I Invoke Multi-Connect?	129
Easy-Mail Mailbox.....	130
Setting Up your Easy-Mail Mailbox.....	131
Mailbox Operation.....	136
Additional Mailbox Features	140
Forwarding:	140
Eliciting Reverse Forwards:	141
Remote Heard Log:	141
Chat Mode:.....	141
Page SYSOP:.....	141
Remote SYSOP:	142
Mailbox CText:	142
Idle Timeout:.....	142
Abort:	142
Mailbox Messages	142
Slotting and Acknowledgment Priority	144
Description.....	144
New Parameters	146
Other Related Parameters	148
Initial Parameter Settings Summary.....	149
What to Expect	149
Packet Picture Transfer	151
Printing Packet Pictures thru Built-in Printer Port.....	151
Using PKTPIX	151
Packet Picture transfer to the computer screen	151
DETAILED HF PACKET OPERATION.....	152
Radio Setup for HF Packet Operation	152
Operating HF Packet.....	155
MFJ-1278B KISS MODE, TNC-2 MODE, HOST MODE	161
KISS INTERFACE FOR TCP/IP.....	161
COMMAND PREFACE	163
ENTERING COMMANDS	163
Command List.....	164
COMMAND NAME	164
Defaults	164

Link Status Messages	302
MFJ-1278B SPECIFICATIONS	305
GENERAL DESCRIPTION	306
DETAILED CIRCUIT DESCRIPTION	307
Oscillator.....	307
Dividers and Baud-rate Generator.....	307
CPU Complex	308
Serial Interface	308
Watch-dog Timer	309
Modem	309
Power Supply	309
RS-232C HANDSHAKING PROTOCOL.....	310
JUMPER FUNCTIONS	312
PARALLEL PRINTER PORT PIN FUNCTION,J12.....	315
TTL INTERFACE PORT PIN FUNCTION,J5	316
MULTI-LEVEL INTERFACE CONNECTOR,J13.....	317
EXTERNAL MODEM INTERFACE CONNECTOR - J14.....	317
MODEM DISCONNECT HEADER, J4.....	318
HF TUNING INDICATOR	320
GENERAL TESTS	321
Step 1: Power Supply	322
Step 2: Obvious Problems.....	322
Step 3: Assembly Problems.....	322
Step 4: Cabling Problems.....	323
SPECIFIC SYMPTOMS.....	323
Symptom: TNC appears dead	323
Oscillator and Reset Circuits	323
Digital Logic Lines	323
Symptom: Modem won't calibrate or key transmitter.....	324
Symptom: Uncopyable transmitted or received packets.....	325
TERMINAL INTERFACE TROUBLESHOOTING.....	325
Symptom: MFJ-1278B won't sign on to the terminal.....	325
Symptom: The MFJ-1278B appears to be signing on but only gibberish is printed on the terminal	326
Symptom: The MFJ-1278B signs on OK but won't accept commands	326
Symptom: The MFJ-1278B appears to have "lock-up" i.e. not responding to any commands	326
EXPLANATION OF PROTOCOL.....	327
Physical Layer	327
Data Link Layer	327
HDLC FRAMES	328
ASYNC LEVEL TWO	328

Comprehensive Alignment Procedure	340
Set Modulator Tones Using Built-in Calibration Software	340
Demodulator Center Frequency Alignment	341
Tuning Indicator Alignment	342
CW MODEM TUNE-UP PROCEDURE	346
Detailed CW Demodulator Alignment Procedure	347
AUDIO OUTPUT CALIBRATION	350
Audio Output Level Adjustment Procedure	350
HF RADIO ALIGNMENT	352
FIRST METHOD: NOISE AVERAGE FREQUENCY	352
SECOND METHOD: FILTER SKIRT AVERAGE FREQUENCY	353
CONVERTING THE MFJ-1278B TO "LIKE-TNC 2"	354
MFJ-1278B 2400 BPS PACKET	356
2400 BPS PACKET SETUP	356
2400 BPS Receive Audio Setting	357
2400 BPS Transmit Audio Setting	357
JUMPER FUNCTIONS AND LOCATIONS	358
COMMAND SUMMARY	362
MFJ-1278B/1278BT PARTS LIST	373

INTRODUCTION

Welcome to the exciting world of Amateur Digital Communications. By choosing the MFJ-1278B, you have chosen the most versatile and powerful Multi-mode Data Controller manufactured for the Amateur Radio Service.

The MFJ-1278B interfaces your radio with any personal computer that has an RS-232 or TTL level Serial Port and a terminal program. While most communications programs will work, MFJ recommends the use of MFJ Starter Pack for those who have IBM or compatible, Macintosh, Amiga or Commodore C64/128 computers. With an IBM or compatible computer, the MFJ Multicom terminal program gives you some added features that a standard terminal program just can not offer. Features such as color SSTV, color FAX, 16 gray level FAX, and color VGA packet picture transfer, just to mention a few. Multicom is menu driven, making it easy to operate all modes offered by the MFJ-1278B. Dedicated functions keys are programmed to operate most functions with a single key stroke.

Even though the MFJ Multicom programs offered for other computers may have features different from the IBM version, they do offer features that will make operating the MFJ-1278B very fun and very easy.

This compact versatile controller employs the **genuine** TAPR TNC 2 AX.25 protocol packet firmware plus many added features to receive and transmit VHF packet, HF packet, AMTOR, CW, ASCII, RTTY, color FAX, and color SSTV. The new 16 gray level fax board built in the MFJ-1278B gives you the ability to receive and transmit color SSTV and multi-gray level FAX pictures. In addition, MFJ-1278B lets you monitor the new and growing NAVTEX broadcasting system. The MFJ-1278B also has a Contest Memory Keyer mode.

Also a feature which so many have asked about, Pactor has been added to the operating modes. The new Pactor mode gives the user operating features such as **Digital Memory ARQ**, full **On-Line Data Compression**, **FEC Unproto** operation, just to mention a few. Also included with the PACTOR mode is a PACTOR Mailbox. With the Pactor mode also comes the ability to monitor AMTOR ARQ connect requests.

The MFJ-1278B offers the most versatile mailbox available when compared to the mailbox in other controllers. This mailbox allows a dedicated **mailbox callsign** so that the mailbox stays on while you operate packet. Other features like auto forwarding or reverse forwarding of mail to and from other BBS systems, remote sysop access, sysop paging, mailbox ctext, chat mode and a "has mail" LED indicator. The MFJ-1278B has 32K mailbox memory which is user expandable to 128K or 512K by simply replacing the mailbox memory IC -- a feature that no other controller offers.

You also get MFJ's 20-segment, 10 Hz Precision Tuning Indicator that makes tuning simple

The new "packet collision prevention" features -- Prioritized Acknowledgments and Slottime are installed. This new technology helps prevent many packet collisions inherent in the current packet protocol.

The EPROM containing the MFJ-1278B firmware, previously 512K bits, has been expanded to 1 Megabits giving the MFJ-1278B twice the room to grow in.

You also get a Key Paddle input jack so you can use your MFJ-1278B as an Iambic Keyer or Memory Keyer. The ten user-programmable memory buffers are provided for use with the contest memory keyer function. In addition you also get contest serial numbering and a random code generator.

A speaker jack lets you plug in a speaker and monitor transmit and receive audio and CW side tone as it is received and transmitted by your MFJ-1278B. The speaker output also provides for the packet connect signal alarm.

A Centronics compatible parallel printer port (DB-25) lets you directly interface your printer to the MFJ-1278B for printing received text, Packet, FAX and SSTV pictures.

The MFJ-1278B provides dual radio ports for HF and VHF operation. These dual radio ports let you connect 2 radios at the same time in any combination. Independent transmit audio output controls provide even further flexibility. This will enable the user to individually adjust the audio output for each radio port. The radio ports are not dedicated to either VHF or HF operation. They are totally independent of each other.

You also get a Threshold control for optimizing your demodulator filter for the different modes of operation. This is a very useful tool when trying to receive signals during bad band conditions.

A 20-pin header provided for the MFJ-1278B to operate packet at 2400 or 9600 baud packet by simply plugging in an optional modem board. The MFJ-1278BT already has a 2400 modem installed. If your MFJ-1278B does not have the 2400 modem installed, it can be purchased separately (MFJ-2400) and installed by you. With the 2400 modem installed, your MFJ-1278B can operate 300, 1200 and 2400 packet. You may also purchased the MFJ-9600 modem board that allows the MFJ-1278B to operate at 9600 baud packet.

The list goes on.... This is just a few of the features available. In short the MFJ-1278B offers you tons of features that the other multi-mode controllers just can't match. This in conjunction with the new MFJ Multicom (TM) software will put you leagues ahead in the ever changing field of Ham Radio Digital communications.

Items supplied with MFJ-1278B/MFJ-1278BT package

1. One MFJ-1278B or MFJ-1278BT Multi-Mode Data Controller
2. One AC adapter power supply for 110V AC. 240V AC adapter supplied for MFJ-1278BX (export model for country which operate on 220-240V AC).
3. Two open end radio port cables with 5-pin DIN male connectors.
4. One 10-pin connector for the TTL port.
5. One MFJ-1278B Instruction Manual.
6. One MFJ-1278B Fast-Start Manual.

There are many additional items available for the MFJ-1278B. In the table below is a list of these items:

Optional items available for the MFJ-1278B

Model No	Description
MFJ-1289	Advanced Starter pack for IBM & compatibles
MFJ-1289M	Same as MFJ-1289 but on 3.5" Disk
MFJ-1282B	Starter pack for Commodore C64/128
MFJ-1287B	Starter pack for Macintosh
MFJ-1290	Starter pack for Amiga
MFJ-1272B	MFJ-1278B to Microphone switch box
MFJ-5024	Radio connecting cable for Icom/Yaesu/RS HTs
MFJ-5026	Radio connecting cable for Kenwood HTs
MFJ-5080	Radio connecting cable for Yaesu 8-pin radio
MFJ-5084	Radio connecting cable for ICOM 8-pin radio
MFJ-5086	Radio connecting cable for Kenwood 8-pin radio
MFJ-280	Monitor speaker for transmit/receiver audio
MFJ-1292	Video digitizer for IBM & compatibles
MFJ-48BE	Packet encryption EPROM
MFJ-43	TNC Real time clock, keeps your 1278B on-time
MFJ-44	Internal Scope tuning board
MFJ-45B	128K RAM IC for additional mailbox memory
MFJ-45C	512K RAM IC for additional mailbox memory
MFJ-2400	2400 bps internal modem for packet

COMPUTER INTERFACING

You are now ready to connect your MFJ-1278B to your station's computer or terminal. Throughout this manual we will use the term "computer" to refer to the computer or terminal you use to communicate with your MFJ-1278B.

The MFJ-1278B communicates with your computer through a serial port, using signals corresponding to a standard called RS-232C. Why an RS-232C interface? Nearly every computer in production today either incorporates an RS-232C style serial port as a standard feature, or has one available as an optional accessory, either from the computer manufacturer or from a manufacturer of computer accessories. In addition to the RS-232C port, the MFJ-1278B has a built-in TTL port to allow interfacing with computers which need TTL signals such as the Commodore C-64, C-128 or the VIC-20.

In order to use the MFJ-1278B with your computer, the computer must have an RS-232C serial port, or a TTL serial port. Also a program which supports the serial or TTL port must be used. The program will typically be called a modem program, terminal emulator, or communications program.

Since there are so many computers on the market today, it is impractical for this chapter to provide detailed instructions for each computer. Detailed information is given for some of the popular models available in the United States. Also provided is general computer interfacing information.

MFJ Starter Packs

MFJ Enterprises, Inc. offers Starter Packs for some of the most popular computers. These Starter Packs contain a terminal program and a cable for connecting the MFJ-1278B to your computer. The Starter Packs available are as follows:

- MFJ-1282B: Commodore VIC-20, C64, C128 in 5-1/4" diskette.
- MFJ-1283: Commodore VIC-20, C64 on tape.
- MFJ-1289: IBM PC & compatibles in 5-1/4" diskette.
(Supports color SSTV and 16 gray-level FAX)
- MFJ-1289M: IBM PC & compatibles in 3-1/2" diskette.
(Supports color SSTV and 16 gray-level FAX)
- MFJ-1287B: Macintosh, in 3-1/2" diskette.
(Supports color SSTV and 16 gray-level FAX)
- MFJ-1290: Amiga in 3-1/2" diskette.
(Supports 8 levels SSTV and 8 levels FAX)

Computer Interface with MFJ Starter Pack

If you are using one of the MFJ Starter Packs, you should use the cable provided to connect the MFJ-1278B to your computer. Follow the instruction manual provided with the Starter Pack to operate the terminal program and to connect the MFJ-1278B to your computer. When finished with installation of the MFJ-1278B proceed to the "Computer Baud Rate", for further information about TNC installation. The "Computer Baud Rate" section in this chapter will continue to explain installation of the MFJ-1278B.

Computer Interface without MFJ Starter Pack

If you are **not** using an MFJ Starter Pack you should follow the instructions in this chapter for computer interfacing.

SERIAL PORT SIGNALS

The serial port connector is on the rear panel your MFJ-1278B. There are several signals available at this connector labeled "**RS-232 SERIAL**". You will not need all of these serial port signals for normal operation. For some special applications, such as binary file transfers or some Bulletin Board operations, you may want to use more of them. In that case, see **MFJ-1278B Serial Port Pin Functions** in this chapter.

In Table 2-1 the user will see a list of the serial port pins that must be used, between the MFJ-1278B and the computer. The pins listed are required by the MFJ-1278B for normal operation. Note that the MFJ-1278B connects to a computer exactly as if the MFJ-1278B were a standard RS-232C modem. If you have successfully used your computer with a telephone modem, then hook it up to the MFJ-1278B in the same way. Use whatever program you ordinarily use to communicate with the modem.

Pin	Signal Name	Description
2	Transmit Data	Serial data <u>from</u> your computer <u>to</u> the MFJ-1278B.
3	Receive Data	Serial data <u>from</u> theMFJ-1278B <u>to</u> your computer.
7	Signal Ground	The common ground for both data lines.

Table 2-1. Serial port signals required by MFJ-1278B.

If your computer is listed in Table 2-2, refer to the specific information in the following sections to connect your MFJ-1278B to your computer.

Manufacturer	Model
Apple	Macintosh (tm)
Apple	II,II+,IIe,II-gs(tm)
Commodore	VIC-20 (tm),C-64 (tm),C-128 (tm)

Many computers require a serial port adapter card. These cards incorporate the circuitry necessary to add an RS-232C port to the computer. Some popular models in this category are the Apple II series, the IBM Personal Computer, many Radio Shack computers, and the Sanyo MBC-55X series. If you have one of these computers with an "add-in" serial port, or if you have another computer we haven't mentioned, you should skip to one of the sections on "other computers." If your computer has a 25-pin RS-232C serial port, refer to the section on Other Computers with 25-pin RS-232C Ports. Otherwise refer to the section Other Computers with Nonstandard Serial Ports.

Some computers have no serial port and no adapter is commercially available. Such computers are not suitable for use with the MFJ-1278B.

COMPUTER WITH SPECIFIC SERIAL INTERFACES

Apple Macintosh

The Macintosh serial port is an RS-422 compatible port, but it will work fine with the RS-232C serial port on your MFJ-1278B.

MFJ Enterprises, Inc. offers an optional Starter Pack for the Macintosh. The Macintosh Starter Pack is available from MFJ Enterprises, Inc. or any dealer of MFJ products. The Starter Pack includes a cable for

connecting the MFJ-1278B to the Macintosh and a terminal program. The Starter Pack for Macintosh is MFJ-1287B. If you wish to use your own cable, you will need a cable wired as shown in Fig. 2-1.

Macintosh 8 Pin	MFJ-1278B DB-25P	Macintosh DB-9P	MFJ-1278B DB-25P
1 (HSKO)	4	1	1
2 (HSKI)	6	5	2
3 (TXD-)	2	9	3
4 (GND)	7	3	7
5 (RXD-)	3	7	8
6 (TXD+)	N/C	6	4
7 (GPi)	N/C		

Fig. 2-1. Serial port wiring for Apple Macintosh.

Note that pin 1 of the DP-9P connector is not connected inside the Macintosh or the MFJ-1278B. We highly recommend the use of shielded cable, when making interconnections

Commodore C64, C128 and VIC-20

The MFJ-1278B has a built-in TTL-level port for interfacing with the Commodore C64, C128 or the VIC-20 computers. You do not need a RS-232C converter to interface with the MFJ-1278B.

An optional Starter Pack for the C-64, C-128 or the VIC-20 is available from MFJ Enterprises, Inc. or any dealer of MFJ products. The Starter Pack includes a cable from the MFJ-1278B TTL port to the user I/O port on the Commodore computer. Included also is a terminal program. To order, specify MFJ-1282B for software on disk or MFJ-1283 for software on tape. If you wish to construct your own cable, the information below in Figure 2-2A will be helpful:

MFJ-1278B J-5, Pin#	Mnemonic	Name	C-64/128*, VIC-20 Pin#
1	RXD	Receive Data	B,C
2	DCD	Data Carrier Detected	H
3	GND	Ground (Frame and Signal)	N
4	RTS	Ready To Send	E**
5	TXD	Transmit Data	M
6	DSR	Data Set Ready	L
7	CTS	Clear to Send	K

Fig. 2-2A TTL Port wiring for VIC-20, C64 and C128

*C-128 is used in the C-64 mode for these connections.

**Pin E is not needed when using terminal program referred to in this chapter for the Commodore computers.

The TTL port (J5), is numbered from left to right as viewed from the back panel of the MFJ-1278B. The user's terminal program may not use all of these connections. The MFJ-1278B requires RXD, TXD and GND connected for proper operation. Programs that utilize file transfer and printer routines will probably use RTS and CTS as well. Consult your software documentation.

IBM PCjr

The PCjr uses standard serial voltage levels for it's RS-232C interface; however, the connector used is non-standard and not readily available from electronic supply dealers. The pin-out information for this connector is referred to in the IBM PCjr Technical Reference Manual.

IBM dealers call on "IBM PCjr Adapter Cable for Serial Devices". This Adapter Cable is

Radio Shack Color Computer

The Color Computer series (except for the Micro Color Computer) uses a 4-pin DIN-style connector for its serial port. If you wish to construct your own cable, the information in Figure 2-2 will be helpful. All necessary parts should be available from Radio Shack dealers.

Color Computer	DB-25P
4	2
2	3
3	7

Fig. 2-2. Serial port wiring for Radio Shack

Color Computers

Radio Shack Model 100/102 and NEC 8201Radio Shack Model 100, serial port interfacingThese computers have built-in standard RS-232C serial ports that are compatible with the MFJ-1278B. You will need a standard male-to-male RS-232C cable to connect the computer to the MFJ-1278B.

IBM PC/XT/AT/386/486 and compatibles Computer

"Include other computers with 25-pin RS-232 Ports"If your computer is an IBM or compatible, you should have a serial port with standard DB-25 or DB-9 pin connector. You may use a standard IBM **serial modem cable** with the correct gender on each end of the cable.

MFJ Enterprises, Inc. offers optional Starter Pack (MFJ- 1289) for the IBM or compatible computers. A computer connecting cable is included with the Starter Pack. The supplied cable is of male to female gender, to connect your MFJ-1278B to the computer.

For other computers with a 25-pin RS-232C port, consult the manual for your computer or accessory to see which pins it uses to send and receive data on, as well as the pin used for signal ground. Follow the computer manufacturer's recommendations for connecting the serial port to a modem. You may also find the technical information in this section useful.

Your MFJ-1278B is configured as **Data Communications Equipment (DCE)**, the technical term for an RS-232C modem. Most computers are configured as **Data Terminal Equipment (DTE)**. If this is the case for your computer, you may be able to wire pin 2 of the MFJ-1278B connector to pin 2 of your computer's RS-232C port. Then wire pin 3 to pin 3 and pin 7 to pin 7 on the computer's RS-232C port. You can provide these connections with a standard 3-wire male-to-female or male-to-male RS- 232C extension cable, depending on whether your computer has a DB25S or DB25P connector.

If your computer is configured as DCE, you will have to wire pin 2 of your MFJ-1278B to pin 3 of the computer RS-232C connector. Then wire pin 2 of the computer's RS-232C connector to pin 3 of your MFJ-1278B. Please note that pin 7 of the computer's RS-232C connector will still connect to pin 7 of your MFJ-1278B serial port. Some computers may require that pin 5 of the computer serial port connector be connected. Others may require connections for pin 8 and pin 20. You can use the computer's output signals on pins 4 and 6 as shown in Fig. 2-3.

MFJ-1278B RS-232C	Computer RS-232C
2	2
3	3
7	7
	4
	5
	6
	8
	20

Fig. 2-3. Serial port wiring with jumpers for auxiliary signals.

Other Computers with Nonstandard Serial Ports

Computers with non-standard serial ports must meet the following conditions. First, the signal levels should be RS-232C compatible. The MFJ-1278B requires that the voltage levels sent from the computer be greater than about +3 volts in one state and less than about +1 volt in the other state.

Second, the polarity of the signals must conform to the RS-232C standard. This means that the low voltage state must correspond to a logical "1" and the high voltage state to a logical "0".

Third, the computer must be able to correctly receive a signal that meets the RS-232C specification. The MFJ-1278B supplies signals that meet this specification.

Make or buy a cable that provides the following connections. The common pin on the computer's RS-232C serial port must be connected to pin 7 on the MFJ-1278B serial port. Connect the line that sends data **from** the computer to pin 2 on the MFJ-1278B RS-232C port. Connect the line that your computer receives data on to pin 3 on the MFJ-1278B RS-232C port.

TERMINAL SOFTWARE REQUIREMENTS

Any software package that enables your computer to act as an ASCII terminal with an ordinary telephone modem should work with your MFJ-1278B. If you have a program that you have used successfully with a telephone modem and that you are familiar with, use that program to communicate with your MFJ-1278B.

If you are using a terminal program provided by the MFJ Starter Pack, proceed to the "Computer Baud Rate" section in this chapter. Follow the instruction provided by the program.

If you are not using a MFJ terminal program, then proceed with the instruction for your type of computer.

Note: Some terminal programs require the initialization of DCD before they receive any characters. This is also true for different types of serial port cards (such as the Apple II+ Super Serial Card). If this is the case, place a jumper across pin 1 and 2 of JMP 1. The DCD LED on the front panel will function normally indicating received packets.

Apple Macintosh

There is an MFJ Starter Pack available for Macintosh, the MFJ-1287B. Included in the MFJ-1287B is a terminal program to allow compatibility between MFJ-1278B and the Macintosh. Also included is a cable to connect the MFJ-1278B to the Macintosh. In Table 2-3 you will find a list of parameters should want to use a terminal program such as MacTerm.

Compatibility	Terminal
1200 baud	VT100
7 bits/character	ANSI
even parity	UNDERLINE
Handshake Xon/Xoff	US
modem connection	80 Columns
"telephone" port	ON LINE UTOREPEAT

Table 2-3. MacTerm Parameters for MFJ-1278B

Apple II, II+, IIe, IIc

For the Apple II family of computers with Apple or third-party RS-232C serial cards, you may use ASCII Express Pro, Hayes Smartcom IIe and DataCapture 4.0 for the MFJ-1278B. There are others that may be compatible with the MFJ-1278B, but have not been tested.

Commodore C64, C128 and VIC-20

The optional Starter Pack for the C-64, C-128 and VIC-20 is available from MFJ Enterprises, Inc. or from any dealer of MFJ products. Included in the Starter Pack is a cable to connect the MFJ-1278B TTL port to the user I/O port on the Commodore computer. Also included with the Starter Pack is a terminal program. The terminal program allows compatibility between the MFJ-1278B and the Commodore computer. To order, specify MFJ-1282B for software on disk or MFJ-1283 for software on tape.

If you do not have the MFJ Starter Pack, then you may use the BASIC communications program given in the Programmer's Reference Guide published by Commodore. Use the program listing for "true ASCII," as these computers use a modified ASCII format internally. You will probably want to run your MFJ-1278B at 300 baud on the serial port with these computers.

NOTE: When using the BASIC communications program above, you must first use the "COMMODORE" key to shift to lower case before using this program. Also line 200 should read **For J=0 to 64:T%(J)=J:NEXT.**

The information given on page 5 of this chapter is used to make a cable for use with the BASIC communications program mentioned above. However, do not use pin E connection for this program.

IBM PCjr

The IBM PCjr has a built-in terminal program in the BASIC cartridge. Start this program by typing **TERM**. Refer to your PCjr BASIC manual for details on this program. For best results with PCjr, do not run the MFJ-1278B serial port faster than 1200 baud.

IBM and Compatible Computers

The optional Starter Pack, (MFJ-1289) for the IBM PC and compatible computers is available from MFJ Enterprises, Inc. or from any dealer of MFJ products. Included in this Starter Pack is a graphics terminal program. This program allows compatibility between the MFJ-1278B and the computer. Also included is a cable used to connect the MFJ-1278B to your computer. The MFJ-1289 program allows you to transmit and receive 16 gray level FAX as well as color SSTV pictures. The MFJ-1289 also allows for display of these signals on the computer screen. It will also store the pictures on disk for later viewing or transmitting. This software also sets up compatibility between the MFJ-1278B and the computer when operating the other mode, that the MFJ-1278B has to offer.

You may also use many commercial, "shareware" and public-domain terminal programs for the IBM PC and compatible computers. Special programs written for packet radio and packet bulletin board services can be used with the MFJ-1278B. Note that these types of

Radio Shack Color Computer

There are several terminal programs available for the Color Computer. You will probably want to use a commercial program (rather than writing your own) since the Color Computer has a "software UART" that is difficult to program in BASIC.

Some of the terminal programs available are COLORCOM 64, AUTOTERM and RICKEYTERM (for Coco III). Others are WIZ and XTERM for OS-9.

Radio Shack Model 100/102 and NEC 8201

These computers have built-in terminal programs in ROM. Consult your computer's documentation for instructions in their use.

MFJ-1278B SERIAL PORT PIN FUNCTIONS

This section describes the pins used on the MFJ-1278B RS-232C serial port connector. It is intended for users with special applications requiring hardware handshaking. This information should not be needed by most users.

Pin #	Mnemonic	Name
1	FG	Frame Ground
2	TXD	Transmit Data
3	RXD	Receive Data
4	RTS	Request To Send
5	CTS	Clear To Send
6	DSR	Data Set Ready
7	SG	Signal Ground
8	DCD	Data Carrier Detect
9	---	+ 12V unregulated reference
10	---	- 12V unregulated reference

Table 2-4. RS-232C Pin Designations

Pin 1 Frame Ground

The Frame Ground pin is provided for attachment to the chassis of the MFJ-1278B and the chassis of the attached device (computer or terminal). This pin is available at a feed-through hole on the MFJ-1278B PC board near pin 1 of the serial connector. It is not electrically connected anywhere else on the MFJ-1278B circuit board.

Pin 2 Transmit Data

Pin 3 Receive Data

The Receive Data pin is an output line from the MFJ-1278B on which the attached device receives data. The attached device is generally a computer or data terminal.

Pin 4 Request To Send

The Request To Send pin is an input line to the MFJ-1278B on which the attached device requests clearance to transmit data to the MFJ-1278B.

Pin 5 Clear To Send

The Clear To Send pin is an output from the MFJ-1278B signaling the attached device to send or refrain from sending data to the MFJ-1278B. This line is used for systems that require hardware flow control.

Pin 6 Data Set Ready

The Data Set Ready pin is an output from the MFJ-1278B telling the attached device that the MFJ-1278B is operational.

Pin 7 Signal Ground

The Signal Ground pin is the common or return path for all signals between the MFJ-1278B and the attached device.

Pin 8 Data Carrier Detect

The Data Carrier Detect pin is an output from the MFJ-1278B. As normally configured, DCD reflects the status of the CON LED: It is true when an AX.25 connection exists between your MFJ-1278B and another station; it is false when no connection exists. This configuration is useful when the MFJ-1278B is used with a telephone style Bulletin Board system. Since the AX.25 protocol connection, analogous to a modem signal on the telephone, indicates the presence of a user. Shorting pins 1 and 2 of JMP1 on the MFJ-1278B mother board will cause this output to always be true.

COMPUTER BAUD RATE**Autobaud**

The MFJ-1278B performs an **AUTOBAUD** routine upon each power on cycle of the MFJ-1278B. The **AUTOBAUD** command is user selectable. The **AUTOBAUD** command is 1.6. The ON/OFF of AUTOBAUD is ON MFJ-1278B. The ON/OFF of AUTOBAUD is 1.6.

time the MFJ-1278B signs on you will not need to press the return key to execute the Autobaud routine. In setting **AUTOBAUD** to OFF, you should remember that if you change the terminal program baud rate is changed, then MFJ-1278B will no longer be able to match the new baud rate. You must change the baud rate of your terminal program to match the baud rate you set for the MFJ-1278B or you may remove JMP 5 on the MFJ-1278B board to reset the battery back-up RAM. Once reset, the MFJ-1278B will restore all parameters to the default values, including the **AUTOBAUD** command. The default setting for the **AUTOBAUD** command is ON. When the MFJ-1278B is powered on after resetting memory, it will attempt to match the new baud rate and sign on after receiving the return key presses sent by the user.

Changing Terminal Baud Rate

The MFJ-1278B RS-232 port will operate at the rate of 300*, 1200, 2400, 4800, 9600 or 19,200* baud.

The MFJ-1278B employs an **AUTOBAUD** routine that automatically matches it's terminal baud rate to that of the rate set on the terminal program. The **AUTOBAUD** routine is executed by pressing the "Return" key several times upon each power on cycle of the MFJ-1278B. This means if the terminal program baud is set at 9600 baud, the MFJ-1278B will set it's terminal speed to 9600 baud to match the program.

We suggest that once you select a terminal baud rate that you wish to operate your MFJ-1278B on, you should set **AUTOBAUD** command to OFF. Once **AUTOBAUD** is turned OFF, the MFJ-1278B will automatically sign-on without you having to press the "Return" key. This is important if power a outage occurs, the MFJ-1278B will sign-on when power is on again. If **AUTOBAUD** is OFF, and the terminal program baud rate does not match the MFJ-1278B, then once the MFJ-1278B is turned off, it will not sign on again. If you reset the MFJ-1278B or the terminal program baud rate, then the MFJ-1278B will sign-on. Once reset, the MFJ-1278B will default **AUTOBAUD** to ON and it will sign on upon power up and with a few strikes of the return key. The MFJ-1278B can be reset by removing JMP 5 on the main PC board of the MFJ-1278B.

*The MFJ-1278B terminal baud rates of 300 and 19,200 is selectable by a jumper on JMP 18 on the mother board. Please refer to Chart XX on page ?? to locate JMP 18. For 300 baud set the shorting jumper to positions 2-3 and for 19,200 baud set the shorting jumper to positions 1-2. The factory setting for JMP18 is positions 1-2.

VERIFYING SERIAL PORT OPERATION

Now that you have a terminal program and the connecting cable for attaching the MFJ-1278B to your computer, you are ready to verify that the MFJ-1278B will communicate with your computer.

1. Turn on your computer. Load and run the terminal program.
2. Set the parameter of the terminal program as follow:

Word Length	8 bits
Duplex	Full
Parity	None
Stop Bits	1
Baud Rate	300, 1200, 2400, 4800, 9600, or 19,200

3. Turn on your MFJ-1278B, and note that the **PWR**, **STA** and **CON** LEDs are lit.
4. If the MFJ-1278B terminal parameters match your terminal program parameter, the MFJ-1278B will sign on and the **STA** and **CON** LEDs will extinguish. If not, you will see an asterisk (*) or other meaningless characters on the screen at this time. This is because the MFJ-1278B has not been set to match the parameter of your terminal program. You will need to execute the **AUTOBAUD** routine.
5. Execute the **AUTOBAUD** routine by pressing the **RETURN** key few times in succession on your computer. The MFJ-1278B will execute the **AUTOBAUD** routine and set itself to the terminal program parameter. Your computer screen will display the sign-on message:

```
*:J
bbRAM:LOAD WITH DEFAULTS
|A
MFJ ENTERPRISES, INC.
MODEL MFJ-1278B
AX.25 LEVEL 2 VERSION 2.0
RELEASE XXXXX (date) - 32K RAM
CHECKSUM XXX
cmd:
```

After the sign-on message the **STA** and **CON** on the MFJ-1278B will extinguish. If the sign-on message fails to appear, you should check the connecting cable between and the computer and the MFJ-1278B. When you can successfully read the sign-on message from the MFJ-1278B, type:

The MFJ-1278B has a parallel printer port in which to attach a parallel printer. The parallel printer port is located on the left-hand side of the MFJ-1278B. The printer port can be used to make hard copies of either text or graphics.

Printer Port Connection

The printer port is configured as a Centronics compatible parallel port. A cable with male DB-25 on one end and a 36 pin Centronics male connector for the printer end should be used. You may use a standard IBM parallel printer cable instead of trying to wire your own. A Printer cable for connection from the MFJ-1278B printer port to a Centronics compatible printer is available from MFJ Enterprises, Inc. Model No. is MFJ-5412.

If you are using a terminal program that supports graphic printing from the computer to the printer, then you should connect the printer to the computer printer port and not to the MFJ-1278B printer port.

The MFJ-1278B printer port is available for printing graphics. This feature can be used whether your terminal program supports graphics printing to the computer screen or not. It can be used to print graphics such as Packet, SSTV or FAX pictures. If you want to print graphics, then you should connect the printer to the MFJ-1278B printer port. In this case the printer must be either EPSON or IBM graphic compatible in order to insure successful graphic receiving to the printer.

The MFJ-1278B printer port configuration is shown in Table 2-5.

MFJ-1278B DB-25 Printer Port Pin #	Name
1	Strobe
2	Data Bit 1
3	Data Bit 2
4	Date Bit 3
5	Data Bit 4
6	Data Bit 5
7	Data Bit 6
8	Data Bit 7
9	Data Bit 8
10	Acknowledge
11	Busy
12 thru 17	No connection
18 thru 25	Ground

Printer Consideration

The MFJ-1278B printer port will work with any printer that is compatible with EPSON or IBM graphics. Printers that are not EPSON or IBM graphics compatible can not be used to print FAX or SSTV pictures.

In addition to being able to print such as weather FAX, FAX and SSTV pictures, the printer connected to the MFJ-1278B printer port can also print incoming text in all modes as it is received on the screen. This means that you can keep a log of all your QSOs. To print text to the printer, you will need to connect an IBM compatible parallel printer to the MFJ-1278B printer port. Printers without Epson compatible graphics will not be able to print Weather FAX, FAX or SSTV.

Printer Port Test

After properly connecting your printer to the MFJ-1278B, you may verify its compatibility as follows:

1. Turn on your computer. Load and run the terminal program.
2. Turn on the MFJ-1278B. The MFJ-1278B should sign-on with the cmd: prompt sign.
3. Type: **PRINTTES <CR>**

If the printer is connected correctly and is compatible, it will print a string of 223 characters. Again this only shows that the printer connected can print text. It does not necessarily indicate that your printer can print graphics unless it is Epson or IBM graphics compatible.

4. Printing will start with ASCII SPACE (value 32 decimal) and end with the value 255 decimal that is not an ASCII character but may be a graphics character.
5. Once the printer has completed the printing, the MFJ-1278B will return to cmd: prompt sign.

This completes the printer test. If the printer test was satisfactory, proceed to connect your radios to the MFJ-1278B.

The above test is only valid if your printer is connected to the MFJ-1278B parallel port. This test can not be performed if the printer is connected to the parallel port of the computer.

RADIO INTERFACING

Computer interfacing, covered in the previous chapter, is only half the interfacing task. The other half is connecting your MFJ-1278B to your radios.

MFJ-1278B Radio Ports

Interfacing the MFJ-1278B to your radios involves connecting the following signals at Radio Port 1 and Radio Port 2. The pin outs of Radio Port 1 and Radio Port 2 are shown in Fig. 3-1.

- Pin1 Microphone audio, from the MFJ-1278B to your transmitter.
- Pin 2 Ground, audio and PTT common.
- Pin3 Push-to-talk, to allow the MFJ-1278B to key your transmitter.
- Pin 4 Receive audio, from your receiver to the MFJ-1278B.
- Pin 5 Squelch input (optional) to allow the MFJ-1278B to detect activity on a shared-mode channel.

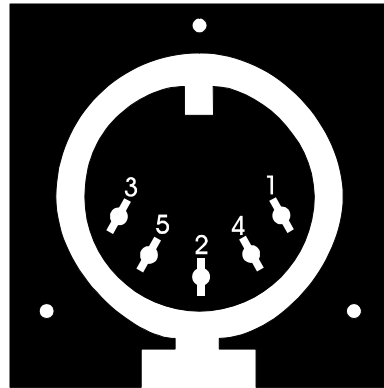

Fig.3-1 Radio Port 1 and Radio Port 2 Connector

This chapter describes how to connect the MFJ-1278B to your radio and how to adjust the receive and transmit audio levels appropriately. The interconnection needs to be well thought out, to minimize pickup of stray audio and RF noise by the lines. If possible, you should set up your station with a monitor speaker and be able to operate on voice without disconnecting the MFJ-1278B.

RADIO PORTS CONNECTION

The MFJ-1278B gives the user two (2) radio ports. This allows for both FM and HF operation from either radio port. Since the radio ports are independent of each other, the user is not restricted to FM or HF operations. The radio ports on the MFJ-1278B allow an FM radio and an HF radio to be connected at all times. In fact you can have any combination of HF radios or VHF radios connected to the radio ports at any time. The pin designations for both radio ports are exactly the same. See Fig. 3-1 for the radio port pin designations. The radio ports on the MFJ-1278B are switched by using the **RADio** command. We will discuss radio port switching in the next chapter.

Once the user obtains the proper microphone connector (**not provided**), use Fig. 3-2 to wire the 5 pin DIN cable (provided) to the microphone connector. If two radios are to be used with the MFJ-1278B, you will need to wire two radio cables.

You may obtain the specific pin designations for your radio's microphone connector from your radio's manual. **Appendix A** at the end of this Instruction Manual lists pin assignments for some of the most popular radios. The accuracy of this information is not guaranteed. You should verify this information with your radio manual.

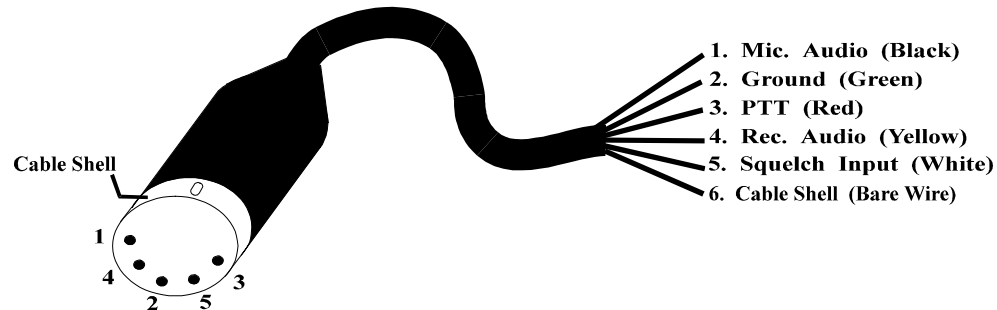

Fig. 3-2 Radio Connector Pin Diagram

Two 5-pin male DIN cables are provided with the MFJ-1278B. These cables have a 5-pin DIN connector on one end, with the other end of each cable being unterminated. The unterminated end of each cable is for wiring the appropriate microphone connector which matches your radio.

CHECK THIS CABLE WITH AN OHM METER TO IDENTIFY EACH WIRE BEFORE WIRING IT TO THE MIC CONNECTOR THAT FITS YOUR RADIO.

HANDHELD RADIO CONNECTION

Some HTs key the transmitter by drawing a small amount of current from the microphone input pin (see Fig. 3-3 below). Radios with this type of special keying circuit are ICOM-2AT (tm) and Yaesu FT-x09, FT-x3, FT-727 (tm) and others.

Appendix A at the end of this instruction manual provided pin designation for some of the radios. Also consult the instruction manual of your radio.

If your HT has this type of microphone circuit, you can wire the microphone like the one shown in Fig. 3-3 or you can remove the cover of the MFJ-1278B and install a shorting jumper at JMP L for Radio Port 1 or JMP K for Radio Port 2. Installing JMP K or JMP L will eliminate the need of soldering "Cx" and "Rx" to the microphone cable. "Cx" and "Rx" are installed on the MFJ-1278B mother board. Fig. 3-4 shows the location of JMP L and JMP K connectors. On the MFJ-1278B mother board, the "Rx" resistor for Radio Port 1 is R140 and the "Rx" resistor for Radio Port 2 is R107. If your radio still will not key properly after installing JMP L or JMP K, you may need to change R140 or R107 to a smaller value. Be sure to remove **JMP K** or **JMP L** when connecting the MFJ-1278B to another type of radio.

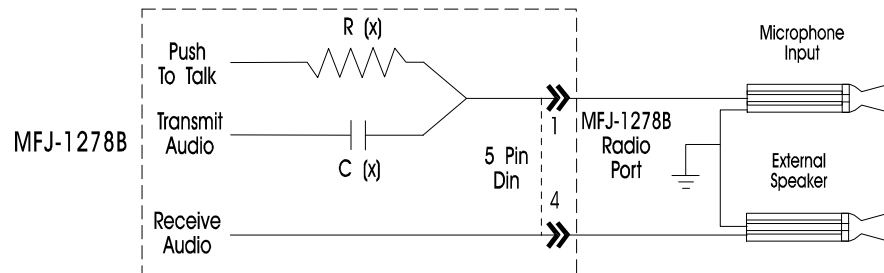
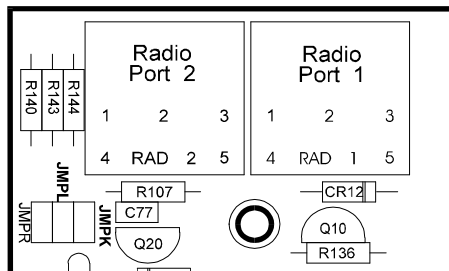

FIG. 3-3 HT Special Keying Circuit

Left Rear Corner of the MFJ-1278B



RADIO INTERFACING METHODS

The MFJ-1278B allows radio connection without any modifications to the radio or any signal balancing devices in the cables. There are two types interfacing methods presented in this chapter.

Method 1: Direct Connection to Microphone and Speaker

For Method 1, shown in Fig. 3-5, the MFJ-1278B's audio is fed directly into the microphone connector or similarly connected auxiliary jack. The output of the MFJ-1278B will be adjusted to give a proper modulation level. The receiver audio will be taken from an earphone plug or speaker jack and fed directly to the MFJ-1278B. The user can connect a monitor speaker to the SPEAKER jack of the MFJ-1278B. This allows you to monitor the transmit and receive audio on the channel.

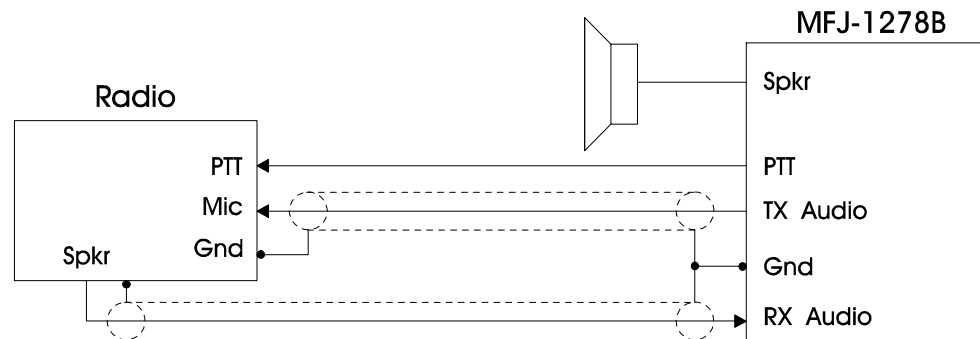

Fig. 3-5 Method One Interconnect.

The transmit audio levels for both radio ports are factory preset at 250 mV p-p to be compatible with the mic input of most radios. However, if the transmit audio is too low or distorted, then adjust the appropriate output level control as stated in the section. Use the following procedure to calibrate:

Transmit Audio Level Adjustment for Method I Interface

1. Connect your MFJ-1278B and radio as shown in Fig. 3-5. Turn on the MFJ-1278B and computer and start your terminal program. Connect the radio to a dummy load and listen to the transmission with another nearby radio.
2. Enter the modem calibration procedure by typing

CALIBRA

followed by a carriage return. Press the **X** key on your keyboard to hear the transmission. Then

3. With the MFJ-1278B keying the transmitter and transmitting the higher of the two tones, adjust the transmit audio level as follows. With a small flat-tipped screwdriver, adjust trimpot located on the left side of them MFJ-1278B (R157 for radio 1 or R158 for radio 2) while you listen to the monitoring receiver. Adjusting the trimpot CW increases the output, while CCW decreases the output. Turn the adjustment on the trimpot clockwise (CW) until no increase in output level is heard at the monitoring receiver.
4. Rotate the adjustment on the trimpot counter-clockwise until the audio signal on the monitoring receiver decreases by half of the maximum level. This can be estimated by ear or accurately by measuring the output voltage at the transmit audio pin of the radio port with an oscilloscope or AC voltmeter.
5. Press the **K** key to return to receive mode and type **Q** to exit the calibration routine. Be sure to remove JMP4 if you placed it to defeat the watch-dog timer. You have now set your transmitter deviation to approximately the correct level.

If you notice a significant hum level in the monitored audio in Step 3, take measures to remove it. This may require shielded wire (recommended in any event) in your microphone audio circuit. The use of shielded cable is always necessary, in projects such as this. If your transmitter has an adjustable microphone gain control, try reducing the sensitivity of the transmitter microphone circuit and increasing the signal level from the MFJ-1278B to minimize hum or other noise problems.

Setting the Receiver Audio Input Level

The modem in your MFJ-1278B implements an advanced phase coherence type data carrier detection (DCD). There is a threshold control and a sensitive tuning indicator. Together they set the correct receive audio level for the modem, also to optimize the DCD characteristics for the various methods of operation.

With your radio in the receive mode, open the squelch control so that a steady hiss is present on a speaker. Set the volume control to the minimum volume position. The tuning indicator on the MFJ-1278B should drift off to one side of the display and become stationary. It may drift enough to disappear off the end of the display. Slowly advance the audio output level with the volume control until the tuning indicator "springs to life" and dances around a point near the middle of the display. This is the absolute minimum audio level for marginal copy. Continue to advance the volume control until there is approximately twice as much audio present at the receiver output. This can be estimated by ear or measured with an oscilloscope or AC voltmeter. This will be near the correct amount of audio for NBFM operation. Levels higher than this will not degrade the modem performance as long as the receiver audio amplifier is capable of producing the chosen output level without distortion (clipping).

The bandwidth of the receiver audio will have an effect on modem sensitivity to false DCD. Some receivers produce wideband audio that will NOT produce any false DCD activity regardless of the threshold control setting. In this case, set the DCD threshold control to its maximum clockwise rotation. This will not effect modem performance.

Method 2: Accessory Jack or Interface Box Connection

If your radio has an accessory jack with PTT, transmit audio, and receive audio signals, the interconnection can be done through this jack (shown in Fig. 3-6).

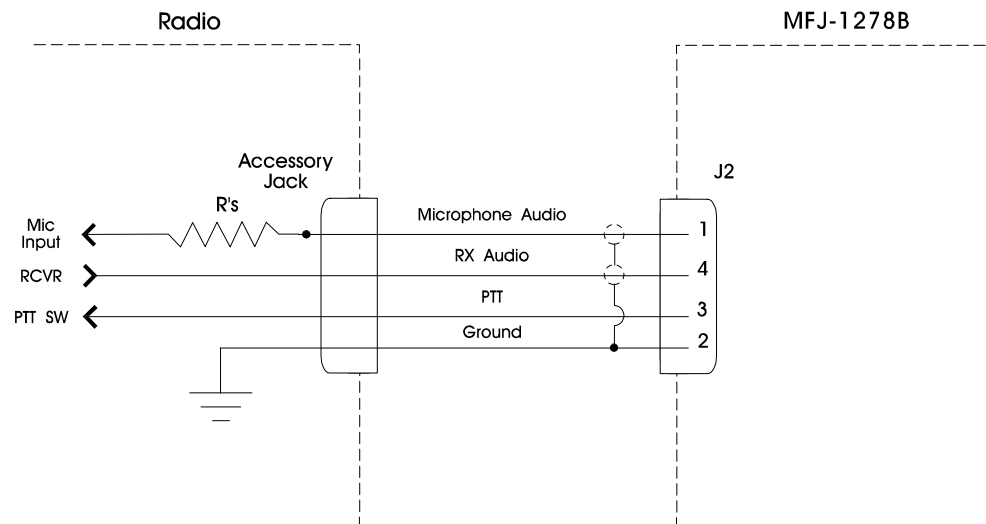

Fig. 3-6 Accessory Jack Interface.

If your radio does not have an accessory jack and you don't wish to add a connector to your radio, you may construct a separate external interface box. This box will permit simultaneous connection of your MFJ-1278B and a microphone. Figure 3-7 shows a schematic of an external interface box.

A microphone interface box similar to the one shown in Fig. 3-7 is available from MFJ Enterprises, Inc. or from any dealer of MFJ products. The Model No. of the microphone interface box is MFJ-1272B.

Regardless of whether you use an accessory jack or an external interface box, you should use shielded wire for all signal carrying leads. The connectors and fittings on your radio will be the deciding factor, as to what hardware you will need. The user may also want to refer to manuals of the equipment involved in the interconnections for some information.

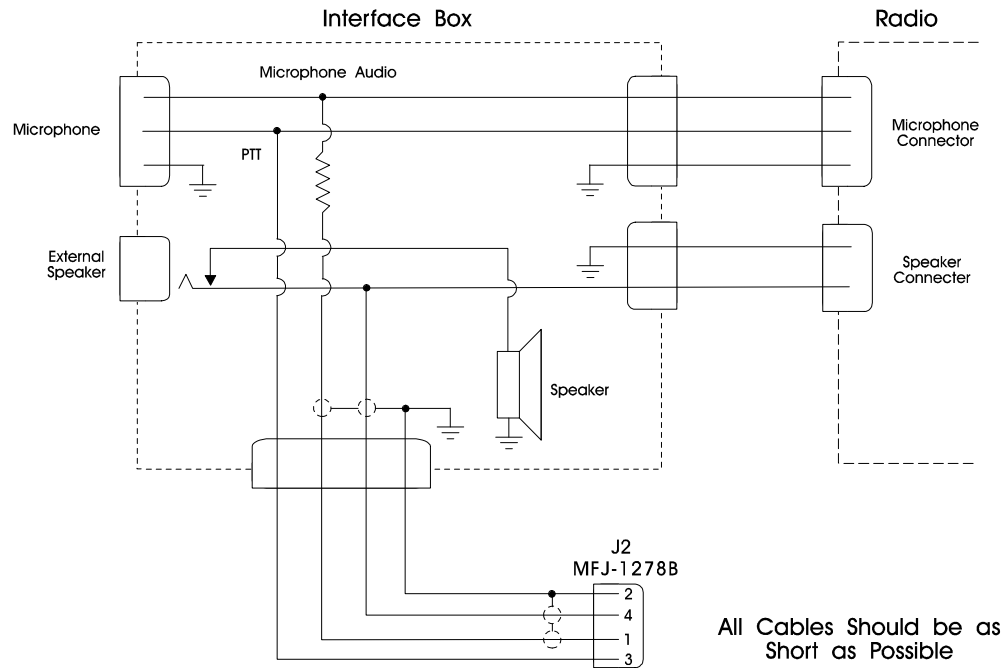

Fig. 3-7 External Interface Box

If you built the external interface box as in Fig.3-7, then follow this procedure to adjust R(s).

1. Install JMP J on the MFJ-1278B PC board.
2. Temporarily solder a variable resistor in place of R(s) Fig. 3-7. The maximum value of this resistor can be determined by experiment. However, a 500K resistor should be adequate most cases. Connect your MFJ-1278B to the radio. Connect the microphone to the radio, or to the interface box if one is being used. Connect the radio to a dummy load and listen to the transmission with another nearby radio. Adjust R(s) for proper modulation as the next sections describe.

Transmit Audio Level Adjustment for Interface Method II

1. Turn on the MFJ-1278B and computer and start your terminal program. Enter the modem calibration procedure by typing

CALIBRA

Press the **K** key to key the transmitter, then tap the space bar until the higher of the two tones is heard. Pressing the **K** key again will unkey the transmitter. After the transmitter has been keyed for a few seconds, it will shut off automatically by the transmit watch-dog circuit. As you perform the adjustments below, you will have to periodically unkey then re-key the transmitter by typing the **K** key. If you wish to defeat the watch-dog timer, place a shorting jumper at JMP4.

2. With the MFJ-1278B keying the transmitter and transmitting the higher of the two tones, adjust the transmit audio level as follows.
3. Adjust R(s) the variable resistor installed for proper modulation level (typically between 3.0 and 4.5 kHz deviation for Amateur FM). If FM test equipment is not available, adjust R(S) until the audio signal on the monitoring receiver is decreased by half of the maximum level. This can be estimated by ear or accurately determined by measuring the output voltage across the speaker with an oscilloscope or AC voltmeter. If there is not adequate audio level from the MFJ-1278B to make adjustment of R(s), then you can increase the output level of the MFJ-1278B by adjusting R157 for radio port 1 or R158 for radio port 2. The transmitting audio output of both radio ports is factory set at 250 mV p-p.
4. Press the **K** key to return to receive mode and type **Q** to exit the calibration routine. You have now set your transmitter deviation to approximately the correct level. Remove JMP4 if you placed it in Step 4.
5. Carefully remove the variable resistor and measure its value. This is the proper value of R(S) for your particular radio.
6. Select the nearest standard value fixed resistor (1/4 watt is fine) and permanently install this resistor as R(S) in the interface circuit.
7. If you have access to FM test equipment, check to see that the modulation level is still within the limits of 3 to 4.5 kHz deviation. If the modulation level is not within 3 to 4.5kHz limits, then make a final adjustment with the MFJ-1278B transmit audio level controls. These controls are R157 for Radio 1 and R158 for Radio 2.

Receiver Audio Setting

The modem in your MFJ-1278B is equipped with an advanced phase coherence type data carrier detection (DCD). A threshold control and a sensitive tuning indicator is also provided. Together these can be used to set the correct receive audio level for the modem. These can also be used to optimize the DCD characteristics for the various methods of operation.

With your radio in the receive mode, open the squelch control so that a steady hiss is heard on a speaker. Set the volume control to the minimum volume position. The tuning indicator on the MFJ-1278B should drift off to one side of the display and become stationary. It may drift enough to disappear off the end of the display. Slowly advance the audio output level with the volume control until the tuning indicator "springs to life" and dances around a point near the middle of the display. This is the absolute minimum audio level for marginal copy. Continue to advance the volume control until there is approximately twice as much audio present at the receiver output. This can be estimated by ear or measured with an oscilloscope or AC voltmeter. This will be near the correct amount of audio for NBFM operation. Levels higher than this will not degrade the modem performance as long as the receiver audio amplifier is capable of producing the chosen output level without distortion (clipping).

While still listening to unsquelched receiver noise, rotate the DCD threshold control on the front panel of your MFJ-1278B clockwise until the DCD LED just flickers with false data carrier indications. This control should be set to produce approximately a 10% duty cycle of false DCD activity when receiving unsquelched NBFM receiver noise.

The modem sensitivity to false DCD will be affected by the bandwidth of the audio coming out of the receiver. some receivers produce wideband audio which will NOT produce any false DCD activity regardless of the threshold control setting. In this case, set the DCD threshold control to its maximum clockwise rotation. Modem performance will not be affected.

IMPORTANT NOTE: Harmonics Interference

If you experience harmonic interference from the crystal oscillator in the MFJ-1278B, adjust trimmer capacitor, C47. Trimmer capacitor C47 is located near the crystal. Slowly adjust C47 to move the frequency of the harmonic.

MONITOR SPEAKER CONNECTION

The MFJ-1278B has a built audio amplifier to provide audio for an external monitor speaker. A Monitor speaker such as the MFJ-280, can be connected to the **SPEAKER** jack on the MFJ-1278B. The MFJ-1278B requires only one speaker for RADIO 1 and RADIO 2. The MFJ-1278B will automatically switch the monitor speaker to the radio port in use.

If wiring of a speaker plug is necessary, use a 3.5 mm (1/8") mono or stereo plug for this connection. The **tip** of the plug is **positive** and the **sleeve** of the plug is **negative**. The **tip** of the plug must be connected to the **positive** side of the speaker. The **sleeve** of the plug must be connected to the **negative** side of the speaker. Note that only one speaker is needed for both radio ports. The MFJ-1278B will automatically switch the speaker to the correct radio port in use.

The speaker jack on the MFJ-1278B is for monitoring of received and transmitted audio including CW side tone. The speaker is used to provide a signal to the operator when a packet connection has been established. A small audio amplifier is built in the MFJ-1278B to drive the external speaker. Volume of the monitor speaker is adjustable by using the "Monitor" control on the left side of the MFJ-1278B. If the internal amplifier of the MFJ-1278B does not provide adequate volume you may use an external audio amplifier.

You can disable received audio, transmitted audio or the packet connect tone from the speaker monitor jack by cutting a trace between the pins of the following jumpers. See **Appendix G** for the locations and functions of JMP jumpers:

- JMP X** Transmitting Audio
- JMP Y** Receiving Audio
- JMP Z** Packet Connect Tone

For example, if you like to have the packet connect tone, then leave JMP Z intact. If you do not wish to hear the transmitted or received packet signal, then disconnect JMP X to disable the transmitted audio and JMP Y for received audio.

CW INSTALLATION

The MFJ-1278B user can send and receive CW by using your computer keyboard. However, the MFJ-1278B expands CW operating fun by allowing you to connect an iambic paddle to the **KEY** input jack of the MFJ-1278B. This feature allows you to use the MFJ-1278B as a CW memory keyer. So now the user can operate CW from either the computer or an iambic paddle. Connect the MFJ-1278B for CW operation as follows:

Keying Connection

Connect a two-conductor shielded cable from the **Keying Output** jack of the MFJ-1278B to the keying input of your radio. The keying output jacks of the MFJ-1278B accept a standard RCA phono plug.

The keying output of the MFJ-1278B provides both the "Direct" or "Grid Block" type of keying output for your radio. The default output setting for the MFJ-1278B is "Direct" type keying. If your radio requires "Grid Block" type of keying, you may set the keying output to "Grid Block" by moving the shorting jumper on JMP22 from positions 2 & 3 to positions 1 & 2. See Appendix G at the end of this manual to locate JMP 22 on the MFJ-1278B mother board. After properly connecting the keying cable, you must determine what kind of keying circuit your radio has. If your radio is a solid state or cathode keyed type, then you should use the **DIRECT** keying output. If your radio is tube type you should use the **GRID BLOCK** keying output. If you are unsure of which output to use, try both outputs. The keying outputs of the MFJ-1278B are diode protected. If the wrong output is used you will notice a constant key down effect on the transmitter. The **DIRECT** output keys a positive voltage to ground. The **GRID BLOCK** output keys a negative voltage to ground.

Key Paddle Connection

The KEY paddle input jack of the MFJ-1278B accepts a 3.5mm **stereo** plug. (Radio Shack Part No. 274-284). **DO NOT USE A MONO plug, IT WILL SHORT OUT THE KEY INPUT.** A two conductor fully shielded cable should be used. Wire the **tip** of the plug for the dash contact and the **ring** of the plug for the dot contact (See Figure 3-8 below). Be sure to use the shield of the cable for the paddle ground contact.

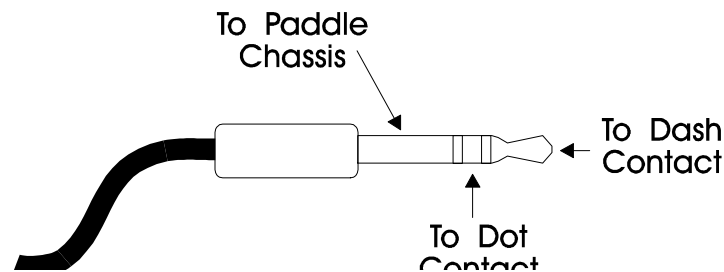

FSK CONNECTION

If your HF radio permits FSK operation, an FSK output is provided. The FSK output is at pin 8 of the TTL port on the rear panel of the MFJ-1278B. Only two lines (Pin-8 FSK and Pin- 3 ground) are needed in making the FSK connection to your radio. Use the 8-pin IDC connector supplied with your MFJ-1278B to make the FSK cable. See Figure 3-9 below.

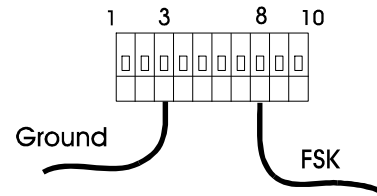

Figure 3-9 FSK Cable

Note: The factory setting of the FSK signal polarity is normal on the MFJ-1278B. If your radio requires you to provide a reverse FSK signal you will need to relocate the shorting jumper to position 2 & 3 of the JMP 14 header on the MFJ-1278B mother board.

GETTING STARTED

This chapter will guide you through the basic operation on all the modes that the MFJ-1278B is capable of performing. It contains the basic information required to operate PACKET, PACTOR, RTTY, ASCII, CW, AMTOR, NAVTEX, FAX, SSTV and CW Memory Keyer.

Note: In this section you will see this symbolism, <ENTER>. This means to press the **Carriage Return** or **Enter** key on your keyboard.

First Steps

1. Make sure that your computer is connected to the RS-232C port or the TTL port on the MFJ-1278B according to Chapter 2.
2. Make sure that your radios are connected to the MFJ-1278B according to Chapter 3.
3. Turn on your computer. Load and run the terminal program.
4. Turn on the MFJ-1278B. The MFJ-1278B will sign on with "cmd:" prompt sign. If the MFJ-1278B fails to sign-on, press the return key on your computer a few times in succession, the MFJ-1278B will sign-on as as follow:

```
*:J
bbRAM:LOADED WITH DEFAULTS
|A
MFJ ENTERPRISES, INC.
MODEL MFJ-1278B
AX.25 Level 2 Version 2.0
Release XXXXXX (date) - XX K RAM
Checksum XXX
cmd:
```

Note: The "|A" may display as a vertical-bar and any capital letter from "A" through "J".

The first five lines are the sign-on message, which you will normally see only when you power up the MFJ-1278B. The Command Mode prompt, **cmd:** will appear when the MFJ-1278B is in **Command Mode**. The **cmd:** prompt indicates that the MFJ-1278B is now ready to accept your instructions. Upon sign-on the MFJ-1278B is in the VHF packet mode. Before the MFJ-1278B can be fully operational, some of the basic parameters must be set.

Basic Commands

With the MFJ-1278B signed-on and in the VHF packet mode, you are ready to start setting up the basic commands you will use. The commands in the MFJ-1278B are set to their defaults. Some of these defaults may be sufficient for the way you wish the MFJ-1278B to

followed by a carriage return. Now let's try entering your callsign using one of the basic commands, **MYCALL**, by typing from the cmd command prompt:

MYCALL K5FLU

followed by a carriage return.

The MFJ-1278B will respond with:

**MYCALL was NOCALL
cmd:**

followed by the the system command mode prompt, **cmd:**. Of course, you should substitute your own call sign for **K5FLU**. Do not forget the <ENTER> at the end of the line. Your callsign will be used by the MFJ-1278B as its "address." The MFJ-1278B responds by telling you the previous value of the **MYCALL** parameter, and gives you a new Command Mode prompt.

Note that commands are entered by inserting a carriage return <ENTER> after each command is typed. Note also that carriage return may also be marked as <ENTER> on some computer keyboards.

Now try typing just the command by itself:

cmd: **MYCALL**

The MFJ-1278B will respond with:

MYCALL K5FLU

You can see the current value of most parameters by typing the command that sets the parameter followed by just a <ENTER>. This verifies that the MFJ-1278B accepted your callsign.

The next section describes the commands you will use to configure the MFJ-1278B for proper text display for your particular computer. You may not use these commands again unless you change computers or terminal programs.

SERIAL PORT CONFIGURATION

This section describes the commands you will use to set up the MFJ-1278B to work best with your computer. These commands will determine how the computer or terminal and the MFJ-1278B communicate back and forth. There are commands that determine how the MFJ-1278B displays data on your computer or terminal screen. So let's start talking about Serial Port Configuration.

Parity and Word Length

If you are using one of the optional MFJ Starter Packs, then you should follow the instructions given by the terminal program documentation with the starter pack. If you are not using one of the MFJ starter packs, then you should use the following instructions to set the parity and word length for the MFJ-1278B.

If messages from the MFJ-1278B appear garbled, with incorrectly displayed characters, you may need to change the MFJ-1278B's serial port parity and word length. There could also be a problem with the terminal baudrate. See Chapter 2 if the baud rate needs to be changed. The MFJ-1278B's default value is 8 bits and no parity. If your computer receives 8 bits as data, you may have to set space parity, since text may otherwise be interpreted as graphics or other special characters. The **AWLEN** and **Parity** commands set the word length and parity, respectively. To set the wordlength to 8 bits, and parity to NONE, use the following combination:

AWLEN 8 (8-bit words)
PARITY 0 (no parity bit)

For setting a wordlength of 7 bits, and even parity, set

AWLEN 7 (7-bit words)
PARITY 3 (even parity)

One of these combinations will satisfy most computers. You are more likely to require a different setting if you have a terminal rather than a computer, or if you have configured your terminal port for some special application.

If your computer requires odd parity, set **PARITY 1**. If your computer detects framing errors, try setting

AWLEN 7 (7-bit words)
PARITY 0 (no parity bit)

for shorter characters. For longer characters, set:

AWLEN 8 (8-bit words)
PARITY 1 or **PARITY 3**

Echos

You may see two characters on your screen for every character you type, for example:

cmd: RREESSEETT

Your computer is echoing the characters you type, and the MFJ-1278B is also echoing them. In this case, set duplex to **FULL** on your terminal to stop the terminal from echoing

New Lines and Line Wrapping

If everything displayed appears to be double-spaced, your computer is adding an extra linefeed (<LF>) whenever it displays a carriage return (<ENTER>). Set **AUTOLF OFF** to keep the MFJ-1278B from also adding an <LF>. If you change equipment you may have to set **AUTOLF ON** to restore the MFJ-1278B's automatic linefeeds.

The screen-width parameter is set by default to 80, the width of many CRT displays. The MFJ-1278B will send an extra <ENTER> (or <ENTER> <LF> if **AUTOLF** is **ON**) when 80 characters have been displayed on a line. If your computer does not automatically break long lines, you will need to set the screen width to the width of your display. For example, for a computer using a TV set for a display, you would set **SCREENLN 40**. If your computer does automatically break long lines, you should set **SCREENLN 0** to disable this feature on the MFJ-1278B. Otherwise, you will get two <ENTER>s when the line wraps around.

A few computers will frequently lose the first characters of a line when several lines are typed in rapid succession, for example, in the sign-on message. You can give the computer more time between lines by setting **NUCR ON** (delay after <ENTER>), or **NULF ON** (delay after <LF>). The delay is adjusted by **NULLS** parameter. The **NULLS** parameter sets a number of character-times for the delay.

With the basic parameters set up which enable the MFJ-1278B to be able to communicate with your computer, we can now discuss some basic functions and features of the MFJ-1278B.

THE MFJ-1278B MULTI-MODE MODEM

The MFJ-1278B modem has five sets of pre-set modem components. These modem components allow the MFJ-1278B to operate efficiently in its various modes of operation. These modes of operation include VHF and HF Packet, PACTOR, AMTOR, VHF RTTY, HF RTTY, VHF ASCII, HF ASCII, CW, Modulated CW, CW Memory Keyer, 16 gray level FAX (including Weather FAX), color SSTV and monitoring of NAVTEX.

All modem components have been individually calibrated for each mode of operation. The MFJ-1278B has been factory calibrated and does not require re-calibration when operating any the operational modes.

The modes used with each modem are shown in Table 4-1. The tones and shifts produced by each modem are shown in Table 4-2.

MODEM	OPERATION MODES
P	VHF Packet, 2 level FAX
H	HF Packet, HF Baudot RTTY, HF ASCII, PACTOR, AMTOR, NAVTEX
V	VHF RTTY, VHF ASCII
C	CW, Memory Keyer, Modulated CW
M	Multi-level FAX, Color SSTV

Table 4-1: MFJ-1278B Modem and Operation Modes

MODEM	LOW TONE(Hz)	HIGH TONE(Hz)	SHIFT(Hz)
P	1200	2200	1000
H	2125	2295	170
V	2125	2975	850
V*	1275	1445	170
C	700	----	----
M	1100, 1200, 1300, 1500 and 1550 thru 2250 in 50-Hz steps		

Table 4-2: Tones & Shifts Produced by the MFJ-1278B Modems.

* The MFJ-1278B will transmit and receive these tones when shorting jumpers for JMP E, F, G, and H are removed on the mother board.

OPERATIONAL MODES

Verifying Operation Status

Upon initial power up, the MFJ-1278B defaults to VHF Packet mode. The radio baud rate defaults to 1200 baud. Radio port 1 is the default radio connection. You can verify the operating status of the MFJ-1278B at any time by using the command **MODE** after the display of the CMD: prompt. To check operation mode, type:

```
MODE <ENTER>
```

The MFJ-1278B will respond with modem status display lines followed with the cmd: prompt.

Mode Switching With the MODE Command

Since the MFJ-1278B is a multi-mode controller, you will need to familiarize yourself with the commands for changing operating modes from one to another.

The MFJ-1278B provides an easily used command to change the mode of operation. The **MODE** command allows you to enter any operational mode. The **MODE** command also enables the selection of any desired radio baud rate and modem. Table 4-3 lists the valid codes that are used by the **MODE** command. The format for the **MODE** command is:

```
MODE xx,bbbb,m <ENTER>
```

Where **xx** is a 2 letter operational mode code as listed in Table 4-3, **bbbb** is the desired baud rate or speed, and **m** is the desired modem as listed in Table 4-1. Leaving the **m** parameter off of the **MODE** command, will cause the MFJ-1278B to select the default modem for the selected mode using the modem as listed in Table 4-1. Most of the time, there is no need to alter the baud rate settings, because the default settings are sufficient. So to specify HF RTTY operation at the default baud rate of 45 baud and using the default narrow shift modem, for example, you would type:

```
MODE HB <ENTER>
```

The user can alter any of the three parameters without having any effect on the other two. We can change the operational mode to HF RTTY at 110 baud, just by adding the number 110 on the end of the **MODE** command entry. You would do this by entering the following command:

```
MODE HB,110 <ENTER>
```

Similarly, to select the wide shift modem without changing either the operating mode or the baud rate you would type:

```
MODE HB,110,V <ENTER>
```

On the CW, MCW and Memory Keyer operation modes, instead of selecting a baud rate you will select CW sending speed by entering a number from 5 thru 99. If you do not select a speed, the MFJ-1278B will use the last speed selected. The default value is 20 WPM.

MODE CODE	OPERATION MODE	DEFAULT BAUD RATE	SELECTABLE BAUDRATE/SPEED/FORMAT
VP	VHF Packet	1200	300, 1200, 2400*, 9600*
HP	HF Packet	300	300
PT	Pactor	100	100, 200
VB	VHF Baudot RTTY	45	45, 50, 57, 75, 100, 110,150, 200, 300
HB	HF Baudot RTTY	45	45, 50, 57, 75, 100, 110,150, 200, 300
VA	VHF ASCII RTTY	110	45, 50, 57, 75, 100, 110,150, 200, 300
HA	HF ASCII RTTY	110	45, 50, 57, 75, 100, 110,150, 200, 300
AM	AMTOR/NAVTEX	100	100
CW	CW/ Mem. Keyer	20	5 WPM thru 99 WPM
MC	Modulated CW	20	5 WPM thru 99 WPM
FX	FAX(2-level)**	3(120L/M)	60, 90, 120, 180, 240, 360, 480 (LPM)
	FAX(16-level)***		
TV	SSTV**	1 (8.5S)	8.5, 12, 17, 24, 36(s)
	Color SSTV***	-----	Robot 72, Scotty 1, 2 Martin 1, 2

Table 4-3: MODE Command Codes and Baud Rates.

* With optional internal modem

** Supported by the built-in printer port: 2-level FAX and 4-level B&W SSTV.

*** When using MFJ Multicom terminal program MFJ-1278B will support 16-level FAX and Color SSTV.

Radio Port Switching

The MFJ-1278B provides the user with two independent radio ports, Radio 1 and Radio 2. The MFJ-1278B selects Radio port 1 when first initialized. After receiving the **cmd:** command prompt, you can select the desired radio port by typing "**RAD 1**" or "**RAD 2**" followed by a "Return" key press.

MFJ-1278B will display a new operation status and end with **cmd:** prompt.

MEMORY BUFFERS

The MFJ-1278B gives you ten user programmable memory buffers. The Memory Buffers are numbered 0 thru 9. These Memory Buffers are accessible by the **BUF** command. Each memory buffer is capable of storing up to 120 characters, including punctuations. The user

Loading the Memory Buffers

The ten memory buffers are empty when the MFJ-1278B is first initialized. To load the memory buffers the user can invoke the **BUF** command.

To load the memory buffers, please note the example below for loading buffer 1. The MFJ-1278B must be in COMMAND mode:

BUF1 The QTH here is Starkville, Mississippi. <ENTER>

Where **1** is the memory buffer number, that can range from 0 thru 9. "**The QTH here is Starkville, Mississippi,**" is the buffer message. Messages of up to 120 characters, including punctuations are permitted.

Note: Notice that there is NO space between "BUF" and "1" but remember to put a space between the buffer number and the buffer message.

Transmitting the Memory Buffers

The Memory Buffers can be transmitted by using the **BUFKEY** command. If **BUFKEY** is left at the default value of "9," then the user can transmit any buffer (0-9) by pressing the "TAB" key followed with a buffer number (0 thru 9). The MFJ-1278B will return to the receive mode when finished transmitting the buffer. Users do not have to type "CTRL-R" to go back to receive. The **BUFKEY** command is functional only in the CW/MCW modes.

The **BUFKEY** command is not valid in the RTTY or ASCII modes. In the RTTY and ASCII modes you will press a "CTRL-T" and a buffer number to initiate a buffer transmit and you will press a "CTRL-R" to revert the MFJ-1278B to the receive mode.

If you are using the MFJ-1278B with MFJCOM, IBM terminal program, you must change the **BUFKEY** value of "TAB" (9) key to "\" (\$5C) key.

Buffer Serial Numbering

If the memory buffer text includes a # sign, the MFJ-1278B will replace the # with a number. This is performed each time the user sends the buffer. The number is the current value of the serial number counter, **SERIALNO**. Once used, this serial number counter value is incremented by one up to a maximum of 65535, where the counter rolls over to zero.

If for any reason the serial number must be changed, you may return to the CMD: command prompt and enter the new serial number by typing:

SERIALNO ##### <ENTER>

Where ##### is the desired serial number from 0 to 65535.

Memory Repeat and Buffer Repeat Time

Of the ten memory buffers provided by the MFJ-1278B, memory buffer 0 has a repeat function. The user can enable the repeat function, moreover specify a time interval. The **BUFTIME** specifies the time interval between repeats of memory buffer 0. Values from 0 to 65,535 are suitable for the **BUFTIME** command. The increments of the **BUFTIME** are in seconds. A **BUFTIME** of 0 seconds represents no repeat after sending Buffer 0, thus disabling the repeat of Buffer 0. The **BUFTIME** command is usable only in the CW, MCW and Memory Keyer modes. The **BUFTIME** command is not effective for memory buffers 1 thru 9.

BUFTIME is the TOTAL time for one cycle of the **Buffer 0** message. This means that if your buffer message is 10 seconds long, then you must set the **BUFTIME** command longer than ten seconds. So if you need to have a 5 second delay between repeats, then set **BUFTIME** to 15. If you do not set the **BUFTIME** command longer than your message, then the message will be repeated maybe before it is finished. This will result in incomplete copy by the receiving station of the Buffer 0 message.

If your buffer 0 message is 10 seconds long, and you want Memory Buffer 0 to repeat every 5 seconds, under CMD: command prompt, type:

BUFTIME 15 <ENTER>

Memory buffer 0 will repeat every 5 seconds. To stop memory buffer 0 from repeating, set **BUFTIME TO 0**.

If **BUFTIME** is a non-zero value, the MFJ-1278B will automatically release the PTT line and revert to the receive mode between repeats. This allows you to monitor the frequency, possibly for a reply message. If uninterrupted during the pre-set delay time, then the MFJ-1278B will continuously repeat buffer 0, until **BUFTIME** is set to non-zero value.

Chaining the Memory Buffers

Chaining of the ten memory buffers in order is possible. This enables the transmitting of the buffers in any order. For example, you may transmit memory buffers 0, 2, and 5 respectively in one transmission. To achieve this, you should program the message in memory buffers as follows from the cmd: prompt type:

CMD: BUF0 XXXXXXXXXXXXX...XXXXX CTRL-T 2 <ENTER>

CMD: BUF2 XXXXXXXXXXXXX...XXXXX CTRL-T 5 <ENTER>

CMD: BUF5 XXXXXXXXXXXXX...XXXXX <ENTER>

Where **XXXX** is the desired text you wish to program into the memory buffers.

In the example above the **CTRL-T 2** does not mean you type CTRL-T 2. It means you hold-

Note: If BUFTIME is a non-zero value, MFJ-1278B will automatically release the PTT line and revert to the receive mode between repeats. This allows you to monitor the frequency for any replies to your message. If the MFJ-1278B is not interrupted during the pre-set delay time, it will continually repeat until buffer 0 is interrupted.

TUNING INDICATOR

Your MFJ-1278B comes equipped with a very accurate and sensitive tuning indicator. The tuning indicator is extremely useful not only for tuning to signals for optimum reception, but also for filter alignment and audio level indication.

The position of the tuning indicator LED is only meaningful for tuning a signal under the following conditions:

1. The station is transmitting data (both tones NOT just a single carrier).
2. The DCD LED is lit indicating that the signal is within the capture range of the PLL demodulator.
3. That there is sufficient audio output from the receiver for proper operation of the demodulator.

If the conditions above are met, tuning in a station with the tuning indicator is quite simple. Just set the receiver frequency so that the tuning indicator LED is centered in the display. Actually there are 2 LEDs which represent the center of the display. Either or both may be used. The use of the tuning indicator will be further discussed later in each mode of operation.

PACKET OPERATION**VHF Packet**

If you are not familiar with packet operation, then you can learn quite a bit about it with the MFJ-1278B without transmitting anything. For your first experiments, the MFJ-1278B will be "talking to itself," allowing you to become familiar with it before you go on the air.

If you are already familiar with the packet operation, then you may not want to perform this exercise. In this case go the other modes of operation in this chapter.

Disconnect your radio from the MFJ-1278B and turn off the MFJ-1278B. Install the digital loopback jumper, JMP10. Do not install the analog loopback jumper JMP7 while JMP10 is in place. Connect your computer to the MFJ-1278B with your serial cable. Turn on the computer and start your terminal program.

A Connecting and Disconnecting Exercise

A connect sequence initiates all Packet radio QSOs. The connect sequence sets up the "handshaking" between the two stations that ensures error-free communications. A disconnect sequence terminates all Packet radio QSOs. The disconnect sequence leaves both stations free to start new Packet QSOs. Packet QSOs can also make use of digipeaters, other packet stations that can automatically relay packets from one station to the other over a specified route.

To see how this works, you can have the MFJ-1278B connect to itself. Since you have set the MFJ-1278B up for digital loop-back, it will receive all packets that it sends. Try the following:

```
cmd: FULLDUP ON  
cmd: CONNECT K5FLU  
*** CONNECTED to K5FLU
```

replacing **K5FLU** with your own call sign. The MFJ-1278B generates packets initiating and confirming the connection. The packets are not actually converted to audio signals and transmitted over the radio, but they are otherwise just like packets you will be transmitting later on.

The *** **CONNECTED** to message tells you that the connection was successful. You should also notice that the CON LED has lit up and that you do not see a new **cmd:** prompt on the next line. You are now in Converse Mode, ready to start talking. Try it.

Type your message, ending the line with a <ENTER>, like the example given below:

The <ENTER> causes your message to be put into a packet, or "packetized," and transmitted. (We explain in the next chapter how you can use a different character to send packets.) The underlined text is a message that the MFJ-1278B received in a packet and displayed. Whenever you are in Converse Mode anything you type will be assembled into a packet addressed to the station you are talking to and transmitted. If there is not a QSO (connection) in progress, the packet will be sent to the address **CQ**.

In the example above, the MFJ-1278B entered Converse Mode automatically after the connect took place. You can also command the MFJ-1278B to move back and forth between Command Mode and Converse Mode.

To return to Command Mode, you must enter a special character, Control-C (abbreviated <CTRL-C>), or else send a BREAK signal. "Control" characters are usually entered by holding down a special control key and then typing another key without releasing the control key. If your keyboard does not have a key marked **CTRL** or something similar, consult the documentation for your computer or terminal program to see how to enter control characters. A BREAK signal is a special transmission (not an ASCII character) which your computer may be able to produce.

NOTE: If <CTRL-C> will cause your computer to do something to interfere with packet operations, such as halting the terminal program, and you can't send BREAK signals, you will have to change the character that returns you to Command Mode. See the section on "Special Input Characters," below.

Now type a <CTRL-C>. The MFJ-1278B does not echo the <CTRL-C>, but you should immediately see a Command Mode prompt. To return to Converse Mode, enter the command **CONVERS**:

```
<CTRL-C>
cmd: CONVERS
Whatever I type in Converse Mode is transmitted.
Whatever I type in Converse Mode is transmitted.
<CTRL-C>
cmd:
```

To terminate the QSO, you must end the connect by giving the **DISCONNE** command. The MFJ-1278B will transmit packets terminating the conversation and notify you when the disconnect is complete:

```
cmd: DISCONNE
*** DISCONNECTED
```

An actual QSO might be terminated by the other station, of course. In that case, you would see the ***** DISCONNECTED** message without having issued the command.

Be sure to remove the jumper from JMP10 after you complete this "Connecting and Disconnecting Exercise".

Digipeating

You may wish to have a QSO with another packet station that is beyond your direct radio range. If a third packet station is on the air and both you and the station you want to talk to are in range of this third station, that station can relay your packets. You set up the packet routing when you initiate the connection. The MFJ-1278B will then automatically include the routing information in the packets it sends.

The diagram below shows Example 1 situation in which digipeating is useful.



You are station K5FLU, and you want to have a packet QSO with N2WX. There is a mountain in the way and you are not in simplex range of each other. However there is a station located on the ridge, AD7I, which is in range of both you and N2WX.

You direct the MFJ-1278B to set up a connection to N2WX using AD7I as an intermediate digipeater as follows:

cmd: **CONNECT N2WX VIA AD7I**

You can specify a routing list of up to eight intermediate stations. Consider Example 2 below, as a modification of Example 1 above:

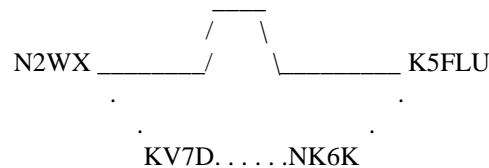

AD7I has turned off his station, but you can contact N2WX by going around the mountain through NK6K and KV7D. This time you issue the connect command like this:

cmd: **CONNECT N2WX VIA NK6K, KV7D**

You specify the digipeaters in the order you would encounter them going from your station to the station to which you wish to connect.

Unsuccessful Connections

Sometimes you will initiate a connect sequence that can't be completed. The station may not be on the air, or it may not be within range of your station. You may have even mis-typed the other call sign. If the MFJ-1278B does not get a response to its first connect packet, it will try again. You can control the number of attempts the MFJ-1278B will make with the command **RETRY**. The default number of retry attempts is 10. If the MFJ-1278B does not get an answer after this number of transmissions, it will give up and display the message:

```
*** retry count exceeded
*** DISCONNECTED
```

The retry count is also used once the QSO has started. Each transmission sent to the other station is "acknowledged," or ACKed by the other station, and vice versa. The ACK means that the packet was received and that the CRC checksum indicated that it was received without errors. This is the means by which packet radio can ensure error-free communications. Sometimes a packet will not be received correctly by the other station, either because of accidental interference from another packet station (a collision), or because of other channel noise.

If the MFJ-1278B does not get an ACK soon enough, it retransmits the packet and increments the retry count. If the count set by **RETRY** is exceeded, the MFJ-1278B will automatically disconnect and display the same message:

```
*** retry count exceeded
*** DISCONNECTED
```

The automatic disconnect feature keeps a MFJ-1278B from indefinitely retransmitting a packet and tying up the channel under hopeless conditions. For example, an intermediate digipeater might have been shut down, or the RF channel might have deteriorated to the point of being unusable. The other operator might have even turned off his station without disconnecting. If you are operating under special conditions, such as a marginal HF channel, you can set **RETRY 0** to disable all automatic disconnects (the retry limit is never reached).

Monitoring Channel Activity

The MFJ-1278B can monitor packet activity on the channel while connected to another station. You can "read the mail," displaying packets between other stations. The MFJ-1278B will also keep track of stations heard during a session. This section will describe some of the monitor functions.

Monitoring is enabled or disabled by the **MONITOR** command. You can try this out in digital loop-back mode while disconnected. Type:

```
cmd: MONITOR ON
cmd: CONVERS
```

Since you are not connected to another station your packets are sent to the address "CQ," i.e., anyone. The packet you sent was "heard" by the MFJ-1278B and displayed, along with the sending station and the destination.

If you also want to see any intermediate digipeater stations being used, you can set **MRPT ON**. This feature would be useful if you later want to connect to one of the stations you are monitoring and will need a digipeater route in order to reach it. For example, you might see the following display:

```
WB6YMH>WD0ETZ,KV7B:Hello, Bill!
```

This packet was sent from WB6YMH via KV7B to WD0ETZ.

If there are several digipeaters, or if the message lines are long, the display may be difficult to read. The **HEADERLN** command can make reading the displayed information much easier. You can put the address header on a separate line from the text by setting **HEADERLN ON**:

```
WB6YMH>WD0ETZ,KV7B:  
Hello, Bill!
```

Ordinarily, the MFJ-1278B will stop displaying monitored packets if you connect to another station, permitting you to converse without interruption. The reason for this is that the setting of the **MCON** command. The **MCON** command is defaulted to the **OFF** state. If you want to monitor activity while connected to a packet station, set **MCON ON**.

While the MFJ-1278B is monitoring the packet frequency, it is keeping a record of all the stations heard. These stations are recorded into the **MHEARD** log or list. To display the list of stations heard since the last time your MFJ-1278B was powered up, type the following from the cmd: prompt:

```
MHEARD <ENTER>
```

the MFJ-1278B will respond with a list of stations much like the example below:

```
AD7I  
WA7GXD  
N2WX  
NK6K  
KV7B*
```

followed by the cmd: prompt. The last several stations whose packets were heard by your MFJ-1278B are displayed. The entry "KV7B*" means that KV7B was heard digipeating a packet rather than sending one of his own. You can clear the "heard log" with the **MHCLEAR** command.

Your First Packet QSO

Although there are still a number of features you should be familiar with, you are probably eager to get **on-the-air** and try out your new MFJ-1278B. Arrange to have another packet operator get on the air to help you get started. Make sure that your friend will be close enough to ensure solid copy, with no FM "popcorn" noise.

It's best if you can get an experienced packet operator to help you get started. If you are both beginners, try to have both stations in the same room and operate on low power or into dummy loads.

The first step in starting packet radio operating is to remove the shorting jumper from Digital Loopback header, JMP10. Connect your radio to the MFJ-1278B. Turn on your computer, the MFJ-1278B, and your radio. Be sure you have adjusted the MFJ-1278B and radio according to one of the methods described in Chapter 3. When the other station transmits, the DCD LED on the MFJ-1278B should glow steadily for the duration of the transmission. You can work through the remainder of the examples in this chapter while you try out the MFJ-1278B on the air.

Starting the QSO

Once you have the MFJ-1278B connected to your radio, you are ready to initiate a connect. For the sake of example, we will continue to use K5FLU in place of your call sign, and we will use WB0QRP for your friend's call. Make sure you are in Command Mode, and type:

cmd: **CONNECT WB0QRP**

After a moment you should see the message:

***** CONNECTED to WB0QRP**

and you will be in Converse Mode. Your friend will see the message:

***** CONNECTED to K5FLU**

and he will also be in Converse Mode. You have just begun your first packet QSO.

If you have trouble connecting, make sure your microphone drive level is set properly, as described in Chapter 3. It may be helpful to have an experienced packet operator monitor your transmissions with his TNC. You can also try the following procedure:

- a. Both you and your friend should set **MONITOR ON**.
- b. Enter Converse Mode and send some packets.
- c. Each station should display packets sent by the other. If only one station is "hearing" properly, you can concentrate on the modulator and transmitter of that station and the demodulator and receiver of the other station. You can try experimenting with the **TXDELAY** timing command for the sending TNC.

Exchange several messages to get a feel for this new mode. If you monitor the radio transmit indicators and listen to the speaker audio from the two rigs, you will have a better idea of what is happening. Your radio will be inactive most of the time, even while you are actually typing. When you come to the end of a line while typing, press the <ENTER> to send the data to the MFJ-1278B. The MFJ-1278B will key the radio briefly, after it receives the data you typed. When the MFJ-1278B keys the radio, data will be sent to the radio, and your friend will hear a "brrraaapp" sound on his speaker. As your friend's TNC displays your message on his screen, his radio will key for even a shorter time. When your friend's TNC sends data back to your station, you will hear a short "brrapp" sound on your speaker. The short "brrapp" sound on your speaker is an **ACK**, or **packet acknowledgment**. The MFJ-1278B takes note that the packet was received correctly, but nothing is displayed on your screen.

Digipeating

Now that you are on the air, you and your friend can try out the MFJ-1278B's digipeating capabilities. This is actually more interesting if you have at least three stations participating, but you can get the feel for it with two stations.

Return to the Command Mode and disconnect from the other station:

```
<CTRL-C>  
cmd: DISCONNE  
*** DISCONNECTED
```

Now issue the following command.

```
cmd: CONNECT K5FLU VIA WB0QRP
```

As before, substitute your call for K5FLU and your friend's call for WB0QRP. You are requesting a connect to yourself, as you did before in digital loop-back mode, but this time you are using a sort of RF loop-back. You transmit packets to your friend's TNC, which relays them back to you. When the connection is established you will see

```
*** CONNECTED to K5FLU VIA WB0QRP
```

and you will be in Converse Mode. Your friend will not see anything displayed on his computer and his TNC's state will not be affected at all by your QSO. In fact, your friend could issue this connect request,

```
cmd: CONNECT WB0QRP VIA K5FLU
```

and you can carry on two separate conversations completely independently. Monitor the radio transmit indicators and listen to the speaker audio. See if you can follow the packets and the acknowledgments back and forth.

Monitoring on the Air

This is a good time to try out the MFJ-1278B's monitor functions. While you and your friend are separately connected, type

```
<CTRL-C>  
cmd: MONITOR ON  
cmd: MCON ON  
cmd: CONVERS
```

You will be able to see both your "conversation" and your friend's conversation. Also try **HEADERLN ON** and **MHEARD**.

Special Input Characters

The MFJ-1278B has a number of special characters that can be used to control its actions. Many of these special characters can be used to "edit" commands and packet text as they are entered. These features can all be customized to suit you and your computer. Most of the special input characters we will describe are active in both Command Mode and Converse Mode; the exceptions will be noted.

The character used to return to Command Mode from Converse Mode is by default a <CTRL-C>. (Sending a BREAK signal also works.) This character does nothing in Command Mode, so if you accidentally enter it twice you will not mess up the next command line. You can change the Command Mode entry character with the command **COMMAND**. This is one of several commands that set special character functions. You can choose any character for this function, by entering the ASCII character code for the key. For example, you can use a <CTRL-E> to enter Command Mode by setting

```
cmd: COMMAND 5  
was $03
```

The MFJ-1278B displays the previous value in hex, and you can also enter character codes in hex if you prefer. All of the special characters described below can be changed in the same way as **COMMAND**.

We have already mentioned that you can erase mis-typed characters by typing the <BACKSPACE> character. You can change this character with the command **DELETE**. If you set **DELETE ON**, you can erase characters by typing the <DELETE> character; setting **DELETE OFF** returns to using <BACKSPACE>. You will probably want to use the same key that your computer normally uses to rub out characters. <BACKSPACE> is more commonly used than <DELETE> by personal computers.

If you are not sure whether your rubout key produces <DELETE> or <BACKSPACE> characters, you can try both settings of the **DELETE** command and see which works

If you make several mistakes in a line, or if you change your mind, you may want to cancel the whole line rather than rubbing out the characters one at a time. You can cancel the line by typing <CTRL-X>. The MFJ-1278B will display a <BACKSLASH> followed by a <ENTER>. If you are in Command Mode, you will see a new prompt:

```
cmd: Hi, John, how are you?<CTRL-X>\
[You started typing text while in Command Mode.]
cmd: CONVERSE
Hi, John, how are you?
```

The cancel-line character can be changed to any ASCII character by the command **CANLINE**.

If you have changed your input by rubbing out and retyping characters, you may want to see a "fresh" copy of your input, especially if you have set **BKONDEL OFF**. The MFJ-1278B will retype the line you are entering when you type <CTRL-R>:

```
cmd:CONNECT KB7\\WA7<CTRL-R>\
[You mis-typed the call sign.]
cmd:CONNECT WA7GXD
```

Here the user mis-typed the first three characters of the call sign and rubbed them out. The MFJ-1278B displayed "\" for each character rubbed out. The user then retyped the characters correctly and redisplayed the line. He finished typing the call sign on the new line. The redisplay-line character can be changed to any ASCII character by the command **REDISPLA**.

If the MFJ-1278B displays information faster than you can read it before it scrolls off the screen, you can halt the display by typing <CTRL-S>. To resume output from the MFJ-1278B to your computer, enter <CTRL-Q>. These characters can be changed to any ASCII character by the commands **STOP** and **START**, respectively.

You may occasionally want to include one of the special input characters in a packet. For example, to send several lines at once in the same packet, you would have to include <ENTER> in the packet at the end of each line, bypassing its "send-packet" function except at the actual end of the packet. You can include any character in a packet including all special characters by prefixing it with the pass character, <CTRL-V>. For example,

```
I wasn't at the meeting.<CTRL-V><ENTER>
What happened?
```

Ordinarily, this message would be sent as two packets. By prefixing the first <ENTER> with <CTRL-V>, the operator sends it all at once, but maintains the <ENTER> in the text. The pass character can be changed to any ASCII character by the command **PASS**.

BASIC HF PACKET OPERATION

The requirements for optimum performance with a typical HF or OSCAR 10 path are very different compared to local VHF FM environment. Lower signal to noise ratios require lower baud rates, noise spikes and fades require shorter packet lengths, and a higher rate of false carrier detects lowers the total usable dynamic range in the audio input. The MFJ-1278B hardware and software improves throughput in the noisy and fading HF environment. The setting of the **MAXFRAME** and **PACLEN** commands in the MFJ-1278B, provide the possibility of several continuous frames of long data length. For HF operation at 300 baud, we recommend setting **MAXFRAME** to 1. Depending on HF band conditions a setting of 128 or less for the **PACLEN** command.

The MFJ-1278B detects a busy channel by monitoring the lock- detect signal from the demodulator. The presence of a lock-detect signal is indicated by the Data Carrier Detect (DCD) LED. Each time DCD goes off the MFJ-1278B will start a **DWAIT** interval which must elapse before the channel is considered to be available. On a noisy channel spurious lock-detect signals may be generated. For HF and OSCAR operation you should set **DWAIT** to 0. The random wait before retry transmissions can be disabled by setting **TXDELAY 0** and using **AXDELAY** to set the required keyup delay. Of course, **AXHANG** should be 0 for this application.

If you are operating a full-duplex radio station (simultaneous transmit and receive) such as an OSCAR 10 station, you should set **FULLDUP ON**. The MFJ-1278B is always electrically capable of full duplex operation, but this parameter causes the protocol to behave differently in acknowledging packets. In addition, the MFJ-1278B will ignore the state of the DCD line.

Although intuition tells you that lower baud rates will reduce the number of packet retries, there is usually a small range between "too fast" and "too slow." A slower packet takes longer to transmit and is therefore a larger target for fades and static crashes. The entire packet must be received correctly in order to be accepted. Data rates of 1200 baud have been used on both HF and through OSCAR 10.

HF activity may generally be found on 7.090 to 7.106 or 14.090 to 14.107 MHz. Use LSB or USB - it really does not matter (although most stations use LSB when referring to the suppressed carrier frequency).

Tune through a few packet signals. Tune slowly! You will find a point at which the display becomes bright. As you continue tuning, you will see the moving bar display slide across your tuning indicator. When one of the center LEDs is illuminated, you are tuned in and you should be able to copy the packets.

Each bar on the tuning indicator represents about 10 Hz. Thus, if a packet comes through

If you cannot contact anyone using another frequency, call CQ on one of the above mentioned frequencies. If you do make a contact with someone, then **QSY immediately after establishing contact!** Be careful on 20 meters especially that you don't operate +/- 2KHz around 14.100 MHz (you will cause interference to propagation beacons and give packet a bad name...).

HF Packet Operation Hints

There are a few operating hints which apply to HF Packet. These few hints are listed below:

1. Try to keep all packets below 80 characters in length.
2. Set **MAXFRAME** to 1. This will minimize transmission time.
3. Avoid multiple connections and digipeated packet operation.
4. Qsy away from the standard calling frequencies as soon as possible.
5. Set **FRACK** to a sensible long value.

For more details on HF packet operation please refer to the next chapter in this instruction manual.

PACTOR

In this section of this manual we will talk about **PACTOR** operation. We will cover basic operation along with an explanation of the commands related to **PACTOR**, including the new **Pactor Mailbox**. Before we talk about Basic Operation, let's explain a little about **PACTOR**.

NOTE: **Pactor** operations apply to the **Model MFJ-1278B** or **MFJ-1278 TNC2** only. The **MFJ-1278** must have the **MFJ-56A, B, or C** installed to take advantage of the Pactor option.

What is Pactor?

PACTOR is a new form of digital communications. **PACTOR** was brought about to compensate for the shortcomings in both Packet and Amtor, for HF operation.

PACTOR combines some of the features of both the AMTOR and the HF Packet modes. Pactor retains the short frame sizes and synchronous transmission format of AMTOR. It also allows the data flexibility of which Packet users have grown accustomed to.

The radio used for PACTOR HF operations must be capable of switching between transmit and receive modes in 130 milliseconds. A radio capable of operating in the AMTOR mode will operate well in the PACTOR mode as well.

Now that we have explained a little about PACTOR, let's get into the Basic Operation.

PACTOR Operation

The PACTOR operation section will deal mainly with PACTOR operations. We will briefly explain about the different operating modes and what they will do. We will explain about the new PACTOR mailbox feature and how it works. There are also several operational commands that are related to Pactor operation. These operational commands are explained in Chapter 6 in detail. So without any further delay here we go into PACTOR Operation.

First we need to get the MFJ-1278B to sign-on. To sign-on the MFJ-1278B please perform the following:

1. Verify the power switches to both the computer and the MFJ-1278B are OFF.
2. Connect the MFJ-1278B to both the radio and the computer.
3. Connect the radio to a dummy load.
4. Set the POWER switch on the computer to the ON position, then load the terminal program.

Now that we have the MFJ-1278B signed-on to the computer, let's put it into the PACTOR mode.

To put the MFJ-1278B into PACTOR mode, please type the following:

MODE PT <ENTER>

The MFJ-1278B will respond with:

**[MFJ PACTOR \$2c-1022 free]
p_cmd:**

At the above prompt, you are in the PACTOR mode. Any commands entered such as TXDELAY or ECHO, will only affect the PACTOR mode. Many of the commands of PACTOR have the same name as the general commands but DO NOT share the same parameters. At the **p_cmd:** prompt, you can monitor AMTOR ARQ requests to your SELCALL, PACTOR ARQ requests, and PACTOR FEC.

Enter your call in the MYCALL parameter (up to 8 characters). The format of the **MYCALL** command is as follows:

MYCALL n <ENTER>

where **n** is your amateur callsign up to 8 characters.

FEC Unproto operation

There are two **FEC** modes, 100 baud and 200 baud. Properly tune the radio before entering either of the **FEC** modes. The reason for this is as soon as you initiate an **FEC** unproto mode the radio will start transmitting immediately. To initiate 100 baud **FEC**, please type the following from the **p_cmd:** prompt:

U1 <ENTER>

The cursor will go to the next line. At this point start typing whatever you want. You normally issue your CQ's in **FEC** mode. Someone will see your **FEC** mode CQ's and probably try to "connect" with you.

To terminate an unproto session type a CTRL-C followed by the letter D and the <ENTER> key. This is done after sending CQ or when terminating a Pactor contact. If the standard D command does not work, then use the DD command to terminate the unproto session.

The situations in which the two **FEC** modes are different. Generally, the **U1** or 100 Baud **FEC** mode is for use in **normal** HF band conditions, while the **U2** or 200 Baud **FEC** mode is for use in **clear** HF band conditions. Your transmitter must be capable of transmitting 100% duty cycle. Because when transmitting PACTOR **FEC**, you are **ALWAYS** transmitting a signal- just like RTTY.

PACTOR ARQ

For ARQ operation you will need to know the other person's callsign. Normally you can get the other person's call by monitoring the channel for connect requests or other ARQ contacts.

To establish contact with another station, you must be at the **p_cmd:** prompt. To initiate a connect sequence, please type the following:

C n <ENTER>

where **n** is the **CALLSIGN** of the station you want to connect with. The callsign is not to be over eight characters in length. Again, properly tune the radio, because you will immediately start transmitting packets.

When a station is over 40,000 Km away, the **LC** command should be used. The **LC** is the abbreviation for **Longpath Connect**. To initiate a Longpath Connect sequence, please type the following:

LC n <ENTER>

where **n** is the **CALLSIGN** of the station you want to connect with. Callsigns are not to be over 8 characters in length. Again properly tune the radio, because you will immediately start transmitting packets. If the **C** command does not work, the **LC** command might. Generally, if one command works the other will not.

Changeover

In AMTOR the changeover (from TX to RX) command is +?. In PACTOR the changeover command is CTRL-Y, i.e. hold down the CTRL key then press the Y key. The changeover character can be re-defined with the CHOCHAR command. How the CHOCHAR character is re-defined will be discussed later. When in Pactor Mailbox operations, the **changeover is semi-automatic**. The remote user must issue a manual changeover, CTRL-Y, when talking to the Pactor Mailbox. The Pactor Mailbox always issues an automatic changeover, when it is finished sending its information back to the remote user.

To terminate an ARQ contact, type CTRL-C, then **D**, then <ENTER>. This will cause a graceful disconnect at the other end. If you do a "**dirty disconnect**" or **DD**, the other Station will still be trying to acknowledge your packets. The use of **DD** automatically tears down the contact and does not wait for acknowledgments from the other station. The use of the **DD** command is considered bad manners. Always do a D disconnect, if possible.

Monitoring

While in the PACTOR mode, you are always in Listen mode. There is no listen command in the Pactor protocol. Therefore you do not need to issue listen command just to listen on a PACTOR frequency. To monitor a PACTOR conversation, just tune the signal in until the

information how the CON and STA leds react to incoming signals please refer to the chart on Page 30 of this chapter..

Monitoring AMTOR ARQ requests

AMTOR ARQ requests monitored while the MFJ-1278B in PACTOR mode. If the controller detects your selcall in an AMTOR ARQ request packet, the controller will switch to AMTOR and try to establish the link. This feature allows someone who doesn't have PACTOR capability to connect to you in AMTOR mode. Upon termination of the link, the MFJ-1278B will switch back to the PACTOR. The **a_cmd:** is active when the MFJ-1278B switches to the AMTOR operation. When the MFJ-1278B switches back to the PACTOR, you will see the **p_cmd:** prompt again.

Exiting PACTOR Mode

To exit the PACTOR mode, please type CTRL-C and the **p_cmd:** prompt will appear. Once the **p_cmd:** prompt is on the computer screen, type the following:

EXIT <ENTER>

the MFJ-1278B will respond with the standard **cmd:** prompt. Once back at the **cmd:** prompt you can go to any other mode by use of the MODE command as discussed earlier in this instruction.

Operating Hints

Threshold Control Setting

Adjustment of the Threshold control on the MFJ-1278B is critical during PACTOR operations. Adjust the Threshold control until the DCD lights with each received packet and goes out when not receiving. If the threshold control is improperly adjust, communications will not be good. This could result in the inability to make a contact or monitor a PACTOR conversation.

TXDELAY (TXD)

Timing in PACTOR is more critical than any other mode. This is where the **TXDELAY** or **TXD** command comes into play. The **TXDELAY** command is one of the more critical parameters. If you are having problems connecting, try adjusting TXD a little higher than the default value of 2. This is especially good practice on the lower frequency bands such as 80 meters. A typical setting for 80 meters may be 4 or 6. The setting of TXDELAY is also dependent on the time required for the radio to switch between transmit and receive.

NO200

If you turn the parameter **NO200** to ON, the MFJ-1278B will stay in 100 baud. For noisy band conditions setting NO200 to ON may get your data through quicker. This is because if the controller switches to 200 baud you may have more retries on a noisy channel. It's better to

As indicated in the preceding paragraph, the usual terminal/radio/modem parms are available.

As in Packet, Pactor also contains **COMMAND** and **CONVERSE** modes. Please note that switching between them is modeled on the "NEWMODE ON" procedures in packet. The MFJ-1278B is in **COMMAND** mode, if the **p_cmd:** prompt is on the computer screen. To switch to **CONVERSE** mode from **COMMAND** mode the **K** key followed by an <ENTER> is issued by the user. The **CMDCHR** character switches the MFJ-1278B from **CONVERSE** mode back to **COMMAND** mode. The **CMDCHR** character is defined as **CTRL-C**. Once connected, the link acts much like AMTOR.

The station originating the connection is the master and he remains in transmit mode until he or the slave initiates a changeover. Either station may reverse the direction of the link by issuing a control-Y changeover (^Y) in converse mode.

PACTOR FEATURE DEFINITIONS

DIGITAL MEMORY ARQ

The MFJ-1278B's Pactor incorporates a **Digital Memory ARQ** mode. **Digital Memory ARQ** enables reconstruction of a good packet from a bad packet. A bad packet is one repeatedly received with one or more bit errors. **Digital Memory ARQ** accumulates the bit value, 1 or 0 derived from the RF port during successive reception of the same error-laden packet. These bit accumulations are sent to the receiver shift register. Thus a good packet is reconstructed from 2 or more "bad" packets.

The **MAXSUM** parameter controls the number of accumulations performed for each bit. Larger **MAXSUM** values increase the effectiveness of the Digital Memory ARQ scheme, but only to a certain point. The reception of an almost perfect packet will be inadequate to overcome the accumulated noise, if **MAXSUM** is too large. Also the presence of excessive QRM, QRN, or QSB effects the reception of good packets. On the other hand, if **MAXSUM** is too small the accumulation of samples will be too few to correct for moderate error rates. The factory setting for **MAXSUM** represents a good compromise--feel free to play with it.

FEC UNPROTO

Unproto: "**FEC/UNPROTO**" packets are transmitted UREPEATS+1 times. Selecting larger values of UREPEATS reduces throughput, but enhances reliability. To transmit in UNPROTO mode, issue the appropriate unproto command and type away. When done, break out to "p_cmd:" mode and type 'D' or 'DD' to terminate transmission.

MONITORING

Monitoring unproto: If **MONITOR** is **ON** the MFJ-1278B is always in **listen** mode,

To prevent Uncontrolled Disconnects, we are unable to listen to all kinds of third party Pactor transmissions for (WAIT x Cycle_Time) seconds after receiving the other side's last disconnect. This includes all unproto and connected packets, along with connect requests. The actual cycle time is 1.25 or 1.4 seconds.

CONNECT

[Connect] message: The MFJ-1278B monitors connect attempts received from other station's with a message containing the called station's callsign when idle. To successfully monitor a connect attempt to someone else, the called callsign must be at least 4 characters in length, and the signal be of sufficient quality that the 200 baud area be error-free when received. Unfortunately, the callsign in the connect-attempt packet (unlike all other monitored data) is subject to corruption; the Pactor protocol did not provide for error-free connect packets. Therefore, you may at times see a garbled callsign in a [Connect] message, but it should be rare. Remember, this "garbling" affects only monitored connect-attempt packets. It does NOT affect ARQ or FEC data packets because they are error-protected by a sophisticated CRC checking scheme.

SPEEDup/SPEEDdown

Speedup and **speeddown**: When the MFJ-1278B is the receiving station or **IRS**, and after four consecutive failures to receive a 200 baud packet the TNC requests a **SPEEDDOWN** to 100 baud. A **SPEEDUP** occurs when the MFJ-1278B receives 10 error free 100 baud packets. If **NO200** is set to **ON** all **SPEEDUP** requests are inhibited

Bad band conditions: During poor band conditions links will be quicker by avoiding use of the 200 baud mode. Setting **NO200** to **ON** instructs the MFJ-1278B to avoid 200 baud operation in a compatible way.

AUTOMATIC ON-LINE COMPRESSION

Huffman coding: Huffman coding offers somewhere between 2:1 and 4:1 compression on lower case German and English plain text. In receiving modes, conversion to 8 bit data is automatic.

On transmit, the MFJ-1278B packetizes outgoing data and transparently selects the mode. **Huffman coding** will be used if a) all data are 7 bit ASCII characters, and b) Huffman coding is at least as efficient as straight 8-bit coding.

FLOW CONTROL

Flow control: **Hardware flow control** is always on. **Software flow control** defaults to on using the **XON** and **XOFF** parameters. Unlike TNC operations, the same characters are used for receive flow control as for transmit flow control. **Type-in flow control** is only effective while entering commands at the "p_cmd:" prompt.

AMTOR selective call sign in the "a_cmd:" MYSELCAL parameter. Furthermore, you must have the appropriate sideband, usually, LSB selected because unlike PACTOR, AMTOR is polarity dependent.

Amtor Detection in Pactor

The MFJ-1278B's Pactor continuously monitors the channel for Pactor packets, and for AMTOR call packets that match your AMTOR SELCALL. When PACTOR hears your AMTOR SELCALL, the TNC enters the "a_cmd:" AMTOR mode in an attempt to complete the link. After entry into the AMTOR mode the MFJ-1278B will automatically return to Pactor mode if the link is not established within 30 seconds. If the link is established, the MFJ-1278B remains in AMTOR mode for the duration of the contact, and for an additional 30 seconds after the link terminates.

PACTOR STATUS INDICATORS.

While in the PACTOR mode of operation, you have PACTOR mode Status Indicators available to you. These Status Indicators are comprised of the CON and STA leds. These leds react in different ways according to what is happening. Below is a table as to how the leds will act:

Status Indicator			
STA	CON	Pactor Status	
0	0	RX	N/A
		TX	N/A
		MON	The TNC is idling and has not monitored any information packets in the past second.
0	1	RX	Sending ack control signal
		TX	Last packet acknowledged
		MON	Received new packet
1	0	RX	Dupe rcvd; sending Request control signal
		TX	Received request control
		MON	Received dupe packet
1	1	RX	Info packet missing; sending request
		TX	Control sign missing; retransmitting
		MON	N/A

PACTOR MAILBOX

The MFJ-1278B now includes a new feature called a **PACTOR MAILBOX**. In this section we will cover basic operation of the new Pactor Mailbox, and the operative commands. The Pactor Mailbox includes the basic commands of the Packet mailbox. The Pactor Mailbox is very simple and easy to use. Any amateur radio operator who has Pactor capability can access your Pactor Mailbox, after establishing the initial connection to your station. You MFJ-1278B must be in the PACTOR operating mode. You must also have the **MAILBOX** command ON in the Pactor command set. The Pactor **MAILBOX** command is **separate** from the Packet mailbox command. The Packet **MAILBOX** command needs to be ON too. The Packet **MAILBOX** command defaults to **ON**. Once the remote user connects to your Pactor Mailbox the user can obtain a list of the messages in your mailbox, read or kill any message addressed to him. A few functions such as the SYSop command, forwarding, and reverse forwarding are performed from the Packet mailbox.

The Pactor Mailbox in the MFJ-1278B provides the sysop with about 32K of RAM for message storage. The Pactor and Packet Mailboxes share the same 32K RAM. The mailbox RAM is in addition to the system RAM. However, you can increase the RAM size to 128K or even an enormous 512K. You can increase the RAM size by simply replacing the mailbox RAM chip on the MFJ-1278B motherboard. The mailbox RAM is battery backed up, just like the system RAM. Additional RAM chips are available from MFJ Enterprises, Inc. and easily installed by the user. The user can order the 128K RAM chip as the MFJ-45B, or the 512K RAM chip as the MFJ-45C. The number of slots and space available for each memory size are as follows:

Memory Size	# of Slots	Bytes Avail.
32K	99	32,000
128K	99 per bank	128,000
512K	99 per bank	512,000

Setting Up your Pactor Mailbox

The new Pactor Mailbox is operative only while the MFJ-1278B is in the Pactor mode of operation. The Pactor mailbox uses the callsign used during standard Pactor operations. The user must set a few of the Pactor commands before operating the Pactor mailbox. As we mentioned earlier there are a few functions that are performed only in the Packet mailbox. The functions that are performed only in the Packet are the SYSop command, forwarding, and reverse forwarding. We will go over the different commands while we talk about the Pactor setup.

NOTE: Whenever we refer to <ENTER> in this instruction this means to press the RETURN

1. From the **cmd:** prompt please type the following:

MODE PT <ENTER>

the MFJ-1278B will respond with:

[MFJ PACTOR \$2c-1022 free]

followed by the **p_cmd:** prompt on the next line. The **\$2c** is the checksum of MFJ's Pactor release. You will probably notice a slight delay in obtaining the **p_cmd:** prompt. This is because the MFJ-1278B is figuring up the Pactor checksum, this is perfectly normal.

2. Under the **p_cmd:** prompt, type:

MYCALL n <ENTER>; where **n** is your standard amateur callsign.

The MFJ-1278B will respond with:

MYCALL n

where **n** is the callsign you entered in the MYCALL parameter. The MFJ-1278B will give the **p_cmd:** prompt on the next line.

3. If you want your messages time and date stamped, then set **DAYTIME** with the current information.

The **DAYTIME** command is in the standard Packet command set, not in the Pactor commands.

NOTE: An optional TNC real-time clock, the MFJ-43 for the MFJ-1278B is available from MFJ Enterprises. With this real-time clock module installed in your MFJ-1278B, the clock will continue to keep time even with the MFJ-1278B turned off. You will not have to set your MFJ-1278B's "DAYTIME" every time your MFJ-1278B is powered up.

4. From the **p_cmd:** prompt, type:

MAILBOX ON <ENTER>

As we mentioned earlier, there are two MAILBOX commands. One of the MAILBOX commands is in the Packet command set, the other being in the Pactor command set. Both of the MAILBOX commands must be ON. If either of the MAILBOX commands is OFF, then the Pactor mailbox will not function.

Your MFJ-1278B is ready for Pactor Mailbox operations. As we mentioned earlier, the SYSop command must be issued from the Packet mailbox. You can access the SYSOP in

The MFJ-1278B will respond with the standard **cmd:** prompt. From the cmd: prompt type:

SYSOP <ENTER>

Your MFJ-1278B will respond with:

**|K[MFJ-2.1-IH\$]
Mailbox ready
n free Mailbox (B, E, H(elp), J, K, L,M, R, S, T)>**

You are now in the Packet mailbox, as the SYSOP. All of the above command are available to you as the SYSop. Please refer to the **Easy-Mail™** mailbox section in Chapter 5 of this manual, for further information on the above command.

From this prompt you as the SYSop can Kill, List, Read, Send messages in the mailbox. You can also send private messages, edit the messages headers, bank switch the mailbox RAM.

General Overview

This section will deal with the Pactor Mailbox in general. We will take a look at the Pactor mailbox from mainly a remote user's stand point. However, lets take first things first. You very well cannot operate the Mailbox without knowing the functions of the commands. When a remote user connects to the Pactor mailbox, and issues the changeover, your mailbox will present the following prompt:

**Mailbox Ready
n free de callsign (H(elp), K, L, R, S)>**

The Pactor mailbox will automatically issue a changeover, after it sends the proper response to the user's commands. The **n free** is the amount of RAM space available for messages. The **de callsign** is the callsign of your Pactor mailbox, that the mailbox sends back to the remote user. So, lets take a brief look at the command functions of the Pactor Mailbox commands. The command functions are as follows:

H(elp)

The Help command displays the Pactor Mailbox help list to the remote user. A brief description of the commands available to the remote user is given. Below is an example of the Help list, as seen by the remote user:

H	This message
K	Kill msgs
L	List msgs
R	Read msgs
S	Send msg

These are the basic commands, however there are derivatives of the basic commands.

Kill

Allows the remote user to kill messages that are addressed specifically to the user. If the message is not addressed to the user, then the mailbox will respond with "**not yours**", and present the user with the mailbox prompt.

Kill ##

Allows the remote user kill a message in a particular slot, **nn**. Slot **nn** is a particular slot number from 1 to 99. Remote users may only kill messages that are addressed only to them or originated by them. The local and remote SYSOP can kill any messages, depending on the setting of the command REMsysop. Please refer to the REMsysop for more detailed information.

There are three (3) different methods to kill messages in the mailbox, when the remote user is connected. We will give you a brief overview of these methods below:

1. The remote user can kill a message in a particular slot, when connected to the mailbox. To kill a message in a certain slot, type:

K## <ENTER>, followed by a changeover character, CTRL-Y.

Where the **##** is the slot number of the message the remote user wants to kill.

The Mailbox will respond with:

Mailbox Ready
n free de **callsign (H(elp), K, L, R, S)**>

The **n free** is the amount of RAM space available for messages. The **n** will be no higher than 65K, if a 512K or a 128K Mailbox is in operation. If the Mailbox is 32K then nn will be 32K. The **de callsign** is the callsign of your Pactor mailbox, that the mailbox sends back to the remote user.

2. The remote may also kill any message that is addressed to specifically to the user. To kill a message that is addressed only to the user, type:

K <ENTER>, followed by a changeover character, CTRL-Y.

This is whether or not the message flag is set to an N or a Y. Note that the remote users may only kill messages which are addressed them. The originator can kill any message that he/she originated. The local SYSOP can kill any or all messages in the Mailbox.

3. The remote user can perform a Global Kill on a group of messages that are under the same callsign. To perform a Global Kill on a group of messages, the following conditions apply:

If the above conditions are met then all the remote user must type:

K <ENTER>, followed by a changeover characters, CTRL-Y.

This will go out to Mailbox, then the messages with the message flags set to Y with all of the proper callsigns will be killed. The Mailbox will respond back to the remote user with all message numbers killed during the Global Kill process. Also the Mailbox prompt will be given again. The Mailbox will update the "bytes free" indicator when the messages are killed. The local SYSOP cannot perform a Global Kill. The SYSOP must individually kill any messages.

List

This command allows the remote user, local or remote SYSOP to list all messages in the mailbox. All of slots that are currently in use will be listed. They all will have the slot number, flag field, the destination callsign, originator callsign, subject field. Also the Mailbox command line will be on the next line.

To List the messages in the Mailbox, first the Mailbox prompt must be obtained by either a connection to the Mailbox or through the local SYSOP command. The local SYSOP command is accessible through the Packet Mailbox. Please type the following to List messages from the Mailbox:

L <ENTER>, followed by a changeover character, CTRL-Y.

The Mailbox will respond with a listing of currently used slots in the following format:

Slot:## t m To: From: Subject:

Where **Slot##** column is the number of the slot that the message is in. The number of message slots present in the standard 32K Mailbox is 99. The lower case **t** is the **Type Flag** block. The lower case **m** is the **Message Flag** block. The **To:** column will contain the callsign of the person who the message is addressed to. The **From:** column will contain the callsign of the person who left the message. The **Subject:** column will contain a brief message title.

After the Mailbox lists all messages it will issue the Mailbox prompt:

nn free de callsign(H(elp), K, L, R, S)>

The **n free** is the amount of RAM space available for messages. The **n** will be no higher than 65K, if a 512K or a 128K Mailbox is in operation. If the Mailbox is 32K then **nn** will be 32K. The **de callsign** is the callsign of your Pactor mailbox, that the mailbox sends back to the remote user.

The Pactor Mailbox will send an automatic changeover after it lists all mailbox messages. After the automatic changeover is sent, the mailbox will send a CTRL-G character back to

Read

This command lets you read messages addressed to you. When you list the messages in the mailbox you notice an N flag next to the messages which you have not read. Once you read those messages the N flag will change to a Y flag. This is an indicator to both you and the SYSOP that the messages have been read. From there you can perform a global kill on all of your messages or the SYSOP can kill them individually.

NOTE: The only way an N flag can get changed to Y flag during a read is that the person who the message is addressed to needs to read it. The flag will not change for any other person who reads the message.

Read ##

Allows you to read the message in slot ##. Where ## is a particular slot number. This command works the same as the R command, except its for reading the individual slots.

Send call

This allows the remote user, local or remote SYSOP to send a message to the designated callsign. "CALL" must be a callsign valid under the same format as the MYCALL, CONNECT or other callsign commands. You can also send messages in NTS (National Traffic System) format. You will need to refer to the ARRL NET DIRECTORY for more detailed information on the NTS system.

SP call

This allows the remote user, local or remote SYSOP to send a personal message to the designated callsign. This is a private message and only the person to whom the message is addressed can read or kill it. The SYSOP can also read the private messages. When a private message is listed a P flag is shown in the "Message Type" flag block. The P flag can also be inserted by the originator or the SYSOP through the Edit command.

Detailed Pactor Mailbox Overview

In the previous section, **Brief Overview of Pactor Mailbox**, we briefly discussed the Pactor Mailbox in general. In this section, we will go into more detail about the commands that are presented by the mailbox prompt shown below:

Mailbox Ready

n free de callsign (H(elp), K, L, R, S)>

The **n free** is the amount of RAM space available for messages. The **n** will be no higher than 65K, if a 512K or a 128K Mailbox is in operation. If the Mailbox is 32K then nn will be 32K. The **de callsign** is the callsign of your Pactor mailbox, that the mailbox sends back to the remote user.

1. First a remote must establish a connection to your Mailbox, via your Pactor callsign.
2. If your Pactor Mailbox is **ON**, then it will answer back with the Pactor Mailbox prompt:

Mailbox Ready
n free de callsign (H(elp), K, L, R, S)>

The **n free** is the amount of RAM space available for messages. The **n** will be no higher than 65K, if a 512K or a 128K Mailbox is in operation. If the Mailbox is 32K then nn will be 32K. The **de callsign** is the callsign of your Pactor mailbox, that the mailbox sends back to the remote user.

Once the remote user receives the the Pactor Mailbox prompt, the user must issue a changeover, **CTRL-Y**, to enter the Pactor Mailbox. Now at this point all of the Mailbox are available to you. You may then type **K** to kill a message, **L** to list all messages, **R** to read the messages, **S** to send a message, or **H** for the **HELP** menu.

3. To send a message the **S** or the **SP** commands must be used. The **S** or **SP** commands are used in conjunction with a callsign as in the examples below:

S AA5XO <ENTER>, this will send an ordinary message to the callsign AA5XO.
or
SP AA5XO <ENTER>, this will send a private message to the callsign AA5XO.

The Mailbox will respond with:

Enter Subject: (Max. 40 Characters)

—

The remote user will enter the message subject or title at cursor prompt, then press the **<ENTER>** key.

The Mailbox will respond with:

Send msg; Control-Z or /EX on it own line ends:

—

The remote user will then enter the message at the cursor prompt. The remote user needs to press the **<ENTER>** key after entering the message. The remote user needs to enter **/EX or CTRL-Z**, followed by a changeover, after the **<ENTER>** key press. This will tell your Pactor mailbox to store the message, and to send the Pactor mailbox prompt back to the remote user. Your Pactor mailbox will send an automatically changeover back to the remote user. If you are using a 128K or even a 512K Mailbox, then you can actually upload disk files into the Mailbox. The 32K version has the same capability but with 32K RAM capacity.

4. There are two (2) different ways the remote user can kill messages. The first is give in the example below:

a. To kill a message in a particular slot, the remote user would type:

K## <ENTER>

Where the ## is the message number the remote user wants to kill.

The Pactor Mailbox will respond with:

**Message ## deleted;
nn free {n} Mailbox (H(elp),K, L, R, S)>**

This is whether or not the message flag is set to an N or a Y. Note that the remote users may only kill messages which are addressed them. The originator can kill any message that he/she originated. The local SYSOP can kill any or all messages in the Mailbox.

b. You can perform a Global Kill on a group of messages that are under the same callsign. To perform a Global Kill on a group of messages, the following conditions apply:

- I. All messages must have been read and the message flag must be a Y.
- II. The callsign contained in the **MY**call must be the same as the callsign in the **MY**call command.

If the above conditions are met then all the user must type:

K <ENTER>

This will go out to Mailbox, then the messages with the message flags set to Y and all of the proper callsigns will be killed. The Mailbox will respond back to the remote user with all message numbers killed during the Global Kill process. Also the Mailbox prompt will be given again. The Mailbox will update the "bytes free" indicator when the messages are killed. The local SYSOP cannot perform a Global Kill. The SYSOP must individually kill any messages.

5. The remote user or local SYSOP can List messages from the Mailbox. In order to do this first the Mailbox prompt must be obtained by either a connection to the Mailbox or through the local SYSOP command. Please type the following to List messages from the Mailbox:

L <ENTER>

The Mailbox will respond with a list of currently used slots in the following format:

Slot## t m To: From: Subject:

Where **Slot##** column is the number of the slot that the messages are in. The number of message slots present in the standard 32K Mailbox is 99. The lower case **t** is the **Type Flag** block. The lower case **m** is the **Message Flag** block. The **To:** column will contain the callsign of the person who the message is addressed to. The **From:** column will contain the callsign of the person who left the message. The **Subject:** column will contain a brief message title.

After the Mailbox lists all messages it will issue the Mailbox prompt:

nn free {n} Mailbox (H(elp), K, L, R, S)>

The Pactor Mailbox will send an automatic changeover after it lists all mailbox messages. After the automatic changeover is sent, the mailbox will send a CTRL-G character back to the remote user. The CTRL-G character will sound the computer bell in the user's computer.

6. Anyone who accesses the Mailbox can read messages that are addressed to him/or her. Also a message which is addressed to **ALL**, such as bulletins are readable by anyone. Messages are read by two (2) different methods. Below are the two methods:

- a. This method will allow the remote user, local or remote SYSOP to read a group of messages. This is only good for a group of messages with the same callsign as MYcall. The set conditions of the Type or message flags have an effect on a read process. They can be set to an N, Y or an F. To perform this type:

R <ENTER>

- b. Messages can also be read individually by the slot number. This is good for reading other messages like bulletins or messages addressed to **ALL**. In order to do an individual read type:

R## <ENTER>

Where **##** is the slot number of the message that you wish to read.

- c. The Mailbox will respond with the message from the slot specified.

All messages read will be in the following format.

Slot## tm To: From: Subject:

This is an example of a message from the Mailbox

Where **Slot##** column is the number of the slot which the messages are in. The lower case **t** is the **Type Flag** block. The lower case **m** is the **Message Flag** block. The **To:** column will

is proper Pactor etiquette. If you access your Mailbox via the SYsop command, then you must issue a CTRL-C to exit the Mailbox and return to command mode. The SYSOP mode is accessed through the Packet mailbox, as mentioned earlier in this section. The command prompt will indicate the stream you are on. The command prompt may look like this:

|**Acmd:** where |A indicates that you are on packet stream A.

To re-enter the Pactor mailbox you would type the following from the cmd: prompt:

PACTOR <ENTER>

This is the only way the remote users can access your Mailbox.

Mailbox Messages

You have new mail!

Upon accessing the mailbox this message will appear if there are any new messages are addressed following the last time you logged into the mailbox.

You have mail!

Upon access to a mailbox, this message will appear if there are messages addressed to you.

?EH

This message occurs when a command issued is not understood by the mailbox. This could be out of range slot number, missing slot number where one is required, or bad command.

Cannot, not yours

This message occurs when a remote user attempts to kill a message which is not his, or he tries to read personal message by or for someone else.

?Mailbox full

This message occurs when either all of the available slots are full, or the actual message space is full. Messages must be killed to recover from this error.

Not found

This message occurs when one attempts to read or kill a non-existent message from an empty slot.

None found

A parameterless Kill or Read command did not find any messages addressed to the user.

No mail

CW OPERATION

The MFJ-1278B provides many unique features in the CW mode that are not found in other multi-mode controllers.

The MFJ-1278B can key your CW transceiver in the CW mode of operation. The MFJ-1278B can accommodate either positive (direct) or negative (grid block) keying voltages.

The MFJ-1278B also has a code practice mode built-in, that can be used with VHF FM radios in the Modulated CW (MCW) mode. This mode holds the radio PTT line down and feeds keyed audio into the microphone input.

The CW mode in the MFJ-1278B is very easy and versatile. Take for instance, the user can send code either from the computer keyboard or a key paddle. The key paddle must be connected to the **CW KEY-IN** jack on the back panel of the MFJ-1278B. When working CW on the MFJ-1278B with a key paddle you have a full fledged Memory Keyer at your disposal. The MFJ-1278B provides the user with ten programmable memory buffers. These memory buffers are able to be programmed with message of up to 120 characters. Besides the buffer memory, MFJ-1278B provides automatic serial numbering. The WEIGHT command determines the DOT/SPACE ratio. This is to allow compensation for leading or trailing edge delays in many transceiver keying circuits. The built in random code generator allows CW code practice. A TUNE command is also built in for radio tuning.

The MFJ-1278B supports all Alpha and Numeric characters. It also will transmit and receive punctuations and major prosigns as listed in Table 4-4 below:

PROSIGNS	ASCII CHARACTER Keyboard Symbol	PROCEDURE
SK	*	End of Work
AS	&	Wait
AR	+	End of Message
BT	=	Break
SN	!	Understood
KA	%	Signal Starting
K	K	Invitation to Transmit
DN	/	
KN	(Response from Contacted Call Only
PUNCTUATIONS		
, COMMA	:	COLON
. PERIOD	;	SEMI-COLON
? QUESTION MARK	'	APOSTROPHE
\$ DOLLAR SIGN	-	HYPHEN
(LEFT PARENTHESIS	"	QUOTATION
) RIGHT PARENTHESIS		

Receiving CW

The MFJ-1278B receives international Morse Code from 1 to 99 WPM. Reception of alphabetic and numeric characters, including the punctuations and prosigns listed in Table 4-4.

From command mode, put the MFJ-1278B in the CW Mode by typing:

MODE CW,xx <ENTER>, where "xx" is the CW transmit speed.

The MFJ-1278B will respond with the mode status lines, and end with the command prompt. Note that if the user does not select a transmit speed, the MFJ-1278B selects the default speed of 20 WPM.

The MFJ-1278B is now in the CW mode of operation. To receive CW you go into **CONVERSE** mode. Enter **CONVERSE** mode by typing:

K <ENTER>

The MFJ-1278B is now ready to receive Morse code.

The Tuning Indicator and the DCD led on the front panel, assist the user in tuning in CW signals. Tune your receiver to approximately center the tuning indicator when there is a CW audio tone actually present. Note that between code elements (dots and dashes), the tuning indicator will indicate randomly. Once the CW signal has been coarsely tuned in by using the tuning indicator, further **CAREFUL** tuning should reveal a spot where the **DCD LED** flashes in **synchronism** with the incoming code. If the DCD LED does not light, then you must rotate the **THRESHOLD** control on the MFJ-1278B clockwise until the DCD LED flashes with the CW signal. If the DCD LED is lit, but does not flash with the CW signal, then rotate the **THRESHOLD** control counter-clockwise until the DCD LED does flash with the CW signal.

The demodulator is an extremely narrow filter. It is much narrower than the 500 Hz CW filter in your radio (if you have such a filter in the radio). This means that very careful tuning will be required for proper CW demodulation. You should attempt to tune for the center of the range where the DCD flashes with the incoming CW tone. Once tuned to that spot, the **THRESHOLD** control setting should be reduced (counter-clockwise) to a point just above where the DCD LED stops flashing with the incoming CW tone. The adjustment of the **THRESHOLD** control is critical and must be based upon your judgment of best copy. Once the optimum setting is found it can be pre-set and all remaining tuning done with the receiver frequency control.

The MFJ-1278B will automatically **LOCK** and **TRACK** the speed of the signal, once proper tuning of the signal has been established. The automatic **LOCK** and speed **TRACKING**

If the **AUTOTRAC** command is OFF, then before the MFJ-1278B can copy the tuned-in CW signal, it must be **manually locked** to the speed of the received signal. To manually lock the MFJ-1278B to the incoming signal, type a **CTRL-U**. The MFJ-1278B will respond with "locking...". The MFJ-1278B will analyze the incoming CW signal. When the analysis of the incoming CW signal is complete, the MFJ-1278B will respond with "**Locking...xxwpm.**" The "**xx**" is the speed of the received CW speed from 1 thru 99. When the MFJ-1278B issues the response "Lockingxxwpm," there will be CW copy on your computer screen. You shouldn't have to re-lock unless the station you're listening to changes its CW sending speed.

Transmitting CW

The MFJ-1278B will transmit International Morse code from 5 to 99 WPM.

The CW transmitting speed defaults to 20 WPM. The **MSPeed** command specifies the CW transmit speed. If the **FARnswor** command is ON, and **MSPeed** signifies 15 WPM, then the MFJ-1278B uses 15 WPM characters, but spaces the characters so the transmitted text is at a slower speed. To set the MFJ-1278B to 15 WPM, type:

MSPeed 15 <ENTER>

or

MODE CW,15 <ENTER>

Be sure the MFJ-1278B is in command mode when issuing the **MSPeed** or **MODE** command.

The MFJ-1278B provides yet another way to set the CW transmit speed, and that is the **CWSPEEDM** command. If the **CWSPEEDM** command is ON, then the MFJ-1278B will match your transmit speed with the transmit of the person you are in QSO with. The CW speed matching feature causes your MFJ-1278B to adopt the speed of the received CW signal as it's transmit CW speed. This is the same CW speed that the MFJ-1278B analyzed last, either through the **AUTOTrac** or by use of the **ALOCKCHAR** character, **CONTROL-U**.

To give the user with more flexibility in controlling how the MFJ-1278B will transmit CW/MCW, the **CWSEndch** command is provided. This command applies whether the keyboard or key paddle is the transmit medium. **CWSEndch** is only effective for CW and MCW modes.

The **CWSEndch** command determines which keyboard character transmits the CW/MCW characters. This gives the user more control how pending characters are transmitted. For example, setting the **CWSEndch** to \$02 will tell the MFJ-1278B to buffer all CW characters, until the user enters a **CTRL-B** from the computer keyboard. Entering the **CTRL-R**

If **CWSEndch** is left at the default setting of 255 or \$FF, the MFJ-1278B will transmit all characters immediately when typed. The requirement for pressing the <**ENTER**> is eliminated.

Note: If you are using a terminal program such as "**PROCOMM**" for IBM PC and compatibles that buffers the transmit data, then a **CARRIAGE-RETURN** will be needed to transmit.

The MFJ-1278B employs full CW break-in for transmitting in the CW/MCW modes. The **CWSEndch** command enables the full CW break-in feature. Setting the **CWSEndch** to something other than the default, will disable the break-in feature. Users do not have to press Ctrl-R to force the MFJ-1278B to receive or to press Ctrl-T to force the MFJ-1278B to transmit. MFJ-1278B will always go back to receiving mode at the end of each transmission. CW break-in is effective for both CW and MCW mode.

Transmitting from Memory Buffers

The user can use the **BUFKEY (nnn)** command to define a particular key to transmit the memory buffers. The MFJ-1278B uses the **TAB** key, (\$09) as the default for the **BUFKEY** command. The user can transmit any memory buffer, 0 through 9 by using the **TAB** and the appropriate buffer number. For example, to transmit memory buffer 3, the user would press the **TAB** key followed by the number 3 key. When pressing the **TAB** key, **DO NOT** hold the **TAB** key down, just press it, then let up. Once the MFJ-1278B transmits the memory buffer, the MFJ-1278B will revert to receive mode. There is no need to issue a CTRL-R to make the MFJ-1278B go back to receive mode.

Note: If you are using **MFJCOM** terminal program, you will not be able to use the "TAB" key as the **BUFKEY**. Change **BUFKEY** to another key on the keyboard. See **BUFKEY** command in Chapter 6 for more detail.

CW Weighting

The MFJ-1278B allows you to increase or decrease the weight of the code elements generated by the keyboard or key paddle. The user can set the **WEIGHT** by using the **WEIGHT** command. The weight factor defaults to dot-to space ratio of 1:1. A number from 0 thru 255 represents the weight value used. The default setting of the **WEIGHT** command, 0 sets a weight factor of 1:1. Select a number from 1 to 127 to **INCREASE** the dot/space ratio. Select a number from 128 to 255 to **DECREASE** the dot/space ratio (weight). You can easily change the weight the MFJ-1278B uses by typing:

WEIGHT ### <ENTER>

Where **###** is a number from 1 to 127 to increase weight, or from 128 to 255 to decrease

Tuning your Radio

The MFJ-1278B lets you tune your radio with the **TUNE** command. The **TUNE** command is issued from the command mode. The user can use the **TUNE** command in any of the MFJ-1278B operating modes.

The **TUNE** command activates the PTT line for 30 seconds. After 30 seconds MFJ-1278B will automatically return to command mode. To abort tuning before 30 seconds, press any key on the keyboard.

Random Code Generator

If you want to improve your CW copying proficiency, you will find the CW Random Code Generator helpful.

The **RANDOMCW** command invokes the Random Code Generator. Setting the **RANDOMCW** command to **ON**, activates the Random Code Generator. The Random Code Generator can generate Pseudo Ransom Code in two formats. The two formats of Pseudo Random Code are **NORMAL CW** and **FARNSWORTH CW**. The MFJ-1278B uses the setting of the **FARNswor** command to determine which format to send when **RANDOMCW** is **ON**. To end CW random code generation, type:

CONTROL-C

to return to command mode and then type:

RANDOMCW OFF <ENTER>

CW random code speed is set by using the **MSPEED** command described above.

Many find training for CW tests with a **FARNSWORTH** method of code generation more valuable. It teaches letter recognition at a speed fast enough to avoid the common learning "plateau." The learning "plateau" proves to be difficult for some people to get over. This is because as their code speed increases, they must re-learn the sound of the characters.

To select the Farnsworth method of random code generation, set the **FARNSWOR** command to **ON** before entering the **RANDOMCW** mode.

When the **FARNSWOR** command is **ON**, the MFJ-1278B generates random code using standard 15 word-per-minute timing for all code elements. When using the Farnsworth generation method, the inter-character spacing is increased to send the text at the slower selected speed. So with the **FARNSWOR** command **ON**, the code generator sends the CW characters faster, but slows the text down to a slower speed. The **FARNSWOR** command controls the transmission of CW characters, whether the computer keyboard or key paddles are used.

Setting Up the for Code Practice

You can monitor the random code sent by the MFJ-1278B without a radio connected. In order to monitor the random code, attach a small speaker to the "SPEAKER" jack, located on the back panel of the MFJ-1278B

Note: If a radio is connected and you do not wish to transmit the random code, the radio should be turned OFF. The MFJ-1278B will key PTT line and the keying output is active while RANDOMCW is ON.

Under the cmd: command prompt, type:

MODE MC,## <ENTER> (## is the desired code speed)

The MFJ-1278B will respond with the "Modem Status" display, verifying the operation mode, and cmd: prompt will appear. Next type:

RANDOMCW ON <ENTER>,

Next type:

K <ENTER>

followed by a **Ctrl-T**. The MFJ-1278B will generate 5 letter groups and display them on the computer screen. If you do not wish to see the characters as are sent, you can turn off your computer screen. You can then turn on the computer screen once you finish copying the code and compare the result.

To stop the random code sending, type:

Ctrl-R

To start the random code again, type:

Ctrl-T

To exit random code practice, type:

Ctrl-C

The MFJ-1278B will return to **cmd:** command prompt.

To stop random code generation, type:

RANDOMCW OFF <ENTER>

CW CONTEST MEMORY KEYER OPERATION

For CW enthusiasts who like to use a key paddle to send CW, the MFJ-1278B provides an input for an iambic key paddle. See CW KEY PADDLE INSTALLATION in chapter 3 in this MFJ-1278B manual for installation of your iambic key paddle.

Sending CW with External Key Paddle

The MFJ-1278B sends key paddle generated CW at 5 to 99 WPM.

The transmission speed for key paddle CW defaults to the same speed as keyboard CW, 20 WPM. The user can change the transmit speed by changing the **MSPEED** command. To set the MFJ-1278B to 15 WPM, you would type:

MSPEED 15 <ENTER>

Be sure you are in command mode when issuing the MSPEED command.

It is always a good idea to match your CW transmit speed with the person to whom you are in QSO with. The MFJ-1278B makes it easier for you to match your transmit speed to someone else's through the **CWSPEEDM** command. The CW speed matching feature causes your MFJ-1278B to adopt the speed of the received CW as its transmit speed. When the **CWSPEEDM** command is **ON**, then the MFJ-1278B will match its CW transmit speed with the whatever speed was last locked to through the **AUTOTRAC** routine. The MFJ-1278B will also adopt whatever transmit speed is locked-in by the **ALOCKCHAR** character, **CTRL-U** will also be

The **CWSEndch (nnn)** command provides the user more flexibility in controlling how CW/MCW characters are transmitted from the key paddle. The **CWSEndch** command is only effective for CW and MCW modes.

The user needs to leave the **CWSEndch** command at the default value of 255 or \$FF, when sending CW using a key paddle. The MFJ-1278B will transmit all CW characters immediately if the **CWSEndch** command is at the default setting of 255 or \$FF. Once the MFJ-1278B completes the CW transmission, the MFJ-1278B will revert to the receive mode.

Buffer transmission in the Memory Keyer Mode is the same as in the CW mode. Weighting of key paddle CW is achieved by using the **WEIGHT** command. Please refer to the CW mode section as to setting of the **WEIGHT** command.

MODULATED CW OPERATION

The MFJ-1278B allows the transmission of CW code practice over a VHF FM radio. To send code practice over a VHF FM radio, the user would use the Modulated CW mode, or MCW. When using the Modulated CW, the MFJ-1278B will key the PTT line of the Radio port and send a keyed audio tone to the microphone input of your radio. Modulated CW can be used on either radio port1 or radio port 2.

You do not have to re-wire the Radio cable when operating Modulated CW. You can use the same cable that you use for the other modes of operation.

To enter MCW mode type:

MODE MC <ENTER>

The MFJ-1278B will respond with the mode status as shown below, followed the **cmd:** command prompt.

Radio: 1

Terminal: 9600

Mode: Modulated CW, 20

cmd:

Operation of MCW is the same as in standard CW. Please refer to "CW OPERATION" for further details.

BAUDOT RTTY & ASCII OPERATION

The user can configure the MFJ-1278B RTTY/ASCII modems to copy several shifts, including 170, 425, and 850 Hz shifts. The user can use the **MODE** command to configure the RTTY/ASCII modems for the different shifts. The MFJ-1278B will transmit and receive RTTY and ASCII at speeds of 45, 50, 57, 75, 100, 110, 150, 200, and 300 baud.

The MFJ-1278B transmit and receive **WIDE** and **NARROW** shift RTTY or ASCII. Wide shift RTTY/ASCII operates on standard tone pairs of **2125 Hz** for **MARK** and **2975 Hz** for **SPACE**. The **frequency shift** for WIDE shift RTTY/ASCII is **850 Hz**. Narrow shift RTTY/ASCII operates on standard tone pairs of **2125 Hz** for **MARK** and **2295 Hz** for **SPACE**. The **frequency shift** for NARROW shift RTTY/ASCII is **170 Hz**.

In the RTTY mode, the MFJ-1278B will receive and transmit both the American Western Union and the internationally recognized CCITT character set. In ASCII mode MFJ-1278B will transmit and receive 7 bit ASCII code.

Note that the MFJ-1278B provides you with the option to select **Low Tone** RTTY/ASCII. **Low Tone** RTTY/ASCII uses standard tones of **1275 Hz** for **MARK** and **1445 Hz** for **SPACE**. The **frequency shift** for Low Tone RTTY/ASCII is **170 Hz**. You can select Low Tone RTTY/ASCII through the "V" modem. The Low Tone pairs are the standard used in Europe for RTTY and ASCII operations. Please refer to **APPENDIX H** on how to select the Low Tone pairs.

The MFJ-1278B can transmit or receive RTTY or ASCII by using inverted tone pairs. The **RXINVERT** and **TXINVERT** commands allow inverting of the tone pairs, in the RTTY or ASCII modes. When operating in the inverted mode, the tone pairs are **MARK** for the **high tone**, and **SPACE** for the **low tone**.

The MFJ-1278B also allows you to transmit from any one of the ten memory buffers when in one of the asynchronous modes. Memory buffer programming and use are the same as for CW operation.

Setting Up for ASCII and RTTY Operation

From command mode, you can set the MFJ-1278B into the desired RTTY or ASCII mode by using the **MODE** command. Type:

MODE ## <ENTER>

Where **##** is the two letter code for the desired RTTY or ASCII mode.

Code designations for RTTY and ASCII modes are as follows:

VHF RTTY VB

If you do not specify a baud rate for the RTTY or ASCII modes, the MFJ-1278B selects the default baud rates. The default baud rates for the RTTY and ASCII modes are 45 and 110 baud respectively. You can select a desired speed by typing the baud rate after the two character code. For example, to enter 110 baud VHF Baudot RTTY, you would type:

MODE VB,110 <ENTER>

Note: The only baud rates that you can select are those the MFJ-1278B is capable of receiving and transmitting. Selecting an illegal baud rate will cause the MFJ-1278B to respond with an error message, such as:

bad?

In this case the MFJ-1278B will change to default settings and return to the command mode.

RTTY and ASCII Receiving

After properly setting the MFJ-1278B to the desired RTTY or ASCII mode, type "**K**" on the computer keyboard to enter CONVerse mode. The STA LED on the MFJ-1278B will light. MFJ-1278B is ready to receive RTTY or ASCII signals tuned in by your radio.

Set the volume of your radio for normal listening level. Tune your radio until you hear a signal that you want to decode. Fine tune your receiver until the 10th or 11th segments are lit on the tuning indicator. When you have the signal tuned in properly, the DCD LED will light and the MFJ-1278B will start to decode the signal.

If the displayed text appears garbled, then the specified speed in the MODE command might be incorrect. Garbled displayed text may mean that the signal you are trying to copy is encrypted. If you suspect an encrypted signal, you can use the **RBITMASK** command to match the inversion pattern of the signal. If you suspect that the speed is incorrect, then you can specify a new speed setting. The speed is set by using the MODE command.

RTTY and ASCII Transmitting

While the MFJ-1278B is in RTTY or the ASCII mode and it is in command mode, you can initiate RTTY or ASCII transmission by typing:

K <ENTER>

followed by a **CONTROL-T**.

The MFJ-1278B is now ready to transmit. Type your message on the keyboard. The MFJ-1278B will transmit your message as it is received from your computer.

Messages stored in memory buffers 0 thru 9 can be transmitted when in RTTY or ASCII modes. To transmit a memory buffer, when already in transmit mode, type:

Note: If the MFJ-1278B is not in transmit mode (i.e. in receive mode), then in order to initiate transmission from a buffer, you must type **CONTROL-T** twice then enter a number for the buffer. You can tell if the MFJ-1278B is in transmit mode, by observing the PTT LED on the front panel. If PTT LED is lit, MFJ-1278B is in transmit mode.

Once the MFJ-1278B completes the transmission, press a **CONTROL-R**. When the MFJ-1278B receives the **CONTROL-R** from the computer, it will return to receive mode. When the MFJ-1278B is in receive mode, note that the PTT and STA leds are not lit.

Some terminal programs do not support the **CONTROL-T** or **CONTROL-R** characters. The MFJ-1278B require the **CONTROL-T** and **CONTROL-R** characters to switch between transmit and receive modes.

If the terminal program does not support the **CONTROL-T** and **CONTROL-R** characters, you can re-assign the **ASENDCHAR** and **ARCVCHAR** commands in the MFJ-1278B to other keys. See Chapter 6 of this manual for detail on the **ASENDCHAR** and **ARCVCHAR** commands.

Note: When operating RTTY or ASCII it is recommended that you operate at about 50% of full power. This is to prevent damage to the finals of your radio. Some modern radios allow operation of RTTY and ASCII at full power. You should consult the owner's manual of your radio to see what is the acceptable power level at which your radio should operate.

BAUDOT RTTY OPERATION HINTS

In this section we will cover a few of operative hints for the RTTY and ASCII modes.

To set the MFJ-1278B to RTTY mode type:

MODE HB <ENTER>

for HF operation. This sets the MFJ-1278B to the standard RTTY mode that most amateurs use. On HF this is 45 baud or 60 wpm. As mentioned earlier, if you do not designate a speed after the two letter, the MFJ-1278B selects the default of 45 baud.

Some RTTY bulletin boards use 75 baud or 100 wpm, in which case you should type:

MODE HB,75

The number after the "HB" sets the character transmission and receive speeds in baud. Some operators will refer to the speed as words-per-minute. However, the normal terminology is to refer to the speed in **BAUD RATE**. Although speeds up to 300 baud are available, only 45

To enter the converse mode type:

K

This will take the MFJ-1278B out of the command mode and into converse mode. When the MFJ-1278B enters converse mode, the STA will illuminate. Also after entry into converse mode the MFJ-1278B is in receive mode. You can enter transmit mode by typing CONTROL-T. To re-enter receive mode type a CONTROL-R. The command **CONTROL-C** will return you to the command mode, where you will get the **cmd:** prompt on your screen. Use lower side band, LSB unless you have an RTTY position on your rig. Tune your radio until the 10th or 11th segments on the tuning indicator light during receive. Ensure that the yellow DCD led is illuminated also during receive. It is possible to tune to the center of the bar graph, and not have the DCD led lit. If the DCD led does not light, then check the setting of the Threshold control on the front panel. The DCD led needs to be lit for reception. Some bouncing of the LED is normal, since any audio other than the signal (QRM/QRN) will also affect how it responds. From the converse mode you should now see text being printed on the screen as it is heard. Contacts usually take place on a one-way at a time basis. So one side will transmit and the other will receive, and then the sides are reversed.

To allow the MFJ-1278B to transmit RTTY or ASCII, type:

CTRL-T

while in converse mode to key the PTT on the radio. The green PTT light should light and you should see power on your wattmeter. All keystrokes are now sent out over the air. Alpha-numeric (numbers and upper/lowercase letters) characters are the only kind of keystrokes accepted. Some punctuation is allowed. When the transmission standards were set up, only mechanical typewriters (tele-type) were used and these were the only keys in use. Most other characters such as Greek and graphics are usually translated wrong, and you'll see the other guy's 'mistakes' when he types one of the characters. To go back to the receive mode, type **CTRL-R** in converse mode to unkey the radio, and you will return to the receive mode. This will start the transmit/receive cycle over.

Commercial RTTY Reception

Commercial RTTY presents a special problem for amateurs and short wave listeners. Several conditions must be met before you can get a decent printout. You have to locate the frequency of a particular station, get the schedule right, pick the sideband, set the baud rate, set the frequency shift, and finally, unencrypt the text.

You can receive many of these stations using the 425 shift, 50 baud, and lower sideband during the daylight hours. For this setup use **MODE VB,50**. Some military frequencies are unencoded, as well as some of the UPI broadcasts. A good source of frequencies is Popular Communications and Monitoring Times magazines.

AUTOMATIC SIGNAL ANALYSIS

The **Automatic Signal Analysis** or **ASA**, feature installed in the MFJ-1278B firmware can analyze received signals such as RTTY, ASCII, AMTOR mode b and HF Packet. ASA will tell you the speed, data bits, and if the signal is inverted. ASA automatically switches the MFJ-1278B to the correct mode once you accept the results of the signal analysis by typing OK and <ENTER>. As you see ASA is extremely helpful when tuning across the amateur or the shortwave bands. Let ASA help you determine what kind of signals you are listening to.

ASA OPERATION

ASA is effective in analyzing RTTY, ASCII, AMTOR FEC mode b and HF Packet. Once invoked, ASA only takes a few seconds to analyze the tuned-in signal. Once the result is displayed, the user can decide whether to accept by issuing the **OK** command. If the user questions the results, ASA will continue to analyze the signal and will display the results after each cycle.

When the ASA routine is entered, the MFJ-1278B will enter the "converse" mode automatically and display:

Wtg:CD,

All the you have to do now is to tune in the signal you wish to decode. This is done in accordance with the MFJ-1278B operations manual.

Once invoked, ASA will first display the speed and the confidence factor followed by a pause. After a 5 to 10 second pause it will display the speed of modem used to analyze the signal, data bits of the signal which will be either 5, 6, 7 or 8. Any data bit analysis of 6 should not be used and the signal should be re-analyzed. Last it will display the setting of what it will change the RXInvert command to (On or Off). This is what ASA will switch the MFJ-1278B to, if the user accepts its result.

The display is in the following format:

<Speed><Confidence Factor>.<Speed><Data Bits><RXInvert On/Off>

A typical result will look like this:

80 baud, 90% Confidence. 75 baud used 7 bits, RXInvert Off

Once the result is displayed, the user can exit ASA signal mode by pressing any key. MFJ-1278B will return cmd: command prompt without changing the operation mode.

If the analyzed result is acceptable, the user will simply type:

OK <ENTER>

In the case of analyzing a 300 baud signal, the MFJ-1278B will prompt the user that the signal could be PACKET. If this occurs then the user can enter the following command from the cmd: prompt:

OK Packet <ENTER>

The MFJ-1278B will switch to the 300 baud HF packet mode.

If the user just issues the OK command, then the MFJ-1278B will switch to the 300 RTTY or ASCII mode. The number of data bits ASA analyzed, determines if the MFJ-1278B switches into RTTY or ASCII modes. If data bits was 5, then ASA will switch the MFJ-1278B into RTTY mode. If the data bits were 7 ASA will switch the MFJ-1278B into ASCII mode.

If the ASA result is a 100 baud signal, the MFJ-1278B will prompt the user that the signal could be AMTOR. If this occurs then the user can enter the following from the cmd: command prompt:

OK AMTOR <ENTER>

When the "OK AMTOR" command is given the MFJ-1278B will switch to AMTOR mode B. Follow the AMTOR operating procedure to go to any of the other AMTOR modes.

If the user does not issue the "OK AMTOR" command the MFJ-1278B will switch to 100 baud RTTY.

Note that if RTTY or ASCII signals are analyzed, and the user accepted the result (by typing OK) and the MFJ-1278B still does not copy the signal correctly. This may be due to the signal being encrypted with bit inversion. Most of the time, two or three bits of the RTTY character may be inverted and it is possible for all 7 bits to be inverted.

If the baud rate and the type of signal has been determined by ASA and the MFJ-1278B still does not copy correctly, the signal may be encrypted with bit inversion. In this case, you may want to try to use the **RBitmask** command to set various inversion patterns to match the receive signal, but manual setting of the RBitmask command is not necessary. The RBitmask command can be invoked when the MFJ-1278B is in the RTTY or ASCII receive mode by simply issuing the "CTRL-U" while the MFJ-1278B is in converse mode.

Once "CTRL-U" is pressed, MFJ-1278B will automatically cycle through each of the bit combinations, and then display a sample text of each one of the combination on the screen. Examine the list of the displayed text on the screen and if one of the 32 sample text looks normal then make note of the combination number next to the text. Do the following to select this combination:

Press **CTRL-C** to go into the cmd: prompt, then type the number noted above with the

MFJ-1278B will enter converse mode and begin to display text normally.

If another RTTY or ASCII signal from another station is received, RBIT must be reset to copy that signal by following the same procedure as described above. RBIT can be set to normal (no inversion) by setting it to "RBIT 0".

Note that when using ASA, noise will have major effect on the degree of its effectiveness. If no signal is present while the MFJ-1278B is in ASA mode, the display will display:

Wtg:CD,

User will simply press the "Return" key to return to CMD: command prompt. There is no need to type **ASA** to go back into the ASA mode, because once invoked ASA is always active.

MARS OPERATION

The MFJ-1278B sets a few commands to simplify **MARS** operation. These commands are **PROfmars** and **MARsmode**.

With **PROfmars** and **MARsmode**, the MFJ-1278B is more compatible with MARS than ever. We have made operating MARS with the MFJ-1278B more fun and enjoyable. The following section should be very useful to the MARS operator.

Configuring for MARS

When **PROfmars** is invoked, profiles the MFJ-1278B for MARS operations. When this command is invoked it sets the following parameters as specified.

Command	MARS Setting
AUTOLF	OFF
CCITT	OFF
DIDDLE	OFF
LFADDALT	OFF
LFIGNORE	OFF
MARSMODE	\$01
UNSHIFT	OFF
RXLFNOCR	ON

Once the MFJ-1278B is profiled for MARS operations, the user must set the MFJ-1278B into HF RTTY mode by typing:

MODE HB,75 <ENTER>

Once you have set your operating mode, the user must press the **K** key and a **<ENTER>** in order to enter RECEIVE mode. The MARS operator is now ready to receive MARS traffic.

The operator must then tune the VFO on the radio so the tuning indicator on the MFJ-1278 is centered on the bar graph display. The received traffic should be coming to the screen, in the proper MARS format.

Operating MARS with MultiCom for IBM

Operating **MARS** using the MFJ-1278B and the MultiCom™ software, makes operating much easier. Let's say that you have 20 pieces of traffic, but you only need to send 10 of them, this is where MultiCom™ comes in handy. The MultiCom™ software has a very good text editor, **Multi Word™**. You can use the Multi Word™ editor to send MARS messages. All received data is stored in a 32K COMM buffer that MultiCom™ opens when loaded. So, at anytime the operator can see all traffic that has been received. The operator can go into the Multi Word™ editor by pressing the **F10** key, followed an **ALT-B**. The ALT-B key sequence fills the Multi Word™ editor with the contents of the COMM buffer.

Insert a **CTRL-T** at the beginning of each piece of traffic and a **CTRL-R** at the end of each piece of traffic. Use the Multi Word™ commands, F1 and F2 respectively, to block off the pieces of traffic you want to send. After blocking off the traffic, use the F9 key to send the traffic to the MFJ-1278B to be transmitted.

The operator will need to perform this operation for each piece of traffic to be sent. If all pieces of traffic are all together, one right after the other then the procedure will only need to be done once.

The MARsmode Command

The **MARsmode** command provides two levels of MARS compatibility. The "QSO" mode provides minimal translation. In the QSO mode, the MFJ-1278B assumes the user is manually sending and receiving. Maximum translation is provided for sending and storing files of MARS messages, while preserving all of the formatting information, using the special MARS ASCII equivalent characters, and differs from QSO mode only because of its extra ASCII output translations.

MARSMODE 1- QSO Mode

In the MARS QSO mode the Transmit translations are as follows:

1. All carriage returns are converted to **CR/CR/LF**, or to **LF** only if preceding character was also CR.
2. "NNNN" is sent as "NNNN" followed by 12 LTRS
3. Characters are translated as follows:

Key Press	Trans. Characters
*	CR
=	LF
+	12 LTRS
@	BELL
\	NULL
>	FIGS
<	LTRS

MARSMODE 3- Storage Mode

The **MARS Storage Mode** has all of the same transmit translations as the QSO mode, plus these Receive translations:

Received Char	Printed Char
CR	*
LF	=
BELL	@
NULL	\

AMTOR OPERATION

AMTOR, (AMateur Teletype Over Radio), an error correcting protocol suite, is fully supported by the MFJ-1278B. Two modes are available with AMTOR. These are mode A and mode B.

From command mode, AMTOR modeB is entered by typing:

MODE AM <ENTER>

Note that the MFJ-1278B displays an "a_cmd:" once the AMTOR mode has been entered. This "a_cmd:" command prompt lets you know that you are in AMTOR mode and only AMTOR commands are recognized by the MFJ-1278B. To issue other non AMTOR commands you will have to return to the normal command mode ("cmd:" command prompt) by typing "CTRL-C".

Operation of the Tuning Indicator in the AMTOR mode is the same as all other modes. Simply tune the signal so that the center LED segment of the Tuning Indicator is lit with each burst of AMTOR signal received.

Mode A "ARQ"

Automatic request for re-transmission mode, known as "Mode A", is similar to packet radio in a number of ways.

The calling station must know the ID of the station being called, in order for communications to occur.

The "ARQ"command initiates a link attempt with the station being called. A link attempt in AMTOR, is similar to a CONNECT attempt in Packet.

Mode A is a one-on-one protocol, meaning that it is used for QSOs, and not for calling CQ or broadcasting. (see FEC and SELCALL for more on broadcasting.)

ARQ Mode A introduces a few new terms, "**Information Sending Station,**" (ISS) and "**Information Receiving Station,**" (IRS). In ARQ, a station must be either the ISS or the IRS, and the station that is transmitting data is called the ISS.

One becomes an ISS either by issuing a successful AMTOR call, with the ARQ command, or when the ISS relinquishes control of the link through the changeover, +?. Finally, if an IRS link CHANGE is requested.

Setting up for Mode A Operations

First you should decide upon a selective call identifier and enter it as your **MYSEL CALL**. A

Examples are:

Amateur callsign is **N2WX**; Amtor MYSELCAL is **NNWX**

Amateur callsign is **WB2SPE**; Amtor MYSELCAL is **WSPE**

AMTOR depends on everyone having a unique selective call. If you find there is already a station using the same call that you would use then you may need to base your ID upon the call district that you're in. Select a letter based upon the table below:

1=Q 2=W 3=E 4=R 5=T 6=Y 7=U 8=I 9=O 0=P

Example:

N2WX becomes NWWX (using zone 2)

When **MYSELCAL** is set the MFJ-1278B is ready to receive and respond to AMTOR calls.

Operating Mode A

To start the ARQ call, type "**ARQ <selcall>**" and <ENTER>. The <selcall> must be four characters long. Both the **CON** and **STA** leds on the MFJ-1278B will light, and your transmitter will start keying on and off repetitively. If the other station responds, you can start sending data or you can abort the call by typing **QRT** or **R**.

When the **CON** lights a link is established. You may now type **CONVERSE** or **K** to enter the data mode and start transmitting data. The **CON** and **STA** will be turning on and off at various times depending on how much data you transmit and how good the link is.

When you are through transmitting, always use the AMTOR ending signal "+?". **NEVER** use a "K" since this will not relinquish the ISS function and the station you're working will be unable to transmit until the information sender sends a "+?".

If you wish to end the contact, go back to AMTOR command mode with a CTRL-C and type "QRT".

While you are the current receiving station, you can't send any new data to the other station. Should you wish to break in for some reason before the other station sends "+?", and you want to become the transmitter, go to AMTOR command mode with CTRL-C and type CHANGE. This forces the remote ISS to revert to the IRS. Then you can start transmitting data.

If the CPU oscillator of the MFJ-1278B is improperly set, then you may experience a phasing problem or a loss of sync, during ARQ operations. The CPU oscillator is factory set at

Monitoring Mode A, "ARQ"

The **LISTEN** command is useful for monitoring other people's ARQ contacts. To use, tune in a **Mode A** signal and type **LISTEN**. Both the **CON** and **STA** leds will light until the station is synchronized, at which time the MFJ-1278B will start to receive.

Since the monitoring of **MODE A** signals is not error protected, you may see occasional errors. How well the MFJ-1278B receives **Mode A** signals depends on the quality of the signal. The quality of **Mode A** signals depends on how well the MFJ-1278B hears both sides of the QSO. Band conditions also have an effect on **Mode A** signal quality. The **LISTEN** mode is most useful for allowing amateurs to continue to self police their bands.

Mode B "FEC"

Mode B FEC is a "One transmitter, many receivers" mode. Unlike packet or ARQ, **FEC** does not establish a one-on-one link setup, nor does it have a re-transmission feature. Mode B, FEC is mainly used for calling CQ. The amtor operator would first call CQ in **Mode B**, then wait for a call from another operator in **Mode A**.

Setting up for Mode B "FEC"

Setup for **Mode B FEC** is the same as ARQ, although a selective call is not required.

Mode B "FEC" Operations

To receive **Mode B FEC**, tune the FEC signal in so the center segments on the MFJ-1278B tuning indicator light. When the MFJ-1278B detects the synchronization pattern, either the **CON** or **STA** led will light. The exact point in the transmission to which you tuned to, determines if the **CON** or **STA** led lights. When either the **CON** or **STA** led lights the received data will begin to display on the terminal screen.

Use **Mode B FEC**, for calling CQ, operating in round tables, and for transmitting bulletins to more than one station at a time. To transmit **MODE B FEC**, type **FEC** followed by a carriage return, at which time your transmitter will key up. Now type **CONVERSE** or **K** to enter the data mode and you're on the air with **FEC**. Anything entered from the keyboard once in the data mode is transmitted.

When you're done transmitting, return to the **AMTOR** command mode, **a_cmd:** with **CTRL-C**. In order to release the transmitter type **R** or **QRT** followed by a carriage return. At this point again the MFJ-1278B will automatically attempt to synchronize to any mode B signal it hears.

Mode S "SELCALL"

Mode S is exactly like **Mode B**, **EXCEPT** that the broadcasting station can select one or a

AMTOR Status LED Indicators

The **CON** and **STA** LEDs have special meanings in the AMTOR modes.

STA OFF CON OFF

This led combination indicates that Mode B is unlocked, and in **STANDBY** mode. Standby mode is where the MFJ-1278B is ready to respond to Mode A or B "FEC" Amtor signals. The MFJ-1278B will also print Mode S "SELCAL" signals, depending on the setting of the **SRXALL** and **MYSELCAL** commands.

STA OFF CON ON

Indicates Mode B is locked in and is in the **Idle mode**. Broadcast text will be printed if in receive mode. Also if in receive mode, the MFJ-1278B is receiving an AMTOR "idle" signal. The other station is still being received ok, though he is not transmitting any text.

In Mode A, this signal could also mean that a send-receive **CHANGE** is pending or that the sender is repeating a block.

STA ON CON OFF

This led combination indicates Traffic mode. The MFJ-1278B is currently sending or receiving text.

STA ON CON ON

This is the phasing error mode. If in a Mode A contact, this means that the MFJ-1278B is either trying to re-establish a link or is sending indication of a receive error.

If in Mode **L** or "**Listen**", the MFJ-1278B is hunting for a synchronization signal.

AMTOR OPERATION HINTS

To receive AMTOR, from the **cmd:** command line, type:

MODE AM <ENTER>

Now you should see the **a_cmd:** prompt. This mode is used for **FEC** type reception. To enter Listen mode type:

LISTEN <ENTER>

To enter the ARQ listen mode to monitor ARQ signals type:

AMTOR <ENTER>

The **STA** and **CON** LEDs will light. When a station is 'zero beat' on frequency, the connect

in idle mode. If you can hear both sides, you can hear the alternate chirps as they are in sync with each other.

If you operate Mode B or Mode S, then you should have no problems with AMTOR. These are the broadcast modes and are almost identical to teletype in the way you make contacts. The whole purpose behind Mode B (FEC) is, making the initial contact. After you make a contact, you should arrange with your contact to move off the calling frequency to a working frequency. Moving off the calling frequency is proper etiquette so that way others can then use the calling frequency for the same purpose. Mode B allows you to make a blanket broadcast to all stations within range. Think about teletype and you've got the right idea. One side talks and the other listens, and then the stations change sides. To the ear, mode B sounds almost identical to teletype. Type **FEC** to enter Mode B transmit and **K** to enter converse mode. It works like teletype, because you transmit 100% of the time while keyed up.

Mode S is almost identical to mode B, with the exception that it allows several stations to link in a round-robin type of network between stations. **Mode B** and **Mode S** are not necessarily error free, since there is no acknowledgement from the receiving station.

Mode A, ARQ mode is the mode used by most amateurs, and is sent with no errors once a link is made between stations. Enter your own AMTOR **4-letter call** at the AMTOR prompt with:

MYSELCAL xxxx <ENTER>

Once you have a frequency selected, at the command line type:

ARQ xxxx <ENTER>

where the **xxxx** is the selected **SEL**call of the other station. The status light should remain lit once a link is established.

Type **K** followed by the <ENTER> key to enter converse mode.

The MFJ-1278B will transmit all data typed just like you type it on the keyboard. You can type as long as you like or as long as the other station does not get tired of listening, or the band fades out. Type **+?** to transfer control of the link to the other station. Only one station has control of the link at a time, so try to be considerate. If you want to take control of the link to send a quick reply you would go back to the **a_cmd:** prompt and type **CHANGE**, then type **K** to return to converse mode. Type **CTRL-C** once to take you back to the AMTOR command line -- **a_cmd:**. If you make a mistake and type the Ctrl-C twice or more, it will take you back to the main **cmd:** line. Type **R** or **QRT** at the **a_cmd:** to terminate the link. It's usually a good idea to let the other station know before you do though. Think about how

You can obtain hardcopy printouts from the built-in printer port of the MFJ-1278B. Hardcopy printouts are done with the same printer that you used in the other modes of operation. To make hardcopy printouts type the following at the **a_cmd:** command prompt:

PRINT ON <ENTER>

to activate the built-in printer port. Ensure that the printer is turned on and is **ON-LINE**. Now all AMTOR received will go to the printer port, until a **PRINT OFF** command is issued, or you exit back to the main **cmd:** line.

Summary of AMTOR Contact Sequence

1. At the **cmd:** command prompt, type **MODE AM**, this will take you to AMTOR mode B (FEC) mode. Indicated by the **a_cmd:** command prompt.
2. **LISTEN** or **LI** allows you to monitor mode A (ARQ), and switches from mode B.
3. Issuing an **R** will switch from mode A to mode B from the **a_cmd:** prompt.
4. **ARQ xxxx** connects you with a station heard calling cq.
5. **R** or **QRT** in ARQ mode removes the link between stations.
6. **FEC** keys the transmitter and broadcasts a mode B message.
7. **CRTL-C** from the converse mode will return you to the **a_cmd:** prompt, and twice will exit back to the main **cmd:** prompt.

NAVTEX OPERATION

Navtex is a new direct printing service operating on 518 KHz.

NAVTEX stands for **Navigational Telex**. Navtex broadcasts urgent weather, navigational and other information that is intended for ships.

Navtex Stations and Frequencies

Navtex Stations currently cover most coastal areas of Europe and the Eastern United States. West Coast Stations for the United States are in various phases of planning or construction, and will begin transmitting within a few years.

Currently operational Navtex stations in the United States include locations in Portsmouth, Virginia, Boston, Miami, and New Orleans. A station in Sydney, Nova Scotia can also be received in many parts of the United States.

Several Navtex stations are planned or already under construction on the West coast, including locations in San Francisco, Astoria, Oregon, Adak and Kodiak, Alaska, Long Beach, California and Honolulu.

The system is fully installed in Europe, and is well on its way to becoming an international standard for navigational information.

A partial list of stations and their broadcasting time is listed in Table 4-5 below:

Station QTH	Station ID	Broadcast Time (UTC)
Miami	O	0000,0600, 1200, 1800
Portsmouth	M	0130, 0730, 1330, 1930
New Orleans	G	0300, 0900, 1500, 2100
San Juan	R	0415, 1015, 1615, 2215
Bermuda*	B	0100, 0700, 1300, 1900

Table 4-5 Navtex Station & Frequencies

*Bermuda station is not yet on line.

Navtex Operation

Navtex is part of the Mode B (FEC) AMTOR mode. Each Navtex transmission is prefaced by the characters **ZCZC** followed by a four character code of two letters that identify the station and type of message followed by a number code from 00 to 99 that identifies the particular message. This prevents your MFJ-1278B from receiving messages that have

The types of Navtex messages currently are:

- A. Navigational warnings**
- B. Storm Warnings**
- C. Reports of Ice**
- D. Search/Rescue Information**
- E. Weather forecasts**
- F. Pilot Service Messages**
- G. DECCA System**
- H. LORAN-C**
- I. Omega Systems**
- J. SATNAV Systems**

K thru-Z are not in use at this time. They are reserved for future use.

To exit the NAVTEX mode, issue a CTRL-C to obtain the **n_cmd:** command prompt. After the **n_cmd:** prompt is received from the MFJ-1278B, type:

NAVTEX OFF <ENTER>

The MFJ-1278B will return to the **a_cmd:** command mode. You can issue another **Control-C** to return to the **cmd:** command prompt for non-amtorg operation. You also have the alternative to stay in the Amtorg mode, and do some Amtorg operations.

NAVTEX commands are explained in the **COMMANDS** chapter in this instruction manual.

FAX OPERATION

The MFJ-1278B provides an independent multi-gray level modem to transmit and receive FAX with up to 16 levels of gray. The FAX modes supported by the MFJ-1278B are listed in Table 4-6. These FAX modes include **Weather FAX**, FAXMODE 3 and **Wire Photographs**, FAXMODE 1. These 16 gray level FAX modes are supported to the computer screen with the appropriate software and hardware. However, the MFJ-1278B's built-in printer port supports **2 level, black/white FAX** and not FAX with multi-gray levels. In order to support more than 2 levels in FAX, you must have the specific terminal program for your computer that will support FAX in multi-gray levels.

FAX operations with the MFJ-1278B, does not require any special computer or software to receive FAX pictures on your Epson graphics compatible printer. However, to print a FAX picture to your computer screen or to save FAX pictures to disk, you need software that allows these operations.

MFJ Enterprises, Inc. offers terminal software for some computers to support this operation. This software allows you to print FAX pictures to your computer screen in near real time and to save FAX pictures to disk. The FAX pictures saved on disk can be re-transmitted, sent to your printer, or recalled to screen at any time.

MFJ terminal programs which support on screen multi-gray level FAX operation are as follows:

1. MFJ-1289 for IBM PC and compatibles on 5-1/4" disk.
2. MFJ-1289M same as MFJ-1289, but on 3-1/2" disk.
3. MFJ-1287B for Apple Macintosh computer.
4. MFJ-1282B for Commodore C-64 and C-128 on 5-1/4" disk.

If you are using one of the above terminal programs that supports Gray Level FAX operations, **you should follow the instructions given by the terminal program** to receive and transmit FAX. The instruction given in this manual for FAX operation are for receiving FAX with the MFJ-1278B's built-in printer port.

FAX Formats

The MFJ-1278B lets you receive and transmit FAX. The FAX modulator and demodulator of the MFJ-1278B are pre-set at the factory to allow FAX operations without any recalibration. Recalibration is not needed under normal conditions. The MFJ-1278B will support FAX formats listed in Table 4-6.

FAXMODE(n)	Lines per Minute	Lines per Second	Type of Service
1	60 line/min.	1 line/sec.	Wire Photographs
2	90 line/min.	1.5 line/sec.	
3	120 line/min.	2 line/sec.	Weather FAX
4	240 line/min.	4 line/sec.	Satellite Weather FAX
5	360 line/min.	6 line/sec.	
6	480 line/min.	8 line/sec.	
7	180 line/min.	3 line/sec.	

Table 4-6: MFJ-1278B FAX Formats

You may change the FAX format with the FAXMODE command. From the **cmd:** command mode prompt, type:

FAXMODE n <ENTER>

Where **n** is a number from 1 to 7 as listed in the Table 4-6 above.

For example, if you want to change the FAX format to 1 or 60 lines per minute, type:

FAXMODE 1 <ENTER>

The MFJ-1278B will be set to receive or transmit Fax picture files in FAX 1 format.

Note: If you are using one of the special terminal programs that supports multi-gray level FAX operation, **you should follow the procedure given in its operating instruction manual** to receive and transmit FAX.

FAX operation procedure given in this instruction only applies to receiving 2-level FAX and printing it to an EPSON graphic printer attached to the MFJ-1278B printer port.

FAX Frequency

FAX transmitting stations are usually found on the HF bands. Weather FAX stations are generally upper sideband. Some of these stations maintain a regular schedule. Table 4-7 lists the frequencies of some FAX stations.

Service	Band	Frequency (KHz)
Weather	USB	3,357.00 4,268.00 4,975.00 6,946.00
		10,865.00 12,125.00 20,015
Photographs	LSB	10,680.70 17,673.90 18,434.90 20,738.00

Other FAX Frequencies

The following frequencies were obtained from Popular Communication Magazine:

FREQUENCIES (KHz, USB)	LOCATIONS
4,271.00 9,890.00 13,510.00	Halifax, Canada
8,502.00 12,750.00	Boston, MA
9,389.50 11,035.00	Brentwood, NY
4,793.50 10,185.00 12,201.00 14,671.50	Washington, DC
9,157.50 17,447.50	Mobile, AL
8,080.00 10854.00 16,410.00	Norfolk, VA
4,802.50 7,770.00 9,440.00 11,090.00 13,627.50 13,862.50	Hawaii
8,459.00	Alaska
4,346.00 8,682.00 12,730.00 17,151.20	San Francisco, CA
8,646.00 17,410.50	San Diego, CA

Table 4-7: FAX STATION FREQUENCIES

FAX Installation

The radio interface for FAX operation is the same as for the other modes of operation. The radio connection between the MFJ-1278B and your radio is described in Chapter 3 of the MFJ-1278B manual.

Printer Connection

If you have a terminal program that supports FAX printing to the computer screen, then you should attach your printer to your computer printer port and not to the MFJ-1278B. In this case turn the **PRINTGRA** command OFF. If you intend to receive the FAX picture and send it to the printer that is attached to the MFJ-1278B parallel port, then turn the **PRINTGRA**

Receiving FAX

From command mode, the MFJ-1278B can be set to FAX mode by typing:

MODE FX <ENTER>

Select the desired FAX mode by typing:

FAXMODE n <ENTER>

where **n** is the FAX format as indicated by the FAX Format Table 4-6. For HF weather FAX, select FAXMODE 3. The default FAX mode for MFJ-1278B is FAXMODE 3 or 120 lines per minute format. This is the format used by most weather FAX stations. For other FAX format use other **n** value as listed in Table 4-6.

Set the **PRINTGRA** command to ON if you are printing the FAX pictures to the printer attached to the MFJ-1278B parallel printer port. Set the **PRINTGRA** command to OFF if you are printing the FAX pictures to the computer screen. Note that to print FAX picture to the computer screen requires a terminal program that will perform this function.

Set the audio output of your radio to normal volume. Tune your radio to a desired frequency. If you are not familiar with recognizing FAX signals, you may want to select one of the weather FAX frequencies listed above. Weather FAX, Faxmode 3 is usually transmitted at 120 lines per minute. This is a horizontal scanning rate of 2 lines per second. So by listening to the scanning rate, you can determine what format you should set the MFJ-1278B on to receive the signal.

After tuning in the desired FAX frequency on your radio, set the **THRESHOLD** control to maximum clockwise rotation. Tune the radio so that the DCD LED remains lit. Now observe the TUNING INDICATOR of the MFJ-1278B while fine tuning your radio. You will notice that with each scan the tuning indicator will move toward the center. Tune the radio so that the tuning indicator is centered at the end of each FAX scan. Once you achieve this, the FAX signal is tuned in and the MFJ-1278B is ready to decode the FAX signal.

Receiving FAX to the Printer

This section applies if you have your "EPSON" or "IBM" graphics compatible printer attached to the built-in printer port on the MFJ-1278B.

Most commands that affect FAX printing default to a value that will allow successful printing. However, before printing, make sure the commands **EPSON** and **PRINTGRA** are ON. Printing a FAX image directly to a printer will not function unless **EPSON** and **PRINTGRA** are ON.

After selecting the desired FAX mode, type K to leave command mode and enter the CONVERSE mode. Once in CONVERSE mode the MFJ-1278B is in standby-receive mode. This means that the MFJ-1278B is listening to the radio for the distinctive "tic-tic" that indicates the synchronization period at the beginning of a picture. If the MFJ-1278B hears the "tic-tic" well enough, it will establish a lock onto the signal and start printing to the printer. The printer will print upon each scan of the FAX picture.

The MFJ-1278B's built-in **LOCK** feature detects the beginning of each picture before starting to print. This insures each picture will be printed from top to bottom. If you want the printer to start to print in the middle of the picture, you may force a lock on the picture and the printer will begin to print upon the "force lock". To force a lock, you simply type the letter **L** while in the FAX standby-receive mode.

The **LOCK** detect feature on the MFJ-1278B is effective for **FAXMODE 3**. For other FAXMODEs, you will want to force a **LOCK** at the beginning of the picture to insure proper printing.

If the FAX picture appears to be printed shifted to the right, you can type the "<" key to shift the picture to the left. Each repetition of the "<" key will shift the picture 1/10" to the left. To shift the picture to the right, use the ">" key. Each repetition of the ">" key will shift the picture to the right 1/10". For example, if you needed to shift the picture to the left 1 inch, you would press the "<" key ten times. The picture can be shifted to the right or left at any time during printing.

If your picture is elongated horizontally or vertically, you can correct this by setting the **ASPECT** ratio. **ASPECT** is used to establish a reasonable aspect ratio between the horizontal and vertical presentation of FAX graphics. **ASPECT** ratio can be set between 2 thru 8, with 2 being the optimum aspect ratio for weather FAX. The default **ASPECT** ratio of the MFJ-1278B is 3. The **ASPECT** ratio can be set by using the command **ASPECT** followed by a number from 2 thru 8. If you find that your picture seems to be elongated horizontally, you should decrease the value of aspect. If the picture is elongated vertically, you should increase the aspect value.

If you notice spaces in the printed picture, you should set **GRAPHLF** to OFF. The **GRAPHLF** command determines whether the MFJ-1278B will issue a line feed before the carriage return on every line of graphics. The **GRAPHLF** command defaults to OFF. For most printers **GRAPHLF** should be set to ON.

If the printed picture appears to be slanted to the left or to the right, this indicates that the master CPU clock on the MFJ-1278B may not be in frequency with the transmitting signal. To correct this problem, you will need to remove the cover of the MFJ-1278B and adjust the white capacitor trimmer **C47**. This adjustment does not require any special equipment.

Display FAX Picture on Computer Screen & Save it to Disk

The MFJ-1278B firmware does not support printing to your computer screen or allow you to save FAX pictures in disk files. Printing of fax pictures to your computer screen, and saving pictures to disk are a function of the computer software. Any good terminal program has a save to disk routine. In order to print the fax pictures to your screen, you need special software for your particular computer that provides this feature.

For IBM PC and compatibles, Macintosh, Amiga and Commodore C64/128 computer users, MFJ offers an optional Starter Pack that will allow you to receive SSTV/FAX in near real time to your computer screen. SSTV/FAX pictures can also be saved on disk with software supplied with the Starter Pack. Pictures saved on disk may be re-transmitted or recalled to print to the screen at any time.

If you are using one of the above terminal program you should first turn **PRINTGRA OFF**. **Follow the instructions given in the software documentation** to receive FAX pictures on the screen or to save the pictures to disk files.

For those who wish to write special software to handle FAX graphics and display it on screen, the following information may be useful for you.

When the **PRINTGRA** command of the MFJ-1278B is ON, FAX pictures received will be sent to the graphics printer attached to the MFJ-1278B printer port. If the **PRINTGRA** command is OFF, then the MFJ-1278B will direct the picture graphics to your terminal thru the RS-232C port of the MFJ-1278B. This FAX format thru the RS-232 port will be in either 2 level (MULTIFAX OFF) or multi-level raw data format (MULTIFAX ON). The default is the 2 level data format. To save to disk or display on your computer screen, the terminal program you used must be compatible with the multi-level raw data format or it must be compatible with the 2 level "FAX frame" format:

LF, CR, ESC x x, ESC x x x, <<nnn character of graphics>>

Two Level FAX Picture Format

The FAX frame sent to the user's terminal contains carriage control information, graphics setup information and "**nnn**" columns of 6-row high dot graphics.

Special note: In order to allow the FAX frames to pass through without special handling, each character in the frame is biased upward with the value \$30 (Hex), so only characters of ASCII value \$30 through \$7F are sent to the terminal.

A few side effects of the special handling:

The number of graphics characters, "nnn", following a FAX frame header, depends on the FAXMODE. See horizontal density under the FAXMODE command for more information.

Multi-level FAX Picture Raw Data Format

In FAX mode the MFJ-1278B can provide data thru the RS-232 port in raw data format. With special terminal software which can support this data format, you can display and save multi-gray levels pictures. The number of gray levels which the raw data format provides thru the RS-232 port is determined by the command **TVBREAK**. Current TVBREAK is set to 16 levels of gray.

To invoke multi-level FAX receiving, under the cmd: prompt, type:

MULTIFAX ON <ENTER>

then, make sure that you are in the FAX mode by typing:

MODE FX <ENTER>

Type **K** to enter **CONVERSE** mode, then type **L** to start receiving raw FAX data. Note that with MULTIFAX turned On, you must type **L** to start receiving data. Unlike the 2 level format which the MFJ-1278B firmware detects the beginning of a FAX picture and also signal the end of the FAX picture, in multi-level FAX the terminal program will establish synchronization and decide when to start and when to finish printing picture to the screen.

Note that when **MULTIFAX** is turned ON, the **PRINTGRA** command will be ignored. This means that in FAX mode and with MULTIFAX turned ON, MFJ-1278B will start to send raw data to the terminal regardless of the setting of **PRINTGRA** command.

For those who wishes to write program to support this multi- level raw data format, the following information will be useful to you:

Upon typing the **L** character, MFJ-1278B will start to send the raw-data stream. Terminal program should look for the distinctive sync pattern at this time to detect the beginning of the picture. Raw-data stream will continue to be sent thru the RS-232 port until the end of picture pattern is detected or a "CTRL-C" is received. Therefore for multi-level FAX the terminal program is responsible for attaining synchronization to begin a picture and to detect the end-of-picture to stop printing.

In 8-gray levels raw multi-level data are packed two pixels- per-byte. To enable ASCII transparency of the raw data, the MFJ-1278B biases each byte with +30H. On transmit, you must likewise bias the outgoing data with 30H.

There are two exceptions. If the actual data byte, before unbiasing, is **p** or **q**, then the 1200

After unbiasing: bit # 7 6 5 4 3 2 1 0
data x x a a a b b b
x = don't care
a,b = first and second pixel groups

Coding: If, prior to unbiasing, the value of the data byte is an ASCII p, q, or r, then the received byte is a sync byte. Otherwise, the received byte contains actual display information as described above. The color level of each pixel contain in the data byte is given below:

000	001	110	111
white	lightest grey	darkest grey	black

NOTE: If the data byte is **NOT** a sync byte, you must remove the 30H bias **BEFORE** extracting the pixel information.

For example, if an ASCII '9' is received, then the following steps should be taken:

1. Remove bias: $39H-30H = 9H$
2. Extract pixel information: $aaa = 001$ $bbb = 001$
3. Display two pixels of lightest grey level.

If an ASCII 'p', 'q', or 'r' is received, then process the byte as a sync tone. Information can be requested on the raw data format for 16 gray level fax from MFJ Enterprises, Inc.

Transmitting FAX

The MFJ-1278B is capable of transmitting 2 level or multi-gray level pictures in the FAX mode. To transmit FAX picture you must use a special terminal program capable of FAX operation.

Two Level FAX Transmitting

In this section we will cover procedures for transmitting 2-level FAX images with the MFJ-1278B. The 2-level FAX images that are transmitted by the MFJ-1278B are stored on disk, in the format required by the MFJ-1278B. You recall the stored FAX images from disk depending on the terminal program being used. You will need to refer to the terminal program instructions to learn how to recall the FAX images from disk. The 2-level FAX mode in the MFJ-1278B requires that the use of a monochrome graphics system, with software that will run on a monochrome graphics system, such as MFJCOM by MFJ Enterprises, Inc. The advanced terminal program, MFJ MultiCom™ does not perform 2-level FAX operations.

Enter the FAX mode by using the MODE command. Type:

MODE FX <ENTER>

The FAX format is changeable by using the FAXMODE command. The MFJ-1278B supports receive or transmit of all FAX formats listed in Table 4-6 in both transmit and receive.

In 2 level FAX, pictures saved under one format may NOT be transmitted under a different format. For instance, you can **NOT** receive and save a FAX picture under FAX format 3, then re-transmit it under FAX format 2 or another FAX format as listed in Table 4-6.

After entering the FAX mode and selecting the desired FAX format to transmit, enter the CONVERSE mode by typing:

K

followed by typing a:

CTRL-T

The MFJ-1278B is now ready to transmit a picture and respond with: "**Send PIX Now**". In FAX transmit mode MFJ-1278B will not key the transmitter until it has been given around 1,500 characters of FAX graphics. User should follow the normal "**File Upload**" procedure given by the terminal program.

In 2 levels FAX, when the MFJ-1278B keys the transmitter it sends (6* (ASPECT+1)) rows of synchronization pulses before starting to transmit the picture.

The MFJ-1278B determines that it is finished transmitting by looking at its input buffer: If the buffer is empty, the transmission is assumed complete, and the MFJ-1278B then sends an **IDLE** signal for approximately 15 to 18 seconds. This signals the end of the transmission.

NOTE: If your computer does not transmit the data to the MFJ-1278B rapidly enough, partial picture transmission will result. Also if your computer does not support flow control, incorrect operation may result.

Multi-level FAX Transmitting

The MFJ-1278B is capable of transmitting up to 16 levels of gray in the FAX mode. To achieve this you must use a terminal program that supports the multi-level data format required by the MFJ-1278B. Each level of gray is represented by a tone produced by the MFJ-1278B modem. The tones that can be produced by the MFJ-1278B FAX/SSTV modem are: 1100, 1200, 1300, 1500, 1550, 1600, 1650, 1700, 1750, 1800, 1850, 1900, 1950, 2000, 2050, 2100, 2150, 2200, and 2250. All frequencies are in **KILOHERTZ (kHz)**.

The tone being transmitted determines the shade of gray in the picture. The higher the tone the lighter the shade of gray. The 1500 Hz tone is for the **sync**, 1550 Hz is **black** and 2250

The command **PIXTONES** is used to set the multi-gray levels FAX and SSTV pictures being transmitted. The current **PIXTONES** is set to 16 gray levels. **PIXTONES** defines the gray levels of the SSTV and FAX transmitted by the MFJ-1278B. To achieve this you must use a terminal program which supports the multi-gray levels SSTV and FAX transmitting, such the advanced MFJ MultiCom™ terminal program for IBM and compatibles.

PIXTONES is defined as 16 values in hexadecimal form. They are defined as follows:

PIXTONES aaa, bbb, ccc,,mmm, ooo, ppp

where,

aaa is the value which determines extreme of the "**white**" area of the transmitted picture.

ppp is the value which determines extreme of the "**black**" area of the transmitted picture.

The values between **aaa** and **ppp** defines the gray areas of the transmitted pictures.

The default **PIXTONES** values are:

\$BF, \$BB, \$BD, \$B9, \$BE, \$BA, \$BC, \$B8, \$B3, \$B5, \$B6, \$B2, \$B0, \$AD, \$9D, \$8E

Note that in 4 or 8 level SSTV or FAX transmission, MFJ-1278B will automatically select only 4 or 8 **PIXTONES** values of which you have chosen respectively. **PIXTONES** does not affect 2 levels FAX transmitting.

If the picture transmitted does not seem to have the right contrast or brightness, try and reset the **PIXTONES** values. The HEX values which represent the **PIXTONES** for the pictures to be transmitted is listed in Table 4-8 below on the next page.

In SSTV and MULTIFAX mode, the MFJ-1278B automatically transmits the sync tone. Therefore, the sync tone does not need to be selected for **PIXTONES** parameters.

PIXTONES Values (HEX)	FAX/SSTV Transmit Tones (Hz)
\$86	1100 (sync)
\$8E	1200 (sync)
\$92	1300 (sync)
\$AC	1500 (sync)
\$9D	1550
\$AD	1600
\$B0	1650
\$B2	1700
\$B6	1750
\$B5	1800
\$B3	1850
\$B8	1900
\$BC	1950
\$BA	2000
\$BE	2050
\$B9	2100
\$BD	2150
\$BB	2200
\$BF	2250

Table 4-8: FAX/SSTV Multi-Gray PIXTONES

Creating FAX Pictures for Transmitting

FAX pictures captured by the MFJ-1278B and saved on disk can be re-transmitted at a later time. However, the FAX pictures must be re-transmitted with the same format with that they were saved.

MFJ Starter Packs for the IBM or compatibles computers can be used in conjunction with other graphics generating programs that support the PCX format to create your own drawings and graphics.

MFJ-1292 "Picture Perfect" Video Digitizer for the IBM and compatible computers allows you to digitize a picture with a Camcorder or video camera. The digitized picture is stored on disk and can be transmitted by the MFJ-1278B.

Contact us or your MFJ dealer for more information concerning the MFJ-1292 Video Digitizer and other graphics generating programs for use with the MFJ-1278B.

SLOW SCAN TELEVISION OPERATION

The MFJ-1278B opens up a whole new world of digital communications, Slow Scan Television or SSTV. The MFJ-1278B lets you receive black and white SSTV pictures with the built-in printer port in 4 levels of gray. However, with additional software for your computer, it can receive and transmit **COLOR** or **B&W** SSTV pictures with up to 16 levels of gray. If you are using a standard terminal program that does not support screen printing of SSTV pictures, you must attach an "EPSON" or "IBM" graphics compatible printer to the MFJ-1278B's parallel printer port in order to allow printing of SSTV pictures.

If you are using the MFJ-1278B's parallel printer port, then SSTV pictures with 4 levels of gray will be supported. Pictures received with more than 4 levels of gray will be printed on the printer with only 4 levels of gray.

The MFJ-1278B will receive through its printer port, all of the SSTV pictures formats listed in Table 4-9. It will receive COLOR and BLACK and WHITE SSTV pictures and print black and white on any "EPSON" or "IBM" graphics compatible printer.

To use the SSTV mode in the MFJ-1278B, a special computer and program are not required. However, if you intend to print pictures to the screen or save to disk, you will need a program that allows this type of operation.

MFJ Enterprises, Inc. offers terminal software for some computers to support screen printing of SSTV pictures. This software allows you to print COLOR and multi-gray level SSTV pictures to the screen and to save SSTV pictures to disk. The SSTV pictures saved on disk can be re-transmitted or recalled to screen at any time for viewing. Screen printing of full COLOR SSTV pictures is not possible on the Commodore C64 and C128 computer. Screen printing of multi-level SSTV pictures is possible on the Commodore C64 and C128 computers, with the below mentioned software.

MFJ terminal program which supports transmit and receive of COLOR and/or multi-gray levels SSTV printing to the computer screen are as follows:

1. MFJ-1289 for IBM PC and compatibles in 5-1/4" disk.
2. MFJ-1289M for IBM PC and compatibles in 3-1/2" disk.
3. MFJ-1287B for Macintosh
4. MFJ-1290 for Amiga
5. MFJ-1282B for C64/128

SSTV Formats

The MFJ-1278B provides a dedicated multi-gray level modem for SSTV operation. The modulator and demodulator frequencies of the MFJ-1278B are pre-set at the factory to allow SSTV operation **without** any recalibration. The MFJ-1278B supports all SSTV formats listed in Table 4-9.

TVMODE(n)	Formats
1	8.5 seconds B&W Robot
2	12 seconds B&W Robot
3	17 seconds B&W Robot
4	24 seconds B&W Robot
5	36 seconds B&W Robot
TVX*	72 seconds Color Robot
TVX*	Color Scotty 1, 2
TVX*	Color Martin 1, 2

Table 4-9: MFJ-1278B SSTV Formats

*These formats require using a special terminal program.

The SSTV format can be changed by using the **TVMODE (n)** command. The **n** is a number from 1 through 5 as listed in the Table 4-9. For example, to set MFJ-1278B to 12 second SSTV format, you would type:

TVMODE 2 <ENTER>

The MFJ-1278B would be set to receive or transmit SSTV in the 12 seconds format. Other SSTV formats can be invoked by tuning the TVX command ON.

SSTV Installation

Installation of the MFJ-1278B for SSTV operation is the same as for the other modes of operation. Installation of MFJ-1278B to your radio is described in Chapter 3 of this instruction manual. You can use either Radio port for SSTV operation.

Printer Connection

If you have a terminal program which supports SSTV picture printing to the computer screen, then you should attach your printer to your computer printer port and not to the MFJ-1278B. In this case turn the **PRINTGRA** command **OFF**. If you intend to receive the SSTV picture and send it to the printer that is attached to the MFJ-1278B parallel port, then you should turn **PRINTGRA** command ON.

Receiving SSTV Pictures

Note that if you are using one of the special terminal programs that supports color or multi-gray levels SSTV operation, you should follow the instructions given in its operating instruction manual to receive and transmit SSTV.

The SSTV operation procedure given in this instruction applies to the receiving of 4-level SSTV pictures with a EPSON graphic printer attached to the MFJ-1278B printer port.

From command mode, the MFJ-1278B can be set to SSTV mode by typing:

MODE TV <ENTER>

Select the desired SSTV formats by using the **TVMODE** command. To select the desired TVMODE type the following from the cmd: prompt:

TVMODE n <ENTER>

where **n** is the TV format 1 through 5 as listed in SSTV Format Table 4-9. For example for 8.5 Second TV format, you will type: TVMODE 1.

The default SSTV mode for MFJ-1278B is **TVMODE 1** (8.5 seconds format).

After tuning to the desired SSTV frequency, observe the **TUNING INDICATOR** of the MFJ-1278B while fine tuning the radio. You will notice that with each scan the tuning indicator will move toward the center. Tune the radio so that the 10th LED segment from left is lit at the end of each SSTV line scan. Once you achieve this, the SSTV signal is tuned in. The DCD LED should light. If DCD LED on the MFJ-1278B is not lit, rotate the **THRESHOLD** control until it is lit.

SSTV Printing to the Printer

At this point you will want to ensure that your printer is properly set. Make sure that your printer is set to "**EPSON GRAPHICS**" or "**IBM GRAPHICS**" mode. This is usually selected by DIP switches on the printer. "**IBM GRAPHICS**" mode is not the same as "**EPSON GRAPHICS**" mode. If you are using an EPSON graphics printer, you should turn the **IBM GRAPHICS** mode off and set your printer to **EPSON GRAPHICS** mode.

Although most commands of the MFJ-1278B that affect SSTV printing are defaulted to allow successful printing, you should check these commands before printing any SSTV picture. You should insure that the commands **EPSON** and **PRINTGRA** are ON. The default values of these commands are ON. SSTV printing to the printer will not function unless these commands are turned on.

Note that **PRINTGRA** should be turned ON only if you are printing pictures through the

After entering the SSTV mode and you have properly selected the correct TV format, type:

K

to leave command mode and enter the CONVERSE mode. Once in CONVERSE mode the MFJ-1278B is in standby-receive mode. This means that the MFJ-1278B is listening to the radio for the synchronization signal at the beginning of each SSTV picture. If the MFJ-1278B hears the synchronization signal well enough, it will establish a lock onto the signal. Once the signal is locked in MFJ-1278B will display a "!" . A "!" indicates that a lock on the signal is established and MFJ-1278B begins to decode the signal. Once decoding is completed, the printer attached to the MFJ-1278B will begin to print the captured SSTV picture.

The MFJ-1278B detects the beginning of each picture before starting to print. This insures each picture will be printed from top to bottom. If you want the printer to start to print in the middle of the picture, you may force printing to begin at any time by typing the letter "L" while in the SSTV standby-receive mode.

If you notice spaces in the printed picture, you should set **GRAPHLF** to OFF. The **GRAPHLF** command determines whether the MFJ-1278B will issue a line feed before the carriage return on each line of graphics. The default for **GRAPHLF** is **OFF**. For most printers **GRAPHLF** should be turned ON.

If the picture printed appears to be distorted in large black areas, you should make sure that the command **TVHSYNC** is set to OFF. The default for **TVHSYNC** is **OFF**. For most SSTV receiving **TVHSYNC** should be turned OFF.

The 4 level SSTV pictures received by the MFJ-1278B thru the built-in parallel printer port can be adjusted for brightness and contrast by using the **TVBREAKS** command. The **TVBREAKS** command controls the brightness and contrast of the SSTV received on the MFJ-1278B printer port as well as when SSTV picture is printed to the screen. SSTV pictures sent to the MFJ-1278B printer port are set at 4 gray-levels. With terminal software which supports multi-gray levels SSTV you can receive SSTV pictures with up to 16 levels of gray.

The MFJ-1278B can be set to operate SSTV both in Color and 16 gray levels by turning the command **16LEVELS** ON and the command **8LEVELS** OFF.

If your terminal program does not support 16 gray levels, the 16Levels command must be turned off and you must follow the instruction given by your terminal program to operate SSTV. If your terminal program does not support SSTV you must follow the instructions given in the main MFJ-1278B manual to operate SSTV thru its built-in printer port.

TVBreaks are arranged in the following format:

White	gray	Black
area	area	area

\$ss, \$aa, \$bb, \$cc, \$dd, \$ee, \$ff, \$gg, \$hh, \$ii, \$jj, \$kk, \$ll, \$mm, \$nn

\$ss is the Sync value.

The default TVBreak value is:

\$80, \$46, \$47, \$48, \$4C, \$4F, \$52, \$54, \$59, \$5C, \$5E, \$60, \$63, \$67, \$69

The **RXBright** command has been updated to support the 16 levels gray. The new RXBright values are as follows:

0TVB\$80,\$46,\$47,\$48,\$4C,\$4F,\$52,\$54,\$59,\$5C,\$5E,\$60,\$63,\$67,\$69
 1TVB\$80,\$48,\$4A,\$4C,\$4E,\$50,\$52,\$54,\$56,\$58,\$5A,\$5C,\$5E,\$60,\$62
 2TVB\$80,\$49,\$4B,\$4D,\$4F,\$51,\$53,\$55,\$57,\$59,\$5B,\$5D,\$5F,\$61,\$63
 3TVB\$80,\$4A,\$4C,\$4E,\$50,\$52,\$54,\$56,\$58,\$5A,\$5C,\$5E,\$60,\$62,\$64
 4TVB\$80,\$4B,\$4D,\$4F,\$51,\$53,\$55,\$57,\$59,\$5B,\$5D,\$5F,\$61,\$63,\$65
 5TVB\$80,\$4C,\$4E,\$50,\$52,\$54,\$56,\$58,\$5A,\$5C,\$5E,\$60,\$62,\$64,\$66
 6TVB\$80,\$4E,\$50,\$52,\$54,\$56,\$58,\$5A,\$5C,\$5E,\$60,\$62,\$64,\$66,\$68
 7TVB\$80,\$4F,\$51,\$53,\$55,\$57,\$59,\$5B,\$5D,\$5F,\$61,\$63,\$65,\$67,\$69
 8TVB\$80,\$50,\$52,\$54,\$56,\$58,\$5A,\$5C,\$5E,\$60,\$62,\$64,\$66,\$68,\$6A
 9TVB\$80,\$51,\$53,\$55,\$57,\$59,\$5B,\$5D,\$5F,\$61,\$63,\$65,\$67,\$69,\$6B

The default RXBright value is 4. Remember that the higher RXBright value (from 1-9) the brighter the received picture will be.

If your terminal program does not support 16 gray levels, remember to set the command **8 Levels** on and **16 Levels** off. The MFJ-1278B will automatically select 8 TVBreak values.

In SSTV transmitting, the **PIXtones** command has been update to 16 levels. The default Pixtones values are as follows:

PIXtones is arranged in the format:

White	gray	Black
area	area	area

\$aa, \$bb, \$cc, \$dd, \$ee, \$ff, \$gg, \$hh, \$ii, \$jj, \$kk, \$ll, \$mm, \$nn, \$ss

The \$aa is the Sync value

Pixtones command serves the same function as the TVBreak command, but in transmitting of SSTV and FAX pictures.

Printing SSTV Pictures to the Screen

The MFJ-1278B does not support printing graphics to the computer screen without specific terminal software designed for your particular computer. MFJ offers an optional Starter Pack (MFJ-1289) which will allow you to receive SSTV and display to the computer screen. The MFJ Starter Pack software allows for saving SSTV pictures to disk. Pictures saved on disk may be re-transmitted or recalled to the screen at any time.

When using a terminal program which allows printing of SSTV pictures to the computer screen, the command **PRINTGRA** must be turned OFF. MFJ-1278B will send pictures to the computer screen through the RS-232 port instead of the built-in printer port.

For those who wish to write their own software to handle SSTV printing to the computer screen, the following information may be useful for you.

When the **PRINTGRA** is turned OFF, **TVX** is ON and MFJ-1278B will send free running raw data thru the RS-232 port. Note that this is not the 4 levels data which is used for printing to the printer port of the MFJ-1278B. Raw data format is provided so that user can use special terminal program to achieve more than the 4 levels of gray provided by the MFJ-1278B firmware. This raw data graphic format is the same for SSTV mode and FAX mode.

Upon hearing the sync tone for SSTV, raw-data stream is sent to the RS-232 port until a "CTRL-C" is received. For multi-level SSTV and FAX modes, the terminal program is responsible for attaining synchronization and end-of-picture detection of pictures.

In 8-gray levels the raw multi-level data are packed two pixels-per-byte. To enable ASCII transparency of the raw data, the MFJ-1278B biases each byte with +30H. On transmit, you must likewise bias the outgoing data with 30H.

There are two exceptions. If the actual data byte (Before unbiasing) is "p", or "q" then the 1200 Hz Syne tone is being received. "p" means it was received in the first time position, "q" the second.

After unbiasing: bit# 7 6 5 4 3 2 1 0
data x x a a a b b b
x = don't care
a,b=first and second pixel groups

Coding: If, prior to unbiasing, the value of the data byte is an ASCII p, q, or r, then the received byte is a sync byte. Otherwise, the received byte contains actual display information as described above. The color level of each pixel contain in the data byte is given below:

000	001	110	111
white	lightest grey	darkest grey	black

NOTE: If the data byte is NOT a sync byte, you must remove the 30H bias BEFORE extracting the pixel information.

For example, if an ASCII '9' is received, then the following steps should be taken:

1. Remove bias: $39H-30H = 9H$
2. Extract pixel information: $aaa = 001$ $bbb = 001$
3. Display two pixels of lightest grey level.

If an ASCII 'p', 'q', or 'r' is received, then process the byte as a sync tone.

Saving SSTV Pictures to Disk

When the **PRINTGRA** command of the MFJ-1278B is ON, SSTV pictures received will be sent to the graphics printer attached to the printer port. If **PRINTGRA** is OFF, the MFJ-1278B will direct the picture graphics, in raw data format, to the user's terminal through the RS-232C port of the MFJ-1278B. If your terminal program allows you to save a file to disk, then you can save the picture on disk and re-transmit it later.

Terminating SSTV Printing

Printing of an SSTV picture can be terminated at any time during the printing. User will type "ESC" then CTRL-C. Printing will stop and the MFJ-1278B will return to command mode.

Transmitting SSTV Pictures

The MFJ-1278B is capable of transmitting color and up to 16 gray level B&W SSTV. To achieve this you must use a terminal program which support the multi-level SSTV data format required by the MFJ-1278B.

Each level of gray is represented by a tone produced by the MFJ-1278B modem. The 19 tones which can be produced by the MFJ-1278B FAX/SSTV modem (in Hz) are:

1100, 1200, 1300, 1500, 1550, 1600, 1650, 1700, 1750, 1800, 1850, 1900, 1950, 2000, 2050, 2100, 2150, 2200, and 2250.

The tone being transmitted determines the shade of gray in the picture. The sync tone of

The **PIXTONES** command defines the gray levels of the SSTV and FAX picture being transmitted by the MFJ-1278B. To transmit an SSTV picture, you must use a terminal program such as MFJ-1289 that supports the multi-gray levels SSTV and FAX transmitting. PIXTONES values for SSTV mode is the same as in the FAX mode. Refer to FAX Operation section in this instruction for pixtones information.

Note that sync tone of 1500 Hz is automatically transmitted when MFJ-1278B enters SSTV transmitting. The Sync tone can not be changed.

The SSTV pictures received by the MFJ-1278B and stored on disk can be retransmitted under the same SSTV format. How a file is recalled and transmitted will depend on the terminal program used. Refer to the instruction manual of your terminal program.

To enter the SSTV transmit mode, first Type:

MODE TV <ENTER>

Select the desired SSTV format with the TVMode command. If you are using a terminal program which supports multi-level SSTV transmitting, you should follow the transmitting procedure given by the program manual.

Note that under multi-level SSTV, selection of TVMode for transmitting is not required.

After entering the SSTV mode, and selecting the desired TV Mode, enter the CONVERSE mode by typing:

K.

Then, switch to transmit mode by typing:

CTRL-T

Terminal program will send raw data stream to the MFJ-1278B thru the RS-232 port. Transmit to receive switching is automatic and occurs when the data stream has been exhausted. Note that TVMODE setting is NOT required for multi-level transmitting. Follow the normal "File Upload" procedure given by the terminal program.

CAUTION: If your terminal program is not fast enough to support a data transfer rate of **480 cps** sustained then you will be unable to transmit multi-level SSTV or multi-level FAX transmitting.

Creating SSTV Pictures for Transmitting

SSTV pictures captured by the MFJ-1278B and saved on disk can be re-transmitted.

MFJ-1292 "Picture Perfect" Video Digitizer for the IBM and compatible computers allows you to digitize a picture with a Camcorder or video camera. The digitized picture is stored to disk and it can be converted to any of the SSTV formats supported by the MFJ-1278B. Converted SSTV picture can be transmitted by the MFJ-1278B.

Contact MFJ Enterprises, Inc. or your MFJ dealer for more information concerning the MFJ-1292 Video Digitizer.

ADVANCED PACKET OPERATION

This chapter describes some other aspects of Packet operation that you will not need to be concerned with for everyday conversational operation. You will want to consult this chapter if you are using your station for special applications such as a Packet Personal Mailbox, Bulletin Board, binary file transfers, Packet picture transfers or running a "host" program. In this chapter also discuss use of the newly developed packet anti-collision feature. HF and OSCAR packet operation is also discuss in detail in this chapter.

We will use the term "computer" to refer to computers or terminals. In the command examples, the MFJ-1278B's prompts and other messages are shown in ordinary type, your responses are shown in **bold face**, and received packets are shown underlined. Commands and other special keywords are shown in upper case; other text entered to the MFJ-1278B is shown in upper and lower case.

SPECIAL CHARACTERS

The MFJ-1278B recognizes a number of special characters for input editing, flow control, and other control functions. You can change any of these special characters to customize the MFJ-1278B to suit your applications, your computer, or your whim. Commands within the MFJ-1278B set these special characters. These special character commands specify the ASCII character code for the desired character. You can disable any special character feature by setting the character value to 0. The user can disable the input editing characters without no serious side-effects. You should use caution in disabling the flow-control or Command Mode entry characters. Also be careful not to set two special characters to the same value.

Various control characters are normally used for special characters. The user would enter control characters by holding down the **CONTROL** key, **CTRL** while typing another character. For example, to enter a **Control-C**, or **<CTRL-C>**, the user would hold down the **CONTROL** key, **CTRL** and press the **C** key at the same time. If your computer does not have a special control key, you will have to consult your computer's documentation to see how to enter these characters. If you will have difficulty entering control characters, you can change the special characters to, for example, seldom used punctuation. The action of each special character is described in detail under the entry in Chapter 6 for the command that sets that character.

You can enter the code for a character in either Hexadecimal (**base 16**) or Decimal notation. The MFJ-1278B displays character codes in Hexidecimal notation. A number in Hexidecimal notation is indicated by beginning a number with a \$ in front of it, such as **\$1B**. Each of the "digits" of a Hexidecimal number represents multiples of the **powers of 16**. The values 10 through 15 are represented by the letters **A** through **F**, which may be upper or lower case. For example, take a look at break down of hexidecimal value \$1B:

So **\$1B** in **hexidecimal** notation is equal to **27** in standard **decimal** notation. Table 5-1 presents a list of ASCII character codes that are available in most computer manuals. A table of ASCII codes for control characters follows:

Dec	Hex	Control	Mnemonic	Dec	Hex	Control	Mnemonic
0	\$00	<CTRL-@>	NUL	16	\$10	<CTRL-P>	DLE
1	\$01	<CTRL-A>	SOH	17	\$11	<CTRL-Q>	DC1
2	\$02	<CTRL-B>	STX	18	\$12	<CTRL-R>	DC2
3	\$03	<CTRL-C>	ETX	19	\$13	<CTRL-S>	DC3
4	\$04	<CTRL-D>	EOT	20	\$14	<CTRL-T>	DC4
5	\$05	<CTRL-E>	ENQ	21	\$15	<CTRL-U>	NAK
6	\$06	<CTRL-F>	ACK	22	\$16	<CTRL-V>	SYN
7	\$07	<CTRL-G>	BEL	23	\$17	<CTRL-W>	ETB
8	\$08	<CTRL-H>	BS	24	\$18	<CTRL-X>	CAN
9	\$09	<CTRL-I>	HT	25	\$19	<CTRL-Y>	EM
10	\$0A	<CTRL-J>	LF	26	\$1A	<CTRL-Z>	SUB
11	\$0B	<CTRL-K>	VT	27	\$1B	<CTRL-[>	ESC
12	\$0C	<CTRL-L>	FF	28	\$1C	<CTRL-\>	FS
13	\$0D	<CTRL-M>	CR	29	\$1D	<CTRL-]>	GS
14	\$0E	<CTRL-N>	SO	30	\$1E	<CTRL-^>	RS
15	\$0F	<CTRL-O>	SI	31	\$1F	<CTRL-_>	US
				127	\$7F	<DELETE>	

Table 5-1. ASCII Codes for Control Characters.

PACKET OPERATING MODES

In Chapter 4 we discussed two of the packet operating modes, **Command Mode** and **Converse Mode**. Packet also can operate in the third mode, **Transparent Mode** which is a data-transfer mode like Converse Mode, but is intended primarily for computer data interchange rather than human conversation. In the following sub-sections we will briefly describe all three of these modes.

Command Mode

Command Mode is used to enter commands that alter the MFJ-1278B's operating parameters. All the other MFJ-1278B operating modes are entered from Command Mode. When the MFJ-1278B is in Command Mode, the Command Mode prompt,

cmd:

is printed at the beginning of each input line. Note, however, that if the MFJ-1278B has

stored in the system EPROM. The bbRAM memory stores most of the parameter values in a permanent, but easily changed form.

The following commands set special characters that are active in Command Mode. Please refer to the discussions of the special character commands in Chapter 6 for details on the operation of the characters in Command Mode. Also see the section on special input characters in Chapter 4.

CANLINE	Cancel current line
CANPAC	Cancel output (Command Mode function only)
DELETE	Character deletion
PASS	Insert following special character
REDISPLA	Re-display current line
START, STOP	User's flow control characters (sent to MFJ-1278B)
XOFF, XON	MFJ-1278B flow control characters (sent to terminal)

The following commands enable display features that are active in Command Mode. Please refer to the discussions of these commands in Chapter 6 for details on the operation of these characters in Command Mode. Also see the section on terminal configuration in Chapter 4.

AUTOLF	Add <LF> after <CR> in data sent to terminal
BKONDEL	Echo after character deletion
ECHO	Automatic echo of serial port input
FLOW	Type-in flow control
LCOK	Lower case translation
NUCR	Nulls after <CR>
NULF	Nulls after <LF>
NULLS	Null count
SCREENLN	Automatic <CR> insertion

Entering Data-Transfer Modes

There are several ways to enter a data-transfer mode from Command Mode. You can type the command **CONVERS** or **K** to enter Converse Mode or the command **TRANS** or **T** to enter Transparent Mode, and the MFJ-1278B will immediately enter the specified mode. If the user is in Command Mode and establishes a Packet connect, then the MFJ-1278B will enter a data transfer mode. You can specify the data-transfer mode for automatic entry with the command **CONMODE**:

cmd: **CONMODE TRANS**

will specify Transparent Mode to the MFJ-1278B when the user establishes a connect, and

The timing of the automatic entry into data-transfer mode depends on whether you or the other station initiated the connection. If you receive a connect request that your MFJ-1278B accepts, then you will enter data-transfer mode, when your MFJ-1278B sends the **connect acknowledgment** (ACK) and displays the message:

***** CONNECTED TO <callsign>**

on your computer monitor screen.

If you initiate the connection with the **CONNECT** command, then you can control the timing of the mode change with the command **NEWMODE**. If **NEWMODE** is **OFF**, the mode will change when the connect ACK is received and the ***** CONNECTED TO: <callsign>** message is displayed on your computer screen. If **NEWMODE** is **ON**, you will enter data-transfer mode immediately, without waiting for a successful connection. Any text sent to the MFJ-1278B at this point will be queued up in packets which will wait for a successful connection before being sent. If the connect attempt fails, you will be returned to Command Mode. You will also be returned automatically to Command Mode when either station disconnects and ends the QSO.

Converse Mode

The data mode used most often for ordinary QSOs is **Converse Mode**. In Converse Mode, the information you type is assembled by the MFJ-1278B into packets and transmitted over the radio. The send-packet character causes the input to be packetized for transmission. If you type a full packet-length of characters without typing the send-packet character, your input will be packetized and transmitted anyway.

The default send-packet character is <CR>, but you can specify any character with the command **SENDPAC**. You may also choose to have the send-packet character transmitted in the packet or not. If the send-packet character is <CR> it is natural to include it in the packet as part of the text as well as interpreting it as a command. This is accomplished by setting **CR ON**. If you use some other character to force packet transmission, you may want to set **CR OFF** and inhibit transmission of the send-packet character. If you set the send-packet character to something other than <CR>, you can cancel packets of more than one line with the cancel-packet character, that is set with the command **CANPAC**. Single-line packets can be canceled with either the cancel-line character or the cancel-packet character.

In order to return to Command Mode from Converse Mode, you must type the Command Mode entry character, or send a BREAK signal over the serial port. A BREAK is not a regular ASCII character, but it can frequently be transmitted by typing a special key on the keyboard.

The following commands set special characters which are active in Converse Mode. Refer to the discussions of these commands for details on the operation of the characters in Converse Mode.

CANLINE	Cancel current line
CANPAC	Cancel current packet
COMMAND	Command Mode entry
DELETE	Character deletion
MFILTER	Characters to be filtered in monitored packets
PASS	Insert following special character
REDISPLA	Re-display current line
SENDPAC	Send current packet
START, STOP	User's flow control characters (sent to MFJ-1278B)
XOFF, XON	MFJ-1278B flow control characters (sent to terminal)

The following commands enable display features which are active in Converse Mode. Refer to the discussions of these commands for details on the operation of these characters in Converse Mode.

8BITCONV	Retain high-order bit from serial port in converse mode
AUTOLF	Add <LF> after <CR>
BKONDEL	Echo after character deletion
ECHO	Automatic echo of serial input
ESCAPE	<ESCAPE> translation
FLOW	Type-in flow control
LCOK	Lower case translation
NUCR	Null characters after <CR>
NULF	Null characters after <LF>
NULLS	Null count
SCREENLN	Automatic <CR> insertion

Transparent Mode

Packet radio is very well suited to the transfer of data between computers. In some cases Converse Mode will work well for computer data transfer. However, files such as a .CMD file on a CP/M system, a BASIC program, or even a word-processor text file, may contain characters that conflict with special characters in Converse Mode. Some of these files may utilize all eight bits of each byte rather than the seven bits required by ASCII codes. If you transfer such files you will have to use Transparent Mode.

Transparent Mode is a data-transfer mode like Converse Mode. In this mode there are no special characters...everything you type and everything your computer sends to the MFJ-

The display characteristics of the MFJ-1278B are also modified in Transparent Mode. Data is sent to the computer exactly as it is received over the radio, including all 8 bits of each byte received. Features such as auto-linefeed insertion and screen wrap are disabled, and echoing of input characters is disabled. The parameters that control these features in Command Mode and Converse Mode are not changed by entering Transparent Mode, and all display features are re-enabled when the MFJ-1278B is returned to Command Mode. Most of the link status messages that appear as the MFJ-1278B moves between disconnected and connected states are also disabled in Transparent Mode.

In order to permit the Command Mode entry character to be transmitted freely in Transparent Mode, the escape to Command Mode from Transparent Mode has been made a little more complicated. You can still return to Command mode by transmitting a BREAK signal, just as in Converse Mode. You can also utilize the Command Mode entry character in the following way.

You must wait for a time period after typing the last character to be sent. This time is set by the command **CMDTIME**. Following this wait, you must type three Command Mode entry characters (default <CTRL-C>) within an interval **CMDTIME** of each other. After a final **CMDTIME** interval in which no characters are typed, you will see the

cmd:

prompt. If any characters are typed during this interval (even Command Mode entry characters) the escape will be aborted and all the Command Mode entry characters that have been typed will be sent as packet data. If you set **CMDTIME** to zero you will not be able to escape from Transparent Mode using this second procedure.

FLOW CONTROL

Whenever data is transferred to computers (home computers or TNCs), there is a chance that the data will be received faster than the computer can handle it. Some programs try to deal with this by providing data buffers for storing incoming data until the program is ready for it. However, this merely postpones the problem, since there is a limited amount of room in any buffer. In order to prevent loss of data the computer must be able to make whatever is sending data stop sending, and later tell it to resume sending. If you are a home computer user, you are probably already familiar with one type of flow control, which allows you to stop the output from the computer while you read it and restart it when you are ready for more.

Data lossThe MFJ-1278B's input buffer may fill up in Command Mode if you try to type too long a command. In Converse Mode the buffer may fill up for any of several reasons: you may be using a faster serial port baud rate than the radio data rate: radio data transmission

A computer file transfer program may be unable to process data fast enough to keep up with output from the MFJ-1278B. In order to be sure of reading every character, a computer must respond to interrupts from its I/O devices. Some simple programs may poll the input register for new data. If the polling is not done often enough, data may be lost. Some computers disable interrupts during disk accesses. If the program enters a routine which will not allow it to check for data or respond to it, it should signal the MFJ-1278B to stop sending data.

There are two methods of providing flow control which are supported by the MFJ-1278B. XON/XOFF flow control, sometimes called "software flow control," is accomplished by sending a special character (usually <CTRL-S>) to request that the output stop and another special character (usually <CTRL-Q>) to restart output. Hardware flow control may be used if both computers use the Clear To Send (CTS) and Data Terminal Ready (DTR) lines of the RS-232C standard. Data is also halted if you press the space bar while in command mode. Press <CR> to resume.

Some commonly used terminal programs and file transfer programs for home computers do not implement flow control in software, and many serial ports do not support hardware flow control. Although the DTR and CTS lines appear at the connector, they may not be used on some computers unless the software reads the state of the CTS line. If you find that the MFJ-1278B seems to lose data during file transfers, you should immediately suspect a flow control problem.

XON/XOFF Flow Control

If you are using a terminal (rather than a computer) or if your computer does not support DTR/CTS flow control, you should use XON/XOFF flow control, which is enabled by setting **XFLOW ON**. The special flow control characters are set to <CTRL-S> and <CTRL-Q> by default, but they may be changed. The commands **XON** and **XOFF** set the characters which will be sent to the terminal by the MFJ-1278B, and the commands **START** and **STOP** set the characters to be sent to the MFJ-1278B by the terminal. Your computer may receive as many as 4 characters from the MFJ-1278B after sending a STOP character, since some characters may already be "in route" through serial I/O chips.

If you send a STOP (START) character to the MFJ-1278B when it is already stopped (started), the character will be ignored. If the STOP and START character are the same character, this character will "toggle" the output, turning it off if it is on, and on if it is off.

You can disable XON/XOFF flow control in one direction only by setting the appropriate flow control characters to 0. If you do this, the MFJ-1278B will automatically use CTS flow control to stop input from the terminal. XON/XOFF flow control is normally disabled in Transparent Mode, since all characters are treated as data. If you cannot use DTR/CTS flow control, you may enable the XON and XOFF characters, the commands from the MFJ-1278B to the terminal being **XFLOW ON** and **XFLOW ON**. The **START** and **STOP**

Hardware Flow Control

Hardware flow control is less likely to depend on the programming of a particular communications program. DTR and CTS are normally used for flow control signals in Transparent Mode. The command **XFLOW OFF** enables hardware flow control in Converse Mode and Command Mode. Your computer may receive as many as 2 characters after it signals the MFJ-1278B to stop sending, since some characters may already be "in route" through serial I/O chips. Refer to Chapter 7, Hardware for details on the interface required for hardware flow control.

Type-in Flow Control

Type-in flow control, enabled with the command **FLOW**, is really a display feature. It can keep the MFJ-1278B from interrupting you with incoming packets when you are in the middle of typing a command line or an outgoing packet. As soon as you type the first character of a line, the MFJ-1278B will put a "hold" on all output (except for echoing your input). The "hold" remains in effect until you type a <CR> to end the command line, or a send-packet character to mark the end of a packet, or until you erase or re-display the line you have started.

Some computers have difficulty simultaneously sending and receiving characters over the serial port. This is most commonly the case for computers with "software UARTs." Type-in flow control will improve the operation of such computers with the MFJ-1278B.

DETAILED VHF PACKET OPERATION

The previous chapter's discussion of "Basic Operation" contains enough information for most packet operation. This section describes a few other aspects of packet operation.

Station Identification

Your station identification (call sign) is set with the command **MYCALL**, as described in the previous chapter. If you will have more than one station on the air operating with the same call sign, they must be distinguished, no two stations can have identical station identifications, or the packet protocol will fail. You can distinguish additional stations by setting the "secondary station ID", or SSID. This is a number from 0 to 15, appended to the call sign with a dash:

cmd: **MYCALL W3IWI-3**

If you do not specify the SSID extension, it will be 0, and the MFJ-1278B will not explicitly show SSIDs that are 0. If you want to connect to a station with a SSID other than 0, or use such a station as a digipeater, you must specify the SSID:

The MFJ-1278B can send an automatic identification packet every 9-1/2 minutes when your station is operating as a digipeater. You can enable this feature with the command **HID ON**. An ID packet is displayed as follows by a monitoring station:

```
W3IWI-3>ID:W3IWI/R
```

You can request a final identification as you take your station off the air with the command **ID**. The MFJ-1278B will only send identification packets if it has been digipeating.

Automatic Operations

Normally, any packet station can be used by other stations for relaying, or digipeating, packets to a more remote destination. If you don't want your station digipeating packets, you can give the command **DIGIPEAT OFF**. Unless there are special circumstances, such as a station operating on emergency power, most packet operators set **DIGIPEAT ON** in the spirit of Amateur cooperation.

Your station will normally accept a connect request from another station if it is not already connected. You can disable this capability by setting **CONOK OFF**. If you receive a connect request when **CONOK** is **OFF**, the MFJ-1278B will display the message

```
*** connect request: <callsign>
```

and send a "busy signal" rejection packet to the other station. If you receive a rejection packet from a station you try to connect to, your MFJ-1278B will display

```
*** <callsign> busy  
*** DISCONNECTED
```

If you want to have a special message sent automatically to stations connecting to you, you can specify the message with the command **CTEXT**. This message can consist of any text string up to 120 characters, and you may include <CR>s by prefixing them with the pass character:

```
cmd:CTEXT Sorry, I can't talk right now.<CTRL-V><CR>  
I'll be on the air again after 8 PM.<CTRL-V><CR>  
Joe
```

In order for this message to be sent to stations connecting to you, you must set **CONOK ON** so that t(e connection takes place (default), and enables the automatic message with **CMSG ON**.

You can have your station periodically send an automatic message by enabling "beacons." A beacon can be used to make general-interest announcements, provide packets for other stations to use to test their ability to receive, or announce the presence of a bulletin-board operation. The beacon message is set with the command **BTEXT**, which works the same way as the **CTEXT** command. You enable beacon transmission and set the frequency at which beacons are sent with the command **BEACON**. To transmit the beacon at 10-second intervals, for example, give the command

cmd: **BEACON EVERY 1**

The beacon function also has a transmit-after mode, enabled by using the keyword **AFTER** in place of **EVERY**, in which a beacon packet is only transmitted after activity is heard on the channel. This feature might be used to leave an announcement for other packet users. If someone transmits on an otherwise idle channel, a beacon can be sent a short time later. No beacons are sent in this mode if there is a lot of packet activity on the channel, since the required period of quiet will not occur.

Unattended Operations

Individuals who want to leave their MFJ-1278B on overnight can monitor packets even with the terminal or computer off. Just type **CTRL-S** then turn the terminal or computer off. The next morning turn the computer on, then type **CTRL-Q**. The MFJ-1278B will dump everything monitored during the night limited only by the amount of available RAM.

The MFJ-1278B can operate unattended for extended periods of time. If you would like to have the MFJ-1278B operate as a digipeater but not connect with a station, be sure to set **DIGIPEAT ON** and **CONOK OFF**. This is probably most useful when setting up a dedicated digipeater in a remote location.

Packet Formatting

The maximum length of a packet is determined by the command **PACLEN**. If you type more than the maximum number of characters without entering a send-packet character, the MFJ-1278B will transmit a maximum-length packet. In Transparent Mode, a packet will be sent if the maximum number of characters is entered before the delay conditions set by **PACTIME** force a packet to be sent. Some MFJ-1278Bs may not be able to accept packets longer than 128 characters.

If you have set the send-packet character to <CR>, you probably want the <CR> to be included in the packet for display at the other end. If you set the send-packet character to a special non-printing character, you probably want the character to be treated as a command only. The command **CR** controls whether the send-packet character is to be echoed and included in the packet.

Commands Affecting Protocol

This section describes some of the commands that affect the operation of the packet protocol. Details of the protocol are given in Chapter 9.

The MFJ-1278B implements AX.25 Level 2 protocol, a set of rules for formatting messages to other TNCs. The version of AX.25 Level 2 protocol used by the MFJ-1278B can be set to Version 2.0 with the command **AX25L2V2 ON**, or to Version 1.0 with the command **AX25L2V2 OFF**. Digipeating may not be successful if some MFJ-1278Bs are running Version 1.0 and some are running Version 2.0. In addition, the command **CHECK** controls a timing function that depends on the protocol version selected.

You can specify the "address" to be used for unconnected packets, as well as intermediate digipeaters with the **UNPROTO** command. The format is similar to that of the **CONNECT** command:

cmd: **UNPROTO QST VIA NK6K**

The default address for unconnected packets is **CQ**.

The following functions may be useful for tracking down protocol problems. They are seldom useful for ordinary packet operations. The **PASSALL** command disables the error-checking function of the packet protocol for monitored packets.

The MFJ-1278B will display any packets if they meet the following conditions, if the **PASSALL** command is **ON**:

1. It must start with a flag sequence; and it must contain an integral number of 8-bit bytes.
2. The **TRACE** command enables the display of the address and control fields of packets, as well as the text. The trace function displays all bytes in hex as well as ASCII equivalents.

Packet Timing Functions

Transmit Timing

Amateur radio equipment varies greatly in the time delays required in switching from receive to transmit and from transmit to receive. If the MFJ-1278B starts sending data before the transmitter is operating or before the receiver has had time to switch from transmitting and lock up on the incoming signal, the packet will not be received properly. The delay between transmitter keyup and the beginning of data transmission is controlled by the command **TXDELAY**. During the time the MFJ-1278B is keying the transmitter but not sending data

1278B will assume is required for the repeater to drop. If the MFJ-1278B has detected channel activity recently enough that the repeater transmitter should still be on, it will wait only the **TXDELAY** time before sending data, rather than adding an **AXDELAY** time as well.

The commands **TXDELAY**, **AXDELAY**, and **AXHANG** all set times in units of 10 ms. If **AXDELAY** is in effect the total keyup delay will be

$$\text{Keyup delay} = (\text{TXDELAY} + \text{AXDELAY}) * 10 \text{ in milliseconds.}$$

If channel activity has been heard more recently than $\text{AXHANG} * 10$ ms ago, the keyup delay will only be

$$\text{Keyup delay} = \text{TXDELAY} * 10 \text{ in milliseconds.}$$

Packet Timing

The AX.25 protocol provides for re-transmitting packets if no acknowledgment is heard from the intended destination station within a certain period of time. A packet might not be acknowledged due to channel noise or "collision" with another packet transmission, and since there may be other stations on the channel, the receiving station may not be able to acknowledge the received packet immediately. The time lapse before the originating station re-transmits the packet is set by the command **FRACK** (frame acknowledge time). The maximum number of re-transmissions before the originating station terminates the connection is set by the command **RETRY**. The maximum number of transmissions of a packet is $\text{RETRY} + 1$, since the initial transmission does not count as a re-transmission. Setting **RETRY** to 0 specifies an infinite number of retries.

The frame-acknowledge time is automatically corrected for the additional time required for digipeating. The time interval before MFJ-1278B re-transmits an unacknowledged packet is:

$$\text{Retry interval} = \text{FRACK} * (2 * n + 1)$$

in seconds, where n is the number of digipeaters in use for this connection.

Acknowledgments of digipeated packets are made from end to end, and digipeaters do not acknowledge the packets they relay. If there are several intermediate relays, the chance of either the original packet or the acknowledgment to be lost increases drastically. To reduce this problem, an automatic wait time can be imposed on any station not transmitting a digipeated packet. Stations waiting for a clear channel to transmit packets wait for this time interval after the channel clears before transmitting. This wait does not apply if the station will be transmitting one or more digipeated packets. This usually gives the digipeater a clear

The wait time is set by the command **DWAIT**, which specifies 40 ms intervals. If no digipeating is being done by anyone in the local area, this parameter can be set to 0, but in any event it should be set to the same value by all members of a local packet group.

In order to avoid unnecessary packet retries, the MFJ-1278B implements a collision-avoidance strategy which applies to all packets except those being digipeated. On the second and subsequent transmissions of a particular packet, the MFJ-1278B waits an additional random time after detecting a clear channel before beginning transmission. This prevents repeated collisions of transmissions by the same two stations. The random time is a multiple (0-15) of the TXDELAY time.

The interval, in milliseconds, between the MFJ-1278B detecting carrier-drop and beginning to transmit is

$$\text{Wait time} = \text{DWAIT} * 10$$

for the first transmission of a packet. For subsequent transmissions of the same packet the interval is

$$\text{Wait time} = \text{DWAIT} * 10 + (r * \text{TXDELAY}) * 10$$

where r is a random number from 0 to 15. Thus, if your MFJ-1278B is forced to re-transmit packets, you will occasionally hear a fairly long delay before transmission begins.

Multiple packets may be transmitted before waiting for an acknowledgment. This permits more efficient channel use when large amounts of data are being transferred. The maximum number of packets which the MFJ-1278B will send before waiting for acknowledgment is specified by the command **MAXFRAME**. This does not mean that the MFJ-1278B will wait until several packets have been entered before transmitting. **MAXFRAME** in combination with the command **PACLEN**, which sets the maximum number of characters in a packet, determines how much information can be sent in a single transmission. The best combination for efficient data transfer is determined partly by the channel quality and partly by the rate at which the terminal can process data. For a 1200 baud terminal data rate, you should start with a combination that produces about 300 characters outstanding at one time.

Radio Baud Rate

The radio data transmission rate is software selectable for 300 baud and 1200 baud. External modem (if installed) can also be selected thru software command.

Note that there is no relationship between terminal baud rate and radio baud rate. In order to communicate with another packet station you must use the same radio baud rates. The length

signals up to 9600 baud, but an external modem is required for operation above 1200 baud. An optional 2400 bps PSK modem board is available from MFJ Enterprises, Inc. This 2400 bps PSK modem board can be installed inside the MFJ-1278B. Radio data rate of 2400/9600 is selectable with software command by the MFJ-1278B. When an external modem is installed and when it is in selected to operate the **TURBO** LED on the front panel of the MFJ-1278B will light. Contact MFJ Enterprises, Inc. for more detail. For installation of an external modem, see **APPENDIX F** in this manual for more details.

Special Protocol Timing

You can set up a connection time-out with the command **CHECK**, which specifies a time in multiples of 10-second intervals. This function prevents the MFJ-1278B from getting stuck in a connection when the other station disappears for longer than the specified time. The MFJ-1278B uses this time somewhat differently depending on the setting of **AX25L2V2**.

The command **RESPTIME** sets a delay between the receipt of a packet and the transmission of the acknowledgment packet. This delay is used to prevent collisions between an acknowledgment and another packet from the sending station. This is primarily necessary during file transfers; otherwise the delay is best set to 0. During file transfers the stations receiving the file should set **RESPTIME** to 10 or 12 (default).

The timing of packet transmission in Transparent Mode is determined by the command **PACTIME**. You can choose the way packet transmission is timed. If you are typing input to a remote computer it is usually best to have packets transmitted at regular intervals. If your computer is operating a remote-host or bulletin board program you should send packets after an interval with no further input from the computer. You can enable the use of **PACTIME** in Converse Mode with the command **CPACTIME**.

Monitor Functions

The MFJ-1278B's protocol is designed for setting up "circuits" between two stations. However it can also operate in a mode more suitable for a "net" or "round-table" discussion with several participants, although reliable reception of all transmissions by every station cannot be guaranteed. This is done by enabling the monitor functions. Most of the monitor functions are described in Chapter 4.

Monitoring is enabled by the command **MONITOR ON**, and separate monitor functions are individually enabled.

If connected packet QSOs are taking place on the frequency of your group conversation, you may wish to ignore all connected packets while your group operates in unconnected mode. The command **MALL OFF** causes the MFJ-1278B to ignore connected packets.

If you want to monitor stations selectively, you can set up a list of up to eight callsigns with the command **LCALLS**. The callsigns in this list are regarded as "buddies," i.e., the only stations you want to listen to if **BUDLIST** is **ON**. Otherwise, the stations in the list will be ignored, and all other stations will be monitored.

You can operate a group conversation with some data integrity by having the stations connect in pairs and setting **MALL ON** and **MCON ON**. This does not insure that every packet is received at every station, but it does insure that a packet involved in a collision will be retried. If you have an odd number of stations participating in this sort of conversation, one station can connect to himself via another station as digipeater.

or example, WB6YMH, WD0ETZ, WA0TTW, W1BEL, and K9NG wish to carry on a group conversation. In order to make all the transmissions as reliable as possible, the following connections are made.

WB6YMH **connects** to W1BEL
WA0TTW **connects** to K9NG
WD0ETZ **connects** to WD0ETZ via W1BEL

If each station specifies **MCON ON** and **MALL ON**, each station will see the packets sent by all the others.

Ordinarily, only text packets are displayed. If you want to see some of the protocol packets, you can set **MCOM ON** and connect, disconnect, disconnect acknowledgments, and DM (connect-request rejection) packets will be displayed. For example,

WB9FLW>N7CL <C>
KV7B>N2WX <D>

indicates connect and disconnect packets. Disconnect acknowledgments are designated <UA>, and DM packets are <DM>.

You can cause the MFJ-1278B to "filter" certain characters from monitored packets with the command **MFILTER**. This allows you to remove, for example, form-feeds, bell characters, or extra <LF>s that may be necessary to the stations involved in a connection, but which may interfere with your display. You can specify up to four characters by giving the ASCII character codes in hex or decimal.

Real-Time Clock and Time Stamping

You can enable the MFJ-1278B's real-time clock by setting the date and time with the command **DAYTIME**. Once you have set the clock, you can request the time by entering

Multiple connection capability is a very powerful addition to the MFJ-1278B. It is very useful for traffic net operation, multi-user bulletin boards, path checking and so forth.

Multiple connection operation is not the same as multi-way operation. With multiple connect, you may establish several point-to-point "links" with various stations. Multi-way, which is not available, would enable multiple stations to be simultaneously interconnected to each other, with each station seeing all data passed from any station in the group, error free.

Multiple connection operation is another step on the road to proper networking, and networking should eventually allow multi-way operation.

Setting the MFJ-1278B to Normal Operation

The MFJ-1278B defaults the multi-connection-related commands to the following parameters:

CONPERM	OFF
STREAMCAll	OFF
STREAMDoubLe	OFF
STREAMSWitch	
USERS	1

This sets up the MFJ-1278B to act just like a "normal" TNC does, that does not support multiple connections. The key to obtaining this traditional operation is to set **USERS 1**.

How do I Invoke Multi-Connect?

If **USERS** is not **1**, you are telling the MFJ-1278B to allow multiple connections to your stations from other stations. In addition, **TRANSPARENT** mode will operate differently, in that incoming data will be prefixed with the current **STREAMSWitch** character and identifier (such as "|A"). Thus, truly transparent operation is not possible with this software release supporting multiple-connections.

The **STREAMSWitch** character, defaulted to "|", should be set to a character you won't normally use. Note that this character may be set to a hex value between \$0 and \$FF. This may allow you to use 8-bit characters (**AWLEN 8**) if your terminal or computer is capable of generating such "characters." This could help prevent confusion in interpreting incoming data from other stations if they happen to send data that includes your selected **STREAMSWitch** character.

Although not fool proof, enabling **STREAMDBL** may also help in sorting out **STREAMSWitch** characters included in the received data from a valid stream switch generated by the MFJ-1278B.

If all this seems a bit confusing, don't worry, it is! The only way to really understand multiple connect operation is to try it! Tested and on-the-air, Once you have gained confidence in "normal" packet operation, try setting **USERS 2** and get a couple of friends to connect to you. Play with the commands (you can't hurt the MFJ-1278B by issuing commands to it!) and see their effects.

Easy-Mail Mailbox

The Easy-Mail mailbox feature is only valid for the HF and VHF packet mode. The operation of the Easy-Mail mailbox is quite simple. There is a command in the MFJ-1278B called **MAILBOX**. Being as the **MAILBOX** command in your MFJ-1278B is already turned ON, makes your Mailbox ready for use, as soon as your MFJ-1278B is powered on. Anyone who operates AX.25 packet can access your mailbox by establishing a connection to your station by using the standard packet **CONNECT** command. Once the connection is made, he can send a message, obtain a list of the messages in your mailbox, read the messages or kill any messages addressed to him.

The Easy-Mail mailbox in the MFJ-1278B provides approximately 32K bytes of memory (in addition to the 32K of system RAM) for message storage. However, you increase the mailbox memory on your MFJ-1278B to 128K or even an enormous 512K by simply replace the mailbox RAM chip on the MFJ-1278B motherboard. This additional memory is also battery back-up by the lithium battery on the MFJ-1278B mother board. Addition memory chip can be purchased separately from MFJ Enterprises, Inc. and it can be easily installed by the user inside the MFJ-1278B. Order MFJ-45B for 128K RAM IC or MFJ-45C for 512K RAM IC. The number of slots and space available for each memory size are as follows:

Memory Size	# of Slots	Bytes Avail.
32K	99	32,000
128K	99 per Bank	128,000
512K	99 per Bank	512,000

Setting Up your Easy-Mail Mailbox

The MFJ Easy-Mail Mailbox can now be operated independently from the standard packet operation. There are certain commands which need to be set. These will be explained later in this instruction.

NOTE: Whenever <CR> is found in this instruction this means to press the **RETURN** key, not to type <CR>.

1. Under the cmd: prompt, type:

MYMCALL n <CR>

where **n** is the callsign you wish to use for your mailbox station identification. The MFJ-1278B will respond with the previous setting of the **MYM**call command, followed by the cmd: prompt on the next line.

2. From the cmd: prompt please type:

USERS 1 <CR>

The MFJ-1278B will respond with the previous setting of the **USERS** command., followed by the cmd: prompt on the next line.

3. If you want your messages time and date stamped, then set **DAYTIME** with the current information. Please refer to Chapter 6 Page 43 in your MFJ-1278B operations manual, as to how to set the **DAYTIME** parameter.

Note: An optional TNC real-time clock (MFJ-43) for the MFJ-1278B is available from MFJ Enterprises. With this real-time clock module installed in your MFJ-1278B, the clock will continue to keep time even with the MFJ-1278B turned off. You will not have to set your MFJ-1278B's "DAYTIME" every time your MFJ-1278B is powered up.

4. To access the mailbox type the following from the cmd: prompt:

MAILBOX ON <CR>

Now your MFJ-1278B is ready for simultaneous Mailbox/Packet operations. You as the **SYSOP** can access your Mailbox by typing:

SYSOP <CR>

Your MFJ-1278B will respond with:

```
[K[MFJ-2.1a-IH$]
Mailbox ready
n free Mailbox (B, E, H(elp), J, K, L, M, R, S, T)>
```

First of all lets find out what the **n free** is for. The **n free** is a "Bytes Free" indicator. This applies only to the Mailbox. This is a great feature, because all users will always know how much space is left in your Mailbox. The Mailbox will update the "Bytes Free" indicator whenever messages are forwarded, added or deleted.

Now you are ready to operate your mailbox. However, lets take first things first. You very well cannot operate the Mailbox without knowing the functions of the commands. So, lets take a look at the functions of the Mailbox commands. The functions are as follows:

- B** Logout: This initiates a disconnect sequence from the Mailbox.
- E** Edit Message Header: This allows editing of the message header. This is necessary for the Forward and Reverse Forward functions of the Mailbox. The current is first displayed, then the Mailbox gets the new values, according to what is entered at the prompts it gives the user. The local and remote SYSOPs may edit any messages in the Mailbox. Remote users may only messages TO and FROM himself, and any message of T'raffic. Below are the edit prompts and an explanation as to what their functions are:

To: The callsign of the person the message is going to goes here. It must be different than MYcall or MYMcall.

@: The callsign of the BBS you wish to Forward the message to is placed here. This BBS should be the one where the person whom you are sending the message to gets his mail.

From: The callsign of the person who originated the message is placed here.

Type: The Type of message you are sending is placed here. This will turn on a flag in the first flag box. There are a few message types, and here are a couple listed below:

1.**"T" messages**These are NTS (**National Traffic System**) type messages. This message system was developed by the ARRL. These messages must be formatted in a certain way. Please refer to the **ARRL Net Directory** for more detailed view and information on this message system.

Flag: The message Flag is now very important. All of flags can be set via the S (send) or E (edit) commands. This flag will either be an N or a Y. This will appear in the flag block closest to To: block in the message header. There are different types of flags are as follows:

N**Messages with this flag set are all able to forwarded, providing all other criteria is met for a message to be forwardable). Only messages with the N flag set, trigger the "You have new mail!" message.

T**The T flag indicates that the message is an NTS message.

Y**Messages with the Y flag set are eligible to be killed by the "K" global kill command.

F**This flag is set when a message is forwarded. Messages which are eligible to forwarded are:

1. Messages where the N flag is set.
2. Messages that have no @ addresses that are different from MYMcall.

P**Messages with this flag set are private to the sender, recipient, and the SYSOP. Only the person to which the message is addressed to can read or kill it. The local or remote SYSOP can read or kill any message in the system.

Here is an example of a Mailbox message with a Type flag and a message flag inserted:

Slot:1 PN To:KB5JNZ From:KF5C BBS Bulletin

The P is in the Type flag block, which indicates that the message is a Private message. The N is in the Message flag block, that tells you that the message has not been read by the callsign KB5JNZ. When KB5JNZ reads the message the N flag will become a Y flag.

H(elp) This command displays the Mailbox command list. A brief description of the commands available to user is given.

J This command replies with the TNC's MHeard list. The eleven most recently heard callsigns will be displayed. The "J" command only applies to remote users.

K Allows you to kill messages which are addressed to you. This works in conjunction with the Y flag. In order to perform a Global Kill, first of all of the messages to be killed during this must have the Y flag set in the header. Secondly, all messages to be killed must have the same callsign as MYMcall.

- K##** Allows you kill the message in slot nn, where nn is a particular slot number. Remote users may only kill messages that are addressed only to them or originated by them. The local and remote SYSOP can kill any messages, depending on the setting of the new command REMsysop. Please refer to the REMsysop for more detailed information.
- L** This command allows the remote user, local or remote SYSOP to list all messages in the mailbox. All of slots which are currently in use will be listed. They all will have the slot number, flag field, the destination callsign, originator callsign, subject field. Also the Mailbox command line will be on the next line.
- M** This allows the remote user, local or remote SYSOP to change memory banks in the mailbox ram. The current memory bank is indicated on the mailbox command line. The bank will be inside a pair of { }, which will be after the "bytes free" indicator. Below is an example of a typical command line from the mailbox:

nn free {n} Mailbox (B,E,H(elp),J,K,L,M,R,S,T) >

Where {n} is the bank number. The bank number will vary from 0 to 7 depending on the size of the expanded memory ram. The bank numbers in relation to the RAM size are as follows:

MEMORY SIZE	NUMBER OF BANKS
32K	0
128K	0 or 1
512K	0 thru 7

NOTE: There will be only one (1) number in the { } at anytime.

For example let's say that you are running a 128K mailbox, and a remote user wants to access memory bank #1. First a connection to your mailbox must be made. Once the Mailbox command line is obtained the user will type:

M 0 <CR>

This will be received by your Mailbox and then your Mailbox will send back a new Mailbox command line:

nn free {0} Mailbox (B, E, H(elp), J, K, L, M, R, S, T)>

Thus the {0} indicates the memory bank has been switched to bank #1.

R This command lets you read messages addressed to you. When you list the messages in the mailbox you notice an N flag next to the messages which you have not read. Once you read those messages the N flag will change to a Y flag. This is an indicator to both you and the SYSOP that the messages have been read. From there you can perform a global kill on all of your messages or the SYSOP can kill them individually.

NOTE: The only way an N flag can get changed to Y flag during a read is that the person who the message is addressed to needs to read it. The flag will not change for any other person who reads the message.

R## Allows you to read the message in slot nn. Where nn is a particular slot number. This command works the same as the R command, except its for reading the individual slots.

S call This allows the remote user, local or remote SYSOP to send a message to the designated callsign. "CALL" must be a callsign valid under the same format as the MYCALL, CONNECT or other callsign commands. You can also send messages in NTS (National Traffic System) format. You will need to refer to the ARRL NET DIRECTORY for more detailed information on the NTS system.

SP call This allows the remote user, local or remote SYSOP to send a personal message to the designated callsign. This is a private message and only the person to whom the message is addressed can read or kill it. The SYSOP can also read the private messages. When a private message is listed a P flag is shown in the "Message Type" flag block. The P flag can also be inserted by the originator or the SYSOP through the Edit command.

T This command allows the remote user to page the SYSOP. When the T command is invoked from the remote user the following message appears on the SYSOP's computer screen and it also is sent back to the remote user's screen:

Paging SYSOP; any key aborts...

The Mailbox will page the SYSOP by ringing the SYSOP's terminal bell 30 times. If the SYSOP is at his or her terminal, the asterisk character will appear on the screen every time the terminal bell (CTRL-G) rings. If the SYSOP does not answer the Mailbox will send the message back to the user saying no answer. Below is an example of a typical screen:

Paging SYSOP; any key aborts...
*****No answer

Mailbox Operation

This section will depict the use of the **Easy Mail™** mailbox from a remote users point of view. We will discuss the different prompts and messages given by Easy Mail™ and what they mean. So without any further delay, lets get started.

1. The remote user must first establish a connection to your Mailbox station.
2. If your Mailbox is ON, then it will answer the remote user back with the Mailbox prompt:

Mailbox Ready

nn free {n} Mailbox (B, E, H(elp), J, K, L, M, R, S, T)>

NOTE: The **nn free** indicates the amount of RAM space available for messages in the Mailbox to which the remote user is connected to. The **nn** will be no higher than 65K, if a 512K or a 128K Mailbox is in operation. If the Mailbox is 32K then **nn** will be 32K.

NOTE: The{**n**} indicates the memory bank being used for the Mailbox. Please refer to the explanation of the M command for the Mailbox, in this section.

Now at this point all of the Mailbox are available to you. The remote user may then type M to switch the memory bank of the Mailbox, K to kill a message, L to list all messages, R to read the messages, S to send a message, B to logout and disconnect from the Mailbox or H for the HELP menu.

3. To send a message the S or the SP commands must be used. It must be used in conjunction with a callsign as in the examples below:

S KB5JNZ <CR>, this will send an ordinary message to the callsign KB5JNZ.

or

SP KB5JNZ <CR>, this will send a private message to the callsign KB5JNZ.

The Mailbox will respond with:

Title:

—

The remote user will enter the message subject or title at cursor prompt, then press the

The Mailbox will respond with:

Send msg; Control-Z or /EX to end:

—

The remote user will then enter the message at the cursor prompt. If you are using a 512K or 128K Mailbox then users can upload disk files into the Mailbox. The 32K version has the same capability, but with 32K RAM capacity. At the end of the message press a Control-Z and the ENTER key. The message will be sent.

The users message will be seen on your mailbox station's screen, then the mailbox will respond with the mailbox command prompt:

nn free {n} Mailbox (B, E, H(elp), J, K, L, M, R, S, T)>

Where **nn** is the "bytes free" indicator. This tells the user how much ram space is available in your Mailbox. Also **{n}** is the indicator of the current memory bank in use by the Mailbox.

4. There are two (2) different ways to kill messages. The first is given in the example below:

A. To kill a message in a particular slot type:

K## <CR>

Where the **##** is the message number you want to kill. The message must be one that is addressed to the remote user. If the message is not addressed to the remote user, then Easy Mail™ will respond with:

Cannot, not yours

If the message is addressed to the remote user, then the Mailbox will respond with:

**Message ## deleted;
nn free {n} Mailbox (B, E, H(elp), J, K, L, M, R, S, T)>**

This is whether or not the message has an N or a Y flag attached to it. Note that the remote users may only kill messages that are addressed them. The originator can also kill the message. The local SYSOP can kill any or all messages in the Mailbox.

- B. You can perform a Global Kill on a group of messages which are under the same callsign. To perform this two (2) conditions must be met:
 - i. All messages must have been read and the message flag must be a Y.
 - ii. The callsign contained in the MYMcall must be the same as the callsign in the MYcall command.

If the above conditions are met then all the user must type:

K <CR>

This will go out to Mailbox, then the messages with the message flags set to Y and all of the proper callsigns will be killed. The Mailbox will respond back to the remote user with all message numbers killed during the Global Kill process. Also the Mailbox prompt will be given again. The "**bytes free**" indicator will be updated also. The SYSOP either remote or local can do a Global Kill. The SYSOP must individually kill any messages.

- 5. The remote user or local SYSOP can List messages from the Mailbox. In order to do this first the Mailbox prompt must be obtained by either a connection to the Mailbox by the remote user or through the local SYSOP command. Then to List messages from the Mailbox:

- A. From the mailbox prompt, type:

L <CR>

The Mailbox will respond with a list of currently used slots in the following format:

Slot:## t m To: From: Subject:

Where **Slot##** column is the number of the slot that the messages are in. The lower case **t** is the **Type Flag** block. The lower case **m** is the **Message Flag** block. The **To:** column will contain the callsign of the person who the message is addressed to. The **From:** column will contain the callsign of the person who left the message. The **Subject:** column will contain a brief message title.

Note that the number of slots for an MFJ-1278B without memory expansion board is 30. For an MFJ-1278B with the memory expansion installed the maximum slots per memory bank is 99.

After the Mailbox lists all messages it will issue the Mailbox prompt:

6. Anyone who accesses the Mailbox can read messages or that are addressed to him/her. Also a message that is addressed to ALL, such as bulletins can be read by anyone. Messages can be read by two (2) different methods. Below are the two methods:

A. This method will allow the remote user, local or remote SYSOP to read a group of messages. This is only good for a group of messages with the same callsign as MYcall. The set conditions of the Type or message flags have an effect on a read process. They can be set to an N, Y or an F. To perform this type:

R <CR>

B. Messages can also be read individually by the slot number. This is good for reading other messages like bulletins or messages addressed to ALL. In order do an individual read type:

R## <CR>

Where ## is the slot number of the message that you wish to read.

C. The Mailbox will respond with the message from the slot specified.

All messages read will be in the following format:

Slot## t m **To:** **From:** **Subject:**
This is an example of a message from the Mailbox

Where **Slot##** column is the number of the slot that the messages are in. The lower case **t** is the **Type Flag** block. The lower case **m** is the **Message Flag** block. The **To:** column will contain the callsign of the person who the message is addressed to. The **From:** column will contain the callsign of the person who left the message. The **Subject:** column will contain a brief message title. Then at the end of the message the Mailbox prompt will be issued.

7. The remote user can also disconnect from the Mailbox without having to issue a CTRL-C, D and a RETURN. All that needs to be done is to type: **B** to logout of the Mailbox and disconnect from the it. If you access your Mailbox via the SYsop command, then you must issue a CTRL-C to exit the Mailbox and return to command mode. The command prompt will indicate the stream you are on. The command prompt may look like this:

|**Acmd:** where |A indicates that you are on packet stream A.

This is the only way the remote users can access your Mailbox. If you stay in the **SYSop** mode, then when a user tries to connect to your Mailbox he will a message like this:

*****CALLSIGN Busy
Disconnected**

The **SYSOP** will receive a message like the example below when he is in the **SYSOP** mode and someone tries a connect:

*****connect request:CALLSIGN**

Additional Mailbox Features

Other MFJ-1278B mailbox features are as follows:

Forwarding:

The MFJ-1278B Mailbox now has the ability to Forward mail to most full service and personal mailboxes. This feature allows you to compose your mail on your TNC, at your leisure, and then Forward the resulting messages for eventual delivery.

Messages may be forwarded any one of three ways either manually, by command, or by automatic forward. You can either forward messages hourly, or by your local full-service mailbox's reverse forward request.

Manual and hourly forwards may proceed through up to eight (8) digipeaters, allowing the messages to be forwarded through **ROSE** switches. Also **NODE** forwarding is can be done too, thus allowing you to forward mail through **NETROM**, **THENET**, and **KA-NODE** switches. Please refer to the **NODEforw** command in this manual.

In order to conserve RAM, space the **SYSOP** may specify that forwarded messages be killed upon successful forwarding. However, if conserving RAM is not a concern, then forwarded messages will be flagged "F". This flag will appear in the message flag block. Messages with F flags will be saved in the mailbox for the **SYSOP**'s disposition.

All forwarding events are monitored on the screen, in order to inform the **SYSOP** of the forwarding progress.

In order for a message to be eligible for the forwarding process two (2) conditions must be met:

1. Messages must have N flags in the message flag block.

The command used to forward a message is **FO**. All forwards must be done in the stream cmd:mode. This command is by pressing a CTRL-C while in the SYSOP mode. Below is a typical example as to how to use the FO command:

FO CALLSIGN <CR>

Where CALLSIGN is the callsign of the destination mailbox. This callsign must also reside in header of the message to be forwarded. The message header can be altered through the Mailbox Edit command. Please refer to the EDIT command in this manual. When the FO CALLSIGN is issued the MFJ-1278B will initiate a connect request to the destination BBS. If the connection is successful the your mailbox will proceed to send the message to the destination BBS.

Eliciting Reverse Forwards:

This very unique feature, when combined with the hourly automatic forward, enables the MFJ mailbox to query another BBS, regularly and automatically, for the purpose of polling the other BBS for the TNC user's mail. Thus, even if your local full-service BBS operator is unwilling to forward to you, you can still have most of the benefits of auto-forwarding because your own TNC will elicit your mail for you on an hourly basis.

Reverse forwards may be restricted to a particular callsign. This prevents others users from "stripping" messages off of the mailbox prior to their being forwarded to the legitimate destination.

When all messages are forwarded, if the destination mailbox supports reverse forwarding (as determined by \$ in it's SID) then the MFJ-1278B will attempt to elicit a reverse forward.

Remote Heard Log:

This handy feature allows the remote user to query the TNC heard log at any time. From this log the remote can determine band conditions, or just see who has been around. The log holds eleven (11) of the most recently stations.

Chat Mode:

The Chat mode feature in the MFJ-1278B Mailbox is similar to the standard TNC "converse mode". It enables the SYSOP to break onto a mailbox link, and get one-on-one with mailbox user. This is just like a regular "Packet QSO". This is good for discussing problems maybe with the link or with the mailbox in general. Chat mode terminates any user or forwarding operation in progress. The mailbox will stay in Chat mode until the SYSOP returns to command mode.

Page SYSOP:

The Mailbox has the capability to be remotely controlled. A callsign can be specified by the SYSOP for this purpose. This would be useful in the case where the SYSOP is out in the field. It would allow him to control the mailbox, and do most of the local SYSOP's duties, such as killing messages, reading, editing message headers for forwarding purposes.

Mailbox CText:

This is a message dedicated to the Mailbox, but is used when a connect is made to the MYMcall callsign. It is limited to 120 characters in length. If **MCText** is empty, then no message will be sent.

Idle Timeout:

The Mailbox incorporates an idle timeout function. This is to ensure that the mailbox is still accessible in the event of a remote user drop out during a connection or walks away from the TNC for too long. The Mailbox will automatically do a disconnect from the link after the time which the SYSOP specifies.

Abort:

This command gives the SYSOP control over the mailbox by allowing him to force a disconnect on the mailbox link. It may also be used to avoid any QRM, to abort a forward-in-progress. You can also use it to terminate mailbox usage by an unwelcome user.

The new Mailbox system is fully compatible with NTS packet messages also. It allows you to format NTS type messages, and send them to another destination.

The MFJ-1278B also incorporates a new "**bytes free**" counter. It is updated as the mailbox fills or empties. It keeps up with the available RAM in multiple memory banks.

Mail waiting is indicated by the flashing of the **STA/MAIL** LED on the front panel of the MFJ-1278B. The **STA/MAIL** LED of the MFJ-1278B serves two functions. It lights when unacknowledged packets are pending during a packet connection. If the **MAILBOX** is **ON** and you have mail waiting, the **STA/MAIL** LED will flash on and off if the MFJ-1278B is not connected to another packet station.

The "mail-waiting" LED function can be disabled by using the **MAILED** command. **MAILED** is defaulted to **ON**. When **MAILED** is **OFF** or when MFJ-1278B is in a connected state, **STA/MAIL** LED will not flash.

Mailbox Messages**You have mail!**

Upon access to the mailbox, this message will appear if there are messages addressed to you.

You have new mail!

This is basically the same as the You have mail! message, but this indicates that new mail has been added to the mailbox since the last time it was accessed.

?EH

This message occurs when a command issued to the Easy Mail mailbox is not understood. This could be an out of range slot number, missing slot number where one is required, or bad command.

Cannot, not yours

This message occurs when a remote user attempts to kill or read a message that is not his, or he tries to read personal message by or for someone else.

?Mailbox full

This message occurs when either all of the available slots are full, or the actual message space is full. Messages must be killed to recover from this error.

Not found

This message occurs when one attempts to read or kill a non-existent message from an empty slot.

None found

A parameterless Kill or Read command did not find any messages addressed to the user.

No mail

A parameterless read command did not find any mail addressed to user or due to mailbox being empty.

Slotting and Acknowledgment Priority

The addition of the **SLOTTING AND ACKNOWLEDGMENT PRIORITY** feature makes the MFJ-1278B more efficient on packet frequency channels. The MFJ-1278B achieves this greater efficiency by preventing or minimizing packet collisions on busy packet channels.

Use of the optional **SLOTTING and ACKNOWLEDGMENT PRIORITY** routine now in the MFJ-1278B firmware significantly improves the reliability of packet radio connections on shared channels. The greatest improvement is yielded when all stations in a network are so equipped and configured with the appropriate, matching parameters.

SLOTTING improves channel efficiency by requiring each TNC to "flip" a many sided die whenever the channel goes from busy to not-busy. The result of the "flip" is the number of 10ms DEADTIME intervals the TNC waits before transmitting.

SLOTTING solves most of the problems that occur when there are two or more stations waiting to transmit when a third is already transmitting. Before slotting, the first two stations are definitely going to transmit at the same time, guaranteeing a collision. With slotting, the first station will probably choose a "slot" different from the second. If everyone is hearing everyone else, collisions are very unlikely.

In conjunction with slotting, the **ACKNOWLEDGMENT PRIORITY** feature helps improve channel utilization by assigning priority to acknowledgments (AX.25 frame types "S"), i.e. acknowledgments are never delayed by slotting.

The reason this works is because each TNC recognizes when another is transmitting. It also recognizes the destination of each packet it hears. If a TNC hears a packet not addressed to it, it can assume that somewhere another TNC will send an acknowledgment. Therefore, on hearing packets for others, a TNC will always wait at least one slot time in case the addressed TNC acknowledges. And it will never delay it's own acknowledgments.

Description

The idea behind the prioritized acknowledgment (ACK) protocol is quite simple. The idea is to give ACKs priority access to the channel so that time is not wasted retrying packets that have already been correctly copied but for whatever reason, the ACK is not received within the time limit defined by the FRACK timer.

The present protocol does not handle a simplex LAN with hidden terminals as well as it possibly could. This is primarily because, the present protocol is more likely to synchronize collisions with acknowledgment packets than with any other type of packet.

To this collision synchronization mechanism the current version of AX.25 adds a propensity

Once the FRACK timer times out, even if the ACK finally makes it through before the MFJ-1278B sends the retry, the MFJ-1278B sends the original packet anyway. This obviously wastes much time that could be better used clearing the channel of some of the legitimate offered load.

It is this feature of the current AX.25 protocol that accounts for most of the abysmally poor performance of the currently popular NETROM and THENET nodes when are used as omnidirectional single channel (or even multi-channel if there is more than a single other node on each channel) systems. It should be noted that these node chips CAN handle point to point links to a single other node perfectly adequately.

The prioritized ACK protocol avoids the above problems by giving ACKs priority access to the channel. It does this in such a way that even ACKs coming from hidden terminals are protected from collision.

The current protocol gives a limited version of this priority access only to digipeated frames. Although it will be possible to support digipeating in a compatible (with the new protocol) fashion, compatible digipeating support was not an objective that was addressed in this release.

Ack prioritization works with slotted channel access in the following way:

1. Response frames (ACKs) are always sent immediately with no time delays unrelated to hardware limitations applied. Ultimately, not even DCD will be checked for sending an ACK. However, in this release DCD will still hold an ACK off the channel.
2. Stations queued up to access the channel but waiting for a channel busy condition (DCD true) to clear, will start a slotted access procedure only AFTER enough time for a response frame to clear the channel has transpired (whether or not the response frame is detectable by the queued up station).
3. Slot time windows are selected to be large enough that the local TNC will be able to unambiguously determine whether any other detectable station has selected any slot, preceding the slot selected by the local TNC.

This is to prevent two TNCs which have selected adjacent slots from colliding.

As you can see, under this protocol there will never be a condition where an ACK is delayed from being sent beyond the FRACK timer limitation. In fact, the FRACK timer becomes relatively meaningless in this context. However, in the current firmware release, The FRACK timer is still active and must be set to a value that is long enough to allow time for `PACLEN + ACKWAIT` to expire before `FRACK` does. This time will depend on the radio

Enforcing a channel access delay for all stations on the channel for whom the packet that caused the queue was not intended (& who therefore aren't going to ACK it) allows even ACKs from hidden terminals to get back to the expecting station. This clears that traffic from the offered load list. If the packet was indeed copied and ACKed, further retrys of the same information will not be necessary.

New Parameters

There are several new parameters that relate to this modification of the protocol. They are as follows:

ACKPRIOR ON|OFF

This enables prioritized acknowledgments if turned on.

If **ACKprior** is turned off and **SLots** (see below) is set to 0, this modification of the AX.25 protocol is effectively disabled. The MFJ-1278B will behave like normal AX.25 protocol.

Being independent of each other, the enabling and disabling of slotted channel access and Prioritized acknowledgments are the same. So you could if you wished run normal AX.25 with slotted channel access or the new protocol without slotted channel access.

DEADTIME 0 - 250 (each increment represents 10 milliseconds)

This is the time between when a remote TNC has pressed PTT and when the local TNC can reasonably be expected to detect this fact.

This must be set to a value that accounts for the slowest acceptable station on the channel. It includes the time required for the remote station's radio to come on the air properly after assertion of PTT (**TXDelay**) and the time required for the local station's squelch (if used) and TNC DCD circuits to allow generation of a "DCD true" signal in the local TNC. Ideally, once the proper value for this timer is ascertained, all stations on the channel will use the same value.

Very preliminary testing done here on VHF indicates that measurements of the above delay times should be multiplied by 1.5 for use as the **DEAdtime** parameter. We had carefully measured the times for all stations participating in our tests. This gave us a worst case delay total of 210 milliseconds. When we ran the test, we were still getting about a 5 percent collision rate on the acknowledgments. We were required to increase the **DEAdtime** parameter to 30 (300 milliseconds) to completely eliminate collisions with ACKs.

The amount of delay for a station to detect a packet is about 20 milliseconds. This amount of

Some HTs and every Azden PCS-2000s that I have ever seen are incapable of operating in a LAN which is using a 300 millisecond setting for this parameter.

Most HF linear mode radios are MUCH faster than VHF FM radio. A reasonable setting for HF work is 120 milliseconds (DEAdtime set to 12). This should work fine with virtually any HF radio stable enough to consider using on HF packet.

ACKTIME 0 - 250 (also 10 millisecond increments)

This represents the time required to send a response frame (with no I field appended) at the baud rate being used on the radio port.

The current 100 millisecond default is close but should be adjusted for 1200 baud work to 130 milliseconds (ACKTime set to 13).

For 300 baud HF work this parameter should be set to 520 milliseconds (ACKTime set to 52).

SLOTS n $0 \leq n \leq 127$

This parameter determines how many sides are on the slot time dice. SLOTS represents an n+1 sided dice the MFJ-1278B "throws" before transmitting. The SLOTS command allows any number of slots from 1 thru 127 to be defined.

SLOTS (n)	REMARKS
1	Disables Slotting
2	
4	This should be the default setting
8	Use only if the channel is VERY busy.
16	VERY VERY VERY busy!
32	You get the idea.
64	
128	Might as well print it out & send it in the mail.

The value used on a particular channel should be agreed on by the channel users. Access to the channel will be equitably distributed among all users if everybody is using the same value for the SLOtmask and DEAdtime parameters.

The idea is to pick a value large enough that the probability of two queued up stations picking

The actual value used will depend on the average number of queued up stations there are on the channel during busy periods.

ACKWAIT (not directly user settable)

This timer actually consists of the sum of the 2 user settable parameters ACKTime and DEAdtime. It represents the time the queued up TNC will wait before transmitting if it has selected slot 0. This allows time for a completely inaudible (to this TNC) ACK to have been sent on the channel without molestation. It was split into two timers because it has two unrelated components. One is related only to the baud rate being used on the channel. The other is related only to the absolute times the hardware requires to transport carrier information from one station to another on the channel.

Other Related Parameters

Several of the existing TNC parameters will affect the operation of the modified protocol. Most of these are parameters in TNCs on the channel which AREN'T using the new channel access procedure. One, FRACK, must be set correctly in any TNC which IS using prioritized ACK protocol.

FRACK should be set to a value which allows time for the TNC to send its packet AND receive the ACK. This value will depend on the settings being used for PAClen and the radio port baud rate. This is because, for some reason which I can't even begin to understand, the FRACK timer starts at the BEGINNING of the packet rather than at the end. For this reason, it is probably best to set FRACK to its worst case value for whatever baud rate you are using on the radio port. This way you can make adjustments to PAClen without having to worry about interaction with the setting of FRACK.

The FRACK settings that should be used (at least initially for BETA testing) are as follows:

BAUD RATE	FRACK (SECONDS)
1200	3
300	8

Note that these settings apply when everyone on the channel is running the new protocol. This assumes that all stations on the channel have both DWait and RESptime set to 0.

If you are running the new protocol on a channel where some of the stations have long RESptime delays, those stations will not be able to successfully communicate with you after connecting. If you wish to communicate with these stations you will have to set your FRACK timer to a number which is longer than the other stations RESptime delay.

Initial Parameter Settings Summary

The settings for use at 1200 baud on a VHF FM channel are:

ACKprior	ON
SLots	3
DEAdtime	33
ACKTime	13
RESptime	0

If you require a nonzero value for this parameter in order to prevent ACKing individual packets in a MAXframe greater than 1 blast, your DCD circuit is not working. Please get it fixed.

DWait	0
--------------	---

DWait should be set to 0 even if there are digipeaters on the channel. The new system will not degrade the performance of digipeaters on the channel because the ACKWAIT can be used by the DIGI.)

MAXframe	1 - 7 depending on channel quality
FRACK	3

The settings to use for 300 baud work on a linear mode HF channel are:

ACKprior	ON
SLots	3
DEAdtime	12
ACKTime	52
DWait	0
RESptime	0
MAXframe	1
FRACK	8

What to Expect

This modification to the protocol is compatible with stations using the current protocol in the following respect. A station using the new protocol will not degrade the channel for users of the current protocol. So there is nothing wrong with firing up the new stuff on a channel where the majority of the users aren't yet using it. You will be able to communicate with users of the other system without difficulties.

However, if the users of the old channel access procedures have DWait and RESptime set to 0, they will tend to hog the channel from users of the newer, more polite access system.

While these settings seem extremely long, they will assure that the stations NOT using the new protocol always get a shot at slot #1. With these settings, the users of the NEW protocol will occasionally capture the channel.

Settings of 43 for 1200 baud and 64 for 300 baud could be used to assure that stations NOT using the new protocol always have a shot at slot #0. This will result in users of the new protocol almost never being able to capture the channel unless all traffic from users of the old protocol has been cleared. This should NOT be done unless ALL stations are using some type of slotted channel access procedure with compatible numbers of slots and compatible slot times.

Remember that the objective of the new channel access procedures is to increase aggregate throughput for the CHANNEL, not necessarily for an individual user (not even you!). It may seem to you at first when you get on a very busy channel where you are the only station that is using the new system, that you aren't getting to transmit very frequently. This is because you aren't getting to transmit very frequently. However, the OTHER users on the channel will see an incremental increase in the overall amount of data that the channel can pass per unit time because you are being such a nice guy. Remember that transmitting isn't necessarily communicating.

There is ONE benefit that you should be able to see even under the above circumstances. If you are communicating with another station who is also running the new system, the channel should appear more reliable to you even if quite slow. You should not be getting retried out waiting for his ACK to come back & have to keep reconnecting.

As a higher and higher percentage of the users on the channel begin using the new system, the performance of the channel should increase quite a bit. However, we all must remember that if a channel is mathematically capable of transferring (for example) 1000 characters per unit time, the very best it can possibly do (if CSMA is working right) is reliably pass about 620 characters per unit time. If it is offered more than this to handle, performance falls off sharply with increased offered load. Currently the typical AX.25 simplex channels observed on the HAM bands tend to hover around 10 to as high as 18 percent throughput. This is far below the 62 percent that is possible when the protocol is working right.

Packet Picture Transfer

The MFJ-1278B gives you the unique ability to transmit and receive Packet Pictures. Unlike the binary file transfer ability common to all packet controllers that lets you transmit and receive picture files, MFJ-1278B lets you transmit and receive actual packet pictures directly. You can also transmit and receive FAX, SSTV and other graphics formats pictures with the MFJ-1278B in the VHF packet mode. Packet pictures received are directed to and printed on the built-in printer port on the MFJ-1278B. Any EPSON™ or IBM™ graphics compatible printer may be used. Packet pictures can also be sent to the computer screen if special software, such as the MFJ-1284, is used.

Printing Packet Pictures thru Built-in Printer Port

This routine is for users who do not have a special terminal program like, MFJ MultiCom™ to receive high resolution Packet Pictures. Packet picture data transmitted from the connecting packet station is received and data is sent directly to the printer attached to the MFJ-1278B, without any intervening modification. Therefore, all data **MUST** use the same printer control codes that your printer uses. Typically **EPSON** format codes will be used.

The **PKTPIX** command provides a method for the MFJ-1278B to print packet pictures other graphics-format data transmitted by another station in the VHF packet mode. When you set **PKTPIX**, your MFJ-1278B becomes ready to print graphics data.

Using PKTPIX

Packet picture printing to the MFJ-1278B printer port requires you to first establish a packet connection with the station who is going to send the picture. Note that you won't be able to call up PKTPIX until the connection is made. You must have the printer powered and selected before MFJ-1278B will let you use the **PKTPIX** command.

Once these conditions are met, all data received over the packet link are sent directly to the printer. You can exit **PKTPIX** by using the escape-to-cmd: mode sequence for **TRANSPARENT** connections. Press CTRL-C three times within one CMDTIME increment (default), or asynchronous **BREAK**.

Packet Picture transfer to the computer screen

Packet pictures can also be received and displayed on the computer screen in real time. To achieve this a special terminal program must be used. The MFJ Starter Pack for IBM and compatible computer includes terminal program, MultiCom™ that allows you to transmit and receive SVGA, VGA, EGA or CGA pictures in real time and display them on the screen. Multicom can transfer binary files in addition to picture files. It also allow you to set up your personal packet pictures bulletin board. Graphics that you create with certain "paint" software, such as QSL cards, drawings and pictures can be saved and transmitted to the connecting packet station with Multicom. Also, pictures created with digitizers, such as the

DETAILED HF PACKET OPERATION

Here we will go into further detail on the HF Packet mode of operation. We will discuss modem center frequency, HF tuning indicator, etc. So without any further delay lets get into HF Packet operation.

Radio Setup for HF Packet Operation

Setting up your Radio interface will follow exactly the same procedure as for VHF NBFM operation with the exception that you will probably not need to set the modem output level. This is because linear mode radios typically have a transmit audio level control on the front panel and an indicator that tells you when you have set the level correctly. You will adjust the audio level just as you would for SSB operation.

If you are using an auxiliary audio input connector, such as an accessory port, you **MAY** need to adjust the transmit audio level from the MFJ-1278B modulator. This is because many auxiliary audio inputs are intended for phone patch audio. These levels are typically much higher than microphone levels. If you do adjust the output level of the MFJ-1278B to a relatively high value for this type of application, do not operate the MFJ-1278B with a VHF NBFM radio unless you take steps to assure that the audio level for the FM radio will not produce excessive deviation. If both radios are to remain connected to the MFJ-1278B, you can set the audio level for each radio independently by using the audio output level adjustments, R157 & R158, on the left side of the MFJ-1278B with a small screw driver.

The modem center frequency used by the MFJ-1278B for all of the narrow shift AFSK modes including HF packet operation is 2210 Hz (2125 and 2295 Hz tones). Most frequencies listed for packet operations in the HF bands were established using a modem center frequency of 1700 Hz (1600 and 1800 Hz tones) in lower sideband mode. This is a 520 Hz offset (2220-1700) between the two modem standards. So a listed frequency of 7093, for example, will cause you to have a frequency display on your radio of 520 Hz PLUS the listed frequency (IF you are also using lower sideband mode). Thus you should find the 7093 KHz packet activity centered around 7093.52 KHz.

Your tuning indicator, when properly centered, is easily capable of 10 Hz alignment accuracy per segment. It should be used as the tuning reference on any individual signal regardless of the frequency indicated on the radio dial.

NOTE: The signal actually transmitted by your SSB transceiver (F(emission)) when using the MFJ-1278B for AFSK HF packet operation using lower sideband will cover a band of frequencies approximately 400 Hz wide and centered at the transmitter indicated carrier frequency (F(ind)) minus the modem center frequency (Fc).

So you would use:

NOTE: Regardless of the type of modem, whether or not the modem has audio filtering built in, 300 baud AFSK modem performance on a High Frequency linear mode (SSB as opposed to NBFM) radio channel will NOT be optimum UNLESS a filter of approximately 500 Hz bandwidth is used in the radio IF strip.

There are two reasons why this is the case. First, for the filtering to be fully effective, it has to precede the first hard limiter in the system. This limiter is typically located in the first stage of the demodulator. Second, no filter at audio can prevent an off channel interfering signal from capturing the receiver AGC system and causing wide variation in the level of the audio presented to the demodulator. All demodulators are affected by audio level variations.

If the user uses a narrow filter, say approximately 500 Hz. in the radio for HF Packet and RTTY operations, then it may be necessary to use a tone pair centered on the radio's filter, rather than the "standard" 2125/2295 or 1600/1800Hz. pairs. It is **STRONGLY RECOMMENDED** that a narrow filter be used for HF Packet and RTTY operations. If the radio lacks IF shift capability, this will almost certainly be necessary. If this is the case, it will be necessary to determine the center frequency of the audio spectrum output from the receiver when the narrow filter is selected and the radio is in the LSB mode.

Most radios that provide for direct FSK RTTY operation use the radio's narrow CW filter if installed. The Kenwood TS-820 is one example. Packet operation using direct FSK is a viable mode but extreme caution should be exercised to make sure TX and RX frequencies are identical and that the transmitted frequency pair is centered in the radio's 500 Hz filter passband. Once the user determines the center frequency for the particular radio's FSK mode, the user should use modem alignment procedure presented in the troubleshooting/calibration section of the owners manual. Since there is no standardization among the various radio manufacturers in this regard, a method for making the determination of transmitter FSK output frequencies and their relation to the LSB carrier oscillator and center of the 500 Hz filter is NOT presented here. Contact the manufacturer of the radio to obtain this information.

Radios that have provision for an auxiliary "narrow SSB" filter can have the 500 Hz bandwidth filter installed instead of the approximately 1.8 KHz wide "narrow" SSB filter. This will allow direct selection of the narrow filter for AFSK work when in SSB mode. If the filter is also desired for CW operation and you don't want to invest in 2 identical filters, it is usually a relatively simple modification to cause the radio to also select this filter when in CW mode. In the TS-430, for example, this requires moving one end of one diode on the IF board. The 270 Hz filter can then be installed in the "normal" narrow CW filter position making two bandwidths of narrow filter available for CW operation with all filters selectable from the front panel.

Some of the newer HF radios (and many older ones) allow selection of filter independent of

If the HF radio is to be dedicated to packet use, the 500 Hz filter can be installed in place of the SSB filter. This is possible on ANY radio designed for SSB and CW use.

It is important to use lower sideband rather than upper sideband if you are going to use a CW filter in the radio for packet operations. The reason for this is simple. The filter designed for CW operation is usually centered approximately 800 Hz. away from the upper sideband suppressed carrier. This is the carrier oscillator which is normally used as the BFO on CW. This means that if the two carrier oscillators are 3 KHz apart, the CW filter center will be near 2200 Hz below the lower sideband carrier. This is the reason 2220 Hz was selected for the center frequency of the modem.

If you are going to use a narrow filter, and serious HF operation is NOT recommended without one, it will be necessary to take steps to be certain that the filter passband is centered over the modem center frequency. If your radio has IF shift, this is a simple matter. The tuning indicator and DCD LED are used to give you an indication of filter centering. The following discussion assumes that your radio has provision for IF shift.

To center your radio passband over the modem, use the following procedure:

1. Set your radio for maximum RF gain.
2. Set the radio for lower sideband operation.
3. Make sure the MFJ-1278B is in HF Packet mode and that the HF Packet modem has been selected.
4. Set the audio output level so that the tuning indicator is responding to the background noise coming through the filter. This can be verified by observing whether or not the tuning indicator "follows" the noise as the IF shift control is rotated.
5. Tune to a frequency which has ABSOLUTELY NO signals in the passband. It is very important that only noise is coming through the filter. If you have access to a RX noise bridge, an alternative is to use the bridge as a noise source for the receiver. No antenna is required in this case.
6. Adjust the IF shift control on the radio so that the tuning indicator on the MFJ-1278B is centered in its display area.
7. Adjust the DCD threshold control on the front panel of the MFJ-1278B so that the DCD LED is flickering with false DCD indications. Make the adjustment so that the DCD duty cycle is more than 10 but less than 50 percent.

If your radio has no provision for IF shift, you will have to determine the center frequency of the audio which is passed through the filter and realign the modem to the center frequency of the filtered audio. If you are lucky, this may turn out not to be necessary. The tuning indicator and DCD LED can be used to give you an indication when the modem is aligned with the filter similar to the indications described above. If the tuning indicator hovers around the center of the display when the modem is listening to noise being passed through the narrow filter as described above, realignment of the modem is unnecessary.

If you have determined that it is necessary to realign the modem center frequency to the radio filter center frequency. You should refer to **Appendix D** at the end of this instruction manual for the alignment procedure.

Operating HF Packet

Much has been said and written about the relative merits of HF versus VHF packet operation. HF packet operation is made to appear more difficult than VHF NBFM packet operation by several factors. Some of these are:

1. HF propagation is much more time variable and is more prone to produce intersymbol errors than is VHF propagation.
2. On the "published HF packet frequencies" many more stations are trying to use a single channel simultaneously than is the usual case on VHF.
3. Due to the wide area propagation characteristic of HF radio waves (sometimes nonreciprocal) with relatively dead "skipped" zones, the carrier sense multiple access (CSMA) feature of packet radio is a less than perfect arbitrator for time sharing the channel between users.
4. Many of the commercially available Terminal Node Controllers (TNC) for use on HF packet have data carrier detect (DCD) circuits which are of limited use or no use at all on a HF packet channel. This further degrades the effectiveness of CSMA.

The DCD circuit in the MFJ-1278B has been optimized for the HF packet mode. It can be adjusted to ignore background noise while still being able to promptly respond to a valid data carrier. It has a "hang time" feature that prevents DCD dropouts when short multipath hits occur or collisions put phase discontinuities in the received data carrier. Thus, most multipath conditions will not cause the MFJ-1278B to begin transmitting before the other station is in a listening mode. The DCD hang time also prevents the MFJ-1278B from "piling on" a collision between 2 other stations on the channel. The DCD circuit in the MFJ-1278B is NOT affected by the fact that there is a large amplitude difference between different signals on the same channel. So it will not allow you to collide with a relatively weak station which is transmitting immediately after a relatively strong station has finished

5. Many of the stations on HF packet have no tuning indicator at all and many others have an indicator that is only marginally useful. Unlike VHF FM operation, frequency error between transmitter and receiver cause frequency errors in the modem tones. This is the reason that a good tuning indicator is absolutely essential for HF packet operation. The tuning indicator makes it possible for the operator to reduce the modem to modem frequency error to near zero. Reliable HF packet operation requires tuning errors of \pm 30 Hz or less.
6. Many of the stations currently operating HF packet do not have their radio bandwidth matched to the characteristics of a 300 baud 200 Hz shift FSK signal. This causes a severe degradation in modem performance resulting in unnecessarily increased numbers of retries and drastic reduction in data throughput for the SHARED channel.

Serious HF packet operation should not be considered without a 500 Hz filter in the receiver IF. An audio filter is NOT an acceptable substitute.

"Squeezing" the edges of SSB filters together with so called variable bandwidth tuning (VBT or PBT) to produce a 500 Hz bandpass is difficult to properly align and results in operation near the edges of the filters where the phase response and group delay characteristics are particularly poor. So while this offers some marginal improvement over wide filters, it is not a good substitute for a real 500 Hz filter.

In spite of the above factors, HF packet communications can be a reliable and enjoyable mode. The trick is to operate in a manner that allows you to avoid the problems mentioned above. Your purchase of an MFJ-1278B has already helped you avoid the DCD and tuning indicator difficulties. Configuring your radio bandwidth to match the spectral characteristics of the HF packet FSK signal will allow you to avoid the modem performance degradation that results from excessive radio bandwidth. However, you will still be affected by other station's problems in these areas when operating on a crowded packet channel.

If you do have your radio configured for the proper bandwidth, you will notice that many stations you connect to will seem to not be able to copy you as well as you copy them. Don't worry, your transmitter output isn't low, you are just observing the difference between a good demodulator behind the correct radio bandwidth and any kind of demodulator behind a radio which has far too much bandwidth for the mode.

The actual mechanics of operating the MFJ-1278B in the HF packet mode are the same as for the VHF packet mode. The main differences that will be apparent to you will be the slower baud rates, the higher incidence of propagation related effects and QRM, and the requirement for accurate tuning. It will take some practice before you can rapidly acquire another station's signal and initiate a contact.

The adjustment is very easy to perform. Simply tune the radio to a channel which has only noise (no signals whatsoever), then adjust the threshold control so that the DCD LED just flickers occasionally. Set it so that the DCD duty cycle is between 10 and 20 percent. DO NOT set the threshold control so that the DCD LED never comes on even when receiving a signal!

If your radio has a bandwidth which is wide compared to the packet signal spectrum, the DCD LED may not flicker at ANY setting of the threshold control when monitoring only noise. In this case, set the threshold control to its maximum clockwise rotation. The data carrier detector will function normally when monitoring a signal in this case.

Tuning in a signal is relatively easy to do once you get the hang of it. You must wait until the other station is sending a packet, and then tune the transceiver so that the tuning indicator LED is centered. If the DCD LED is not lit, the tuning indicator information is **NOT** valid.

Each bar on the tuning indicator represents about 10 Hz. Thus, if a packet comes through and you are 4 bars off, re-tune your transceiver 40 Hz in the indicated direction. The direction depends on the sideband you selected and the manner in which you have the tuning indicator oriented. One or two tries will quickly tell you which way to go! Bars to the left of center indicate you should tune higher, while the other side of center means to tune lower.

Once you have the other station tuned in, you may initiate a connect request just as you would on VHF.

Many BBS stations forward traffic on HF at the above frequencies. Call CQ a couple KHz away from such channels. If you can't raise anyone, call CQ on one of the above frequencies, **but QSY immediately after establishing contact!** Be careful on 20 meters especially that you don't operate +/- 2KHz around 14.100 MHz (you will cause interference to propagation beacons and give packet a bad name...)

Calling CQ on HF is a bit different than on VHF. One technique which has proven effective when NOT operating on one of the congested calling frequencies is to do the following:

1. Find a clear frequency and monitor it for long enough to make sure it really is clear.
2. Set "UNProto" to CQ if it isn't already. This is the default field for this parameter.
3. Command the MFJ-1278B into converse mode by typing either:

K<CR>

or

4. Rapidly type a string of 15 to 20 carriage returns <CR>. This will cause the MFJ-1278B to send a continuous string of unconnected information (UI) frames. Since this will be a relatively long burst of packet transmission, the potential receiving station will have plenty of time to tune your signal in. To a receiving station this will appear on his screen as:

YOURCALL > CQ:

YOURCALL > CQ:

YOURCALL > CQ:

YOURCALL > CQ:

YOURCALL > CQ:

.
. .
. .
. .

One for each carriage return you typed.

Even a station which has no tuning indicator can eventually get you tuned in using this type of signal as he can tune around and watch his screen to see where printing is effective.

If you are meeting a friend on a schedule, you just set the "UNProto" field to "HISCALL" and do the same thing. When your friend finds you, this will appear on his screen as:

YOURCALL > HISCALL:

YOURCALL > HISCALL:

YOURCALL > HISCALL:

.
. .
. .

For as many <CR>s as you typed. Your friend will have little trouble finding you and tuning you in for the QSO.

5. After the MFJ-1278B finishes sending the string of CQ packets, listen for 5 to 10

The above method of calling CQ is NOT appropriate for use on one of the crowded calling frequencies. There, everyone is already tuned more or less to the same frequency. To call CQ on one of the calling frequencies do the following:

1. Find the "center" of the channel by tuning the radio so that the tuning indicator is centered on most of the signals.
2. Make sure your "UNProto" field is set to CQ.
3. Enter converse mode.
4. Occasionally strike a <CR> (2 a minute or so if DCD lets your packets clear the channel that fast) and wait for the MFJ-1278B to get an opportunity to squeeze the packet into the activity on the channel. Allow some time after your packet has been sent for someone to attempt a connect with you and then send another CQ packet by typing a <CR>.
5. If (when) someone connects, immediately negotiate a QSY to a clear channel. Then call him on the new frequency as outlined above (in the clear channel CQ procedure) for a scheduled contact.

Please use care in selecting the QSO frequency so as to avoid unnecessary interference to other amateur services. As in all amateur communication modes, it is polite to listen before you transmit!

Monitoring a propagation beacon frequency will not necessarily be sufficient to reveal this activity to you. It is best to make a note of which INDICATED frequencies you should avoid so that your radiated packet spectrum (from F(emission) above) will not get within several hundred Hz of a propagation beacon.

HF packet operation is fundamentally different than other modes of operation in 1 major respect. If you are on a clear channel, talking to only 1 other station, there will be long periods of silence. People using other modes and tuning around looking for a clear frequency to use may be fooled by the silence. Don't assume that an interfering station who shows up considerably after you have begun using the frequency is interfering on purpose, he may honestly not have been aware of your QSO in progress. For this reason, it is a good idea to keep the flow of the conversation going so that the lapses aren't too long. It can also be advantageous to have more than one packet QSO on the channel but if more than a very few get on the same channel, the throughput falls off very fast as the likelihood that all stations are properly configured and have working DCD circuits is small.

Here are a few simple suggestions for operating HF packet that should help to get you started.

1. Do NOT try to hold a QSO on one of the calling frequencies. Use the calling frequency only to establish contact and then MOVE OFF TO A CLEAR FREQUENCY to carry on the QSO. Remember to be aware of the frequencies your station is actually transmitting so you can avoid interference to other services such as propagation beacons etc.
2. Configure your station so that you can hear the activity on the channel. This will allow you to easily avoid interfering with other stations and also to quickly diagnose the problem when throughput suddenly falls off for some reason (usually propagation or interference).
3. If possible, use the highest frequency band possible to communicate with any specific station. The closer you are to the maximum usable frequency (MUF) the less intersymbol interference you will have from multipath effects. If you have a schedule with another station, arrange your times and frequencies accordingly.
4. Set the following parameters off unless you have some specific reason for doing otherwise:

DIGIPEAT OFF**There is NO reason good enough to enable this function on HF.

DWAIT 0 OFF

AX25V2 OFF

CHECK 0 OFF

CMSG OFF

RETRY 0**Try forever, but NOT if unattended operation. This allows YOU to be the one to decide when or whether to give up rather than the MFJ-1278B. Typically you know more than the MFJ-1278B does about whether the other station is still trying or is likely to recover from the latest fade.)

MAXFRAME 1**Multiple frames OFF.

RESPTIME 0**Some stations may have trouble copying your ACKnowledgments (ACKs) when you respond this fast. This is due to the fact that some radios pump up the AGC voltage during transmit and if the AGC time constant is long, they are essentially deaf for a while after transmitting. You will want to experiment with this value. In general you

6. Restrict your use of beacon transmissions as much as possible. If you **MUST** use a beacon, keep it short and keep the repetition rate as low as possible. More than once a minute is definitely too frequent. Once or twice in 10 minutes is more polite. Do not allow your beacons to continue if you are not in attendance. Nobody wants to connect to you just to be ignored.
7. If your radio allows you to select the AGC time constant (fast or slow AGC), set it to the fastest setting available to you.

If you cannot select fast AGC, it may be advantageous under some circumstances to partially defeat the AGC function by reducing RF gain and increasing AF gain. The demodulator in the MFJ-1278B is extremely insensitive to absolute audio level. It will function properly with input levels from the low hundreds of millivolts up to many tens of volts. Thus, the variation in audio level produced by partially defeating the AGC system will not degrade the modem's ability to copy. The limiting factor on the high end is usually the ability of the receiver output stage to produce the voltage without clipping. The limiting factor on the low end is the hundred millivolts or so required to exceed the MFJ-1278B's digital system noise seen at the demodulator input.

MFJ-1278B KISS MODE, TNC-2 MODE, HOST MODE

One unique feature offered by the MFJ-1278B is that it can be switched into KISS mode to run programs such as TCP/IP, or it can be converted into a "like-TNC-2" controller. Once MFJ-1278B is converted, it can run any firmware written for the TNC-2, such as NET/ROM™, THE NET™ and other firmwares for the TNC2 & clones. The procedure to convert the MFJ-1278B into a "like-TNC-2" is described in **Appendix E** in the instruction manual.

Host Mode installed in the MFJ-1278B requires a special terminal program to operate. Documentation for Host Mode is available on disk from MFJ upon request.

KISS INTERFACE FOR TCP/IP

The KISS interface is installed in firmware of the MFJ-1278B. Additional modifications or replacement of firmware is not necessary.

KISS enables the MFJ-1278B to act as a modem for a host computer. Turning KISS on allows the MFJ-1278B to run programs such as TCP/IP, MSYS and other programs which use the **S**erial **L**ink **I**nterface **P**rotocol (SLIP).

Before enabling KISS, make sure radio baud rate and terminal baud rate are set to the desired values. The terminal baud rate that's determined at sign on is the same that will be used for

Once the operating parameters have been selected, set KISS ON and then issue a RESTART command. The CON and STA LEDs will blink on and off three times to indicate that the MFJ-1278B has entered the KISS mode. Now you may call up a TCP/IP, or another host program that can use KISS or "SLIP".

If you find that the MFJ-1278B will not stay in KISS mode, then you will need to deactivate the **KISSDOG** timer. Deactivation of the **KISSDOG** is done by sending these three bytes to the TNC, **\$C0, \$FD, \$C0**. This sequence will keep the TNC in KISS mode, until the MFJ-1278B is told to exit KISS properly. Before enabling KISS, make sure radio baud rate and terminal baud rate are set to the desired values. The terminal's baud rate that's determined at sign on is the same that will be used for KISS. Once the operating terminal parameters have been selected you may enter KISS mode operation. If you are using the KA9Q TCP/IP software package, to return to normal AX.25 operation, issue the command:

param ax0 255

Note that this command must be issued under the TCP/IP "net>" prompt and lower case letters must be used. Once the MFJ-1278B receives the "**param ax0 255**" command, turns KISS off and will revert back to ordinary AX.25 mode of operation. When the MFJ-1278B is powered on again, it will sign on to the AX.25 operation mode. If you are not using the TCP/IP software package, you will need to send the three bytes **\$C0, \$FF, \$C0** to the MFJ-1278B to restore normal operation. Once the MFJ-1278B receives the "**param ax0 255**" command, it turns KISS off and will revert back to ordinary AX.25 mode of operation. When the MFJ-1278B is powered on again, it will sign on to the AX.25 operation mode. If you cannot send these character values with the software you intend to use, you must power the MFJ-1278B off, then disconnect the bbRAM battery by removing JMP 5 on the MFJ-1278B main board for several minutes, then reconnect the battery and power up again to restore normal operation. The commands available in KISS mode are:

Command	Function	Comments
0	Data Frame	The rest of the frame is data to be sent.
1	TXDELAY	The next byte is the transmitter keyup time in 10 mSec units, with a default of 50 (500 mSec).
2	P	The next byte is the persistence parameter, p, scaled to the range 0- 255. The probability of transmitting at the next opportunity is p/255. The default is 64 (for a probability of 0.25).
3	Slot Time	The next byte is the slot interval in 20 mSec increments. The default is 10 (100 mSec).
4	TXtail	The next byte is the time to hold the transmitter after the FCS as been sent, in 10 mSec units. The command is obsolete and is included for completeness with earlier implementations.
5	FullDuplex	The next byte is 0 for half-duplex (normal) or any other number for full duplex (e.g., for operation with MicroStas).

COMMAND PREFACE

This chapter serves as a complete reference to all the MFJ-1278B operational commands. These commands control the many variable values, that affect the MFJ-1278B's operation, as well as causing it to perform specific functions, such as connecting to another station to start a QSO. You can enter a command to the MFJ-1278B whenever you see the command-mode prompt:

cmd:

You will change parameters and issue instructions to the MFJ-1278B by typing commands composed of English-like words or word abbreviations. The English-like words or word abbreviations, referred to as keywords, sometimes contain variables that are numbers or strings of characters chosen by the user. You will probably never change some of these parameters; however, one of MFJ's goals is to allow each user maximum flexibility to adapt the MFJ-1278B to his environment.

ENTERING COMMANDS

You may use either upper case (capital letters) or lower case (small letters) when you enter commands. In order to have the MFJ-1278B accept a command, you must finish command entry with a <CR>, or carriage return character. This will not be mentioned explicitly in the examples below. Before you type the final <CR> of your command, you can correct typing mistakes or cancel the line completely. If any command is misspelled to the point where the MFJ-1278B does not understand it, then an error message will occur. See Chapter 4 for a discussion of input line editing.

This chapter will use UPPER CASE for commands and lower case for explanatory text. In examples showing input typed by the user together with the responses of the MFJ-1278B, the user's input will be shown in **bold face**.

Whenever the MFJ-1278B accepts a command that changes a value, it will display the previous value. For example, if you type

XFLOW OFF

the MFJ-1278B will respond with:

XFLOW was ON

This reminds you of what you have done, and indicates that the value has been successfully changed. If you type something the MFJ-1278B can't understand you will get an error message. If you type an unrecognized command, you will see the message **?EH**. If you get a command name correct, but the arguments are wrong, you will see the message **?BAD**. A complete list of error messages appears at the end of this chapter. For example,

cmd: **ASDFASDF** This is not a command.

?EH This response indicates MFJ-1278B did not understand the command.

cmd **BEACON E**This is a valid command, however a parameter was left out.

?BAD This response indicates a bad command. Maybe the command was a valid command, but a parameter is missing.

Command List

The commands are listed alphabetically, and each command entry contains several sections, as follows:

COMMAND NAME

The boldface command name at the top of the entry is the word you will type to have the MFJ-1278B execute this command. In this section the command names have some of the characters underlined. These underlined characters form the minimum abbreviation required so that the MFJ-1278B still understands your command. Of course, you may type out the entire command word, or any abbreviation longer than the minimum abbreviation, if you like. The MFJ-1278B accepts either format of command entry used by the user.

For example, the MFJ-1278B requires the minimum abbreviation of, **MY** for the command **MYCALL**. The abbreviation **M** is not recognized by the MFJ-1278B as the abbreviation of the **MYCALL** command. The MFJ-1278B recognizes the abbreviation **M** as the minimum abbreviation for the **MONITOR** command. The MFJ-1278B also accepts the abbreviations **MY**, **MYC**, **MYCA**, **MYCAL** or **MYCALL** for the **MYCALL** command.

If the command requires parameters, they will be indicated after the command name.

Defaults

For commands that set values, the MFJ-1278B assumes a "most often used" or default

Parameters

There are several types of parameters. Some parameters can have one of only two values, such as **ON** and **OFF** or **EVERY** and **AFTER**, known as **KEYWORDS**. If a parameter must be one of two values, the choices are separated by a forward slash, /. You may use **YES** instead of **ON** and **NO** instead of **OFF**.

A parameter designated as **n** is a numeric value. These values may be entered as ordinary decimal numbers, or as hexadecimal, or "hex", numbers by preceding the number with the \$ symbol. When the MFJ-1278B shows some of these numeric parameters, those that set special characters, they will be given in hex. The "digits" of a hex number represent powers of 16, analogous to the powers of 10 represented by a decimal number. The numbers 10 through 15 are denoted by the hex digits A through F. For example,

$$\begin{aligned} \$1B &= 1*16 + 11 = 27 \\ \$120 &= 1*16*16 + 2*16 + 0 = 288 \end{aligned}$$

A parameter designated as **text**, such as the argument to **CTEXT**, may be entered in upper or lower case, and may include numbers, spaces, and punctuation. The MFJ-1278B accepts the parameter text as entered by the user.

Several commands require **callsigns** as parameters. While these parameters are normally amateur callsigns, they may be any collection of numbers and at least one letter, up to six (6) characters. The six (6) characters used in parameters identify stations sending and receiving packets. A **callsign** may additionally include sub-station ID, SSID. The MFJ-1278B accepts decimal numbers from 0-15 as the sub-station ID or SSID. The SSID distinguishes two or more stations on the air with the same Amateur call, such as a base station and a repeater. The call sign and SSID are entered and displayed as call-n, e.g., KOPFX-3. If the SSID is not entered, it is set to 0, and SSIDs of 0 are not displayed by the MFJ-1278B.

Some commands have parameters that are lists of items. For example, you may specify as many as eight callsigns to be selectively monitored with the command **LCALLS**. The second and later items in the list are optional, and you may separate the list items with blank spaces or with commas.

These examples may help you to understand the previous explanations on commands.

BEACON EVERY/AFTER n

means that the command **BEACON** requires an argument that must be either **EVERY** or **AFTER** abbreviated either **E** or **A** respectively, and an argument **n** that the user may choose from a range of values. An acceptable command might be **BEACON E 2**.

means that the command **CONNECT** requires a **callsign** argument, **call1**. You may optionally include the keyword **VIA**, followed by a list of one to eight **callsigns**, **call2** through **call9**. The **callsigns** in the list, if included, must be separated by commas (as shown), or by blank spaces. An acceptable command might be **C N2WX V AD7I WB9FLW**.

You can see the current value of the command's arguments by typing the command name by itself, without any arguments. For example,

cmd: CONOK Y	Sets the value to YES (ON) .
CONOK was OFF	Displays previous value.
cmd: CONOK	Command with no arguments
CONOK ON	Displays present value.

A special command, **DISPLAY**, allows you to see the values of all parameters or groups of related parameters.

Remarks

This section describes the command's action and the meaning of each argument. Examples may be included of situations in which the command might be used.

All of the commands available in the MFJ-1278B are listed in the following pages. The commands for all of the other modes besides PACTOR are shown in bold UPPER case letters, such as **TXDELAY**. The commands listed for the PACTOR mode are shown in bold **UPPER** and **LOWER** case letters, such as **CWIdmode**. The PACTOR commands are executed from the PACTOR p_cmd: command prompt.

COMMAND EXPLANATION**8BITCONV ON/OFF**

Mode: Packet

Default: OFF

Parameters:

ON The high-order bit is not stripped in Converse Mode.**OFF** The high-order bit is stripped in Converse Mode.

This command enables transmission of 8-bit data in Converse Mode. If **8BITCONV** is **OFF**, the high-order bit (bit 7) of characters received from the terminal is removed before the characters are transmitted in a packet. The standard ASCII character set requires only 7 bits, and the final bit is used as a parity bit or ignored. Setting bit 7 in text characters transmitted over the air may cause confusion at the other end.

If you need to transmit 8-bit data, but do not want all the features of Transparent Mode, you should set **8BITCONV ON** and **AWLEN 8**. This may be desirable, for example, if you are using a special non-ASCII character set.

Bit 7 is always removed in Command Mode, since commands require only the standard 7-bit ASCII character set.

8LEVELS ON/OFF

Mode: FAX/SSTV

Default: OFF

Parameters:

ON The MFJ-1278B will transmit and receive FAX and SSTV in 8 gray levels**OFF** The MFJ-1278B will transmit and receive FAX and SSTV in 4 gray levels

In the FAX and SSTV modes, if **8LEVELS** is **ON**, the MFJ-1278B will receive and transmit FAX and SSTV data in 8 levels of gray. The **8LEVELS** command is effective only when **MULTIFAX** and **TVX** are turned **ON**. With the **MULTIFAX** and **TVX** set to **OFF**, the MFJ-1278B transmits and receives 2 level FAX and 4 level SSTV regardless of the setting of the **8LEVELS** command. The built-in printer port on the MFJ-1278B does not support printing of 8 level data, whether it is FAX or SSTV. A Special terminal program, such as MFJ MultiCom™ must be used to decode and display Multi-level FAX and SSTV.

With **8LEVELS** set to **OFF**, and **MULTIFAX** and **TVX** commands set to **ON**, the MFJ-

MFJ-1278B MULTI-MODE

OPERATIONAL COMMANDS

16LEVELS ON/OFF

Mode: FAX/SSTV

Default: ON

Parameters:

ON The MFJ-1278B will transmit and receive FAX and SSTV in 16 gray levels.

OFF The MFJ-1278B will transmit and receive FAX and SSTV in 8 or 4 gray levels depending on how the **MULTIFAX** and **8LEVELS** commands are set.

In FAX and SSTV modes, if **16LEVELS** is **ON** and 8Levels is **OFF**, the MFJ-1278B will receive and transmit FAX and SSTV data in 16 gray levels. As in **8LEVELS**, the **16LEVELS** command is effective only when the **MULTIFAX** command is turned **ON**. If **MULTIFAX** is turned **OFF**, the MFJ-1278B is set to transmit and receive in 2 level FAX and 4 level SSTV, regardless of the setting of **16LEVELS**. The built-in printer port does not support printing of 16 level data. A Special terminal program, such as MFJ MultiCom™ must be used to decode and display the multi-level FAX and SSTV data. Note that turning 16Levels ON will not turn 8Levels OFF, you must turn 8Levels OFF when setting the MFJ-1278B to operate 16 gray levels.

AALT ON/OFF

Mode: AMTOR

Default: OFF

Parameters:

ON Allows use of the SELCALL set up in the ALTCALL command.

OFF The MFJ-1278B uses the SELCALL set up in the MYSELCAL command.

AALT determines whether the SELCALL set by the ALTCALL command, or the MYSELCAL command is used in Mode A ARQ.

ABORT

Mode: Mailbox

Immediate command

This command gives the **SYSOP** total control over the Mailbox by allowing him to force a disconnect on the Mailbox link. It immediately terminates any mailbox activity currently in progress. You may use it to avoid any **QRM**, to cancel a FORWARD or NODEFORW in progress. You can also use it to terminate mailbox usage by an unwelcome mailbox users.

ACKPRIORITY ON/OFF

Mode: Packet

Default: ON

ACKPRIORITY permits an acknowledging TNC to transmit without regard to the slotting delay. Turning **ACKPRIORITY** ON to enable prioritized acknowledgement.

If **ACKprior** is turned off and **SLots** (see **SLots**) is set to 0, the modified AX.25 protocol is effectively disabled. The MFJ-1278B will behave like normal AX.25 protocol.

Prioritized acknowledgments and slotted channel access can be enabled or disabled independently of one another. So you could if you wished run normal AX.25 with slotted channel access or the new protocol without slotted channel access.

ACKTIME nnnn

Mode: Packet

Default: 14

Parameters:

nnnn 0-250, in 10 ms intervals.

The **ACKTIME** parameter controls a delay that occurs whenever any packets have been received by the MFJ-1278B that are not addressed to the MFJ-1278B.

ACKTIME should be calculated by the radio channel baud rate, and by the keyup and keydown (**TXDELAY** and fixed timer, in TNC) delays. It should reflect the time it takes for an acknowledging TNC on the channel to keyup, send its acknowledgement, and release the PTT. This represents the time required to send a response frame, with no I field appended, at the baud rate being used on the radio port.

The current 140 millisecond default is close but should be adjusted for 1200 baud work to 130 milliseconds (**ACKTime** set to 13).

For 300 baud HF work this parameter should be set to 520 milliseconds (**ACKTime** set to 52).

ALOCKCHAR nm

Mode: CW/MCW

Default: \$15

This command controls which character is used to force the MFJ-1278B to lock its CW receive speed to the incoming receive signal. See CW operating instructions for more detail information when using **ALOCKCHAR**. Control-U is the default value for the **ALOCKCHAR** command.

MFJ-1278B MULTI-MODE

OPERATIONAL COMMANDS

ALTCALL ssss

Mode: AMTOR

Default: blank

Parameter:

ssss Designates a four letter SELCALL for use in Mode A Amtor. The SELCALL used in the ALTCALL command is the alternate SELCALL for Mode A Amtor operations.

ALTCALL is used to set up an alternate SELCALL that the MFJ-1278B responds to in mode A. Whether the MFJ-1278B uses this SELCALL or not, depends on the setting of the AALT command.

ANSBSTR cccc

Mode: AMTOR

Default: blank

ANSBSTR will enable the MFJ-1278B to respond to a "Who Are You?", WRU Mode A AMTOR signal. The text **cccc** may be up to 15 characters.

When the MFJ-1278B hears a WRU request, it will respond with the text in the ANSBSTR string.

MFJ-1278B MULTI-MODE

OPERATIONAL COMMANDS

ANSWRQRA ON/OFF

Mode: Packet

Default: ON

Parameter:

ON MFJ-1278B responds to non-digipeated UI frames addressed to QRA, within 1 to 16 seconds, with an empty ID packet.

OFF Disables MFJ-1278B 's ping-response function.

QRA ("Who are you") pinging is supported by the MFJ-1278B. A QRA ping polls all of the TNCs within range. A random number of seconds later, each TNC that heard the QRA ping will transmit its identification packet. The purpose of this feature is to reveal to the packeteer, particularly the transient one, the names of all reachable TNCs and digipeaters.

In order to send a QRA ping:

1. Set the unprotocol callsign to QRA

cmd: **UNPROTO QRA**<CR>

The MFJ-1278B will respond with whatever the **UNPROTO** command was set to previously.

2. Manually send an unconnected packet

cmd: **CONVERSE**<CR>

<CR>

^C

cmd:

This sequence will send an unconnected packet. Once the local TNCs have responded with ID packets, then the user can press a "CTRL-C". The MFJ-1278B will respond with the cmd: prompt.

ARCVCHAR nn

Mode: RTTY/ASCII

Default: \$12

Parameter:

nn = 0 to 127, decimal or \$00 to \$7F, hexadecimal

The **ARCVCHAR** command specifies the character used in RTTY/ASCII/CW modes to return to the receive mode after transmitting.

MFJ-1278B MULTI-MODE

OPERATIONAL COMMANDS

The **ARQ** command initiates a Mode A "ARQ" link. **ssss** is the SELCAL of the station you wish to link with.

When ARQ is first issued, the MFJ-1278B begins to key the transmitter in attempt to establish the link, to the specified SELCALL. Both the **CON** and **STA** LEDs immediately light to indicate the 'phasing' condition.

If the remote station answers, the link is established. The **STA** LED extinguishes and the **CON** LED remains lit. An **IDLE** (ready) state is indicated by this combination. The MFJ-1278B is now ready to accept text for transmission. Type **K** or **CONV** to get into text transmit mode, CTRL-C to exit.

ASA

Mode: Packet/ASCII/RTTY

Immediate Command

ASA is an immediate command. When invoked the MFJ-1278B will analyze incoming signals such as RTTY, ASCII, AMTOR and HF packet. It will display the result for speed, data bits and whether or not the signal is inverted.

When invoked and the MFJ-1278B is told to analyze the incoming signal. A message will be generated in the following format:

<Speed> <Confidence Factor>. <Data Bit> <RXInvert On/Off>

The **ASA** command is used in conjunction with the **OK** command. Once the user accepts the results given by **ASA**, the MFJ-1278B will select the appropriate modem, match the data rate, set the RXInvert and will be ready to receive the signal. **ASA** is not effective in analyzing FAX, SSTV, CW signals and noise.

ASENDCHA nm

Mode: RTTY/ASCII

Default: \$14

Parameter:

nm = 0 to 127, decimal or \$00 to \$7F hexadecimal

ASENDCHA specifies the character that initiates transmit while in RTTY/ASCII/CW. Note that other events, particularly in CW mode, may cause entry to the transmit state.

The user would not need to use the ARCVCHA command to transmit CW. This is due to the full break-in CW operation incorporated in the MFJ-1278B. The full CW break-in operation is dependant on the setting of the **CWSENDCH** command. See CWSENDCH.

ASPECT n

Mode: FAX

Default: 3

Parameter:

n = 2 thru 8

ASPECT is used to establish a reasonable aspect ratio between horizontal and vertical presentation of 2-Level or 8-Level FAX graphics. The **ASPECT** command does not apply to 16 Level FAX graphics. It is necessary to have an **ASPECT** control because the vertical density a dot matrix printer can represent is much less than the representable horizontal density.

The **ASPECT** setting is a ratio of printed: non-printed rows of FAX graphics. The default of 3 means that for every 1 printed FAX row, two rows are discarded. This is the optimum aspect ratio for HF weather FAX.

If your pictures seem to be elongated horizontally, you should decrease the value of aspect. The reverse (vertical elongation) is corrected by an increased aspect value.

AUTOBAUD ON/OFF

Mode: All

Default: ON

Parameter:

ON Tells the MFJ-1278B to set itself to the users terminal baudrate**OFF** Tells the MFJ-1278B to remember the last terminal baudrate it last set itself to.

When the **AUTOBAUD** command is **ON**, the MFJ-1278B will attempt to synchronize with the user's terminal baud rate. When powered up, the MFJ-1278B will wait until it detects a carriage return from the keyboard. You should repeatedly press the carriage return key upon initial power up, until the MFJ-1278B recognizes it. When recognized, the MFJ-1278B will set it's baud rate, to match the terminal baud rate of your computer before signing on.

Once the MFJ-1278B has signed on, you may turn AUTOBAUD OFF. If AUTOBAUD is turned OFF, the MFJ-1278B will store the terminal baud rate that it signed on to last. Therefore, each time the MFJ-1278B is powered up, it will sign on without executing the autobaud routine. You should remember that if you turn AUTOBAUD OFF, and if the terminal baud rate is changed, the MFJ-1278B will not be able to automatically reset itself to the new baud rate. The terminal baud rate must be reset to the original setting. This being the setting before it was changed, or RESET the bbRAM so the AUTOBAUD command is turned ON. The MFJ-1278B will then be able to automatically seek a new terminal baud rate.

If you must force the MFJ-1278B to autobaud due to **AUTOBAUD** being turned **OFF**, and the terminal baud rate being changed, you will need to either remove the jumper from JMP 5, on the MFJ-1278B circuit board. This must be done for a few minutes to reset the RAM which stores the non volatile operating parameters. Once reset in this manner, the MFJ-1278B will restore all parameters to the default values. Then the AUTOBAUD command will now be at it's default setting of ON. The next time the MFJ-1278B is powered up after such a reset, it will attempt to match the new baud rate and sign on after detecting several carriage returns input to the serial port.

AUTOLF ON/OFF

Mode: Packet

Default: ON

Parameters:

ON A linefeed character (<LF>) is sent to the terminal after each carriage return character (<CR>).

OFF A <LF> is not sent to the terminal after each <CR>.

AUTOLF controls the display of carriage return characters received in packets as well as echoing those that are typed in.

If the MFJ-1278B's sign-on message lines appear to be typed over each other, you should set **AUTOLF ON**. If the MFJ-1278B's sign-on message appears that it is double-spaced, then you should set **AUTOLF OFF**. If the MFJ-1278B's sign-on message appears to be single-spaced, you have **AUTOLF** set correctly.

This command only affects what is displayed, not the data sent in packets. If you want to add linefeed characters to outgoing packets, use the command **LFADD**.

AUtoLF ON/OFF

Mode: Pactor

Default: ON

Parameters:

ON A linefeed character (<LF>) is sent to the terminal after each carriage return character (<ENTER>).

OFF A <LF> is not sent to the terminal after each <ENTER>.

The **AUTOLF** command controls the display of carriage return characters received during PACTOR monitoring, as well as echoing those that are typed in. For further information on this command please refer to the **AUTOLF** command in Chapter 6 in the MFJ Data Controller main instruction manual.

AUTOTRAC ON/OFF

Mode: CW

Default: ON

Parameters:

ON Allows automatic speed tracking of incoming CW signals.

OFF Automatic speed tracking of incoming CW signals is disabled.

When **AUTOTRAC** is set ON, the MFJ-1278B attempts to continually track the speed of all incoming CW signals as the speed changes, of a station that is being received.

When the last reception speed greatly differs from the speed being received now, the MFJ-1278B will automatically initiate a LOCK, just as if you had requested one with "Control-U". If **CWSPEEDMatch** is on when this automatic locking takes place, then the newly locked speed also becomes your new transmit speed.

Small received speed changes do not cause your transmit speed to change, **AUTOTRAC** to try and re-establish a speed lock to the incoming CW signal.

The **AUTOTRAC** feature is useful for listening while roaming the bands or for net operation.

AWLEN n

Mode: All

Default: 8

Parameters:

n 7 - 8, specifying the number of data bits per word.

This value defines the word length used by the serial IO terminal port.

For most packet operations, including conversation, bulletin board operation, and transmission of ASCII files, you should set **AWLEN 7**. If 8 bit words are transmitted to the MFJ-1278B in Command Mode or Converse Mode, the eighth bit is normally removed, leaving a standard ASCII character, regardless of the setting of **AWLEN**.

To transmit and receive packets retaining all 8 data bits of each character, as you need to do if you send executable files or other special data, you should use Transparent Mode and set **AWLEN 8**. Alternatively, you can use Converse Mode and set **AWLEN 8** and **8BITCONV ON** (however, the data you then send must handle the Converse Mode special characters with the **PASS** prefix).

AX25L2V2 ON/OFF

Mode: Packet

Default: ON

Parameters:

ON The MFJ-1278B will use AX.25 Level 2 Version 2.0 protocol.**OFF** The MFJ-1278B will use AX.25 Level 2 Version 1.0 protocol.

Some implementations of the earlier version of AX.25 protocol (e.g., TAPR's TNC 1) will not properly digipeat version 2.0 AX.25 packets. This command exists to provide compatibility with these other TNCs until their software has been updated. During the protocol transition period, you should set **AX25L2V2 OFF**.

After your local area TNCs are updated to the newer protocol version, you should set **AX25L2V2 ON**. When **AX25L2V2** is ON, the MFJ-1278B answers L2 UI frames with P and C set with either: RR if connected (regardless of rcvr flow control state), or DM if not connected. If retry limit is exceeded, or the MFJ-1278B receives a "disconnected" response to a poll, the connection is ended.

AXDELAY n

Mode: Packet

Default: 0

Parameters:

n 0 to 180, specifying the voice repeater keyup delay in 10 ms intervals.

AXDELAY specifies a period of time the MFJ-1278B is to wait, in addition to the normal delay set by **TXDELAY**, after keying the transmitter and before data is sent. This feature will be used by groups using a standard "voice" repeater to extend the range of the local area network. Repeaters with slow mechanical relays, split sites, or other circuits which delay transmission for some time after the RF carrier is present require some amount of time to get RF on the air.

If you are using a repeater that hasn't been used for packet operations before, you will have to experiment to find the best value for **n**. If other packet stations have been using the repeater, check with them for the proper setting. Note that this command acts in conjunction with **AXHANG**.

Note that the TAPR TNC 1 and other TNCs using the same version 3.x firmware interpret **n** in 120 ms intervals. The value set by **AXDELAY** on MFJ-1278B will thus be 12 times the value used by a TNC 1 user to give the same delay time. The default setting for **AXDELAY** is 0.

MFJ-1278B MULTI-MODE

OPERATIONAL COMMANDS

AXHANG n

Mode: Packet

Default: 0

Parameters:

n 0 - 20, specifying the voice repeater hang time in 100 ms intervals.

This value can be used to increase channel efficiency when an audio repeater with a hang time greater than 100 ms is used. For a repeater with a long hang time, it is not necessary to wait for the repeater keyup delay after keying the transmitter if the repeater is still transmitting. If the TNC has heard a packet sent within the hang period, it will not add the repeater keyup delay (**AXDELAY**) to the keyup time.

If you are using a repeater that hasn't been used for packet operations before, you will have to experiment to find the best value for **n**. If other packet stations have been using the repeater, check with them for the proper setting.

Note that the TAPR TNC 1 and other TNCs using the same version 3.x firmware interpret **n** in 120 ms intervals. The value you set on MFJ-1278B for **AXHANG** will thus be 6/5 the value used by a TNC 1 user for the same hang time when converting, round down to the nearest integer.

BBSMSGs ON/OFF

Mode: Packet

Default: OFF

This command controls how the MFJ-1278B displays certain messages in command and CONVERSE modes. The messages affected are described below:

<u>MESSAGE</u>	<u>EFFECT WHEN BBSMSGs ON</u>
CONNECTED to xxxx	A newline is added just before""
DISCONNECTED	A newline is added just before""
retry limit exceeded	A newline is added just before""
xxxx Busy	A newline is added just before""
FRMR sent	A newline is added just before""
FRMR rcvd	A newline is added just before""
***Connect request:xxxx	This message is omitted.

The **BBSMSGs** command is primarily useful for host operation. Primarily with WORLI and like bulletin board systems that require link status messages to begin in the first output column.

The connect request message is omitted during **BBSMSGs** mode. This should be most

BEACON EVERY|AFTER **n**

Mode: Packet

Default: EVERY 0

Parameters:

n 0-250, specifying beacon timing in 10 second intervals. A value of 0 disables the beacon.**EVERY** Send beacon at regular intervals.**AFTER** Send beacon once after the specified time interval with no packet activity.

This command enables the sending of beacons and causes the first beacon frame to be transmitted. A beacon frame consists of the text specified by the **BTEXT** command in a packet addressed to "BEACON" and sent via the digipeat addresses.

This command enables beacon sending and causes the first beacon frame to be transmitted. A beacon frame consists of the text specified by **BTEXT** in a packet addressed to "BEACON" and sent via the digipeat addresses specified by the **UNPROTO** command, if any.

If the keyword **EVERY** is specified, a beacon packet is sent every **n***10 seconds. This mode might be used to transmit packets for testing purposes.

If **AFTER** is specified, a beacon is sent only after **n***10 seconds have passed with no packet activity. In this case, the beacon is sent only once until further activity is detected. This mode can be used to send announcements or test messages only when packet stations are on the air. If you choose **n** properly you can avoid cluttering a busy channel with unnecessary transmissions.

Beacon frames from other TNCs can be monitored by setting **MONITOR ON**.

NOTE: BEACONS will not be sent if BTEXT is null.

BKONDEL ON/OFF

Mode: Packet

Default: ON

Parameters:

ON The sequence <BACKSPACE> <SPACE> <BACKSPACE> is echoed when a character is deleted from the input line.

OFF The <BACKSLASH> character (\) is echoed when a character is deleted.

This command determines the way the display is updated to reflect a character deletion in Command Mode or Converse Mode.

The <BACKSPACE> <SPACE> <BACKSPACE> sequence will properly update the screen of a video display. If you have a video display terminal or computer, you should set **BKONDEL ON**.

The <BACKSPACE> <SPACE> <BACKSPACE> sequence on a printing terminal would result in overtyped text. If you have a paper-output display, or if your terminal does not respond to the <BACKSPACE> character (<CTRL-H>), you should set **BKONDEL OFF**. The MFJ-1278B will type a <BACKSLASH> for each character you delete. You can display the corrected input line by typing the redisplay-line character, which is set by the command **REDISPLA**.

MFJ-1278B MULTI-MODE

OPERATIONAL COMMANDS

BLP ON/OFF

Mode: Packet

Default: OFF

Parameters:

ON Puts the MFJ-1278B into Host Mode

OFF Takes the MFJ-1278B out of Host Mode

Setting the BLP command to ON, puts the MFJ-1278B into Host Mode. After you turn BLP ON and enter transparent mode the host code will run. Once BLP is ON, subsequent RESTARTS and power up cycles will be directly and silently into transparent mode and it will continue to do so until you turn BLP back OFF or the bbRAM fails.

In order to run the Host Mode code the following commands must be set up as stated:

CONMODE TRANS/CONV

You MUST set CONMODE to TRANS else the first time you're connected you'll lose the DLC connection! This is actually putting the MFJ-1278B into Transparent mode.

PARITY 0

The Parity must be set to 0 for Host Mode operations.

AWLEN

Set the AWLEN command for 8 bits!

MON ON/OFF

If you have BLP ON and MON ON, >ALL< packets-data, command, beacons, whatever - will be sent to the host on BLP channel 0x71. If you're being inundated with countless frames when debugging you might want to turn monitor off to avoid the mess.

MYDLCNUM

DEFLTDL

Effective only when non-0 MYDLCNUM, this parm tells the TNC what the DLC address is of the host (ex, MTHOST). Default is 254.

BTEXT text

Mode: Packet

Default: ""

Parameters:

text Any combination of characters, numbers and spaces, up to a maximum length of 128 characters.

BTEXT specifies the content of the data portion of a beacon packet. The default **text** is an empty string, i.e., no message. Beacon packets are discussed in more detail under the **BEACON** command.

NOTE: BEACONS will not be sent if BTEXT is null.

You can send multiple-line messages in your beacon by including carriage return (<CR>) characters in the text. The <CR> character can be included by preceding it with the pass character. The pass character is set by the **PASS** command. If you enter a text string longer than 120 characters, an error message will appear and the command will be ignored.

For example, a Bulletin Board program might set the beacon **text** to a message like this, updating the **text** after each connection:

Mailbox on line. Messages for WB9FLW, AD7I, K9NG.

To clear the **BTEXT text** without issuing the **RESET** command, use a % or & character as the first character in the text.

BUDLIST ON/OFF

Mode: Packet

Default: OFF

Parameters:

ON Ignore frames from stations which are not in the **LCALLS** list.

OFF Ignore frame from stations which are in the **LCALLS** list.

BUDLIST works in conjunction with the command **LCALLS**, which sets up a **callsign** list. These commands determine which packets will be displayed when you have set **MONITOR ON**. **BUDLIST** specifies whether the **callsigns** in the list are the ones you want to ignore or, alternatively, are the only ones you want to listen to.

If you want to listen only for packets from a limited list, you should enter this list with **LCALLS** and set **BUDLIST ON**. You can use this feature, for example, to have your TNC

BUF n

Mode: CW/RTTY/ASCII

Default: empty

Parameter:

n = 0 thru 9

Allows you to load up to ten buffers for use in the CW/RTTY/ASCII modes. Maximum buffer text for each buffer is 120 characters. Note that when loading buffer text, there is no space between the word "BUF" and the buffer number selected.

Buffers may be transmitted by setting up for the appropriate mode, and typing the "ASENDCHAR" character (Ctrl-T). This causes the MFJ-1278B to enter transmit mode. Another ASENDCHAR (Ctrl-T) causes the MFJ-1278B to wait for a buffer number. At this point, enter a digit zero through nine and the buffer will be sent.

A special case occurs when the character "#" (pound sign) occurs in the buffer text. In this case, the MFJ-1278B replaces the "#" with the current value of the SERIALNO counter. Once used, this value is incremented by one up to a maximum of 65535, where the counter rolls over to zero.

Also see: BUFTIME and SERIALNO commands.

BUFKEY nnn

Mode: CW/ASCII

Default: 9

BUFKEY allows user to transmit memory buffers without having to type "Ctrl-T". The default character for **BUFKEY** nnn is the "TAB" key (9). To transmit a buffer, user will press the "TAB" key then follow by a memory buffer number (0-9). For example, to transmit memory buffer 0, press the "TAB" key then type the "0" key. MFJ-1278B will transmit the content of memory buffer 0 then revert to receive at the end of the buffer transmission. **BUFKEY** is useful for CW, MCW, RTTY or ASCII.

BUFTIME n

Mode: CW

Default: 0

Parameter:

n= 0 thru 65535

When a non-zero **BUFTIME** is specified, the MFJ-1278B will transmit Buffer 0 at the repetition rate specified in seconds. **BUFTIME** is effective only in the CW mode. If the transmitter is not keyed, the buffer timer will key it, send Buffer 0, then release it. This is useful for beaconing, calling CQ, etc. **BUFTIME** is disabled by setting it to 0.

BWNL ON/OFF

Mode: AMTOR

Default: OFF

BWNL controls whether the MFJ-1278B in mode B FEC waits for you to send a newline character (<CR>) before it starts transmitting the data.

If **BWNL** is OFF then every character you transmit in mode B will be sent as soon as possible.

If **BWNL** is **ON**, the MFJ-1278B will buffer the entire line sending it only when you have completed it, and pressed the RETURN key. This will allow you to fix typing mistakes before transmission. If the end of the line comes before you finish, then the line is automatically sent.

CALIRA

Mode: All

CALIBRA is an immediate command, and is used to transfer control to the modem calibration routine. Calibration may be performed at any time without altering the current link state.

Briefly, the commands available in the calibration routine are:

<SPACE>

Switches between the Mark and Space transmit audio tones.

D

Alternates between the two transmit tones at a rate determined by the radio baud rate. This will help you to calibrate the demodulator.

K

Activates the modulator and Toggles the PTT line on/off.

Q

Quits the calibration routine, and returns to command mode.

CALSET n

Mode: All

Default: NONE

Parameters:

n 0-65535, specifying the count setting for use by the calibration routine.

The number to be specified by **CALSET** is determined by the frequency **f** to be calibrated as follows.

$$n = (525,000 / f) + 1 \text{ (modulator tones)}$$
$$n = (262,500 / f) + 1 \text{ (demodulator tones)}$$

In calibrating the modulator tones, the frequency **f** will be the actual modulator tone desired. When calibrating the demodulators, frequency **f** is the average frequency between the Mark and Space frequencies.

Round **n** to the nearest integer. To calibrate the modem tones, you will set **n** for the desired frequency using **CALSET**.

CANLINE n

Mode: Packet

Default: \$18

Parameters:

n 0-\$7F, specifying an ASCII character string code.

This command is used to change the cancel-line input editing command character. The parameter **n** is the ASCII code for the character you want to type in order to cancel an input line. You can enter the code in either hex or decimal.

For example, to change the cancel-line character to <CTRL- U>, you would set **CANLINE \$15** or **CANLINE 21**.

If you cancel an input line in Command Mode, the line will be terminated with a <BACKSLASH> character, and you will see a new **cmd:** prompt on the next line. If you cancel a line in Converse Mode, you will see only the <BACKSLASH> and a new line. You can cancel only the line you are currently typing. Once a <CR> has been entered, you can not cancel an input line using the cancel-line character. Note that if your send-packet character is not <CR>, the cancel-line character will cancel only the last line of a multi-line packet. To cancel the entire packet, use the **CANPAC** character.

Line cancellation, like all other input editing features, is disabled in Transparent Mode.

CANPAC n

Mode: Packet

Default: \$19

Parameters:

n 0 - \$7F, specifying an ASCII character string code.

CANPAC is used to change the cancel-packet input editing command character. The parameter **n** is the ASCII code for the character you want to type in order to cancel an input packet. You can enter the code in either hex or decimal.

If you cancel a packet in Converse Mode, the line will be terminated with a <BACKSLASH> character and a new line. You can only cancel the packet that is currently being entered. Once you have typed the send-packet character, or waited **PACTIME** (if **CPACTIME** enabled), the packet can not be canceled even if it has not been transmitted.

Packet cancellation, like other input editing features, is disabled in Transparent Mode.

Cancel Display Output

The cancel-packet character also functions to cancel display output in Command Mode. If you are in Command Mode and type the cancel-packet character, any characters that would be typed on the screen (except echoed characters) are "thrown away" by the MFJ-1278B. Typing the cancel-output character a second time restores normal output. To see how this works, try typing **DISPLAY**, then type a <CTRL-Y>. The command list display will stop. You won't see any response from the MFJ-1278B to commands. Now type another <CTRL-Y>, and type **DISPLAY** again to see that the display is back to normal.

You can use the cancel-display feature if you inadvertently do something that causes the MFJ-1278B to generate large amounts of output to the terminal, such as giving the **DISPLAY** command or setting **TRACE ON**. If you are in Converse Mode or Transparent Mode and want to cancel display output, you must exit to Command Mode and then type the cancel- packet character.

The default character for the **CANPAC** command is a <CTRL-Y>.

CBELL ON/OFF

Mode: Packet

Default: OFF

Parameters:

ON Connect bell enabled**OFF** Connect bell disabled

This command is used to control whether an ASCII \$07 or CTRL-G (BELL) character is sent as part of the connected message.

When set ON, the bell character immediately precedes the asterisk portion of the connected message, e.g.:

<BELL>* Connected to: <callsign>**

When **CBELL** is ON a tone will also be heard on the external speaker. A speaker must be connected to the **SPEAKER** jack in the rear panel of the MFJ-1278B, in order to hear this tone.

CBell ON/OFF

Mode: Pactor

Default:OFF

Parameters:

ON Allows the Connect bell to be heard over the monitor speaker.**OFF** Disallows the Connect bell to be heard over the monitor speaker.

This command is exactly the same as the **CBELL** command used in packet. This command determines whether or not an ASCII \$07 or CTRL-G (BELL) character is sent as part of the connected message. This command must be ON, if the **CHObell** command is to be used, otherwise the CHANGE OVER BELL will not work.

When the **CBELL** command is set to **ON**, the bell character immediately precedes the asterisk portion of the connected message, e.g.

<BELL>* Connected to: <CALLSIGN>**

When **CBELL** is **ON**, and a connect is made a tone will be heard on the external speaker. A *speaker must be connected* to the **SPEAKER** jack on the rear panel of the MFJ-1278B, in order to hear this tone.

CCITT ON/OFF

Mode: RTTY

Default: ON

The **CCITT** parameter selects either an internationally recognized character set (CCITT) or the "U.S. TTY" standard. The latter is used by many older, surplus mechanical teletypes that have been taken out of commercial service and placed into amateur use. This parameter is only significant when in Baudot RTTY mode.

While the standards are nearly identical, stations in the United States are advised that the FCC requires (part 96.69(a)) stations in Baudot RTTY service utilize International Telegraph Alphabet Number 2 (ITA No. 2) as specified by the International Telegraph and Telephone Consultative Committee (CCITT).

Note that when CCITT is ON, Baudot RTTY codes received but not assigned in the ITA No. 2 standard are printed as they would have been had the "U.S. TTY" standard been selected.

CHANGE

Mode: AMTOR

Immediate Command

The **CHANGE** command causes your station to switch from being the mode A "ARQ" receiver to being the transmitter. **CHANGE** forces the direction of the link to switch without using the "+?" over signal. It is valid only during a mode A connection when you are the receiver.

CHAT

Mode: Mailbox

Immediate command

The **SYSOP** may, at any time, break onto the mailbox's connected link. The resulting mode is like the a typical **CONVERS** mode packet connection. **CHAT** immediately terminates any user or forwarding operation in progress. At the point when the **SYSOP** invokes Chat mode, the **SYSOP** and the connectee are in an actual packet QSO. This is good to discuss problems with the Mailbox or equipment failure. **CHAT** mode continues until the **SYSOP** returns to command mode.

CHECK n

Mode: Packet

Default: 30

Parameters:

- n** 0-250, specifying the check time in 10 second intervals. A value of 0 disables this feature.

This command sets a connection timeout. If a link connection exists between the MFJ-1278B and another station, and the other station "disappears," your MFJ-1278B could remain in the connected state indefinitely, refusing connections from other stations. This might happen if propagation changes unexpectedly or an intermediate digipeater station is turned off. In order to prevent this sort of lockup, the MFJ-1278B will try to clean up the link if the specified time elapses without any packets being heard from the other TNC. The operation of this feature depends on the setting of **AX25L2V2**.

If **AX25L2V2** is **ON**, the MFJ-1278B will send a "check packet" to verify the presence of the other station if no packets have been heard from it for **n***10 seconds. This frame contains no information, but is interpreted by the receiving station's TNC as an inquiry as to whether it is still connected. If the receiving TNC is still connected, it sends an appropriate response packet. If the TNC initiating the inquiry does not hear a response after **RETRY+1** attempts, it commences a disconnect sequence, as if the **DISCONN** command had been given.

If **AX25L2V2** is **OFF** and the other station has not been heard for **n***10 seconds, the MFJ-1278B will not attempt an inquiry, but will send a disconnect packet, just as if you had typed the command **DISCONN**.

CHECKV1 ON/OFF

Mode: Packet

Default: OFF

The **CHECKV1** parameter enables the automatic idle-link- disconnect feature for AX.25 Level 2 Version 1 connections. The idle time before disconnecting will be equivalent to the AX.25 **CHECK** parameter (see **CHECK** command).

CHObell ON/OFF

Mode: Pactor

Default: ON

Parameters:

- ON** An ASCII bell character is sent to the terminal when the **PACTOR** link changes direction.
- OFF** An ASCII bell character is not sent to the terminal when the **PACTOR** link changes direction.

Parameter:

nnn Where the **nnn** variable equals $0 \leq n \leq 255$

The **CHOChar** command is used to designate the Pactor changeover character. This character initiates a control direction change in the Pactor signal.

This character can be varied from 0 to 255 decimal, for computers which may not support the default. The default is **CTRL-Y**. A value of 0 disables the Pactor changeover.

CMDchr nnn: 0<=nn<=255

Mode: Pactor

Default: \$03

Parameters:

n $\leq nn \leq 255$, specifying an ASCII character code.

The **CMDchr** command is used to designate the character which is used to change the **COMMAND MODE** entry character. You can enter the code in either hexadecimal or decimal form.

Command Mode is entered from **CONVERSE** Mode, when this character is typed. If you type the Command Mode entry character while you are in Command Mode, nothing will happen. This character must be entered before a disconnect can be issued, from either FEC calling mode or to issue a disconnect from a connected state.

The default character for the **CMDCHR** command is a <CTRL-C>.

CMDTIME n

Mode: Packet

Default: 1

Parameters:

n 0-250, specifying Transparent Mode timeout value in 1 second intervals. If **n** is zero, the only exit from Transparent Mode is to send a BREAK signal or interrupt power to the MFJ-1278B.

This command sets the Transparent Mode timeout value. In order to allow escape to Command Mode from Transparent Mode while permitting any character to be sent as data, a guard time of **n** seconds is set up.

The same Command Mode entry character used for exit from Converse Mode is used to exit Transparent Mode, but the procedure is different. (The Command Mode entry character is set by **COMMAND**.) Three Command Mode entry characters must be entered less than **n** seconds apart, with no intervening characters, after a delay of **n** seconds since the last characters were typed. After a final delay of **n** seconds, the MFJ-1278B will exit Transparent Mode and enter Command Mode. You should then see the prompt

cmd:

The diagram below illustrates this timing.

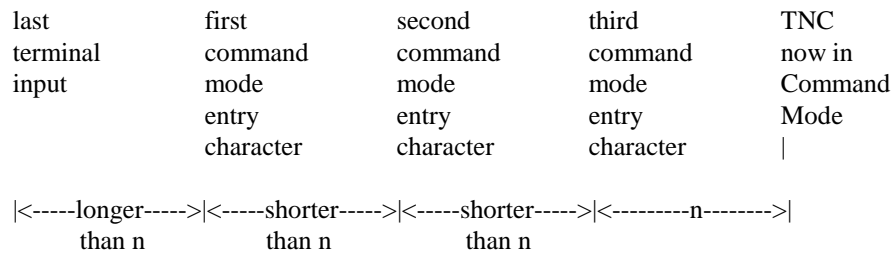

Connect callsign

Mode: Pactor

Immediate Command

Parameter:

callsign where **callsign** is the amateur callsign of the person you want to connect with

CONNECT is an immediate command. It initiates a connect request to the MFJ-1278B with **CALL** using regular timing. The **CONNECT** command should be used when initiating

CONPERM ON/OFF

Mode: Packet

Default: OFF

Parameters:

ON The current connection on the current stream will not be allowed to enter the disconnected state.

OFF The current stream may be connected to and disconnected from other stations.

This command, when switched **ON**, forces the MFJ-1278B to always maintain the current connection, even when frames to the other station exceed **RETRY** attempts to get an acknowledgment. **RESTART** and power off/on cycling will not affect this connected state.

This command only takes effect when a connection is established. It functions on a stream-by-stream basis when multiple connections are allowed.

It is useful for certain networking applications, meteor scatter and other noisy, less-reliable links, while still allowing connections on other streams to operate normally (automatic disconnect based on **RETRY**, etc.).

CMSG ON/OFF

Mode: Packet

Default: OFF

Parameters:

ON A text message is sent as the first packet after a connection is established.**OFF** The text message is not sent.

CMSG enables automatic sending of the message set by **CTEXT** whenever your MFJ-1278B accepts a connect request from another TNC.

For example, if you have left your station running even though you do not want to operate just now, you might want to set **CMSG ON** to let people know that you cannot talk when they connect to your MFJ-1278B. When you are ready to operate, you would set **CMSG OFF**.

CMSGDISC ON/OFF

Mode: Packet

Default: OFF

Parameters:

ON Automatic disconnect enabled**OFF** Automatic disconnect disabled

This command controls whether the MFJ-1278B will initiate a disconnect sequence after it is connected to.

If **CMSG** is OFF, or **CTEXT** has no connected text, the MFJ-1278B initiates a disconnect immediately upon receiving information or acknowledgement frames from the other station.

If **CMSG** is ON and **CTEXT** contains some text information, the MFJ-1278B initiates a disconnect after the packet containing connect text (**CTEXT**) is acknowledged.

This command may be useful to bulletin board operators or others with a need to send a short message, confirm its receipt, and disconnect.

NOTE: Use this command with care! If you find you're able to receive connects, yet never get data, it's possible **CMSGDisc** has been left on. It's also possible is that RS-232 DCD is holding the terminal off. See Chapter 5 for details on hardware flow control.

COMMAND n

Mode: All

Default: \$03

Parameters:

n 0 - \$7F, specifying an ASCII character code.

This command is used to change the Command Mode entry character. You can enter the code in either hex or decimal.

Command Mode is entered from Converse Mode when this character is typed. If you type the Command Mode entry character while you are already in Command Mode, nothing will happen. To see how this works, enter Converse Mode by typing **CONVERS**. Anything you type will become packet data. Now type a <CTRL-C>. You will see the Command Mode prompt, indicating successful exit from CONVERSE mode to Command Mode. The display might look like this:

```
cmd: CONVERS  
Hello World! I'm on the air on packet radio!  
[enter <CTRL-C>]  
cmd:
```

See the entry under **CMDTIME** or the discussion of Transparent Mode in Chapter 5 for information on how the Command Mode entry character is used for escape from Transparent Mode.

For terminals without a "control" key, you will have to reassign another key such as a graphic symbol or punctuation mark which is normally not used in operations.

The default **COMMAND** character is <CTRL-C>.

CONMODE CONVERS/TRANS

Mode: Packet

Default: CONVERS

Parameters:

CONVERS Sets automatic entry to Converse Mode when a connection is established.**TRANS** Sets automatic entry to Transparent Mode when a connection is established.

CONMODE controls which mode the MFJ-1278B will be placed in after a connection is established. The connection may result either from a connect request received over the air or a connect initiated by a **CONNECT** command that you issued. For most operations, you would set **CONMODE** to **CONVERS**. However, if you are using Transparent Mode for a bulletin board program, for example, you would set **CONMODE** to **TRANS** so that the correct mode will be entered when your bulletin board receives a connect request.

If you initiate a connection with the **CONNECT** command, the control of Converse or Transparent Mode is determined by **NEWMODE**.

If the MFJ-1278B is already in Converse or Transparent Mode when the connection is completed, the mode will not be changed. If you have typed part of a command line when the connection is completed, the mode change will not take place until you complete the command or cancel the line. This prevents the last part of your command from inadvertently being sent as a packet.

CONNECT call1 [Via call2[,call3...,call9]] Mode: Packet Immediate Command

Parameters:

call1 **Callsign** of TNC to be connected to.

call2 Optional **callsign** of MFJ-1278B to be digipeated through. As many as eight digipeat addresses can be specified.

The part of the command line in brackets, **VIA call2[, call3...,call9]** is optional. The double-bracketed text, **,call3...,call9**, is also optional, but would only be used if **VIA call2** is present. The brackets are not typed.

Each **callsign** may include an optional sub-station ID specified as **-n** immediately following the **callsign**. The digipeat fields are specified in the order in which you want them to relay the packets to the destination, **call1**.

CONNECT is an immediate command. It initiates a connect request to MFJ-1278B **call1**, optionally through digipeaters. If **NEWMODE** is **ON**, the MFJ-1278B will immediately enter Converse Mode or Transparent Mode, as specified by the command **CONMODE**. If **NEWMODE** is **OFF**, the MFJ-1278B will enter Converse Mode or Transparent Mode when the connection is successfully completed.

An error message is returned if the MFJ-1278B is in a connected state, or is already attempting to connect or disconnect. If no response to the connect request occurs after the number of attempts specified by **RETRY**, the command is aborted and a message is typed. The MFJ-1278B returns to Command Mode if **NEWMODE** is **ON**. If **NEWMODE** is **OFF**, the mode does not change, i.e. the MFJ-1278B remains in Command Mode.

For example, to connect to WA7GXD using N0ADI-1 (who is near your QTH) and WD0ETZ (who is near GXD's QTH) as digipeaters, you would type

CONNECT WA7GXD VIA N0ADI-1,WD0ETZ

Packets coming back from WA7GXD access the digipeaters in the opposite order. Thus, packets from WA7GXD will first be repeated by WD0ETZ, then by N0ADI-1.

CONOK ON/OFF

Mode: Packet

Default: ON

Parameters:

ON Connect requests from other TNCs will be accepted.**OFF** Connect requests from other TNCs will be rejected.

This command determines the action taken by the MFJ-1278B when a connect request for it is received though the radio. If **CONOK** is **ON**, the request will be acknowledged, the standard connect message will be typed and either Converse or Transparent Mode will be entered, depending on the setting of **CONMODE**.

If **CONOK** is **OFF** and the MFJ-1278B is not in Transparent Mode, the TNC will notify you of the connect attempt with the following message.

connect request: <call>

The **callsign** of the station trying to connect will replace **<call>**.

All connect requests from stations with totally blank callsigns are rejected with a busy response.

The MFJ-1278B will also issue a DM packet, or "busy signal" to the requesting station. The user may then issue his own connect command. If the MFJ-1278B receives a DM packet in response to a connect request, it will type the message

***** <call> station busy**

with the **callsign** of the station that sent the DM packet in place of **<call>**.

For example, if you want to leave your station running as a digipeater you might set **CONOK OFF** until you are ready for a conversation. If you get a connect request in the meantime, you can change your mind. Stations attempting to connect to your MFJ-1278B will be able to see that the station is up but not available for connection (it might still be useful as a digipeater).

MFJ-1278B MULTI-MODE

OPERATIONAL COMMANDS

CONSTAMP ON/OFF

Mode: Packet

Default: OFF

Parameters:

ON Connect and disconnect status messages are time stamped.

OFF Connect status messages are not time stamped.

This command enables time stamping of ***** CONNECTED** status messages. The date and time information is then available for use by Bulletin Board programs or other computer applications. The date and time must be set initially by the **DAYTIME** command before time stamping will occur. The date format is determined by the **DAYUSA** command.

For example, if **CONSTAMP** is **ON**, **DAYUSA** is **ON**, and the date and time have been set, a connect message might appear as follows.

***** CONNECTED to N2WX [05/28/85 16:28:31]**

CONVERS

Mode: All

Immediate Command

CONVERS is an immediate command, and will cause the MFJ-1278B to exit from Command Mode into Converse Mode. Any link connections are not affected. Once in Converse Mode, everything you type is packetized and transmitted over the radio. Typing the Command Mode entry character returns the MFJ-1278B to Command Mode. See the discussions of Converse Mode in Chapter 4 and Chapter 5.

CONVERSE

Mode: AMTOR

Immediate Command

Switches from AMTOR command mode ("a_cmd:" prompt) to the text transmission mode. Use **CONVERSE** after a connection or **FEC/SELCALL** broadcast is begun to start exchanging data.

CPACTIME ON/OFF

Mode: Packet

Default: OFF

Parameters:

ON Packet timeout is used in Converse Mode.**OFF** Packet timeout is not used in Converse Mode.

This command enables the periodic automatic sending of packets in Converse Mode. This feature may be used for computer communications, such as Bulletin Board operation, when the full Transparent Mode features are not desired.

If **CPACTIME** is **ON**, characters are packetized and transmitted periodically as they are in Transparent Mode, but local editing and display features of Converse Mode are enabled, and software flow control may be used. For a discussion of how periodic packetizing works, see the command **PACTIME**, which controls the rate and mode of packet assembly.

You should set **CR OFF** in this mode, since otherwise the send-packet character will be inserted in the data being packetized even though it was not typed. In order to include <CR> characters in transmitted packets, set **SENDPAC** to a normally unused character (e.g., <CTRL-P>), at which point the TNC will treat <CR> as an ordinary character.

You can set **CPACTIME ON** for a mode of operation similar to full break-in CW, in which your text is transmitted soon after you type it, but in short bursts of a few characters, and the other station may break in at will. Some operators find it easier to carry on a conversation in this mode, since it eliminates the delays while long packets are being typed.

CR ON/OFF

Mode: Packet

Default: ON

Parameters:

ON The send-packet character, normally <CR>, is appended to all packets sent in Converse Mode.**OFF** The send-packet character is not appended to packets.

When **CR** is **ON**, all packets sent in Converse Mode will include, as the last character of the packet, the send-packet character which forces the packet to be sent. If **CR** is **OFF**, the send-packet character is interpreted solely as a command to the MFJ-1278, not as data to be included in the packet, and furthermore, it will not be echoed to the terminal.

Setting **CR ON** and **SENDPAC \$0D** will force the send-packet character to be <CR>.

CTEXT text

Mode: Packet

Default: ""

Parameters:

text Any combination of characters and spaces, up to a maximum length of 120 characters.

CTEXT specifies the text of the packet to be sent after a connection is made, if **CMSG** is **ON**. The default **text** is an empty string, i.e., no message.

You can send multiple-line messages by including carriage return (<CR>) characters in the text. The <CR> character can be included by using the pass character immediately preceding it (see the **PASS** command). If you enter a **text** string longer than 120 characters, an error message will appear and the command will be ignored.

For example, you might set your **CTEXT** message to

I'm not here right now, but you may leave a message.

To clear the **CTEXT text** without issuing a **RESET** command, use a % or & as the first character in the message. You cannot connect to yourself and see your **CTEXT** unless going thru a digipeater. **CMSG** only takes effect if you are connected to by another TNC.

CSTATUS

Mode: Packet

Immediate Command

CSTATUS is an immediate command which shows the stream identifier and link state of all ten streams (links), the current input and output streams, and whether or not each stream is "permanent" (see **CONPERM**).

An example of a display resulting from issuing a **CSTATUS** command is:

```
cmd: CS
A stream - IO Link state is: CONNECTED to 305MLB
B stream - Link state is: CONNECTED to AD7I P
C stream - Link state is: DISCONNECTED
D stream - Link state is: CONNECTED to N0ADI via K9NG-2
```

.....

```
I stream - Link state is: CONNECT in progress
J stream - Link state is: CONNECTED to KV7B via NK6K-1
```

MFJ-1278B MULTI-MODE

OPERATIONAL COMMANDS

CWCALL ssss

Mode: Amtor

Default: blank

Where "ssss" are 15 characters sent as CW when you issue the ID character. The "ssss" text is sent following the QRA ("The name of my station is _____") signal.

CWidmode nn: 0<=nn<=255

Mode: Pactor

Default 0

Should CW identification be required, the MFJ-1278B now supports 8 CW identification modes. Seven automatic modes are selected by the bit-mapped **CWIDMODE** parameter. Bit positions within the **CWIDMODE** parameter enable *timed cw id*, *cwid on incoming events*, *cwid on outgoing events*, and any combination of the three for a total of 7 modes.

The timed mode requires some explanation. The counter controlling the transmission of the timed CWID must be initially started at the beginning of each link with either the manual "ID" command or one of the initial **CWIDMODE** features selected by CWIDMODE bits 1 or 2. A fully automatic CW ID is achieved by setting CWIDMODE to 3. Reduced levels of automation are selected by other combinations. The eighth mode is manual cwid. Invoke manual CWID by issuing the "ID" command. Also see IDTIME

The CWIDMODE command in Pactor is very complex and provides several combinations of CWID. Below is an example of how CWIDMODE functions:

CWID/ MODE	On Calling	On Connect	On Disc.	Man./ Auto	Comments
1				Man. Only	Mode 1 is manual ID only
2		IRS	IRS		
3	ISS,IRS	IRS	IRS	Auto ISS, ISR	Auto ID interval dependent on the IDTIME setting
4	ISS		ISS		If ISS does changeover, and new ISS disconnects, then the new ISS will ID
5	ISS		ISS	Auto ISS only	If ISS does changeover, then previous ISS auto ID is Disabled
6	ISS	IRS	ISS, IRS		Upon receipt of disconnect from ISS and the disconnect appears on IRS screen, the IRS will ID. After ID from IRS, the ISS will ID
7	ISS, IRS	IRS	IRS, ISS	Auto ISS, IRS	When ISS sends changeover, new ISS AUTO ID enabled. Auto ID for previous ISS is disabled. Disconnects are handled the same as Mode 6

CWSENDCH nnn

Mode: CW

Default:\$FF

Parameter:

nnn = \$00 to \$FF; specifying the CW xmit character.

This controls when the MFJ-1278B transmits the pending text in the CW buffer. It is only effective for CW and MCW modes.

If this is left at the default of 000, the characters to be transmitted are left buffered and unsent until such time as either a SPACE, CARRIAGE-RETURN, or other control character is sent.

To have more control over when pending transmit characters are sent, enter it as the new **CWSEndch** value. For example, setting **CWSEndch** to \$02 will cause the MFJ-1278B to buffer CW characters for transmission until a CTRL-B (or CTRL-R that always transmits the buffer) character is typed.

To enable immediate transmission, enter **CWSEndch** 255 or \$FF. The immediate transmission mode enables the full break-in feature in the CW mode. The full break-in CW feature is defeated, if the CWSENDCH character is set to a value other than \$FF. This tells the MFJ-1278B to send everything right away, without delaying for a space or CARRIAGE-RETURN like **CWSEndch** 000 would.

CWSPEEDM ON/OFF

Mode: CW

Default: OFF

Parameters:

ON Enables the transmit speed synchronization with the received speed.

OFF Disables transmit speed synchronization with the received speed.

When the **CWSPEEDM** command is ON, the MFJ-1278B will adopt the CW speed that was last locked in through the CW "Lock" command as its transmit speed.

When CWSPEEDM is OFF, the MFJ-1278B transmit speed will be the speed set by the user with the MSPEED command.

The default value of CWSPEEDM is OFF.

DAYTIME date&time

Mode: Packet

No default

Parameters:

date&time Current date and time to set.

This command allows you to set the current date and time for the MFJ-1278B. The format for entering the **date&time** is

yymmddhhmm

where **yy** is the last two digits of the year, **mm** is the two-digit month code (01-12), **dd** is date (01-31), **hh** is the hour (00-23), and **mm** is the minutes after the hour (00-59). All these codes must be exactly two digits, so that numbers from 0 to 9 must be entered with leading zeros. The MFJ-1278B does not check thoroughly for the correct number of days in a month, so you should use some judgment when you set the date.

The **date&time** parameter is used by the commands **CONSTAMP** and **MSTAMP** to "time stamp" received and monitored messages. Entries in the "heard" (displayed by **MHEARD**) are also time stamped if **date&time** has been set. The MFJ-1278B's time is updated continuously as long as it is powered up. You must reset the date and time each time you turn on the MFJ-1278B. If you don't do this, the commands **CONSTAMP** and **MSTAMP** will not enable time stamping.

If you type **DAYTIME** without a parameter, the MFJ-1278B will display the current date and time. The format of the display is **dd-mm-yy hh:mm** if **DAYUSA** is **OFF**, and **mm/dd/yy hh:mm** if **DAYUSA** is **ON**. The format for entering **date&time** is not affected. For example,

cmd: **DAYTIME 8402291530**

sets the date and time to February 29, 1984 at 3:30 PM. The display of the date and time, with **DAYUSA ON** would be:

cmd: **DAYTIME**
02/29/84 15:30:26

DAYUSA ON/OFF

Mode: Packet

Default: ON

Parameters:

ON Date is displayed in the format **mm/dd/yy**.**OFF** Date is displayed in the format **dd-mm-yy**.

This command determines the format for the MFJ-1278B's display of the date. If **DAYUSA** is **ON**, the standard U.S. format is used; if **DAYUSA** is **OFF**, the standard European format is used. This command affects the format of the date display used in "time stamps" as well as the display when **DAYTIME** is entered without parameters. The format for entering the time using **DAYTIME** is not affected.

For example, if **DAYUSA** is **ON**, then July 2, 1984 at 9:28:44 AM would be displayed as

```
cmd: DAYTIME
07/02/84 9:28:44
```

If **DAYUSA** is **OFF** the same date and time would appear as

```
cmd: DAYTIME
02-07-84 9:28:44
```

DDisc

Mode: Pactor

Immediate Command

The **DDISC** command is used as a last resort for terminating a PACTOR link. This will work where at times the standard **DISCONNECT** will not. The use of this type of termination is considered RUDE so this is why it is a last resort.

Disconnect

Mode: Pactor

Immediate Command

This command is exactly like the **DISCONNECT** command in Packet. When this command is issued from the p_cmd: prompt a disconnect sequence is initiated. The **DISCONNECT** command is what operators normally used to terminate a Pactor link.

DISplay

Mode: Pactor

Immediate Command

The **DISPLAY** command is used to display the current status of the PACTOR link. It is entered from the p_cmd: prompt.

DEADTIME nnn

Mode: Packet

Default: 33

Parameter:

nnn 0 thru 250 in 10ms.

The **DEADTIME** parameter selects the basic time interval used by the slotting procedures. A delay of length = (random multiple of DEADTIME) will be applied to the all outgoing packets that are not acknowledged.

DEADTIME must be set to a value that accounts for the slowest acceptable station on the channel. It includes the time required for the remote station's radio to come on the air properly after assertion of PTT (TXDelay) and the time required for the local station's squelch (if used) and TNC DCD circuits to allow generation of a "DCD true" signal in the local TNC. Ideally, once the proper value for this timer is ascertained, all stations on the channel will use the same value.

The current default for this parameter is a short 30 milliseconds. This represents only the worst case delay for the TNC's DCD circuit and completely ignores the radio delays.

Most HF linear mode radios are MUCH faster than VHF FM radio. A reasonable setting for HF work is 120 milliseconds (DEADtime set to 12). This should work fine with virtually any HF radio stable enough to consider using on HF packet.

DELAY nn

Mode: AMTOR

Default: 20

The **DELAY** command establishes the interval, in milliseconds, that the MFJ-1278B delays between keying the transmitter and transmitting AMTOR data.

AMTOR mode A ARQ demands a transceiver that switches from receive to transmit, and back to receive, quickly. Some rigs are faster than others. When you install the MFJ-1278B for the first time on a particular radio, it's a good idea to experiment with various **DELAY** times, working towards the minimum delay.

Note that if you're completely unable to work anyone in MODE A, but you can work people in modes B and S, it is possible that you are not using enough DELAY. A delay which is too short, could result in data loss. Try increasing it until MODE A works reliably.

DELETE ON/OFF

Mode: Packet

Default: OFF

Parameters:

ON The delete character input editing character is <DELETE> (\$7F).**OFF** The delete character input editing character is <BACKSPACE> (\$08).

This command is used to change the input editing command for character deletion. When this character is typed, the last character from the input line is deleted. How the TNC indicates the deletion is controlled by the **BKONDEL** command.

You can not use this character to delete past the beginning of a line, although you can delete <CR> characters that have been entered in the text with the pass character.

To see a corrected display of the current line after you have deleted characters, type the redisplay-line character, which is set by the **REDISPLA** command.

DEFLDLC

Mode: Host

Default: 254

Parameters:

Effective only when non-0 MYDLCNUM, this parm tells the TNC what the DLC address is of the host (ex, MTHOST). Default is 254.

DIDDLE ON/OFF

Mode: ASCII/RTTY

Default: ON

During ASCII/RTTY transmit, the MFJ-1278B sends a non-printing synchronization character, DIDDLE, whenever the transmitter is keyed but not sending anything else.

The DIDDLE characters for ASCII and RTTY are NUL and LTRS, respectively.

Diddling while the transmitter is keyed makes it much easier for persons receiving to tune and remain tuned to your transmitted signal.

Some stations running mechanical teletype equipment may ask you not to "Diddle" while you are talking to them since it may cause their older equipment to make a lot of noise, but do nothing. It should be noted that NO damage can occur should mechanical teletypes receive "Diddles", and it is not considered bad practice to leave it ON unless sked otherwise by the other station in the QSO.

MFJ-1278B MULTI-MODE

OPERATIONAL COMMANDS

DIGIPEAT ON/OFF

Mode: Packet

Default: ON

Parameters:

ON The MFJ-1278B will digipeat packets if requested.

OFF The MFJ-1278B will not digipeat packets.

When this parameter is **ON**, any packet received that has your TNC's **callsign** (including SSID) in the digipeat list of its address field will be retransmitted. Each station included in the digipeat list relays the packet in its turn, marking the packet so that it will not accidentally relay it twice, unless so requested, and so that the stations will relay the packet in the correct order. Digipeating takes place concurrently with other MFJ-1278B operations and does not interfere with normal operation of a packet station.

In the spirit of cooperation typical of Amateur operation, you will probably want to set **DIGIPEAT ON** most of the time. However, you might want to disable digipeating if you're not home, or if your transmit relay makes enough noise to wake you up at night.

The command **HID** enables automatic transmission of identification packets if your station is acting as a digipeater.

DISCONN

Mode: Packet

Immediate Command

DISCONN is an immediate command. It will initiate a disconnect request with the currently connected station. A successful disconnect results in the display of:

***** DISCONNECTED**

Other commands may be entered while the disconnect is taking place, although connects are disallowed until the disconnect is completed. If the retry count is exceeded while waiting for the other side to acknowledge, the MFJ-1278B moves to the disconnected state. If a disconnect command is entered while the MFJ-1278B is disconnecting, the retry count is immediately set to the maximum number. In either case, the disconnect message is

***** retry count exceeded**

***** DISCONNECTED**

Disconnect messages are not displayed when the MFJ-1278B is in Transparent Mode.

DISPLAY [class]

Mode: All

Immediate Command

Parameters:

class Optional parameter-class identifier, one of the following:**ASYNC** Displays asynchronous port parameters**CHARACTE** Displays special characters**ID** Displays ID parameters**LINK** Displays link parameters**MONITOR** Displays monitor parameters**TIMING** Displays timing parameters**S** Displays a group of parameters such as memory buffer contents, CW parameters and parameters which affect the printing of graphics to the printer and to the computer screen.**HEALTH** displays 24 counters*

*The twenty four counters in the MFJ-1278B are 16 bits wide, and are ALWAYS initialized to 0000 on power up or "RESTART". These health counters are not listed in the standard command listing. Also when telling the MFJ-1278B to display with the **DISP** command they will not show there either. However, we have listed them here for your convenience.

ASYFRERR:

This is a health counter reflecting the number of hardware-detected asynchronous framing errors. Framing errors are not fatal. They merely indicate that the terminal attached to your MFJ-1278B is not configured correctly with regard to AWLEN/PARITY.

ASYQOVER:

Records the number of times received- connected packets have been rejected due to insufficient space in the buffer holding the data going to the terminal. No actual data loss occurs, provided the connection remains intact. ASYQOVER counts can be avoided by increasing the speed of the attached RS-232 terminal and/or printer. (SEE also SENTRNR)

ASYRXOVR:

Increases when the software does not service the asynchronous receiver in time. Indicates data from the user to the MFJ-1278B is being dropped. This error counter should never

BBFAILED:

Counts number of times bbRAM checksum was in error.

DIGISENT:

Each frame digipeated by the MFJ-1278B causes the counter to increase.

HOVRERR:

Increases when HDLC receiver is not serviced rapidly enough and data is lost. This counter should never increment at any supported data rate.

HUNDRERR

Increases when the HDLC transmitter is not serviced rapidly enough and frames are aborted. This counter should never be non-zero at any supported data rate.

RCVDFRMR:

Increases when Frame reject frames are received from a connected station.

RCVDIFRA:

Increases for each reception of an I frame from a connectee.

RCVDREJ:

Increases for each reception of an REJect frame from a connectee.

RCVDRNR:

Counts the number of AX.25 L2 receiver- not-ready frames received since power-up and during connections. The count may be useful in gauging system throughput.

RCVDSABM:

Each received SABM frame addressed to the MFJ-1278B causes this counter to be increased by one.

RXABORT:

RXABORT is a count of the number of hardware-detected HDLC abort events. A large number of counts is perfectly normal and should not cause concern.

RXCOUNT:

RXERRORS:

Increments each time a received frame is thrown out due to it being too short, suffering overrun(s), or it having a bad CRC. Latter occurs only when CRC checking is enabled (i.e. HGARBAGE is OFF). This counter will often increment in the presence of noise.

RXLENERR:

RXLENERR counts the number of too-short frames received. The counts are of diagnostic use only and here again, non- zero counts are not a matter of concern.

RXRESYNC:

RXRESYNC is a diagnostic health counter recording the number of receiver re-synchronizations handled internally to the MFJ-1278B. Non-zero counts indicate the attached radio may be either turned off or squelched. Note that in almost every situation your radio must to have its squelch fully opened!

SENTFRMR:

Increments each time a Frame reject frame is transmitted.

SENTIFRA:

Increases by one each time an I frame is sent.

SENTREJ:

Whenever a REJect frame is transmitted, this counter is incremented.

SENTRNR:

This health counter tracks the number of times your MFJ-1278B has had to send Receiver-Not-Ready (RNR) frames. Non-zero counts may be an indication that the RS-232 terminal or baud rate is too slow.

TXCOUNT:

Incremented whenever a frame is correctly transmitted.

TXQOVFLW:

Counts how many times frames were disconnected because the outgoing frame queue was too small.

TXTMO.

DISPLAY is an immediate command, and with no **class** parameter will cause all control parameters and their current values to be displayed. Sub-groups of related parameters can be displayed by specifying the optional parameter-class. Individual parameters can be displayed by entering the parameter name with no options.

DISPLAY Mode: AMTOR Immediate Command

Used to display all of the current AMTOR parameters, type **DISPLAY** at the "a_cmd:" prompt. The user must be in the AMTOR mode to obtain the a_cmd: prompt.

DWAIT n Mode: Packet Default: 33

Parameters:

n 0 - 250, specifying default wait time in 10 ms intervals.

This value is used to avoid collisions with digipeated packets. The MFJ-1278B will wait the default wait time after last hearing data on the channel before it begins its own keyup sequence, unless the MFJ-1278B is waiting to transmit digipeated packets. This value should be agreed on by all members of a local area when digipeaters are used in the area. The best value will be determined by experimentation, but will be a function of the keyup time (**TXDELAY**) of the digipeater stations.

This feature is intended to help alleviate the drastic reduction of throughput that occurs on a channel when digipeated packets suffer collisions. It is necessary because digipeated packets are not retried by the digipeater, but must be restarted by the originating station. If all stations specify a default wait time, and the right value of **n** is chosen, the digipeater will capture the frequency every time it has data to send, since digipeated packets are sent without this delay.

The **DWAIT** timer is defeated (superseded) when the command **ACKPRIORITY** is ON.

Ea **ON/OFF** Mode: Pactor Default ON

"**E**cho **A**s **A**cknowledged". When ON the TNC echos transmitted data to the terminal upon receipt of the remote's acknowledgement of the same data.

MFJ-1278B MULTI-MODE

OPERATIONAL COMMANDS

EAS ON/OFF

Mode: CW/RTTY/ASCII

Default: OFF

Parameter:

ON Enables Real Time echoing of out-going CW, RTTY, and ASCII text

OFF Disables Real Time echoing of out-going CW, RTTY, and ASCII text

ECHO-AS SENT is basically the same as the EAS in AMTOR, but is a separate command from AMTOR. This command must be set independently from the AMTOR EAS command. When issued from the cmd: prompt, enables Real Time echoing of out-going CW, RTTY, and ASCII text. When EAS is ON and ECHO is OFF real time echoing of all transmitted CW, RTTY, and ASCII text is enabled.

EASIN ON/OFF

Mode: AMTOR

Default: OFF

EASIN controls whether the MFJ-1278B echos text that you have sent it for transmission at the instant it is sent. Normally the MFJ-1278B is configured to echo as you type, this is the default (OFF) state of this parameter.

Setting **EASIN ON** is useful for monitoring channel quality. If you type a few characters and they quickly echo, it usually means the link is quite good. On the other hand if it is taking a long time before the characters echo then the link is not that good.

ECHO ON/OFF

Mode: All

Default: ON

Parameters:

ON Characters received from the computer or terminal are echoed by the MFJ-1278B.

OFF Characters are not echoed.

This command controls local echoing by the MFJ-1278B when it is in Command or Converse Mode. Local echoing is disabled in Transparent Mode.

If you don't see your input on the display, you should set **ECHO ON**. If you see two copies of every character you type, you should set **ECHO OFF**. If you see the characters you type displayed correctly, you have **ECHO** set correctly.

MFJ-1278B MULTI-MODE

OPERATIONAL COMMANDS

ECho ON/OFF

Mode: Pactor

Default ON

Parameter:

ON Characters received from the computer or terminal are echoed by the MFJ-1278B.

OFF Characters are not echoed.

The **ECho** command in Pactor performs the same function as in Packet mode, except that echoing is deferred when **EAA** is **ON** as described above.

EPSON ON/OFF

Mode: All

Default: ON

Parameter:

ON Enables EPSON graphics mode to the MFJ-1278B printer port.

OFF Disables EPSON graphics mode to the MFJ-1278B printer port.

This parameter specifies whether there is an EPSON (tm) compatible or C. Itoh 8510-P printer attached to the printer port of the MFJ-1278B. If the printer connected to the MFJ-1278B is not an EPSON or C.IToh 8510-P you should set EPSON to OFF.

ERrstrin cccc

Mode: Pactor

Default: [...]

where **cccc** is 1 to 5 characters in length

The **ERrstrin** command designates the character string that is displayed when an unconnected packet is monitored out of sequence. To clear the string set the first character to % or &.

ERUS ON/OFF

Mode: Amtor

Default: ON

AMTOR monitoring is protected to some extent from errors, but not fully. If ERUS is ON, at times when the MFJ-1278B is receiving and detects the reception of errors, the ASCII underscore character (_) is output to the terminal.

Receive errors are likely in mode "L", which is the mode A monitoring mode if you can't hear both sides of the contact very well. Less likely, reception errors can occur while receiving mode B or S. There are extremely unlikely (although still possible) in mode A because this

ESCAPE ON/OFF

Mode: Packet

Default: OFF

Parameters:

ON The <ESCAPE> character (\$1B) is output as "\$" (\$24).**OFF** The <ESCAPE> character is output as <ESCAPE> (\$1B).

This command specifies the character which will be output when an <ESCAPE> character is to be sent to the terminal. The <ESCAPE> translation is disabled in Transparent Mode.

This command is provided because some terminals, and computer programs that emulate such terminals, interpret the <ESCAPE> character as a special command prefix. Such terminals may alter their displays depending on the characters following the <ESCAPE>. If you have such a terminal, you can protect yourself from unexpected text sequences and from other packeteers by setting ESCAPE ON.

See also the MFILTER command, which allows general character stripping (rather than character translation) in monitored packets.

EXActcal ON/OFF

Mode: Pactor

Default:ON

Parameters:

ON Enables exact callsign matching with connect packets**OFF** Disables exact callsign matching with connect packets.

When the EXActcal command is **ON**, the MFJ-1278B responds to connect packets that match all the letters in your callsign and no more. When **OFF**, the looser "buggy" Pactor specification comes into play and your MFJ-1278B responds to any connect packet containing at a minimum the contents of MYCALL. **EXACTCAL** matching will not always work to filter out improper callsigns when the offending unit is the pacomm Pactor version 1.0 unit because of its use of regular ascii 0x55 ("U") characters to fill and terminate callsigns. MFJ uses ascii 0x0f as specified in Pactor documents, instead of 0x55 to fill, and thus fixes the bug.

MFJ-1278B MULTI-MODE

OPERATIONAL COMMANDS

FARNSWOR ON/OFF

Mode: CW

Default: ON

Parameters:

ON Enables the FARNSWORTH special spacing.

OFF Disables the FARNSWORTH special spacing.

Many find training for CW tests with a **FARNSWORTH** method of code generation more valuable because it teaches letter recognition at a speed fast enough to avoid the common learning "plateau". Some people have trouble passing this plateau as they increase their code speed.

When **FARNSWOR** is **ON** the MFJ-1278B transmits CW characters from keyboard or the Memory Keyer using 15 WPM equivalent letters and elements. Setting **FARNSWOR** to **OFF** causes CW text to be sent at normal timing at the selected speed.

FAXEOP ON/OFF

Mode: FAX

Default: ON

When **FAXEOP** is **ON**, the MFJ-1278B detects the end-of-picture for received FAX by looking for a long period of idle tone. Setting it **OFF** disables all FAX end-of-picture detect, and the user must manually terminate reception by returning to command mode.

FAXMODE n

Mode: FAX

Default: 3

n= 1 thru 7; specifying a particular FAX format.

The FAXMODE command of the MFJ-1278B specifies the FAX format, in terms of speed. FAXMODE (n) and speed are shown in the Table below.

FAXMODE(n)	Speed	Horizontal Dot Density
1	60 lines/min. or 1 line/sec.	600
2	90 " or 1.5 "	600
3	120 " or 2 "	900/600
4	240 " or 4 "	480
5	360 " or 6 "	720
6	480 " or 8 "	480
7	180 " or 3 "	400

MFJ-1278B MULTI-MODE

OPERATIONAL COMMANDS

FAXNEG ON/OFF

Mode: FAX

Default: OFF

Parameters:

ON Reverses the FAX image on screen..i.e. black to white

OFF Disables FAX image reversal. Normal operation.

Setting **FAXNEG ON** causes the MFJ-1278B to invert the screen image. This means the white areas of the FAX pictures will be black, and the black areas to be white. The synchronization bar is not inverted.

FAXREV ON/OFF

Mode: FAX

Default: OFF

When **FAXREV** is turned **ON**, the MFJ-1278B will invert all received FAX data including synchronization bars. It is analogous to RXINVERT as used by RTTY/ASCII modes.

FEC

Mode: AMTOR

Immediate Command

FEC immediately causes the MFJ-1278B to start broadcasting with the AMTOR mode B, Forward Error Correction (FEC) protocol.

When the FEC command is issued, the MFJ-1278B keys the transmitter and is immediately ready to accept text to transmit. Type K or CONV to enter the text transmit mode. When you're done transmitting, enter CTL-C and type R to release the transmitter and return the MFJ-1278B to standby/receive.

FIRMRNR ON/OFF

Mode: Packet

Default: OFF

FIRMRNR controls the handling of busy states by the MFJ-1278B. Setting **FIRMRNR ON** improves channel efficiency, but is incompatible with earlier TNC-2 releases. The incompatibility is a result of vague protocol specifications.

FIRMRNR should be always be set **ON** when conversing with network nodes, for example, NET/ROM. In other cases, it is recommended that **FIRMRNR** be left **OFF** unless you can be assured the other TNC you are connected to supports **FIRMRNR**.

FLOW ON/OFF

Mode: Packet

Default: ON

Parameters:

ON Type-in flow control is active.**OFF** Type-in flow control is disabled.

When type-in flow control is enabled, any character entered from the terminal will halt output to the terminal until: (1) a packet is forced (in Converse Mode); (2) a line is completed (in Command Mode); (3) the packet length is exceeded; or (3) the terminal output buffer fills up. Canceling the current command or packet or typing the redisplay-line character will also cause output to resume. Type-in flow control is not used in Transparent Mode.

Setting FLOW ON will keep received data from interfering with data entry. If you (and the person you are talking to) wait for a packet from the other end before starting to respond, you can set FLOW OFF. Some Bulletin Board programs may work best with FLOW OFF. Some computers with "software UARTs" may be unable to send and receive data at the same time; users of such computers should set FLOW ON.

Flow ON/OFF

Mode: Pactor

Default ON

This operates basically the same as the MFJ-1278B packet command, but operates only in **p_cmd:** mode. This limitation is due to the rapidly changing transmit <> receive status of a Pactor link. Applying **FLOW** to data would improperly hold off the important changeover signal and is therefore disallowed.

FORWARD

Mode: Packet

Immediate Command

(dest bbs,[optional via])

FORward is an immediate command. Messages can be forwarded manually, by command, or automatically. They can also be forwarded hourly or by your local full-service mailbox reverse forward request. When invoked the mailbox initiates a connect to the callsign of the destination BBS. When a connect is established the mailbox will proceed to send your messages. Messages that qualify for forwarding must meet two conditions, they are:

1. Have flags of 'N'ot read.
2. Must have a callsign in the @ addresses that are different from MYMCALL.

After forwarding each message flag is set to 'F' to prevent further forwards. When all

Parameters:

n 1 - 15, specifying frame acknowledgment time-out in 1 second intervals.

After transmitting a packet requiring acknowledgment, the MFJ-1278B will wait for the specified frame acknowledgment timeout before incrementing the retry counter and sending the frame again. If the packet address includes relay requests, the time between retries will be adjusted to

Retry interval = n * (2*m + 1) where **m** is the number of intermediate relay stations.

When a retried packet is sent, a random wait time is added to any other wait times in use. This is to avoid lockups in which two TNCs repeatedly send packets which collide with each other. Frack will also reduce timeouts with multiple digipeaters.

FULLDUP ON/OFF

Mode: Packet

Default: OFF

Parameters:

ON Full duplex mode is enabled.

OFF Full duplex mode is disabled.

When full duplex mode is disabled, the MFJ-1278B makes use of the Data Carrier Detect signal from the modem to avoid collisions, and acknowledges multiple packets in a single transmission with a single acknowledgment. When full duplex mode is enabled, the MFJ-1278B ignores the DCD signal and acknowledges packets individually. The latter mode is useful for full-duplex radio operation, such as through OSCAR 10. It should not be used unless both your station and the station you are communicating with are full-duplex stations.

You may find full-duplex mode useful for some testing operations, such as the analog- or digital-loopback tests.

FULLDUP should be **ON** during digital loopback tests.

GRAPHLF ON/OFF

Mode: FAX/SSTV

Default: OFF

Parameters:

ON Graphics line-feed issued before carriage return.**OFF** Graphics lin-feed not issued before carriage return.

For FAX and SSTV receive modes, the **GRAPHLF** setting determines whether the MFJ-1278B will issue a line feed (ASCII value 10 decimal) character before the carriage return on every line of graphics.

For most printers, **GRAPHLF** should be set to **ON**. The setting of **GRAPHLF** to **ON**, could result in blank spaces between printed graphics lines. If this occurs, then set **GRAPHLF** to **OFF** and you should notice the spaces in the printed pictures disappear.

HEADERLN ON/OFF

Mode: Packet

Default: OFF

Parameters:

ON The header for a monitored packet is printed on a separate line from the packet text.**OFF** The header and packet text of monitored packets are printed on the same line.

This command affects the display format for monitored packets. If **HEADERLN** is **OFF**, the address information is displayed with the packet:

KV7D>N2WX: Go ahead and transfer the file.

If **HEADERLN** is **ON**, the address information is displayed, followed by the packet text on a separate line:

**N2WX>KV7D:
Sorry, I'm not quite ready yet.**

If you have set **MRPT ON** or enabled **MSTAMP**, you may wish to set **HEADERLN ON**, as the packet header quickly becomes long enough to fill a screen when these functions are active.

MFJ-1278B MULTI-MODE

OPERATIONAL COMMANDS

HEALED ON/OFF

Mode: Packet

Default: OFF

Parameters:

ON The MFJ-1278B will "dither" the CON and STA LEDs.

OFF The MFJ-1278B will control the CON and STA LEDs in normally.

This command allows the user to redefine the functions of the two CPU controllable LEDs (i.e. the STAtus and CONnect LEDs).

When **HEALED** is set **ON**, the two LEDs flash in a seemingly random fashion. At a glance, the user may be able to make a judgment on whether the software has crashed, since the LEDs will probably not flash if the software fails catastrophically.

With **HEALED** set **OFF**, the LEDs function normally as before.

HID ON/OFF

Mode: Packet

Default: OFF

Parameters:

ON Enables HDLC identification by a digipeater.

OFF Disables HDLC identification.

This command is used to enable or disable the sending of identification packets by the MFJ-1278B. If **HID** is **OFF**, the MFJ-1278B will never send an identification packet. If **HID** is **ON**, the MFJ-1278B will send an identification packet every 9.5 minutes if the station is digipeating packets. The ID command allows the operator to send a final identification packet if the station is being taken off the air.

An identification consists of an unsequenced I frame whose data field is your station identification. The identification packet is addressed to the "CQ" address set by the **UNPROTO** command. Your station identification is your callsign as set by **MYCALL**, with **/R** appended.

ID

Mode: AMTOR

Immediate Command

When issued under the "a_cmd:" amtor command, the **ID** command causes a keyed modulated CW identification of your station to be sent immediately. The identification sent consists of the letters CQ followed by the call sign entered in the **MYCALL** command.

ID Mode: Packet Immediate Command

ID is an immediate command. It will send a special identification packet. **ID** can be used to force a final identification packet to be sent as a digipeater station is being taken off the air. The identification packet will be sent only if the digipeater has transmitted since the last automatic identification.

An identification consists of an unsequenced I frame whose data field is your station identification. The identification packet is addressed to the "CQ" address set by the **UNPROTO** command. Your station identification is your callsign as set by **MYCALL**, with **"/R"** appended.

Id Mode: Pactor Immediate Command

The **ID** command is an immediate command that when used will invoke an immediate **CWID** to be sent. The **ID** will be sent at 20 WPM and will consist of the station callsign.

IDTime nnn Mode: Pactor Default: 590

Parameters:

nnn: 6<=nnn<=255

The **IDTime** parameter specifies the time interval between automatically generated **CWID** events. The actual time yielded is equal to **IDTIME** * 10 seconds. The **IDTime** parameter is relevant only when bit 0 of the **CWIDMODE** parameter is set to 0. The default **IDTime** is 590 seconds.

K (Converse) Mode: Pactor Immediate Command

This command will put the MFJ-1278B into **CONVERSE** mode from the **p_cmd**:

MFJ-1278B MULTI-MODE

OPERATIONAL COMMANDS

KILONFWD ON/OFF

Mode: Mailbox

Default: OFF

Parameters:

ON Messages forwarded out of Mailbox will be killed after a forwarding process is complete.

OFF Default; Messages forwarded out of the Mailbox are not killed after a forwarding process is completed.

The setting of **KILONFWD** determines whether or not the TNC deletes a message after it has been forwarded. If your Mailbox RAM space is critical then you might want to set this command ON. Setting this command to ON, could cause problems, because once a message is killed it cannot be recovered.

KISS ON/OFF

Mode: Packet

Default: OFF

The **KISS** interface is installed in firmware of the MFJ-1278B. **KISS** enables the MFJ-1278B to act as a modem for a host computer. Turning KISS on allows the MFJ-1278B to run programs such as **TCP/IP** and other programs which use the **Serial Link Interface Protocol (SLIP)**.

Before enabling **KISS**, make sure radio baud rate and terminal baud rate are set to the desired values. The terminal's baud rate that's determined at sign on is the same that will be used for KISS.

Once the operating parameters have been selected, set **KISS ON** and then issue a **RESTART** command. The **CON** and **STA** LEDs will blink on and off three times to indicate that the MFJ-1278B has entered the KISS mode. Now you may call up a **TCP/IP**, or another host program that can use KISS or "SLIP".

If you are using the **KA7Q TCP/IP** program and wish to switch to the AX.25 mode of operation, you can issue the command: param ax0 255, then press "RETURN". This command must be issued under TCP/IP "net>" prompt and in lower case letters.

Once the MFJ-1278B receives the "**param ax0 255**" command, it turns KISS off and will revert back to ordinary AX.25 mode of operation. When the MFJ-1278B is powered on again, it will sign on to the AX.25 operation mode.

If KISS is turned on and you have problem revert the MFJ- 1278B back to normal AX.25 operation with the above procedure, you can also turn KISS off by removing JMP5 on the

Lc callsign

Mode: Pactor

Immediate Command

Initiates an ARQ link to the specified **callsign** using extended **LONGPATH** timing to support **long txdelays** or **long skip paths**. This type is generally used when the destination is over 40,000 Km away, where the standard **Connect** command timing will not work.

LCALLS call1[,call2...,call8]

Mode: Packet

Default: ""

Parameters:

call Callsign list. Up to 8 calls, separated by commas.

Each **callsign** may include an optional sub-station **ID** specified as **-n** immediately following the call. The **-n** specification being a sub-station ID of up to 2 digits. This command works in conjunction with **BUDLIST** and allows selective monitoring of other packet stations. These two commands determine which packets will be displayed when you have set **MONITOR ON**. **BUDLIST** specifies whether the callsigns in the list are the ones you want to ignore or, alternatively, are the only ones you want to listen to.

If you want to listen only for packets from a limited list, you should enter your selected list with **LCALLS** and set **BUDLIST ON**.

If you want to ignore packets from a limited list, you should list the callsigns to ignore in **LCALLS** and set **BUDLIST OFF**.

If "%" or "&" is entered into the **LCALLS** parameter, then the **LCALLS** list clears.

LCOK ON|OFF

Mode: Packet

Default: ON

Parameters:

ON The MFJ-1278B will send lower case characters to the computer or terminal.

OFF The MFJ-1278B will translate lower case characters to upper case.

If **LCOK** is **OFF**, lower case characters will be translated to upper case before being output to the terminal. This case translation is disabled in Transparent Mode. Input characters and echoes are not case translated.

If your computer or terminal does not accept lower case characters it may react badly if the MFJ-1278B sends lower case characters. This command allows you to control this behavior.

Parameters:

ON The MFJ-1278B will translate the character immediately following the **STREAMSWITCH** character to upper case before processing it.

OFF The MFJ-1278B will process the character immediately following the **STREAMSWITCH** character as it is entered.

When operating multi-connect, the user must enter a stream identifier (default A through J) after the **STREAMSWITCH** character (default **|**) to select a new logical stream to send data. Normally, the stream identifier must be in upper case, or an error message will result.

When **LCSTREAM** is **ON**, the character immediately following the streamswitch character is converted to upper case before being acted upon. Thus, the case (upper or lower) becomes insignificant. Use of **LCSTREAM** is useful if you are typing in lower case and don't want to be bothered with remembering to switch to upper case when changing streams.

LEdmode 0/1

Mode: Pactor

Default: 1

The **LEdmode** parameter controls whether the MFJ-1278B flashed it's LEDs rapidly for each cycle a 200 baud packet is sent, received, or expected. The user may find the flashing of benefit in evaluating link quality. It is also an indication that the high-throughput 200 baud mode is active. Also see the **NO200** parameter.

LFadd ON/OFF

Mode: Pactor

Default OFF

When **LFADD** is **ON** and **FACTOR** mode is selected, the MFJ-1278B will append an ASCII line feed character, \$OA, to the transmission immediately after a carriage return is sent

LFADD should usually be switched to the **OFF**, as a vast majority of data controllers, including the MFJ-1278B are configured to automatically go to a new line whenever a carriage return is printed. Also see: **AUTOLF** command

MFJ-1278B MULTI-MODE

OPERATIONAL COMMANDS

LFADD ON/OFF

Mode: ASCII/Packet

Default: OFF

When **LFADD** is ON and the ASCII or Packet mode is selected, MFJ-1278 will append an ASCII line feed character, \$0A, to the transmission immediately after a carriage return is sent.

LFADD should usually be switched OFF as the vast majority of TNCs (including the MFJ-1278B) are configured to automatically go to a new line whenever a carriage return is printed.

Also see: AUTOLF parameter

LFADDALT ON/OFF

Mode: RTTY

Default: ON

LFADDALT is very similar to the LFADD command above. However this command applies ONLY to Baudot RTTY mode.

Baudot RTTY operation almost always requires that a line feed be sent along with a carriage return. When LFADDALT is ON the MFJ-1278B will automatically insert the Baudot line feed whenever the user sends a carriage return.

There is one case where line feeds should not be automatically transmitted, that is when sending complex radio teletype pictures.

Also see: AUTOLF parameter

LFIGNORE ON/OFF

Mode: Packet

Default: OFF

Parameters:

ON MFJ-1278B will ignore <LF> characters.

OFF MFJ-1278B will respond to <LF> characters.

This command controls whether MFJ-1278B responds to ASCII Line Feed (<LF> \$0A) characters or ignores them in command and converse modes.

When turned on, line feeds are totally ignored except in transparent mode.

MFJ-1278B MULTI-MODE

OPERATIONAL COMMANDS

LISTEN

Mode: AMTOR

Immediate Command

LISTEN is used to begin monitoring someone else's Mode A connection. You'll need to enter **LISTEN** to tell the MFJ- 1278B to start synchronizing to the desired signal.

LISTENing to Mode A connections can be irritating if conditions are poor because there is no error correction afforded to stations which are not active participants in the QSO. (also see ERUS)

MAILbox ON/OFF

Mode: Pactor

Default OFF

Parameters:

ON Brings the Pactor Mailbox on-line.

OFF Takes the Pactor mailbox off-line.

The **MAILbox** command activates the MFJ-1278B's Pactor Mailbox mode. The **MAILbox** command works in conjunction with the **Packet MAILBOX** command. Both the Packet and Pactor Mailbox commands need to be **ON**, for the Pactor mailbox to function.

MAILBOX ON/OFF

Mode: Packet

Default: ON

Parameters:

ON Brings the Packet mailbox on-line.**OFF** Takes the Packet mailbox off-line.

When the **MAILBOX** command is set to **ON**, all of the mailbox functions are active. Note that the **MAILBOX** is a single-user device; therefore, if you wish to use the **MAILBOX** it is necessary for you to set USER 1 and select Stream A. Note that these are the default settings and selections, respectively. However, as we mentioned in Chapter 5, the Mailbox has been significantly improved. For more extensive information on the new improved Mailbox, please refer to Chapter 5.

The Pactor **Mailbox** command does not need to be **ON** for the Packet mailbox to function.

If you wish to have your messages time and date stamped, then make sure that DAYTIME is set with the correct time or else each message entered without DAYTIME will not be shown.

A basic explanation of the Mailbox commands are as follows:

K Kills all messages addressed to you, depending on the setting of the Y flag.

K ## Kills the message in slot nn, depending of the setting of the Y flag. Remote users may only kill message addressed to them or originated by them. The local SYSOP, however, can kill all messages.

L Lists the all messages in Mailbox. Listed messages will contain the slot number, originator, destination, and subject field of all currently used slots.

R Allows you to Read only the messages which are addressed to you.

R ## Allows Reading of a message in a particular slot number.

S call Lets you Send a message to the specified callsign. "Call" must be a callsign valid under the same format as the MYCALL, CONNECT and other callsign commands.

SP call Lets you Send a personal message to the specified callsign. This is a private message which can only be read by the originating station, the station which it is addressed to and the mailbox SYSOP.

MFJ-1278B MULTI-MODE

OPERATIONAL COMMANDS

- B** Logout: Initiates a disconnect sequence from the mailbox.
- Edit** This allows you to Edit the message headers for a Forwarding or Reverse Forwarding process.
- J** This function when initiated responds with the TNC's MHeard list. This list will contain the eleven most recently heard stations.
- M** This will let a remote user switch memory banks in the Mailbox RAM.
- T** When this command is initiated will allow a remote user to PAGE the SYSOP.
- H(elp)** Displays the mailbox command list, with a brief description of commands, available to the user.

MAILED ON/OFF

Mode: Packet

Default: ON

Parameters:

ON The STA led serves as a Mail present indicator and performs normal functions.

OFF The STA led only performs it's normal functions.

When **MAILED** is ON, the MFJ-1278B's STA LED will not flash while the Mailbox is ON. However, the STA LED will flash if mail is present in the Mailbox for the SYSOP. The STA LED reverts to its normal function, lit when unacknowledged packets are pending, if the MFJ-1278B is in a CONNECTED state, or if MAILED is OFF.

MALL ON/OFF

Mode: Packet

Default: ON

Parameters:

ON Monitored packets include both "connected" packets and "unconnected" packets.

OFF Monitored packets include only "unconnected" packets.

This command determines the class of packets which are monitored. If **MALL** is **OFF**, only otherwise eligible packets (as determined by the **BUDLIST** and **LCALLS** commands) sent by other TNCs in the unconnected mode are displayed. This is the normal manner of operation when this MFJ-1278B is being used to talk to a group of TNCs all of which are

MARSMODE n

Mode: RTTY/ASCII

Default: 0

n n=0 to 3 if n=0, MARS QSO mode

The **MARsmode** command provides two levels of MARS compatibility. Minimal translation is provided by "QSO" mode. In the QSO mode, the MFJ-1278 assumes the user is manually sending and receiving. Maximum translation is provided for sending and storing files of MARS messages while preserving all of the formatting information using the special MARS ASCII equivalent characters, and differs from QSO mode only because of its extra ASCII output translations.

Below are some of the character translations in the Mars QSO mode:

TX Translations:

- ? CR's converted to CR/CR/LF or to LF only if preceding character was also CR.
- ? "NNNN" is sent as "NNNN" followed by 12 LTRS.
- ? Characters are translated as follows:

*	CR
=	LF
+	12 LTRS
@	BELL
\	NULL
>	FIGS
<	LTRS

Here are the character translations in Mars Storage Mode:

The TX translations are the same as for the QSO mode, plus these RX translations:

CR	*
LF	=
BELL	@
NULL	\

For further information on Marsmode operations please see the MARS section in this manual.

MATCH ON/OFF

Mode: AMTOR

Default: ON

MATCH is used for selectively monitoring portions of Mode B FEC transmissions. If **MATCH** is ON, the MFJ-1278B will not start printing a Mode B signal until the string set in **MBEGIN** is matched. Likewise, the search for the terminating string in the **MEND** parameter begins when the MFJ-1278B starts printing. When this ending string is matched the TNC stops printing and goes back to waiting until the next **MBEGIN** sequence is received.

MAXDown nnn

Mode: Pactor

Default: 4

Parameters:

nnn: 5<=**nnn**<=48

MAXDown controls the number of 200 baud information-packets receive errors that the MFJ-1278B will tolerate prior to requesting a **SPEEDdown** to 100 baud.

MAXFRAME n

Mode: Packet

Default: 4

Parameters:

n 1 - 7, specifying a maximum number of packets.

MAXFRAME sets an upper limit on the number of unacknowledged packets that the MFJ-1278B can have outstanding at any one time. The **MAXFRAME** also sets the maximum number of contiguous packets that the MFJ-1278B will send during any given transmission. If the MFJ-1278B acknowledges some of the packets, but not others, the MFJ-1278B will transmit a smaller number of packet frames as long as the number of unacknowledged frames does not exceed **n**. The MFJ-1278B will insert new packet frames during the re-transmission, as long as **n** is not exceeded.

If you perform file transfers, you should experiment with **MAXFRAME** and **PACLEN**. If the link is good, there is an optimum relationship between the parameters set by these commands, so that the maximum number of characters outstanding does not exceed the packet receive buffer space of the MFJ-1278B receiving the data.

MAXSum nn

Mode: Pactor

Default: 30

Parameters:

nnn: 5<=nnn<=120

MAXSum specifies the number of cycles of error-laden information packets received that are accumulated in the **Digital Memory ARQ** sum buffer for reconstruction. When **MAXSUM** consecutive information receive errors occur, on the next receive cycle the sum buffers are re-initialized to inhibit the corruption of real-time reception by historical receive errors.

MAXUp nnn

Mode: Pactor

Default: 10

Parameters:

nnn: 2<=nnn<=48

MAXUp specifies how many consecutive good receptions of 100 baud information packets are required prior to the MFJ-1278B requests a **SPEEDUP** to 200 baud. Note that if **NO200** is set to **ON** then a **SPEEDUP** will not occur because the MFJ-1278B will never request a **SPEEDUP** regardless of the **MAXUP** value. The **MAXUP** value should be small enough to enable timely **SPEEDUP** in relatively good conditions, while being large enough to avoid pointless speedups during bad conditions.

MBEGIN cccc

Mode: AMTOR

Default: <<>>

The **MBEGIN** parameter, which can be up to 15 characters long, is effective when **MATCH** is **ON** and a mode B signal is being received. When **MATCH** is **ON**, the MFJ-1278B will not print a mode B transmission until the string in **MBEGIN** is matched.

MCOM ON/OFF

Mode: Packet

Default: OFF

Parameters:

ON Connect, disconnect, UA, and DM frames are monitored.**OFF** Only information frames are monitored.

This command enables monitoring of connect and disconnect frames when **MONITOR** is **ON**.

When **MCOM** is **OFF**, only I frames (packets containing user information) will be displayed. When **MCOM** is **ON** four protocol packets will also be displayed. Connect, disconnect, UA, and DM packets that are monitored are indicated by <**C**>, <**D**>, <**UA**>, and <**DM**>, respectively. As with other monitor commands, the stations monitored are determined by **BUDLIST** and **LCALLS**.

Path for SABM received while in link-setup state is not checked.

MCON ON/OFF

Mode: Packet

Default: ON

Parameters:

ON Monitor mode remains active when MFJ-1278B is connected.**OFF** Monitor mode is off while the MFJ-1278B is connected.

If **MCON** is **ON**, the **MONITOR** command will enable monitoring while your MFJ-1278B is connected to another TNC. If **MCON** is **OFF**, the display of monitored packets is suspended when a connect occurs, and is resumed when the TNC is disconnected.

If you want to see all packets displayed when you are not connected but have such display suppressed when you connect to another station, you should set **MCON OFF**.

MCTEXT text

Mode: Mailbox

Default: " "

Text: Any combination of characters and spaces, up to 120 characters in length.

The **MCTEXT** command works like CTEXT except that MCTEXT is sent only when the mailbox MYMcall is connected to. There is no express equivalent to the CMSG ON/OFF command. If MCText is empty, no string is sent. If the message is longer than 120 characters an error message will be given and the command is ignored.

The command string can be cleared by typing the command, and then entering the % sign where the text would normally be entered. Also the RESET command will empty the **MCText** command.

For example you might want to set your MCText to:

Welcome to the Mailbox... I'm not here right now , but feel free to use the system...Enjoy!

MEND cccc

Mode: AMTOR

Default: nnnn

Parameters:

cccc: specifying a character string of up to 15 characters in length.

The **MEND** parameter, which may also be up to 15 characters long, is effective when MATCH is ON and a Mode B signal has set off the matching function. The MFJ-1278B will print all of a Mode B transmission received after text matching **MBegin** is received until text matching the **MEND** string is received, or the transmission physically ends.

MFILTER n1,[n2],[n3],[n4]

Mode: Packet

Default: none

Parameters:

n 0 - \$7F, specifying an ASCII character code. Up to 4 characters may be specified.

This command allows you to specify characters to be "filtered," or eliminated from monitored packets. The parameters **n1**, **n2**, etc., are the ASCII codes for the characters you want to filter. You can enter the code in either hex or decimal.

For example, if a <CTRL-L> character causes your screen to be cleared, and you don't want this to happen, you can set **MFILTER 12**. If you also want to eliminate <CTRL-Z>

MFJ-1278B MULTI-MODE

OPERATIONAL COMMANDS

MHCLEAR

Mode: Packet

Immediate Command

MHCLEAR is an immediate command. It causes the list of stations heard to be cleared. You can use this command in conjunction with **MHEARD** to keep track of the stations on the air over a given period of time, such as an evening or a week. Clear the list of stations heard when you first begin to monitor the packet activity.

MHEARD

Mode: Packet

Immediate Command

MHEARD is an immediate command. The **MHEARD** command tells the MFJ-1278B to display a list of stations that has been heard since the last time the command **MHCLEAR** was given. Stations that are heard through digipeaters are marked with a * in the heard log. If you clear the list of stations heard at the beginning of a session, you can use this command to easily keep track of the stations that are active during that period. The maximum number of heard stations that can be logged is 18. If more stations are heard, earlier entries are discarded. Logging of stations heard is disabled when **PASSALL** is **ON**.

If the **DAYTIME** command has been used to set the date and time, entries in the heard log will be time stamped. For example,

```
cmd: MHEARD
K4NTA* 06/09/85 21:08:19
WA4ITD* 06/09/85 21:08:17
W1BEL-2* 06/09/85 21:06:18
K4NTA-2* 06/09/85 20:57:35
N2WX
cmd:
```

Note that no daytime string is displayed next to N2WX. This indicates that when N2WX was last heard the clock had not been set.

MODE

Mode: All

Immediate Command

MODE is an immediate command. The **MODE** command selects which mode the MFJ-1278B will be operating in. The **MODE** command is followed by two characters that denote the mode selected. See Chapter 4 for a more detailed discussion of the **MODE** command.

MNONAX25 ON/OFF

Mode: Packet

Default: OFF

When the **MNONAX25** command is **OFF** the display of non-AX-25 packets is inhibited. The

Parameter:

ON Enables printing Non-Printable Characters.

OFF Discards all Packets containing Non-Printable Characters.

The setting of the MNONPRINT parameter determines whether monitored packets containing non-printable characters (i.e., characters other than ASCII CR, LF, BEL, and not between \$20 and \$7e) are monitored or simply discarded. The default setting permits monitoring all information packets (subject to LCALLS, MONITOR, MNONAX25, etc). When MNONPRIN is **OFF**, information packets containing one or more non-printable characters are discarded. You may find this command helpful when there are binary transfers on the channel that you'd rather not monitor. The MNONPRIN command has no effect on data received during connections.

Monitor ON/OFF

Mode: Pactor

Default: ON

The **MONITOR** command in the **PACTOR** command set is the same as the other modes. When not connected and **MONITOR** is **ON**, the TNC displays monitored data and connect attempts.

MONITOR ON/OFF

Mode: Packet

Default: ON

Parameters:

ON Monitoring of all packet activity is enabled.

OFF Monitoring of all packet activity is disabled.

If the **MONITOR** command is **ON** and the MFJ-1278B is not in Transparent Mode, packets not addressed to your MFJ-1278B may be displayed. The addresses in the packet are displayed along with the data portion of the packet, e.g.:

N2WX>W5FD-3: I'm ready to transfer the file now.

The calls are separated by a ">" and the sub-station ID field (SSID) is displayed if it is other than 0. The MALL, BUDLIST, and LCALLS commands determine which packets are to be monitored. The MCON command controls the action of monitor mode when the MFJ-1278B is connected. All monitor functions are disabled in Transparent Mode. If **MONITOR** is **OFF**, all packets are still monitored, but only packets addressed to you are printed. In the

MRPT ON/OFF

Mode: Packet

Default: ON

Parameters:

ON Display the stations in the digipeat path for monitored packets.**OFF** Display only the source and destination stations for monitored packets.

This command affects the way monitored packets are displayed. If **MRPT** is **OFF**, only the originating station and the destination are displayed for monitored packets. If **MRPT** is **ON**, the entire digipeat list is displayed for monitored packets, and stations that have already relayed the packet are indicated with an asterisk.

For example,

WB9FLW>AD7I,K9NG*,N2WX-7:Hi Paul.

This packet, sent from WB9FLW to AD7I, has been relayed by K9NG but not by N2WX-7. With MRPT OFF, the same packet would be displayed as

WB9FLW>AD7I:Hi Paul.

Setting **MRPT ON** increases the length of the address display, and you may wish to set **HEADERLN ON** as well to display this information on a separate line.

MSPEED n

Mode: CW/MCW

Default: 20

Parameters:

n=5 to 99; specifying a characters transmit speed

The value of the **MSPEED** setting controls the speed of CW sent by the MFJ-1278B. Values below 5 WPM automatically cause a 5 WPM speed to be selected.

When **MSPEED** is less than 15 WPM, and **FARnswor** is **ON**, the MFJ-1278B uses the "Farnsworth" method of transmission, where the element (dot and dash) times are equivalent to 15 WPM but the character spacing of the slower speed is used.

MSTAMP ON/OFF

Mode: Packet

Default: OFF

Parameters:

ON Monitored frames are time stamped.**OFF** Monitored frames are not time stamped.

The **MSTAMP** command enables time stamping of monitored packets. The date and time information is then available for use for automatic logging of packet activity or other computer applications. The date and time are set initially by the **DAYTIME** command, and the date format is determined by the **DAYUSA** command.

Setting **MSTAMP ON** increases the length of the address display, and you may wish to set **HEADERLN ON** as well to display this information on a separate line.

MTIMEOUT n

Mode: Packet

Default: 30

Parameters:

n 0 - 250, specifying 10 sec. intervals.

The **MTIMEOUT** command specifies the packet mailbox timeout in 10 second intervals. Timeouts on the mailbox apply only to remote users (the SYSOP can never time out). The mailbox will timeout and disconnect after $n \times 10$ seconds of mailbox inactivity. Note that the synchronous 10 second clock may cause the timeout to occur as much as 10 seconds before the calculated timeout time. So, if you want to set your Mailbox timeout to 5 minutes then you set the MTimeout command to 30, which would specify a time-out of 300 seconds.

If the **MTIMEOUT** command is a non-zero value, the timeout is disabled.

MFJ-1278B MULTI-MODE

OPERATIONAL COMMANDS

MULTIFAX ON/OFF

Mode: FAX

Default: OFF

Parameters:

ON MFJ-1278B is set to transmit and receive FAX picture in raw data format.

OFF MFJ-1278B is set to transmit and receive FAX picture in 2 levels format.

When **MULTIFAX** is turned **ON**, MFJ-1278B is set to transmit and receive multi-level FAX pictures. FAX Raw data format is sent to the RS-232 port during receiving and raw data is also expected from the terminal program for MFJ-1278B to transmit multi-level FAX picture. Also see **PIXTONES**. Multi-level FAX printing to the MFJ-1278B printer port or printing to the computer screen is not supported by the MFJ-1278B firmware. A Special terminal program must be used for this operation for those who wish to write terminal program to support **MULTIFAX**, more information is provided in the "FAX Operation" section of this manual.

When **MULTIFAX** is **OFF**, the default setting, MFJ-1278B will operate in standard 2 level FAX mode. FAX data format is sent to the MFJ-1278B printer port when **PRINTGRA** is **OFF**. IF **PRINTGRA** is **ON** MFJ-1278B sends **only 2 level data** the the RS- 232 port. Note that when **MULTIFAX** is turned **ON**, the **PRINTGRA** command will be ignored. This means that under FAX mode with **MULTIFAX** turned **ON**, the MFJ-1278B will start to send raw data to the terminal regardless of the setting of the **PRINTGRA** command.

MYCALL call[-n]

Mode: Packet

Default: NOCALL-0

Parameters:

call Callsign of your MFJ-1278B.

n 0 - 15, an optionally specified sub-station ID (SSID).

This command tells the MFJ-1278B what its **callsign** is. This **callsign** will be placed in the FROM address field for all packets originated by your MFJ-1278B. It will accept frames with this **callsign** in the TO field and relay frames with this **callsign** in the digipeat field. **MYCALL** will also be used for identification packets (see **HID** and **ID**).

The default **callsign** must be changed for proper operation of the protocols. There should never be more than one station with the same callsign (including SSID) on the air at once. The SSID can be used to distinguish two stations with the same Amateur call. The SSID will

MFJ-1278B MULTI-MODE

OPERATIONAL COMMANDS

MYcall callsign

Mode: Pactor

Default: MFJPACKTR

The **MYCALL** command is the same as the **MYCALL** command used in the Packet mode. The **MYCALL** command can take callsigns up to 8 characters in length. The callsign used must be at least 4 characters in length.

MYALIAS call[-n]

Mode: Packet

Default: <blank>

Parameters:

call Alternate identity of your MFJ-1278B.

n 0-15, an optionally specified sub-station ID (SSID).

This command specifies an alternate callsign (in addition to the callsign specified in **MYCALL**) for use as a digipeater only.

In some areas, wide coverage digipeaters operators have changed the callsign of their machine to a shorter and (usually) easier to remember identifier. International Civil Aviation Organization (ICAO) airport identifiers, sometimes combined with telephone area codes, have been used.

Use of this command permits HID to identify normally with the MYCALL-specified callsign yet permit an alternate (alias) repeat-only "callsign."

MYDLCNUM

Mode: Host

Default: 0

Set to a non-zero number < 255 (TNCs should start at 1; hosts should start at 254 and go down). When set to a non-0 value, the addressing procedures for multiplexing TNCs on the RS-232 port are enabled.

MFJ-1278B MULTI-MODE

OPERATIONAL COMMANDS

MYHIERAD Text

Mode: Mailbox

Default: " "

Text Any combination of characters and spaces, up to 60 characters in length.

You may use this parameter to generate a customized "@" portion of the tagline your TNC will insert in forwarded messages. If **MYHIERAD** is blank, the default @ portion will read "@:<mymcall>". It is suggested that you insert your hierarchical address, location, and zip/postal code in this parameter. Example: MYHIER for N2WX in Sebastian Florida in the Melbourne LAN at zipcode 32958, using N5AUV as the home bbs, would be entered like this:

cmd: MYHIER N5AUV.#MLBFL.FL.USA.NA [N2WX User/Sebastian] Z:32958

and the tagline would look like this

"R:920801/1200 @:N5AUV.#MLBFL.FL.USA.NA [N2WX User/Sebastian] Z:32958 #:8"

MYMCALL [callsign]

Mode: Mailbox

Default: blank

The MYMCALL command specifies the dedicated callsign for the Packet Mailbox. If MYMCALL equals **MYCALL**, the TNC responds to incoming connections in mailbox mode. When there is no callsign put in MMcall, the mailbox is inaccessible to remote users.

MYSELCAL "ssss"

Mode: AMTOR

Default: blank

The **MYSELCAL** command specifies the AMTOR **SELCAL** that the MFJ-1278B responds to in AMTOR Mode A operations. See section "Mode A: Setup" for information on selecting a SELCAL for your station, based on your amateur callsign.

Note that your MFJ-1278B will not respond to mode A "ARQ" calls unless MYSELCAL is set up.

MFJ-1278B MULTI-MODE

OPERATIONAL COMMANDS

NAVTEX ON/OFF

Mode: Navtex

Default:OFF

Parameters:

ON Navtex receive mode is enabled.

OFF Navtex receive mode is disabled.

NAVTEX is an immediate command. The **NAVTEX** command must be issued under the "a_cmd:" Amtor command prompt. Under the "a_cmd:" command prompt, type **NAVTEX** or the abbreviation to put your MFJ-1278B into **NAVTEX** receive mode. While in **NAVTEX** receive mode the signals on 518 KHz are available to the MFJ-1278B to receive. Tune your radio to 518 KHz.

To receive **NAVTEX**, MFJ-1278B must first receive the **ZCZC** start message, followed by the four character preamble described above. If this is not received intact, the message will not be received. At the end of the message, **NNNN** will be received and the MFJ-1278B will stop receiving the Navtex message.

The MFJ-1278B will remember the last 200 four character preambles received with less than 1/8 of its characters received in error. The MFJ-1278B will not reprint any of these messages when they are re-transmitted from that Navtex station. If you exit the "a_cmd:" command prompt, the preamble memory is erased.

Emergency messages are numbered 00 and will always be printed regardless of whether they have already been received.

NAVSTN Text

Mode: Navtex

Default: ALL

To prevent your MFJ-1278B from receiving certain Navtex stations, just type "**NAVSTN XXXXXXXXXXXXXXX**", where each **X** is the identifying letter of the station you want to receive. Your list of stations to receive may contain up to 26 letters, each representing a station.

For example, if you want to receive only stations A, C and P, then you type "**NAVSTN ACP**". Only signals from these three stations will be received by your MFJ-1278B.

If you want to prevent certain stations from being received, leave them off the list. Then, those stations will not be received while others within the receiving area will.

View manual for more "NAVSTN ALL" (the Default mode) to receive all Navtex stations.

MFJ-1278B MULTI-MODE

OPERATIONAL COMMANDS

NAVMSG

Mode: Navtex

Default: ALL

The **NAVMSG** command works like the **NAVSTN** command with the **ALL** parameter used to exclude all, or to specify the type of messages to receive.

The types of Navtex messages currently are:

- A:** Navigational warnings
- B:** Storm Warnings
- C:** Reports of Ice
- D:** Search/Rescue Information
- E:** Weather forecasts
- F:** Pilot Service Messages
- G:** DECCA System
- H:** LORAN-C
- I:** Omega Systems
- J:** SATNAV Systems

K thru-Z are not in use at this time. They are reserved for future use.

NEWMODE ON/OFF

Mode: Packet

Default: OFF

Parameters:

ON Switching to data transfer mode occurs at the time of the **CONNECT** command and return to command mode is automatic at the time of disconnection.

OFF Switching to data transfer mode occurs at time of connection and no return to command mode occurs at disconnection.

The **NEWMODE** command may be used to select the way the MFJ- 1278B behaves when connections are made and broken.

If **NEWMODE** is **OFF**, the MFJ-1278B will remain in Command Mode after you issue a **CONNECT** command until a connection is actually established. When the connection is established, the MFJ-1278B will enter Converse Mode or Transparent Mode, depending on the setting of **CONMODE**. When the connection is terminated, the MFJ-1278B remains in Converse or Transparent Mode unless you have forced it to return to Command Mode. This is the same as the behavior of TNC 1 (running version 3.x software) under these conditions.

If **NEWMODE** is **ON**, the MFJ-1278B will enter Converse Mode or Transparent Mode as

NO200 ON/OFF

Mode: Pactor

Default: OFF

Parameters:

ON Inhibits 200 baud operation in Pactor mode.**OFF** Allows 200 baud operation in Pactor mode.

The NO200 command controls whether 200 baud links are to be discouraged. The TNC accomplishes this in two ways:

1. Speedups are inhibited.
2. Incoming connect requests are acknowledged for 100 baud.

The **NO200** command works most effectively when both units are capable of NO200 operation. Regardless of the setting of NO200, the TNC complies. This ensures connectivity with non-MFJ units.

NODEFORW node

Mode: Mailbox

Default " "

Parameters:

node [via x...], up to 8 vias.

NODEFORW is an immediate command. It is similar to the **FORWARD** command except that the **NODEFORW** parameter is the callsign+via path to your **NETROM**, **THENET**, or **KA node**. When your TNC establishes the connection to the 'node', it sends the text in NODEPATH to establish a network link to the receiving BBS.

If all goes well, the forwarder will send its sign-on string, and forwarding will commence. To detect failure, **NODEFORW** looks for two strings - "**BUSY**" and "**RETR**" - as node connection failure indications. Upon finding "**BUSY**" or "**RETR**", the forward attempt is considered failed, and the TNC disconnects from the node. The command can contain the callsign of the "node" and up to 8 vias.

MFJ-1278B MULTI-MODE

OPERATIONAL COMMANDS

NODEPATH text string

Mode: Mailbox

Default: " "

Parameters:

text string; specifying node connect string

Enter the command the TNC will command the node connected by the **NODEFORW** command to link with the receiving BBS.

Example:

cmd: NODEPATH C KB4VOL

cmd: NODEFORW PSL5

This sequence first connects to the PSL5 node. When connected, the TNC sends the node connect command "C KB4VOL" to establish a link with the receiving bbs, KB4VOL.

NOMODE ON/OFF

Mode: Packet

Default: OFF

Parameters:

ON The MFJ-1278B will only switch modes (**command**, **converse** or **transparent**) upon explicit command.

OFF The MFJ-1278B will switch modes in accordance with the setting of NEWMODE.

When **NOMODE** is **ON**, the MFJ-1278B will **never** change between **CONVERSE** or **TRANSPARENT** mode to **COMMAND** mode (or vice-versa) on its own. Only user commands (CONV, TRANS, or ^C) may change the type in mode.

If **NOMODE** is **OFF**, then automatic mode switching is handled according to the setting of the NEWMODE command.

NUCR ON/OFF

Mode: Packet

Default: OFF

Parameters:

ON <NULL> characters are sent to the terminal following <CR> characters.

OFF <NULL> characters are not sent to the terminal following <CR> characters.

Parameters:

ON <NULL> characters are sent to the terminal following <LF> characters.

OFF <NULL> characters are not sent to the terminal following <LF> characters.

This command causes transmission of <NULL> characters (ASCII code \$00), producing an effective delay following any <LF> sent to the terminal. The number of <NULL> characters is determined by the command **NULLS**. This delay is required by some display terminals. You need to set **NULF ON** if your terminal sometimes misses characters at the beginning of the line.

NULLS n

Mode: Packet

Default: 0

Parameters:

n 0 - 30, specifying the number of <NULL> characters to send after <CR> or <LF>.

This command specifies the number of <NULL> characters (ASCII code \$00) to send to the terminal after a <CR> or <LF> is sent. In addition to setting this parameter value, **NUCR** and/or **NULF** must be set to indicate whether nulls are to be sent after <CR>, <LF>, or both. Devices requiring nulls after <CR> are typically hard-copy devices requiring time for carriage movement. Devices requiring nulls after <LF> are typically CRTs which scroll slowly. Extra null characters are sent only in Converse and Command Modes.

OK

Mode: ASA

Immediate Command

OK is an immediate command used in conjunction with the ASA command.

When the results are displayed using the ASA mode, the user can issue the **OK** command to accept the results analyzed by ASA.

Typing **OK** will cause the MFJ-1278B to select the operational mode and match the speed automatically against the signal being analyzed.

MFJ-1278B MULTI-MODE

OPERATIONAL COMMANDS

OMLC ON/OFF

Mode: AMTOR

Default: OFF

Parameters:

ON Character convert to lower case enabled

OFF Character convert to lower case disabled.

Output Map to Lower Case (OMLC) when **ON instructs the MFJ-1278B to convert all letter characters, except those echoed, to their lower case equivalent.**

PACLEN n

Mode: Packet

Default: 128

Parameters:

n 0 - 255, specifying the maximum length of the data portion of a packet. The value 0 is equivalent to 256.

The MFJ-1278B will automatically transmit a packet when the number of input bytes for a packet reaches **n**. This value is used in both Converse and Transparent Modes.

If you perform file transfers, you should experiment with both **MAXFRAME** and **PACLEN**. If the link is good, there is an optimum relationship between the parameters set by these commands so that the maximum number of characters outstanding does not exceed the packet receive buffer space of the MFJ-1278B receiving the data.

NOTE: Although there is no requirement for two TNCs exchanging data to have the same **PACLEN** value, allowing more than 128 characters of data in a packet may be incompatible with some varieties of TNCs.

PACTIME EVERY|AFTER n

Mode: Packet

Default: AFTER 10

Parameters:

n 0 - 250, specifying 100 ms intervals.

EVERY Packet timeout occurs every **n***100 milliseconds.

AFTER Packet timeout occurs when **n***100 milliseconds elapse with no input from the computer or terminal.

Parameters:

n 0 - 3, selecting a parity option from the table below.

This command sets the word parity mode for the terminal or computer data transfer according to the following table:

n Value	Parity
0	no parity
1	odd parity
2	no parity
3	even parity

The parity bit, if present, is automatically stripped on input and not checked in Command Mode and Converse Mode. In Transparent Mode, all eight bits, including parity if any, are transmitted in packets. If "no parity" is set and AWLEN is 7, the eighth bit will be set to 0 in Transparent Mode.

PASS n

Mode: Packet

Default: \$16

Parameter:

n 0 - \$7F, specifying an ASCII character code.

This command selects the ASCII character used for the "pass" input editing command. The parameter **n** is the ASCII code for the character you want to type in order to include the following character in a packet or text string. You can enter the code in either hex or decimal.

You can use this character to send any character in packets, even though that character may have some special function. For example, suppose you have set **COMMAND 3**, specifying that <CTRL-C> is your Command Mode entry character. If you use a Bulletin Board program that requires a <CTRL-C> to escape from some operation, you will type

<CTRL-V> <CTRL-C>

to insert a <CTRL-C> character in your packet. Of course, if you do this frequently you would be better off to change your Command Mode entry character. The default PASS character is <CTRL-V>.

Parameters:

nn: 0<=nn<=255

The Factor **PASS** command is the same as the PASS command in the other modes. The PASS command does not work for ^Y Changeover.

PASSALL ON/OFF

Mode: Packet

Default: OFF

Parameters:

ON The MFJ-1278B will accept packets with invalid CRCs.

OFF The MFJ-1278B will only accept packets with valid CRCs.

This command causes the MFJ-1278B to display packets received with invalid CRC fields. Packets are accepted for display despite CRC errors if they consist of an even multiple of 8 bits and up to 339 bytes. The MFJ-1278B will attempt to decode the address field and display the **callsign**(s) in the standard monitor format, followed by the text of the packet.

This mode is not normally enabled, since rejection of any packet with an invalid CRC field is what insures that received packet data is error-free. This mode might be enabled for testing a marginal RF link or during operation under other unusual circumstances.

If you set **PASSALL ON** and monitor a moderately noisy channel you will periodically see "packets" displayed in this mode, since there is no basis for distinguishing actual packets received with errors from random noise.

Logging of stations heard (for display by **MHEARD**) is disabled whenever If **PASSALL** is **ON**, since the callsigns detected may be incorrect.

PIXTONES n

Mode: FAX/SSTV

Default: (see below)

Parameters:

n = \$aa,\$bb,\$cc,.....\$mm,\$nn,\$ss

The **PIXTONES** are arranged in the following format:

White area	Lt gray area	Dark gray area	Black area
\$aa, \$bb, \$cc, \$dd, \$ee, \$ff, \$gg, \$hh, \$ii, \$jj, \$kk, \$ll, \$mm, \$nn, \$ss			Syn _____

The default **PIXtones** values are as follows:

\$BE, \$BB, \$BD, \$B9, \$BE, \$BA, \$BC, \$B8, \$B3, \$B5, \$B6, \$B2, \$B0, \$AD, \$9D, \$BE

The Pixtones command serves the same function as in TVBreak, but is for transmitting of the SSTV and FAX pictures.

The brightness of the transmitted SSTV and FAX pictures can be adjusted by using the PIXTONES command.

Note that in transmitting 4 or 8 gray-levels of SSTV or FAX (16LEVELS command is OFF), the MFJ-1278B will automatically select only four (4) or eight (8) of the PIXTONES values you have chosen. PIXTONES does not affect 2 levels FAX transmitting.

PIXTONES determine which levels of gray that the MFJ-1278B will transmit. MFJ-1278B's multi-gray levels board is capable of transmitting up to 19 tones. However, only a total of 16 tones can be selected by the **PIXTONES** command.

To use PIXTONES the terminal program which you are using on your computer must be able to support the raw data format required by the MFJ-1278B. See Chapter 4 in this manual under "Multi-level FAX/SSTV Transmitting" for more details about the raw data format.

The 19 tones which can be produced by the MFJ-1278B FAX/SSTV modem (in Hz) are:

1100, 1200, 1300, 1500, 1550, 1600, 1650, 1700, 1750, 1800, 1850, 1900, 1950, 2000, 2050, 2100, 2150, 2200, and 2250.

The tone being transmitted determines the shade of gray in the picture. The higher the tone

The **PIXTONES** values are in **Hexidecimal** format. If the picture transmitted does not seem to have the right contrast, try resetting the PIXTONES values.

The HEX values that represent the PIXTONES for the pictures to be transmitted are listed in Table below:

PIXTONES Values (In HEX)	FAX/SSTV TransmitTones (Hz)
\$86	1100 sync
\$8E	1200 "
\$92	1300 "
\$AC	1500 "
\$9D	1550 White
\$AD	1600 "
\$B0	1650 "
\$B2	1700 "
\$B6	1750 "
\$B5	1800 Light Gray
\$B3	1850 "
\$B8	1900 "
\$BC	1950 "
\$BA	2000 "
\$BE	2050 Dark Gray
\$B9	2100 "
\$BD	2150 "
\$BB	2200 "
\$BF	2250 Black

PKTPIX ON/OFF

Mode: Packet

Immediate Command

PKTPIX is an immediate command that provides a method for the MFJ-1278B, to print packet pictures, and other graphics format data transmitted by another station in the VHF packet mode. The user must be connected to another station, with a printer connected to the built-in printer port. Once connected you must go back to command mode with a CTRL-C, and obtain the cmd: prompt. When the characters PK are typed the MFJ-1278B will display the following message:

Entering transparent mode for packet-pix reception

The MFJ-1278B is now ready to print packet graphics. Packet pictures data transmitted from the connecting packet station are received and data is sent directly to the printer attached to the MFJ-1278, without any intervening modification. Therefore, all data **MUST** use the same printer control codes that your printer uses. Typically **EPSON** format codes will be used.

Packet picture printing to the MFJ-1278B printer port requires you to first establish a packet connection with the station who is going to send the picture. Note that you won't be able to call up **PKTPIX** until the connection is made. You must have the printer powered and selected before MFJ-1278B will let you use the **PKTPIX** command.

Once these conditions are met, all data received over the packet link are sent directly to the printer.

Exit **PKTPIX** by using the escape-to-cmd: mode sequence for **TRANSPARENT** connections. Use CTRL-C three times (default), or asynchronous **BREAK**.

MFJ-1278B MULTI-MODE

OPERATIONAL COMMANDS

PRINTGRA ON/OFF

Mode: FAX/SSTV

Default: ON

For FAX and SSTV modes, the setting of **PRINTGRA** determines what the MFJ-1278B does with demodulated graphics. In Multi-Level FAX mode when **MULTIFAX** command is turned **ON**, the setting **PRINTGRA, ON** or **OFF**, will not be useful.

Under 2 level FAX/SSTV format, when **PRINTGRA** is ON, the MFJ-1278B expects and prints to the Epson graphics printer attached to the printer port. When **OFF**, graphics are sent to the user's terminal in format:

LF, CR, ESC x x, ESC x x x , <<nnn characters of graphics>>

The FAX/SSTV frame sent to the user's terminal contains carriage control information, graphics setup information and "nnn" columns of 6-row high dot graphics.

Special note: In order to allow the FAX/SSTV frames to pass through without special handling, each character in the frame is biased upward with the value 30Hex, so only characters of ASCII value 30H through 7FH are sent to the terminal.

A few side effects of the special handling:

1. FAX/SSTV frames and pictures may be transmitted in PACKET or ASCII or logged to disk without concern for binary transfers
2. The "x" values in the FAX/SSTV header are not useful for determining the format of the FAX/SSTV picture (since 2 bits of the 8 bit lengths are lost). This is not serious provided you are aware of which format a FAX/SSTV picture was copied under.

The number of graphics characters, "nnn", following a FAX/SSTV frame header, depends on the FAXMODE/TVMODE. See horizontal density under the FAXMODE/TVMODE command for more information.

PRINTER ON/OFF

Mode: All

Default: OFF

The **PRINTER** command turns the parallel printer port **ON** and **OFF**. If the printer is not connected to the built-in printer port, the computer will not lock-up. The message **PRINTER NOT READY** is given to the user.

PRINTTES

Mode: ALL

Immediate Command

PRINTTES is an immediate command used to test the printer connected to the parallel port

The **PROfmars** command causes the MFJ-1278B to set itself up for MARS operations. The MFJ-1278B sets the following parameters for MARS operation:

AUTOLF	OFF
CCITT	OFF
DIDDLE	OFF
LFADDALT	OFF
LFIGNORE	OFF
MARSMODE	\$01
UNSHIFT	OFF
RXLFNOCR	ON

PTOver nnn: 0<=nn<=255

Mode: Pactor

Default: \$19

Parameters:

nnn Where the **n** variable equals $0 \leq n \leq 255$

The **PTOver** character designates the Pactor changeover character. The **PTOver** command was added in order to make the MFJ-1278B command set compatible with other Pactor controllers. This character initiates a control direction change in the Pactor signal.

This character can be varied from 0 to 255 decimal, for computers which may not support the default. The default is **CTRL-Y**. A value of 0 disables the Pactor changeover.

PTSend

Mode: Pactor

Immediate Command

The **PTSend** command is basically the same as the U1 Unproto command. Entering **PTSend** from the **p_cmd**: prompt will invoke the 100 baud unproto mode. The **PTSend** is to make the MFJ-1278B's Pactor command set compatible with other Pactor controllers.

QRT

Mode: AMTOR

Immediate Command

The **QRT** command is an immediate command is used to:

1. End a mode A "ARQ" connection

When the contact is completed and you are ready to break the link, issue **QRT** to break it and return the MFJ-1278B to standby/receive mode.

2. Stop a broadcast in mode B (FEC) and mode S (SELCALL)

When you're broadcast is complete type **QRT** to return the MFJ-1278B to standby / receive mode. Also please refer see also R

R

Mode: AMTOR

Immediate Command

R is equivalent to **QRT**. The **R** command returns the MFJ-1278B to standby / receive mode. Also please refer to **QRT**.

RADIO n

Mode: All

Default: 1

Parameters:

- n** 1 - 2, Specifying the radio port to be used.

The **RADIO** command allows the user to select the radio ports of the MFJ-1278B. From command mode, typing **RADIO 1** will cause the MFJ-1278B to select radio port 1 as the active radio port. Typing **RADIO 2** will cause the MFJ-1278B to select radio port 2 as the active radio port. When initially powered up, the MFJ-1278B defaults to the radio port it was set to when last powered down.

RANDOMCW ON/OFF

Mode: CW

Default: OFF

Pseudo random CW is sent when in CW mode and **RANDOMCW** is turned ON. To terminate sending random CW, type "CTL-C" and set **RANDOMCW** to OFF again. The random CW is sent at the speed specified by the **MSPEED** command.

RBITMASK **\$xx**

Mode: RTTY/ASCII

Default: 0

Parameters:

\$xx 0 - \$7F, specifying the bit inversion during receiving.

The **RBITMASK** command controls the bit inversion process applied to the received ASCII and RTTY characters. Bit inversion is a simple means of encryption. **RBITMASK** should be selected to match the inversion pattern of the station you are receiving.

RECONNECT **call1 [VIA call2[,call3...,call9]]** Mode: Packet

Parameters:

call1 Callsign of TNC to be reconnected to.

call2 Optional **callsign**(s) of TNCs to be digipeated through. As many as eight digipeat addresses can be specified.

RECONNECT is an immediate command. It may be used to change the path through which you are currently connected to a station. It may only be used when your MFJ-1278B is connected on the current stream to the station you wish to **RECONNECT** to.

Integrity of frames in flight between your station and the **RECONNECT**ed station at the time of **RECONNECT** is not assured.

REDISPLA n

Mode: All

Default: \$12

Parameters:

n 0 - \$7F, specifying an ASCII character code.

This command is used to change the redisplay-line input editing character. The parameter **n** is the ASCII code for the character you want to type in order to redisplay the current input line. You can enter the code in either hex or decimal.

You can type this character to cause the MFJ-1278B to retype a line you have begun. When you type the redisplay-line character, the following things happen: First, type-in flow control is temporarily released (if it was enabled). This displays any incoming packets that are pending. Then a <BACKSLASH> character is typed, and the line you have begun is retyped on the next line. If you have deleted and retyped any characters, only the final form of the line will be shown. You are now ready to continue typing where you left off.

You can use the redisplay-line character to see a "clean" copy of your input if you are using a printing terminal and you have deleted characters. If you have set **BKONDEL OFF**, deletions are designated with <BACKSLASH> characters, rather than by trying to correct the input line display. The redisplayed line will show the corrected text.

You can also use this character if you are typing a message in Converse Mode and a packet comes in. You can see the incoming message before you send your packet, without canceling your input.

REMSYSOP call[-n]

Mode: Mailbox

Default: Blank

Parameters:

Call Callsign to be used for Remote SYSOP ops

-n 0 - 15, optionally specified sub-station ID (SSID)

Entering a callsign here permits the owner of the call to perform sysop functions remotely. Sysop functions include editing, reading, and killing any mailbox message. When this parameter is blank, the remote user may only read non-P messages and messages to or from himself. Furthermore, he may only kill messages to or from himself plus any messages of type "T"(traffic).

This parameter may be reset to the blank (no remote user) state by entering a "@" or "&"

RESTART

Mode: All

RESTART is an immediate command. It re-initializes the MFJ-1278B using the commands previously set by the user, and stored in bbRAM. The effect of this command is the same as turning the MFJ-1278B OFF then ON again.

RESTART does not cause a reset of the parameters in bbRAM. See also the RESET command.

RESET

Mode: All

RESET is an immediate command. When invoked, it resets all parameters to their default settings and re-initializes the MFJ-1278B.

WARNING: All parameter customizing and monitor lists are lost when this command is used.

If you just need to re-initialize the MFJ-1278B using the parameter values in battery backed-up RAM, you can just turn the MFJ-1278B OFF, then ON again rather, than using this command.

RESPTIME n

Mode: Packet

Default: 5

Parameters:

n 0 - 250, specifying 100 ms intervals.

This command sets a minimum delay that is imposed on acknowledgment packets. This delay may run concurrently with default wait set by DWAIT and any random wait in effect.

This delay can be used to increase throughput during operations such as file transfer when the sending TNC usually sends the maximum number of full-length packets. Occasionally, the sending TNC may not have a packet ready in time to prevent transmission from being stopped temporarily, with the result that the acknowledgment of earlier packets collides with the final packet of the series. If the receiving TNC sets **RESPTIME** to **10**, say, these collisions will be avoided.

RESTORE

Mode: AMTOR

Immediate Command

RESTORE restores the MFJ-1278B AMTOR mode parameters to "RTS" mode and is similar

RETries nnn: 0<=nn<=255

Mode: Pactor

Default: 80

Parameters:

nnn; specifying the number of times a packet is transmitted before disconnect

The number of error cycles that the MFJ-1278B will tolerate before unilaterally terminating the link. (Also see WAITDISC)

RETRY n

Mode: Packet

Default: 10

Parameter:

n 0 - 15, specifying the maximum number of packet retries.

The protocol allows for retries, i.e., retransmission of frames that are not acknowledged. Frames are re-transmitted n times before the operation is aborted. The time between retries is specified by the command FRACK. A value of 0 for n specifies an infinite number of retries. If the number of retries is exceeded, the MFJ-1278B goes to the disconnected state (with an informative message if not in Transparent Mode). See also the FRACK command.

REVFLIM call[-n]

Mode: Mailbox

Default: " "

Parameters:

Call Callsign of BBS to enable Reverse-forwards**-n** 0 - 15, an optionally specified sub-station ID (SSID).

When this parameter is empty, the mailbox reverse forwards all of its messages eligible for forwarding to the first SID compatible BBS to elicit a reverse forward with "F>." Since this permissive technique is vulnerable to a malevolent operator who might attempt to connect and force your mailbox to forward to him, the **REVFLIM** parameter is provided to limit your mailbox's response to other's reverse forward requests. Simply place the callsign of the BBS you wish to enable reverse forwarding to in this parameter to limit remotely-initiated reverse forwarding to only that callsign.

RFE ON/OFF

Mode: AMTOR

Default: OFF

Parameters:

ON Continuous retries mode enabled**OFF** Continuous retries mode disables.

RFE is the **R**etry **F**or**E**ver parameter. When the **RFE** command is ON, a Mode A call will continue until either a successful link is established, or the "QRT" or "R" command is issued.

RINV ON/OFF

Mode: AMTOR

Default: OFF

Parameters:

ON Inverting of incoming Amtor data results**OFF** Incoming Amtor data is not inverted.

The **RINV** command controls whether the incoming received signal is inverted before detection/processing. It is similar to RXINVERT in RTTY/ASCII mode.

MFJ-1278B MULTI-MODE

OPERATIONAL COMMANDS

RXBLOCK ON/OFF

Mode: Packet

Default: OFF

Parameters:

ON The MFJ-1278B will send data to the terminal in RXBLOCK format.

OFF The MFJ-1278B will send data to the terminal in standard format.

The **RXBLOCK** command is designed for automated operations, such as packet bulletin board stations. It is intended to help such systems discriminate between data received from the connected station and MFJ-1278-generated messages.

Correct operation of **RXBLOCK** is dependent on the **AWLEN** parameter getting set to 8 (bits) since the character FF hex marks the beginning of a received data unit header.

When **RXBLOCK** is **ON**, data from other stations will be sent from the MFJ-1278B in the following format:

\$FF	L0.....L1	PID	DATA
{ prefix }	{ length }	{ pid }	{ data }

The fields above are defined as follows:

prefix **\$FF** A character with all 8 bits set

length **L0** The high order length of the data, length, and pid fields logically ORed with the value \$F0

L1 The low order length of the data, length, and pid fields

pid **PID** The Protocol IDentifier byte received for the following data field

data **DATA** [Optional], variable length data

For best operation it is suggested that parameters like AUTOLF, MFILTER etc. be set OFF in order to prevent uncertainties in the size of the data field.

RXBRIGHT n

Mode: FAX/SSTV

Default: 4

Parameter:

n 0 - 9; specifying a certain set of TVBreak points

The **RXBRIGHT** command is used to select a certain set of **TVBreak** values for use with the SSTV and Multi-Level FAX modes. The **TVBreak** sets within the **RXBRIGHT** command control the **brightness** and **contrast** of the received SSTV and Multi-Level FAX pictures.

The **smaller** the **RXBRIGHT** number, the **darker** the received picture. The **larger** the **RXBRIGHT** number, the **brighter** the received picture.

When the **RXBRIGHT** number set to 0, then the MFJ-1278B uses the current setting, determined by the setting of the **TVBreaks** command. The **TVBreaks** command may have been changed by the user to something other than the default. The default TVBreak setting when **RXBRIGHT** is set to 0 is shown below:

0 TVB \$80, \$46, \$47, \$48, \$4C, \$4F, \$52, \$54, \$59, \$5C, \$5E, \$60, \$63, \$67, \$69

If the **RXBRIGHT** command is a non-zero value, 1 through 9, the MFJ-1278B uses the TVBreaks set that corresponds to the **RXBRIGHT** number. A list of the TVBreaks settings within the **RXBRIGHT** command is shown below:

RXBR n	TVBreak Values
0	TVB\$80,\$46,\$47,\$48,\$4C,\$4F,\$52,\$54,\$59,\$5C,\$5E,\$60,\$63,\$67,\$69
1	TVB \$80,\$48,\$4A,\$4C,\$4E,\$50,\$52,\$54,\$56,\$58,\$5A,\$5C,\$5E,\$60,\$62
2	TVB \$80,\$49,\$4B,\$4D,\$4F,\$51,\$53,\$55,\$57,\$59,\$5B,\$5D,\$5F,\$61,\$63
3	TVB \$80,\$4A,\$4C,\$4E,\$50,\$52,\$54,\$56,\$58,\$5A,\$5C,\$5E,\$60,\$62,\$64
4	TVB \$80,\$4B,\$4D,\$4F,\$51,\$53,\$55,\$57,\$59,\$5B,\$5D,\$5F,\$61,\$63,\$65
5	TVB \$80,\$4C,\$4E,\$50,\$52,\$54,\$56,\$58,\$5A,\$5C,\$5E,\$60,\$62,\$64,\$66
6	TVB \$80,\$4E,\$50,\$52,\$54,\$56,\$58,\$5A,\$5C,\$5E,\$60,\$62,\$64,\$66,\$68
7	TVB \$80,\$4F,\$51,\$53,\$55,\$57,\$59,\$5B,\$5D,\$5F,\$61,\$63,\$65,\$67,\$69
8	TVB \$80,\$50,\$52,\$54,\$56,\$58,\$5A,\$5C,\$5E,\$60,\$62,\$64,\$66,\$68,\$6A
9	TVB \$80,\$51,\$53,\$55,\$57,\$59,\$5B,\$5D,\$5F,\$61,\$63,\$65,\$67,\$69,\$6B

RXCAL

Mode: All

Immediate Command

RXCAL is an immediate command. When invoked, the MFJ-1278B generates test signals (based on CALSET -- see below) that are used by the internal tuning software to align the demodulator components.

To use the RXCAL feature,

1. Align the modulator components as described in the owners manual.
2. Use the MODE command to select the demodulator to be tuned. Make sure JMP8, JMP7 and JMP 4 are installed.
3. From the cmd: prompt type the command "CALSET **n**". Use the n value from the **CALSET Adjustment & Location Map** on the next page.
4. From the cmd: prompt type the **RXCAL** command.
5. Tune the appropriate trimpot (R79, R113, R114, or R115) until the DCD light is lit fully.
6. Continue tuning this trimpot until the CON and STA LEDs flash either alternately every half second, and/or both light up
7. Return to step 2 until all the demodulators are tuned.

NOTE: RXCAL is not effective for alignment of the CW demodulator.

CALSET Adjustment & Location Map

This is a map of the physical locations of the adjustment potentiometers on the MFJ-1278B circuit board. They are shown as they appear when looking down on top of the board with the board oriented so that the rear panel connectors are to the left. Information in the boxes is organized as shown below.

PART MODE
CALSET #

PART MODE H/L	PART MODE H/L
FREQ / CALSET	FREQ / CALSET

DEMODULATOR

R113 HP CALSET 32
R114 VB CALSET 32
R79 VP CALSET 8
R115 CW NO CALSET SEE NOTE BELOW

MODULATOR

R106 HP L 2125 247	R77 VP H 2200 240
R122 VB L 2125 247	R105 HP H 2295 229
R78 VP L 1200 438	R119 VB H 2975 177
R138 SSTV H 1500 350	R129 MCW 700 751 SEE NOTE

NOTE: Separate procedure required to do alignment of CW demodulator center frequency.

NOTE: MCW modulator tone is also used for SSTV transmission. However, CW receive through a narrow filter for HF CW operation will require the CW demodulator center

RVFALWAY ON/OFF

Mode: Mailbox

Default: ON

Parameters:

ON Initiates forwards and reverse forwards of all forwardable messages.**OFF** Mailbox ignores Forward and NODEforw commands.

The setting of **RVFALWAY**(s) controls whether the TNC will initiate forward events, via the **FORWARD** and **NODEFORW** commands in the absence of forwardable messages. If **OFF**, the TNC will ignore **FORWARD** and **NODEFORW** commands entered in the absence of forwardable messages. When **ON**, the TNC runs the event for the sole purpose of eliciting reverse-forwardable messages from the remote BBS.

RXINVERT ON/OFF

Mode: RTTY/ASCII

Default: OFF

Setting the **RXINVERT** command to **ON** causes the MFJ-1278B to change its decoding scheme for Baudot RTTY and ASCII signals. The MFJ-1278B changes the decoding scheme from the **standard low tone** used for **MARK** to the **inverted high tone** used for **MARK**.

At times, stations you work may inadvertently be in the wrong sideband mode. If you not printing him correctly, then try turning **RXINVERT ON**.

SCREENLN n

Mode: All

Default: 80

Parameters:

n 0 - 255, specifying the screen or platen width, in characters, of the terminal.

This value is used to properly format terminal output. A <CR> <LF> sequence is sent to the terminal at the end of a line in Command and Converse Modes when **n** characters have been printed. A value of zero inhibits this action.

If your computer automatically formats output lines, you should set **SCREENLN 0** to avoid a conflict between the two line formats.

SELCALL ssss

Mode: AMTOR

Immediate Command)

The **SELCALL** command initiates a **Mode L "SELCALL" broadcast**. The **ssss** is the four

Parameters:

n 0 - \$7F, specifying an ASCII character code.

This command selects the character that will force a packet to be sent in Converse Mode. The parameter **n** is the ASCII code for the character you want to type in order to force your input to be packetized and queued for transmission. You can enter the code in either hex or decimal.

For ordinary conversation, you will probably set **SENDPAC \$0D** and **CR ON**. This causes packets to be set at natural intervals, and causes the <CR> to be included in the packet.

If you have set **CPACTIME ON**, you will probably set **SENDPAC** to some value not ordinarily used (say, <CTRL-A>), and set **CR OFF**. This will allow you to force packets to be sent, but will not result in extra <CR> characters being transmitted in the text.

SERIALNO n

Mode: CW

Default: 0

Parameters:

n=0 - 65535

SERIALNO is useful as a contest QSO number counter. When transmitting a buffer, the MFJ-1278B scans the buffer text to see if there are any pound sign "#" characters and if it encounters any then the current value of the **SERIALNO** counter inserted in the buffer text being sent. After this value is loaded, **SERIALNO** is incremented by one until it reaches 65535, where it rolls over to zero.

If for some reason the serial number must be changed during the contest, merely escape to command mode and enter the new serial number by using the **SERIALNO** command.

MFJ-1278B MULTI-MODE**OPERATIONAL COMMANDS****SETUP**

Mode: ALL

Default: see table below

All possible baud rates and modem configurations are displayed on the SETUP menu. The selected baud rates and modem configurations are also shown.

Anytime the MFJ-1278B default values are loaded the baud rate and modem default profile is loaded as well. The defaults are shown in the below table:

Modem	Mode	Default Baud Rate/ Speed/ Format
P	VHF Packet	1200
H	HF Packet	300
V	VHF Baudot RTTY	45
H	HF Baudot RTTY	45
V	VHF Ascii RTTY	110
H	HF Ascii RTTY	110
C	CW	20 WPM
C	Memory Keyer	20 WPM
P	Wefax/Fax	3 (120 Lines/Min.)
P	SSTV	1 (8.5 Sec. format)
H	Amtor/Navtex	100
M	Multi-level FAX/SSTV	All Formats

The terminal baud rate and modem configurations may be changed by using the SETUP command.

SFNL ON/OFF

Mode: AMTOR

Default: OFF

SFNL controls whether the MFJ-1278B adds a new line character to "+?" and WRU.

SLOTS nnn

Mode: Packet

Default: 3

Parameter:

nnn 0 - 127, specified the number of sides on the slot time dice.

The **SLOTS** parameter determines how many sides are on the slot time dice. **SLOTS** represents an n+1 sided dice the TNC "throws" before transmitting. The **SLOTS** command allows any number of slots from 1 thru 127 to be defined.

SLOTS (n)	REMARKS
1	Disables Slotting
2	
4	This should be the default setting
8	Use only if the channel is VERY busy.
16	VERY VERY VERY busy !
32	You get the idea.
64	
128	Might as well print it out & send it in the mail.

The value used on a particular channel should be agreed on by the channel users. Access to the channel will be equitably distributed among all users if everybody is using the same value for the **SLots** and **DEAdtime** parameters.

The idea is to pick a value large enough that the probability of two queued up stations picking the same value is relatively small. On the other hand, the value chosen should be small enough that most of the time, ONE of the queued up stations will have a significant probability of picking the first available slot. In this way, the channel is reliably arbitrated and at the same time the overhead required for the arbitration is minimized so that overall throughput on the channel is maintained. The actual value used will depend on the average number of queued up stations there are on the channel during busy periods.

SOLF ON/OFF

Mode: AMTOR

Default: ON

SOLF determines whether only **LINEFEED** characters from the AMTOR receiver are sensed as newline characters. If **SOLF** is **OFF** then carriage return and linefeed characters are passed directly through to the terminal, otherwise every received linefeed character will generate a <CR>,<LF> newline sequence.

MFJ-1278B MULTI-MODE

OPERATIONAL COMMANDS

SRXALL ON/OFF

Mode: AMTOR

Default: ON

The MFJ-1278B will print all receivable mode S transmissions when SRXALL is on.

Taking advantage of the ability to receive an addressed mode S transmission requires **SRXALL ON** and a match between the address being sent and your MYSELCAL.

If **SRXALL** is **OFF** and MYSELCAL does not match the address in the received mode S transmission, the MFJ-1278B ignores the transmission.

START n

Mode: All

Default: \$11

Parameters:

n 0 - \$7F, specifying an ASCII character code.

The **START** command selects the **User Restart character**, that is used to restart the output from the MFJ-1278B to the terminal after it has been halted by typing the **User Stop character**. You can enter the code in either hex or decimal.

The User Stop character is set by the **STOP** command.

If the User Restart and User Stop characters are set to \$00, software flow control to the MFJ-1278B is disabled, and the MFJ-1278B will only respond to hardware flow control (CTS).

If the same character is used for both the User Restart and User Stop characters the MFJ-1278B will alternately start and stop transmission upon receipt of the character.

STatus

Mode: Pactor

Immediate Command

STATUS is an immediate command used for display of debug information. This is helpful for troubleshooting Pactor problems. If any Pactor problems occur and you are still able to talk to the MFJ-1278B, then type this command from the p_cmd: prompt. The MFJ-1278B will send the Pactor Status to the screen. Copy all displayed information on a piece of paper and call our technicians.

STATUS

Mode: AMTOR

Immediate Command)

The **STATUS** command returns diagnostic information useful for helping us help you with

STOP n

Mode: All

Default: \$13

Parameters:

n 0 - \$7F, specifying an ASCII character code.

The **STOP** command selects the **User Stop character**, which is used to stop output from the MFJ-1278B to the terminal. You can enter the code in either hex or decimal. This is the character you will type to halt the MFJ-1278B's typing so that you can read text before it scrolls off your display.

Output is restarted with the User Restart character, which is set by the START command.

If the **User Restart** and **User Stop characters** are set to \$00, software flow control to the MFJ-1278B is disabled, and the MFJ-1278B will only respond to hardware flow control (CTS).

If the same character is used for both the **User Restart** and **User Stop characters** the MFJ-1278B will alternately start and stop transmission upon receipt of the character.

STREAMCA ON/OFF

Mode: Packet

Default: OFF

Parameters:

ON Callsign of other station displayed.**OFF** Callsign of other station not displayed.

This command is used to enable the display of the connected-to station after the stream identifier. This is particularly useful when operating with multiple connections allowed. It is somewhat analogous to the use of **MRPT** to show digipeat paths when monitoring.

In the example below, the characters inserted by enabling **STREAMCA** are shown in bold face type.

```
A:K4NTA:hi howie
ello ted how goes it?
B:WA7GXD:*** CONNECTED to WA7GXD
Bmust be a dx record. ge lyle
Aunreal ted! fl-az no digis!
B:WA7GXD:big band opening...ge
```

etc.

The same sequence with **STREAMCA** **OFF** would look like the following:

```
Ahi howie
hello ted how goes it?
B*** CONNECTED to WA7GXD
Bmust be a dx record. ge lyle
Aunreal ted! fl-az no digis!
Bbig band opening...ge
```

etc.

Thus, what would have looked like "|B" now appears as "|B:<callsign>:". This option is very useful for human operators trying to operate multiple simultaneous connections. It is probably less useful for "host" operations.

Note that, in the first example, the **STREAMSW** characters "|A" and "|B" with no ":" after them were entered by the operator of the TNC to switch streams for his multiple-connection QSO(s). If you intend to operate multiple connections (as opposed to having your

STREAMDB ON/OFF

Mode: Packet

Default: OFF

Parameters:

ON Double all received **STREAMSWitch** characters.**OFF** Do not "double" received **STREAMSWitch** characters.

This command is used to display received **STREAMSWitch** characters by "doubling" them. The example below illustrates this action.

With **STREAMDB** on, and **STREAMSWitch** set to "|", the following might be displayed from your MFJ-1278:

|| this is a test.

In this case the sending station actually transmitted

| this is a test.

The same frame received with **STREAMDBL** OFF would be displayed as:

| this is a test.

When operating with multiple connections, this is useful for differentiating between **STREAMSWitch** characters received from other stations and **STREAMSWitch** characters internally generated by your MFJ-1278B.

NOTE: The **STREAMSWitch** character must NOT be one of the stream letters (A - J) for this command to function properly.

STREAMSW n

Mode: Packet

Default: \$7C

Parameters:

n = 0 - \$FF, usually specifying an ASCII character code.

This command selects the character used by both the MFJ- 1278B and the user that a new "stream" (connection channel) is being addressed.

The character can be **PASSEd** in **CONVERS** mode. It is always ignored as a user-initiated stream switch in **TRANSPARENT** mode, and flows through as data. This means that the

When the **MAILBOX** is **ON**, the **System Operator** can access the mailbox by typing the immediate command, **SYSOP**. All commands are available to the **SYSOP**. When the **SYSOP** has completed operating the **MAILBOX**, he must return to command mode with "Control-C" (or the current **COMMAND** character) to allow the remote users access to the **MAILBOX**.

TIMEDCMD text string Mode: Mailbox Default: " "

Parameters:

[string- max 119 chars]

This string in the **TIMEDCMD** parameter is executed as a TNC command whenever the minutes register in the time of day clock equals the value in the **TIMEDMIN** parameter. The string is executed when seconds equals one; execution is deferred while the user is entering a command.

TIMEDMIN n Mode: Mailbox Default: 60

Parameters:

n 0 - 60, specifying 1 minute intervals

The **TIMEDMIN** parameter is compared against the minutes register of the real time clock to determine when the **TIMEDCMD** string is sent to the command interpreter. Setting this parameter to 60 disables the feature. Combined with the **TIMEDCMD** string, the user may configure his TNC to perform hourly automatic forwards and reverse forwards.

TINV ON/OFF Mode: AMTOR Default: OFF

Parameters:

ON Transmit signal is inverted from standard low tone MARK, to high tone MARK.

OFF Transmit signal is standard low tone MARK.

TINV controls whether the MFJ-1278B inverts the transmitted AMTOR signals. It is similar to **TXINVERT** in RTTY/ASCII modes.

TRACE ON/OFF

Mode: Packet

Default: OFF

Parameters:

ON Trace mode is enabled.

OFF Trace mode is disabled.

This command is used to enable the protocol debugging function. When the **TRACE** command is **ON**, all received frames will be displayed in their entirety, including all header information. In normal operation you will probably never need this function; however, if you need to report an apparent software bug, we may ask you to provide trace information if possible.

A trace display will appear in four columns on an 80-column display. Following is an example trace display. For comparison, the frame shown in the trace example would be monitored as follows:

KV7B>CQ,KF7B*:this is a test message

The trace display would look like this:

```

byte -----hex display-----shifted ASCII-----ASCII-----
000: 86A24040 40406096 AC6E8440 4060968C CQ 0KV7B 0KF ..@@@`.n.@`.
010: 6E844040 E103F074 68697320 69732061 7B P.x:449.49.0 n.@...this is a
020: 20746573 74206D65 73736167 650D      .:29:.6299032. test message.
    
```

The **byte** column shows the offset into the packet of the beginning byte of the line. The **hex display** column shows the next 16 bytes of the packet, exactly as received, in standard hex format. The **shifted ASCII** column attempts to decode the high order seven bits of each byte as an ASCII character code. The **ASCII** column attempts to decode the low order seven bits of each byte as an ASCII character code. In a standard AX.25 packet, the **callsign** address field will be displayed correctly in the **shifted ASCII** column. A text message will be displayed correctly in the **ASCII** column. Non-printing characters and control characters are displayed in both ASCII fields as ".". You can examine the **hex display** field to see the contents of the sub-station ID byte and the control bytes used by the protocol. Protocol details are discussed in Chapter 9.

TRace ON/OFF

Mode: Pactor

Default: OFF

This command displays continuous debug information to the computer screen. This is the

TRANS

Mode: Packet

Immediate Command

This is an immediate command. It causes the MFJ-1278B to exit from Command Mode into Transparent Mode. The current link state is not affected.

Transparent Mode is primarily useful for computer communications. In this mode, the "human interface" features such as input editing capability, echoing of input characters, and type-in flow control are disabled. You may find **Transparent Mode** useful for computer Bulletin Board operations or for transferring non-text files. See the discussion of Transparent Mode in Chapter 5.

TRFLOW ON/OFF

Mode:Packet

Default: OFF

Parameters:

ON Software flow control can be enabled for the computer or terminal in Transparent Mode.

OFF Software flow control is disabled for the computer or terminal in Transparent Mode.

If **TRFLOW** is **ON**, the settings of **START** and **STOP** are used to determine the type of flow control used in Transparent Mode. If **TRFLOW** is **OFF**, only hardware flow control is available to the computer and all characters received by the MFJ-1278B are transmitted as data. If **START** and **STOP** are set to \$00, disabling the **User Stop** and **User Restart** characters, hardware flow control must always be used by the computer.

If **TRFLOW** is **ON**, and **START** and **STOP** are non-zero, software flow control is enabled for the user's computer or terminal. The MFJ-1278B will respond to the User's Restart and User's Stop characters (set by **START** and **STOP**) while remaining transparent to all other characters from the terminal. Unless **TXFLOW** is also **ON**, only hardware flow control is available to the MFJ-1278B to control output from the terminal.

TRIES n

Mode: Packet

Default: NONE

Parameters:

n = 0 -15, specifying the current **RETRY** level on the currently selected input stream.

This command is used to retrieve or force the count of "**tries**" on the currently selected input stream.

When used with no argument:

1. If the MFJ-1278B has an outstanding unacknowledged frame, it will return the current number of tries.
2. If the MFJ-1278B has no outstanding unacknowledged frames, it will return the number of tries required to obtain an acknowledgment for the previous frame.

If **RETRY** is set to 0, the value returned by issuing a **TRIES** command will always be 0.

This command is useful for obtaining statistics on the performance of a given path or channel. It should be especially useful for automatic optimizing so such parameters as **PACLEN** and **MAXFRAME** by computer-operated stations, such as automatic message forwarding stations using less-than-optimum paths (noisy HF or satellite channels, for example).

When used with an argument, **TRIES** will force the "tries" counter to the entered value. Use of this command to force a new count of tries is **NOT** recommended.

TUNE

Mode: All

Immediate Command

The **TUNE** command is an immediate command. The **TUNE** command keys the PTT and low tone for the current modem for 30 seconds or until you strike a key on your computer keyboard.

TUNEPROC

Mode: All

Immediate Command

TUNEPROC is a immediate command. It is used to calibrate the MFJ-1278B modulators and demodulators. See APPENDIX B under "Modulator and De-Modulator Calibration" for the use of **TUNEPROC**.

TVBREAKS n

Mode: SSTV

Default: (see below)

Parameters:

n = \$aa,\$bb,\$cc,\$dd,.....,\$kk,\$ll,\$mm,\$nn,\$ss

TVBreaks are arranged in the following format:

```

*   White           *   gray           *   Black   *
*   area           *   area           *   area   *
$ss, $aa, $bb, $cc, $dd, $ee, $ff, $gg, $hh, $ii, $jj, $kk, $ll, $mm, $nn
|___ Sync
    
```

The default TVBreak values are as follows:

TVB \$80, \$46, \$47, \$48, \$4C, \$4F, \$52, \$54, \$59, \$5C, \$5E, \$60, \$63, \$67, \$69

Note that the values for the **TVBREAKS** command are in **HEX**. The smaller values represent the lighter shade of gray. The value **\$46** is the **white** and **\$69** is **black** and the values in between define the gray areas. **Sync** is the first value at **HEX \$80**. Sync value should not be changed when resetting the **TVBREAK** values.

TVBREAKS control the **brightness and contrast** of the SSTV images received on the MFJ-1278B computer screen and also the printer port. SSTV pictures sent to the MFJ-1278B printer port are set to **4 gray-levels**. With special terminal software which supports multi-gray level SSTV, you can receive color SSTV and 16 gray level B&W SSTV.

If the picture you are receiving does not seem to have the right contrast or tint, reset the **TVBREAK** values. This can also be done by changing the setting of the **RXBRIGHT** command. Please see the **RXBRIGHT** command in this chapter.

Note that if you choose to operate only **4 level SSTV** such as printing to the MFJ-1278B printer port, the MFJ-1278B will automatically select 4 TVBREAK values from the 16 TVBREAK values which you have selected.

TVHSYNC ON/OFF

Mode: SSTV

Default: OFF

When receiving SSTV pictures, your MFJ-1278B will usually maintain correct synchronization with the picture as long as the transmitting station is keeping accurate time. However, some stations may attempt to use a tape recorder or some other unstable picture source. In case the received picture is shown as very unstable, setting **TVHSYNC ON** may

TVMODE **n**

Mode: SSTV

Immediate Command

Parameter:

n = 1 to 5; specifying a SSTV picture format

The **TVMODE** command selects the formats under the SSTV mode for the MFJ-1278B. When the built-in printer port is used to receive SSTV, the MFJ-1278B supports all SSTV formats listed in table below.

TVMODE(n)	Formats
1	8.5 seconds
2	12 seconds
3	17 seconds
4	24 seconds
5	36 seconds

The SSTV format can be changed by using the **TVMODE (n)** command, where **n** is a number from 1 thru 5 as listed in the above table. For example, to set the MFJ-1278B to 12 seconds SSTV format, you would type: **TVMODE 2 <CR>**.

TVMODE is ineffective when the command TVX is turned ON. When TVX is on, MFJ-1278B supports additional SSTV formats listed Table 4-9 in this manual.

TVX ON/OFF

Mode: SSTV

Default: OFF

Parameters:

- ON** Multi-level SSTV raw data is sent to the terminal without presetting the SSTV format.
- OFF** Multi-level SSTV raw data is sent to the terminal in format set by the TVMODE command

TVX command sets the format that the MFJ-1278B sends the SSTV pictures to the terminal. When TVX is turned ON, the SSTV picture format is not preset. The terminal program must be responsible to detect the end of the SSTV picture. The MFJ-1278B does not detect the end of the picture no matter what TVMODE is set. This means that MFJ-1278B can receive any format of SSTV picture, like a "free running mode". It is not limited by the TVMODE command. Picture lengths longer than 36 seconds are possible as long as the terminal program can detect the end of the picture when the picture is being received.

When TVX is turned OFF, SSTV picture format is determined by the setting of the TVMODE command. For example, if TVMODE is set to 5 (36 seconds format), the picture sent to the terminal will end at 36 seconds. Which means that if you set the TVMODE too short, you may not receive the whole picture.

TVX is automatically turned **OFF** when **PRINTGRA** is turned **ON**; this sends SSTV picture being received to the built-in printer port. When SSTV pictures are sent to the printer port in 4 gray levels when **PRINTGRA** is set to ON.

TXDELAY n

Mode: Packet

Default: 33

Parameters:

n 0 - 120, specifying 10 ms intervals.

This value tells the MFJ-1278B how long to wait after keying up the transmitter before sending data. Some startup time is required by all transmitters to put a signal on the air; some need more, some need less. In general, crystal controlled rigs with diode antenna switching do not need much time, synthesized rigs need time for PLL lockup, and rigs with mechanical T/R relays will need time for physical relay movement. The correct value for a particular rig should be determined by experimentation. The proper setting of this value may also be affected by the requirements of the station you are communicating with.

MFJ-1278B MULTI-MODE

OPERATIONAL COMMANDS

TXDelay **n**

Mode: Pactor

Default: 2 (60ms)

Parameters:

$$n = \text{Actual Delay Time equals } n + 10\text{ms} * 5\text{ms}$$

Similar to **AMTOR's DELAY** and packet's **TXDELAY**. The actual delay yielded is equal to $(10\text{ms} + (\text{TXDELAY} * 5\text{ms}))$. If the combined TXDELAYs of both stations involved in the link exceeds about 180ms, then shortpath connections may not work, particularly at longer distances. If difficulty is experienced, try using the Longpath Connect ("LC") command to connect.

TXDELAYC **nnn**

Mode: Packet

Default: 2

Parameter:

$$nnn \text{ 0 thru 255 in 1 ms step}$$

The time delay between when the MFJ-1278B depresses the PTT and when it starts sending packets is specified in terms of how long it takes to send (TXDELAYC) characters at the current radio baud rate. TXDELAYC controls a new timer that runs after the regular TXDELAY time has expired (see TXDELAY).

High speed radio users will find this command useful because they can select transmit delays much smaller than the 10 ms grains in TXDELAY. For high speed use, set TXDELAY to 0 and set TXDELAYC according to the formula below:

$$\text{TXDELAYC} = \text{Radio-PTT-delay-time} / \text{Time-per-character}$$

The time-per-character as related to the radio baud rate is as follows:

Baud Rate	Time-per-character
9600	.83 ms
2400	3.30 ms
1200	6.70 ms
300	26.00 ms

Examples:

1. For a 200 ms 2 meter HT at 1200 baud, TXDELAYC is:

TXDIDDLE ON/OFF

Mode: Packet

Default: OFF

Parameters:

ON The MFJ-1278B uses the efficient square wave TXDIDDLE routine.

OFF The MFJ-1278B uses flags during TXDELAY period.

TXDIDDLE determines whether or not the MFJ-1278B uses a highly efficient square wave signal in place of flags during the transmitter delay (TXDELAY) period. When **TXDIDDLE** is **ON**, you may select even smaller TXDELAY intervals because the square wave presents four times as many transitions as **TXDIDDLE OFF** does for your connectees' receive synchronization.

TXDIDDLE is defaulted to the **OFF** setting to reflect that the function is inactive. However, there are a number of TNCs on the market which claim to be AX.25 compatible, but do not recognize valid AX.25 packets preceded by the **TXDIDDLE** keyup technique. You may recognize the need to set **TXDIDDLE OFF**, if it appears that the station you're working is unable to successfully receive your packets despite your adequate signal.

This failure of some TNCs to receive **TXDIDDLEd** packets may be a result of some software carrier-detect schemes. All TAPR and derivative TNCs utilizing hardware-generated carrier-detect receive both **TXDIDDLEd** and **non-TXDIDDLEd** packets with equal efficiency.

Note that when **TXDIDDLE** is OFF, TXDELAYC is irrelevant! Therefore, the actual TXDELAY yielded when TXDIDDLE is OFF is equal to TXDELAY*100ms plus any AXDELAY time.

MFJ-1278B MULTI-MODE

OPERATIONAL COMMANDS

TXFLOW ON/OFF

Mode: All

Default: OFF

Parameters:

ON Software flow control can be enabled for the MFJ-1278B in Transparent Mode.

OFF Software flow control is disabled for the MFJ-1278B in Transparent Mode.

If **TXFLOW** is **ON**, the setting of **XFLOW** is used to determine the type of flow control used in Transparent Mode. If **TXFLOW** is **OFF**, the MFJ-1278B will use only hardware flow control and all data sent to the terminal remains fully transparent.

If **TXFLOW** and **XFLOW** are **ON**, the MFJ-1278B will use the MFJ-1278B Restart and MFJ-1278B Stop characters (set by **XON** and **XOFF**) to control input from the terminal. Unless **TRFLOW** is also **ON**, only hardware flow control is available to the computer or terminal to control output from the MFJ-1278B.

Note that if the MFJ-1278B **Restart** and **Stop** characters are set to **\$00**, hardware flow control will always be selected regardless of the setting of **TXFLOW**.

TXINVERT ON/OFF

Mode: RTTY/ASCII

Default: OFF

When the **TXINVERT** command is **ON**, the transmitted RTTY/ASCII data by the MFJ-1278B is sent inverted, i.e. the marks are sent as spaces and vice versa.

TXTMO n

Mode: Packet

Default: 0

Parameters:

n = 0 - 65535

TXTMO is a **HEALTH** counter that registers the number of packet transmitter timeout/recovery events that have occurred since the MFJ-1278B was powered up.

MFJ-1278B MULTI-MODE

OPERATIONAL COMMANDS

TXUIFRAME ON/OFF

Mode: Packet

Default: ON

TXUIFRAME is used to tell the MFJ-1278B what to do with unconnected information left in its buffers. When this parameter is ON, all unconnected data are transmitted as "UI" (unconnected) frames.

The **TXUIFRAME** command should be **OFF** for bulletin-board stations as it precludes the unnecessary transmission of text that occurs when the BBS user disconnects and unacknowledged packets remain.

U1 UNproto

Mode: Pactor

Immediate Command

Issuing the **U1** command from the **p_cmd:** prompt initiates the 100 baud FEC. The **U1** mode is mainly used during poor band conditions. The MFJ-1278B will request a SPEEDdown to the **U1** mode depending on the number of error-laden 200 baud information packets received. (ALSO SEE MAXDdown and NO200)

U2 UNproto

Mode: Pactor

Immediate Command

Issuing the **U2** command from the **p_cmd:** prompt will initiate the 200 baud FEC mode. The **U2** mode can also be used during good band condition where communications are real good. The MFJ-1278B will request a SPEEDUP to the 200 baud depending on the number consecutive good 100 baud information packets it receives. (ALSO SEE MAXUP and NO200)

UNPROTO call1

Mode: Packet

Default: "CQ"

[VIA call2[,call3...,call9]]

Parameters:

call1 Callsign to be placed in the TO address field.

call2 Optional digipeater call list, up to eight calls.

This command is used to set the digipeat and destination address fields of packets sent in the unconnected (unprotocol) mode. Unconnected packets are sent as unsequenced I frames with the destination and digipeat fields taken from call1 through call9 options. When no destination is specified, unconnected packets are sent to CQ. Unconnected packets sent from

MFJ-1278B MULTI-MODE

OPERATIONAL COMMANDS

UNSHIFT ON/OFF

Mode: RTTY

Default: ON

In Baudot RTTY receive mode only, UNSHIFT ON forces the receiver shift to the LTRS case whenever the Baudot SPACE character is received. This helps in many situations in reducing garbling when conditions are not good.

Some stations, particularly those transmitting weather information and other strings of numeric text, are not compatible with unshift on space (USOS). When receiving those stations, UNSHIFT should be turned OFF.

URpeats nm

Mode: Pactor

Default: 1

Parameters:

nm = 1<=nn<=7

The **UREPEATS** parameter specifies how many retransmissions to perform for each FEC data packet sent.

For example **UREPEATS + 1** causes each FEC packet to be sent two times.

USERS n

Mode: Packet

Default: 1

Parameters:

n = 0 - 10, specifying the number of active connections that may be established to the MFJ-1278B by other TNCs.

USERS affects only the manner in which incoming connect requests are handled, and has no effect on the number or handling of connections you may initiate with this MFJ- 1278B.

For example,

USERS 0	Allows incoming connections on any free stream
USERS 1	Allows incoming connections on stream A only
USERS 2	Allows incoming connections on streams A & B
USERS 3	Allows incoming connections on streams A, B & C

and so on through **USERS 10**.

VISTICKS **nnnn**

Mode: SSTV

Default:0

Parameters:

nnnn 0<nnnn<65535

The **VI**sticks parameter specifies the number of pixels to send at the beginning of a **SSTV** picture that will use the alternate **VISTONES** modem configuration list. After **VISTICKS** pixels are sent, remaining picture data use the **PIXTONES** list.

Note that setting the **VISTICKS** command to its Default of 0, the **VIS** routine is disabled. This command is significant only during transmit. The value is ignored in the FAX mode.

VISBREAK [TVBREAKS-like list]

Invoke the **TVBREAKS-like list** by sending the letter 'V' to the MFJ-1278B, when the TNC is receiving. Sending anything but 'V' causes the MFJ-1278B to use **TVBREAKS**.

To support **VIS** reception, the terminal program *must* first manually lock onto the signal (send 'L'), where upon the TNC is free running and receiving according to the **TVBREAKS** parameters. The terminal program should set **VISTONES** (the defaults may not be appropriate) to detect 1100,1200,1300,and >= 1500 hz, and send 'V' to the TNC to begin reception according to **VISTONES**. The terminal program must monitor the data stream for lock and VIS data. Upon detecting lock and acquiring VIS, the terminal program must then send any character other than 'V' to restore the TNC and begin ordinary reception.

VISTONES PIXTONES-like list]

The tones specified by **VISTONES** are used in place of the **PIXTONES** values for the first **VISTICKS** pixels of a transmitted picture.

Defaults:

<u>Nibble</u>	<u>Tone</u>
0..10	1300Hz
11..14	1200Hz
15	100Hz

MFJ-1278B MULTI-MODE

OPERATIONAL COMMANDS

WAITDISC nn

Mode: Pactor

Default: 20

Parameters:

nn = 10<=nn<=255

The **WAITDISC** command determines the number of cycles the MFJ-1278B waits to reply to the other TNC, that having requested a disconnect, fails to hear our disconnect acknowledgement.

WDMODE ON/OFF

Mode: AMTOR

Default: OFF

WDMODE, word mode, determines whether a Mode A transmission takes place any time you type a SPACE or RETURN character, or only when you type a carriage return.

WDMODE OFF, the default condition, sets the MFJ-1278B so that it buffers you're transmitted text a line at a time before sending it. If it's **ON**, the MFJ-1278B immediately sends each word as you end it with a **SPACE** or **RETURN**.

WEIGHT n

Mode: CW

Default: 0

Parameters:

n = 0 thru 255

The **WEIGHT** command is used to set the weight factor applied to paddle and CW keyboard generated code elements. The value of weight is represented as a 2's complement byte and it alters the dot / space ratio. Therefore one should use values between **128 and 255** to **DECREASE** the weight factor, and 1 to 127 to **INCREASE** the weight factor.

The number specified results in an absolute increase or decrease in the ratio of dot to space time that is equivalent to approximately 8.67 ms.

NOTE: For weight calculation purposes, a dash gets the factor applied to only 1 of its 3 dot times. So that the time added to or removed from each element whether it is a dot or a dash is either removed from or added to the space following the element.

WRU

Mode: AMTOR

Default: (command)

The **WRU** command is used to set the "A" character to be used for the "A" character in the "A" character.

Parameters:

ON XON/XOFF flow control is enabled.

OFF XON/XOFF flow control is disabled and hardware flow control is enabled.

If **XFLOW** is **ON**, the computer or terminal is assumed to respond to the MFJ-1278B **Restart** and **Stop** characters set by **XON** and **XOFF**. If **XFLOW** is **OFF**, the MFJ-1278B will communicate flow control commands via **RTS**.

XMITOK ON/OFF

Mode: Packet

Default: ON

Parameters:

ON Transmit functions are enabled.

OFF Transmit functions are disabled.

When **XMITOK** is **OFF**, transmitting is inhibited. All other functions of the board remain the same, in other words, the MFJ-1278B generates and sends packets as requested, but does not key the radio PTT line.

You might use this command to insure that your MFJ-1278B does not transmit in your absence if you leave it operating to monitor packet activity. This command can also be used for testing using loopback or direct wire connections when PTT operation is not relevant.

XOFF n

Mode: All

Default: \$13

Parameters:

n 0 to \$7F, specifying an ASCII character code.

This command selects the MFJ-1278B Stop character, that is sent by the MFJ-1278B to the computer or terminal to stop input from that device. You can enter the code in either hex or decimal.

This character would ordinarily be set to <CTRL-S> for computer data transfers. If you are operating your station in a Converse Mode and there is some chance that you might fill up the MFJ-1278B's buffers, you might set this character to <CTRL-G> (\$07), which rings a bell on
----- terminate

XOff nn

Mode: Pactor

Default: ^S

Parameters:

 $nn = 0 \leq nn \leq 25$

This command determines the Flow Control **STOP** character. The Pactor **XOFF** command is the same as the **XOFF** command in the standard MFJ-1278B command set. For further information on the **XOFF** command please refer to the explanation of the **XOFF** command in Chapter 6 of the MFJ Data Controller Main Instruction Manual.

XOn nn

Mode: Pactor

Default: ^Q

Parameters:

 $nn = 0 \leq nn \leq 255$

This command determines the Flow Control **START** character. The Pactor **XON** command is the same as the **XON** command in the standard MFJ-1278B command set. For further information on the Pactor **XON** command please refer the explanation of the **XON** command in Chapter 6 of the MFJ Data Controller Main Instruction Manual.

* see discussion above for more on XON/XOFF software flow control

XON n

Mode: All

Default: \$11

Parameters:

 n 0 to \$7F, specifying an ASCII character code.

This command selects the MFJ-1278B Restart character, which is sent by the MFJ-1278B to the computer or terminal to restart input from that device. You can enter the code in either hex or decimal.

This character would ordinarily be set to <CTRL-Q> for computer data transfers. If you are operating your station in Converse Mode, and there is some chance that you might fill up the MFJ-1278B's buffers, you might set this character to <CTRL-G> (\$07), which rings a bell on many terminals.

MFJ-1278B SYSTEM MESSAGES

This chapter describes the messages your MFJ-1278B may produce and the circumstances under which they can appear.

PACKET MESSAGES

***:J**

bbRAM:LOAD WITH DEFAULTS

MFJ Enterprises, Inc.

Model MFJ-1278B

AX.25 Level 2 Version 2.0

RELEASE X.X.X - DATE - 32K RAM

Checksum XXX

cmd:

This is the MFJ-1278B sign-on message that appears when you turn your MFJ-1278B ON or when you issue the **RESET** command. The MFJ-1278B updates the **RELEASE** number whenever the user changes the firmware. The checksum is a hex number that you can compare with the correct checksum given for the firmware version you are using.

bbRAM loaded with defaults

This message appears along with the sign-on message above if the battery backed-up RAM checksum verification fails at power-on time, causing the MFJ-1278B to load the default parameters from ROM. This will be the case the first time you turn on your MFJ-1278B.

This message also appears if the MFJ-1278B loads the defaults in response to the **RESET** command. If the user issues the **RESET**, all parameters set by the user are lost.

cmd:

This is the **Command Mode** prompt. When this prompt appears, the MFJ-1278B is waiting for you to issue a command. Anything you type after this prompt will be interpreted as a command to the MFJ-1278B. If a monitored packet has been displayed, the prompt may not be visible, even though you are in Command Mode. You can type the redisplay-line character (set by REDISPLA) to retype the prompt.

was

Whenever you change the setting of one of the MFJ-1278B's parameters, the previous value will be displayed. This confirms that the MFJ-1278B properly interpreted your command, and reminds you of what you have done.

too many packets outstanding

This message would appear in response to a CONVERS or TRANS command, under special circumstances. If you have previously entered packet data, filling the outgoing buffer in Converse Mode or Transparent Mode and then returned to Command Mode. You will be allowed to enter one of these modes when some of the packets have been successfully transmitted.

Mailbox Messages**? Expected bank n....x**

This message occurs when you try to switch to an extended Mailbox memory bank which does not exist. For example trying switch to memory bank 8, using the 512K memory extension. Memory bank 8 **does not exist**, only banks 0 thru 7 are present.

You have new mail!

Upon accessing the mailbox, this message will appear if there are any new messages addressed to you. These will be the messages with the N message flag set. Once the message is read and the Y message is set, this message will not occur.

Message saved

The Message Saved occurs when a Mailbox message is actually stored after pressing the **CTRL-Z** and **ENTER**. This message also appears if the **/EX** and **ENTER**.

Cannot, not yours

This message occurs when a remote user attempts to kill a message that is not his, or he tries to read personal message by or for someone else. The **SYSOP** can **READ** or **KILL** any message in the Mailbox system.

?Mailbox full

This message occurs when either all of the available slots are full, or the actual message space is full. The number of slots and message space for the different mailbox versions are as follows:

Memory size	# Slots	Message Space
Unexpanded*	30	2,900 Bytes
32K**	99	32,000 Bytes
128K**	99/Bank	128,000 Bytes
512K**	99/Bank	512,000 Bytes

Not found

This message occurs when one attempts to read or kill a non-existent message from an empty slot. For example if the user issues the command **R 30** to read the message in message slot 30, and there is no message in message slot 30.

None found

A parameterless Kill or Read command. The **NONE FOUND** message occurs when the MFJ-1278B mailbox is unable to find any messages addressed to the user.

No mail

The No Mail message occurs when a Read command with no slot designator is done, but mail does not exist for the remote user.

COMMAND MODE ERROR MESSAGES

If you make a mistake typing a command to the MFJ-1278B, an error message will be printed. You may see any of the following messages depending on the type of error you have made.

?bad

You typed a command correctly, but the remainder of the command line couldn't be interpreted.

?call

You entered a **callsign** argument that does not meet the MFJ-1278B's requirements for **callsigns**. A **callsign** may be any string of numbers and letters, including at least one letter. Punctuation and spaces are not allowed. The sub-station ID, if given, must be a (decimal) number from 0 to 15, separated from the call by a hyphen.

?EH

This message occurs when a command issued is not understood by the MFJ-1278B. This will happen if you are in the mailbox or just during standard operation.

?clock not set

This message appears if you give the command **DAYTIME** to display the date and time without having previously set the clock. The **DAYTIME** command sets the clock if it is given with the daytime parameters, and displays the date and time if it is given without parameters.

?not enough

You did not give enough arguments for a command that expects several parameters. For example the command to initiate a beacon every 10 seconds is **B E 1**. If you issue the command **B E** the MFJ-1278B gives this message. The MFJ-1278B knows there is supposed to be another argument.

?not while connected

You attempted to change **MYCALL** or **AX25L2V2** while in a connected or connecting state. In order to eliminate this message either disconnect or halt the connect attempt, then change **MYCALL** or **AX25L2V2**.

?range

A numeric argument for a command was too large.

?too long

You entered too long a command line, and the line was ignored. This might happen, for example, if you try to enter too long a message with **BTEXT** or **CTEXT**. If you get this message, the previous text entry was not changed.

?too many

You gave too many arguments for a command that expects several parameters. For example, **MFILTER** if you issue the below **MFILTER** command to the MFJ-1278B:

cmd: MFILTER \$1B,\$0C,\$1A,\$03,\$07

?too many

The MFJ-1278B gives the **?TOO MANY** message because the maximum arguments for the **MFILTER** command is 4.

?VIA

This message appears if you attempt to enter more than one callsign for the **CONNECT** or **UNPROTO** commands without being preceded by the **VIA** keyword. For example:

C AA5XO AA5MT (No VIA between callsigns)

should be

C AA5XO VIA AA5MT Notice the VIA between callsigns.

Link Status Messages

These messages inform you of the status of AX.25 connections your MFJ-1278B may be involved in. You can always interrogate the link status by giving the **CONNECT** command without parameters. If you attempt a connection when your MFJ-1278B is not in the disconnected state, the MFJ-1278B will display the link status but will take no other action. The following messages appear in response to the **CONNECT** command.

Link state is: CONNECTED to call1 [VIA call2[,call3...,call9]]

This display shows the station your MFJ-1278B is connected to and the digipeater route if any. The **callsign** sequence is the same sequence you would enter to initiate the connection.

Link state is: DISCONNECTED

No connection currently exists. You may issue the **CONNECT** command to initiate a connection.

Link state is: CONNECT in progress

You have issued a connect request, but the acknowledgment from the other station has not been received. If you issue a **DISCONN** command, the connect process will be aborted.

Link state is: DISCONNECT in progress

You have issued a disconnect request, but the acknowledgment from the other station has not been received. If you issue a second **DISCONN** command, the MFJ-1278B will go immediately to the disconnected state.

Link state is: FRMR in progress

The MFJ-1278B is connected but a protocol error has occurred. This should never happen when two TAPR TNCs are connected. An improper implementation of the AX.25 protocol could cause this state to be entered. The MFJ-1278B will attempt to re-synchronize frame numbers with the TNC on the other end, although a disconnect may result. Connects are not legal in this state, and a disconnect will start the disconnect process.

The MFJ-1278B will inform you whenever the link status changes. The link status may change in response to a command you give the MFJ-1278B (**CONNECT** or **DISCONN**), a connect or disconnect request packet from another station, a disconnect due to the retry count being exceeded, an automatic time-out disconnect (**CHECK**), or a protocol error.

***** CONNECTED to: call1 [VIA call2[,call3...,call9]]**

This message appears when the MFJ-1278B goes from the "disconnected" or "connect in progress" state to the connected state. The connection may be a result of a **CONNECT** command you issued, or of a connect request packet received from another station.

***** connect request:call1 [VIA call2[,call3...,call9]]**

This message indicates that the MFJ-1278B has received a connect request from another station which it has not accepted. This can happen if you have set **CONOK OFF** or if you are already connected to another station. When the MFJ-1278B types this message it also sends a **DM** packet (busy signal) to the station that initiated the connect request. If the MFJ-1278B rejects a connect request because you have set **CONOK OFF**, you can issue your own request to the station that called.

***** DISCONNECTED**

This message is displayed whenever the MFJ-1278B goes to the disconnected state from any other link state. This message may be preceded by a message explaining the reason for the disconnect, below.

***** retry count exceeded******* DISCONNECTED**

This message is given if the disconnect was caused by a retry failure rather than by a disconnect request from one of the stations.

***** <callsign> busy******* DISCONNECTED**

This message indicates that your connect request was rejected by a **DM** packet (busy signal) from the other station. The MFJ-1278B will reject a connect request if **CONOK** is **OFF**, or if it is already connected to another station, or the connect request is from a station with a totally blank callsign.

frmr frame just sent:**FRMR sent: xxxxxx**

The MFJ-1278B is connected, and a protocol error has occurred. The MFJ-1278B has sent a special **FRMR** packet to attempt to re-synchronize frame numbers with the MFJ-1278B on the other end. The string xxxxxx is replaced with the hex codes for the three bytes sent in the information part of the **FRMR** frame. This message will not appear if your MFJ-1278B is in Transparent Mode.

FRMR rcvd:

This message is followed by a display of the **FRMR** packet received in the trace display format. This format is explained in the **TRACE** command entry. This message will not appear if your MFJ-1278B is in Transparent Mode.

*****LINKOUTOFORDER, possible dataloss[opt.daytime stamp]:**

This message indicates failure of a **CONPERMed**. One or more packet nodes in the link have failed. The time of failure may be appended to this error message if the stamping mode is on.

HARDWARE

This chapter details the specifications and the functional description of the MFJ-1278B hardware design.

MFJ-1278B SPECIFICATIONS**Processor**

CMOS Z-80A

Clocks

Processor master clock input frequency: 4.9152 MHz

User Port Clock:

Switch selectable at 16x baud rate.

Memory

All memory in industry-standard JEDEC Byte-Wide sockets.

Standard complement of ROM: 1 Megabit (128K x 8) 1 x 27C101

Standard complement of system RAM: 32K 1 x 43256C-15L

Standard complement of mailbox RAM: 32K (expandable to 512K)1 x 43256C-15L

Serial Port

A Z8440 SIO/0 type device, port B configured as UART plus low- Portpower TTL-to-RS-232C signal level interface.

Baud rates supported: 300, 1200, 2400, 4800, 9600 and 19,200.

Standard female DB-25S (DCE) RS-232C connector. An 8-pin molex male connector for TTL serial port.

Modem

Demodulator: XR2211 PLL demodulator circuit plus related components to receive up to 1200 baud.

Modulator: XR2206 modulator circuit plus related components to produce tones for all modes of operation.

Built-in modem calibration system.

bbRAM

Non-volatile storage of all important operating parameters is accomplished by using a battery backed-up system for the entire 32K bytes of system RAM and all mailbox RAM.

Protocol

AX.25 Level 2 is supported. Pre-Version 2.0 support is compatible with earlier TAPR TNCs running 3.x software. Full support of Version 2.0 protocol is provided. Full duplex radio link operation is supported.

Packet Operating Modes

Command Mode: Allows the user to communicate with the MFJ-1278B Multi-Mode, via commands typed in by the user. Command Mode is where all of the MFJ-1278B operations start from. Mode and command changes, packet connects, graphics initialization, to name just a few start from command mode.

Converse Mode: This is where the MFJ-1278B accepts digital data. All data that transmitted or received is accepted from Converse Mode. Converse Mode also permits terminal editing features such as, character and line deletion, input and output packet deletion along with redisplay input, via special characters trapped by the MFJ-1278B. Converse Mode provides escape to command mode via a special character or BREAK signal. Optional use of packet completion timer as in Transparent mode.

Transparent Mode: Just as with Converse Mode, Transparent Mode is where the MFJ-1278B accepts digital data. The MFJ-1278B transmits packets via the packet completion timer or buffer full only. The MFJ-1278B also receives packets in Transparent Mode. Transparent Mode does not have all the local editing features of Converse Mode. Escape to command mode via specially timed character sequence or BREAK signal.

Power Required

+12 volts DC at 500 mA.

GENERAL DESCRIPTION

The MFJ-1278B is based on the Zilog Z80™ family of microprocessor components.

Major electronic devices in the MFJ-1278B include a CPU (**C**entral **P**rocessing **U**nit) for controlling the MFJ-1278B and a SIO (**S**erial **I**nput/**O**utput) chip for providing serial interface ports to the on-board modem that connects to your radio and to the RS-232C serial or TTL terminal port, that connects to your computer or terminal.

Other integrated circuits are used for functions including clock oscillator, baud-rate generator, memory-space decoder, power supply and voltage inverter, clock recovery, transmit watch-dog timer and modem. Refer to the schematic diagram while reading the following circuit descriptions.

DETAILED CIRCUIT DESCRIPTION

Oscillator

Components U10a, U10b, U10c, R46, R47, R48, C24, C47, C51, and crystal Y1 provide an accurate crystal-controlled oscillator for system timing.

Resistor R48 forces inverter U10a into its linear region and provides a load for crystal Y1. Capacitor C47 provides an adjustable reactive element to allow the oscillator's frequency to be precisely set (this precision is not normally required). Inverter U10c buffers the clock for additional stability before driving additional dividers.

Resistor R46 is used to bias "HCT" logic to the proper levels for best oscillator operation; it is not necessary if U10 is an "HC" logic element.

Dividers and Baud-rate Generator

Components U10e, U10f, U4a, U4b, U1, U30 and U31 provide clock outputs derived from the oscillator. Electronics switches within U30 and U31 provide all the terminal and RF baud rate signals under software command.

Inverter U10f provides buffering and isolation between the divide-by-two output of counter U4a and the capacitive load presented by the CPU (U22) and the SIO (U21). U10f's input may be at 2.4576 MHz or 4.9152 Mhz. The MFJ-1278B operates at the faster clock of 4.9152 MHz. Capacitors C59 and C60 are used to slow the edges of the outputs of U4a, and capacitor C61 is used to slow the edges from U10f, helping to reduce RFI.

Counter U1 is a multiple-stage divide-by-two circuit that divides the signal at its input many times. This allows the switches within U30 and U31 to select the desired signaling (baud) rate to be used for your computer or terminal as well as the radio channel baud rate.

The output from counter U1 at pin 12 provides a real-time clock interval signal for the SIO. During normal operation, the SIO will be programmed to interrupt the CPU on every transition of this 600 Hz signal. This interrupt occurs 1200 times a second, and is used for protocol and calibration timing functions.

Inverter U10e buffers the radio port "16x" baud-rate signal in case it is routed, via modem disconnect J4 pins 11 and 12, to an external modem. If this buffer were not included, reflections from the distant termination might cause counter U1 to generate count errors.

Counter U4b provides a properly scaled clock for the transmit NRZ to NRZI encoder (see Serial Interface, below).

CPU Complex

EPROM U23 provides system ROM for program storage. Selector U12a acts as a ROM decoder, mapping the ROM into the CPU's memory address space beginning at address 0.

Static RAM provides system RAM for temporary scratch-pad storage, message buffers, etc. Also, because the RAM is backed up by a battery and will not lose its contents when the main power is removed, it is used to provide semi-permanent storage of user-supplied information, such as your callsign. Selector U12b acts as a RAM address decoder, with RAM starting at address 8000 hex.

The sections of CMOS switch U13 are used to insure that the RAM is not selected when main power is removed. This ensures that the contents of the RAM are not accidentally scrambled as the CPU loses power; it also ensures that the RAM is in the "power-down" state for minimum battery power consumption.

Serial Interface

Serial Input/Output, or SIO device U21, provides two channels of serial I/O.

The B SIO channel is used for the computer or terminal interface. Operational amplifier sections U3a, U3b, and U3d act as RS-232C drivers while Schmitt trigger inverters U9a and U9b act as RS-232C receivers. These circuits consume less power than conventional RS-232C drivers and receivers.

The A SIO channel is used for the radio/modem interface and is normally operated as a full duplex HDLC channel for compatibility with the AX.25 protocol specification. Latch U5 and ROM U6 provide a "state machine" for recovering the clock from the received NRZI data. The state machine also converts NRZI data to NRZ for the SIO. Inverter U9c and flip-flop U11a provide NRZ to NRZI conversion for the transmit side of the radio channel. This conversion between NRZ formatted data and NRZI formatted data is necessary because the AX.25 protocol specification requires NRZI operation while the SIO is only capable of NRZ. Jumper JMP11 may be used to bypass the NRZ and NRZI conversion for use with external modems, if required.

Watch-dog Timer

Inverters U7c, U7d, U7e, and Q10 and Q20 provide a "watch- dog" timer on the transmit key line to ensure that the transmitter does not remain keyed for more than about 30 seconds should the TNC fails. This allows you to leave a station (such as a remote digipeater) on-the-air and unattended without much chance of having a malfunction "lock up" the packet channel. This also helps ensure compliance with FCC regulations regarding unattended station operation.

Jumper JMP4 is provided for testing purposes. When JMP4 is installed, timing capacitor C31 is shunted, disabling the watch-dog timer.

Modem

U16, an XR2206, is a **F**requency **S**hift **K**eying (FSK) modulator that generates an audio data signal for use by the radio transmitter. Two tones are used, one for each digital level, and these tones may be calibrated via trimpots R77/R78, R105/R106, R119/R122 and R139/R138 in conjunction with the on-board calibration support circuitry and software. When the transmitter is not being keyed, transistor Q9 is switched on, thus preventing U16 from producing tones. This allows you to leave a microphone connected to your packet transmitter for voice operation.

R157 and R158 are used to set the audio output levels to the transmitter.

U20, an XR2211, provides a Phase Locked Loop (PLL) FSK demodulator. It converts the received audio FSK signals into digital data at standard logic levels. This data is sent to the state machine clock recovery and NRZI to NRZ format conversion circuits. Trimpots R79, R113, R114 and R115 are used to calibrate the PLL demodulator's free-running frequency that is set midway between the FSK tones being received. These tones are measured by the calibration software and the output signal produced by U8a and U8b, which is a frequency doubling shaping circuit.

Power Supply

Regulator Q3 and associated components provide a +5 volt regulated output for the MFJ-1278B digital logic circuitry. In order to reduce conducted RFI from the digital power source, series inductor L1 is provided. Transistor Q4, in conjunction with CMOS the inverters in U14, provide a "power failure" circuit for the battery-backed RAM chips to ensure that RAM is in the "power-down" state when the main power is removed. In addition, this circuit provides the main power- on reset signal via U7f.

Transistors Q5 and Q6 are used to isolate the battery from the +5 volt line when main power is available. R33 protects the lithium battery from overload conditions and provides a convenient means of monitoring battery current drain when the TNC is switched off. JMP5 provides a means of disconnecting the negative side of the lithium battery for MFJ-1278B maintenance.

U2 and associated components form a charge-pump voltage inverter which generates an unregulated negative supply for the RS-232C drivers.

U3c, Q2, CR6 and surrounding components provide a regulated source of -5 volts for the modem chips.

The modem power sources and ground are isolated from digital logic switching noise by inductor L2.

RS-232C HANDSHAKING PROTOCOL

The CTS, DSR and DTR lines of the RS-232C port, J1, are used for hardware "**handshaking**" protocol to control the flow of data between the terminal (DTE) and the MFJ-1278B (DCE).

The MFJ-1278B always asserts **D**ata **S**et **R**eady (DSR) on J1 pin 6 via resistor R16. Thus, whenever the MFJ-1278B is powered up, it signals to the terminal connected to J1 that the MFJ-1278B is "on line."

The terminal indicates it is ready to receive data from the MFJ-1278B by asserting its **D**ata **T**erminal **R**eady (DTR) output, J1 pin 20. The MFJ-1278B will send data when it has data to send and DTR is asserted. If the terminal is **not** ready to receive data, it should negate (make false) DTR to the MFJ-1278B. Thus, data flow **from** the MFJ-1278B **to** the terminal is controlled by the use of the DTR line. The state of the DTR line is ignored by the software if "software flow control" is enabled in this direction.

The MFJ-1278B asserts its **C**lear **T**o **S**end (CTS) output, J1 pin 5, whenever it is ready to receive data from the terminal. If the MFJ-1278B's buffers fill, it will negate CTS, signaling the terminal to stop sending data. The MFJ-1278B will assert CTS when it is again ready to receive data from the terminal. Thus, data flow **from** the terminal **to** the MFJ-1278B is controlled by the use of the CTS line. The CTS line is always asserted if "software flow control" is enabled in this direction.

Some serial I/O ports do not implement CTS, DTR and DSR handshaking. If these pins are not connected at the terminal end, they will be pulled up (and thus asserted) by resistors at the MFJ-1278B end. However, a non-standard serial connector may use some pins for other purposes, such as supplying power to a peripheral device, so **be sure that your system either implements the CTS, DTR and DSR handshake or has no connections to these pins of J1 whatsoever.** Note that reference to RS-232C "compatibility" or the presence of a DB-25 type connector does not guarantee that you have a full RS-232C serial port!

The MFJ-1278B supports most standard baud rates from 300 through 9600. The port supports standard parity options as well as 7 or 8-bit character lengths. Setting these terminal parameters is discussed in Chapter 4.

If you want to interface your MFJ-1278B with a device configured as DCE, such as a telephone modem or another TNC, a so-called "null modem" cable may be constructed to interchange the data and handshake signals. See for example Byte, February, 1981, page 198.

JUMPER FUNCTIONS

The following table lists the function of each jumper on the MFJ-1278B. For normal operation a shorting jumper must be placed on the following connectors: JMP 5; JMP 8; JMP 9 pins 2,3; JMP 13; JMP 14 pins 1,2; JMP 16 pins 1,3 and pins 2,4; JMP 18 pins 1,2; JMP 19 outside pair (one top,one bottom); JMP 22 pins 2,3; JMP 24 pins 1,2; JMP 26 pins 1,2; JMP E, F, G, H. Also on the mode disconnect header J4 the following pins need jumpers pins 1,2 11,12 13,14 17,18.

Table 8-1: Jumper Function

Jumper #	Position	Function
JMP1	Pin 1 & 2	!DCD (RS-232C) stays on
	Pin 2 & 3	!DCD (RS-232C) stays off
	OFF (default)	!DCD reflects connect status
JMP2	Pin 1 & 2 (default)	4.92 MHz CPU clock
	Pin 2 & 3	2.46 MHz CPU clock
JMP4	ON	disable Tx watch-dog
	OFF (default)	enable Tx watch-dog
JMP5	ON (default)	Lithium battery connected
	OFF	Lithium battery disconnected
JMP7	ON	analog loopback mode
	OFF (default)	normal modem operation
JMP8	ON (default)	demodulator enabled
	OFF	demodulator calibrate
JMP9	Pin 1 & 2	calibrate U16 tones
	Pin 2 & 3 (default)	normal modem operation
JMP10	ON	digital loopback mode
	OFF (default)	normal modem operation
JMP11	LEFT	transmit data NRZ
	RIGHT (default)	transmit data NRZI

Table 8-1: Jumper Function (Cont.)

Jumper #	Position	Function
JMP16	Pin 1 & 2	Without multi-gray levels
	Pin 1 & 3 (default)	With multi-gray levels
	Pin 2 & 4 (default)	With multi-gray levels
JMP17	Pin1 & 2	2400 baud ext. modem clock
	Pin 2 & 3 (default)	9600 baud ext. modem clock
JMP18	Pin 1 & 2 (default)	Enable 19.2K baud termial
		Disable 300 baud terminal
	Pin 2 & 3	Enable 300 baud termial
		Disable 19.2K baud terminal
JMP19	Outside pair(default)	Enable 32K mailbox RAM
	Middle pair	Enable 128K mailbox RAM
	Inside pair	Enable 512K mailbox RAM
JMP20	ON (default)	512K mailbox RAM installed
	OFF	32K or 128K mailbox RAM
JMP21	Pin 1 & 2	154 KHz to multi-level PCB
	Pin 2 & 3 (default)	307 KHz to multi-level PCB
JMP22	Pin 1 & 2	Enable CW Grid Block Keying
	Pin 2 & 3 (default)	Enable CW Direct Keying
JMP23	ON	Enable memory RESET
	OFF (default)	Normal operation
JMP24	Pin 1 & 2 (default)	1 Megabit firmware EPROM
	Pin 2 & 3	512K bit firmware EPROM
JMP25	Pin 1 & 2 (default)	Normal Demodulator operation
	Pin 2 & 3	Demodulator Bypass
JMP26*	Pin 1 & 2 (default)	Normal +5Vb bbRAM operation

Table 8-1: Jumper Function (Cont.)

Jumper #	Position	Function
JMPB	ON (default)	On board transmit low tone
	OFF	Out board transmit low tone
JMPC	ON	Enable external DCD
	OFF (default)	Disable external DCD
JMPD	NOT used	
JMPE***	ON (default)	Disable Low Tone RTTY Demod
	OFF	Enable Low Tone RTTY Demod
JMPF***	ON (default)	Disable Low Tone RTTY Demod
	OFF	Enable Low Tone RTTY Demod
JMPG***	ON (default)	Disable Low Tone RTTY Mod
	OFF	Enable Low Tone RTTY Mod
JMPH***	ON (default)	Disable Low Tone RTTY Mod
	OFF	Enable Low Tone RTTY Mod
JMPJ	ON	TX audio has flat response
	OFF (default)	TX audio 6db/oct pre-emphasized
JMPK	ON	TX audio loopback to PTT
	OFF (default)	(for Radio Port 2)
JMPL	ON	TX audio loopback to PTT
	OFF (default)	(for Radio Port 1)
JMPR	ON	Analog audio loopback
	OFF (default)	(for Radio Port 1)
JMPX	ON (default)	Speaker Transmit Tone Enable
	OFF	Speaker Transmit Tone Disable
JMPY	ON (default)	Speaker Receive Tone Enable
	OFF	Speaker Receive Tone Disable

NOTE:

* When JMP23 is shorted, it will RESET the MFJ-1278B. This means that all parameters will be reset to the default values. This is the same as removing the bbRAM battery except it is much quicker.

** MFJ offers an optional Real-time clock module (MFJ-43) that can be installed on the MFJ-1278B mother board. This clock keep the MFJ-1278B clock running all the time. You will not have to reset the clock everytime you turn the MFJ-1278B on.

*** When these jumpers (JMP E, JMP F, JMP G, JMP H) are removed the MFJ-1278B will operate European RTTY tone when the VB modem is selected. All four jumpers must be removed to operate European RTTY.

PARALLEL PRINTER PORT PIN FUNCTION, J12

The MFJ-1278B provides the user with a built-in Parallel Printer Port. The user can use the built-in printer port to print received text or graphics. The built-in printer port is compatible with most Epson and IBM parallel printers. Below in Table 8-2 is the pin out of the Parallel Printer Port, J12:

Table 8-2 Parallel Port Pin Out

Printer Port Pin #	Pin Function
1	Strobe
2	Data Bit 1
3	Data Bit 2
4	Data Bit 3
5	Data Bit 4
6	Data Bit 5
7	Data Bit 6
8	Data Bit 7
9	Data Bit 8
10	Acknowledge
11	Busy
12 thru 17	No connection
18 thru 25	Ground

TTL INTERFACE PORT PIN FUNCTION, J5

The MFJ-1278B provides the user with a TTL level I/O port, J5. The TTL level I/O port, J5 is compatible with computers and terminals that do not support RS-232C serial voltage levels, such as the Commodore C64 and C128 computers. Voltage levels of 0 and 5 VDC are available at J5. Below in Table 8-3 is the pin out of the TTL level I/O port, J5:

Table 8-3 TTL Port, J5 Pin Out

J5 Pin #	Pin Function
1	Receive Data
2	Data Carrier Detect
3	Ground
4	Request to Send
5	Transmit Data
6	Data Set Ready
7	Clear to Send
8	Frequency Shift Keying
9	Space Output for Scope
10	Mark Output for Scope

MULTI-LEVEL INTERFACE CONNECTOR, J13

The MFJ-1278B provides the user with the capability to perform Multi-Level FAX operations as well as Color SSTV work. Multi-Level FAX and Color SSTV operations are accomplished through the addition of a Multi-Level Interface. The Multi-Level Interface controls both transmit and receive operations for the Multi-Level FAX and Color SSTV modes. Below in Table 8-4 are the pin outs for the ribbon cable connected at J13:

Table 8-4 J13 Pin Out

J13 Pin #	Pin Function
1	No connection
2	No connection
3	Connect Tone Output
4	Ground
5	SSTV/FAX receive signals
6	153.6/307 KHz Clock Select
7	SSTV/FAX select
8	SSTV/FAX transmit tones
9	SSTV/FAX receive control
10	SSTV/FAX transmit control
11	-5 Volts
12	Data Bit 7
13	Data Bit 6
14	Data Bit 5
15	Data Bit 4
16	Data Bit 0
17	Data Bit 1
18	Data Bit 2
19	Data Bit 3
20	+5 Volts

EXTERNAL MODEM INTERFACE CONNECTOR - J14

The External Modem Interface Connector, J14 is available for easy and quick addition of the MFJ-2400 or MFJ-9600 modems. The External Modem Interface Connector, J14 is a 5-pin straight type header located just in front of the RS-232C serial port connector. Below in Table 8-5, is the pin out of the External Modem Interface connector, J14:

Table 8-5 External Modem Interface Pin Out

MODEM DISCONNECT HEADER, J4

The modem disconnect header, J4, on the MFJ-1278B PC board is provided for using an external modem with the MFJ-1278B. This allows use of higher-speed modems, such as 9600 baud, or more sophisticated, higher-performance modems for OSCAR or other uses.

The following information is primarily for those who wish to interface external modems to the MFJ-1278B. Familiarity with modem and serial data channel terms is assumed. The use of the modem disconnect header, J4 requires a definite working knowledge of modems and serial data communications and associated terminology. A person without the required knowledge should not do any type of modifications in the area of the modem disconnect header, J4.

The signals used at connector J4 are at standard TTL interface levels. A TTL high, or 1, is greater than +2.4 volts but less than +5.25 volts. A TTL low, or 0, is less than 0.8 volts but greater than -0.4 volts. **DO NOT** connect an RS-232C level modem directly to J4!

NOTE: The modem disconnect is **similar**, but **not** identical to that used in TNC 1. Be very careful about interfacing an external modem using the same cabling you may have prepared for use with TNC 1!

For users that require pin out information on the modem disconnect header, J4, MFJ provides the following pin out information. The connector pin-outs are as follows.

Pin 1 Carrier Detect Input

This pin tells the SIO radio port that a valid data carrier has been detected. It should be pulled high when no carrier is detected and low when a carrier is present. This line must be implemented unless the software release notes indicate otherwise. It is normally jumpered to pin 2 when the on-board modem is used.

Pin 2 Carrier Detect Output

This pin is an output from the the on-board modem and satisfies the requirements outlined for pin 1 above. It is normally jumpered to pin 1 when the on-board modem is used.

Pin 3 SIO Special Interrupt Input

This signal is routed to the radio port DCD input pin on SIO U21. This signal is normally used during modem calibration. It may also be used for other purposes; if so, these functions will be listed in the software release notes. This pin is normally jumpered to pin 4 when the on-board modem is used.

Pin 5 SIO RTS Output

This signal is used for transmitter activation. The SIO will pull this output low when the MFJ-1278B wants to transmit; otherwise it will remain high. This pin is normally jumpered to pin 6 when the on-board modem is used.

Pin 6 Transmitter Key Input

This signal is an input to the on-board modem. It activates the PTT pin of the radio connector via the watch-dog timer. It should be left high and pulled low only when transmission is desired. This pin is normally jumpered to pin 5 when the on-board modem is used.

Pin 7 CONNECT Status Output

This pin is an output from the SIO. It is normally low and goes high only when the MFJ-1278B is in the connected (error-free) mode with another packet station. Its status is monitored via the CON LED.

Pin 8 Unacknowledged Packets Pending Status Output

This pin is an output from the SIO. It is normally low and goes high only when this MFJ-1278B has unacknowledged packets in its transmit buffer. Its status is monitored via the STA LED.

Pin 9 CTS Input

This pin is an input to the SIO. It is high when the attached modem is not ready to accept data, and low when the attached modem is ready to accept data. The TNC will not attempt to send data when this pin is high. This pin is normally jumpered to pin 10 when the on-board modem is used.

Pin 10 Transmitter Key Input

This pin is physically tied to pin 6, above. It is used in conjunction with pin 9, above to allow the MFJ-1278B to use the on-board modem whenever the transmitter is activated.

Pin 11 Transmitter Clock (16x) Input

This pin is tied to the NRZ-to-NRZI converter, which expects a clock signal at 16 times the desired radio port data rate, e.g., 4800 Hz for 300 baud. This pin is normally jumpered to pin 12 when the on-board modem is used.

Pin 12 Transmitter Clock (16x) Output

This pin is tied to the radio baud rate switch network. It provides a clock at 16 times the

Pin 13 Receive Clock Input

This pin is tied to the SIO receive clock input pin. It expects a clock at the desired data rate (1200 Hz for 1200 baud), of the proper phase relationship to the received data. This pin is normally jumpered to pin 14 when the on-board modem is used.

Pin 14 Receive Clock Output

This pin is the received data clock signal derived from the NRZI-to-NRZ state machine. This pin is normally jumpered to pin 13 when the on-board modem is used.

Pin 15 MFJ-1278B Ground Reference

This pin ties to the MFJ-1278B digital ground system, at the SIO.

Pin 16 Turbo LED output

This pin is used to connect the Turbo LED on the mother board to the external modem board. When this pin is high (+5Vdc), the Turbo LED will light.

Pin 17 Receive Data Input

This pin is the received data input to the NRZI-to-NRZ state machine. This pin is normally jumpered to pin 18 when the on-board modem is used.

Pin 18 Receive Data Output

This pin provides receive data from the on-board modem. This pin is normally jumpered to pin 17 when the on-board modem is used.

Pin 19 Transmit Data Output

This line is the NRZ or NRZI (depending on the state of JMP11) data output. This pin is normally jumpered to pin 20 when the on-board modem is used.

Pin 20 Transmit Data Input

This input line accepts data to be transmitted by the modem. This pin is normally jumpered to pin 19 when the on-board modem is used.

If you elect to use an off-board modem, be sure to properly shield the interconnecting cables for RFI protection.

HF TUNING INDICATOR

The MFJ-1278B has a built-in tuning indicator for HF operation. It is set for a center

TROUBLESHOOTING

WARNING: Never remove or insert an IC with power on!

Your MFJ-1278B is a very complex piece of electronic equipment. Servicing must be approached in a logical manner. The best preparation for troubleshooting is to study the detailed hardware description in Chapter 7. While it is not possible to present all possible problems, symptoms and probable cures, this section of the manual will give you direction to troubleshooting based on our experiences.

In order to troubleshoot the MFJ-1278B in a logical manner, a few things must be kept in mind:

1. Always perform any troubleshooting work in a clean work area.
2. **NEVER REMOVE** any parts, including ICs from the MFJ-1278B with the power switch in the ON position. Damage to the MFJ-1278B will be the result!!
3. When performing any troubleshooting and the problem is found, **NEVER** do any work with the MFJ-1278B **ON** and connected to the computer or terminal.
4. If performing any repair on the MFJ-1278B, always ensure the power switch is OFF.
5. When doing any soldering, always keep the soldering tip clean and use only enough solder to do the job properly. A good solder joint has a nice shiny look, where a "cold solder joint presents a dull, grayish appearance.

GENERAL TESTS

In most cases we have found that careful visual inspection combined with simple measurements generally reveals the problem. The most useful single instrument for successful troubleshooting is a good DVM that can read AC and DC volts, and can non-destructively test resistance while the ICs are still in their sockets.

While a number of checks may be made without the aid of an oscilloscope, you will need one to check signals at various points on the board if you fail to locate the problem by visual means or with a meter. Be very careful about shorting pins on ICs when applying meter or scope probes to the board. It is a good idea to attach a secure ground lead to the meter or scope, one that will not accidentally short across components on the board. A good place to pick up this ground is on the head of the screws which mount the printed circuit board to the case.

Step 1: Power Supply

The first thing to check in any malfunction is the power supply. Check the power supply levels at the outputs of the voltage regulators, Q2 and Q3 as well as the output of the inverter (U2). Are they close to their nominal values? Do all the ICs in the suspected area have the proper voltage on their power pins? Is there a voltage return path, ground on the ICs ground pin? Is there excessive ripple in any of the DC voltage lines? If so, check the regulator and associated components, working backwards toward the input power switch. If the voltage is low, in conjunction with a hot regulator, suspect a short circuit on the board.

If the problem is in the -5 volt supply, work backwards from Q2's collector (also at U16 pin 1), that should be -5 volts regulated, to the junction of C9 and CR2 (-V unregulated). If no voltage appears at -V, then U2 or a related component may be at fault. Verify that U2 is oscillating by looking at the wave form at U2 pin 5. If -V is more negative than -7 volts (i.e., normal), but the -5 volt regulated voltage is wrong, check the negative regulator components U3, Q2, R5, R6, R7, R8, CR6, C10, C11 and C158. If both -V and the -5 volt regulated voltage are wrong, look for shorts.

Step 2: Obvious Problems

CAUTION: A word of **WARNING** here. **DO NOT** touch any component that is suspect of being **HOT**. This could result in **BURNS** from the **HOT** component. If you have never left finger prints on top of an IC, it is an experience you will not soon forget.

Look for any unusual physical symptoms. Are any components discolored? Does something smell burnt? Do any of the parts seem excessively warm? If you have never had your fingers on operating digital integrated circuits before you may erroneously conclude they are too hot when they are actually operating normally. Take for instance, the Z80 CPU and the Z80 SIO. They generally are warm to the touch. In general their normal temperature will be well below the boiling point of water, but you may not want to keep your finger on them very long.

Step 3: Assembly Problems

Carefully inspect the PC board and component installation. Are any cold solder joints present? Is a metal screw shorting to the board anywhere? Are all ICs firmly seated in their sockets? Are any IC leads tucked under the chip or otherwise bent in such a manner that they are not making proper contact with the IC socket?

Inspect the diodes and electrolytic capacitors for proper installation. Are the diode cathodes pointing the correct way? Are the negative ends of the electrolytic capacitors pointing the correct way?

Step 4: Cabling Problems

Inspect the interconnection cabling. Does it work on another TNC? Has the radio and/or terminal been successfully used on packet with this or another TNC? Are all the connections tight? Has the cable frayed or broken?

SPECIFIC SYMPTOMS

While the steps described above may seem obvious, careful inspection often will point to the problem or give significant clues as to the probable area of the MFJ-1278B most suspect. After the above inspection has been completed and apparent problems are dealt with, it is time to proceed to more specific analysis.

Symptom: TNC appears dead

If the MFJ-1278B powers up with the PWR, STA, and CON LEDs lit, followed by STA and CON extinguishing a second or so later, the processor is working and the software is probably working correctly. You should suspect the RS-232C serial port at this point. Check all connections and verify the logic levels according to the terminal interface troubleshooting section in this chapter.

Oscillator and Reset Circuits

If no LEDs wink during the reset cycle the problem may be more serious. Check to see that the crystal oscillator is working and that an "M1" signal (154 kHz square wave, 0 to +5 volts) is coming from U22 pin 27. The crystal oscillator input to the processor (U22) is pin 6. The input clock should be a (possibly distorted) square wave signal. Verify that the clock input at pin 6 of U22 is running at the correct frequency (near 4.9152 MHz).

Verify that the battery backed-up RAM protection circuit, composed of Q4, U14 and associated devices, is going to +5 volts at U14 pin 6 after input power is applied. This signal enables normal operation of U24 and U25. There should be a logical low on the output of U7 pin 12 coincident with the application of power and lasting for a few hundred milliseconds. Without this RESET signal, the Z80 probably won't start up properly.

Digital Logic Lines

Remember that all the logic circuits operate at standard TTL levels (a "low" is less than +0.8 V and a "high" is greater than +2.4 volts), and all digital inputs and outputs switch between these two levels. Thus, if you see logic signals switching between 0 and, say, 1 volt, you can be sure there is a problem (usually a short). On the other hand, do not mistake switching transients on digital logic lines for improper operation -- these show up as ringing and other distortions.

Verify that there is activity on the control bus READ and **WRITE** lines, the 3 **CHIP-ENABLE** lines on the memories (U23-25, pins 20), the **IOREQ** line on U21 pin 36, and the INT line on pin 16. Each of these lines should show activity, and if any line is quiet this is a sign of trouble.

Logic lines that show no activity may often be traced to a short on the pc board, probably due to a solder splash or bridge. Logic lines that look the same can be traced back to a short between two or more of the logic lines. Shorted data or address lines are found with a DVM, in a point-to-point continuity check.

Address and data line shorts may also show up as lack of activity on the control bus lines, especially the chip selects. Check each of the 16 address and 8 data lines for activity. Any lines showing a lack of activity are not operating properly.

If you suspect problems with address or data lines, try removing all the memory chips. Each address and data line will now show a distinct pattern. The address lines should be (possibly distorted) square waves whose periods increase by a factor of two on successive lines as you step line by line from A0 to A15.

If you decide to use an ohmmeter to check for shorted lines, use a low voltage/low current test instrument. (Most Modern DVMs are fine for this.) If in doubt, remove any ICs connected to the lines you are measuring. If you suspect a short, check the high density areas of the PC board for the problem. In most cases the short will be found there. It is very unlikely that the PC board itself will have a short.

Symptom: Modem won't calibrate or key transmitter.

Troubleshooting improper calibration amounts to checking for proper signals at U21 and following up any improper signal. If the calibration signal is present, but you cannot successfully calibrate the frequency, you may have an out-of-spec frequency determining component. Check the values of the appropriate passive components. Also, check the placement of jumpers! As a last resort, check the signal frequency with a frequency counter. Note that, due to frequency jitter while calibrating the demodulator, the STA and CON LEDs may blink somewhat even when the 1700 Hz demodulator frequency is correct.

Calibration of the demodulator and the modulator tones are discuss in the Appendix chapter.

If the transmitter doesn't key, the problem may be in the watchdog timer, U7, or the PTT transistors, Q10 or Q20. Check especially for an open timing capacitor C31 or a bad solder connection associated with R83.

Symptom: Uncopyable transmitted or received packets

If no one seems able to decode your packet transmissions, it is often the case that your transmitter is being overdriven. The solution is to reduce the drive level via trimpots R157 and R158. Note that direct connection to typical microphone inputs requires R157 or R158 to be turned to near the minimum signal position to produce sufficiently low signal levels.

If you are having problems hearing other stations, the demodulator circuitry associated with U20 may be at fault. Check the center frequency of the VCO in U20 using the calibration procedure. Working in the direction of flow of the input signal from the radio, verify that it is being passed through to pin 2 of U20, the input pin. The signal there should be above 50 mV and below 3 V peak-to-peak for proper operation of the demodulator. It should be relatively clean, although a few tens of millivolts of noise is normal, and the signal amplitude should not change by more than about 25% between high and low tones.

Note: Make sure that JMP 8 is on.

TERMINAL INTERFACE TROUBLESHOOTING

If you can't get the MFJ-1278B to sign on and accept data from your terminal or computer, the problem may be in the RS-232C interface. The troubleshooting guide below is provided as an aid to help in resolving problems that may be related to the RS-232C port.

Symptom: MFJ-1278B won't sign on to the terminal

If you find the MFJ-1278B won't send data to your terminal, one of the first things to do is to verify that the RTS line at pin 4 of J1 is not being held low. If the software flow control option is disabled, the MFJ-1278B will not send data to the terminal unless its RTS is asserted. If the terminal does not implement the RTS/CTS protocol, the RTS/CTS lines (pins 4 and 5 on J1) should remain unconnected.

Verify that the voltages on the MFJ-1278B are correct. If the MFJ-1278B is in otherwise good condition, check the following pins on the SIO, U21 (Z8440). Pin 23 should be TTL low (between 0 and +0.8 volts). If this voltage is incorrect, check the voltage at U9 pin 3 and verify that it is greater than +3 volts. If this voltage is correct, U9 or the traces around it may be bad. If this is not the problem, disconnect the terminal and check it again. If this doesn't help, U9, R20 or R22 may be at fault.

If the above checks are ok, observe pin 26 of U21 with an oscilloscope and cycle the power switch on the MFJ-1278B. Transitions on this pin shortly after reset indicate that the MFJ-1278B is sending data. Verify that transitions are also present on U3 pin 1. If these tests fail, the fault could be with U13, R25, R26, U21, J1, the attached cable or faulty soldering (shorts, cold joints, etc.)

Symptom: The MFJ-1278B appears to be signing on but only gibberish is printed on the terminal

eThis indicates that some combination of the data rate (baud rate), parity option, or number of start and stop bits are not set the same at the MFJ-1278B and at the terminal. If possible, set your terminal to 1200 baud. Also verify that the terminal is set for eight data bits, no parity, and 1 stop bit. These are the default settings stored in EPROM. Perform a hard reset by the power switch OFF then ON (out then in). The sign on message should appear.

If the MFJ-1278B still prints gibberish, verify that the terminal is set to the MFJ-1278B's baud rate and do a power off then on cycle on both the MFJ-1278B and terminal. If the message still fails to appear try troubleshooting with an oscilloscope, looking first at the TXD pin (pin 26) of U21 (Z8440), then at the x16 baud rate clock (19200 Hz at 1200 baud) on pin 27 of U21.

Symptom: The MFJ-1278B signs on OK but won't accept commands

After the MFJ-1278B signs on, try giving it a command such as **MYCALL** or any other command. If the default settings are in effect, it will attempt to echo each character you type back to the screen. If it does not echo, be sure that U21 pin 23 has a voltage level between 0 and +0.8 volts on it. The voltage on U9 pin 3 should be greater than +3 volts. If these voltages aren't correct, the fault could be in U9, U21, J1, R20, R22, soldering, or the interconnecting cable.

If the above checks are OK, use an oscilloscope to verify that data is present on U21 pin 28 and U9 pin 1 when you strike a key on your terminal. If not, the data isn't getting from your terminal to the MFJ-1278B. Check J1, the cable and U9 again. Finally, be sure that your terminal actually uses levels less than -3 volts and greater than +3 volts for signal levels. 0 and +5 volts may not work, especially if they are being used direct from a computer.

Symptom: The MFJ-1278B appears to have "lock-up" i.e. not responding to any commands

This may be due to some invalid parameters having been stored in the memory. Try turning the MFJ-1278B off and disconnect JMP 5 on the MFJ-1278B board. This will disconnect the memory back-up circuit and allow the memory to be erased. Re-install JMP 5 after about 2 minutes and try operating again.

PACKET RADIO PROTOCOL

EXPLANATION OF PROTOCOL

The intention of this chapter is to give the user an overview of the packet protocol used to transmit data by the TAPR software. The MFJ-1278B employs the **genuine** TAPR TNC 2 packet software. We give references to more detailed information required by those wishing to implement these protocols on other hardware. The material presented below is somewhat tutorial in nature for those who have not had previous exposure to layered network protocols, but it presumes some knowledge of general communications hardware and software. Persons already well versed in networking may want to skip this chapter and refer to the primary defining document, Amateur Packet-Radio Link-Layer Protocol, AX.25 Version 2.0, available from the ARRL, 225 Main Street, Newington, CT 06111 (\$8.00 US, postpaid in the United States as of this writing).

Organization of the MFJ-1278B hardware and software structure is according to the **International Standards Organization** layered network model. The ISO model, sometimes referred to as the **ISO Reference Model of Open Systems Interconnection**, describes the seven protocol levels. The model and many other interesting topics are discussed in Computer Networks by Andrew S. Tanenbaum.

The ISO model provides for layered processes, each supplying a set of services to a higher level process. The MFJ-1278B currently implements the first two layers, the **Physical layer** and the **Data Link layer**.

Physical Layer

The duty of the Physical Layer, layer one, is to provide for the transmission and reception of data at the bit level. The only concern of the Physical Layer is how each bit is physically transmitted, i.e., voltages on a hardwire line, modem tones on a telephone line or RF links.

Chapter 7, Hardware, gives a description on the physical layer in the MFJ-1278B. It is compatible with the various TNCs currently available to radio Amateurs. The actual modem interface is compatible with the Bell 202 standard that is similar to the CCITT V.23 standard. Any other hardware device that is compatible with the Bell 202 standard should be compatible with the MFJ-1278, at least at level one of the ISO reference model.

Data Link Layer

The duty of the Data Link layer is to supply an error-free stream of data to higher levels. Since level one simply passes any bits received to level two and is unaware of the content or overlying structure of the data, transmission errors are not detectable at level one. Level two carries the responsibility of detecting and rejecting bad data, re-transmitting rejected data,

Level two accomplishes this task by partitioning data to be transferred by level one into individual frames, each with its own error detection field and frame identification fields. The MFJ-1278B supports two versions of a level-two layer, AX.25 version 1.0 and AX.25 version 2.0. Each of these protocols is based on the **H**igh-**L**evel **D**ata **L**ink **C**ontrol, HDLC, protocol defined by the ISO.

HDLC FRAMES

Exact knowledge of the format of HDLC frames is unnecessary by the advent of LSI and VLSI communication chips that interface directly with level one hardware. The level two software need only supply data to fill in various fields and the chip takes care of the rest. For completeness however, an HDLC frame looks like this:

| **FLAG** | **ADDRESS** | **CONTROL** | **PID & DATA** | **FCS** | **FLAG** |

FLAG

HDLC uses a unique bit sequence (01111110) to detect frame boundaries. A technique called "bit stuffing" is used to keep all other parts of the frame from looking like a flag.

ADDRESS

The **ADDRESS** field holds the specified destination address. The AX.25 protocol uses a minimum of 14 bytes and up to a maximum of 70 bytes that contains the actual callsign of the source, destination and optionally up to eight digipeaters.

CONTROL

The **CONTROL** field holds a byte that identifies the frame type. In the AX.25 protocol, the control field may include frame numbers in one or two 3-bit fields.

PID

The **PID** field holds the **P**rotocol **I**dentification byte. The PID appears as the first byte of the HDLC DATA field in AX.25 Level Two information frames. The PID identifies which Level 3 protocol is implemented, if any. In the case where no Level 3 protocol is implemented, PID = \$F0.

DATA

The **DATA** field contains the actual information to be transferred. The DATA field need not be present. Most frames used only for link control do not have data fields.

FCS

The communications chip recognizes the opening and closing flags and passes the **address, control, and data fields**, including **PID** to the software. The **FCS** field is a **Frame Check Sequence** computed by the transmitting chip and sent with the frame. The receiving chip recomputes the FCS based on the data received and rejects any frames in which the received FCS does not match the computed FCS. There is virtually no chance of an undetected bad frame using this method. This satisfies the level two task of bad data detection.

The MFJ-1278B uses the **Zilog 8440 SIO** communication chip. The Zilog 8440 operates in conjunction with a two-chip "state machine" that is used to recover the data clock. The transmitted data is encoded in NRZI form, that encodes a "0" data bit as a transition in the encoded bit stream and a "1" data bit as no transition. The data encoding in conjunction with the bit stuffing, ensures that no more than five "1"'s occur in a row, except when FLAG bytes are being transmitted, guarantees that a logic level transition occurs at least once every 5 bit times. These frequent transitions allow the receiver to synchronize its clock with the transmitter. Other chips that are compatible with the SIO and the "state machine" are the Western Digital 1933/1935, the Intel 8273, used on the VADCG and Ashby TNCs and the Zilog 8530, used on the Xerox 820 FAD adapter.

While the AX.25 protocol uses the HDLC format supplied by the communications chip, there are several other Layer Two concerns. The other Layer Two concerns being duplicate frame detection, connection and disconnection of the Level Two layers on a different TNCs, and buffer overrun avoidance. The AX.25 protocol solves these problems as described below.

AX.25 LEVEL TWO

The foundation for the AX.25 protocol is the Balanced Link Access Procedure or BLAP of the CCITT X.25 standard. BLAP in turn conforms to the HDLC standard. The AX.25 protocol adds two extensions to BLAP, extended address fields and unnumbered information, or UI frames. BLAP limits addresses to eight bits, while AX.25 uses from 112 to 560 bits, containing the originator's call sign, the destination call sign and an optional list of one to eight digipeater and simplex digital repeater call signs.

The AX.25 protocol uses the UI frames to send information, bypassing the normal flow control and acknowledgment protocol. The UI frame is not acknowledged and is transmitted at layer two without fear of disturbing higher layers. The AX.25 protocol also uses UI frames for beacons frames, automatic identification packets, and for sending information frames when the MFJ-1278B is not connected to another TNC, e.g., CQ and QSO activities.

The ARRL publication **Amateur Packet-Radio Link-Layer Protocol AX.25 Version 2.0** shows the exact specification for the AX.25 protocol. The TAPR implementation adheres to this standard for AX.25 version 2.0. The implementation of version 1.0 is almost identical to the TAPR TNC 1 version of AX.25 protocol in software releases 3.x. This provides

provided by the **TRACE** command. Some texts, including the AX.25 protocol specification, list the bits in the order in which they are transmitted, which is low order bit first.

The AX.25 protocol presents the control bytes in hexadecimal with "x" used to indicate four bits that depend on the acknowledge functions the packet is performing. Usually "x" is a frame number. Frame numbers fit into three bits and are used to ensure that frames are received in order and that no frames are missed. Since only three bits are available, the frame number is counted module 8. This is why the **MAXFRAME** parameter has a ceiling of 7: no more than seven frames can be "in flight" (transmitted but unacknowledged) at one time. A short description of the use of the frames is given after the table.

Table 10-1. AX.25 Control Codes

Code	Abbrv	Frame Type
x1	RR	Receive Ready
x5	RNR	Receive Not Ready
x9	REJ	Reject
03	UI	Unnumbered Information
0F	DM	Disconnected mode
2F	SABM	Connect request
43	DISC	Disconnect request
63	UA	Unnumbered Acknowledge
87	FRMR	Frame reject
even	I	Any frame ending in an even number (including \$A, \$C, and \$E) is an information frame.

Below is a short explanation of the different types of frames associated with the AX.25 protocol:

I

This and UI frames are the only frame types containing user data. The control byte contains this frame's number and the number of the next frame expected to be received from the other end of the link.

RR

The RR frame is usually used to acknowledge receipt of an I frame. The RR function can also be performed by sending an I frame with an updated "expected next frame number" field.

RNR

The RNR frame is used when the buffer space on the receiving side is full.

REJ

Used to request retransmission of frames starting from "x". Missed frames are detected by receiving a frame number different from that expected.

DM

Sent in response to any frame received other than a connect request (SABM) when the TNC is disconnected. Sent in response to an SABM whenever the TNC is on the air but can't connect to the requesting user, e.g., if the TNC is already connected to someone else or if **CONOK** is **OFF**.

SABM

Set Asynchronous Balanced Mode - initiates a connect.

DISC

Initiates a packet disconnect sequence.

UA

Sent to acknowledge receipt of an **SABM** or **DISC**.

FRMR

Sent when an abnormal condition occurs, i.e., the control byte received is undefined or not proper protocol at the time received.

UI

An I frame without a frame number. It is not acknowledged.

CHANNEL USE AND TIMING FUNCTIONS

The following discussions mention timing parameters which are set by various commands. These timing functions are also discussed in Chapter 5.

An important part of any packet radio protocol is the means by which many stations make efficient use of an RF channel, achieving maximum throughput with minimum interference. The basis for this time domain multiplexing is **Carrier-Sensed Multiple Access (CSMA)** with collision detection and collision avoidance.

CSMA means simply that (as every Amateur knows) no station will transmit if the frequency is in use. The MFJ-1278B continually monitors for the presence of an audio data carrier on frequency and transmits only if there is no carrier. (The RF carrier is not normally detected; however, an input is available on the MFJ-1278B radio interface connectors to allow such an input.) In order to make detection of a busy channel more reliable, the MFJ-1278B sends an audio signal (continuous flags) any time the transmitter is keyed and a packet is not being sent, as during the transmitter keyup delay (**TXDELAY**), or while a slow audio repeater is being keyed (**AXDELAY**).

By itself, CSMA is not enough to insure a minimum, or even low, interference rate, due to the likelihood of simultaneous keyup by two or more stations. This is where collision detection and collision avoidance come in. The MFJ-1278B detects a collision by the absence of an **ACK** from the station it is sending to. The receiving station does not acknowledge the frame that suffered the collision, since either the **FCS** was incorrect or the packet was not heard. There are other possible reasons for non-receipt of the packet, but the MFJ-1278B's response is based on the assumption of a collision.

After transmitting a packet, the MFJ-1278B waits a "reasonable" length of time (**FRACK**) for an acknowledgment. "Reasonable" is determined by the link activity, frame length, whether the packet is being digipeated, and other time-related factors. If no **ACK** is received, the packet must be re-sent. If the un**ACK**ed frame was lost due to a collision, the assumption is that there is at least one other packet station out there that also lost a frame and will probably have exactly the same criterion for deciding when to retry the transmission as this station is using.

In order to avoid a second collision, the collision avoidance protocol calls for the stations retrying transmissions to wait a random time interval after hearing the frequency become clear before they key their transmitters. There must be enough different random wait times to provide a reasonable chance of two or more stations selecting different values. The difference between adjacent time values must be similar to the keyup time delay of typical stations on the frequency. This is the time lapse after a station keys its transmitter before other stations detect its presence on the channel, and is a function of the keying circuitry of

through the same digipeaters to the originating station. Since the digipeated packets are not acknowledged to the digipeater, an unsuccessful transmission must be retried from scratch by the originating station. In order to help alleviate the congestion of the frequency that tends to result when digipeated packets suffer collisions, the digipeater is given first shot at the frequency every time it becomes clear. Other stations, instead of transmitting as soon as they hear the channel clear, must wait a short time (**DWAIT**). This restriction applies to all stations except the digipeater, which is permitted to transmit relayed packets immediately. This prevents digipeated packets from suffering collisions except on transmission by the originating station.

A special time delay (**RESPTIME**) is used as the minimum wait time prior to transmitting acknowledgment frames, to prevent TNCs accepting data at high speed from the asynchronous port from colliding with acknowledgment frames when fewer than **MAXFRAME** packets are outstanding. The receiving TNC will wait long enough before sending the ACK so that it will hear the data packet which would have caused the collision, thus avoiding a fairly frequent source of delay in versions of AX.25 prior to 2.0.

CHANNEL FLOW CONTROL

Flow control of data through the link is determined by the rate at which data is being supplied to a sending TNC and accepted from a receiving TNC.

A TNC receiving data from the link will send an RNR when the next I frame successfully received will not fit into the buffer for output to the serial port.

Whenever a TNC transmitting data received from the serial port over the link runs out of temporary buffer space, the serial port will be halted by an XOFF character or CTS signal. In the MFJ-1278B implementation this happens whenever there are 7 packets built and less than 210 characters left in the buffer for input from the serial port.

When the TNC receiving data from the link clears out its buffers, it sends an RR to the transmitting TNC. In order to guard against the possibility of the RR being lost and the link becoming permanently locked, the transmitting TNC will periodically re-transmit the packet that provoked the RNR. The receiving TNC will continue to respond with RNR until it can accept the packet.

RADIO HOOKUP

Table: A-1 HOOKUP FOR SPECIFIC RADIOS

MFGS. OR RADIOS	CONNECTOR TYPE	MIC. AUDIO To pin 1 of 1278B	PTT To Pin 3 of 1278B	RX. AUDIO To pin 4 of 1278B	GROUND To pin 2 of 1278B
KENWOOD	4 pin	Pin 1	Pin 2	Speaker	Pin 3,4
	5 pin	Pin 1	Pin 2	Speaker	Pin 4,5
	6 pin	Pin 1	Pin 2	Speaker	Pin 6
	8 Pin	Pin 1	Pin 2	Speaker	Pin 7,8
TR-2500	HTs	Tip-Lg.	Sleeve-Lg	Tip-Sm.	Sleeve-Sm
TR-x600	HTs	Ring-Lg.	Sleeve-Lg	Tip-Sm.	Sleeve-Sm
TH-x1xx	"	"	"	"	"
TH-x15	"	"	"	"	"
TH-x5	"	"	"	"	"
TS-450S	8-Pin	Pin 1	Pin 2	Speaker	Pin 8
ICOM	4 pin	Pin 1	Pin 2	Speaker	Pin 4
	8 pin	Pin 1	Pin 5	Speaker	Pin 6,7
	HTs*	Tip-Sm	Tip-Sm	Tip-Lg.	Sleeves
IC-27A	8-Pin	Pin 1	Pin 5	Pin 8	Pin 6,7
IC-28A	8-Pin	Pin 1	Pin 5	Pin 8	Pin 6,7
IC-735	8-Pin	Pin 1	Pin 5	Pin 8	Pin 6,7
YAESU	4 pin	Pin 2	Pin 3	Speaker	Pin 1
	8 Pin	Pin 8	Pin 6	Speaker	Pin 7
FT-208	HTs	Pin 1	Pin 3	Pin 2	Pin 4
FT-x09	HTs*	Tip-Sm	Tip-Sm	Tip-Lg	Sleeves
FT-x3	HTs*	"	"	"	"
FT-727	HTs*	"	"	"	"
FT-747	8-Pin	Pin 8	Pin 6	Speaker	Pin 7
FT-757	8-Pin	Pin 8	Pin 6	Speaker	Pin 7
FT-767	8-Pin	Pin 8	Pin 6	Speaker	Pin 7
ALINCO					
DR-1200	8-Pin	Pin 1	Pin 2	Pin 6	Pin 8
ALR-22H	8-Pin	Pin 1	Pin 2	Speaker	Pin 8

*: Some ICOM and Yaesu HTs key the transmitter by completing the ground connection on the microphone. If your HT is one that is noted in the above chart, you must follow the instruction given in Chapter 3 of this instruction manual.

Table A-1.2 Other Radio Connections

MFGS. OR RADIOS	CONNECTOR TYPE	MIC. AUDIO To pin 1 of 1278B	PTT To Pin 3 of 1278B	RX. AUDIO To pin 4 of 1278B	GROUND To pin 2 of 1278B
ALINCO					
DR-110T	8-Pin	Pin 1	Pin 2	Speaker	Pin 7
DR-119T	8-Pin	Pin 1	Pin 2	Speaker	Pins 7,8
DR-570T	8-Pin	Pin 1	Pin 2	Speaker	Pins 7,8
DR-590T	8-Pin	Pin 1	Pin 2	Speaker	Pin 7
DJ-160T	HT	Small Tip	Small Tip	Lrg. Tip	Both Sleeves
DJ-560T	HT	Small Tip	Small	Lrg. Tip	Both Sleeves
AZDEN					
PCS 3000	12-Pin	Pin 12	Pin 9	Speaker	Pin 2
PCS-4000	8-Pin	Pin 1	Pin 7	Speaker	Pin 2,8
PCS-6000	8-Pin	Pin 1	Pin 7	Speaker	Pins 2,6
DRAKE					
TR-7A	4-Pin	Pin 1	Pin 2	Speaker	Pin 3
ICOM					
IC-25A/255A	8-Pin	Pin 1	Pin 5	Pin 8 or Spkr.	Pin 7
IC-726	8-Pin	Pin 1	Pin 5	Pin 8 or Spkr.	Pins 6,7
KDK					
2016	5-Pin	Pin 2	Pin 3	Pin 4	Con. Shell
KENWOOD					
TM-231A	8-Pin	Pin 1	Pin 2	Pin 6	Pin 7,8
TS-440S	13-Pin	Pin 11	Pin 13	Pin 3	Pins 4, 8, 12
TS-711/811	13-Pin	Pin 11	Pin 9	Pin 3	Pins 4, 8, 12
TS-850S	8-Pin	Pin 1	Pin 2	Speaker	Pins 7, 8
TS-940S	13-Pin	Pin 11	Pin 13	Pin 3	Pins 4, 8, 12
TS-950S	8-Pin	Pin 1	Pin 2	Speaker	Pins 7,8
TS-2530/2550	8-Pin	Pin 1	Pin 2	Speaker	Pin 8
TS-2570	8-Pin	Pin 1	Pin 2	Speaker	Pin 8
TS-7950	8-Pin	Pin 1	Pin 2	Speaker	Pin 6
TANDY					
HTX-100	8-Pin	Pin 1	Pin 2	Speaker	Pins 7,8
RANGER					
AR-3500	8-Pin	Pin 8	Pin 6	Speaker	Pin 7
YAESU					
FT-301	4-Pin	Pin 2	Pin 3	Speaker	Pin 1
FT 101Z/ZD	4-Pin	Pin 2	Pin 3	Pin 1	

MFJ-1278B MULTI-MODE APPENDIX B MODEM CALIBRATION

MODEM CALIBRATION

The MFJ-1278B Modem is factory calibrated to operate all the operational modes it is capable of. If it becomes necessary to re-calibrate the MFJ-1278B modem, please follow the following procedure:

MODULATOR/DEMODULATOR FREQUENCY CALIBRATION

Here we present you with two (2) Modulator and Demodulator Calibration. Calibration Method I requires test equipment as noted, and is the most accurate. Calibration Method II does not require test equipment, and is meant for those who do not have test equipment.

Calibration Method I

Calibration Method I below, as mentioned previously is the most accurate method. In order to do the best job possible, please follow the procedure as closely as possible. Following the procedure closely will ensure that you will calibrate the MFJ-1278B accurately. If any step is missed or not performed properly, then the performance of the MFJ-1278B becomes questionable.

Test equipment needed:

- a. Calibrated Frequency Counter with 10:1 probe
- b. Computer with terminal software or terminal
- c. RS-232 Serial Cable
- d. MFJ-1315 Power Supply/ or 12 VDC supply

Calibration Procedure:

1. Install jumpers on JMP4 and JMP7.
2. Place frequency counter at Pin 1 of JMP 9. Pin 1 is the top pin of JMP 9.
3. In the following procedure all frequencies must be calibrated to within +/- 2 Hz.
4. Type: **TUNEPROC** <CR>

The MFJ-1278B will respond with:

Calibration
Install loopback for TX alignment
R139 For 700Hz..

A line R139 For 700Hz. / 0Hz. Press the SPACE BAR on the computer keyboard

MFJ-1278B MULTI-MODE APPENDIX B MODEM CALIBRATION

7. Adjust **R77** for **2200Hz +/- 2Hz**. Press the **SPACE BAR**.
8. Adjust **R105** for **2295Hz +/- 2Hz**. Press the **SPACE BAR**.
9. Adjust **R106** for **2125Hz +/- 2Hz**. Press the **SPACE BAR**.
10. Adjust **R122** for **2125Hz +/- 2Hz**. Press the **SPACE BAR**.

NOTE: If recalibrating the **VB modem** for Low Tone RTTY, then remove the jumper from **JMP G**, and adjust this control for **1275Hz. +/- 2Hz**.

11. Adjust **R119** for **2975Hz +/- 2Hz**.

NOTE: If recalibrating the **VB modem** for Low Tone RTTY, then remove the jumper from **JMP H**, and adjust this control for **1445Hz. +/- 2Hz**.

12. Press the **SPACE BAR**, the MFJ-1278B will respond with:

Multilevel xmit...1900

13. Adjust **R307** for a reading of **1900Hz. +/- 1Hz**.

NOTE: For step 14 the frequency readings on the frequency counter should be compared to the frequency readouts indicated by the MFJ-1278B. Note that the difference in the two readings can be as much as 20Hz, this is normal.

14. With each press of the **SPACE BAR**, the MFJ-1278B will display the following frequencies:

1550Hz.....+/- 20Hz.
1600Hz..... "
1650Hz..... "
1700Hz..... "
1750Hz..... "
1800Hz..... "
1850Hz..... "
1950Hz..... "
2000Hz..... "
2050Hz..... "
2100Hz..... "
2150Hz..... "
2200Hz..... "

MFJ-1278B MULTI-MODE APPENDIX B MODEM CALIBRATION

15. Press the **SPACE BAR**, the MFJ-1278B will display:

**Multilevel demod: 307 {154}KHz.
1550 Hz: 106 {53}**

At this time there will be some numbers scrolling on the computer screen. The numbers on the screen will vary from 103 to 110.

16. Press the **SPACE BAR**, the MFJ-1278B will display:

2250 Hz: 70 {35}

NOTE: This may take a few seconds to appear due to the sampling rate of the MFJ-1278B. The numbers on the screen again will vary from 65 to 75.

17. Press the **SPACE BAR**, the MFJ-1278B will respond:

**DEMODULATOR ALIGNMENT
Tune R113 until STA & CON LEDS ALTERNATE;
then tune R212 until 10th LED from the LEFT is lit..**

18. Adjust **R113** until the **STA & CON LEDS alternate back and forth**. This means neither one should stay ON all of the time.

19. Then adjust **R212** until the 10th LED from the **LEFT** on the tuning indicator is lit.

20. Press the **SPACE BAR**. The MFJ-1278B will respond:

**Tune trimpot indicated until the 10th LED from the LEFT is lit.
R115**

21. Adjust **R115** until the **10th LED from LEFT** on the tuning indicator is lit.

22. Press the **SPACE BAR**, the MFJ-1278B will respond:

R79

23. Adjust **R79** until the 10th LED from the **LEFT** on the tuning indicator is lit.

24. Press the **SPACE BAR**, the MFJ-1278B will respond:

Tune R114 until the 6th LED from the LEFT is lit

MFJ-1278B MULTI-MODE APPENDIX B MODEM CALIBRATION

NOTE: If recalibrating the **VB modem** for **Low Tone RTTY**, then remove the jumpers from **JMP E, F, G, and H** and tune **R114** until the **10th LED** from the left is lit.

26. Press the **SPACE BAR**. The MFJ-1278B will display the **CMD:** prompt. This indicates the completion of the MFJ-1278B **MODULATOR** and **DEMODULATOR CALIBRATION**.

If there any problems or difficulties with this procedure, feel free to contact our Technical Staff at 1-800-647-8324, and they will be more than happy to help you.

Calibration Method II

The MFJ-1278B Modulator and Demodulator Calibration with CALSET. The below procedure needs no test equipment, and is accurate if done properly. This procedure relies on the internal calibration routine, that uses the STA and CON leds as calibration indicators. Be sure to follow each step carefully. If any problems arise, please go back and check the preceding step, to make sure it works as specified.

Calibration Procedure:

Calibration Method II is a three (3) step process. The three steps areas follows:

1. Center the modulator tones over the required modem center frequency (Fc).
2. Align the demodulator center frequency.
3. Align the tuning indicator.

NOTE:ALL THREE STEPS SHOULD BE PERFORMED IN THE ABOVE ORDER!

If they are not all done at the same time, or in the correct order, the modem may not be receiving and transmitting on the same frequency, and the tuning indicator may give false indications.

The third step, alignment of the tuning indicator, should only be used in conjunction with alignment of the 300 baud 200 Hz shift demodulator.

The other AFSK modems available in the MFJ-1278B can be aligned using exactly the same steps presented here but substituting the appropriate part numbers for the adjustments. However, do NOT align the tuning indicator to anything but the 300 baud 200 Hz shift HF packet modem.

MFJ-1278B MULTI-MODE APPENDIX B MODEM CALIBRATION

Comprehensive Alignment Procedure

It is important that the tuning indicator alignment be optimized for the 300 baud 200 Hz shift HF packet modem. It will indicate correctly for all other modes when aligned for the HF packet modem.

As described elsewhere in this manual, the exact configuration of your radio's filters and whether it has IF shift or not will determine the exact required center frequency for the modem. Once the required center frequency has been determined, the modem calibration can be carried out.

NOTE: It is essential that the modulator tones be properly aligned **FIRST** as they will be used to align the demodulator center frequency.

Set the modulator tones to Fc MINUS 1/2 of the shift for the low tone and Fc PLUS 1/2 of the shift for the high tone. For the 170 Hz shift 300 baud modem used for HF packet this would be Fc + 100 Hz for the high tone and Fc-100 Hz for the low tone.

Set Modulator Tones Using Built-in Calibration Software

1. Make sure that the modem and TNC are both configured for 170 Hz shift 300 baud operation. This is done by typing **MODE HP <CR>** from the cmd: command prompt on the MFJ-1278B.
2. Place a push on jumper at JMP 4.
3. Place a push on jumper at JMP 9, pins 1 and 2. This connects the modulator square wave output to the SIO chip so that the CPU can measure the tone frequency for you. Also install a push on jumper at Pins 1 & 2 and 3 & 4 of JMP 16. The two jumpers when installed properly will be positioned vertically. This would be if the leds on the MFJ-1278B are facing you.
4. Type "**CALSET n <CR>**". Where n is a number determined by:

$$n = \text{INT} [525000 / F(\text{low})] + 1$$

This tells the CPU what tone frequency you are trying to achieve.

A table of CALSET numbers to use for the various "standard" modem tone frequencies will be included at the end of this procedure.

5. Command the MFJ-1278B into calibrate mode by typing **CALI** followed by a <CR>".

MFJ-1278B MULTI-MODE APPENDIX B MODEM CALIBRATION

8. Adjust **R106** carefully until both the "CON" and "STA" LEDs on the front panel of the TNC are lit. One of the leds may flicker slightly. This is normal.
9. Type a "Q". This exits the MFJ-1278B from calibrate mode to command mode.
10. Type **CALSET n <CR>**". Where n is a number determined by:
$$n = \text{INT} [525000 / F(\text{high})] + 1$$
11. Command the MFJ-1278B into calibrate mode by typing "CAL <CR>".
12. Command the MFJ-1278B to key the modem by typing "K".
13. Select the high tone by pressing the space bar until a voltmeter connected to U16, pin 9 reads + 5 volts.
14. Adjust **R105** carefully until both the "CON" and "STA" LEDs on the front panel of the MFJ-1278B are lit. One of the leds may flicker slightly. This is normal.
15. Type a "Q". This exits the MFJ-1278B from calibrate mode to command mode.

This completes the modulator tone alignment using the built in calibration facility. If you had any problems with this section, then DO NOT go beyond this point. If you do the calibration will be inaccurate. However, if all went well, then you may proceed.

Now that the modulator tones have been properly centered over the intended modem center frequency (Fc), now the demodulator center frequency will be aligned.

Demodulator Center Frequency Alignment

1. Place push on jumpers at JMP 4 and JMP 7, if they are not already in place.
2. Remove jumper at JMP 9 pins 1 and 2. Place it at pins 2 and 3.
3. Remove the the jumpers at pins 1 and 2 and pins 3 and 4 of JMP 16. Replace the jumpers at JMP 16 at pins 1 and 3, and pins 2 and 4. When finished the two jumpers at JMP 16 should be positioned from side-to-side, with the leds on the MFJ-1278 facing you.
4. Set the baud rate for use by **RXCAL** to 300 baud by typing "**CALSET 32 <CR>**". This

MFJ-1278B MULTI-MODE APPENDIX B MODEM CALIBRATION

5. Command the MFJ-1278B to do a demodulator calibration by typing "RXCAL <CR>".
6. CAREFULLY adjust R113 until the DCD LED on the front panel is fully illuminated.

NOTE: The threshold control on the MFJ-1278B must be set to a position which will allow the DCD circuit to function properly. A setting approximately 1/3 to 1/2 of the total range starting from maximum CCW should be adequate.

Continue to **VERY CAREFULLY** adjust **R113** until the **STA** and **CON** LEDs on the front panel either change state very slowly (alternate which one is lit) or until both are simultaneously illuminated.

NOTE: This is a very critical adjustment. It is very unlikely that you will be able to cause both LEDs to be turned on simultaneously, for longer than a very brief instant. Just fine tune R113 very carefully, and notice the action between the STA and CON leds. If they flash back and forth this is acceptable.

7. Return the MFJ-1278B to command mode by typing a "Q".

This completes demodulator center frequency alignment using the built in calibration software. If there were any problems in the preceding procedure, then **DO NOT** go beyond this point. If you do the calibration will be inaccurate.

Now that the demodulator and modulator are properly aligned to one another, the tuning indicator can be set for proper center indication.

Tuning Indicator Alignment

This procedure adjusts the tuning indicator so that it correctly indicates when a signal is properly tuned in relation to the demodulator center frequency. In order for the Tuning Indicator to be properly aligned the above calibration must be done properly, otherwise you will align the Tuning Indicator improperly.

NOTE: The tuning indicator should **ONLY** be adjusted in reference to the 300 baud 200 Hz shift modem used for HF packet and RTTY. If adjusted for this modem, it will indicate with sufficient accuracy for all other modes.

If you have not just finished aligning the modem as per the above instructions, do so now. Otherwise you may be aligning the tuning indicator to incorrect calibration settings.

Alignment Procedure

1. Install push on jumpers at JMP 4 and JMP 7, if they are not still in place from the

MFJ-1278B MULTI-MODE APPENDIX B MODEM CALIBRATION

3. Command the calibration routine to send 50 percent duty cycle square wave data from the modulator by typing "**RXCAL**" <CR>.
4. While observing the LEDs in the tuning indicator, adjust R212 in the tuning indicator area so that either the 10th or 11th led from the left (or both) are illuminated.
5. Return the MFJ-1278B to command mode by typing "Q".
6. Remove jumpers at JMP 4 and JMP 7.

This completes the tuning indicator alignment.

Now the modulator, demodulator, and tuning indicator are all aligned to the same center frequency. If you notice that on the air reports suggest that you are transmitting and receiving on significantly different frequencies after successfully completing the above alignment procedure, it is possible that the radio needs realignment. Many different transceivers for HF are capable of being misaligned due to reference oscillator crystal aging or careless alignment by amounts exceeding 500 Hz. RIT inadvertently left on can also cause hard to detect problems in this area. Reliable HF packet communications requires that the frequency error presented to the demodulator be below 30 Hz. If several stations are to successfully share a single channel, transmitter / receiver offsets larger than this will be intolerable.

MFJ-1278B MULTI-MODE APPENDIX B MODEM CALIBRATION

MFJ-1278B Adjustment Location Map

This is a map of the physical locations of the adjustment potentiometers on the MFJ-1278B circuit board. They are shown as they appear when looking down on top of the board with the board oriented so that the rear panel connectors are to the left. Information in the boxes is organized as shown below.

PART MODE
CALSET #

PART MODE H/L	PART MODE H/L
FREQ / CALSET	FREQ / CALSET

DEMODULATOR

R113 HP CALSET 32
R114 VB CALSET 32
R79 VP CALSET 8
R115 CW NO CALSET SEE NOTE BELOW

MODULATOR

R106 HP L 2125 247	R77 VP H 2200 240
R122 VB L 2125 247	R105 HP H 2295 229
R78 VP L 1200 438	R119 VB H 2975 177
R138 SSTV H 1500 350	R129 MCW 700 751 SEE NOTE

NOTE: Separate procedure required to do alignment of CW demodulator center frequency.

NOTE: CW receive through a narrow filter for HF CW operation will require the CW

MFJ-1278B MULTI-MODE APPENDIX B MODEM CALIBRATION

Calset Values for Various Modulator Tone Frequencies

Tone	CALSET #	Adjust	Modem / Remarks
2125	247	R106	HF Packet & RTTY Fc = 2200 Hz
2295	229	R105	170 Hz shift
1300	404	R78	Packet / Fc = 1700 Hz, 800 Hz shift. CCITT V.23 std., preferable for HF 1200 baud, works well on VHF FM too.
2100	250	R77	
1200	438	R78	Packet / 1000 Hz shift standard. Too wide to fit comfortably through SSB filters for linear mode 1200 baud use
2200	240	R77	
2125	248	R122	VHF RTTY Fc = 2550 Hz
2975	177	R119	850 Hz shift
750	701	R139	CW
775	678	R139	CW
800	657	R139	CW
825	637	R139	CW
700	751	R139	CW / SSTV
1500	351	R138	SSTV
2178	242	R122	HF RTTY/ASCII/AMTOR Fc = 2220 Hz
2263	233	R119	850 Hz shift.
1275	412	R122	Low Tone RTTY (European Standard); 170Hz shift
1445	364	R119	Fc = 1360Hz.

MFJ-1278B MULTI-MODE APPENDIX B MODEM CALIBRATION

CW MODEM TUNE-UP PROCEDURE

The CW modem in the MFJ-1278B is fundamentally different from the other modems. It is NOT an AFSK modem. It sends and receives only 1 tone. For this reason, it requires a different alignment procedure than the others.

NOTE: If the Modulator and Demodulator are not EXACTLY on the same frequency for BOTH stations involved in VHF FM MCW operations, the CW receive functionality becomes degraded if not eliminated.

NOTE: If the DEMODULATOR is not EXACTLY centered in the receiver's CW filter passband, CW receive performance through a narrow filter will be degraded. Also, the demodulator will likely not be receiving on the transmitted signal frequency. This note is for the HF direct keyed radio case (NOT MCW via SSB transmitter microphone audio which is discouraged).

Since MCW operation is primarily intended to provide a means to transmit code practice and not for CW reception, the demodulator center frequency may be set to a different frequency than the modulator without penalty in most cases. Typically, the modulator will be set to 700 Hz, and the demodulator will be set to whatever frequency is dictated by the HF radio with which it is to be used.

The CW demodulator can be used without a narrow filter in the radio. It will of course be subject to more noise and QRM in this case. The tuning range for the demodulator will be VERY restricted even though the wide filter is used in the radio since the demodulator itself acts as a very narrow filter.

An oscilloscope will be required to adjust the demodulator to a 50 percent duty cycle square wave output. The main difference when aligning the CW modem is that there will be only 1 continuous tone presented to the demodulator for this adjustment.

Tuning the CW modem is basically a 4 step procedure. The steps should be followed in the order presented. The steps (in broad outline) are:

1. Determine the required demodulator center frequency (F_c) for the radio you intend using in the direct keyed CW mode.
2. Set the CW modulator tone to this frequency.
3. Set the demodulator center frequency using the modulator tone as reference.
4. Set the modulator tone to 700Hz.

MFJ-1278B MULTI-MODE APPENDIX B MODEM CALIBRATION

Detailed CW Demodulator Alignment Procedure

1. Determine the required Fc for the demodulator. If the radio has a narrow filter for CW, one of the 2 methods presented on Pages 19 and 20 in the appendix of this manual should be used to determine the filter center frequency. This frequency should be used for Fc. If the radio has no narrow CW filter, use the CW carrier offset frequency of the radio. This information should be available in the your radio manuals.
2. Set the modulator tone to the required Fc using the following procedure.
 - a. Command the MFJ-1278B into MCW mode by typing "MODE MC <CR>".
 - b. Install push on jumper at JMP4. This is the watchdog timer defeat jumper.
 - c. Place a push on jumper at JMP 9, pins 1 and 2. This connects the modulator square wave output to the SIO chip so that the CPU can measure the tone frequency for you.
 - d. Install a push jumper at JMP16 pins 1 and 2 and pins 3 and 4. The two jumpers when installed correctly will be positioned from side-to-side, with the leds on the MFJ-1278 facing you.
 - e. Type "CALSET n <CR>". Where n is a number determined by:

$$n = \text{INT} [525000 / F(\text{low})] + 1$$

This tells the CPU what tone frequency you are trying to achieve.

- f. Command the MFJ-1278B into calibrate mode by typing "CAL <CR>".
- g. Command the MFJ-1278B to key the modem by typing "K".
- h. Select the MCW tone by pressing the space bar until a voltmeter connected to U16, pin 9 reads + 5 volts. This signal is more conveniently available at the collector of Q12.
- i. Adjust R139 carefully until both the "CON" and "STA" LEDs on the front panel of the MFJ-1278B are lit.
- j. Remove the jumper placed at JMP 9 pins 1 and 2, and install at pins 2 and 3
- k. Return the MFJ-1278B to command mode by typing "Q".

MFJ-1278B MULTI-MODE APPENDIX B MODEM CALIBRATION

NOTE: If you have a square wave on the scope face but the tuning indicator is not near center, you are on a false setting. Adjust R115 so that the tuning indicator is near center and THEN set the square wave duty cycle.

4. If MCW transceive operation with another station is desired, do the above procedure to BOTH MFJ-1278s using an agreed upon frequency for Fc. Then leave the modulator tone on the agreed on frequency with the demodulator Fc.
5. Remove jumpers placed at JMP 4 and JMP 7.
6. Remove the jumper at JMP9 pins 1 and 2. Place it on JMP9 pins 2 and 3.
7. Remove the two jumpers from JMP16 pins 1 and 2 and pins 3 and 4. Place these jumpers on JMP16 pins 1 and 3 and pins 2 and 4. The jumpers on JMP16 will now be positioned horizontally, if the leds on the MFJ-1278 are facing you.

This completes the CW modem alignment procedure.

AUDIO OUTPUT CALIBRATION

The transmit audio output levels of MFJ-1278B Radio Port 1 and Radio Port 2 both are factory set to 250 mV. You may find it necessary to set the output levels differently to match your radio specifications, then you should follow the procedure given in this appendix.

Note that the user can set the audio levels of both Radio Ports independently. Adjust R157 for Radio Port 1 and R158 for Radio Port 2. Both controls are accessible on the left side of the MFJ-1278B. There are two access holes located on the left rear side of the MFJ-1278B. It is not necessary to remove the cover to make the output level adjustments.

In most cases the user can set the audio output level of the MFJ-1278B, by simply monitoring the transmitted audio with a connecting station. However, if you require a more precise audio output level setting, then use the procedure given here.

Audio Output Level Adjustment Procedure

1. After the cmd: prompt sign, set the MFJ-1278B to VHF packet mode by typing:

MODE VP <CR>

2. Verify that you have the MFJ-1278B connected to Radio Port 1, by typing:

RADIO 1 <CR>

3. Enter the following command to activate the calibration mode:

CALI <CR>

4. Press the "K" key on the computer keyboard to activate the MFJ-1278B modulator circuit. The PTT LED on the front panel of the MFJ-1278B should illuminate.
5. Place an oscilloscope probe at the right pin of JMP7. The signal on the scope will be approximately 4 volts p-p.
6. Verify that the voltage on pin 9 of U16 is -5 Vdc. If it is +5 Vdc instead of -5 Vdc, press the space bar one time. The voltage should now be -5 Vdc. If not, then press and hold the space bar and see if the voltage at U16 Pin 9 changes at all. Set U16 Pin 9 to -5 Vdc.
7. Move the probe to J9 pin 1 (TX audio). Adjust R157 for a signal of 250 mV p-p. This should be near mid-range on R157. Or set it to a level recommended by your radio.

8. Move the probe to J9 pin 4, RX audio. The signal should be approximately 1 V p-p.
9. Press the space bar and again measure the peak to peak voltage at J9 pin 4. The audio level should not change. Both mark and space audio should be at the same level.
10. Type:

Q

the **cmd:** prompt will appear on the computer screen.

11. Switch the MFJ-1278B to Radio Port 2 by typing:

RADIO 2 <CR>

The MFJ-1278B will respond with:

cmd:

12. Enter the following command to set the MFJ-1278B to calibration mode:

CALI <CR>

13. Press the "K" key on the computer keyboard to activate the modulator circuits in the MFJ-1278B. The PTT LED on the front panel of the MFJ-1278B should illuminate.
14. Verify that the voltage on pin 9 of U16 is -5 Vdc. If it is +5 Vdc instead of -5 Vdc, push the space bar one time. The voltage should now be -5 Vdc. If not, then press and hold the space bar and see if the voltage at U16 Pin 9 changes at all. Set U16 Pin 9 to -5 Vdc.
15. Place the scope probe on J2 pin 1, TX audio. Adjust R158 for a signal of 250 mV p-p or for a level recommended by your radio instruction manual.
16. Move the scope probe to J2 pin 4, Rx Audio. The voltage should be approximately 1 V p-p.
17. Press the space bar and again measure the peak to peak voltage at J2 pin 4. The audio level should not change. Both mark and space audio should be at the same level.
18. Type:

HF RADIO ALIGNMENT

If you have determined that it is necessary to realign the MFJ-1278B modem center frequency to your radio filter center frequency, one of the following 2 methods should be used to make the radio filter center frequency (Fc) determination. Both methods require access to a frequency counter capable of measuring audio frequencies to a resolution of 1 Hz. Almost any frequency counter should be capable of this.

FIRST METHOD: NOISE AVERAGE FREQUENCY

Method I requires an active noise source like a receiver noise bridge. There are several suitable units available for this purpose.

1. Set the receiver to LSB mode with the 500 Hz. filter selected.
2. Connect the noise source to the receiver input. Make sure there is no antenna connected to the system and that the receiver is tuned to a frequency which is free of coherent internally generated signals (birdies).
3. Set the noise source output for a reading of approximately S-9 on the receiver S meter.
4. Connect the counter to the receiver audio output
5. Adjust the receiver output level for enough audio to reliably trigger the counter.
6. Make sure the radio's IF shift control, if one is present, is in its proper position (centered or on detente).
7. Record the frequency indicated by the counter. The counter should indicate the average frequency of the noise spectrum passed by the filter in the receiver and translated to audio by the product detector. This will be the frequency used for the modem center frequency (Fc).

NOTE: If the counter is a phase locked loop (PLL) based prescaling type, its PLL may not lock properly to the noise signal. If this is the case, use method 2 below. If your counter can resolve 1 Hz. with a counting gate time of less than 1 second, it is a PLL prescaling counter.

SECOND METHOD: FILTER SKIRT AVERAGE FREQUENCY

1. Set the receiver to LSB mode with the 500 Hz filter selected.
2. Make sure the radio's IF shift control, if one is present, is in its proper position (centered or on detente).
3. Using either a signal generator or a stable, relatively strong carrier from an AM broadcast transmission (preferably ground wave signal), tune the receiver so that the carrier falls near the center of the filter passband. Choose a signal level near S-9 for this test. If your rig has a built in calibration oscillator, this is a good source for this signal.
4. Slowly and carefully tune the receiver so that the tone frequency is decreasing.
5. Find the point where the signal is reduced by 1 S-UNIT from the peak value reached near the center of the filter passband.
6. Measure this tone frequency with the counter. Record this value as F(low).
7. Slowly and carefully tune the receiver so that the tone frequency is increasing.
8. Find the point where the signal is reduced by 1 S-UNIT from the peak value reached near the center of the filter passband.
9. Measure this tone frequency with the counter. Record this value as F(high).
10. Calculate the required modem center frequency as:

$$F_c = [F(\text{low})+F(\text{high})]/2$$

Once the required center frequency has been determined, the modem calibration can be carried out.

NOTE: It is essential that the modulator tones be properly aligned **FIRST** as they will be used to align the demodulator center frequency.

Set the modulator tones to Fc MINUS 100 Hz for the low tone and Fc PLUS 100 Hz for the high tone using the procedure given in the owners manual. Align the demodulator to the modulator tones using the built in demodulator alignment routine invoked with the **RXCAL** command as described in the Appendix B section of this instruction manual.

MFJ-1278B MULTI-MODE APPENDIX E CONVERTING TO TNC-2

CONVERTING THE MFJ-1278B TO "LIKE-TNC 2"

With a simple modification as described in this section, APPENDIX E, the user can easily convert the MFJ-1278B to a "like TNC 2" controller. Once converted, the MFJ-1278B can run programs such as **NET/ROM™**, **THE NET™** and other special firmware that have been developed for the TNC 2. The modification described below sets the MFJ-1278B into a "like" TNC 2 mode. What this means is the MFJ-1278B will work like an MFJ-1270C/1274C TNC-2. The modification forces the MFJ-1278B to operate 1200 baud VHF packet, and to select Radio Port 1. The modification also forces the terminal baud rate to 4800 baud.

The modification involves replacing IC **U27** and **U28** with pre-programmed headers as shown in **Figures E-1** and **E-2**. Firmware EPROM, U23 will be replaced by an EPROM that contains programs such as **NET/ROM™** and **THENET™**, etc.

Modification of MFJ-1278B for "Like" TNC 2 operation involved making it to default 4800 baud for the terminal baud rate, 1200 baud radio baud using VHF packet tones on Radio Port 1. The procedure is as follow:

1. Remove power from the MFJ-1278.
2. Construct Header U27 by connecting pins 9, 12, 16 and 19 to ground at pin 10. Connect pins 2, 5 and 15 to +5 Volts at pin 20. See Figure E-1 below.

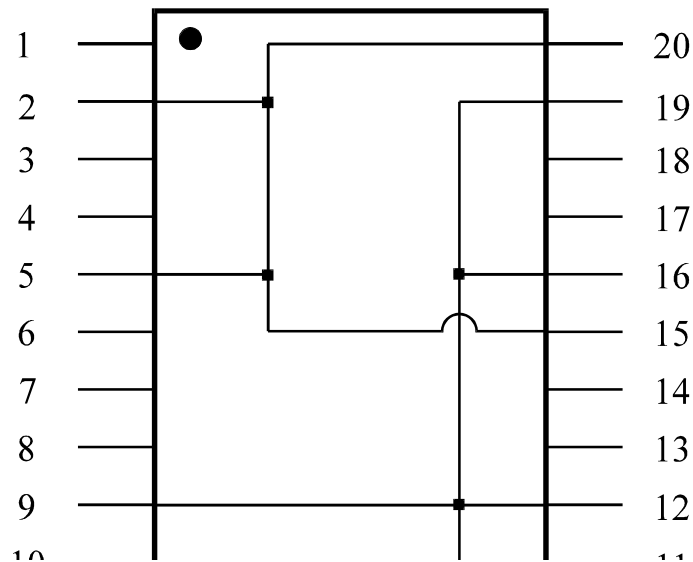

MFJ-1278B MULTI-MODE APPENDIX E CONVERTING TO TNC-2

3. Construct Header U28 by connecting pins 2, 5, 6, 12, 15 and 19 to ground pin 10. Connect pins 9 and 16 to +5 Volts at pin 20. See Figure E-2 below.

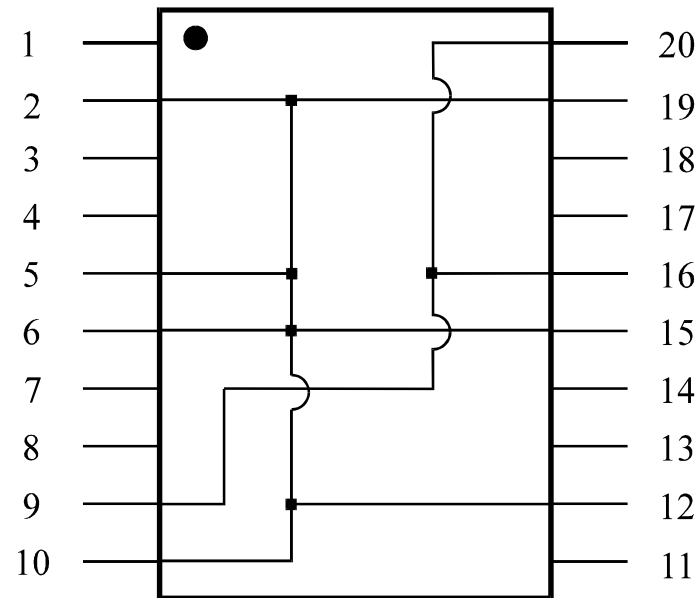

Fig. E-2: Header U28

4. Remove U27 on the MFJ-1278B PC board and replace it with Header U27.
5. Remove U28 on the MFJ-1278B PC board and replace it with Header U28.
6. Set the terminal program parameters as specified by the NET/ROM documentation.

Upon power on the MFJ-1278B should signed on like a TNC 2 and it is ready to operate NET/ROM or other TNC 2 firmwares.

MFJ-1278B 2400 BPS PACKET

If your MFJ-1278B does not have the 2400 bps packet capability, then the user can easily install the proper hardware. The user can purchase the optional **MFJ-2400 BPS** modem, and is easily installed. Installation is simple, because your MFJ-1278B is equipped with all the appropriate connectors necessary to make this installation quick and easy without modifications or soldering. If you have the MFJ-1278BT the 2400 modem is already installed inside the unit.

With the **MFJ-2400** modem installed, your MFJ-1278B is capable of operating 300, 1200 or 2400 baud packet. With the **MFJ-2400 BPS** modem has no effect on the 300 and 1200 baud packet mode operations. The addition of the 2400 modem feature will in no way require any internal modification to your transceiver.

2400 BPS PACKET SETUP

All the default parameter settings for 1200 baud packet operation can be used for 2400 bps packet operation. 2400 bps operations need no special setup or parameter changes. There are however, some changes that the user can make later on to the MFJ-1278B parameters that will enable you to improve the speed of the throughput performance of the 2400 bps operation. The "**honing**" of the parameters may not seem like much, but we have found that at 2400 bps, the MFJ-1278B seems to be more responsive to the **TXDELAY**, **DWAIT**, **RESPONSE** and **SLOTTIMES**. When using direct connects and good paths, the user can increase the **MAXFRAME** and **PACLEN** commands to allow larger packets to be moved during each transmission. When returning to the active throughput frequencies, these two commands should be reduced to their original settings. You may find that if you were using a **TXDELAY** of **50**, then a **TXDELAY** of **40** will now perform better. The **DWAIT** command can be shortened or lengthened to suit the AGC recovery time of your radio. For instance, if you have been running the **DWAIT** of **16**, it may now perform better at **DWAIT** of **12** or even **10**. The **FRACK** will appear to exercise more at 2400 also.

2400 BPS operation really shows its place in the packet world when used to pass large ASCII, BINARY and PICTURE files. It is always good to use clear frequency and/or use direct connects to the target station rather than going thru a node or digipeater. The reason is obvious. There are few 2400 nodes at the present time. However, it should be pointed out that implementation of a 2400 node is just as easy as building and using a 1200 node.

To select 2400 packet operation, under the CMD: command prompt, type:

MODE VP,2400 <CR>

The MFJ-1278B changes its operating mode to 2400 bps packet. The **TURBO LED** will

2400 BPS Receive Audio Setting

The MFJ 2400 modem employs automatic gain control (AGC) for its receive audio. The receive audio level is pre-set for proper 2400 operation, and no adjustment is necessary in most cases. If you set the receive audio of your radio properly for 1200 operation, then in most cases will be suitable for the 2400 operation also. No adjustment for the receiver audio on the 2400 modem board is needed.

2400 BPS Transmit Audio Setting

Transmit audio on the 2400 board is set by adjusting **R38**, next to T2 on the 2400 modem board. Transmit audio for the 1278BT is pre-set at the factory to match the audio level of the 1200 modem on the MFJ-1278B mother board. Once the 1200 and the 2400 transmit audio are set to the same level, then you may adjust the audio level going into your radio by using the "**Transmit Audio**" controls on the left side of the MFJ-1278B. Note that these controls set the transmit audio levels for all the operation modes of the MFJ-1278B, including the 2400 packet operation.

When adjusting the transmit audio level please note that the range of R38 on the 2400 board is pre-set by CN-6 header. The shorting jumper on CN-6 header sets range as follows:

<u>CN-6 Jumper Position</u>	<u>Transmit Audio Range (no load)</u>
no jumper	50 mV - 60 mV p-p
1 & 2 (default)	100 mV - 200 mV p-p
2 & 3	250 mV - 3 V p-p

MFJ-1278B MULTI-MODE APPENDIX G: JUMPER FUNCTIONS

JUMPER FUNCTIONS AND LOCATIONS

The MFJ-1278B mother board has many jumper connectors. Each jumper connector has a special function. The Jumper Function chart, Table G-1 in this appendix, will help in identifying each jumper function. Figure G-1 will help in locating the jumper connectors easily.

For normal operation a shorting jumper must be placed on the following connectors: JMP 5; JMP 8; JMP 9 pins 2,3; JMP 13; JMP 14 pins 1,2; JMP 16 pins 1,3 and pins 2,4; JMP 18 pins 1,2; JMP 19 outside pair (one top,one bottom); JMP 22 pins 2,3; JMP 24 pins 1,2; JMP 26 pins 1,,2; JMP E, F, G, H. Also on the mode disconnect header J4 the following pins need jumpers pins 1,2 11,12 13,14 17,18.

Table G-1: Jumper Function

Jumper #	Position	Function
JMP1	Pin 1 & 2	!DCD (RS-232C) stays on
	Pin 2 & 3	!DCD (RS-232C) stays off
	OFF (Default)	!DCD reflects connect status
JMP2	Pin 1 & 2 (Default)	4.92 MHz CPU clock
	Pin 2 & 3	2.46 MHz CPU clock
JMP4	ON	Disable Tx watch-dog
	OFF (Default)	Enable Tx watch-dog
JMP5	ON (Default)	Lithium battery connected
	OFF	Lithium battery disconnected
JMP7	ON	Analog loopback mode
	OFF (Default)	Normal modem operation
JMP8	ON (Default)	Demodulator enabled
	OFF	Demodulator calibrate
JMP9	Pin 1 & 2	Calibrate U16 tones
	Pin 2 & 3 (Default)	Normal modem operation
JMP10	ON	Digital loopback mode
	OFF (Default)	Normal modem operation
JMP11	LEFT	Transmit data NRZ
	RIGHT (Default)	Transmit data NRZI
JMP13	ON (Default)	TTL, RTS enable
	OFF	TTL, RTS disable
JMP14	Pin 1 & 2 (Default)	FSK out normal
	Pin 2 & 3	FSK out reverse
JMP16	Pin 1 & 2	Without multi-gray levels

MFJ-1278B MULTI-MODE APPENDIX G: JUMPER FUNCTIONS

Table G-1: Jumper Function (Cont.)

Jumper #	Position	Function
JMP18	Pin 1 & 2 (default)	Enable 19.2K baud terminal
		Disable 300 baud terminal
	Pin 2 & 3	Enable 300 baud terminal
		Disable 19.2K baud terminal
JMP19	Outside pair (default)	Enable 32K mailbox RAM
	Middle pair	Enable 128K mailbox RAM
	Inside pair	Enable 512K mailbox RAM
JMP20	ON	512K mailbox RAM installed
	OFF (default)	32K or 128K mailbox RAM
JMP21	Pin 1 & 2	154 KHz to multi-level PCB
	Pin 2 & 3 (default)	307 KHz to multi-level PCB
JMP22	Pin 1 & 2	Enable CW Grid Block Keying
	Pin 2 & 3 (default)	Enable CW Direct Keying
JMP23*	ON	Enable memory RESET
	OFF (default)	Normal operation
JMP25	Pin 1 & 2 (default)	Normal Demodulator operation
	Pin 2 & 3	Demodulator Bypass
JMP26**	Pin 1 & 2 (default)	Normal +5Vb bbRAM operation
	Pin 2 & 3	Real-time clock installed
JMPA	ON	Disable multi-gray levels PCB
	OFF (default)	Enable multi-gray levels PCB
JMPB	ON (default)	On board transmit low tone
	OFF	out board transmit low tone
JMPC	ON	Enable external DCD
	OFF (default)	Disable external DCD
JMPD	NOT used	
JMPE***	ON (default)	Disable Low Tone RTTY Demod
	OFF	Enable Low Tone RTTY Demod

MFJ-1278B MULTI-MODE APPENDIX G: JUMPER FUNCTIONS

Table G-1: Jumper Function (Cont.)

JMPF***	ON (default)	Disable Low Tone RTTY Demod
	OFF	Enable Low Tone RTTY Demod
JMPG***	ON (default)	Disable Low Tone RTTY Mod
	OFF	Enable Low Tone RTTY Mod
JMPH***	ON (default)	Disable Low Tone RTTY Mod
	OFF	Enable Low Tone RTTY Mod
JMPJ	ON	TX audio has flat response
	OFF (default)	TX audio 6db/oct pre-emphasized
JMPK	ON	TX audio loopback to PTT
	OFF (default)	(for Radio Port 2)
JMPL	ON	TX audio loopback to PTT
	OFF (default)	(for Radio Port 1)
JMPR	ON	Analog audio loopback
	OFF (default)	(for Radio Port 1)
JMPX	ON (default)	Speaker Transmit Tone Enable
	OFF	Speaker Transmit Tone Disable
JMPY	ON (default)	Speaker Receive Tone Enable
	OFF	Speaker Receive Tone Disable
JMPZ	ON (default)	Speaker Connect Tone Enable
	OFF	Speaker Connect Tone Disable

* When JMP23 is shorted, it will RESET the MFJ-1278B. This means that all parameters will be reset to the default values. This is the same as removing the bbRAM battery except it is much quicker. DO NOT SHORT THIS JUMPER MORE THAN A COUPLE OF SECONDS, OTHERWISE BATTERY DAMAGE COULD RESULT!!

** MFJ offers an optional Real-time clock module (MFJ-43) that can be installed on the MFJ-1278B mother board. This clock keep the MFJ-1278B clock running all the time. You will not have to reset the clock everytime you turn the MFJ-1278B on.

*** When these jumpers (JMP E, JMP F, JMP G, JMP H) are removed the MFJ-1278B will operate RTTY using the European tone standard, when the VB modem is selected. All four jumpers must be removed in order to operate RTT using the European tone standard.

MFJ-1278B MULTI-MODE APPENDIX G: JUMPER FUNCTIONS

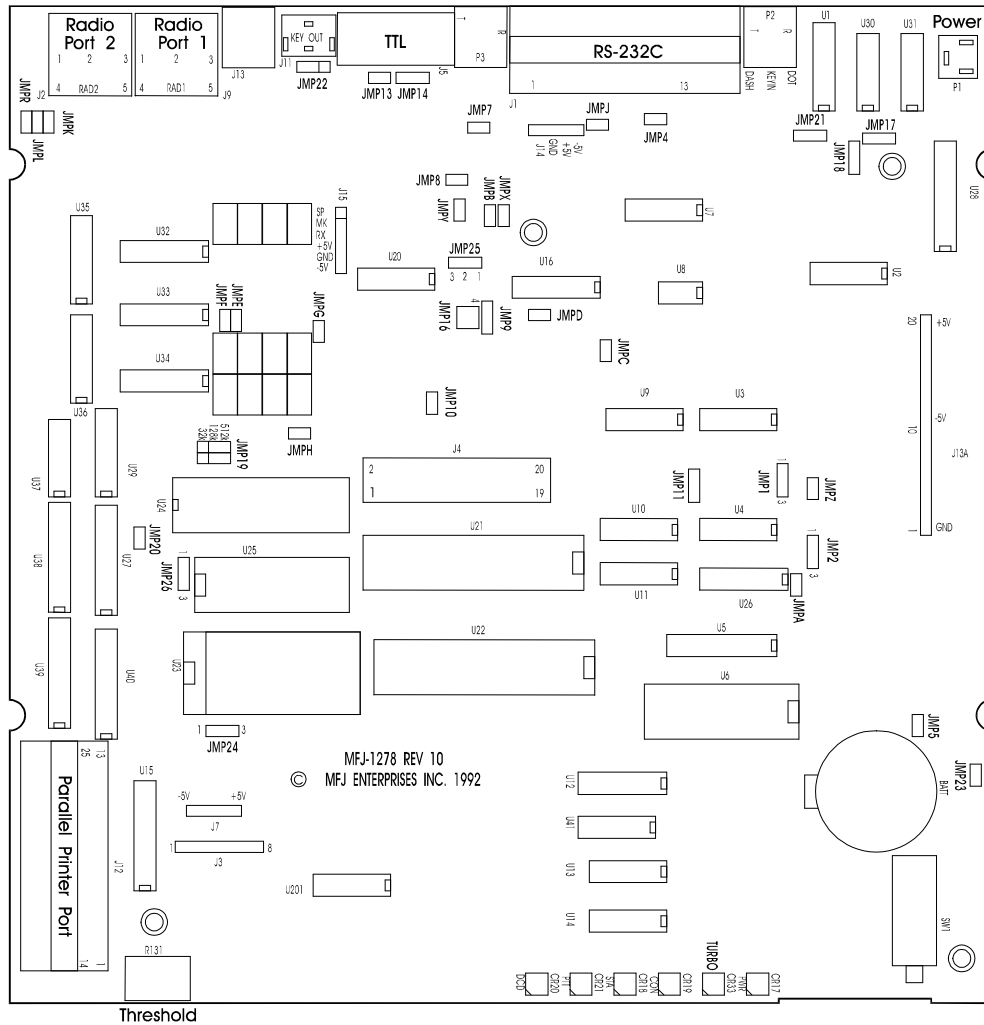

Fig. G-1: Jumper Connector Location

MFJ-1278B MULTI-MODE APPENDIX H COMMAND SUMMARY

COMMAND SUMMARY

Command	Parameter	Default	Mode	Function	Page
<u>8BITCONV</u>	ON OFF	off	Packet	Enables transmission of 8-bit data in converse mode	6-5
<u>8LEVELS</u>	ON OFF	off	FAX/SSTV	Enables MFJ-1278B to operate 8 gray levels in FAX and SSTV modes.	6-5
<u>16LEVELS</u>	ON OFF	on	FAX/SSTV	Set MFJ-1278B to transmit and to receive 16-gray levels FAX and SSTV.	6-6
<u>AALT</u>	ON OFF	off	AMTOR	Enables the alternate SELCALL set by the <u>ALTCALL</u> command in mode A <u>ARQ</u> .	6-6
<u>ABORT</u>	--	I-command	M-Packet	Allows <u>SYSOP</u> to force a disconnect on the Mailbox link.	6-6
<u>ACKPRIORITY</u>	ON OFF	on	Packet	Permits an acknowledging TNC to transmit without regard to slotting delay.	6-7
<u>ACKTIME</u>	n	14	Packet	Controls a delay that occurs whenever any packets that have been received are not addressed to that unit.	6-7
<u>ALOCKCHAR</u>	nn	\$15 (^U)	CW/MCW	Character used to force the MFJ-1278B to match its transmit speed to that of the incoming signal.	6-8
<u>ALTCALL</u>	ssss	blank	AMTOR	Sets an alternate SELCALL that the MFJ-1278B responds to in AMTOR mode A.	6-8
<u>ANSBSTR</u>	cccc	blank	AMTOR	Enables the MFJ-1278B's response to a "Who Are You?".	6-8
<u>ANSWRQRA</u>	ON OFF	on	Packet	Set MFJ-1278B to poll all TNCs within range.	6-9
<u>ARCVCHAR</u>	nn	\$12 (^R)	RTTY/CW/	Specifies the character used to ASCII return to receive after transmitting.	6-10
<u>ARQ</u>	ssss	I-command	AMTOR	Initiates mode A "ARQ" connection.	6-10
<u>ASA</u>	--	I-command	RTTY/ASCII/AMTOR/ Packet	Invokes MFJ-1278B to analyze incoming signals.	6-10
<u>ASENDCHA</u>	nn	\$14 (^T)	RTTY/CW/ASCII	Specifies the transmit character.	6-11
<u>ASPECT</u>	n	3	FAX	Sets a reasonable aspect ratio between the Hor/Ver. representation of the FAX picture.	6-11
<u>AUTOBAUD</u>	ON OFF	on	All	Enables the autobaud function which matches MFJ-1278B terminal baud rate to terminal program baud rate.	6-12
<u>AUTOLF</u>	ON OFF	on	Packet	Determines the way the <CR> characters are displayed.	6-13
<u>AUTOTRAC</u>	ON OFF	on	CW/MCW	Automatically locks onto the incoming cw signal and displays the speed.	6-14
<u>AWLEN</u>	n	8	All	Defines the word length used by the MFJ-1278B's RS-232 port.	6-15
<u>AX25L2V2</u>	ON OFF	on	Packet	Determines the use of AX.25 Level 2 Ver. 2 or Ver. 1 Protocol.	6-15
<u>AXDELAY</u>	n	0	Packet	Sets the voice repeater Kevin delay in 10	6-16

MFJ-1278B MULTI-MODE APPENDIX H COMMAND SUMMARY

Command	Parameter	Default	Mode	Function	Page
<u>BKONDEL</u>	ON OFF	on	Packet	Determines the way the screen is updated when a character is deleted in the command mode.	6-19
<u>BLP</u>	ON OFF	on	Packet	Allows Host Mode operation	6-20
<u>BTEXT</u>	text	blank	Packet	Specifies the text of the beacon packet.	6-21
<u>BUDLIST</u>	ON OFF	off	Packet	Determines if the packets listed in LCALLS are to be displayed.	6-22
<u>BUF</u>	n	0-9	CW/RTTY/	Allows addressing of the ten user ASCII programmable memories.	6-22
<u>BUFKEY</u>	nnn	9	CW/RTTY/	Allows the user to transmit the ASCII buffer without using the (CTRL-T).	6-23
<u>BUFTIME</u>	n	0	CW	Used to transmit buffer 0 when it is a non-zero value at the set interval.	6-23
<u>BWNL</u>	ON OFF	off	AMTOR	Causes the MFJ-1278B to transmit when it receives a <CR>.	6-23
<u>CALIBRA</u>	--	I-command	All	Used to transfer the control to the modem calibration routine.	6-24
<u>CALSET</u>	n	0	All	Specifies the count setting for use by the calibration routing.	6-24
<u>CANLINE</u>	n	\$18 (^x)	Packet	Changes the cancel-line input editing command character.	6-25
<u>CANPAC</u>	n	\$19 (^Y)	Packet	Changes the cancel-packet input editing command character.	6-26
<u>CBELL</u>	ON OFF	off	Packet	Sends a bell tone through the computer or terminal speaker when a packet connection is made.	6-27
<u>CBell</u>	ON OFF	OFF	Pactor	Sends a bell through the computer terminal speaker when a Pactor connect is established.	6-27
<u>CCITT</u>	ON OFF	on	RTTY	Determines whether U.S. standard or the internationally recognized character set is used.	6-28
<u>CHANGE</u>	-	I-command	AMTOR	Switches from receiver to transmitter in AMTOR mode A "ARQ".	6-28
<u>CHAT</u>	-	I-command	M-Packet	Allows SYSOP to break onto the mailbox's connected link.	6-28
<u>CHECK</u>	n	30	Packet	Sets a connection timeout.	6-29
<u>CHECKV1</u>	ON OFF	off	Packet	Enables the automatic idle-link-disconnect feature for AX.25 L2V1 connections.	6-29
<u>CHObell</u>	ON OFF	on	Pactor	Sends a bell tone to the computer or terminal when a Pactor changeover is done.	6-30
<u>CHOChar</u>	nnn	25	Pactor	Designates the Pactor changeover character.	6-30
<u>CMDchr</u>	nnn	\$03	Pactor	Designates the Pactor return to command mode character.	6-30

MFJ-1278B MULTI-MODE APPENDIX H COMMAND SUMMARY

Command	Parameter	Default	Mode	Function	Page
<u>CONPERM</u>	ON OFF	off	Packet	Allows a connection to become permanent.	6-32
<u>CMSG</u>	ON OFF	off	Packet	Enable a message to be transmitted whenever there is a connection made.	6-33
<u>CMSGDISC</u>	ON OFF	off	Packet	Controls whether the MFJ-1278B will initiate a disconnect sequence after it is connected to.	6-33
<u>COMMAND</u>	n	\$03 (^C)	All	Sets the character used to enter the command mode from CONVERS mode.	6-34
<u>CONMODE</u>	C T	C	Packet	Sets the MFJ-1278B to enter the transparent mode or converse mode automatically.	6-35
<u>CONNECT</u>	C1 Cx	none	Packet	Issues a connect from the command mode to another packet station.	6-36
<u>CONOK</u>	ON OFF	on	Packet	Determines the action taken by the MFJ-1278B when it receives a connect request.	6-37
<u>CONSTAMP</u>	ON OFF	off	Packet	Enables the time stamping when a disconnect occurs.	6-38
<u>CONVERS</u>	--	I-command	All	Forces the MFJ-1278B to enter the converse mode.	6-38
<u>CONVERSE</u>	--	I-command	AMTOR	Switches from the command mode to the text transmission mode in AMTOR.	6-38
<u>CPACTIME</u>	ON OFF	off	Packet	Enables the automatic transmission of packets in the converse mode.	6-39
<u>CR</u>	ON OFF	on	Packet	Causes the MFJ-1278B to send a <CR> every time a new line character is sent.	6-40
<u>CTEXT</u>	text	blank	Packet	Determines the packet text to be sent when a connect is made.	6-40
<u>CSTATUS</u>	--	I-command	Packet	Shows streams identifier and link state of all streams.	6-41
<u>CWCALL</u>	ssss	blank	AMTOR	Characters are sent as CW when ID character are issued.	6-41
<u>CWIDmode</u>	nn	0	Pactor	Determines the CWIDmode used when in the Pactor mode.	6-42
<u>CWSENDCH</u>	nnn	\$ff	CW	Controls how MFJ-1278B transmits the pending text in the CW buffer.	6-43
<u>CWSPEEDM</u>	ON OFF	off	CW	Causes the MFJ-1278B to adopt the incoming CW speed as its transmit speed.	6-43
<u>DAYTIME</u>	D/T	none	Packet	Sets the time and date used by the MFJ-1278B.	6-44
<u>DAYUSA</u>	ON OFF	on	Packet	Determines the display format for the time and date.	6-45
<u>DDisc</u>	--	I-Command	Pactor	This is the last resort disconnect for the Pactor mode.	6-45
<u>DISCONNECT</u>	--	I-command	Pactor	Initiates a standard Pactor disconnect.	6-45
<u>DISplay</u>	--	I-command	Pactor	Displays all Pactor commands, while in	6-45

MFJ-1278B MULTI-MODE APPENDIX H COMMAND SUMMARY

Command	Parameter	Default	Mode	Function	Page
DEADTIME	nnn	33(330Ms)	Packet	Determines the basic time interval used by the slotting procedure.	6-46
DELAY	nn	20 (20Ms)	AMTOR	Sets the delay between keying the transmitter and transmitting AMTOR.	6-46
DELETE	ON/OFF	off	Packet	Changes the input editing command.	6-47
DEFLDLC	0-254	254	Host	Sets default DLC number for Host Mode	6-47
DIDDLE	ON/OFF	on	ASCII/	Synchronization character sent by RTTY the MFJ-1278B each time transmitter is is keyed in RTTY/ASCII	6-47
DIGIPEAT	ON/OFF	on	Packet	Allows your station to be used as a digipeater.	6-48
DISCONN	--	I-command	Packet	Used to disconnect a connected station in packet.	6-48
DISPLAY	--	class	Packet	Used to list all the commands the MFJ-1278B acknowledges.	6-49
DISPLAY	--	I-command	AMTOR	Used to list all the commands used in AMTOR.	6-52
DWAIT	n	33	Packet	Used to avoid collisions with digipeating.	6-52
EAA	ON/OFF	on	Pactor	Echos pactor transmitted data upon receipt of remote's acknowledgement.	6-53
EAS	ON/OFF	off	CW/RTTY/ASCII	Enables real-time echoing of out-going CW, RTTY and ASCII text.	6-53
EASIN	ON/OFF	off	Amtor	Determines echoing of transmitted amtor data as you send it.	6-53
ECHO	ON/OFF	on	All	Allows the MFJ-1278B to transmit back to you everything that you type in all mode of operation.	6-54
ECho	ON/OFF	on	Pactor	Performs the same as the Packet ECHO command.	6-54
EPSON	ON/OFF	on	All	Determines if you are using an EPSON/IBM or C. ITOH printer.	6-54
ERrstrin	cccc	[...]	Pactor	Designates the character displayed when an unconnected packet is monitored.	6-55
ERUS	ON/OFF	on	AMTOR	Inserts an underscore if the MFJ-1278B detects an error while receiving AMTOR.	6-55
ESCAPE	ON/OFF	off	Packet	Specifies the character which will be output when an <escape> character is to be sent.	6-55
EXActcal	ON/OFF	on	Pactor	Determines if exact callsign matching mode is used or not	6-56
FARNSWOR	ON/OFF	on	CW	Enables the MFJ-1278B to transmit CW in Farnsworth method.	6-56
FAXEOP	ON/OFF	on	FAX	Determines if the user will have to terminate the end of a FAX picture	6-56
FAXMODE	n	3	FAX	Sets the FAX formats in FAX mode.	6-57
FAXNEG	ON/OFF	off	FAX	Causes the receiving FAX picture to print	6-57

MFJ-1278B MULTI-MODE APPENDIX H COMMAND SUMMARY

Command	Parameter	Default	Mode	Function	Page
<u>FEC</u>	--	I-command	AMTOR	Initiates the broadcasting of Mode B forward error correcting mode.	6-58
<u>FIRMRNR</u>	ON OFF	on	Packet	Controls the handling of busy states by MFJ-1278.	6-58
<u>FLOW</u>	ON OFF	on	Packet	Sets type-in flow control to the terminal.	6-58
<u>FLow</u>	ON OFF	on	Pactor	Performs the same as the packet flow command.	6-59
<u>FORWARD</u>	--	I-command	Packet Mailbox	Mail forwarding to the destination bbs.	6-59
<u>FRACK</u>	n	3	Packet	Sets the time interval between retries.	6-59
<u>FULLDUP</u>	ON OFF	off	Packet	Allows communication in full duplex.	6-60
<u>GRAPHLF</u>	ON OFF	off	FAX/SSTV	Adds an extra line feed in graphic printing to the printer.	6-60
<u>HEADERLN</u>	ON OFF	off	Packet	Affects the display format of monitored packets.	6-61
<u>HEALED</u>	ON OFF	off	Packet	Redefines the function of the STA and CON LEDs.	6-61
<u>HID</u>	ON OFF	off	Packet	Controls the sending of identification packets by the MFJ-1278B.	6-62
<u>ID</u>	--	I-command	AMTOR	Sends a keyed modulated CW ID of your station in AMTOR.	6-62
<u>ID</u>	--	I-command	Packet	Sends a special identification packet to be sent in packet.	6-62
<u>Id</u>	--	I-command	Pactor	Initiates an immediate CWID to be sent.	6-63
<u>IDTime</u>	nnn	590	Pactor	Specifies the CWID time interval in the Pactor mode.	6-63
<u>K</u>	---	I-command	Pactor	Puts the MFJ-1278B into CONVERSE mode while in Pactor mode.	6-63
<u>KILONFWD</u>	ON OFF	off	M-Packet	Determines whether or not the MFJ-1278B deletes a message after it has been forwarded.	6-63
<u>KISS</u>	ON OFF	off	Packet	Allows the MFJ-1278B to work as a modem for special programs such as TCP/IP.	6-64
<u>Lc</u>	--	I-command	Pactor	Initiates a LongPath connect in the Pactor mode.	6-65
<u>LCALLS</u>	call	none	Packet	Used in conjunction with BUDLIST, allows selective monitoring of other packets.	6-65
<u>LCSTREAM</u>	ON OFF	on	Packet	Allows the MFJ-1278B to understand lower case characters as upper case after the streamswitch is entered.	6-66
<u>LCOK</u>	ON OFF	on	Packet	Determines whether the lower or upper case characters are set.	6-66
<u>LEDmode</u>	0/1	1	Pactor	Rapid flashing of STA and CON leds for the 200 baud Pactor mode.	6-67
<u>LFadd</u>	ON OFF	off	Pactor	Appends LF after a received carriage	6-67

MFJ-1278B MULTI-MODE APPENDIX H COMMAND SUMMARY

Command	Parameter	Default	Mode	Function	Page
<u>LFADDALT</u>	ON OFF	on	RTTY	Enables the MFJ-1278B to go to the next line when a <CR> character is received in RTTY mode.	6-67
<u>LFIGNORE</u>	ON OFF	off	Packet	Line feeds are ignored except in transparent mode.	6-68
<u>LISTEN</u>	--	I-command	AMTOR	Used to monitor someone else's Mode A AMTOR connection.	6-68
<u>MAILbox</u>	ON OFF	off	Pactor	determines if Pactor Mailbox is on-line.	6-68
<u>MAILBOX</u>	ON OFF	on	Packet	Enables the Packet personal mailbox.	6-69
<u>MAILED</u>	ON OFF	on	Packet	Controls the STA/MAIL LED. Flashes when mail is presence.	6-70
<u>MALL</u>	ON OFF	on	Packet	Determines the class of packets which are monitored.	6-71
<u>MARSMODE</u>	n	0	RTTY/ASCII	Use with Promars command to set the type of MARS QSO.	6-72
<u>MATCH</u>	ON OFF	on	AMTOR	Used for selectively monitoring portions of mode B FEC transmissions.	6-73
<u>MAXFRAME</u>	n	4	Packet	Sets the upper limit for the outstanding packets that can occur at one time.	6-73
<u>MAXSum</u>	nn	30	Pactor	Specifies the number of cycles of error-laden information packets received.	6-74
MAXUp	nnn	10	Pactor	Specifies the number of good 100 baud packets before a SPEEDUP is requested.	6-74
<u>MBEGIN</u>	cccc	<<>>	AMTOR	Allows the display of mode B transmissions only after the reception of the beginning of the signal.	6-74
<u>MCOM</u>	ON OFF	off	Packet	Enables monitoring of connected and disconnected packet when monitor is on.	6-75
<u>MCON</u>	ON OFF	off	Packet	Allows the monitoring of other packets while connected to another station.	6-75
<u>MCTEXT</u>	text	blank	Packet	Allows storing of text messages to be stored for mailbox. Text is sent when mailbox is connected.	6-76
<u>MEND</u>	cccc	nnnn	AMTOR	Used with MBEGIN and MATCH and the mode B receiving end when the MEND string is received	6-76.
<u>MFILTER</u>	n1-n4	\$00	M-Packet	Allows you to eliminate certain characters from received packets.	6-76
<u>MHCLEAR</u>	--	I-command	Packet	Clears the MHEARD list.	6-77
<u>MHEARD</u>	--	I-command	Packet	A list of all monitored packet stations.	6-77
<u>MODE</u>	--	I-command	All	Selects the operation mode of the MFJ-1278B.	6-77
<u>MNONAX25</u>	ON OFF	off	Packet	Allows MFJ-1278B to monitor non AX.25 packet.	6-78
<u>MNONPRIN</u>	ON OFF	on	Packet	Determines whether monitored packets containing non-printable characters are	6-78

MFJ-1278B MULTI-MODE APPENDIX H COMMAND SUMMARY

Command	Parameter	Default	Mode	Function	Page
MRPT	ON OFF	on	Packet	Affects the way monitored packets are displayed.	6-80
MSPEED	nn	20	CW	Sets the operational speed which the MFJ-1278B will use for CW.	6-80
MSTAMP	ON OFF	off	Packet	Enables the time stamping of monitored packets.	6-81
MTIMEOUT	0-250	30	M-Packet	Mailbox connect will timeout after a time set by this command.	6-81
MULTIFAX	ON OFF	off	FAX	Enables multi-level FAX transmitting and receiving.	6-82
MYCALL	call	nocall	Packet	Sets the callsign of the MFJ-1278B.	6-82
MYcall	callsign	MFJPACTR	Pactor	Your Pactor amateur callsign	6-83
MYALIAS	call-n	blank	Packet	Specifies an alternate callsign for use as a digipeater only.	6-83
MYDLCNUM	0-254	0	Host	Sets the DLC number for Host Mode.	6-83
MYHIERAD	nnnn	text	M-Packet	Sets the heiarcal address text sent by a Mailbox forward.	6-84
MYMCALL	call	nocall	M-Packet	Dedicated mailbox callsign.	6-84
MYSELCAL	ssss	blank	AMTOR	Tells the MFJ-1278B what SELCALL your station should respond to.	6-84
NAVTEX	--	I-command	NAVTEX	Allows you to receive NAVTEX signals.	6-85
NAVSTN	xxxxx	all	NAVTEX	Allows you to receive certain NAVTEX stations.	6-85
NAVMSG	x	all	NAVTEX	Allows you to receive certain NAVTEX messages.	6-86
NEWMODE	ON OFF	off	Packet	Selects the way the MFJ-1278B behaves when connections are made and broken.	6-87
NO200	ON OFF	OFF	Pactor	Enables or inhibits 200 baud Pactor mode.	6-88
NODEFORW	--	I-command	M-Packet	Similar to Forward command but with callsign+ up to 8 vias.	6-88
NODEPATH	--	I-command	M-Packet	Commands connected node by Nodeflow to link with the receiving BBS.	6-89
NOMODE	ON OFF	off	Packet	Determines if the MFJ-1278B will switch manually or automatically to command mode.	6-89
NUCR	ON OFF	off	Packet	Causes transmission of <null> characters, producing a delay following any <cr> sent to the terminal.	6-90
NULF	ON OFF	off	Packet	Same as NUCR, instead of <cr> it sends a delay after a <lf>.	6-90
NULLS	n	0	Packet	Used in conjunction with NUCR and NULF, and specifies how many <null> characters are sent.	6-90
OK	--	I-command	ASA	Use with ASA command to accept the analyzed signal.	6-91
OMLC	ON OFF	off	AMTOR	Instructs the MFJ-1278B to convert all	6-91

MFJ-1278B MULTI-MODE APPENDIX H COMMAND SUMMARY

Command	Parameter	Default	Mode	Function	Page
<u>PACTIME</u>	n10	Packet	Determines the length of time between transmit and receive.	6-92	
<u>PARITY</u>	n	0	Packet	Sets the parity mode for terminal or computer data transfer.	6-92
<u>PASS</u>	n	\$16 (^V)	Packet	Selects the ASCII character used for the "pass" input editing character.	6-93
<u>Pass</u>	nnn	\$16	Pactor	Same as the PASS command in other modes.	6-93
<u>PASSALL</u>	ON OFF	off	Packet	Causes the MFJ-1278B to display packets received with invalid CRC fields.	6-94
<u>PIXTONES</u>	n	--	FAX/SSTV	Sets transmit tones for multi-level FAX/SSTV pictures.	6-95
<u>PKTPIX</u>	ON OFF	off	Packet	Allows the MFJ-1278B to print packet pictures to the built-in printer port.	6-97
<u>PRINTGRA</u>	ON OFF	on	FAX/SSTV	Determines whether the MFJ-1278B will print the graphics to the printer or the terminal screen.	6-98
<u>PRINTER</u>	ON OFF	off	All	Turns the parallel printer port on or off.	6-98
<u>PRINTES</u>	--	I-command	All	Used to test the printer connected to the parallel printer port.	6-99
<u>PROFMARS</u>	--	I-command	RTTY/ASCII	Invokes pre-set commands for MARS operation.	6-99
<u>PTOver</u>	nnn	I-command	Pactor	Designates the Pactor changeover character.	6-99
<u>PTSend</u>	--	I-command	Pactor	Same as issuing the U1 unproto command.	6-100
<u>QRT</u>	--	I-command	AMTOR	Used to break a link in AMTOR.	6-100
<u>R</u>	--	I-command	AMTOR	Is the equivalent to QRT.	6-100
<u>RADIO</u>	n	1	ALL	Allows the user to select the radio port on the MFJ-1278.	6-100
<u>RANDOMCW</u>	ON OFF	off	CW	Allows the used of the random code generator.	6-101
<u>RBITMASK</u>	\$xx	0	RTTY/ ASCII	Set the bit inversion during receiving data	6-101
<u>RECONNECT</u>	call1-9	I-command	Packet	Used to change the path through which you are currently connected to a station.	6-101
<u>REDISPLA</u>	n	\$12 (^R)	All	Used to change the redisplay-line input editing character.	6-102
<u>REMSYSOP</u>	call 0-15	blank	M-Packet	Permits the SYSOP to perform sysop functions remotely.	6-102
<u>RESTART</u>	--	I-command	Packet	Re-initializes the MFJ-1278B using the stored parameters.	6-103
<u>RESET</u>	--	I-command	All	Resets all parameters to their default values and reinitiates the unit.	6-103
<u>RESPTIME</u>	n	0	Packet	Sets a minimum delay that is imposed on	6-103

MFJ-1278B MULTI-MODE APPENDIX H COMMAND SUMMARY

Command	Parameter	Default	Mode	Function	Page
<u>RE</u> Tries	nnn	I-command	Pactor	Specifies number of error packet cycles.	6-104
<u>RE</u> TRY	n	10	Packet	Allows retransmission of frames that are not acknowledged.	6-104
<u>RE</u> VFLIM	call-n	blank	M-Packet	Callsigns of BBS to enable reverse-forwards.	6-105
<u>R</u> FE	ON OFF	off	AMTOR	Will continue to retry until a QRT is received.	6-105
<u>R</u> INV	ON OFF	off	AMTOR	Controls the incoming received signal to be inverted before detection/processing occurs.	6-105
<u>R</u> XBLOCK	ON OFF	off	Packet	Determines whether the information will be sent in standard or block format.	6-106
<u>R</u> XBRIGHT	n	4	SSTV/FAX	Determines brightness and contrast of SSTV or FAX pictures	6-107
<u>R</u> XCAL	--	I-command	All	Generates test signals that are used by the internal tuning software to align the demodulator circuit.	6-108
<u>R</u> VFALWAY	ON OFF	on	M-Packet	Initiates forwards and reverse of all forwardable messages.	6-110
<u>R</u> XINVERT	ON OFF	off	RTTY/ASCII	Inverts the mark and space tones.	6-110
<u>S</u> CREENLN	n	0	All	Used to properly format terminal output.	6-110
<u>S</u> ELCALL	ssss	I-command	AMTOR	Initiate a mode L "SELCALL" broadcast.	6-111
<u>S</u> ENDPAC	n	\$0D (CR)	Packet	Selects the character that will force a packet to be sent in CONVERSE mode.	6-111
<u>S</u> ERIALNO	0-65535	0	CW	Used for contest serial numbering.	6-111
<u>S</u> ETUP	n	I-command	All	Used to set the mode and baud rate. Similar to the MODE command.	6-112
<u>S</u> FNL	ON OFF	on	AMTOR	Controls whether the 1278B adds a new line character to "+?" and WRU.	6-112
<u>S</u> LOTS	nn	3	Packet	Determines how many sides are on the slot time dice.	6-113
<u>S</u> OLF	ON OFF	on	AMTOR	Determines whether only <lf> characters from the AMTOR receiver are sensed as newline characters.	6-113
<u>S</u> RXALL	ON OFF	on	AMTOR	Causes the MFJ-1278B to print all receivable mode S transmissions.	6-114
<u>S</u> TART	n	\$11 (^Q)	All	Selects the user restart character.	6-114
<u>S</u> Tatus	--	I-command	Pactor	Displays debug information helpful in troubleshooting Pactor problems.	6-114
<u>S</u> TATUS	--	I-command	AMTOR	Returns useful diagnostic information for helping us help you with your problems.	6-115
<u>S</u> TOP	n	\$13 (^S)	All	Selects the user stop character.	6-115
<u>S</u> TREAMCA	ON OFF	off	Packet	Used to enable the display of the connected to station after the stream identifier.	6-116
<u>S</u> TREAMDB	ON OFF	off	Packet	Used to display received	6-117

MFJ-1278B MULTI-MODE APPENDIX H COMMAND SUMMARY

Command	Parameter	Default	Mode	Function	Page
<u>STREAMSW</u>	n	\$7C (I)	Packet	Selects the character used by both the MFJ-1278B and the user to select a new "stream".	6-118
<u>SY SOP</u>	--	I-command	Packet	Enables the MAILBOX systems operator to enter in messages to the BBS system/bbs.	6-118
<u>TIMEDCMD</u>	text	blank	M-Packet	Text string in this command is executed at a time pre-set by Timedmin command.	6-118
<u>TIMEDMIN</u>	n	60	M-Packet	Set the time for Timedcmd command.	6-119
<u>TINV</u>	ON OFF	off	AMTOR	Allows the user to invert the transmitted AMTOR signals	6-119
<u>TRACE</u>	ON OFF	off	Packet	Enables the debugging protocol function.	6-120
<u>TRace</u>	ON OFF	OFF	Pactor	Displays continuous debug information on the terminal screen.	6-120
<u>TRANS</u>	--	I-command	Packet	Transparent mode.	6-121
<u>TRFLOW</u>	ON OFF	off	Packet	Enables and disables the software flow control.	6-121
<u>TRIES</u>	nn	one	Packet	Retrieves the count of "tries" on the currently selected input stream.	6-122
<u>TUNE</u>	--	I-command	All	Keys the PTT and low tone for the current modem for 30 seconds or until you strike a key on your keyboard.	6-122
<u>TUNEPROC</u>	--	I-command	All	Used to tune the MFJ-1278B modulator and demodulator.	6-122
<u>TVBREAKS</u>	n	see 6-122	SSTV	Sets the brightness and contrast of SSTV picture received on the built-in printer port.	6-123
<u>TVHSYNC</u>	ON OFF	off	SSTV	Allows MFJ-1278B to look for Hsync on dark area around the picture.	6-124
<u>TVMODE</u>	n	1	SSTV	Selects the formats under the SSTV mode.	6-124
<u>TVX</u>	ON OFF	off	SSTV	Enables multi-gray levels SSTV raw data to be sent to the terminal without any SSTV format.	6-125
<u>TXDELAY</u>	n	33	Packet	Tells the MFJ-1278B how long to wait after keying up the transmitter before sending data.	6-125
<u>TXDelay</u>	n	2	Pactor	Sets time between PTT key up and actual data transmit.	6-126
<u>TXDELAYC</u>	n	2	Packet	Controls a new timer that runs after the regular TXDELAY time has expired.	6-126
<u>TXDIDDLE</u>	ON OFF	off	Packet	Invokes efficient key up technique in transmitted packet to increase throughput.	6-127
<u>TXFLOW</u>	ON OFF	off	All	Enables the software flow control for the transparent mode.	6-128
<u>TXINVERT</u>	ON OFF	off	RTTY/ASCII	Inverts the mark and space on the transmitted signals on RTTY/ASCII	6-128

MFJ-1278B MULTI-MODE APPENDIX H COMMAND SUMMARY

Command	Parameter	Default	Mode	Function	Page
<u>TXUI</u> FRAME	ON OFF	on	Packet	Used to tell the MFJ-1278B what to do with the unconnected information left in its buffer.	6-129
<u>U1</u> Unproto	--	I-command	Pactor	Initiates a 100 baud unproto connect.	6-129
<u>U2</u> Unproto	--	I-command	Pactor	Initiates a 200 baud unproto connect.	6-129
<u>UN</u> PROTO	call1	CQ	Packet	Sets the digipeat and destination address fields of packets sent in the unconnected mode.	6-129
UNSHIFT	ON OFF	on	RTTY/ASCII	Determines the way the SPACE character is displayed in the RTTY/ASCII modes.	6-130
<u>UR</u> epeats	nn	1	Pactor	Specifies number of FEC data packet re-transmissions.	6-130
<u>US</u> ERS	n	1	Packet	Controls the manner in which the incoming connect requests are handled.	6-130
<u>VIS</u> TICKS	n	0	Color SSTV	Specifies the number of pixels sent at the start of an SSTV picture that will use the alternate Vistones modem configuration list.	6-131
<u>VIS</u> BREAKS	n	see 6-132	Color SSTV	This is the TVBreaks-like list used for VIS decoding.	6-131
<u>VIS</u> TONES	n	see 6-132	Color SSTV	This is the PIXTones-like list used for transmitting ROBOT sync tones of 1100, 1200 and 1300 Hz.	6-131
<u>W</u> aitdisc	nn	20	Pactor	Specifies number of cycles before replying to other TNCs	6-132
<u>W</u> DMODE	ON OFF	off	AMTOR	Determines whether A mode Transmission takes place any time you type a SPACE or RETURN character.	6-132
<u>W</u> EIGHT	n	0	CW	Sets the weight factor for the CW transmission.	6-132
<u>W</u> RU	--	I-command	AMTOR	Causes the remote mode A "ARQ" station currently in contact with you to transmit its answer back message.	6-133
<u>X</u> FLOW	ON OFF	on	All	Enables the flow control.	6-133
<u>X</u> MITOK	ON OFF	on	Packet	Enables the transmit function.	6-133
<u>X</u> OFF	n	\$13 (^S)	All	Selects the MFJ-1278B stop character.	6-134
<u>X</u> off	nn	\$13	Pactor	Sets the Flow Control STOP character for the Pactor mode.	6-134
<u>X</u> On	nn	\$11	Pactor	Sets the Flow Control START character for the Pactor mode.	6-134
<u>X</u> ON	n	\$11 (^Q)	All	Selects the MFJ-1278B restart character.	6-135

MFJ-1278B/1278BT PARTS LIST

<u>MFJ P/N</u>	<u>Description</u>	<u>Component ID</u>
RESISTORS, 1/4 WATT, 5%		
100-0002	10 OHM	R128, R150
100-0003	100 OHM	**R14, **R15, R17, R18 R19, R59
100-0004	200 OHM	R60, R126
100-0009	470 OHM	R4, R97, R53, R34, R35
100-0056	680 OHM	R211
100-0010	1 K	R8, R36, R46, R47, R48 R11, R33, R144, R143, R56
100-0012	2.2 K	R16, R145, R146
100-0099	4.3 K	R152
100-0014	4.7 K	R32, R74, R140, R107
100-0017	10 K	R9, R10, R12, R2, R7, R22 R23, R26, R29, R30, R38 R49, R50, R51, R52, R61 R67, R68, R69, R70, R71 R75, R96, R99, R100, R28 R104, R207, R213, R108 R124, R125, R127, R130 R132, R134, R135, R136 R137, R98, R109
100-0019	15 K	R156, R151
100-0094	22 K	R73, R148, R149
100-0020	24 K	R76, R163, R162

MFJ-1278B MULTI-MODE**APPENDIX I PARTS LIST**

		R27, R37, R42 R72, R43 R20, R31, R64, R65, R133 R147 R155, R40, R41
100-0060	180 K	R154
100-0033	200 K	R205
100-0073	470 K	R203, R204
100-0063	750 K	R95
100-0040	1 M	R83
RESISTORS, 1/8 WATT, 1%		
102-5301	301 K	R129
102-0057	182 K	R102
102-5229	229 K	R118*
102-4392	39.2 K	R116, R141
102-0026	13.3 K	R111, R117*
102-4180	18 K	R120*
102-0052	16.2 K	R112
102-4150	15.0 K	R123
102-0018	10.00 K	R82, R81, R121*
102-0053	22.1 K	R92
102-0054	47.50 K	R93
102-0055	100.00 K	R94

MFJ-1278B MULTI-MODE**APPENDIX I PARTS LIST**

<u>MFJ P/N</u>	<u>Description</u>	<u>Component ID</u>
TRIMPOTS, BOURNS OR EQUAL		
108-6014	10 K, BOURNS 3299W-1-103	R79, R113, R114
108-7005	20 K, BOURNS 3299W-1-203	R77, R78, R106, R105,
108-7006	50 K, BOURNS 3299W-1-503	R115, R138, R139, R122
108-7008	25 K, BOURS 3299W-1-253	R119
108-7001	1 K, BOURNS 3299W-1-102	R212
TRIM POT: SINGLE TURN, MINIATURE		
104-1103	10 K, Single-turn Trimmer	R157, R158, R160
POT: 17MM SINGLE TURN, PCB MOUNT		
104-3104	100 K LINEAR TAPER, RIGHT ANGLE	R131
CAPACITORS: MULTI-LAYER, MONOLITHIC CERAMIC		
205-0010	10 PF, NPO, 10%, 50V	C51
205-0100	100 PF, "	C61
205-0220	220 PF, "	C60, C72
205-0470	470 PF, "	C59
205-1010	.001 UF, "	C5
205-1015	.0015 UF, "	C67
1205-1022	.0022 UF, "	C54
205-1047	.0047 UF, NPO, 10%	C53, C71
205-1147	.017 UF X7R 10%	C76 C80 C81 C82 C83

MFJ-1278B MULTI-MODE**APPENDIX I PARTS LIST**

<u>MFJ P/N</u>	<u>Description</u>	<u>Component ID</u>
201-1210	.1 UF, Z5U, 20%	C1, C4, C11, C32, C21, C23 C9, C13, C14, C25, C26 C15, C17, C27, C28, C29 C30, C49, C50, C37, C38 C40, C41, C78, C43, C46 C48, C63, C66, C202, C205 C206, C208, C209, C91* C70*, C92*, C94*, C95* R93*, C33*
CAPACITORS: MYLAR, 50V/100V		
201-0018	.01 UF, MYLAR, 5%	C64#, C68#, C90#
201-0006	.022 UF, MYLAR, 5%	C55, C52
201-0001	.15 UF, MYLAR, 10%	C45
201-2247	.47 UF, MYLAR, 10%	C89, C57
201-2233	.33 UF, MYLAR, 10%	C97, C98
CAPACITORS: ELECTROLYTIC		
203-0006	1 UF, 16 V, RADIAL	C58, C44
203-0002	2.2 UF, 16V, RADIAL	C65
203-0012	10 UF, 16 V, RADIAL	C3, C6, C7, C22, C8, C18 C201
203-0014	47 UF, 16 V, RADIAL	C10, C31, C203, C204, C99
203-0003	100 UF, 16 V, RADIAL	C16
203-2100	1000 UF, 25 V, AXIAL	C12
203-0004	470 UF, 16 V, RADIAL	C75

<u>MFJ P/N</u>	<u>Description</u>	<u>Component ID</u>
CAPACITOR: OTHER TYPES		
203-8010	1 UF, 16 V, RADIAL TANTALUM TYPE	C20
204-0060	60 PF, TRIMMER (2 LEADS, .20" SPACING)	C47
IC SOCKETS: LOW PROFILE		
625-0184	8-PIN SOCKET	U8
625-0031	14-PIN SOCKET	U2, U3, U4, U7, U9, U10 U11, U13, U14, U20, U30 U31, U37, U41, U201
525-0030	16-PIN SOCKET	U1, U12, U16, U26, U29 U32, U33, U34, U35, U36
625-0291	20-PIN SOCKET	U5, U15, U27, U28, U38 U39, U40
625-0292	28-PIN SOCKET	U6, U25
625-0132	32-PIN SOCKET	#U23, U24
625-0181	40-PIN SOCKET	U21, U22
IC'S		
311-0358	LM358, Dual Op-AMP	U8
311-0004	LM348N, QUAD OP-AMP	U3
311-0040	LM324N, QUAD OP-AMP	U201
311-1556	LM556CN, OSC/TIMER	U2
311-2045	XR2206CP, FSK GENERATOR, EXAR BRAND ONLY	U16

MFJ-1278B MULTI-MODE**APPENDIX I PARTS LIST**

<u>MFJ P/N</u>	<u>Description</u>	<u>Component ID</u>
312-2512	27C1001, CMOS EPROM, 100 NS OR BETTER, (ERASABLE TYPE ONLY, DO NOT USE FUJUTSE TYPE)	U23
312-2081	27C64, CMOS EPROM, 200 NS OR BETTER, PROGRAM WITH "STATE" 1.09 (ONE-TIME PROM, OK TO USE)	U6
312-0075	43256LP-10, 32K STATIC RAM, 100 NS OR BETTER	U24, U25
312-0067	Z084404PSC, 4 MHZ, Z80A SIO/O DUAL SERIAL PORT, ZILOG, TOSHIBA OR EQUAL	U21
312-0044	Z0840004PSC, CMOS, 4 MHZ, Z80A CPU, ZILOG, TOSHIBA OR EQUAL	U22
310-0044	4040B, CMOS DIVIDER	U1
310-34066	74HC4066P, QUAD CMOS SWITCH	U13
310-4004	74HCT04, HEX INVERTER	U10
310-3014	74HC14P, HEX SCHMITT INVERTER (Do not use 74HCT14 for these ICs)	U7, U9, U14
310-3107	74HC107N, DUAL J-K FLIP FLOP	U11
310-4374	74HCT374, OCTAL LATCH	U5, U27, U28, U39, U40*
310-4373	74HCT373, OCTAL TRANSPARENT LATCH	U38
310 4303	74HCT303N DUAL BINARY	U14

MFJ-1278B MULTI-MODE**APPENDIX I PARTS LIST**

<u>MFJ P/N</u>	<u>Description</u>	<u>Component ID</u>
310-3138	74HC138, 3-to-8 LINE DECODER	U29#, U12#
310-0054	4053B, TRIPLE 2-CH CMOS ANALOG SWITCH	U26, U35, U36
310-0053	4052B, DIFFERENTIAL 4-CH CMOS ANALOG SWITCH	U32, U33, U34
310-0040	4066, QUAD CMOS SWITCH	U30, U31
310-3021	74HCT21, DUAL 4-INPUT AND	U41*
310-3273	74HCT273, QUAD D FLIP FLOP	U40
DIODES/LEDS		
301-0012	1N754, 6.8 V ZENER	CR6, CR8
301-1004	1N4001, 1A RECTIFIER	CR22, CR7, CR2, CR3, CR4 CR5
301-1005	1N4006, 1A RECTIFIER	CR27, CR28
301-0003	1N4148, SWITCHING	CR9, CR10, CR11, CR13 CR15, CR14, CR24, CR16 CR23, CR29, CR30, CR201 CR202, CR32, CR25, CR26
301-1015	1N4746, 18 V ZENER	CR1
301-5257	1N5257B, 33 V ZENER	CR12, CR31
320-0001	RED LED, 5 MM ROUND	CR17, CR19, CR18, CR33
320-0003	YELLOW LED, 5 MM ROUND	CR20
320-0002	GREEN LED, 5 MM ROUND	CR21

TRANSISTORS:

MFJ-1278B MULTI-MODE**APPENDIX I PARTS LIST**

<u>MFJ P/N</u>	<u>Description</u>	<u>Component ID</u>
305-0001	2N3904, GENERAL PURPOSE NPN	Q9, Q1, Q2, Q4, Q6, Q7 Q22, Q15, Q13, Q14, Q16 Q19
305-0002	2N3906, GENERAL PURPOSE PNP	Q8, Q5, Q12, Q21, Q23
305-2006	MPS-A92	Q18
VOLTAGE REGULATOR		
307-2006	7805CT, TO-220, +5 VOLTS	Q3
CONNECTORS		
612-1010	10-PIN, .1 CENTER, RIGHT ANGLE MALE HEADER, 22-05-3181	J5#
612-0032	2-PIN, .1 CENTER, MALE HEADER, MOLEX 22-03-2021 OR EQUAL	JMP4, JMP5, JMP7, JMP8, JMP10, JMP13, JMP 16(2) JMP 23*, JMP A, JMP E JMP F, JMP G, JMP H JMP J, JMP K, JMP L JMP R
612-0033	3-PIN, .1 CENTER, MALE HEADER, MOLEX 22-03-2031 OR EQUAL	JMP1, JMP9, JMP14, JMP18*, JMP19*(2) JMP22*, JMP24*
612-0035	5-PIN, .1 CENTER, MALE HEADER, MOLEX 22-03-2051 OR EQUAL	J14
612-0036	6-PIN, .1 CENTER, MALE HEADER, MOLEX 22-03-2061	J15*
612-0036	20-PIN, .1 X .1 CENTER, MALE HEADER,	J4
611-1005	5-PIN, DIN FEMALE, PC MT., RIGHT ANGLE SWITCHCRAFT	J2, J9

MFJ-1278B MULTI-MODE**APPENDIX I PARTS LIST**

<u>MFJ P/N</u>	<u>Description</u>	<u>Component ID</u>
601-6021	2.0 MM PIN, COAXIAL JACK, PC MOUNT, MALE	P1
601-5003	3.5 MM, MINIATURE PC MOUNT JACK, STEREO	P2, P3, P11#
600-0011	RCA PHONO JACK, RIGHT ANGLE PCB MOUNT	J11
612-4001	2-POSITIONS, PUSH-ON JUMPER MOLEX 15-38-1024 OR EQUAL PUSH-ON JUMPER TO BE : INSTALLED ON	JMP5, JMP8, JMP 9 (2) JMP13, JMP14 (1) JMP 16 (2), JMP18 (1) JMP19 (32K), JMP22 JMP24, JMP26, JMP A JMP E, JMP F, JMP G JMP H, JMP J, J4 (4)
MISCELLANEOUS		
402-1100	10 UH, 20%, MOLDED INDUCTOR NYTRONICS: RFS-10 OR EQUAL	L1
401-0102	10 UH, 20%, MOLDED INDUCTOR DALE IM-4 OR EQUAL	L2, L4
405-0090	4.9152 MHZ, HC-18/U CRYSTAL	Y1
504-0022	DPDT, ON/OFF SWITCH SW1 ITT SHADOW F-2UEE OR EQUAL	
760-2140	RED CAP FOR SW1, ROUND	
760-0030	KNOB FOR R131	
730-1305	3-VOLTS, LITHIUM BATTERY, COIN TYPE CR2430 OR EQUAL	BATT 1
730-2293	COIN BATTERY HOLDER	BATT 1
752-1268	BAR GRAPH DISPLAY FILTER RED	

MFJ-1278B MULTI-MODE**APPENDIX I PARTS LIST**

<u>MFJ P/N</u>	<u>Description</u>	<u>Component ID</u>
715-8082	6-32 x .5" Hex or round Aluminum spacer threaded with 6-32 threaded on both ends. To be installed on mother board. Use mounting hole next to C201 and C203.	
700-3063	6-32 x .25" machine screw. For installing above spacer.	
705-1617	MOUNTING NUT FOR R131	
710-4017	PANEL WASHER FOR R131	
701-7163	M3 X 6, SCREW FOR MOUNTING PCB TO CHASSIS & REGULATOR TO CHASSIS.	
705-1403	NUT FOR MOUNTING VOLTAGE VOLTAGE TO CHASSIS	
701-2236	#4 X 1/4 TYPE B, BLACK, FOR MOUNTING FACE PLATE	
700-2221	4-40 X 1/4, BLACK, SCREWS FOR INSTALLING COVER	
862-1278-1	PC BOARD, 7" X 9.5", REV. 10	
50-1274-2	DISPLAY PC BOARD ASSEMBLY (SAME AS 1274)	
50-1278-3	GRAYSCALE PC BOARD ASSEMBLY	
800-0210-1278	ALUMINUM CHASSIS WITH PRESS-ON SPACERS AND PEM NUT INSERT.	

NOTE: MASK OUT PAINT ON BOTH SIDES OF THE BOTTOM CHASSIS PIECE. THIS IS TO INSURE GOOD CONTACT WITH COVER. REDUCE EMI.

MFJ-1278B MULTI-MODE**APPENDIX I PARTS LIST**

<u>MFJ P/N</u>	<u>Description</u>	<u>Component ID</u>
----------------	--------------------	---------------------

806-0210-1278	CABINET COVER.	
---------------	----------------	--

**NOTE: MASK OUT PAINT ON THE INSIDE OF THE TOP CHASSIS PIECE.
THIS IS TO INSURE GOOD CONTACT WITH CHASSIS REDUCE EMI.**

770-1162	STICK-ON RUBBER FEET	
----------	----------------------	--

781-2110	FCC STICKER, INSTALL UNDER CHASSIS	
----------	------------------------------------	--

781-1118	SERIAL NO. STICKER. INSTALL ONE UNDER CHASSIS AND ONE ON OUTSIDE OF GIFT BOX.	
----------	--	--

852-1027	SMALL FORM PACKING INSERT	
----------	---------------------------	--

852-1028	LARGE FORM PACKING INSERT	
----------	---------------------------	--

850-1108	1278B PRINTED GIFT BOX, WITH REVISED ARTWORK FOR REV. 10 PCB.	
----------	--	--

ADDITION PARTS FOR MFJ-1278BT ONLY

50-2400B-1	2400 BAUD MODEM PCB ASSEMBLY	
------------	------------------------------	--

10-22008	MODEM CONNECTING CABLE ASSEMBLY: 3", 5 PIN CONNECTOR JUMPER CABLE WITH 5 POS. IDC SOCKET ON EACH END.	
----------	---	--

716-2050	.5" NYLON MOUNTING SPACER	
----------	---------------------------	--

700-3063	6-32 X .25", MACHING SCREW FOR MOUNTING MODEM PCB.	
----------	---	--

**NOTE: FOR MFJ-1278T, BEFORE INSTALLING 50-2400B-1 MODEM PCB
ASSEMBLY, REMOVE ALL SHORING JUMPERS ON J4.**

BOM for Display PC Assembly: P/N: 50-1274-2

100-0009	470 ohm, 1/4 W, 5%	
----------	--------------------	--

		R209, R210
--	--	------------

MFJ-1278B MULTI-MODE**APPENDIX I PARTS LIST**

<u>MFJ P/N</u>	<u>Description</u>	<u>Component ID</u>
205-1210	.1 UF, Z5U, 20% MONOLITHIC CAPACITOR	C209
625-0182	18-PIN IC SOCKET	U204, U205
625-0291	20-PIN IC SOCKET	U202, U203
311-1056	LM3914N, BAR GRAPH DISPLAY DRIVER	U204, U205
320-2010	MV57164, 10 SEG. BAR GRAPH. DISPLAY, RED, GI OR LTA-1000P OR EQUAL	U202, U203
861-1274-2	PC BOARD FOR 50-1274-2	
620-6108	8-COND. RIBBON JUMPER CABLE	
735-1128	RIGHT ANGLE BRACKET FOR MOUNTING DISPLAY PCB	

BOM for Grayscale PC Assembly: P/N: 50-1278-3**RESISTORS: 1/8W, 1%**

102-3215	2.15K	R301
102-3113	1.13 K	R302
102-0604	604 ohm	R303
102-3301	3.01 K	R304
102-3158	1.58 K	R305
102-0845	845 Ohm	R306
102-4137	13.7 K	R308

Trimpot: 15 Turns Bourns or Equal

MFJ-1278B MULTI-MODE**APPENDIX I PARTS LIST**

<u>MFJ P/N</u>	<u>Description</u>	<u>Component ID</u>
Capacitor: Monolithic Ceramic		
205-1210	.1 UF, Z5U, 20%	C301, C304
Capacitor: Electrolytic		
203-0012	10 uf, 16V, Radial	C302, C303
IC Sockets		
625-0031	14-pin Socket	U301, U302
625-0030	16-pin Socket	U305, U306
625-0291	20-pin Socket	U303, U304
IC's		
310-3074	74HCT74, D Flip-Flop	U301
310-4393	74HCT393, Dual Binary Divider	U302
310-4374	74HCT374, Octal Latch	U303, U304
310-0054	4053B, Triple 2-CH CMOS SWITCH	U305, U306
Miscellaneous		
620-6110	Right Angle "L" Brackets for Mounting add-on pcb. Same as bracket for tuning indicator pcb.	
620-6110	10-conductor Ribbon Jumper. Same as ribbon jumper used on the tuning indicator board except 20 conductors.	
862-1278-3 PCB, GRAYSCALE BOARD, APPROX. 1" X 5.312"		

<u>MFJ P/N</u>	<u>Description</u>	<u>Component ID</u>
BOM for 2400 Baud Modem PC Assembly: P/N: 50-2400B-1 (For 1278T only)		
RESISTOR, 1/4 WATT, 5%		
100-0009	470 OHM	R5
100-0065	620 OHM	R48
100-0010	1 K	R49
100-0012	2.2 K	R29
100-0046	2.7 K	R19
100-0014	4.7 K	R3, R50
100-0015	7.5 K	R43
100-0050	8.2 K	R41
100-0017	10 K	R37, R4, R51, R10, R39
100-0019	15 K	R25, R23, R11
100-0043	18 K	R13, R16
100-0022	30 K	R2
100-0061	33 K	R18, R26
100-0101	36 K	R28
100-0023	47 K	R20, R40
100-0025	62 K	R1
100-0053	68 K	R14, R17
100-0029	100 K	R32, R6, R33, R24, R34, R31

MFJ-1278B MULTI-MODE**APPENDIX I PARTS LIST**

<u>MFJ P/N</u>	<u>Description</u>	<u>Component ID</u>
100-0042	1.8 M	R53
100-0087	3.9 M	R52
RESISTOR, 1/8 WATT, 1%		
102-0037	9.09 K	R21, R22
102-0038	9.53 K	R12, R15
RESISTOR, NETWORK, SINGLE-ON-LINE, ISOLATED		
107-6104	100 K	RP2
RESISTOR, TRIM POT, SINGLE TURN, MINIATURE, HORIZONTAL		
104-4008	1 M	R38
CAPACITORS: DISC CERAMIC		
200-0020	33 PF, 50V, 20%	C8, C9
CAPACITORS: MULTI-LAYER, MONOLITHIC CERAMIC		
205-1047	.0047 UF, X7R, 10%, 50V	C1, C2, C13
205-1122	.022 UF, X7R, 10%, 50V	C3
205-1210	.1 UF, Z5U, 20%, 50V	C6, C12, C15, C16, C17 C18, C19, C20, C21, C22 C23, C24
205-1010	.001 UF, X7R, 10%, 50V	C5, C14
205-1110	.01 UF, X7R, 10%, 50V	C7, C10
CAPACITORS: ELECTROLYTIC, RADIAL		
203-0006	1 UF, 50V	C4

MFJ-1278B MULTI-MODE**APPENDIX I PARTS LIST**

<u>MFJ P/N</u>	<u>Description</u>	<u>Component ID</u>
DIODES:		
300-0003	1N4148	D1, D4
300-8001	1N34A	D6
TRANSISTORS:		
305-0001	2N3904	T2, T5, T6
305-0003	2N5088	T1
305-6005	VN10KM	T3
IC'S		
311-2049	XR2123ACP, PSK MODEM	IC7
311-0001	741CN, SINGLE OP-AMP	IC10
311-2069	MF10CCN, DUAL ACTIVE FILTER	IC3, IC4
310-3157	74HC157P, QUAD 2-IN MULTIPLEXER	IC9
310-0010	4024B, 7 STAGE BINARY COUNTER	IC6
310-3004	74HC04, HEX INVERTER	IC8
310-4193	74HCT193, UP/DOWN COUNTER	IC5
311-0039	TL084CN, BI-FET QUAD OP-AMP	IC1
IC SOCKETS: LOW PROFILE		
625-0031	14 PIN	
625-0030	16 PIN	

MFJ-1278B MULTI-MODE**APPENDIX I PARTS LIST**

<u>MFJ P/N</u>	<u>Description</u>	<u>Component ID</u>
625-0292	28 PIN	
MISCELLANEOUS:		
405-0095	CRYSTAL, HC18/U, 4.608 MHZ	Y1
612-1021	.1 CENTER, RIGHT ANGLE, 5 POS. HEADER	JMP 14B
612-3210	.1 CENTER, TOP ENTRY, 10 POS DUAL ROW SOCKET CONNECTOR	CN1
612-0033	.1 CENTER, 3 POS. HEADER	CN 6
612-4001	2-POS. SHORTING JUMER FOR	CN6
862-2400B	PCB, FOR 50-2400B-1 APPROX. 4" X 3.5"	

Manual Index

*

*.ix Identification packet, callsign text, 254

<

<CR>, inserting in text strings, 265

<LF>, followed by <NULL>, 262

3

300 baud operation, demodulator DCD filter, 319

9

9600 baud operation, 135, 328

A

Acknowledgment, 45

ACKNOWLEDGMENT PRIORITY, 153

Acknowledgment, digipeated packets, 132

Acknowledgment, minimum delay, 275

Acknowledgment, of multiple packets, 232

Acknowledgment, retries before, 276

Address, routing information, 44

Address, setting with callsign, 254

ADDRESS\, HDLC field, 338

ALOCKCHAR, 73

Analog loopback, 305

Analog loopback, full duplex operation, 232

Apple Macintosh, serial port interfacing, 6

Apple Macintosh, terminal program, 11

ARCVCHAR, 81

ASENDCHAR, 81

Audio repeaters, 188

auto speed tracking, 72

Automatic operations, beacons, 130

Automatic operations, connect, 128

Automatic operations, connect message transmission, 128, 205

Automatic operations, connect refusal, 128

Automatic operations, data packetizing, 135

Automatic operations, data packetizing in Converse Mode, 211

Automatic operations, digipeating, 128, 220

Automatic operations, disconnect, 201, 276

Automatic operations, entry to data-transfer mode, 207, 259

Automatic operations, inclusion of send-packet character in pack, 212

Automatic operations, transmit operation, 128, 305
AUTOTRAC, 72
AWLEN, 278
Awlen, 34
AX.25 Level 2 protocol, 187, 337

B

Baud rate, Radio, 124
Baud rate, Serial port, 124
Baud rate, serial port, 17, 315, 321, 336
Baud rate, switch, 317
Baud-rate generator, 317
bbRAM, 118, 316
bbRAM loaded with defaults, 308
bbRAM, protection circuit, 318
bbRAM, troubleshooting, 333
Beacons, sent as UI frames, 339
Beacons, setting address, 301
Beacons, unnecessary transmissions, 190
binary file transfers, 5
BUF command, 38
Buffer 0 Repeating, 40
Buffer sizes, 344
BUFKEY, 39, 74
BUFTIME, 40
Bulletin Board operations, 5
Bulletin board systems, automatic packet transmission, 211
Bulletin board systems, beacon message, 193
Bulletin board systems, compatibility with TNC 1, 259
Bulletin board systems, time stamping of connections, 210
Bulletin board systems, Transparent Mode, 293
Bulletin board systems, type-in flow control, 230
Busy signal, sent as DM frames, 342

C

Cables, troubleshooting, 333, 336
Calibration, commands, 196
Calibration, formula for demodulator tones, 196
Calibration, formula for modulator tones, 196
Calibration, troubleshooting, 334
Callsign parameter, setting, 254

- Clock, NRZ to NRZI encoder, 318
- Clock, speed selection, 317
- Collision, avoidance, 231, 275, 343
- Collision, detection, 343
- Command abbreviations, 173
- Command Defaults, 173
- Command list, format, 173
- Command Mode, 32
- Command Mode entry character, Transparent Mode, 203
- Command Mode, <NULL> transmission, 262
- Command Mode, automatic entry, 121, 261
- Command Mode, display output cancellation, 198
- Command Mode, echos, 226
- Command Mode, entry from Converse Mode, 43, 121, 206
- Command Mode, entry from Transparent Mode, 124
- Command Mode, entry to data-transfer mode, 259
- Command Mode, error messages, 310
- Command Mode, exit to Converse Mode, 210
- Command Mode, exit to Transparent Mode, 293
- Command Mode, line cancellation, 197
- Command Mode, prompt, 118
- Command Mode, special characters, 119
- Command, AUTOLF, 35
- Command, Defaults, 118
- Command, NUCR, 35
- Command, NULF, 35
- Command, NULLS, 35
- Command, SCREENLN, 35
- commands, 16levels, 178
- Commands, 8BITCONV, 176
- commands, 8LEVELS, 176
- commands, AALT, 178
- Commands, ABORT, 178
- Commands, ACKPRIORITY, 179
- Commands, ACKTIME, 179
- Commands, ALOCKCHAR, 180
- Commands, ALTCALL, 180
- Commands, ANSBSTR, 180
- Commands, ANSWRQRA, 181
- Commands, ARCVCHA, 183
- Commands, ARCVCHAR, 182
- Commands, ARQ, 182

Commands, AUTOLF, 185
Commands, AUtolf, 185
Commands, AUTOTRAC, 186
Commands, AWLEN, 176, 187
Commands, AX25L2V2, 187, 201
Commands, AXDELAY, 52, 188
Commands, AXHANG, 52, 188
commands, basic, 32
Commands, BBSMSGs, 189
Commands, BEACON, 193
Commands, BEACON EVERY/AFTER, 190
commands, BKONDEL, 49
Commands, BLP, 192
Commands, BTEXT, 190, 311
Commands, BUDLIST, 237
Commands, BUF, 194
Commands, BUFKEY, 195
Commands, BUFTIME, 195
Commands, BWNL, 195
Commands, CALIBRA, 196
Commands, CALSET, 196
Commands, CANLINE, 50, 197
Commands, CBELL, 199
Commands, CCITT, 200
Commands, CHANGE, 200
Commands, CHAT, 200
Commands, CHECK, 201
Commands, CHECKV1, 201
Commands, CMDTIME, 203
Commands, CMSG, 205, 212
Commands, CMSGDISC, 205
Commands, COMMAND, 206
Commands, CONNECT, 42, 207, 208, 312
Commands, Connect, 204
Commands, CONOK, 209, 313
Commands, CONPERM, 204
Commands, CONSTAMP, 210, 216
Commands, CONVERS, 207, 210
commands, CONVERS, 43
Commands, CONVERSE, 210
Commands, CPACTIME, 211, 283
Commands, CP, 211, 212, 283

Commands, CWIDMODE, 214
Commands, CWSSENDCH, 215
Commands, CWSPEEDM, 215
Commands, DAYTIME, 210, 216, 249, 253, 310
Commands, DAYUSA, 210, 217, 253
Commands, DDisc, 217
Commands, DEADTIME, 218
Commands, DEFLTDLC, 219
Commands, DELAY, 218
Commands, DELETE, 219
commands, DELETE, 49
Commands, DIDDLE, 219
Commands, DIGIPEAT, 220
Commands, DISCONNE, 220
commands, DISCONNE, 43
Commands, Disconnect, 217
Commands, DISPLAY, 198, 217, 224
Commands, DISPlay, 221
Commands, DWAIT, 52, 224
Commands, EAa, 225
Commands, EAS, 225
Commands, EASIN, 225
Commands, ECHO, 226
Commands, ECho, 226
Commands, EPSON, 226
Commands, ERrstrin, 227
Commands, ERUS, 227
Commands, ESCAPE, 227
Commands, EXActcal, 228
Commands, FARNSWOR, 228
Commands, FAXEOP, 228
Commands, FAXMODE, 229
Commands, FAXNEG, 229
Commands, FAXREV, 229
Commands, FEC, 230
Commands, FIRMRNR, 230
Commands, FLOW, 230
Commands, FLow, 231
Commands, FORWARD, 231
Commands, FRACK, 231
Commands, FULLDUP, **52**, 232
Commands, GRADHE, 232

Commands, ID, 234, 235
Commands, Id, 234
Commands, IDTIME, 235
Commands, K (Converse), 235
Commands, KILONFWD, 235
Commands, KISS, 236
Commands, LC, 237
Commands, LCALLS, 194, 237
Commands, LCSTREAM, 238
Commands, LEDmode, 239
Commands, LFADD, 239
Commands, LFadd, 239
Commands, LFADDALT, 239
Commands, LFIGNORE, 240
Commands, LISTEN, 240
Commands, MAILBOX, 241, 290
Commands, MAILbox, 240
Commands, MAILED, 242
Commands, MALL, 243
Commands, MARSMODE, 244
Commands, MATCH, 245
Commands, MAXDown, 245
Commands, MAXFRAME, 245
Commands, MAXSum, 246
Commands, MAXUp, 246
Commands, MBEGIN, 246
Commands, MCOM, 247
commands, MCON, 46
Commands, MCTEXT, 248
Commands, MEND, 248
Commands, MHCLEAR, 249
Commands, MHEARD, 249
Commands, MNONAX25, 250
Commands, MNONPRIN, 250
Commands, MONITOR, 194, 251
Commands, MONitor, 250
commands, MONITOR, 45
Commands, MRPT, 233, 252
commands, MRPT, 46
Commands, MSPEED, 252
Commands, MSTAMP, 216, 233, 253
Commands, MTIMEOUT, 253

Commands, MYcall, 255
Commands, MYDLCNUM, 255
Commands, MYHIERAD, 256
Commands, MYMCALL, 256
Commands, MYSELCAL, 256
Commands, NAVMSG, 258
Commands, NAVSTN, 257
Commands, NAVTEX, 257
Commands, NEWMODE, 207, 259
Commands, NODEFORW, 260
Commands, NODEPATH, 261
Commands, NOMODE, 261
Commands, NUCR, 262
Commands, NULF, 262
Commands, NULLS, 262
Commands, OK, 263
Commands, OMLC, 263
Commands, PACLEN, 245, 263
Commands, PACTIME, 211, 264
Commands, PARITY, 264
Commands, PASS, 50, 193, 265
Commands, PAss, 265
Commands, PASSALL, 249, 266
Commands, PIXTONES, 267
Commands, PKTPIX, 269
Commands, PRINTER, 270
Commands, PRINTGRA, 270
Commands, PRINTTES, 271
Commands, PROFMARS, 271
Commands, PTOver, 271
Commands, PTSend, 272
Commands, QRT, 272
Commands, R, 272
Commands, RADIO, 272
Commands, RANDOMCW, 273
Commands, RBITMASK, 273
Commands, RECONNECT, 273
Commands, REDISPLA, 50, 274
Commands, REMSYSOP, 274
Commands, RESET, 275, 308
Commands, RESPTIME, 275
Commands, RESTART, 275

Commands, RVFALWAY, 282
Commands, RXBLOCK, 278
Commands, RXBRIGHT, 279
Commands, RXCAL, 280
Commands, RXINVERT, 282
Commands, SCREENLN, 282
Commands, SELCALL, 283
Commands, SENDPAC, 283
Commands, SERIALNO, 283
Commands, SETUP, 284
Commands, SFNL, 284
Commands, SLOTS, 285
Commands, SOLF, 285
Commands, SRXALL, 286
Commands, START, 50, 286
Commands, STATUS, 287
Commands, STAtus, 286
Commands, STOP, 50, 287
Commands, STREAMCA, 288
Commands, STREAMDB, 289
Commands, STREAMSW, 290
Commands, TIMEDCMD, 290
Commands, TIMEDMIN, 291
Commands, TINV, 291
Commands, TRACE, 198, 292
Commands, TRace, 292
Commands, TRANS, 293
Commands, TRFLOW, 293
Commands, TRIES, 294
Commands, TUNE, 294
Commands, TUNEPROC, 294
Commands, TVBREAKS, 295
Commands, TVHSYNC, 296
Commands, TVMODE, 296
Commands, TVX, 297
Commands, TXDELAY, 52
Commands, TXDelay, 298
Commands, TXDELAYC, 298
Commands, TXDIDDLE, 299
Commands, TXFLOW, 300
Commands, TXINVERT, 300
Commands, TXTMO, 300

- Commands, UNPROTO, 190
- Commands, UNSHIFT, 302
- Commands, URepeats, 302
- Commands, USERS, 302
- Commands, VISBREAK, 303
- Commands, VISTICKS, 303
- Commands, VISTONES, 303
- Commands, WAitdisc, 304
- Commands, WDMODE, 304
- Commands, WEIGHT, 304
- Commands, WRU, 305
- Commands, XFLOW, 305
- Commands, XMITOK, 305
- Commands, XOff, 306
- Commands, XON, 306
- Commands, XOn, 306
- Commands. MODE, 249
- Commodore 64 or VIC-20, terminal program, 12
- Computer interfacing, Apple Macintosh, 6
- Computer interfacing, computers with 25-pin RS-232C ports, 9
- Computer interfacing, IBM PCjr, 8
- Computer interfacing, NEC 8201, 9
- Computer interfacing, non-standard serial ports, 10
- Computer interfacing, Radio Shack Model 100, 9
- computer or terminal, 4
- CONNECT, 44
- Connect, acknowledged by UA frames, 342
- Connect, automatic, 128
- Connect, automatic message transmission, 128
- Connect, errors, 208, 312
- Connect, in progress, 312
- Connect, initiated by SABM frames, 342
- Connect, message, 313
- Connect, request message, 313
- Connect, starting a QSO, 47
- Connect, timeout, 201
- Connect, unsuccessful, 45
- CONTROL), HDLC field, 338
- Converse Mode, <NULL> transmission, 262
- Converse Mode, 8-bit data, 176
- Converse Mode, automatic data packetizing, 135, 211, 264
- Converse Mode, automatic entry, 261

Converse Mode, entry from Command Mode, 119, 210, 259, 309
 Converse Mode, escape to Command Mode, 43, 206
 Converse Mode, flow control to computer, 306, 307
 Converse Mode, line cancellation, 197
 Converse Mode, packet cancellation, 198
 Converse Mode, send-packet character, 283
 Converse Mode, special characters, 122
 CRC checksum, disregarding, 266
 CW KEY-IN, 71
 CW, operation of, 71
 CWSEndch, 73
 CWSPEEDM, 73

D

Data Carrier Detect, 52
 Data Communications Equipment, **9**, 321
 Data loss, 262
 Data Set Ready, 320
 Data Terminal Equipment, 9
 Data Terminal Ready, 320
 Data-transfer mode, automatic entry, 121
 Data-transfer mode, Converse Mode, 42, 121
 Data-transfer mode, entry from Command Mode, 119
 Data-transfer mode, Transparent Mode, 122
 DATA\, HDLC field, 338
 Date setting, 216
 DCD LED, 52
 Demodulator DCD filter for 300 baud operation, 319
 Demodulator, troubleshooting, 335
 digipeating, 48
 Digipeating, adjusted retry interval, 231
 Digipeating, avoiding collisions, 224
 Digipeating, default wait time, 134
 Digipeating, display route, 312
 Digipeating, enabling and disabling, 220
 Digipeating, end-to-end acknowledgments, 132, 224, 344
 Digipeating, frame-acknowledge time, 132
 Digipeating, identification, 128
 Digipeating, monitoring route addresses, 252
 Digipeating, multiple digital stations, 44
 Digipeating, protocol dependence, 131

- Diodes, incorrect installation, 332
- DIP header, U15, 319
- DISC frames, 342
- DISC frames, monitored, 247
- Disconnect, acknowledged by UA frames, 342
- Disconnect, after exceeding re4ry count, 276
- Disconnect, causes, 312
- Disconnect, in progress, 312
- Disconnect, initiating a request, 220
- Disconnect, message, 313
- Disconnect, sent as DISC frames, 342
- DISPLAY, 46
- Display features, <ESCAPE> translation, 227
- Display features, <NULL> transmission, 262
- Display features, cancel output, 198
- Display features, character filtering, 137, 248
- Display features, Converse Mode, 122
- Display features, double typing, 226
- Display features, echos, 226
- Display features, line wrapping, 282
- Display features, lower case translation, 238
- Display features, overtyping, 262
- Display features, redisplay line, 50
- Display features, rubout echo, 191
- Display features, Transparent Mode, 124, 293
- Display features, type-in flow control, 230
- Display format, FRMR, 314
- Display format, monitored packets, 233
- Display format, TRACE, 292
- Displays (computer), printing, 191, 262
- Displays (computer), video, 191, 262
- DM frames, 209, 313, 342
- DM frames, monitored, 247
- dot-to space ratio, 74
- Double typing, 226
- duplex, 34

E

- echoing characters, 34
- Electrolytic capacitors, incorrect installation, 332
- Entering commands, Input editing, 172

F

FARnswor, 73, 75
FARNSWORTH CW, 75
FCS\, HDLC field, 338
Fig. 2-1. Serial port wiring for Apple Macintosh., 6
Fig. 2-2. Serial port wiring for Radio Shack, 9
Fig. 2-3. Serial port wiring with jumpers for, 10
File Transfer, 8-bit data, 122, 187
File transfer, ASCII, 187
File transfer, binary files, 122, 187
File transfer, limiting unacknowledged data, 245, 263
File transfer, non-text files, 293
Filtering received characters, 248
FLAG\, HDLC field, 338
Flow control, disabling in one direction, 125, 286, 287, 293, 300, 306, 307
Flow control, disabling of, 124
Flow control, hardware, 127
Flow control, link, 344
Flow control, packet, 344
Flow Control, Resuming output, 124
Flow control, RNR frames, 344
Flow control, RR frames, 344
Flow Control, Software, 125
Flow control, software, 286, 287, 305, 306, 307
Flow Control, Stopping output, 124
Flow control, toggle character, 125
Flow control, Transparent Mode, 125, 293, 300
Flow control, type-in, 127, 230
Flow control, XON/XOFF, 125
FRMR frames, 313, 342
Full duplex operation, 52, 232, 316

G

Gibberish, 336
Ground, signal location, 331

H

Hardware description, 316
Hardware flow control, 127
HDLC, frame format, 338
HDLC, ... 318

I

I frames, 340
IBM PCjr, 8
IBM PCjr, serial port interfacing, 8
IBM PCjr, terminal program, 12
IBM Personal Computer, 6
Identification packets, 234
Identification, automatic, 128
Identification, station, 127
iming, frame-acknowledge time for digipeated packets, 132
Input Editing, character deletion, 49
Input editing, character deletion, 49, 219
Input editing, disabled in Transparent Mode, 293
Input editing, line cancellation, 50, 197
Input editing, packet cancellation, 121, 198
Input editing, pass character, 265
Input editing, redisplay line, 50, 274
Integrated circuits, incorrect installation, 332
Integrated circuits, normal temperatures, 332
Interfacing, Radio, 20
INTRODUCTION, *1*

J

J1 serial port connector, 320
J2 radio port connector, 20
J4 modem disconnect, 318, 328
JMP1 DCD override, 15
JMP10 digital loopback, 42, 47
JMP2 clock speed selection, 317
JMP4 watch-dog timer override, 319
JMP5 ROM memory size selection, 318
JMP7 analog loopback, 42
Jumper functions, 322

K

keying, negative (Grid Block), 71
keying, positive (direct), 71
Keywords, AFTER and EVERY, 174, 190, 264
Keywords, ASYNC, 223
Keywords, CHARACTE, 223
Keywords, CONVERTS TO TRANS, 227

L

LED normal power-up display, 333
Line Spacing, packet text, 130
Line wrapping, 35, 282
Link status messages, 312
Logic lines, troubleshooting, 334
Lower case characters, translation to upper case, 238

M

Macintosh, serial port interfacing, **6**
Macintosh, terminal program, 11
memory buffers, 38
memory buffers, chaining, 40
memory buffers, loading of, 39
memory buffers, numbering of, 39
memory buffers, transmitting of, 39
Memory Keyer, 71
Memory space decoder, 317, 318
Messages, error, 310
Messages, link status, 312
Messages, sign-on, 308
MHCLEAR, 46
MHEARD, 46
Microprocessor, 315
MODE command, 37
Modem, 316, 319
modem components, sets of, 35
modem program, 4
Modem, demodulator modification, 319
Modem, external, 135, 315, 328
Modem, J4 disconnect, 328
Modem, modulator modification, 319
Modem, negative power supply, 320
Modem, radio, 135
Modem, telephone, 9, 11
Modem, troubleshooting, 334
Modulator, 315
Monitoring, 45
Monitoring On the Air, 49
Monitoring, callsign list, 237
Monitoring, character filtering, 248

Monitoring, selected stations, 137
Monitoring, time stamping, 253
Monitoring, while connected, 46, 247
MSpeed, 73
Multiple packets, for 1200 baud, 134

N

NEC 8201, serial port interfacing, **9**
NEC 8201, terminal program, 13
New lines, 35
Noise, cause of retransmissions, 45
NORMAL CW, 75
NRZ to NRZI encoder, 318
NRZ to NRZI encoder, clock, 318
NRZI encoding, 339
Null modem cable, 321

O

Operating modes, 316
Operation, Packet, VHF, 127
OSCAR operation, 328
OSCAR operation, full duplex, 232
Oscillator, 317
Oscillator, troubleshooting, 333
Outstanding packets, 245

P

packet mode, VHF, 42
Packet reception, troubleshooting, 335
Packet transmission, troubleshooting, 335
Packet, maximum length, 130, 263
Packet, protocol, 131
Packet, re-transmission, 276
Pactor Mailbox Entry, 67
Parameters lists, 311
parameters, \$ hex designator, 174
Parameters, callsign, 174
Parameters, current value, 33
parameters, n designator, 174
Parameters, text, 174
Parity, 34

Power supply, troubleshooting, 332
Power-on reset, 319
Power-on reset, LED display, 333
Protocol, 337
Protocol errors, result in FRMR frames, 342
Protocol, AX.25 Level 2, 316, 337
Protocol, compatibility, 316
Protocol, control byte format, 340
Protocol, data link layer, 337
Protocol, debugging function, 292
Protocol, errors, 312, 313
Protocol, HDLC frames, 338
Protocol, HDLC implementation, 318
Protocol, monitoring control packets, 137
Protocol, problems, 131

R

R76 tone level adjustment, 319, 335
R77 modulator tone adjustment, 319
R78 modulator tone adjustment, 319
R79 demodulator adjustment, 319
Radio 1, 38
Radio 2, 38
Radio baud rate, optimum, 52
Radio baud rate, switch, 317
Radio interfacing, 20
Radio interfacing, using accessory jack or interface box, 25
Radio port, 318
Radio Shack Color Computer, terminal program, 13
Radio Shack Model 100, serial port interfacing, 9
Radio Shack Model 100, terminal program, 13
Radio Shack Model 100/102 and NEC 8201, 13
Radio signals, Ground, 20
Radio signals, Microphone audio, 20
Radio signals, Push-to-talk, 20
Radio signals, Receive audio, 20
Radio signals, Squelch input, 20
RAM memory, 316, 318
Random wait, 231
Real-time clock, error message, 310
Real-time clock, setting, 216

- RS-232C, 4
- RS-232C signals, Clear To Send, 15, 125
- RS-232C signals, Data Carrier Detect, 15
- RS-232C signals, Data Set Ready, 15
- RS-232C signals, Data Terminal Ready, 125
- RS-232C signals, Frame Ground, 13
- RS-232C signals, Request to Send, 15
- RS-232C signals, Signal Ground, 15
- RS-232C signals, Transmit Data, 13
- RS-232C, baud rate, 17
- RS-232C, handshaking, 320
- RS-232C, negative power supply, 320
- RS-232C, signal levels, 10
- RS-232C, signals, 13
- RS-232C, troubleshooting, 335

S

- SABM frames, 342
- SABM frames, monitored, 247
- Sanyo MBC-55X, 6
- Send-packet character, 283
- Send-packet character, automatic inclusion in packet, 212
- Send-packet character, set to <CR>, 130
- Serial port, 316, 318
- serial port adapter card, 6
- Serial port baud rate, switch, 317
- serial port connector, 5
- Serial port problems, baud rate, 336
- Serial port problems, data signals, 335, 336
- Serial port problems, handshaking signals, 335
- Serial port problems, parity, 336
- Serial port problems, won't accept data, 336
- serial port signals, 5
- Serial port, baud rate, 17, 321
- Serial port, hardware handshaking, 13
- Serial port, jumpers for auxiliary signals, 10
- Serial port, non-standard, 321
- Serial port, parity, 264
- Serial port, signals, 13, 336
- Serial port, troubleshooting, 335
- Serial port, word length, 187

signal lock, 72
SLOTTING, 153
Software UART, Color Computer, 13
Special Characters, 117
Special characters, Converse Mode, 122
Special characters, Transparent Mode, 122
special input characters, 49
Specifications, 315
State machine, 318
Station identification, 234
Station identification, callsign text, 254
Station identification, sent as UI frames, 339
Stations heard, clearing list, 249
Stations heard, displaying list, 249
Stopping output, 50
SW2\, baud rate selection, 317

T

Table 2-3. MacTerm Parameters for MFJ-1278B, 11
Table 4-1, 36
Table 4-2, 36
telephone modem, 5
Temperature of components, 332
Terminal program, 11
Terminal program, Apple Macintosh, 11
Terminal program, Commodore 64 or VIC-20, 12
Terminal program, IBM PCjr, 12
Terminal program, NEC 8201, 13
Terminal program, Radio Shack Color Computer, 13
Terminal program, Radio Shack Model 100, 13
text parameter, maximum length, 193, 212, 311
Time setting, 216
Time stamping, 210, 216
Time stamping, list of stations heard, 249
Time stamping, monitored packets, 253
Timing, 343
Timing, collision avoidance, 343
Timing, default wait, 134, 344
Timing, minimum acknowledgment delay, 275, 344
Timing, packet retransmission, 132, 343
Timing, packet transmission, 224
Timing, protocol 201

Timing, Transparent Mode escape, 203
TNC 1, AX.25 Level 2 version, 187
TNC 1, AXHANG parameter, 188
TNC 1, Command Mode entry and exit, 259
TNC 1, protocol compatibility, 339
TNC 1, TXDELAY parameter, 297
TNC Restart character, 300, 305
Transmit keying, troubleshooting, 334
Transmit, inhibiting, 128, 305
Transmit, watch-dog timer, 319
Transparent Mode, automatic entry, 261
Transparent Mode, automatic packet transmission, 264
Transparent Mode, display features, 124
Transparent Mode, entry from Command Mode, 119, 259, 293, 309
Transparent Mode, escape timing, 203
Transparent Mode, packet formatting, 130
Transparent Mode, software flow control, 293, 300
Transparent Mode, special characters, 122
Troubleshooting, 331
Troubleshooting, equipment, 331
TTL logic levels, 333
TUNE, 71, 75
Tuning Indicator, 41
Tuning indicator, 315
TXDELAY, 47

U

U15 modulator configuration header, 319
U19 demodulator configuration header, 319
UA frames, 342
UA frames, monitored, 247
UI frames, 234, 301, 342
Unconnected packets, sent as UI frames, 339, 342
Unconnected packets, setting address, 301
User Stop character, 293

V

VIC-20, terminal program, 12

W

Watch-dog timer, 319