

Modification Kit

for the



HP-1144 POWER SUPPLY

Model 830-33

The purpose of this Modification Kit is to prevent an overvoltage condition to your SB-104 Transceiver by adding a crowbar circuit to your HP-1144 Power Supply. If the output voltage from the Power Supply should exceed a safe voltage for your SB-104, the crowbar circuit will blow the 20-ampere fuse.

PARTS LIST

Check each part against the following parts list. The key numbers refer to the parts shown below. Any part that is packed in an envelope with a part number on it should not be removed from the envelope until it is called for in a step. Some parts are marked with a "171-" number. These numbers are for our use in packaging and do not appear in the Manual. Save all packaging material until you locate all the parts.

To order a replacement part, use the Parts Order Form furnished with this kit. If a Parts Order Form is not available, refer to "Replacement Parts" inside the rear cover of this Manual. For prices, refer to the separate "Heath Parts Price List." NOTE: Never use a "171-" packaging number if you must order a replacement part; use only the part numbers listed in the Parts List.

KEY No.	HEATH Part No.	QTY.	DESCRIPTION	CIRCUIT Comp. No.
---------	----------------	------	-------------	-------------------

RESISTORS

A1	6-6819-12	1	68.1 Ω , 1%, 1/4-watt (blue-gray-brown-gold-brown)	R5
A1	6-5110-12	1	511 Ω , 1%, 1/4-watt (green-brown-brown-black-brown)	R3
A1	6-9090-12	1	909 Ω , 1%, 1/4-watt (white-black-white-black-brown)	R6
A1	6-102-12	2	1000 Ω , 5%, 1/4-watt (brown-black-red-gold)	R8, R10
A1	6-103-12	1	10 k Ω , 5%, 1/4-watt (brown-black-orange-gold)	R9
A2	6-220	2	22 Ω , 5%, 1/2-watt (red-red-black-gold)	R7, R11
A3	1-30-2	1	270 Ω , 10%, 2-watt (red-violet-brown-silver)	R12
A3	1-14-2	1	1500 Ω , 10%, 2-watt (brown-green-red-silver)	R13
A4	10-383	1	10 k Ω control	R4

CAPACITORS

B1	21-195	1	.1 μ F ceramic	C3
B2	25-257	1	10 μ F electrolytic	C4
B3	25-199	1	500 μ F electrolytic	C10
B3	25-241	1	1200 μ F electrolytic	C6
B4	27-47	1	.1 μ F Mylar	C5, C7, C8, C9

DIODES

C1	56-56	1	1N4149	D3
C1	56-620	1	15V zener	D4
C1	57-65	2	1N4002	D1, D2
C2	57-86	1	NL576A SCR	Q4

KEY No.	HEATH Part No.	QTY.	DESCRIPTION	CIRCUIT Comp. No.
---------	----------------	------	-------------	-------------------

TRANSISTORS — INTEGRATED CIRCUIT (IC)

NOTE: Transformers and IC's are marked for identification in one of the following four ways:

1. Part numbers.
2. Type number. (For IC's, this refers only to the letters and numbers listed. Disregard any other letters or numbers on the IC.)
3. Part number and type number.
4. Part number with a type number other than the one listed.

D1	417-823	1	MPU131 transistor	Q5
D2	417-215	1	2N3055 transistor	Q3
D2	417-254	2	MJ802 transistor	Q1, Q2
D3	442-626	1	78MGT4 IC	U1

HARDWARE

E1	250-89	2	6-32-3/8" screw
E2	252-3	2	6-32 nut
E3	252-183	1	1/4"-28 nut
E4	254-1	2	#6 lockwasher
E5	254-14	1	1/4" lockwasher
E6	259-1	1	#6 solder lug
E7	259-23	1	Large solder lug
E8	259-20	1	Connector pin

WIRE

340-11	36"	Bare wire
344-31	24"	Brown wire
346-4	30"	Black sleeving

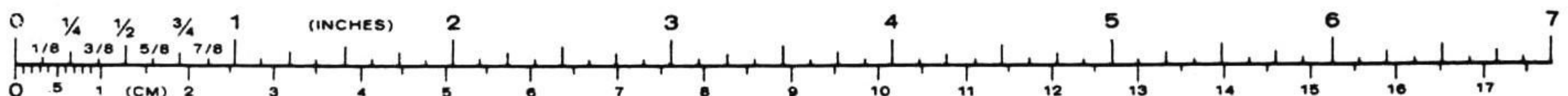



KEY HEATH QTY. DESCRIPTION
 No. Part No. _____

CIRCUIT
 Comp. No. _____

MISCELLANEOUS

75-44	2	Mica insulators (between cardboard)
85-1928-2	1	Circuit board
352-31	1	Thermal compound
391-34	1	Blue and white label
421-18	1	20-ampere fuse
597-260	1	Parts Order Form Modification Manual (See front cover for part number.)

Solder

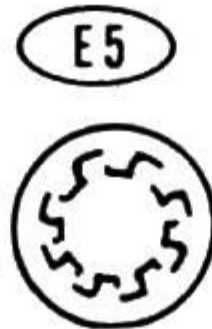
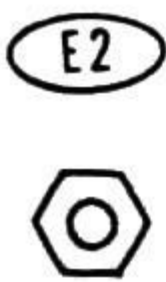
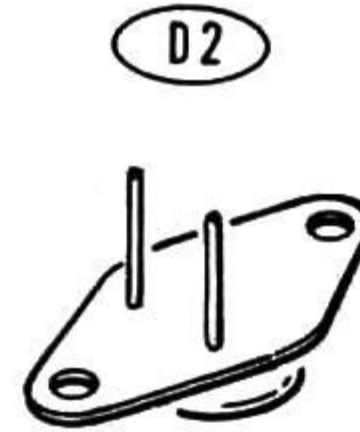
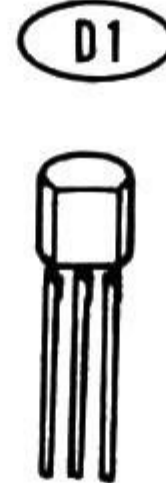
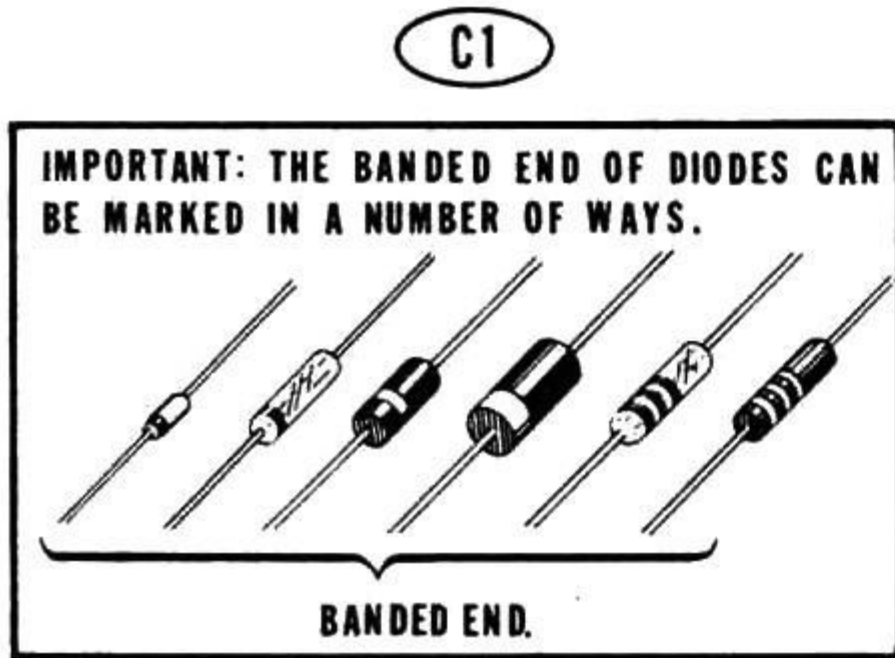
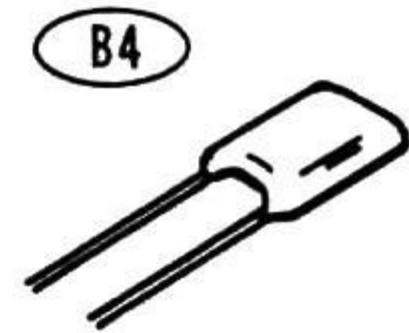
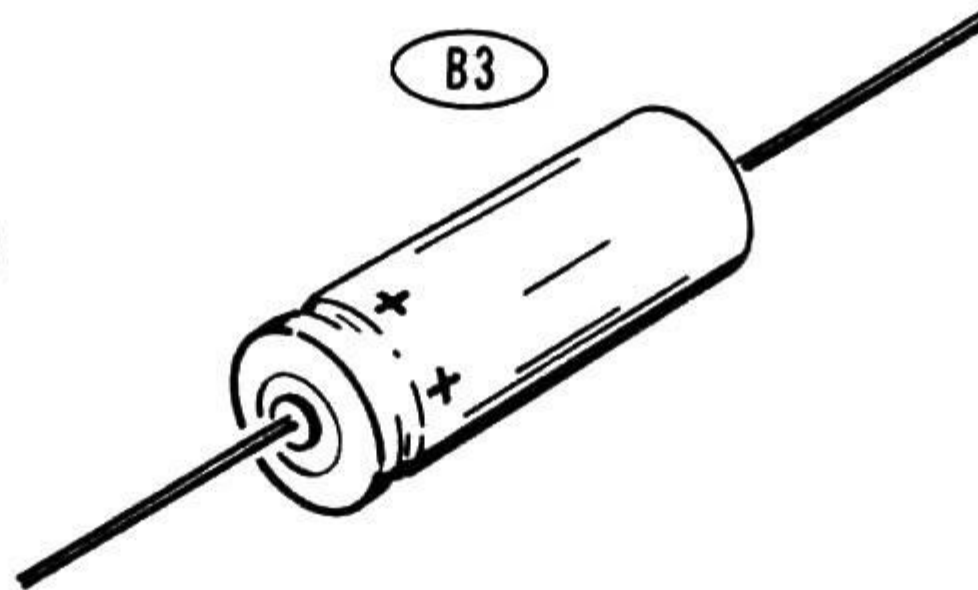
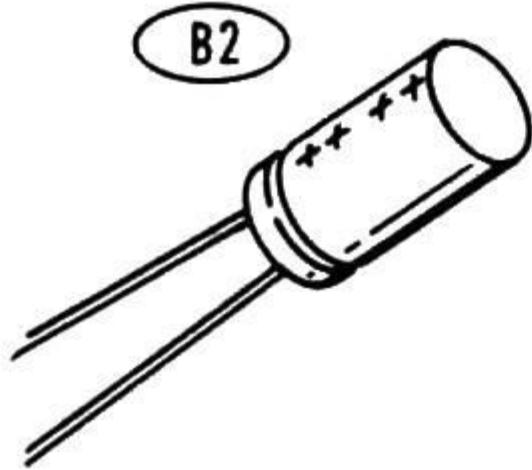
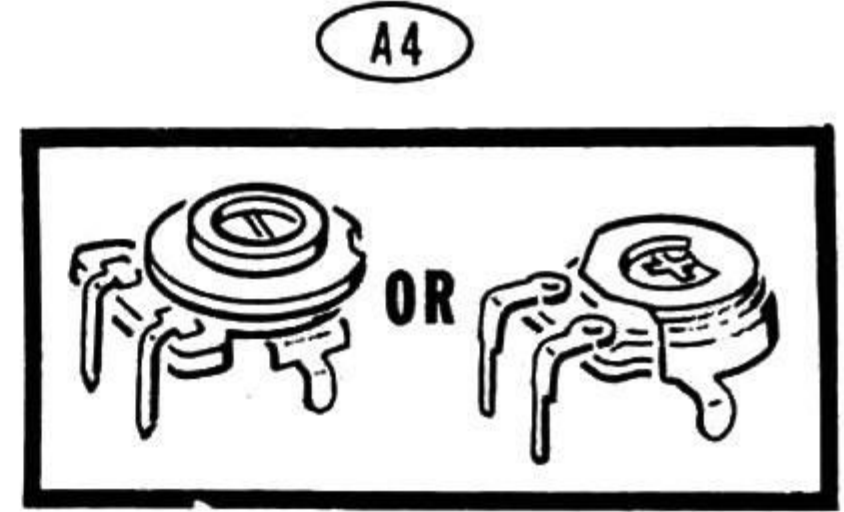
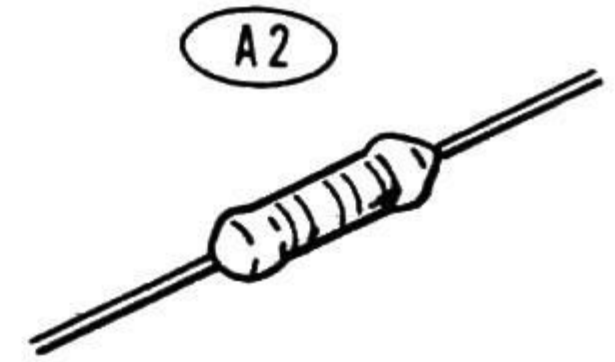
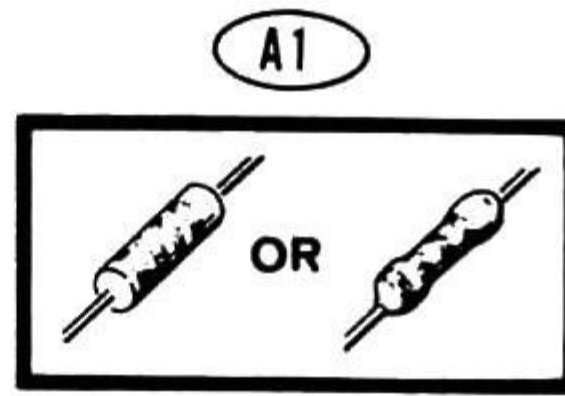

CIRCUIT BOARD ASSEMBLY

START →

- () Position the circuit board as shown and complete the following steps.
- () R9: 10 kΩ, 5%, 1/4-watt (brown-black-orange-gold).
- () R8: 1000 Ω, 5%, 1/4-watt (brown-black-red-gold).
- () R11: 22 Ω, 5%, 1/2-watt (red-red-black-gold).
- () R10: 1000 Ω, 5%, 1/4-watt (brown-black-red-gold).
- () R7: 22 Ω, 5%, 1/2-watt (red-red-black-gold).
- () R6: 909 Ω, 1%, 1/4-watt (white-black-white-black-brown).
- () R5: 68.1 Ω, 1%, 1/4-watt (blue-gray-brown-gold-brown).
- () R3: 511 Ω, 1%, 1/4-watt (green-brown-brown-black-brown).
- () Solder the leads to the foil and cut off the excess lead lengths.

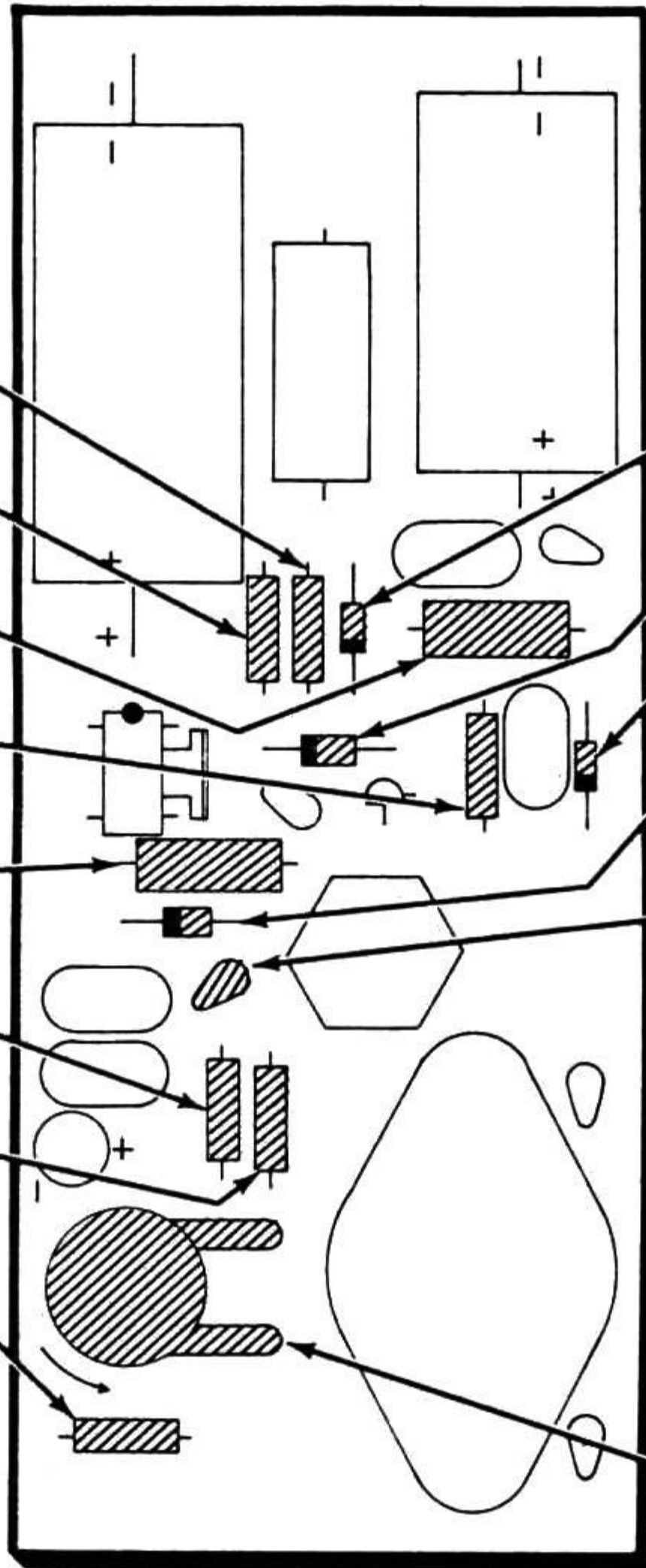

PICTORIAL 1-2

CONTINUE →

NOTE: When you install a diode, always position the banded end as shown on the circuit board.

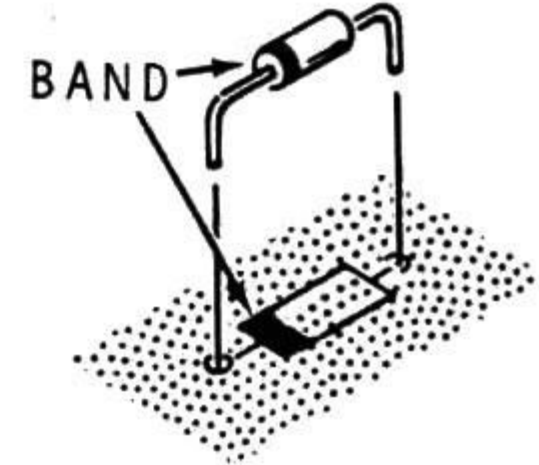

- () D4: 15 V zener diode (#56-620).
- () D3: 1N4149 diode (#56-56).
- () D2: 1N4002 diode (#57-65).
- () D1: 1N4002 diode (#57-65).
- () Solder the leads to the foil and cut off the excess lead lengths.
- () Install a connector pin in hole A. Solder it to the foil. Cut off and discard the upper tab.

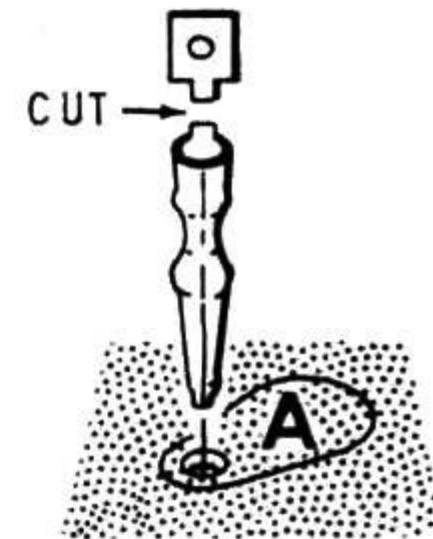

- () R4: 10 kΩ control (#10-383). Solder the lugs to the foil.

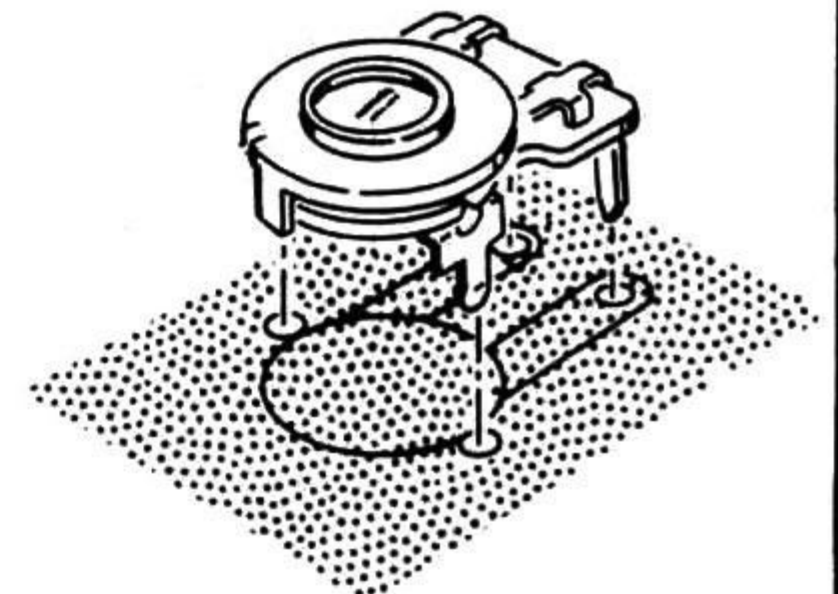

START ↘

NOTE: When you install an electrolytic capacitor, be sure to position the plus (+) or minus (-) marked end as shown on the circuit board.

PLUS MARK (+)

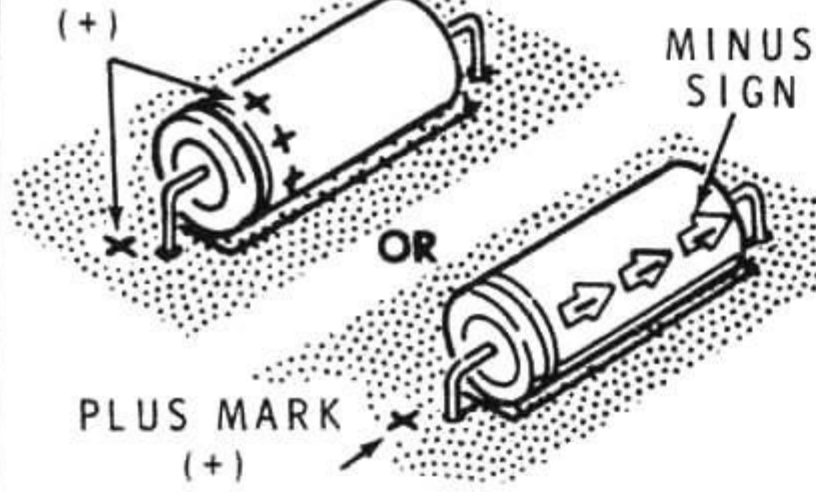

() C6: 1200 μ F electrolytic.

() R12: 270 Ω , 10%, 2-watt (red-violet-brown-silver).

() U1: 78MGT4 IC (#442-626). Be sure to line up the index mark on the IC with the mark on the circuit board. The IC may have two metal tabs instead of one. If so, bend both tabs up.

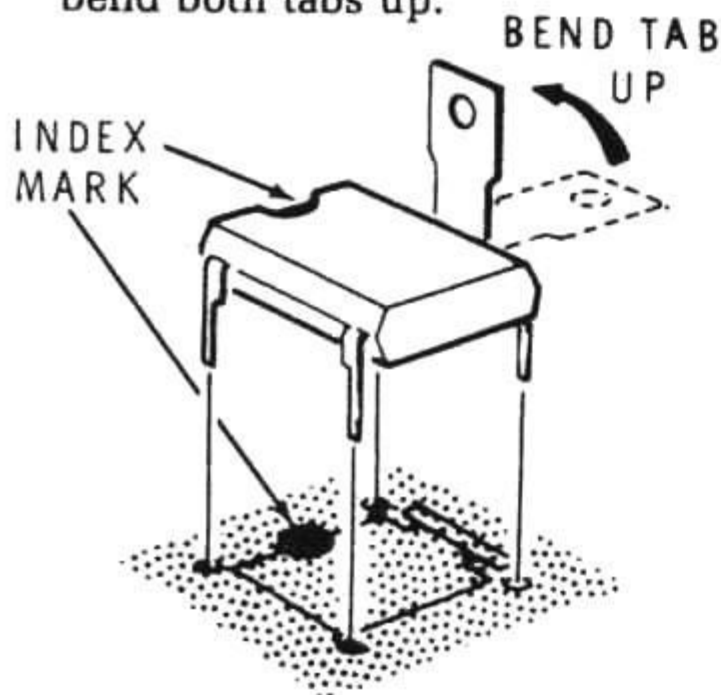

() C8: .1 μ F Mylar.

() C5: .1 μ F Mylar.

() C4: 10 μ F electrolytic. Be sure to position the plus (+) or minus (-) marked side of the capacitor as shown on the circuit board.

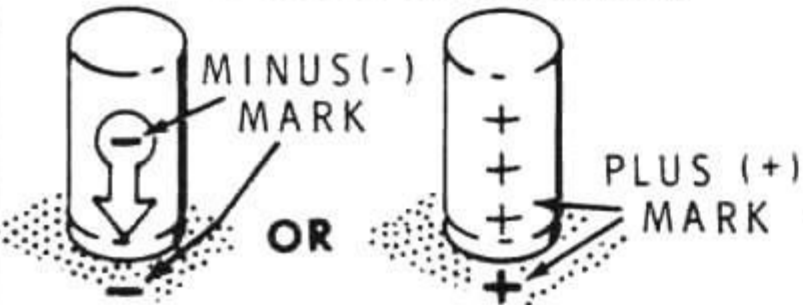

() Solder the leads to the foil and cut off the excess lead lengths.

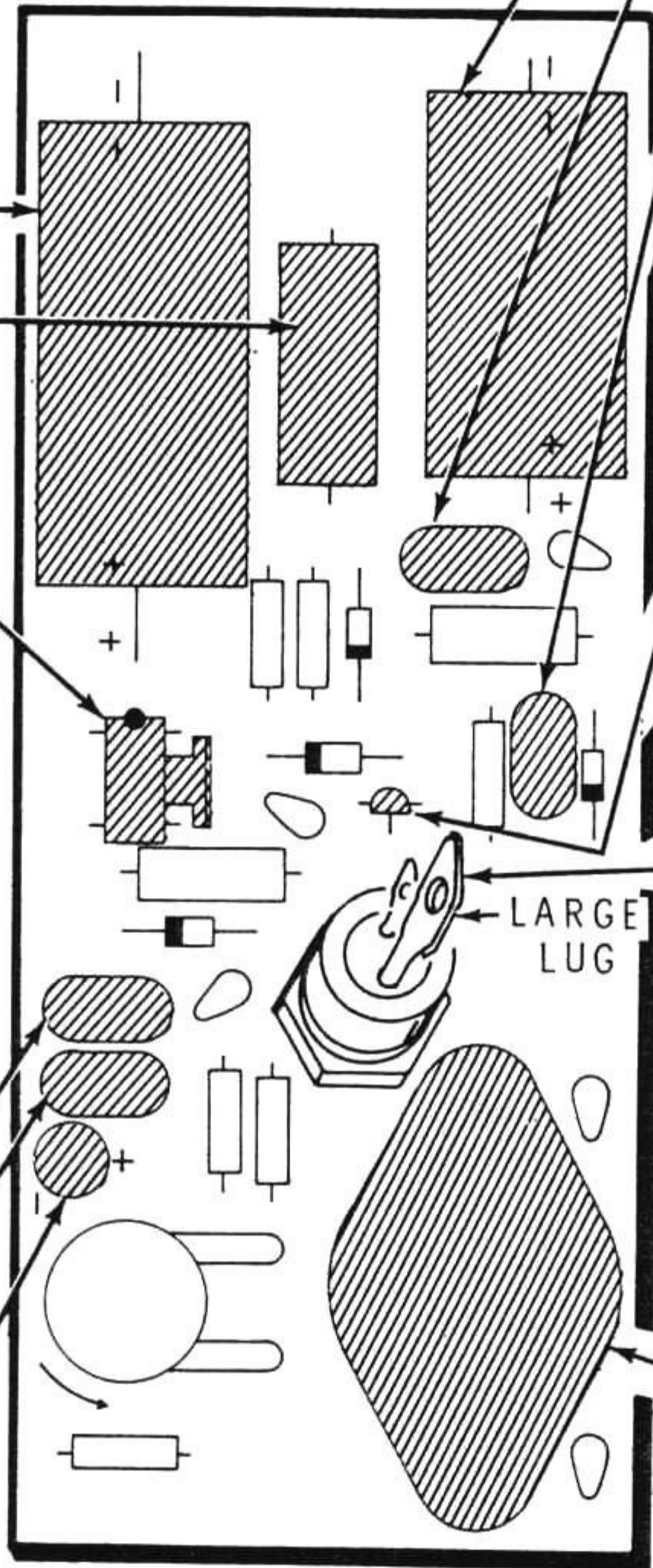

PICTORIAL 1-3

CONTINUE ↘

() C10: 500 μ F electrolytic.

() C9: .1 μ F Mylar.

() C7: .1 μ F Mylar.

() Solder the leads to the foil and cut off the excess lead lengths.

() Q5: MPU131 transistor (#417-823). Position the transistor with its flat over the outline of the flat on the circuit board. Then insert the C, G, and A leads into their correct holes. Solder the leads to the foil and cut off the excess lead lengths.

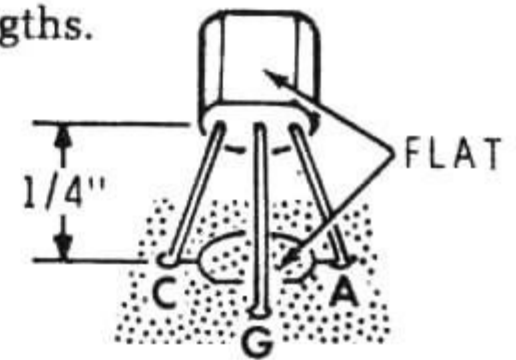

() Q4: NL576A SCR (#57-86). Be sure to position the large lug as shown.



() Q3: 2N3055 transistor (#417-215). Note the spacing between the leads and the mounting holes. Solder the leads to the foil after the hardware is installed and cut off the excess lead lengths.

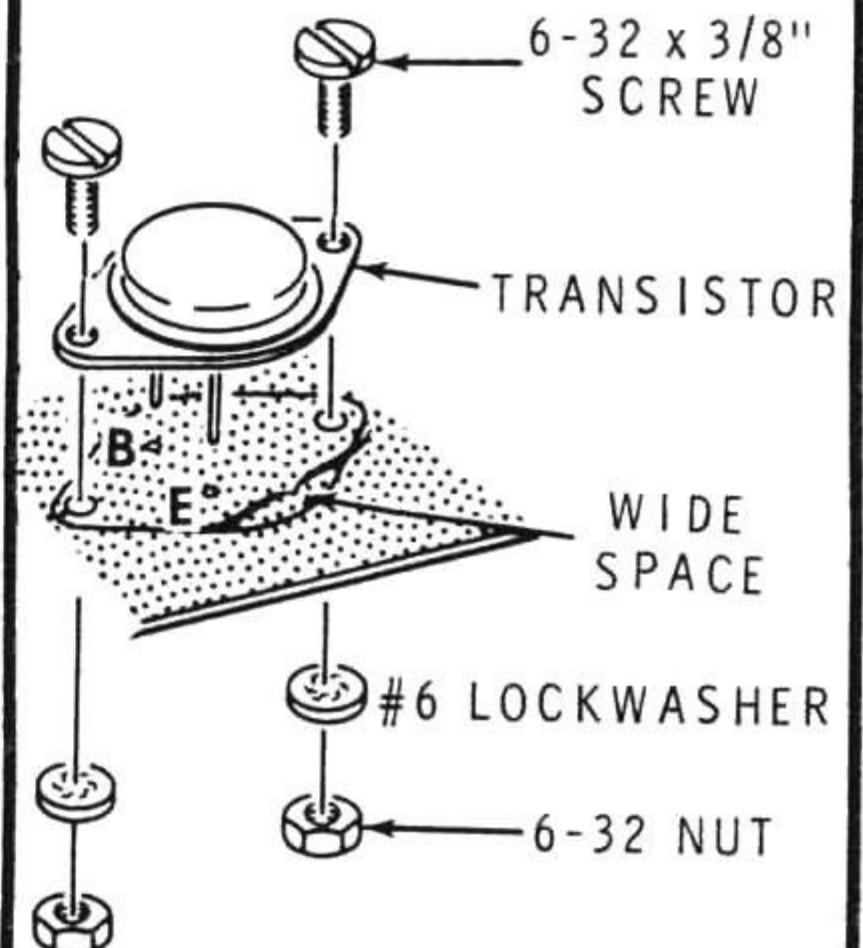

START ↘

NOTE: When wiring this kit, you will be instructed to prepare the wires ahead of time. To prepare a wire as in the next step, cut it to the indicated length and remove 3/8" of insulation from each end. At each wire end, twist the small wires together and melt solder on them. The wires are listed in the order in which they will be used.

() Prepare the following brown wires: 2", 5-1/2", 3-1/2", and 3-1/2". Solder these wires as you connect them in the following steps.

() 2" wire between hole G and the small lug on SCR Q4.

() 5-1/2" wire at E.

() 3-1/2" wire at C.

() 3-1/2" wire at B.

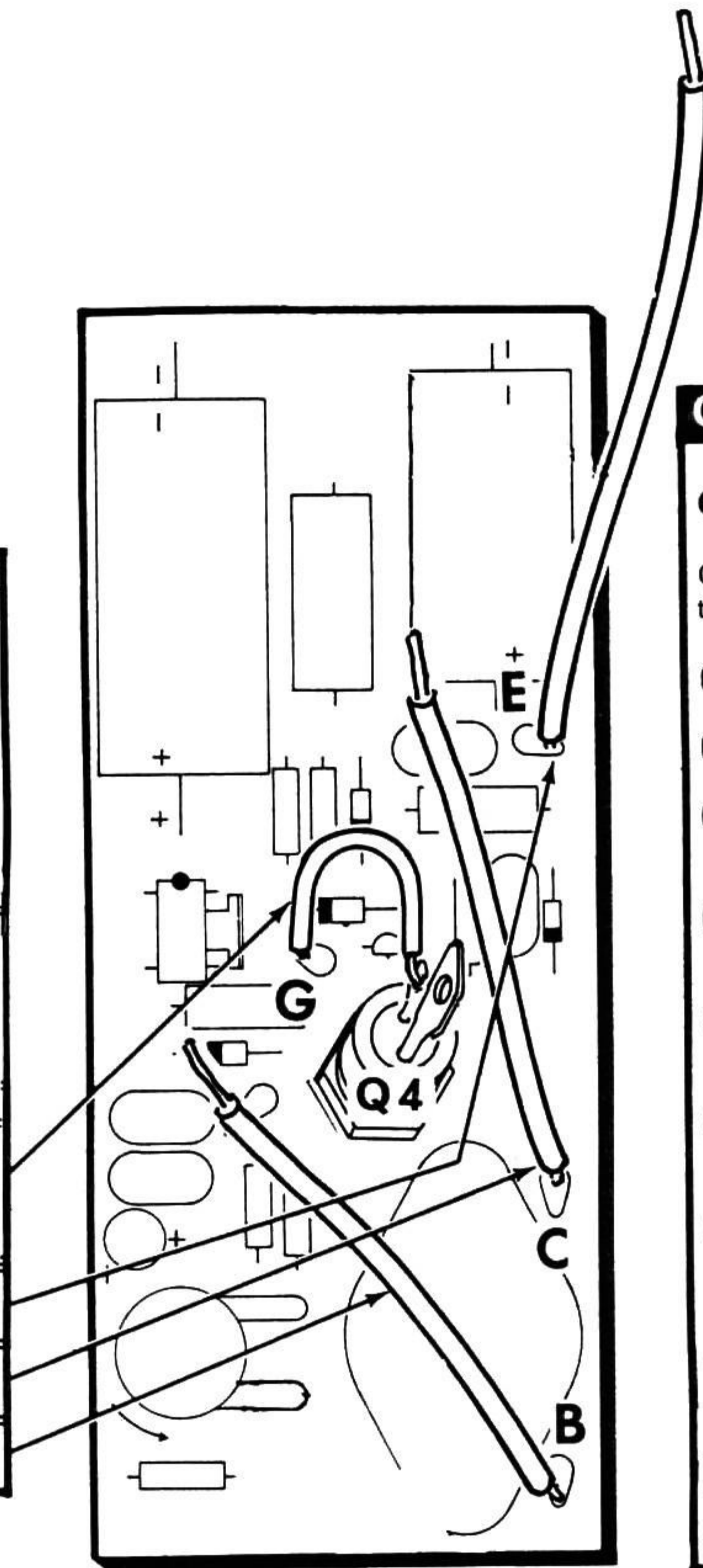

CONTINUE ↘

CIRCUIT BOARD CHECKOUT

Carefully inspect the circuit board for the following conditions.

- () Unsoldered connections.
- () Poor solder connections.
- () Solder bridges between foil patterns.
- () Protruding leads which could touch together.
- () Integrated circuit for the proper type and installation.
- () Transistor for the proper type and installation.
- () Electrolytic capacitors for the correct position of the positive (+) or negative end.
- () Diode for the correct position of the banded end.

The circuit board wire connections will be made later. Temporarily set the circuit board aside.

FINISH

PICTORIAL 1-4

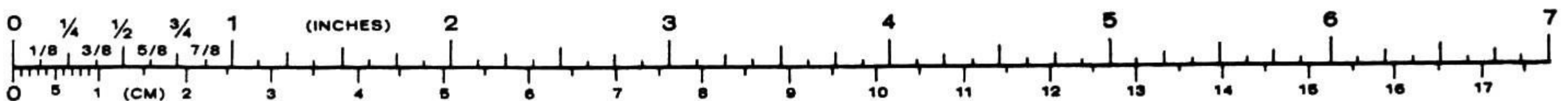



CIRCUIT BOARD AND WIRING REMOVAL

Refer to Pictorial 2-1 (Illustration Booklet, Page 1) for the following steps.

- () Remove the top cover and position your Power Supply as shown.
 - () Temporarily remove the 7-ampere and the 20-ampere fuses and lay them aside.
 - () Locate the bare wire that is connected between fuseholder F2 lug 1 and the terminal board. Cut this bare wire 1" from the terminal board. Then bend the wire into a loop as shown in the inset drawing. Be careful that you do not break the terminal board. Position this loop so it does not extend above the terminal board.
 - () Unsolder and discard the other end of this bare wire from fuseholder F2 lug 1.
- NOTE: In the following steps, you will only be told to remove a wire from a connection. You may unsolder the connection if you wish, but it may be easier to cut the wire first and then unsolder the wire from the lug.
- () Remove the brown wire from the terminal board lug 9.
 - () Remove the brown wire from transistor Q2 lug C.
 - () Remove the brown wire from transistor Q2 lug B.
 - () Remove the white wire from circuit board connector pin A.
 - () Remove and discard the circuit board. Save the screws.
 - () Remove the circuit board spacers from the Power Supply chassis. Install these on the new circuit board.
 - () Remove and discard the bare wire between electrolytic capacitor C1 lug 1 and transistor Q1 lug C.
 - () Cut all wires at the large solder lug. Then remove and discard the large solder lug. Save the mounting hardware.
 - () Remove and discard the bare wire from electrolytic capacitor C1 lug 2.
 - () Remove the orange wire from terminal strip B lug 5.
- Remove the brown, black and red wires from fuseholder F2 lug 2.
- () Remove the yellow wire from fuseholder F1 lug 1.
 - () Remove cable clamp K and remove the 9-wire cable. Save the cable clamp and hardware.
 - () Cut the wires at the end of the 9-wire cable so they are even at the ends.

CABLE, CIRCUIT BOARD AND WIRE INSTALLATION

NOTE: When a bare wire or brown wire is called for in the following steps, use the wire supplied in the modification kit.

- () Refer to Pictorial 2-2 and prepare the end of the 9-wire cable.
- () Insert the prepared end of the 9-wire cable through grommet A from outside the power supply.
- () Cut a 10-1/2" bare wire. Place 9-3/4" of sleeving over this wire.
- () Prepare a 5" brown wire. Remove 1/2" insulation from both ends.

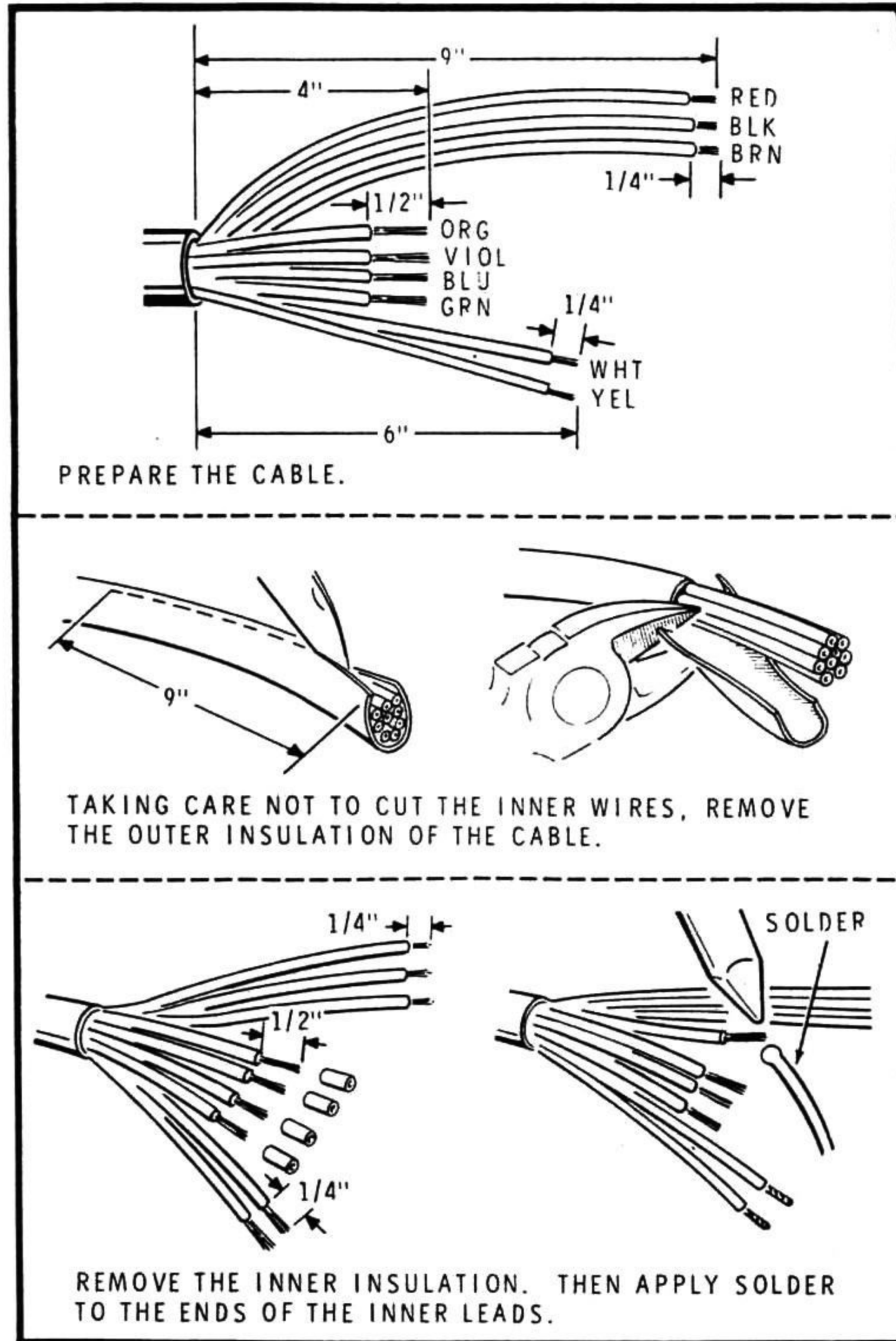

PICTORIAL 2-2

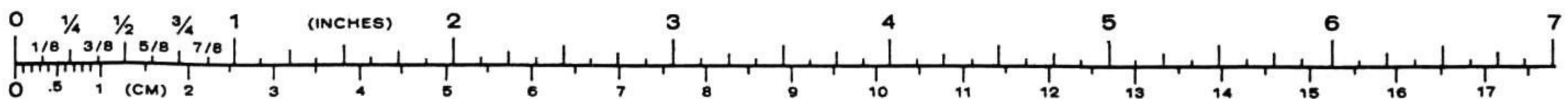

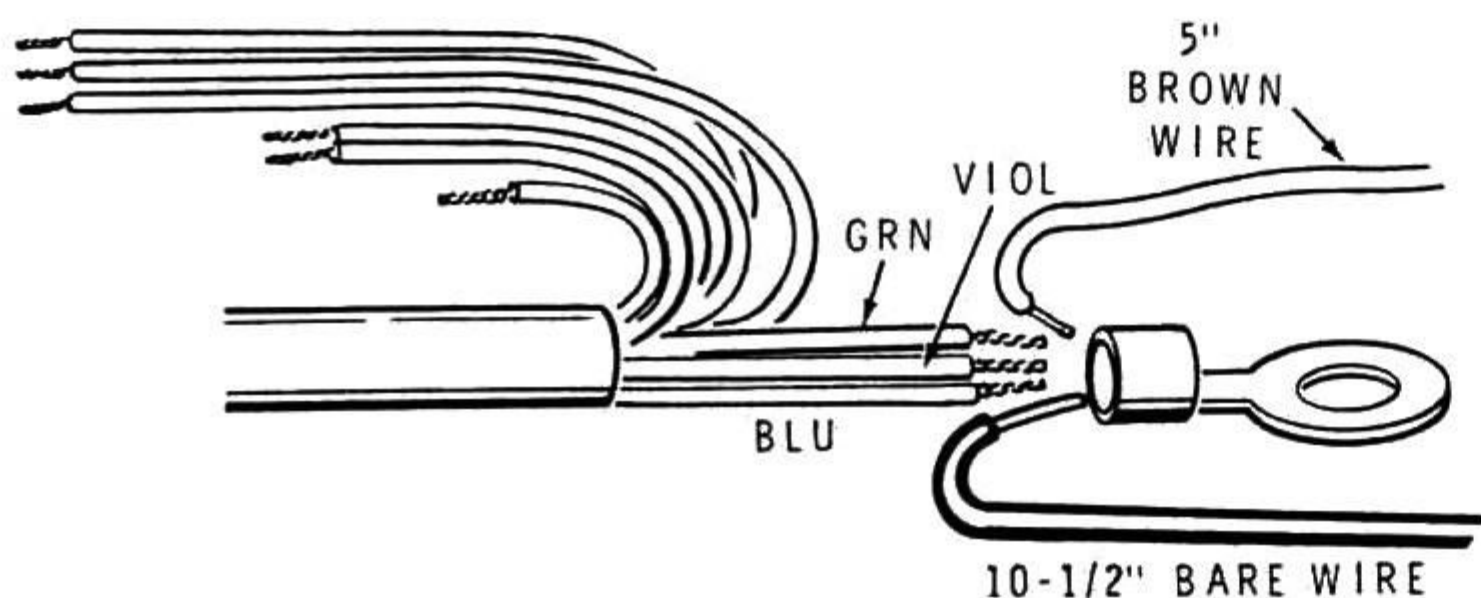

INSERT THE INDICATED WIRES INTO THE LARGE SOLDER LUG AND SOLDER THEM IN PLACE.

PICTORIAL 2-3

- () Refer to Pictorial 2-3 and insert the green, blue, and violet cable wires, the 5" brown wire and the 10-1/2" bare wire into the large solder lug. Solder these wires to the lug.

Refer to Pictorial 2-4 for the next two steps.

- () Mount the large solder lug at J with the hardware that was removed earlier.
- () Remount the cable clamp over the cable at K. Use the hardware that was removed earlier.

Refer to Pictorial 2-5 (Illustration Booklet, Page 2) for the following steps.

- () Route the 10-1/2" bare wire coming from the large solder lug close to the chassis as shown and solder it to bridge rectifier BR1 lug 3. There is one wire already on this lug.
- () Install the new circuit board in the power supply. Use the hardware that was removed earlier.
- () Solder the 5" brown wire coming from the large solder lug to the large lug on Q4.
- () Route the brown wire coming from hole E on the circuit board up behind the terminal board and solder it to lug 8.
- () Solder the brown wire coming from hole B on the circuit board to transistor socket Q2 lug B. There is one other wire already on this lug.
- () Connect the brown wire coming from hole C on the circuit board to transistor socket Q2 lug C. Do not solder this connection at this time.
- () Remove the screw from the terminal board at M and place a #6 solder lug between the spacer and the terminal board. Then replace the screw.

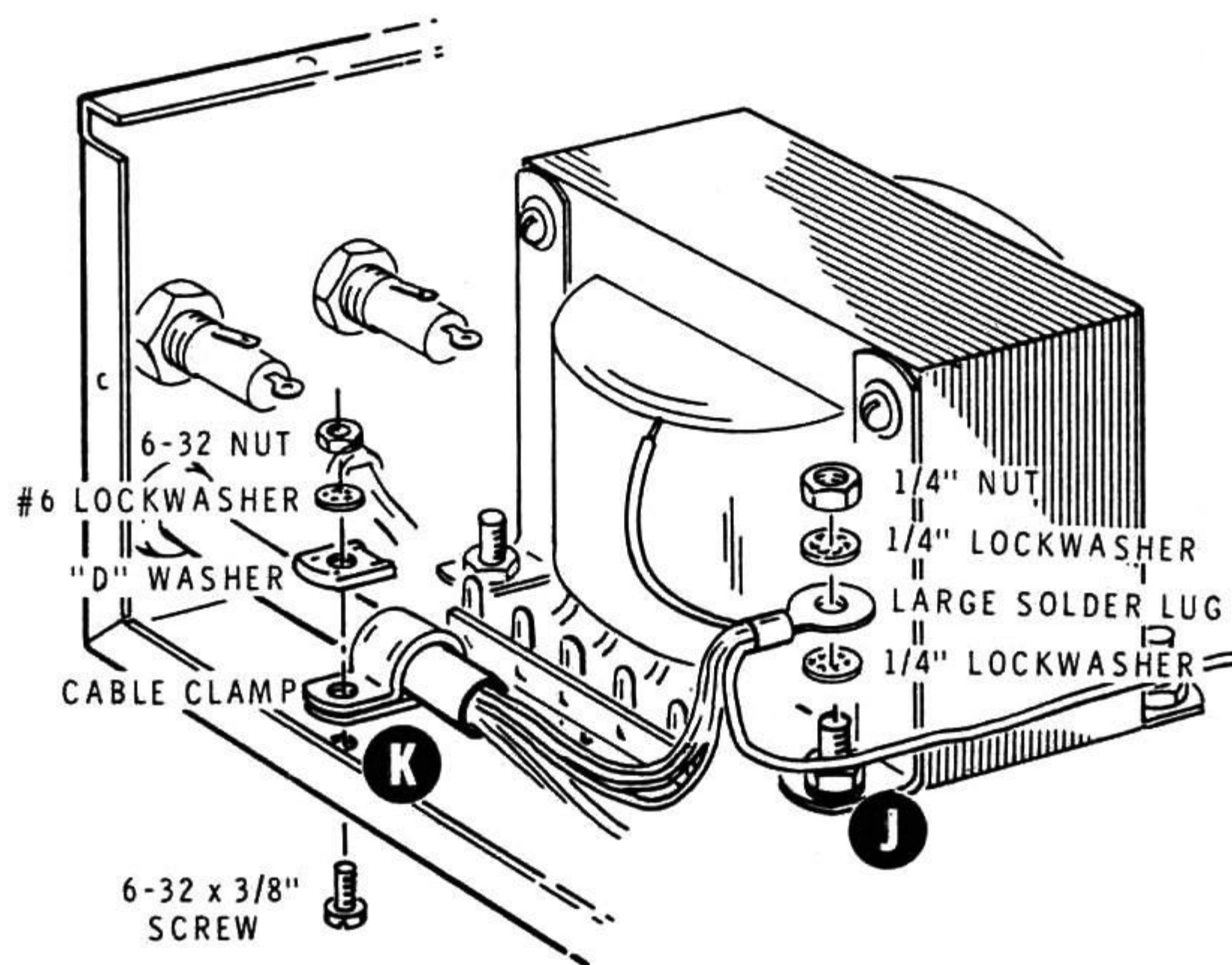

PICTORIAL 2-4

- () Solder a .1 uF ceramic capacitor between transistor socket Q1 lug C and the solder lug at M. A wire is already soldered to lug C.
- () Solder the black, brown and red wires coming from the 9-wire cable to the loop on the terminal board.
- () Solder the white wire coming from the 9-wire cable to connector pin A on the circuit board.
- () Solder the orange wire coming from the 9-wire cable to the 5-lug terminal strip lug 5. Two other wires are already on this lug.
- () Solder the yellow wire coming from the 9-wire cable to fuseholder F1 lug 1.
- () Cut a 12" bare wire. Then place 11" of sleeving over this wire.
- () Route the 12" bare wire between the power transformer and the chassis. Bend the wire as necessary to reach its connecting points. NOTE: If necessary, loosen the power transformer mounting hardware and position the transformer away from the rear panel as far as the mounting screws will permit.
- () Solder the 12" bare wire to fuseholder F2 lug 2 and bridge rectifier BR1 lug 1. Be careful that you do not break the lugs.
- () Cut a 9" bare wire. Then place 8" of sleeving over this wire.
- () Solder the 9" bare wire between fuseholder F2 lug 1 and transistor socket Q2 lug C. There are two wires already on lug C.
- () R13: Solder the 1500 Ω , (brown-green-red-silver) 2-watt resistor to capacitor C1 between lugs 1 and 2. Other wires are already on these lugs.
- () Remove and discard transistors Q1 and Q2 from the heat sink. Also discard the old mica insulators. Save the screws.
- () Locate the two new mica insulators, and apply thermal compound to both sides of each insulator. Then place one insulator on each MJ802 transistor (#417-254).
- () Q1: Refer to Detail 2-5A and install one transistor from the previous step into transistor socket Q1. Use the screws that were removed earlier. Make sure that the ridges in the socket are seated in the mounting holes as you tighten the screws.
- () Q2: In the same manner, install the other transistor into the socket at Q2.
- () Reinstall the 7-ampere and 20-ampere fuses in their respective fuseholders.

This completes the modification of your Power Supply. Proceed to "Test and Adjustments."

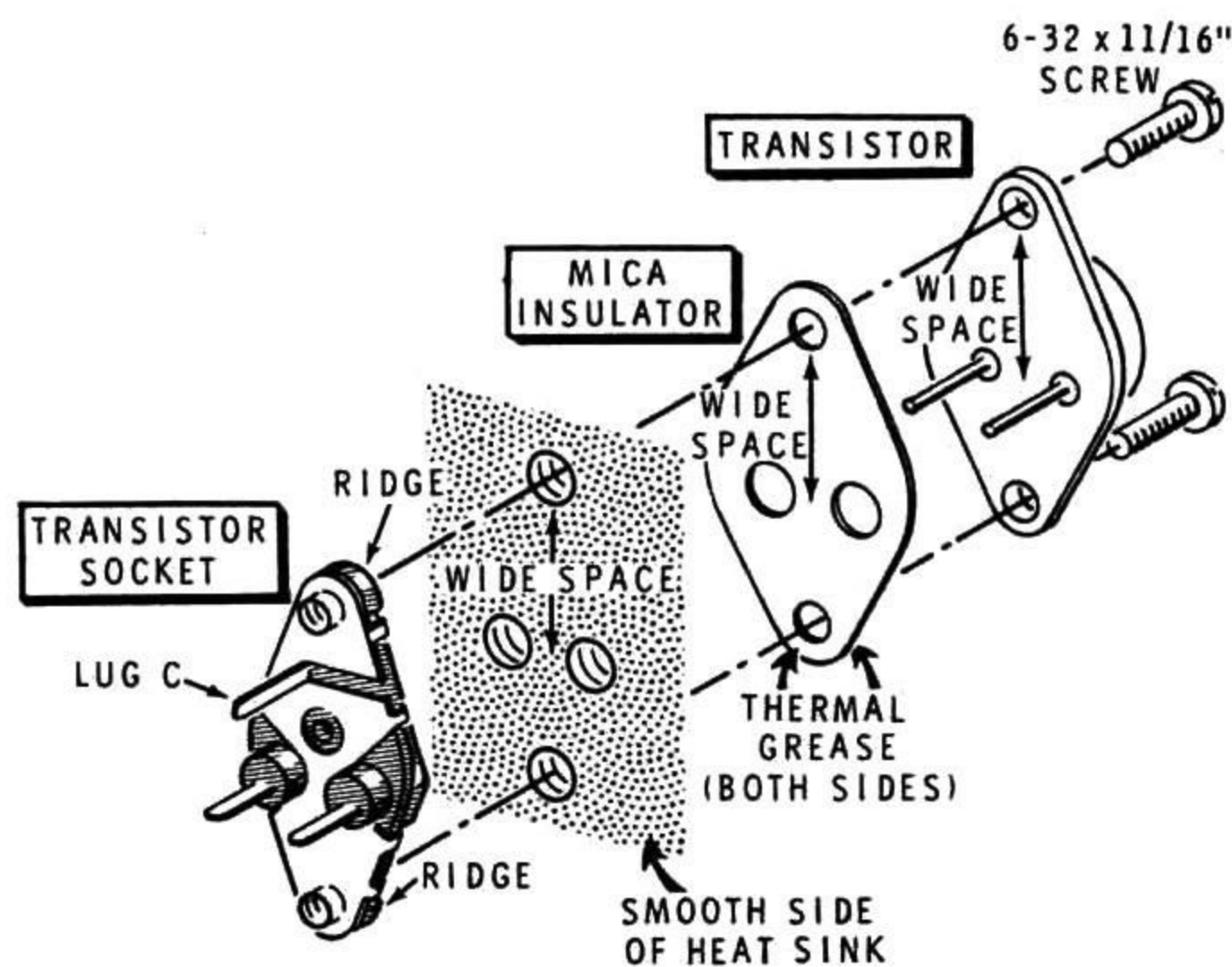

Detail 2-5A



TEST AND ADJUSTMENT

Refer to Pictorial 3-1 (Illustration Booklet, Page 3) for the following steps.

- () Prepare a 5" brown wire.
- () Temporarily solder this wire between fuseholder F1 lug 1 and terminal strip B lug 5.
- () Set your voltmeter to measure 15 volts DC.
- () Connect the negative meter lead to the center lug (ground lug) of the 5-lug terminal strip.
- () Connect the positive meter lead to the wire loop on the terminal board.
- () Set the VOLTAGE ADJUST control on the circuit board fully clockwise.

CAUTION: When the line cord is connected to an AC outlet, AC voltage will be present at several places on the chassis as shown in Pictorial 3-1. Be careful that you do not contact this voltage or electrical shock will result.

- () Plug the line cord into an AC outlet. The voltmeter should read between 10 and 15 volts DC.

- () Turn the VOLTAGE ADJUST control until the meter reads 13.8 volts. Be careful that you do not exceed this voltage or the fuse may blow.
- () Momentarily short across resistor R3 with a piece of wire or pliers. Fuse F2 should blow. This indicates that the crowbar circuit is working properly.
- () Disconnect the line cord from the AC outlet and remove the meter leads.
- () Remove the temporary wire from between fuseholder F1 lug1 and terminal strip B lug 5.
- () Replace fuse F2 with the 20-ampere regular fuse that is supplied.
- () Remove the protective paper backing from the blue and white label. Then press the label to the inside of the chassis over the fuseholders. Refer to the numbers on this label in any communications you may have with the Heath Company concerning this kit.
- () This completes the test and adjustment. Replace the cover with the hardware that was removed earlier.

OPERATION

The output voltage of the AC Power Supply is adjustable to 13.8 VDC, which is needed for correct operation of your transceiver. Just connect the power cable

to your transceiver and the line cord to the proper AC line. The Power Supply will be switched remotely by your transceiver.



IN CASE OF DIFFICULTY

CAUTION: When the line cord is connected to an AC outlet, AC voltage will be present at several places on the chassis. Be careful you do not contact this voltage or an electrical shock can result.

NOTE: Refer to the "X-Ray View" (Page 14) for the physical location of parts on the circuit board.

1. Recheck the wiring. Trace each lead in color pencil on the Pictorial as it is checked. It is frequently helpful to have a friend check your work. Someone who is not familiar with the unit may notice something you have consistently overlooked.
2. About 90% of the kits that are returned for repair do not function properly due to poor connections and soldering. Therefore, you can eliminate many troubles by carefully inspecting the connections to make sure they are soldered. Reheat any doubtful connections. Be sure all the wires are soldered at places where several wires are connected.
3. Be sure the transistors and the integrated circuit are in the proper locations (correct part number and type number). Be sure that each transistor lead is in the right hole and has a good solder connection. Check the integrated circuit for proper positioning and for good contact at each pin connection.
4. Check capacitor values carefully. Be sure the proper part is wired into the circuit at each capacitor location. Check each electrolytic capacitor to be sure the lead near the positive (+) marking is at the correct position.
5. Check each resistor value carefully.
6. Be sure the correct diode is installed and that the banded end is positioned correctly.
7. Check all component leads connected to the circuit board.
8. Make sure bare wires do not touch the chassis or other lugs and make sure all wires are properly soldered.

Troubleshooting Chart

PROBLEM	PROBABLE CAUSE
No output voltage.	1. F1. 2. F2.
Primary fuse F1 blows.	1. Bridge rectifier BR1. 2. Capacitor C1, C2.
Output fuse F2 blows.	1. Excessive loading (keydown). 2. Output shorted. 3. Q1, Q2. 4. U1. 5. Output voltage set too high. 6. D4 reversed.
Unable to obtain +13.8 VDC WITH Voltage Adjust control.	1. U1. 2. Q3. 3. R7. 4. D1.
Voltage drops significantly when transmitting.	1. U1. 2. Q1, Q2, Q3.

In an extreme case where you are unable to resolve a difficulty, refer to the "Customer Service" information inside the rear cover of the Manual. Your Warranty is located inside the front cover.

SPECIFICATIONS

Output Voltage	13.8 VDC regulated (adjustable).
Maximum Output Current	20 amperes intermittent. 8 amperes continuous.
Power Requirements	110 to 130 VAC, 6 amperes; or 220 to 260 VAC, 3 amperes; 50/60 Hz maximum.
Over Voltage Protection	Crow bar circuit will blow 20-ampere fuse if the output exceeds 15.5 volts.
Regulation	Less than 2% from no load to 20 amperes.
Ripple	Less than 1% at 20 amperes.
Fuses	7-amp, 3 AG, slow-blow primary. 20-amp, 3 AG, output.
Dimensions	5-1/2" high × 9-1/4" wide × 10-1/4" deep. (13.97 cm H × 23.49 cm W × 26.03 cm D).
Net Weight	23 lbs. (10.4 kg).

The Heath Company reserves the right to discontinue products and to change specifications at any time without incurring any obligation to incorporate new features in products previously sold.

CIRCUIT DESCRIPTION

The line voltage is coupled through fuse F1 and the power switch in your transceiver to the power transformer. The power transformer steps the voltage down from 120 VAC (or 240 VAC) to approximately 14 volts AC. This voltage is then rectified by bridge rectifier BR1 and filtered by capacitors C1 and C2 to provide a DC voltage. This voltage is then coupled through Fuse F2 to the regulator circuit.

Transistors Q1, Q2, and Q3 form a Darlington-type regulation circuit that provides high gain. Q1 and Q2 are in parallel in a series regulation circuit. The out-

put voltage from this circuit is controlled by the base bias to Q3, which is provided by integrated circuit U1.

U1 has a zener reference diode built into it. This integrated circuit samples the output voltage which is coupled back through resistors R6, R5, R3, and R4, and compares it to the internal reference voltage. Then U1 automatically adjusts the bias voltage to Q3 so the output voltage will remain fixed. The sensing voltage is taken from the load end of the power cable so any voltage that is lost due to cable length is accounted for.

The output voltage is adjusted by control R4. Increasing or decreasing this sampling voltage to U1 will result in a corresponding decrease or increase at the output. Resistors R3, R5, and R6 establish the narrow adjustable range of control R4. Capacitor C8 provides RF filtering.

Capacitor C6 provides a DC voltage of sufficient amplitude to permit U1 to regulate properly. Diode D1 allows capacitor C6 to charge but prevents it from discharging. In this way, only the small load of U1 is placed on C6. Resistor R7 prevents excess current flow through D1 when the Power Supply is in operation.

When the output voltage exceeds a safe level, zener diode D4 starts to conduct, causing a 0.4 volt drop across R11. This turns unijunction transistor Q5 on, which allows current to flow through Q5 and diode D3 to SCR Q4. This turns Q4 on, which shorts the collector of Q3 to ground, blowing fuse F2. Resistor R8 prevents SCR Q4 from accidentally triggering. Capacitor C7 provides an RF bypass to prevent accidental triggering of Q5.

Resistors R1 and R2 balance the current between regulator transistors Q1 and Q2. Resistor R12 is a bleeder resistor, while capacitors C9 and C10 provide transient protection for the Power Supply.

CIRCUIT BOARD X-RAY VIEW





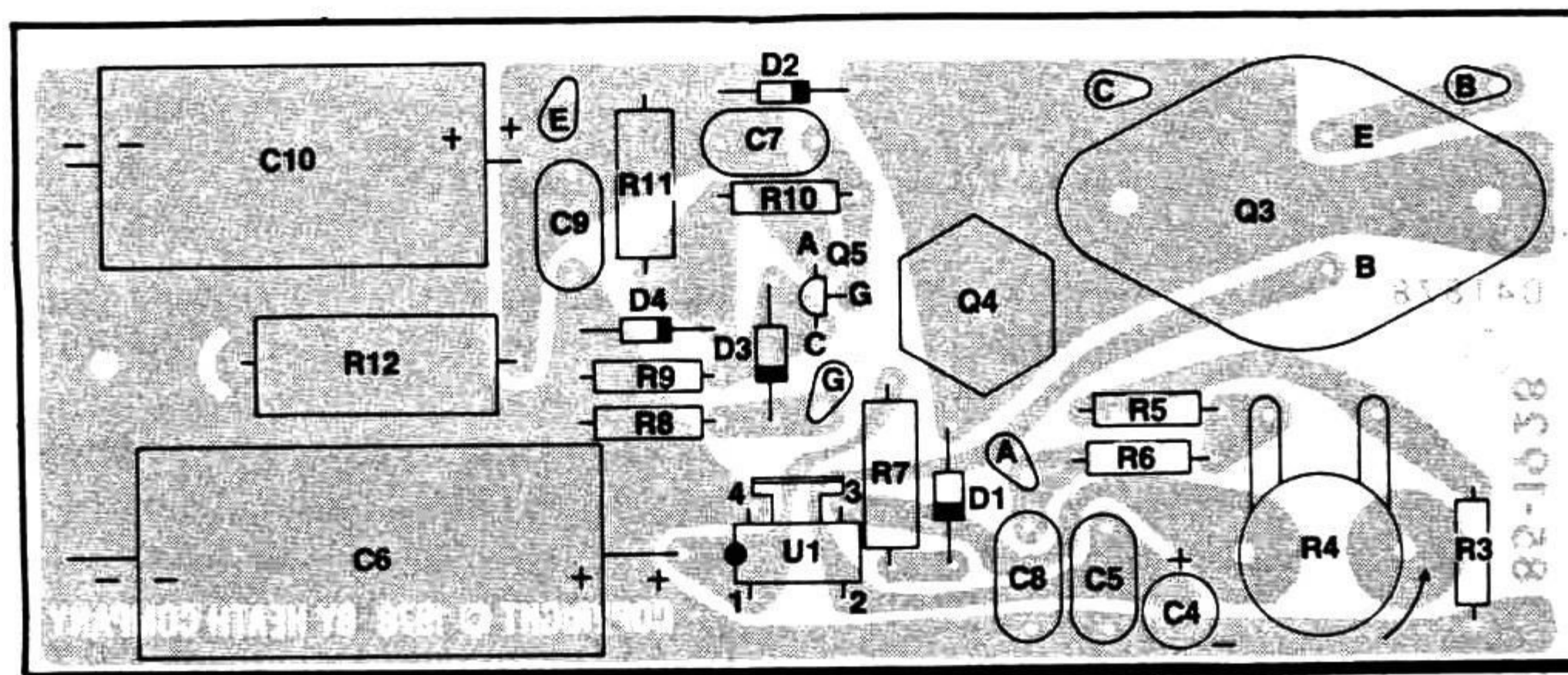

NOTE: To find the PART NUMBER of a component for the purpose of ordering a replacement part:

- A. Find the circuit component number (R5, C3, etc.) on the X-Ray View.
- B. Locate this same number in the "Circuit Component Number" column of the "Parts List" in the front of this Manual.
- C. Adjacent to the circuit component number, you will find the PART NUMBER and DESCRIPTION which must be supplied when you order a replacement part.

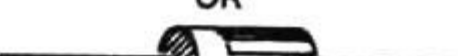

(VIEWED FROM THE COMPONENT SIDE)

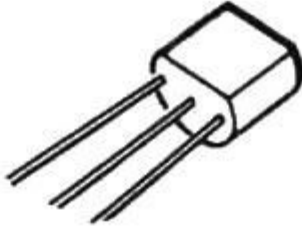
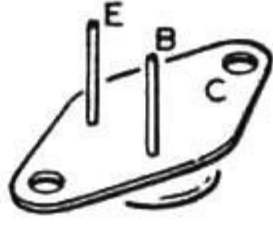
SEMICONDUCTOR IDENTIFICATION CHART

COMPONENT NUMBERS	HEATH PART NUMBER	REPLACED BY	DESCRIPTION	LEAD CONFIGURATION
D1, D2	57-65	1N4002	DIODE	NOTE: HEATH PART NUMBERS ARE STAMPED ON MOST DIODES.  OR  OR  OR  OR  OR 
D3	56-56	1N4149	DIODE	
D4	56-620		15V ZENER DIODE	
Q5	417-823	MPU131	TRANSISTOR	
Q1, Q2	417-254	MJ802	TRANSISTOR	
Q3	417-215	2N3055		
U1	442-626	MFC6030 78MGT4	INTEGRATED CIRCUIT	
Q4	57-86	NL576A	SCR	