

# AnyTone<sup>®</sup>

## AT-588UV

### USER'S MANUAL



FC

CE



RoHS  
COMPLIANT

ISO9001  
ISO14001

## Dual Band FM Transceiver

# MOBILE RADIO



Nice Housing, Stoutness & Stability, Advanced and Reliable functions, Perfect & Valuable.    Approval. AT-588UV mobile radio especially designs for drivers and it pursues company philosophy of innovation and practicality.

*We only do best radio!*



**NOTE**

When programming the transceiver, read the factory initial data firstly, then rewrite the frequency and signaling etc., otherwise errors may occur because of different frequency band etc..

AT-588UV Mobile Radio Applicable Software: QPS588UV Model Apply To This Manual: AT-588UV Mobile radio

# MOBILE RADIO

---

---

Thank you for choosing this **AnyTone**® mobile transceiver, **AnyTone**® always provide high quality products, and this transceiver is no exception AT-588UV is a ruggedly-built, high quality Dual Band FM transceiver providing 50 Watts of power output on the VHF band and 40 Watts on the UHF band. It owns many advanced characters like cross band repeat function, built with a direct-flow heat sink and thermostatically-controlled cooling fan maintaining a safe temperature for the transceiver's circuit.

AT-588UV has four independent receiving bands, consist of UU, UV,VU,VV for dual receive and dual output, plus receiving for AM/FM signal of air band, marine band, PMR, etc. also able to receive FM/TV radio and analogue TV signal. It owns 758 memory channels, full duplex operation with independent volume and squelch controls, optional compander and builtin CTCSS/DCS, DTMF, 5TONE,2TONE signaling, detachable front panel for flexible installation.

Though friendly design for user, this transceiver is technically complicated and some features may be new to you. Consider this manual to be a personal tutorial from the designers,allow the manual to guide you through the learning process now, then act as a reference in the coming years.

## Precautions

Please observe the following precautions to prevent fire, personal injury, or transceiver damage:

- ⚠ Do not attempt to configure your transceiver while driving,it is dangerous.
- ⚠ This transceiver is designed for a 13.8V DC power supply. Don't use a 24V battery to power on the transceiver.
- ⚠ Do not place the transceiver in excessively dusty, humid or wet areas, nor unstable surfaces.
- ⚠ Please keep it away from interferential devices (such as TV, generator etc.)
- ⚠ Do not expose the transceiver to long periods of direct sunlight nor place it close to heating appliances.
- ⚠ If an abnormal odor or smoke is detected coming from the transceiver, turn OFF the power immediately. Contact an Anytone service station or your dealer.
- ⚠ Do not transmit with high output power for extended periods; the transceiver may overheat.

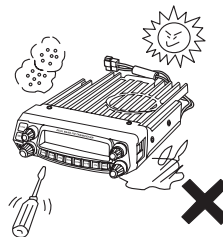

---

---

## CONTENTS

<b>New and Innovative Features</b> .....	1	High/Mid/Low Power Switch .....	13
Frequency Range .....	1	Frequency Reverse.....	13
<b>Supplied Accessories/Optional Accessories</b> .....	2	Band-width Selection .....	13
Supplied Accessories .....	2	HOME Channel.....	13
Optional Accessories .....	2	Dual Watch.....	14
<b>Initial Installation</b> .....	3	Emergency Alarm.....	14
Mobile installation .....	3	Channel/Frequency Scan .....	14
DC Power Cable Connection.....	4	Channel Scan Skip .....	14
Antenna Connection .....	6	Channel Edit .....	14
Accessories Connections.....	7	Channel Copy .....	14
<b>Getting Acquainted</b> .....	8	Channel Delete.....	14
Front panel.....	8	<b>General Setting</b> .....	15
Rear panel .....	9	APO (Autom atic Pow er off).....	15
DISPLAY .....	9	Automatic offset .....	15
Microphone .....	10	Frequency Channel Step Setup.....	15
<b>Basic Operations</b> .....	11	VFO Band lockout.....	16
Switching The Power On/Off.....	11	Beep Function.....	16
Adjusting The Volume .....	11	CPU Clock frequency Change .....	16
Switch between VFO and Channel mode.....	11	2TONE Encode select .....	16
Adjusting Frequency .....	11	5TONE Encode select .....	17
Adjusting Channel.....	11	Add Optional signaling .....	17
Switch Between Main Band and Sub band.....	12	CTCSS encode Setup .....	17
Selecting the frequency band .....	12	CTCSS decode Setup.....	18
Receiving .....	12	Sub Band Display Setup.....	18
Squelch Off/Squelch Off Momentary.....	12	DTMF Encode Pre-Loading time .....	18
Transmitting .....	12	DTMF Encode Transmitting Time .....	19
<b>Shortcut Operations</b> .....	13	DTMF Encode setup .....	19
Squelch level Setup .....	13	Squelch Mode Setup.....	19
Transmit DTMF/2TONE/5TONE signaling.....	13	Compander .....	20

## CONTENTS

Scrambler Setup .....	20	Password Function .....	28	
Tone Bust (Pilot Frequency).....	20	<b>Microphone Operation .....</b>	<b>29</b>	
Keypad Mode Setup .....	21	Send DTMF signaling .....	29	
Keypad Lockout .....	22	Main/Sub band switching .....	29	
TX OFF (PTT Lockout) .....	22	Function operation through PA-PD keys.....	29	
Squelch Level setup.....	22	<b>Cable Clone.....</b>	<b>31</b>	
TALK AROUND .....	22	<b>Programming Software Installing and Starting (in windows</b>	<b>XP system) .....</b>	<b>32</b>
Sub band mute setup.....	23	Install USB Cable Driver Programme .....	32	
Editing Channel Name .....	23	<b>Maintenance.....</b>	<b>33</b>	
Microphone PA,PB, PC,PD key setup .....	23	Trouble Shooting.....	33	
RF Squelch level setup.....	24	<b>Specifications.....</b>	<b>34</b>	
OFFSET Direction setup.....	24	<b>Attached Chart.....</b>	<b>35</b>	
Scan Dwell Time Setup.....	24	50 groups CTCSS Tone Frequency(Hz) .....	35	
Priority channel scan.....	24	1024 groups DCS Code.....	35	
Offset frequency Setup .....	25			
Display mode Setup.....	25			
Busy Channel Lockout.....	25			
Radio's DTMF SELF ID ENQUIRY .....	25			
5TONE SELF ID ENQUIR .....	26			
TOT (Time-out timer) .....	26			
VFO Frequency Linkage .....	26			
Wide/Narrow band .....	26			
Cross Band repeat.....	27			
LCD backlight.....	27			
Keypad backlight brightness.....	27			
Calling Record .....	27			
AM Function.....	28			
Automatic AM function .....	28			
VHF External speaker port.....	28			



AT-588UV Mobile Radio has nice housing, stoutness & stability, advanced and reliable functions, perfect & valuable. This amateur mobile radio especially designs for drivers and it pursues company philosophy of innovation and practicality. More functions as follows:

- ▼ 758 memory channels, full duplex operation with independent volume and squelch controls
- ▼ 50 Watts of power output on the VHF band and 40 Watts on the UHF band with cross band repeater function.
- ▼ Four independent receiving bands, consist of UU, UV,VU,VV for dual receive and dual output, plus receiving for AM/FM signal of air band,marine band, PMR, etc; able to receive FM/TV radio and analogue TV signal.
- ▼ Display on a large LCD with adjustable brightness, convenient for nighttime use. There are Amateur operation mode and Professional operation mode for option.
- ▼ Distribute buttons reasonably, convenient for operation. Adopt superior quality material, better technology and direct-flow heat sink to ensure stable and durable operation.
- ▼ 758 programmable memory channels, identified by editing name.
- ▼ Programming different CTCSS, DCS, 2Tone, 5Tone in per channel, rejecting extra calling from other radios.
- ▼ Various scan functions including CTCSS/DCS Scan function.
- ▼ Using 5Tone to send Message, Emergency alarm, Call all, ANI, Remotely kill, Remotely Waken, etc.
- ▼ Automatic calling Identification function by DTMF--ANI or 5Tone--ANI .
- ▼ Scramble function.
- ▼ Compander function for decrease the background noise and enhance audio clarity, it can set compander ON/OFF per channel.
- ▼ Different band width per channel, 25K for wide band, 20K for middle band ,or 12.5K for narrow band.
- ▼ Theft alarm provides extra safety.

## FREQUENCY RANGE

RX: 118~174MHZ(AM/FM)	TX: 136~174MHZ
220~260MHZ	400~490MHZ
350~399.995MHZ	
400-490 MHZ	
49-870 MHZ(Optional)	

## SUPPLIED ACCESSORIES

After carefully unpacking the transceiver, identify the items listed in the table below. We suggest you keep the box and packaging.

- Transceiver
  - Microphone (QHM-04)  
(with DTMF keyboard)
  - Mobile Mounting  
Bracket (QMB-01)
  - DC Power Cable with  
Fuse Holder(QPL-01)
  - Hardware Kit for Bracket
- Black screws  
(M4X8mm)  
4PS(QSS-01A)



Tapping screws  
(M5X8mm)  
4PS(QSS-01B)



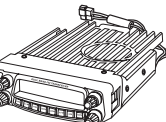

S-Washer  
(QSS-01D)

- 

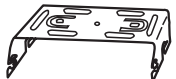





- Spare Fuses  
(QF-01)





• User Manual



## OPTIONAL ACCESSORIES

- Cloning Cable (CP51)
  - USB Programming  
Cable (PC51)
  - Cigar-Plug Connection  
Line (QCC-01)
  - Programming Software  
(QPS-588UV)
  - Car Antenna  
(QCA-02)
  - Car Antenna  
(QCA-03)
- 





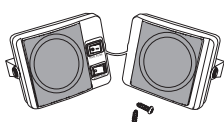

- External Speaker (SP-02)

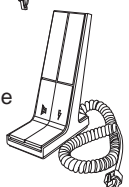

• Power supply (QRP-01)

- Desktop  
Microphone  
(QDM-01)





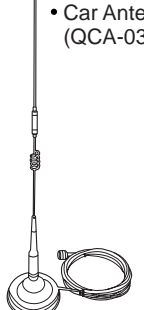



## MOBILE INSTALLATION

To install the transceiver, select a safe, convenient location inside your vehicle that minimizes danger to your passengers and yourself while the vehicle is in motion. Consider installing the unit at an appropriate position so that knees or legs will not strike it during sudden braking of your vehicle. Try to pick a well ventilated location that is shielded from direct sunlight.

1. Install the mounting bracket in the vehicle using the supplied self-tapping screws (4pcs) and flat washers (4pcs).

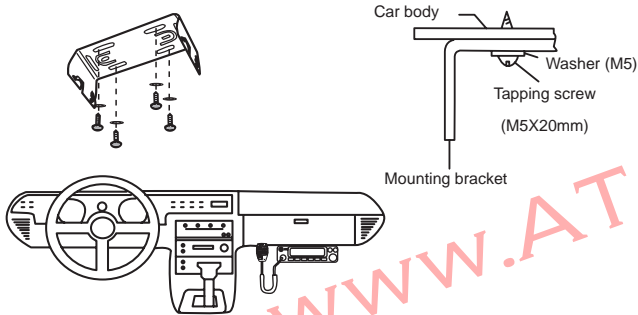

2. Position the transceiver, then insert and tighten the supplied hexagon SEMS screws.

▼ Double check that all screws are tightened to prevent vehicle vibration from loosening the bracket or transceiver.

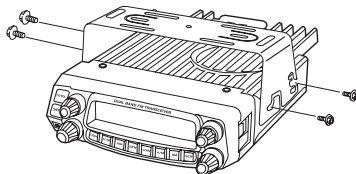

- ▼ Determine the appropriate angle of the transceiver, using the 3 screw hole positions on the side of the mounting bracket.

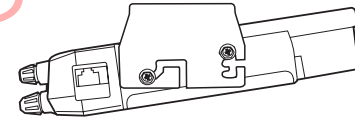
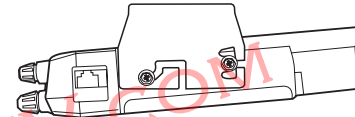
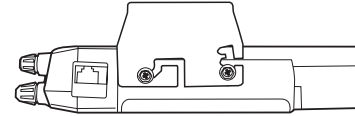

## DC POWER CABLE CONNECTION



Locate the power input connector as close to the transceiver as possible.

### MOBILE OPERATION

The vehicle battery must have a nominal rating of 12V. Never connect the transceiver to a 24V battery. Be sure to use a 12V vehicle battery that has sufficient current capacity. If the current to the transceiver is insufficient, the display may darken during transmission, or transmitting output power may drop excessively.

- Route the DC power cable supplied with the transceiver directly to the vehicle's battery terminals using the shortest path from the transceiver.
  - ▼ We recommend you do not use the cigarette lighter socket as some cigarette lighter sockets introduce an unacceptable voltage drop.
  - ▼ The entire length of the cable must be dressed so it is isolated from heat, moisture, and the engine secondary (high voltage) ignition system/ cables.
- After installing cable, in order to avoid the risk of damp, please use heat-resistant tap to tie together with fuse box. Don't forget to reinforce whole cable.
- In order to avoid the risk of short circuit, please cut down connection with negative (-) of battery, then connect with radio.
- Confirm the correct polarity of the connections, then attach the power cable to the battery terminals; red connects to the positive (+) terminal and black connects to the negative (-) terminal.
  - ▼ Use the full length of the cable without cutting off excess even if the cable is longer than required. In particular, never remove the fuse holders from the cable.

- Reconnect any wiring removed from the negative terminal.

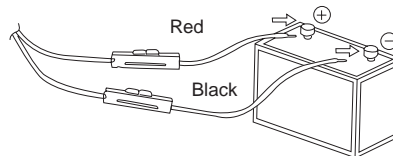

- Connect the DC power cable to the transceiver's power supplyconnector.

▼ Press the connectors firmly together until the locking tab clicks.

If the ignition-key on/off feature is desired(optional feature),use the

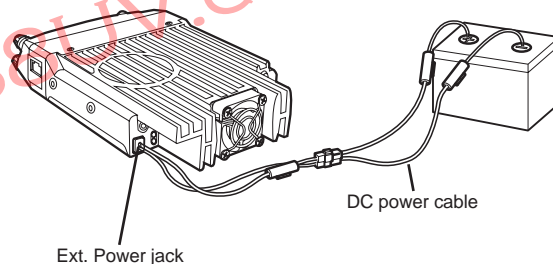

optional QCC-01(For Cigar-Plug connection) cable. Connect one of the cables between the ACC terminal or a Cigar-Plug that operates with the vehicle ignition or ACC switch on the vehicle and EXT POWER jack on the rear side of the unit.



In many cars,the cigar-lighter plug is always powered. If this is the case, you cannot use it for the ignition key on/off function.

7. When the ignition key is turned to ACC or ON(Start) position with the radio turned off, the power switch illuminates. The illumination will be turned off when the ignition key is turned to the off position. To turn on the unit, press the power switch manually while it is illuminated. (While ignition key is at ACC or ON position)
8. When the ignition key is turned to ACC or ON position with the radio's power switch on, the unit turns on automatically and the power switch will be lit. Turn the ignition key to OFF position or manually turn the power switch off to shut down the radio.
9. Using extra cable, power consumption: 5MAH.
10. Without this function, user can turn on/off radio by Power knob.

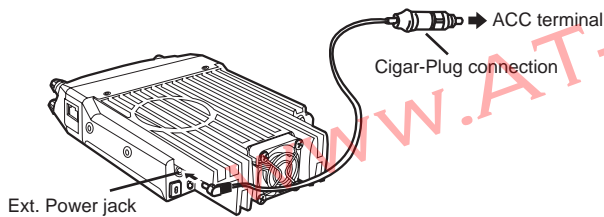

### ✕ FIXED STATION OPERATION

In order to use this transceiver for fixed station operation, you will need a separate 13.8V DC power supply (not included), power supply (QRP-01) as optional accessories. Please contact local dealer to require.

The recommended current capacity of your power supply is 12A.

1. Connect the DC power cable to the regulated DC power supply and ensure that the polarities are correct. (Red: positive, Black: negative).
  - ▼ Do not directly connect the transceiver to an AC outlet.
  - ▼ Use the supplied DC power cable to connect the transceiver to a regulated power supply.
  - ▼ Do not substitute a cable with smaller gauge wires.

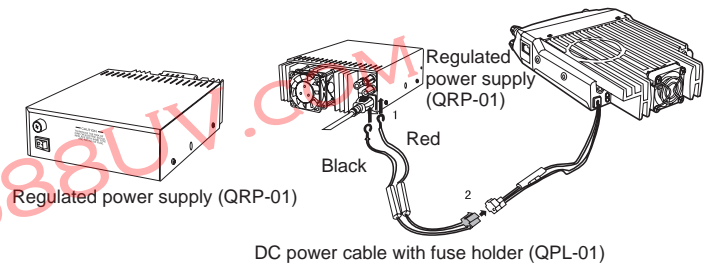

2. Connect the transceiver's DC power connector to the connector on the DC power cable.
  - ▼ Press the connectors firmly together until the locking tab clicks.



NOTE

- ▼ Before connecting the DC power to the transceiver, be sure to switch the transceiver and the DC power supply OFF.
- ▼ Do not plug the DC power supply into an AC outlet until you make all connections.

### ✕ REPLACING FUSES

If the fuse blows, determine the cause, then correct the problem. After the problem is resolved, replace the fuse. If newly installed fuses continue to blow, disconnect the power cable and contact your authorized **AnyTone**® dealer or an authorized **AnyTone**® servicecenter for assistance.

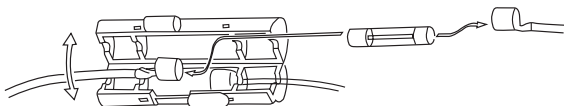

Fuse Location	Fuse Current Rating
Transceiver	15A
Supplied Accessory DC power cable	20A

Only use fuses of the specified type and rating, otherwise the transceiver could be damaged.



If you use the transceiver for a long period when the vehicle battery is not fully charged, or when the engine is OFF, the battery may become discharged, and will not have sufficient reserves to start the vehicle. Avoid using the transceiver in these conditions.

### ■ ANTENNA CONNECTION

Before operating, install an efficient, well-tuned antenna. The success of your installation will depend largely on the type of antenna and its correct installation. The transceiver can give excellent results if the antenna system and its installation are given careful attention.

Use a 50Ω impedance antenna and low-loss coaxial feed-line that has a characteristic impedance of 50 Ω, to match the transceiver input impedance. Coupling the antenna to the transceiver via feed-lines having

an impedance other than 50Ω reduces the efficiency of the antenna system and can cause interference to nearby broadcast television receivers, radio receivers, and other electronic equipment.



- ▼ Transmitting without first connecting an antenna or other matched load may damage the transceiver. Always connect the antenna to the transceiver before transmitting.
- ▼ All fixed stations should be equipped with a lightning arrester to reduce the risk of fire, electric shock, and transceiver damage.

The possible locations of antenna on a car are shown as following:



## ACCESSORIES CONNECTIONS

### EXTERNAL SPEAKER

If you plan to use an external speaker, choose a speaker with an impedance of 8  $\Omega$ . The external speaker jack accepts a 3.5 mm (1/8") mono (2-conductor) plug.

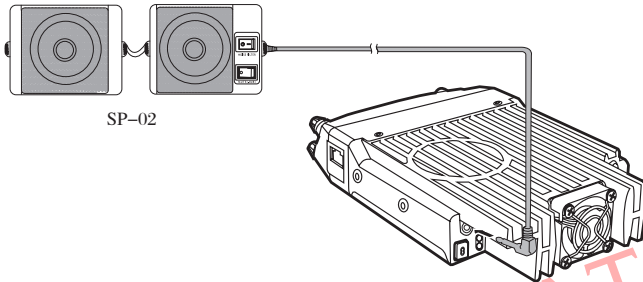

### MICROPHONE

For voice communications, connect a microphone equipped with an 8-pin modular plug into the modular socket on the front of the main unit. Press firmly on the plug until the locking tab clicks. Attach the supplied microphone hanger in an appropriate location using the screws included in the screw set.

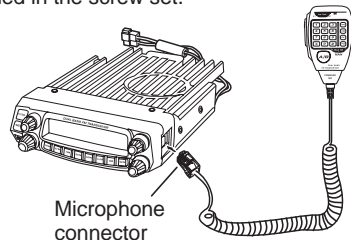

Antenna[QCA-02]

Microphone[QHM-04]

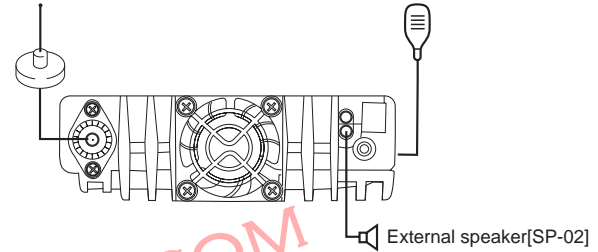

### PC CONNECTING

To utilize the QPS588UV software, you must first connect the transceiver to your PC then using an optional programming cable PC50 (via Data socket ).

Please use QPS-588UV software for programming.

<http://www.qxdz.cn>



NOTE Ask your dealer about purchasing a Programming Cable PC51.

## FRONT PANEL

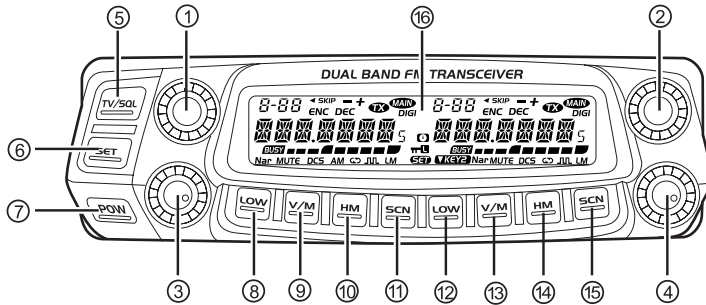

## 8 • Basic Functions

NO.	KEY	FUNCTION
1	Left Dial Knob	Rotate it to choose frequency /channel. Press it to set the left band as "Main Band"; In VFO mode, press it to choose the frequency band; In function setup as confirm key; in scan mode, rotate it to change scan direction
2	Right Dial Knob	Rotate it to choose frequency /channel. Press it to set the right band as "Main Band"; In VFO mode, press it to choose the frequency band; In function setup as confirm key; in scan mode, rotate it to change scan direction
3	Left Volume Knob	Adjust left band volume level.
4	Right Volume Knob	Adjust right band volume level.
5	[ TV/SQL ]	In standby, press this key to turn On/Off TV function. Hold this key to cancel squelch

6	Function set Key	In standby, press this key to enter function menu
7	Power	Press it to power On /Off the transceiver
8	Left [ LOW ] Key	In standby press to change H/L power for present channel. Long press it to turn On/Off Talk Around Function
9	Left [ V/M ] Key	In standby, press to switch between channel mode and VFO mode. Long press it to set Wide/ Narrow band.
10	Left [ HM ] Key	In standby, press to switch between HOME channel and normal channel. Long press it to enter dual watch of VFO channel and current channel.
11	Left [ SCAN ] Key	In standby, press to start channel or frequency scan. In channel mode, hold it to set current channel scan skip.
12	Right [ LOW ] Key	In standby press to change H/L power for present channel. Long press it to turn On/Off Talk Around Function
13	Right [ V/M ] Key	In standby, press to switch between channel mode and VFO mode. Long press it to set Wide/ Narrow band.
14	Right [ HM ] Key	In standby, press to switch between HOME channel and normal channel. Long press it to enter dual watch of VFO channel and current channel.
15	Right [ SCAN ] Key	In standby, press to start channel or frequency scan. In channel mode, hold it to set current channel scan skip.
16	LCD	For display of channel, frequency and function setup.

REAR PANEL

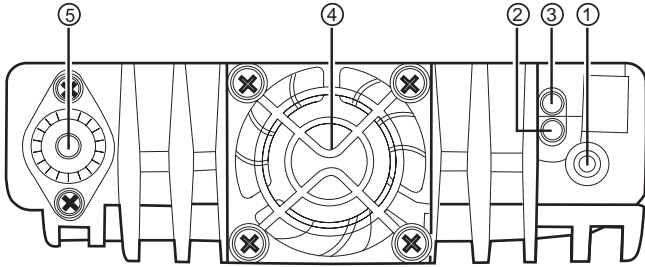

NO.	KEY	FUNCTION
1	Ext. Power Jack	Terminal for connecting optional cable QCC01 for use with ignition key On/Off function. The radio will auto power on when car is driving. The radio will auto power off when car stops.
2	Ext. Speaker Terminal	Terminal for optional external speaker SP02
3	TV/AV port	Connect to television TV/AV port.
4	Heat -sink fan	Runs Automatically when radio temperature rise up.
5	Antenna Connector	Connect a 50 Ω antenna

DISPLAY

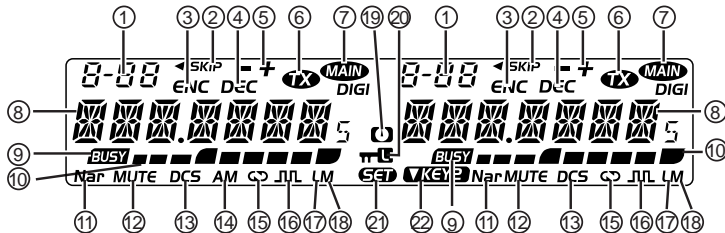

NO.	INDICATOR	FUNCTION
1	8-88	Displays the channel number and Menu number.
2	◀ SKIP	Appears when current channel is set Scan Skip
3	ENC	Appears when current channel has CTCSS Encode
4	DEC	Appears when current channel has CTCSS Decode
5	- +	Appears when the Offset function is ON
6	TX	Appears while transmitting.
7	MAIN	Displays the Main channel.
8	Frequency and Channel Name	Displays the operating frequency, channel name
9	BUSY	Displays when receiving a signal or Monitor is ON
10	Signal Strength Bars	Signal strength for receiving and power level for transmitting
11	Nar	Appears while in Narrow band.
12	MUTE	Appears when mute has been turned ON.
13	DCS	Appears when the DCS function is ON.
14	AM	Appears while in AM mode
15	Scrambler	Appears when the Scrambler function is ON
16	JUL	Appears when the Compander function is ON.
17	L	Appears while using Low output power
18	M	Appears while using Middle output power
19	Auto Power Off	Appears while Auto power off function is ON.
20	Key Lock	Appears when the Key Lock function is ON.
21	SET	Appears when press SET key.
22	KEY2	Appears when choose KEY2 mode.



## MICROPHONE

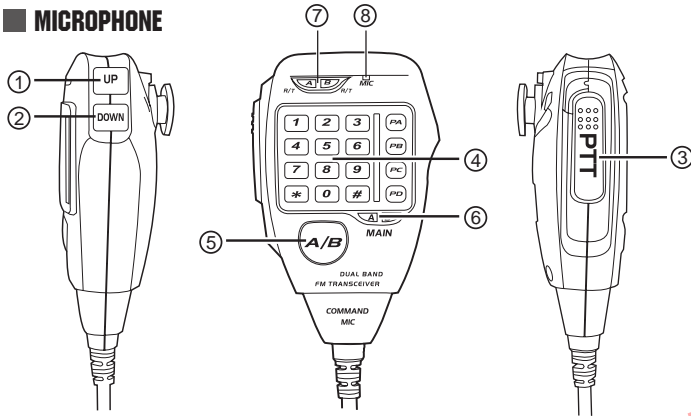

MIC Connector Diagram(in the front view of connector)

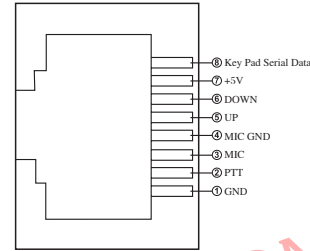

NO.	KEY	FUNCTION
1	UP	Increase frequency ,channel number or setting value.
2	DOWN	Decrease frequency, channel number or setting value.
3	PTT	Press the PTT (Push-TO-Talk) key to transmit.
4	Number Key	Input VFO frequency or DTMF dial out etc.
5	A/B band	Choose left band or right band as Main band
6	Band Indicator	The indicator light on for Main band.
7	TX/RX Indicator	Light green while receiving, Light red while transmitting.
8	MIC	Speak here during transmission.

## SWITCHING THE POWER ON/OFF

### POWER ON

Press **[POW]** key to switch the transceiver ON, the LCD displays "WELCOME ANYTONE", then display current frequency or channel.

### POWER OFF

Press **[POW]** key for over 0.5 Second to switch the transceiver OFF.

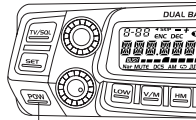

POW

## ADJUSTING THE VOLUME

Rotate the [VOLUME] knob of selected band clockwise to increase the volume, counterclockwise to decrease the volume.

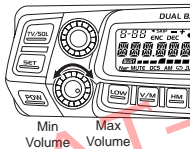

NOTE

Hold **[TV/SQ]**, keep press Monitor the background noise after the transceiver emits a DU beep, meanwhile adjust the [VOLUME] knob. During communication, volume can be adjusted more accurate.

## SWITCH BETWEEN VFO AND CHANNEL MODE

In standby, press correspondent **[V/M]** key to switch between Frequency and channel mode, when the transceiver is in channel mode, the LCD will displays current channel.

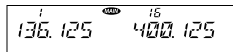
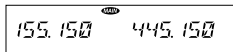

## ADJUSTING FREQUENCY

### ADJUSTING FREQUENCY THROUGH SELECTOR KNOB

In frequency (VFO) mode, turn the selector knob clockwise to increase frequency; counterclockwise to decrease frequency. Every gear will increase or decrease frequency by one step. To adjust the Main band frequency, press correspondent selector knob, the left side of decimal point will flash. In this status, turn the selector knob will increase or decrease frequency quickly by 1MHz step

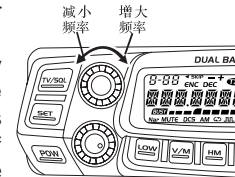

NOTE

The microphone [UP/DOWN] key also able to adjust frequency. Press [UP/DOWN] key will increase(decrease) the frequency by one step size. Hold [UP/DOWN] key will adjust the frequency continuously.

### INPUT FREQUENCY THROUGH MICROPHONE NUMBER KEY

In VFO mode, you can input the frequency by the microphone numeric key. It is invalid to input frequency out of the frequency band.

For example:

to input 150.125Mhz, press 1, 5, 0, 1, 2, 5 continuously.

to input 152 MHz, press 1, 5, 2, # continuously.



NOTE

When the Band lockout function is on, the input or adjusting of frequency band. The right band only limited in 136-174Mhz and 400-470Mhz.

## ADJUSTING CHANNEL

### ADJUSTING CHANNEL THROUGH SELECTOR KNOB

In the channel mode, you can adjust the channel directly by the channel knob. Turn clockwise to increase one channel; turn counterclockwise to decrease one channel. To adjust the Main band channel, press

correspondent selector knob, the channel number flashes in this situation, the channel number will increase 10 channels by each gear of selector knob. Press microphone [ UP/DOWN ] key also able to adjust the channel.

 If there is any empty channel, the adjustment will ignore it and jump to next channel.

#### ✕ INPUT CHANNEL THROUGH MICROPHONE NUMBER KEY



In channel mode, you can switch to desired channel by press 3 of the microphone numeric key (001-758). For example input 001 get channel 1; input 030 is channel 30; input 512 is channel 512. If the input channel is not programmed with frequency, the transceiver will emit a warning beep and return to last channel.

#### ■ SWITCH BETWEEN MAIN BAND AND SUB BAND

This transceiver is default on dual receive, a "MAIN" icon will displays in the top right of the working frequency. The transmitting is only on the Main band. When the left Band is Main band, press the right selector knob will switch the right Band to Main band. Then press the left selector knob will switch the left Band to Main band.



#### ■ SELECTING THE FREQUENCY BAND

1. Choose for Left band: press the left side  key to switch it to VFO mode, press the left selector knob over 1 second then repeater above operation will switch the left band between 118~180Mhz (RX: 118-174Mhz, TX: 136-174Mhz), 220~260Mhz (RX only), 350~399Mhz (RX only) or 400~490Mhz.
2. Choose for right band: press the right side  key to switch it to VFO mode, press the right selector knob over 1 second then repeater above operation will switch the right band between 136-174Mhz, 400~490Mhz.



This transceiver can be set working on 2 UHF band or 2 VHF band.

#### ■ RECEIVING

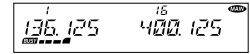

In standby, both left band and right band able To receive. When they receive any signal, the BUSY icon and signal strength icon will appear in the correspondent area of the LCD. And you can hear the calling.



If the transceiver has set at higher squelch level, it may fail to hear the calling. If the Busy and signal strength icon display inleft band or right band, but can not hear the calling, means the signal is with matching carrier but dis-matching signaling.

#### ■ SQUELCH OFF/SQUELCH OFF MOMENTARY

Long press of  key can be programmed as Squelch Off or Squelch Off Momentary to monitor the weak signal.

1. Squelch Off: Hold  key until hear "Du" beep, the squelch is off, repeat the above operation to resume squelch.
2. Squelch Off Momentary: Keep hold  key to disable squelch, Release the key to resume squelch.

#### ■ TRANSMITTING

Hold PTT key, the transceiver change to transmitting. Please hold the mic-rophone approximately 2.5-5.0cm from your mouth, and then speak into the microphone in your normal voice to get best timbre.



The transmitting only available on Main band, the TX icon will display in the top right corner of the Main band frequen

## SQUELCH LEVEL SETUP

his function is used to setup the strength of receiving signal, when the strength reach a certain level, the calling can be heard, otherwise, the transceiver will keep mute.

In standby, press and hold  key, meanwhile switch the selector knob to adjust the squelch level of Main band.

**1-20:** Total 20 squelch levels available.

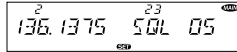

**OFF:** turn off squelch. The background noise always on.



The squelch level shall setup separately for right band and left band.

## TRANSMIT DTMF/2TONE/5TONE SIGNALING

If the current channel is with DTMF/2TONE/5TONE signaling, hold PTT and [ UP ] key will transmit selected Pre-programmed signaling

## HIGH/MID/LOW POWER SWITCH

In standby, repeat press  key to choose power levels as following:

When LCD displays HIGH, the power on current channel is high.

When LCD displays MID1, the power on current channel is middle 1

When LCD displays MID2, the power on current channel is middle 2.

When LCD displays LOW, the power on current channel is low.

Output power for each level:

HIGH	MID1	MID2	LOW
VHF ( 50W )	VHF ( 20W )	VHF ( 10W )	VHF ( 5W )
UHF ( 40W )	UHF ( 20W )	UHF ( 10W )	UHF ( 5W )



In channel mode, this operation is for temporary use only

## FREQUENCY REVERSE

In standby, hold  key for over 0.5second to turn On/ Off frequency reverse function. When reverse function is on, the TX frequency will change to RX frequency and RX frequency change to TX frequency.

The signaling will also be reversed if CTCSS/DCS signaling existed in this channel.



This function is valid only when current channel setup with offset frequency and offset direction

## BAND-WIDTH SELECTION

This transceiver has 3 band widths, select suitable band width in accordance with different local conditions.

In standby, hold  key for over 0.5 second to choose the 3 band widths

When LCD displays **WIDE**, current channel is work on wide band 25KHz

When LCD displays **MIDDLE**,current channel is work on middle band 20KHz

When LCD displays **NARROW**, current channel is work on narrow band 12.5KHz

## HOME CHANNEL

In standby, press  key to switch to HOME channel, and communicate on HOME channel. repeat press it to return to last channel.

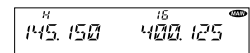

## DUAL WATCH

In standby, hold  key for over 0.5 second to enter Dual Watch mode. The radio will scan the channel in every 5 seconds. When the radio receives match signal, it pause scanning until the signaling disappear. Repeat above operation to exit Dual watch.



## EMERGENCY ALARM

To start emergency alarm, hold the right volume knob until the transceiver displays **ALARM** and emit alarm. Re-power on the transceiver to exit alarm. This transceiver has 4 kind of alarm which can be setup by programming software.



## CHANNEL/FREQUENCY SCAN

### ✕ FREQUENCY SCAN

14 In VFO mode, this function is designed to monitor signal of every communicative frequency point of "step size" you have set.

1. In VFO mode, press the Main Band  key to enter channel scan.
2. During the scanning adjust the Main band selector knob or press microphone [ UP/DOWN ] key will change the scan direction.
3. Press  key to exit scan.

### ✕ CHANNEL SCAN

1. In channel mode, press the Main Band  key to enter channel scan.
2. During the scanning, adjust the Main band selector knob or press microphone [ UP/DOWN ] key will change the scan direction.
3. Press  key to exit scan.



## CHANNEL SCAN SKIP

In channel mode, switch selector knob to choose the channel, then hold

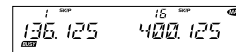
 for over 0.5 second, the radio prompts "DU DU", and LCD displays "SKIP", and now the current channel is Scan Skip.



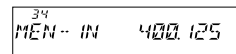
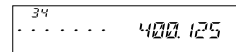

## CHANNEL EDIT

1. In VFO mode, turn selector knob to select the desired frequency or input frequency by MIC's numeric keys.
2. Hold  key until the transceiver prompt DU and the display of channel number flashes.
3. Turn selector knob to select the channel number to store. (If the storage has data, the LCD will display the frequency, otherwise will display-----)
4. Press  key, the LCD display **MEN-IN**, the channel edit completed.



## CHANNEL COPY

1. In channel mode, turn the selector knob to choose the channel.
2. Hold  key until the transceiver prompt a Du and channel number display flashes.
3. Turn selector knob to choose channel number for storage. ( If the storage has data , the LCD will display the frequency, otherwise will display-----)
4. Press  key, the LCD displays **MEN-IN**, channel copy completed.

## CHANNEL DELETE

1. In standby, hold  key until the transceiver prompt DU, and channel number flashes.
2. Turn selector knob to choose channel number for delete. (If the storage has data, the LCD will display the frequency, otherwise will display-----)
3. Hold Main band volume knob, until the transceiver emit DU DU prompt and LCD displays **MEN-OUT**, the channel delete completed.

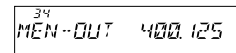

## operation steps of Function menu

1. Press **[SET]** key to enter function menu.
2. Turn the Main band selector knob to choose wanted function.
3. Press the Main band selector knob to enter function setup.
4. Switch the Main band selector knob to choose wanted value.
5. Press the Main band selector knob to store value and back to function menu. Press **[TV/SQ]** key or hold selector knob for over 0.5 second to store setup and exit.

## ■ APO (AUTOMATIC POWER OFF)

Once APO is activated, the transceiver will be automatically switched off when the pre-set timer running out.

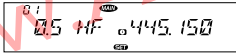
1. Press **[SET]** key to enter function menu.
2. Turn the Main band selector knob to choose No. 01 menu. the LCD displays "APO" 
3. Press the Main band selector knob to enter function setup.
4. Switch the Main band selector knob to choose wanted value. Available Values: 0.5-12 hours, OFF 
5. Press the Main band selector knob or **[SET]** key to store value and back to function menu.  
Press **[TV/SQ]** key or hold selector knob for over 0.5 second to store setup and exit.

## ■ AUTOMATIC OFFSET

This transceiver has automatic offset function. When this function is on, the transceiver will automatically transmitting with RX frequency  $\pm$  offset frequency. The operation as following:

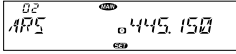
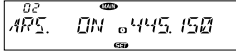
1. Press **[SET]** key to enter function menu.
2. Turn the Main band selector knob to choose No. 02 menu. the LCD displays "ARS" 
3. Press the Main band selector knob to enter function setup
4. Switch the Main band selector knob to choose wanted value.  
**ON:** Auto Offset function is turned on.   
**OFF** Auto Offset function is turned off.
5. Press the Main band selector knob or **[SET]** key to store value and back to function menu.  
Press **[TV/SQ]** key or hold selector knob for over 0.5 second to store setup and exit.

 **NOTE** When the Automatic offset is ON, the offset for 136-174Mhz is default on 0.6Mhz, and for 400-490 is default on 5Mhz.

## ■ FREQUENCY CHANNEL STEP SETUP

Only in frequency (VFO) mode, this function is valid. Turn selector knob to to select frequency or frequency scanning which is restricted by frequency step size.

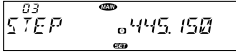
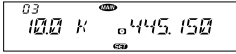
1. Press **[SET]** key to enter function menu.
2. Turn the Main band selector knob to choose No. 03 menu. the LCD displays "STEP" 
3. Press the Main band selector knob to enter function setup.
4. Switch the Main band selector knob to choose wanted value.  
Available Values: 2.5K, 5K, 6.25K, 10K, 12.K, 15K, 20K, 25K, 30K,50K. 
5. Press the Main band selector knob or **[SET]** key to store value and back to function menu.  
Press **[TV/SQ]** key or hold selector knob for over 0.5 second to store setup and exit.



NOTE This function is auto-hidden in channel mode

### VFO BAND LOCKOUT

In VFO mode, when this function is on, the scanning or input of frequency will be restricted within the current VFO frequency band.

1. Press **[SET]** key to enter function menu.
2. Turn the Main band selector knob to choose No. 04 menu. the LCD displays "**BAND**"
3. Press the Main band selector knob to enter function setup.
4. Switch the Main band selector knob to choose wanted value.

**ON:** Turn on VFO band lockout function

**OFF:** Turn off VFO band lockout function

04 BAND 445.150

04 BAND ON 445.150

- 16
5. Press the Main band selector knob or **[SET]** key to store value and back to function menu. Press **[TV/SQ]** key or hold selector knob for over 0.5 second to store setup and exit.

### BEEP FUNCTION

1. Press **[SET]** key to enter function menu.
2. Turn the Main band selector knob to choose No. 05 menu. the LCD displays "**BEEP**"
3. Press the Main band selector knob to enter function setup.
4. Switch the Main band selector knob to choose wanted value.

**ON:** Turn on Beep function.

**OFF:** Turn off Beep function

05 BEEP 445.150

05 BEEP ON 445.150

5. Press the Main band selector knob or **[SET]** key to store value and back to function menu. Press **[TV/SQ]** key or hold selector knob for over 0.5 second to store setup and exit.

### CPU CLOCK FREQUENCY CHANGE

When any harmonic or image frequency in the CPU clock disturbs the working frequency, turn on this function will cut the disturbing

1. Press **[SET]** key to enter function menu.
  2. Turn the Main band selector knob to choose No. 06 menu. the LCD displays "**CLK.SFT**"
  3. Press the Main band selector knob to enter function setup.
  4. Switch the Main band selector knob to choose wanted value.
- ON:** Turn on CPU Clock frequency Change  
**OFF:** Turn off CPU Clock frequency Change
5. Press the Main band selector knob or **[SET]** key to store value and back to function menu. Press **[TV/SQ]** key or hold selector knob for over 0.5 second to store setup and exit.

06 CLK.SFT 445.150

06 SFT ON 445.150

### 2TONE ENCODE SELECT

1. Press **[SET]** key to enter function menu.
2. Turn the Main band selector knob to choose No. 07 menu. the LCD displays "**2TN ENC**"
3. Press the Main band selector knob to enter function setup.
4. Switch the Main band selector knob to choose wanted value.

Available Values: **0-23**, total 24 groups.



NOTE if the 2TONE encode are programmed with name, the LCD will display correspondent name.

5. Press the Main band selector knob or **[SET]** key to store value and back to function menu. Press **[TV/SQ]** key or hold selector knob for over 0.5 second to store setup and exit.

07 2TN ENC 445.150

08 2TON 00 445.150



NOTE After choose the 2TONE encode group. Press PTT will transmit selected code.



**STONE ENCODE SELECT**

1. Press **[SET]** key to enter function menu.
2. Turn the Main band selector knob to choose No. 08 menu. the LCD displays "5TN ENC"
3. Press the Main band selector knob to enter function setup.
4. Switch the Main band selector knob to choose wanted value.  
Available Values: **0-99**, total 100 groups.

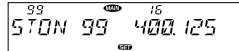

**NOTE** If the 5TONE encode are programmed with name, the LCD will display correspondent name.

5. Press the Main band selector knob or **[SET]** key to store value and back to function menu. Press **[TV/SQ]** key or hold selector knob for over 0.5 second to store setup and exit.

**NOTE** After choose the 5TONE encode group. Press PTT will transmit selected code.

**ADD OPTIONAL SIGNALING**

This transceiver has 3 optional signaling: DTMF/5Tone/2Tone, those signaling function similar as CTCSS/DCS signaling. When the receiver adds an optional signaling, the caller shall transmit matching signaling. DTMF and 5Tone signaling can be applied for other advanced features such as ANI, PTT ID, group call, select call, remotely stun, remotely kill waken...etc

1. Press **[SET]** key to enter function menu.
2. Turn the Main band selector knob to choose No. 09 menu. the LCD displays "TON DEC"
3. Press the Main band selector knob to enter function setup.

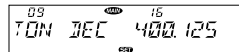

4. Switch the Main band selector knob to choose wanted value

**DTMF:** means DTMF signaling is added.

**2TONE:** means DTMF signaling is added.

**5TONE:** means DTMF signaling is added.

**OFF:** Turn off optional signaling

5. Press the Main band selector knob or **[SET]** key to store value and back to function menu. Press **[TV/SQ]** key or hold selector knob for over 0.5 second to store setup and exit.

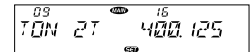
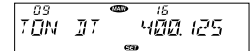

**NOTE** The working of optional signaling shall be work associated with the squelch mode setup. (Refer to Squelch Mode setup in page 19)





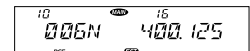
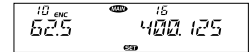
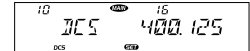
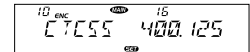
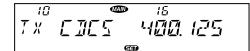

**CTCSS ENCODE SETUP**

1. Press **[SET]** key to enter function menu.
2. Switch the Main band selector knob to choose No 10 menu, the LCD displays "TX CDCS"
3. Press the Main band selector knob to enter function setup.
4. Switch the Main band selector knob to choose wanted value  
**OFF:** Turn off CTCSS/DCS encode.  
**CTCSS:** Choose CTCSS encode.  
**DCS:** Choose DCS encode.
5. Press the Main band selector knob to enter the menu.
6. Switch the Main band selector knob to choose wanted CTCSS, DCS code.  
**CTCSS:** 62-254.1Hz, and one self-define group, total 52 groups  
**DCS:** 000N-7771, total 1024 groups

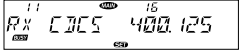



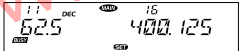

7. Press the Main band selector knob or **SET** key to store value and back to function menu. Press **TV/SQ** key or hold selector knob for over 0.5 second to store setup and exit.

### CTCSS DECODE SETUP

- Press **SET** key to enter function menu.
- Switch the Main band selector knob to choose No 11 menu, the LCD displays "RX DCDS" 
- Press the Main band selector knob to enter function setup
- Switch the Main band selector knob to choose wanted value  
**OFF:** Turn off CTCSS/DCS decode.   
**CTCSS:** Choose CTCSS decode.   
**DCS:** Choose DCS decode. 
- Press the Main band selector knob to enter the menu.
- Switch the Main band selector knob to choose wanted CTCSS, DCS code.  
**CTCSS:** 62-254.1Hz, and one self-define group, total 52 groups   
**DCS:** 000N-777I, total 1024 groups 
- Press the Main band selector knob or **SET** key to store value and back to function menu. Press **TV/SQ** key or hold selector knob for over 0.5 second to store setup and exit.

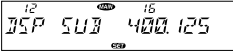
 The working of CTCSS/DCS decode shall be work associated with the NOTE squelch mode setup. (Refer to Squelch Mode setup in page 19)

### SUB BAND DISPLAY SETUP

- Press **SET** key to enter function menu. 
- Turn the Main band selector knob to choose No. 12 menu. the LCD displays "DSP SUB"
- Press the Main band selector knob to enter function setup
- Switch the Main band selector knob to choose wanted value.  
**FREQ:** display sub band frequency,   
**DC-IN:** display sub bad voltage,   
**OFF:** turn off display for sub Band 
- Press the Main band selector knob or **SET** key to store value and back to function menu. Press **TV/SQ** key or hold selector knob for over 0.5 second to store setup and exit.

### DTMF ENCODE PRE-LOADING TIME

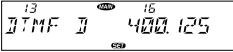
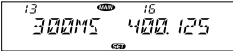

- Press **SET** key to enter function menu. 
- Turn the Main band selector knob to choose No. 13 menu. the LCD displays "DTMF D"
- Press the Main band selector knob to enter function setup
- Switch the Main band selector knob to choose wanted value.  
**100MS:** The Pre-Loading time is 100MS   
**300MS:** The Pre-Loading time is 300MS  
**600MS:** The Pre-Loading time is 500MS  
**800MS:** The Pre-Loading time is 800MS  
**1000MS:** The Pre-Loading time is 1000MS
- Press the Main band selector knob or **SET** key to store value and back to function menu. Press **TV/SQ** key or hold selector knob for over 0.5 second to store setup and exit.

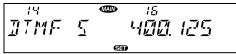
## DTMF ENCODE TRANSMITTING TIME

1. Press **SET** key to enter function menu.
2. Turn the Main band selector knob to choose No 14 menu. The LCD displays "DTMF S"
 
3. Press the Main band selector knob to enter function setup.
4. Switch the Main band selector knob to choose wanted value.
 

**30MS:** The time for transmit a single DTMF encode and the interval is 30MS,  
**50MS:** The time for transmit a single DTMF encode and the interval is 50MS,  
**80MS:** The time for transmit a single DTMF encode and the interval is 80MS,  
**100MS:** The time for transmit a single DTMF encode and the interval is 100MS,  
**150MS:** The time for transmit a single DTMF encode and the interval is 150MS,  
**200MS:** The time for transmit a single DTMF encode and the interval is 200MS,  
**250MS:** The time for transmit a single DTMF encode and the interval is 250MS.
5. Press the Main band selector knob or **SET** key to store value and back to function menu. Press **TV/SQ** key or hold selector knob for over 0.5 second to store setup and exit.

## DTMF ENCODE SETUP

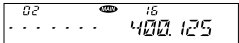
1. Press **SET** to enter function menu
  2. Switch the Main band selector knob to choose No 15 menu, the LCD displays **DTMF W**

  3. Press the Main band selector knob to enter function setup.
  4. Switch the Main band selector knob to choose DTMF group. Then press **SET** key back to DTMF menu. Press PTT will transmit with selected DTMF code.
 

- 06-16:** total 16 group of DTMF code.

5. When the selected group is empty, the LCD displays '-----'
 
6. Press the selector knob to enter the DTMF signaling edit. The LCD display "-- -- -- -- --", the last character flashes.
7. Switch the selector knob to choose wanted character. Press the selector knob to confirm selected value and start edit for next character.
8. Press **SET** key to store value and exit code editing. Press **SET** key again to store setup and exit. Press **TV/SQ** key or hold selector knob for over 0.5 second to store setup and exit.

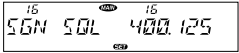
## SQUELCH MODE SETUP

This transceiver has 5 squelch modes available. Squelch function is used for increase the level of filtering unwanted signal, and free from disturb.

1. Press **SET** key to enter function menu.
2. Turn the Main band selector knob to choose No 16 menu. The LCD displays "SGN SQL"
 
3. Press the Main band selector knob to enter function setup.
4. Switch the Main band selector knob to choose wanted value
 

**SQ:** You can hear the calling once receives matching carrier.  
**CTSS/DCS:** You can hear the calling when receives matching carrier and CTCSS/DCS code.  
**CT\*TO:** You can hear the calling when receives matching carrier + optional signaling.  
**TONE:** You can hear the calling when receives matching carrier + CTCSS/DCS + optional signaling.  
**CT/TO:** You can hear the calling when receives any matching carrier or CTCSS/DCS or optional signaling.



5. Press the Main band selector knob or **[SET]** key to store value and back to function menu. Press **[TV/SOL]** key or hold selector knob for over 0.5 second to store setup and exit.

 **NOTE** Only when the transceiver is set with CTCSS/DCS or optional DTMF/5TONE/TONE signaling, the values will be available.

## COMPANDER

Compander function will decrease the background noise and enhance audio clarity, especially in long range communication.

1. Press **[SET]** key to enter function menu
2. Turn the Main band selector knob to choose No 17 menu. The LCD displays "**COMP**"
3. Press the Main band selector knob to enter function setup.
4. Switch the Main band selector knob to choose wanted value.

**ON:** Compander function is turn on  
**OFF:** Compander function is turn off

5. Press the Main band selector knob or **[SET]** key to store value and back to function menu. Press **[TV/SOL]** key or hold selector knob for over 0.5 second to store setup and exit.

 **NOTE** When using compander, to avoid distortion during communications, both radios need turn on this function.

## SCRAMBLER SETUP

This special audio process can offer a more confidential communication; other radio with at same frequency will receive only disordered noises.



1. Press **[SET]** key to enter function menu.
2. Turn the Main band selector knob to choose No 18 menu. The LCD displays "**SCR**"
3. Press the Main band selector knob to enter function setup.
4. Switch the Main band selector knob to choose wanted group  
**1-9** (9 fix groups) **U1,U2** (2 self defined scrambler groups)
5. Press the Main band selector knob or **[SET]** key to store value and back to function menu. Press **[TV/SOL]** key or hold selector knob for over 0.5 second to store setup and exit.

 **NOTE** To enable commutation with scrambler, 2 transceivers shall set with same group.

## TONE BUST (PILOT FREQUENCY)

This function uses to start repeater .It needs certain intensity Pilot Frequency to start a dormant repeater. As usual, no need to send pilot frequency again once repeater started.





1. Press **[SET]** key to enter function menu.
2. Turn the Main band selector knob to choose No 19 menu. The LCD displays "**TBST**"
3. Press the Main band selector knob to enter function setup.
4. Switch the Main band selector knob to choose wanted frequency.
- 1000:** Pilot Frequency is 1000Hz.  
**1450:** Pilot Frequency is 1450Hz.  
**1750:** Pilot Frequency is 1750Hz.  
**2100:** Pilot Frequency is 2100Hz.

- Press the Main band selector knob or  key to store value and back to function menu. Press  key or hold selector knob for over 0.5 second to store setup and exit.





After the above setup, hold microphone PTT key and [ DOWN ] key, the radio will transmit selected tone.





## KEYPAD MODE SETUP

- Press  key to enter function menu.
  - Turn the Main band selector knob to choose No 20 menu. The LCD displays "KEYMOD" 
  - Press the Main band selector knob to enter function setup.
  - Switch the Main band selector knob to choose wanted mode.
- KEY1:** key1 mode, Normal mode, the left 4 keys have same functions as the right 4 keys. 
- KEYE2:** the left 4 keypads will shared by both band. And the right 4 key pads will re-defined.
- Press the Main band selector knob or  key to store value and back to function menu. Press  key or hold selector knob for over 0.5 second to store setup and exit.

**Notice:** Definition of 4 Right band Keypad in KEY2 mode:

-  **Short press:** In VFO mode, short press this key, the frequency step size changes to 1Mhz, in channel mode, adjust selector knob will jump 10 channels.
-  **long press:** In standby, long press this key to add/delete optional signaling, repeat the long press it, will set optional signaling DTMF, 5TONE or 2TONE. When the LCD displays

DT means DTMF, displays 5T means 5TONE, displays 2T means 2TONE. In VFO mode, long press this key, the step size change to 10Mhz.

-  **short press:** Frequency reverse function, when current channel is setup with offset direction and offset frequency, press this key will turn on frequency reverse function. When frequency reverse function the TX frequency turns to RX frequency & RX frequency changes to TX frequency. The signaling will also be reversed if CTCSS/DCS signaling existed in this channel. Repeat short press it will turn off Frequency reverse function.
-  **long press:** In standby, hold this key until the LCD displays , means the compander function is on, repeat above operation to turn off compander function.
-  **short press:** In standby, press this key to set the CTCSS/DCS code for current channel. When the LCD displays ENC, the current channel is with CTCSS encode function. When the LCD displays ENC and DEC, the current channel is with CTCSS /DCS code function. When the LCD displays DCS and DCS icon, the current channel is with CTCSS code function. When the LCD displays OFF, the current channel is without CTCSS /DCS function.
- [ SCAN ] short press, short press this key, the sub band will display "MAIN" and flashes.
- [ SCAN ] long press, choose scrambler group for Main band. In standby, hold this key, the LCD displays SCR X and  icon. X stands for the group number, repeat above operation to choose wanted group.

### KEYPAD LOCKOUT

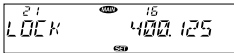

1. Press  key to enter function menu. 
2. Turn the Main band selector knob to choose No 21 menu. The LCD displays "LOCK"
3. Press the Main band selector knob to enter function setup.
4. Switch the Main band selector knob to choose wanted mode.

**ON:** The keypad lockout function is turn on all keys beside  and band switch knob is valid.

**OFF:** The keypad lockout function is turn off.

5. Press the Main band selector knob or  key to store value and back to function menu. Press  key or hold selector knob for over 0.5 second to store setup and exit.

### TX OFF (PTT LOCKOUT)



1. Press  key to enter function menu. 
2. Turn the Main band selector knob to choose No 22 menu. The LCD displays "LOCKT"
3. Press the Main band selector knob to enter function setup.
4. Switch the Main band selector knob to choose wanted mode.

**BAND R,** lock the right band PTT. Only able to transmit by left band.





**BAND L,** lock the left band PTT. Only able to transmit by right band.

**BAND BOTH,** lock both band PTT. Not able to transmit by any side.

**OFF:** PTT no lock.



5. Press the Main band selector knob or  key to store value and back to function menu. Press  key or hold selector knob for over 0.5 second to store setup and exit.

### SQUELCH LEVEL SETUP

1. Press  key to enter function menu. 
2. Turn the Main band selector knob to choose No 23 menu. The LCD displays "SQL"
3. Press the Main band selector knob to enter function setup.
4. Switch the Main band selector knob to choose wanted value  
**1-20:** total 20 squelch levels  
**OFF:** Turn of squelch function, the background noise keep on.
5. Press the Main band selector knob or  key to store value and . Press  key or hold selector knob for over 0.5 second to store setup and exit.

### TALK AROUND

With this function on, the transceiver will able to communicate with a trans ceiver in same network without through a repeater.

1. Press  key to enter function menu. 
2. Turn the Main band selector knob to choose No 24 menu. The LCD displays "REV"
3. Press the Main band selector knob to enter function setup.
4. Switch the Main band selector knob to choose wanted value.



**ON:** Talk Around is turn on, The TX and RX frequency will be exchanged, the CTCSS DCS signaling also will be exchanged if existed in current channel.

**OFF:** Turn off Talk Around

5. Press the Main band selector knob or  key to store value and back to function menu. Press  key or hold selector knob for over 0.5 second to store setup and exit.

## SUB BAND MUTE SETUP

To avoid the receiving of sub band disturbing the communication of the main band, you can turn on this function. The RX of the sub band will be mute during the RX or TX of the main band.

1. Press  key to enter function menu.
2. Turn the Main band selector knob to choose No 25 menu. The LCD displays "MUTE" 
3. Press the Main band selector knob to enter function setup.
4. Switch the Main band selector knob to choose wanted value.

**TX:** When the Main band is transmitting, the sub band receiving will be mute.

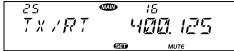
**RX:** When the Main band is receiving, the sub band receiving will be mute. 



**RX/TX:** the sub band receiving always mute.

5. Press the Main band selector knob or  key to store value and back to function menu. Press  key or hold selector knob for over 0.5 second to store setup and exit.

## EDITING CHANNEL NAME

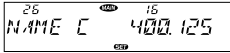
After edit a name for a channel, if the display mode is channel name, the will displays the name edited in this menu. Otherwise it will display the frequency.

1. Press  key to enter function menu. 
2. Switch the selector knob to choose NO 26 function menu, the LCD displays "NAME C".
3. Press the Main band selector knob to enter function setup.
4. Switch the selector knob to choose wanted character.

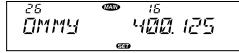

5. Press the selector knob to confirm current character and start edit next character, after editing all 7 characters, press the selector knob to edit and back to function menu.
6. If the editing not reach 7 characters, press  key back to function menu, then press  key or hold selector knob for over 0.5 second to store setup and exit. 

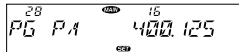
## MICROPHONE PA,PB, PC,PD KEY SETUP

1. Press  key to enter function menu.
2. Turn the Main band selector knob to choose No 28-31 menu. The LCD displays "PG PA" PG PB, PG PC, PG PD. 
3. Press the Main band selector knob to enter function setup.
4. Switch the Main band selector knob to choose wanted value.
 

**TX:** When the Main band is transmitting, the sub band receiving will mute.

**RX:** When the Main band is receiving, the sub band receiving will mute.

**RX/TX:** the sub band receiving always mute.
5. Press the Main band selector knob or  key to store value and  back to function menu. Press key or hold selector knob for over 0.5 second to store setup and exit.







For Menu details, please refer to Page 30-31, Microphone Operation.







**RF SQUELCH LEVEL SETUP**





When squelch level function is on, you can cancel squelch only when the signal strength reach the level setup by users.

1. Press  key to enter function menu.
2. Turn the Main band selector knob to choose No32 menu. The LCD displays "RF SQL" 
3. Press the Main band selector knob to enter function setup.
4. Switch the Main band selector knob to choose wanted value.
  - S-2:** Able to hear the calling when the power meter reach 1 bar.
  - S-5:** Able to hear the calling when the power meter reach 4 bar.
  - S-9:** Able to hear the calling when the power meter reach 8 bar.
  - S-FULL:** Able to hear the calling when the power meter reach full bar.
5. Press the Main band selector knob or  key to store value and back to function menu. Press  key or hold selector knob for over 0.5 second to store setup and exit. 



**OFFSET DIRECTION SETUP**

1. Press  key to enter function menu.
2. Turn the Main band selector knob to choose No33 menu. The LCD displays "RPT MOD" 
3. Press the Main band selector knob to enter function setup.
4. Switch the Main band selector knob to choose wanted Offset direction.
  - : Minus offset, means transmitting frequency lower than receiving frequency.
  - +: Plus offset, means transmitting frequency higher than receiving frequency.
  - OFF:** OFFSET is turn off. Transmitting frequency is same as receiving frequency.
5. Press the Main band selector knob or  key to store value and back to function menu. Press  key or hold selector knob for over 0.5 second to store setup and exit. 

**SCAN DWELL TIME SETUP**

1. Press  key to enter function menu. 
2. Turn the Main band selector knob to choose No34 menu. The LCD displays "SCAN"
3. Press the Main band selector knob to enter function setup.
4. Switch the Main band selector knob to choose wanted value.
  - TIME:** it pauses 5s once scanning a matching signal, then resume scan.
  - BUSY:** it pauses once scanning a matching signal, then resume scan after the signal disappeared for 2 seconds.
  - SECEDE:** It Stops once scanning a matching signal, and exit scan.
5. Press the Main band selector knob or  key to store value and back to function menu. Press  key or hold selector knob for over 0.5 second to store setup and exit. 

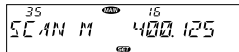
**PRIORITY CHANNEL SCAN**

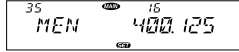
1. Press  key to enter function menu. 
2. Turn the Main band selector knob to choose No35 menu. The LCD displays "SCAN M"
3. Press the Main band selector knob to enter function setup.
4. Switch the Main band selector knob to choose wanted value.
  - MEN:** Channel Scan, the transceiver will scan all the channel after enter channel scan.
  - MSN:** Priority Channel Scan, the transceiver will only scan the priority channel after enter channel scan.
5. Press the Main band selector knob or  key to store value and back to function menu. Press  key or hold selector knob for over 0.5 second to store setup and exit. 

**NOTE** The edited channel shall be programmed as P SCAN before using Priority channel scan function.

### ■ OFFSET FREQUENCY SETUP

1. Press **[SET]** key to enter function menu.
2. Turn the Main band selector knob to choose No36 menu. The LCD displays "SHIFT" 
3. Press the Main band selector knob to enter function setup.
4. Switch the Main band selector knob to choose wanted value.  
Available Offset frequency for this transceiver is **0-100MHz.**
5. Press the Main band selector knob or **[SET]** key to store value and back to function menu. Press **[TV/SQ]** key or hold selector knob for over 0.5 second to store setup and exit.

### ■ DISPLAY MODE SETUP

1. Press **[SET]** key to enter function menu.
2. Turn the Main band selector knob to choose No37 menu. The LCD displays "DISPLAY" 
3. Press the Main band selector knob to enter function setup.
4. Switch the Main band selector knob to choose wanted value.

**FREQ:** The radio displays channel number + frequency in channel mode, if press **[V/M]** key, it will change to VFO mode.

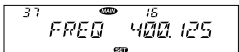

**CH:** Displays only channel number.

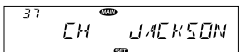

**NAME:** In channel mode, It displays the channel number and channel name if the current channel is programmed with a name. Otherwise, it display the channel

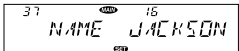

number and frequency. If press **[V/M]** key, it will change to VFO mode.

5. Press the Main band selector knob or **[SET]** key to store value and back to function menu. Press **[TV/SQ]** key or hold selector knob for over 0.5 second to store setup and exit.

### ■ BUSY CHANNEL LOCKOUT

With this function on, the transceiver will not transmitting on a busy channel, to avoid disturbing other transceiver using same frequency. Once the channel is busy and you press PTT, the transceiver will beep as warning and return to receiving.

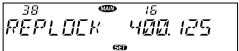
1. Press **[SET]** key to enter function menu.
2. Turn the Main band selector knob to choose No38 menu. The LCD displays "RELOCK" 
3. Press the Main band selector knob to enter function setup.
4. Switch the Main band selector knob to choose wanted value.

**RLORP:** Signaling busy channel lockout, transmitting is inhibited when current channel receives a matching carrier but dis-matching CTCSS/DCS.

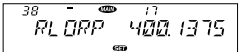

**RLOBU:** Channel busy channel lockout, transmitting is inhibited when current channel receives a matching carrier;

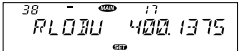



**OFF:** Busy channel lockout is disabled. Transmitting is allowed in any receiving status.

5. Press the Main band selector knob or **[SET]** key to store value and back to function menu. Press **[TV/SQ]** key or hold selector knob for over 0.5 second to store setup and exit.

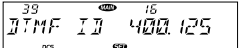



### ■ RADIO'S DTMF SELF ID ENQUIRY

1. Press **[SET]** key to enter function menu.
2. Switch the selector knob to choose No 39 

function. The LCD displays "DTMF ID"

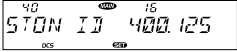
- Press the Main band selector knob to enter function setup. The LCD will show the DTMF self ID. 
- Press the Main band selector knob or  key to store value and back to function menu. Press  key or hold selector knob for over 0.5 second to store setup and exit.

### STONE SELF ID ENQUIR

- Press  key to enter function menu.
- Switch the selector knob to choose No40 function. The LCD displays "5TONE ID" 
- Press the Main band selector knob to enter function setup. The LCD will show the DTMF self ID. 
- Press the Main band selector knob or  key to store value and back to function menu. Press  key or hold selector knob for over 0.5 second to store setup and exit.

### TOT (TIME-OUT TIMER)

The time-out timer limits the amount of continuous transmitting time.

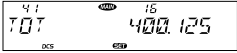

When the transmitting reaches the time limit which has been programmed, the transmission will be cut off and emit warning beep.

- Press  key to enter function menu.
- Turn the Main band selector knob to choose No41 menu. The LCD displays "TOT" 
- Press the Main band selector knob to enter function setup.
- Switch the Main band selector knob to choose wanted value.
 

1-30 MIN, total 30 levels,

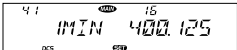
OFF: TOT is turn off.





- Press the Main band selector knob or  key to store value and back to function menu. Press  key or hold selector knob for over 0.5 second to store setup and exit.

### VFO FREQUENCY LINKAGE

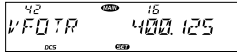
Enable this function, the adjustment any band of VFO frequency, will bring same frequency change to both bands. Adjust one gear, the frequency for both band will increase or decrease one step size value.

- Press  key to enter function menu.
- Turn the Main band selector knob to choose No42 menu. The LCD displays "VFOTR" 
- Press the Main band selector knob to enter function setup.
- Switch the Main band selector knob to choose wanted value.
 

Available Values: **ON, OFF.**

- Press the Main band selector knob or  key to store value and back to function menu. Press  key or hold selector knob for over 0.5 second to store setup and exit.



NOTE This function only valid when both bands work on VFO mode.

### WIDE/NARROW BAND

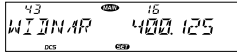

- Press  key to enter function menu.
- Turn the Main band selector knob to choose No43 menu. The LCD displays "WINNAR" 
- Press the Main band selector knob to enter function setup.
- Switch the Main band selector knob to choose wanted value.

**WIDE:** Wide band (25KHz)

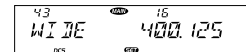
**MIDDLE:** Middle band (20KHz)



**NARROW:** Narrow band (12.5KHz)

- Press the Main band selector knob or  key to store value and back to function menu. Press  key or hold selector knob for over 0.5 second to store setup and exit.





### CROSS BAND REPEAT

Set the left band and right band as VHF (136~174MHz) and UHF(400~470MHz)then turn of this function will enable Cross Band repeater function.



- Press  key to enter function menu.
- Switch the selector knob to choose No 44 function. The LCD displays "X-RPT"
- Press the Main band selector knob, the LCD displays "XSTART".
- Press the Main band selector knob, the radio prompt "DU-DU", the Mix Band repeater function is on.



### LCD BACKLIGHT

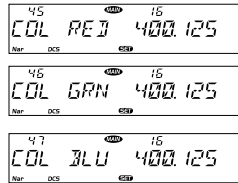

- Press  key to enter function menu.
- Turn the Main band selector knob to choose No. 45-47 menu. The LCD displays "COL RED", "COL GRN", "COL BLU"
- Press the Main band selector knob to enter function setup.
- Switch the Main band selector knob to choose wanted value.Each color (Red, blue, Green) with 32 brightness levels.
- Press the Main band selector knob or  key to store value and back to function menu. Press  key or hold selector knob for over 0.5 second to store setup and exit.

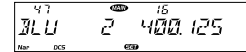

 key to store value and back to function menu. Press  key or hold selector knob for over 0.5 second to store setup and exit.



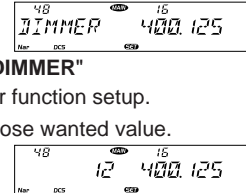

### KEYPAD BACKLIGHT BRIGHTNESS

- Press  key to enter function menu.
- Turn the Main band selector knob to choose No. 48 menu. The LCD displays "DIMMER"
- Press the Main band selector knob to enter function setup.
- Switch the Main band selector knob to choose wanted value. Available value: 32 brightness levels.
- Press the Main band selector knob or  key to store value and back to function menu. Press  key or hold selector knob for over 0.5 second to store setup and exit.



### CALLING RECORD

The transceiver offers enquiry of calling record.

- Press  key to enter function menu.
- Turn the Main band selector knob to choose No. 49 menu. The LCD displays "NOTE"
- Press the Main band selector knob to enter function setup.
- Switch the Main band selector knob to choose wanted value. This transceiver able to record 16 calling at most.
- Press the Main band selector knob or  key to store value and back to function menu. Press  key or hold selector knob for over 0.5 second to store setup and exit.

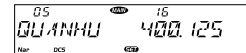

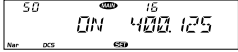

## AM FUNCTION

1. Press **[SET]** key to enter function menu.
2. Turn the Main band selector knob to choose No. 50 menu. The LCD displays "AM" 
3. Press the Main band selector knob to enter function setup.
4. Switch the Main band selector knob to choose wanted value.  
**ON:** turn on AM function.   
**OFF:** turn off AM function.
5. Press the Main band selector knob or **[SET]** key to store value and back to function menu. Press **[TV/SQ]** key or hold selector knob for over 0.5 second to store setup and exit.

 NOTE This function is only valid when the Main band frequency is VHF 118-174MHz, the function is invalid when the right band is set as Main band.

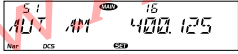

## AUTOMATIC AM FUNCTION

1. Press **[SET]** key to enter function menu.
2. Turn the Main band selector knob to choose No. 51 menu. The LCD displays "AUT AM" 
3. Press the Main band selector knob to enter function setup.
4. Switch the Main band selector knob to choose wanted value.  
**ON:** turn on auto AM function.   
**OFF:** turn off auto AM function.
5. Press the Main band selector knob or **[SET]** key to store value and back to function menu. Press **[TV/SQ]** key or hold selector knob for over 0.5 second to store setup and exit.

 NOTE The radio will automatically boot AM function when the frequency is under 136Mhz.

## VHF EXTERNAL SPEAKER PORT

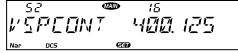
When the function setup as external (EXT), an external Dual Track speaker (SP-02) must be connected in order to hear the calling on VHF. The calling from VHF and UHF are separated in 2 tracks.

1. Press **[SET]** key to enter function menu.
2. Turn the Main band selector knob to choose No. 52 menu. The LCD displays "VSPCONT" 
3. Press the Main band selector knob to enter function setup.
4. Switch the Main band selector knob to choose wanted value.  
**INT:** Internal speaker, VHF and UHF band share one speaker  
**EXT:** External speaker, the calling on VHF only audible through the external Dual Track speaker. 
5. Press the Main band selector knob or **[SET]** key to store value and back to function menu. Press **[TV/SQ]** key or hold selector knob for over 0.5 second to store setup and exit.

## PASSWORD FUNCTION

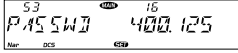
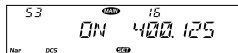
1. Press **[SET]** key to enter function menu.
2. Turn the Main band selector knob to choose No. 53 menu. The LCD displays "PASSWD" 
3. Press the Main band selector knob to enter function setup.
4. Switch the Main band selector knob to choose wanted value.  
**ON:** Turn on password function.   
**OFF:** Turn off password function.
5. Press the Main band selector knob or **[SET]** key to store value and back to function menu. Press **[TV/SQ]** key or hold selector knob for over 0.5 second to store setup and exit.

 NOTE When password function is on, correct password shall be input after power on. The password shall be programmed before using this function.

when the LCD displays "-", means minus offset.



NOTE This function is valid only when current channel set with offset frequency.

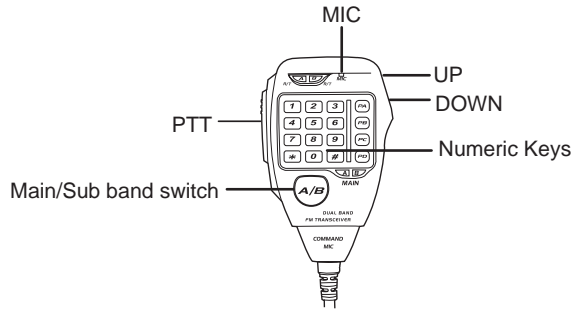

You can operate the transceiver by keypad or input desired frequency and channel through the QHM-04 microphone.

## SEND DTMF SIGNALING

Hold the PTT key; input the desired DTMF signaling by the numeric keys.

## MAIN/SUB BAND SWITCHING

This transceiver is defaulted on dual receive, in this status, a MAIN icon will displayed in the top right corner of the Main band frequency,transmitting only available on the Main band. In standby, you can switch Main band and sub band by the A/B key.

## FUNCTION OPERATION THROUGH PA-PD KEYS

The PA,PB,PC,PD, keys are programmable, they can be endowed with the following functions.

**RPTR:** OFFSET direction setup, in standby, press the key programmed as RPTR function will change the offset direction. when LCD displays "+", means plus offset,

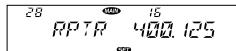

**PRI:**

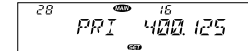

**LOW:** Output power setup, in standby, press the key programmed as LOW function will change the lower level. When LCD displays HIGH, the transmitting power on current channel is high. When LCD displays MID1, the transmitting power on current channel is middle1, When LCD displays MID2, the transmitting power on current channel is middle 2. When LCD displays LOW, the transmitting power on current channel is low.

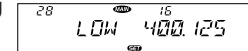

**TONE:** CTCSS/DCS code setup. In standby, press the key programmed as TONE function will able to setup CTCSS/DCS code. when the LCD key to choose CTCSS encode. When the LCD displays "ENC","DEC" and CTCSS frequency,press the microphone [ UP/DOWN ] key to choose CTCSS decode. When the LCD displays "DCS" and DCS code,press microphone displays "ENC" and CTCSS frequency, press the microphone [ UP/DOWN ] key to choose DCS code.

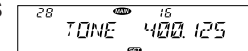

**MHZ:** In VFO mode, press the key programmed as MHZ function, the megabit digital in the LCD flashes, now turn the channel know or microphone [ UP/DOWN ] key to adjust frequency by 1Mhz step. In channel mode, press this key, the channel number flashes, now adjust selector knob or microphone [ UP/DOWN ] key to adjust channel.

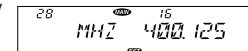

**REV:** In standby, press the key programmed as "REV" function to turn on or turn off Talk Around function.

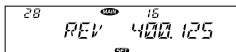

**HOME:** HOME channel switch, in standby press the key programmed as "HOME" function press the key programmed as HOME function to switch between HOME channel and current channel.

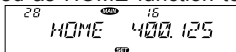

**MAIN:** Main band switch, in standby press the key programmed as "MAIN" function to choose left band or right band as Main band.

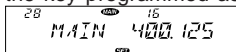

**VFO/MR:** Working mode switch. in standby, press the key programmed as "VFO/MR" function to switch between channel mode and frequency mode.

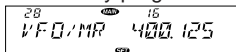

**SCAN:** scan function in standby, press the key programmed as "SCAN" function to start channel scan or frequency scan.



**SQL OFF:** Turn off Squelch, in standby, press the key programmed as "SQL OFF" function to turn off squelch, you can hear very weak signal, repeat the above function to turn on squelch.

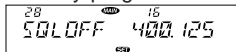

**TBST:** Transmit tone burst, in standby; press the key programmed as "TBST" function to transmit selected tone burst. This function is used to wake sleeping repeater.

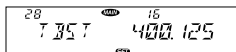

**CALL OUT:** Calling, in standby, press the key programmed as "CALL OUT" function to transmit pre-programmed DTMF, 2TONE, 5TONE code.

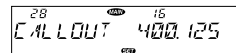

**COMP:** Compaander function in standby, press the key programmed as "COMP" to turn on or turn off Compaander function.

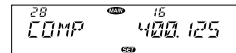

**SCR:** Scrambler function, in standby, press the key programmed as "SCR" function to turn on or turn off Scrambler function. And choose optional scrambler groups (from 9 fixed groups and 2 self defined groups).



**TONE DEC:** Add Optional Signaling, in standby press the key programmed as "TONE DEC" function to choose DTMF(DT), 2TONE(2T), 5TONE(5T) or OFF.

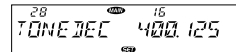

**W/N:** Wide narrow band setup in standby, press the key programmed as "W/N" function to choose Wide band, middle and narrow band.

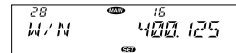

**OFF:** No function.



This feature will copy the programmed data and parameters in the master unit to slave units. It copies the parameters and memory program settings.

1. Use optional CP51 cloning cable, connect the cable between the data jacks on both master and slave.
2. Press and hold **[FUN]** key, then press **[CAL]** key to enter into cloning mode, LCD displays "CLONE".

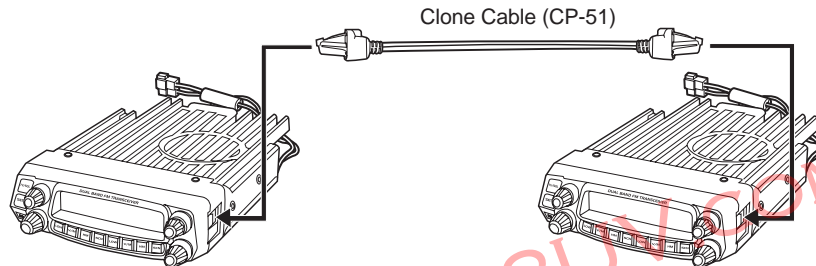

3. Press master unit's [PTT] key, LCD displays "SD XXX", "XXX" indicates data volume in transmitting. Slave unit displays "LD XXX", "XXX" indicates received data volume. When the transmission is successfully finished, the master and slave unit both display "PASS". Turn off the power, disconnect the cable and repeat step 2 to step 3 operations to clone the next slave unit.



NOTE

If the data is not successfully transmitted, turn off both units, make sure the cable connection is correct and repeat the entire operation from the beginning.

# 10 Programming Software Installing and Starting (in windows XP system)

Double click "QPS588UV setup.exe", then follow the installing instruction.

## INSTALL USB CABLE DRIVER PROGRAMME

1. Click start menu in computer, under "ALL PROGRAMS" menu, choose and click "USB To Com port" in QPS588UV program, install "USB To Com port" driver by indication.
2. Connect the optional PC50 USB Programming cable to USB port in PC with transceiver.(As pic 2)
3. Double click QPS588UV shortcut or click QPS588UV in procedure index of start menu, choose serial com port as indicated then click OK to start programming software. (As pic 2)
4. According to instruction,select correct"COM Port"(As pic 3),then click "OK" to start programming software.



图1



图2

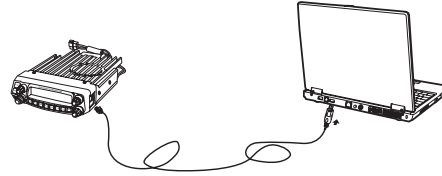

图3

32 **NOTE:** Even in same computer,the selective COM Port is different when USB cable connects with different USB port.

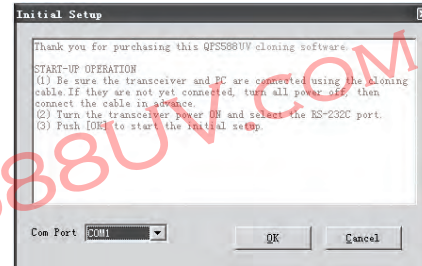
You shall install software before connecting the USB cable line. Switch on transceiver before writing frequency.You had better not switch on or off the power supply of transceiver when it is connected with computer, otherwise, it will make transceiver unable to read or write frequency. In this case, you have to turn off programming software, pull out USB cable, then reinsert USB cable and open software, then rechoose COM Port, it will turn into normal operation. Therefore, please connect transceiver with computer after switching on the transceiver. Don't restart transceiver power when it is connected with computer.

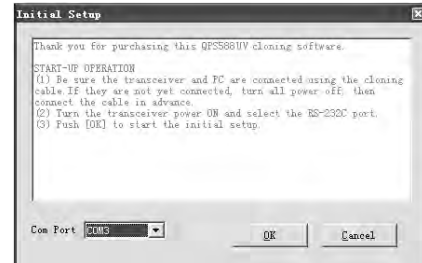

**NOTE** This software has product identify system, so when firstly installing the software, you have to connect the transceiver,otherwise you can not start the software.

## ■ TROUBLE SHOOTING

Problem	Problem Possible Causes and Potential Solutions
(a) Power is on, nothing appears on Display.	+ and - polarities of power connection are reversed. Connect red lead to plus terminal and black lead to minus terminal of DC power supply.
(b) Fuse is blown.	Check and solve problem resulting in blown fuse and replace fuse with new fuse.
(c) Display is too dim.	Dimmer setting is "LAMP-L". Please make the dimmer setting "LAMP-H".
(d) No sound comes from speaker.	<ul style="list-style-type: none"><li>• Squelch is muted. Decrease squelch level.</li><li>• Tone or CTCSS/DCS squelch is active. Turn CTCSS or DCS squelch off.</li></ul>
(e) Key and Dial do not function.	Key-lock function is activated. Cancel Key-lock function.
(f) Rotating Dial will not change memory channel.	Transceiver is in CALL mode. Press the VFO or memory mode.
(g) PTT key is pressed but transmission does not occur.	<ul style="list-style-type: none"><li>• Microphone connection is poor. Connect microphone properly.</li><li>• Antenna connection is poor. Connect antenna properly.</li></ul>

## General

Frequency Range	TX: 144~146MHz (EXP:136~174MHz) 430~440MHz (EXP:400~490MHz) RX: 136~174MHz 400~490MHz
Number of Channels	758 channels
Channel Spacing	25KHz(Wide band) 20KHz(Middle band) 12.5KHz (Narrow band)
Phase-locked Step	2.5KHz、 5KHz、 6.25KHz、 10KHz、 12.5KHz、 15KHz、 20KHz、 25KHz、 30KHz、 50KHz
Operating Voltage	13.8V DC $\pm 15\%$
Squelch	Carrier/CTCSS/DCS/5Tone/2Tone/DTMF
Frequency Stability	$\pm 2.5\text{ppm}$
Operating Temperature	-20~+60°C
Dimensions(WxHxD)	139(W)x40(H)x212(D)mm
Weight	about 1.14kg

## Receiver (ETSI EN 300 086)

	Wide band	Narrow band
Sensitivity (12dB SINAD)	$\leq 0.25\mu\text{V}$	$\leq 0.35\mu\text{V}$
Adjacent Channel Selectivity	$\geq 70\text{dB}$	$\geq 60\text{dB}$
Spurious Rejection	$\geq 70\text{dB}$	$\geq 60\text{dB}$
Audio Response	+1~-3dB(0.3~3KHz)	+1~-3dB(0.3~2.55KHz)
Hum & Noise	$\geq 45\text{dB}$	$\geq 40\text{dB}$
Audio distortion	$\leq 5\%$	
Audio power output	$> 2\text{W}@10\%$	

## Transmitter (ETSI EN 300 086)

	Wide band	Narrow band
Power Output	50W /25W/10W/5W(VHF)	40W/25W/10W /5W(UHF)
Modulation	16K $\Phi$ F3E	11K $\Phi$ F3E
Adjacent Channel Power	$\geq 70\text{dB}$	$\geq 60\text{dB}$
Hum & Noise	$\geq 40\text{dB}$	$\geq 36\text{dB}$
Spurious Emission	$\geq 70\text{dB}$	$\geq 70\text{dB}$
Audio Response	+1~-3dB(0.3~3KHz)	+1~-3dB(0.3~2.55KHz)
Audio Distortion	$\leq 5\%$	

## ■ 50 GROUPS CTCSS TONE FREQUENCY(HZ)

62.5	77.0	91.5	107.2	127.3	151.4	167.9	183.5	199.5	225.7	254.1
67.0	79.7	94.8	110.9	131.8	156.7	171.3	186.2	203.5	229.1	自定义
69.3	82.5	97.4	114.8	136.5	159.8	173.8	189.9	206.5	233.6	
71.9	85.4	100.0	118.8	141.3	162.2	177.3	192.8	210.7	241.8	
74.4	88.5	103.5	123.0	146.2	165.5	179.9	196.6	218.1	250.3	

## ■ 1024 GROUPS DCS CODE

000	001	002	003	004	005	006	007
010	011	012	013	014	015	016	017
020	021	022	023	024	025	026	027
030	031	032	033	034	035	036	037
040	041	042	043	044	045	046	047
050	051	052	053	054	055	056	057
060	061	062	063	064	065	066	067
070	071	072	073	074	075	076	077
100	101	102	103	104	105	106	107
110	111	112	113	114	115	116	117
120	121	122	123	124	125	126	127
130	131	132	133	134	135	136	137
140	141	142	143	144	145	146	147
150	151	152	153	154	155	156	157
160	161	162	163	164	165	166	167
170	171	172	173	174	175	176	177
200	201	202	203	204	205	206	207
210	211	212	213	214	215	216	217
220	221	222	223	224	225	226	227
230	231	232	233	234	235	236	237
240	241	242	243	244	245	246	247
250	251	252	253	254	255	256	257
260	261	262	263	264	265	266	267
270	271	272	273	274	275	276	277
300	301	302	303	304	305	306	307
310	311	312	313	314	315	316	317
320	321	322	323	324	325	326	327
330	331	332	333	334	335	336	337

340	341	342	343	344	345	346	347
350	351	352	353	354	355	356	357
360	361	362	363	364	365	366	367
370	371	372	373	374	375	376	377
400	401	402	403	404	405	406	407
410	411	412	413	414	415	416	417
420	421	422	423	424	425	426	427
430	431	432	433	434	435	436	437
440	441	442	443	444	445	446	447
450	451	452	453	454	455	456	457
460	461	462	463	464	465	466	467
470	471	472	473	474	475	476	477
500	501	502	503	504	505	506	507
510	511	512	513	514	515	516	517
520	521	522	523	524	525	526	527
530	531	532	533	534	535	536	537
540	541	542	543	544	545	546	547
550	551	552	553	554	555	556	557
560	561	562	563	564	565	566	567
570	571	572	573	574	575	576	577
600	601	602	603	604	605	606	607
610	611	612	613	614	615	616	617
620	621	622	623	624	625	626	627
630	631	632	633	634	635	636	637
640	641	642	643	644	645	646	347
650	651	652	653	654	655	656	657
660	661	662	663	664	665	666	667
670	671	672	673	674	675	676	677
700	701	702	703	704	705	706	707
710	711	712	713	714	715	716	717

720	721	722	723	724	725	726	727
730	731	732	733	734	735	736	737
740	741	742	743	744	745	746	747
750	751	752	753	754	755	756	757
760	761	762	763	764	765	766	767
770	771	772	773	774	775	776	777



**AnyTone**

*We only do best radio!*

WWW.AT-5880V.COM

Qixiang Electron Science & Technology Co., Ltd.

www.qxdz.cn