

PRICE: \$30.00

DZ COMPANY · LOVELAND, COLORADO

DZKIT

ASSEMBLY MANUAL



SIENNA
HF RECEIVER/TRANSCEIVER

DZ COMPANY CONTACT INFO

Orders, parts, phone assistance(970) 667-2254

Email orders sales@dzkit.com

Email technical support support@dzkit.com

Web site www.dzkit.com

Mail:

DZKit

710 Grove Ct.

Loveland, CO 80537

YOUR DZKIT 90-DAY FULL WARRANTY

During your first ninety (90) days of ownership, DZ Company will replace or repair free of charge—as soon as practical—any parts which are defective, either in materials or workmanship. You can obtain parts directly from DZ Company by writing us, emailing us or telephoning us. And we'll pay shipping charges to get those parts to you—anywhere in the world.

We warrant that during the first ninety (90) days of ownership, our products, when correctly assembled, calibrated, adjusted and used in accordance with our printed instructions, will meet published specifications.

You will receive free consultation (except for the cost of your long distance phone call) on any problem you may encounter in the assembly or use of your DZKit product. Just drop us a line, email us, give us a call, or visit our website and click on "Support". That will give you access to free on-line support and a discussion group. Sorry, we cannot accept collect calls.

Our warranty, both expressed and implied, does not cover damage caused by the use of corrosive solder, defective tools, incorrect assembly, misuse, fire, customer-made modifications, floods or acts of God, nor does it include reimbursement for customer assembly or setup time. The warranty covers only DZKit products and is not extended to non-DZ allied equipment or components used in conjunction with our products or uses of our products for purposes other than as advertised.

If you are ever dissatisfied with our service—warranty or otherwise— or our products, please write or email the president, Brian Wood, W0DZ, and he will make certain your problems receive prompt, personal attention.

THE DZ COMPANY, LLC
LOVELAND, CO 80537

Assembly

Of the



Sienna HF Receiver/Transceiver



DZ COMPANY
LOVELAND, COLORADO

Copyright © 2014
The DZ Company, LLC
All rights reserved

11-20-2014

Sienna

TABLE OF CONTENTS

Introduction	4
General assembly/safety notes	6
Step-By-Step Assembly	
Chassis, DC power, Tuner	14
Initial tests.....	34
Front Panel integration	32
Front Panel tests.....	42
Receiver Integration	44
Receiver alignment/test	53
Transmitter integration	63
Transmitter resistance/voltage	65
Transmitter alignment/tests	67
100W PA Integration	73
100W PA alignment/tests.....	76
Final assembly	79
Appendix A: (Reserved).....	81
Appendix B: RS232 Board.....	85
Appendix C1: DCD: Power	87
Appendix C2: DCD: SWR	95
Appendix C3: DCD: Tuner.....	97
Appendix C4: 5V Regulator.....	101
Appendix D1: Blank Front Panel ..	103
Appendix D2: Full Front Panel	105
Appendix E: IF Filter Board.....	109
Appendix F: RXBPF Board.....	115
Appendix G: Receiver Board	120
Appendix H: Transmitter Board ...	129
Appendix I: 100W PA Board.....	141
Appendix J: Installing Filters	152
Appendix K: IF Test Procedure.	156
Appendix L: RXBPF Test Proc	158



INTRODUCTION

The Sienna family of receivers/transceivers represents a revolution in amateur radio. Now you can start with a relatively inexpensive remote-control-only receiver, using a PC to control it using your favorite software, and then add a front panel, transmitter, tuner and amplifier, as well as numerous IF filters, as your desires or budget allow. Or you can start with any combination of modules to create just the right radio for your needs.

The time-tested triple-conversion receiver design assures general coverage receive with no dead spots and excellent image rejection. It also has very good dynamic range by virtue of a 5KHz roofing filter at the 70.455MHz first IF, and compatibility with a wide variety of high performance crystal filters and Collins mechanical filters at the 2nd and third IF's to provide excellent selectivity. We've also added innovations in AGC control, band-pass filtering with GaAsFET switches instead of PIN diodes, and the ability to run full-duplex and cross-band at HF fre-

quencies.

Sienna transceivers are also a study in duality: dual preamps, dual keying (manual and paddle inputs available at the same time on both the front and back panel), dual audio (headphones and speakers available at the same time), dual receive (front panel access to the audio from an external secondary receiver), and dual backlit analog meters, which give the rig a nice glow that harkens back to the early days of radio when all radios glowed. Dual microprocessors are in total control of the radio.

The Sienna can be built in several stages and in several combinations. This manual is thus a complete assembly manual for the fully loaded Sienna. As you upgrade your Sienna, you can still use this one manual as a complete assembly reference.

Thanks for trusting in DZKit to provide not only unique electronic products, but to give you hours of building fun too.





General Assembly Notes

1. Most screws in this kit are Phillips Panhead Machine Screws. For simplicity, we refer to them simply as “screws” unless a different style is used. These may be stainless steel or zinc-plated steel.
2. Almost all sheet metal parts are attached to each other using 6-32 x 1/4” screws that are inserted into captive fasteners that have been pressed into the sheet metal. These screws have a locking compound on them to keep them from vibrating loose.
3. Most PC boards attach to the sheet metal using 6-32 x 1/4” screws with attached lock-washers (“SEMS” screws) but there are some exceptions, which are explained in the steps.
4. As you tighten a screw, it is very important that you do not strip the threads. All screws should fasten smoothly. If a screw appears to be very hard to fasten, something else is probably wrong—a cable could be in the way, you are trying to use the wrong size screw or something else is wrong. DO NOT FORCE SCREWS! Instead, inspect the assembly carefully and try to see why you are having difficulty. Screws with locking compound on them are normally a little harder to fasten.
5. A PC within arms reach of your workbench is useful in helping you locate the parts on the boards. Shipped with your kit is a USB flash drive containing the PCB layout files for all boards (without traces). To find the location of a part, simply install and run the “ExpressPCB” program (free download from www.expresspcb.com) and open the board you wish to work on. Press “Ctrl-F” to find a part, and then enter it in the box that pops up (e.g., “R1”, without the quotes). The program will show you exactly where that part is located. Take a few minutes to familiarize yourself with this program before beginning construction. You can also find parts manually by just looking for the part on the silkscreen, but on the denser boards, this can take a long time. We highly recommend using ExpressPCB to locate parts.
6. There are three large sheet metal brackets. Two are identical and are placed opposite each other lengthwise from front to back. These brackets are referred to as “large bracket LR” (for Left/Right). The other large bracket runs from side to side in the front, attaching to the other brackets. It is called the



- "front bracket".
7. All references to left and right, front and back are with the chassis in an orientation such that the front of the radio faces you. The large openings on the bottom of the chassis are to the right, with the folded sides pointed up.
 8. Each circuit part has its own component number (R1, L4, Q3, etc.). R1 on one assembly will not be the same as R1 on a different assembly, so be sure you are looking at the right set of parts when comparing part numbers with the printed parts list. Check off each part at the beginning of each section to make sure all the parts are there. If you find any missing, give us a call or email us and we will rush a replacement to you.
 9. Most electronic kits that are returned for service have poor soldering jobs. **Please** take a moment to familiarize yourself with proper soldering technique. And do not, under **ANY** circumstances, use corrosive ("acid-core") solder! That will void your warranty and render your kit inoperative. Also be sure to avoid the use of products that may be called solder but are really glue (e.g., LePage's Liquid Solder, nothing more than metallic-grey colored airplane glue).
 10. Soldering should only be done in an area with good ventilation and with a properly heated soldering iron.
 11. Resistors are identified by their values in Ohms, Kilohms (K) or Megohms (M) and by color codes. Your kit uses resistors of several types. Axial leaded resistors have color coded bands on them. For 5% resistors, the first two bands represent the numeric value and the third band represents a multiplier, which is a power of 10. Thus, a 56 Ohm resistor is Green-Blue-Black. A 10K Ohm resistor is Brown-Black-Orange, and so on. The fourth band is the tolerance – no band represents 20%, a silver band 10%, and a gold band 5%. Your Sienna uses mostly one percent or better resistors, which have 4 bands for the value. A 4.75K resistor is Yellow-Violet-Green-Brown. We have placed resistors of given types in individual bags for you, but should they get mixed and you have trouble reading the color code, we recommend an inexpensive volt-ohmmeter be used to check the values. A fluorescent light is also useful to "bring out" the colors,

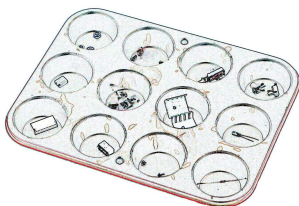

Most kit builders find it helpful to separate the parts into categories for quick identification. Muffin tins and egg cartons serve this purpose admirably.



and a magnifying glass is also handy.

12. Capacitors are identified by their type – disk, polystyrene, polypropylene, electrolytic, trimmer, etc.) and capacitance values are in microfarads (μF) or picoFarads (pF). Polarized types have the positive pin marked on the silkscreen and also have a square pad.

13. Inductors are represented either by their inductance in nanoHenries (nH), microHenries (μH), milliHenries (mH) or by the number of turns in the coil if you are doing the winding.

14. Diodes are marked with a band on the cathode end. The PC boards have a bar silkscreened across one side of the component outline and a square pad which identifies the cathode.

15. Transistors have either a tab or a flat side that you can match to the silkscreened component outline. Most transistors will need to have their leads “sprung” a little to fit in the holes. Do so carefully to avoid breaking the leads off.

16. ICs have a notch, beveled side and/or a dot representing the side containing pin 1. When you hold an IC with the notch or the beveled side up, pin 1 is in the upper left corner. The silkscreened outlines on the board all have notches and pin 1 also has a square pad.

It is CRITICAL that you mount polarized parts correctly! Double check your work to be sure that all such parts match the photos. See Detail 1.

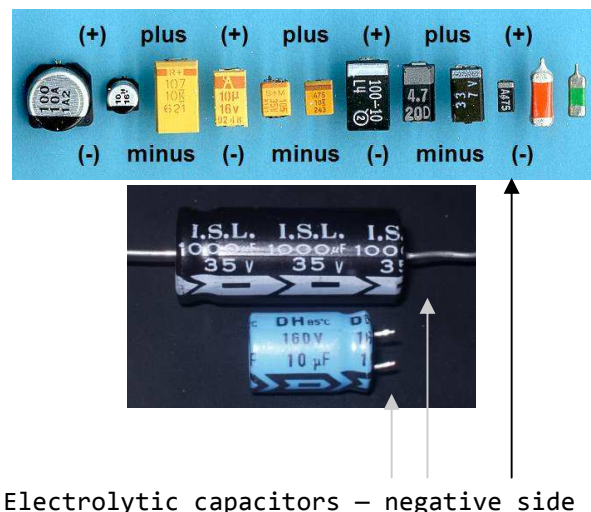
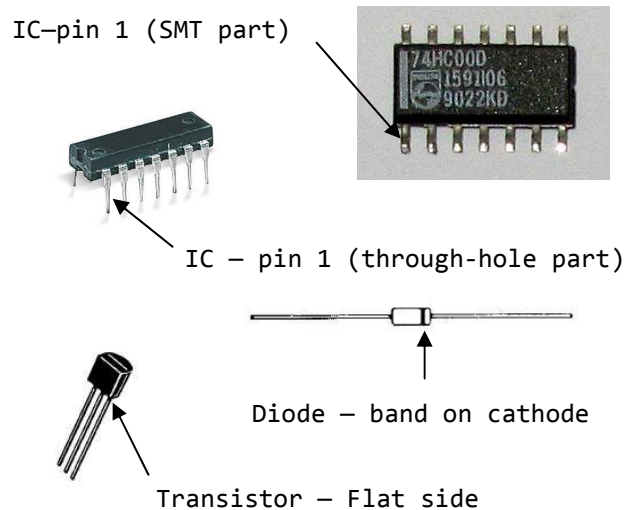

Detail 1. Identifying polarity of diodes, transistors, ICs and polarized capacitors.



Abbreviations and definitions of terms used in this manual:

PC = Personal Computer

PCB = Printed Circuit Board

PH = Panhead

FH = Flathead

M/S = Machine Screw (typically 2-56, 4-40, 6-32 and 10-32 sizes)

P/L = Patch lock (material added to threads to help screws stay in)

PCB-mt = Printed Circuit Board mounting

AMP MTA = Tyco Electronics connector with .1" or .156" pin spacing

IDC = Insulation Displacement Connector (MTA connectors are IDC type)

Ribbon cable = Flat, gray cable with connectors on each end

Header = PCB-mounted connector

A word about what lies ahead...

This manual is designed to allow you to build confidence in your kit-building ability as you go along. You start by building the DC power distribution circuitry, which is the simplest of all the circuitry. You then install this board in the chassis. You will then be able to turn on the power and measure some voltages. This will give you confidence that the kit-building is progressing normally. You will also be able to use a PC to help you locate parts on the boards using the PCB layout files that we have included. The project continues with building of the RS-232 interface and front panel circuit board (if you purchased a front panel) and integration with the pre-assembled controller board. At that point, you will be able to experiment with the front panel controls and/or the remote control functions. Once all that works, you will build and install the receiver's IF and bandpass filter boards. Next you will finish building the partially pre-assembled receiver. At this point, you will be able to test and align the receiver and use the built-in keyer. If you purchased the base Sienna model, which is a receiver, you're done! Otherwise, you might want to take a break and spend a few hours using the receiver before continuing! Next, you will install the assembled and tested transmitter and build the 100W amplifier (if purchased). These boards are the most complex, which is why they have been saved for last. But once you get to them, you will have great confidence that you have built the radio correctly to that point. So let's get started!

NOTE: If you would prefer to build all the boards first, you may go directly to the Appendices and do so.



KIT-BUILDING PROCEDURES

The steps involved in building a kit are listed below. Be sure to follow them and you will have a lot of fun building, aligning, testing and using your kit.

1. **Do a parts inventory.** At each major section and in the Appendices, there's a list of parts used in that section (or that will be used shortly). Check off each part to be sure you are not missing anything. Our method of bagging parts is different from all other kit vendors and will make the task much faster and less error prone. But despite our valiant efforts, mistakes can happen. If you are missing any parts, call or email us and we'll rush replacements to you immediately.
2. **Do not remove parts from the bags until called for,** to avoid mixing parts up (especially resistors).
3. **Pay attention to soldering techniques.** Keep your soldering iron clean by using a wet sponge, use appropriate heat and maintain heat long enough to make good solder joints. Solder problems are the number one cause of problems when building electronic products (not just kits!), so try extra hard to do it right.
4. **Some boards have been pre-loaded with surface mount parts.** Be careful not to flex these boards to avoid having parts snap off.
5. **Take your time!** We know you want to get it done and start using it, but doing it wrong will only delay that moment. Before you start, set up a ventilated, static-free work area with enough room to build the kit. Prepare parts bins and get the tools you will need (needle-nose pliers, wire-cutter, wire stripper, Phillips head screw drivers, wrenches, soldering iron, solder, insulated tool, awl or other sharp-ended tool, scissors, magnifying glass, etc.) If you're tired, take a break. Enjoy building your kit!
6. **Make sure that you are loading the part that's called for in the right holes.** Once loaded, it can be hard to find a misloaded part. Be especially careful to load polarized parts (ICs, diodes, electrolytic capacitors) the right direction. If you are not sure about any step, call or email us!
7. **Once you've done a step, put a checkmark inside the parentheses.** This helps you remember where you left off when you build in stages.
8. **After you have assembled a circuit board, take a moment (just one) to marvel at your handiwork, then spend a few more minutes critiquing it!** Check for solder bridges, unsoldered or insufficiently soldered connections, solder blobs (especially on insulated magnet wire used on toroids), loose screws and electronic parts, reversed polarized components, etc. Sometimes it helps to have a friend check your work.



Safety First!

Your safety is of utmost importance to us. Please read this information before you get started, and remember these rules as you continue building and testing your Sienna.

1. Always have a healthy respect for electricity. While the voltages present inside the Sienna are not lethal, high currents are available (up to 30 Amps when the 100 Watt amplifier is used). Use a power supply with overcurrent foldback or crowbar protection so that in case of high currents the supply will shut down. Set the output current only as high as necessary for a given step.
2. When measuring voltages inside electronic equipment, it is generally a good idea to use only one hand, wear rubber-soled shoes and avoid areas with standing water. However, remember that slightly humid environments can prevent static electricity that could damage the electronic parts! Use a humidifier in dry climates.
3. Do not work on powered electronics by yourself if at all possible. Have a parent, spouse or friend nearby. If you must work alone, keep a telephone handy in the event you run into problems.
4. Soldering irons are hot. They can burn your skin and cause damage to workbenches and carpets. We recommend you use one with an automatic shutoff in case you forget to turn it off when you are done.
5. Do not work on electronic projects when you are tired. We know you want to finish it, but accidents are more likely when you are tired. Take breaks! Be careful!
6. Use proper ventilation in your work area. Solder contains tin and lead (or tin and silver), and solder fumes should not be allowed to “hover” near your work. Open a door or window, use a fan, and be cognizant of the potential dangers.
7. When clipping leads, use eye protection and/or be sure to direct the flying leads down into a nearby trash can. As you gain experience clipping component leads, you will learn how to clip them so that they fall harmlessly away from the board.
8. Be careful not to cut yourself when handling sharp objects such as connectors and sheet metal. Keep some tissues, bandages and antibiotic ointment nearby in the event of an injury.
9. Use common sense in dealing with unfamiliar things. If you don't understand something, call us or ask a friend for help.



SOLDERING INSTRUCTIONS

Poor soldering accounts for almost all kit building problems. The photographs below show examples of the most common types of bad solder connections and a good one. If you locate any of these bad solder connections in your kit, correct them as described. Study this section carefully before you start building your kit.

Solder blob. In this example, solder flowed onto a lead, but the heat was not maintained long enough for it to flow onto the circuit board pad. Solution: re-heat the connection, touching the iron to both the component lead and the pad at the same time.

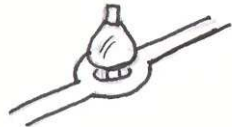

Use a good quality, variable temperature soldering iron with a conical, narrow tip, and set the temperature to 750 degrees F. Use thin, non-corrosive, rosin core solder to assemble your kit. Keep the sponge damp and wipe the tip on the sponge after each solder step.



Solder bridge. Solder that stretches from one trace or pad to another creates a short circuit. Solution: Hold the board upside down and reheat the area. The excess solder will flow down the soldering iron. Another solution is to use a "solder sucker" or solder wick to remove excess solder. Solder suckers work well one or two times on a given connection. If used too much, they can pull pads and traces off of PC boards.

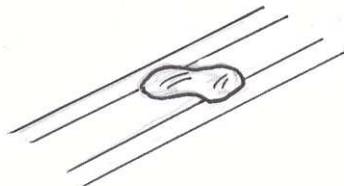

Good solder connections. A good solder connection looks like this. Solder flows evenly onto both the part and the PC board or chassis component. It is shiny and even, not lumpy and dull. Component leads that are properly soldered can not be moved in the hole. The component lies flat on the board.

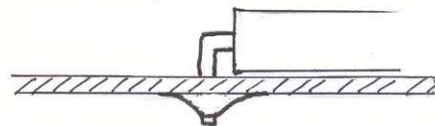



STATIC PRECAUTIONS

Many of the components in your kit can be damaged by exposure to static electricity. Please read this page to familiarize yourself with the causes of and solutions to this problem.

When the climate is dry, you can generate thousands of volts simply by walking across a carpet. When you then touch a metal object you can feel the effects of this as you draw a spark! That same spark, often too small to see or feel, can destroy sensitive electronic components. You **MUST** take precautions when working with electronics to prevent damage.

The best solution is to outfit your workbench with anti-static devices – floormats, grounded soldering irons, and workmats with grounded wriststraps. If these are not practical for you, the very least you should do is to discharge yourself to ground after you sit down and before you touch any electronic items, by touching a grounded object such as the corner of a wall.

In a dry environment, simply standing up after sitting in a non-grounded chair can also charge you with electricity. If you stand up to stretch, for example, be sure to re-ground yourself before getting back to work. Don't wear insulated sole shoes and avoid nylon, wool or other

static-producing material in your clothing.

If your work area floor is carpeted, spray fabric softener on it using a hand spray bottle. Fabric softener is conductive and will bleed away carpet static for a few hours.

Don't use a plastic table unless you have a grounded workmat on it. Use a wood or metal table if possible.

Cats are notorious for inducing static into your work area. Don't allow them anywhere near your workbench!

All electronic components are susceptible to static, but semiconductors and assembled boards containing semiconductors are the most prone to damage. These include diodes (including light-emitting diodes [LEDs]), transistors and integrated circuits (ICs).

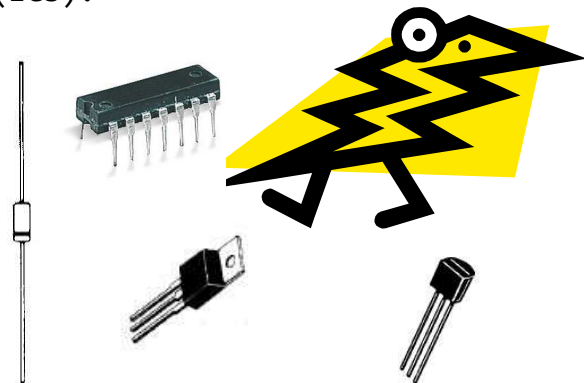

You are a walking lightning bolt! Be careful!



Chassis Parts

Item	Description	Stock bin	Qty
1	Connector RF SO-239 bulkhead rear mount	77	2
2	Connector RCA phono red panel-mount	431	1
3	Connector BNC w/solder lug panel-mount	530	1
4	Surge Suppressor 3kV Gas-discharge tube	514	3
5	Hardware Anderson Powerpole mounting clamp	579D	1
6	Hardware rubber foot with metal washer 1.00"x0.75"	139	2
7	Hardware rubber foot with metal washer 0.28 X 0.625"	140	2
8	Hardware PCB card guide 6" plastic	138	1
9	Hardware 6-32 x 1/4in thread-cutting screw SS	466	4
10	Hardware 6-32 x 1/4in FH 100 degree Phillips Black SS M/S	270	12
11	Hardware 6-32 x 1/4in PH Phillips M/S SS patchlock	642	39
12	Hardware 6-32 x 1/4in PH Phil M/S ext tooth lockwasher SS	644	16
13	Hardware 6-32 x 1/2in PH Phillips M/S SS	90	17
13	Hardware 6-32 x 1in PH Phillips M/S SS	91	2
14	Hardware 10-32 x 5/8in PH Phillips M/S SS	476	1
15	Hardware 4-40 x 5/16in Jackscrew	477	2
16	Hardware 6-32 x 1/2in Hex M/F Spacer SS	468	2
16	Hardware 6-32 x 5/8in Hex M/F Spacer SS	469	12
17	Hardware 6-32 x 2in Hex F/F Spacer SS	556	1
18	Hardware #10 Flat Washer 1/2in OD, .05in Thick Zinc-Plated Steel	473	2
19	Hardware 10-32 KEPS Nut SS	475	1
19	Hardware 6-32 KEPS Nut SS	464	20
20	Hardware 10-32 Wing Nut Zinc-Plated Steel	474	1
21	Hardware #10 internal tooth lockwasher with solder lug	510	1
22	Hardware 1/2in Hole plug Nylon	518	1
23	Hardware 6-32 angle bracket	413	4

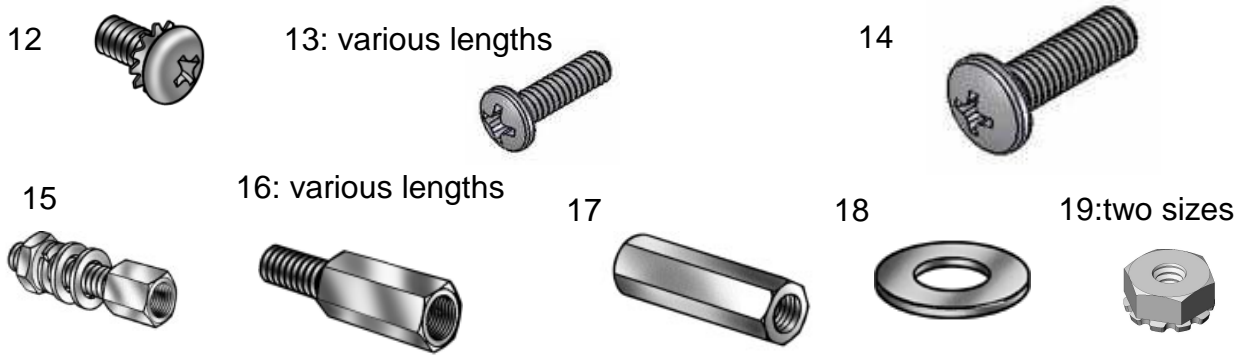



Item	Description	Qty
	Heat Shrink Tubing 3/32"	6"
24	Sienna serial number sticker	1
25	Fan - 12V 60x60x25	2
26	Bottom cover plate	1
27	Chassis bottom	1
28	Speaker	2
29	Finger guard—metal	2
30	Finger guard—plastic	2
31	EMI shield—metal	2

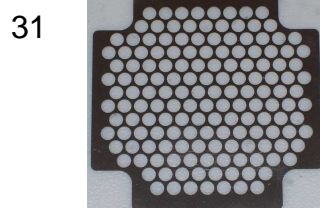
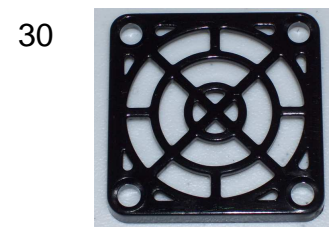
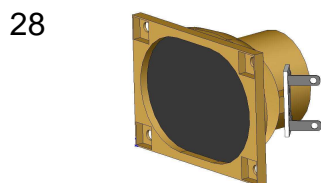
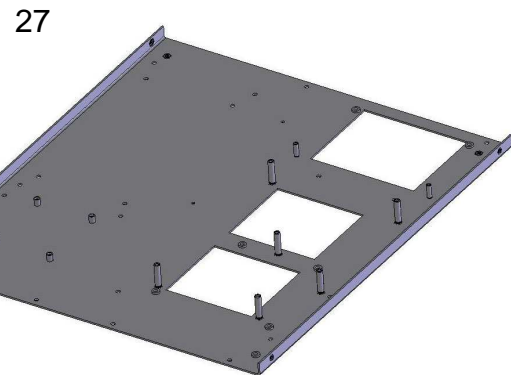
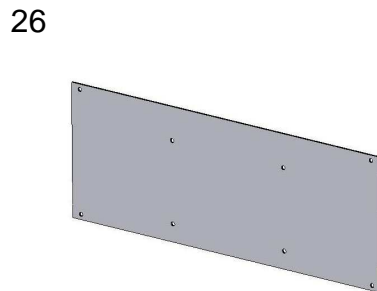
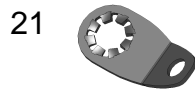



Item	Description	Qty
32	Large Bracket Front	1
33	Large Bracket LR	2
34	Small Bracket	1
35	Exhaust plate	1
36	Rear Panel	1
37	Rear Panel Tray	1
38	Top cover	1

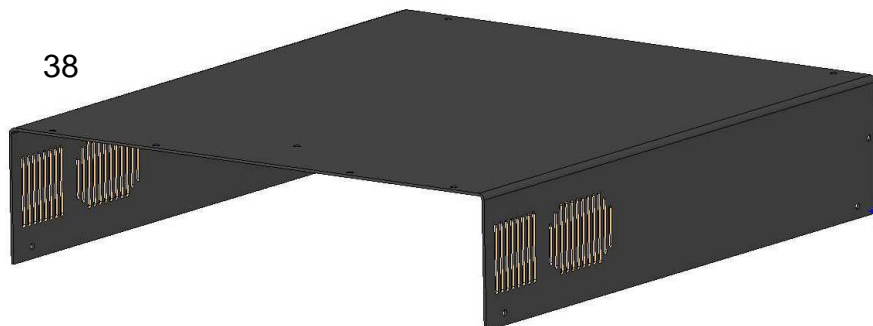
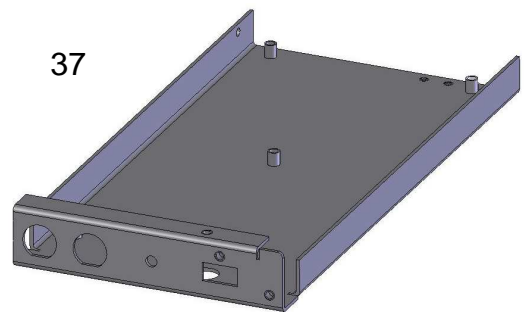
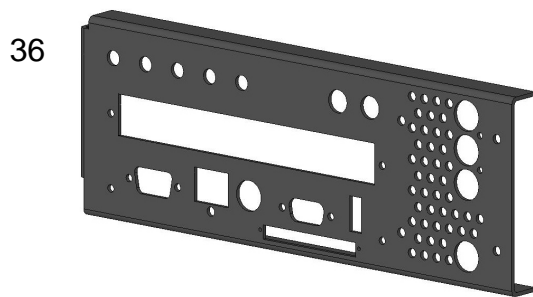
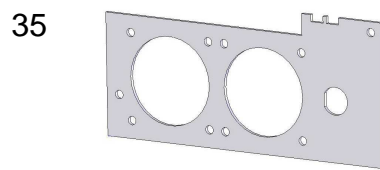
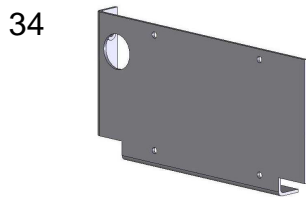
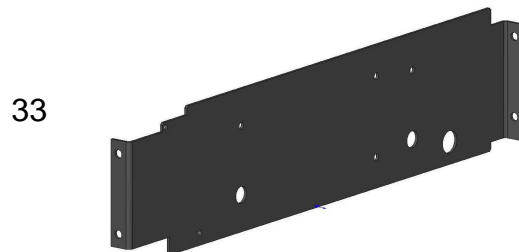
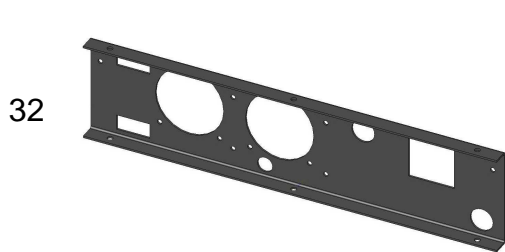



Boards:

Controller (assembled and tested)

DCD (kit)

IF Filter (kit)

RXBPF (partially assembled kit)

Receiver (partially assembled kit)

RS-232 (kit)

Options:

Front Panel (kit)

Transmitter/TXBPF (assembled and tested) and

SWR Meter (kit, parts added to DCD board)

100W amplifier (partially assembled kit)

Antenna Tuner (kit, parts added to DCD board)



Cables

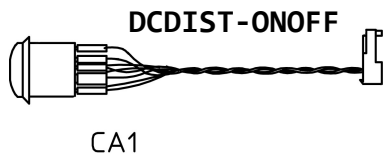

CA-APP DC power input

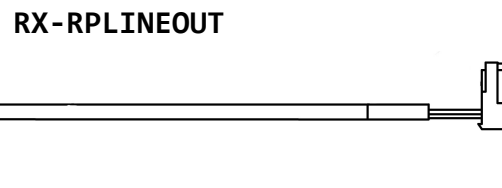
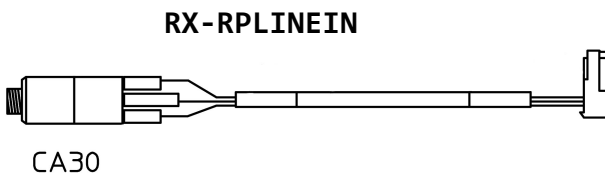
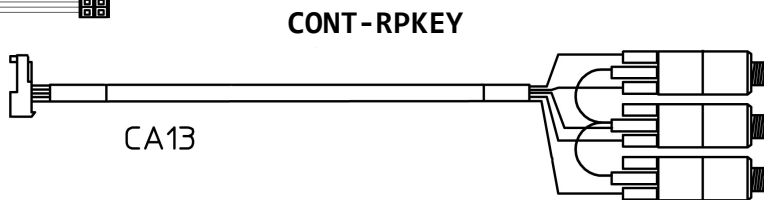
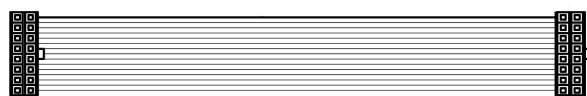
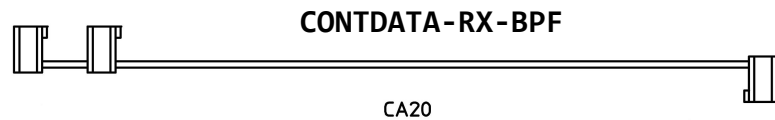
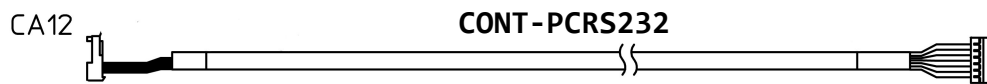



CONT-MIC

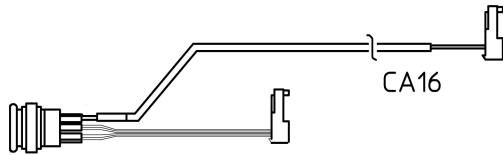

RX-HP

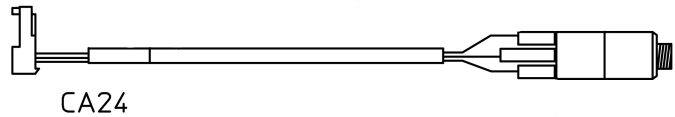

AMP MTA-MTA Cables

Use:

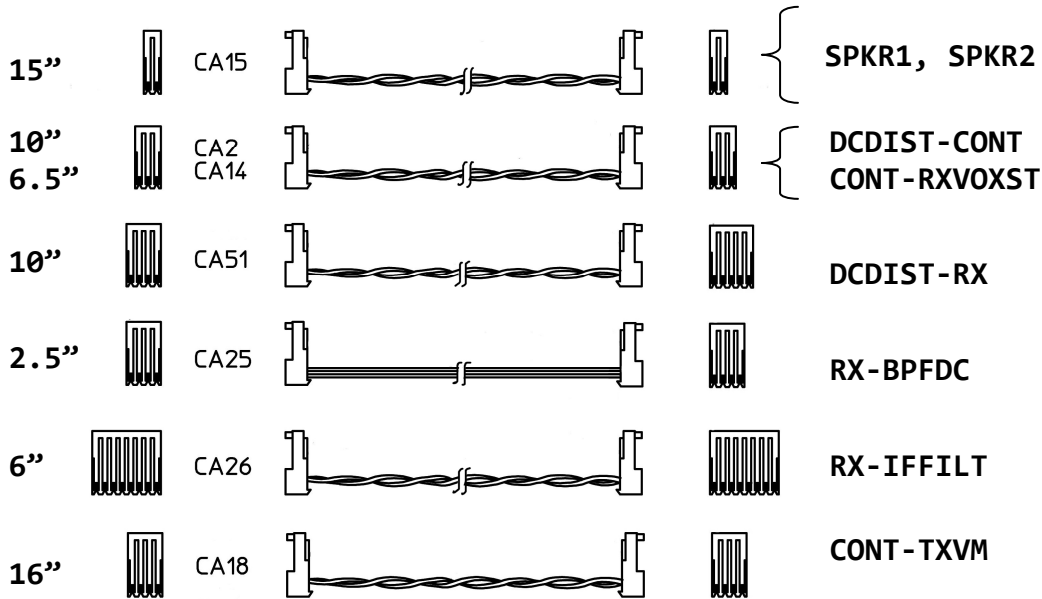

RF CABLES

CA33	RXBPFMAIN-TX/AMP
CA34	RXANT
CA35	RF1 (RXBPF to RX)
CA36	RXLO1
CA37	RXLO4
CA38	TXBFO
CA39	RXLO2
CA40	RXLO3
CA41	IF1
CA42	IFOUT
CA43	IF4
CA44	TXVFO
CA45	IF2
CA46	IF3

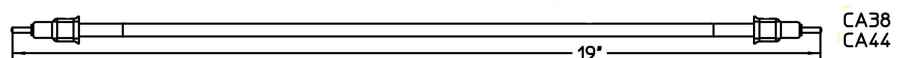
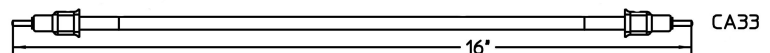
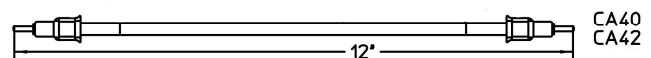
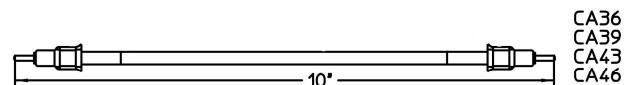
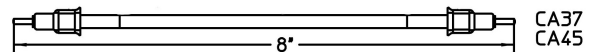
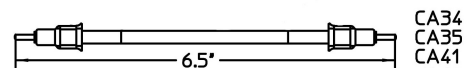



STEP-BY-STEP ASSEMBLY: Chassis, DC Power

Refer to Pictorial 1 for the following steps.

- () Place the chassis bottom on a hard surface. Push the 6" plastic board guide into the holes in the center transmitter compartment until the guide is firmly seated.
- () Position the front bracket with the top and bottom folded sides facing you and the fan mounting holes toward your left. Attach the fans to the back side of this bracket with four 6-32 x 1/2" screws, a metal finger guard and four 6-32 KEPS nuts. (Hint: use a 5/16" socket wrench on 6-32 KEPS nuts.) Make sure the airflow arrow on the fans points toward the back, with the power cable on the bottom. Holding the front bracket as described, the KEPS nuts should be visible to you and the screw heads should touch the fans. See Photo 1.
- () Attach the front bracket to the chassis bottom using one 6-32 x 1/4" PL screw in the middle hole. (Note: "PL" refers to the Nylon patch that is on the threads. Do not use the screws with attached lockwashers, called "SEMS".)
- () Attach the two large rubber feet to the bottom of the

chassis and into the outer two holes on the front bracket using two 6-32 x 1" screws. See Photo 2.

- () Attach the two small rubber feet to the two holes on the back, directly opposite the front feet, using two 6-32 x 1/4" PL screws. See Photo 2.

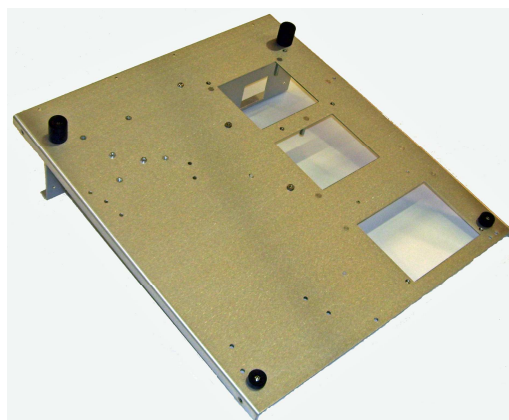
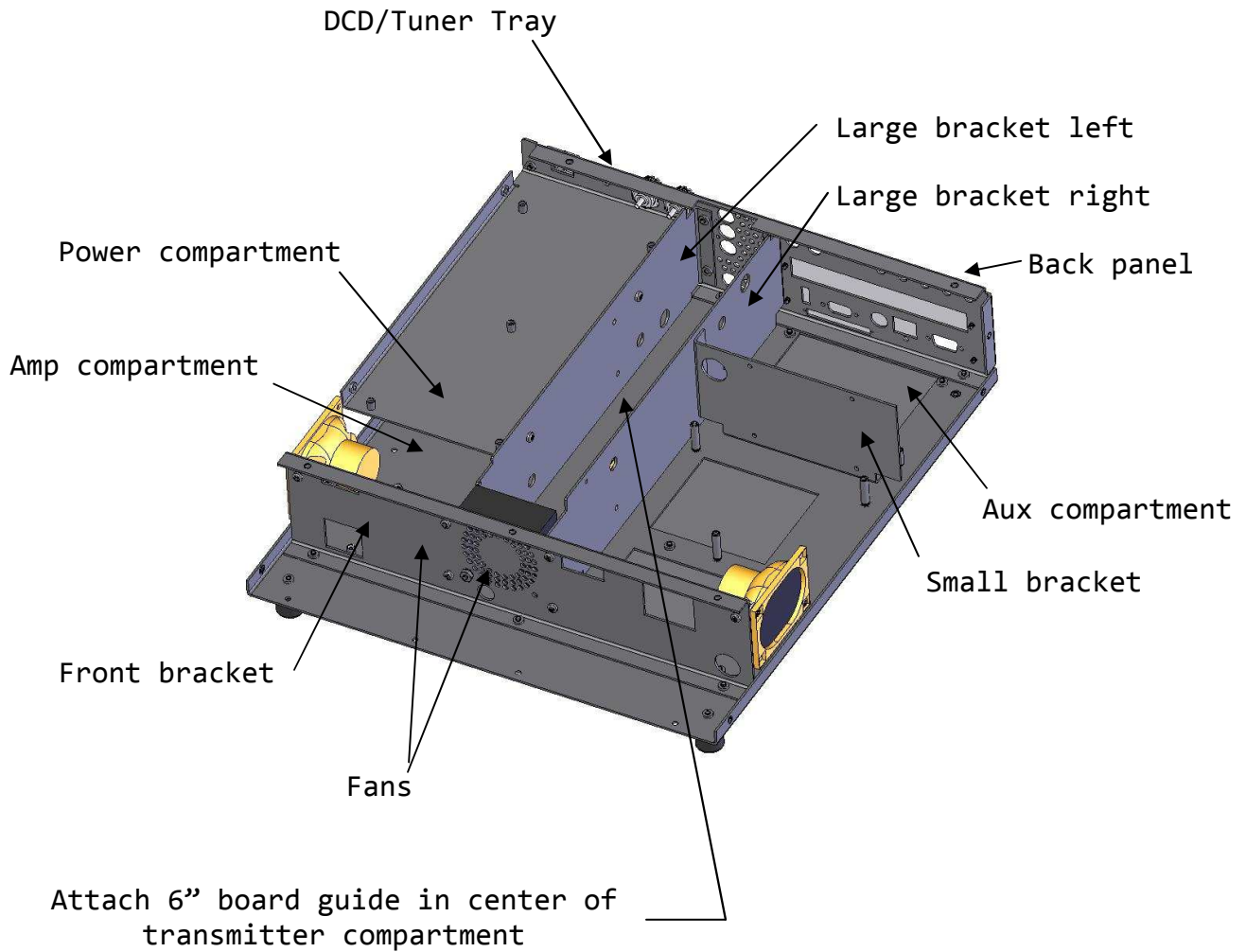

Photo 2. Feet mounting

- () Position the two large brackets on each side of the fan such that the long side is perpendicular to the front of the radio and the back folds face each other. Attach these brackets to the front bracket using four 6-32 x 1/4" PL screws.
- () Attach the small bracket to the right large bracket using two 6-32 x 1/4" PL screws. The folded sides on the small bracket face toward the back.



Pictorial 1

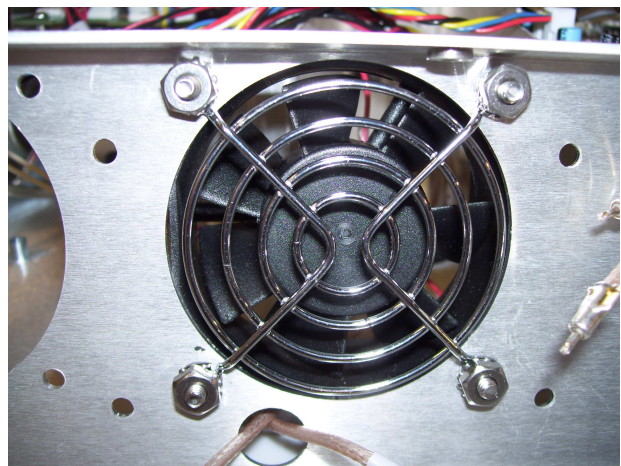
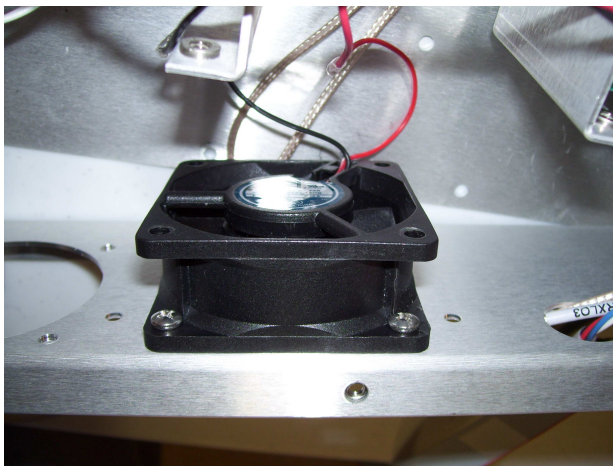

Photo 1. Fan mounting



- () Locate a 2-pin MTA cable (CA15). Cut it so that one length is 10". Cut the other piece so that it is 4" long. Strip all exposed ends of both cables to a length of 1/4". Tin all 4 ends. Twist the wires about 2 turns per inch if they are not already twisted. Place a 1/2" length of 1/8" heatshrink tubing over each wire. Using the 10" length of cable, solder the red wire to + and the black wire to - on one loudspeaker. Position the heatshrink over the terminals and heat them with a heatgun or soldering iron.
- () Using the 4" length of 2-wire cable you just prepared, solder the red wire to + and the black wire to - on the other loudspeaker. Position the heatshrink over the terminals and heat them with a heatgun or soldering iron.
- () Refer to Photo 3 and Detail 1. Attach the speaker with the 4" cable to the right side (as viewed from the front of the unit) of the chassis bottom using one angle bracket, one 6-32 x 1/2" hex male/female spacer, one 6-32 KEPS nut and two 6-32 x 1/4" PL screws. Position the terminals such that they point towards the front of the unit.
- () Attach the diagonally opposite mounting hole on the right speaker to the front bracket using one angle bracket, one 6-32 KEPS nut and two 6-32 x 1/4" PL screws.
- () Repeat the previous two steps for the left speaker, mounting it to the left side of the chassis.



Photo 3. Fans and speakers

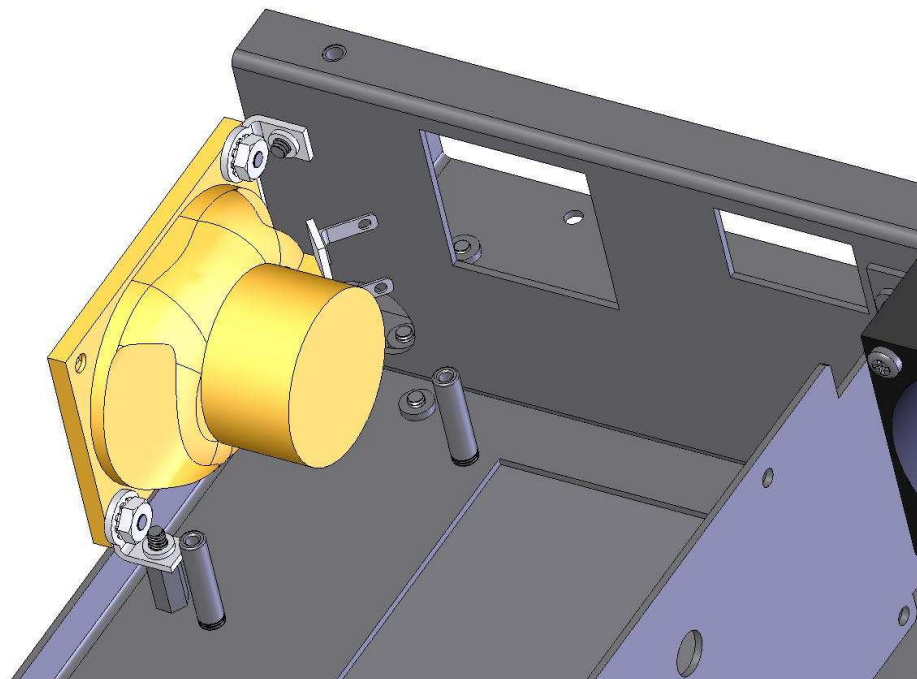

Detail 1. Right side speaker mounting



- () Build the RS232 Board (see Appendix B). Remove the two jackscrews from the 9-pin connector and insert the connector into the hole on the back panel labeled "RS-232C". Secure it using two 4-40 x 3/16" x 5/16" jackscrews (included with Chassis HW).
- () Locate the 24" 6-pin IDC to rectangular connector cable labeled CONT-PCRS232 (CA12). Pass the IDC end from the receiver compartment through the round hole at the bottom right of the front bracket and leave the 6-pin IDC connector in the front controller compartment. See photo.

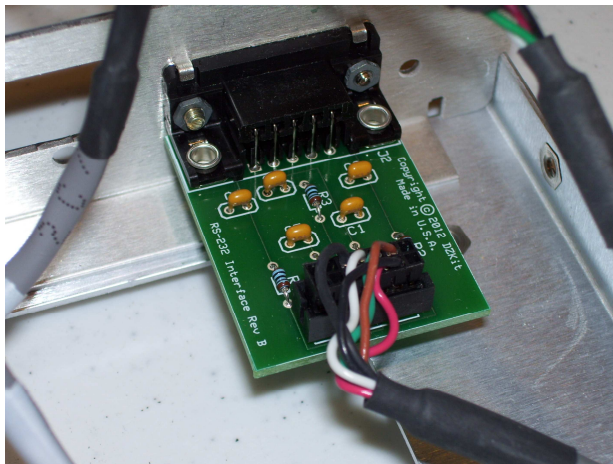

- () Pass the other end of CA12 under the notch in the right side of the small bracket and connect the 2mm rectangular connector to J1 on the small RS232 Board that you earlier attached to the back panel. See picture for correct cable orientation in the connector.

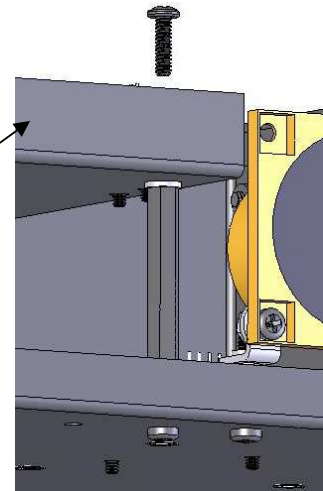
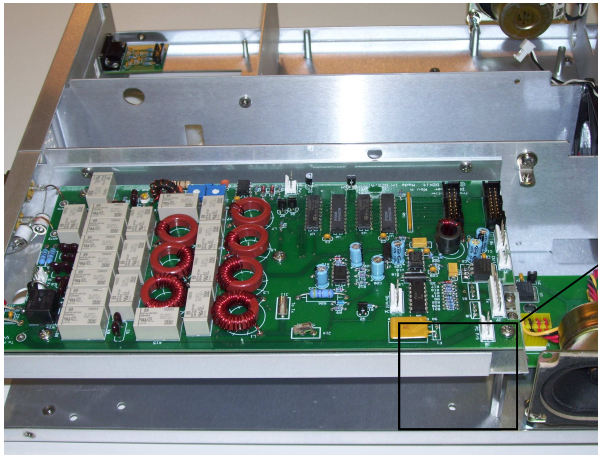

Exhaust plate

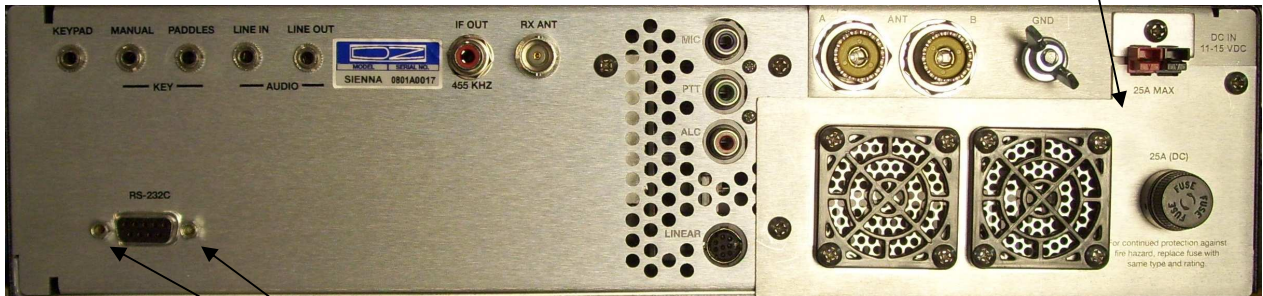

Back panel

Jackscrews

Pictorial 3



Refer to Pictorial 3 for the following steps.

- () Attach the back panel to the back of the chassis bottom using two 6-32 x 1/4" PL screws on the bottom, two more on the right bracket, and one on the top of the two left bracket holes.
- () Insert two SO-239 connectors from the inside of the DCD/Tuner tray into the large "D"-shaped holes. The lock-washer and nut go on the *outside* of the panel (the side with lettering). Tighten the nuts, being careful not to mar the sheet metal.
- () Attach the ground lug to the hole next to the SO-239 connectors: Place a #10 solder lug on the 10-32 screw and then insert it into the tray from inside. Position the solder lug so that it faces the SO-239 connectors. Secure it tightly with a 10-32 KEPS nut on the outside. (Hint: Use a 3/8" socket wrench.) Place two #10 washers over the screw and then fasten the #10 wingnut finger-tight.
- () Build the DC distribution section of the DCD/Tuner Board. See Appendix C1.
- () If you have purchased the transmitter, build the SWR meter section of the DCD/Tuner board. Parts are provided in the transmitter kit. See Appendix C2.
- () If you have purchased the Tuner option, build the Tuner section of the DCD/Tuner Board. Parts are provided in the tuner kit. See Appendix C3.
- () Affix a Thermasil insulator to the DCD tray on the 4-40 captive nut at the front of the tray. (Early version of the tray had two such nuts; use the one closest to the center of the tray.) Align the hole in the insulator with the hole in the tray and make sure the insulator extends toward the back.
- () Attach the DCD/Tuner board to the tray using four 6-32 x 1/4" SEMS screws in three corners and the center. Do not put a screw in the front left corner (near J8). Do not tighten the screws.
- () Apply heat to the pin you soldered earlier on Q1 and push it down flush with the chassis. Move it back and forth until the hole in the tab lines up precisely with the hole in the chassis. Be careful not to let the soldering iron touch the connectors that are nearby.
- () Insert a #4 shoulder washer



in the tab hole, then insert a 4-40 x 1/4" screw through the washer and tab. Do not tighten it.

- () Carefully tighten the 4-40 screw, wiggling the board if needed to assure that the screw goes in without binding. If you meet resistance, loosen the 6-32 screws. The 4-40 screw must be inserted without resistance or the shoulder washer can be crushed, causing shorts. Once the screw is tight and the shoulder washer is firmly seated, tighten the four 6-32 DCD mounting screws.
- () Using an ohmmeter, verify that the resistance from the tab of Q1 to chassis is greater than 400 ohms. If you read a short to ground, remove the screw, reposition the part and try again.
- () Solder all 3 pins of Q1. Clip the leads, making sure that clippings do not fly into the chassis. Be careful not to let the soldering iron touch the plastic connectors that are nearby.
- () Build the 5V Regulator Board Kit. See Appendix C4.
- () Place the regulator (U1) from the 5V Regulator Board kit on the holes marked U1 on that board, but do not bend the leads yet. "Test fit" the

regulator by holding it on the board as you position the board on the chassis bottom as shown in Detail 3. This will show you where to bend the leads of U1 up so that they fit into the board when it is screwed to the chassis. Bend the leads up at that point and insert U1 from the bottom of the board. Do not solder it in place yet.

- () Affix a Thermalsil insulator to a TO-220 heatsink as shown below. Position the heatsink under regulator U1. Insert a 4-40 x 1/4" screw through a shoulder washer, regulator, heatsink and into the chassis.

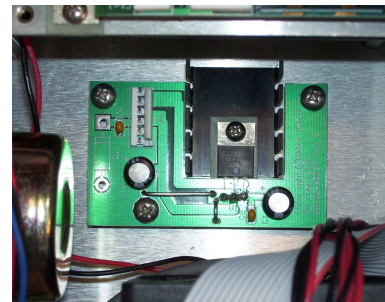
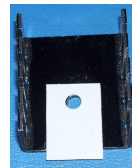

Detail 2. Regulator board mounting

- () Attach the 5V Regulator Board to the chassis with three 6-32 x 1/4" SEMS screws. Do not tighten them yet. Note: some older chassis bottoms cannot accept a 6-32 screw in the mounting hole closest to the front of the chassis. Just omit this screw.
- () Solder U1 into place on the 5V Regulator board.



- () Tighten the three 6-32 screws and the 4-40 screw.
- () Locate the "DCDIST-REG" (CA3) cable provided with the 5V Regulator Board kit. Attach the 6-pin connector to J1 on the 5V Regulator Board and the 3-pin connector to J15 on the DCD board.
- () Solder one pin of a gas discharge tube and a 1.5" length of 18 AWG bare wire to each SO-239 antenna connector's center terminal. Connect the other end of each tube to the #10 solder lug as shown in Detail 3. Dress the parts neatly along the chassis and be careful they do not short to each other or to the chassis. Solder the other end of the bare wires into the pads labeled ANTA and ANTB. Refer to the lettering on the back of the tray for reference.



Detail 3. Gas discharge tube mounting

- () Attach the front left corner of the DCD/Tuner tray to the chassis bottom as shown in the inset drawing in Pictorial 3, using a 6-32 x 2" hex female/female spacer, a #6 x

.05" Nylon spacer, a 6-32 x 1/2" screw on top and a 6-32 x 1/4" PL screw on the bottom.

- () Attach the DCD/Tuner Tray to the left large bracket using two 6-32 x 1/4" PL screws.
- () Attach the Anderson Powerpole clamp to the back panel using one 6-32 x 1/4" PL screw. Insert the small tab on the clamp into the opening between the red and black connectors.
- () Attach the plastic finger guards and metal EMI shields to the outside of the Exhaust Plate using four 6-32 x 1/2" screws and four 6-32 KEPS nuts for each guard. When instructed by the manual, insert the hole plug or fuseholder into the bracket too. When complete, the plate should look like Detail 4A and 4B:

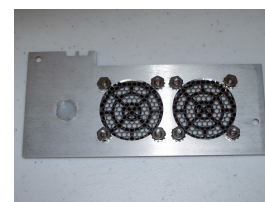

Detail 4A. Exhaust plate assembly, inside view



Detail 4B. Exhaust plate assembly, outside view



STEP-BY-STEP ASSEMBLY - Initial Tests

If you purchased the 100W PA:

() Attach a fuseholder (provided with the amplifier kit) to the Fan mounting plate using the provided plastic nut. The rubber washer goes on the outside of the back panel. Tighten it securely.

() Insert a 25A 3AG fuse into the fuseholder and attach the cap.

Note: If you did not purchase the 100W PA, you can place a battery inside and bring its power cable out the fuse hole. A 1/2" hole plug is provided to cover this hole if you do not plan to use a battery.

() Attach the Exhaust plate to the back panel using two 6-32 x 1/4" PL screws, inserting the small tab at the top between the red and black power connectors.

() Connect the DCD Regulator Cable that is coming from the TO-220 heatsink assembly on the chassis to J15 on the DCD board.

() Locate CA1, the on/off switch with attached cable. Connect the 5-pin connector to J4 on the DCD/Tuner board. Let the other end hang loose, but be careful not to short it to the chassis. (If this cable

is not available, short pins 4 and 5 together on J4. These are the two pins closest to the orange Resettable fuse.)

() Run the left fan cable along the left side of the DCD tray and push it onto J5. Dress the center (transmitter compartment) fan cable under the left bracket and plug it onto J6.

() Locate the pre-assembled Anderson Powerpole cable in the Cable bag. Attach it to the connectors on the back panel and connect the other end to a DC power supply that is capable of delivering 4A at 9-15VDC. (Red to positive.)

() Apply 12VDC power to the rig. Push the on/off switch. The green LED inside the on/off switch should light and the fans should run with air moving from front to back. Remove power immediately if you smell smoke or see anything wrong.

() Using a voltmeter, verify that you can measure the applied power supply voltage between the pad marked "V+ To P.A." near the back of the DCD/Tuner board and chassis ground.

() Using a voltmeter, measure the voltages on J10 (Rx) of



Measurement point	Voltage
J10 pin 1	5.0V +/- .15V
J10 pin 2	-9.5V +/- .5V
J10 pins 3 and 5	0.0V +/- .05V (ground)
J10 pin 4	Applied voltage (9-15V)
Anode (unbanded side) of D7	0.25 * applied voltage
Cathode (banded side) of D9 and D5	2.7V +/- 0.2V
Junction of R24 and R25	0.17 * applied voltage

Table 1. DC Voltages on DCD/Tuner board

the DCD/Tuner board. They should agree with the voltages in Table 1. If any voltages are incorrect, refer to the troubleshooting guide in the Service Manual.

- () Slowly lower the input voltage. As it reaches about 11V, the on/off switch should turn red. Below about 10V it should go off. Now slowly

raise the voltage. Power should come back on once the voltage reaches about 11V and the light should turn green once it reaches 12V. If this does not happen, refer to the troubleshooting guide in the Service Manual.

- () Push the on/off switch to the off position and verify that the power LED goes off.





STEP-BY-STEP ASSEMBLY: Front Panel Integration Models without controls

If you have purchased a Sienna *with* front panel controls, (SF-100 models), go to page 38.

If you are upgrading an existing Sienna by adding a full front panel:

- () Remove power from the connectors at the back of the unit.
- () Remove the top cover.
- () Remove the 4 screws along the bottom of the front panel that hold the front panel to the chassis.
- () Remove all cables from the controller board.
- () Disconnect the on/off switch

from the DCD/Tuner board and push the connector through the hole in the front bracket.

- () Remove the front panel assembly from the unit.
- () Carefully remove the controller board from the existing front panel. Observe static control precautions while handling this board. The controller is attached with six 6-32 x 1/4" SEMS screws.
- () Discard the old front panel.

Go to page 38.

Refer to Pictorial 4 for the following steps. (See Parts List in Appendix D1).

- () Remove the controller board carefully from its anti-static bag and observe static control precautions while handling this board. Attach the controller board to the front panel using six 6-32 x 1/4" SEMS screws.

- () Clean any oil residue off the front panel sheet metal with a tissue or clean, dry towel.

- () Remove the backing from the front panel Lexan® overlay and attach it to the front panel sheet metal, aligning it carefully before pressing hard to stick it to the sheet metal.

Go to page 43.

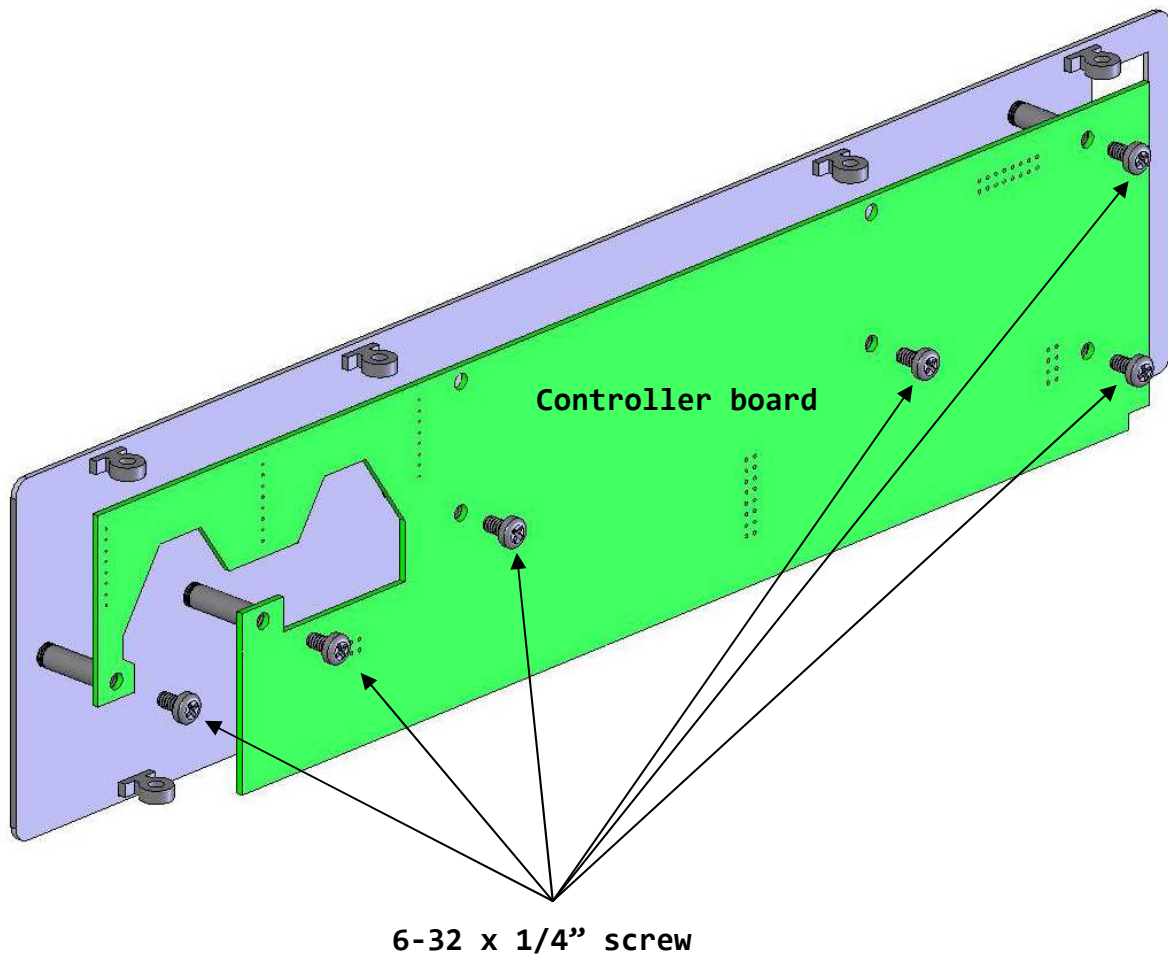

Pictorial 4



STEP-BY-STEP ASSEMBLY - Front Panel Integration Models with controls

- () Remove the front panel assembly from its anti-static bag. It has been partially assembled for shipment. Remove and save the nuts and lockwashers holding the rotary pulse generators (RPGs) on, then set the polycarbonate overlay in a safe place. Unscrew the several screws holding the controller board to the front panel. Remove the controller board and re-insert it by itself into the bag for safe-keeping. Remove the remaining screws holding the front panel to the sheet metal.
 - () Build the Front Panel board (See Appendix D).
- Refer to Pictorial 5 for the following steps.
- IMPORTANT! It is very easy to mistake the 1/2" spacers for 7/16" spacers. Be sure you use the right ones where called out. Measure them if you need to!***
- () Attach two 6-32 x 1/2" hex male/female spacers to the top two Vacuum Fluorescent Display (VFD) mounting holes and secure with 6-32 KEPS nuts.
 - () Place the front panel sheet metal upside down on a towel or other smooth surface. Now place the VFD over the large rectangular opening with the glass facing down and connectors to the right. Line up the two bottom mounting holes with the two short captive standoffs on the sheet metal. Insert two 6-32 x 1/2" hex male/female spacers in the bottom two holes, with the threads going into the standoffs on the sheet metal.
 - () ***Make certain that the nut and washer on the rotary switch have been removed and saved, and that the tab has been bent so it does not face out.***
 - () Push the front panel board onto the back of the steel front panel. Attach it with four 6-32 x 7/16" hex male/female spacers, and six 6-32 x 1/4" SEMS screws.
 - () Locate the two analog meters. Push the meters into the back of the steel front panel (meter faces visible from the front). Put the RX meter closest to the side of the sheet metal (left side as viewed from the back) and the TX meter toward the inside (right side as viewed from the back). Handle the front panel sheet metal by the edges to avoid getting oil from your fingers on it. File the

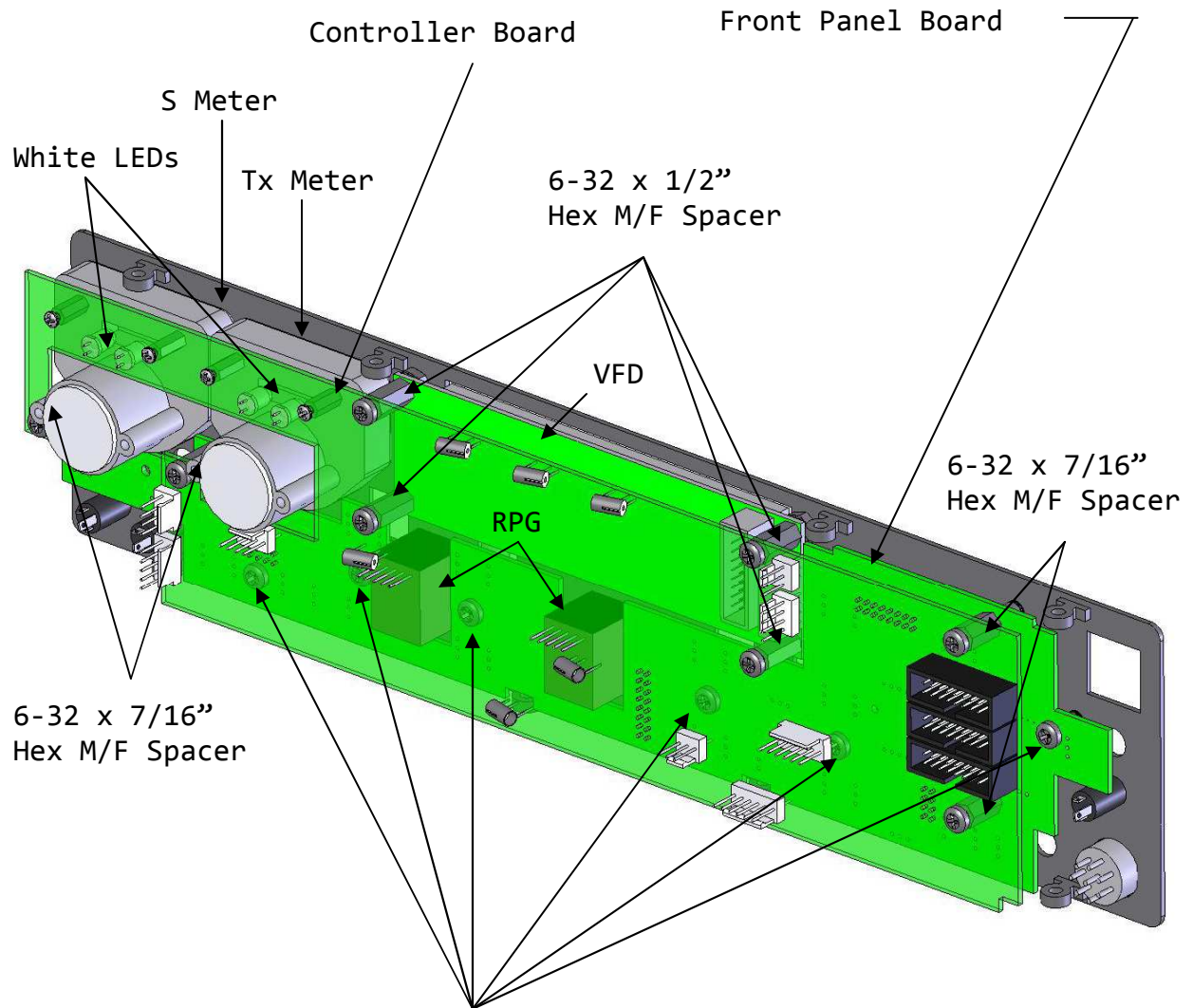

6-32 x 7/16"
Hex M/F Spacer

Six 6-32 x 1/4" SEMS screws secure
front panel board to sheet metal

Eight 6-32 x 1/4" SEMS
screws secure control-
ler to VFD and front
panel board

Pictorial 5



edges of the holes if necessary so that the meters snap in firmly without being crooked.

For the following steps, be sure that you are properly grounded and working on a static-free work surface. Static can damage the sensitive control board.

- () Remove the controller board from its anti-static bag.
- () Attach the controller board to the front panel assembly. A fair amount of pressure is required to align the five connectors (four to the front panel and one to the display) while aligning the RPGs with their holes in the sheet metal. Push and wiggle the board gently but firmly until all connectors are lined up. The board may flex a little during this process. Once snug, tighten the controller to the front panel and display using eight 6-32 x 1/4" SEMS screws.
- () Fasten the meters to the controller board using four 2-56 nuts and lockwashers.
- () ***Make certain that the nut and washer on the rotary switch have been removed and saved.***
- () Clean any oil residue off the front panel sheet metal with a tissue or clean, dry towel.
- () Remove the backing from the front panel Lexan® overlay and attach it to the front panel sheet metal, aligning it carefully before pressing hard to stick it to the sheet metal. Smooth it carefully to avoid having air bubbles form in it.
- () Attach the RPG nuts and lockwashers to the two RPGs and tighten. Do not over-tighten to avoid dimpling or cracking the overlay.
- () Attach the nut and washer to the rotary switch and tighten the nut.
- () Do not attach knobs at this time in the event you need to disassemble the unit for any reason. They will be attached during final integration.



STEP-BY-STEP ASSEMBLY - Connect Controller Cables

Make sure that no DC power is applied to the DC input connectors on the back panel while you connect internal cables. Do not simply rely on the on/off switch being off, because you could accidentally bump it to the ON position while working on the cables.

If you have purchased the full front panel:

- () Run the free ends of the meter cables through the large rectangular hole on the right of the front bracket and into the Receiver compartment.
- () Remove the knurled nuts from the minijacks on the CONT-FPKEY (CA11) cable. Insert the minijacks into the front panel with the minijack having all three pins attached to wires into the hole marked **Paddles** and the other one into the hole marked **Manual**. Fasten the knurled nuts tightly against the front panel. Do not overtighten to avoid dimpling the polycarbonate overlay. Connect the free end of CA11 to J32 on the controller board.

If you have purchased the transmitter:

- () Insert one end of a 20.5" gray ribbon cable (CONTDATA-TX – CA21) into the top of three 16-pin connectors, J2 (Tx), on the Controller board. Dress the other end through the top rectangular hole in the front bracket. Fold the cable at a right angle close to the DCD/Tuner board. Fold it over 90 degrees downward into the transmitter compartment. Fold it again at right angles such that it runs along the middle of the left bracket toward the back.



- () Locate the 10" stereo minijack to 3-pin IDC connector (RX-HP – CA24). Remove the knurled nut and save it. Pass the minijack through the front panel hole on the far left side with a headphone symbol next to it. Reattach the nut and tighten securely. Pass the IDC end through the round hole on the upper right side of the front bracket.
- () Locate the 8-pin microphone connector to 6-pin IDC and 2-pin stereo cable (CONT-MIC – CA16). Remove the nut and lockwasher. Insert the 6-pin IDC connector and stereo cable through the mic hole in the bottom left of the front panel. Pass the long cable through the lockwasher and then the nut and then do the same for the 6-pin IDC connector. Tighten the nut on the back side of the panel. Attach the 6-pin connector to J20 on the controller board. Pass the shielded cable through the bottom of the two rectangular holes on the left side of the front bracket, then under the large left bracket and into the transmitter compartment. Note that this cable is provided whether you have the transmitter or not. This allows you to use a hand-held mic to increment or decrement the operating frequency using buttons commonly available on some hand mics.
- () Locate the 16" 4-pin IDC cable (CONT-TXVM – CA18). Connect one end to J7 on the controller board. Pass the other end through the round hole under the fan in the front bracket and into the Transmitter compartment. If you did not purchase the transmitter, pass this cable under the left bracket and into the Power compartment. Connect CA18 to J8 (labeled "TXVM (no Tx)").
- () Unplug the 5-pin on/off switch cable from the DCD/Tuner board. Insert this cable assembly through the square opening in the upper left of the front panel assembly, IDC connector first. Finally, push the on/off switch into the hole until it snaps into place. Insert the IDC connector through the rectangular opening in the front bracket and push it onto connector J4 (on/off) on the DCD/Tuner board.
- () Locate the 15" triple stereo minijack to 5-pin IDC cable (CONT-RPKEY – CA13). Pass the 5-pin IDC through the round hole at the bottom right side of the front bracket and connect it to J3 on the controller board. Run the cable

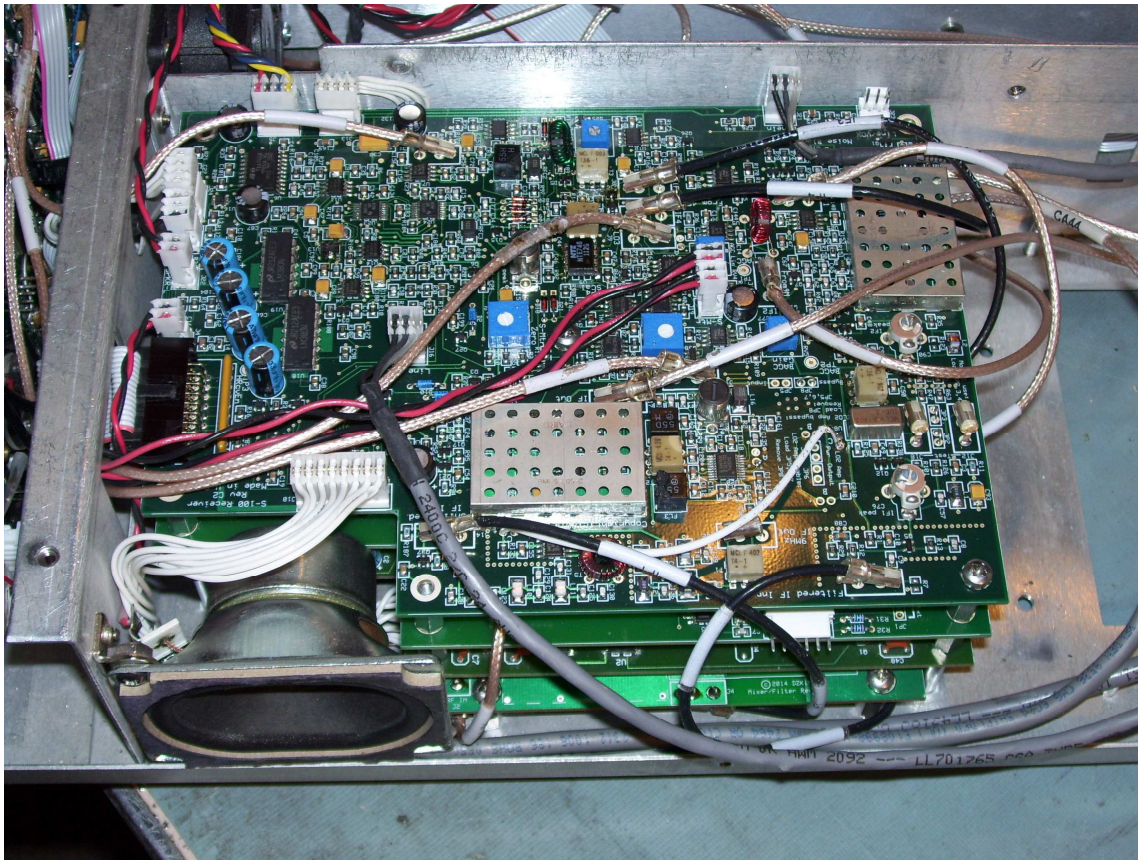

Pictorial 6. Completed unit showing cable dress from controller



along the bottom of the chassis and under the bottom right side of the small bracket. Remove the three knurled nuts and save them. A white wire is connected to all three connectors. In addition to this wire, one connector has a black wire, one a red wire and the other has white and green wires. Insert the one with the black wire into the hole labeled *Keypad*. Insert the one with the red wire into the hole labeled *Manual*. Insert the other into the hole labeled *Paddles*. Tighten the nuts carefully.

- () Locate a 6 1/2" 4-pin IDC cable (CONT-RXVOXST – CA14). Connect one end to J11 (ST/VOX) on the Controller board. Dress the cable through the round opening on the upper right side of the front bracket.

In the next steps you will connect some RF cables. These connectors can be a little tricky to insert into the mating connectors on the PC boards, and they can work loose if inserted and removed more than about 20 times. They have a friction fit and must be aligned perfectly to go in. Once aligned, a gentle but firm push will seat them. Using your fingernails on the "ears" of each cable's connector will help you push them in. Be sure that any strands at the end of the center conductor

of the cables are either clipped or lined up with the centerline to avoid difficulty getting the center pin into the mating hole. Once you see how to get the first one in properly, the rest will be easier.

- () Insert RF cable RXL01 into J24 (RXL01) on the Controller board. Dress the cable through the large rectangular hole on the right side of the front bracket.
- () Insert RF cable RXL02 into J25 (RXL02) on the Controller board. Dress the cable through the large rectangular hole on the right side of the front bracket.
- () Insert RF cable RXL03 into J26 (RXL03) on the Controller board. Dress the cable through the large rectangular hole on the right side of the front bracket.
- () Insert RF cable RXL04 into J23 (RXL04) on the Controller board. Dress the cable through the round hole on the upper right side of the front bracket.
- () Insert RF cable TXVF0 into J22 (TxVF0) on the controller board. Insert the other end through the round hole in the front bracket and into the transmitter compartment. Put a small piece of heatshrink tubing over the end and heat



it, so that the connector does not touch the chassis.

- () Insert RF cable TXBF0 into J27 (TXBF0) on the controller board. Insert the TXBF0 cable through the round hole in the front bracket and into the transmitter compartment. Put a small piece of heatshrink tubing over the end and heat it, so that the connector does not touch the chassis.

If you have purchased the transmitter:

- () Locate a 3-pin IDC cable (CONT-TUNER – CA17) and connect one end to J21 (SWR) on the controller board and the other to J3 (Fwd/Ref1) on the DCD/Tuner board.
- () Connect the 6-pin IDC connector on CA12 (RS-232 cable) to J4 (RS232C) on the Controller board.
- () Insert one end of an 8" gray ribbon cable (CONTDATA-TUNER – CA22) into the *bottom* of three 16-pin connectors, J18, on the controller board. Dress the other end through the rectangular hole in the front bracket. Make two right-angle folds in the cable close to the DCD/Tuner board so that the cable enters the DCD/Tuner board lined up with connectors J1 and J2. Insert the end of

this cable into J1 on the DCD/Tuner board.

- () Locate a 14.5" gray ribbon cable having one connector on one end and two on the other end (CONTDATA-RX-BPF – CA20). Push the end with one connector into the *middle* of three 16-pin connectors, J15, on the Controller board. Fold the cable at a right angle and dress the cable along the underside of the top fold in the front bracket. Fold the other end at a right angle and position it in front of the large rectangular opening on the right side of the front bracket.
- () Locate a 10" 3-pin IDC cable (DCDIST-CONT – CA2). Connect one end to J1 (Power) on the Controller board. Run the other end through the rectangular hole on the left side of the front bracket and into the DCD compartment. Connect CA2 to J9 on the DCD/Tuner board.
- () Temporarily attach the front panel assembly to the chassis bottom using two 6-32 x 1/4" screws. (Four are used when assembly is complete - these just hold it down while you work on other things.)
- () If you have a full front panel, make sure that jumpers JP1 and JP2 are NOT installed on the controller board.



STEP-BY-STEP ASSEMBLY-Front Panel/Controller Tests

Units with full front panels

These jumpers are located near the meters. If the jumpers are in place, remove them and reinsert them with only one pin making contact. This is a handy way to keep them with the radio so they won't get lost.

- () Turn on the radio by applying DC power to the APP connectors on the back panel and pushing the on/off switch.

NOTE! The LED backlights behind the meters should flash briefly and then go out. Do not be alarmed at this! They can be turned on at various degrees of brightness using the menu system. Refer to the User's Manual for more information.

- () The front panel pushbuttons

should light up briefly and then go out. The display should show a frequency of 14.00000 MHz.

- () Push all buttons one at a time and note the response. The LEDs inside the buttons should light when you push the button. Turn the controls to observe their responses. At this point, since you have not yet installed the receiver or transmitter, many of the front panel controls will not seem to do anything. That's OK. As long as it lights up and some buttons respond, you can be sure that the controller and front panel boards are working.
- () Turn off the power and remove the DC inputs.



STEP-BY-STEP ASSEMBLY-Front Panel/Controller Tests

Units without full front panels

- () If you do NOT have a full front panel, make sure that jumpers JP1 and JP2 ARE installed on the controller board.
 - it for 9600 baud, 8 bits, no parity, 1 stop bit, no hand-shake.
- () Enter the following commands:
 - ID; { Response: ID710; }
 - FA; { Response: FA00014000000; }
- () If using an external PC to control the rig, connect its RS-232 port to the DB9 connector on the back panel.
 - If you want to experiment with other commands to observe the responses, consult the Sienna Operator's Guide.
- () Turn on the radio by applying DC power to the APP connectors on the back panel and pushing the on/off switch.
 - () Turn off the power and remove the DC inputs.
- () From the PC, start the "Hyperterm" program and set



STEP-BY-STEP ASSEMBLY-Receiver Integration

Refer to Pictorial 7A for the next step.

- () Insert the cable labeled CA35 (“RF1”) into J2 (“RF In”) on the roofing filter board.
- () Insert the cable coming from the controller labeled CA36 (“RXLO1”) into J1 (“LO”). Route it beneath the speaker.
- () Insert the other two cables that are included in the roofing filter bag into connectors J3 (“Filtered Out”) and J4 (“Unfiltered Out”).
- () Install the roofing filter board on the two short stand-offs in the receiver compartment. Use two 6-32 x 1/4” SEMS screws that are included with the roofing filter board.

Refer to Pictorial 7B for the following steps.

- () Build the IF Filter board (See Appendix E).
- () Locate the 4" 8-pin IDC cable (RX-IFFILT – CA26). Connect one end to the IF Filter board. Leave the other end disconnected for now.
- () Install the IF Filter board on the 6 tall standoffs in the receiver compartment with the filters facing down. Use six 6-32 x 5/8" hex male/female spacers to secure the board. Tighten the spacers securely, but do not overtighten to avoid damage to the PC board.
- () Dress the 8-pin cable under the speaker and around to the top as shown.
- () Install any standard and optional filters. See Appendix K for information on how to install them and tell the control firmware they are there. Be careful not to let the unconnected wires touch circuitry on the board.
- () Perform the IF Filter test procedure as described in Appendix L.
- () Attach cables IF1 to J2 (9MHz In), IF2 to J3 (9MHz Out), IF3 to J4 (455kHz In) and IF4 to J5 (455kHz Out) on the IF Filter board.
- () Build the RXBPF board (See Appendix F).
- () Locate the 2.5" 4-pin IDC cable (RX-BPFDC – CA25). Connect one side to J1 on the RXBPF board with the cable extending upward.
- () Lay the RXBPF board on top of

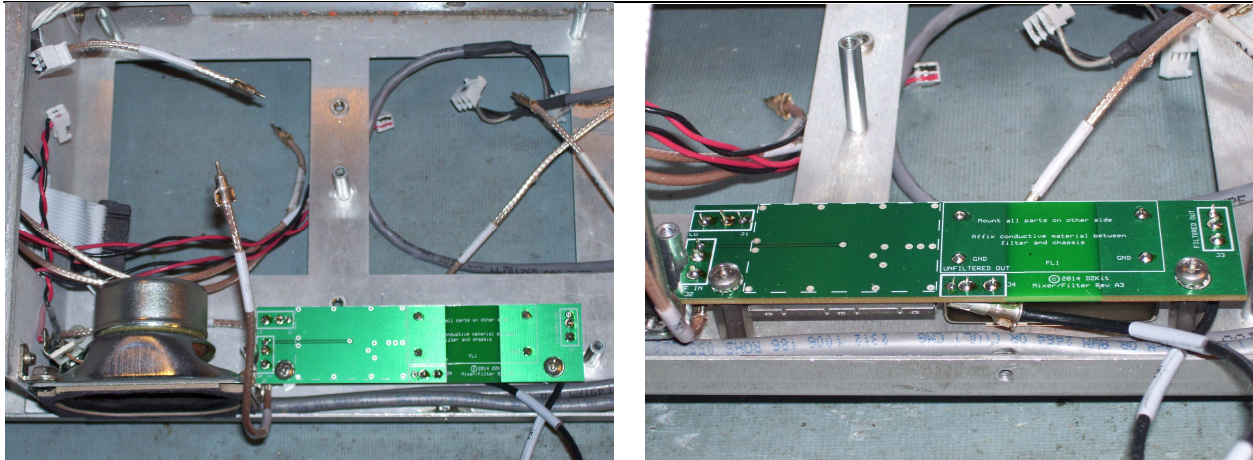

Pictorial 7A. Roofing Filter Board Mounting

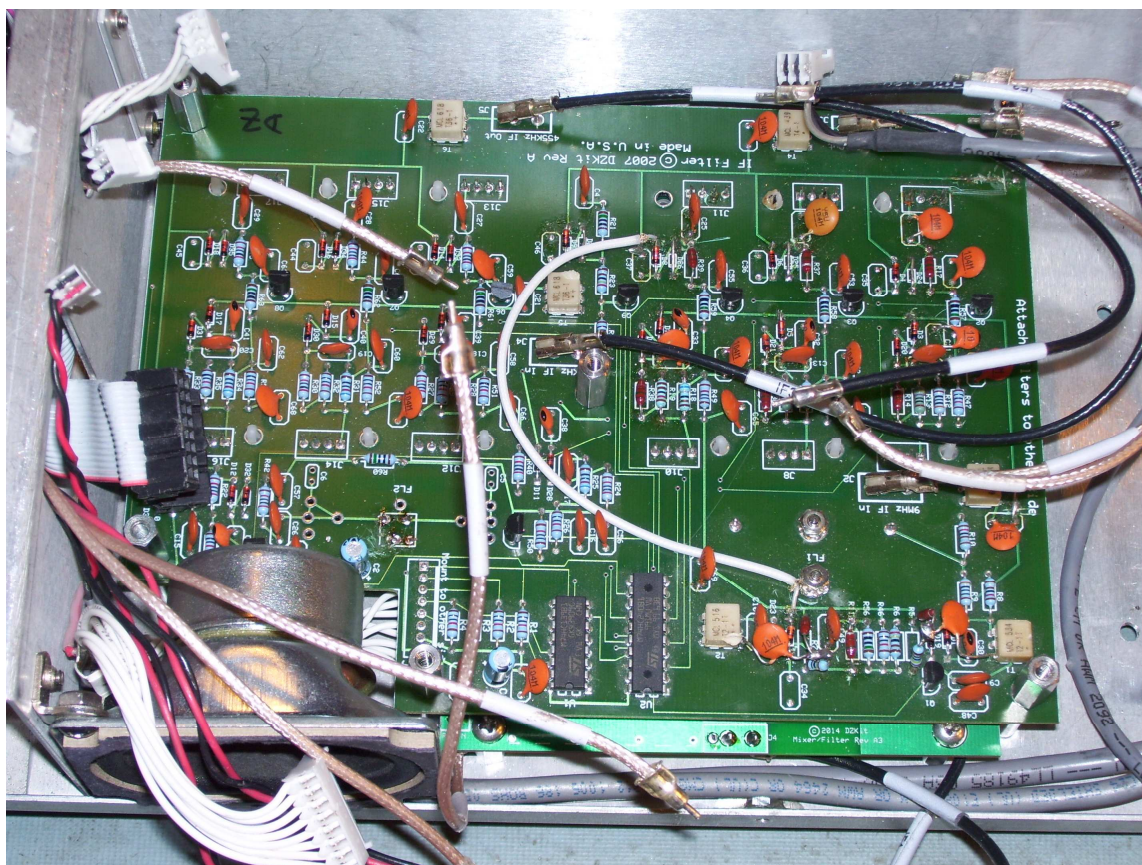

Pictorial 7B. IF Filter Board Mounting

Note: The white jumper and the modifications shown are no longer present. This photo was taken before new boards were available.



the 5/8" hex male/female spacers, moving cables IF1-4 out of the way so that they extend out beyond the back end of the boards. Secure the RXBPF board with six 6-32 x 5/8" hex male/female spacers. Tighten the spacers securely, but do not overtighten to avoid damage to the PC board.

- () Remove the mounting nut and solder lug from a BNC connector and insert the connector from the outside of the back panel at the location marked "RX ANT". Reattach the solder lug and nut and tighten it. Bend its solder lug at a 45 degree angle. (See photo below)
 - () Solder a gas discharge tube between the BNC center conductor and the solder lug. Be careful not to short the metal ends to the chassis.
 - () Attach the phono connector to the back panel at the hole marked IF OUT with the solder lug positioned to the right as shown in the photo below. Tighten the nut.
 - () Solder the center conductor of the RXANT cable to the center terminal of the BNC connector. Solder the braid to the solder lug. If the braid does not reach easily, add a short piece of hookup wire as shown in the photo.
- () Solder the center conductor of the IFOUT cable to the center terminal of the phono connector. Solder the braid to the solder lug.
 - () Pass the other end of the RXANT cable through the large round hole in the small bracket and insert it into the RF connector labeled J3 (Rx Antenna) on the RXBPF board.
 - () Leave the other end of the IFOUT cable unconnected for now.
 - () Connect the bottom of the two connectors at the end of the gray ribbon cable to J5 on the RXBPF board.
 - () Insert RF cable RXBPFMAIN-TX into the RF connector labeled J2 (Main Antenna) on the RXBPF board. Dress the other end of this cable through the large round hole in the small bracket and into the aux compartment, then into the top round holes in large bracket right, large bracket left and into the DCD/Tuner compart-





- ment. Connect the end to J11 on the DCD/Tuner board.
(Note: if you plan to add the transmitter later, this is a temporary connection so that you can test the receiver.)
- () Connect the bottom of the two connectors on the ribbon cable to J5 on the RXBPF board.
 - () Perform the RXBPF test procedure described in Appendix M.
 - () Build the Receiver board (See Appendix G).
 - () Remove the 4-pin power connector from J8 on the RXBPF board (“From DCD (test)”) and place it out of the way while installing the Rx board.
 - () Carefully place the receiver board on top of the six hex standoffs. Secure it with six 6-32 x 1/4" SEMS screws. Make sure no cables are stuck or pinched beneath the board.

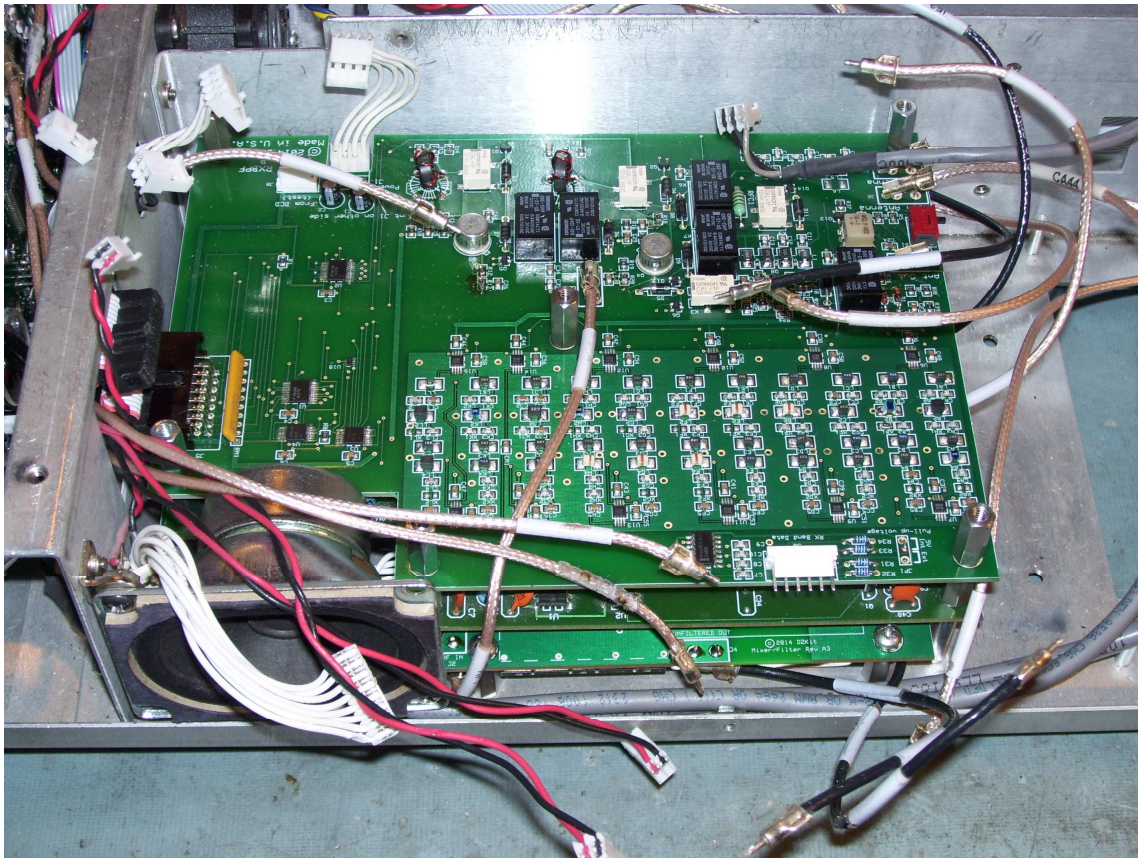

Pictorial 7C. RXBPF board mounting and cable connections



Refer to Pictorial 8 for the following steps.

If you have installed the full front panel:

- () Connect the 2-pin connector coming from the S-meter to J19 (Meter) on the Receiver board.
- () Connect the 2-pin connector coming from the Tx Meter to J25 (Tx Mtr) on the Receiver board. This meter is present even if you did not purchase the transmitter.
- () Connect the cable that is wired to the headphone jack (RX-HP – CA24) to J6 (Phones) on the receiver board.
- () Locate the IDC cable that is connected to J11 (CONT-RXVOXST – CA14) on the Controller board. Connect the other end to J24 (Sidetone/VOX) on the Receiver board.
- () Locate the 2.5" 4-pin IDC cable coming from the RXBPF board (RX-BPFDC – CA25). Connect it to J13 on the Receiver board.
- () Locate the 3" 8-pin IDC cable coming from the IF filter board (RX-IFFILT – CA26). Connect it to J10 on the Receiver board.
- () Locate the 10" 3-pin IDC cable labeled RX-TXLINE (CA29). Attach one end to J23 (Line/VOX) on the receiver board. Run the other end through the large round hole in the small bracket and then through the round hole in the right bracket and into the Transmitter compartment.
- () Locate the 10" stereo minijack to 3-pin IDC cable (RX-RPLINEIN – CA30). Remove the knurled nut from the minijack and save it. Connect the IDC end to J21 (Line In) on the Receiver board. Pass the other end through the large round hole in the small bracket and through the hole in the back panel labeled "Line In". Reattach the nut and tighten securely.
- () Locate the 15" stereo minijack to 3-pin IDC cable (RX-RPLINEOUT – CA31). Remove the knurled nut from the minijack and save it. Connect the IDC end to J16 (Line Out) on the receiver board. Pass the other end around the right side of the receiver stack, under the right side of the small bracket and through the hole in the back panel labeled "Line Out". Reattach the nut and tighten securely.
- () Insert RF cable IF1 coming from the IF Filter board into J17 (IF1-To 9M) on the Re-

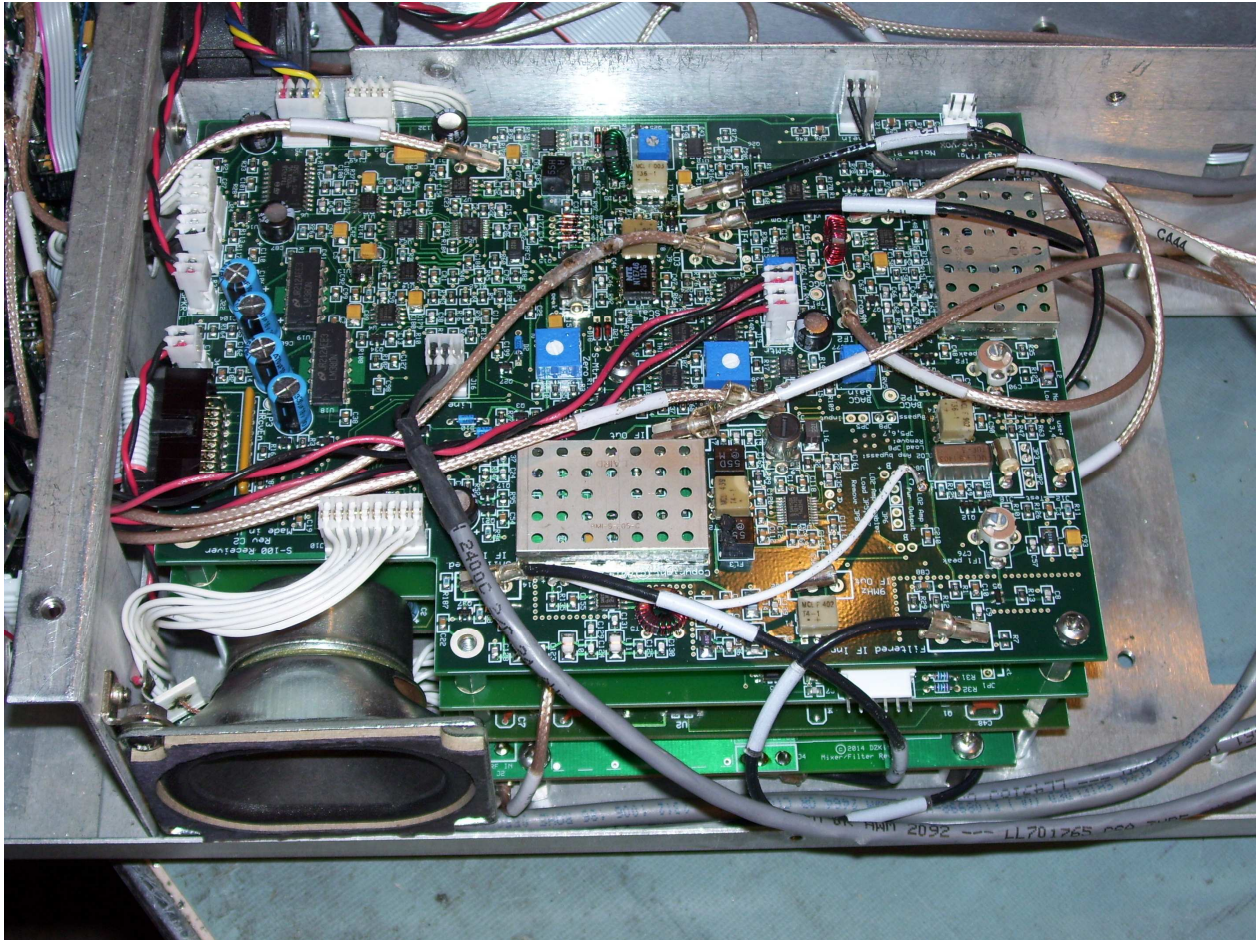

Pictorial 8. Completed receiver stack



ceiver board.

- () Insert RF cable IF2 into J11 (IF2-From 9M) on the Receiver board.
 - () Insert RF cable IF3 into J8 (IF2-To 455) on the Receiver board.
 - () Insert RF cable IF4 into J7 (IF2-From 455) on the Receiver board.
 - () Insert RF cable RXLO2 into J15 (marked L02) on the Receiver board.
 - () Insert RF cable RXLO3 into J9 (marked L03) on the receiver board.
 - () Insert RF cable RXLO4 into J1 (marked L04) on the receiver board.
 - () Locate the IF OUT cable (CA42) that was left unconnected in an earlier step. If you want the output signal to be at the 9MHz IF, insert the free end into J32 (9MHz IFOut), otherwise insert it into J26 (455kHz IFOut) on the receiver board.
 - () There are two cables labeled IF1 coming from the right side of the roofing filter board. Insert the one closest to the front into J14 (Unfiltered IF Input). Insert the other one into J2
- (Filtered IF input).
- () Connect the top connector on the CONTDATA-RX-BPF ribbon cable (CA20) into J3 on the receiver board.
 - () Locate a 10" 4-pin-5-pin IDC cable (DCDIST-RX – CA51). Connect the 5-pin end to J10 (Rx) on the DCD/Tuner board. Dress this cable along the top of the unit, around the fan and into the receiver compartment. It is important that this cable not protrude above the fan so that it does not get pinched when the top cover is installed, so position it in the gaps around the back and sides of the fan. Connect the 4-pin end to J5 (Power) on the Receiver board.
 - () Dress the left speaker cable along the top of the chassis, next to the fan, and plug the connector into J22 (SPKR-L) on the Receiver board.
 - () Dress the right speaker cable along the top of the Receiver board and plug the connector into J4 on the board.
 - () Verify that all connections are solid, screws are tightened, and no loose wires are touching the board. If all appears good, you're ready to try the receiver!



The receiver board uses two types of variable resistors, or trimmer potentiometers, called “trimpots”. These trimpots are normally set very close to their midpoint when shipped. When we refer to their settings, we use the terms “7:00” to “5:00”, as if you were setting the time on a 12-hour analog clock. 12:00 is the midpoint. See pictures below. Both of these trimpots are at the 12:00 position.

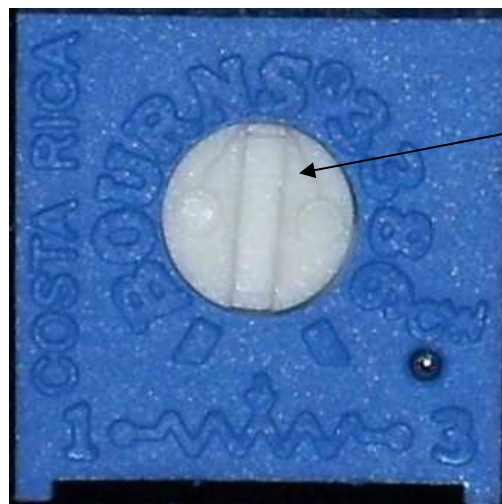

Arrow



Dots

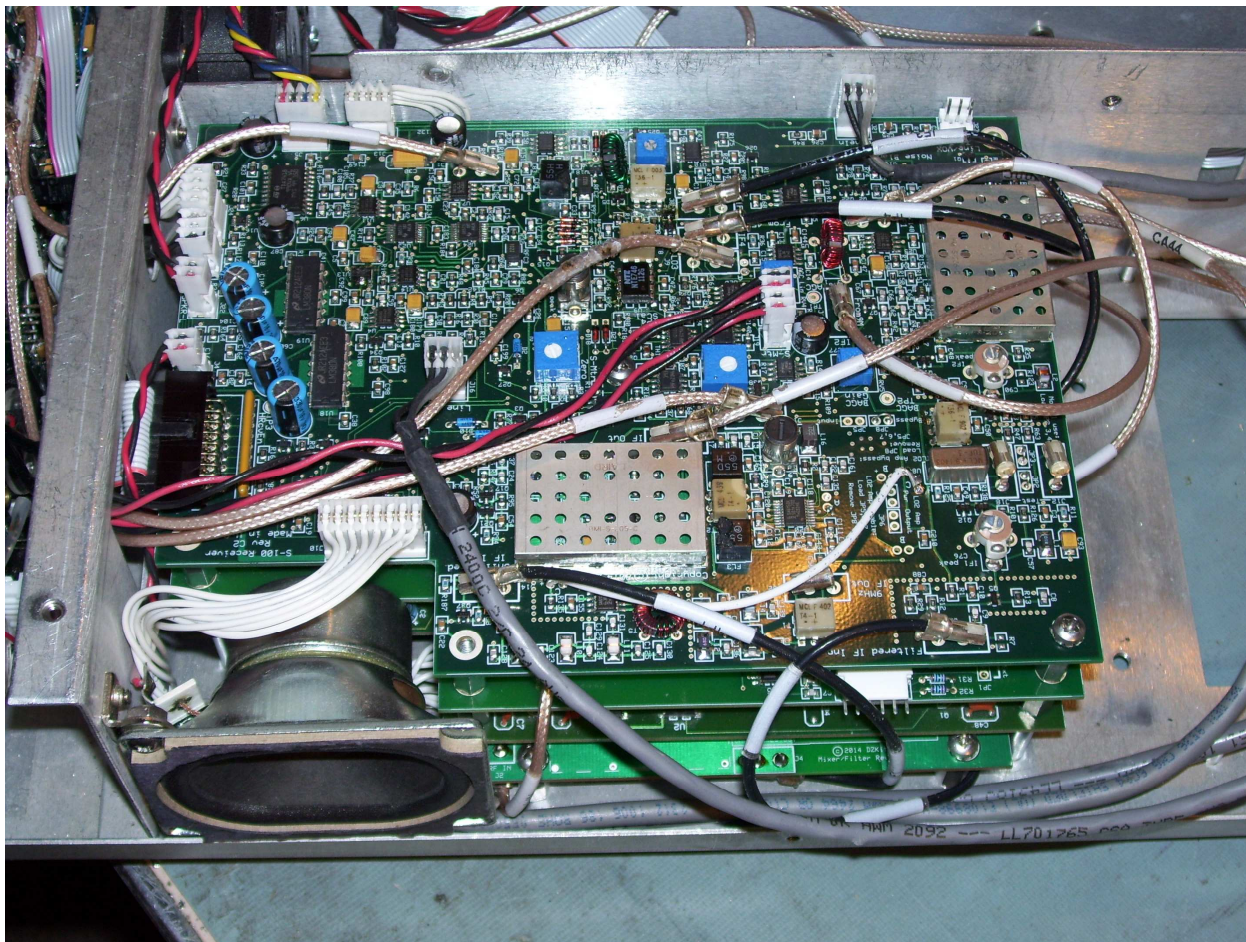

Rx stack (above)

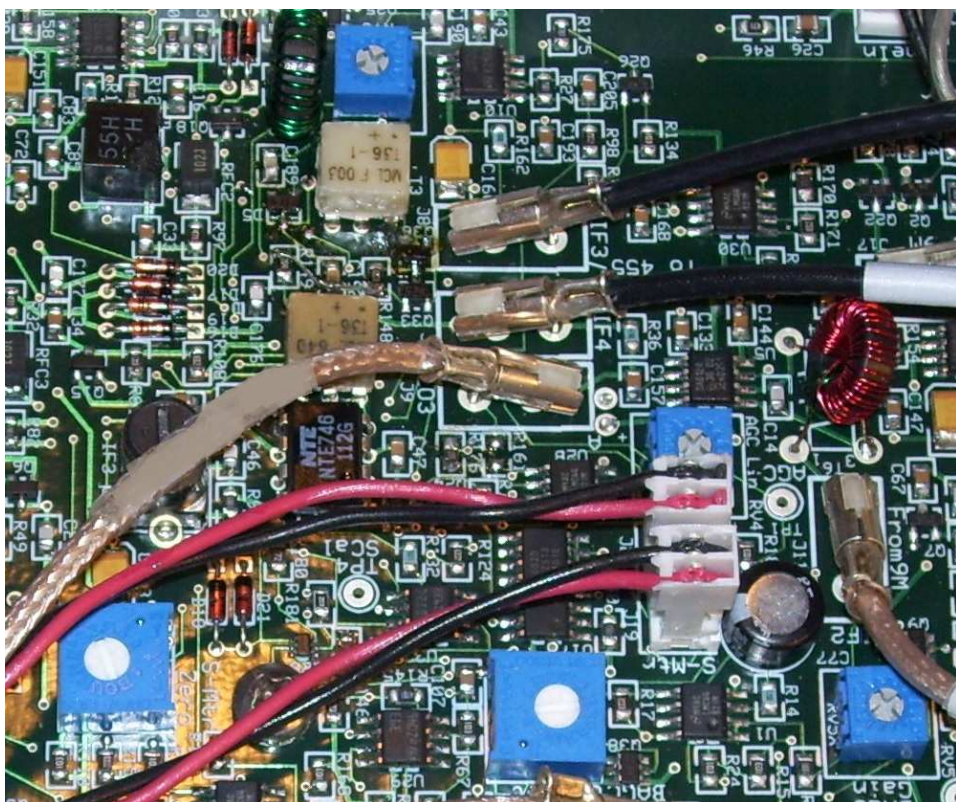

Trimpots (right)



STEP-BY-STEP ASSEMBLY - Receiver Alignment/Tests

Using full front panel

If you have a blank front panel, go to page 59

When so instructed, connect a voltmeter to the test points described below (red to the noted test point, black to any point on the chassis).

If you are using an S-100 model (no front panel controls), go to page 59.

The radio should be off before starting these steps.

- () Temporarily disconnect the 5-pin power cable from the DCD/Tuner board (J10) that goes to the 4-pin connector J5 on the Receiver board (DCDIST-RX - CA51).
- () On the 5-pin connector at the end of CA51, measure the resistance between pin 1 and ground. (Use the exposed metal pins on the side of the connector.) It should be $>1K$ ohms. Now measure the resistance between pin 2 and ground. It should read >400 ohms. Finally, measure the resistance between pin 4 and ground. It should read $>100K$ ohms. Pin 3 is grounded and should read less than 1 ohm. Pin 5 is not connected and should read open. If you measure incorrect values at any of these points, refer to the troubleshooting section of the Service Manual.
- () Disconnect any antennas from the antenna jacks on the Back Panel.
- () Reconnect the Receiver power cable to the DCD/Tuner board (J10).
- () Connect the TXBFO cable to the Main Antenna input (J2) on the RXBPF board. This feeds a signal of approximately $-13dBm$ (60dB over S9) into the receiver.
- () Make sure that switch S1 on the RXBPF board is set to the "Cal" position. This adds about 50dB of attenuation to the signal, resulting in a $-63dBm$ signal (10dB over S9).
- () Set trimpot RV1 on the Receiver Board to the 11:00 position. Set RV2 to the 2:00 position. Set RV3 to the 11:00 position. Set RV4 to the 1:00 position. Set RV5 to the 3:00 position. See photos on pages 51 and 52.
- () Rotate the NB Thr/FM Sql knob all the way counterclockwise.
- () Set the RF Gain control to the maximum clockwise position.
- () Turn on the radio by applying DC power to the APP connect-



- ors on the back panel and pushing the on/off switch.
- () Turn off both preamps.
 - () Measure the voltages on page 58. If any are incorrect, turn off power, remove the receiver board and check carefully for soldering problems.
 - () If not already set to CW(USB) mode, press PAGE/MODE to allow the mode to be changed, then rotate the small tuning knob to select CW(USB) mode. Press PAGE/MODE again to exit. If the frequency is not already on the 20M band, press BAND and rotate the large tuning knob until the 20M band (14.000-14.350 MHz) shows in the display. Press FAST and use the small tuning knob to adjust the frequency for 11.985 MHz.
 - () Verify that the receiver noise level increases and decreases as you adjust the Volume control knob. Do not proceed with alignment if you cannot hear any noise.
 - () Make sure the receive antenna is set to use the main antenna ("Rx-T" in the display)
 - () With the Multi-position rotary switch in the Filter position (fully counterclockwise), rotate the Adjust knob to select the narrowest 9 MHz filter present in your rig. If you have only purchased the stock filters, this will be 6kHz. Press the Adjust knob to select the 3rd IF (the asterisk moves to the "4") and select the narrowest 3rd IF Filter. If you have only purchased the stock filters, this will be 5.8kHz. If you have any empty slots, select one of those for either or both of the filters. The goal is to minimize the received noise. If the filters are not centered on the vertical line, put the multi-function switch in position 8 (fully clockwise) and press the Adjust knob, which centers all IFs.
 - () Make sure the AGC setting is Auto ("AGC-Auto" in the display). If not, press MENU, then rotate the large tuning knob (the PAGE/MODE LED will go off) until the AGC selection (bottom left side of display) is highlighted. Rotate the small tuning knob until the AGC setting is "AGC-Auto".
 - () While in the menu, press PAGE/MODE to re-enable menu paging, then rotate the small tuning knob until the menu page appears that has "AGC AM" at the bottom and verify that the value is 160. Change it to that value if it is not. Now go to the page with "RFG Cal (F)" at the top.



Verify that the entries on that page are (top to bottom) 8/13/93/120/166. These are the default values, so they should already be set to these values.

```
RFG cal (F): 8038
RFG cal (S): 133
AGC CW: 93
AGC SSB: 120
S-Mtr cal: 166
```

- () The S-meter should now be reading 0. If it is off slightly, adjust RV2 (S meter Zero) so that the S meter reads exactly zero.
- () Locate the menu page that has the setting "Open Tx", and set it to "On".

```
DspFrg=TXVFO: Off
Open Tx: Off
TCXO Tweak: 128
Mic Gain cal: 250
ALC Thresh: 2
```

This allows the transmitter BFO and VFO to operate outside the ham bands. (Note: It is not intended to allow the rig to be operated outside the ham bands. This is only used for calibration purposes.)

- () A strong tone should now be audible. Adjust the frequency to peak the loudness. If the S-meter moves, adjust the frequency to peak it. This normally occurs at about 11.9849 MHz.

- () Adjust trimmer capacitors C76 and C90 for a peak reading on the S-meter.
- () Using a small flat-blade screwdriver, adjust variable inductor L5 for a peak on the S-meter. This normally occurs with the slug extending out of the top of the can about 1/8". It is not a sharp peak.
- () With the trimpots set as described earlier, you should see about 10dB (almost two S-units) change in the reading when you turn on preamp1 and again with preamp1 and pre2/atten on, and a 10dB reduction with only pre2/atten on. If you have a large difference from this, tweak trimpots RV1, RV4 and RV5 a little at a time until you do see these results. With preamps and attenuator off, the meter should read a little over S9. You can also change the AGC CW and AGC SSB menu settings to fine tune the performance.

- () Turn on the notch filter by selecting Adjust switch position 3 and pushing the Adjust knob. A notch display appears:

```
14170.00 kHz USB
├───┘
```

Dip the S-meter using the Ad-



just knob. Then adjust trim-pot RV3 for a minimum. Once done, turn the Adjust switch back to the first (“Filter”) position.

NOTE: If no dip is observed, change the “Notch cal” menu setting by 25 counts (up or down), exit the menu, and try again. Repeat until the dip is found with the notch display approximately centered.

```
FM/UDX Zero: 128
Rx DDS enab: 1234
Tx DDS enable: UB
Notch cal: 225
AGC AM: 100
```

- () Flip the cal switch on the RXBPF board back to “Rcv”.
- () Locate the menu page with the settings beginning with “Tx Controls”, and set “IFOut/FM” to “Enable”. The exit the

```
Tx Controls: Enab
Rx Ant Out: Off
IFOut/FM: Disable
Ext Rx track: Off
```

menu.

- () Press PAGE/MODE and turn the small knob to select “FM”. Press PAGE/MODE again to exit.
- () Using a small screwdriver, adjust variable inductor L9 (“FM Peak”) about 1/2 turn from the bottom so that the noise peaks. You should be

able to hear a strong “quieted” signal. As you tune around the frequency, the background noise should increase.

Note – After all calibration is done and the receiver is working, if a source of FM is available, you can readjust L9 for the best reception.

- () Reset the frequency to one in the 20M band (e.g., 14.000 MHz).

The above steps calibrate the receiver’s RF gain so that a signal at the antenna of 50uV (-73dBm) causes the S-meter to read S9 when using no preamps. It will not be as accurate when using one or two preamps or the attenuator. Each preamp adds about 10dB of gain, and the attenuator adds about 10dB of loss. You should see about this much movement on the S-meter (a little less than 2 S-units) when you turn these functions on or off. When the transmitter is present, the total loss from antenna connector through the transmitter low pass filters, T/R switch, bandpass filters, preamps (while not enabled) is about 10dB. So, with an S9 signal at the antenna jack, you should expect to see -83dBm at the output of the RXBPF board. If you have an RF signal generator and adjustable attenuator, you can do a more accurate alignment by feeding that signal into the receiver directly, then testing it at various levels.



- () Remove the TXBFO cable and double-female adapter from the RXBPFMAIN-TX/AMP cable and place it in the transmitter compartment. Place electrical tape on the end to keep it from shorting if there is no transmitter there. Connect the RXBPFMAIN-TX/AMP cable between J11 on the DCD board (“From Tx or Amp”) to the Main Antenna input (J2) on the RXBPF board. Route the cable through existing openings in the left and right brackets.
- () Press the “PAGE/MODE” button and select AM by rotating the small knob. Also select the receive antenna by highlighting “Rx-T” (transmit antenna A or B) and changing it to “Rx-R” (Receive Antenna). Press “Page/Mode” again to exit this mode. Connect an antenna to the back panel Rx Antenna input. Exit the menu.
- () Press BAND and rotate the large tuning knob to change bands to 160 Meters (160-1). Press BAND again to exit. Tune in an AM station in the AM broadcast band (e.g., 950 kHz).
- () Re-enter menu mode and select the AGC AM setting.
- () Adjust the value until the station is at a comfortable listening level. You will most likely need to turn off the preamps and may also need to turn on the attenuator depending on the strength of the AM station. (Note – you can use antenna A or B for this, but this also tests the receive antenna path.)

Note – If you have very strong nearby AM stations, they can interfere with the front end of the radio, causing unwanted intermodulation distortion. If this happens, you can enable the 1.8MHz high pass filter on a per-VFO-memory basis. It is located in the filter setup menu:

```
455k Slot 1: 5800
455k Slot 2: 2600
455k Slot 3: none
455k Slot 4: 400
1.8MHz HPF: Off
```

Refer to the Operator’s Manual for a complete discussion on the menu settings.

This completes receiver alignment.

```
FM/VOX Zero: 128
Rx DDS enab: 1234
Tx DDS enable: UB
Notch cal: 225
AGC AM: 100
```



STEP-BY-STEP ASSEMBLY

Receiver Voltage checks

Pin	Voltage (+/-5%)
J5 pin 1	+5.0V
J5 pin 2	-9.5V
J5 pin 4	+11 to +15V
J13 pin 4	10.0V
TP3	>4.0V
U13 (leftmost)	+5.0V
U18 pin 14	+11 to +15V
U19 pin 14	+11 to +15V
U4 pin 8	+4.5V
U4 pin 4	-9.0V
U22 pin 8	+5.0V
Q5 gate 1	+2.0V
Q5 source	+1.9V
Q5 drain	+8.6V
Q20 gate 1	+2.0V
Q20 source	+1.9V
Q20 drain	+8.7V
U25 pin 7	+10.0V
U30 pin 8	+10.0V
U30 pin 4	-5.0V
U5 pin 8	+5.0V
U9 pin 2	+9.5V
U26 pin 7	+9.9V
U7 pin 8	+5.0V
U11 pin 4	+5.0V
U11 pin 11	-5.0V



STEP-BY-STEP ASSEMBLY - Receiver Alignment/Tests

Using remote control

Skip this section if you have a full front panel

When so instructed, connect a voltmeter to the test points described below (red to the noted test point, black to any point on the chassis).

If you are using an S-100 model (no front panel controls), go to page 59.

The radio should be off before starting these steps.

- () Temporarily disconnect the 5-pin power cable from the DCD/Tuner board (J10) that goes to the 4-pin connector J5 on the Receiver board (DCDIST-RX - CA51).
- () On the 5-pin connector at the end of CA51, measure the resistance between pin 1 and ground. (Use the exposed metal pins on the side of the connector.) It should be $>1K$ ohms. Now measure the resistance between pin 2 and ground. It should read >400 ohms. Finally, measure the resistance between pin 4 and ground. It should read $>100K$ ohms. Pin 3 is grounded and should read less than 1 ohm. Pin 5 is not connected and should read open. If you measure incorrect values at any of these points, refer to the troubleshooting section of the Service Manual.
- () Disconnect any antennas from the antenna jacks on the Back Panel.
- () Reconnect the Receiver power cable to the DCD/Tuner board (J10).
- () Connect the TXBFO cable to the Main Antenna input (J2) on the RXBPF board. This feeds a signal of approximately $-13dBm$ ($60dB$ over S9) into the receiver.
- () Make sure that switch S1 on the RXBPF board is set to the "Cal" position. This adds about $50dB$ of attenuation to the signal, resulting in a $-63dBm$ signal ($10dB$ over S9).
- () Set trimpot RV1 on the Receiver Board to the 11:00 position. Set RV2 to the 2:00 position. Set RV3 to the 11:00 position. Set RV4 to the 1:00 position. Set RV5 to the 3:00 position. See photos on pages 51 and 52.
- () Rotate the NB Thr/FM S_q1 knob all the way counterclockwise.
- () Send an RS-232 command to set the RF Gain control to maximum.
- () Turn on the radio by applying DC power to the APP connectors on the back panel and pushing the on/off switch.



- () Send a command to turn off both preamps.
 - () Measure the voltages on page 58. If any are incorrect, turn off power, remove the receiver board and check carefully for soldering problems.
 - () Send a command to set the mode to CW(USB) mode.
 - () Send a command to set the frequency to 11.985 MHz.
 - () Verify that the receiver noise level increases and decreases as you send commands to adjust the speaker volume. Do not proceed with alignment if you cannot hear any noise.
 - () Send a command to set the receive antenna to the transmit antenna.
 - () Send commands to select the narrowest filters in your rig.
 - () Send a command to set the AGC to Auto.
 - () Send a command to set "AGC AM" to 160. Set RFG(F), RFG(S), AGC CW, AGC SSB and S-Mtr Cal to 8/13/93/120/166 respectively. These are the default values, so they should already be set to these values.
- Note: If a 100uA meter is available, it would be handy to connect it temporarily to the S-meter connector.
- () The S-meter connector, pin 1, should now read 0 Volts. If it is off slightly, adjust RV2 (S-meter Zero) so that the S-meter connector reads exactly zero.
 - () Send a command to open the Tx to operation outside the ham bands.
 - () A strong tone should now be audible. Adjust the frequency to peak the loudness. If the S-meter moves, adjust the frequency to peak it. This normally occurs at about 11.9849 MHz.
 - () Adjust trimmer capacitors C76 and C90 for a peak reading on the S-meter.
 - () Using a small flat-blade screwdriver, adjust variable inductor L5 for a peak on the S-meter. This normally occurs with the slug extending out of the top of the can about 1/8". It is not a sharp peak.
 - () With the trimpots set as described earlier, you should see about 10dB (almost two S-units) change in the reading when you turn on preamp1 and again with preamp1 and pre2/atn on, and a 10dB reduction with only pre2/atten on. If you have a large difference from this, tweak trimpots RV1, RV4 and RV5 a little at a time until you do see these results. With preamps and at-



tenuator off, the meter should read a little over S9. You can also change the AGC CW and AGC SSB menu settings to fine tune the performance.

- () Set a command to turn on the notch filter and adjust the notch tuning for a dip in the S-meter reading. Then adjust trimpot RV3 for a minimum.
 - () Flip the cal switch on the RXBPF board back to "Rcv".
 - () Enable IFOut/FM.
 - () Set the mode to FM.
 - () Using a small screwdriver, adjust variable inductor L9 ("FM Peak") about 1/2 turn from the bottom so that the noise peaks. You should be able to hear a strong "quieted" signal. As you tune around the frequency, the background noise should increase.
- Note – After all calibration is done and the receiver is working, if a source of FM is available, you can readjust L9 for the best reception.
- () Reset the frequency to one in the 20M band (e.g., 14.000 MHz).
 - () Remove the TXBFO cable and double-female adapter from the RXBPFMAIN-TX/AMP cable and place it in the transmitter compartment. Place electrical tape on the end to keep it from shorting if there is no transmitter there. Connect the RXBPFMAIN-TX/AMP cable between J11 on the DCD board ("From Tx or Amp") to the Main Antenna input (J2) on the RXBPF board. Route the cable through existing openings in the left and right brackets.
 - () Select the receive antenna. Connect an antenna to the back panel Rx Antenna input.
 - () Set the frequency to that of a local AM station.
 - () Adjust the AM AGC value until the station is at a comfortable listening level. You will most likely need to turn off the preamps and may also need to turn on the attenuator depending on the strength of the AM station. (Note – you can use antenna A or B for this, but this also tests the receive antenna path.)

This completes receiver alignment.



Front view of transmitter sitting atop chassis for testing

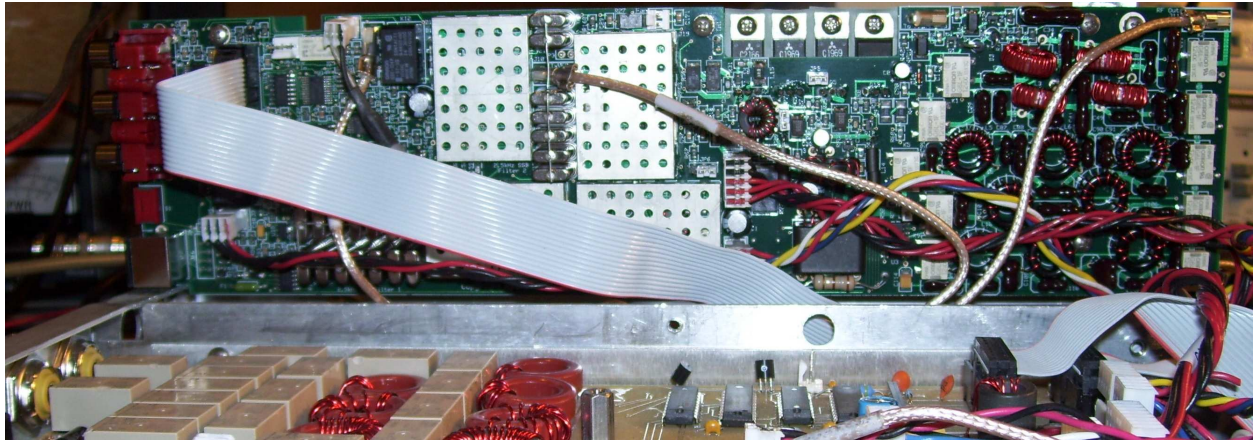

Back view of transmitter sitting atop chassis for testing

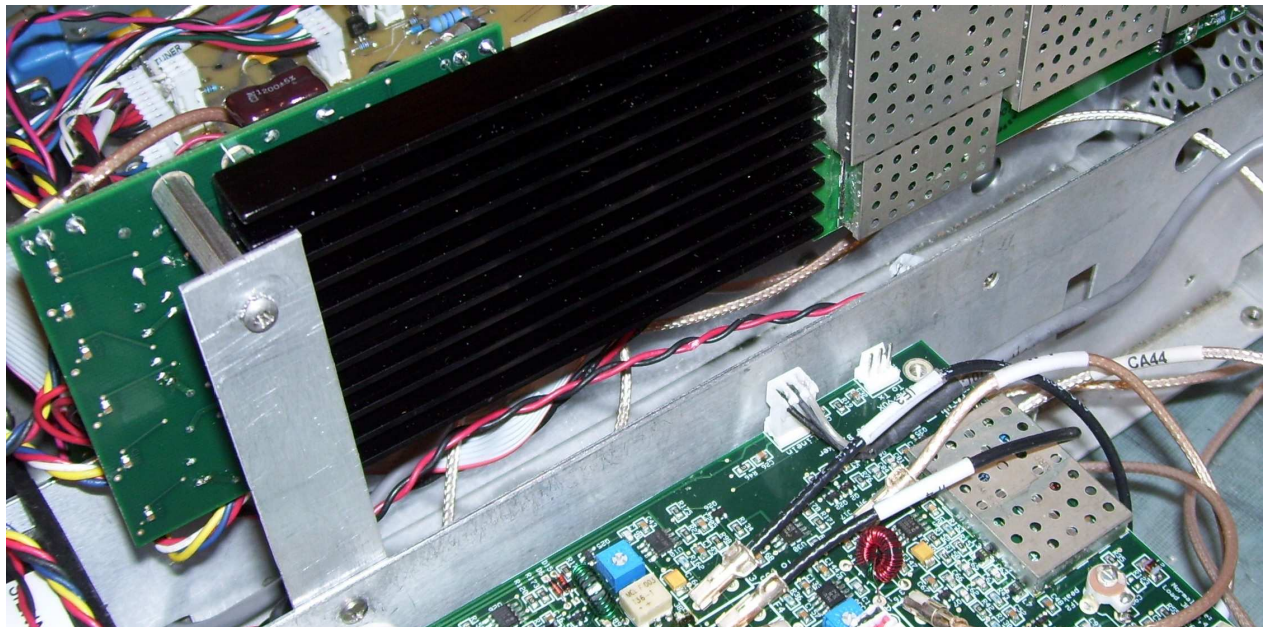



STEP-BY-STEP ASSEMBLY-Transmitter Integration

Note: If you have not already installed the SWR meter and/or antenna tuner on the DCD board, remove the DCD board before performing the next two steps.

- () If not already done, install the SWR meter parts on the DCD board. See Appendix C2.
- () If you have purchased the antenna tuner, and if not already done, install antenna tuner parts on the DCD board (see Appendix C3).
- () Attach CA17 to J3 (“Fwd/Refl”) on the DCD board. Route it through the top rectangular hole in the front bracket and connect it to J21 (“SWR”) on the controller board.
- () Attach the transmitter extender plate to the large right bracket using a 4-40 x 3/8” screw and a 4-40 KEPS nut. Position the plate so that it stands up vertically above the radio.
- () Rest the back end of the transmitter on the back panel and attach the top of the extender plate to the 4-40 x 1 1/4” spacer using a 4-40 x 3/16” SEMS screw. Make sure both 4-40 screws are tight to keep the transmitter from falling.
- () Remove the central fan cable from the DCD board and reconnect it to J15 (Fan) on the Transmitter board.
- () Locate the 8-pin to 5-pin/3-pin cable (DCDIST-TX – CA4). Connect the 8-pin connector to J7 (Tx) on the DCD/Tuner board. Dress this cable into the notch at the bottom front of the large left bracket and into the transmitter compartment.
- () Attach the 5-pin connector on the end of the DCDIST-TX (CA4) cable to J5 on the Transmitter board. Attach the 3-pin connector to J3 on the Transmitter board.
- () Locate the 4-pin IDC cable coming from the front panel compartment. Connect it to J14 on the Transmitter board.
- () Insert RF cable TXBFO into J9 (TXBFO) on the Transmitter board.
- () Insert RF cable TXVFO into J10 (TXVFO) on the Transmitter board.
- () Push the connector on the gray ribbon cable (CONTDATA-TX – CA21) into J1 on the Transmitter board. Fold it neatly so that it lays flat against the large bracket, then fold it again at right



angles to get it into the DCD compartment near the fan. Fold it again and route it through the rectangular hole in the front bracket and push it into J2 (“Tx”) on the controller board.

- () Insert RF cable TX-TUNER/AMP (CA47) into J11 (RF Out). This is the transmitter’s RF output cable. Route it through the hole in the left large bracket and into the DCD compartment and insert it into J11 (“To Tx”) on the DCD board. See Detail 7.
- () Connect the 2-pin IDC Microphone cable coming from the front panel to J4 (Mic) on the Transmitter board.
- () If RF cable RXBPFMAIN-TX is still connected between the

Main Antenna jack on the RXBPF board and J11 (“From Tx or Amp”) on the DCD board, remove it from J11 on the DCD board, pull it through the opening in the Left Large bracket and reconnect it to J8 (“To RxBPF”) on the Tx board. Route it through the notch on the top of the Tx board.

- () Connect the 3-pin IDC cable coming from the receiver to J6 (VOX/Lin) on the Transmitter board.

If you built the transmitter, proceed to the transmitter resistance and voltage checks. These tests can be skipped if you bought the transmitter assembled and tested. Proceed instead to the SWR/Alignment tests.

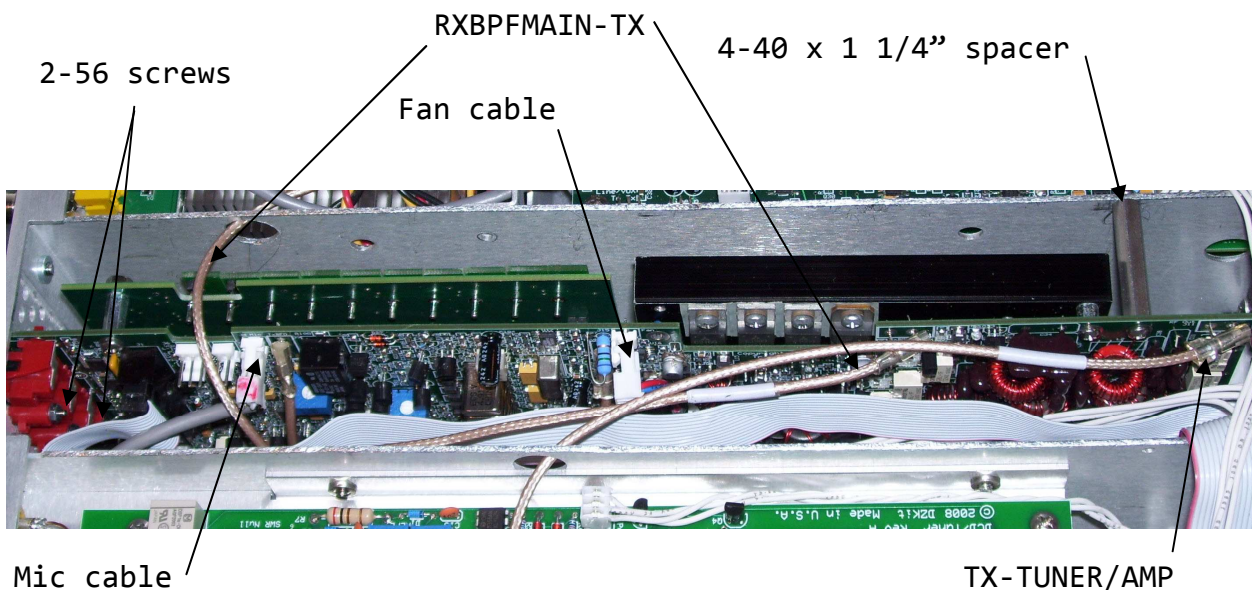

Detail 7. Transmitter integration



STEP-BY-STEP ASSEMBLY

Transmitter Resistance and Voltage checks

- () Temporarily remove J5 and J3, the two DC power cables going to the transmitter. Using an ohmmeter, verify the following resistances:

J3 pin 1 (right pin) to ground: > 1K
 J5 pin 5 (bottom pin) to ground: > 35K

(Wait until the reading stabilizes, which could take about 30 seconds.)

Tab of power transistors to chassis: Open (should not be shorted to ground. If they are, remove the screws and re-install them as described in Appendix H.

- () Reinstall the power connectors.
- () Remove all jumpers except JP8, which is a 3-pin jumper.

Place JP8 on the left two pins.

- () Turn on power. If you have a full front panel, use the menu to select "Amp" and change its setting from "None" to "Int 10W". If you do not have a front panel, send the command "PW1;" via the RS-232 port.

All voltages are +/-10%. All references to top, bottom, left and right are with board viewed with phono connectors to your left.

If a measurement refers to a mode (AM, USB, CWUSB, etc.), select that mode by pressing the "Page/Mode" button and rotating the small tuning knob. On units without front panels, use the commands as noted in the chart.

VCC = raw DC input voltage from your power supply (11-15V).

Pin	Voltage	Mode	Mode Commands	Menu setting
J3 pin 1 (right)	5.0V			
J5 pin 5 (bottom)	VCC			
U18 pin 3 (top)	10.0V			
Test Point: CWF	9.5V	CWUSB, CWLSB, FM	md3; md7; md4;	
Test Point: AMSSB	9.5V	AM, USB, LSB, DIGUSB, DIGLSB	md5; md2; md1; md6; md9;	
Test Point: AM-ESSB	9.5V	AM, USB, LSB, DIGUSB, DIGLSB	md5; md2; md1; md6; md9;	ESSB on (es1;)
Test Point: SSB	9.5V	USB, LSB, DIGUSB, DIGLSB	md2; md1; md6; md9;	ESSB off (es0;)
JP12 (top)	5.0V			
JP12 (bottom)	5.0V			
J6 pin 1 (left)	2.5V			



Pin	Voltage	Mode	Mode Commands	Menu setting
JP3 (top)	2.5V			
JP4 (top)	2.5V	USB, LSB, DIGUSB, DIGLSB	md2; md1; md6; md9;	ESSB off (es0;)
U20 pin 1	2.5- 3.5V	USB, LSB, DIGUSB, DIGLSB	md2; md1; md6; md9;	ESSB off (es0;)
U20 pin 2	3.0V			
U20 pin 4	2.5V			
C162 (bottom)	1.8V	USB, LSB, DIGUSB, DIGLSB	md2; md1; md6; md9;	ESSB off (es0;)
U17 pin 1	2.5- 3.5V	As Tx drive is varied Transmitter keyed*	md3; md7; md4;	Tx Drv CW/FM
U17 pin 1	2.5- 3.5V	AM, USB, LSB, DIGUSB, DI- GLSB	md5; md2; md1; md6; md9;	Tx Drv AM/SB
U17 pin 2	3.0V			
U17 pin 4	2.5V			
U8 pin 1	2.5- 3.5V	as RF Power is varied Transmitter keyed*		Tx ALC off (al0;)
U8 pin 2	3.0V			
U8 pin 3	2.5V			
U8 pin 4	2.5V			
JP7 (left)	1.4V	Transmitter keyed*		
Q3 base (left pin)	1.2V	Transmitter keyed*		
Q3 emitter (right pin)	0.4V	Transmitter keyed*		
Q3 collector (center pin)	VCC			
R21, C9 or C133 (top)	9.5V	CWUSB, CWLSB, FM Transmitter keyed*	md3; md7; md4;	
Q4 collector (center pin on 2SC1969)	VCC			
Q5 collector (center pin on 2SC1969)	VCC			
R42 (top)	10.0V	Transmitter not keyed		
R42 (top)	<0.7V	Transmitter keyed*		
D3 or D4 cathode (square pad)	4.3V	Transmitter not keyed		
D3 or D4 cathode (square pad)	4.2V	Transmitter keyed		
Top right pin on K2	<0.8V	Freq < 2 MHz	fa00001800000;	
Top right pin on K4	<0.8V	Freq 2-6 MHz	fa00003500000;	
Top right pin on K6	<0.8V	Freq 6-12 MHz	fa00007000000;	
Top right pin on K8	<0.8V	Freq 12-20 MHz	fa00014000000;	
Top right pin on K10	<0.8V	Freq 20-30 MHz	fa00021000000;	

* Key down in CW modes, PTT pressed in phone modes



STEP-BY-STEP ASSEMBLY

Transmitter, SWR Alignment/Tests—Models with front panels

- () If all voltage and resistance tests passed, install all jumpers and move JP8 to the right two pins.
- () Connect an RF power meter to the Antenna A jack and terminate the power meter into a 50 ohm dummy load. Connect a key to the front panel (if present) or back panel MANUAL key jack.
- () Apply power to the radio.
- () Set the operating privileges to “Extra” by setting the “License Class” entry to “E” in the menu.
- () Select CW(USB) mode and set the band to 160 Meters (1.800 MHz).
- () Select “Fwd Pwr” on the “Meter” entry in the menu. Set the front panel RF Power control counterclockwise. If you are performing this procedure after having already installed the 100W amplifier, set the “Tx/Amp” option in the Menu for “Int 10W”, which tells the radio that the amp is not installed. This will cause it to be bypassed for the following tests.
- () Select the menu page containing the item “Tx Drv CW/FM” and select that item. This is the IF drive level, which sets how much power is fed into the early stages of the transmitter. There is one of these for every band. The menu shows the current value for the band you are on.
- () If you were provided cal constants for your transmitter that are different from the default, enter them now, one for CW and one for SSB, one per band. Otherwise leave the settings at their default values.
- () Turn off ALC by setting “ALC Thresh” to 0 in the menu. This will keep the transmitter from trying to set the power before the SWR meter has been calibrated. When you exit the menu, the power section of the display will read P-Rel, indicating relative power.
- () Press the key. As you do so, gradually increase the RF Power control to maximum (clockwise) and make sure you can get at least 10 Watts out as measured on an external wattmeter. With the front panel RF Power control at maximum, Adjust the “Tx Drv CW/FM” setting if needed until you can get full power out, but do not let the maximum setting of the RF Power control generate more than 13 Watts. Typical values are 0-



- 30.
- () Repeat the previous step on all other bands, using frequencies of 3.5, 5.3305, 7.0, 10.1, 14.0, 18.068, 21.0, 24.89 and 29.0 MHz.
 - () Set the frequency to 14.0 MHz and adjust the RF Power control so that the *external* RF power meter reads 10.0 Watts when you press the key.
 - () Measure the voltage on pin 1 of J3 (or the cathode of D4) on the DCD/Tuner board as you key the rig. Adjust trimmer C17 on the DCD/Tuner board for as close a reading to 0V as possible.
 - () Adjust RV1 on the DCD/Tuner board (FWD) until Sienna's digital Fwd Power meter (in a menu) reads as close to 10.0W as possible.
 - () Select "Ref1 Pwr" on the meter from the "Meter" menu. Adjust RV2 (REFL) on the DCD/Tuner board to approximately the same physical setting as RV1. The reflected power should read close to 0. If it doesn't, tweak the trimmer capacitor slightly and repeat.
 - () If you have a 25 ohm 10W dummy load, you can use this to set the reflected power pot more accurately. With 25 ohms, the SWR should read 2.0.
 - () Select FM mode on the transmitter and monitor receiver. Press the PTT button and speak into the microphone. Verify that your FM signal is readable as an FM signal. The default bandwidth of the narrow-band signal is 2.5kHz. If you plan to use 4 or 5kHz, change it to this in the appropriate menu. Keep the power level less than 5W (50W with 100W amp) on FM. Note: In FM mode, when transmitting, the only control that can be used is the mic gain.
 - () If the FM frequency when you are not talking is off frequency, you can compensate by adjusting the menu item "FM/VOX Zero". See the Operator's Guide for details.
 - () Select "ALC Thresh" in the menu and change its setting to 10. Now the RF Power control should allow you to accurately set the power level. The displayed value should match that of the external meter.
- Note: When you change bands, the ALC resets itself to half scale and adjusts up or down from there. Thus, on first keydown after a band change, the ALC may take a second or so to re-acquire the correct power level.
- Note: The RF Speech compression threshold can be changed in a menu option call "Proc Gain Cal". It defaults to 150, which should allow sufficient adjustment range with the



front panel "Proc Level" knob when the Spot/Proc button is pressed. If not, you can increase the amount of available compression by increasing the menu item.

- () Turn off power.
- () Remove the extender plate from the transmitter. Keep it in a safe place should you ever want to work on the transmitter.
- () Holding the cables up against the left bracket, lower the transmitter into its compartment and align it with the

board guide on the bottom. Slide it up against the back panel, feeding the three phono connectors through their holes. Insert two 2-56 x 5/8" panhead machine screws from inside and attach two #2 lockwashers and two 2-56 nuts to the screws on the back panel.

- () Attach the 1 1/4" spacer to large bracket right using a 4-40 x 3/16" SEMS screw.

This completes alignment and test of the Transmitter board and SWR meter.



STEP-BY-STEP ASSEMBLY

Transmitter, SWR Alignment/Tests—Models without front panels

- () Connect a dummy load to the antenna A jack via an RF power or SWR meter. Connect a key to the front panel (if present) or back panel MANUAL key jack.
- () From a PC, start the “Hyperterm” program and set it for 9600 baud, 8 bits, no parity, 1 stop bit, no handshake.
- () Apply power to the radio. If you observe anything out of the ordinary, turn off power at once. With the transmitter installed but not transmitting, you should see no change in anything – the receiver should work, the front panel should light up, and you should not see smoke!
- () Send the following commands:

```
MD7; { CW(USB) mode }  
FA0000014300000 { 14.3MHz }  
PW1; { 10W Tx present }  
PL000; { 0 RF Proc level }  
PC000; { 0W RF Power level }  
MG128; { Mic Gain=midscale }  
RM7; { RF Power Meter }
```
- () Connect a voltmeter between pin 1 of J25 (“TxMtr”) and ground on the Receiver board. This is the meter output for the selected transmitter measurement function (in this case, Forward Power). Voltages on this pin are never greater than 2V so choose a range on your voltmeter as close as possible to this value.
- () Press the key. As you do so, gradually increase the RF Proc and RF Power functions, alternating between them a little at a time until the output power reaches 5.0W on an external power meter. (In this cal mode, RF Proc controls “Drive” at the first IF frequency, and RF Power controls “Final” amplifier gain at the output frequency.) Use the following commands:

```
PCnnn; { RF Power }  
PLnnn; { RF Proc }
```

where nnn goes from 000 (low) to 255 (high).
- () Now look at the voltmeter reading. Adjust RV1 on the DCD/Tuner board (FWD) until the meter reads as close to 0.833V as possible.
- () Send the command “RM8;”, which selects Reflected Power. Adjust RV2 (REFL) on the DCD/Tuner board until the meter reading dips. Adjust trimmer C17 on that board for as close a reading to 0 as



possible.

- () Repeat the previous two steps until the forward power reading is 0.833V (5.0W on the power meter) and the reflected power reads 0V (0W).
- () Release the key.
- () Send the following command:

```
MD2; { USB mode }
```
- () Set up a nearby monitor receiver to listen to your transmitted signal. If one is not available, send the command "FD;" to put your Sienna into Full Duplex mode, allowing you to hear your transmitted signal. Keep the audio volume low by sending the command "AG010;"
- () Connect a Yaesu style microphone to the front panel mic jack. Press the PTT button. Adjust RV1 on the Transmitter board so that the carrier (audible tone) is at a minimum.
- () Send the command "MD1;" (LSB). Re-adjust RV1 for minimum carrier. Alternate between USB and LSB until both have equally low carrier. Although you may be able to hear it when monitoring your own signal, the carrier suppression is sufficient that it will not be au-

dible on the air.

- () Send the command "MD5;" (AM) on the transmitter and select AM mode on the monitor receiver. Press the PTT button and speak into the microphone. Verify that your AM signal is readable as an AM signal. Keep the power level at less than 3W when using AM.
- () Send the command "MD4;" (FM) on the transmitter and select FM on the monitor receiver. Press the PTT button and speak into the microphone. Verify that your FM signal is readable as an FM signal. The default bandwidth of the narrow-band signal is 2.5kHz. If you plan to use 4 or 5kHz, change it to this in the appropriate menu. Keep the power level below 3W when using FM (30W with the 100W amp enabled).
- () Enable TXALC by sending the command "AL1;". Now the RF Power command ("PCxxx;") should allow you to accurately set the power level. The displayed value should match that of the external meter.

Note: When you change bands, the ALC resets itself to half scale and adjusts up or down from there. Thus, on first keydown after a band change, the ALC may take a second or



so to re-acquire the correct power level.

Note: The RF Speech compression threshold can be changed in a menu option call "Proc Gain Cal". It defaults to 150, which should allow sufficient adjustment range with the front panel "Proc Level" knob when the Spot/Proc button is pressed. If not, you can increase the amount of available compression by increasing the menu item.

- () Turn off power.
- () Remove the extender plate from the transmitter. Keep it in a safe place should you ever want to work on the transmitter.
- () Lower the transmitter into its compartment. Do not worry about cable positioning or alignment with the board guide at the bottom yet. With one hand, slightly lift up the circuit board while run-

ning a long tool, such as a screwdriver along the board, starting at the back of the radio and working toward the front, and capture all the wires behind this tool. Keeping the wires trapped, use your other hand to position the circuit board in the card guide. Slide it up against the back panel, feeding the three phono connectors through their holes. Insert two 2-56 x 5/8" panhead machine screws from inside into the red phono connector block and attach two #2 lockwashers and two 2-56 nuts to the screws on the back panel. It may be necessary to loosen the exhaust plate and move it out of the way to tighten the bottom nut.

- () Attach the 1 1/4" spacer to large bracket right using a 4-40 x 3/16" screw.

This completes alignment, test and integration of the Transmitter board and SWR meter.



STEP-BY-STEP ASSEMBLY-100W PA Integration

Refer to Pictorial 10 and Detail 8 for the following steps.

- () Build the 100W PA Board and attach it to its heatsink (See Appendix J).
- () Remove power from the Sienna.
- () Remove the two screws holding on the Exhaust plate and pull it off.
- () If you have not already mounted the fuseholder to the Exhaust plate, do so at this time.
- () Remove the two screws that hold the DCD/Tuner tray to the large left bracket.
- () Remove the screws, spacer and 6-32 x 2" hex F/F spacer that holds the tray to the chassis bottom.
- () Rotate the tray up 90 degrees and re-insert a 6-32 x 1/4" PL screw into the front mounting hole and into the left bracket.
- () Place the assembled 100W PA in the chassis with the toroids facing towards the front. Line the chassis mounting holes up with the four 1 1/4" spacers. Attach the PA to the chassis using four 6-32 x 1/4" PL screws.
- () Attach a CA15 cable from J14 on the DCD board along the left side of the tray, into the notch near the back panel and into the amp compartment. Connect it to J6 on the 100W PA board.
- () Make sure the left fan is still connected to J5 (marked "Fan") on the DCD board.
- () Remove jumpers JP1 and JP2 on the DCD board.
- () Locate one 12" 14AWG red wire with a male insulated terminal (tab) on one end and a female terminal (receptacle) on the other. Cut it into three pieces, each 4" long. You will end up with two wires with a lug on one end and one wire with no lugs. Strip the free end of each wire to 1/2" and tin the ends.
- () Solder the tinned end of the wire having the female lug into the pad labeled "V+" on the DCD board. Position the cable over the side of the chassis, through the notch in the side of the tray. Be careful not to let the wire touch the chassis after insertion into the V+ pad.
- () Solder the tinned end of the wire having the male lug into the side lug on the fusehold-

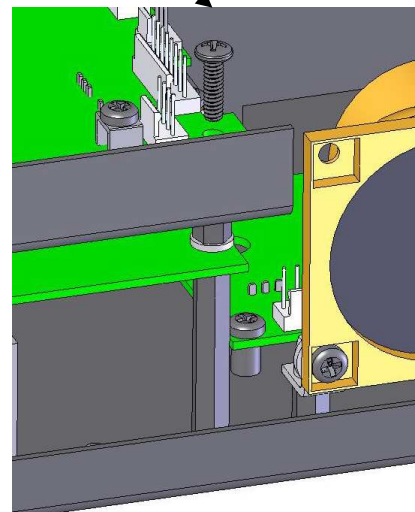
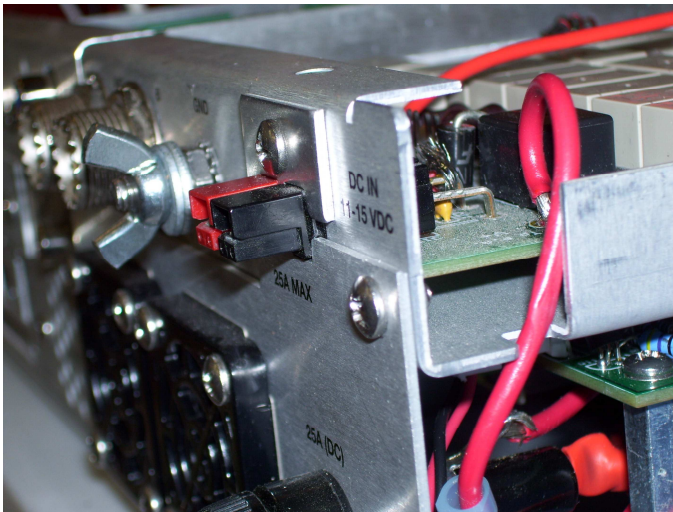
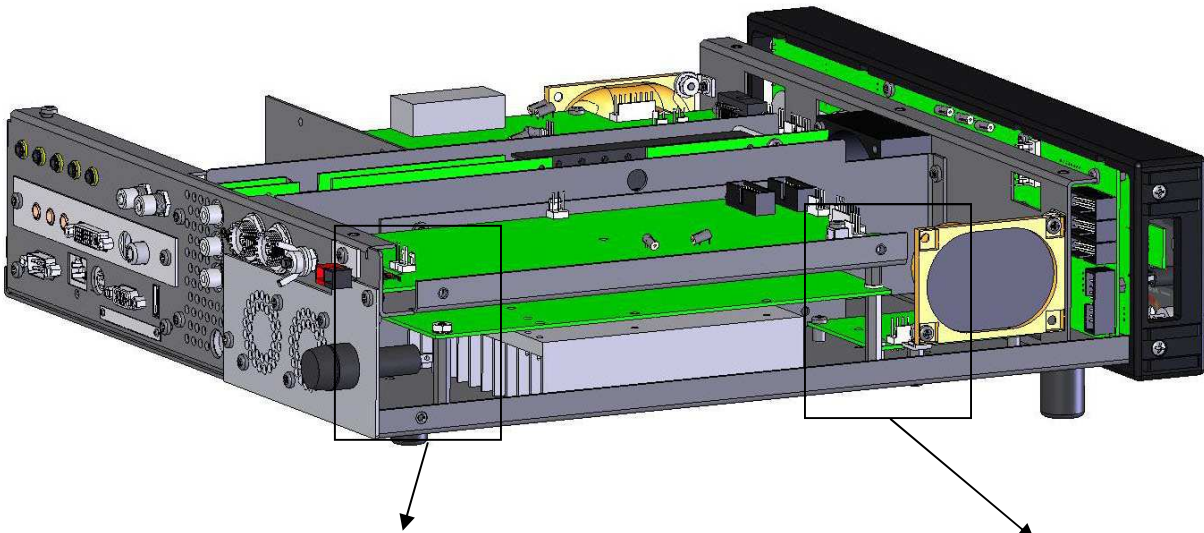

Pictorial 10. 100W PA Mounting

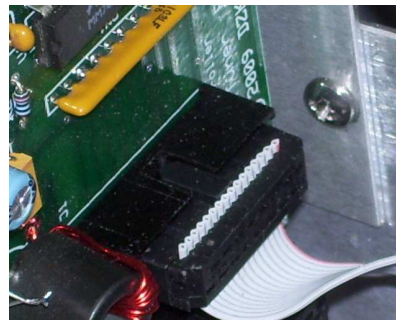

Detail 8. Photos of vertical tray mounting



er. You may need to spring the side lug out slightly first.

- () Insert one end of the remaining 4" wire into the bottom side of the 100W PA Board into the pad marked V+ ("From Fuse"). Solder the other end to the end lug on the fuseholder. Bend the wire so that it does not touch the heatsink.
- () Locate the other 12" 14AWG wire with a male lug on one end and a female on the other. Plug the male end into the 4" cable coming from the DCD/Tuner board. Plug the female end into the cable that is attached to the fuseholder.

Note: Once the tray is lowered into its normal position (after test), this extender cable will be removed and the other cables connected together. This minimizes wire length for this high current wire.

- () Locate a CA15 2-pin MTA cable. Connect one end to J19 ("Amp") on the Controller board. Route the other end of the cable through the lower rectangular opening on the left side of the front bracket and connect the end to J1

("PA Curr") on the PA board. Dress this cable between the board and the heatsink so that it won't get pinched by the top cover when it is attached later.

- () Remove the end of the TX-TUNER/AMP RF cable (CA47) that is connected to J11 on the DCD/Tuner board. Feed this cable through the lower hole in the large left bracket and connect it to J4 ("Tx In") on the 100W PA Board.
- () Remove the RF cable that goes from the RXBPF board to the transmitter (CA33 - RXBPFMAIN-TX/AMP) from the transmitter and feed it through the same opening in the left bracket that was used in the previous step. Connect it to J5 ("To RXBPF").
- () Insert a short gray ribbon cable between J6 ("To PA") on the DCD/Tuner board and J3 on the 100W PA board. This cable goes underneath the other one that is connected to J2 on the DCD board.
- () Connect RF cable AMP-TUNER (CA49) between J2 ("Antenna") on the 100W PA board and J11 ("From Tx or Amp") on the DCD/Tuner board. Dress this cable around the front end of the tray.



100W PA Alignment/Tests

Note: If your results are different from the expected ones, refer to the troubleshooting guide in the Service Manual.

- () Using an ohmmeter, measure the resistance between V+ (W1 – "From Fuse") and ground. It should be > 1500 ohms.
- () Turn trimpot RV1 ("PA Bias") all the way *clockwise* (right).
- () Connect power to the Sienna DC input terminals and turn on the unit. If you smell smoke or observe power cycling on and off, switch the power off.
- () Using a voltmeter, measure the voltage on TP3. It should read 5.0V +/- 0.15V.
- () Verify that the fan is running at low speed. If you have a heat gun (a hairdryer will work), blow some heat on thermistor TH1, aiming at the bottom of the board. When the temperature rises enough, the fan should switch to high speed. You can hear the difference as it runs faster. As the temperature cools back down, it should switch back to normal, low speed. If low speed is too low and/or the fan appears "stuck", replace R35 with a short.

If you have the full front panel (SF-100x models):

- () Press the MENU button and then use the small knob to select the menu item labeled "Tx/Amp". Press the PAGE/MODE button to disable paging, or simply rotate the large knob off of the selection and back on it, then rotate the small knob until the selection reads "Int 100W". Press MENU again to exit MENU mode.

- () Press the BAND button and then use the large knob to cycle through the bands. As you do so, you should hear the low-pass filter relays K4-K13 switch on and off.

The relays on the transmitter board also change when the bands are changed, so listen carefully to be sure the ones on the amp are also changing.

- () Set the mode to CW(USB) and the frequency to 14.000 MHz and connect a dummy load rated for 100W to antenna jack A. Be sure Antenna A is the one selected.



If you have a remote-control-only version (S-100xx) of Sierra:

- () Connect to Sierra using Hyperterm or other RS-232 control program.
- () Enter the following command to enable the 100W amp:

PW2;
- () Enter the following commands. After each one, you should hear the low-pass filter relays K4-K13 switch on and off:
FA00001800000;
FA00003500000;
FA00007000000;
FA00014000000;
FA00021000000;

The relays on the transmitter board also change when these commands are used, so listen carefully to be sure the ones on the amp are also changing.
- () Select CW(USB) and leave the frequency set to the 20M band by sending:

MD3;
FA00014000000;
- () Connect a dummy load rated for 100W to antenna jack A. Make sure antenna A is selected by sending:

AN1;

- () Short TP2 to ground using a clip lead or insulated wire. Measure the voltage at TP1 (“100V Back Bias”). It should read 100V +/-5V. Remove the clip lead. The voltage on TP1 should return to about 12V.
- () Place a voltmeter on test point TP4. Slowly adjust pot RV1 (“Bias”) until the voltage reads 0.1V +/-0.02V. This sets the Class AB bias level such that each RF power transistor draws about 320mA of collector current. If you have a front panel, you can see the “PA Curr” value in the voltage/current monitor menu page. A reading of 0.4 to 0.7 Amps is normal.
- () Insert a key into the Manual key jack and key the rig. Adjust the RF Power control for 100W and verify that the RF Power meter shows 100W output. If you have an external meter, that should also show 100W out. The TxALC menu option should be ON (“AL1;”).
- () Change bands and verify that all bands have full power out.
- () Turn off the radio and remove the power.

NOTE: Minor changes may be necessary to the transmitter gain calibration and/or SWR meter with the 100W amplifier in place.



- () Disconnect the red power cable assembly that goes from the DCD board to the amp. Remove the middle section of cable and save it for future use in the event your amp needs service.
- () Remove the end of the RXBPF-MAIN-TX/AMP RF cable (CA33) from J8 ("To RxBPF") on the Transmitter board. Pass it through the rectangular hole in the back of the large left bracket and connect it to J5 ("To RxBPF") on the 100W amp board.
- () Remove the 6-32 x 1 1/2" screw from the left front corner of the board, leaving the two spacers in place. They are loose and easily dislodged, so try not to jar the chassis.
- () Lower the tray back down and insert the 6-32 x 1 1/2" screw into the left front corner of the DCD/Tuner board, into the spacers. Tighten it.
- () Re-attach the tray to the left bracket using two 6-32 x 1/4" screws.
- () Re-attach the Exhaust plate to the back panel using two 6-32 x 1/4" screws.
- () Connect the two short pieces of red power cable together and route the cable into the amp compartment through the small notch in the side of the tray.
- () Re-attach the Anderson Power Pole Mounting tab to the Exhaust Plate using one 6-32 x 1/4" screw.

This completes installation of the 100W PA Option.



STEP-BY-STEP ASSEMBLY-Final Assembly

- () Secure the front panel to the bottom chassis using four 6-32 x 1/4" screws (one or two should already be in place on the bottom).
- () If you installed the 100W amp, insert the Tuner Shield that is provided with that kit over the DCD/Tuner board with the metal beneath the back folded edge of the DCD Tray and inside the tray on the left side. The right side should be flush with the folded edge. Secure the shield to the tray using five #4 x 1/4" flathead sheet metal screws.
- () Place the top cover on the radio and secure it to the chassis using eleven 6-32 x 1/4" flathead black anodized screws.
- () If you have a model with a full front panel, install all knobs. Use the provided 1/20" (.050") hex key to tighten the small knobs, the 1/16" (.063") hex key to tighten the large tuning knob, and the 5/64" (.078") hex key to tighten the small tuning knob. Small knobs have pointers on them. Be sure to first rotate the control counterclockwise to its stop and position the knob with the pointer at about the 7:00 position so that one of the two setscrews hits the flat in the shaft.
- () Attach the bottom cover plate to the chassis bottom using eight 6-32 x 1/4" PL screws.
- () Affix the serial number sticker to the back panel between the LINE OUT and IF OUT connectors.

This completes assembly and test of the Sienna transceiver.





Appendix A:

Reserved for future use









Appendix B: RS232 Board

PARTS LIST

Item	Part	Description	Qty
1	J1	14-pin 2mm connector	1
2	J2	DB-9 Right-angle connector (female)	1
3	R1,R2,R3,R4,R5	100 ohm 1/8W resistor	5
4	C1,C2,C3,C4,C5	150pF monolithic capacitor	5
5		RS232 Board blank	1

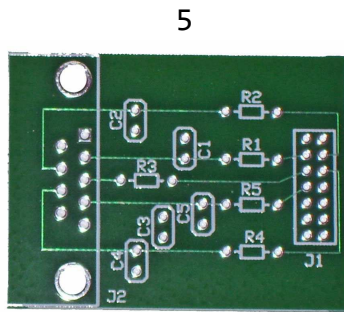

RS232 Board, blank

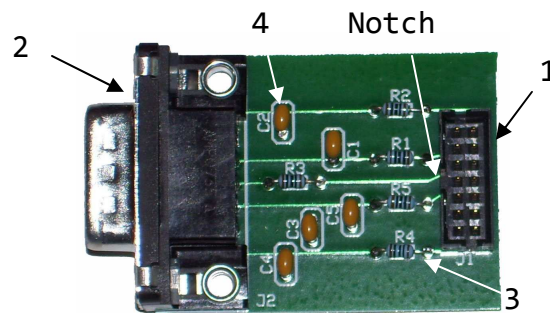

RS232 Board, assembled



STEP-BY-STEP ASSEMBLY-RS232 Board

- () Load and solder all resistors. Clip the leads.
- () Load and solder all capacitors. Clip the leads.
- () Load and solder the 14-pin rectangular connector. The side with a notch faces inward (See note on photo.)
- () Load and solder the 9-pin D-subminiature connector.

This completes assembly of the RS-232 Board.



Appendix C1: DCD/Tuner Board [DCD Section]

PARTS LIST

S0100-40001 DCD Board Kit - Bag 1				
Reference Designator(s)	Item	Description	Stock bin	Quantity
C24,C27	1	Capacitor 22uF tant D 25V low ESR	191F	2
C32,C33	2	Capacitor 1000pF disk ceramic radial 50V Y5P 10%	3	2
C3,C4,C16,C18,C19,C21,C25,C26,C28,C30,C31	3	Capacitor .1uF MLCC 50V radial X7R 5%	232	11
C1,C2,C20,C22,C23	4	Capacitor 100uF/25V aluminum electrolytic radial 20%	57	5
C29	5	Capacitor 330uF/16V aluminum electrolytic radial 20%	534	1
R28	6	Resistor 165K ohm 1/8W metal film axial 1%	356-165K	1

S0100-40001 DCD Board Kit - Bag 2				
Reference Designator(s)	Item	Description	Stock bin	Quantity
C40,C61,C62	3	Capacitor .01uF MLCC radial 50V X7R 10%	575D	3
D5,D9	7	Diode Zener 1N5223B 2.7V 1/2W DO-35 5%	224	2
D6	8	Diode rectifier 1N5404 axial 400V 3A DO-201AD	225	1
D7	9	Diode Schottky rectifier 1N5711 70V 15mA DO-35	226	1
F1	10	Fuse resettable PTC 9A	320	1
R12,R19,R23,R27	6	Resistor 1.0M ohm 1/8W metal film axial 1%	356-1M	4
D8,D12	11	Diode 1N4007B rectifier 1000V 1A DO-41	53	2

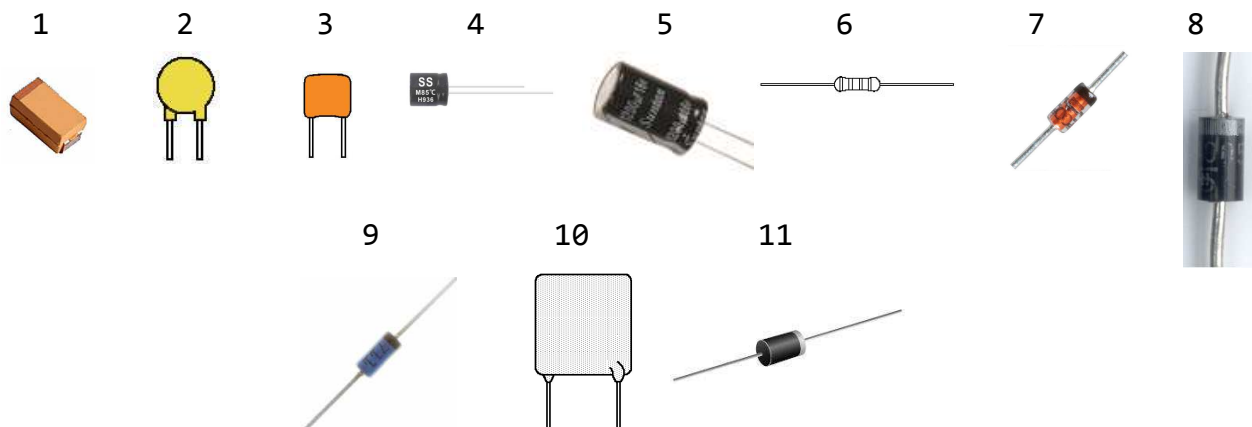

**S0100-40001 DCD Board Kit - Bag 3**

Reference Designator(s)	Item	Description	Stock bin	Quantity
J1,J2	12	Connector 16-pin 2-row shrouded header vert low profile	132	2
J5,J6,J14	13	Connector 2-pin friction lock header .1in straight post tin	172	3
J15	14	Connector 3-pin friction lock straight post tin	367	1
J4,J10	15	Connector 5-pin friction lock header straight post tin	369	2
J11	16	Connector RF 45-degree pcb-mount (Taiko Denki)	407	1
J12	17	Hardware Anderson Powerpole connector - red	579A	1
J13	17	Hardware Anderson Powerpole connector - black	579B	1
J7	18	Connector 8-pin friction lock header straight post tin	79	1
J8,J9	19	Connector 4-pin friction lock header .1in straight post tin	88	2
JP1,JP2	20	Connector 2-pin header vert tin (for jumper)	84B	2
JS1,JS2	21	Jumper 2-pin tin	84A	2
R10,R15,R17	6	Resistor 3.16K ohm 1/8W metal film axial 1%	356-3.16K	3
	22	Hardware Anderson Powerpole contact, r/a	579C	2

12

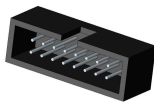

13

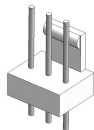

14

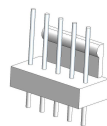

15



16



17



18

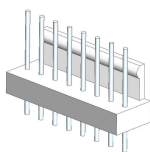

19

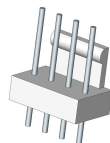

20

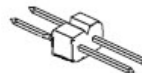

21



22





S0100-40001 DCD Board Kit - Bag 4				
Reference Designator(s)	Item	Description	Stock bin	Quantity
D10	10	Diode 1N5818 Schottky rectifier 30V 1A axial	328	1
L8,L9	23	Inductor 47uH iron core axial 10% shielded	360	2
K17,K18	24	Relay 8A SPST-NO sealed 8A 12V coil pcb-mount	512	2
RFC1	25	Toroid 5977001901 1/2in dia x 1/2in H .312 ID AL=2400	537	1
K19	26	Relay sealed Form-C 25A 16V	69	1
RN1	27	Resistor 7-el array 10K bussed 8-pin	78	1
R3,R11,R13,R24	6	Resistor 22K ohm 1/8W metal film axial 1%	356-22K	4
		Hookup wire - white 24 AWG	701	6"
		Bare wire 18AWG	717	6"
		Wire 24 AWG red magnet wire	721	8"
	28	Hardware 4-40 x 1/4in PH Phillips M/S SS	479	1
	29	Hardware Insulator with adhesive back for TO-220	523	1
	30	Hardware shoulder washer plastic TO-220	303	1



S0100-40001 DCD Board Kit - Bag 5				
Reference Designator(s)	Item	Description	Stock bin	Quantity
Q2,Q5	31	Transistor 2N7000 MOSFET N-ch 60V TO-92	227	2
Q1	32	Transistor TIP41C NPN Power 100V 6A TO-220	498	1
R1,R2,R9,R14	6	Resistor 10K ohm 1/8W metal film axial 1%	356-10K	4
R29,R30	33	Resistor 47 ohm 1W metal oxide axial 5%	335	2
U10	34	IC MAX765 DC-DC converter negative output 8-pin DIP	542	1

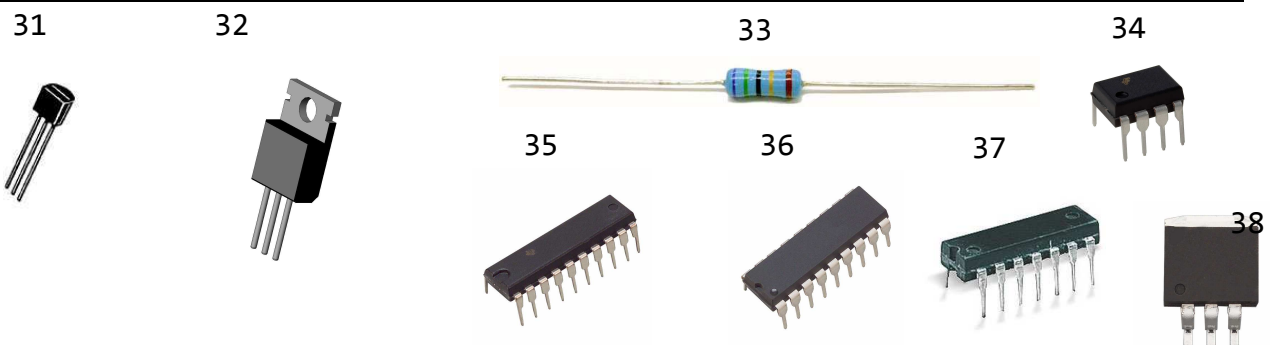

**S0100-40001 DCD Board Kit - Bag 6**

Reference Designator(s)	Item	Description	Stock bin	Quantity
R25,R35	6	Resistor 4.7K ohm 1/8W metal film axial 1%	356-4.7K	2
U2	35	IC 74HC273 octal D-flip-flop with clear 20-pin DIP	275	1
U4	36	IC ULN2803 relay driver 8-el w/diodes 18-pin DIP	392	1
U6	37	IC LM339 quad comparator 36V 14-pin DIP	126	1
U7	34	IC LM393 dual comparator 36V 8-pin DIP	219	1
U9	38	IC LM2940CS-9.0 Voltage regulator 9V LDO 1A TO-263	502	1

S0100-40001 DCD Board Kit - Bag 7

Reference Designator(s)	Item	Description	Stock bin	Quantity
R20	6	Resistor 100 ohm 1/8W metal film axial 1%	356-100	1
R26	33	Resistor 470 ohm 2W metal oxide axial 5%	268	1

S0100-40001 DCD Board Kit - Bag 8

Reference Designator(s)	Item	Description	Stock bin	Quantity
R8,R16,R18,R21,R22,R34	6	Resistor 1K ohm 1/8W metal film axial 1%	356-1K	6

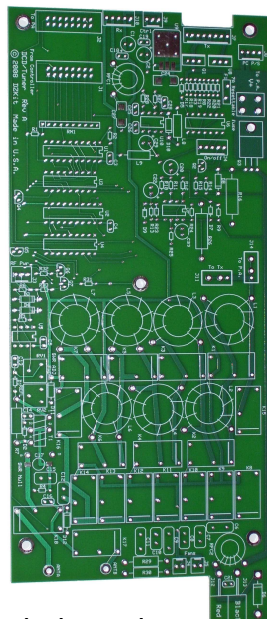

39 – Blank board



STEP-BY-STEP ASSEMBLY-DCD Board

Highlight or check off each part on the parts list that came inside the bag as you install it on the board. Unless otherwise instructed, load all parts of the same type from each bag and clip the leads after soldering.

TIP: Load parts into the holes on the board, then fold the leads back slightly so they don't fall partway out as you solder them. This will assure that they lay flat on the board.

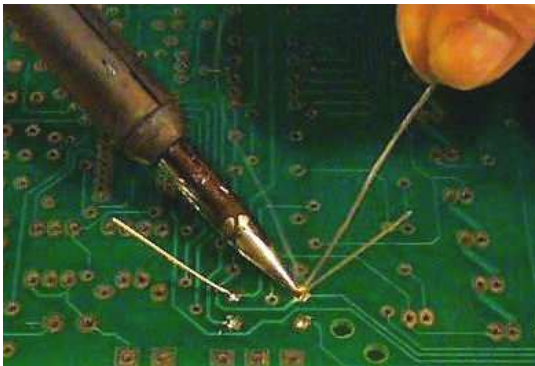

- () Load and solder all capacitors, one bag at a time, including electrolytic capacitors, being careful to observe polarity (see page 8).

Note: The tantalum electrolytics C24 and C27 mount with the stripe aligned with the angled side of the silkscreen:

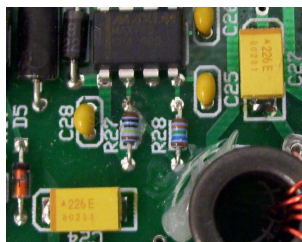

- () Load and solder all resistors, one bag at a time. Clip the leads. Note that some resistors are in bags that also contain other parts.
- () Load and solder all diodes, one bag at a time, being careful to observe polarity (page 8). The side with a band (the cathode) goes in the square pad. Note that some diodes are in bags that also contain other parts.
- () Load and solder inductors L8 and L9.
- () Load and solder F1, the 9A Resettable fuse. Bend this part up at a slight angle so that it does not hit the top cover when it is installed.
- () Load and solder the resistor network. Be sure that the pin with the dot goes into the square pad.
- () Load and solder Q2 and Q5. Line up the flat side of the transistor with the flat side of the silkscreened outline. Spread the transistor leads apart as you insert the part into the board. The part should be inserted until the bottom of the plastic transistor body is about .1" off the board.



- () Insert the right angle Anderson Powerpole (APP) contacts into the red and black bodies as shown:

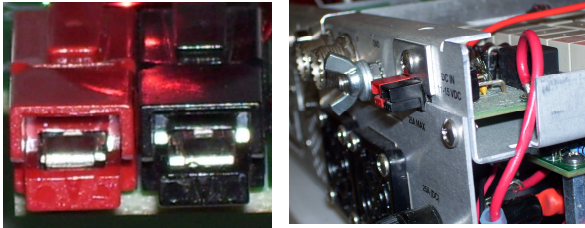

Right picture shows how APP connectors will look when attached to the DCD tray.

- () Attach the APP connectors together with the red and black bodies in the orientation labeled on the board. Position the connectors so that their bodies match the outline on the board, then bend the leads down. Load and solder the connectors to the board. Clip the excess leads off on the bottom of the board.
- () Wrap five turns of 24 AWG magnet wire around Toroid RFC1. Insert the toroid into the board with the cylinder facing vertically. Solder the leads. Maintain heat for about 1 minute, long enough to melt the coating and cause solder to flow onto the lead and the pad. Be sure your soldering iron is set to at least 750 degrees. Clip any excess leads. Using an ohmmeter, verify that there is continuity from one pad to the other. If not, reheat the connections.
- () If you plan to install the antenna tuner parts (see Appendix C3) during initial assembly of this board, skip the next step.
- () Cut a 3 1/2" length of white wire. Strip and tin the ends to a length of 1/8". Insert one end into the L1 pad that is connected to T1 pin 6. Insert the other end into the L7 pad that is closest to C59. Pull the wire taut. Solder both ends.
- () If you plan to install the SWR meter parts (provided with the transmitter, see Appendix C2) during initial assembly of this board, skip the next step.
- () Place a 2" length of 18 AWG bare wire in the holes marked "5" and "6", next to transformer T1. Solder the wires and clip extra lead length.
- () Load and solder relays K17, K18 and K19. They will only go in one way.
- () Place U9, an SMT regulator, on the board where marked. Hold it in place while soldering one pin, then solder the other two pins. Finally, heat the tab and apply solder until it flows evenly along the bottom and sides of the tab.
- () Load and solder all remaining Integrated Circuits, one bag at a time. Make absolutely



- sure that the ICs are inserted with pin 1 oriented correctly. When holding an IC horizontally so that you can read the printing from left to right, pin 1 is in the lower left corner. It is often marked with a dot, and there is also often a notch on that side of the IC. Pin 1 goes in the square pad on the board. Be especially careful when loading U5 and U7, since they look alike.
- () Load and solder connectors J1 and J2. Pin one of these connectors is marked with an embossed triangle on one side. Line this up with the square pad. The side with a single notch faces the resistor network. Be sure the connectors are flush with the board.
 - () Load and solder the RF connector, J11. This connector is mounted at a 45 degree angle. First bend the end pin down, compress the two larger pins slightly, and push the connector into the holes. It is OK for the body of the part to touch the board—it will not short out the center conductor.
 - () Load and solder jumper headers JP1 and JP2, and install the jumpers JS1 and JS2 on them. Orient the jumpers so the metal tab is on top.
 - () Load and solder all other connectors **except J3**, which is included with the SWR kit. Be sure to align the tab on the white AMP MTA connectors with the thick silkscreened bar. Not all connectors point the same direction! Be sure the connectors are flush with the board.
 - () Clip the pins of 8-pin connector J7 as close as possible to the board.
 - () Bend the leads of Q1 *up* 0.8" from the end of the tab. Insert U8 from the **bottom** of the board, such that the bottom of the tab is 1/4" from the bottom of the PC board. Solder only one pin, just enough to keep the part from falling out. It will be secured to the chassis when the board is installed.
 - () Check your work. Pay particular attention to connectors and ICs, making sure that every pin is soldered. Hold the board at an angle and make sure all leads have been clipped.
 - () Save the 4-40 screws, Thermalsil insulator and shoulder washer, which will be installed when the board is mounted to the DCD tray.
- This completes construction of the DCD portion of the DCD/Tuner board.

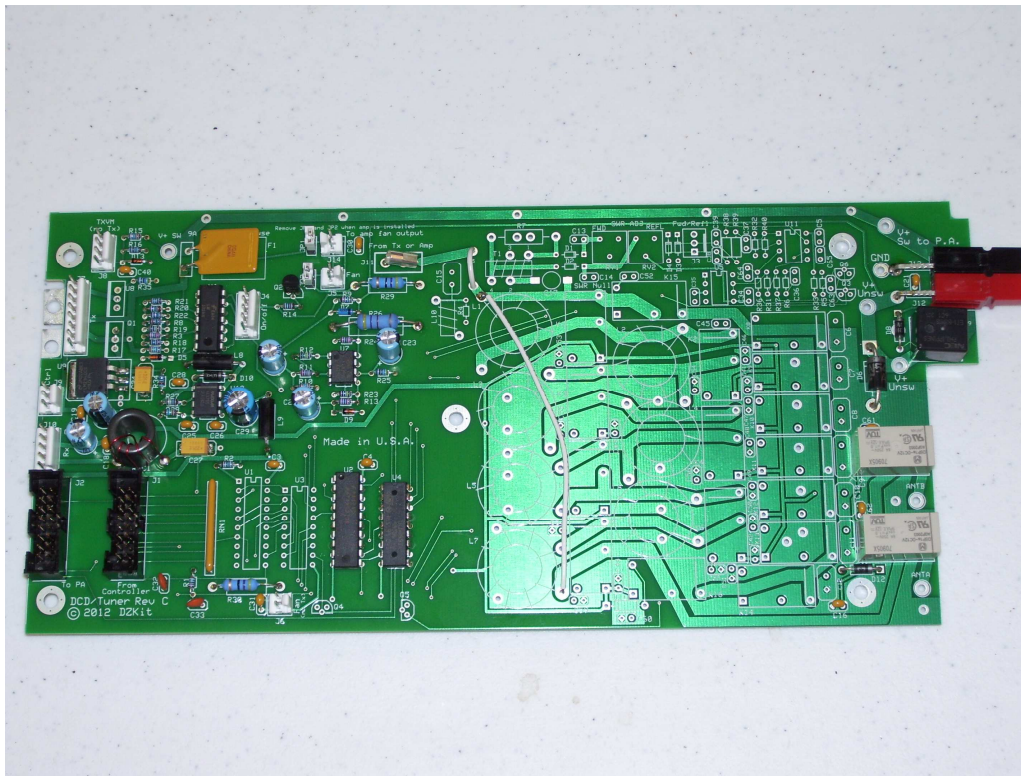

DCD Board, front, tuner and power meter circuits not installed

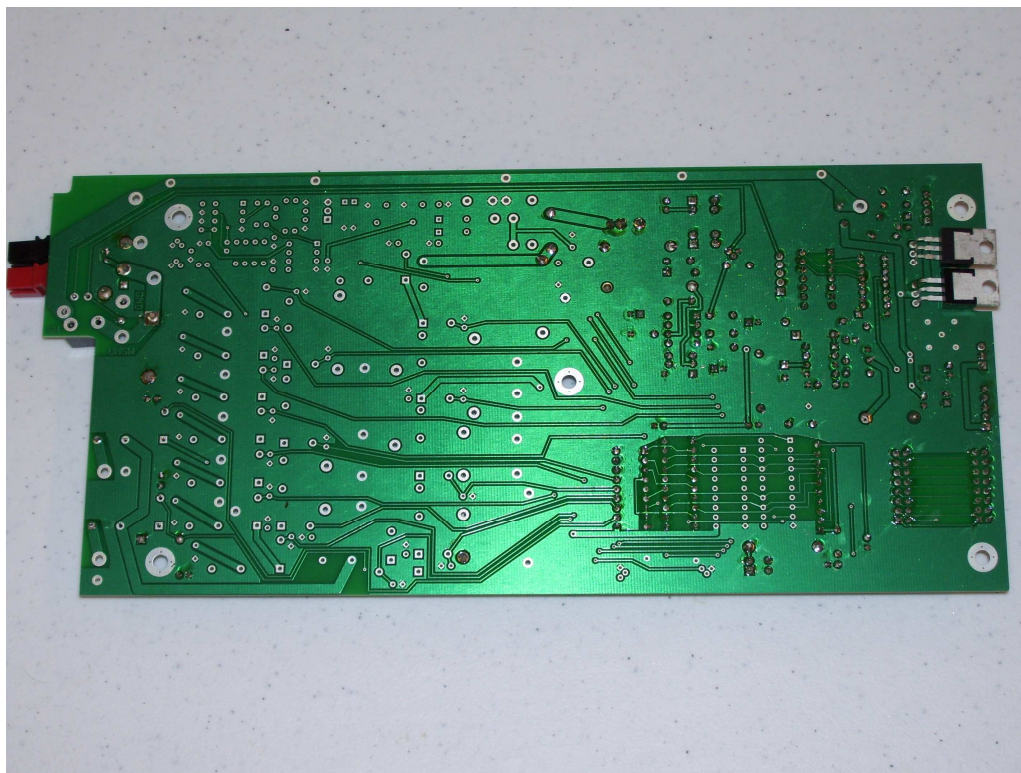

DCD Board, back, tuner and power meter circuits not installed



Appendix C2: DCD/Tuner Board [SWR Section]

PARTS LIST

Note: These parts are included with the transmitter board

Option 101 - SWR Meter Kit Bag 1 of 1 - S0100-40035-1				
Reference Designator(s)	Item	Description	Stock bin	Quantity
RV1,RV2	1	Resistor 100K ohm 1/2W trimpot 1-turn top-adjust	168D	2
D3,D4	2	Diode Zener 1N5230B 4.7V 1/2W DO-35 5%	645	2
D1,D2	3	Diode Schottky rectifier 1N5711 70V 15mA axial DO-35 (blue)	226	2
Q3,Q6	4	Transistor 2N7000 MOSFET N-ch 60V TO-92	227	2
C63	5	Capacitor 1000pF disk ceramic radial 50V Y5P 10%	3	1
C17	6	Capacitor 6-70pF trimmer	9	1
C15	7	Capacitor 100pF silver mica radial 500V 5%	353K	1
C5,C13,C14,C34,C35,C36,C37,C38,C39,C64,C65	8	Capacitor .01uF MLCC radial 50V X7R 10%	575D	11
R5,R31,R32	9	Resistor 10K ohm 1/8W metal film axial 1%	356-10K	3
R4	9	Resistor 3.16K ohm 1/8W metal film axial 1% (bent leads)	356-3.16K	1
R6,R36,R37,R40	9	Resistor 4.7K ohm 1/8W metal film axial 1% (twisted leads)	356-4.7K	4
R7	10	Resistor 200 ohm 1W metal oxide axial 5%	336	1
R38,R39	11	Resistor 100 ohm 1/4W metal film axial 1%	21	2
R33	9	Resistor 100 ohm 1/8W metal film 1%	356-100	1
J3	12	Connector 3-pin friction lock straight post tin	367	1
T1,L10	13	Toroid FT50-43	61	2
U5,U11	14	IC LM358 Dual op-amp dual GP 14-pin DIP	70	2
		Wire 24 AWG green magnet wire	724	12"
		Wire 24 AWG red magnet wire	721	30"
		Wire 18 AWG bus wire (bare)	717	6"

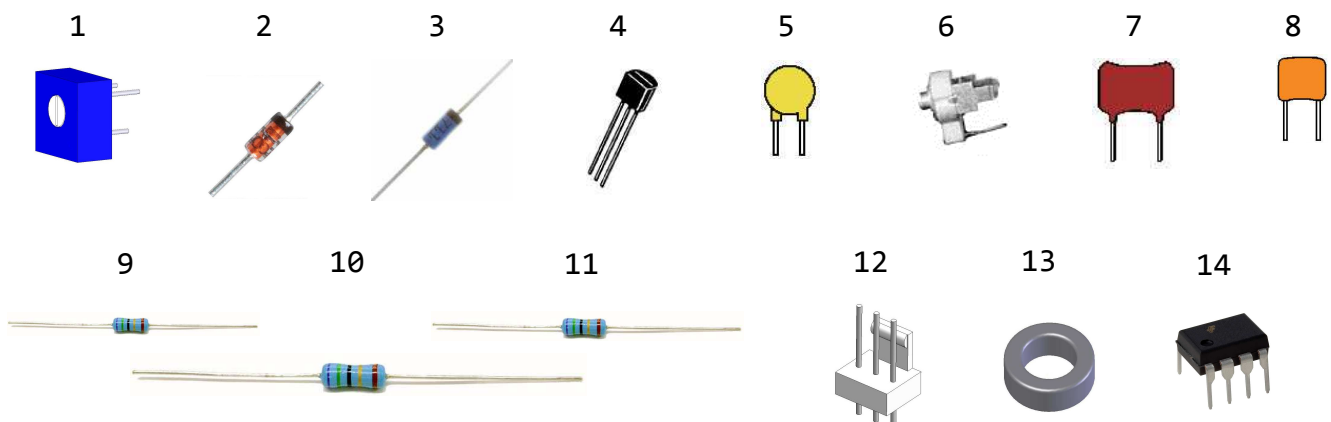



See the photos in the tuner section (Appendix C3).

- () Load and solder all capacitors, including C17, the 30pF trimmer capacitor. The trimmer can be installed either direction.
 - () Using an ohmmeter, measure the twelve resistors and sort them by value. Load and solder them at their appropriate place. Clip the leads.
 - () Load and solder all diodes, one bag at a time. Make sure the side with the band goes into the square pad.
 - () Load and solder the trimpots, RV1 and RV2.
 - () Load and solder U5 and U11, LM358 8-pin DIPs. Be sure pin 1 goes into the square pad.
 - () Load and solder Q3 and Q6. Spring the leads slightly when inserting these transistors, and make sure the flat side of the transistor lines up with the flat side on the silkscreen.
 - () Load and solder J3, the 3-pin MTA connector. Be sure the side with the vertical tab is aligned with the thick white bar on the silkscreen.
 - () If you installed a wire between pins 5 and 6 of T1 when building the DCD section of the board, remove it before installing T1.
- () Cut two lengths of #24 magnet wire 12" in length, one red and one green. Twist the two wires together, about 2 turns per inch. Wrap twelve turns of the finished wires around toroid T1. Insert the toroid into the board with the red leads going into pins 1 and 2 and the green leads into pins 3 and 4. See detail C2-1.
 - () Cut 2" of 18 AWG bare wire. Insert the wire through toroid T1 and solder the ends to pins 5 and 6. Cut excess leads.

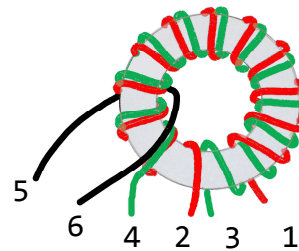

Detail C2-1. T1 construction

- () Cut an 18" length of green magnet wire. Wrap 24 turns clockwise around toroid L10. Insert it into the pads for L10 and solder the leads. Clip excess leads.
- () Check your work. Pay particular attention to connectors and ICs, making sure that every pin is soldered. Hold the board at an angle and make sure all leads have been clipped.

This completes assembly of the SWR section of the DCD/Tuner board.



Appendix C3: DCD/Tuner Board [Tuner Section] (Option 102)

Option 102 - Tuner - S0100-70102		PARTS LIST		1139B
Reference Designator(s)	Item	Description	Stock bin	Quantity
Q4	1	Transistor 2N7000 MOSFET N-ch 60V TO-92	227	1
D11	2	Diode 1N4007B rectifier 1000V 1A DO-41	53	1
U1	3	IC 74HC273 octal D-flip-flop with clear 20-pin DIP	275	1
U3	4	IC ULN2803 relay driver 8-el w/diodes 18-pin DIP	392	1
L1,L2,L3,L4,L5,L6,L7	5	Toroid T80-2	317	7
C41,C42,C43,C44,C45,C46, C47,C48,C49,C50,C51,C52, C53,C54,C55,C56,C57,C58, C59,C60	6	Capacitor .01uF MLCC radial 50V X7R 10%	575D	20
C12	7	Capacitor 10pF silver mica radial 500V 5%	353A	1
C11	7	Capacitor 20pF silver mica radial 500V 5%	353C	1
C10	7	Capacitor 39pF silver mica radial 500V 5%	353F	1
C9	7	Capacitor 82pF silver mica radial 500V 5%	353J	1
C8	7	Capacitor 150pF silver mica radial 500V 5%	353M	1
C7	7	Capacitor 330pF silver mica radial 500V 5%	353R	1
C6	7	Capacitor 560pF silver mica radial 300V 5%	353T	1
K1,K2,K3,K4,K5,K6,K7,K8,K9, K10,K11,K12,K13,K14,K15,K16	8	Relay 8A SPST-NO sealed 8A 12V coil pcb-mount	512	16
	9	Wire 20 AWG red magnet wire	719	120"

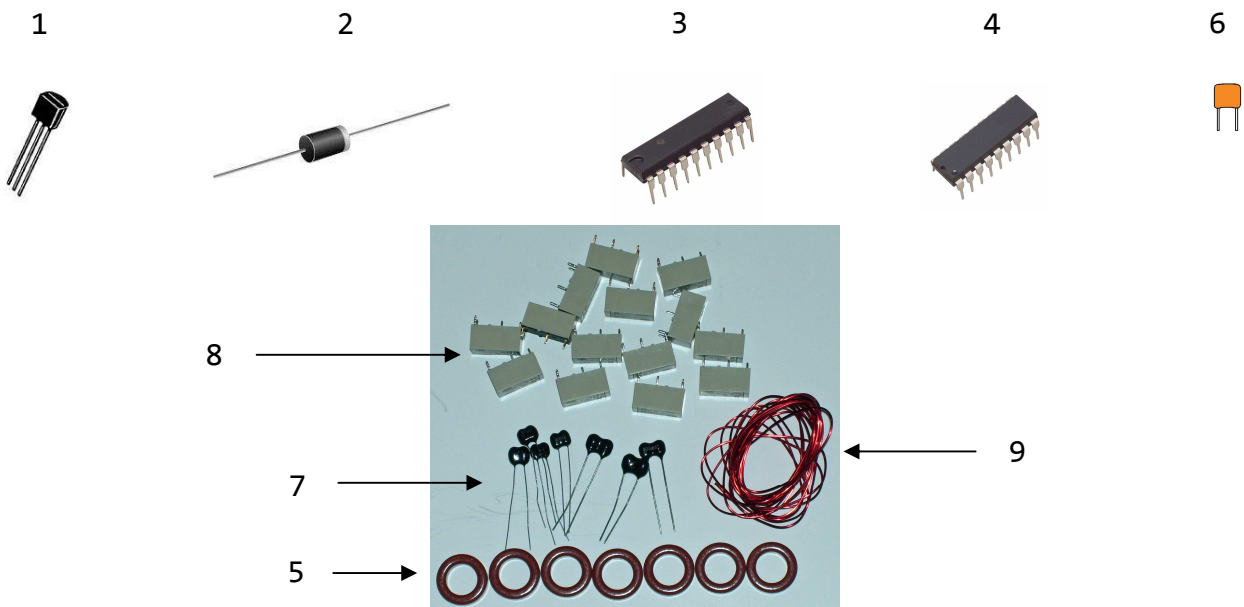

Note: Capacitors are marked with actual value, e.g. "330", in pF.



STEP-BY-STEP ASSEMBLY-Tuner Board

Note: Be very careful not to let your soldering iron touch plastic parts on the DCD board as you install these parts.

- () If you are installing this option after you finished wiring your Sienna, first disconnect power, remove all cables and screws from this board, remove the Fan mounting bracket, unsolder the antenna A and B leads, and pull the DCD/Tuner board out of the unit. Also unsolder the wire that runs diagonally across the board.
- () Load and solder transistor Q4. Make sure the flat side lines up with the flat side of the silkscreen.
- () Load and solder diode D11. Make sure the banded side goes in the hole with the square pad.
- () Load and solder both ICs, making sure pin 1 goes into the hole with the square pad.
- () Load and solder all 20 .01uF capacitors.
- () Load and solder all 16 relays.
- () Cut 31" of 20 AWG gauge magnet wire and wrap 31 turns around toroid L1. See detail photo on next page. Each time the wire enters the toroid counts as one turn. Leave about 1/2" lead exposed. Do not space the leads evenly around the core – wind them tightly together. See photo of assembled unit.
- () Load and solder the toroid where noted on the board. Be sure it lies flat on the board and tighten the leads as much as possible. Once the board has been tested, you will apply a small amount of glue to keep the toroids from moving, but it is not necessary to do so at this time. Apply heat to each lead for at least one minute to be sure that the coating melts off and the lead is securely soldered to the board. Then clip excess leads.
- () Wind 22 turns (use 22") of magnet wire around toroid L2. Solder the toroid in place.
- () Wind 15 turns (use 15") of magnet wire around toroid L3. Solder the toroid in place.
- () Wind 10 turns (use 11") of magnet wire around toroid L4. Solder the toroid in place.
- () Wind 5 turns (use 6") of magnet wire around toroid L5. Solder the toroid in place.
- () Wind 3 turns (use 5") of magnet wire around toroid L6. Solder the toroid in place.
- () Wind 2 turns (use 4") of mag-



net wire around toroid L7.
Solder the toroid in place.

() Using an ohmmeter, verify continuity (< 1 ohm) between the two pads that each toroid's wires are soldered to. If any do not read correctly, re-heat the connections making sure that all enamel is removed.

() Load and solder all silver mica capacitors. Clip the leads.

() Check your work.

() If this is an upgrade, reinstall the board and reconnect cables.

This completes assembly of the Tuner section of the DCD/Tuner board.

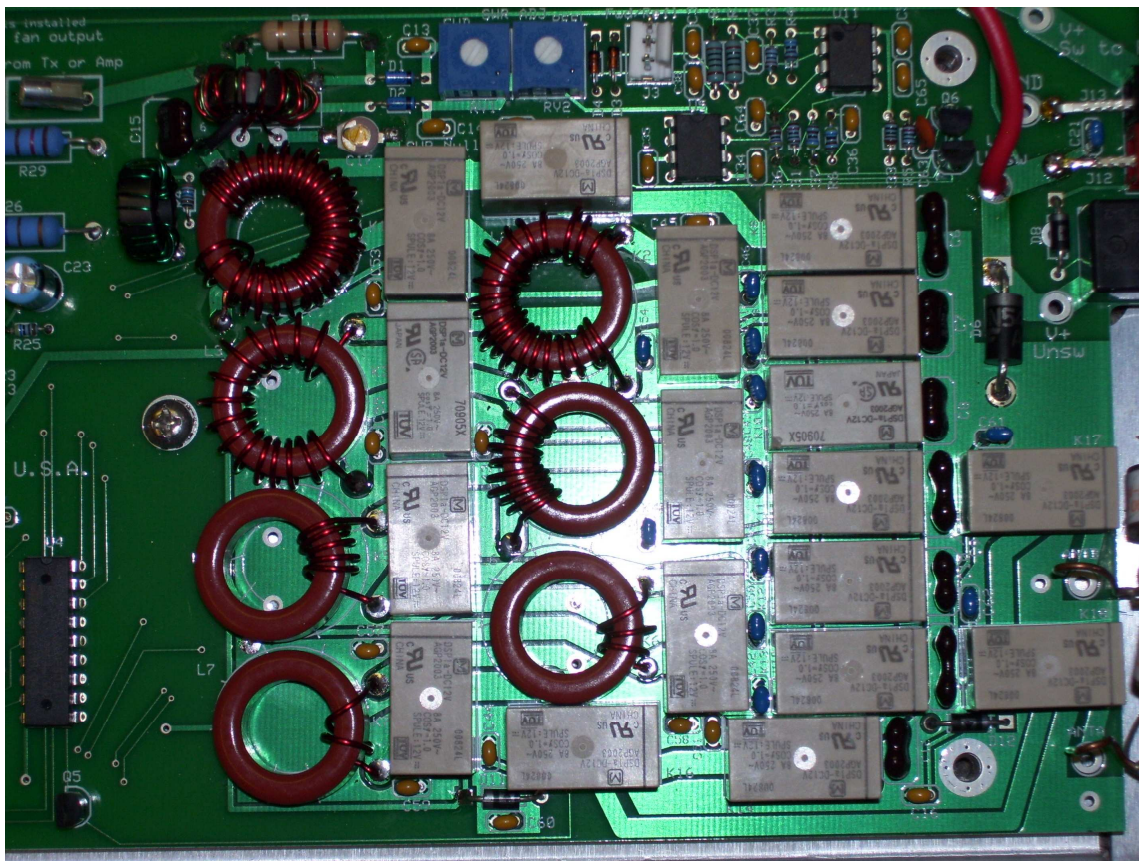

Detail photo showing correct winding of tuner toroids

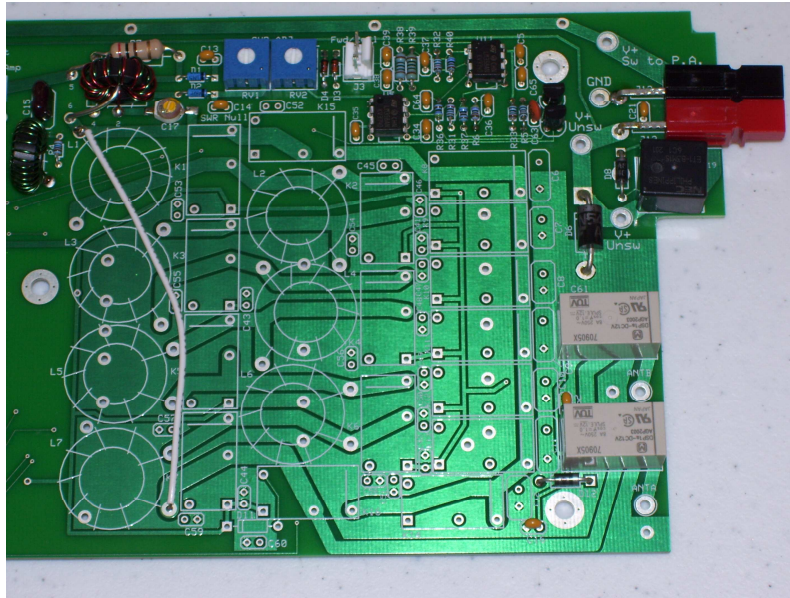

DCD Board, SWR meter installed, tuner not installed

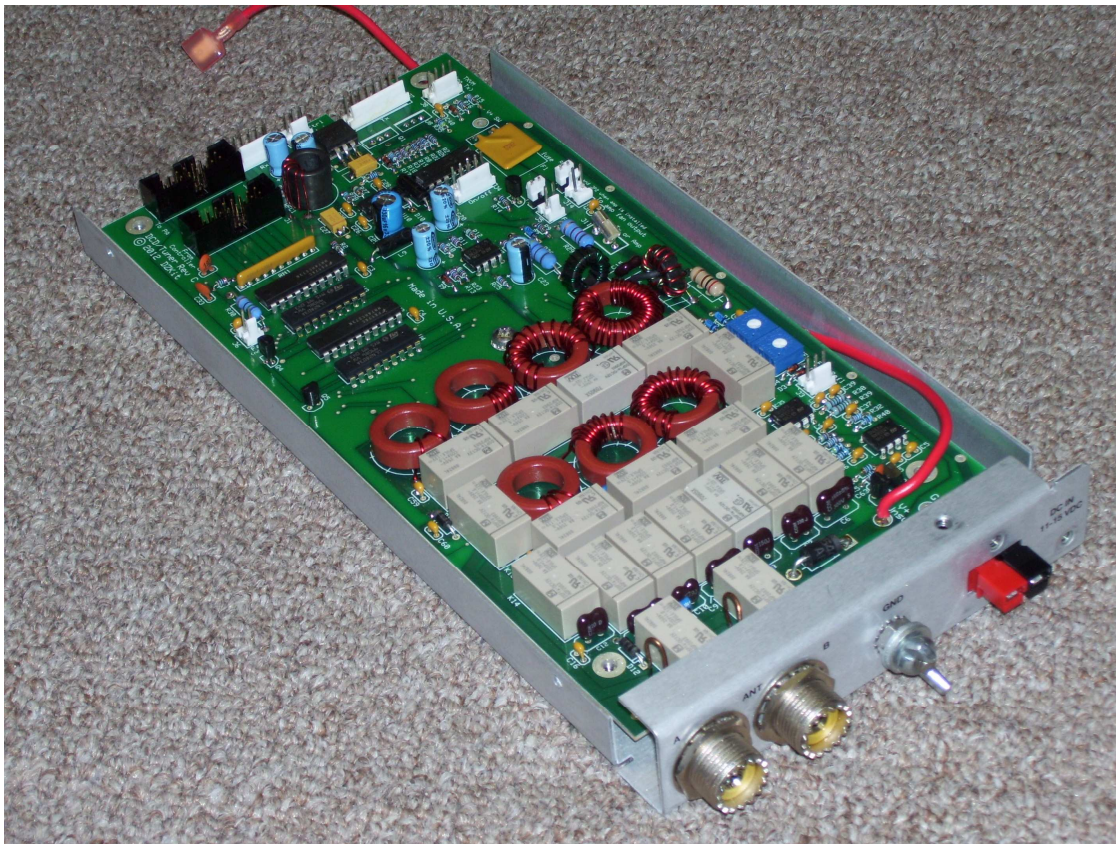

DCD Board, tuner and SWR meter installed, on tray



Appendix C4 — 5V Regulator Board

PARTS LIST

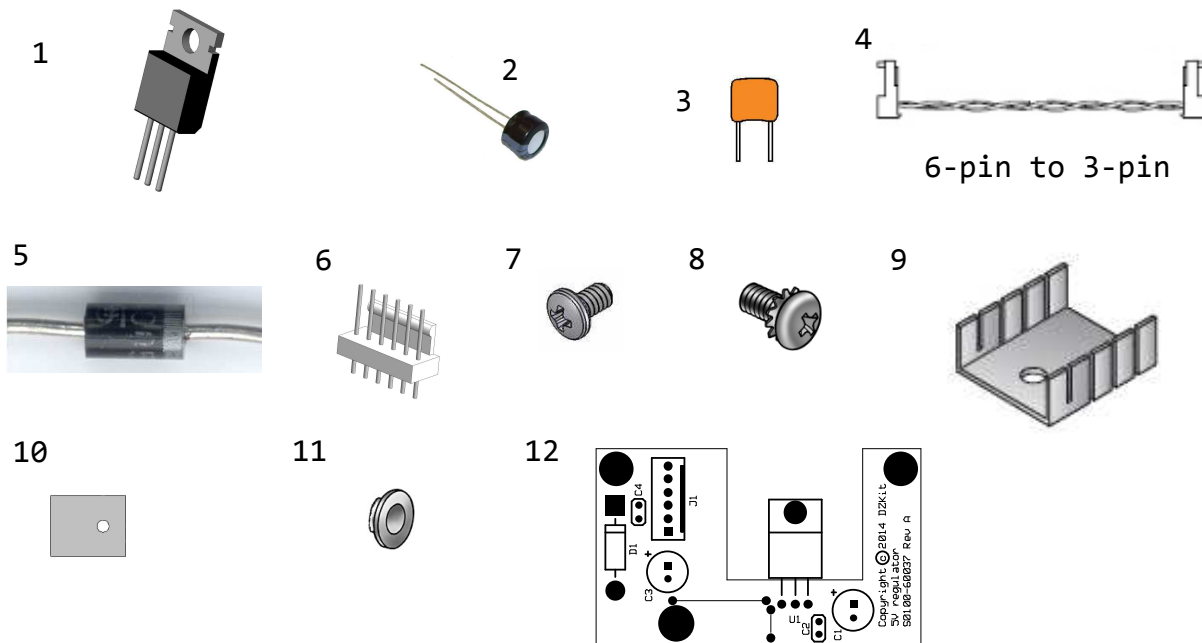

Reference Designator(s)	Item	Description	Stock bin	Quantity
U1	1	IC AP1084T50L Voltage regulator 5V 5A LDO TO-220	497	1
C1,C3	2	Capacitor 100uF/25V aluminum electrolytic	57	2
C2,C4	3	Capacitor .1uF MLCC 50V radial X7R 5%	232	2
CA3	4	DCD Regulator Cable	808	1
D1	5	Transient Voltage Suppressor 6.8V	663	1
J1	6	Connector 6-pin friction lock header straight	371	1
		Bare wire 24AWG (inches)	718	6
	7	Hardware 4-40 x 1/4in PH Phillips M/S SS	479	1
	8	Hardware 6-32 x 1/4" PH SEMS M/S SS	644	3
	9	TO-220 heat sink	307	1
	10	Hardware Insulator with adhesive back for TO-220	523	1
	11	Hardware shoulder washer plastic TO-220	303	1
	12	5V Regulator Board Blank - S0100-20037	748	1



STEP-BY-STEP ASSEMBLY-5V Regulator Board

- () Load and solder capacitors C1 and C3. Make sure the positive terminal goes in the holes with the square pads. Cut excess lead lengths.
- () Load and solder capacitors C2 and C4.
- () Load and solder connector J1. Be sure to line up the tab on the connector with the silk-screened bar.
- () Load and solder transient voltage suppressor D1. This part can be inserted in either direction.
- () Cut the bare wire into two lengths of 3" each. Insert the two wires where noted on the silkscreen (white lines). Solder all ends and cut off excess leads.

Save the hardware and U1 for installation on the chassis bottom.

This completes assembly of the 5V regulator board.



Appendix D1-Blank Front Panel

PARTS LIST

Item	Description	Qty
1	Screw - 6-32 x 1/4" PH Phillips M/S SEMS	6
2	Front Panel sheet metal	1
3	Front panel polycarbonate overlay	1
4	Controller Board	1

1



2

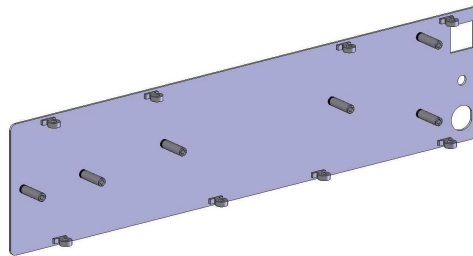

3



4

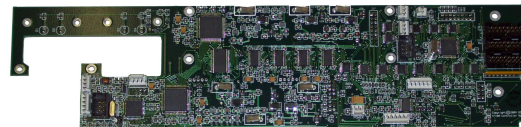



There are no assembly steps here. See the integration pages (pp 36-37) for front panel assembly for information regarding assembly of this module.



Appendix D2-Front Panel with controls

35

PARTS LIST—PC Board

Item	Part	Description	Qty	Bag
1	C1, C2	.1uF monolithic capacitor	2	1
2	C3	100uF/25V axial leaded electrolytic capacitor	1	1
3	RV1,RV3, RV5-RV12	10K 9mm snap-in pot	10	1
4	J2,J4	8-pin 2-row male header	2	2
5	J3, J5	16-pin 2-row male header	2	2
6	RN1,RN2	1K - 5 isolated resistor network	2	1
7	R4	100 ohm 1/4W resistor	1	1
7	R1,R2	1K ohm 1/4W resistor	2	2
8	S1-S14	NKK Lighted Pushbutton	14	2
9	S16	Rotary Encoder/switch	1	1
10	S15	SP8T Rotary switch	1	1
11	RV2,RV4	Trimpot 10K top adjust	2	1
12		Blank board	1	-

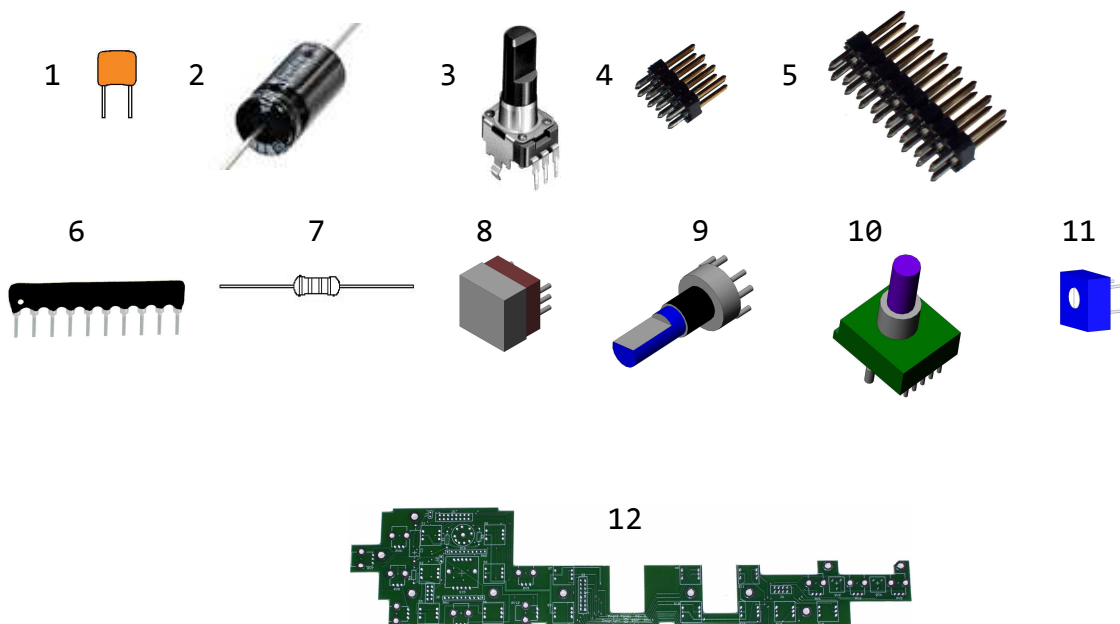



PARTS LIST—Hardware

Item	Part	Description	Qty	Bag
1		Knob-small	12	1
2		RIT Knob	1	1
3		Tuning knob	1	1
4		1/20" (.050") Hex key	1	2
4		1/16" (.063") Hex key	1	2
4		5/64" (.078") Hex Key	1	2
5		Screw - 6-32 x 1/4" PH Phillips M/S SEMS	14	2
6		Hole plug—.25" Nylon	2	2
7		Nut - 2-56	4	2
8		Hex M/F spacer - 6-32 x 7/16"	4	2
8		Hex M/F spacer - 6-32 x 1/2"	4	2
9		S-meter	1	2
9		Transmit meter	1	2
10		Vacuum Fluorescent Display (VFD)	1	2
11		Front panel sheet metal	1	2
12		Front panel polycarbonate overlay	1	2
13	CA11	CA11—CONT-FPKEY cable	1	2
14		Controller Board (assembled)	1	-

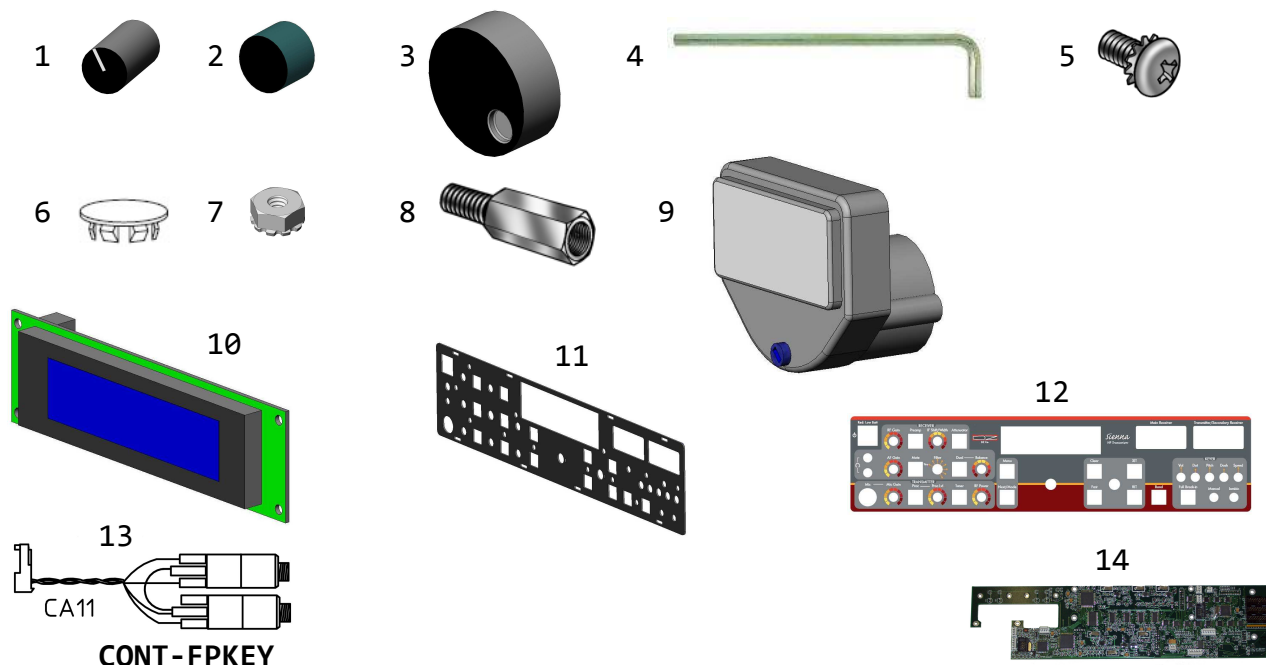



STEP-BY-STEP ASSEMBLY-Front Panel Board

NOTE: The blank front panel board is shipped attached to the controller and front panel sheet metal. This must be disassembled. Remove the screws holding the controller in, and remove the nuts and lockwashers from the Rotary Pulse Generators, then carefully remove the controller (with attached RPGs) to gain access to the front panel board. Remove it before assembly.

- () Load and solder the two monolithic capacitors (Bag 1) at C1 and C2. Clip the leads.
- () Load and solder the 100uF electrolytic capacitor C3 (Bag 1). The positive side has an indentation in the body and goes in the hole with the square pad. Clip the leads.
- () Load and solder the two resistor networks (Bag 1). Although these are symmetric, so orientation does not matter, it is good practice to put the dotted side in pin 1, the square pad.
- () Load and solder the 100 ohm resistor (Bag 1). Clip the leads.
- () Load and solder the two 1K ohm resistors (Bag 2) at R1 and R2. Clip the leads.
- () Load and solder all rotary pots (Bag 1). Make sure they lie flush on the board.
- () Load and solder the rotary encoder (Bag 1).
- () Load and solder the two trim-pots, RV2 and RV4 (Bag 1).
- () Bend the small tab on the 8-position rotary switch (Bag 1) 90 degrees. **Remove and save the Lockwasher and nut.** Load and solder the switch.
- () Mount all connectors (Bag 2) to the back of the board - the non-silkscreened side; i.e., solder them on the top side. Make sure they are flat against the bottom side of the board.
- () Insert the NKK pushbutton switches into the front panel board one at a time. (See note on next page.) Solder each one as it is installed before doing the next one. Be sure that the text on the back of the switch faces UP. There is a "+" symbol next to the middle pin on one side and a "-" symbol on the middle pin on the other side of the switch. The "+" side goes to the square pad. It is very important to get these right as the lights will not work if you get them reversed, and removing the switches is not trivial. **Tip: solder one pin while holding the board vertically, then lay it on a flat surface and heat that pin back up while you seat the switch on the board.**

This completes assembly of the Front Panel board. Keep the hardware bags for use in front panel integration.

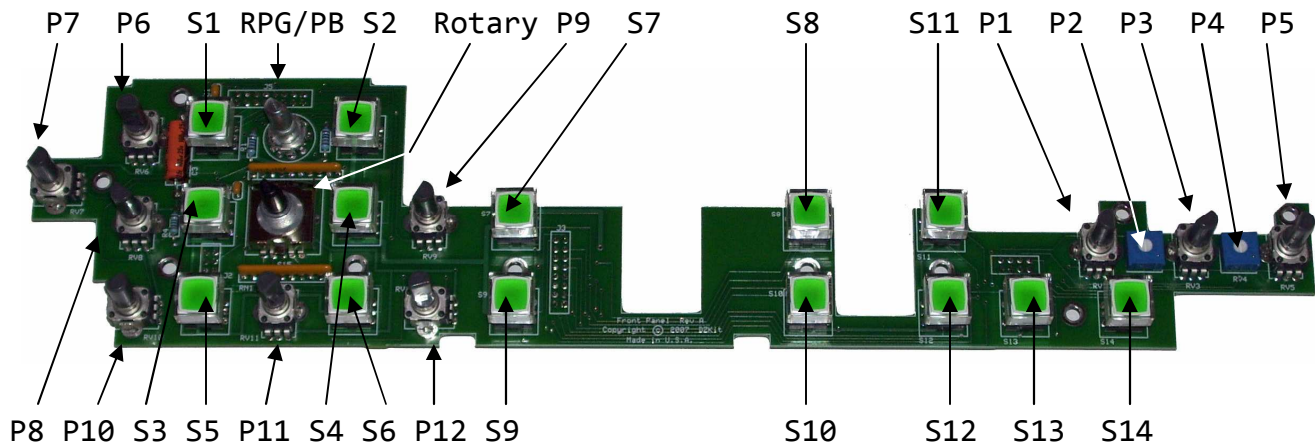

() Measure resistances to ground on connector pins as shown below. Values shown are +/-20%. Values of 0 can read 0 to 1 ohm. Use any mounting hole as a ground point. When a connector pin is shown as "Px", vary the corresponding potentiometer as shown above. Values will go from approx. 0 to approx 10K ohms*. When a pin is shown as "Sx", push and hold the corresponding switch. The reading should go from infinite (or high resistance) to approximately 0 ohms. The pushbutton in the RPG is called PB. If your volt/ohm meter has a "diode measurement" function, it should read 1.8V from "Power" to the noted LED pin (Lx). (Lx is the LED inside Sx.)

* Because the pots are not connected to power at this time, some will read from 0 to 2.5K and then go back down to about 550 ohms.

	L2	L1	L4	L3	P11	P9	P8	P7	
L9	S10	S2	S1	S4	S3	P10	PB	P6	P12
L12	S9								
L11	S8								
L10	S7								

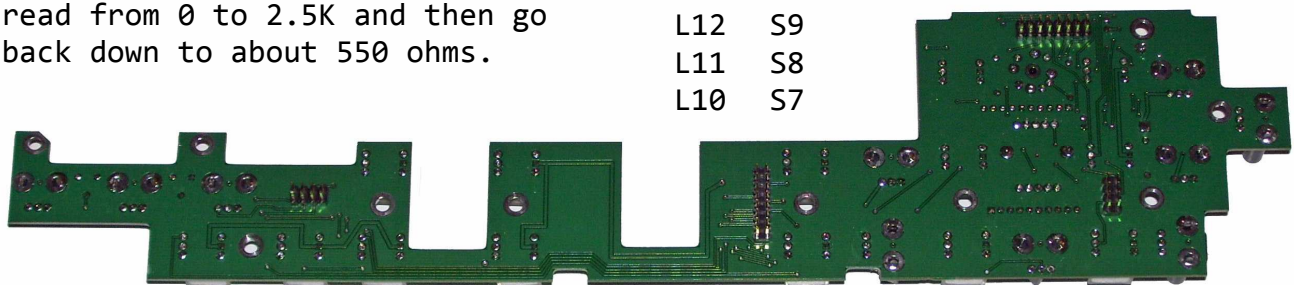

P5	P2	P4	2.5K
P1	10K	P3	0

L7	S14	LED Power	RPG
L8	S13	Rotary	RPG
L13	S12	L5	S5
L14	S11	L6	S6

Note: If you bought your front panel with specific LED colors and/or keycaps, be sure to look at the front panel polycarbonate panel and determine which ones you want where before soldering them in. Keycaps are fairly easy to interchange, but LEDs are not, since they are integral to the switch. If you bought a combination of colored LEDs, they will have been packed in separate bags. Be careful not to intermix them prior to assembly, because they are hard to tell apart.



Appendix E: IF Filter Board

PARTS LIST

S0100-40005 IF Filter Board Kit - Bag 1				
Reference Designator(s)	Item	Description	Stock bin	Quantity
C30,C31,C32,C33,C38,C39,C40,C41	1	Capacitor 10pF ceramic disk radial 50V NP0 5%	233	8
L1-L10	2	Inductor 100uH 370mA 1.7 ohms axial	646	10
R18	3	Resistor 68 ohm 1/4W metal film axial 1%	433	1

S0100-40005 IF Filter Board Kit - Bag 2				
Reference Designator(s)	Item	Description	Stock bin	Quantity
C5,C6	1	Capacitor 27pF ceramic disk 50V NP0 5%	119	2
C3,C4,C7,C8,C9,C10,C11,C12,C13,C14,C15,C16,C17,C18,C19,C20,C21,C22,C23,C24,C25,C26,C27,C28,C29,C34,C35,C48,C49,C50,C51,C52,C53,C54,C55,C56,C57,C58,C59,C60,C61,C62,C63,C64,C65,C66,C67,C68,C69,C70	1	Capacitor .1uF ceramic disk radial 50V Y5U 5%	8	50
C1,C2	4	Capacitor 10uF aluminum electrolytic 25V radial 20%	56	2
R21,R56,R57,R58,R59,R60,R61,R62,R63	3	Resistor 150 ohm 1/4W metal film axial 1%	340	9

S0100-40005 IF Filter Board Kit - Bag 3				
Reference Designator(s)	Item	Description	Stock bin	Quantity
D1,D2,D3,D4,D5,D6,D7,D8,D9,D10,D11,D12,D13,D14,D15,D16,D17,D18,D19,D20,D21,D22,D23,D24,D25,D26	5	Diode 1N914 signal 100V 300mA DO-35	50	26
Q1,Q2,Q3,Q4,Q5,Q6,Q7,Q8,Q9,Q10	6	Transistor 2N7000 MOSFET N-ch 60V TO-92	227	10
R9,R12,R15	3	Resistor 300 ohm 1/4W metal film axial 1%	246	3
U1	7	IC 74HC139 dual 2:4 decoder 16-pin DIP	312	1
U2	8	IC 74HC240 octal 3-st buffer 20-pin DIP	401	1

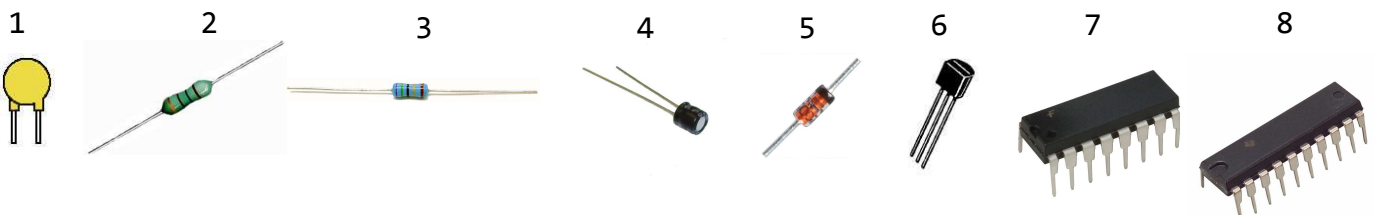



S0100-40005 IF Filter Board Kit - Bag 4				
Reference Designator(s)	Item	Description	Stock bin	Quantity
FL2	9	IF Filter - Ceramic filter 455kHz 6kHz BW	649	1
J1	10	Connector 8-pin friction lock header straight post tin	79	1
J2,J3,J4,J5	11	Connector RF 45-degree pcb-mount (Taiko Denki)	407	4
Jy,Jx	12	Connector 36-pin header straight .510in tin	397A	2
R13,R16	3	Resistor 470 ohm 1/4W metal film axial 1%	44	2
	13	Hardware Board lock 3/16in Nylon	107	12

S0100-40005 IF Filter Board Kit - Bag 5				
Reference Designator(s)	Item	Description	Stock bin	Quantity
R11,R14,R25,R28,R31,R34	3	Resistor 620 ohm 1/4W metal film axial 1%	435	6

S0100-40005 IF Filter Board Kit - Bag 6				
Reference Designator(s)	Item	Description	Stock bin	Quantity
R8,R10,R17,R19	3	Resistor 1.2K ohm 1/4W metal film axial 1%	436	4

S0100-40005 IF Filter Board Kit - Bag 7				
Reference Designator(s)	Item	Description	Stock bin	Quantity
R5,R7,R20,R23	3	Resistor 2.4K ohm 1/4W metal film axial 1%	437	4
T5,T6	14	Transformer Z=1:36 30kHz-20MHz 6-pin DIP	364	2

S0100-40005 IF Filter Board Kit - Bag 8				
Reference Designator(s)	Item	Description	Stock bin	Quantity
R1,R2,R3,R4,R26,R29,R32,R35,R46,R47, R48,R49,R50,R51,R52,R53,R54,R55	3	Resistor 10K ohm 1/4W metal film axial 1%	17	18
T3,T4	14	Transformer 4:1 6-pin DIP	118	2

S0100-40005 IF Filter Board Kit - Bag 9				
Reference Designator(s)	Item	Description	Stock bin	Quantity
R22,R24,R27,R30,R33, R40,R41,R42,R43,R44,R45	3	Resistor 20K ohm 1/4W metal film axial 1%	248	11
T1,T2	14	Transformer Z=1:2CT 70kHz-200MHz 6-pin DIP	362	2

Blank board

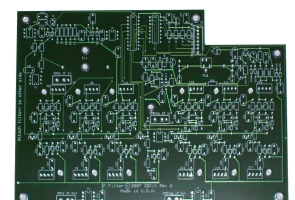
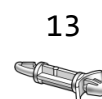
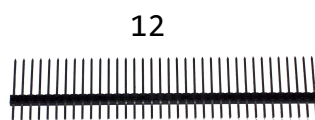
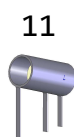
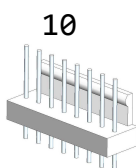



STEP-BY-STEP ASSEMBLY-IF Filter Board

IMPORTANT! ALL parts are mounted on the top (silkscreened) side of the board EXCEPT: J1, all filters and the connectors that are formed out of the 36-pin, single row connector.

Highlight or check off each part on the bag label as you install it on the board. Unless otherwise instructed, load all parts of the same type from each bag and clip the leads after soldering. Use silkscreened text and/or ExpressPCB to help you locate the parts.

- () Load and solder all 1N914 diodes. Make sure that the side with a band on it goes into the hole with a square pad. Clip the leads as close to the board as possible (called "close-clipping").
- () Load and solder all capacitors. Make sure the electrolytic capacitors are loaded with the long (+) lead in the holes with square pads and marked on the silkscreen with a '+'. Close-clip the leads.
- () Load and solder all resistors. Close-clip the leads.
- () Load and solder all inductors. Close-clip the leads.
- () Load and solder transformers T1 and T2. These are marked T2-1T. Pin 6 (yes, pin 6) is marked with a dot. It must be loaded into the hole with the square pad.
- () Load and solder transformers T3 and T4. These are marked T4-1.
- () Load and solder transformers T5 and T6. These are marked T36-1.
- () Load and solder IC's U1 and U2. Make sure that pin 1 goes in the hole with the square pad.
- () Load and solder transistors Q1-Q10. Make sure the flat side of the transistor is lined up with the flat side of the silkscreened outline.
- () Load and solder 4 Taiko-Denki RF connectors at J2, J3, J4 and J5.
- () Load connector J1 **on the bottom side of the board.** Make sure that the tab on the con-

Note: In the next three steps, you will load transformers. They look exactly the same but there are three different values. Be sure to load the one that is called out and double check before soldering!

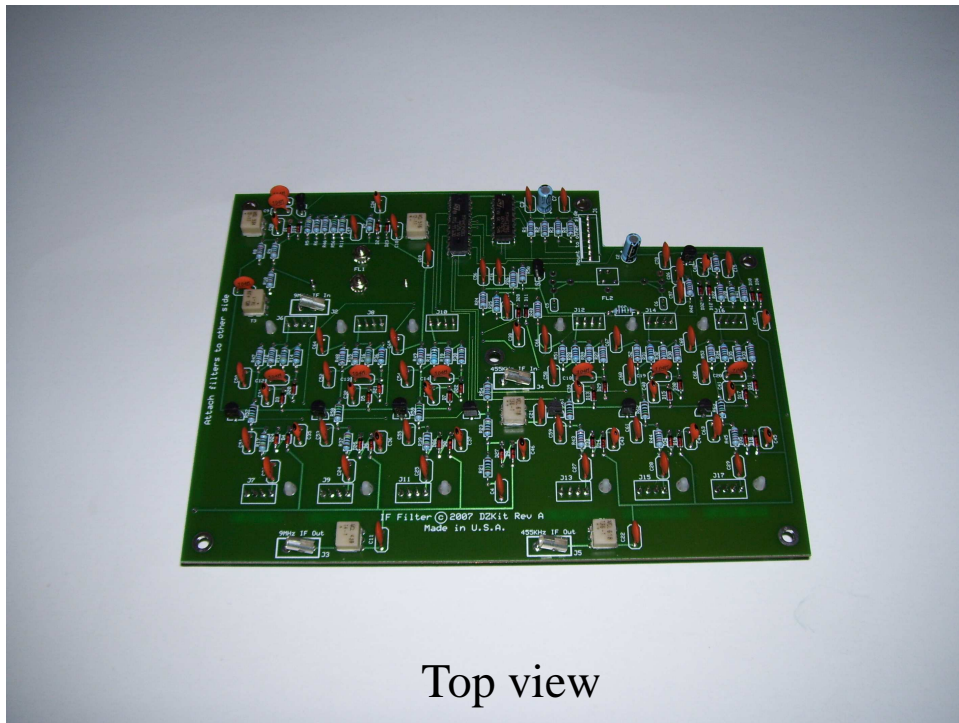

Top view

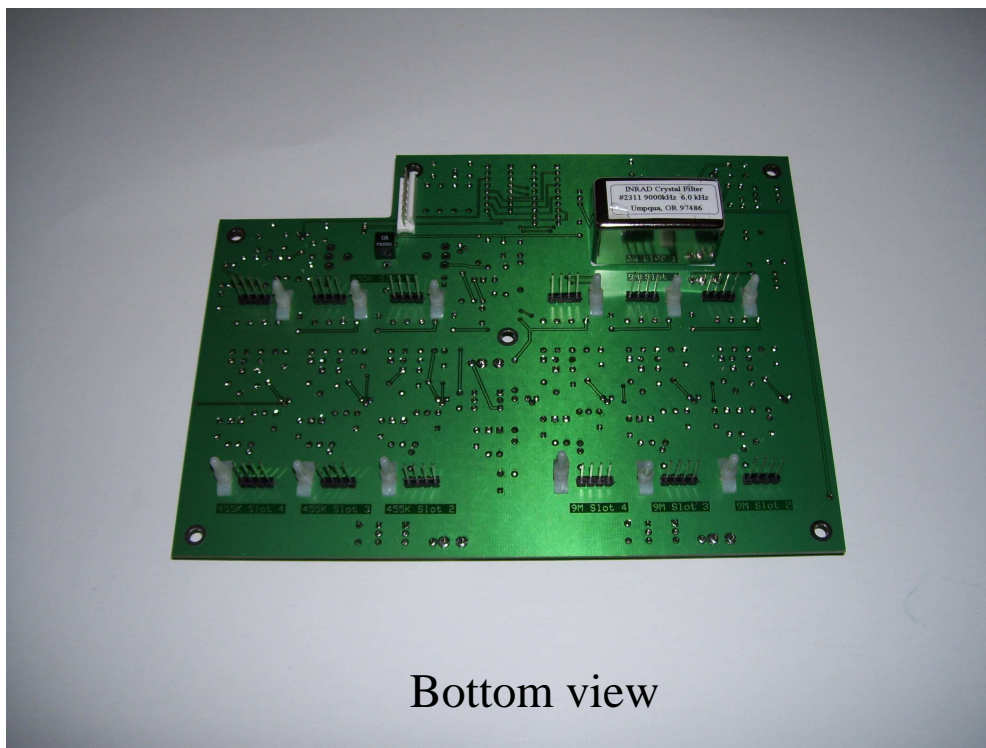

Bottom view

IF Filter Photographs



connector is on the side with the heavy bar on the silk-screen.

- () If you have purchased a 5.8KHz Collins mechanical filter for 455KHz, install it on the bottom side of the board in the location marked FL2.
- () If you have NOT purchased the Collins filter, load and solder the 455kHz ceramic filter in FL2 on the bottom side of the board.
- () Cut the 36-pin connectors into 12 4-pin connectors. (There will be extra pins left over.) Use wire cutters on the indented sections of the plastic. These connectors are very sharp. Be careful! Solder all 12 **to the bottom side of the board**. Disregard the square pad. See Photo E1.
- () If you have purchased the 9.0MHz 6KHz AM filter, remove it and the white plastic sheet from its box. Cut the sheet into two small squares about 1/4" on a side. Carefully punch holes in the center of each square. Push the squares onto the two insulated pins, shiny side toward the filter, and place the filter on the board at FL1 **on the bottom side of the board**. Attach the nuts and lockwashers to the top side of the board. Solder both pins. Clip the leads.

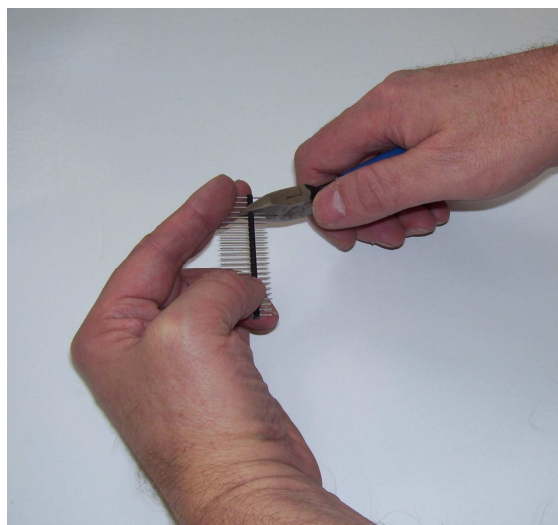

Photo E1. Cutting 36-pin connector into 12 4-pin connectors

- () Push a Nylon fastener into each of the 12 holes located near the 12 4-pin connectors as shown in the bottom photo on page 115. Push the tabbed end into the board so that the tab compresses and lies flat against the board. You will hear a click as the tab locks into place.
- () After installation, you will add plug-in filters, including the 4-pole SSB filter that is included in this kit. Do not load it at this time, but set it aside in a secure place.
- () When this board is installed, it sits directly above the roofing filter board. To make sure none of the pins short against the metal shield on that board, clip the leads of the components that will be near that shield as short as possible.



- () Measure the resistance to ground of each of the 8 pins on J1. Only pin 6 should read less than 1 ohm. All others should read a very high resistance (typically > 1 Megohm).

This completes assembly of the IF filter board.



Appendix F: RXBPF Board

PARTS LIST

Reference Designator	Item	Description	Bin	Qty
C1,C2	1	Capacitor 10uF aluminum electrolytic 25V radial 20%	56	2
D1,D2	2	Diode Schottky rectifier 1N5711 70V 15mA axial DO-35	226	2
D3,D4,D5,D6,D7,D8, D9,D10,D11	3	Diode 1N4007B rectifier 1000V 1A DO-41	53	9
RFC1	4	Inductor 1mH axial axial 5%	19	1
J1	5	Connector 4-pin friction lock header r/a post tin	373	1
J5	6	Connector 16-pin 2-row header shrouded r/a low profile	379	1
J2,J3,J4,J7	7	Connector RF 45-degree pcb-mount (Taiko Denki)	407	4
J6	8	Connector 6-pin (8-pin Rev B1 & later) friction lock header r/a post tin	414 or 683	1
J8	9	Connector 4-pin friction lock header post tin	88	2
JP1	10	Connector 3-pin header vert tin (for jumper)	85	1
JS1	11	Jumper 2-pin tin	84A	1
S1	12	Switch DPDT Slide r/a on-on-on pcb-mount	517	1
T1,T2	13	Toroid FT37-43 (may be pre-wound)	59	2
T3	14	Transformer 4:1 6-pin DIP	118	1
K4,K5,K6,K7,K8	15	Relay SPDT 12V Low Signal NL 200mW pcb	636	5
R31,R32,R33,R34	16	Resistor 10K ohm 1/8W metal film axial 1%	356-10K	4
RN1	17	Resistor 7-el array 10K bussed 8-pin	78	1
Q3,Q4	18	Transistor 2N5109 NPN RF 40V TO-39	45	2
		RxBPF Preload - S0100-30006	923	1
		Wire 24 AWG green magnet wire (unless pre-wound)	724	18"
		Wire 24 AWG red magnet wire (unless pre-wound)	721	18"

1



2



3



4



5

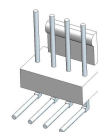

6



7



8 Rev B



8 Rev B1 or later



9

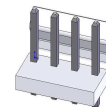

10

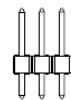

11



12



13



14



15



16



17



18



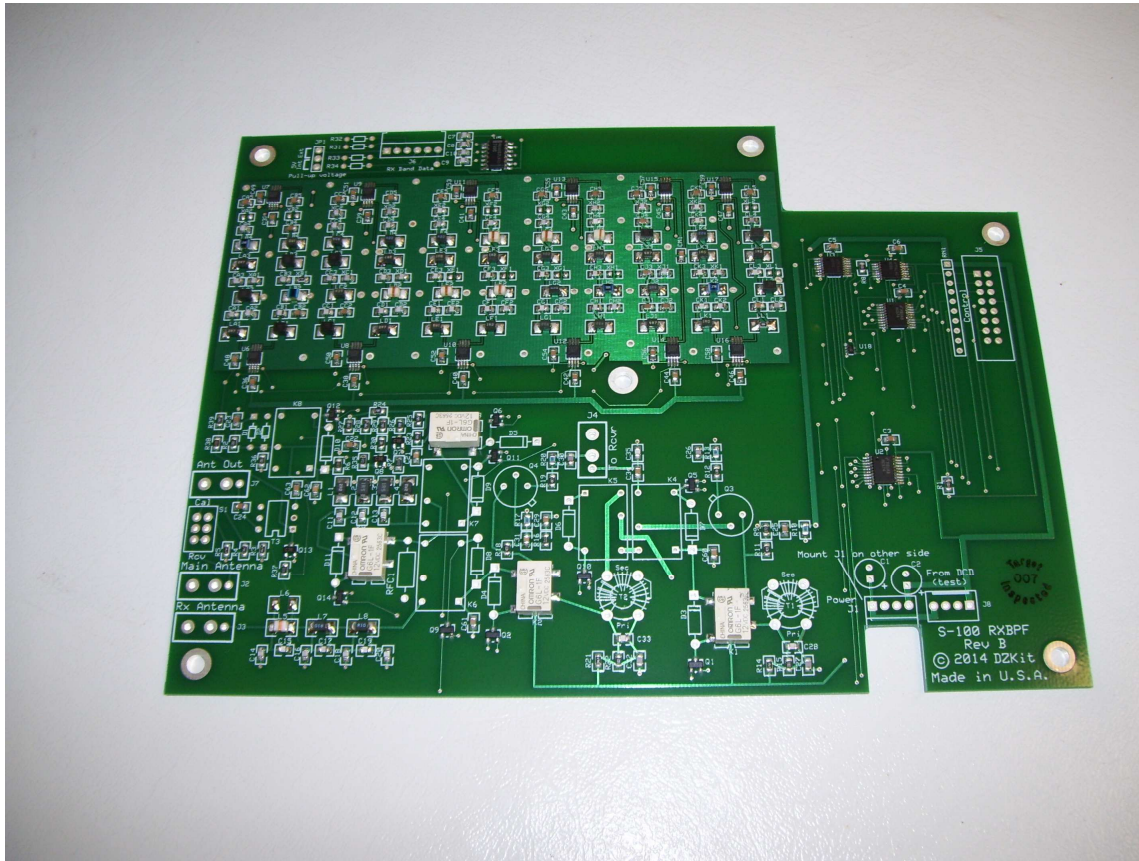

RXBPF board before loading



STEP-BY-STEP ASSEMBLY-RXBPF Board

Highlight or check off each part on the bag label as you install it on the board. Unless otherwise instructed, load all parts of the same type from each bag. Solder the pins after you have installed a couple of bags of parts and then clip their leads. You do not want to do too many parts at once because you may miss some, and with too many leads, they can interfere with each other. When clipping leads, note whether parts move, indicating that they have not been soldered, and apply solder.

- () Remove the RXBPF board carefully from its antistatic bag. Observe static control precautions while adding parts to this partially-loaded board. The GaAsFET switches that have been loaded are very sensitive devices and will have a direct effect on receiver performance if they are damaged. Be careful! After each step, cut excess leads.
- () Load and solder both electrolytic capacitors (item 1). Make sure they are loaded with the long (+) leads in the holes with square pads and marked on the silkscreen with a '+'. Use silkscreened text and/or ExpressPCB to help you locate the parts.
- () Load the four through-hole resistors (item 17). Use silkscreened text and/or ExpressPCB to help you locate the parts.
- () Load and solder coil RFC1 (item 5).
- () Load and solder both blue (1N5711) diodes (item 2). Make sure that the side with a band on it goes into the hole with a square pad.
- () Load and solder all black (1N4007B) diodes (item 3). Make sure that the side with a band on it goes into the hole with a square pad.
- () Load and solder the two metal transistors, Q3 and Q4 (item 18). These transistors will only go in one way, and the tab on the side should be lined up with the silkscreened tab on the board. Insert the parts all the way down on the board.
- () Load and solder the resistor network, RN1 (item 17). Be sure that pin 1, marked by a dot, goes into the hole with the square pad.
- () Load and solder switch S1 (item 12). Make sure that the switch lever extends out the side of the board.



- () Load and solder 6-pin transformer T3 (item 14). Be sure the dot on the body of the part is aligned with the square pad.
- () Load and solder relays K4-K8 (item 15). These will only go in one way.

If you purchased pre-wound toroids with your kit, skip the next 6 steps.

- () Cut the red magnet wire into two equal pieces, 9" each.
- () Cut the green magnet wire into two equal pieces, 9" each.
- () Twist one red and one green wire together, about 2 turns per inch. Do the same with the other pair of wires.
- () Wind 5 turns of one twisted pair of magnet wire evenly around one of the two FT37-43 toroids (item 13), spreading the windings out so that most of the core is covered. Remember that each pass of the wire through the toroid counts as one turn. See photo.
- () Repeat the above step using the other FT37-43 toroid. See photo.
- () For each toroid, insert the red wires into the holes marked "Pri", and the green wires into the holes marked "Sec". It will be easiest to

mount the toroids if they are standing up and oriented at a slight angle to the pads. Once inserted, cut excess wire, then remove the toroids and carefully strip (or melt) the coating off of the last 1/4". Apply a small amount of solder to the ends to "tin" them.

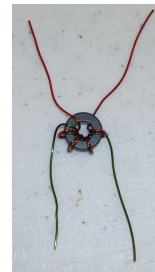

- () Load the toroids (item 13) with the red wires going into the holes marked "Pri" and the green wires into the holes marked "Sec". Solder the leads.
- () Using an ohmmeter, Verify that there is continuity between the "Pri" pads and between the "Sec" pads, on each part. If not, re-solder the wires and re-measure.
- () Load all connectors:

Notes: J1, the 4-pin right-angle connector, mounts on the BOTTOM side of the board with the pins extending into the notch in the board. All others mount on the top.

J5, the right angle 16-pin connector, must be mounted so that the pins face outward



toward the edge of the board.

The white "MTA" connectors must be placed so that the solid back is aligned with the thick white bar on the silkscreen.

The RF connectors (item 7) can be placed all the way up against the board. Bend the small lead down so that it points the same direction as the other two thicker pins. Compress the two larger pins together slightly so that the connector will have a friction fit in the board, helping to hold it in place as you solder it. You can also solder one pin from the top of the board before flipping the board over to solder all three pins more securely.

- () Load and solder 3-pin header JP1. Then place the jumper on the two pins labeled "5V Int".

Note: This causes the receiver band data to be pulled up to the internal 5V through 10K resistors. If you should need to interface this circuit to something requiring a different voltage or different pull-up resistors, you can change the resistors and select the other jumper position ("Ext"), and then you can feed an external voltage into pin 1 of J6.

Typically, band data is used by amplifiers to select the

same band as the transmitter. This data allows you to select external bandpass filters or antennas for the receiver separately from the transmitter if desired. This is needed for "SO2R" operation, or when operating cross-band.

- () Check your work carefully for solder bridges, shorted traces and backwards or missing components.
- () Measure the resistance to ground of each of the 4 pins on J1:
 - Pin 4: > 200 ohms
 - Pin 3: (open)
 - Pin 2: < 1 ohm (ground)
 - Pin 1 (square pad): > 1 Meg-ohm

This completes assembly of the RXBPF board. If you will not be installing this board in the chassis right away, place it back inside the anti-static bag.

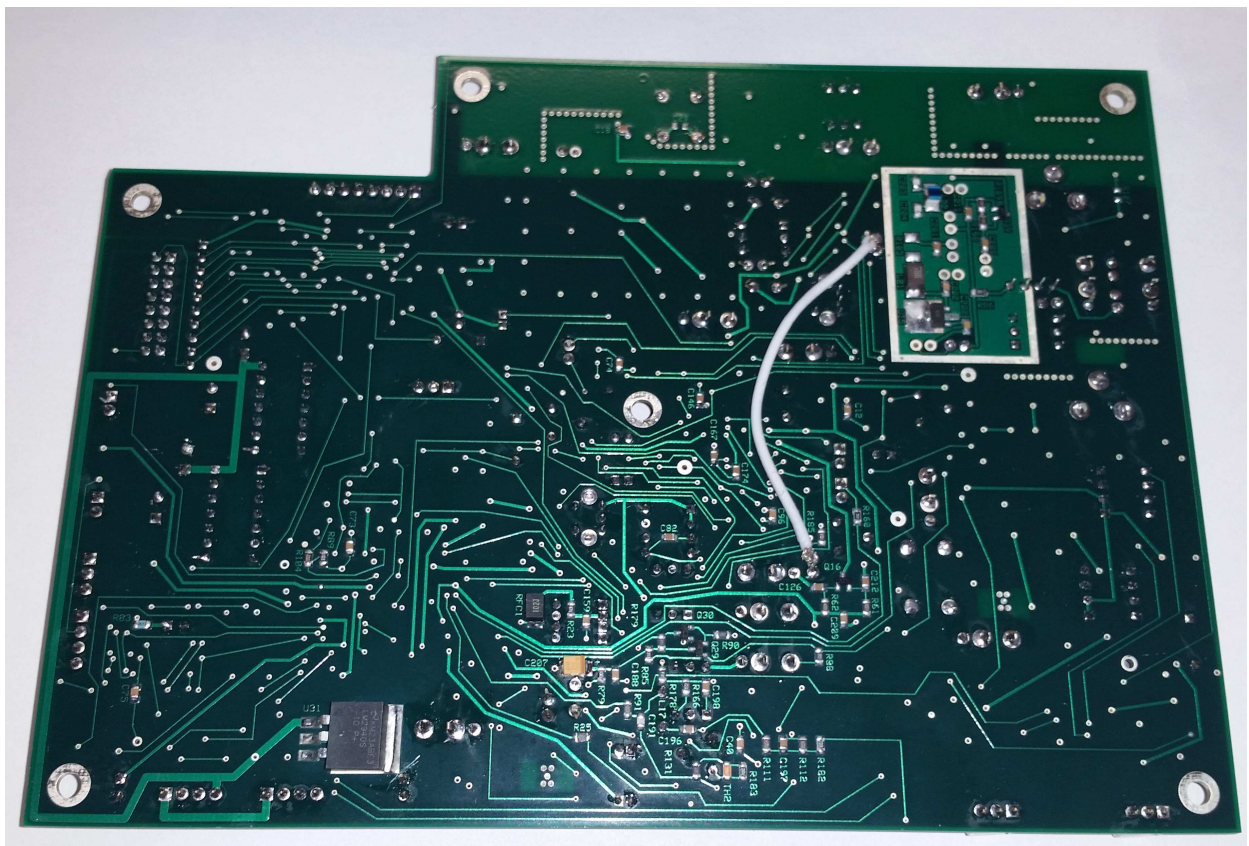
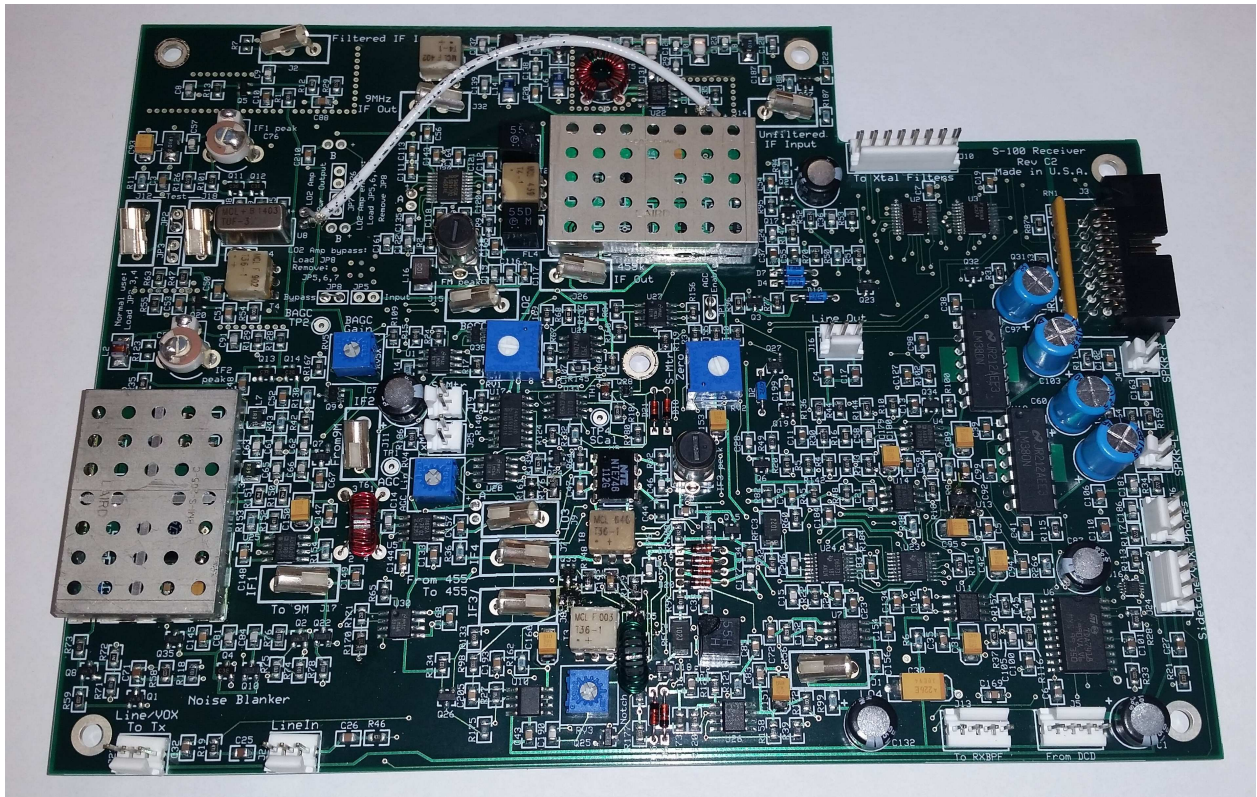



Appendix G: Receiver Board

PARTS LIST

S0100-40007 Rx Board Kit				1066B
Bag 1 of 3				
Reference Designator(s)	Item	Description	Stock bin	Qty
C76,C90	1	Capacitor 6-70pF trimmer	9	2
C1,C77,C87,C132,C170	2	Capacitor 100uF aluminum electrolytic radial 25V 20%	57	5
C60,C97	2	Capacitor 330uF aluminum electrolytic radial 16V 20%	534	2
C103,C104	2	Capacitor 470uF aluminum electrolytic radial 10V 20%	406	2
RV3,RV4,RV5	3	Resistor 5K ohm 1/2W trimpot 1-turn top-adjust	168J	3
D1,D2,D4,D7,D10	4	Diode Schottky rectifier 1N5711 70V 15mA axial DO-35	226	5
D6,D15,D16,D17,D18,D19, D20,D21	5	Diode 1N914 signal 100V 300mA DO-35	50	8

1



2



3

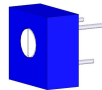

4



5



Notes:

1. The shield on the bottom side of the board is normally not installed.
2. Trimpot style and color may vary.
3. 330uF and 470uF electrolytics look similar but have different voltages. Be sure to get them in the right spots.
4. Not all RF connectors are loaded. If you have to send a board back for test or repair, we may add additional test connectors.
5. Use care when adding through-hole components. All ICs are static sensitive.
6. Some through hole components are installed inside the shields. The top covers can be popped off and re-installed.



S0100-40007 Rx Board Kit		1067B		
Bag 2 of 3				
Reference Designator(s)		Description	Stock bin	Qty
T1,T2	6	Transformer 4:1 6-pin DIP	118	2
RV1	3	Resistor 10K ohm 1/2W trimpot 1-turn top-adjust	168C	1
J4,J19,J22,J25	7	Connector 2-pin friction lock header .1in straight post tin	172	4
L5,L9	8	Inductor variable slug-tuned 100uH	322	2
J6,J16,J21,J23	9	Connector 3-pin friction lock straight post tin	367	4
J3	10	Connector 16-pin 2-row header shrouded r/a low profile	379	1
FL3,FL4	11	IF Filter - 455kHz ceramic filter 20kHz BW	402	2
J1,J2,J7,J8,J9,J11,J14,J15, J17,J26,J32	12	Connector RF 45-degree pcb-mount (Taiko Denki)	407	11
RN1	13	Resistor 7-el array 10K bussed 8-pin	78	1
J10	14	Connector 8-pin friction lock header straight post tin	79	1
J5,J13,J24	15	Connector 4-pin friction lock header .1in straight post tin	88	3
		Coaxial cable (A-A, C-C)	712	12"

6



7



8



9

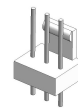

10



11



12



13

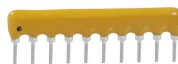

14

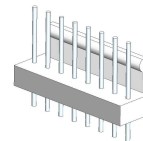

15

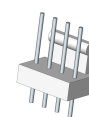



S0100-40007 Rx Board Kit					1068B
Bag 3 of 3					
Reference Designator(s)		Description	Stock bin	Qty	
FL2	11	IF Filter - 455kHz ceramic filter 6kHz BW	649	1	
RV2	3	Resistor 500 ohm 1/2W trimpot 1-turn top-adjust	168G	1	
T5	16	Transformer 4T:31T (green:red)	59	1	
T6	17	Transformer 4T:31T (green:red)	59	1	
L17	18	Inductor 180uH (25T red)	59	1	
T3,T4,T8	6	Transformer Z=1:36 30kHz-20MHz 6-pin DIP	364	3	
U8	19	IC TUF-3 RF diode ring mixer	115	1	
U18,U19	20	IC NTE740A (LM380) Audio amplifier 14-pin DIP	210	2	
U9,U12,U32	21	IC NTE746 (MC1350) Linear IF amp 8-pin DIP	63	3	

16

17

18

19

20

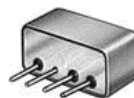

21



Note: If you did not order pre-wound and tinned toroids, your kit will have three of these toroids and a spool of red and green magnet wire.

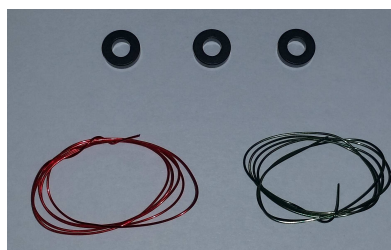





STEP-BY-STEP ASSEMBLY-Receiver Board

It can take quite a while for you to locate the parts visually. We recommend that you use the free ExpressPCB software to help you find the parts. Load the file

receiver_revx_no_traces.pcb

(the x represents a revision letter).

Highlight or check off each part on the parts list that is inside the bag as you install it on the board. If parts have long leads, solder the leads after you have installed about 5-10 of them and then clip their leads. You do not want to do too many parts at once because you may miss some, and with too many leads, they can interfere with each other. When clipping leads, note whether parts move, indicating that they have not been soldered well, and re-solder them.

Hint: Some parts fit loosely in the pads. To solder them, hold the board upright and use one finger to hold the part in place while you solder one lead on the bottom. It doesn't matter if the part is not flush. Once you've "tacked" it in, push it flat while reheating the pin, then lay the board upside down and solder the remaining leads. Note – this works well on multi-pin con-

nectors, but you can burn your finger if you are touching the lead you are tacking down. Be sure to touch other pins or the connector body instead of the lead you are soldering!

- () Remove the Receiver board from its antistatic bag. Handle this board with care and observe anti-static precautions to avoid damaging the pre-loaded parts.
- () Load and solder the two 70pF trimmer capacitors (Bag 1).
- () Load and solder the two 470uF/10V electrolytic capacitors and five 100uF/25V aluminum electrolytic capacitors (Bag 1) flush with the board. Be sure to put the longer ('+') lead in the square pad, also marked with a '+' symbol. (The caps are very close together, and the '+' symbol can be interpreted as belonging to the wrong part, so be sure to look at the square pad!)
- () Load and solder the two 330uF/16V electrolytic capacitors (Bag 1).
- () Load and solder all 1N5711 diodes (Bag 1). Be sure that the side with a band goes into the hole with a square pad. These parts are colored blue.



- () Load and solder all 1N914 diodes (Bag 1). Be sure that the side with a band goes into the hole with a square pad. These parts are colored red.
- () Load and solder FL3 and FL4 (Bag 2), 20KHz ceramic filters. Do not mistake these for the 6kHz filter in bag 3. They look identical.
- () Load and solder L5 and L9 (Bag 2), the two variable inductors.
- () Load and solder resistor network RN1 (Bag 2). Be sure that the dot marking pin 1 goes into the hole with the square pad.
- () Load and solder FL2 (Bag 3), a 6 kHz ceramic filter.
- () Load and solder trimpots RV3, RV4 and RV5 (Bag 1). These are marked on the side with a "502" (5k Ohms).
- () Load and solder trimpot RV1 (Bag 2). The value of this pot is marked on the side with a "103" (10k ohms).
- () Load and solder trimpot RV2 (Bag 3). The value of this pot is marked on the side with a "501" (500 ohms). Clip excess leads on all pots.
- () Load and solder T1 and T2, a Minicircuits T4-1 transformer (Bag 2). Make sure the dotted pin goes in the hole with the square pad. *The other 6-pin transformers look exactly like this one. Make sure you load the T4-1 transformer into T1 and T2.*
- () Load and solder three T36-1 Minicircuits transformers (Bag 3) into T3, T4 and T8. Make sure the dotted pin goes in the hole with the square pad.
- () Load and solder U8, TUF-3 RF mixer (Bag 3). Make sure the body is oriented so that it does not extend beyond the silkscreened outline. Leave a small gap (less than 1/32"/0.8mm) between the bottom of the part and the board to avoid shorts between the pads and the case.
- () Load and solder the two LM380 (NTE740) audio amplifier ICs, U18 and U19 (Bag 3). Be sure that pin 1 goes into the hole with the square pad.
- () Load and solder U9, U12, and U32 (Bag 3), the MC1350 (NTE746) IF amplifier ICs. Be sure that pin 1 goes into the hole with the square pad.
- () If you purchased pre-wound toroids, do only the bold



sections of the next three steps.

- () Locate the toroid and magnet wire (Bag 3). Cut a 16" length of red 28 gauge magnet wire. Wind 31 turns completely around the toroid. Each time the wire passes through the center is considered 1 turn. Leave about 1/2" of lead extending out from the toroid. Then cut a 3" length of green magnet wire and wind 4 turns on top of the side of the toroid that does not have leads extending out from it. Tin the leads flush with the body of the toroid, being careful not to melt the coating off the windings. Keep the soldering iron (set to 750 degrees F) on the leads until the coating melts away and the solder flows onto both the pad and the wire smoothly. This can take about one minute per lead. **Solder the four leaded toroid with leads on opposite sides (item 16) at T5. The side with 4 turns goes into the holes marked Primary (pins 1 and 2).**

- () Make another toroid with 4 turns and 31 turns, this time orienting the toroid so that it will stand up vertically. To do this, wind the 31 turn secondary, then wind the primary on top of the primary so that all four leads extend down. Tin the leads. **Solder the 4-leaded toroid into T6.**

The 4-turn primary leads go into pins 1 and 2.

- () Cut a 14" length of 26 gauge magnet wire. Make a third toroid by winding it with 26 turns. Tin the leads. **Solder the two-leaded toroid into L17. It will sit on top of other components. This is OK.**

- () Clip excess leads from the toroid wires.

- () Using an ohmmeter, verify that there is continuity (<1 ohm) from pins 1 to 2 and from 3 to 4 on T5 and T6 and between the two leads of L17. If not, apply more heat to the leads and re-measure.

- () Load and solder all white AMP MTA connectors (Bag 2). Be sure the tab along the back lines up with the heavy line on the silkscreened outline. Load these connectors one at a time. See the soldering hint at the beginning of this section.

- () Load and solder J3 (Bag 2), a right-angle 16-pin ribbon cable connector. Pin 1 on this connector is marked with an embossed triangle. Be sure this pin goes into the hole with the square pad.

- () Load and solder 11 RF connectors at J1, J2, J7, J8, J9, J11, J14, J15, J17, J26 and J32. Do not load connectors into J12 or J18. To in-



stall these, bend the small lead down, then squeeze the thicker leads together slightly so the connector will not fall out while you solder it. Solder one lead, then push the connector down so that the end with the small pin is flush with the board and solder all three pins. These connectors point up at a 45 degree angle.

the pad marked "+".

- () Check your work carefully. Make sure all polarized parts are inserted correctly, that pin 1 of the ICs and resistor network are on the square pads, and that all parts are soldered. Also check to be sure that all leads are clipped and not shorting other leads.

- () Prepare two lengths of coaxial cable as shown below. Solder the 3" length between the points marked A and A, and the other between C and C with the center conductor in

This completes assembly of the Receiver board.

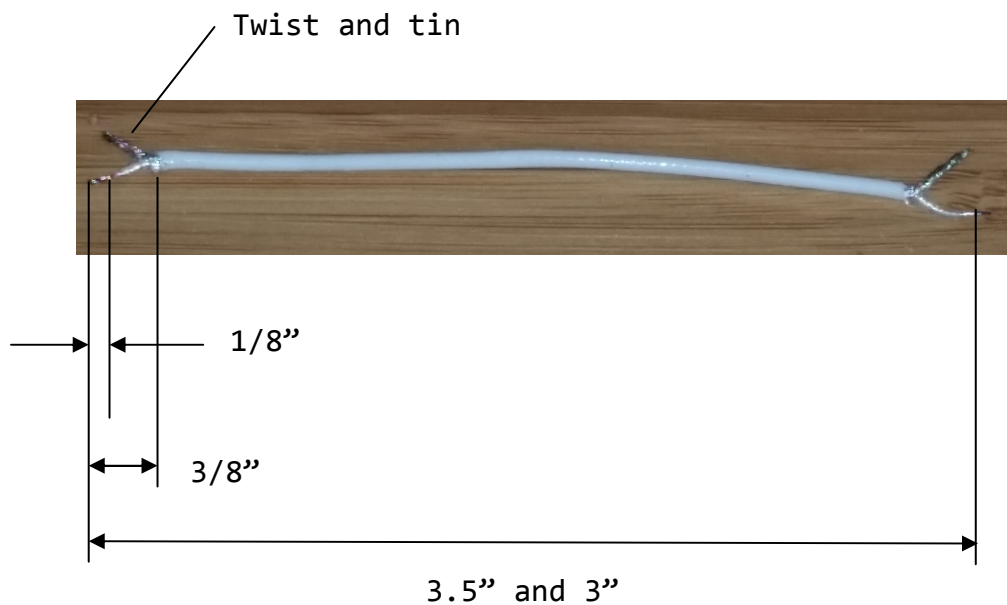



Appendix H: Transmitter Board

PARTS LIST: PC Board

Item	Part	Description	Qty	Bag
1	C108	18pF silver mica (sm)	1	1
1	C86,C103	27pF sm	2	1
1	C112	33pF sm	1	1
1	C40,C95	39pF sm	2	1
1	C110	47pF sm	1	1
1	C105	56pF sm	1	1
1	C107	68pF sm	1	1
1	C85,C89	82pF sm	2	1
1	C49	100pF sm	1	
1	C106	120pF sm	1	1
1	C91,C101, C109, C111	150pF sm	4	1
1	C36,C87,C99	220pF sm	3	1
1	C55,C59,C88,C104	270pF sm	4	1
1	C13,C39,C56,C90	330pF sm	4	1
1	C38	390pF sm	1	1
1	C11, C41	1000pF sm	2	1
1	C34,C39	1200pF sm	2	1
1	C37	2200pF sm	1	1
2	C84, C121, C122	22uF/16V bi-polar aluminum electrolytic	3	1
3	C2, C30	10uF/25V aluminum electrolytic	4	1
4	C1, C60, C116	100uF/25V aluminum electrolytic	5	2
5	D12, D13	1N914 signal diode (red)	2	2
6	D3, D4, D5, D11, D17	1N4007B rectifier diode (black)	5	2
7	D1, D2, D6, D15	1N5711 Schottky diode (blue)	4	2
8	F1	250mA axial picofuse	1	2

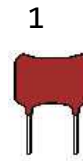

2



3



4



5



6



7



8





Item	Part	Description	Qty	Bag
9	J1	16-pin 2-row .1" centers shrouded male header	1	3
10	J4, J15	2-pin AMP MTA male keyed header	3	3
11	J6, J3	3-pin AMP MTA male keyed header	2	3
12	J14	4-pin AMP MTA male keyed header	1	3
13	J5	5-pin AMP MTA male keyed header	1	3
14	J13, J17	4-pin 2-row female bd mt socket	2	3
15	J12, J16	8-pin 2-row female bd mt socket	2	3
16	J2	8-pin DIN PC-mt	1	3
17	J8, J9, J10, J11	RF Jack	4	3
18	J7	Triple phono connector	1	3
19	S1	Switch DPDT Slide r/a on-on-on pcb-mount	1	3
20	JP1-6, 9-12	2-pin jumper header	10	3
21	JP8	3-pin jumper header	1	3
22	JS1-6, 8-12	2-pin jumper shorting bar	11	3
23	K12, K13	SPDT 12V relay	2	3
24		Hex M/F spacer - 4-40 x 3/16"	4	3
25		Thermalsil sticky-back insulator	4	3
26		Screw - 4-40 x 3/16" PH Phillips M/S SEMS	6	3
27		Screw - 4-40 x 3/16" PH Phillips M/S	4	3
28		Fiber shoulder washer	4	3

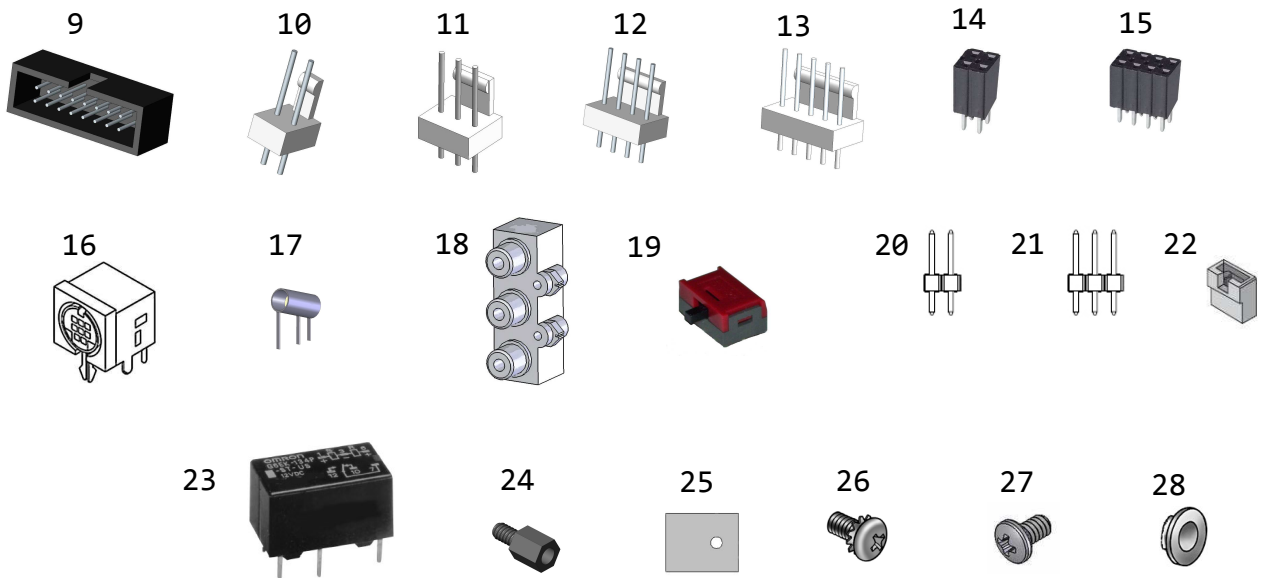



Item	Part	Description	Qty	Bag
29	L1-L4	T50-2 toroid (red)	4	4
30	L5-L12	T50-10 toroid (black)	8	4
31	L13, L14	Ferrite Bead	4	4
		#24 red magnet wire	180"	4
		#24 green magnet wire	36"	4
5	D7,D8,D10	1N5230B 4.7V Zener diode	3	5
32	Q14	2N5109 NPN low-noise RF transistor	1	5
34	Q4, Q5	2SC1969 NPN RF power transistor	2	5
36	R27	47 ohm 1W power resistor	1	5
38	R39	180 ohm 1W axial power resistor	1	6
5	D16, D18	1N5239B 9.1V Zener diode	2	6
34	Q3	2SC2166C NPN RF power transistor	1	6
39	T2	T36-1 6-pin transformer	2	6
34	Q13	TIP31A NPN power transistor	1	7
40	RN1	Resistor network, 10-pin 10K ohm	1	7
41	RV1	10K trimpot - top adjust	1	7
42	T1, T3	FT37-43 toroid	2	7
43	T5	Binocular core	1	7
44	T4	FT50-43	1	7
39	T6	T9-1 9:1 transformer 6-pin DIP	1	7
45	TH1	Thermistor - 10K ohm	1	7
46	U10	TUF-3 RF mixer	1	7
47	Y1-Y21	11.98135 MHz Crystal	21	8
47		Mylar crystal insulator—HC-49/U	21	8
		#24 bare wire	15"	8
48		Heatsink - 2.5" x 4.5", black anodized	1	-
49		Partially loaded Transmitter Board	1	-

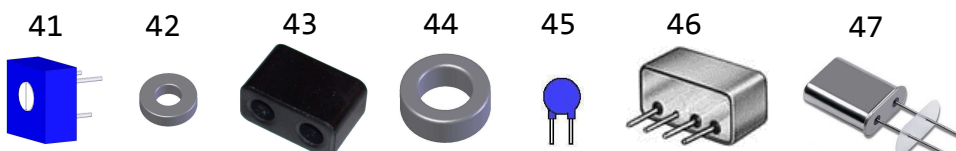
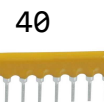
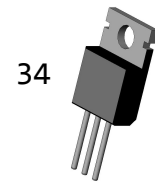



PARTS LIST: Mounting Hardware

Item	Description	Qty	Bag
	SWR Meter Kit (parts added to DCD board—see App. C2)	1	-
	TXBPF (Assembled and Tested)	1	-
50	Screw - 4-40 x 3/8" PH Phillips M/S	1	HW
51	Screw - 2-56 x 5/8" PH Phillips M/S	2	HW
52	Nut—4/40 KEPS nut	1	HW
53	Nut - 2-56	2	HW
54	Hex F/F spacer, 4-40 x 1 1/4"	1	HW
55	Lockwasher - #2	2	HW
56	Transmitter extender bracket	1	HW
57	Screw - 4-40 x 3/16" PH Phillips M/S SEMS	2	HW
	CA4, CA17, CA21, CA29, CA47 cables	1 ea	HW

48

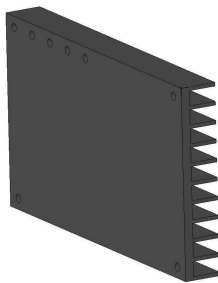

49

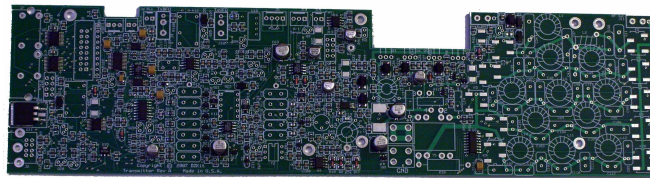

50



51



52



53



54



55



56



CA21 CONTDATA-TX

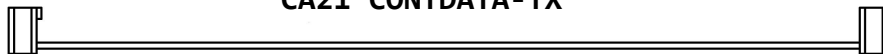

CA21

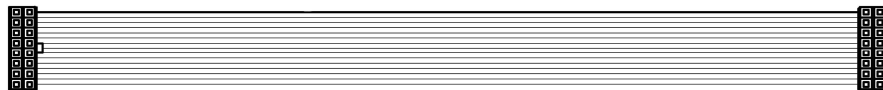

RX-TXLINE

CA29

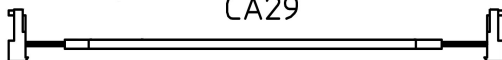

CA47 TX-TUNER/AMP

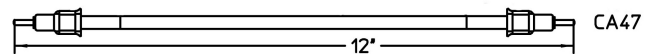

57



CA4 DCDIST-TX

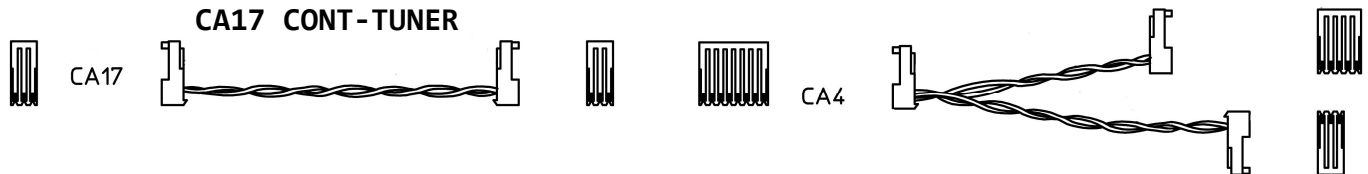



STEP-BY-STEP ASSEMBLY-Transmitter Board

Remove the transmitter board from its antistatic bag. Handle this partially assembled board carefully and observe antistatic precautions to avoid damaging the board.

Check off each of the parts on the parts list that is inside the bags as you install them on the board.

NOTE: Some parts may have been pre-soldered for implementation of production changes. If the part called out in these instructions has already been loaded, do not remove it.

- () Load and solder small 10uF aluminum electrolytic capacitors C2 and C30 (Bag 1) and large 100uF aluminum electrolytic capacitors C1, C60, C116 (Bag 2). Make sure the long lead goes in the hole with the square pad, also marked on the silkscreen with a "+". Clip the leads.
- () Load and solder red diodes D12 and D13 (Bag 2). Be sure that the side with the band goes into the hole with a square pad. Clip the leads.
- () Load and solder blue diodes D1, D2, D6 and D15 (Bag 2). Be sure that the side with the band goes into the hole with a square pad. Clip the leads.
- () Load and solder black diodes D3, D4, D5, D11 and D17 (Bag 2). Be sure that the side with the band goes into the hole with a square pad. Clip the leads.
- () Load and solder diodes D7, D8, and D10 (Bag 5). Be sure that the side with the band goes into the hole with a square pad. Clip the leads.
- () Load and solder diodes D16 and D18 (Bag 6). Be sure that the side with the band goes into the hole with a square pad. Clip the leads.
- () Load and solder fuse F1 (Bag 2). Clip the leads.
- () Load and solder resistor network RN1 (Bag 7). Be sure that pin 1, marked with a dot, goes into the hole with the square pad. *Be very careful not to blob solder onto the small adjacent pads.*
- () Load and solder trimpot RV1 (Bag 7). Clip the leads.
- () Load and solder U10, a TUF-3 RF mixer (Bag 7). Make sure the body is oriented so that it does not extend beyond the



silkscreened outline. Clip the leads.

- () If not already done, place a 2-pin Mylar insulator on each of the crystals (Y1-Y21, Bag 8). Insert the crystal on the board and solder one pin while pushing on each crystal to be sure it lies flat against the board. Once secure, solder the other pin. Clip the leads.
- () Cut the 24 AWG bare wire (Bag 8) into three 5" pieces and solder each wire to the top of all the crystals in each of the three groups, then solder the other end of each wire to the pad labeled GND that is near each group of crystals. Do not apply any more heat than necessary to the tops of the crystals.
- () Read this entire step before soldering connectors! Load and solder each connector, one at a time, including RF connectors and 2- and 3-pin jumpers (Bag 3). Be sure to line up the tabs on the white AMP MTA connectors with the silkscreened bar. Make sure the embossed triangle on the 16-pin connector is aligned with the square pad. Bend the center conductor pin on the RF connectors so that the connector sits at a 45 degree angle when inserted into the board. **J12, J13, J16 and J17 mount on the back side of the board. Be sure these lie flat**

against the board. After soldering, insert jumper shorting bars JS1-6,8-12 on the jumper headers. JS8 mounts on the right two pins of JP8.

NOTE: Unless specified otherwise, all toroids should be built by inserting a wire in from the front as the opening faces you and wrapping clockwise through the core. Most silkscreening on the board is only a rough indication of a generic toroid, not actual winding information.

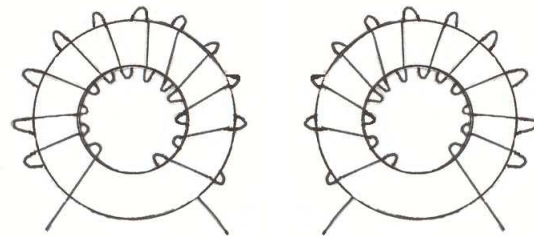

Clockwise

Counterclockwise

- () Locate the four red toroids (Bag 4). Cut the **red** magnet wire into 12 lengths as shown in the table below. Wind the specified number of turns of magnet wire around each toroid. Each time the wire passes through the center is considered 1 turn. Leave about 1/2" of lead extending out from the toroid. Load these toroids into L1-L4. Note that these toroids stand up while L5-L12 lay flat on the board. **L2 must be wound counterclockwise**, the others clockwise. Solder the leads, keeping the soldering iron



(set to 750 degrees F) on the leads until the coating melts away and the solder flows on to both the pad and the wire smoothly. This can take about one minute per lead. Clip the leads.

- () Repeat the previous step with the eight black toroids (Bag 4). Load and solder these toroids into L5-L12. Clip the leads.

L1: 27 turns (18") RED
L2: 25 turns (17") RED-ccw
L3: 18 turns (14") RED
L4: 18 turns (14") RED
L5: 17 turns (10") BLACK
L6: 16 turns (12") BLACK
L7: 16 turns (12") BLACK
L8: 11 turns (8") BLACK
L9: 10 turns (7") BLACK
L10: 9 turns (7") BLACK
L11: 8 turns (6") BLACK
L12: 8 turns (6") BLACK

- () Measure resistance between the pins on each toroid. They should read less than 1 ohm. If they don't, reheat the connections.
- () Load and solder all silver mica capacitors (Bag 1). Clip the leads. Save two of the large diameter leads.
- () Place two ferrite beads (Bag 4) over a clipped lead from the previous step. Bend the ends of the wire down so that the resulting inductor fits in the holes for L13. Load and solder this part and clip

the leads.

- () Repeat the previous step for inductor L14.
- () Load and solder a T36-1 transformer (Bag 6) at T2. Pin 6 is marked with a dot and goes in the hole with the square pad.
- () Load and solder a T9-1 transformer (Bag 7) at T6. Pin 6 is marked with a dot and goes in the hole with the square pad.
- () Cut 10" of red 24# magnet wire and wrap 9 turns completely around an FT37-43 toroid (the smaller ones in Bag 7). Cut 4" of green 24# magnet wire and wrap 3 turns around the red wire, overlapping it evenly. Leave 1/2" of all leads extending from the toroid. Lay the toroid down and solder its leads at T1. The red wires go in holes 1 and 2. Clip the leads. See pictures below.



Red (primary)



Red (primary)
Green (secondary)

T1 construction

- () Cut 13" of red 24# magnet wire and wrap 12 turns com-



pletely around an FT37-43 toroid (the smaller ones in Bag 7). Cut 8" of green 24# magnet wire and wrap 8 turns around the red wire. Leave 1" of leads extending out from the toroid. Lay the toroid down flat and solder its leads at T3. Fold the green wires under the toroid and into holes 3 and 4. The red wires go into holes 1 and 2. Clip the leads.



Red (primary)



Red primary) Green(sec)-to sides



Fold green leads under part.

T3 construction

- () Cut 6" lengths of red and green magnet wire. Twist the wires together about 2 turns per inch. Wind 5 turns completely **counterclockwise** around an FT50-43 toroid (the

larger one in Bag 8). Stand the toroid up and solder its leads at T4. The red and green leads on the same side of the toroid go in the holes marked 1 and 3, respectively (1=red, 3=green). The other red wire goes in 2. The other green wire goes in 4. Clip the leads.

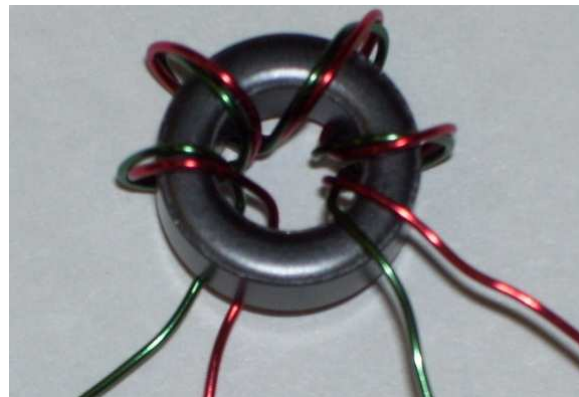

Grn(3) Red(1) Grn(4) Red(2)

T4 construction

- () Locate the gray binocular core (Bag 7). Wind 2 turns of red magnet wire in the center holes and leave 1" extending out from the body of the core. Wind 3 turns of green magnet wire from the other side and leave about 1" extending out from the body facing the other direction. Load the core at T5, with the green wires going into the holes closest to the bottom of the board (adjacent to R39). Solder and clip the leads. See photos on next page.
- () Cut two 2" lengths of red magnet wire and feed one



through one hole in the core and one through the other. Insert the leads in the remaining holes on each side of the core. See drawing on next page. Solder and clip the leads.



Red(primary) Green(secondary)

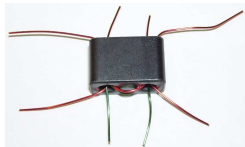

Completed toroid T5

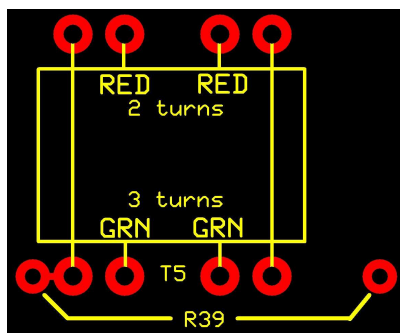

T5 Installation

- () Load and solder power resistor R39 (Bag 6).
- () Load and solder relays K11, K12 and K13 (Bag 3).
- () Insert thermistor TH1 (Bag 7) from the **back side of the board**. It must physically touch the heatsink that will be attached next, so position it slightly off the board so that you can bend it into place against the heatsink.
- () Solder and clip the leads on the top side of the board.
- () Q4 and Q5 are the 2SC1969 RF power transistors that make up the 10W final amplifier. These transistors have a pin orientation of “Base Collector Emitter” (BCE). For BCE transistors, put a bare jumper wire between pads a and 3 and pads b and 2b. Do this step twice, once for Q4 and once for Q5. Solder all four jumpers and clip any excess close to the board.
- () Affix four Thermalsil sticky-back insulators on the heatsink as shown in pictorial H1 so that the large hole in the insulator lines up with the transistor mounting holes.
- () Insert and tighten four 4-40 x 1/4” hex male/female stand-offs in the four threaded mounting holes in the heatsink. Refer to Pictorial H1.
- () Place the four power transistors on the heatsink as shown in the pictorial in the order shown (Q3, Q4, Q5, Q13) using a fiber shoulder washer and a 4-40 x 3/16” screw through each mounting hole and into the threaded holes in the heatsink. **Do not tighten the screws. Make sure the screws are seated against the fiber washers and the washers are in turn seated against the metal transistor tabs. Do not**



force the screws in, as this could crush the washers. The screws and washers should go in smoothly.

- () Place the heatsink into position on the board and note where the transistor leads must be bent up so that they will fit into the holes in the PC board. Remove the heatsink and bend the leads up.
- () Line up the heatsink mounting holes with the mounting holes on the board as you insert the four transistors into their PC board holes. Secure the heatsink with four 4-40 x 3/16" SEMS screws but do not tighten them.
- () Solder the four power transistor leads on the top side of the board. Clip off any excess lead length.
- () Tighten the four transistor mounting screws and the four heatsink mounting screws.
- () Push the TXBPF board onto connectors J12, J13, J16 and J17 with the notch in the board lined up with the notch in the top of the transmitter board. Secure the board with two 4-40 x 3/16" SEMS screws.
- () If you are adding the transmitter later to an already built Sienna, remove the DCD board and add the SWR meter components to it. See Appendix C2.

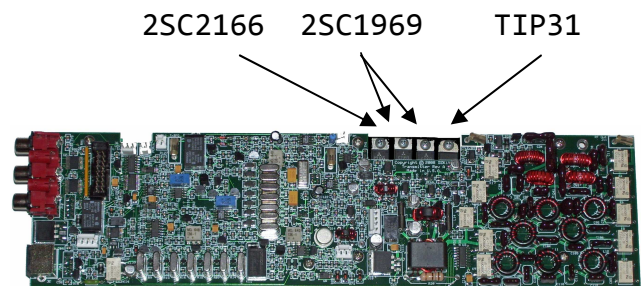
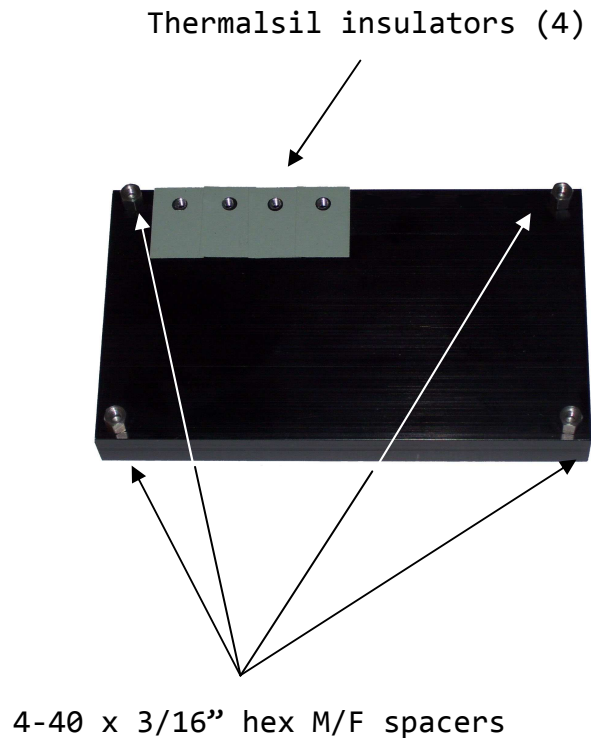

Transmitter board, top view

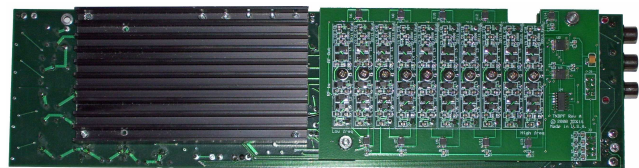

Transmitter board, bottom view

Pictorial H1. Transmitter heatsink



() Load and solder power resistor R27 (Bag 5). Stand this part up vertically so that the body of the resistor touches the board. Fold the top lead over and insert it into the other hole.

() Check your work carefully.

This completes assembly of the Transmitter.





Appendix J: Option 104: 100W PA

PARTS LIST

S0100-40010 Amp Board Kit				
- Bag 1				
Reference Designator(s)	Item	Description	Stock bin	Quantity
C9	1	Capacitor 100pF disk ceramic radial 100V NP0 5%	14	1
C58	2	Capacitor 18pF silver mica radial 500V 5%	353B	1
C44,C53	2	Capacitor 27pF silver mica radial 500V 5%	353D	2
C62	2	Capacitor 33pF silver mica radial 500V 5%	353E	1
C38,C50	2	Capacitor 39pF silver mica radial 500V 5%	353F	2
C60	2	Capacitor 47pF silver mica radial 500V 5%	353G	1
C55	2	Capacitor 56pF silver mica radial 500V 5%	353H	1
C57	2	Capacitor 68pF silver mica radial 500V 5%	353I	1
C63,C47	2	Capacitor 82pF silver mica radial 500V 5%	353J	2
C40	2	Capacitor 100pF silver mica radial 500V 5%	353	1
C56	2	Capacitor 120pF silver mica radial 500V 5%	353L	1
C52,C49,C61,C59	2	Capacitor 150pF silver mica radial 500V 5%	353M	4
C32,C51,C45	2	Capacitor 220pF silver mica radial 500V 5%	353N	3
C41,C43,C46,C54	2	Capacitor 270pF silver mica radial 500V 5%	353P	4
C36,C37,C42,C48	2	Capacitor 330pF silver mica radial 500V 5%	353R	4
C34,C70	2	Capacitor 390pF silver mica radial 500V 5%	353S	2
C35,C39,C81	2	Capacitor 1000pF silver mica radial 500V 5%	353V	3
C31	2	Capacitor 1200pF silver mica radial 500V 5%	353W	1
C33	2	Capacitor 2200pF silver mica radial 500V 5%	353X	1
D1	3	Diode Zener 1N5230B 4.7V 1/2W DO-35 5%	645	1
D2,D4,D5,D12	4	Diode 1N4007B rectifier 1000V 1A DO-41	53	4
R4	5	Resistor 130K ohm 1/8W metal film axial 1%	356-130K	1
R16,R15	6	Resistor 10 ohm metal oxide axial 2W 5%	499	2

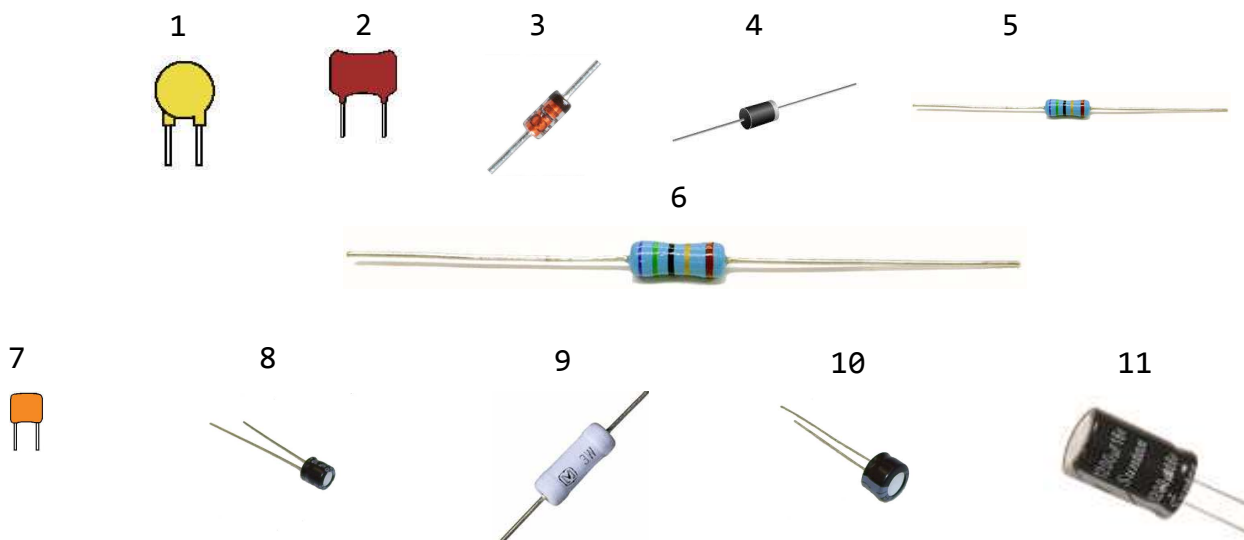



S0100-40010 Amp Board Kit -				
Reference Designator(s)	Item	Description	Stock bin	Quantity
C21,C23,C24	1	Capacitor .01uF ceramic disk radial 500V Y5P 10%	386	3
D11	3	Diode Zener 1N5239B 9.1V 1/2W DO-35 5%	627	1
R5	5	Resistor 10M ohm 1/8W carbon film axial 5%	356-10M	1
R25	6	Resistor 120 ohm 2W metal oxide axial 5%	255	1
		Small sleeving	640	6"

S0100-40010 Amp Board Kit - Bag 3				
Reference Designator(s)	Item	Description	Stock bin	Quantity
C25	1	Capacitor 1000pF disk ceramic radial 50V Y5P 10%	3	1
C3,C4,C5,C22,C26,C27,C28, C29,C30,C64,C65,C66,C67, C68,C72,C73,C74,C75,C76, C77,C78,C79,C80,C82	7	Capacitor .047uF MLCC 100V X7R 10%	576H	24
C69	8	Capacitor 10uF aluminum electrolytic radial 25V	56	1
R3,R21,R31,R34	5	Resistor 3.16K ohm 1/8W metal film axial 1%	356-3.16K	4
R17	9	Resistor 15 ohm 3W metal oxide axial 5%	555	1

S0100-40010 Amp Board Kit - Bag 4				
Reference Designator(s)	Item	Description	Stock bin	Quantity
R6,R8,R22,R28,R39	5	Resistor 1K ohm 1/8W metal film axial 1%	356-1K	5
C8,C10,C14,C15, C16,C18,C19,C20	7	Capacitor .1uF MLCC 200V X7R 10%	388	8
R13,R14	9	Resistor 1.6 ohm 2W metal film axial 5%	561	2
C7,C11	10	Capacitor 100uF aluminum electrolytic radial 25V 20%	57	2
C6	11	Capacitor 470uF aluminum electrolytic radial 5mm Is 25V 20%	97	1



Partially loaded 100W P.A. board

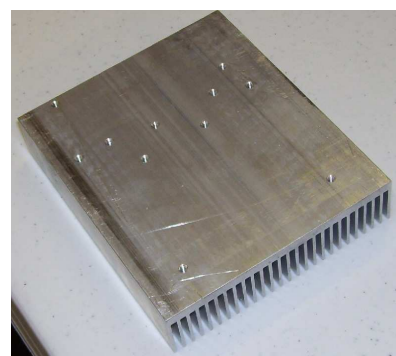

Heatsink



S0100-40010 Amp Board Kit - Bag 5				
Reference Designator(s)	Item	Description	Stock bin	Quantity
C17,C71	7	Capacitor 1uF MLCC 50V X7R 10%	387	2
D3	12	Diode rectifier 1N5404 axial 400V 3A DO-201AD	225	1
D6	4	Diode 1N5818 Schottky rectifier 30V 1A axial	328	1
D7,D8,D9,D10	3	Diode 1N914 signal 100V 300mA DO-35	50	4
K1,K2,K4,K5,K6,K7,K8,K9,K10,K11,K12,K13	13	Relay SPDT 12V Low Signal NL 200mW pcb	636	12
Q1,Q4,Q11	14	Transistor 2N7000 MOSFET N-ch 60V TO-92	227	3
Q3	15	Transistor TIP31A NPN power 60V 3A TO-220	259	1
Q6,Q7	16	Transistor MJE182 NPN GP 80V 3A SOT-32	228	2
Q8,Q9	17	Transistor 2SC2879A NPN RF Power 30MHz (matched pair)	121	2
R18	6	Resistor 300 ohm 2W metal oxide small axial 5%	536	1
R30	5	Resistor 1.0M ohm 1/8W metal film axial 1%	356-1M	1
U1	18	IC 74HC273 octal D-flip-flop with clear 20-pin DIP	275	1
U2	19	IC ULN2803 relay driver 8-el w/diodes 18-pin DIP	392	1

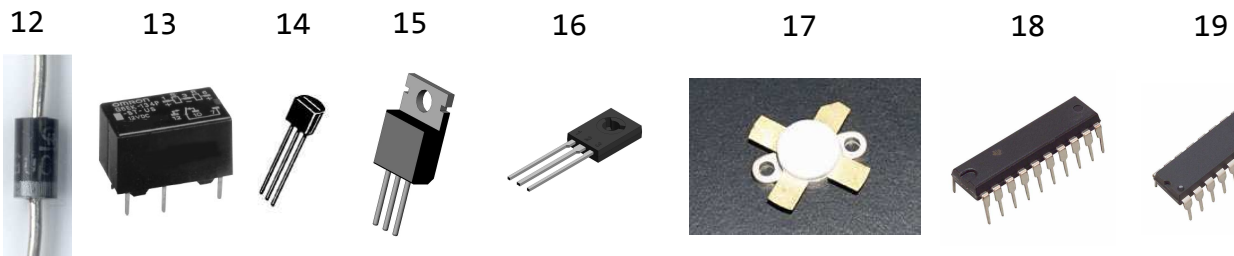

S0100-40010 Amp Board Kit - Bag 6				
Reference Designator(s)	Item	Description	Stock bin	Quantity
J1,J6	20	Connector 2-pin friction lock header tin	172	2
J2,J4,J5	21	Connector RF 45-degree pcb-mount (Taiko Denki)	407	3
J3	22	Connector 16-pin 2-row header shrouded r/a low profile	379	1
L1,L2,L3,L4	23	Toroid T50-2	199	4
L5,L6,L7,L8,L9,L10,L11,L12	24	Toroid T50-10	200	8
R1,R2,R9,R26,R29,R33	5	Resistor 10K ohm 1/8W metal film axial 1%	356-10K	6
		Wire RG-178B/U Coaxial cable 50 ohm	712	6"
		Wire 22 AWG red magnet wire	720	160"

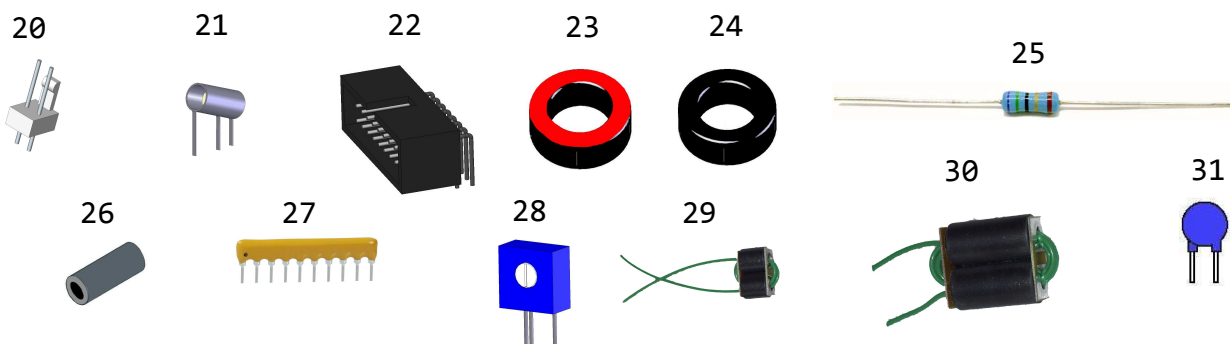



S0100-40010 Amp Board Kit - Bag 7				
Reference Designator(s)	Item	Description	Stock bin	Quantity
R10	25	Resistor 10 ohm 1/4W metal film axial 1%	27	1
R11,R12	9	Resistor 22 ohm 3W metal oxide axial 5%	562	2
R23,R24,R32,R35	6	Resistor 47 ohm 1W metal oxide axial 5%	335	4
R7,R20,R27,R36	5	Resistor 51 ohm 1/8W metal film axial 1%	356-51	4
RFC1A,RFC1B	26	Inductor Ferrite bead Type 73 40MHz	216	2
RN1	27	Resistor 7-el array 10K bussed 8-pin	78	1
RV1	28	Resistor 1K ohm 1/2W trimpot 1-turn side-adjust	169A	1
Q5,Q10	14	Transistor 2N3904 NPN GP 40V TO-92	52	2
T1	29	Transformer RF 9:1 binocular core	197	1
T2	30	Transformer RF 16:1 binocular core	198	1
TH1	31	Thermistor 10K 1/2W radial NTC	215	1

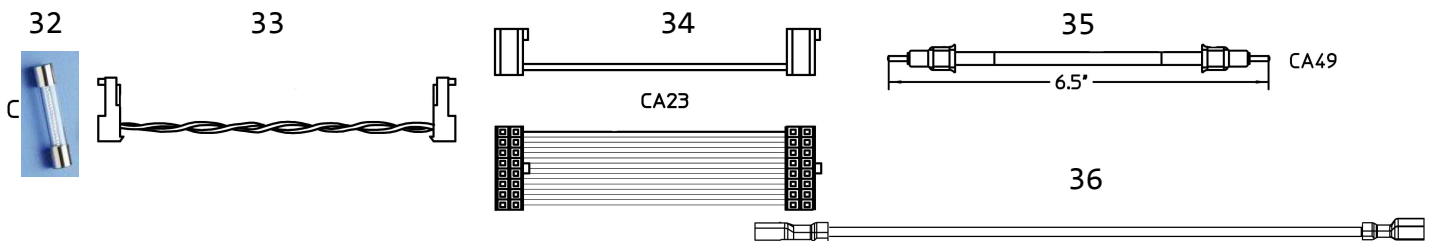

S0100-70104 Hardware Bag				
Reference Designator(s)	Item	Description	Stock bin	Quantity
F1	32	Fuse 25A AGC 32VAC/DC	257	1
CA15	33	CA15 MTR-RX (2-pin to 2-pin IDC)	820	2
CA23	34	CA23 TUNERDATA-AMP (16-pin ribbon)	828	1
CA49	35	CA49 AMP-TUNER	854	1
CA50-1,CA50-2	36	CA50 12in 16# red wire with insulated terminals	855	2
	37	Hardware 4-40 x 3/16in Hex M/F Spacer SS	452B	4
	38	Hardware #6 x 11/16in unthreaded hex spacer SS	130	1
	39	Hardware 6-32 x 1 1/4in Hex F/F Spacer SS	598	4
	40	Hardware 6-32 x 1/4in PH Phillips M/S SS SEMS	644	3
	41	Hardware 6-32 x 1 1/2in PH Phillips M/S SS	133	1
	42	Hardware 4-40 x 1/4in PH Phillips M/S SS	479	7
	43	Hardware 4-40 x 3/16in PH Phillips M/S SEMS	643	4
	44	Hardware 6-32 x 1/4in PH Phillips M/S SS PL	642	4
	45	Hardware shoulder washer plastic TO-220	303	1
	46	Hardware fuseholder 30A 3AG-style panel-mount	516	1
	47	Hardware Insulator with adhesive back for TO-220	523	3
	48	Chemical silicon grease Wakefield 4g tube	167	1
	49	Hardware #4 x 1/4in FH Undercut Philips S/M/S SS	650	5

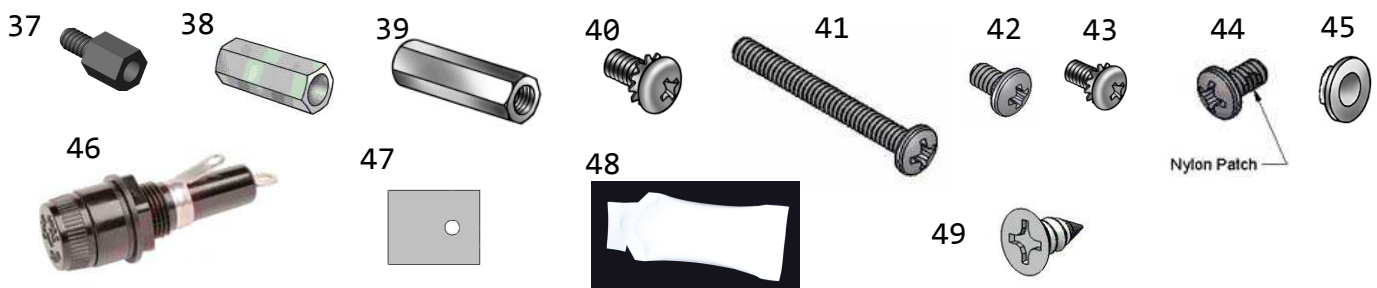



STEP-BY-STEP ASSEMBLY-100W PA Board

When loading the following parts, locate the appropriate bag and remove only the specified parts, one value at a time. Check off the parts on the parts list in each bag as you remove them, and then check off each step once you have completed it.

- () Cut the leads on small transformer T1 (Bag 7) to 1/2". Strip 1/8" off the ends.
- () Lay T1 on top of the board inside the silkscreened outline, with the leads facing toward the edge of the board. Note that the PC boards that form each side of the transformer have two pads on one side that line up with the pads on the 100W PA board. On the other side, one center pad lines up with a long pad on the 100W PA Board. While holding the part in place, solder one pad of the transformer to the corresponding pad on the 100W PA Board, followed by the other two. Insert the leads into the pads labeled "T1 In" and solder them. (Note: rev C boards are incorrectly labeled "T1 Out".) Clip excess leads. It is very difficult to remove this part once installed, so take your time and be sure that it is installed correctly. Use plenty of solder and heat to assure a good contact.
- () Repeat the above 2 steps for large transformer T2 (Bag 7), placing the two loose wires into the pads labeled "T2 Out".
- () Load and solder aluminum electrolytic capacitors C6, C7 and C11 (Bag 4) and C69 (Bag 3). Note that these are not all the same value capacitors. The long lead is positive and must be mounted in the hole with the square pad. Clip the leads.
- () Load and solder resistor network RN1 (Bag 7). Be sure that pin 1, marked with a dot, goes into the hole with the square pad.
- () Load and solder all monolithic and ceramic disk capacitors **except C21, C23 and C24** (Bags 1-5). Note that these are not all the same value. Clip the leads. DO NOT load the silver mica capacitors at this time.
- () Cut two lengths of small sleeving (Bag 2) so that when placed on C21's leads, there is 1/4" of exposed lead remaining at the ends. Insert C21 from the **bottom** of the board between the two pads each labeled "C21". Solder the leads from the top side of the board. Make sure no exposed portion of the leads touches any other components. See Detail J3 on page 156.



- () On Rev C boards, C23 and C24 will have been loaded for you. On C1 boards (or later), load these capacitors on the top side of the board normally.
- () Load and solder all 1/8W, 1/4W, 1W, 2W and 3W resistors (Bags 1-7). Clip the leads. Save one of the clipped leads from a 2W resistor.
- () Place two ferrite beads (Bag 7) over a clipped lead from the previous step. Bend the ends of the wire down so that the resulting inductor fits in the holes for RFC1. Load and solder this part and clip the leads.
- () Load and solder all diodes (Bags 1, 2 and 5). Make sure the banded side goes in the hole with a square pad. Clip the leads.
- () Load and solder trimpot RV1 (Bag 7). Clip the leads.
- () Load and solder 2N3904 NPN transistors Q5 and Q10 (Bag 7). Bend the leads slightly as you insert the parts and line up the flat side with the silkscreening. Clip the leads.
- () Load and solder 2N7000 MOSFET transistors Q1, Q4 and Q11 (Bag 5). Clip the leads.
- () Load and solder ICs U1 and U2 (Bag 5). Be sure pin 1, marked by a notch in the IC, goes in the square pad.
- () Load and solder connector J3 (Bag 6). Pin 1 on J3 is marked by an indented triangle. Line this up with the square pad.
- () Load and solder 2-pin AMP MTA connectors, J1 and J6 (Bag 6). Be sure to line up the thick side of the connector with the thick silkscreened outline of the part.
- () Load and solder the RF connectors J2, J4 and J5 (Bag 6). Clip the leads.
- () Locate the four red toroids (Bag 6). Cut the magnet wire into 14 lengths as shown in the table below. Wind the specified number of turns of magnet wire around each toroid. Each time the wire passes through the center is considered 1 turn. Leave about 1/2" of lead extending out from the toroid. Load these toroids into L1-L4. Solder the leads, keeping the soldering iron (set to 800 degrees F) on the leads until the coating melts away and the solder flows onto both the pad and the wire smoothly. This can take about one minute per lead. Clip the leads.
- () Repeat the previous step with the eight black toroids (Bag 6). Load and solder these toroids into L5-L12. Clip the leads.



- L1: 27 turns (18") RED
 - L2: 25 turns (17") RED
 - L3: 18 turns (14") RED
 - L4: 18 turns (14") RED
 - L5: 17 turns (13") BLACK
 - L6: 16 turns (12") BLACK
 - L7: 16 turns (12") BLACK
 - L8: 11 turns (8") BLACK
 - L9: 10 turns (7") BLACK
 - L10: 9 turns (7") BLACK
 - L11: 8 turns (6") BLACK
 - L12: 8 turns (6") BLACK
- () Load and solder all silver mica capacitors (Bag 1). Clip the leads. The component value in picoFarads is printed on the body of the cap. For example, a 330pF capacitor is marked 330. Ignore any suffix, such as "J".
 - () Load and solder all relays, K1, K2, K4-K13 (Bag 5).
 - () Strip the insulation off of one end of the RG-178B/U coaxial cable to a length of 1/2". Using an awl or other sharp tool, open a small hole in the shield near the point where it touches the insulation, and pull the center conductor out through the hole. Twist the shield. Cut 1/4" of insulation off of the center conductor and twist the wires. Tin both of the leads you have just created. If you make a mistake, you can cut the leads off and try again.
 - () Cut the coax to an overall length of 5". Repeat the previous step on the other end of the cable.
- () On the top side of the board, insert the center conductor of each end of the coaxial cable into the pads marked "A", and the shields into the pads marked "GND". Solder the leads and clip any excess.
 - () Insert and tighten four 4-40 x 3/16" hex male/female spacers into the four mounting holes on the heatsink as shown in Detail J2.
 - () Affix three Thermalsil insulators to the heatsink as shown.
 - () Place Q8 and Q9 (Bag 5) on the heatsink in the orientation shown in Detail J2. The collectors have an angled cut in the fin. Insert a 4-40 x 1/4" non-SEMS screw into the mounting holes on each transistor, into the threaded holes on the heatsink. Secure the screws but do not tighten them.
 - () Place the board over the heatsink, lining up the four mounting holes. Insert two 4-40 x 3/16" SEMS screws in diagonally opposite holes to keep it in place.
 - () Solder a fin on Q8 and Q9 from the top side of the board, using the large holes on the emitter pads, allowing the solder to "wick" down in-



to the holes. It is only necessary to tack one fin on each transistor at this point, just to keep the parts from moving. See detail J3.

- () Remove the mounting screws from the heatsink and from Q8 and Q9 and remove the board.
- () Solder the other three fins on Q8 and Q9. Apply plenty of solder to be sure the fins are fully attached to the pads. Re-heat the pad you tacked earlier, applying more solder if necessary.
- () Line up the other three transistors (Q3, Q6 and Q7—Bag 5) in the correct locations on the heatsink. Note where the leads of the transistors need to be bent up to fit in the PC board holes. Bend the leads up and insert them into the PC board holes from the bottom side of the board **but**

do not solder them yet.

- () Insert thermistor TH1 (Bag 7) **from the bottom of the board.** Push it over slightly toward the center of the board, but not all the way, so that when the heatsink is attached it will compress the thermistor against the heatsink. **Do not solder it yet.**
- () **In the next few steps you will attach the heatsink, after which the bottom of the PC board will no longer be accessible, so take a few minutes to check every solder connection! There is a virtually 100% chance that you will find a few pins unsoldered. Better to fix them now than to take the heatsink off and fix them later.**
- () Apply a liberal amount of heatsink compound to the bottom metal body of Q8 and Q9.

Thermalsil insulators

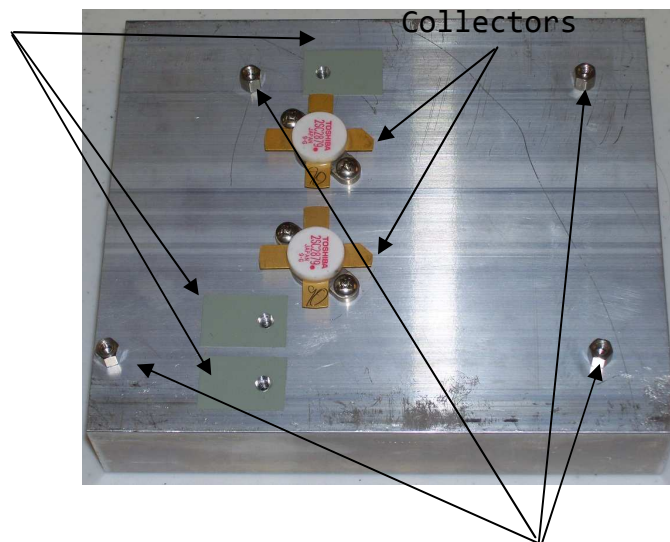

Detail J2.

4-40x3/16"
spacers



- () Place the board onto the heatsink, being careful to line up the mounting holes.
 - () Re-insert four 4-40 x 1/4" non-SEMS screws into the mounting holes for Q8 and Q9 and 4-40 x 3/16" SEMS screws into the four PC board mounting holes.
 - () Insert a shoulder washer in Q3's mounting hole.
 - () Gently wiggle Q3, Q6 and Q7 so that their mounting holes line up perfectly with the corresponding threaded hole in the heatsink. Insert a 4-40 x 1/4" non-SEMS screw into the three transistor mounting holes. Make sure as you do this that the screws go in smoothly without any difficulty and that Q3's shoulder washer remains fully inserted in the transistor mounting hole. If you encounter resistance, back off on the screw, re-seat the washer, check to make sure the hole is centered and try again. Tighten the screws, but do not overtighten to avoid damaging the parts.
 - () Solder the pins on Q3, Q6 and Q7 and clip their leads.
 - () Solder thermistor TH1.
 - () Insert four 6-32 x 1 1/4" hex female-female spacers from the bottom side of the board in the four corner holes of the board and attach 6-32 x 1/4" SEMS screws to the top of three of the four spacers. On the spacer that is next to the RF connector marked "Antenna", use a .05" Nylon washer and an 11/16" hex double-female unthreaded spacer and temporarily insert a 6-32 x 1 1/2" screw into the assembly from the top.
- This completes assembly of the 100W power amplifier. Save remaining hardware for installation.

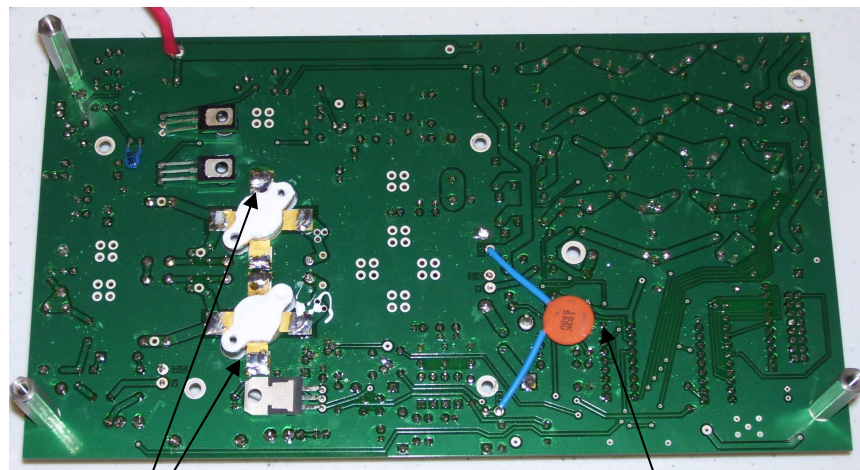

"Tack" solder Q8 and Q9 here

Detail J3.

C21

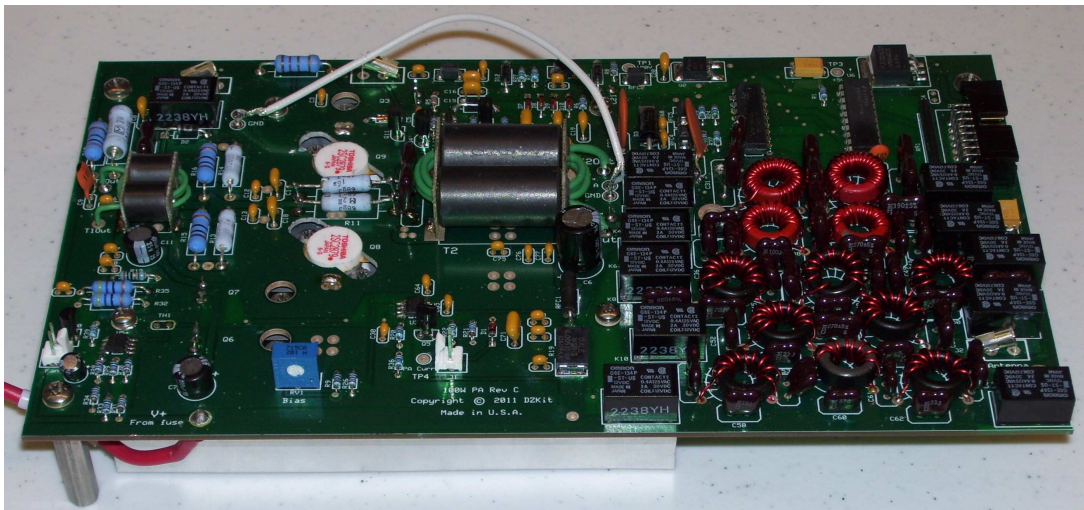

Detail J4. Completed 100W PA





Appendix K: Installing IF Filters

Refer to Photo K1 on the next page for the following steps.

There are three Intermediate Frequencies (IF's) used in the Sienna:

1st IF: The entire radio spectrum from DC to 56MHz is upconverted to a first IF frequency of 70.455MHz and uses an Inrad 5kHz 6-pole crystal filter. This ensures good AM reception while still offering good rejection for CW and SSB signals, which will be later filtered by two more IF's. The FM path is split off ahead of this filter, so it is unaffected by the narrow bandwidth. This filter is mounted on a small board next to the IF Filter board. It has been carefully engineered to provide maximum stop-band attenuation, which contributes to Sienna's excellent receiver blocking dynamic range and strong signal handling capability.

2nd IF: The second IF is at 9MHz and uses only Inrad crystal filters. A 4-pole SSB filter is shipped with all Sienna radios standard, and mounted on a Yaesu-style snap-in "C" board. This filter should be inserted into 9MHz Slot 2 from the bottom of the board. Other optional filters are of

two types: the AM filter, which solders and screws directly to the IF Filter board because of its unusually tall form factor. All other filters snap in from the bottom of the radio into filter slots labeled 9MHz Slot 2, 3 and 4. Although the order is not important, most prefer to arrange them in decreasing bandwidth from Slot 2 through Slot 4. If you purchased a higher quality (more poles) SSB filter, you can install it *instead* of the standard 4-pole unit in Slot 2.

3rd IF: The final IF is 455kHz, and the filters for this IF are of three types:

1. Standard 6kHz ceramic filter. This small black cube is soldered directly to the bottom of the board in Slot 1.

2. Collins mechanical filters. The 5800 Hz mechanical filter, if present, must be soldered into the bottom of the board at Slot 1 instead of the ceramic filter noted above. Other mechanical filters are provided on Yaesu "C"-style snap-in boards.

3. Inrad crystal filters, all of which are mounted on Yaesu "C"-style snap-in boards.



Once filters are installed, the control firmware in the Sienna main microprocessor must be told which filter is located in which slot. If you have a front panel, press the menu button and rotate the small tuning knob until the IF filter choices show up. This screen shows the values installed in the 455kHz slots 1-4:



Once the page you want to change is selected, press the "Page/ Mode" button (which takes you out of Page mode) and then rotate the large tuning knob to the desired slot. Rotate the small tuning knob until the desired bandwidth is shown for the selected slot. Once all filter values have been set, press Menu again to exit menu mode. Allow 10 seconds for the internal read-only-memory to be updated before turning off power. Photo K1 shows a typical installation of crystal, mechanical and ceramic filters.

NOTE: Slot 1 of the 455kHz filters MUST be set to 5800.

Note: Sienna's processor "knows" what the actual center frequency of the available filters is (e.g., 9000.75, 9001.5 MHz). Non-standard choices may not work.

455kHz IF: 6kHz ceramic filter in slot 1



455kHz IF: Collins mechanical filter in slot 2

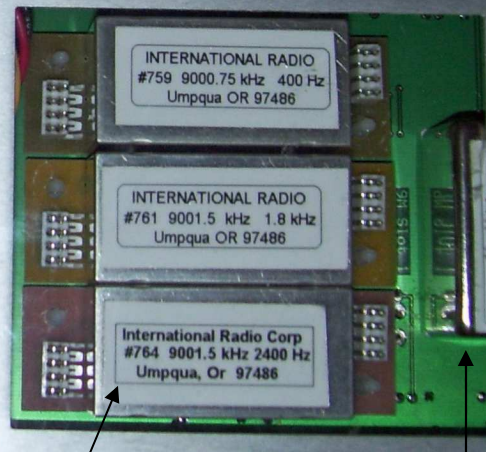

Photo K1: Typical filter installation

9 MHz IF: AM filter in slot 1

Snap-in "C" boards

If you have a front panel-less model of the Sienna, you must en-



ter the filter information by sending commands in the following form:

(Use Hyperterm or other RS-232 communications program at 9600 baud, 1 stop, no parity, no handshake)

“IR0;” (if you have the standard 70MHz filter)

“IR1;” (if you have the optional Inrad 70.455MHz filter)

455kHz filters:

“IXnnnn;” n =

0,1,2,3,4,5,6,7,8,9,a,b,c,d

where:

0=20K, 1=5800, 2=2800,
3=2600, 4=2100, 5=2000,
6=1800, 7=1000, 8=500,
9=400, a=300, b=250, c=125,
d=none

9MHz filters:

“IYn;” n = 0,1,2,3,4,5,6,7,8

where:

0 = 6000, 1=2800, 2=2400,
3=2100, 4=1800, 5=1000,
6=400, 7=250, 8 = none

Entries are in slot 1-4 order.

Example:

IX0269; installs the 20KHz filter in slot 1, 2800Hz in slot 2, 1800Hz in slot 3 and 400Hz in slot 4 for the 455kHz filters. If you want to verify that the commands “took”, send just the characters “IR;” or “IX;” or “IY;”. The returned data will tell you which filters it thinks are in those slots.



Photo L1. IF Filter Board test connections



Appendix L: IF Filter Test Procedure

Refer to Photo L1 for the following steps.

- () Locate the RF cable that has been inserted into the Tx compartment, labeled "TXVFO". Insert the end of this cable into J2 ("9MHz In") on the IF Filter Board.
- () Using the test cable, which has a miniature RF connector ("TD") on one end and a female BNC connector on the other, connect the TD end of the test cable to J3 ("9MHz Out"). Connect the BNC end to the antenna jack of a monitor receiver. You may need an extension for the BNC cable, and, depending on the receiver you use, you may also need an adapter to convert the BNC to PL-259. BNC cables and adapters are available at Radio Shack and other electronics stores.
- () If your monitor receiver has an RF attenuator, turn it on. If not, turn down the RF Gain to about halfway.
- () Make certain that all cables that are not in use are not shorting to the chassis or to other components on any boards.
- () Apply power to the radio and press the on/off switch.

When measuring voltages in the next two steps, be VERY CAREFUL not to short pin 7 to pin 8! This could damage your transceiver!

- () Measure the DC voltage on pin 7 of J2 (or the side of R1 that is not connected to JP3). It should be +5V +/-5%. (The negative voltmeter lead can be connected to any point on the chassis.)
- () Measure the DC voltage on pin 8 of J1 on the IF Filter Board. It should be the same as your DC input voltage to Sienna's back panel (11-15V). Call this voltage "VDD".
- () For units with front panels:

Make sure that you have not activated "Split" mode (Split LED is off). Set the mode to USB and the frequency to 9000.00 kHz. Use the FAST button and the small tuning knob to quickly change frequency. In menu mode, select TXVFO=DspFrq ON. (This sets the TXVFO oscillator to the frequency shown in the display rather than offset by the TXBFO IF frequency.)
- () For units without front panels:

Connect the RS-232 port and issue the following commands



using Hyperterm or any RS-232 remote control program (9600 baud, 1 stop bit, no parity, no handshake):

```
FT0;          { Split off }
MD2;          { USB mode }
FA0000900000;
              { Freq=9.000MHz }
CF1;          { Test Mode On }
```

- () Tune around the frequency with the monitor receiver until you hear a tone in the speaker. (For faceless units, send the FA command above, changing the frequency by 10 Hz at a time.)
- () Change the filter slot settings by connecting a jumper wire from point A and/or B to G (ground). If not connected, A or B are a logical "1". If connected to G they are a logical 0. This selects one of the four 9MHz filters. (BA = 00 = slot 1, 01=slot 2, 10=slot 3, 11=slot 4). Select each slot for which you have installed a filter, and verify that you can still hear the tone. The amplitude may vary slightly from one filter to the next and should go away completely if you select a slot that has no filter installed.
- () Remove the TXVFO cable from J2 on the IF Filter Board and reconnect it to J4 ("455kHz In") on the IF Filter Board.
- () Remove the test cable from J3

on the IF Filter Board, and insert the test cable into J5 ("455kHz Out").

- () For units with front panels:

Set the display frequency of Sienna and the monitor receiver to 455.00 kHz. Use the FAST button and the small tuning knob to quickly change frequency.
- () For units without front panels, send the command:

FA00000455000;
 { Freq=455kHz }
- () Verify any 455 kHz slots that you have installed in the same way you verified the 9MHz slots.
- () Disable test mode ("CF0;" command for faceless Siennas or set menu item TXVFO=DspFrq Off).
- () Turn off the radio and remove the test cable. Restore IF2 and IF4 cables.
- () If any tests failed, look carefully for backwards diodes or unsoldered parts. Those account for almost all problems with this board.



Appendix M: RXBPF Test Procedure

- () Connect the Receiver power cable between J10 (“Rx” - 5-pins) on the DCD Board and J8 (“From DCD (test)” - 4-pins) on the RXBPF Board.
- () Connect an antenna (or an RF signal generator, if one is available) to Sienna’s Antenna A or B connector.
- () Temporarily remove the RF1 cable from J4 on the RXBPF board (“To Rcvr”) that goes to the roofing filter board. Leave it connected to the roofing filter board.
- () Connect the test cable between J4 (“To Rcvr”) on the RXBPF board and the antenna input of a monitor receiver. You will probably need adapters to convert the female BNC to whatever antenna connector is on your monitor receiver.
- () Set the “Cal/Rcv” switch on the RXBPF board to the “Rcv” position.
- () Make certain that all cables that are not in use are not shorting to the chassis or to other components on any boards.
- () Apply power to Sienna’s power connector and press the on/off switch.
- () If you have a full front panel, select any frequency and set your monitor receiver to the same frequency.

If you are using a remote control model, connect the RS-232 port and issue the following commands using Hyperterm or any RS-232 remote control program (9600 baud, 1 stop bit, no parity, no handshake):

FA000xx000000;
 { Freq=xx.000MHz }
- () The above steps pass an antenna signal through the antenna switch, tuner (if present), bandpass filters, pre-amp(s) and attenuator. Any signals you can hear with an antenna connected to your monitor receiver should still come through fine as long as Sienna is set to the same frequency. As you change frequencies in Sienna, different bandpass filters are engaged. Verify that signals in your monitor receiver can be heard as you select a frequency in each of the 12 bands (and tune your monitor receiver to the same range of frequencies):



0-1.8 MHz (AM Broadcast band)
1.8-3 MHz
3-4 MHz
4-6.3 MHz
6.3-8.4 MHz
8.4-11 MHz
11-16 MHz
16-20 MHz
20-24 MHz
24-30 MHz
50-54 MHz (leave radio on
28MHz, then enable XVT in the
menu and select 50 or 52 MHz)

Note that if you select, say, the 11-16 MHz band in Sienna but set your monitor receiver to, say, 3.5MHz, the monitor receiver should not pick up signals nearly as well as when Sienna is tuned to a frequency between 3 and 4 MHz.

- () You can make signals stronger or weaker by engaging the preamps and attenuator. From the front panel, simply push the "Preamp1" button to engage the first preamp and then the "Pre2/Atten" button to enable both of them. In each case you should be able to hear relays click on the RXBPF board and the signal should get louder. With both preamps enabled, press just the "Preamp1" button again to turn off the preamps and turn

on the Attenuator. You should then hear the signal get much weaker. If you do not have a front panel model, use the following commands instead:

```
RA00; { Attenuator off }  
PA0; { Preamp 1 and 2 off }  
PA1; { Preamp1 on, 2 off }  
PA2; { Preamp1 and 2 on }  
RA01; { Atten on, preamps  
off }
```

- () Turn off the radio and remove the test cable and the power cable from the DCD board. Reconnect the RF1 cable between the roofing filter board and the RXBPF board.









DZ COMPANY

LOVELAND, COLORADO

UNIQUE ELECTRONIC EQUIPMENT IN KIT FORM