

The DZKit *Sienna* HF Transceiver Sets “The State-Of-The-Art” for Engineering, Styling and Flexibility, and now you can have it “your way” with many upgrade choices, starting at only \$1699!

Now with 6M receive coverage!

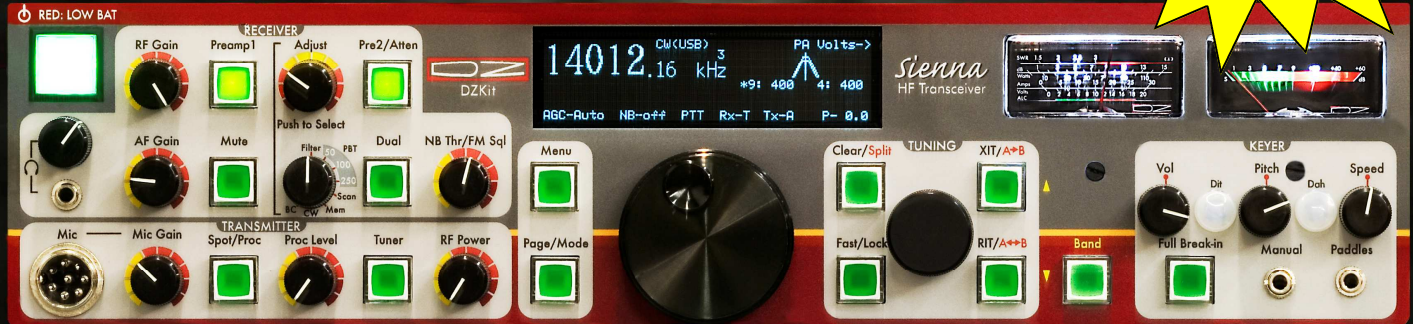

Sienna’s front panel has a well-designed control layout: lighted buttons with a positive tactile response; two velvet-smooth tuning knobs; an easy to navigate menu system that uses plain language; a beautiful blue-green vacuum fluorescent display; two backlit analog meters; controls that are grouped logically for ease of use; mic jack; headphone jack; separate paddles and manual key inputs; and much more!

- Receiver hears signals as low as -140dBm , $\text{BDR} > 130\text{dB}$
- Two-tone Transmitter IMD: -41dB (10W), -38dB (100W)
- 3-band parametric audio equalizers for transmitter and receiver
- Full duplex operation. Transmit and receive at the same time
- Two 10dB preamps and a 10dB attenuator
- Split operation allows transmit and receive on different bands and modes. Also useful for transmitting CW while in SSB receive
- Wide RIT/XIT range ($\pm 16\text{MHz}$)
- External secondary receiver audio can be routed to one speaker, internal receiver to the other. (Sienna is available as a receiver only, upgradeable to a transceiver, or use any other audio source)
- Manual key and paddles active simultaneously with front and back panel access, 4 jacks total
- Headphones and speakers active simultaneously with separate volume controls
- Two analog backlit meters, one for transmit, the other for receive
- Dual passband tuning (at 9MHz 2nd IF and 455KHz 3rd IF)
- Two transceive antenna ports and a receive-only antenna port
- Customizable front panel color schemes
- Easy-to-use front panel with grouped functions and minimal use of dual or triple function controls. No “tap” vs. “push” operation
- Two mic inputs— one balanced input (150-600 ohms or Hi-Z via built-in FET preamp), and one unbalanced line level input
- Ultimate in modularity. Can be purchased as a receiver or transceiver, 10W or 100W, with optional tuner and up to 9 crystal filters (with over 20 bandwidth choices).
- DZKit exclusive SALC™ and PSB™
- CW sidetone frequencies range from 196 to 976 Hz,
- “Hear between the dits” QSK at over 60 wpm with no clicks
- Downloadable firmware updates

SALC (Smart Automatic Level Control) is DZKit’s method of keeping the transmitter from “spiking” to high power levels when you change bands. While this may require extra time to let the rig stabilize at the requested power level when changing bands, it is much gentler on amplifiers that may be attached. PSB (Passive Signal Boost) allows you to bypass the receiver’s bandpass filters, adding about 5dB to the signal strength at the expense of letting a little more noise into the front end. This can help bring in weak signals on a fading band.

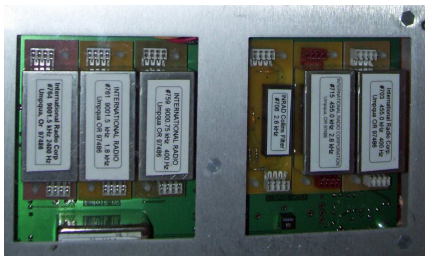

This bottom view shows how you get access to the IF filters by removing a cover plate. In addition to non-removable AM filters at each IF, there are three IF filters at the 9MHz 2nd IF and three more at the 455kHz 3rd IF that can be snapped in as shown above.

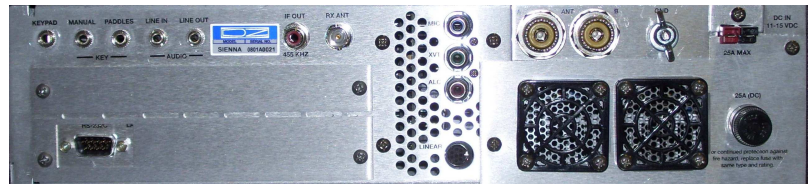

The back panel is laid out cleanly. On the lower left is the computer control interface (RS-232C) and expansion space. On the upper left are connections to the optional external keypad (compatible with the Yaesu FH-2), keyer paddles, straight key, line level audio in and out, 455kHz IF Out and receive antenna. Transmitter I/O is in the center (top-to-bottom: unbalanced mic in, PTT in, ALC in and Yaesu-compatible linear control). Main antenna jacks, ground lug and power are to the right. The 100W amplifier is protected by a 25A fuse.

Think you can't have high performance in a kit radio? Think again! Sienna offers top-notch performance for the most demanding operators!

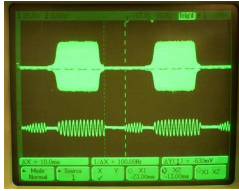

World-class QSK! Hear between the dits at over 70 wpm. The top trace above is the RF output at the antenna jack, with Sienna sending two dits at 60 wpm. The bottom trace shows the Sidetone, and between the dits, received audio. You can see that the receiver recovery time is only 10ms. Also note the "clickless" audio (no glitches in the waveform), and the smooth rise and fall time of the RF envelope.

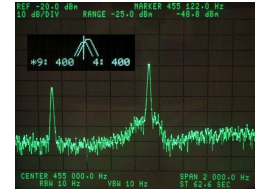
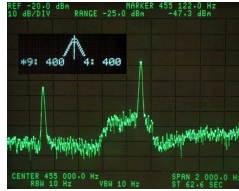

Sienna has up to 4 selectable IF filters at the 2nd IF, and 4 more at the 3rd IF. Each IF can be "slid" back and forth against the other to effectively narrow the bandwidth. Above left, you can see the front panel display with both filters centered and the resulting spectrum plot of a signal in the passband. On the right, one filter has been slid over 200Hz, and you can see the resulting smaller bandwidth.

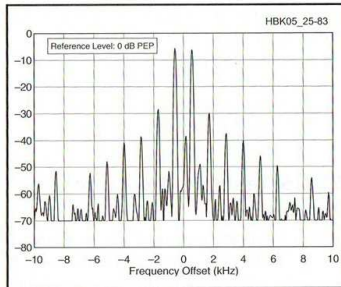
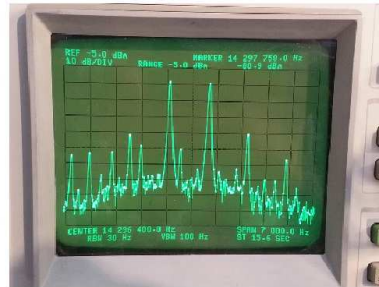

Fig 25.83 — An SSB transmitter two-tone test as seen on a spectrum analyzer. Each horizontal division represents 2 kHz and each vertical division is 10 dB. The third-order products are 30 dB below the PEP (top line), the fifth-order products are down 37 dB and seventh-order products are down 40 dB. This represents acceptable (but not ideal) performance.

-- Page 25.47, 2010 ARRL Handbook



Sienna SSB transmitter two-tone test. Reference level is 6dB above the two tones. Output power was 100W. Carrier is at -48dB. 3rd order products are at -38dB. 5th order products are at -50dB. Other mixing products visible on left side are down more than 50dB. This represents excellent performance.

ARRL measurements (competitive product):

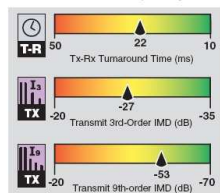

Sienna (10W) DZKit measurements:

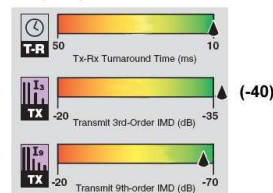

Sienna Specifications. **Frequency range:** 10 kHz to 30 MHz. (Specs valid 1.8MHz-29.7MHz), + 50-54 MHz receive **Modes:** SSB, CW, AM, FM and Digital (via external PC). **FM modulation:** frequency modulated carrier with 2122 Hz pre-emphasis; selectable deviations of +/-2, 4 and 5kHz. **FM receive IF:** 455kHz, includes two 4-pole +/-10KHz ceramic filters. **MDS (PSB off):** -115/-125/-134dBm (preamps off/1/2). **MDS (PSB on):** -120/-130/-135dBm (preamps off/1/2). **BDR:** >105dB at spacings greater than 1kHz, >130dB at spacings of 5kHz and greater (preamps off). **IMDDR3:** >100dB regardless of spacing. **Tx 2-tone IMD (ref PEP):** 3rd order: -38dB @ 100W, -41dB @ 10W; 5th order: -43dB @ 100W, -53dB @ 10W. **Noise Blanker:** Variable threshold, retriggerable pulse width (4 selectable widths). **Freq stability:** +/-1 ppm (0-50C) after 30 minute warm-up, using included TCXO. **Displayed resolution:** 1 or 10 Hz (internal resolution is sub-Hz). **Tuning step size:** 1, 10, 100, 1k, 10k Hz. **RIT, XIT range:** +/-16MHz, with two speeds. **Memories:** 147, including 85 programmable GP memories preset to desired bandplan, one scratchpad preset to WWV, 5 VFOA memories per band, one VFOB memory, ten 12-character CW memories with selectable Farnsworth mode output. **Mic input impedance:** 150-600 Ohms, balanced (switchable to Hi-Z) and unbalanced line level. Front panel mic jack is Yaesu-compatible. **CW/SSB/AM IF frequencies (Rx):** 70.455 MHz, 9.0 MHz, 455 kHz. **CW/SSB/AM IF Filter selection:** 70.455MHz/5kHz roofing, 9.0015MHz/2.4kHz 4-pole SSB crystal filter standard, 455KHz/6kHz ceramic filter standard (can be replaced with Collins 5.8KHz filter); Choose up to three additional Inrad snap-in filters for 9.000, 9.0015 or 9.00075MHz; Choose up to three additional Inrad or Collins snap-in filters for 455kHz. **Broadband IF frequency output:** 455kHz +/-250kHz, 50 ohms. **Transmitter IF:** 11.985MHz (single conversion) **Transverter:** Use 0-10W Tx output and Receive antenna. Display frequency shows actual frequency. 28MHz IF. **Stereo audio output power:** 1.5W/ch (available even while using headphones). **Linear control outputs:** TX Enable in, TXGND out, TTL band data, fuse-protected 12V@250mA, Yaesu band data connector pinout via 8-pin mini-DIN connector. **External ALC input:** 0 to -5V. **IF Notch Filter** 455kHz. **DSP:** auto-notch (SSB), manual notch (CW), variable bandwidth filters, NR, AGC software included with Sedona via Chromasound audio DSP software. **DC power requirements:** 2.5A receive (11-15V), 6A transmit @10W (12-15V), 2.5A transmit @100W output (13.8-15V). **Dimensions:** 3.5"H x 14"W x 16"D (rubber screw-on feet located in a 12.25" x 14.0" area). **Weight:** <12 lbs fully loaded. **Preassembled boards:** Controller, transmitter, bandpass filters. **Complete kit boards:** DC power distribution/tuner, RS232, IF filters, RXBPF, Front panel. **Partially preassembled kit boards:** Receiver, 100W amp. Specifications subject to change without notice.

Compartmentalized for isolation, strength and expansion

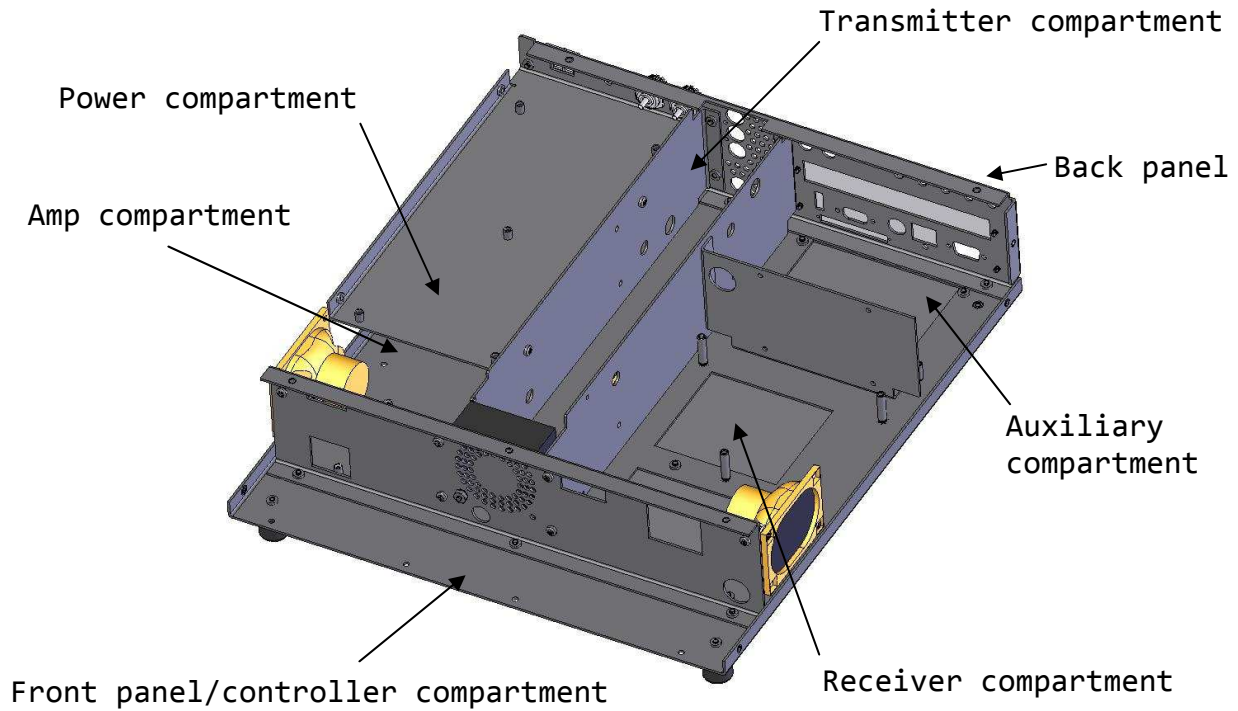

Sienna is compartmentalized. The controller/front panel, DC power conditioning, receiver, transmitter and amplifier are all in different compartments. In addition, there's a small 4 x 6 area near the back panel called the "auxiliary compartment". All are available for your use depending on which options you have installed. For example, if you have a receiver model, the amplifier, transmitter and auxiliary compartments are available. If you have a 10W transceiver, the amplifier and auxiliary compartments are available. If you have a 100W transceiver, the auxiliary compartment is available. If you're an experimenter, you will find the availability of these compartments and access on the back panel very handy.

Built-in serviceability makes assembly and troubleshooting easy!



The DC power and tuner tray rotates up for access to the 100W amp. The 10W transmitter can be lifted out of its compartment. These are just two of the many features that make it easy to build and service your Sienna.



This switch puts a 70dB attenuator in the transmit oscillator path, allowing it to be used as an S9 signal source for receiver S-meter calibration.

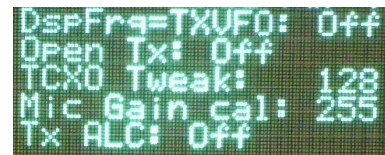

Menu options allow you to do calibration and run tests. For example, when you turn on the first item in this menu (DspFrq = TXVFO), the transmitter's VFO is set to the display frequency instead of its normal value. This allows you to use it as an RF signal generator to test or troubleshoot the receiver.

Add a panadapter or secondary receiver to your Sienna.



Made by RFSpace, the SDR-IQ is a software defined radio (SDR) receiver that connects to the 455kHz IF Output jack on Sienna's back panel. or to a separate receive antenna. Connect the USB cable to your PC, select SIENNA from the list of supported radios, and you'll be able to monitor up to 190kHz of spectrum around your operating frequency. As you change frequency, the SDR-IQ keeps up with you, and if you click on a signal of interest, the SDR-IQ will re-program Sienna to go to that frequency. This product fits inside our "Sedona" enclosure.

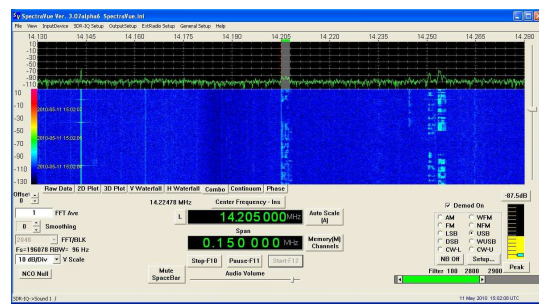
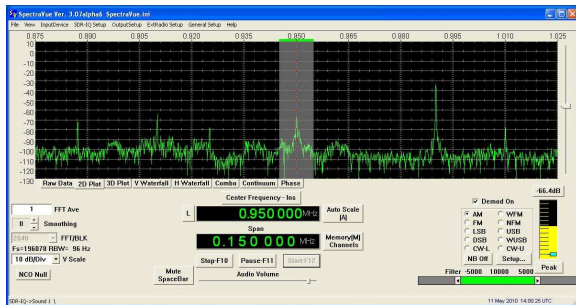
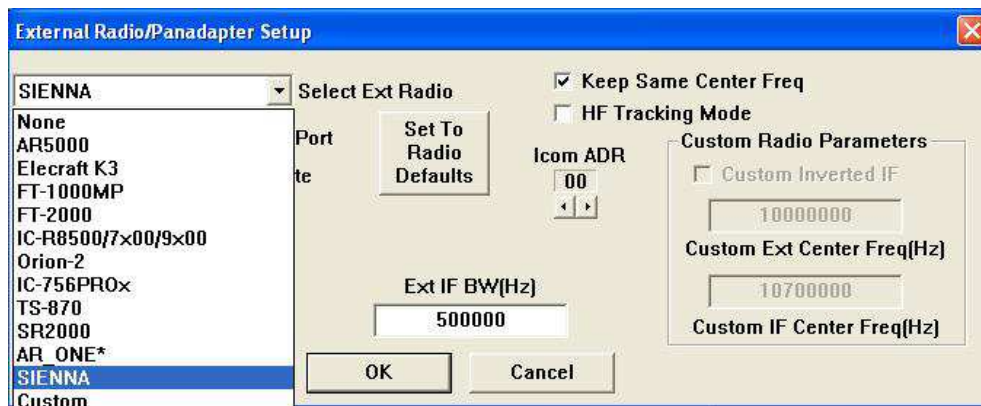

You can view the spectrum either as a traditional spectrum analyzer, or as a horizontal or vertical "waterfall".

DZKit does not sell the SDR-IQ. It must be purchased through other retailers. It typically sells for about \$500.

Add DSP to your Sienna

ChromaSound provides audio DSP capabilities. Available from Silicon Pixels (www.barberdsp.com) for \$50.

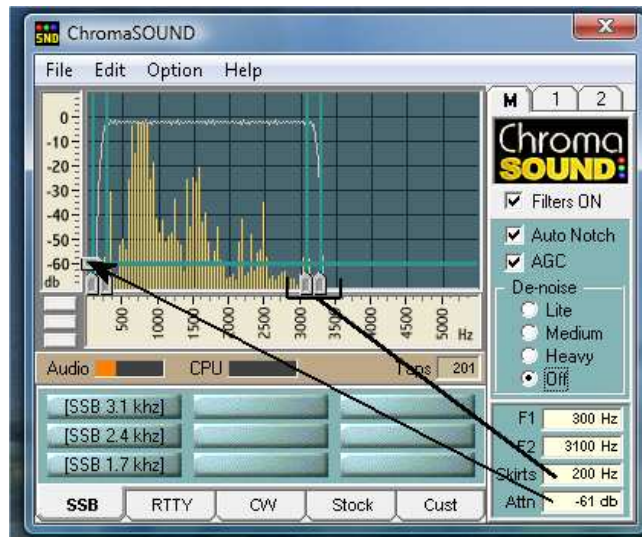

- SSB "de-noise", for reducing static on SSB signals
- Automatic notch filter, for removing tones, heterodynes, and those pesky carriers
- Bandpass, Low-Pass, High-Pass, and Band-stop (manual notch) filters
- User-defined filters, using the built-in *Graphical Filter Designer*. Just drag your filter from the design window to an empty button!
- Selection of pre-defined filters,
- AGC, or *Automatic Gain Control* for operation under varying conditions

Add a PC and other accessories to your Sienna using our new Sedona!



Sienna is compatible with DXLab Suite and Ham Radio Deluxe (ver. 6 and higher) software. It's shown here running N3FJP logging software. The SDR-IQ, shown on the opposite page, is also compatible and can be installed inside Sedona and run from a mini-ITX-based PC that can also be installed. Sedona monitors supply current and voltage (shown on a color LCD dual panel meter) and provides a 12-button keypad that can be used to change bands and access memories and CW buffers in Sienna. You can buy mini-ITX motherboards from a wide variety of places. We sell the "Fairywren" board, which can hold the popular Raspberry Pi and Arduino boards.

Can you build a DZKit? Yes! The key to your success...DZKit Manuals.



KIT-BUILDING PROCEDURES

The steps involved in building a kit are listed below. Be sure to follow them and you will have a lot of fun building, aligning, testing and using your kit.

1. **Do a parts inventory.** At each major section and in the Appendices, there's a list of parts used in that section (or that will be used shortly). Check off each part to be sure you are not missing anything. Our method of bagging parts is different from all other kit vendors and will make the task much faster and less error prone. But despite our valiant efforts, mistakes can happen. If you are missing any parts, call or email us and we'll rush replacements to you immediately.
2. **Pay attention to soldering techniques.** Keep your soldering iron clean by using a wet sponge, use appropriate heat and maintain heat



Chassis Parts

Item	Description	Qty
1	Connector — SO-239 RF chassis mount	2
2	Connector — RCA phono chassis mount - red	1
2	Connector — RCA phono chassis mount - black	1
3	RTV silicone adhesive	1
4	Gas discharge tube	3
5	Anderson Powerpole mounting clamp	1
6	Polycarbonate overlay - 1 meter	1
7	Meter face - Multipurpose	1
8	Knob-small	10
9	RIT Knob	1
10	Tuning knob	1
11	Foot - front 1.00 X .75"	2

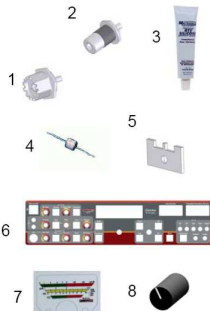

until the tubing has shrunk around the contacts. No bare wires should be exposed.

- () Repeat the previous procedure for the second fan.
- () Insert the fan cables through the hole in the back panel tray and up into top compartment.

If you purchased the 100W PA:

- () Attach a fuseholder to the PS



Safety First!

Your safety is of utmost importance to us. Please read this information before you get started, and remember these rules as you continue building and testing your Sienna.

1. Always have a healthy respect for electricity. While the voltages present inside the Sienna are not lethal, high currents are available (up to 30 Amps when the 100 Watt amplifier is used). Use a power supply with overcurrent foldback or crowbar protection so that in case of high currents the supply will shut down. Set the output current only as high as necessary for a given step.
2. When measuring voltages inside electronic equipment, it is generally a good idea to use only one hand, wear rubber-soled shoes and avoid areas with standing water. However, remember that slightly

brackets, one 6-32 x 1/2" hex male/female spacer, two 6-32 KEPS nuts and four 6-32 x 1/4" screws. See detail 3.

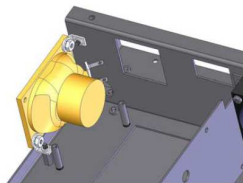

1. **Tips on kit-building.** Each DZKit manual has a number of pages at the beginning that explain how to solder safely and well, how to avoid static electricity that could damage sensitive electronics, how to sort parts, and how to follow the step-by-step instructions.
2. **Detailed Parts List.** Each board or chassis construction section has a list of parts along with a picture or drawing of the each part for easy identification.
3. **Simple Step-By-Step procedures.** Every step has a set of parentheses next to it so that you can check off the step as you finish it. The steps are written in non-technical, everyday language so everyone can understand.
4. **Detail drawings, pictorials, and color pictures** are used to show exactly what the board or chassis should look like.
5. **Exclusively with DZKit, parts bags are pre-sorted.** When parts look similar, they are placed in different bags. Each bag contains a printout of actual part names (C12, R22, etc.) and their values. Match the part with the silkscreened text on the board and you can't go wrong.
6. **Also exclusive to DZKit, if you have access to a nearby PC while building your kit, you can bring up the board layout using free software** and search for a part name. The software will show you exactly where the part goes.
7. **Operating/Troubleshooting Instructions.** Our more complex manuals are broken into three parts - assembly, operating and service/troubleshooting, and each of these are very detailed.
8. **Circuit Description, Block Diagram and Schematics.** If you are technically inclined, or interested in learning about electronics, you'll find the Theory section of the Service Manual very helpful as well as educational.
9. **Warranty.** DZKit warrants all kit parts against defects in workmanship and materials for a period of 90 days after shipment.

Want someone else to build your kit for you? Meet a "Builder-for-Hire"

Alan Wilcox, W3DVX
www.wilcoxengineering.com
 (570) 321-1516



Alan has met DZKit standards for quality, but he does not work for us. We do not pay him, and he does not pay us. You work out details directly with him. He can build some or all of any of our kits, and can also service them if the need arises. If you would like us to drop-ship a kit directly to him, please let us know when you order!

Sienna's modularity makes assembly straightforward and fun!

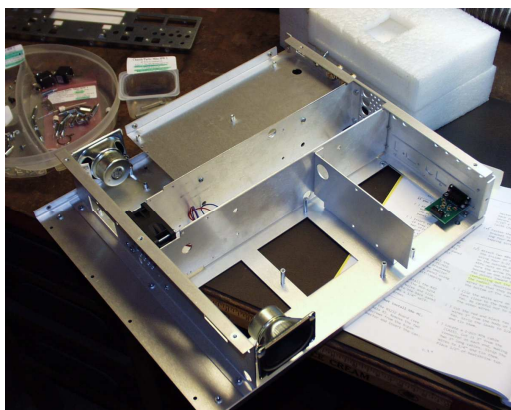

Step 1: Build the chassis. Including time to unpack and sort hardware, this step takes about 2 hours.

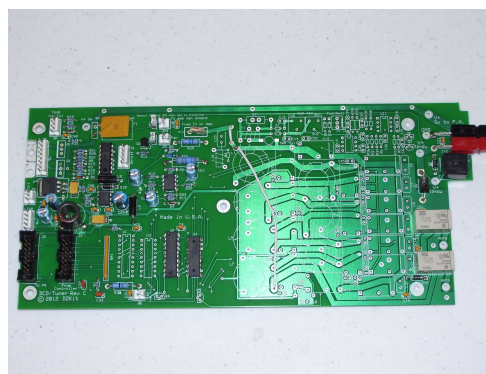

Step 2: Build the DC power distribution board. Although this board is simple, it usually takes about 5 hours because it is the first board and you will be getting used to the assembly procedures.

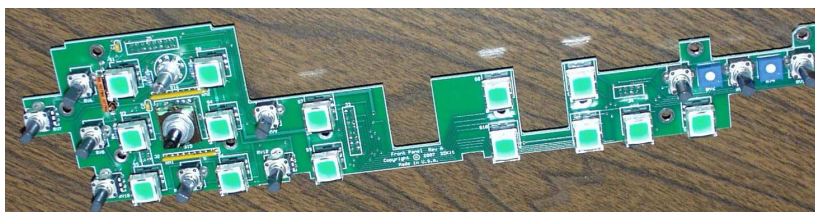

Step 3: Build the front panel board and attach it to the preassembled and tested controller, adding the display, tuning controls and meters. Total assembly time for the front panel is about 5 hours.

Step 4: At this time, you are able to turn on your Sienna, measure DC voltages and verify that the front panel works. You can then experiment with the controls and even connect it to a PC and run remote control software such as Ham Radio Deluxe or DXLab Suite.

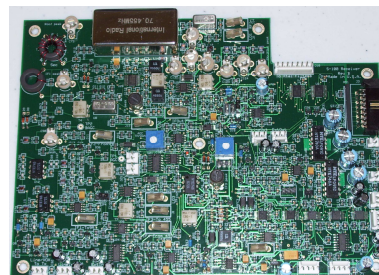
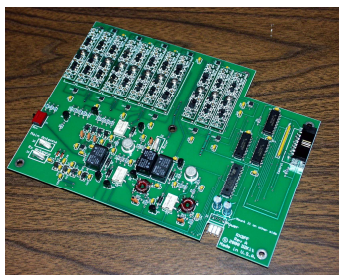
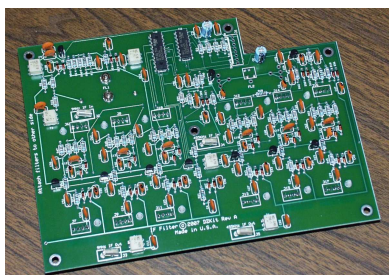

Step 5. Build the three boards making up the receiver: IF Filters (left), Bandpass filters/preamp (middle), and Receiver board (right). All surface-mount parts are pre-loaded, so you only have to add through-hole parts. Each of these boards takes about 4 hours to build. You can even use the electronic layout files to help locate parts!

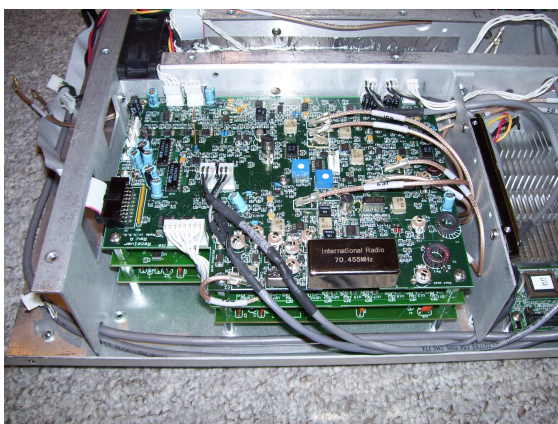

Step 6. Install the receiver into the chassis, one board at a time. Each board is tested as it is installed. After installation, the manual guides you through the simple calibration steps using only a voltmeter and by dipping and peaking signals on the S-meter. The transmitter's oscillators are used as internal RF signal sources, so you don't need fancy test equipment.

If you bought a receiver-only Sienna, you're done! If not, you move on to the pre-assembled/tested transmitter board and the 100W amplifier kit (about 5 hours). See photos of these boards on the next page.

Total construction time for a fully-loaded Sienna is about 40 hours, roughly as long as it used to take to build a Heathkit DX-100 or SB-100!

Add these options to your Sienna for peak performance

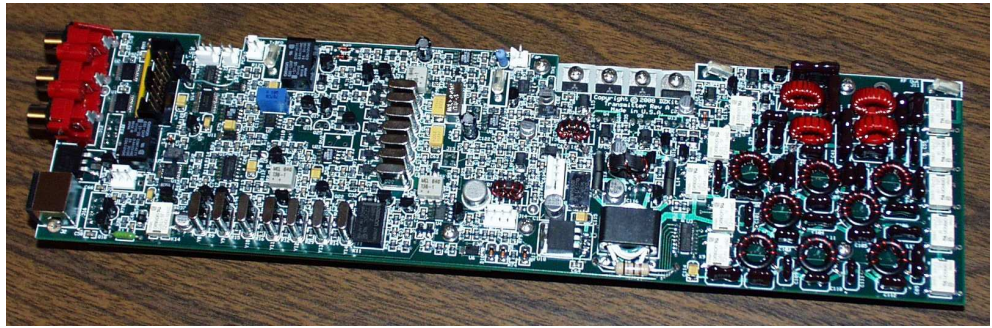

Option 101. 10W Transmitter. Add this 10W 1.8MHz-29.7MHz transmitter (software limited to bands appropriate for your license) to the S-100 or SF-100 Sienna receiver at any time to turn your receiver into a transceiver. (Included in all transceiver models.) Balanced mic input and line level input. 3-band parametric audio equalizer. 12th order 2.8kHz crystal filter for SSB, 7th order 5kHz filter for AM/ESSB. Also includes an RF speech processor. Push-pull finals with five bands of toroid filtering produce a clean output signal. Includes mic input, PTT and linear control outputs. Cannot be used outside the Sienna enclosure. Requires internally generated control signals and local oscillators. Also includes power meter circuitry for DCD/Tuner board. **Assembled and tested, 2lb.....\$800.00**

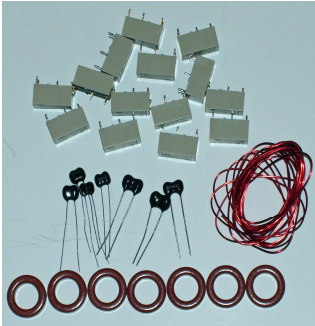

Option 102. Internal Antenna Tuner Kit. Handles 100W. A switched-L-style matching network tunes 6-800 ohm antenna impedances via the antenna A/B SO-239 antenna connectors at full rated power. Not intended to match long-wire antennas without baluns. The kit consists of relays, toroids, Polythermaleze magnet wire and capacitors that you add to the DCD/Tuner board. No additional firmware to load. Just add the parts and you're ready to go. Each of the five VFO-A memories on each band maintains current tuner settings. Sienna includes a manual mode as well as automatic mode, allowing you to control the inductance and capacitance yourself, and to place the capacitor on either side of the inductor. Once you have found a setting you like, you can save that setting in memory. Setting are memorized for every 32kHz of spectrum, independently for antenna A and B. *Requires transmitter option.* **Kit, 1 lb.....\$190.00**

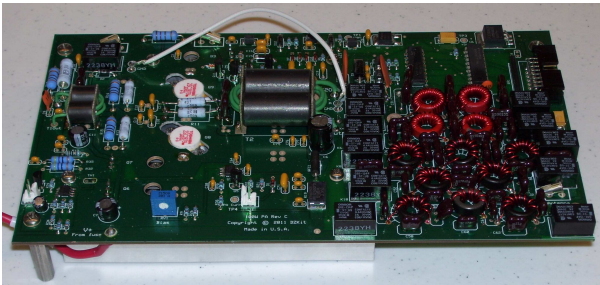

Option 104. 100 Watt Output (CW/SSB) Power Amplifier. Also provides 25W carrier power on AM and FM. Mounts inside the Sienna. Fuse and fan protected. Thermistor detects heat rise and increases fan speed when necessary. Cannot be used outside the Sienna enclosure - requires built-in firmware and control lines. Uses two 2SC2879A RF power transistors in push-pull. *Requires transmitter option.* **Kit, 3 lbs.....\$450.00**
With pre-wound toroids, 3 lbs.....\$500.00

Sienna now includes a general coverage bandpass filter module. This was previously a \$285 option. We found a way to lower our cost of this option and since almost everyone ordered Sienna with it, we have now included it standard. This feature provides 11 bands of filters for the front end. Our unique Passive Signal Boost (PSB) feature also allows you to bypass these filters, which can provide about 5dB less loss at the expense of additional noise from the wider bandwidth signals entering the receiver. Low pass filters are always engaged, so there is some wide filtering even with the bandpass filters bypassed.

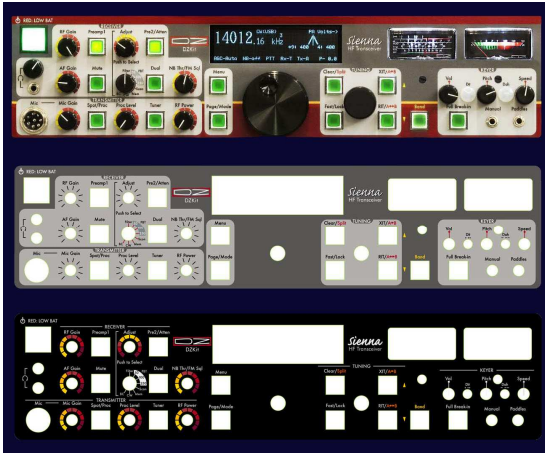

Choose one of three styles of overlay—burgundy/yellow/gray with color wheels around knobs, gray on gray with minimal color, or gray on black with no two-tone group highlights.

Available with green, red, yellow and/or blue LEDs and white/colored, white/clear or gray/frosted key caps. (Blue LEDs available only with white/clear or gray/frosted keycaps.)

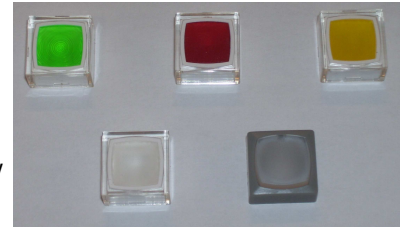

Option 103. Front Panel. This kit consists of two precision, "velvet-touch" rotary pulse generators (for the tuning controls), two analog meters (one for transmit functions, one for receive), vacuum fluorescent graphics display, lighted pushbuttons with a positive tactile sensation (not "squishy"), pots, mic/headphone/key jacks, PC board, cables, knobs, steel sub-panel and polycarbonate overlay. To add this to an existing Sienna model, you build the simple front panel board and attach it to the new sheet metal sub-panel along with the meters and vacuum fluorescent display. You then remove the controller board from the existing blank front panel and snap it onto the new assembly. Entire assembly procedure takes about 5 hours. (Included in all transceiver models.) **Kit, 2 lb.....\$700.00**



Option 201. IF Filter Package #1. 8-pole 400Hz CW filters for the 9MHz and 455KHz IF's in the Sienna. Highly recommended for CW operation. These are Inrad 759 and 703 crystal filters on snap-in Yaesu FT-1000MP style "C" boards. **Fully assembled, 1 lb.....\$295.00**



Option 202. IF Filter package #2. 8-pole 250Hz filter for the 455KHz IF. It is mounted on a Yaesu FT-1000MP style "C" board. **Fully assembled, 1 lb.....\$170.00**

Option 203. IF Filter package #3. 9.0015MHz and 455KHz 8-pole 1.8 kHz SSB filters mounted on Yaesu FT-1000MP style "C" boards. **Fully assembled, 1 lb.....\$295.00**



Option 204. Upgrades standard 20KHz ceramic filter to 5.8KHz Collins mechanical filter (455KHz IF). **Fully assembled, 1 lb.....\$120.00**

Option 205. 9.0015MHz 10-pole 2.4 kHz SSB filter mounted on Yaesu FT-1000MP style "C" board. Use in place of standard 4-pole filter for better selectivity. Can also be installed with standard filter, but occupies a filter slot that you may wish to use for other filters. **Fully assembled, 1 lb.....\$140.00**
If ordered as an upgrade to the stock 4-pole filter (Opt. 205U).....\$115.00

Option 207. 9.0000MHz 8-pole 6 kHz AM filter. Required for AM modes. (You can listen to AM using an SSB filter by zero-beating the carrier, but this filter gives a more natural sound to AM broadcasts.) **Fully assembled, 1 lb.....\$130.00**

Note: Sienna now includes a high-performance 5kHz roofing filter at 70.455MHz standard.

Inrad (www.inrad.net) offers many other filters for Sienna. You can order them directly from Inrad, or we'll be happy to get them for you. If you order from our web site (www.valleyhamshack.com), a complete selection is shown in addition to those described above. Also please visit our web page specifically dealing with filter selection at www.dzkit.com/filters.htm.

How to Order a Sienna

Pick a Sienna base model (most popular model shown in bold):

S-100	\$1699.00	Receiver, no front panel (Upgradeable to transceiver)
SF-100	\$2399.00	Receiver with front panel (Upgradeable to transceiver)
SF-100L	\$3199.00	10W Transceiver with front panel
SF-100E	\$3389.00	10W Transceiver with tuner and front panel
SF-100H	\$3649.00	100W Transceiver with front panel
SF-100X	\$3839.00	100W Transceiver with tuner and front panel

Add options (recommended options shown in bold):

*201	\$295.00	IF Package 1—400 Hz CW filters (2nd and 3rd IF)
202	\$170.00	IF Filter Package 2—250 Hz CW filter (3rd IF)
203	\$295.00	IF Filter Package 3—1800 Hz SSB Filters (2nd and 3rd IF)
204	\$120.00	Upgrade 20 kHz 3rd IF filter to Collins 5.8 kHz mechanical filter
205	\$140.00	High performance 10-pole SSB filter (2nd IF)
205U	\$115.00	Same as 205, but replaces stock 4-pole SSB filter (Must order with initial kit purchase)
*207	\$130.00	2nd IF AM Filter (9 MHz / 6 kHz BW)

* = recommended (Option 201 is recommended if you plan to use CW)

Note: IF filters can also be ordered directly from Inrad, and they offer many other combinations too. See the DZKit Sienna pages at www.inrad.net.

If you have picked a model with a full front panel (SF-xxxx models), choose a color scheme:

No charge	Front Panel (highlight choices)
	1. Faceplate color scheme: Burgundy , Gray or Black
	2. LED color: Red, Yellow, Green or Blue
	3. Keypad style:
	White with colored lens (color must match LED, blue n/a)
	White with clear lens (any color LED)
	Gray with frosted lens (any color LED)

Note: Although you can use different keycaps and colors for the various buttons, we recommend sticking with one keycap and one color LED.

Our most popular model with typical options is highlighted in bold. Cost of this model as shown is \$4379.00 plus shipping. If this is too pricey for you, we recommend starting with the SF-100L, which is only \$3199.00 plus shipping. All options can be added at any time.

The S-100 model makes an excellent secondary receiver, especially when combined with the Sedona with a built-in PC. (You can, of course, use any PC to control it.) In that configuration, you use the PC to control the second Sienna, feed its Line Out audio into the Line In jack on the primary Sienna, and when the "Dual" button is pushed, you get one receiver in each speaker! That's typically used by contesters who need a secondary receiver to hunt for band openings and contest multipliers while using the main Sienna for contacts. You can also put a full front panel on the secondary receiver if you'd rather not control it from a PC. That gives you a world-class receiver that is completely upgradeable to a transceiver at any time.

If you already have a Sienna, pick one of these upgrade options:

101	\$800.00	10W Transmitter (only for S-100, SF-100 receiver models) (A&T)
102	\$190.00	Antenna Tuner (requires option 101) (Standard with E, X models)
103	\$700.00	Front Panel (highlight choices) (Standard with SF models) 1. Faceplate color scheme: Burgundy, Gray or Black 2. LED color: Red, Yellow, Green or Blue 3. Keycap style: White with colored lens (color must match LED, blue n/a) White with clear lens (any color LED) Gray with frosted lens (any color LED) Note: Although you can use different keycaps and colors for the various buttons, we recommend sticking with one keycap and one color LED.
104	\$450.00	100W amplifier (CW/SSB; 25W carrier power on AM/FM)(Requires option 101)(Standard with H, X models)
104A	\$500.00	Same as option 104, but includes 12 pre-wound toroids

Add a Sedona station accessory:

S-200	\$399.00	Sedona chassis with blank front panel.
SF-200	\$599.00	Includes chassis, 12-button keypad, color LCD display, back panel I/O connectors (two BNCs, USB, audio minijack), and power monitor Board. Does not include PC or SDR.

Note: As with Sienna, choose a front panel color scheme. See option 103 above for color options.

Fairywren	\$99.95	Mini-ITX motherboard for Raspberry Pi and Arduino (not included) (For standard PC motherboards, we recommend TigerDirect or Microcenter. Write for a complete list of recommended boards to create your own high-performance PC inside Sedona!)
-----------	---------	---

Add sales tax to orders if you plan to pick up your Sienna at Valley Ham Shack in Loveland, CO:

Colorado	2.9%
Larimer County	0.6%

Add shipping costs:

Flat rate FedEx Home Delivery (or Ground) shipping: \$50.00 (U.S. destinations)
International: Please contact us. Shipping costs vary dramatically from country to country

Why is shipping so expensive? A typical Sienna order weighs 20-25 lbs and the box is large, which typically costs about \$25. In addition, insuring it for between \$3000 and \$5000 adds another \$25.

Because of the stated price, a "direct signature" is required. Please make arrangements for someone to be present when the package is delivered. We provide a tracking number when we ship so that you will know when to expect it.

If you would like help calculating total cost, please email us at sales@dzkit.com or call 1-877-HAM-SHACK (1-877-426-7422).

Highlight the base model and any options above to describe your order, then call, email or copy these two pages and mail it to us. Then send a check or money order to:

Valley Ham Shack
710 Grove Ct.
Loveland, CO 80537

(Call if you would prefer to pay by credit card or Paypal)



The DZ Company, LLC
www.dzkit.com

When in northern Colorado, visit our retail store, offices and DZKit manufacturing plant, known locally as

Valley Ham Shack
710 Grove Ct.
Loveland, CO 80537
www.valleyhamshack.com

Call toll free: 877-HAM-SHACK
(1-877-426-7422)

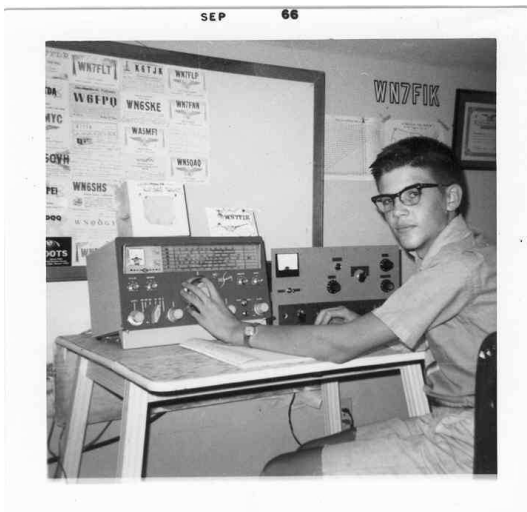

The Story of DZKit

From the early 1900's on, kit-building has been a way of life for many people. In the post-WWII era, there were many companies making electronic kits. One was Heathkit, a large company (\$100M in sales in 1979) based in Benton Harbor, Michigan. They made kits of every kind, from simple learning tools to organs, color TVs, stereos, CB radios, test instruments, marine electronics, darkroom equipment, garage door openers and amateur radio equipment. The large influx of imported electronics in the mid-1970's along with the computer phenomenon starting in the late 1970's caused many American electronics businesses to fail. Heathkit became another victim of the day, bought and sold numerous times until only its educational products remained. They remained in business until 2012 when they filed for bankruptcy.

In 1965, a 14-year old ham radio enthusiast named Brian Wood discovered Heathkit products and eagerly built many of them. His interest in electronics led him into an electrical engineering career at Hewlett-Packard®, and then to Agilent Technologies®, which was spun off of HP in 1999. Eager to show the fun of kit-building to a new generation, and after 33 years of "training" at HP/Agilent, Brian retired at 55 and, with 3 other hams, formed The DZ Company, based on the last two initials in his amateur radio call letters (W0DZ). The first product, in development for five years, was Sienna, an all-mode HF transceiver with features not available on many existing rigs.

Thus was laid the groundwork for DZKit products — no "me too" products, but rather products that make a contribution to the industry by offering features not available elsewhere, with solid engineering and excellent customer support. We also believe strongly in avoiding outsourcing wherever possible. All of our products are designed and manufactured in the U.S.