

EMPEROR TS-5010 AMATEUR RADIO

# SERVICE MANUAL

VERSION : TS-5010-03A

ADJUSTMENTS AND INSPECTIONS FOR EACH VFO PCB

1. Adjust the core of coils(L503,504,506,517 and 518) to the lowest position.  
Adjust semi-fixed resistor VR501,502 to the center (12:00 position).
2. PLL Adjustment ① (LOCK Voltage Adjustment)

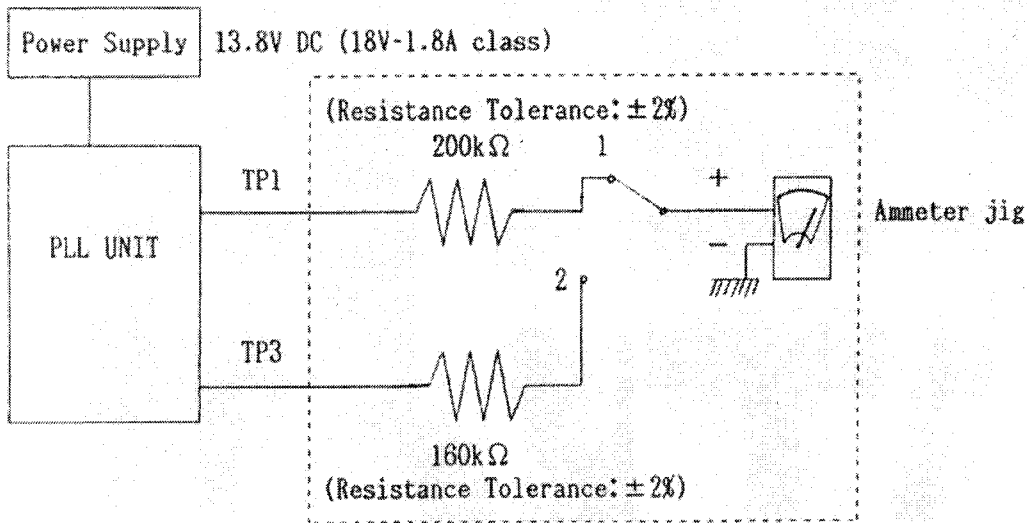

- ① Set the switch of the Ammeter jig at 1 position, adjust L502 to 25 $\mu$ A reading on the DC Ammeter.
- ② Set the switch of the Ammeter jig at 2 position, adjust L515 to 25 $\mu$ A reading on the DC Ammeter.

3. PLL Adjustment ② (Balance Adjustment)

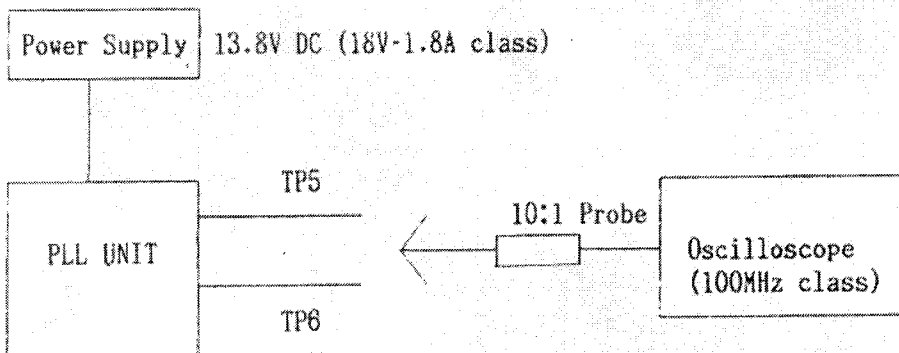

- ① Adjust VR501 to obtain the best waves watching the TP6.
- ② Adjust VR502 to obtain the best waves watching the TP5.

#### 4. LOCK Voltage Inspection

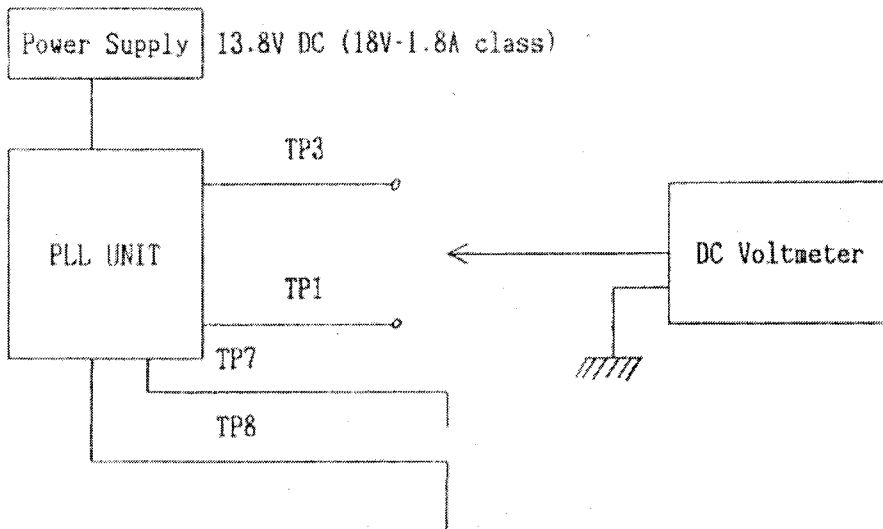

Check the Voltage of TP3 and TP1. and adjust them within the value mentioned below.

No.of Band (1 Ch.)	TP3 Voltage (V)	TP1 Voltage (V)
a	4.0 ±0.5	5.0 ±0.5
b	4.3 ±0.5	5.0 ±0.5
c	4.6 ±0.5	5.0 ±0.5
d	4.9 ±0.5	5.0 ±0.5
e	3.1 ±0.5	2.5 ±0.5
f	3.4 ±0.5	2.5 ±0.5
g	3.7 ±0.5	2.5 ±0.5
h	5.0 ±0.5	5.0 ±0.5
C	3.2 ±0.5	2.5 ±0.5

Operate the adjustment mentioned below after assembly of PLL UNIT.

### 5. Frequency Adjustment

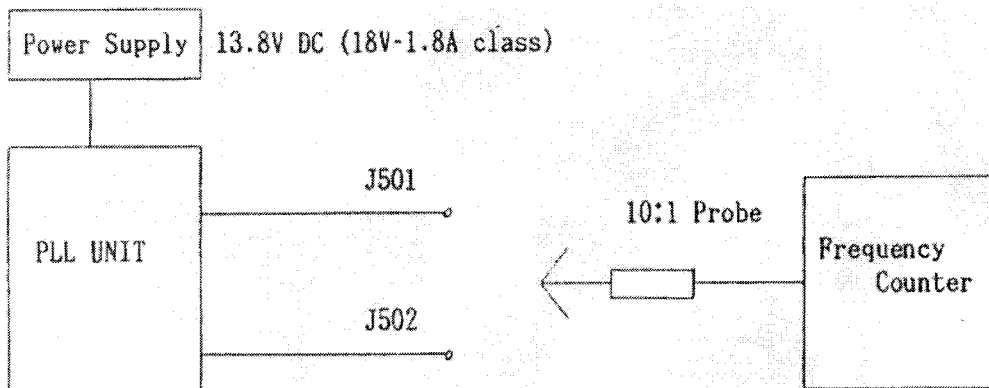

- ① Set RIT Volume (VR1003) to the center (12:00 position), and adjust L516 to make the output frequency of J501 at  $10.240\text{MHz} \pm 10\text{Hz}$ .
- ② Set at 1Ch of a-band and adjust L501 to make the output frequency of J502 at  $38.695\text{MHz} \pm 100\text{Hz}$ .
- ③ Connect the counter to TP1 and adjust frequency at following modes.

	Mode	Remarks
1	USB	Adjust L108 to set the frequency at $10.6975\text{MHz} \pm 100\text{Hz}$
2	LSB	Adjust L109 to set the frequency at $10.6925\text{MHz} \pm 100\text{Hz}$
3	CW	Adjust L107 to set the frequency at $10.695\text{MHz} \pm 100\text{Hz}$

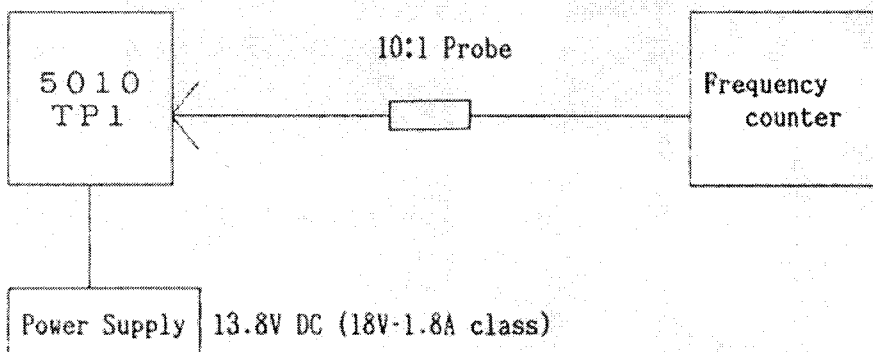

### 6. TX Frequency Adjustment

Set at 1Ch of a-band and set it at transmission mode, and adjust VR108 to make the TX frequency at  $38.695 \pm 100\text{Hz}$ .

## ALIGNMENT OF TRANSMITTER PORTION

### 1. Test Equipment Required

Power Supply : 13.8V ± 0.05V (more than 10A)

AF OSC AM, FM(1KHz), SSB(2 Signal modulations 500Hz and 2,400Hz )

Oscilloscope, RF Power Meter(CW/PEAK SW:PEAK), AF VTVM, Dummy Load(50 Ω)

FM Linear Detector, DC Ammeter

### 2. Preparation for Alignment

Set Fixed Resistor

VR104, VR112 : Clockwise

VR113 : Counter Clockwise

LOC/DX SW : DX

MIC GAIN Mode : OFF

PA SW : OFF

RF Power Volume : Max.

Frequency: 28.000MHz

### 3. Alignment Procedure

Step	Preset to	Adjustment	Remarks
1	Mode:USB No Mod.	VR112	Remove the PCB(PB-101) from Main PCB. Connect a DC Ammeter (+) to TP101 (-) to TP102. Adjust VR112 for 60mA reading on the DC Ammeter.
2	Mode:USB No Mod.	VR113	Connect the DC Ammeter (+) to TP101, (-) to TP103. Adjust VR113 for 60mA reading on the DC Ammeter.
3	Mode:USB MIC Input: See Remarks 2 SIG.Mod.	L124	Disconnect the DC Ammeter. Reinstall the PB-101 to the Main PCB. Connect an RF Power Meter to the ANT.Jack. Connect an Oscilloscope and an FM Linear Detector across a Trombone to the RF Power Meter. Adjust L124 for maximum reading on the RF Power Meter. During this step, set the AF Oscillator so that the output is less than 8W. Repeat this step twice.
4	Mode:USB 30mV RMS 2 SIG.Mod.	VR103	Adjust VR103 for 24.5W PEP reading on the RF Power Meter
5	Mode:USB or LSB No Mod.	VR105	Adjust VR105 so that the carrier leakage at USB and LSB become minimum. The Oscilloscope reading has to be less than 500mV P-P.
6	Mode:CW No Mod.	VR104	Connect a SW to Key Jack. Change the CW/PEAK SW on the RF Power Meter to CW position. When turn on the SW, adjust VR104 for 24.5W reading on the RF Power Meter. When it is at 28.0MHz and 29.5MHz, RF Power has to be within the range from 21W to 26W. Adjust VR115 for reading 1V RMS on the AF VTVM across a Dummy Load(8Ω) at the EXT.Speaker with maximum volume.

Step	Preset to	Adjustment	Remarks
7	Mode:AM No Mod.	VR111	Adjust VR111 for 10W reading on the RF Power Meter at 29.5MHz.
8			Repeat step6 and step7 once again.
9	Mode:AM No Mod.		To check output power on AM/FM at 28.500MHz and 30.190MHz against nominal 10W. Adjust it slightly lower when it reaches to the upper limit of 11W, or slightly higher when it reaches to the lower limit of 9W, in order to minimize differences in output power of the unit from nominal 10W.
10	Mode:AM No Mod. Meter:CAL		Set the frequency at 28.000MHz. Confirm that CAL Meter exceeds the maximum range under condition of maximum CAL Volume. Adjust SWR Volume to light on to the CAL position on the Meter.
11	Mode:AM No Mod. Meter:SWR		SWR Meter has to show nothing or indicate digit "1" .
12	Mode:AM No Mod. Meter:RF	VR109	Adjust VR109 so that "10" LCD just lights on. After that, adjust VR109 until the LCD indication has become "9" instead of "10", and then stop the turning.
13	Mode:AM 1KHz, 30mV RMS Mod.	VR110	Adjust VR110 to obtain the 90% +/-P reading on the Oscilloscope. Confirm that its positive modulation factor +P has been more than 75%.
14	Mode:FM 1KHz, 30mV RMS Mod. HPF 300Hz LPF 3KHz	VR106	Adjust VR106 for $\pm 3$ KHz deviation on the FM Linear Detector.
15	Mode:AM 1KHz, 1mV RMS Mod. Meter:MOD	VR107	Adjust VR107 so that "9" LCD just lights on.

TEST EQUIPMENT CONNECTION : Refer to attached drawing.

INSPECTION OF TRANSMITTER PORTION

Step	Preset to	Remarks
1	Mode:USB 30mV RMS Mod. (2 Tones)	Set the CW/PEAK SW on the RF Power Meter to the PEAK position. When it is in transmission operation and it is at 28.0MHz and 29.5MHz, RF Power has to be between 24.0W and 26.0W.
2	Mode:CW No Mod.	Set the CW/PEAK SW on the RF Power Meter to the CW position. When the Key Jack is switched on and it is at 28.0MHz and 29.5MHz, RF Power has to be between 21.0W and 26.0W. Confirm that the frequency is within 28.0MHz±100Hz.
3	Mode:AM No Mod.	When it is in transmission operation and it is at 26.5MHz, 28.0MHz, 29.5MHz and 30.19MHz, RF Power has to be between 9.0W and 11.0W. (Consequently, the difference between the highest and the lowest has to be within 2W.)
4	Mode:AM No Mod. Meter:SWR	When it is in transmission operation, adjust the SWR CAL Volume so that CAL Meter indicates "▲". After that, change the Meter to SWR. Then SWR Meter has to show nothing or indicate digit 1.
5	Mode:AM No Mod. Meter:RF	When it is in transmission operation, RF Meter indicates between "9" and "10".
6	Mode:AM 30mV RMS Mod. (1KHz, Single Tone)	When it is in transmission operation, Modulation has to be between 85% and 95%.
7	Mode:AM Meter:MOD 1mV RMS Mod. (1KHz, Single Tone)	When it is in transmission operation, MOD Meter indicates between "8" and "10".
8	Mode:FM 2.2mV RMS and 30mV RMS Mod. (1KHz, Single Tone) HPP 50Hz, LPP 3KHz	When it is in transmission operation, Linear Detector reading has to be more than ±1.5KHz of Deviation at 2.2mV RMS and it has to be between ±2.5KHz and ±3.5KHz of Deviation at 30mV RMS.

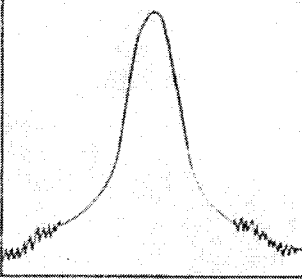
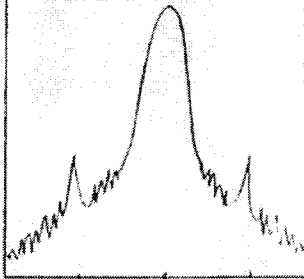
Step	Preset to	Remarks
9	Mode: CW Vol. Max.	When the Key Jack is switched on and set the unit at the maximum volume, the output of AF VTVM across a Dummy Load ( $8\Omega$ ) at the EXT Speaker has to be between 0.9V RMS and 1.1V RMS.
1 0	PA SW: ON MIC Input: 1.4mV	The Output of PA Speaker Dummy Load ( $8\Omega$ ) has to be between 1.6V RMS and 3.0V RMS
1 1	Mode: USB and LSB 30mV RMS Mod. (2 Tones)	<p>Check the Spectrum Analyzer. When it is switched from modulation to no modulation, the ratio of carrier suppression for USB and LSB has to be less than -46dB. At the same time, check the wave form of AM output with no modulation to confirm that spurious leakage of <math>f_0 \pm 10\text{KHz}</math> has not been produced.</p> <div style="display: flex; justify-content: space-around; align-items: flex-start;"> <div style="text-align: center;"> <p data-bbox="654 877 938 940">A. Correct (No spurious leakage)</p>  </div> <div style="text-align: center;"> <p data-bbox="1096 877 1393 978">B. Reject (There are spurious leakage of <math>f_0 \pm 10\text{KHz}</math>)</p>  <p data-bbox="1096 1318 1393 1350">-10KHz    f0    +10KHz</p> </div> </div>



## ALIGNMENT OF RECEIVER PORTION

### 1. Test Equipment Required

Power Supply :  $13.8V \pm 0.05V$

Speaker Dummy Load :  $8\Omega$  (at the EXT Speaker)

SSG

Frequency : 27.500MHz

Modulation Frequency : 1KHz

### 2. Preparation for Alignment

LOC/DX SW : DX

PA SW : OFF

NB ANL Mode : ALL OFF

Squelch : Min. (Auto SQ OFF)

RIT Volume : Connect the counter to TP2.

When you turn fully RIT Volume clockwise and counter clockwise, local frequency has to be varied more than  $38.195MHz \pm 2.3KHz$ .

After above operation, adjust the volume to the center.

Standard Modulation : AM 30%, FM  $\pm 1.5KHz$  DEV

### 3. Alignment Procedure

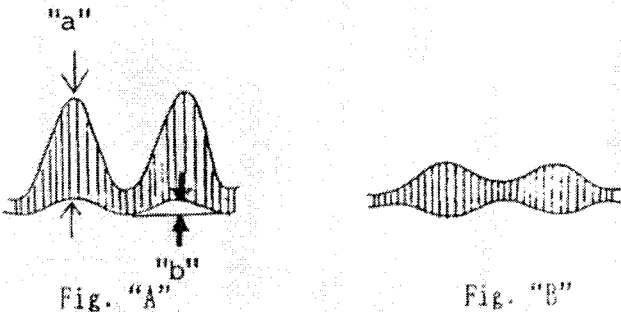
Step	Preset to	Adjustment	Remarks
1	Mode:AM SSG RF Output: See Remarks SSG: 1KHz 30% Mod. (AM)	L101,102, 103,104, 106	Alignment of sensitivity. Adjust coils for maximum reading on the AF VTVM (During this step, set the SSG attenuator so that the standard output is less than $0.5W(2V/8\Omega)$ ). Set the unit at the maximum volume. Adjust them lastly with SSG RF output set at $1\mu V$ .
2	Mode:AM SSG RF Output: Around $20\mu V$ SSG: 1KHz 30% Mod. (AM)	L401	<p>Press the NB/ANL Key once to select NB mode. ( Refer to the figures of "A" and "B" mentioned below. )</p> <p>Pick up the demodulated signal from TP401, and adjust the L401 to get the maximum level of peak "a" and "b" of Fig. "A".</p> <p>If the signal is the same shape as the Fig. "B" adjust the L401 until the signal becomes the same shape as the Fig. "A".</p> <p>After these operations, return the mode to NB off.</p> <div style="text-align: center;">  <p>Fig. "A"                      Fig. "B"</p> </div>

Step	Preset to	Adjustment	Remarks
3	Mode:AM SSG RF Output:1 $\mu$ V SSG: 1KHz 30% Mod.(AM)	L101,102, 103,104, 106	Adjust coils for maximum reading on the AF VTVM (During this step, set the SSG Attenuator so that the standard output is less than 0.5k(2V/8 $\Omega$ ))
4	Mode:AM SSG RF Output: 0.316 $\mu$ V SSG: 1KHz 30% Mod.(AM)	L106	Set the volume to the maximum. Rotate slightly the RIT volume to right and left to get the audio maximum output. If the audio output is more than 2V RMS, reduce the audio output until it gets 2V RMS, and adjust L106 to get the lower peak point.(Adjusting L106 makes two peak points. When the core is located close to the core top, lower peak point is produced and when the core is located close to the core bottom, the other peak point is produced.)
5	Mode:AM SSG RF Output: 1.41 $\mu$ V SSG: 1KHz 30% Mod.(AM)	L103	Set the audio volume of the unit to 2V RMS. Press NB/ANL Key once to check the audio level difference between NB/ANL OFF and NB ON condition. If it is more than 0dB or less than -2dB, return the NB/ANL mode condition to NB/ANL OFF mode, and adjust L103 again. If the difference is within 2dB, go to next step.
6	SSG RF Output:1mV	VR101	Alignment of Squelch. Set the Output of SSG to 60dB $\mu$ V and squelch volume to maximum. Adjust VR101 so that the squelch just breaks. (Adjust VR101 to indicate Audio Signal Wave to be appeared on the Oscilloscope.) In this operation, confirm the distortion of Audio Signal Wave has been less than 8%. Set the volume at the maximum and confirm audio output has not been oscillated.
7	SSG RF Output: 57dB $\mu$ V		Turn the mode switch to USB and return it to AM, then the wave form has to be disappeared on the Oscilloscope at once.
8	SSG RF Output: 62dB $\mu$ V		Turn the mode switch to USB and return it to AM, then the wave form has to be appeared on the Oscilloscope at once.
9	SSG:100 $\mu$ V No Mod. Meter:RF	VR102	Alignment of S-meter. Set the output of SSG to 100 $\mu$ V. Adjust VR102 so that "9" LCD just lights on.

Step	Preset to	Adjustment	Remarks
10	Mode:FM SSG RF Output:1mV SSG:1KHz (±1.5KHz DEV(FM))	L801	Adjust the volume so that the output of EXT. Speaker dummy 8Ω end does not exceed 0.5W(2V/8Ω), then adjust L801 for maximum reading on the AF VTVM.

NOTE:As to Steps 2 and 10, adjust them with each PCB before assembling with the main PCB.

TEST EQUIPMENT CONNECTION : Refer to attached drawing

## INSPECTION OF RECEIVER PORTION

Step	Preset to	Remarks
1	Mode:FM SSG:±1.5KHz DEV(FM) RF Output:1μV	S/N ratio has to be more than 20dB.
2	Change Freq. to 26.500MHz	S/N ratio has to be more than 20dB.
3	Change Freq. to 30.190MHz	S/N ratio has to be more than 20dB.
4	Mode:AM SSG:1KHz 30% Mod.(AM) RF Output:1μV Freq.:27.500MHz	S/N ratio has to be more than 10dB.
5	Mode:AM SSG:1KHz 30% Mod.(AM) RF Output:1.41μV	Set the audio volume to maximum, and rotate the RIT volume slightly. The audio maximum output has to be more than 2V RMS. Reduce the audio output until 2V RMS, and push NB/ANL Key once. The difference of audio output has to be within the range from 0dB to -2dB.
6	Freq.:27.500MHz LOC/DX SW:DX RF Output:0.5μV	Read the audio output level. Change LOC/DX SW to LOC, then the audio output level has to be gone down. Adjust the SSG RF output to higher until the audio output level has been reached to the same level as it was at the beginning of this step. Then the SSG RF output has to be more than 5μV.
7	Change Freq. to 26.500MHz	S/N ratio has to be more than 10dB.
8	Change Freq. to 30.190MHz	S/N ratio has to be more than 10dB.
9	Mode:USB SSG:No Mod. RF Output:0.3μV Freq.:28.001MHz Meter:RF LOC/DX SW:DX	When the SSG RF output is switched on and off, S/N ratio has to be more than 10dB. When the RF output is switched off, RF Meter must not be lit on.
10	Change Mode to LSB Change Freq. to 27.999MHz	When the SSG RF output is switched on and off, S/N ratio has to be more than 10dB. When the RF output is switched off, RF Meter must not be lit on.

Step	Preset to	Remarks
1 1	Change Mode to CW	When the SSG RF output is switched on and off, S/N ratio has to be more than 10dB. When the RF output is switched off, RF Meter must not be lit on.
1 2	Mode:AM SSG:No Mod. RF Output:2 $\mu$ V Freq.:27.500MHz Meter:RF	RF Meter should indicate equal or more than "1"
1 3	Mode:AM SSG:No Mod. RF Output:35.5~44.5dB $\mu$ V Freq.:28.000MHz Meter:RF	RF Meter indicates "9" .
1 4	Mode:AM SSG:1KHz 30% Mod.(AM) RF Output:6dB $\mu$ V SQ Volume:Auto	Audio Signal Wave must not be produced on the Oscilloscope.
1 5	Mode:AM SSG:1KHz 30% Mod.(AM) RF Output:16dB $\mu$ V SQ Volume:Auto	Audio Signal Wave has to be shown on the Oscilloscope.
1 6	Mode:AM SSG:1KHz RF Output:40dB $\mu$ V SQ volume:Auto Freq.:27.6MHz	Start the scanning of the unit, then it has to search 27.6MHz and Audio Signal Wave has to be shown on the Oscilloscope. Press the Manual Key to stop the scanning.
1 7	Mode:AM SSG:1KHz 30% Mod.(AM) RF Output:1 $\mu$ V. SQ Volume:Min. NB check jig:on	Set up the speaker/dummy switch to the speaker position. Hear the noise sound with receiving sound from the peaker. Press the NB/ANL Key to select NB mode, then the pulse noise of audio output has to be decreased and the level of S/N ratio of the wave form must not be changed. Press the NB/ANL Key to select ANL mode. Confirm that the pulse noise on the Audio Signal Wave has been decreased and the S/N ratio of the wave form has been improved. After confirmation, press NB/ANL Key to make the mode back to ordinary condition. Turn off the NB check jig.

Step	Preset to	Remarks
18	Mode:AM SSG:1KHz 30% Mod.(AM) SQ Volume:TIGHT (Clockwise, Max.) RF Output: 55.5dB $\mu$ V(line QC) 54dB $\mu$ V(QA)	Turn the mode switch to USB and return to AM, during this operation Audio Signal Wave must not be produced on the Oscilloscope. Set the audio volume of the unit at the maximum position. Change the frequency to 27.490MHz and check the audio leakage output level. It should be less than 3mV RMS. After checking it, set the audio volume around center position, and return the frequency to 27.500MHz.
19	Mode:AM SSG:1KHz 30% Mod.(AM) SQ Volume:TIGHT (Clockwise, Max.) RF Output:64dB $\mu$ V(line QC) 66dB $\mu$ V(QA)	Turn the mode switch to USB and return to AM, during this operation Audio Signal Wave has to be shown on the Oscilloscope.
20	Mode:AM SSG:1KHz 30% Mod RF Output:3.16 $\mu$ V Freq.:28.070MHz	Cover the unit with top and bottom cases. Select the NB mode and set the unit at the channel 1 and 28.000MHz of "a" band. Adjust the audio volume to maximum, and read the audio output level.
21	Mode:AM SSG:1KHz 30% Mod RF Output:15.8 $\mu$ V Freq.:28.070MHz	Read the audio output, and compare it with the audio output level which is read in step 20. Consequently, the difference has to be within 3dB.
22	Mode:AM SSG:1KHz 30% Mod RF Output:316 $\mu$ V Freq.:28.070MHz	Read the audio output level, it should be less than 300mV RMS.

SPECIFICATION OF TRANSMITTER PORTION

Item	Unit	Specification
1 Frequency Stability (5 Minutes after switch on)	Hz	-300 < , < +300
2 Output Power at FM or AM (No Mod., RF Max.) (No Mod., RF Min.)  Output Power at USB or LSB (30mV Mic In)  Output Power at CW ( RF Max.) ( RF Min.)	W	9.0 < , < 11.0
	W	0.1 < , < 1.5
	W (PEP)	24.0 < , < 26.0
	W W	21.0 < , < 26.0 1.0 < , < 12.0
3 Spurious Harmonic (at all mode)	dB	< -46.0
4 Carrier Suppression at USB or LSB	dB	< -46.0
5 Power Consumption at FM or AM (No Mod.)  Power Consumption at USB or LSB (No Mod.) (Max. Mod.)  Power Consumption at CW	A	< 3.5
	A	< 1.5
	A	< 4.5
	A	< 5.5
6 Mod. Sensitivity at AM (50% Mod.) (90% Mod.)  Mod. Sensitivity at FM (2.2mV Input) HPF 50Hz, LPF 2KHz (30mV Input)	mV	1.1 < , < 2.3
	mV	1.5 < , < 3.3
	KHz DEV.	1.5 <
	KHz DEV.	2.5 < , < 3.5
7 PA Mic Sensitivity (MIC Input: 1.4mV)	V RMS	1.8 < , < 3.0

SPECIFICATION OF RECEIVER PORTION

	Item	Unit	Specification
1	S/N 20dB Sensitivity at FM ( DX )	$\mu V$	< 1.0
2	Maximum Sensitivity at AM ( DX )	$\mu V$	< 3.0
3	S/N 10dB Sensitivity at AM ( DX )	$\mu V$	< 1.0
4	Local Attenuation at AM Maximum sensitivity	dB	20 < , < 26
5	S/N 10dB Sensitivity at USB or LSB	$\mu V$	< 0.3
6	S meter "SI" Sensitivity at AM	$\mu V$	< 2.0
7	S meter "S9" Sensitivity at AM	$\mu V$	50 < , < 200
8	Audio Distortion at 2V RMS Output (at all mode)	%	< 8.0
9	Audio Output at 10% THD	V	4.0 <
1 0	SQ Sensitivity at Auto ( FM or AM )	dB $\mu V$	6.0 < , < 16
1 1	SQ Sensitivity at TIGHT ( FM or AM )	dB $\mu V$	54 < , < 66
1 2	Image Rejection Ratio	dB	60 <
1 3	Adjucent Channel Selectivity +10KHz	dB	60 <
	-10KHz	dB	60 <
1 4	Power Consumption at no signal	mA	< 430
1 5	Power Consumption at Audio MAX.	mA	< 770



# NB/FM PCB ADJUST

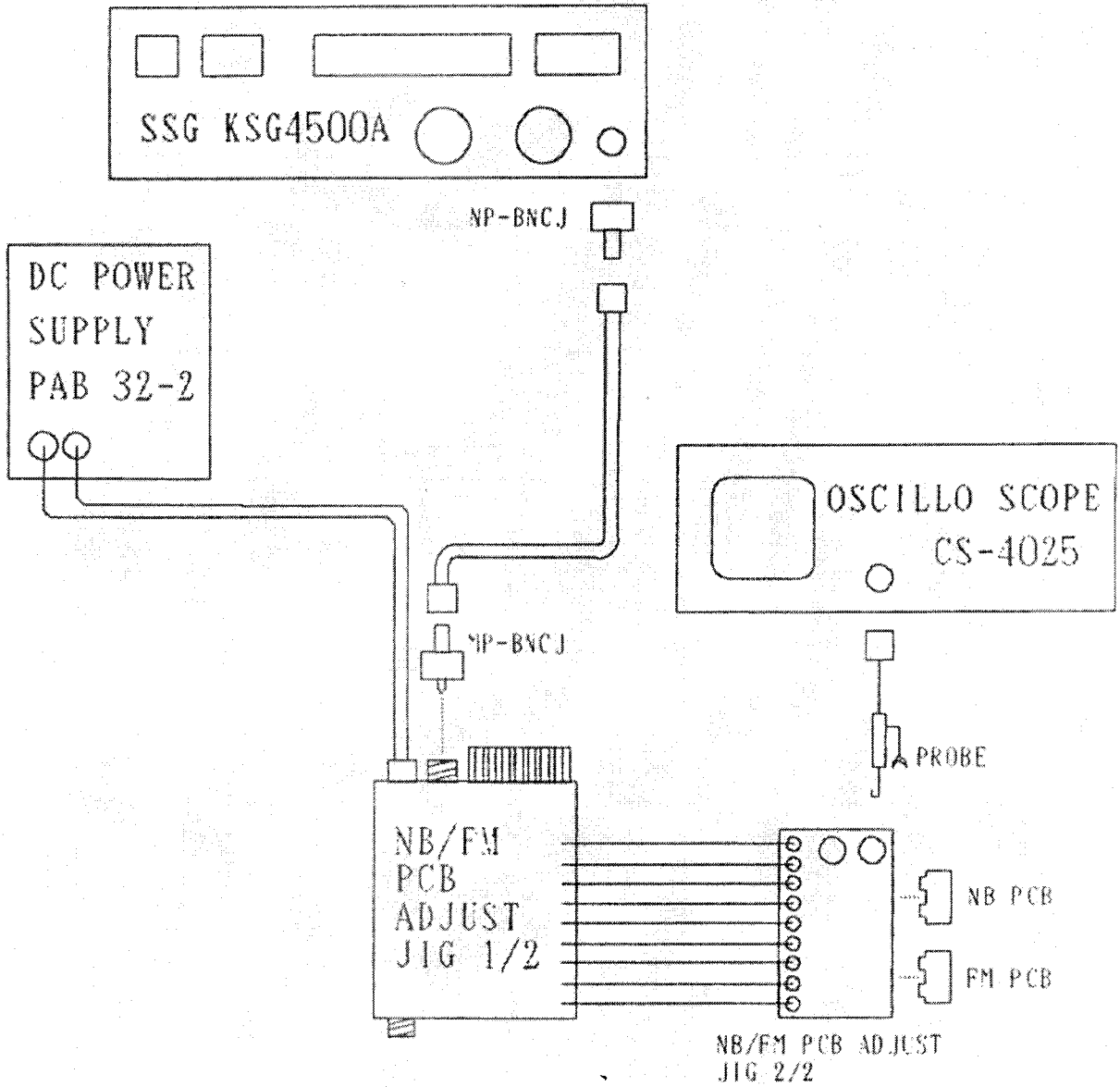

CONNECTOR	Q'TY	CABLE & ETC	Q'TY	CABLE & ETC	Q'TY
MP-BNCJ	1	BNCP-BNCP 1m	1	CLIP-CLIP	0
N-PP	0	BNCP-BNCP 1.5m	0	CLIP-BANANA	1
NP-BNCJ	1	BNC-BANANA	1	BANANA-BANANA	0
		BNC-CLIP	1	SP PLUG-CLIP	1
		MIC PLUG-CLIP	0	DC POWER CABLE	1
		CERAMIC DRIVER	1	DRIVER FOR VR	1

# RX PRE-ADJUST

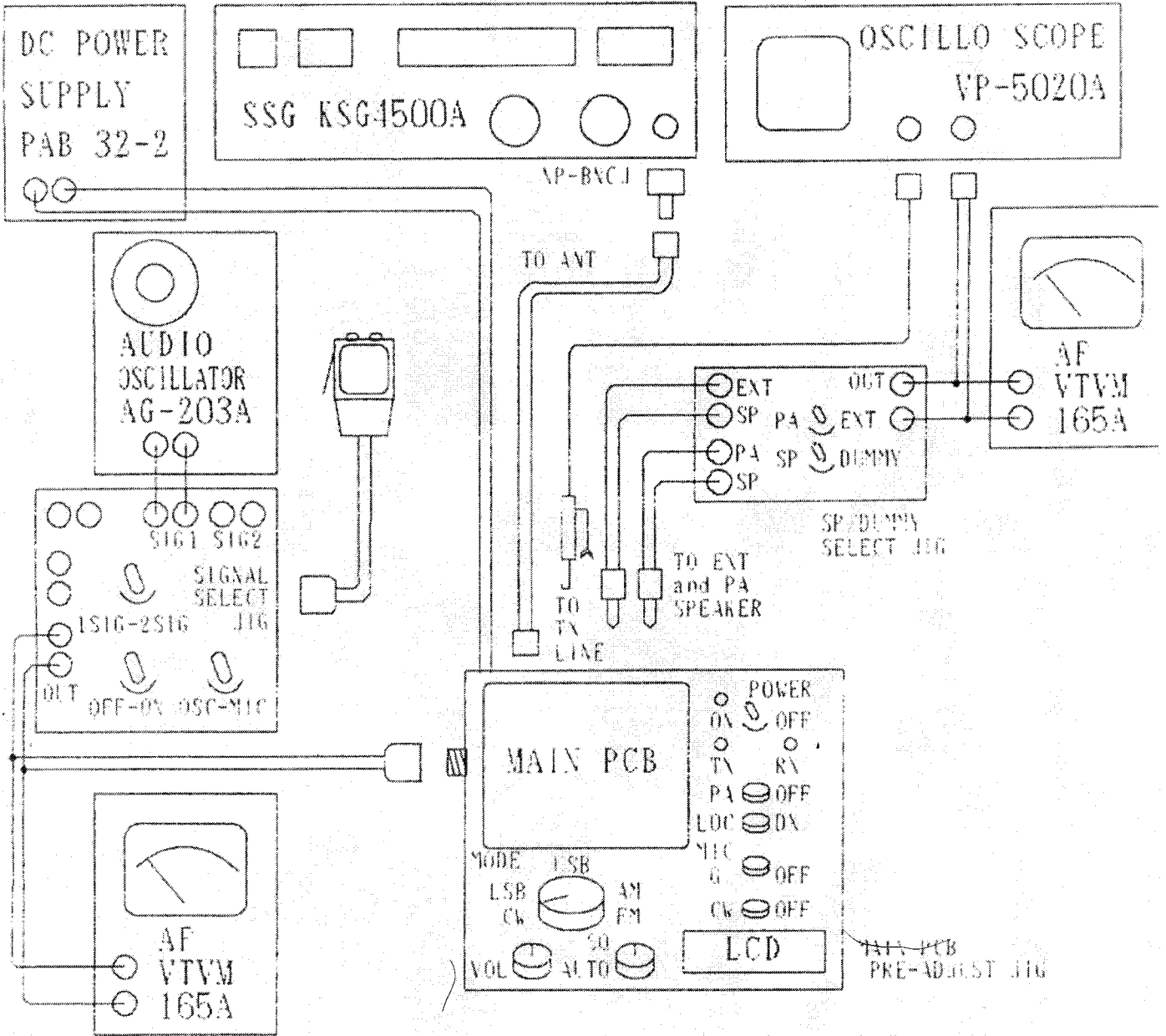

CONNECTOR	Q'TY	CABLE & ETC	Q'TY	CABLE & ETC	Q'TY
MP-BNCJ	0	BNCP-BNCP 1m	1	CLIP-CLIP	0
N-PP	0	BNCP-BNCP 1.5m	0	CLIP-BANANA	0
NP-BNCJ	1	BNCP-BANANA	0	BANANA-BANANA	3
		BNCP-CLIP	1	SP PLUG-CLIP	2
MICROPHONE	1	MIC PLUG-CLIP	1	DC POWER CABLE	1
		CERAMIC DRIVER	1	DRIVER FOR VR	1

# LCD UNIT CHECK

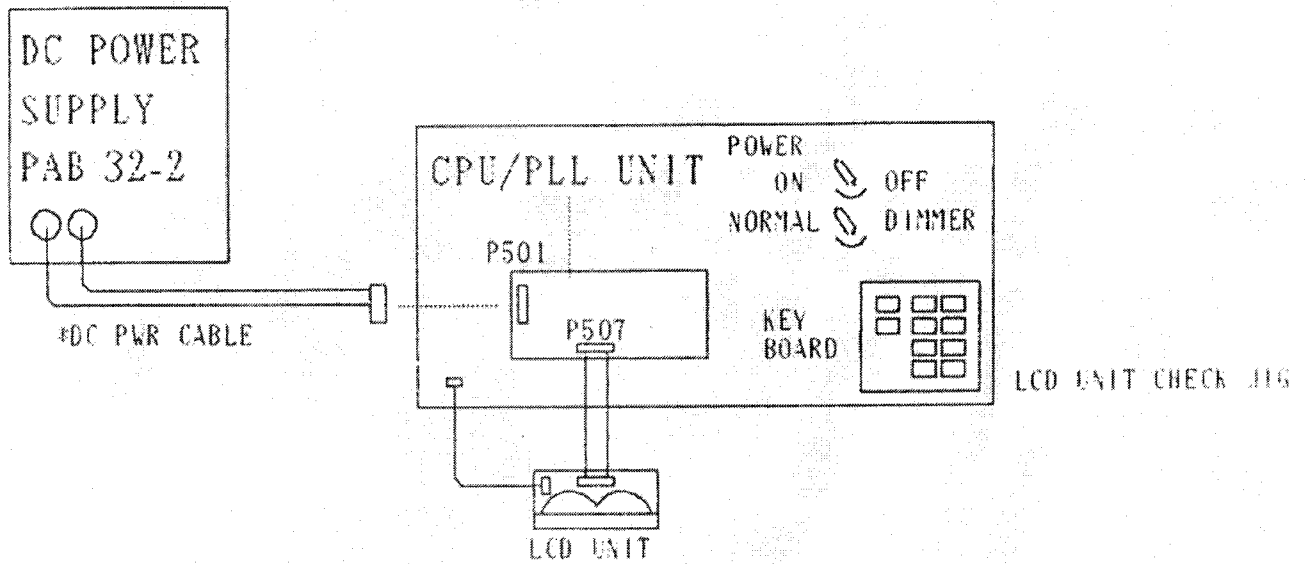

\*MODIFY WIRES ASSEMBLED WA-0170104

CONNECTOR	Q'TY	CABLE & ETC	Q'TY	CABLE & ETC	Q'TY
MP-BNCJ	0	BNCP-BNCP 1m	0	CLIP-CLIP	0
N-PP	0	BNCP-BNCP1.5m	0	CLIP-BANANA	0
NP-BNCJ	0	BNCP-BANANA	0	BANANA-BANANA	0
		BNCP-CLIP	0	SP PLUG-CLIP	0
		MIC PLUG-CLIP	0	DC POWER CABLE	1
		CERAMIC DRIVER	0	DRIVER FOR VR	0

# FRONT CHASSIS CHECK

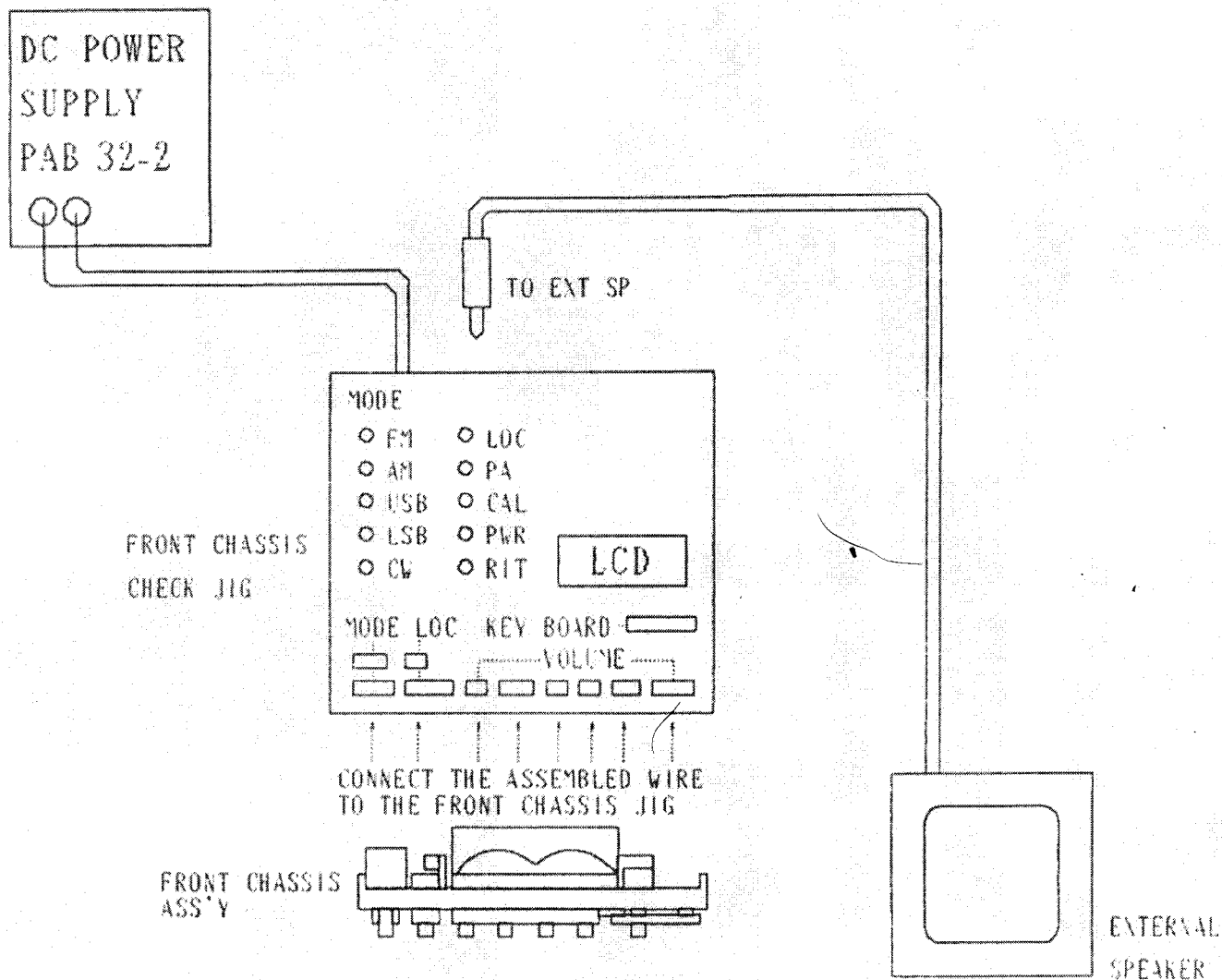

CONNECTOR	Q'TY	CABLE & ETC	Q'TY	CABLE & ETC	Q'TY
MP-BNCJ	0	BNCP-BNCP 1m	0	CLIP-CLIP	0
N-PP	0	BNCP-BNCP1.5m	0	CLIP-BANANA	0
NP-BNCJ	0	BNCP-BANANA	0	BANANA-BANANA	0
		BNCP-CLIP	0	SP PLUG-CLIP	1
		MIC PLUG-CLIP	0	DC POWER CABLE	1
		CERAMIC DRIVER	0	DRIVER FOR VR	0

# CPU/PLL UNIT ADJUST

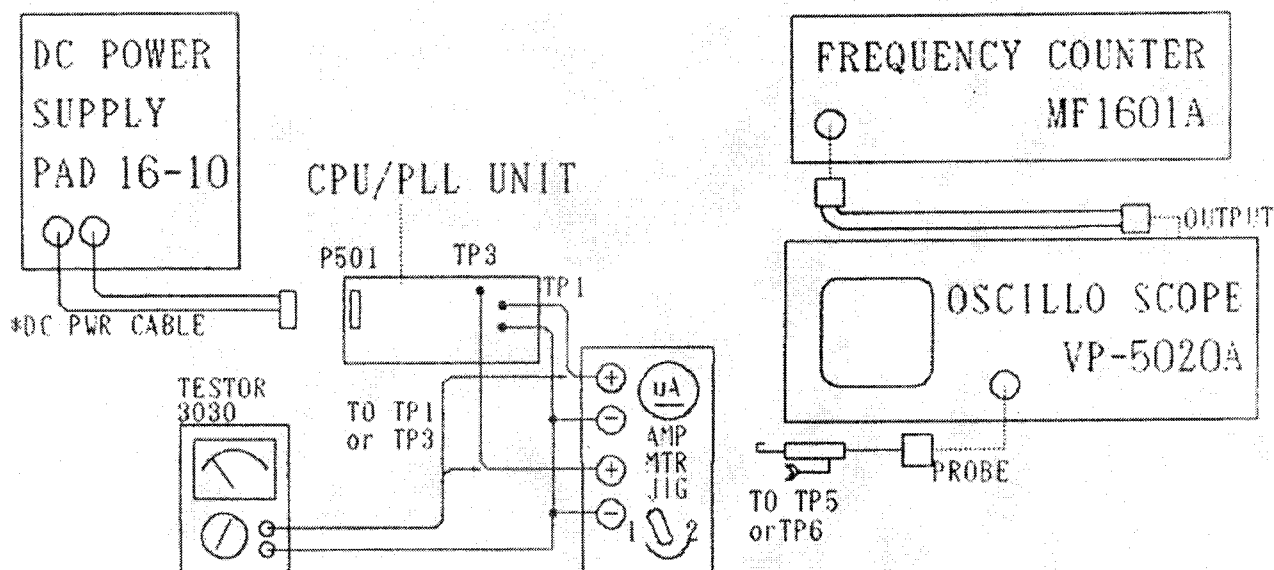

\*MODIFY WIRES ASSEMBLED WA-0170104

CONNECTOR	Q'TY	CABLE & ETC	Q'TY	CABLE & ETC	Q'TY
MP-BNCJ	0	BNCP-BNCP 1m	1	CLIP-CLIP	0
N-PP	0	BNCP-BNCP 1.5m	0	CLIP-BANANA	3
NP-BNCJ	0	BNCP-BANANA	0	BANANA-BANANA	0
		BNCP-CLIP	0	SP PLUG-CLIP	0
		MIC PLUG-CLIP	0	DC POWER CABLE	1
		CERAMIC DRIVER	1	DRIVER FOR VR	1

TX ADJUST

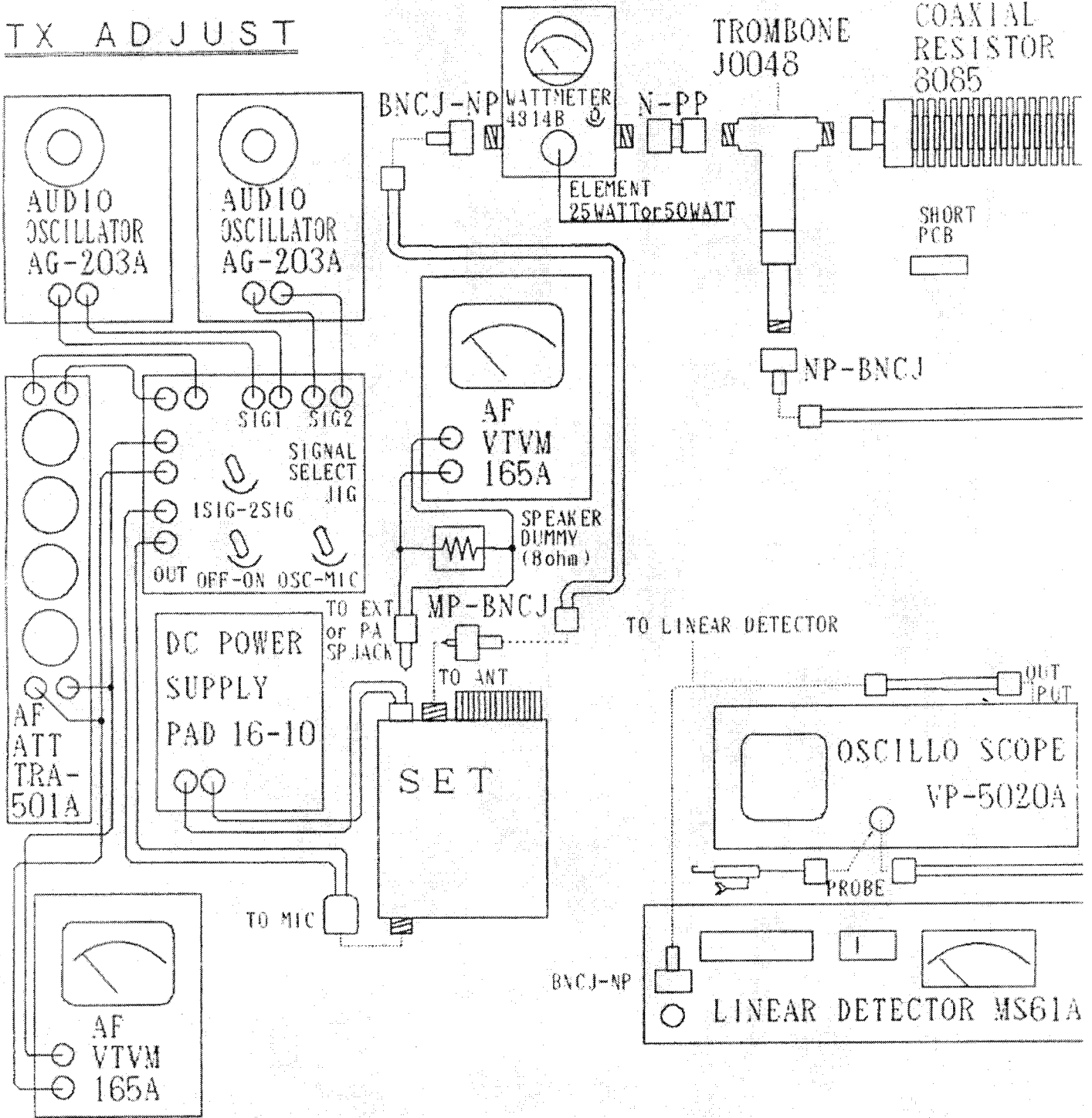

CONNECTOR	Q' TY	CABLE & ETC	Q' TY	CABLE & ETC	Q' TY
MP-BNCJ	1	BNCP-BNCP 1m	2	CLIP-CLIP	0
N-PP	1	BNCP-BNCP 1.5m	1	CLIP-BANANA	2
NP-BNCJ	2	BNCP-BANANA	0	BANANA-BANANA	4
		BNCP-CLIP	0	SP PLUG-CLIP	1
		MIC PLUG-CLIP	1	DC POWER CABLE	1
		CERAMIC DRIVER	1	DRIVER FOR VR	1

RX ADJUST

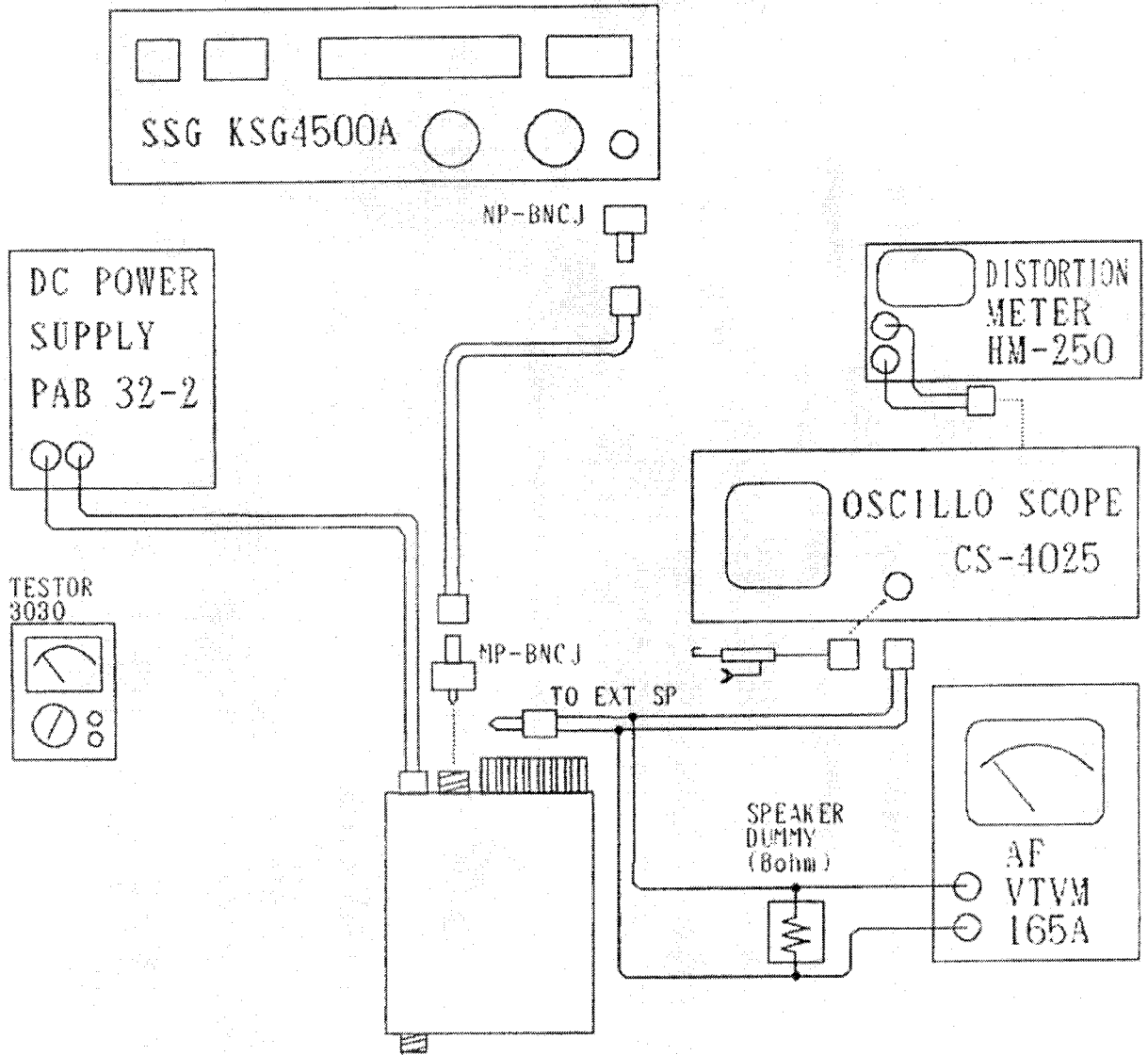

CONNECTOR	Q' TY	CABLE & ETC	Q' TY	CABLE & ETC	Q' TY
MP-BNCJ	1	BNCP-BNCP 1m	0	CLIP-CLIP	0
N-PP	0	BNCP-BNCP 1.5m	1	CLIP-BANANA	0
NP-BNCJ	1	BNCP-BANANA	1	BANANA-BANANA	0
		BNCP-CLIP	1	SP PLUG-CLIP	1
		MIC PLUG-CLIP	0	DC POWER CABLE	1
		CERAMIC DRIVER	1	DRIVER FOR VR	1

TX INSPECTION

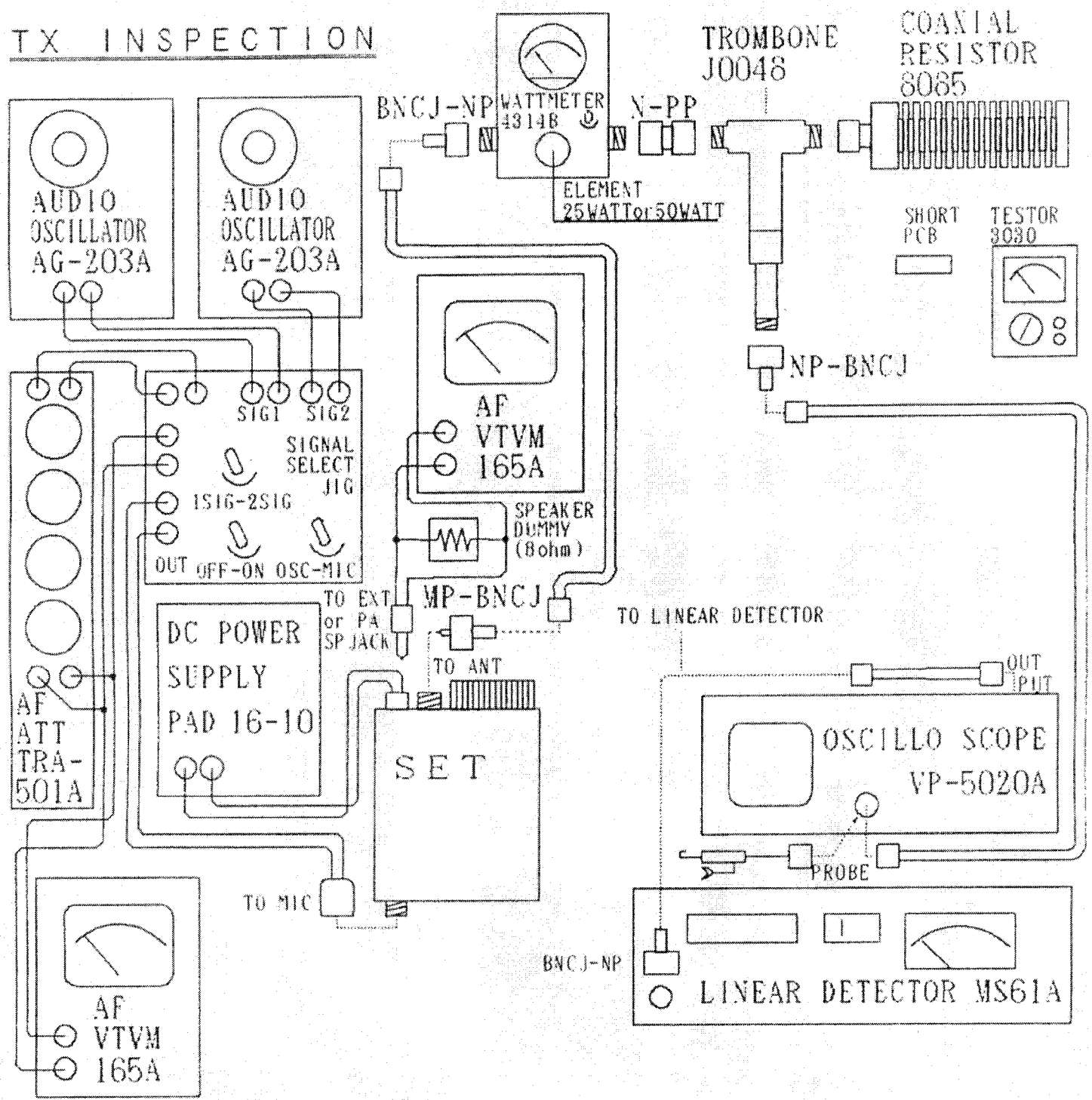

CONNECTOR	Q'TY	CABLE & ETC	Q'TY	CABLE & ETC	Q'TY
MP-BNCJ	1	BNCP-BNCP 1m	2	CLIP-CLIP	0
N-PP	1	BNCP-BNCP 1.5m	1	CLIP-BANANA	2
NP-BNCJ	2	BNCP-BANANA	0	BANANA-BANANA	4
		BNCP-CLIP	0	SP PLUG-CLIP	1
		MIC PLUG-CLIP	1	DC POWER CABLE	1
		CERAMIC DRIVER	1	DRIVER FOR VR	1



QC TX INSPECTION

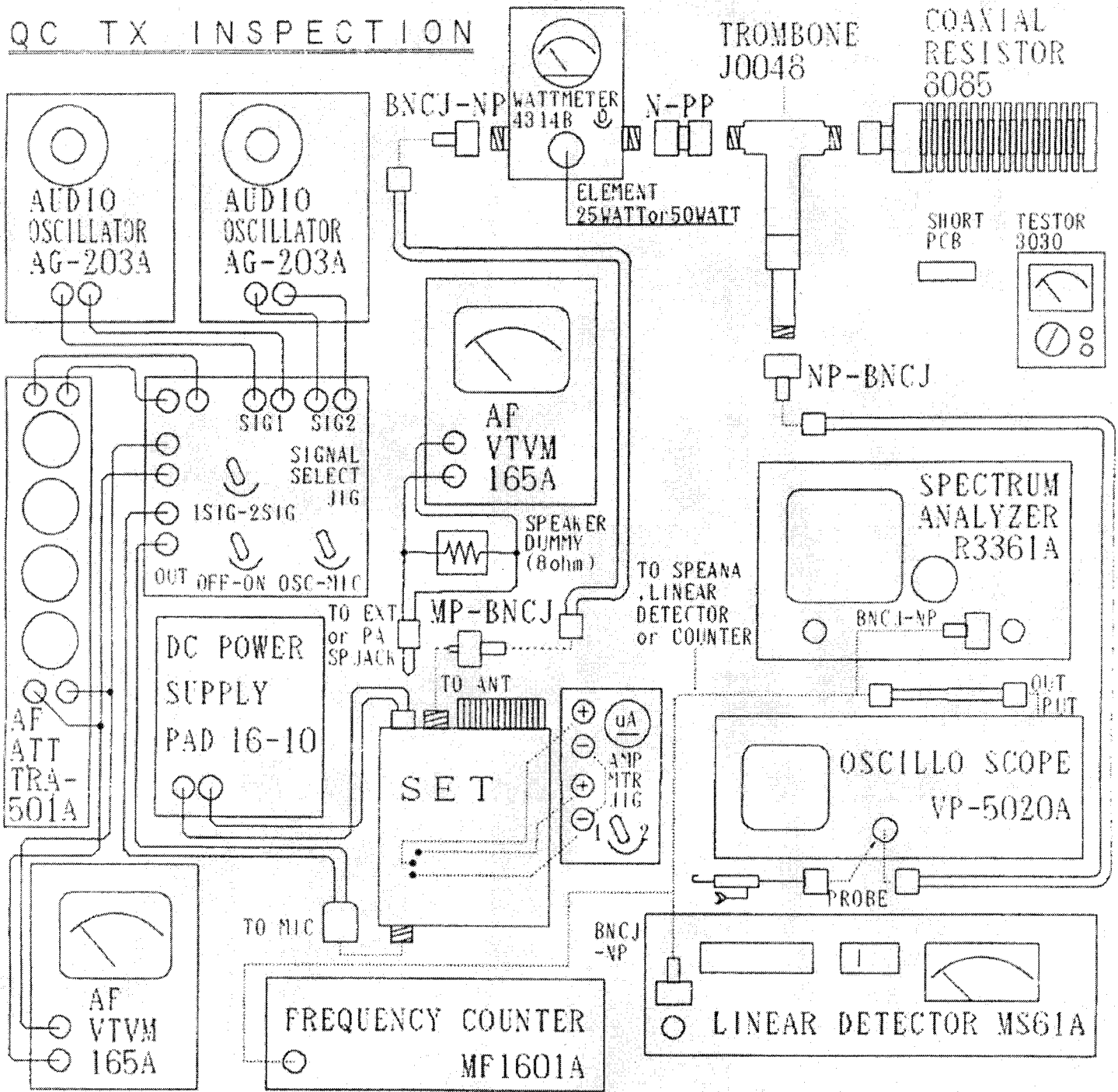

CONNECTOR	Q' TY	CABLE & ETC	Q' TY	CABLE & ETC	Q' TY
MP-BNCJ	1	BNCP-BNCP 1m	2	CLIP-CLIP	0
N-PP	1	BNCP-BNCP 1.5m	1	CLIP-BANANA	2
NP-BNCJ	3	BNCP-BANANA	0	BANANA-BANANA	4
		BNCP-CLIP	0	SP PLUG-CLIP	1
		MIC PLUG-CLIP	1	DC POWER CABLE	1
		CERAMIC DRIVER	1	DRIVER FOR VR	1

QC RX INSPECTION

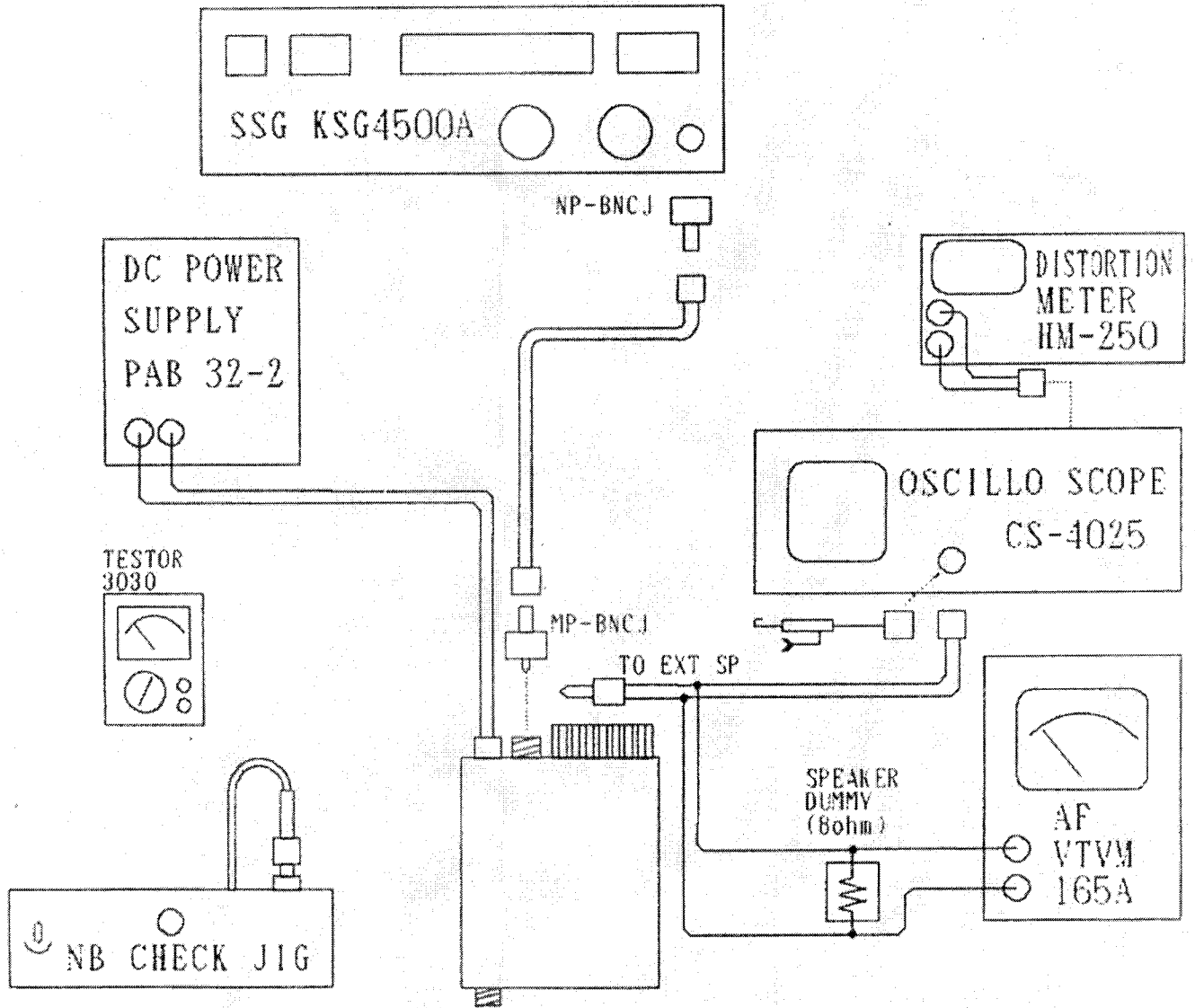

CONNECTOR	Q' TY	CABLE & ETC	Q' TY	CABLE & ETC	Q' TY
MP-BNCJ	1	BNCP-BNCP 1m	0	CLIP-CLIP	0
N-PP	0	BNCP-BNCP 1.5m	1	CLIP-BANANA	0
NP-BNCJ	1	BNCP-BANANA	1	BANANA-BANANA	0
		BNCP-CLIP	1	SP PLUG-CLIP	1
		MIC PLUG-CLIP	0	DC POWER CABLE	1
		CERAMIC DRIVER	1	DRIVER FOR VR	1

REPAIR TX

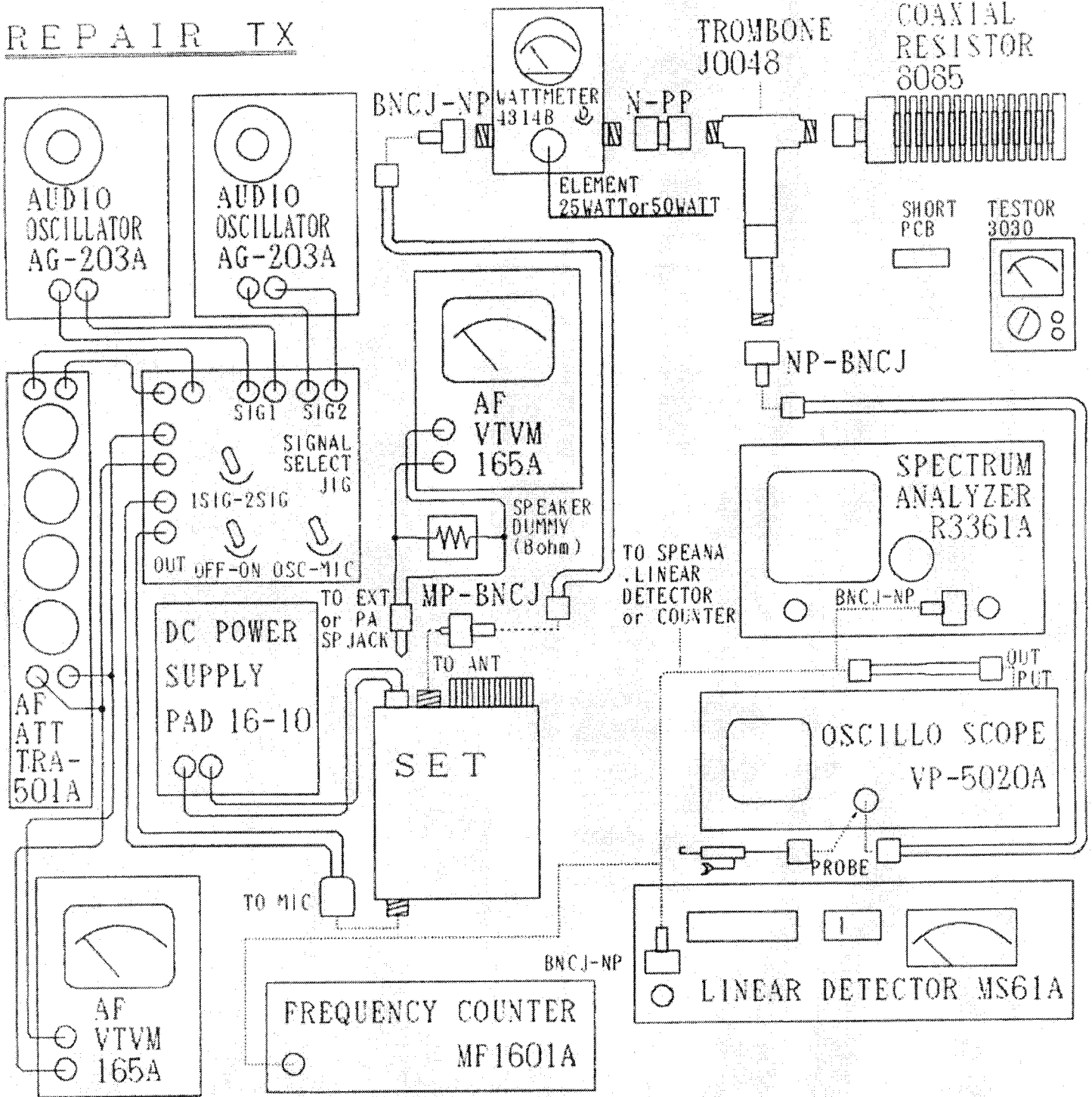

CONNECTOR	Q'TY	CABLE & ETC	Q'TY	CABLE & ETC	Q'TY
MP-BNCJ	1	BNCP-BNCP 1m	2	CLIP-CLIP	0
N-PP	1	BNCP-BNCP 1.5m	1	CLIP-BANANA	2
NP-BNCJ	3	BNCP-BANANA	0	BANANA-BANANA	4
		BNCP-CLIP	0	SP PLUG-CLIP	1
		MIC PLUG-CLIP	1	DC POWER CABLE	1
		CERAMIC DRIVER	1	DRIVER FOR VR	1

REPAIR RX

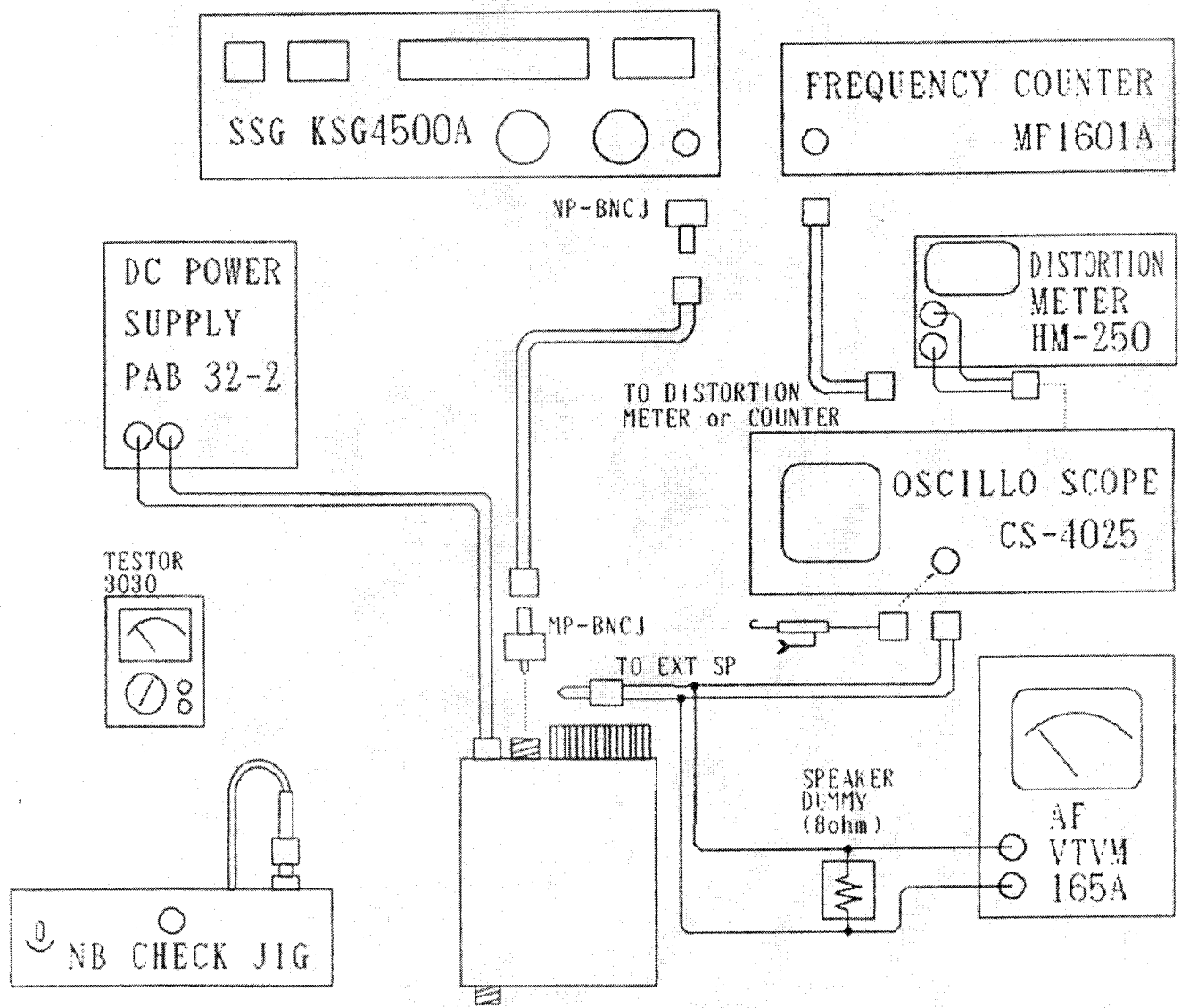

CONNECTOR	Q' TY	CABLE & ETC	Q' TY	CABLE & ETC	Q' TY
MP-BNCJ	1	BNCP-BNCP 1m	1	CLIP-CLIP	0
N-PP	0	BNCP-BNCP 1.5m	1	CLIP-BANANA	0
NP-BNCJ	1	BNCP-BANANA	1	BANANA-BANANA	0
		BNCP-CLIP	1	SP PLUG-CLIP	1
		MIC PLUG-CLIP	0	DC POWER CABLE	1
		CERAMIC DRIVER	1	DRIVER FOR VR	1

QC FINAL FUNCTION

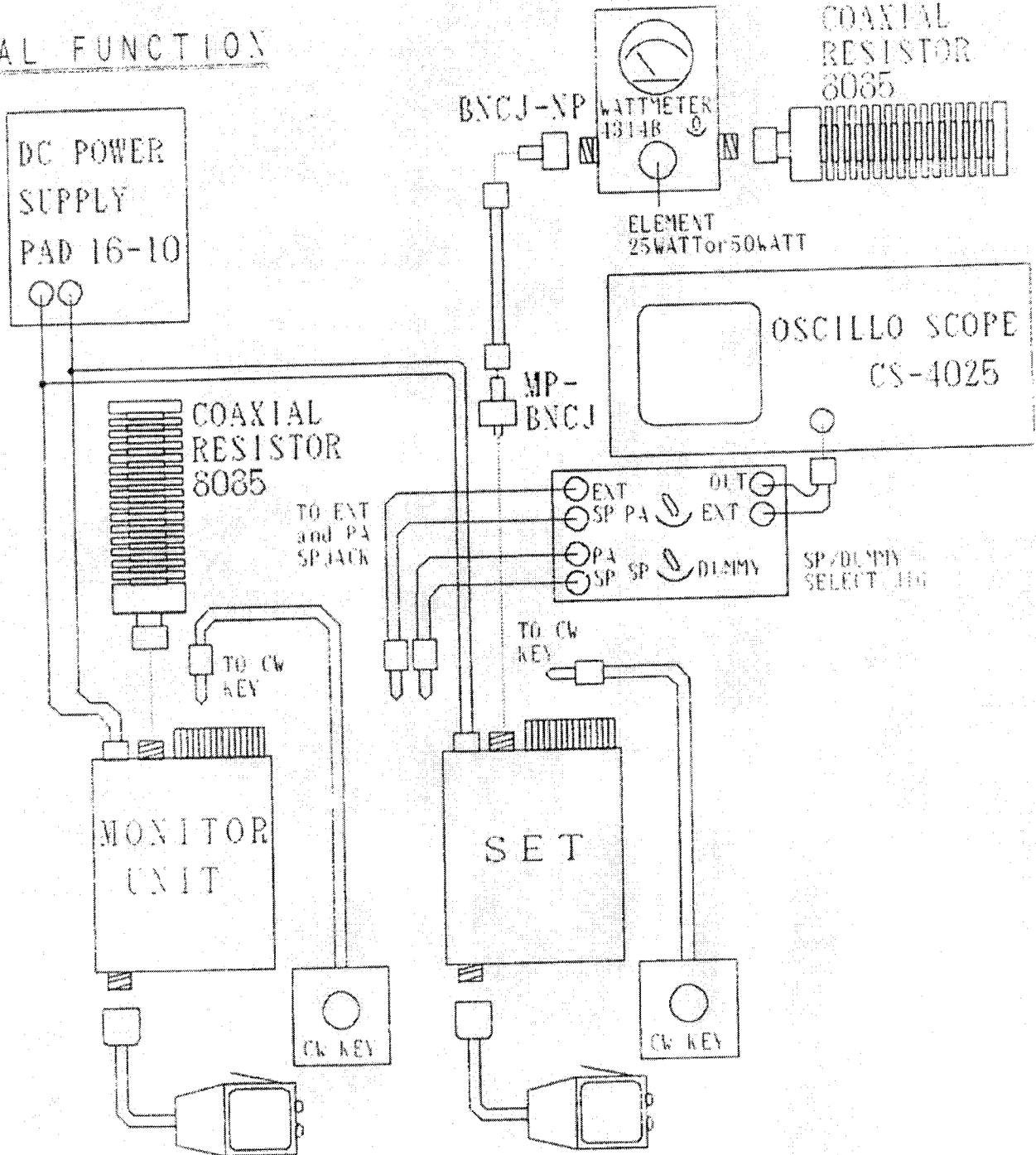

CONNECTOR	Q'TY	CABLE & ETC	Q'TY	CABLE & ETC	Q'TY
MP-BNCJ	1	BNCP-BNCP 1m	1	CLIP-CLIP	0
N-PP	0	BNCP-BNCP 1.5m	0	CLIP-BANANA	0
NP-BNCJ	1	BNCP-BANANA	1	BANANA-BANANA	0
		BNCP-CLIP	0	SP PLUG-CLIP	4
MICROPHONE	2	MIC PLUG-CLIP	0	DC POWER CABLE	2
		CERAMIC DRIVER	0	DRIVER FOR VR	0

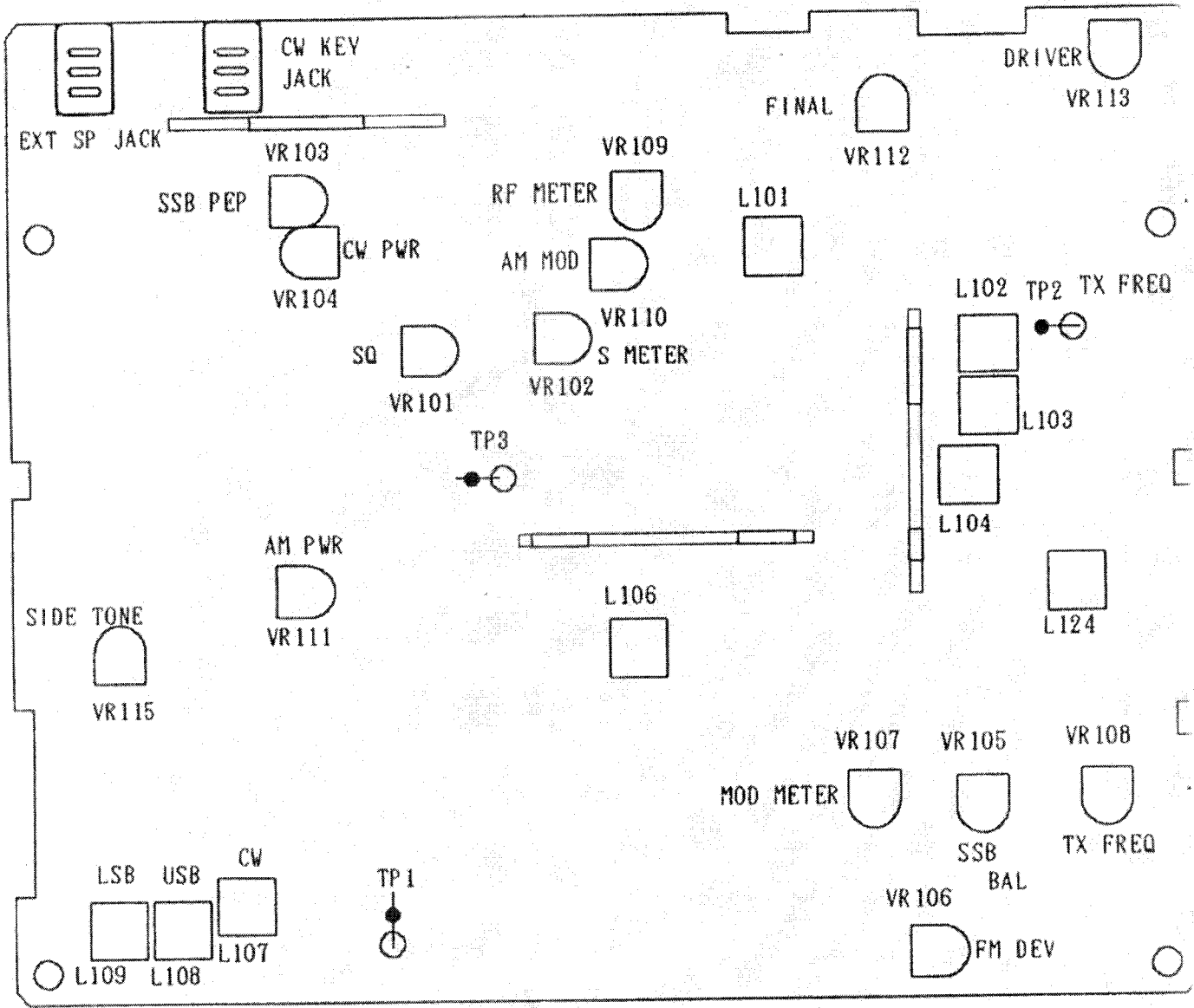







## VOLTAGE CHART

REF. NO.	TX/RX	FUTURE	(AM) <E C B>	FM			SSB(U/L)			CW
				E	C	B	E	C	B	
Q401		NB					0.9	7	1.5	
Q402		NB					0	2.3	0.7	
Q403		NB					1.5	6.9	2.3	
Q404		NB					0.9	7.2	0	
Q405		NB					0	4.2	0	
Q406		NB					6.5	0	4.4	
Q407		NB					0	0	0	
Q801		PM					0.9	3.7	1.5	











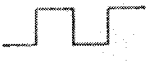



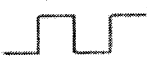
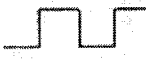





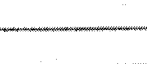

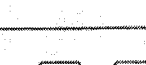
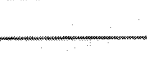



PIN NO.	IC501 L78M08CV	IC502 L78M05CV	IC503 TC4066BP	IC504 M51953BL	IC506 SM5152A1	IC507 NJM2203D	IC508 NJM2203D
1.	13.5	13.5	0 0	4.8 4.8	2 2	3.4 3.4	3.4 3.4
2.	0	0.5	0 0.5	0 0	2.5 2.5	0 0	0 0
3.	8	5.5	0 0	0 0	4.7 4.7	7.8 7.8	7.8 7.8
4.			0 0.5	1 1	3.8 3.8	5.2 5.2	5.5 5.5
5.			0 0	4.8 4.8	0 0	0 0	0 0
6.			5 5		2.4 2.4	0 0	0 0
7.			0 0		0 0	0 0	0 0
8.			0 0.5		0 0	0 0	0 0
9.			0 0.5		0 0	0 0	0 0
10.			0 3			0 0	0 0
11.			0 0.5			0.8 0.8	0.8 0.8
12.			0 0			0.2 0.2	0.2 0.2
13.			0 0			0.8 0.8	0.8 0.8
14.			4.7 5			0.2 0.2	0.2 0.2
15.						0 0	0 0
16.						3.5 3.5	3.5 3.5
17.							
18.							
			↑ ↑ RX TX	↑ ↑ RX TX	↑ ↑ RX TX	↑ ↑ RX TX	↑ ↑ RX TX
AM			AM	AM	AM	AM	AM

PIN NO.	IC509		IC510		IC511	
	M54460L		PLL0305A		NJM3404AS	
1.	0	0	4.8	4.8	7.8	7.8
2.	0	0	0	0	4	4
3.	0	0	4.8	4.8	3.8	3.8
4.	1.5	1.5	4.8	4.8	3.8	3.8
5.	1.5	1.5	4.8	4.8	0	0
6.	4.8	4.8	0	0	3.8	3.8
7.	2.8	2.8	0	0	3.8	3.8
8.	1	1	4.8	4.8	4.8	4.8
9.			2	2	7.8	7.8
10.			0	0		
11.			0	0		
12.			0	0		
13.			4	4		
14.			0	0		
15.			2	2		
16.			2.4	2.4		
17.			2.2	2.2		
18.			0	0		
	↑	↑	↑	↑	↑	↑
	RX	TX	RX	TX	RX	TX

AM MODE

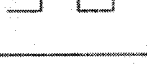
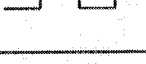
	B (G)		C (D)		E (S)		REMARKS
Q501 2SA1162	4.8	4.8	0	0	4.8	4.8	
Q502 2SC2712	0	0	4.8	4.8	0	0	
Q503 2SC3121	3	3	7.2	7.2	4.5	4.5	
Q504 2SC3121	2.2	2.2	7.7	7.7	1.7	1.7	
Q505 2SC3121	4.2	4.2	7.7	7.7	4.2	4.2	
Q506 2SK302Y	0	0	7	7	0.5	0.5	
Q507 2SC2413	4	4	5	5	3.4	3.4	
Q508 2SK302	0	0	7	7	0.5	0.5	
Q509 2SC3121	4.5	4.5	7.7	7.7	3.9	3.9	
Q510 2SK302	0	0	7.3	7.3	0.3	0.3	
	↑	↑	↑	↑	↑	↑	
	RX	TX	RX	TX	RX	TX	
AM MODE							

IC 701 IR 2429		
1	 2.6V 0V 33Hz	 2.6V 0V 33Hz
2	 2.6V 0V 33Hz	 2.6V 0V 33Hz
3	 2.6V 0V 33Hz	 2.6V 0V 33Hz
4	 2.6V 0V 33Hz	 2.6V 0V 33Hz
5	 2.6V 0V 33Hz	 2.6V 0V 33Hz
6	 2.6V 0V 33Hz	 2.6V 0V 33Hz
7	 2.6V 0V 33Hz	 2.6V 0V 33Hz
8	 2.6V 0V 33Hz	 2.6V 0V 33Hz
9	 2.6V 0V 33Hz	 2.6V 0V 33Hz
10	 2.6V 0V 33Hz	 2.6V 0V 33Hz
11	 2.6V 0V 33Hz	 2.6V 0V 33Hz
12	 2.6V 0V 33Hz	 2.6V 0V 33Hz
13	 2.6V 0V 33Hz	 2.6V 0V 33Hz
14	 2.3V 0V 33Hz	 2.3V 0V 33Hz

IC 701 1R 2429		
15	3.7V	3.7V
16	1.1V	1.1V
17	4.2V	4.2V
18	4.2V	4.2V
19	0.8V	0.8V
20	0V	0V
21	0V	0.8V
22	0V	0V
	 RX	 TX
	( AM MODE )	

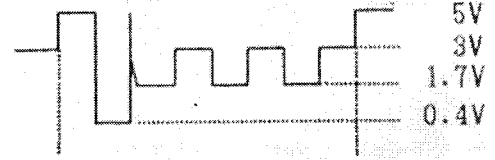
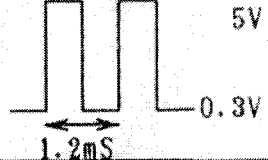
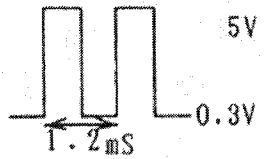
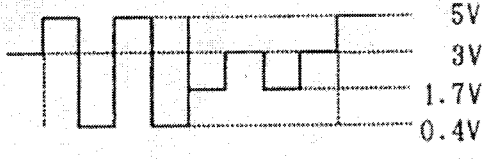
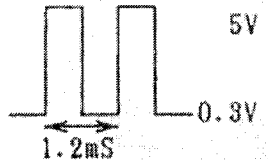
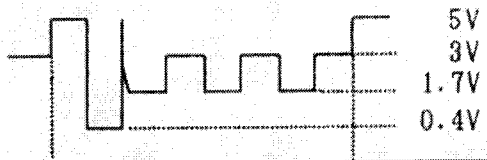
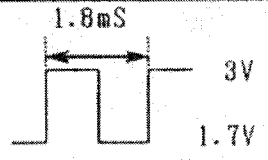
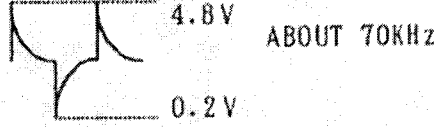
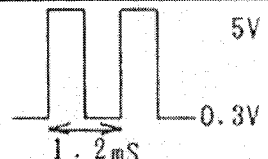
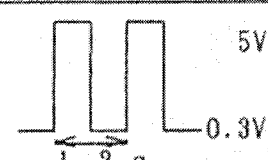
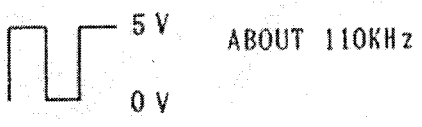
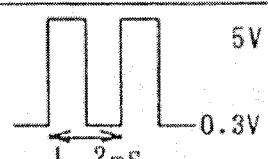
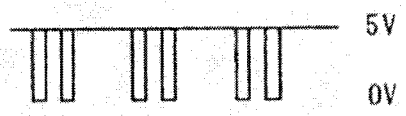
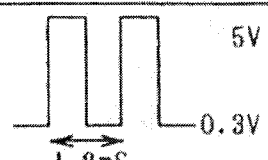
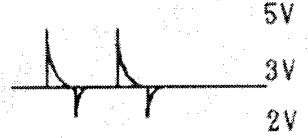
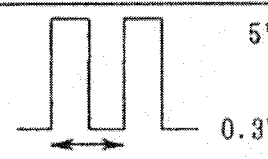
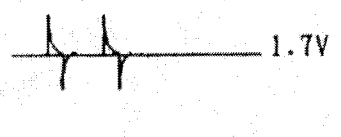

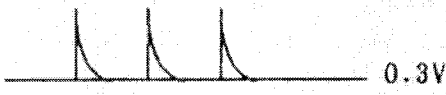
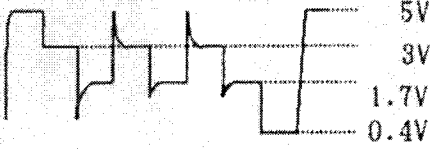
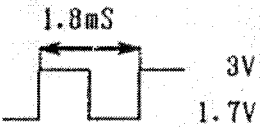
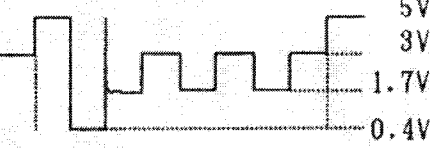
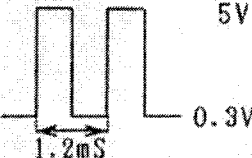
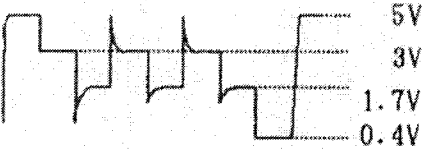
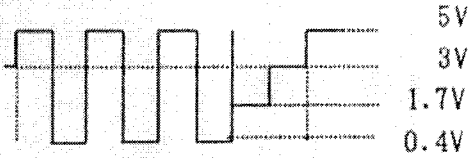
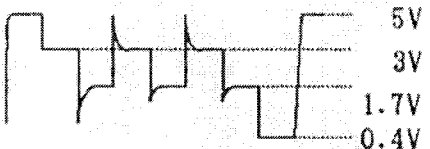
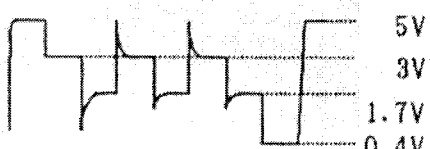
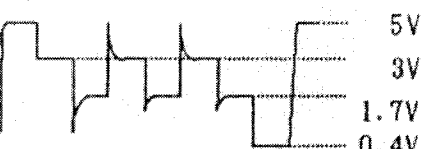
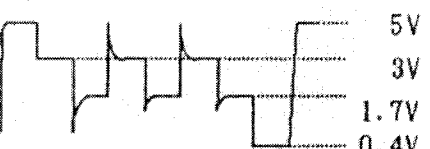
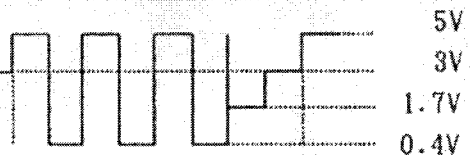
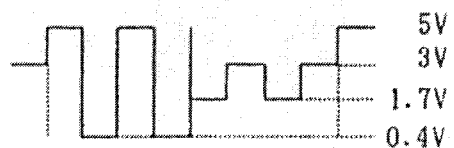

IC 702	
PIN NO.	PIN NO.
1	10
	
2	11
	
3	12
	
4	13
	
5	14
	<p>2.2V</p>
6	15
	
7	16
	
8	17
	
9	18
	

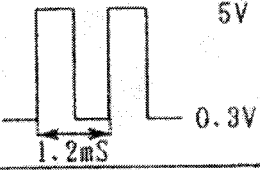
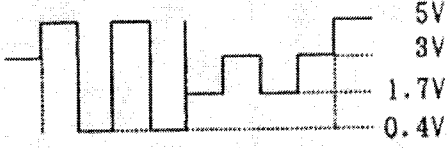
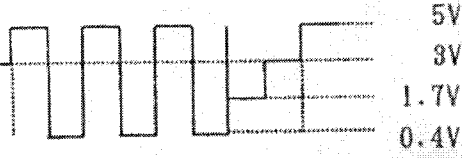
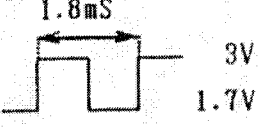
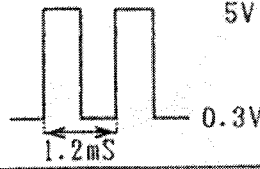
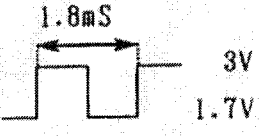
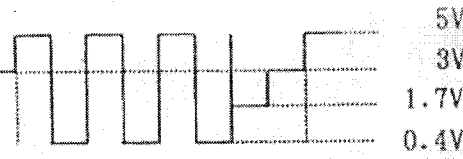
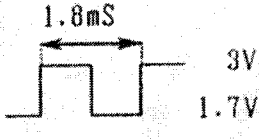
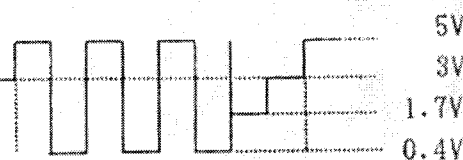
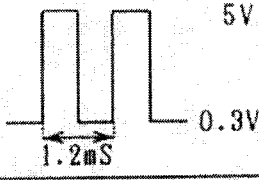
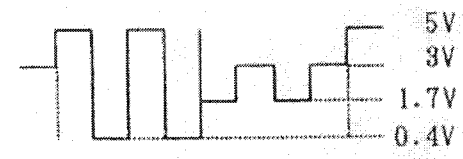
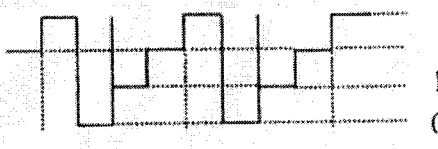

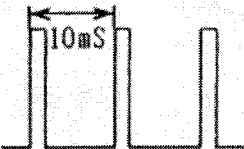
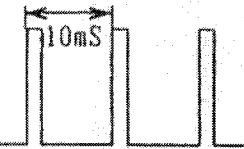
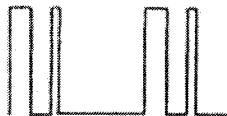
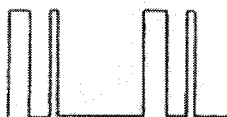
IC 702		PIN NO.	PIN NO.		
19		33			
20	0V	34			
21	5V				
22	5V				
23	5V				
24	5V	35			
25	0V				
26	5V				
27	5V				
28	2.2V	36			
29				37	
30					
31					
32		38			
				39	
		41			

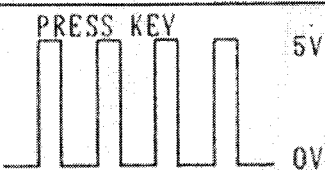
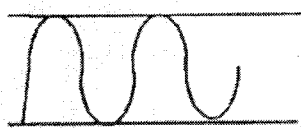
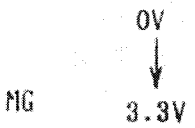
IC 702			
PIN NO.			
42	2.2V	49	5V
43		50	
44		51	
45		52	
46		53	
47		54	
48		55	
		56	2.2V

IC505 MICROCOMPUTER		PIN NO.	
1	5V LCD CHANGE	17	
2	5V LCD CHANGE		
3	5V LCD CHANGE		
4	5V	18	5V
5	5V	19	5V
6	0V	20	5V
7	0V	21	5V
8	0V	22	5V
9	5V	23	5V
10	0V	24	5V
11	0V	25	5V
12	0V	26	5V
13	0V	27	0V
14		28	0V LCD CHANGE
15		29	0V LCD CHANGE
		30	0V LCD CHANGE
		31	0V LCD CHANGE
16		32	5V

IC505			
PIN NO.			PIN NO.
33	KT 0V		51
			OSCILLATION 2M  3.4V 1.2V
34	MT 5V		52
35	0V		
36	MG 0V		53
37	BP 0V		54
38	NB 0V		55
39	NL 5V		56
40	0V		57
41	0V		58
42	0V		59
43	0V		60
44	0V		61
45	5V		62
46	SQ 4.7V		63
47	4.7V		64
48	5V		
49	0V		
50	5V		

## THE PROCESS OF RX PRE-ADJUSTMENT

## 1. Preparation

SP/Dummy Select Jig PA/EXT SW : EXT  
 SP/Dummy SW : Dummy  
 Signal Select Jig 1 Sig/2 Sig SW : 1 Sig  
 OFF/ON SW : OFF  
 OSC/MIC SW : OSC

Mode SW : AM, PA SW : OFF, LOC/DX SW : DX, MIC G : OFF, VOL : center position,  
 SQ : Turn fully counter clockwise ( Note : Auto SQ is at OFF position)

Step	Preset to	Remarks
1	TX/RX SW:TX	TX LED has to light on.
2	TX/RX SW:RX	RX LED has to light on.
3	Mode:AM SSG RF Output: See Remarks SSG: 1KHz 30% Mod.(AM)	Alignment of sensitivity. Adjust coils for maximum reading on the AP VTVM(During this step, set the SSG attenuator so that the standard output is less than $0.5W(2V/8\Omega)$ ). Adjust them lastly with SSG RF output set at $1\mu V$ .
4	SSG RF Output:1mV	Alignment of squelch. Set the output of SSG to $66\pm 2dB$ and squelch volume to maximum. Adjust VR101 so that the squelch just breaks. (Adjust VR101 to indicate audio signal wave to be appeared on the Oscilloscope.)
5	SSG:100 $\mu V$ No Mod. Meter:RF	Alignment of S-meter. Set the output of SSG to $100\mu V$ . Adjust VR102 so that "9" LCD just lights on.
6	Mode:CW SSG RF Output:OFF No Mod. SQ Volume:Min. (Auto SQ:OFF)	During the CW key is pressed, side tone signal is given to EXT. Speaker output, transmission signal wave has to be shown on the Oscilloscope. When the CW key is released, transmission output is stopped at once without any delay.

Step	Preset to	Remarks
7	Meter:Mod. 1KHz 10mV RMS Mod. Sig. Select Jig OFF/ON SW:ON	When the Mode SW is changed, MOD Meter and transmission output should be set as follows at each Mode. Nothing is given from EXT. Speaker output. CW : MOD Meter doesn't move, and transmitting output isn't produced. LSB : MOD Meter moves, and a few seconds later transmitting output is produced. USB : MOD Meter moves, and a few seconds later transmitting output is produced. (At LSB and USB Mode, if MIC input is decreased, transmitting output is also decreased, and at last it stops.) AM : MOD Meter doesn't move, and transmitting output is produced. FM : MOD Meter moves, and transmitting output is produced. (At FM Mode, the carrier of transmitting output doesn't have modulation like it has at AM Mode.)
8	Mode:FM 1KHz 1mV RMS Mod. Sig. Select Jig OFF/ON SW:ON SP/Dummy Select Jig PA/EXT. SW:PA	When the PA SW is switched on, Audio output has to be shown on the Oscilloscope. Then when the MIC G. SW is switched on, audio output has to decrease more than 6dB. After confirmation, turn off the PA and MIC G SW, change the PA/EXT. SW to EXT. position.
9	Mode:FM No Mod. Sig. Select Jig OFF/ON SW:OFF	When the LOC/DX SW is changed to LOC position, noise level of EXT. Speaker output has to decrease more than 6dB.

# INSPECTION PROCESS OF LCD UNIT

## 1. Preparation

Power SW : OFF, Normal/Dimmer SW : Dimmer

Step	Preset to	Remarks
1	Power SW:ON	LCD indicates as follows: a BAND 1CH 28.000.0
2	Push Channel△	LCD indicates as follows: a BAND 2CH 28.010.0
3	Push Channel▽	LCD indicates as follows: a BAND 1CH 28.000.0
4	Push NB/ANL 4 times	LCD indicates and changes at each push as follows: Nothing → NB → NB → → Nothing ANL ANL
5	Push BAND 4 times	LCD indicates and changes at each push as follows: a BAND 1CH 28.000.0 ↓ b BAND 1CH 28.500.0 ↓ c BAND 1CH 29.000.0 ↓ d BAND 1CH 29.500.0 ↓ a BAND 1CH 28.000.0
6	Push SPAN 3 times	LCD indicates and changes at each push as follows: ( Note : Each push changes the position of underline. ) a BAND 1CH 28.000. <u>0</u> ↓ a BAND 1CH 28.00 <u>0</u> .0 ↓ a BAND 1CH 28.000. <u>0</u> .0 ↓ a BAND 1CH 28.000.0 <u>0</u>
7	Push SHIFT, and Push MANUAL	When the SHIFT is pushed, "SHIFT" LCD has to light on, and then the MANUAL is pushed, "SHIFT" LCD has to light off.
8	Push METER 4 times	Meter on the LCD indicates and changes at each push as follows: "RF" → "MOD" → "CAL" → "SWR" → "RF"

Step	Preset to	Remarks
9	Push FLOCK twice	When the FLOCK is pushed once, "FLOCK" LCD has to light on. When it is pushed again, "FLOCK" LCD has to light off.
1 0	Push MIC G twice	When the MIC G is pushed once, "MIC G" LCD has to light on. When it is pushed again, "MIC G" LCD has to light off.
1 1	Push BEEP twice	When the BEEP is pushed once, "BEEP" LCD has to light on. When it is pushed again, "BEEP" LCD has to light off.
1 2	Normal/Dimmer SW: Normal	The lamp becomes bright.
1 3	Normal/Dimmer SW: Dimmer	The lamp lights weakly.
1 4	Power:OFF	Change the LCD unit to next unit.



## INSPECTION PROCESS OF FRONT CHASSIS

## 1. Preparation

Mode SW : CW, LOC/DX SW : DX, PA SW : OFF, VOL : center position

SWR CAL, RF POWER, RIT and SQ Volume : Turn fully all of these SW's counter clockwise.

Step	Preset to	Remarks
1	Change the Mode SW as follows: CW→LSB→USB→AM→FM	Mode LED on the jig has to light on in order of following: CW→LSB→USB→AM→FM
2	Push LOC/DX SW twice	LOC LED has to light on at the first push, and at the second push it has to light off.
3	Push PA SW twice	PA LED has to light on at the first push, and at the second push it has to light off.
4	Turn fully the SWR CAL Volume clockwise.	LCD has to get bright, then CAL LED has to light on.
5	Turn fully the RF POWER Volume clockwise.	PWR LED has to light on.
6	Turn fully the RIT Volume clockwise.	RIT LED has to light on.
7	Turn the SQ Volume clockwise to cancel the state of Auto SQ.	Receiving noise has to be released from the EXT. Speaker.
8	Turn fully the SQ Volume clockwise.	Receiving noise from the EXT. Speaker becomes nil.
9	Turn the frequency selection knob clockwise	Frequencies on LCD display are to be increased.
10	Turn the frequency selection knob counter clockwise.	Frequencies on LCD display are to be decreased.
11	Push these keies on the Key Board in order of following: Channel△ → Channel▽ → →NB/ANL(4times)→BAND→ →SPAN→SHIFT→METER→ → FLOCK (twice) → → MIC G (twice) → → BEEP (twice)	Key tone has to be released from the EXT. Speaker with every push.

## INSPECTION PROCESS OF QC FINAL FUNCTION

## 1. Preparation

SP/Dummy Select Jig PA/EXT SW : EXT  
 SP/Dummy SW : Dummy

## Monitor Unit and Set

Mode SW: CW, LOC/DX : DX, PA : OFF, METER : RF, SWR CAL Volume : DIM,  
 RF POWER Volume : Turn fully clockwise, RIT and VOL Volume : center position  
 SQ Volume : Turn fully counter clockwise, and keep the Auto SQ switched off.  
 RF Power meter element : 50W, CW/PEAK SW : CW, Frequency : a BAND ICH 28.000.0MHz  
 ( Caution : When the mode is changed, it should be simultaneously done on both  
 the monitor unit and the set. )

Step	Preset to	Remarks
1	Mode: CW No Mod.	Connect the microphone to the unit, then the RF Meter must not light on, or indicate digit 1. When the key jack of the set is switched on, RF Power has to be between 21.0W and 26.0W. The side tone for the monitor should be appeared at the audio output of the unit. When RIT Volume of the monitor unit is rotated to the left or right, receiving noise to be heard through the internal speaker.
2	Mode: CW No Mod.	The key jack of the monitor unit is switched on. When RIT Volume of the set is adjusted clockwise or counter clockwise, receiving waves should be seen on the Oscilloscope. While it is shown, the indication of RF meter should be more than 9.
3	Mode: LSB CW/PEAK SW: PEAK	Connect the microphone to the unit, then the RF Meter must not light on, or indicate digit 1. Pushing PTT SW, input the voice into the microphone. Under the condition, the Power Meter should be activated in accordance with the strength of the voice and the voice should be heard through the speaker of the monitor unit.
4	Mode: LSB CW/PEAK SW: PEAK	Pushing PTT SW of the monitor unit, input the voice into the microphone. Under the condition, the audio output of the set should be appeared on the Oscilloscope.

Step	Preset to	Remarks
5	Mode:USB CW/PEAK SW:PEAK	Connect the microphone to the unit, then the RF Meter must not light on, or indicate digit 1. Pushing PTT SW, input the voice into the microphone. Under the condition, the Power Meter should be activated in accordance with the strength of the voice and the voice should be heard through the speaker of the monitor unit.
6	Mode:USB CW/PEAK SW:PEAK	Pushing PTT SW of the monitor unit, input the voice into the microphone. Under the condition, the audio output of the set should be appeared on the Oscilloscope.
7	Mode:AM CW/PEAK SW:CW	Push PTT SW of the monitor unit. Under the condition, RF Power has to be between 9.0W and 11.0W.
8	Mode:AM Meter:MOD	Pushing PTT SW of the set, input the voice into the microphone. Under the condition, the MOD Meter should be activated in accordance with the strength of the voice and the voice should be heard through the speaker of the monitor unit.
9	Mode:FM Meter:MOD	Change SP/Dummy select jig to SP, then change LOC/DX SW of the set to LOC. Under the condition, noise level of EXT. Speaker output has to be decreased. After confirming the above, SP/Dummy select jig can be switched to Dummy and LOC/DX SW can be switched to DX.
10	Mode:FM Meter:CAL	Set SQ volume at auto SQ position. The audio output noise of the set should be disappeared.
11	Mode:FM Meter:CAL	Turn SQ volume clockwise and fix it when the audio output noise becomes nil. Pushing PTT SW of the monitor unit, input the voice into the microphone. Then, the voice should be heard at the audio output of the Speaker Dummy.
12	Mode:FM Meter:CAL	Push PTT SW of the set and turn SWR/CAL volume clockwise until the meter is reached to the CAL position.
13	Mode:FM Meter:SWR	When Meter is switched to SWR, Meter has to indicate less than 1.

Step	Preset to	Remarks
14	Mode:FM Meter:RF PA SW:PA	Set the PA/EXT. SW of the SP/Dummy select jig at PA. Pushing PTT SW of the set, input the voice into the microphone. The audio output from the SP/Dummy end should be appeared on Oscilloscope. After confirming the above PA/EXT. SW of the SP/Dummy select jig can be switched to EXT.
15	Mode:FM Meter:RF	When the frequency selection knob is turned clockwise, the frequency indication on the LCD should be increased accordingly.
16	Mode:FM Meter:RF	When the frequency selection knob is turned counter clockwise, the frequency indication on the LCD should be decreased accordingly.
17	Push Channel△	LCD indicates as follows: a BAND 2CH 28.010.0
18	Push Channel▽	LCD indicates as follows: a BAND 1CH 28.000.0
19	Push NB/ANL 4 times	LCD indicates and changes at each push as follows: Nothing → NB → NB → → Nothing ANL ANL
20	Push BAND 4 times	LCD indicates and changes at each push as follows: a BAND 1CH 28.000.0 ↓ b BAND 1CH 28.500.0 ↓ c BAND 1CH 29.000.0 ↓ d BAND 1CH 29.500.0 ↓ a BAND 1CH 28.000.0
21	Push SPAN 3 times	LCD indicates and changes at each push as follows: (Note : Each push changes the position of underline.) a BAND 1CH 28.000. <u>0</u> ↓ a BAND 1CH 28.00 <u>0</u> .0 ↓ a BAND 1CH 28.00 <u>0</u> .0 ↓ a BAND 1CH 28.000. <u>0</u>

Step	Preset to	Remarks
2 2	Push SHIFT, and Push MANUAL	When the SHIFT is pushed, "SHIFT" LCD has to light on, and then the MANUAL is pushed, "SHIFT" LCD has to light off.
2 3	Push METER 4 times	Meter on the LCD indicates and changes at each push as follows: "RP" → "MOD" → "CAL" → "SWR" → "RP"
2 4	Push FLOCK twice	When the FLOCK is pushed once, "FLOCK" LCD has to light on. When it is pushed again, "FLOCK" LCD has to light off.
2 5	Push MIC G twice	When the MIC G is pushed once, "MIC G" LCD has to light on. When it is pushed again, "MIC G" LCD has to light off.
2 6	Push BEEP twice	When the BEEP is pushed once, "BEEP" LCD has to light on. When it is pushed again, "BEEP" LCD has to light off.

PART NAME	PART NO.	QTY	PART NAME	PART NO.	QTY
1. PANEL	T1-00542	1	36. ROUND NUT	MIC CONN/ACC.	2
2. NOB	T4-00543A	6	37. SPRING WASHER	MIC CONN/ACC.	2
3. CH	T4-00544A	1	38. MIC CONN	5S-LD107	1
4. BUTTON	T4-00545	2	39. LUG TERMINAL	MIC CONN/ACC.	2
5. HOLDER	T3-00546	1	40. CAP FOR LAMP	AG-4019-02123	2
6. CHASSIS	T2-00547	1	41. IC	HA1780RW	1
7. CHASSIS ASSY	T3-00548	1	42. SPEAKER	77R01-1	1
8. CHASSIS	T3-00549	2	43. JACK ANT	M-RML102	1
9. HOLDER	T3-00550	1	44. NUT HEX	JACK ANT. ACC.	1
10. PLATE (A)	T3-00551	1	45. WIRES ASSY	WA-0170101	1
11. COVER	T2-00553	1	46. DIODE	NVS-03	2
12. COVER	T2-00554	1	47. BUSHING	YV-172	2
13. SOCKET (U)	T4-00558	1	48. TRANSISTOR	MPE47	1
14. SOCKET (R)	T4-00559	1	49. TRANSISTOR	2SS2166-C	1
15. MOUNT	T4-00561	4	50. INSULATION	YV-027	1
16. PLATE	T4-00562	1	51. BIND HD. SCREW	M2 X 12 NI	2
17. PLATE	T4-00563	1	52. BIND HD. SCREW	M2.6 X 4 NI	2
18. SPACER	T4-00564A	4	53. BIND HD. SCREW	M3 X 5 NI	19
19. KEYPAD	T3-00569	1	54. BIND HD. SCREW	M3 X 6 BNI	12
20. LABEL	T4-00573	1	55. BIND HD. SCREW	M3 X 6 NI	2
21. NO. LABEL	T4-00574	1	56. FLAT HD. SCREW	M3 X 6 NI	8
22. TERMINAL	T4-00638	2	57. P. TIGHT BIND HD	Ø2.6 X 6 NI	2
23. SPRING	HAKUTO 6500	7	58. FLANGE NUT	M3 2MC	4
24. HANGER	MIC ACC. C-1	1	59. TAPPING PAN HD	Ø4 X 8 NI	2
25. V. PCB	P8-0171400	1	60. TAPPING PAN HD	Ø5 X 10 NI	4
26. E. PCB	P8-0171300	1	61. FLAT WASHER	Ø5 NI	4
27. CONN PCB	P8-0171200	1	62. STAR WASHER	Ø5 NI	4
28. SW PCB	P8-0171100	1	63. STAR WASHER	Ø5 NI	4
29. D. PCB	P8-0170700	1			
30. VOL PCB	P8-0171000	1			
31. PLL PCB	P8-01709500	1			
32. ANT PCB	P8-0170100	1			
33. T. HEX	VOL ACC.	7			
34. WASHER	VOL ACC.	7			

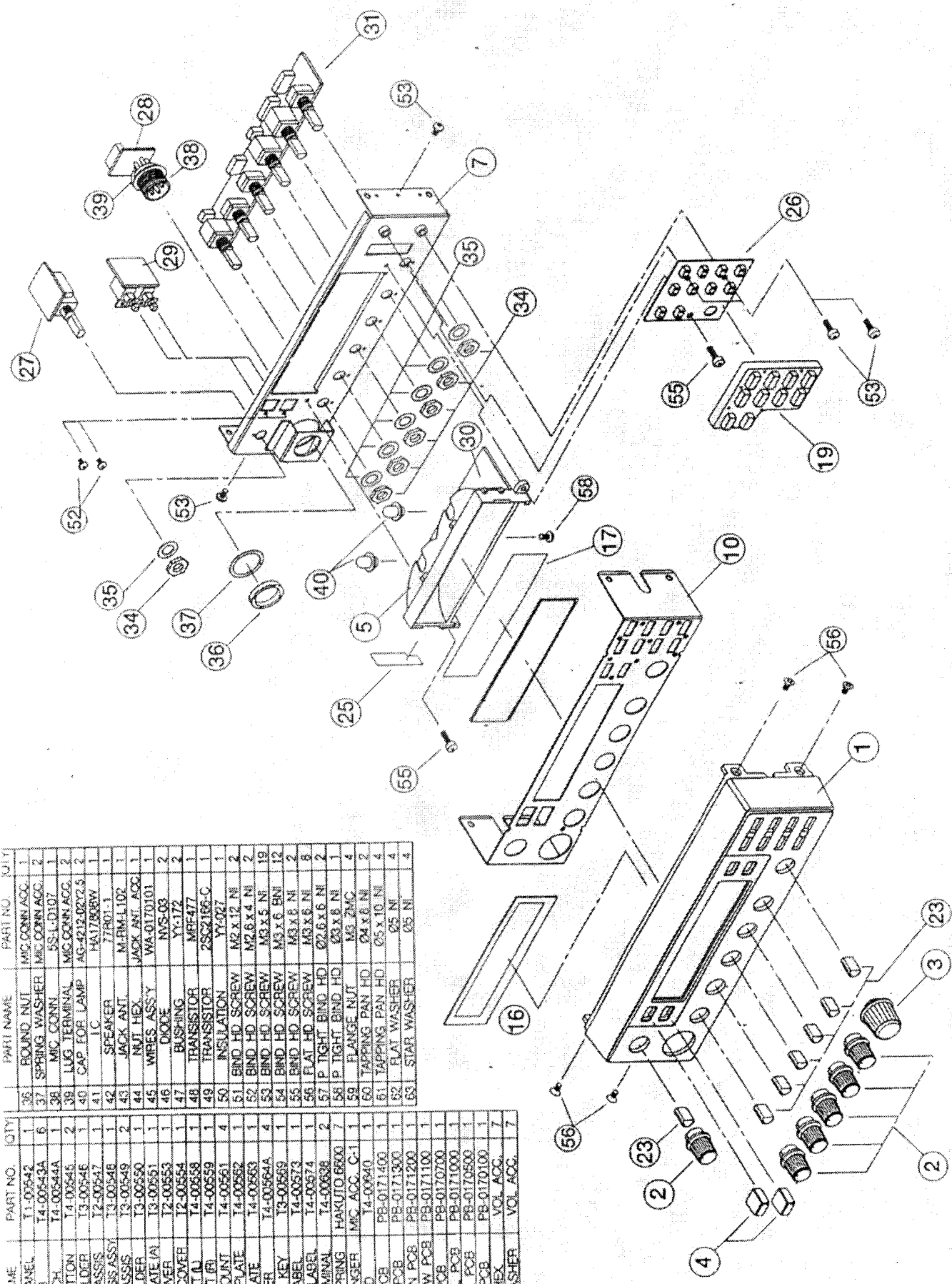

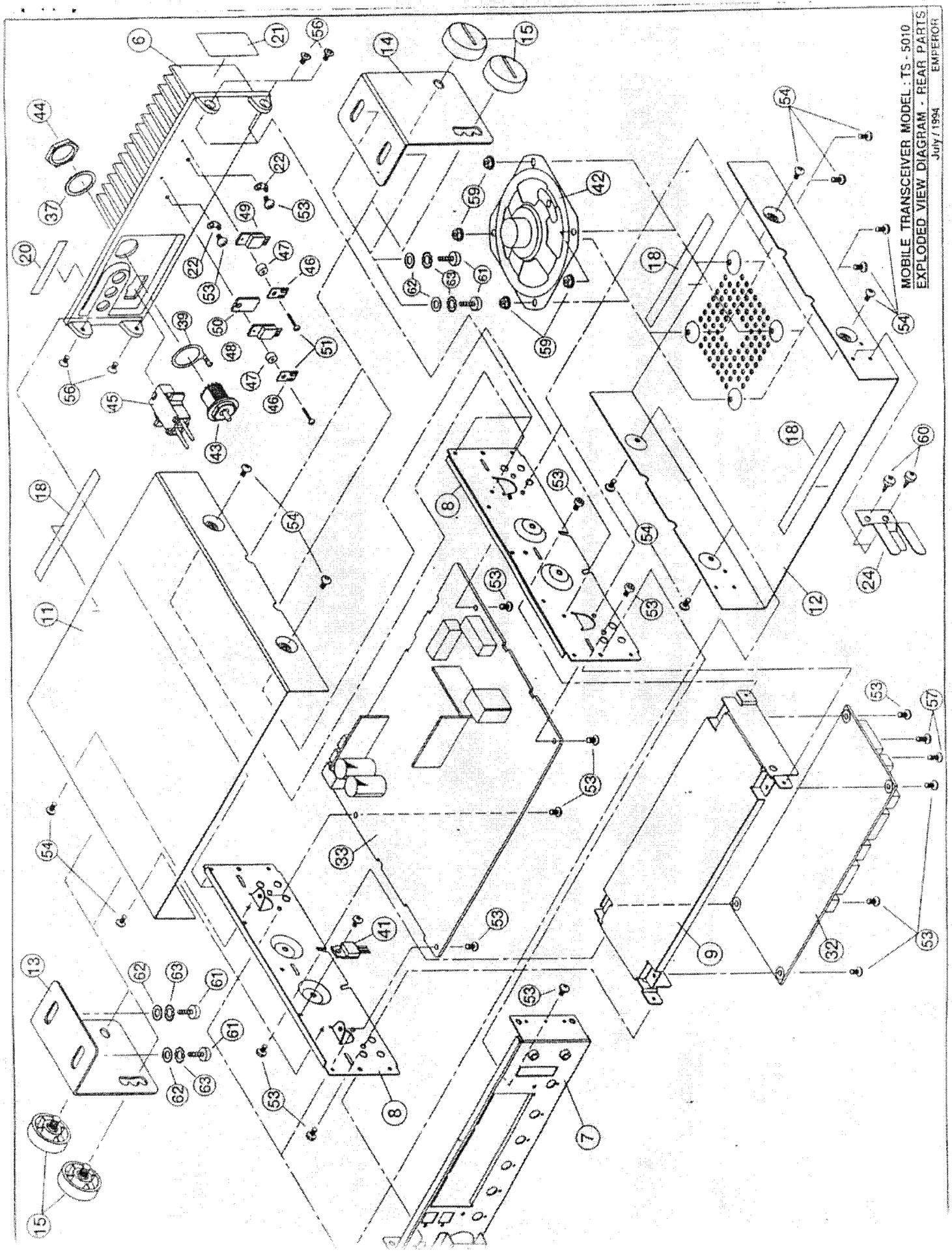

MOBILE TRANSCEIVER MODEL: TS - 5010  
EXPLODED VIEW DIAGRAM - REAR PARTS

July 1994  
EMPEROR

PB-0170700 BOTTOM VIEW

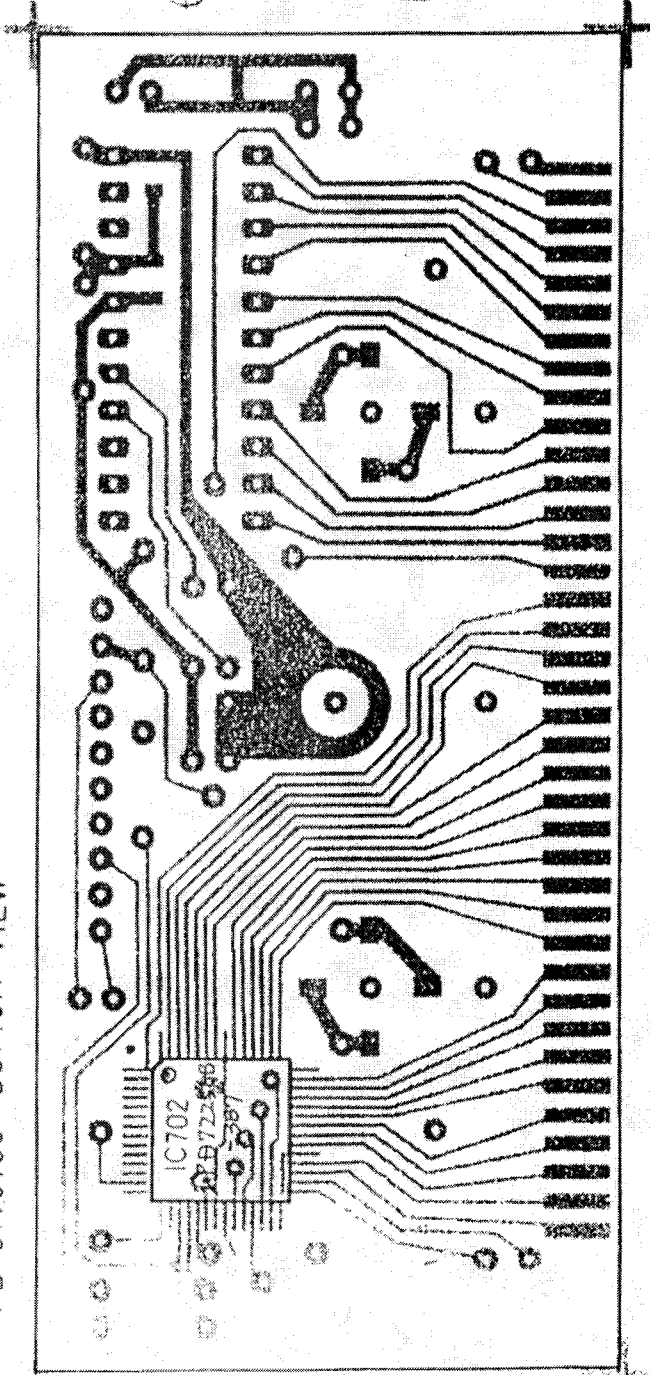

①穴明基準面

穴明基準面

PATTERN BOTTOM
NO PB-0170700
NAME LCD
TEKSTAR CORP.

T55010 "LCD PCB" 部品取付図

30 JUN, 1993

FUKA

TEKSTAR Corp.



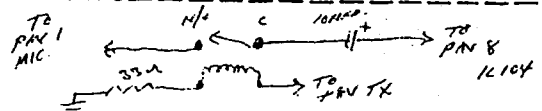

TALKBACK  
OPEN D176

---

D101  
D102 = NTE 553