



**R-530**

**Communications Receiver**

**INSTRUCTION MANUAL**



**GALAXY ELECTRONICS**

*"Pacesetter in Amateur/Commercial Equipment Design"*

10 South 34th Street • Council Bluffs, Iowa 51501

SERIAL NUMBER: \_\_\_\_\_

**R-530**  
**Communications Receiver**

Copyright  
1968

GALAXY ELECTRONICS, Council Bluffs, Iowa.  
Printed in the USA. All rights reserved and  
contents of this publication may not be re-  
produced in any form without permission of  
the copyright owner.

 **NOTICE !**

*This is an interim manual and shall be replaced by the regular manual as soon as the final drawings, parts list and photographs are completed.*

*Please fill out the attached card and return it so we may mail a new manual to you as soon as they are made available.*

*You have chosen one of the finest receivers ever to be designed and we know you will be more than pleased with it's performance. We wish to thank you for being patient with us during this delay.*

*Sincerely,*

*GALAXY ELECTRONICS*

*Bud Henley, Sales Mgr.*

**CONGRATULATIONS!** We at GALAXY feel you have just purchased the finest communications receiver available. To insure warranty validation of your new receiver, this card must be completed and returned to us. Thank you.

NAME \_\_\_\_\_ DATE PURCHASED \_\_\_\_\_  
ADDRESS \_\_\_\_\_ DEALER \_\_\_\_\_  
CITY STATE \_\_\_\_\_ SERIAL NO. 900 / AU 1185  
COUNTRY \_\_\_\_\_

To assist us at GALAXY to more ably fill your communications needs, we ask your answers to the following questions:

This R530 to be used in -

- Amateur Service
- Commercial Service
- Military Service
- Short wave listening
- Laboratory
- Other

To be used by -

- Owner
- Comm. Operator
- Technicians
- Engineers

I became aware of the R530 through -

- Magazine ads in \_\_\_\_\_
- A friend
- Heard about it on the air

New Products I'd like to see from GALAXY:

---

---

# **WARRANTY**

GALAXY ELECTRONICS products are warranted against defective materials and workmanship for a period of 90 days. Parts other than labor, tubes and semi-conductors are warranted for a period of one year from date of purchase by the original owner. The warranty applies to original purchaser only and is not transferable. This warranty does not cover any transportation costs that may be incurred, and our sole liability is repair of any defect, for the period stated.

No person shall assume for us any other liability in connection with the sale of this or other GALAXY products.

Specifications and price change privileges reserved.

# **CONTENTS**

	WARRANTY
	CONTENTS
	LIST OF ILLUSTRATIONS
Section 1	GENERAL INFORMATION
Section 2	INSTALLATION INSTRUCTIONS
Section 3	OPERATING INSTRUCTIONS
Section 4	CIRCUIT DESCRIPTION
Section 5	MAINTENANCE
Section 6	PARTS LIST & DIAGRAMS
	SERVICE INFORMATION

## Section 1 -- GENERAL INFORMATION:

### 1.1 Unpacking:

The R-530 has been inspected both mechanically and electrically prior to shipment. Carefully remove the R-530 from its shipping carton and set aside all packing material for possible future use. Examine the receiver very carefully for any signs of damage which may have occurred in transit. If any signs of damage appear, notify the delivering carrier and file a claim IMMEDIATELY!

### 1.2 Warranty Registration:

Fill out the enclosed Warranty Registration Card immediately and mail it TODAY so that your warranty registration will be on file.

### 1.3 Specifications:

**Receiver Type:** RF Superheterodyne, dual conversion, solid state.

**Frequency Range:** 0.5 to 30 MHz *continuous*

**Frequency Readout:** 1 KHz over entire 500 KHz tuning range of PTO

**Frequency Stability:** From turn-on no more than 100 Hz, including 20% line voltage variation

**Calibration Accuracy:** 1 KHz with 50 KHz calibrator

**Backlash:** Less than 100 Hz.

**Metering:** RF calibrated 0 to 80 db above 1 microvolt, AF calibrated -6 to +4 dbm (600 ohm balanced line)

**AGC:** Selectable FAST or SLOW - Attack time less than 5 milliseconds, with slow release time 2 seconds; fast release time 500 milliseconds. Less than 6 db output change from 1 to 30,000 microvolts.

**Sensitivity:** 0.1 microvolts for 6 db signal plus noise to noise ratio SSB; 0.05 microvolts for 6 db signal plus noise to noise ratio CW; 0.5 microvolts for 6 db signal plus noise to noise ratio AM

**Selectivity:** 2.1 KHz crystal lattice filter, 1.8:1 shape factor, SSB. Optional filters for CW (0.5 KHz) and AM (5.0 KHz) are available and all are front panel selected

### 1.3 Specifications continued:

**Inter-Modulation Distortion:** 3rd order suppressed more than 50 db

**Front-end Overload:** 0.1 volt for 10% distortion (On Signal)

**RF Signal Attenuator:** Variable line attenuator provides 0-20 db attenuation of signal before reaching receiver front-end.

**Harmonic/Spurious Response:** All spurious and harmonic suppressed more than 50 db.

**Noise Blanker:** Adjustable for optimum performance on SSB and CW

**Functional Service:** AM, CW, SSB (Selectable USB & LSB) and RTTY. Variable BFO utilized in CW mode tunable plus or minus 1 KHz.

**Audio Output Level:** More than 1 watt with less than 10% distortion.

**Audio Response:** 250 to 3.0 KHz plus or minus 3 db.

**Audio Output Provisions:** Speaker (8 ohms)  
Line (600 ohms balanced) Headphone

**Calibrator:** 50 KHz

**Antenna Input:** 50 ohms unbalanced

**Front Panel Controls:** AM, USB, LSB; BFO Frequency Tuning; Preselector Tuning; Main Tuning; Frequency Synthesizer Tuning; Meter Switch (AF/RF); AF/RF Gain Control; Band Switch; Blanker/RF Attenuator Control; Selectivity; AGC (Fast/Slow) Switch; Headphone Jack; Function Switch (OFF, STBY, OPR, CAL).

**Rear Panel:** Antenna input, 50 ohms unbalanced; Battery Connections; External Mute; AGC Output; Detector Output; VFO Input/Output; Line Output 600 ohms balanced; Speaker Output 8 ohms.

**Power Requirements:** 115/230 VAC, 50-60 Hz at 24 watts or 18 VDC maximum source drain 600 ma.

**Size:** 6" H x 17" W x 14" D Cabinet; Rack Panel 8¾" H x 19" W x 14" D.

**Weight:** 25 lbs. (Shipping weight BCP 32 lbs.)

**R-530.....Receiver, less accessories .....\$695.00**

**NOTE: Specifications subject to change without notice.**



## Section 2 -- INSTALLATION INSTRUCTIONS:

### 2.1 General:

To obtain maximum performance from your R-530 receiver it is recommended you read Sections 2 and 3 in their entirety before attempting to operate the unit.

### 2.2 Antenna Considerations:

The R-530 "front-end" will provide excellent performance with any antenna which is adequate for reception of the desired frequencies, including beams, dipoles, most long-wire antennas and resonant mobile antennas. However, the R-530 has been designed for use with a 50-ohm antenna, therefore if the receiver is used with an antenna with other than 50 ohms impedance degrading performance will result. When using the R-530 with antennas other than 50 ohms impedance, such as a random length long-wire antenna, you should use an antenna tuner.

### 2.3 Speaker and Audio Output:

2.3.1 Speaker -- the R-530 accessory speaker, Model SPK-530 or any other 8 ohm speaker may be connected to the speaker output jack on the back of the receiver. Figure #2 shows the location of the output jack on the rear panel of the receiver.

2.3.2 Headphones -- any type of headphones may be used with the R-530, high or low impedance. Connect the headphones to the phone jack on the front panel of the R-530 as shown in Figure #3. The phone jack accepts a standard PL-55 phone plug. If a speaker is connected to the receiver it will automatically be silenced when the headphones are plugged into the jack on the front panel. The 600 ohm output on the back panel will not be silenced allowing the receivers output into a 600 ohm line to be monitored such as during teletype operation over phone lines.

2.3.2 600 Ohm Output -- a 600-ohm audio output is available on the back panel as shown in Figure #2. The 600-ohm output transformer is center-tapped and ungrounded to provide maximum versatility. This will allow use of either single-ended or center-tapped grounding when used to feed a 600-ohm line. The audio output level is controlled by the receivers AUDIO GAIN and the RF ATTENUATOR controls. The output level is monitored by placing the METER SWITCH to the AF position.

#### 2.4 Power Requirements:

2.4.1 Fixed AC Operation -- the R-530 operates from 115/230 VAC 50/60 Hertz. Stability is not affected with as much as 20% variation in line voltage, due to the broad capabilities of internal regulating circuitry. The R-530 is shipped wired for 115 VAC operation. See Figure #4 for changing wiring for operation on 230 VAC.

2.4.2 Mobile or Portable Operation -- DC operation of the R-530 requires and +18 VDC supply and a -18 VDC supply. Refer to Figure #4 for proper connections to P2. The +18 VDC will draw 450 ma and the -18 VDC will draw 100 ma. The source should be stable and have good filtering, if it is not a battery source. Improper filtering can cause loud hum from the speaker.

### **CAUTION!**

*When using DC power to operate the R-530 carefully observe POLARITY! Check and double check your connections before applying power as reversed polarity can damage the receiver EXTENSIVELY.*

#### 2.5 Location:

2.5.1 Table-Top Mounted -- the R-530 makes an excellent table-top receiver. When installed in this manner it needs an 8 ohm speaker

2.5.1 -- (such as the SPK-530), a suitable power source (115/230 VAC) and a 50 ohm antenna. The antenna connector required is a PL-259.

Optimum performance under all operating conditions is obtained when using the SPK-530 matching speaker. This speaker has been designed specifically for the R-530 receiver.

2.5.2 Rack Mounted -- the R-530 can be rack mounted in a standard 19" rack panel by using the RPA-530 Rack Panel Adapter shown in Figure #5. The rack panel space required is 8 3/4" and it has standard RETMA screw notch spacing and push-button chassis tilt on ball-bearing slides for easy maintenance and access to rear panel connections.

When rack mounted the receiver will still require an 8 ohm speaker, suitable power source and a 50 ohm antenna as mentioned in Paragraph 2.5.1.

2.5.3 Mobile Mounted -- when the R-530 is used for mobile purposes it should be shock mounted. By shock mounting the receiver can be successfully mounted in any type of vehicle, be it plane, ship, truck or car.

## 2.6 What to Expect:

Ease of operation and high-performance have been carefully engineered into the R-530. Remember that the signals you receive will be influenced by several factors. To enjoy the full advantage of the R-530's capabilities here are some suggestions --

# Remember there is no substitute for a good antenna. The R-530's excellent sensitivity can be used with any antenna you might care to use, but your results will be only as good as your antenna installation.

## 2.6 What to Expect continued --

# Due to the R-530's broad coverage you will be able to listen to many different kinds of signals. Remember that some signals will be stronger than others at different times of the day. The lower ranges (0.5 thru 8 MHz) will be strongest in late afternoon and early evening. As night approaches the lower frequencies will become even stronger. The frequencies above the 8 MHz range will be their strongest during the daylight hours. At times these frequencies will continue to be strong into the late afternoon and evening, caused by atmospheric conditions (sun storms, aurora, etc.).

# Remember to make a good ground connection to the receiver -- even if the installation is a temporary one.

# If you use a poor antenna the reception will be greatly affected. City areas often have high radio noise levels and a poor antenna amplifies this problem. The noise blanker on your receiver has been designed to help you with certain types of radio interference, but it is not a cure-all! Properly used the noise blanker will allow you to pull in signals that cannot be heard on other receivers. Refer to Paragraph 3.2 for proper operation of the noise blanker.

# Remember that a metal-frame building will shield the antennas signal capturing capabilities. By all means use an outside antenna, mounted as high as possible or practical.

# Remember that operating the R-530 for the first time you will be unfamiliar with the controls. Allow time to get the "feel" of the receiver. Don't hamper the performance by operating in a band of frequencies that aren't typically good for the time of day you have chosen to operate the receiver.

## 2.6 What to Expect continued --

# You will find that only a few minutes of practice is required to become quite familiar with the R-530's controls. Choose the mode of operation, the band, set the preselector, set the frequency (phase-lock oscillator) and tune the main tuning dial for the station wanted. The calibration over the entire band is so precise you will soon find yourself tuning to stations of a known frequency to check if THEY are off frequency or not -- it is a thrill to see a precision instrument at work.

# Remember a little time spent becoming familiar with the R-530 will pay great dividends in performance. Above all be sure you have read Sections 2 and 3 before attempting to use the receiver.

## Section 3 -- OPERATING INSTRUCTIONS:

### 3.1 General:

This section assumes that you have read and installed the receiver as specified in Section 2 and that you have checked once again to make sure the antenna, speaker and power connections have been made as shown in Figure #4. Paragraph 3.3 of this section is intended to provide the operator with basic information required to operate the R-530 receiver. Paragraph 3.4 provides a more detailed explanation of the controls.

To get the maximum benefit from the R-530 receiver's capabilities it is strongly recommended that the entire section be read, then come back again to Paragraph 3.3 before actually operating the receiver for the first time.

### 3.2 Typical Control Settings and Identification:

#### 3.2.1 SINGLE-SIDEBAND RECEPTION:

MODE SWITCH --- Normally LSB for 3.5 thru 7 MHz and USB for 7 MHz and above.  
BFO ----- Zero or Mid-Position  
RF GAIN ----- Maximum Clockwise position  
AF GAIN ----- Advance until background noise is audible, once station is tuned-in adjust to desired level.  
BAND SELECTOR - To desired band  
NOISE BLANKER - Normally OFF (maximum CCW), if interference is present, advance the control CW, after signal is tuned-in, to a point where noise is reduced or blanked out completely.  
RF ATTENUATOR = Normally OFF (maximum CCW), used when strong local stations are close to frequency being received, or during RTTY and 600 ohm line output use.  
SELECTIVITY --- 2.1 MHz position  
AGC ----- Slow position  
FUNCTION SWITCH To OPR (operate) position.  
METER SWITCH -- To RF position (meter reading in DB)

### 3.2.1 SINGLE-SIDEBAND RECEPTION continued --

FREQUENCY SELECT Tune to desired frequency range and note when "phase-lock" indicator light goes out.

PRESELECTOR --- Place on desired frequency, then fine-tune for highest meter reading.

MAIN TUNING --- Tune for desired operating frequency, slowly adjust the control until a voice of natural quality is heard. If no tuning adjustment results in natural voice, switch MODE SWITCH to opposite sideband.

### 3.2.2 CW RECEPTION:

Control settings for CW reception are the same as for SSB, but the SELECTIVITY control will be in the 0.5 position; if an 0.5 filter is not installed the SELECTIVITY control will remain in the 2.1 position. The BFO can be adjusted for an audio "beat" signal that is pleasing to the operator when in the CW position.

### 3.2.3 RTTY RECEPTION:

Control settings for RTTY reception are the same as for SSB, but the SELECTIVITY control will be in the 1.5 position; if a 1.5 filter is not installed the SELECTIVITY control will remain in the 2.1 position. The BFO can be adjusted for proper RTTY reception. The RF ATTENUATOR control can also be used for control of the output level when the receiver is being used with a 600 ohm line. Place the METER SWITCH to the AF position (meter now reads output level of 600 ohm line) and adjust the AF GAIN control as required. The meter then gives you a constant monitor and maximum control over the signal output level.

### 3.2.4 AM RECEPTION:

Control settings for AM reception are the same as for SSB, but the MODE SWITCH will be in the AM position, the METER SWITCH will be in the RF position and the SELECTIVITY will be in the 6.0 position. AGC can be in FAST or SLOW positions depending on atmospheric conditions.

### 3.2.5 CONTROL IDENTIFICATION:

For Control Identification see Figure #2 for the back panel and Figure #3 for the front panel.

#### FRONT PANEL--

- 1 - MODE SWITCH -- Selects mode of operation AM,USB,LSB
- 2 - BFO ----- Adjusts +/- 1 KHz, used for CW & RTTY
- 3 - 0-RF ----- RF GAIN control adjusts the RF level normally operated full CW. This control operates like a manual AGC control and the METER remains calibrated above the "threshold" set by the RF GAIN control.
- 4 - o-AF ----- AF GAIN control adjust the audio output for speaker, headphones and 600 ohm lir
- 5 - BAND SWITCH -- Selects band the receiver will operate in.
- 6 - PRESELECTOR -- Adjusts the receiver front-end to the frequency desired.
- 7 - 0-BLANKER ---- Noise Blanker control, activates the noise blanker and adjusts the threshold level.
- 8 - o-RF ATTN ---- RF ATTENUATOR control provides a variable attenuator at the antenna terminals for control of front-end overload, especially useful during monitoring.
- 9 - SELECTIVITY -- Selects the filter desired.
- 10 - AGC ----- The AGC control allows switching from FAST to SLOW AGC action.
- 11 - PHONES ----- Standard phone jack for use with headphones of high or low impedance automatically silences the speaker when headpbones plugged in.
- 12 - FUNCTION SWITCH OFF position fully CCW turn OFF THE POWER TO THE R-530 receiver. STANDBY Position, the RF and IF amplifiers are disabled to mute the receiver. In STANDBY position receiver may be muted externally for operation with a transmitter by grounding the MUTE terminal on rear panel. For normal operation the MUTE terminal is jumpered to GND. OPR position makes the receiver fully operable by disabling any external muting. CAL position turns on the calibrator oscillator and connects it to the antenna input circuits. Receiver can be calibrated every 50 KHz.



### 3.2.5 CONTROL IDENTIFICATION continued --

- 13 - METER SWITCH \_Has two positions AF and RF the RF position allows the meter to readout in db and the AF position allows meter to readout in dbm for use with the 600 ohm line output.
- 14 - FREQUENCY --- This control tunes the "phase-lock" oscillator in 500 KHz increments. When "phase-lock" oscillator is not locked-on the indicator light in the upper right hand corner of the dial will be lighted. When the oscillator is locked-on the light will be extinguished.
- 15 - MAIN TUNING - This control varies the accurate PTO used as a second conversion oscillator in the R-530. The frequency to which the R-530 is tuned is determined by adding the frequency in KHz as indicated on the MAIN TUNING DIAL (17) to the frequency in MHz indicated on the FREQUENCY DIAL (18). See Figure #7a and 7b for examples.
- 16 - PRESELECTOR DIAL indicates what frequency the preselector is tuned to.
- 17 - MAIN TUNING DIAL Indicates frequency in KHz 0-500 or 500-1000 KHz.
- 18 - FREQUENCY DIAL Indicates frequency in MHz at 500 KHz increments that the "phase-lock" oscillator is tuned to. The indicator light in the upper right-hand corner of this dial is extinguished when the oscillator is locked-on.
- 19 - AF/RF METER - Meter readout is controlled by the METER SWITCH (13).

### 3.2.5 CONTROL IDENTIFICATION continued --

BACK PANEL -- (See Figure #2 for location)

- 1 - POWER PLUG J2 -- See Figure #4 for proper connections to power source used.
- 2 - FUSE ----- A 1 ampere fuse for power circuit protection
- 3 - TS1 ACCESSORY STRIP For accessory connections external AVC connection and for external muting.
- 4 - J\*8 ----- Spare
- 5 - J\*7 ----- Spare
- 6 - J6 VFO IN ----- For external VFO connection
- 7 - J5 VFO OUT ----- For external VFO connection
- 8 - J4 DET OUT ----- For external Detector monitoring
- 9 - J1 ANT ----- 50 ohm, unbalanced antenna input
- 10 - AUDIO OUT STRIP 600 ohm line output connections
- 11 - J3 SPKR ----- 8 ohm speaker output.

### 3.3 Operating Instructions (Condensed):

The following condensed instructions provide the operator with the necessary information to adjust the R-530 for reception of SSB, CW, RTTY or AM signals. Set the front panel controls as follows: (Refer to Figure #3 for location)

- (1) MODE SWITCH -- to AM
- (2) BFO ----- to Mid-Range (Ø position)
- (3) RF ----- fully CW
- (4) AF ----- Mid-Range
- (5) BAND ----- to 8-16 position.
- (7) BLANKER ----- Maximum CCW (OFF)
- (8) RF ATTN ----- Maximum CCW (OFF)
- (9) SELECTIVITY -- 6.0 MHz (if no 6.0MHz filter 2.1 MHz)
- ((10) AGC ----- Slow
- (12) FUNCTION ----- OPR (operate) receiver dials now light up)
- (13) METER ----- to RF
- (6) PRESELECTOR -- set to 10 MHz
- (15) MAIN TUNING -- set to Ø (maximum left position)
- (14) FREQUENCY ---- tune the dial to 10.0 and adjust until the phase-lock indicator light is extinguished (upper-right-hand corner of the Frequency Dial (18)

### 3.3 Operating instructions (condensed)-continued-

Now slowly rotate the preselector knob (6) from side to side around the 10.0 MHz mark for the maximum signal as indicated on the METER (19)

You are now tuned to WWV/WWVH in the Western Hemisphere and should hear the familiar ticking of the Standard Time Signal broadcast by the National Bureau of Standards.

You should now have the "feel" of the receiver, try a few more signals, WWV at 5.0 MHz and at 15.0 MHz to become more familiar with the setting of the controls. If you get into the habit of following the controlled check pattern called out in above mentioned condensed operating instructions a lot of troubles caused by the forgetting of a control here and there during the tuning process will be eliminated.

### 3.4 Operating Instructions (Detailed):

Refer to Figure #3 for location of the controls mentioned below.

(1) MODE SWITCH -- This switch is a three-position selector switch used to control the detector used in the receiver for reception of AM/USB/LSB signals. AM -- In this position the AM detector is connected between the receiver IF and audio stages to permit AM reception. Normally the SELECTIVITY SWITCH (9) is in the 6.0 MHz position. When in the AM position the BFO is disabled.

USB -- In this position the BFO is activated and a product detector is placed between the last IF and the audio stages to permit SSB, CW and RTTY reception. Upper Sideband is heard since a crystal controlled USB carrier is generated thru the BFO.

LSB -- In this position the same action takes place as in USB with the exception of the BFO carrier frequency now being changed to a crystal controlled frequency allowing a LSB carrier to be generated thru the BFO.

### 3.4 Operating Instructions (Detailed) - continued -

(2) BFO -- This control varies the BFO frequency + or - 1 KHz and is active when the MODE SWITCH (1) is in either the USB or LSB positions.

(3) RF -- The RF GAIN control is the larger concentric knob located at the lower left-hand corner of the receiver front panel. This control varies the basic gain level of the RF amplifier stage, and 2nd IF amplifier. This "threshold" determines the activity of the receiver's METER reading. Normally the control is left in the fully CW position. In this position the METER is calibrated over the entire meter range.

(4) AF -- The AF or AUDIO GAIN control is the smaller concentric knob located at the lower left-hand corner of the receiver front panel. This control varies the audio output of the receiver at the headphone jack (11) as well as the speaker output and 600 ohm line output on the back panel.

(5) BAND SWITCH -- Selects the BAND of frequencies the receiver will operate in by selecting the proper RF coil combination in the "front-end" of the receiver.

(6) PRESELECTOR -- This knob tunes the receiver "front-end" by varying the inductance of the coils selected by the BAND SWITCH (5).

(7) BLANKER -- The Noise Blanker Control, activates the noise blanker and adjusts the threshold level.

(8) RF ATTN -- The RF Attenuator Control provides a variable attenuator at the antenna terminals for control of "front-end" overload, especially useful during monitoring a strong local station.

(9) SELECTIVITY -- This four-position switch selects the filter desired for the type of signal being received.

### 3.4 Operating Instructions (Detailed) -continued-

(10) AGC -- The AGC (Automatic-Gain-Control) switch allows selection of FAST or SLOW AGC action for desired results.

(11) PHONES -- This 8 ohm impedance phone jack accepts a standard PL-55 plug and can be used with either HIGH or LOW impedance phones. When phones are plugged into the jack the speaker input is disabled but the 600 ohm output is unaffected to allow monitoring signal by using headphones.

(12) FUNCTION SWITCH -- This is a four-position switch controlling the basic functions of the receiver --

OFF -- This position is at the fully CCW point and turns off all power to the R-530 receiver.

STBY -- The Standby position disables the RF and IF amplifiers to mute the receiver. In STBY the receiver may be muted externally for operation with a transmitter by grounding the MUTE terminal on the rear panel. See Figure #2 for location of the MUTE terminal. For normal operation not requiring external muting the MUTE terminal is jumpered (shorted) to GND as seen in Figure #2.

OPR -- The Operate position makes the receiver fully operable by disabling any external MUTING that may be present.

CAL -- In this position the Calibration Oscillator is activated and connected to the antenna input. Receiver can be calibrated every 50 KHz.

(13) METER -- The Meter Switch has two positions, AF and RF. The RF position has a readout in DB. The AF position is used during 600 ohm line operation and allows readout in DBM for accurate output measurement.

(14) FREQUENCY -- This control knob tunes the "phase-lock" oscillator circuitry. When the oscillator is not locked-on to a 500 KHz increment the "phase-lock" oscillator indicator light will be ON. When the desired frequency is positioned correctly on the dial the "phase-lock" oscillator indicator light will be extinguished. The indicator light is located in the upper right-hand corner of the FREQUENCY DIAL (18).

*Eal, Xtal*

### 3.4 Operating Instructions (Detailed) -continued-

(15) MAIN TUNING -- This control knob varies the accurate PTO used as a second conversion oscillator in the R-530 receiver. The frequency to which the R-530 is tuned is determined by adding the frequency in KHz as indicated on the MAIN TUNING dial (17) to the frequency in MHz indicated in the FREQUENCY dial window (18). See Figure #7 for examples of readout.

(16) PRESELECTOR DIAL -- This dial is divided into six bands to correspond with the BAND switch (5) and is calibrated in MHz.

(17) MAIN TUNING DIAL -- This dial has two readouts, one from 0 to 500 KHz and one from 500 to 1000 KHz. The dial is further divided into 20 KHz increments. The MAIN TUNING knob breaks the readout down further into 1 KHz increments.

(18) FREQUENCY DIAL -- This dial is marked off in 500 KHz increments and calibrated in MHz. The dial indicates what increment the "phase-lock" oscillator is locked-on to. When the "phase-lock" oscillator is not locked-on to a 500 KHz increment the indicator light in the upper right-hand corner of the dial will be lighted.

(19) METER -- The METER dial is calibrated in DB (top scale) and DBM (bottom scale). When the METER SWITCH (13) is in the RF position the meter uses the top scale and when in the AF position it uses the bottom scale.

### 3.5 Suggestions for Efficient Operation:

3.5.1 ANTENNA MATCHING -- The most important thing about getting the most out of your R-530 receiver is to make sure the antenna used has a 50 ohm input impedance. Every effort should be made to provide a correct impedance match such as the use of an antenna matching network, if necessary. Proper antenna matching becomes the biggest downfall of most good receivers.

3.5 Suggestions for Efficient Operation -continued-

3.5.2 The R-530 is designed to provide optimum sensitivity in the broadcast band (.5 to 1.6 MHz). Because of the extremely high signal levels in most metropolitan areas, it will become necessary to use the RF ATTN control to attenuate the sometimes tremendous signal level of 1.0 volts at the antenna terminals. The RF ATTN control allows the R-530 to run at optimum sensitivity on the broadcast band in remote areas and with REDUCED sensitivity in the metropolitan areas at the operators descretion. It is very important to tune the PRESELECTOR control carefully on the 0.5-1.0 and 1.0-2.0 MHz bands in particular. Cross-modulation can be increased if the PRESELECTOR is not tuned properly and happens to be on the frequency causing the cross-modulation.

3.6 Accessories:

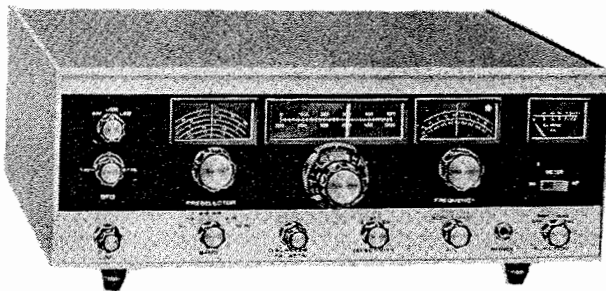

**ACCESSORIES**

	PRICE
RPA-530...Rack Panel Adapter. Standard 19". Adapts the R-530 to Rack Panel Mount .....	\$125.00
SPK-530 Speaker Console with cables and provisions for 24 hour clock in a matching console.....	\$ 40.00
CL-530 24 hour clock, mounts in the SPK-530.....	\$ 30.00
FL-5305 500 Hz crystal lattice filter .....	TBA
FL-53015 1.5 KHz crystal lattice filter.....	TBA
FL-5306 6.0 KHz crystal lattice filter.....	TBA

*\*Other filters available on request.*

## Section 4 -- THEORY OF OPERATION:

### 4.1 Basic Receiver Description:

The R-530 solid-state communications receiver has been designed for both fixed and portable applications, demanding high reliability, extreme tuning accuracy and the best in stability over a wide frequency range. Reception of SSB, AM, CW and RTTY signals are made with ease using the R-530, along with outputs making the receiver useful under usual and unusual applications. Superior performance and high reliability has been built into the R-530 as a result of its complete transistorization and unique modular construction. Portable and field operation, previously difficult or impossible with existing tube type and hybrid receivers, is a natural due to the R-530's low power drain and rugged construction.

Figure #8 shows a block diagram of the R-530 receiver and illustrates the major functional sections of the receiver. The R-530 is a dual conversion receiver. Incoming signals in the 0.5 thru 30.0 MHz range are fed through the RF PRESELECTOR stages with six ranges being selected by the BAND SWITCH.

The oscillator input to the first conversion mixer, a series of 59 discrete frequencies lying between 42.625 and 71.625 MHz, is obtained from the "phase-lock" oscillator portion of the R-530 receiver. This series of frequencies will mix any desired 500 KHz segment of the spectrum as selected by the position of the BANDSWITCH and the PRESELECTOR.

The first mixer output lying between 41.625 and 42.125 MHz is coupled through two bandpass filters to the second conversion mixer together with the output of the pre-mixer operating between 32.625 MHz and 33.125 MHz. The output of the second conversion mixer is at 9 MHz, the IF frequency.



#### 4.1.2 The Second Conversion Mixer and IF Amplifiers:

Output from the second conversion mixer is fed to the various IF filter circuits. The filter selected by the SELECTIVITY SWITCH operates at the operators preference.

Output of the 9 MHz IF amplifiers feed the AM or Product Detector as selected by the MODE SWITCH. The 9 MHz IF amplifiers also feed the AGC amplifier and the meter circuitry. The output of the crystal-controlled BFO is fed into the product detector for selecting USB or LSB signals. The signal is finally processed through the audio amplifiers and into a suitable speaker or line termination.

#### 4.2 The Spectrum Generator:

The operation of the "phase-lock" oscillator portion of the R-530 is best understood by reference to the diagram shown in Figure #9. Fifty-nine discrete oscillator signals are generated from the harmonics of a single, highly stable, crystal oscillator operating at 1 MHz. The discrete oscillator frequencies occur at intervals of 500 KHz starting at 42.625 MHz and ending at 71.625 MHz. The 500 KHz frequencies are derived from the 1 MHz oscillator by dividing by 2 for keying of the spectrum generator. In addition to generation of HF oscillator signals the phase-lock indicator circuits provide a front panel warning that the "phase-lock" oscillator is not locked-on to one of the 500 KHz frequencies. This indication is in the form of a red light in the upper right-hand corner of the FREQUENCY DIAL (18).

The stable 1 MHz crystal oscillator drives a spectrum generator providing a coherent burst of energy. The coherent nature of the spectrum generator signal insures that the output will contain only harmonics of the original 1MHz reference frequency. The harmonic content will however, have an amplitude distribution around the tuned frequency of the spectrum generator

#### 4.2 The Spectrum Generator - continued-

with the harmonics of maximum amplitude always occurring at the spectrum generator frequency. The nature of the frequency and time domain of the spectrum generator tracks the HF oscillator so that the harmonic of maximum amplitude will fall between 47.5 MHz and 76.5 MHz as required for proper phase-lock and control of the phase-lock oscillator portion of the R-530.

The output of the spectrum generator is coupled to a mixer together with a signal from the HF oscillator. This HF oscillator is 4.875 MHz below the desired spectrum generator output. A 4.875 MHz IF signal is obtained. This signal is in turn, amplified and fed to the phase detector.

The second crystal-controlled oscillator operating at 4.875 MHz provides the gating signal to the phase detector. If the output from the IF amplifier is not identical to the output from the 4.875 MHz crystal-controlled oscillator, an audio beat note is generated whose frequency is the difference between the oscillator and the IF output frequencies. This audio note is amplified by the DC amplifier and applied to a varactor in the HF oscillator circuit. The audio signal thus applied will cause the HF oscillator to sweep in frequency at the beat note rate, resulting in a sweep of the 4.875 MHz IF amplifier output. Within one cycle the IF amplifier output will approach and equal the output of the 4.875 MHz crystal-controlled oscillator, at which time the polarity of the varicap control is such that the two frequencies will lock together. With the now identical frequencies, there can be no audio beat note. There will be, however, a DC output whose amplitude and polarity is determined by the phase-angle difference between the two signals arriving at the phase detector. Any drift of the HF oscillator will cause a phase-angle change and, in turn, a DC output change of proper polarity will be applied to the varactor

#### 4.2 The Spectrum Generator - continued-

and cancel the original drift. Thus, the HF oscillator is "phase-locked" on a cycle for cycle basis with the desired harmonic of the 1 MHz crystal-controlled reference oscillator. Reference to Figure #10 will indicate the various oscillator frequencies required for the 59 HF oscillator outputs between 42.625 MHz and 71.625 MHz.

When "phase-lock" control is lost the HF oscillator signal may be widely removed from that required to "phase-lock" with the desired spectrum generator output harmonic. A sweep generator is incorporated to vary the varactor voltage from +3 to +8 volts by the sweep generator sawtooth, thus insuring a wide frequency scan of the HF oscillator until a 4.875 MHz output again occurs at the phase detector. The 4.875 MHz output will cause the phase loop to lock and the sawtooth generator to cease operation.

During those times when the phase-lock loop is sweeping, the output of the sawtooth generator is detected and amplified to light the PHASE-LOCK INDICATOR LIGHT on the front panel. When phase-lock is restored, the sawtooth sweep generator can no longer function therefore no output voltage so the "phase-lock" indicator light is extinguished.

Section 5 -- MAINTENANCE:

5.1 General:

The R-530 maintenance should be performed by qualified personnel. Personnel familiar with lab test equipment and test procedures.

Any one of the lab adjustments or test procedures listed below may be performed individually, provided that the proper test set-up and preliminary adjustments are made.

5.2 Test Equipment Required:

HF OSCILLOSCOPE covering the range from DC to 30 MHz with a sensitivity of 50 mv per centimeter and a low-capacity input probe.

VACUUM TUBE VOLTMETER (VTVM) with a sensitivity of 20,000 ohms per volt or better.

SIGNAL GENERATOR covering the range from 50 KHz to 50 MHz with properly terminated and calibrated output.

FREQUENCY COUNTER, crystal-controlled, or other means of accurate signal generator frequency calibration.

SWEEP GENERATOR capable of sweeping at approximately 60 hertz per second over a frequency range from approximately 25 MHz to 31 MHz.

AUDIO OUTPUT METER, standard, calibrated.

AUDIO OSCILLATOR covering the range from 10 hertz to 100 KHz.

ALIGNMENT TOOLS suitable for adjustment of coils capacitors, etc.

5.3 Alignment:

(Alignment Procedures will follow in completed manual)

5.4 Troubleshooting:

(Troubleshooting Procedures and accompanying voltage  
and resistance charts will follow in completed manual)

Section 6 -- PARTS LIST AND DIAGRAMS

*Note -- parts list will follow in  
completed manual.*

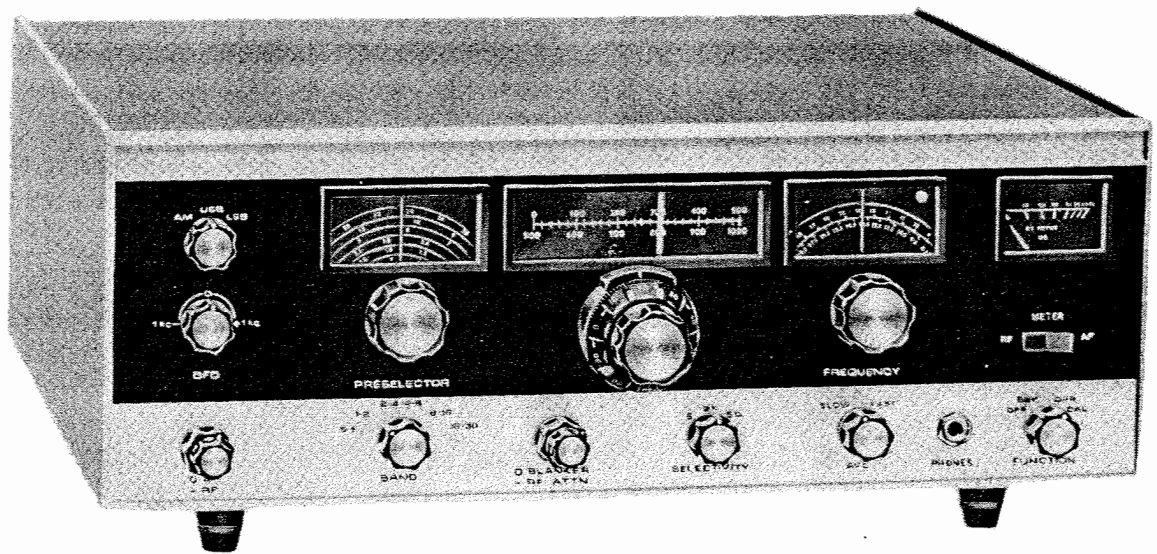

R-530

Figure #1

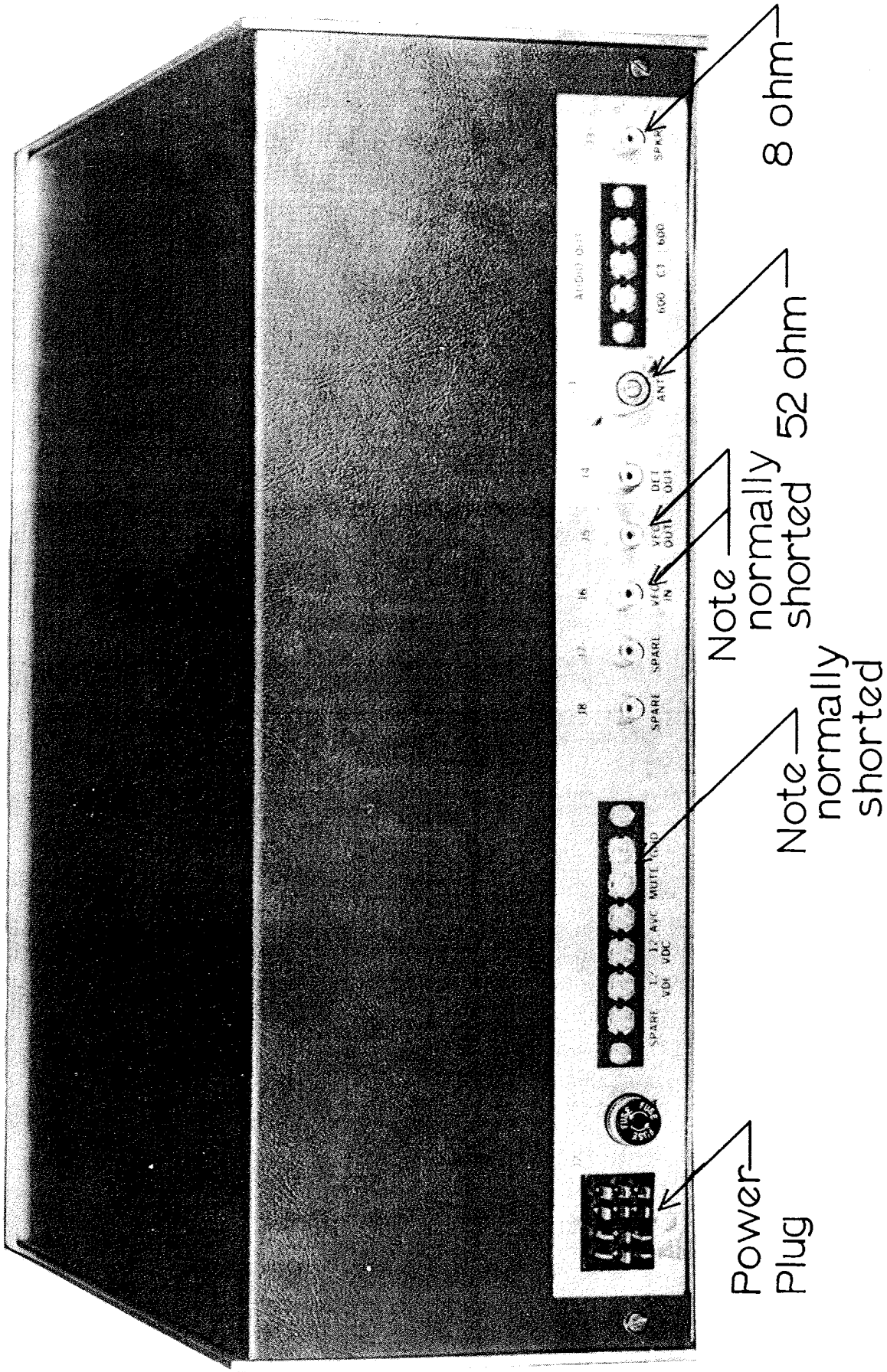

R-530 Back Panel  
Figure #2



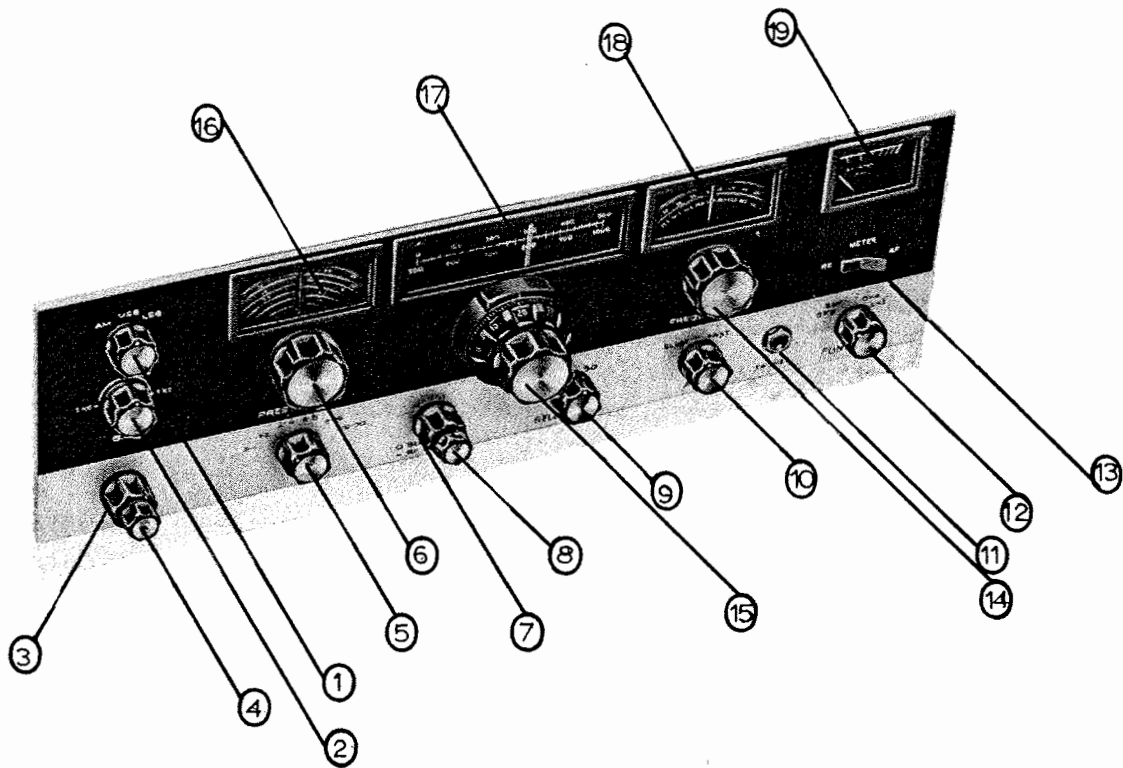

R-530 Front Panel  
Figure #3

Figure 4

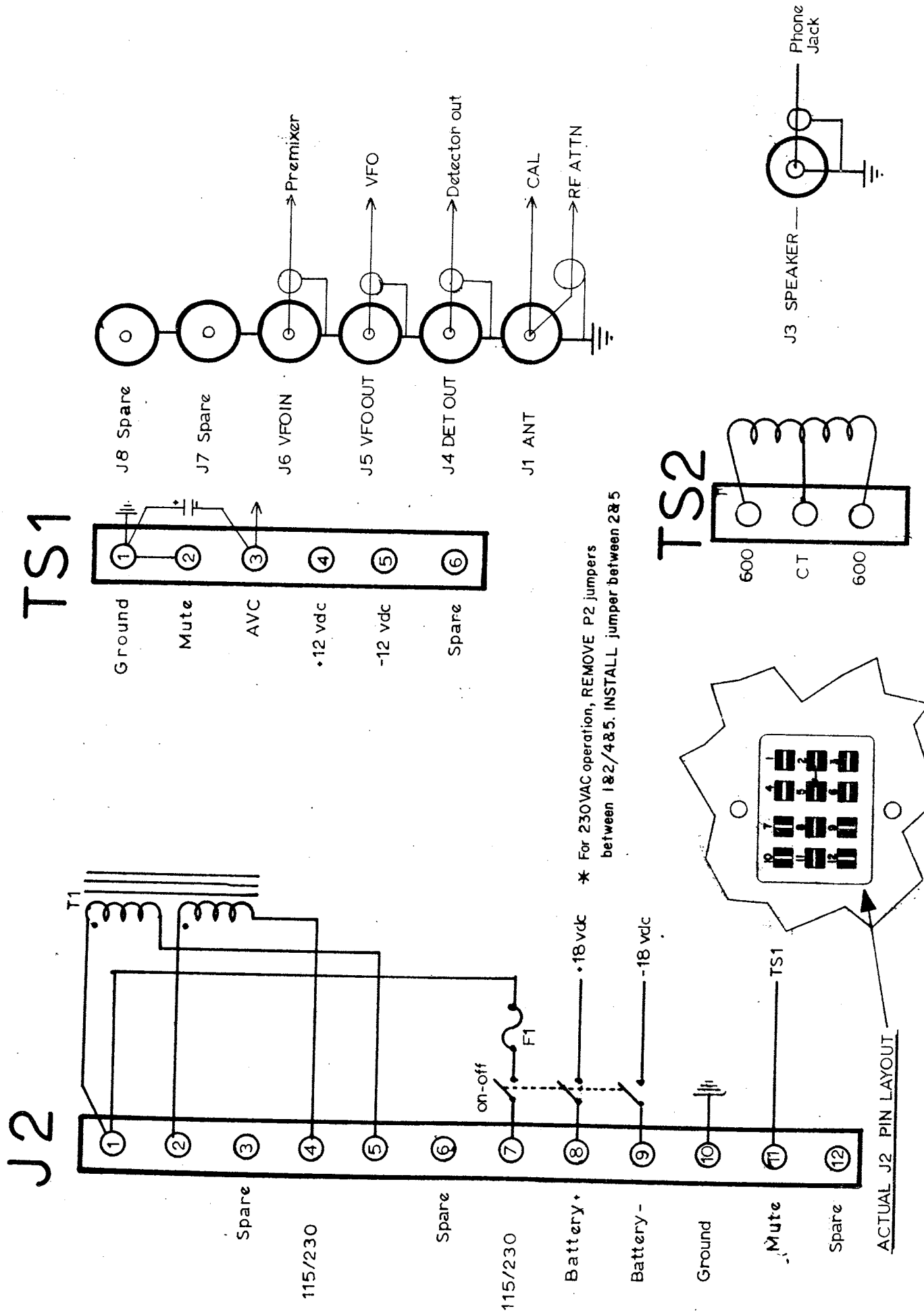

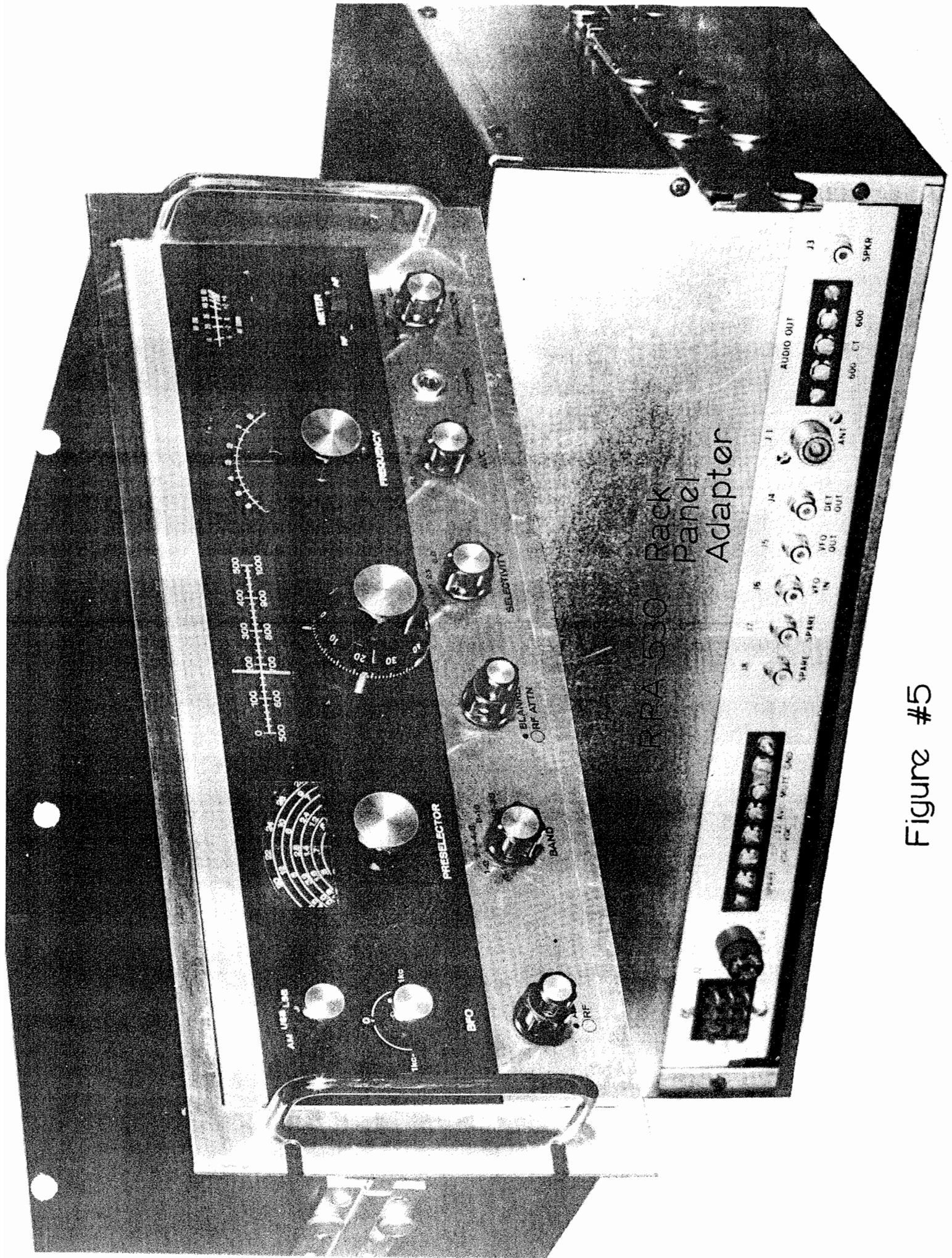
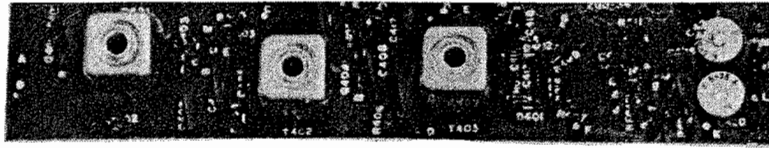
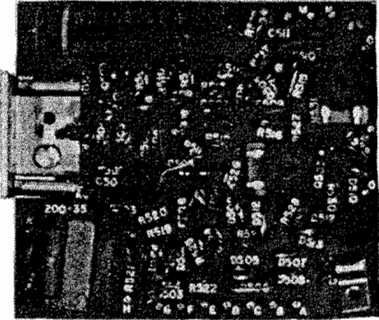

Figure #5



200-34 9MHz IF Strip

200-35  
Audio  
Regulator



200-40  
CAL-AVC  
Board

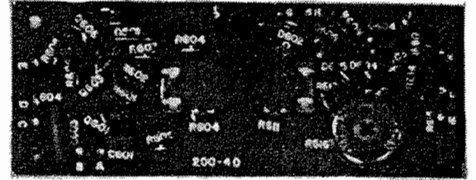

200-41  
Bal. Mixer



200-36  
PTO



200-42  
HF Mixer

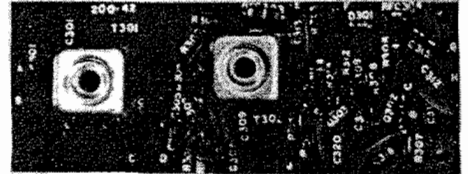

200-37  
Phase-lock  
OSC



200-43  
Pre-Mixer

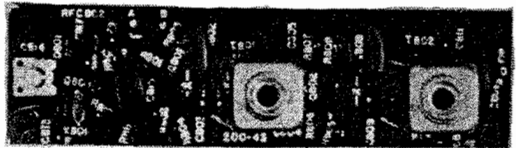

200-38  
Phase-lock  
OSC.

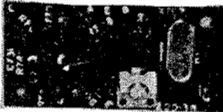

200-39  
Phase-lock  
OSC.

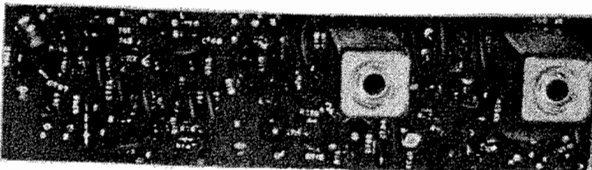

PC Boards  
Figure #6

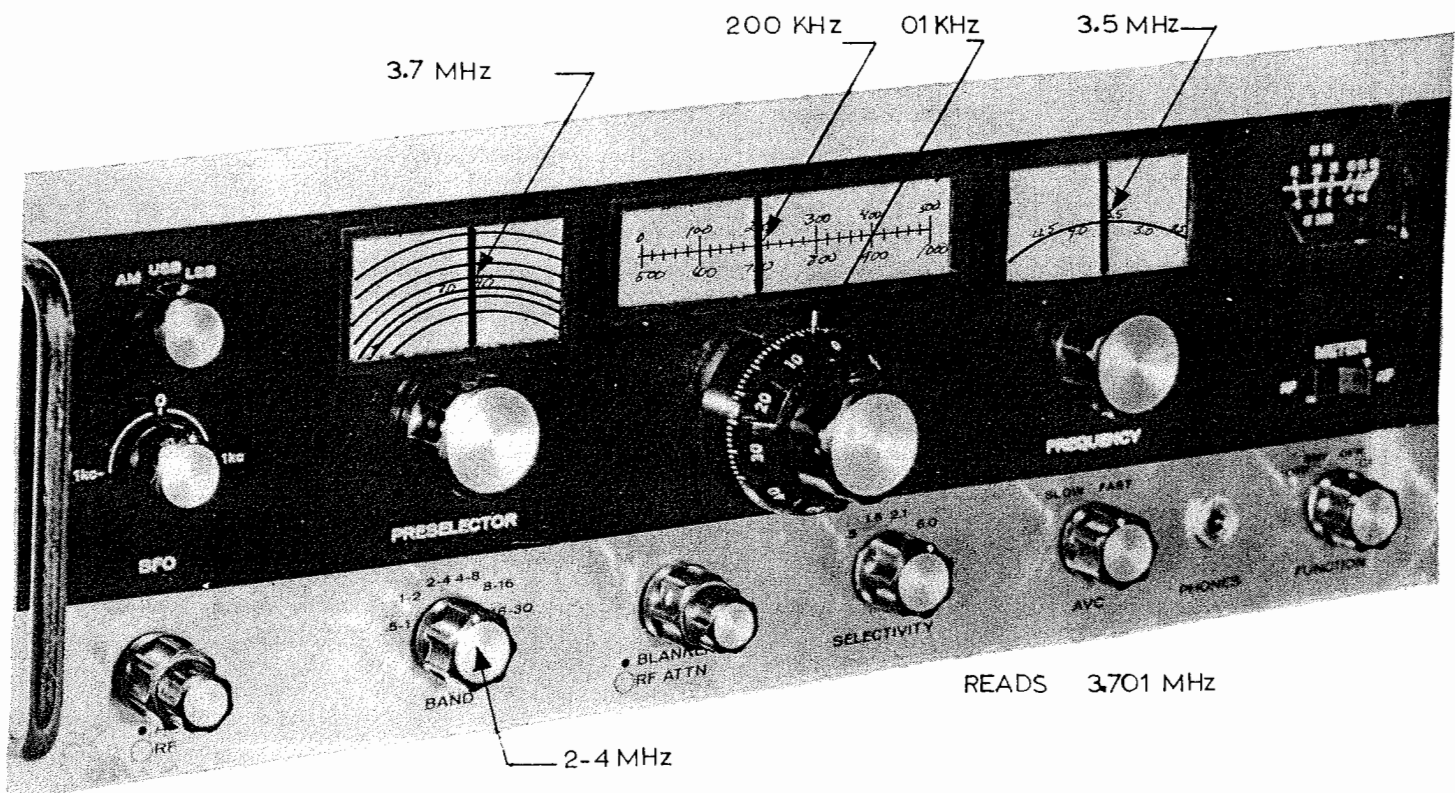
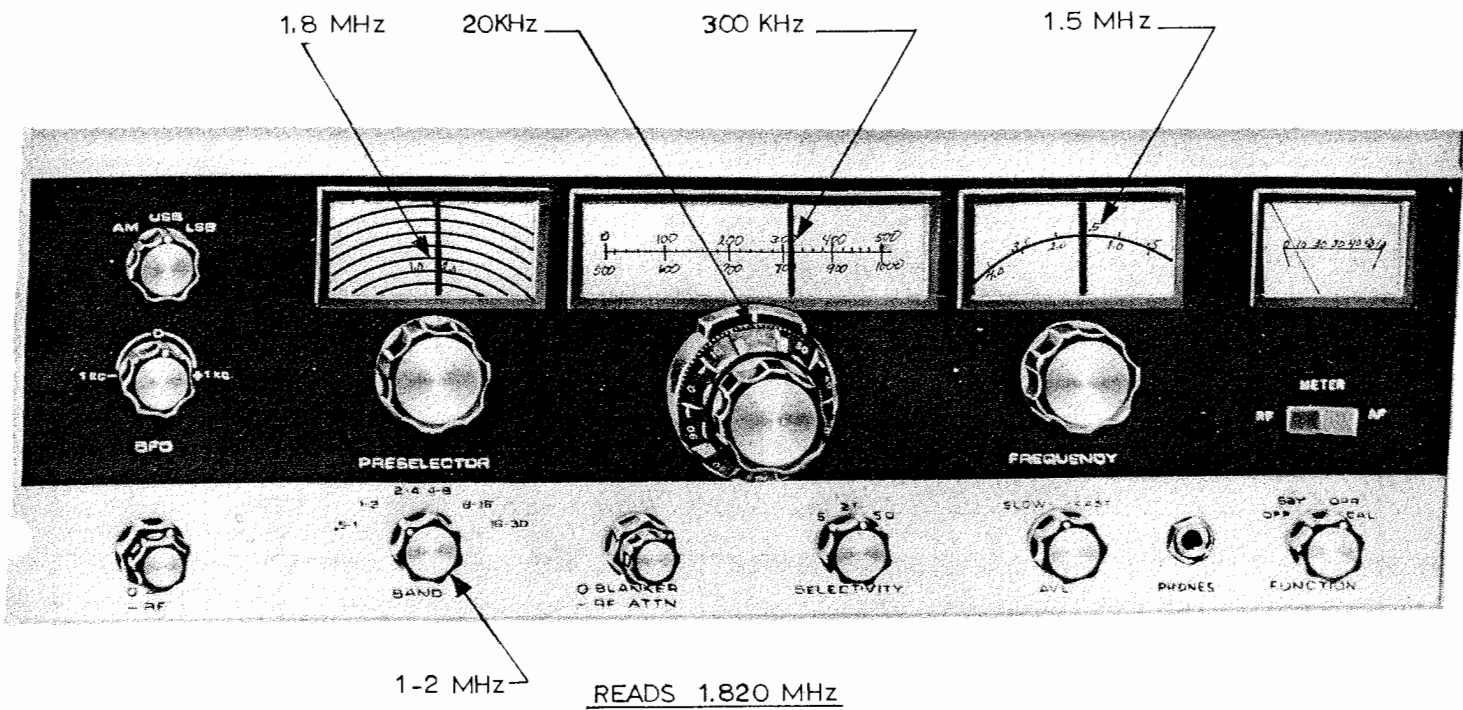

Figure #7

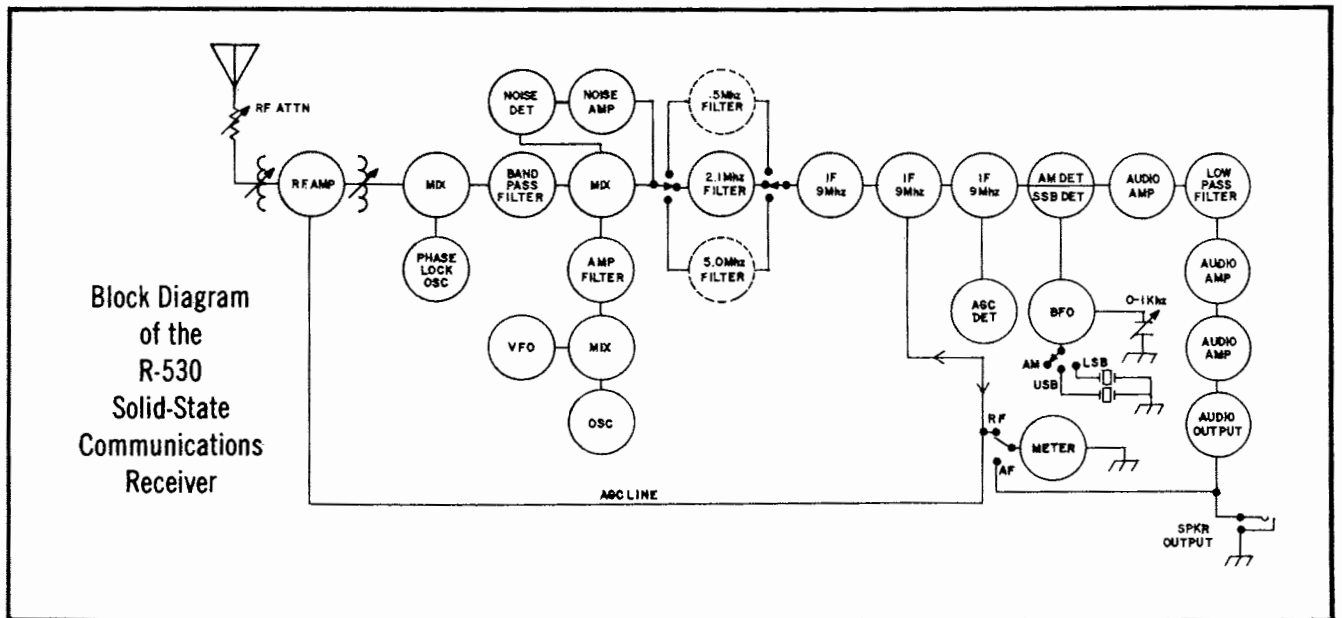
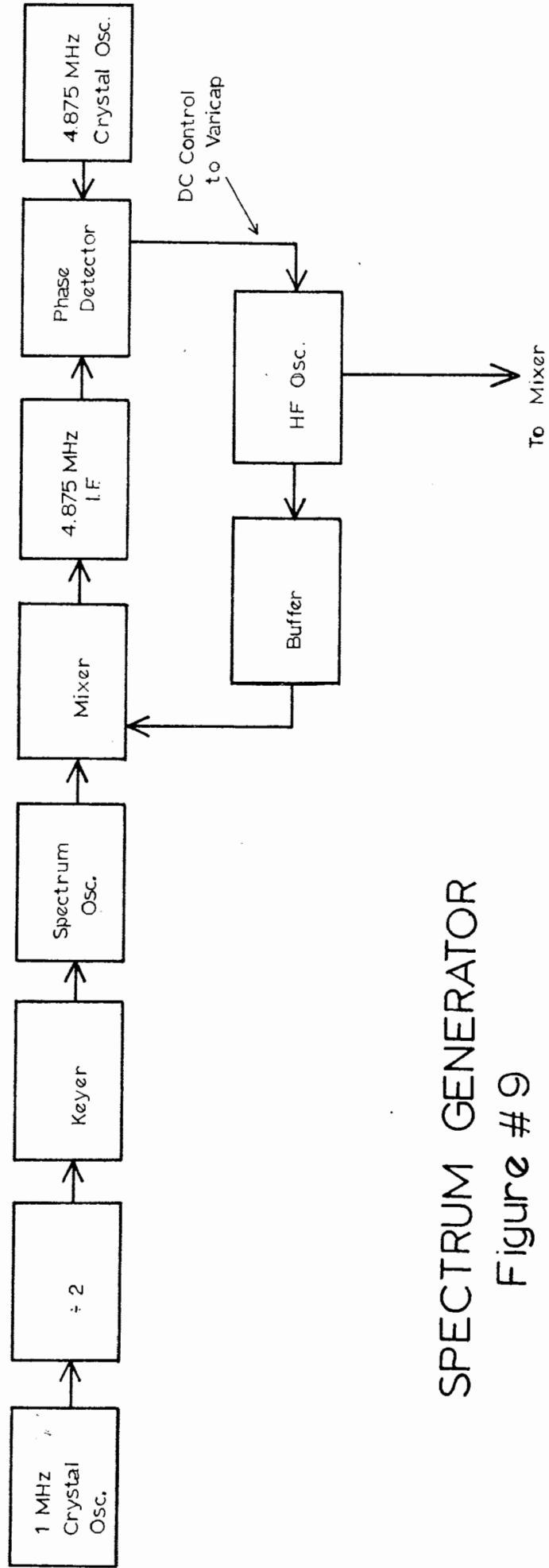
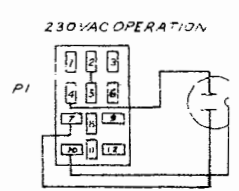
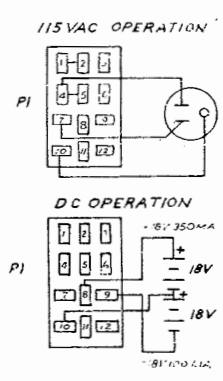
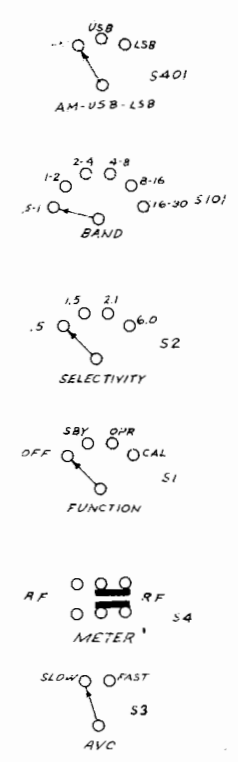
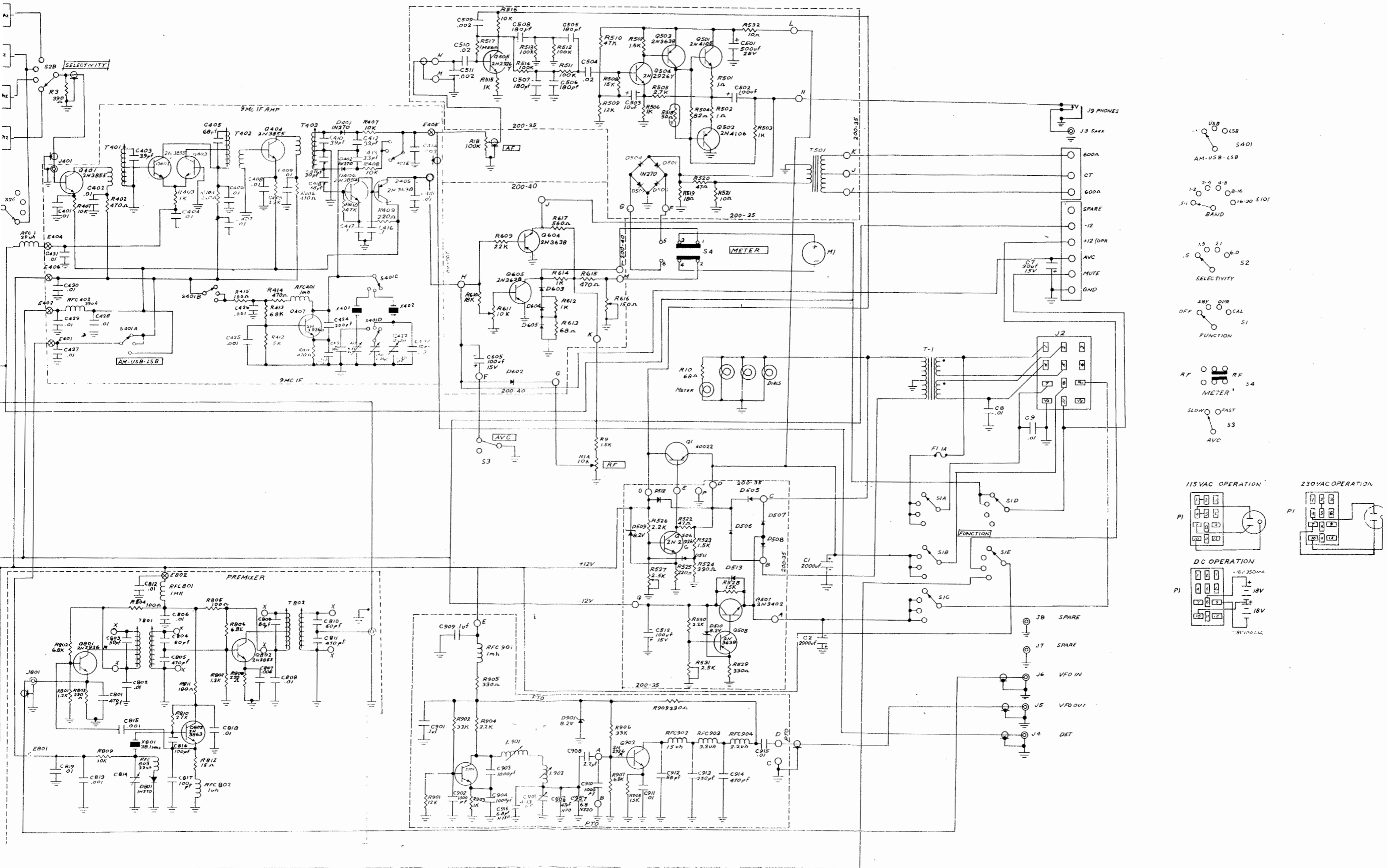

Figure #8



SPECTRUM GENERATOR  
Figure # 9





GALAXY R530 Recv'r

