

62

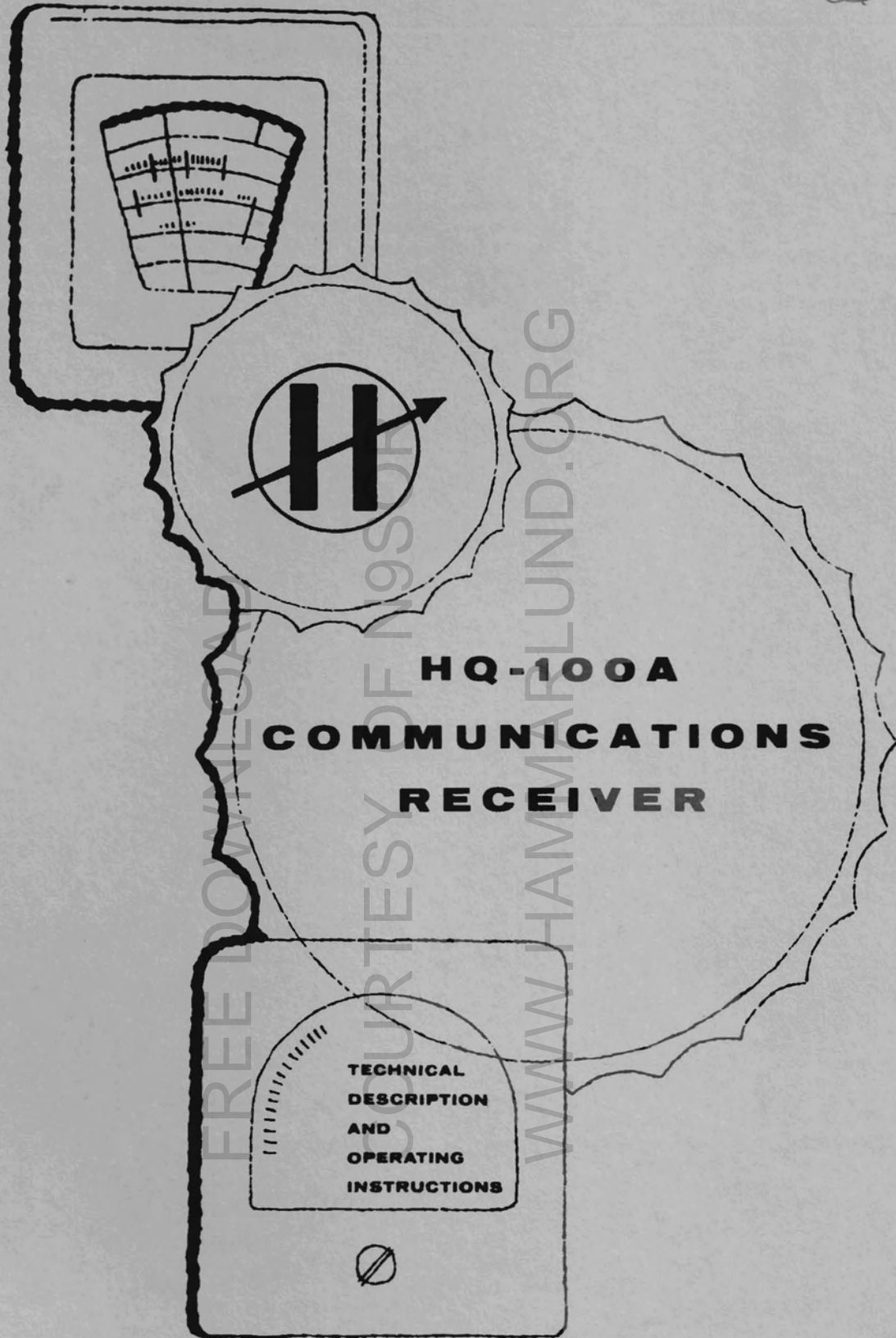

**HQ-100A
COMMUNICATIONS
RECEIVER**

**TECHNICAL
DESCRIPTION
AND
OPERATING
INSTRUCTIONS**

HAMMARLUND

Hammarlund Manufacturing Company
A Giannini Scientific Co.
73-88 HAMMARLUND DRIVE
MARS HILL, NORTH CAROLINA



THE HQ-100A SERIES COMMUNICATIONS RECEIVERS

INSTRUCTION AND SERVICE INFORMATION



ESTABLISHED 1910

ISSUE 3

In order to receive the full unconditional 90-day warranty against defective material and workmanship in this receiver, the warranty card must be filled out and mailed within two weeks of purchase. Please refer to serial number of warranty in correspondence.

THE HAMMARLUND MANUFACTURING CO.
73-88 Hammarlund Drive
Mars Hill, North Carolina 28754



Figure 1. The HQ-100A Receiver

TUBE AND DIODE COMPLEMENT

Symbol	Type	Tube	Function
V1	6BZ6	Pentode	RF Amplifier
V2	6BE6	Pentagrid Converter	Mixer
V3	6C4	Triode	HF Oscillator
V4A	1/2 12AX7	Triode	First AF Amplifier
V4B	1/2 12AX7	Triode	Q-Multiplier
V5	6BA6	Remote Cutoff Pentode	First IF Amplifier
V6	6BA6	Remote Cutoff Pentode	Second IF Amplifier
V7	6BV8	Twin Diode, Triode	Detector, Series Noise Limiter, BFO
V8	6AQ5	Beam Power Amplifier	Audio Power Output
V9	OB2	Gas Filled Diode	Voltage Regulator
CR1	Cer 72c	Diode, Silicon	Rectifier
CR2	Cer 72c	Diode, Silicon	Rectifier



INTRODUCTION

The Hammarlund HQ-100A is an all-new communications receiver representing entirely new concepts in electrical and mechanical design. It will provide years of top performance with minimum maintenance. The HQ-100A series receivers have a self-contained power supply and a universal transformer capable of operation from a 117 volt 60 cp/s or 220/230 volt 50/60 cp/s source, provided the proper adapter plug (P2) is installed.

The HQ-100A is a superheterodyne receiver with a frequency coverage continuously tunable from 540 KCS to 30 MCS with extremely fine control in separation of crowded signals. A very high signal-to-noise ratio plus the famous Hammarlund noise limiter circuit, permits full use of the receiver's excellent sensitivity on the weakest signals. A Q-Multiplier is provided for varying the selectivity of the receiver.

Red segments on the main tuning dial indicate wherein the majority of the international short wave stations can be located.

Electrical band spread tuning is provided with direct calibration every 10 KCS on 80, 40, and 20 meter bands; every 20 KCS on the 15 meter band and every 50 KCS on the 10 meter band. In addition, an arbitrary band spread logging scale is provided for use throughout the tuning range of the receiver. CB Channels are also indicated.

A new audio output circuit feature is the Auto-Response which automatically narrows and widens the frequency range of the audio output, depending upon the gain required. This feature permits the receiver to be used as a high-fidelity receiver on stronger signals, while providing the sharp cutoff required in receiving communication signals. A second advantage of the Hammarlund Auto-Response is the rapid damping of the audio power in the speaker voice coil which greatly minimizes undesirable speaker "hangover." The receiver may be used with either speaker or headphones. Fast acting AVC maintains a constant audio level. Adequate filtering practically eliminates AC power ripple.

The HQ-100A is equipped with a stable beat frequency oscillator which provides the operator with a continuous range of audio tones when receiving telegraph code signals, or excellent single-side band reception.

An "S" meter is provided to obtain accurate reading on received phone signals and to assure "on-the-nose" tuning. A send-receive switch is provided to silence the receiver while transmitting.

Large, comfortable controls in logical groupings are provided for greatest operating ease. The new futuristic front panel is clearly marked to permit full attention to the operating at hand.

The HQ-100A was designed with you in mind. You'll have many hours of pleasure and use in operating this truly fine communications instrument.

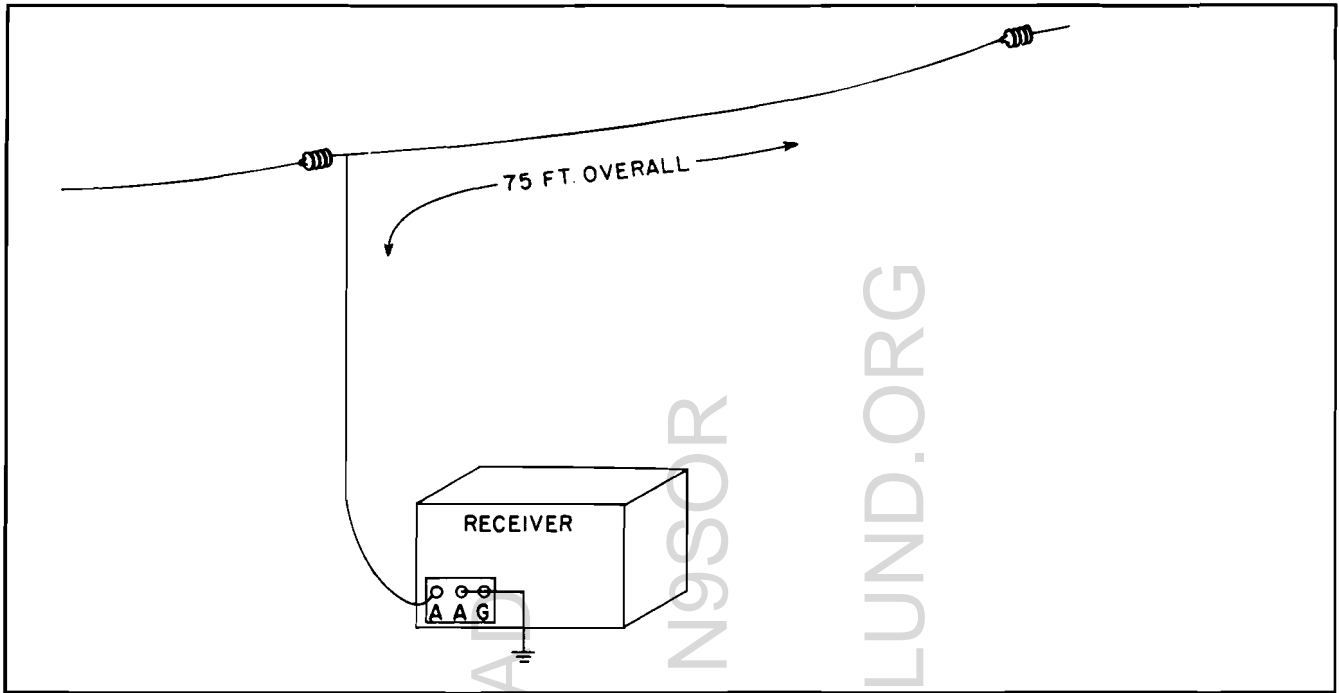
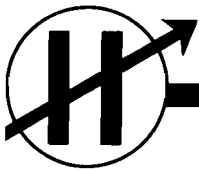

Figure 2. Installation of Single-wire Antenna

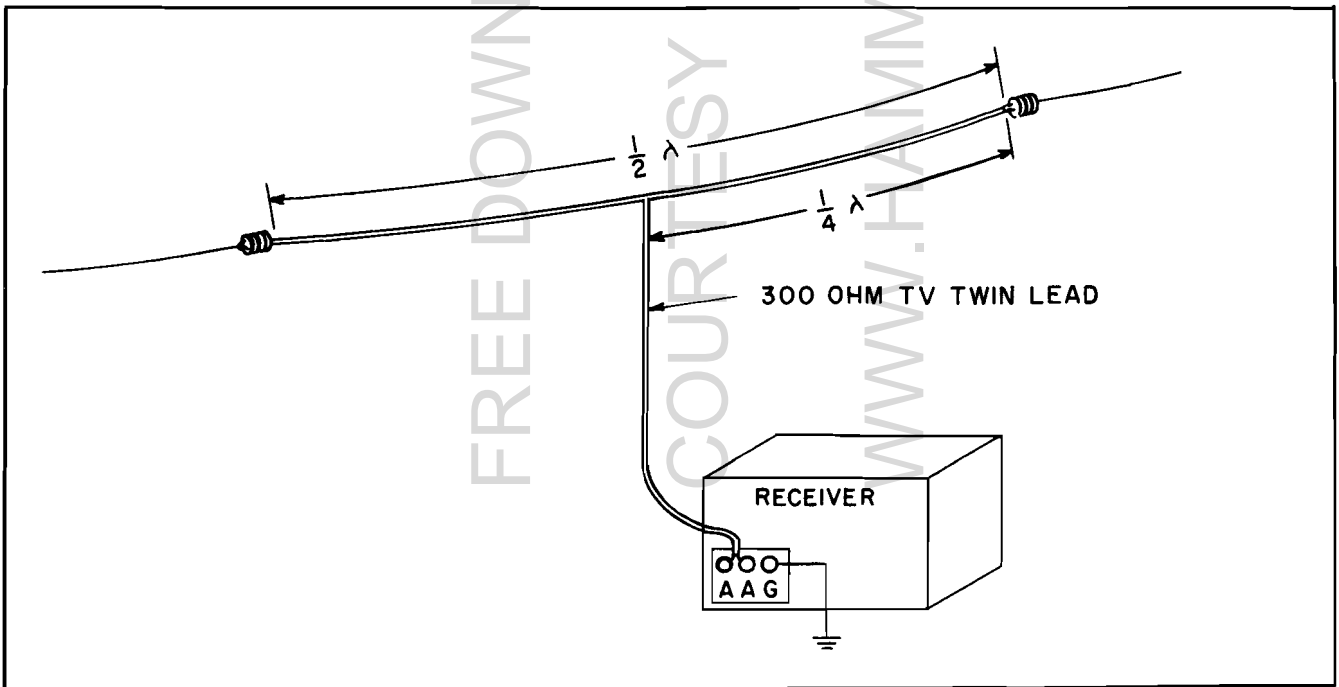

Figure 3. Installation of Folded Dipole Antenna



INSTALLATION

UNPACKING

Unpack the receiver carefully. Make sure the tubes, associated tube shields and pilot lamps are in place.

SPEAKER CONNECTION

Connect a 3.2 ohm permanent magnet dynamic speaker (Hammarlund S-100 Speaker) to the two terminals marked SPKR. on the rear of the chassis. (Note Figure 4). For best performance do not place speaker on top of receiver cabinet.

POWER CONNECTIONS

Before inserting attachment plug into power outlet, make certain power source is of proper voltage and frequency. (Refer to paragraph one of INTRODUCTION.)

INSTALLING ANTENNA

The HQ-100A is designed to operate with a single wire or a balanced type antenna. The front panel antenna trimmer control (Figure 5) permits a good match to most antennae systems of 50 to 600 ohms.

For general coverage, single wire antennae of 20 to 50 feet length will provide surprisingly good recep-

tion. A long single wire outdoor antenna, such as shown in Figure 2, will generally provide entirely satisfactory performance. This wire may be 50 to 150 feet long.

For best reception, the antenna should be isolated as much as possible from neighboring objects and at right angles to power lines or busy highways so as to minimize possible interference pickup.

Optimum performance on a particular amateur band or other narrow tuning range will be obtained by using a tuned half-wave dipole or folded dipole fed with 300 ohm transmission line or other suitable lead-in, as shown in Figure 3.

To tune the one-half wave length dipole, the following formula for the length of the antenna may be used:

$$\text{Length (feet)} = \frac{468}{\text{Freq. (MCS)}}$$

Each half (1/4 wave length) is half the length found from the above formula.

A good ground, although not always necessary, will generally aid in reception and reduce stray line hum. Reversal of polarity of power cord plug may possibly further reduce line hum in some locations.

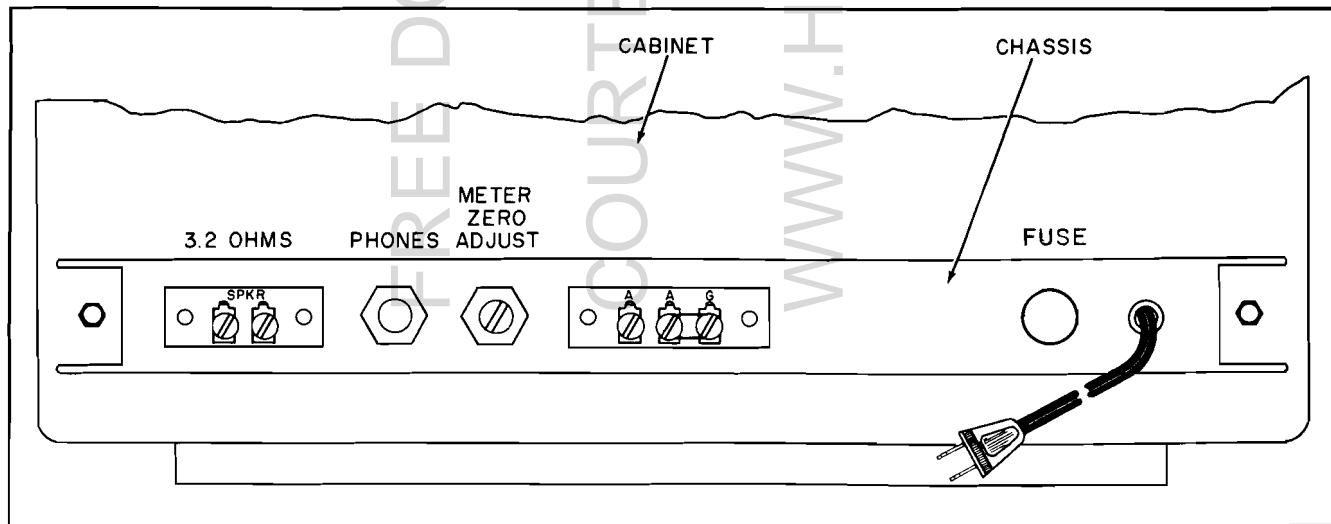
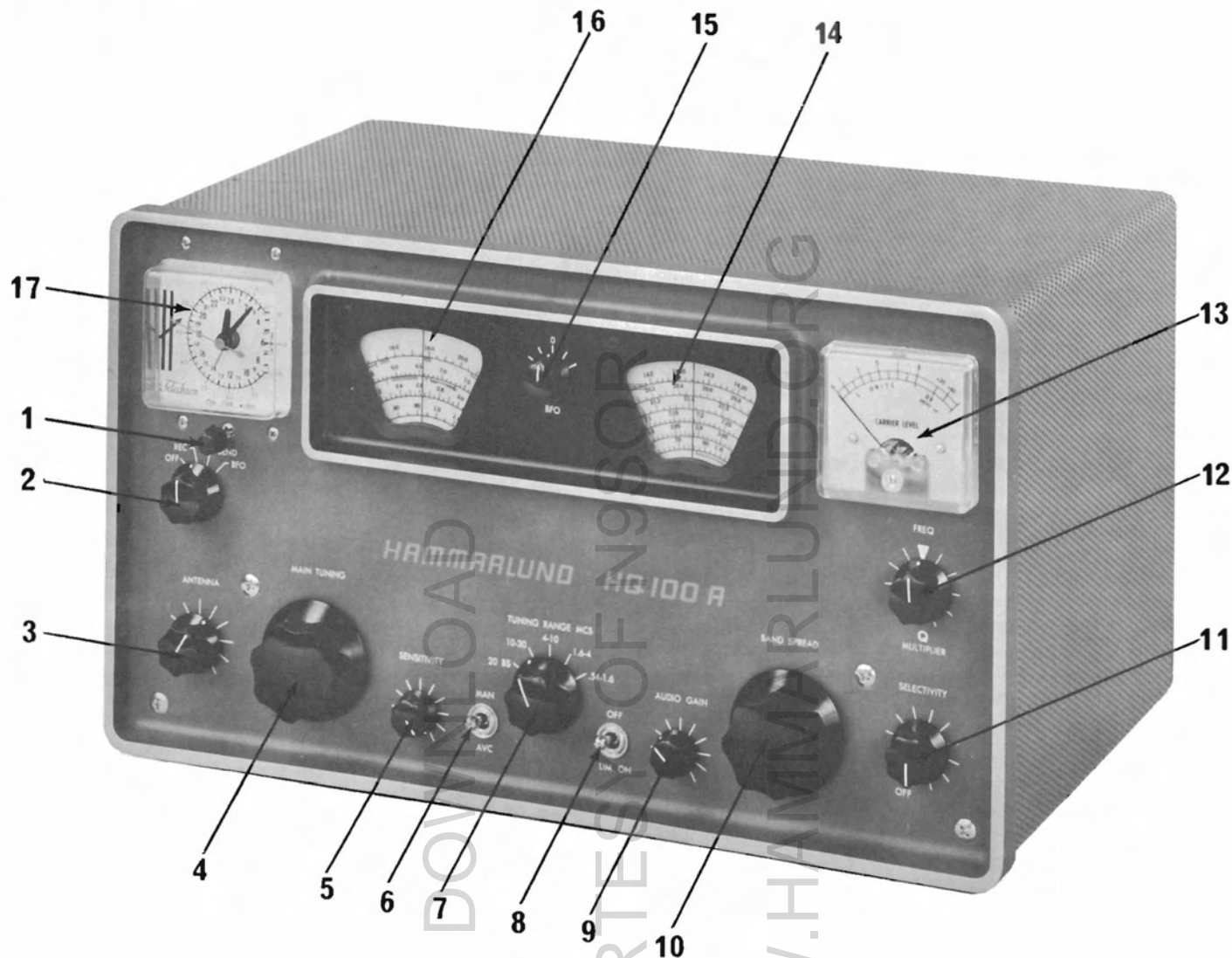

Figure 4. Connection Points at Rear of Chassis



INDEX
NO.

CONTROL

- 1 Automatic Clock-Timer Control
- 2 Function Switch
- 3 ANTENNA Trimmer
- 4 MAIN TUNING Control
- 5 SENSITIVITY Control
- 6 MAN. -AVC Switch
- 7 Band Selector Switch
- 8 Noise Limiter Switch

INDEX
NO.

CONTROL

- 9 AUDIO GAIN Control
- 10 Electrical BAND SPREAD Control
- 11 SELECTIVITY Control, Q - Multiplier
- 12 Frequency Control, Q - Multiplier
- 13 "S" Meter
- 14 Electrical Band Spread Dial
- 15 BFO Frequency Control
- 16 Main Tuning Dial
- 17 Telechron Automatic Clock-Time.

Figure 5. Location of Controls

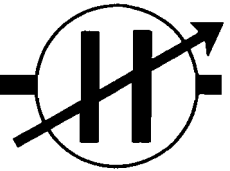

OPERATION

Basically, all that is necessary to operate a radio receiver are the tuning and volume controls. The additional controls found on the front panel of a communications receiver such as the HQ-100A, control functions which greatly improve operating performance and make possible reception of otherwise unintelligible signals.

NORMAL CONTROL SETTINGS

For "normal" operation such as broadcast, short wave listening, etc., the position of the various controls should be as follows:

- Function Switch Receive (REC.)
- ANTENNA Trimmer Tune for highest "S" meter reading on signal.
- MAIN TUNING Control Tune for highest "S" meter reading on signal.
- SENSITIVITY Control Fully clockwise
- MAN. -AVC Switch AVC
- Band Selector (TUNING RANGE MCS) Switch Set to desired frequency range.
- Noise Limiter Switch OFF
- AUDIO GAIN Control Adjust for proper level.
- BAND SPREAD Control Set counterclockwise to "100" on band spread dial.
- SELECTIVITY Control OFF
- Frequency (FREQ.) Control Set pointer to triangular marking.

CODE SIGNAL RECEPTION

For reception of code signals, the controls should be set as follows:

- Function Switch BFO
- ANTENNA Trimmer Peak for maximum output on "S" meter.
- MAIN TUNING Control Peak for maximum output on "S" meter.

- SENSITIVITY Control Adjust for desired output level.
- MAN. -AVC Switch Manual (MAN.)
- Band Selector (TUNING RANGE MCS) Switch Set to desired frequency range.
- Noise Limiter Switch OFF or ON as required by local noise conditions.
- AUDIO GAIN Control 2/3 to 3/4 clockwise rotation.
- SELECTIVITY Control ON position
- BFO FREQ Control Tune signal to zero beat with pointer on zero and then offset either left or right for desired pitch.

FUNCTION SWITCH

Three operating and an OFF position are provided. For AM reception the REC position is used. CW or SSB signals may be received with the FUNCTION switch on BFO. If the receiver is used with a transmitter the switch should be in the SEND position.

SINGLE SIDE BAND OPERATION

The setting of the controls for Single Side Band reception is the same as for CW reception with the BFO being used for carrier reinsertion. The BFO frequency control should be set approximately 2-1/2 divisions to the left or right of the zero indice, depending upon whether the upper or lower sideband intelligence is desired. Final tuning should be accomplished with the BAND SPREAD control in order that proper speech registry be achieved.

BAND SPREAD OPERATION

The BAND SPREAD control may be used for fine tuning by setting it at approximately 90 on the band spread

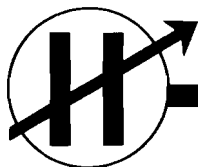

dial and tuning in the signal with the MAIN TUNING control. Final peaking of the signal is then accomplished by adjustment of the BAND SPREAD control. It should be understood that the setting of the BAND SPREAD control will affect the Main Dial calibration in that a higher frequency setting of the main tuning dial will be required. Rotating the band spread dial from 100 toward 0 tunes the receiver to a lower frequency.

For Band Spread operation in the amateur bands, the following procedure must be followed: The main tuning dial is set to the line marking the high frequency (right-hand end) of a given amateur band. The Band Spread tuning and calibration may then be accomplished solely with the BAND SPREAD control and dial.

20BS SWITCH POSITION

A separate switch position is provided on the TUNING RANGE control for spreading the 20-meter band. This switches in another band spread capacitor for optimum spreading of this band.

TELECHRON AUTOMATIC TIMER

If your receiver is equipped with the built-in 24 hour Telechron Automatic Clock-Timer, the following instructions should be noted:

Every radio-frequency device is stable only at pre-determined operating temperatures. In order to elim-

inate waiting for receiver to warm-up to operating temperature, the Telechron Timer automatically turns on the receiver ahead of anticipated operating time. This is accomplished by setting the hand of the timer (small knob at rear of receiver) to approximately one-half hour before operating hour. The front panel control under Timer is then set to "Auto" position. The function switch is set to REC. The receiver is then automatically turned on at the desired time.

The clock hands are set by the rear knob. Push in on the knob to set the switch timing hand and pull out on the knob to set the clock hands. The front switch is set to AUTO and the operation switch is set to REC. when it is desired to use the automatic clock switch for pre-warming the receiver before operation or for use as an alarm to turn the receiver on to a pre-tuned station. To use the operation switch normally, the clock switch should be left in the ON position.

The clock will continue to run as long as the receiver line cord is connected to the power outlet, and is extremely useful for checking sign-in periods and schedules.

If your receiver is not equipped with the Telechron Automatic Clock-Timer, and you would care to have the accessory added, clock kits, with full installation instructions, may be had by writing

Hammarlund Manufacturing Co.
73-88 Hammarlund Drive, Mars Hill, North Carolina
or by contacting the nearest Hammarlund dealer.

POSSIBLE RECEIVER DIFFICULTIES

1. If, upon turning the function switch from "off" to "receive" position, the dials are not illuminated and the receiver fails to operate after two minutes, this indicates that the clock timer switch just above the function switch is not in the proper position. This switch should always be in the ON position unless auto timer is employed.
2. Excessive hum or failure of the Q multiplier to operate properly will usually be due to a defective 12AX7 type tube. Such a defective tube may test good in a tube tester but be unsatisfactory because of higher than normal heater-to-cathode leakage. Poor noise limiter action is usually due to a poor or defective 6BV8 type tube. The use of the noise limiter will result in some distortion which must be tolerated for most efficient noise limiting. Because of this,, when listening to broadcast stations or other strong local signals, the noise limiter switch should be in the "off" position unless the slight distortion is preferable to excessive pulse type noise, such as ignition interference.
3. Erratic S meter performance, lack of sufficient variation, etc., is usually due to the two 6BA6 tubes employed in the S meter circuit. These are the two 6BA6 tubes, V5 and V6, in the schematic diagram. Merely interchanging these tubes will sometimes provide sufficient improvement. Replacing one or both may be found advisable before suspecting other troubles.
4. Excessive drift, after allowing sufficient time for warm up, may be due to a poor type 6C4 tube, V3, in the diagram or 6BE6, V2, in the schematic diagram.

Ninety-nine percent of all receiver trouble has been found to be due to one or more defective tubes. This can undoubtedly be attributed to the rough handling equipments receive in shipment. Please, therefore, be sure to follow the above suggestions in addition to having all tubes tested before writing the Home Office.



CIRCUIT THEORY

The HQ-100A basically a single conversion, four-band, superheterodyne receiver with a noise limiter. Its circuitry incorporates a Q-Multiplier for full control of selectivity and a stable, beat frequency oscillator.

PRESELECTION

The antenna input coupling and RF amplifier stage provide the necessary preselection and gain for high performance and rejection of undesired signals. The high signal level at the mixer grid, V2, contributes to a favorable signal-to-noise ratio.

Both grid and plate circuits of the RF stage are tuned; individual tuning coils are selected for each band.

The antenna compensating capacitor, adjustable from the front panel, permits the receiver to be resonated for optimum performance with the particular antenna in use.

CONVERTER STAGE

A high degree of oscillator stability is attained by the use of a separate mixer (6BE6), V2, and an independent oscillator (6C4), V3.

The output signal from RF amplifier V1 is heterodyned with the output of the local high frequency oscillator, V3, and electronically combined within the mixer tube, V2. On the four frequency ranges the local oscillator is 455 KCS above the signal frequency.

Low-loss tube sockets, low-loss, phenolic temperature compensating capacitors, and stable, coaxial trimmers all contribute to oscillator stability. Additional frequency stability is attained by applying regulated voltage to the oscillator circuit and by the rugged construction of the entire HF oscillator section assembly.

Q MULTIPLIER

The Q-Multiplier frequency control provides a means of peaking any signal within the pass band of the IF amplifier. The degree of peaking is controlled by the SELECTIVITY control. This same SELECTIVITY control when turned completely counter-clockwise disconnects the Q-Multiplier.

If interference is experienced, either between stations close to one another or from an interfering SW signal, gradually advance the Q-Multiplier selectivity control from its normally off or extreme counterclockwise position. This will result in increased selectivity by producing a spike of narrow bandwidth that is adjustable from approximately 3 KCS to 100 cycles in width. The narrowest bandwidth being obtained by adjustment of the Q-Multiplier selectivity control to the point just below that which would cause the Q-Multiplier to break into self-oscillation as evidenced by the receiver blocking with a resultant loss of volume.

The Q-Multiplier is generally never employed on the standard broadcast band or when short wave broadcast stations are being received. The use of the Q-Multiplier under these circumstances will only result in limiting the frequency response of the broadcast band and short wave broadcast stations in view of the very narrow band width that is provided by the Q-Multiplier. Of course, the SELECTIVITY control will make it possible to control this response characteristic. If, by chance, when receiving foreign short wave broadcast stations interference is experienced caused by two stations operating very close to one another, the Q-Multiplier may be employed under these circumstances to minimize, if not eliminate, the interference by the improved selectivity or decreased band width proper adjustment will provide. The proper use of the Q-Multiplier can actually enhance many times the result obtained with this receiver. In view of this, it is suggested that a little time be spent in learning just how to properly adjust the Q-Multiplier frequency and selectivity controls under different receiving conditions. As the Q-Multiplier SELECTIVITY control is advanced, a decided decrease in noise will be apparent. This is due to the narrowing of the pass band. On AM phone signals this control will usually be between the 7 and 11 o'clock positions. The FREQUENCY control should then be adjusted for clarity of signal or for minimum adjacent channel interference. The SELECTIVITY control may be advanced progressively more for SSB and CW reception. The more this control is advanced, the more critical the setting of the FREQUENCY control becomes. Advancing the SELECTIVITY control too far will cause the Q-Multiplier to oscillate. This should be avoided. The Q-Multiplier is a very handy tool in the hands of an experienced operator and, unfortunately, it is beyond the scope of this instruction manual to attempt to be more definite than we have.

IF AMPLIFIER

Seven, stable tuned circuits, in two stages of IF amplification (V5 and V6), contribute to sensitivity and selectivity. Iron core permeability-tuned transformers improve performance and add to the ease of adjustment. The intermediate frequency is 455 KCS, the EIA standard.

AVC SYSTEM

Automatic Volume Control minimizes fading and signal strength variations by controlling the gain of the RF stage V1 and the IF stage V5. As a result, a comfortable and constant level of audio is maintained.



"S" METER (CARRIER LEVEL)

The "S", or Tuning, Meter is provided to assist in tuning and to give an indication of relative signal strength. Because the meter reading are proportional to AVC voltage, it is operative only in the AVC position.

The meter, which is calibrated to 40 db over S-9, is factory adjusted so that a signal input of approximately 50 microvolts gives a reading of S-9. Each "S" unit indicates a 6 db increase, equivalent to doubling signal strength. Should meter readjustment be necessary:

1. Set function switch to REC.
2. Set front panel SENSITIVITY control to "10" and Q-Multiplier SELECTIVITY control to OFF.
3. With receiver off, mechanically zero pointer with a fine screwdriver.
4. With AVC on and the ANT. terminals shorted, zero pointer with ZERO ADJ potentiometer R-15.

DETECTOR AND NOISE LIMITER

One diode section of the 6BV8 tube, V7, is used for the second detector and AVC system. This system produced a minimum of distortion.

The other diode of V7 operates as a series, self-adjusting noise limiter. It will reduce automobile

ignition and other types of impulse noise to a minimum. Intelligibility is not affected by the noise limiter, although it may be switched off if desired.

BEAT FREQUENCY OSCILLATOR (BFO)

The BFO is activated by the FUNCTION switch for reception of CW or SSB signals or as an aid in locating weak SW broadcast stations. The BFO control is used under these conditions to vary the pitch. Each calibration division of this control represents approximately 1000 cycles. When receiving single side band transmission, the generally accepted procedure of setting the beat frequency oscillator approximately 1000 cycles above or below zero beat should be employed. In other words, if the beat frequency oscillator FREQ. control is set one degree clockwise or counterclockwise from the center position, optimum single side band reception will usually be obtained. Whether the beat frequency oscillator control will be set clockwise from zero beat will depend on whether upper or lower side band is being transmitted. If the beat frequency oscillator is on the wrong side of zero beat, it may be impossible to obtain intelligibility of the single side band signal when the band spread dial is tuned very slowly through the single side band signal. Should such a condition arise, merely rotate the FREQ. control from the one degree counterclockwise to the one degree clockwise position and then very carefully adjust the BANDSPREAD for intelligible speech. The BFO frequency control may also be

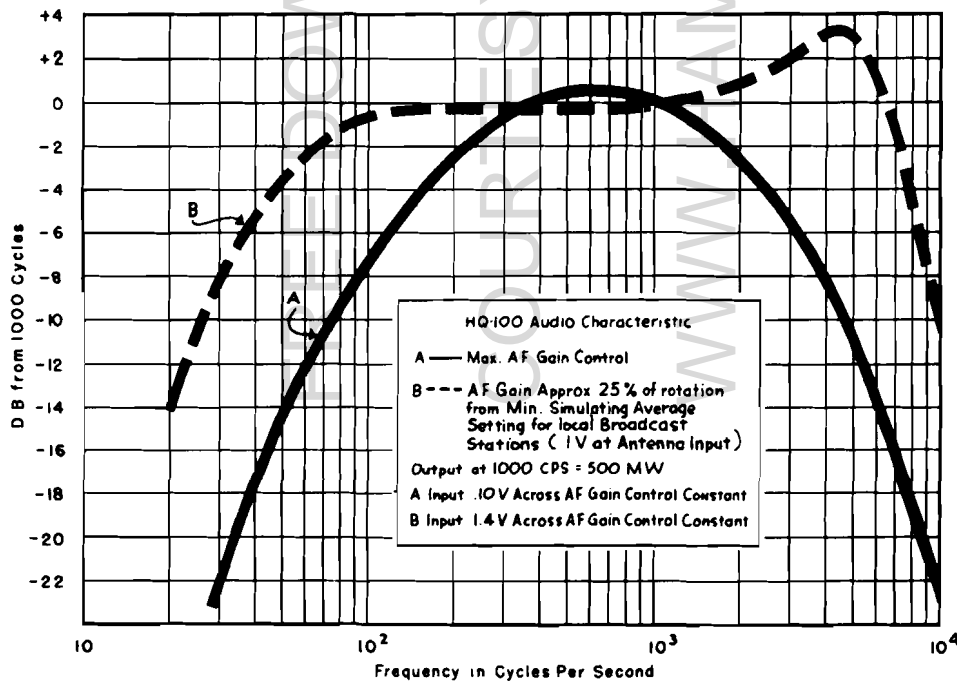

Figure 6. Auto-Response Curve



employed as a fine tuning adjustment to obtain desired speech quality. Here again experience is the best teacher. The stability of both the high frequency oscillator and the beat frequency oscillator employed in this receiver plus the excellent mechanical rigidity will provide excellent single side band reception. Refer to the paragraph on the Q-Multiplier operation for increase selectivity or narrowing of the passband usually permissible with CW and sideband reception.

It may be found desirable to place the function switch on BFO while tuning to aid in locating weak signals. As a result of activating the BFO, each carrier tuned in will produce a beat note or whistle easily discernable. If a phone signal is located in this manner, adjust the bandspread tuning control for the lower pitch tone or zero beat. This will result in centering the desired phone signal and now placing the function switch on REC will allow for normal AM operation.

AUDIO AMPLIFIER

The first audio stage is a resistance coupled voltage amplifier employing the other section of the 12AX7 (V4B). The audio output stage is a 6AQ5 beam power amplifier (V8) providing an undistorted output level of at least one watt.

A feature of the audio system is the variable negative feedback employed (see Auto-Response Curve, Figure 6). Maximum feedback is provided at low settings of the AUDIO GAIN control for the fine quality reception of local broadcast and strong short wave stations. As the AUDIO GAIN control is increased, the feedback decreases so that on reception of weak signals additional selectivity is provided by the audio section. This results in an increased signal-to-noise ratio. A further advantage is the critical damping of the speaker for elimination of speaker "hangover". This upgrades the reception of speech and music and decreases the noise output of the receiver. A further advantage is the reduction of distortion at lower settings of the AUDIO GAIN control.

ACCESSORIES

Now you can get even more out of your HQ-100A receiver!

The XC-100 Crystal Calibrator is available, providing checkpoints every 100 KCs within the range of the receiver.

The kit is quickly and easily installed. It is complete with easy-to-follow instructions, operating switch and mounting hardware.

This is not usually required by the average short wave listener, although it will prove an aid as a means of correcting for possible dial error.

The amateur operator will find this of most value since the 100 KCS checkpoints this unit provides, will make it possible to accurately set amateur band edges. This will result in improving the accuracy of the amateur band spread dial, by determining the exact setting of the main tuning dial.



SERVICE AND REALIGNMENT PROCEDURE

NOTE

To service this receiver, disconnect from power source and remove all leadwires attached to terminal connections at rear of chassis apron. Carefully turn the receiver up onto the front panel face on a smooth clean surface. Remove the two #10 hex machine screws at the extreme ends of the chassis apron at the rear of the cabinet, and the knob from the clock adjustment shaft if receiver is so equipped. Lift cabinet straight up and off of chassis. To reassemble, use reverse procedure.

ANTENNA ADJUSTMENTS

ADJUST SLUG AT 4MC
WITH ANT. CAPACITOR
NEAR MID. CAPACITY

ADJUST SLUG AT 1.2 MC
WITH ANT. CAPACITOR
NEAR MIN. CAPACITY

ADJUST SLUG AT 1.65 MC
WITH ANT. CAPACITOR
NEAR MID. CAPACITY

ADJUST SLUG AT 10MC
WITH ANT. CAPACITOR
NEAR MID. CAPACITY

IF ADJUSTMENTS

BOTTOM SLUG ADJUST
AT 1.65 MC FOR MAX.
AMPLITUDE

TOP SLUG ADJUST
AT 4MC BOTTOM
SLUG ADJUST AT
10 MC

1.5 4 10 30
TOP SLUG ADJUST AT
.6 MC BOTTOM SLUG
ADJUST AT 1.65 MC

TOP SLUG ADJUST AT
4MC BOTTOM SLUG
ADJUST AT 10 MC

RF ADJUSTMENTS

HF OSC. ADJUSTMENTS

Figure 7. Top View of Chassis



IF ALIGNMENT

NOTE

Use a non-metallic alignment tool such as General Cement Co. No. 5097, or equal.

- a. Connect the output cable of a 455 KCS unmodulated, signal generator to the bus lead of the 6BE6 mixer grid. The frequency accuracy of the generator may be checked with sufficient precision by picking up its second harmonic (910 KCS) in any receiver whose calibration at 910 KCS has been checked as correct and then adjusting the generator frequency.
- b. Connect a DC vacuum tube voltmeter, set for negative voltage reading to pin 8 of the V7, 6BV8 socket.

- c. Set the receiver controls as follows:

BAND SPREAD dial on 100
Function switch on REC.
Main tuning dial on .54 MC
Noise limiter switch on OFF
AUDIO GAIN control at minimum
SELECTIVITY control on OFF
Band selector switch on .54 - 1.6 MC
MAN. -AVC switch on MAN.
SENSITIVITY control on 3 from maximum.

- d. During alignment, adjust the generator output and the SENSITIVITY control to prevent overloading. Final adjustment should be made with the SENSITIVITY control at approximately the third indice from its maximum (clockwise) position. Adjust each of the three IF transformers for maximum meter reading. Topside adjustments (Figure 7) are secondaries or grid cir-

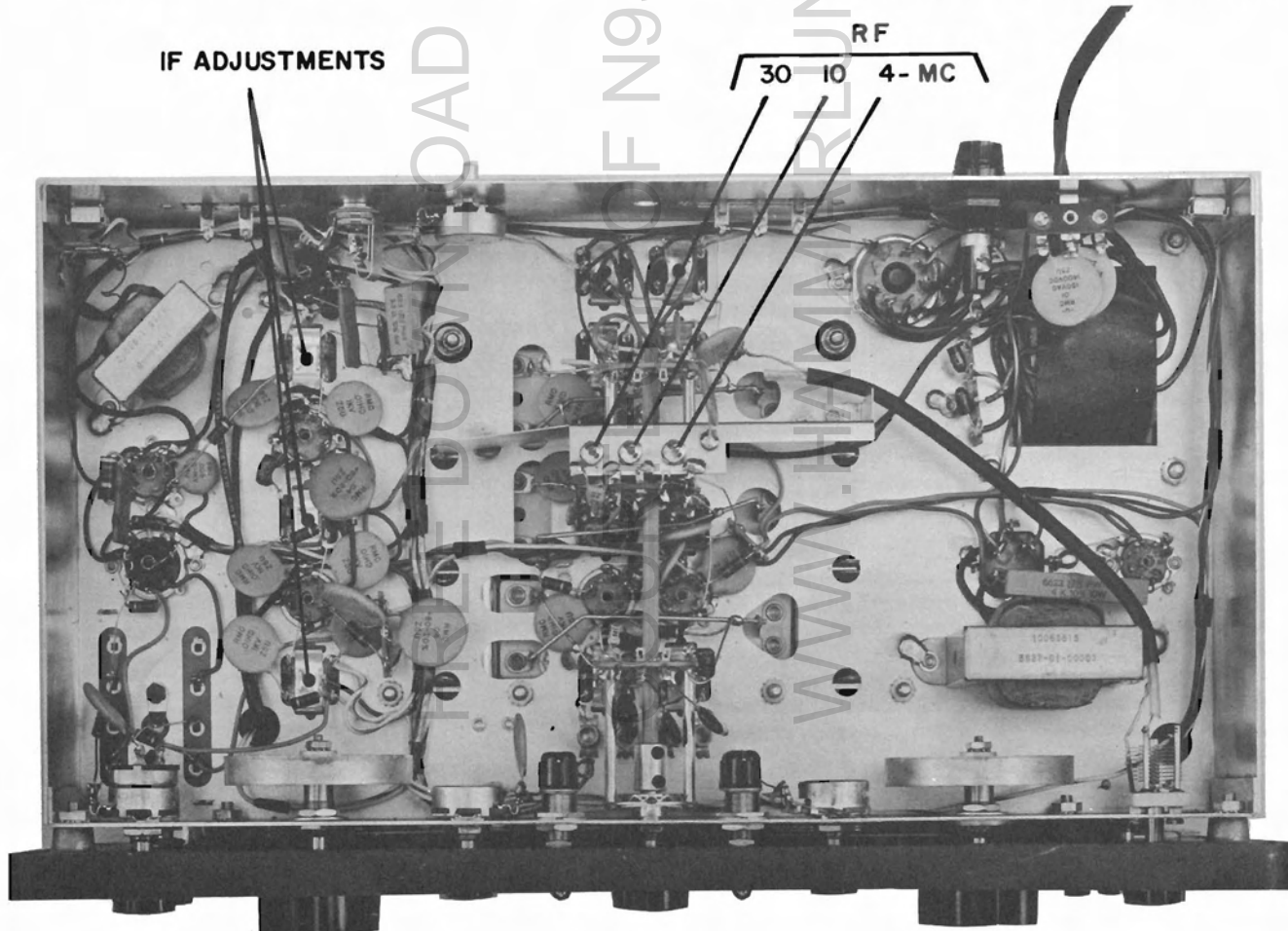
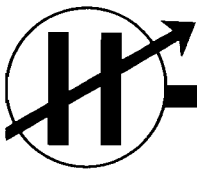

Figure 8. Bottom View of Chassis



cuits; bottom of chassis adjustments (Figure 8) are primaries or plate circuits.

- e. Turn the Q-MULTI. ON and adjust the SELECTIVITY control clockwise to a position below the oscillating point. With its panel bushing nut loosened to permit the frequency shaft to turn without hindrance by the stop, adjust the FREQ. control to obtain a maximum meter indication. The input signal must be adjusted to a value just sufficient to obtain a good meter swing. This adjustment is the center frequency of the pass band. While the meter is at maximum, turn the stop lug to a position 180 degrees directly opposite the stop pin in the frequency shaft. Holding it in this position, tighten the bushing in the nut making sure that the shaft or the stop lug have not turned by checking the zero setting.
- f. Turn FUNCTION switch to BFO. With the BFO frequency control on ZERO adjust the slug in L7 for ZERO beat with the AVC-MAN switch on MAN position and the SENSITIVITY control adjusted at a position below overload.
- g. With the MAN. -AVC switch on AVC, the SENSITIVITY control at maximum, with grid pin 1 of the V5 amplifier tube grounded, and with no signal input, adjust the METER ZERO ADJUST. pot at the rear of the chassis (Figure 4) for a reading of zero on the "S" meter.

RF ALIGNMENT

NOTE

Use a non-metallic alignment tool such as General Cement Co. No. 8282, or equal.

- a. The slugs and trimmers, having been factory adjusted, should require a minimum amount of adjustment for any realignment.
- b. All RF and oscillator slug adjustments are made from the top of the shield cans. See Figure 7.
- c. Connect the unmodulated, signal generator output cable to the antenna and ground terminals of the receiver, with the A terminal adjacent to the G terminal jumped together. See Figure 4.
- d. Set the controls the same as for IF alignment above. Adjust the SENSITIVITY control as required to obtain a sufficient voltmeter reading and to prevent overloading.
- e. The oscillator adjustment is made first. The RF is adjusted next to obtain maximum amplitude. The antenna slugs are adjusted last. A certain amount of interaction will occur between the oscillator and RF adjustments, particularly on the higher frequency bands. Final adjust-

ment should be accomplished by combined or alternate adjustment of the oscillator and RF for maximum amplitude.

NOTE

The trimmer adjustments, if required, should be the final adjustment for each band. See Figure 8 for location of trimmers.

There is no RF amplifier adjustment for the .54 - 1.6 MC band.

- f. Note that the oscillator frequency in the HQ-100 is always on the high side of the signal frequency by 455 MCS. Therefore, it is necessary to make sure that the oscillator frequency is not adjusted below the signal frequency which would be an image response of the signal.
- g. It will be necessary to repeat low and high end alignment adjustments of each band since the adjustments are interdependent. The process should be repeated until maximum amplitude is obtained at both alignment frequencies of each band.

NOTE

The receiver should be warmed up at least one-half hour before final oscillator frequency adjustments are made for the dial calibration check.

DIAL CALIBRATION

- a. Use a crystal calibrator having 100 KCS and 1000 KCS output. Set the arbitrary band spread dial scale to 100. Set the function switch to BFO. Set the BFO FREQ. control to zero. Set the SELECTIVITY control to OFF. Set the MAN. -AVC switch to MAN.
- b. Check to see that the frequencies at or near the alignment frequencies are "on the line." If not, make minor adjustments of the slugs and trimmers (Figures 7 and 8) to make them correct.

CAUTION

Weaker signals will be observed at dial settings approximately 10 KCS above each calibration dial marking. These are image signals from 1 MC above the desired signal and may be recognized by their somewhat weaker strength and may be further reduced by proper adjustment of the gain controls. They will, of course, be more noticeable on the higher bands. Keeping the antenna tuned will help.

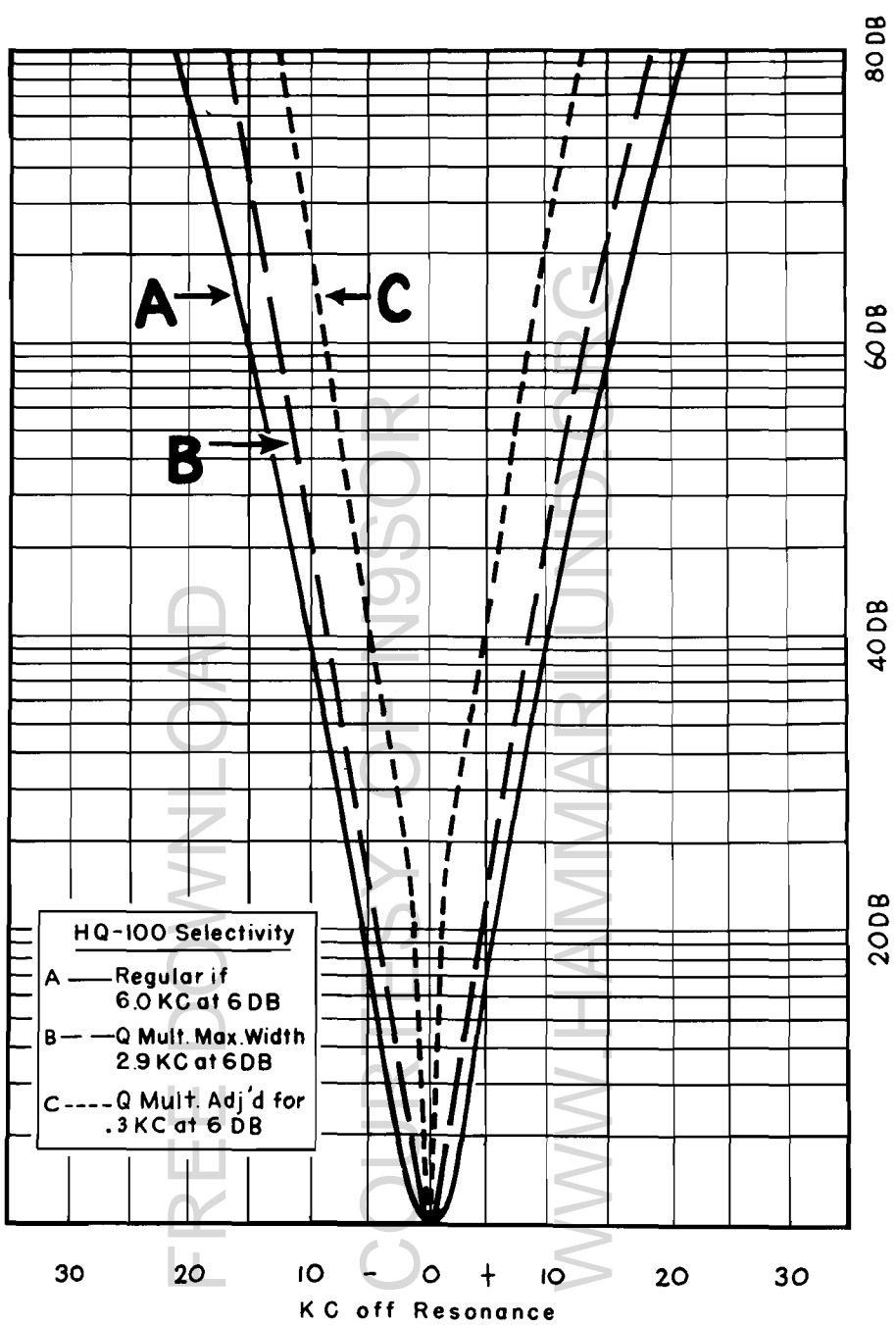

Figure 9. Selectivity Curves

TABLE 1. TUBE SOCKET VOLTAGES

MEASURED FROM TUBE SOCKET PINS TO CHASSIS WITH VTVM AUDIO GAIN MINIMUM. BAND SWITCH ON 10 TO 30 MC. LIMITER OFF. AVC-MAN SWITCH ON MAN. SENSITIVITY MAX. OPERATION SWITCH ON REC. Q-MULTIPLIER OFF. LINE VOLTAGE 117. NO SIGNAL INPUT.

TUBE SOCKET NO.	SOCKET PIN NUMBERS								
	1	2	3	4	5	6	7	8	9
V1 RF 6BZ6	-	1.8	6.3 AC	-	210	105	-	-	-
V2 MIXER 6BE6	-6	1.3	6.3 AC	-	205	70	-	-	-
V3 HFO 6C4	90	-	6.3 AC	-	90	-3 TO -9	-	-	-
V4 12AX7 Q MULT. 1st A-F	90	-	1.5	-	-	60	-	.5	6.3 AC
V5 1st IF 6BA6	-	-	6.3 AC	-	200	100	2.2 12 MIN SENS	-	-
V6 2nd IF 6BA6	-	-	6.3 AC	-	200	95	2.2 12 MIN SENS	-	-
V7 6BV8 DET LIM AVC BFO	-	-8 BFO ON	110 BFO ON	6.3 AC	1.2 AC	-.2 -9 BFO ON	-	-.2 -9 BFO ON	-.3 -10 BFO
V8 6AQ5 AUDIO OUTPUT	-	13	6.3 AC	-	210	205	-	-	-
V9 OA2 V-R	105	-	-	-	105	-	-	-	-

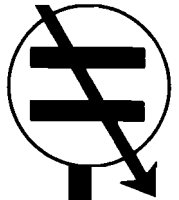
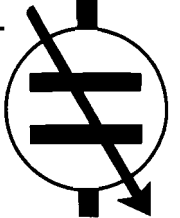

TABLE 2. TUBE SOCKET RESISTANCES

BAND SWITCH ON 10-30 MC. MEASURED FROM TUBE SOCKET PINS TO CHASSIS. AUDIO GAIN MAXIMUM.
 OPERATIONS SWITCH ON REC. BFO OFF. LIMITER ON. SENSITIVITY MAXIMUM. AVC-MAN ON MAN.

TUBE SOCKET NO.	SOCKET PIN NUMBERS								
	1	2	3	4	5	6	7	8	9
V1 RF 6BZ6	10K 2.4M ON AVC	180	0	0	.5 MEG	.5 MEG	0	-	-
V2 MIXER 6BE6	22K	180	0	0	.5 MEG	.5 MEG	0	-	-
V3 HFO 6C4	.5 MEG	INF	0	0	.5 MEG	47K	0	-	-
V4 12AX7 Q MULT. 1st AF	.5 MEG	2.2 MEG	6800 16K SEL OFF	0	0	.5 MEG	1 MEG	2200	0
V5 1st IF 6BA6	0 2.4M ON AVC	0	0	0	.5 MEG	.5 MEG	180 10K MIN SENS	-	-
V6 2nd IF 6BA6	470K	0	0	0	.5 MEG	.5 MEG	200 10K MIN SENS	-	-
V7 6BV8 DET LIM AVC BFO	0	100K	.5 MEG BFO ON	0	3.3	120 K	0	2.2 MEG 100K LIM OFF	190 K
V8 6AQ5 AUDIO OUTPUT	.5 MEG	430	0	0	.5 MEG	.5 MEG	.5 MEG	-	-
V9 OA2 V-R	.5 MEG	0	INF	0	.5 MEG	INF	0	-	-





PARTS LIST

Schematic Designation	Description	Hammarlund Part No.
CAPACITORS		
C1, A thru C	Variable, Main tuning	9441-60-40003
C2, A thru F	Variable, Bandsread	9441-60-40004
C3	Variable, Antenna Compensator	9434-45-40038
C4, 5, 6, 7, 8, 9, 10, 15, 19, 30, 31, 32, 34, 35, 36, 41, 48	Fixed, Ceramic disc .01 mfm 1000V	1509-01-01001
C11, 12, 13	Trimmer 1-8 mmf 500V	1527-01-00001
C16, 17, 18	Fixed, silver mica, 100 mmf 500V	1519-01-00001
C20, 21, 22, 23	Variable 1-8 mmf 500V	1527-01-00002
C24	Fixed, silver mica 430 mmf 300V	1519-02-03010
C25	Fixed, silver mica, 1300 mmf 500V	1519-02-03011
C26, 57	Fixed, silver mica, 3000 mmf 500V	1519-02-03009
C27	Fixed, silver mica, 1100 mmf 500V	1519-01-03001
C28	Fixed, silver mica, 3300 mmf 500V	1519-02-05001
C29	Fixed, silver mica, 510 mmf 500V	1519-01-03002
C33, 45, 46	Fixed, Ceramic disc, .04 mfm 600V	1509-01-01005
C38	Fixed, Three-section electrolytic	1517-01-00001
C38A	60 mfm 450V (Part of 1517-01-00001)	
C38B	40 mfm 450V (Part of 1517-01-00001)	
C38C	25 mfm 50 V (Part of 1517-01-00001)	
C42	Fixed, Ceramic disc, .005 mfm 1000V	1509-01-01003
C43, 44	Fixed, Ceramic disc, .01 mfm 1400 V	1509-01-01015
C47	Fixed, Discap, temperature compensating, 6.8 mmf	1509-01-00022
C49, 50	Fixed, Discap, temperature compensating, 2.7 mmf	1509-01-00001
C51	Fixed, Discap, temperature compensating, 6.8 mmf	1509-02-00003
C52	Fixed, Ceramic, temperature compensating	1509-01-02002
	non-insulated, 1.5 mmf	
C53	Fixed, Silver mica 5 mmf 10% 500V	1519-01-00003
C54	Fixed, Ceramic disc, 4.7 mmf 5% N220	1509-02-00024
C55	Fixed, Ceramic disc, .02 MFD 500V	1509-01-01016
C56	Fixed, Silver mica 350 mmf, 20% 100V	1519-02-00053
C58	Fixed, Silver mica 220 mmf 5% 500V	1519-01-00007
C59	Variable	9434-45-40038
C60	Fixed, Silver mica 2mmf ± .5 mmf, 500V	1519-01-00024
COILS		
L1	R. F. Coil Assembly (Bands 1 and 2)	1809-01-00005
L2	R. F. Coil Assembly (Bands 3 and 4)	1811-01-00011
L3	H. F. Osc. Coil Assembly (Bands 1 and 2)	1809-01-00006
L4	H. F. Osc. Coil Assembly (Bands 3 and 4)	1811-01-00012
L5	Coil and Ferrule Assembly	9001-03-00118
L6	Choke, Filter, 13 Henries at 65 ma D. C.	5626-02-00001
L7	BFO Coil	1804-02-00055
RESISTORS		
R1, 32	22 Ohms, 1/2W	4703-01-00312
R2	Potentiometer, 10,000 Ohms	4735-02-00001
R3	10,000 Ohms, 1/2W	4703-01-00344
R4, 10	1,000 Ohms, 1/2W	4703-01-00332
R5	22,000 Ohms, 1/2W	4703-01-00348
R6, 33	180 Ohms, 1/2W	4703-01-00323
R8	6,200 Ohms, 1/2W	4703-02-00466
R9, 34	47,000 Ohms, 1/2W	4703-01-00352



PARTS LIST

Schematic Designation	Description	Hammarlund Part No.
	RESISTORS (continued)	
R11	2.2 Megohms, 1/2W	4703-01-00372
R12	6,800 Ohms, 1/2W	4703-01-00342
R13	Potentiometer, 10,000 Ohms	4735-01-08002
R14, 16, 21, 29, 35	2,200 Ohms, 1/2W	4703-01-00336
R15	Potentiometer, 200 Ohms	4735-01-00200
R17	1,600 Ohms, 1/2W 5%	4703-02-00452
R19	180 Ohms, 1/2W 5%	4703-02-00429
R20	4,000 Ohms, 10W	4714-01-01002
R27	Potentiometer, 1 Meg	4735-01-00002
R28	47 Ohms, 1/2W	4703-01-00316
R30	100 Ohms, 1/2W	4703-01-00320
R31	430 Ohms, 1W	4704-02-00738
R36	10 Ohms, 1/2W	4703-01-00308
R37	470K Ohms 1/2W	4703-01-00364
R38	100K Ohms, 1/2W	4703-01-00356
R39	3.3 Ohms, 5W	4713-01-00001
R40	22 Ohms, 1W	4704-01-00612
	SWITCHES	
S1A, S1B	Switch Wafer RF	5105-01-00007
S1C	Switch Wafer HF Osc	5106-02-00005
S2	Power-On-Off, SPST (Part of R13)	
S3	OFF-REC BFO, Single Section, four position	5106-02-00007
S4	MAN. -AVC, SPST	5101-01-00001
S5	LIMITER, SPST	5101-01-00001
	TRANSFORMERS AND COIL ASSEMBLIES	
T1	Antenna Transformer Assembly (Band 1)	1809-01-00004
T2	Antenna Transformer Assembly (Band 2)	1810-01-00010
T3	Antenna Transformer Assembly (Band 3)	1811-01-00010
T4	Antenna Coil Assembly (Band 4)	1812-01-00012
T5, 6, 7	Transformer, 1st, 2nd, and 3rd I. F.	1811-01-00018
T8	Transformer, Output, Max power 5W, impedance match; 10,000 Ohms plate to 4 Ohms voice coil	5618-01-00002
T9	Transformer, Power, Primary 115V/230V	5603-01-00011
	MISCELLANEOUS	
CR1, 2	Diode, Silicon CER72C	4807-01-00001
F1	Fuse, 1 amp (115V Operation)	5134-01-00201
F1	Fuse, 1/2 amp (230V operation)	5134-01-00213
I1, 2	Lamp, pilot #47, 6.3V, .15A	3901-01-00001
J1	Phone Jack	2109-01-00001
M1	Meter "S" (Carrier Level)	2902-01-00003
P2	Adapter (115V)	9001-03-00028
P2	Adapter (230V)	9001-03-00029
	Telechron Clock Assembly (115V/60 cps)	9207-01-00001
	Telechron Clock Assembly (230V/60 cps)	9207-01-00002
	Telechron Clock Assembly (230V/50 cps)	9207-01-00003
	Crystal Calibrator XC-100	9205-00-00011

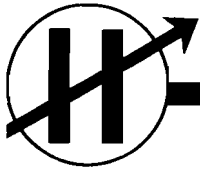

ADDITIONAL HINTS FOR THE NOVICE AND SHORT WAVE LISTENER

A voltage reading of 45 - 50 volts may be obtained between the chassis and a ground as the result of the two power line by-pass condensers that are connected across the power line with the center tap grounded. Since we are dealing with AC, these capacitors will look like resistors to a volt meter. This will also produce a slight shock if the chassis is not grounded, and one happens to contact a grounded object, and the chassis or any exposed part of the receiver. This also will account for a slight spark, if the receiver is connected to the power line and the ground connection is made. For protection a good ground should always be employed.

In using the receiver for CW, or with the BFO, it is absolutely necessary to take the receiver out of the AVC position and put it into the Manual position. Failure to do this will result in the receiver blocking and erratic action of the S meter. The S meter is only usable in the AVC position. When using BFO, the audio control should be used at 2/3 to 3/4 rotation clockwise position and the RF sensitivity control employed as a means of adjusting volume.

When employing the Q multiplier for phone use the function switch will, of course, be in the REC position and it is advisable to start with the Q multiplier selectivity control in the 10 to 12 o'clock position. If this control is advanced past approximately the 2 o'clock position, the Q multiplier may go into oscillation resulting in the blocking of the receiver. For use on phone the Q multiplier selectivity control, will also usually be employed between maximum counter clock wise position and approximately straight up. Beyond this point or even at approximately the straight up position the receiver is usually so selective that it is capable of wiping the modulation off the carrier by actually rejecting the side bands. For normal phone use or broadcast reception the selectivity control should always be employed in the OFF counter clock wise position, since this results in the operation of a switch which disconnects the Q multiplier from the IF system.

If it is desirable to use the BFO to locate a station when tuning for weak signals, after the carrier is tuned in, merely rotate the function switch from the BFO position to the Receiver position which will result in turning off the BFO for phone reception. If interference is experienced either between stations close to one another, or an interfering CW signal, turn the Q multiplier selectivity control. Gradually advance the Q multiplier selectivity control which will result in increasing the selectivity by producing a spike of narrow band width that is adjustable from approximately 3 kc to 100 cycles in width. This spike can be moved around within the IF pass band that is nominally approximately 6 kc wide. The frequency control is the means for varying the position of this spike. Assuming that the selectivity control is adjusted to produce a spike 1 kc wide and also assuming that the band width of the IF system is 6 kc wide, it can be appreciated that the shape of the IF system response curve can be varied by moving the 1 kc band width anywhere within the 6 kc band width. This will produce a valley on either side of the spike or peak. By proper tuning, therefore, of the band spread dial and the frequency control of the Q multiplier, it should be apparent that an interfering signal may be placed in a valley and the desired signal on the peak, with the net result of decreasing the strength or eliminating the signal that is in the valley, without seriously affecting the desired signal intelligibility.

Since the use of the Q multiplier naturally means narrower band width, it should only be employed when interference is present. Never use the Q multiplier on the broadcast band unless you are hunting weak DX signals and are therefore not after maximum fidelity response. The same, more or less, applies to short wave broadcast listening. Here the use of the Q multiplier in addition to functioning as previously described may also prove advantageous from a noise reduction standpoint as a direct result of the decreased band width.

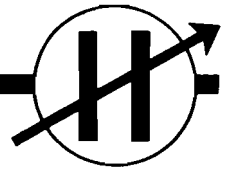

MEMORANDA

FREE DOWNLOAD

COURTESY OF N9SOR

WWW.HAMMARLUND.ORG

HAMMARLUND MFG. CO.
MARS HILL, N.C.

MODEL NO. HQ-100A-

TUBE LOCATION

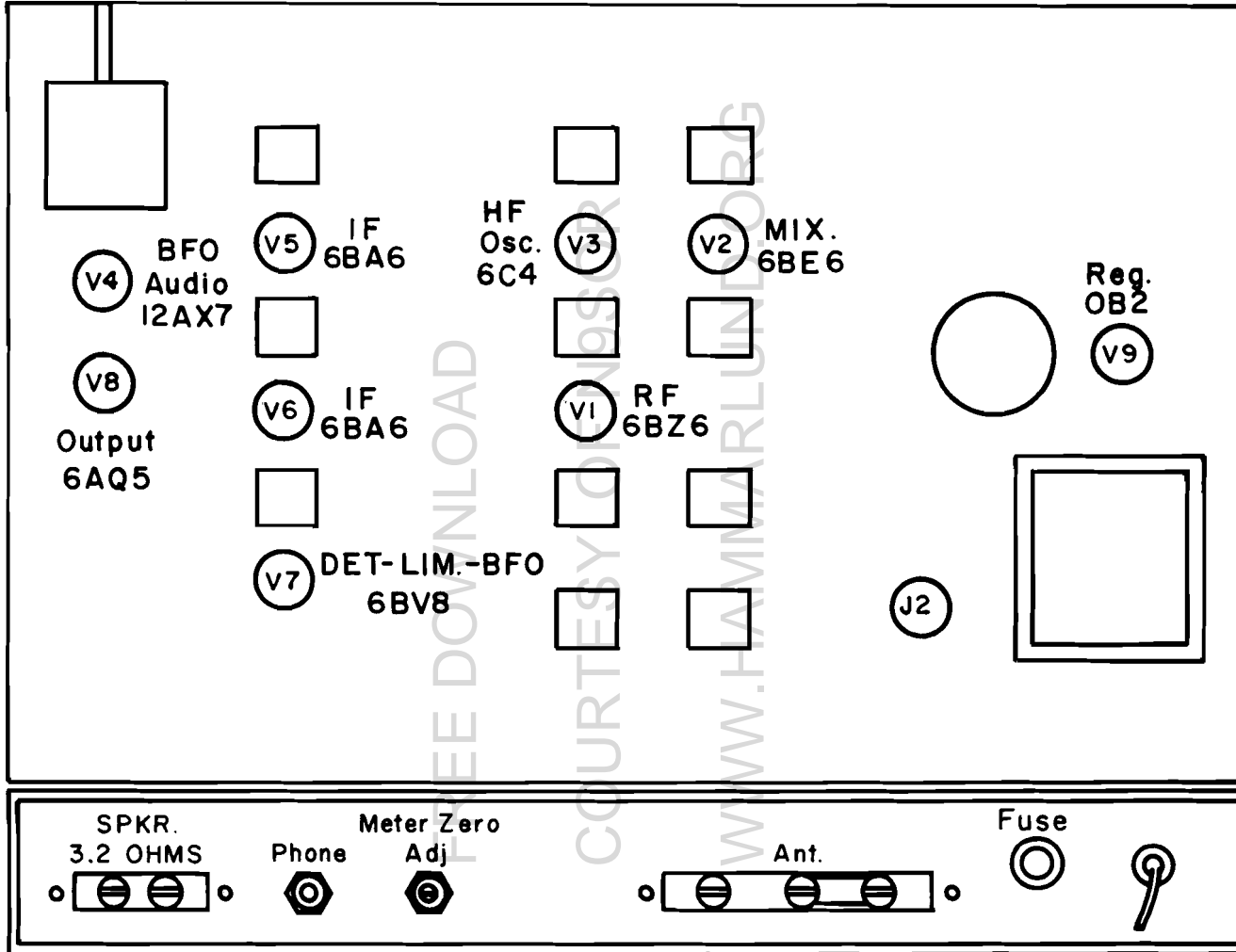

PT. 2418-02-00006

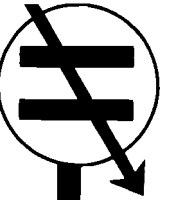

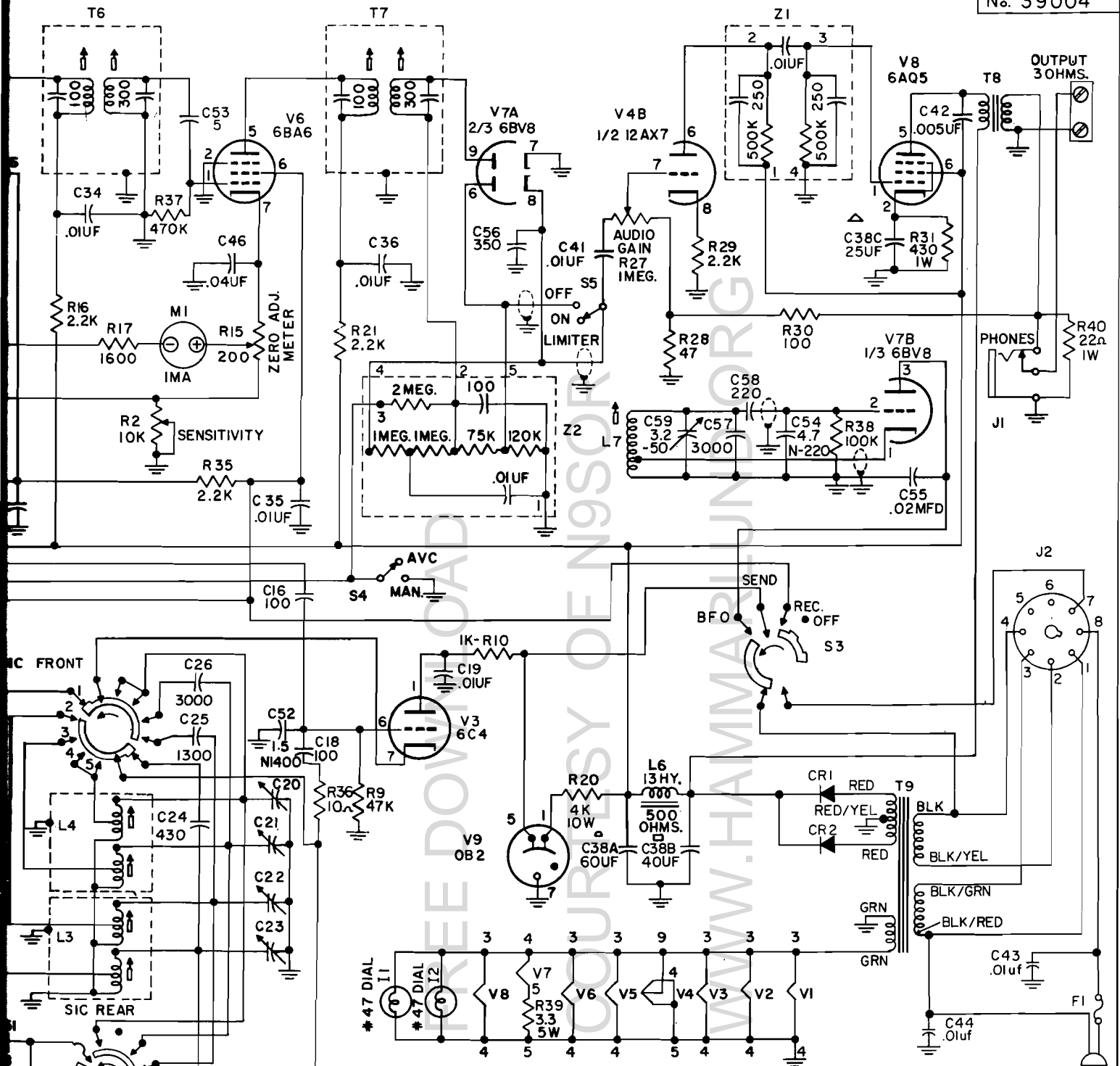

NOTE:
 RESISTORS ARE 1/2 W AND VALUE IN OHMS UNLESS OTHERWISE NOTED.
 CAPACITORS ARE IN MICRO-MICRO FARADS UNLESS OTHERWISE NOTED.
 TRIMMERS C11 TO C13 AND C20 TO C23 ARE 1 TO 9 MMF.

AC INPUT
 50/60~

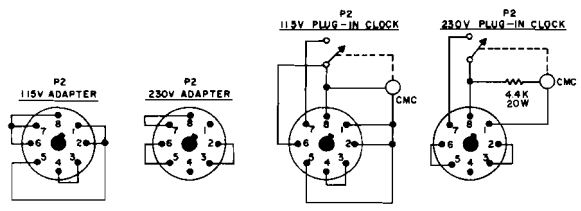
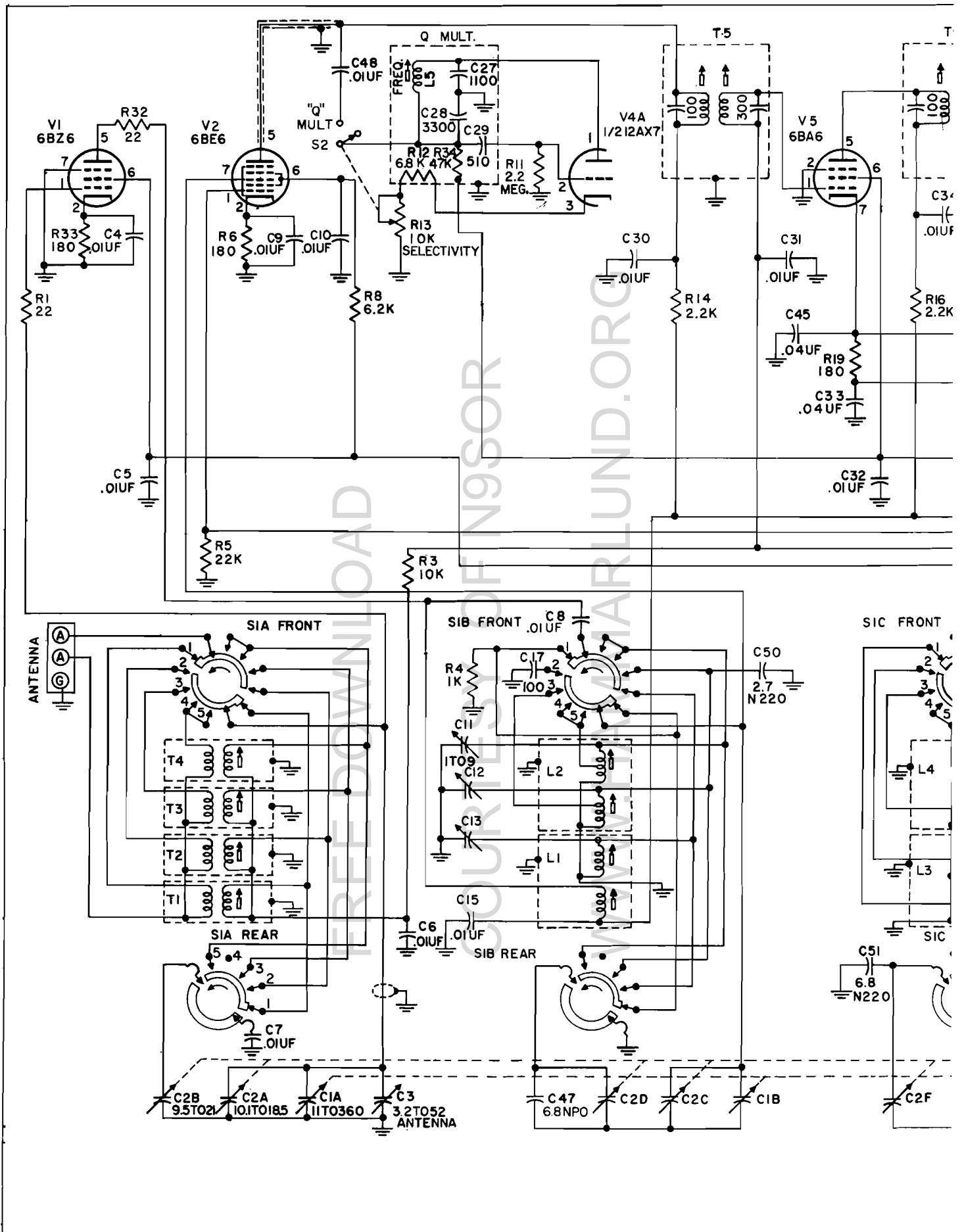

Figure 10. Hammarlund HQ-100A Receiver, Schematic Diagram



THE HAMMARLUND MANUFACTURING COMPANY
Standard Warranty

The Hammarlund Manufacturing Company, warrants this equipment to be free from defects in workmanship and materials under normal and proper use and service for the uses and purposes for which it is designed, and agrees to repair or replace, without charge, all parts thereof showing such defects which are returned for inspection to the Company's factory, transportation prepaid, within a period of 90 days from date of delivery, provided such inspection discloses to the satisfaction of the Company that the defects are as claimed, and provided also, that the equipment has not been altered, repaired, subjected to misuse, negligence or accident, or damaged by lightning, excessive current or otherwise, or had its serial number or any part thereof altered, defaced, or removed. Tubes shall be deemed to be covered by the manufacturer's standard warranty applicable thereto, and such items shall be and are hereby excluded from the provisions of this warranty. Pilot lamps and fuses are not guaranteed for length of service.

Except as herein specifically provided, no warranty, express or implied, other than that of title, shall apply to any equipment sold hereunder. In no event shall the Company be liable for damages by reason of the failure of the equipment to function properly or for any consequential damages.

This Warranty is valid for the original owner of the equipment, and is contingent upon receipt of the Warranty Registration Card by the Company. No equipment shall be returned to the factory for repairs under warranty unless written authorization is obtained by the Company, and the equipment is shipped prepaid by the owner. The Company maintains Authorized Service Stations, names and locations of which will be sent upon request of the owner.

The Hammarlund Manufacturing Company

A Giannini Scientific Co.

73-88 Hammarlund Drive, Mars Hill, N. C.

Export Department: 13 East 40th Street, New York 16, N. Y.



The policy of the Hammarlund Manufacturing Company, is one of continued improvement in design and manufacture wherever and whenever possible, to provide the highest attainable quality and performance. Hence, specifications, finishes, etc. are subject to change without notice and without assumption by Hammarlund of any obligation or responsibility to provide such features as may be changed, added or dropped from previous production runs of this equipment.

Hammarlund Manufacturing Company

A Giannini Scientific Co.

73-88 Hammarlund Drive, Mars Hill, N. C.

Export Department: 13 East 40th Street, New York 16, N. Y.

DO NOT MAKE ANY RETURNS WITHOUT AUTHORIZATION FROM THE FACTORY. ALL AUTHORIZED RETURNS SHOULD BE SHIPPED TO HAMMARLUND MANUFACTURING CO., ATTN. CUSTOMER SERVICE, MARS HILL, NORTH CAROLINA.



ESTABLISHED 1910

FREE DOWNLOAD

COURTESY OF INSUR

WWW.HAMMILLINSTITUTE.ORG