

PRICE \$1.00



**Assembling
and Using Your...**

Heathkit

**AMATEUR
TRANSMITTER**

MODEL DX-40

HEATH COMPANY

A Subsidiary of Dynalene, Inc.

BENTON HARBOR, MICHIGAN

STANDARD COLOR CODE — RESISTORS AND CAPACITORS

AXIAL LEAD RESISTOR	INSULATED UNINSULATED Color	FIRST RING BODY COLOR First Figure	SECOND RING END COLOR Second Figure	THIRD RING DOT COLOR Multiplier	DISC CERAMIC RMA CODE
	BLACK BROWN RED ORANGE YELLOW GREEN BLUE VIOLET GRAY WHITE	0 1 2 3 4 5 6 7 8 9	0 1 2 3 4 5 6 7 8 9	None 0 00 ,000 0,000 00,000 000,000 0,000,000 00,000,000 000,000,000	
RADIAL LEAD DOT RESISTOR 	5-DOT RADIAL LEAD CERAMIC CAPACITOR 			EXTENDED RANGE TC CERAMIC HICAP 	
RADIAL LEAD (BAND) RESISTOR 	BY-PASS COUPLING CERAMIC CAPACITOR 			AXIAL LEAD CERAMIC CAPACITOR 	

The standard color code provides all necessary information required to properly identify color coded resistors and capacitors. Refer to the color code for numerical values and the zeroes or multipliers assigned to the colors used. A fourth color band on resistors determines tolerance rating as follows: Gold = 5%, silver = 10%. Absence of the fourth band indicates a 20% tolerance rating.

The physical size of carbon resistors is determined by their wattage rating. Carbon resistors most commonly used in Heathkits are 1/2 watt. Higher wattage rated resistors when specified are progressively larger in physical size. Small wire wound resistors 1/2 watt, 1 or 2 watt may be color coded but the first band will be double width.

MOLDED MICA TYPE CAPACITORS

CURRENT STANDARD CODE 	RMA 3-DOT (OBSOLETE) RATED 500 W.V.D.C. ± 20% TOL. 	BUTTON SILVER MICA CAPACITOR
RMA (5-DOT OBSOLETE CODE) 	RMA 6-DOT (OBSOLETE) 	RMA 4-DOT (OBSOLETE)

MOLDED PAPER TYPE CAPACITORS

TUBULAR CAPACITOR 	MOLDED FLAT CAPACITOR Commercial Code 	JAN. CODE CAPACITOR
------------------------------	-----------------------------------------------------	--------------------------------

The tolerance rating of capacitors is determined by the color code. For example: red = 2%, green = 5%, etc. The voltage rating of capacitors is obtained by multiplying the color value by 100. For example: orange = 3 × 100 or 300 volts. Blue = 6 × 100 or 600 volts.

In the design of Heathkits, the temperature coefficient of ceramic or mica capacitors is not generally a critical factor and therefore Heathkit manuals avoid reference to temperature coefficient specifications.

ASSEMBLY AND OPERATION OF THE HEATHKIT AMATEUR TRANSMITTER MODEL DX-40

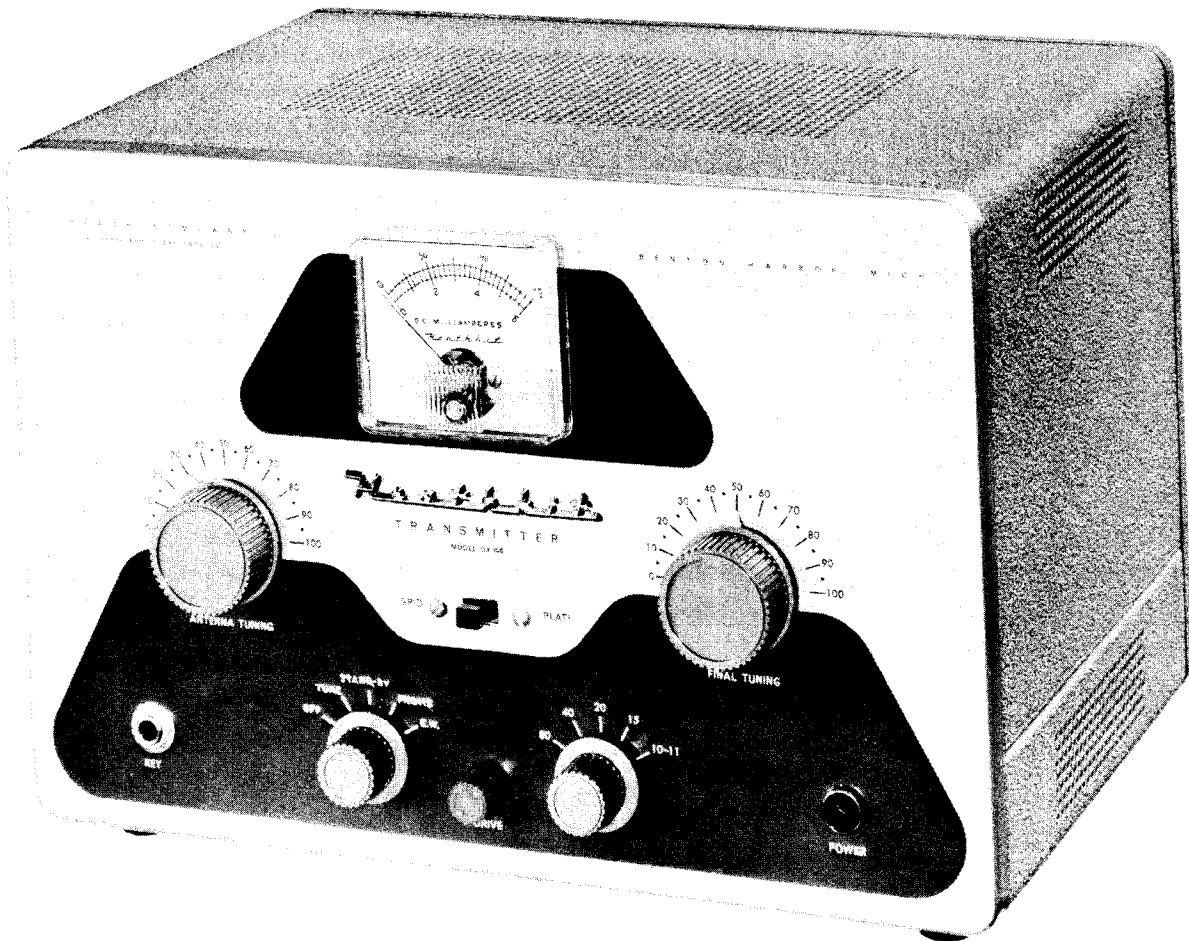

SPECIFICATIONS

Power Input:.....	75 watt CW, 60 watt peak controlled carrier phone
Output Impedance:.....	50-1000 Ω
Output Coupling:.....	Pi network (coaxial)
Operation:	Crystal-VFO, CW, Phone
Band Coverage:.....	80, 40, 20, 15, 11, 10
Tube Complement:.....	5U4GB Rectifier 12AX7 Speech Amplifier 6DE7 Carrier Control, Modulator 6CL6 Crystal Oscillator 6CL6 Buffer 6146 Final Amplifier
Power Requirements:.....	117 volts AC, 60 cycles, 175 watts
Cabinet Size:.....	13" wide x 8 1/2" high x 9" deep
Net Weight:.....	21 lbs.
Shipping Weight:.....	26 lbs.

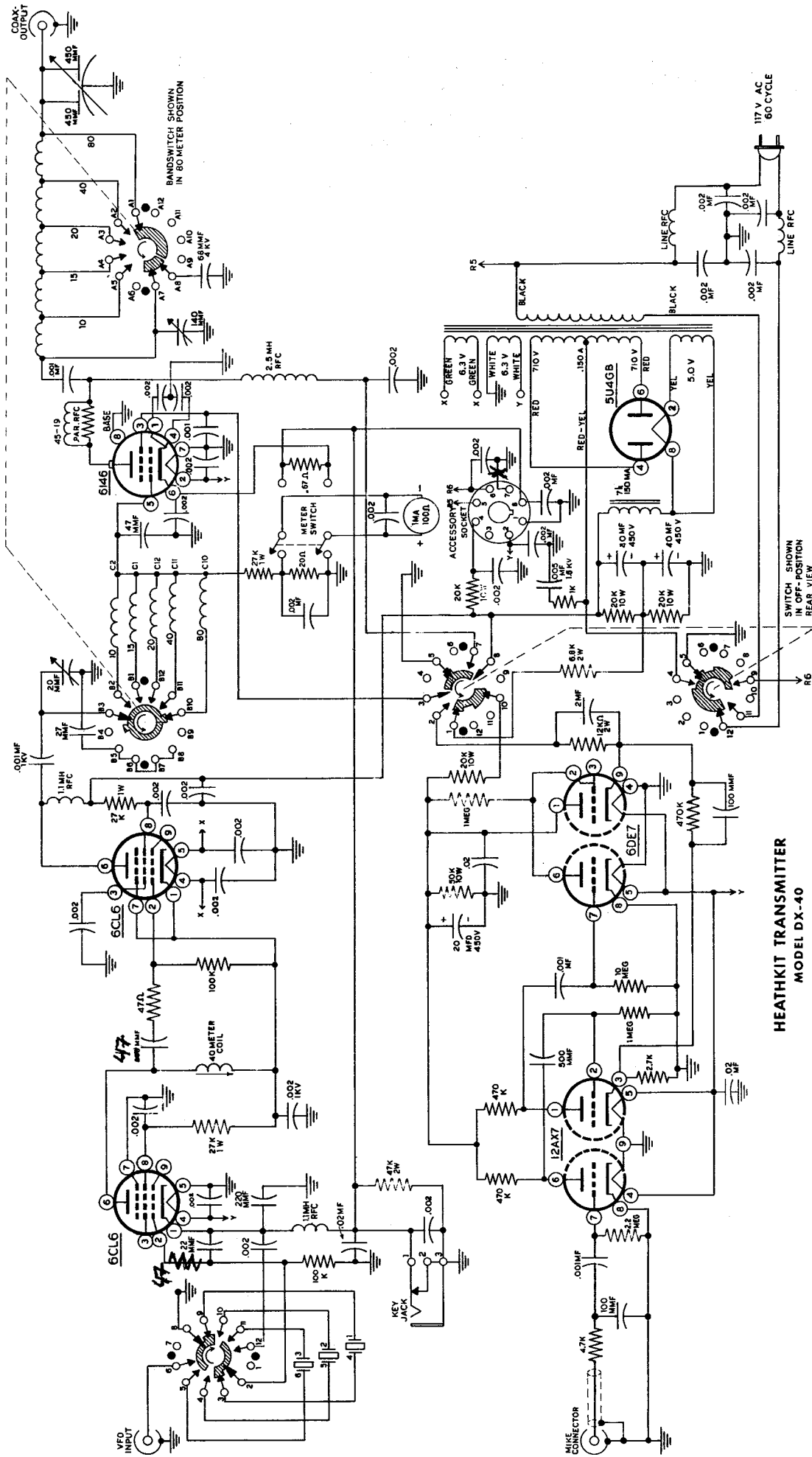

HEATHKIT TRANSMITTER
MODEL DX-40

INTRODUCTION

The Heathkit Transmitter Model DX-40 was designed to permit maximum versatility at a reasonable price. It features up to 75 watts input with three switch-selected crystal positions for the novice operator. It includes controlled carrier phone operation and provision for VFO excitation for the general class ham. It has sufficient output to drive larger transmitters when the station is expanded, yet is small enough for field day operation.

The DX-40 consists of one power supply, three radio frequency stages, and two dual-triode audio stages. Pi network output coupling is used to facilitate antenna matching. The panel controls consists of a key jack, operation switch, band switch, drive control, pilot light, final tuning, meter switch and antenna tuning. The mike connector, crystal switch, output connector, VFO input and auxiliary power socket are located on the rear chassis apron.

The following block diagram and circuit description will give the builder a better understanding of the transmitter. This knowledge is an invaluable aid to construction and as such is well worth reading thoroughly. **LETHAL VOLTAGES ARE PRESENT AT MANY POINTS ABOVE AND BELOW THE CHASSIS. CONSEQUENTLY, GREAT CARE MUST BE EXERCISED WHEN ANY TEST OR ADJUSTMENTS ARE MADE.**

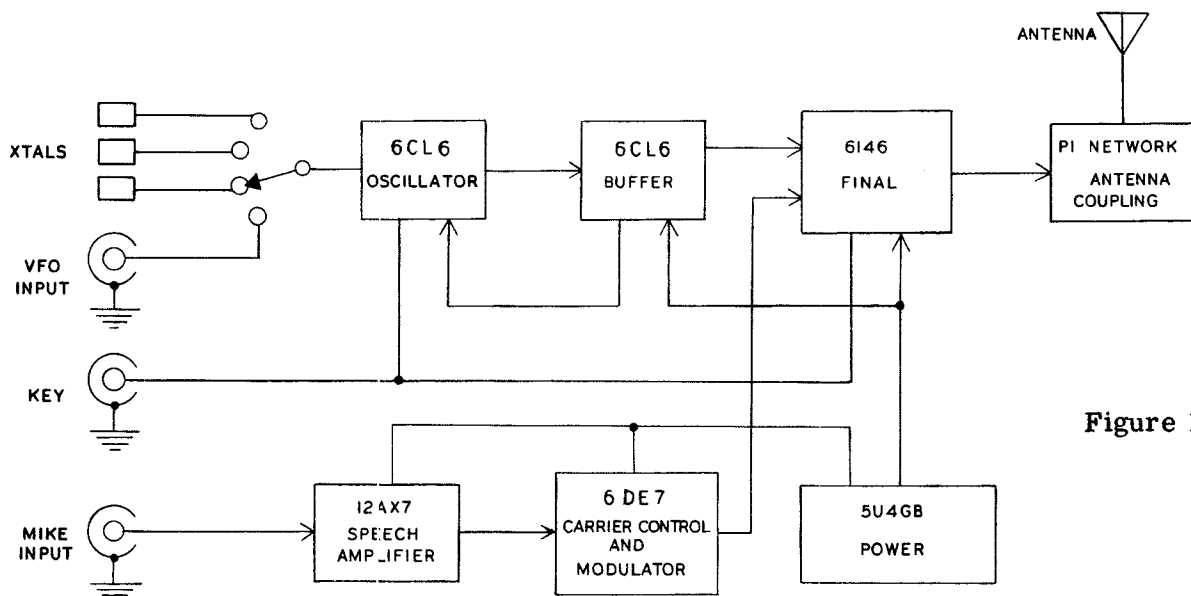

Figure 1

CIRCUIT DESCRIPTION

OSCILLATOR: A 6CL6 tube is operated in a Colpitts circuit to provide efficient harmonic output for use on the high frequency bands. The plate tank circuit consists solely of a slug-tuned coil which is broadly resonant on 40 meters but serves as a radio frequency choke on 80 meters. For operation on 80 through 10 meters the oscillator plate circuit tunes to 40 meters.

Three crystals may be switched into the circuit by means of a double-pole switch which breaks both connections to the crystals to prevent interaction. In the fourth position, the 6CL6 grid is connected to a jack for external VFO control and the cathode RF choke is bypassed to ground.

Plate and screen voltage for the oscillator stage are derived from the buffer stage cathode. The two 6CL6 tubes are operated in series across the 600 volt supply and receive approximately 300 volts each. This eliminates the necessity of power-wasting dropping resistors.

The 6CL6 buffer in most cases, tunes the second, third, or fourth harmonic to obtain the desired frequency. Because the RF level required by the buffer stage is quite low, 80 or 160 meter crystals may be used for output on 80 without the necessity of resonating the oscillator stage plate circuit to these frequencies.

So that the amateur may be guided in his purchases of crystals for this transmitter it may be best to mention that only 160, 80, or 40 meter crystals be used, with the preference being 80 and 40 meter, the fact being that some additional feedback may be required in the oscillator circuit for certain 160 meter crystals.

Sufficient grid drive to the 6146 final should be obtained from an 80-meter crystal for operation on 80 through 10 meters, while only slightly more efficiency is evident on the higher frequency bands by using a 40-meter crystal.

The tuning range of this transmitter is limited to the 80, 40, 20, 15, 10 and 11 meter bands. Operation on the 160-meter band should not be attempted.

BUFFER: The buffer stage is coupled to the 6146 final amplifier by a Pi network circuit which has a tuning range limited to the amateur bands. This limitation avoids tuning a wrong harmonic which would be amplified by the 6146 stage. This method of coupling helps materially in stabilizing the final amplifier, at the same time attenuating the higher order harmonics. This buffer stage has an independent filament supply to prevent heater-to-cathode breakdown as this cathode is 300 volts potential above the other tubes.

FINAL AMPLIFIER: The plate circuit of the final amplifier is shunt fed with a 2.5 mh RF choke and is capacity coupled into the Pi network tank circuit. For operation on 80 meters a 68 $\mu\mu\text{f}$ 4 kv fixed capacitor is automatically paralleled with the plate tuning capacitor by means of the bandswitch. A 900 $\mu\mu\text{f}$ variable capacitor is permanently connected across the output of the Pi circuit for antenna loading.

MODULATOR: A 12AX7 tube is used as a high gain two stage resistance coupled speech amplifier. The output of the speech amplifier is coupled to the 6DE7 through a low capacity coupling capacitor. This low capacity coupling, along with the 470K and 100 $\mu\mu\text{f}$ capacitor which forms the feedback circuit from the modulator cathode back to the speech amplifier cathode, shapes the response to favor the voice frequencies, thus allowing a higher average level to be maintained where it will be the most effective.

The audio energy from the speech amplifier is coupled to the grid of one triode section of a 6DE7. This tube contains two dissimilar triode sections. One triode section is rated at 1.5 watts dissipation and the other at 7 watts dissipation. The lower rated triode is used as a direct coupled driver, its plate being tied to the control grid of the heavier duty triode which forms the modulator. This second triode is biased sufficiently to limit its conduction and therefore the screen voltage on the final, which results in a low resting carrier.

With modulation the conduction of the heavy duty triode section is varied in accordance with the average voice level. This gives a controlled carrier effect by varying the screen voltage on the 6146 tube, at the same time the audio signal is superimposed on this variable voltage. The net result is to produce a carrier output which increases with the percentage of modulation applied.

POWER SUPPLY: The power supply consists of a transformer-operated full wave rectifier circuit with a choke input filter. Two filter capacitors are operated in series to withstand the voltage involved. Two identical resistors across the filter capacitors serve a dual purpose of equalizing the filter voltage and acting as a bleeder resistor to stabilize the output under varying load conditions. A 5U4GB tube is used as the full wave rectifier. This tube is a heavy-duty version of the regular 5U4G. Some of the tube ratings have been exceeded while others are operated under the maximum permissible. Tests have indicated that by using the heavy duty tube with choke input and a light current load, no difficulty should be encountered.

NOTES ON ASSEMBLY AND WIRING

Many of these kits will probably be constructed by people just starting in the amateur radio field. Consequently, the step-by-step instructions in this manual have been covered in considerable detail. Read each step completely through and be sure it is understood before proceeding with the operation called for. This will assure that a complicated step is performed in the proper sequence in order to complete it with the least possible difficulty.

There is considerable similarity between the screws and nuts of the 3-48 and the 4-40 hardware supplied. Before using these pieces, examine them closely to determine that you have the part called for in the instructions. This is particularly true of the small size 4-40 nuts which resemble 3-48 nuts in physical size. These nuts may even hold on a 3-48 screw, but will feel loose. If any doubt exists, try the nut on a 4-40 screw to check it. There are only three of these and they should be used in mounting the crystal sockets.

In the design of the Heathkit DX-40, no effort was spared to obtain the highest quality components and assemble them in the best possible arrangement. By the same token, the kit builder should exercise a great deal of care during assembly and wiring. Only by putting the best possible workmanship into the kit, can best results be obtained from it. There is also a great deal of personal satisfaction in a neat, professional-looking transmitter, resulting from careful assembly and wiring. A common factor of radio frequency instruments is the critical placement of leads and components. The use of extensive bypassing and shielding in the DX-40 has eliminated a great deal of this. However, the lead dress shown in the pictorials and bottom chassis photograph should be followed carefully.

During the assembly and wiring procedure, a rag or some soft material should be placed over the work bench to prevent marring or scratching the chassis or component finish. Capacitors, resistors and transformers usually have leads longer than necessary to make the indicated connections. In the interest of both efficiency and appearance, the leads should be cut to an appropriate length before the connections are made. In many cases, the specified wire lengths may seem long. These lengths were chosen so the wire could be run close to the chassis and formed for the best appearance.

Marking the letters of the tube sockets and terminal strips on the chassis as they are installed will be a great help during the wiring procedure. The actual tube markings may differ from the type specified in the parts list by an additional suffix (A, B, GT, etc.). This denotes a minor variation which will not affect the operation of the completed instrument.

This manual is supplied to assist you in every way to complete the DX-40 with the least possible chance for error. We suggest that you take a few minutes now and read the entire manual, omitting the step-by-step instructions, before any work is started. This will enable you to proceed with the work much faster when construction is begun. The large fold-in pictorials are handy to attach to the wall above your work space. Their use will greatly simplify the construction of the kit. These diagrams are repeated in smaller form within the manual. We suggest that you retain the manual in your files for future reference both in the use of the DX-40 and for its maintenance. During the initial testing of the transmitter, it will be out of its cabinet. **REMEMBER THAT VOLTAGES DANGEROUS TO LIFE ARE PRESENT AT PRACTICALLY ALL POINTS ON THE CHASSIS.**

NOTE: Sometimes the builder may find a place where it is difficult to hold a nut for assembly. Using long-nosed pliers, press a piece of solder across one side of the nut until the solder is forced part way into the threads. This will hold the nut and furnish a narrow handle useful for inserting the nut into tight places.

In order to expedite delivery to you, we are occasionally forced to make minor substitutions of parts. Such substitutions are carefully checked before they are approved and the parts supplied will work satisfactorily. By checking the parts list for resistors, for example, you may find that a 2 K Ω resistor has been supplied in place of a 2.2 K Ω as shown in the parts list. These changes are self-evident and are mentioned here only to prevent confusion in checking the contents of your kit. We strongly urge that you follow the wiring and parts layout shown in the manual. The position of wires and parts is extremely critical in a stable transmitter and changes may seriously affect the characteristics of the circuit. Resistors and condensers generally have a tolerance rating of $\pm 10\%$ unless otherwise stated in the parts list. Therefore, a 100 K Ω resistor may test anywhere from 90 K Ω to 110 K Ω . The letter K is commonly used to designate a multiplier of 1000.

PROPER SOLDERING PROCEDURE

Only a small percentage of Heathkit purchasers find it necessary to return an instrument for factory service. Of these, by far the largest proportion function improperly due to poor or improper soldering.

Correct soldering technique is extremely important. Good solder joints are essential if the performance engineered into the kit is to be fully realized. If you are a beginner with no experience in soldering, a half-hour's practice with odd lengths of wire and a tube socket will be a worthwhile investment.

High quality solder of the proper grade is most important. There are several different brands of solder on the market, each clearly marked "Rosin Core Radio Solder." Such solders consist of an alloy of tin and lead, usually in the proportion of 50:50. Minor variations exist in the mixture such as 40:60, 45:55, etc. with the first figure indicating the tin content. Radio solders are formed with one or more tubular holes through the center. These holes are filled with a rosin compound which acts as a flux or cleaning agent during the soldering operation.

NO SEPARATE FLUX OR PASTE OF ANY KIND SHOULD BE USED. We specifically caution against the use of so-called "non-corrosive" pastes. Such compounds, although not corrosive at room temperatures, will form residues when heated. The residue is deposited on surrounding surfaces and attracts moisture. The resulting compound is not only corrosive but actually destroys the insulation value of non-conductors. Dust and dirt will tend to accumulate on these "bridges" and eventually will create erratic or degraded performance of the instrument.

NOTE: ALL GUARANTEES ARE VOIDED AND WE WILL NOT REPAIR OR SERVICE INSTRUMENTS IN WHICH ACID CORE SOLDER OR PASTE FLUXES HAVE BEEN USED. WHEN IN DOUBT ABOUT SOLDER, IT IS RECOMMENDED THAT A NEW ROLL PLAINLY MARKED "ROSIN CORE RADIO SOLDER" BE PURCHASED.

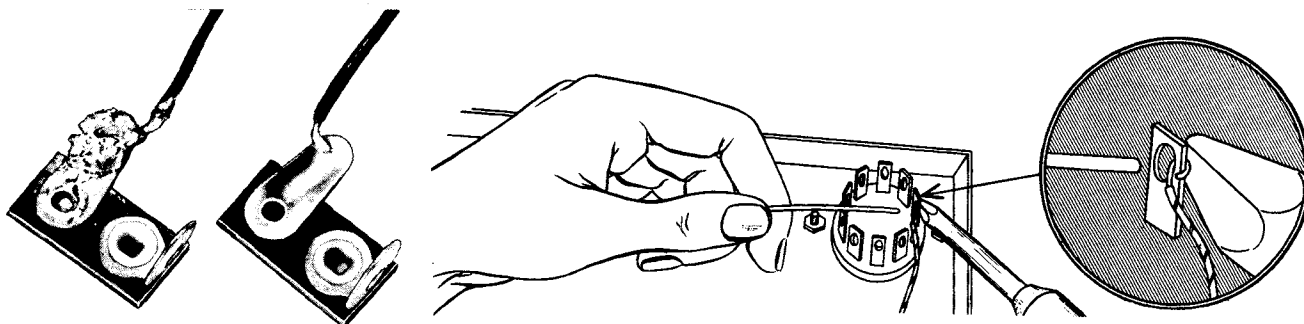

If terminals are bright and clean and wires free of wax, frayed insulation and other foreign substances, no difficulty will be experienced in soldering. Crimp or otherwise secure the wire (or wires) to the terminal, so a good joint is made without relying on solder for physical strength. To make a good solder joint, the clean tip of the soldering iron should be placed against the joint to be soldered so that the terminal is heated sufficiently to melt solder. The solder is then placed against both the terminal and the tip of the iron and will immediately flow out over the joint. Refer to the sketch below. Use only enough solder to cover wires at the junction; it is not necessary to fill the entire hole in the terminal with solder. Excess solder may flow into tube socket contacts, ruining the socket, or it may creep into switch contacts and destroy their spring action. Position the work so that gravity tends to keep the solder where you want it.

A poor solder joint will usually be indicated by its appearance. The solder will stand up in a blob on top of the connection, with no evidence of flowing out caused by actual "wetting" of the contact. A crystalline or grainy texture on the solder surface, caused by movement of the joint before it solidified is another evidence of a "cold" connection. In either event, reheat the joint until the solder flows smoothly over the entire junction, cooling to a smooth, bright appearance. Photographs in the above picture clearly indicate these two characteristics.

A good, clean, well-tinned soldering iron is also important to obtain consistently perfect connections. For most wiring, a 60 or 100 watt iron, or the equivalent in a soldering gun, is very satisfactory. Smaller irons generally will not heat the connections enough to flow the solder smoothly over the joint and are recommended only for light work, such as on etched circuit boards, etc. Keep the iron tip clean and bright. A pad of steel wool may be used to wipe the tip occasionally during use.

Taking the necessary precautions and using reasonable care during assembly of this kit will insure the wonderful satisfaction of having the instrument operate perfectly the first time it is turned on.

ASSEMBLY AND WIRING

To provide a convenience as well as a saving in time, small cardboard boxes, muffin tins or the common paper maché egg containers may be employed along with a cut down corrugated cardboard box for sorting out the small parts and hardware. See illustration.

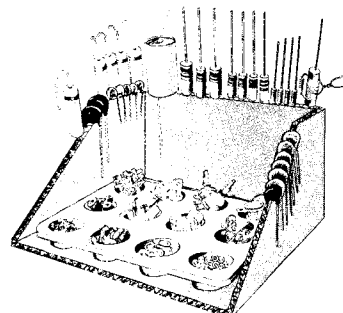

It would be very worthwhile at this time to isolate the various sizes of nuts, screws and lockwashers. Locate the four 4-40 x 3/8" screws, and 4-40 nuts which are used to mount the coax connector (lockwashers are not used here). The four 4-40 nuts look identical to the 6-32 nuts, however, close inspection will show the difference and the four nuts should be screwed on the 4-40 x 3/8" screws to avoid a mix up.

The three 4-40 x 1/2" screws and the smaller size 4-40 nuts are used to mount the crystal sockets and these nuts should be screwed on the 4-40 x 1/2" screws and separated from the others.

The 4-40 nuts will appear to fit a 3-48 screw and may inadvertently be used to mount other parts which will leave a shortage, so it is advisable to sort the hardware properly before beginning construction. Consult the parts list and figures in the back pages of the manual.

NOTE: If color codes on mica capacitors are specified in the instructions, only the significant colors will be given. Silver mica and ordinary mica capacitor body colors are inconsistent and the constructor is advised to consult the information on color coding contained on the inside front cover of the manual.

(S) Means solder. (NS) Means do not solder yet.

NOTE: On miniature sockets, the numbering of the socket is determined by starting clockwise from the blank terminal space. On octal sockets, the numbering is determined in the same way from the keyway. All sockets are numbered from the bottom chassis view. See Figure 2.

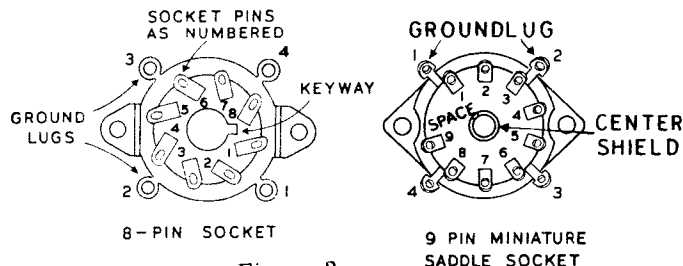

Figure 2

() Mount the three crystal sockets directly behind hole D, using the 1/2" long 4-40 screws and the small 4-40 nuts. Allow the flat sides of the nuts to recess within the socket. Do not force the sockets or tighten the screws to extremes or the sockets may be broken.

NOTE: Before mounting the tube sockets, the four ground lugs around the mounting rings should be bent straight out sideways from the socket. The pin connectors should be fanned out slightly. See Figure 9 on Page 15.

() Mount the 9-pin miniature shielded socket at hole A, positioning the pin connections as shown in Pictorial 1 on Page 8. (This is the black socket with the metal shield base which mounts from the top of the chassis.) Use 3-48 screws and nuts with #3 lockwashers under the nuts.

() Mount the 9-pin regular miniature socket at hole B using the same type hardware and position as shown. This socket mounts from the bottom of the chassis.

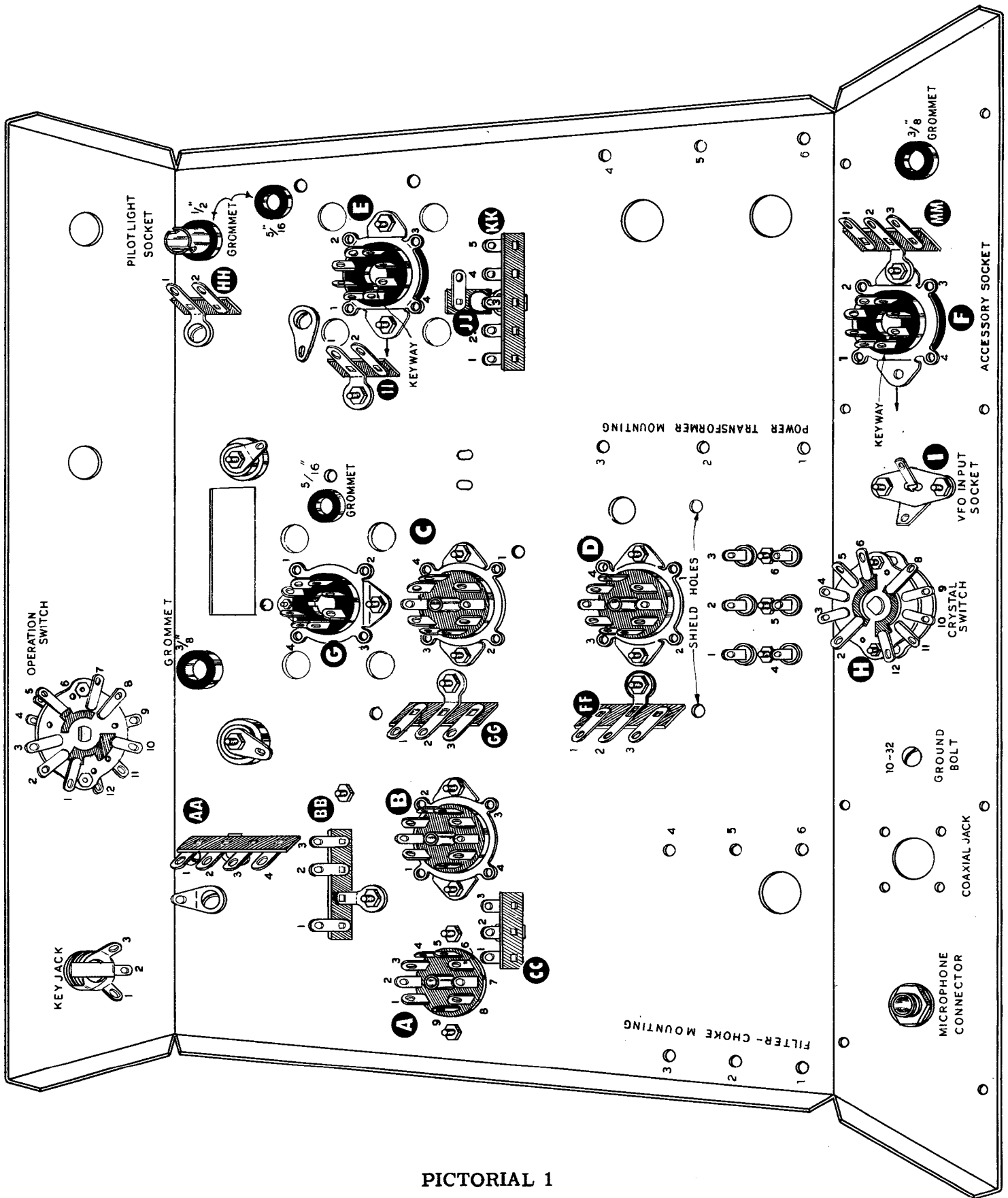

PICTORIAL 1

- () Mount the 9-pin miniature ceramic socket at hole C along with the shield base, which mounts on the top of the chassis using the same type hardware. Position the socket pins as shown in Pictorial 1.
- () With similar hardware mount a 9-pin regular socket at hole D. Check the pin locations of the four sockets just mounted before proceeding further. See Pictorial 1.
- () Mount an octal socket at hole E with the keyway (between pins 1 and 8) toward the chassis center. Use 1/4" x 6-32 screws with #6 lockwashers under the nuts.
- () Mount an octal socket and a 3-lug terminal strip MM at hole F on the rear chassis apron. Observe the position of the keyway and use a 6-32 x 3/8" screw at this time. See Pictorial 1. Insert the mounting screw through the chassis, the tube socket flange, through the terminal strip, a lockwasher, and secure with a 6-32 nut. Mount the other end of the socket with a 6-32 x 1/4" screw, a #6 lockwasher and a 6-32 nut.
- () Mount an octal socket at hole G. Face the keyway toward the front of the chassis as shown in Pictorial 1. Use 6-32 x 1/4" screws, #6 lockwashers and 6-32 nuts.
- () Mount the phono socket at hole I, using 6-32 x 1/4" screws, #6 lockwashers and 6-32 nuts.
- () Mount the crystal switch at hole H, using a 3/8" lockwasher on the inside of the chassis and a 3/8" flat washer and a control nut on the outside. Position the switch so the contacts appear as shown in Pictorial 1.

NOTE: In mounting terminal strips and other parts a "spintite" type of wrench or a similar tool, used in conjunction with a good screwdriver, will enable tightening while maintaining the position of the part with much less effort.

- () Between sockets A and B, mount terminal strips BB and CC as shown in Pictorial 1. Use 6-32 x 1/4" hardware. These are two different types of 3-lug strips. Note pictorial carefully.
- () Mount the 3-lug terminal strip GG at the nearest hole to the left of socket C, using 6-32 x 1/4" hardware.
- () Mount the 3-lug terminal strip FF at the nearest hole to the left of socket D using the same type hardware.
- () Mount a 5-lug terminal strip at KK and a single-lug terminal strip at JJ as shown near socket E in Pictorial 1. Use a 6-32 x 3/8" screw, #6 lockwasher and a 6-32 nut.
- () Using a 6-32 x 1/4" screw, #6 lockwasher and a 6-32 nut, mount a 2-lug terminal strip at II next to socket E.
- () On the top side of the chassis next to the 5U4GB rectifier socket E, with similar type hardware, mount the 2-lug terminal strip OO and a different type 2-lug strip NN next to the 140 $\mu\mu\text{f}$ tuning capacitor. See Figure 13 to clarify.

NOTE: Before continuing into the step-by-step assembly, some time can be saved and a better understanding made by consulting Pictorial 1 and marking the various numbers and letters opposite, or near the tube sockets, terminal strips, etc.

- () Examine Pictorial 1 closely and insert two 3/8" rubber grommets, one 1/2" grommet and two 5/16" grommets in the positions shown.
- () With a 3/8 control nut, temporarily mount the key jack as shown in Pictorial 1.
- () Mount the 2-section variable-loading capacitor on the top side of the chassis in the position shown in Pictorial 4. Refer to Pictorial 1 and mount a solder lug under the 6-32 x 1/4" screw in the hole closest to the key jack. Use a 6-32 x 1/4" screw in the hole next to the front apron with a #6 lockwasher. Mount the 4-lug terminal strip AA as shown with a lockwasher between the terminal strip and the chassis only. Use a 6-32 x 1/4" screw. Align the capacitor squarely with the chassis front edge before tightening the screws

- () Referring to Pictorial 1 and Pictorial 4 work the pilot light socket through the 1/2" rubber grommet. Moistening with a little soapy water will help. Position the socket terminals as shown in Pictorial 4.
- () The 10-32 x 5/8" ground bolt is mounted next to the coax socket hole, using a #10 lockwasher and two 10-32 nuts. Leave the second nut loose for connecting the ground wire.
- () Mount the microphone connector on the chassis rear apron using just a 3/8" lockwasher and 3/8-32 control nut. See Pictorial 1.

() The plate tuning capacitor is mounted with 6-32 x 1/2" screws. See Figure 3. The first 1/2" screw passes through a #6 lockwasher, the 2-terminal tie strip HH, another lockwasher, the chassis, a 1/4" spacer and into the front mounting hole of the 140 $\mu\mu\text{f}$ variable capacitor. Do not tighten yet. The second screw passes through a #6 solder lug, the chassis, a 1/4" spacer and into the rear mounting of the capacitor. Position the terminal strip and solder lug as shown in Pictorial 1 and Figure 3, and tighten both mounting points. Close the plate tuning and the loading capacitors to prevent damage to the plates while working on the chassis.

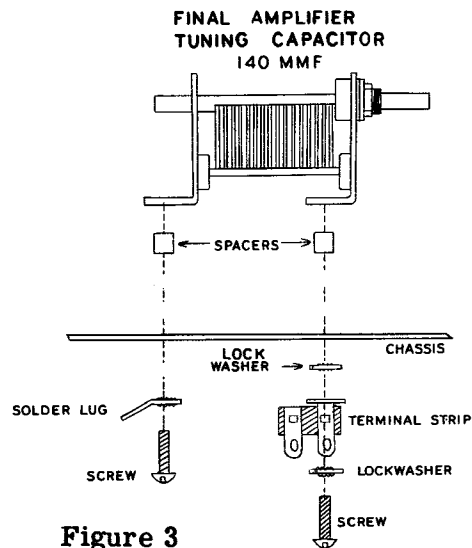

Figure 3

- () Mount the two ceramic feedthrough insulators by disassembling and remounting according to the exploded view through the 5/16" holes at each end of the 3/4 x 2" hole. See Figure 4 and Pictorial 1. Maintain the longer cone end on the top of the chassis.
- () Mount a #6 solder lug between the nuts on each end of the feedthrough insulators. Maintain the positions of the lugs as shown in Pictorial 1 and Pictorial 4 and tighten securely.

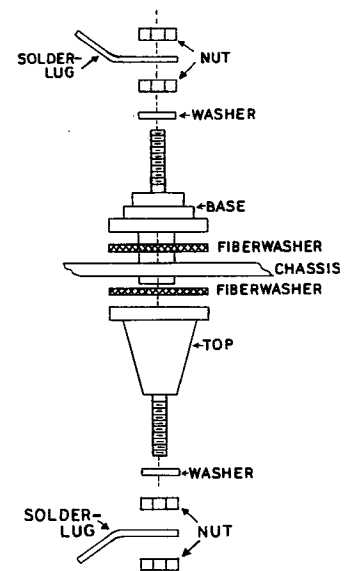

Figure 4

NOTE: Throughout the step-by-step instructions the leads are generally cut to a specific length. This should allow the constructor to insert the stripped end through and around the pin or lug (which forms the connection point) before soldering, without leaving too much slack. However, in some cases, for convenience in wiring, the lead length is only sufficient to allow inserting the end of the wire into the pin or lug connection before soldering.

Leads on the ceramic bypass capacitors should be inserted through and around the connection point wherever sufficient lead length is provided; otherwise the shorter lead ends are retained in the connection point with a slight bend before soldering. The small disc capacitor leads should be kept very short. This is to insure a low inductance path for the flow of RF currents, which will result in increased stability of the RF circuit.

() The final tank coil is mounted on the two feedthrough insulators as shown in Pictorial 4. Straighten all coil leads as shown in Figure 5. Insert the outside coil leads through the inside hole of the lug and draw the coil close into the insulator. Wrap the excess wire around the lug and avoid covering the end hole which is used for additional connections (NS). This coil should be aligned parallel and approximately 5/8" in from the panel edge of the chassis.

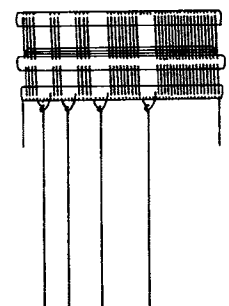

Figure 5

- () Trim the leads on the filter choke to 2" measuring straight out from the pitch retainer. Trim the insulation 3/8" off the ends.
- () Mount the choke in the position as shown in Pictorial 4. You will notice that in Pictorial 1 the mounting holes are numbered one to six. Use 8-32 x 3/8" screws, #8 lockwashers, and 8-32 nuts for number 1, 2, and 3.
- () For hole #4, a 6-32 x 3/8" screw is used through the choke flange, the chassis, the mounting foot of a 2-terminal tie strip, a #6 lockwasher, and a 6-32 nut. See Pictorials 1 and 2.
- () A 6-32 x 3/8" screw is used for hole #5. Insert the screw through the choke flange, the chassis, the mounting foot of a 2-terminal tie strip, a #6 lockwasher, and a 6-32 nut. See Pictorials 1 and 2.
- () The last mounting hole requires an 8-32 x 3/8" screw through the choke flange, the chassis, a #8 lockwasher, and an 8-32 nut.
- () Before mounting the power transformer, the leads should be trimmed to appropriate length. Measure straight out from the transformer pitch retainer. The two heavy white filament leads are trimmed to 2 1/2". The two green filament leads are trimmed to 4"; the two yellow filament leads to 3 1/2" and 4 1/2"; the two red high voltage leads to 3 1/4"; the red with yellow tracer high voltage center tap lead is 1 1/2". The two black line leads are trimmed to 1 1/2" and 2 1/2". Trim the insulation off all ends 3/8".
- () The transformer is mounted as shown in Pictorials 2 and 4. In mounting holes 1, 2, 3, 4, and 6, an 8-32 x 3/8" screw is used, inserting first through a #8 lockwasher, then through the transformer flange, the chassis, another #8 lockwasher and an 8-32 nut. For hole #5 a 6-32 x 3/8" screw is used, inserting first through a #6 lockwasher, then through the flange, the chassis, the mounting foot of 4 terminal tie strip (LL), another #6 lockwasher and a 6-32 nut. See Pictorial 2.
- () Mount the 2.5 mh radio frequency choke on the top side of the chassis, next to the 5/16" grommet near the final tube socket G. See Pictorial 4. Face the choke so that the connection points are toward the chassis front. Use a 6-32 x 3/8" screw through a #6 lockwasher, the chassis, the smaller size #6 fiber washer and into the choke. Do not overtighten to avoid breaking the ceramic.
- () Select the shield bracket and mount the three spade screws and the remaining single terminal tie strip as shown in Figure 6. Use 6-32 x 1/4" screws with #6 lockwashers and 6-32 nuts. Notice that the one spade screw is mounted with the nut on the outside of the shield.
- () Mount the 20 μf variable capacitor on the shield bracket with the ground lug facing as shown in Figure 6. Check the fit of the shield in the chassis and when finished set it aside until it can be mounted. Refer to Pictorial 3.

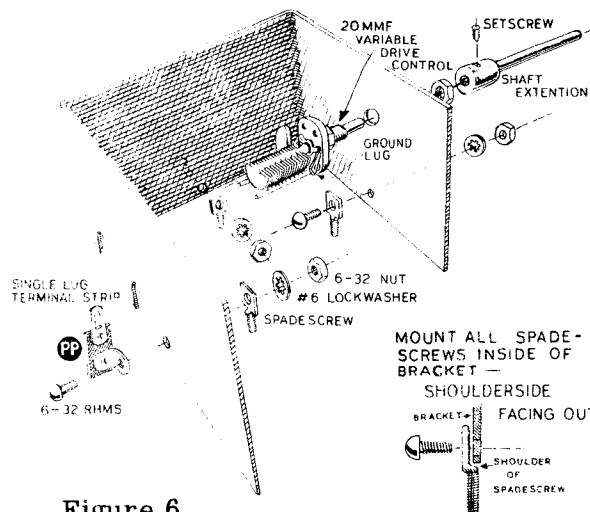

Figure 6

NOTE: The step-by-step process of building an electronic kit is sometimes considered an arduous process. It must be realized that this is a method developed to enable even the inexperienced to transform this kit into an attractive appearing, and efficient operating piece of electronic equipment. The feeling of satisfaction in having the job "well done" will more than pay for any additional effort to follow the instructions carefully.

CABLE WIRING

- () Locate the 5-wire breakout in the wiring harness that should come directly underneath pin #1 on accessory socket F on the rear apron. See Pictorial 2. These are the three brown filament wires, one yellow cathode wire and one gray relay control wire. The wire harness is bent just above the tape points shown. Hold the cable in both hands as shown in Figure 7 on the following page. Apply pressure with both thumbs. Try the cable fit by slipping it under the crystal switch and the accessory socket. If the wires do not come at appropriate points as shown in Pictorial 2, rebend cable to bring breakouts opposite, or near their connection points.

NOTE: Sheet metal screws are used to secure the transmitter in the cabinet. Four of these screws come through the chassis next to the wiring cable. As a precaution against a short, bend the cable away at just these points. Refer to Pictorial 2.

NOTE: The abbreviation (NS) indicates that the connection should not be soldered yet as other wires will be added. When the last wire is installed, the terminal should be soldered and the abbreviation (S) is used to indicate this. Note that a number appears after each solder (S) instruction. For example, if the instructions read, "connect a 47K resistor from pin #1 (NS) to pin #6 on socket E (S-2)" it will be understood that there will be two leads connected to pin #6 at the time it is soldered. This additional check will help avoid errors. Read **SOLDERING** under **GENERAL SERVICE** on page 35.

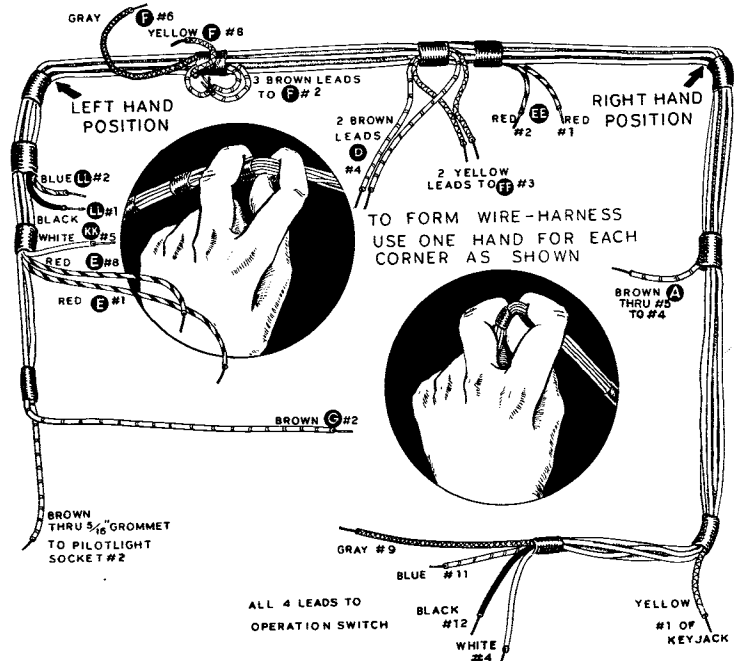
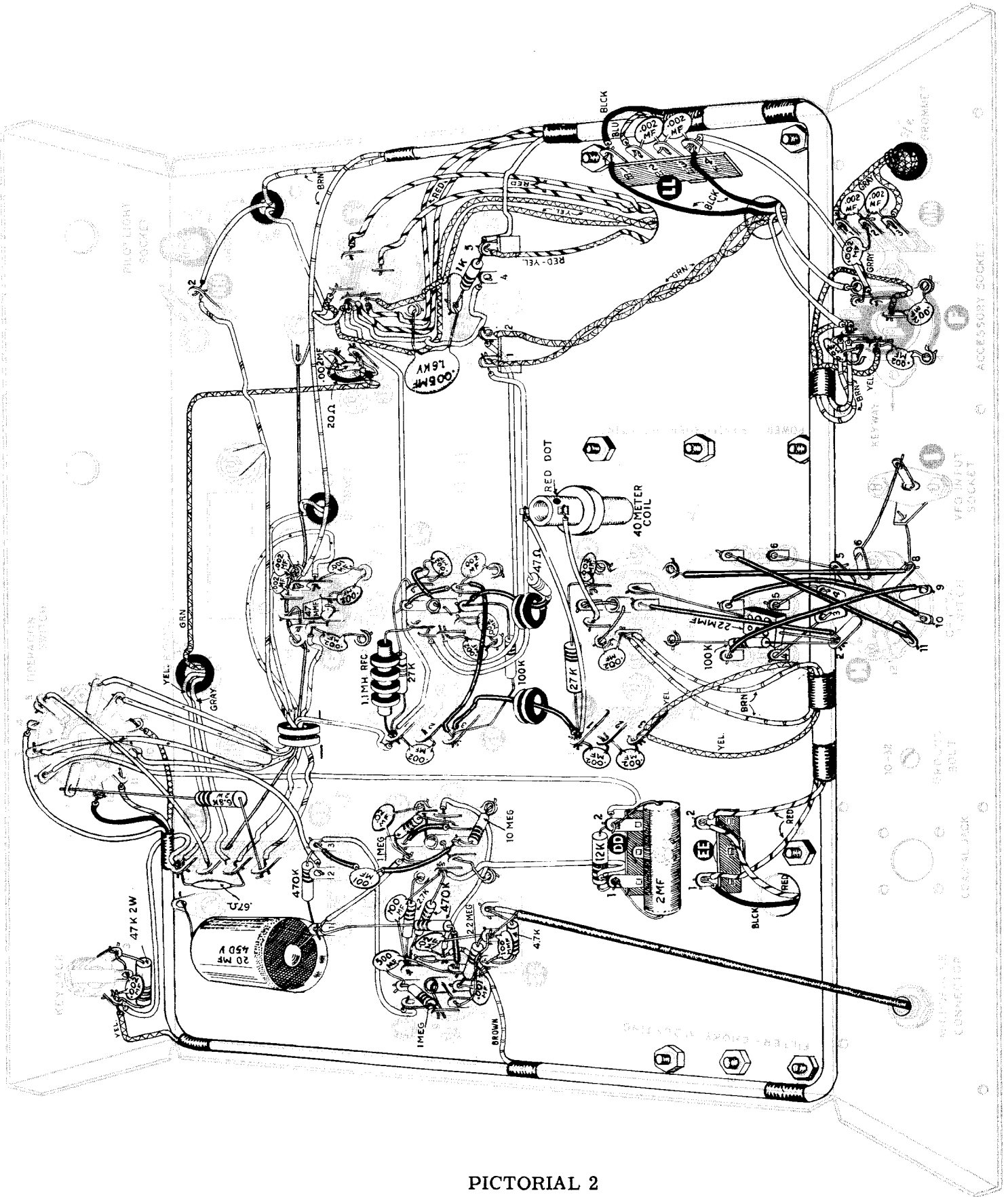

Figure 7

- () Facing the chassis rear apron as in Pictorial 2, run the longer brown lead over to and through pin terminal #2 on the 6146 socket G (NS).
- () The shorter brown lead goes down through the 5/16" rubber grommet to pilot light terminal #2 (S-1).
- () The longer red lead is formed around socket E and connects to pin #1 on socket E (NS). See Pictorial 2.
- () Run the shorter red lead in the same respect and connect it to pin #8 on socket E (NS).
- () The short white lead connects to #5 on terminal strip KK (NS).
- () The black lead goes to #1 on terminal strip LL (NS).
- () Connect the blue lead to #2 on LL (NS).
- () Connect the three brown filament leads to pin #2 on accessory socket F (NS).
- () The single yellow cathode lead connects to pin #8 on accessory socket F (NS).
- () The gray antenna relay lead loops up around accessory socket F and connect to pin #6 (NS).
- () Next to the crystal switch, connect the two brown filament leads to pin #4 on the oscillator socket D (NS).
- () The two yellow cathode leads connect to #3 on terminal strip FF (NS).
- () Connect one red lead to #1 on terminal strip EE (NS). Connect the other red lead to #2 on EE (NS).
- () Following the cable around the corner we come to a single brown filament lead which goes through pin #5 (NS) and pin #4 (S-1) on the speech amplifier socket A.
- () The yellow cathode lead goes to key jack terminal #1. (NS).

OPERATION SWITCH

NOTE: A little more care and patience should be exercised in wiring the operation switch to avoid breakage. See Pictorial 1 for terminal numbering. You will note there are no contacts at position #6 even though it is numbered.



PICTORIAL 2

- () Put a 3/8" lockwasher on the switch and insert it in the mounting hole, leaving the washer and nut off. Rotate the switch so that #1 terminal is facing up. Terminal #9 should now be sufficiently exposed to enable connecting the gray antenna relay lead (S-1).
- () Connect the blue lead to #11 (S-1).
- () The black lead is connected to #12 (S-1).
- () Locate the switch back to its proper position as shown in Pictorial 1 and secure temporarily with a 3/8" flat washer and a control nut.
- () Connect the white lead to switch terminal #4 (S-1). This completes the cable wiring.

POWER TRANSFORMER WIRING

- () One red high voltage lead connects to pin #4 on the rectifier socket E (S-1). See Pictorial 2.
- () The other red high voltage lead connects to pin #6 on socket E (S-1).
- () See Pictorial 2 for placement and run the longer yellow filament lead around terminal strips KK and JJ and connect to pin #2 on socket E (S-1).
- () The shorter yellow filament lead connect to pin #8 on socket E (S-2).
- () Connect the red and yellow high voltage center tap lead to #5 on KK (NS).
- () Twist the two green filament leads together and connect one lead to #1 on KK (NS) and the other to #2 on KK (NS).
- () Before connecting the two heavy white filament leads, remove the gray relay lead temporarily from pin #6 on accessory socket F and bend it out of the way. Connect one white filament lead to ground lug #2 on the power socket mounting ring (S-1).
- () Connect the other white filament lead to pin #2 on accessory socket F (NS).
- () Reconnect the gray relay lead to pin #6 (NS).
- () Connect the short black transformer primary lead to #4 on LL (NS).
- () The longer black primary lead connects to #1 on LL (S-2).
- () Connect either filter choke lead to #1 on EE (S-2). The color coding makes no difference.
- () Connect the other choke lead to #2 on EE (S-2).

Locate the shield bracket in its place and draw a 1/2" line through the center of the 5/16" grommet hole in the bracket near terminal strip AA. See Figure 8. Remove the shield and set it aside. This forms a marker for running the RF ground lead to clear the shield bracket.

- () Cut a piece of #14 bare wire 7 1/8" long. Connect one end through the bottom hole of the grounded lug #2 on AA. See Figure 9. Slip a 5/16 rubber grommet over the free end and maintain the position of the grommet over the 1/2" mark on the chassis. Continue over and insert the wire 1/8" through the solder lug which is located between HH and II. Solder just this solder lug connection.
- () Form this RF ground lead as shown in Figure 9. Press the wire tight around socket G and under ground lugs #1 and #4. Provide room for other leads to ground to lugs #1 and #4. Allow this grounded wire and the grommet to pass directly over the 1/2" mark on the chassis.

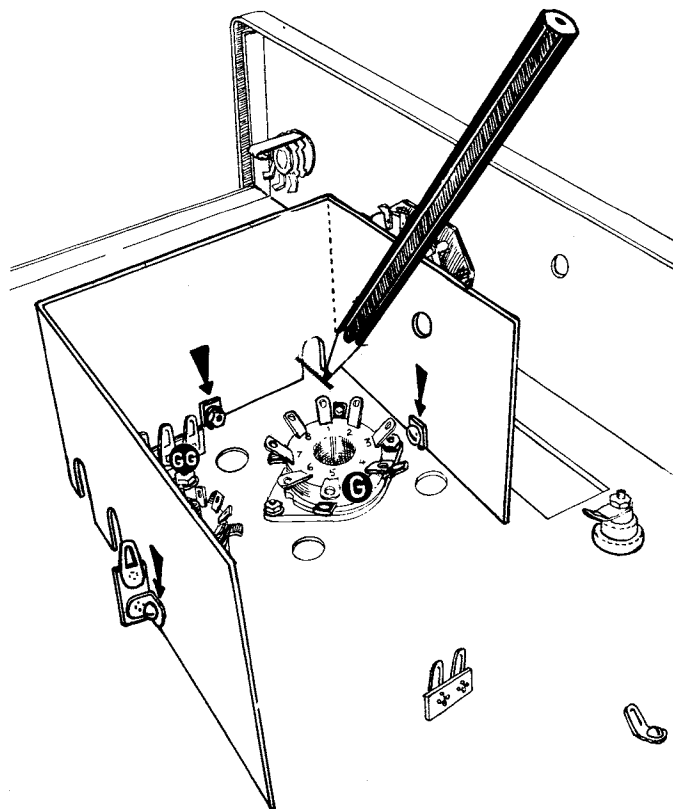

Figure 8

SPEECH AMPLIFIER AND MODULATOR WIRING

- () Cut the piece of microphone cable to 4 1/2" and strip the leads as shown in Figure 10. (Do not confuse this cable with coax cable shown in Figure 11.)
- () Solder the center conductor to the mid point of the microphone connector. The shield is not grounded here.
- () On the other end, the outside shield lead connects to #2 on CC (NS). The center conductor connects to #3 on CC (NS). See Pictorial 2.
- () Trim the leads on the 4700Ω (yellow-violet-red) 1/2 watt resistor to 3/8" and connect one end to #1 on CC (NS) and the other end to #3 on CC (S-2).

NOTE: For identification and convenience of possible future servicing, wherever practical, mount components such as ceramic and mica capacitors with the side showing the value exposed to view. However, do not rearrange the circuit layout or distort any part of the kit to make this possible.

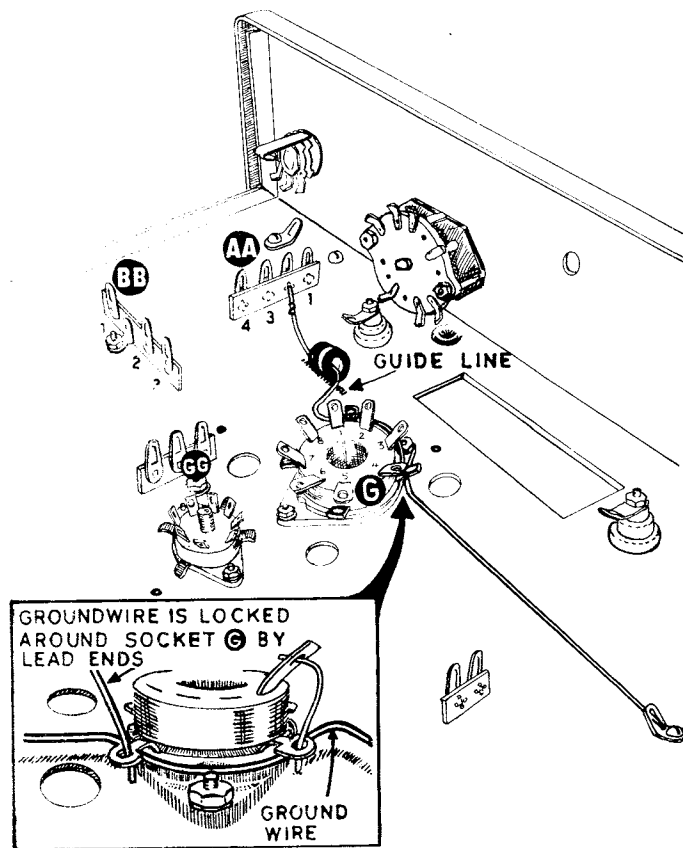

Figure 9

- () Trim the leads on a 100 μμf disc capacitor to 3/8" long. Connect one end to #1 on CC (NS) and the other end to #2 on CC (NS).

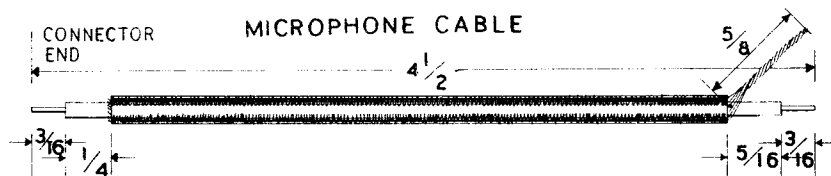

Figure 10

- () Trim the leads on a .001 μf 1 kv disc capacitor to 3/8" and connect one end to pin #7 on socket A (NS) and the other end to #1 on CC (S-3).
- () Trim the leads on the 2.2 megohm (red-red-green) 1/2 watt resistor to 3/8". Connect one end to #2 on CC (NS). Connect the other end to pin #7 on socket A (S-2).
- () Thread a piece of #20 bare wire 2 1/2" long through the center shield and pin #8 of socket A (NS). Continue over to and through #2 on CC (NS). Bend the other end around and through pin #9 on socket A. Solder the center shield and pin #8 on socket A. Avoid shorting this lead to other components.
- () Cut a piece of gray hookup wire to 5" long. Trim the insulation 1/4" off the ends. Connect one end to pin #5 on socket A (NS). Connect the other end to pin #5 on socket B (S-1).
- () Trim the leads on a .02 μf disc capacitor to 1/2" long. Connect one end to #2 on CC (NS). Connect the other end to pin #5 on socket A (S-3).
- () Trim the leads on a 1 megohm (brown-black-green) 1/2 watt resistor to 3/8" long. Connect one end to pin #2 on socket A (NS). Connect the other end to pin #3 on socket A (S-2).

- () Trim the leads on a 500 $\mu\mu\text{f}$ disc capacitor to 3/8" long. Connect one end to pin #6 on socket A (NS). Connect the other end to pin #2 on socket A (S-2).
- () Trim one lead of a 470K (yellow-violet-yellow) 1/2 watt resistor to 3/4" long and the other lead to 1" long. Bend the 3/4" lead to a right angle next to the resistor body, cover with a 1/2" piece of insulating sleeving and insert it through pin #6 on socket A (S-2). The other end connect to #1 on BB (NS).
- () Cut a piece of gray hookup wire to 3" long. Trim the insulation 1/4" off the ends. Connect one end to pin #1 on socket A (S-1). Connect the other end to #3 on BB (NS).
- () Trim the leads on a 470K (yellow-violet-yellow) 1/2 watt resistor to 3/4" long. Connect one end to #1 on BB (NS). Connect the other end to #3 on BB (NS).
- () Trim the leads on the 2700 Ω (red-violet-red) 1/2 watt resistor to 3/4" long. Connect one end to pin #3 on socket A (NS). Connect the other end to ground lug #1 on socket B (S-1).
- () Trim the leads on a 470K (yellow-violet-yellow) 1/2 watt resistor to 3/4" long. Connect one end to pin #3 on socket A (NS). Connect the other end to pin #9 on socket B (NS).
- () Trim the leads on a 100 $\mu\mu\text{f}$ disc capacitor to 1" long. Connect one lead to pin #3 on socket A (S-3). Connect the other end to pin #9 on socket B (NS).
- () Cut a piece of gray hookup wire to 2 1/4" long. Trim the insulation 1/4" off the ends. Connect one end to #1 on DD (NS). Connect the other end to pin #9 on socket B (S-3). Position this lead close to the chassis.
- () Cut a piece of gray hookup wire to 1 3/4" long. Trim the insulation 1/4" off the ends. Connect one end to pin #1 on socket B (NS). Connect the other end to #1 on BB (NS).
- () Trim the leads on a 20 μf 450-volt electrolytic capacitor to 3/4" long. Connect the positive (red end) lead to #1 on BB (NS). Connect the negative (outside casing) lead to the solder lug located under the key jack (S-1). See Pictorial 2.
- () Trim the leads on a 20 K Ω 10-watt resistor to 1" long. Connect one end to #2 on BB (NS). Connect the other end to #1 on BB (NS). See Fictorial 3.
- () Cut a piece of gray hookup wire to 4" long. Trim the insulation 1/4" off the ends. Connect one end to #10 on the operation switch (S-1). See Pictorial 2. Connect the other end to #2 on BB (S-2).
- () Trim the leads on a 50 K Ω 10-watt resistor to 1" long. Connect one end to #1 on BB (S-6). Connect the other end to the grounded lug #2 on CC (S-6).
- () Trim the leads on a .02 μf large disc capacitor, one to 1/2" long and the other to 1/4" long. Connect the short end to ground lug #2 on socket B (S-1). Connect the long end to pin #1 on socket B (NS).
- () Cut a piece of #20 bare wire to 1 1/2" long. Insert one end through pin #8 on socket B and on through ground lug #4 on socket B. Solder just the ground lug for now. Bend this lead back over the socket center shield and connect the other end through pin #4 (NS). Now solder pin #8, the center shield, and pin #4.
- () Trim the leads on a .001 μf 1 kv disc capacitor to 3/4" long. Slip a 5/8" piece of insulated sleeving over each lead. Connect one end to pin #7 on socket B (NS). Connect the other end to #3 on BB (S-3).
- () Trim the leads on the 10 megohm (brown-black-blue) 1/2 watt resistor to 3/8" long. Connect one end to pin #7 on socket B (S-2). Connect the other end to ground lug #3 on socket B (S-1).

- () Trim one lead of a 1 megohm (brown-black-green) 1/2 watt resistor to 1/2" long. Connect this short end to pin #1 on socket B (S-3). Connect the long end through pin #6, bend it up, cover with a piece of insulated sleeving 3/4" long and connect the end to pin #2 on socket B. Now solder pin #6 and #2. See Pictorial 2.
- () Cut a piece of gray hookup wire to 7 1/4" long, trim the insulation 1/4" off each end. Connect one end to #2 on DD (NS), run it close to the chassis, under the RF ground lead from the 6146 socket and up to terminal #2 on the operation switch (S-1).
- () Cut the leads on the 2 μ f paper capacitor to 1" long. Bend both leads inward and connect to #1 and #2 on DD (NS).
- () Cut the leads on the 12K (brown-red-orange) 2-watt resistor to 3/4" long. Connect one end to #1 on DD (S-3). Connect the other end to #2 on DD (S-3). See Pictorial 2. This completes your speech amplifier and modulator circuit.

OSCILLATOR CIRCUIT WIRING

Consult Pictorial 2 for crystal switch numbering and wiring. You will note that there are no contacts on switch positions #1 and #7, even though they are numbered.

- () Cut a piece of #20 bare wire to 7/8" long. Connect one end to crystal socket #4 (S-1). Connect the other end to crystal switch #3 (S-1).
- () Cut a piece of #20 bare wire to 3/4" long. Connect one end to crystal socket #5 (S-1). Connect the other end to crystal switch #4 (S-1).
- () Cut a piece of #20 bare wire to 7/8" long. Connect one end to crystal socket #6 (S-1). Connect the other end to crystal switch #5 (S-1).
- () Cut a piece of #20 bare wire to 2 1/4" long. Cover with a piece of insulated sleeving 1 3/4" long. Connect one end to crystal socket #1 (S-1). Connect the other end to crystal switch #9 (S-1).
- () Cut a piece of #20 bare wire to 2" long. Cover with a piece of insulated sleeving 1 3/4" long. Connect one end to crystal socket #2 (S-1). Connect the other end to crystal switch #10 (S-1).
- () Cut a piece of #20 bare wire to 2 1/4" long. Cover with a piece of insulated sleeving 1 7/8" long. Connect one end to crystal socket #3 (S-1). Connect the other end to crystal switch #11 (S-1).
- () Trim the leads on a 100 K Ω (brown-black-yellow) 1/2 watt resistor to 5/8" long. Connect one end to #2 on the crystal switch (NS). Connect the other end to ground lug #2 on socket D (S-1).
- () ~~Use 47 Ω 1/2 W Resistor~~ Cut a piece of #20 wire to 1 3/4" long. Cover with a piece of insulated sleeving 1 1/4" long. Connect one end to crystal switch #2 (NS). Connect the other end to pin #2 on socket D (S-1).
- () Trim the leads on a 22 μ f (red-red-black) silver mica capacitor to 3/4" long. Connect one end to pin #1 on socket D (NS). Connect the other end to #2 on the crystal switch (S-3).
- () Cut a piece of #20 bare wire to 3 1/2" long and a piece of insulated sleeving 1 7/8" long. Insert one end of the wire through crystal switch terminal #8 (NS), through the sleeving, and then through ground lug #1 of socket D. Bend the other end over and through the grounded connection of the VFO input socket. Now solder just ground lug #1 and the ground connection of the VFO socket. See Pictorial 2.

- () Cut a piece of #20 bare wire to 1 1/4" long. Connect one end to crystal switch #6 (S-1). Connect the other end to the center ungrounded terminal of the VFO input socket (S-1).
- () Trim the leads on a 220 $\mu\mu\text{f}$ (red-red-brown) silver mica capacitor to 3/4" long. Connect one end to pin #1 on socket D (NS). Connect the other end to crystal switch terminal #8 (S-2).
- () Trim the leads on a .002 1 kv disc ceramic capacitor to 1" long. Connect one end to pin #1 on socket D (NS). Connect the other end to crystal switch #12 (S-1).
- () Trim the leads on a .002 1 kv disc capacitor to 3/8" long. Connect one end to ground lug #3 on socket D (NS). Connect the other end to pin #4 on socket D (S-3).
- () Cut a piece of #20 bare wire to 1 1/2" long. Connect one end through pin #5 and on through ground lug #3 on socket D (NS). Bend the lead down to contact the socket center shield and insert the other end through pin #7. Now solder all four points. See Pictorial 2.
- () Trim the leads on a 27 K Ω (red-violet-orange) 1-watt resistor to 5/8" long. Form the leads to allow the resistor to lay close to the chassis. Connect one lead to #1 on terminal strip FF (NS). Connect the other lead to pin #8 on socket D (NS).
- () Trim the leads on a .002 μf disc ceramic capacitor to 3/8" long. Connect one end to pin #8 on socket D (S-2). Connect the other end to ground lug #4 on socket D (S-1).
- () Connect one end of a 1.1 mh RF choke to #3 on terminal strip FF (NS). Connect the other end to pin #1 on socket D (S-4). Bend the choke over slightly toward the crystal switch to prevent burning it while making other connections.
- () Trim the leads on a .02 μf disc ceramic capacitor to 3/8" long. Connect one end to #2 on terminal strip FF (NS). Connect the other end to #3 on FF (S-4).
- () Trim the leads on a .002 μf disc capacitor to 3/8" long. Connect one end to #1 on terminal strip FF (NS). Connect the other end to #2 on FF (S-2).
- () Mount the 40-meter slug tuned coil in the 5/16" hole next to socket D. Allow the red dot outside lead connection to face the rear of the chassis. Push the coil in from the underside of the chassis until the two small ears of metal spring out on the top side of the chassis.
- () Cut a piece of gray hookup wire to 1 7/8" long. Trim the insulation 1/4" off the ends. Connect one end to the 40-meter coil outside winding (red dot) (NS). Connect the other end to pin #6 on socket D (S-1).
- () Cut a piece of gray hookup wire to 2 1/2" long. Trim the insulation 1/4" off the ends. Connect one end to #1 on terminal strip FF (NS). Connect the other end to the remaining 40-meter coil connection (S-1).
- () Cut a piece of #20 bare wire to 1 3/4" long. Cover with a piece of insulated sleeving 1 1/4" long. Connect one end to #1 on terminal strip FF (S-4). Put a 5/16" rubber grommet over the other end, bend the lead close to the chassis and connect it to #3 on terminal strip GG (NS). See Pictorial 2.

BUFFER CIRCUIT WIRING

- () Trim the leads on a .002 μf disc capacitor to 3/8" long. Connect one end to pin #5 on socket C (NS). Connect the other end to ground lug #3 on socket C (S-1).
- () Trim the leads on a .002 μf disc capacitor to 3/8" long. Connect one end to pin #3 on socket C (S-1). Connect the other end to ground lug #2 on socket C (NS).
- () Trim the leads on a .002 μf disc capacitor to 3/8" long. Connect one end to pin #4 on socket C (NS). Connect the other end to ground lug #2 on socket C (S-2).

- () Cut two pieces of gray hookup wire to 4 1/2" long. Trim the insulation 1/4" off the ends. Connect the end of one lead to pin #5 on socket C (S-2). Connect the other end of this lead to #1 on terminal strip KK (S-2).
- () Connect one end of the other 4 1/2" lead to pin #4 on socket C (S-2). Connect the other end of this lead to #2 on terminal strip KK (S-2).
- () Cut a piece of #20 bare wire to 2 1/2" long and two pieces of insulated sleeving, one 1 1/4" long and the other 5/8" long.
- () Run one end of the #20 wire through pin #7 on socket C, the 5/8" piece of sleeving, through pin #1 on socket C, through the 1 1/4" piece of sleeving, bend and connect to #3 on terminal strip GG. Solder just pin #7.
- () Trim the leads on a .002 disc capacitor to 3/8" long. Connect one end to ground lug #1 on socket C (S-1). Connect the other end to pin #1 on socket C (S-2).
- () Trim the leads on a 100 K Ω (brown-black-yellow) 1/2 watt resistor to 3/4" long. Mount the resistor as shown in Pictorial 2. Connect one end to pin #2 on socket C (NS). Connect the other end to #3 on GG (S-3).
- () Trim the leads on a 47 Ω (yellow-violet-black) 1/2 watt resistor to 3/4" long. Cover one lead with a piece of insulated sleeving 5/8" long. Insert the insulated lead through a 5/16" rubber grommet and connect to pin #2 on socket C (S-2). Bend the insulated lead down toward the chassis. The other end of the resistor is left free.
- () Trim the leads on a 27K (red-violet-orange) 1-watt resistor to 5/8" long. Form the leads to allow the resistor to lay close to the chassis. Connect one lead to #1 on GG (NS). Connect the other lead to pin #8 on socket C (NS).
- () Trim the leads on a .002 μ f disc capacitor to 3/8" long. Connect one end to ground lug #4 on socket C (NS). Connect the other end to pin #8 on socket C (S-2).
- () Cut a piece of #20 bare wire to 1" long. Cover with a piece of insulated sleeving 1/2" long. Connect one end through the center shield of socket C (S-1). Connect the other end to ground lug #4 on socket C (S-2).
- () Trim the leads on a .002 μ f disc capacitor to 3/8" long. Connect one end to #1 on GG (NS). Connect the other end to #2 on GG (S-1).
- () Cut a piece of gray hookup wire to 4 1/4" long. Trim the insulation 1/4" off the ends. Connect one end to #1 on GG (NS). Run the other end through the 5/16" grommet on the #14 RF ground lead and connect to operations switch #8 (S-1). See Pictorials 1 and 2.
- () Cut a piece of gray hookup wire to 5 1/2" long. Connect one end to #1 on GG (NS). Run the other end close to the chassis and connect to pin #1 on socket E (NS).
- () Cut one lead of a 1.1 mh RF choke to 1/2" long. Connect this end to #1 on GG (S-5). Connect the longer end to pin #6 on socket C (NS).
- () Cut a piece of gray hookup wire to 2" long. Connect one end to pin #6 on socket C (S-2). Leave the other end free.

FINAL AMPLIFIER CIRCUIT WIRING

- () Cut a piece of gray hookup wire to 7" long. Connect one end to #7 on the operation switch (S-1). Thread the other end through the 5/16" grommet, that contains the #14 wire RF ground lead and down through another 5/16" grommet next to socket G. Connect to the bottom terminal of the 2.5 MH RF choke (NS). See Pictorial 4.

- () Trim the leads on a .002 μ f disc capacitor to 7/8" long. Connect one end to the grounded terminal on the rear of the 140 μ μ f tuning capacitor (S-1). See Pictorial 4. Connect the other end to the bottom terminal of the 2.5 mh RF choke (S-2).
- () Cut a piece of #20 bare wire to 1 1/4" long. On socket G thread one end through the (close to socket) hole of pins #7 and #8 and through ground lug #4. Maintain the #14 RF ground wire tight to the #4 ground lug and solder this and pin #7.
- () Cut the leads on a 47 μ μ f (yellow-violet-black) silver mica capacitor to 1/4" long. Connect one end through the (close to socket) hole of pin #5 on socket G (NS). Connect the other end to the (close to socket) hole of pin #8 (S-2).
- () Trim the leads on a .002 μ f disc capacitor to 3/8" long. Connect one end to ground lug #1 on socket G (NS). Connect the other end to the (close to socket) hole of pin #1 (S-1).
- () Trim the leads on a .002 μ f disc capacitor to 3/8" long. Connect one end to ground lug #1 on socket G (NS). Connect the other end to the (close to socket) hole of pin 2 (S-2).
- () Cut a piece of #16 bare wire to 1 5/8" long. Push one end straight down through ground lug #1 on socket G. This lead should lock the RF ground lead tight to the socket (S-4). Allow the other end of this 1 5/8" lead to stick straight up, to be soldered later to the drive capacitor.
- () Solder the end of the RF ground wire just where it connects to #2 on AA. See Figure 9.
- () Trim the leads on a .001 μ f 1 kv disc ceramic capacitor to 3/8" long. Connect one end to ground lug #2 on socket G (NS). Connect the other end through the (close to socket) hole of pin #3 on socket G (NS).
- () Cut a piece of gray hookup wire to 6 1/2" long. Connect one end to pin #3 on socket G (S-2). Thread the other end under the RF ground lead next to the socket, through the 5/16" grommet (containing the #14 RF ground lead) and up to operation switch #3 (S-1).
- () Trim the leads on a .002 μ f disc capacitor to 3/8" long. Connect one end to ground lug #2 on socket G (NS). Connect the other end to pin #4 (hole close to socket) on socket G (S-1).
- () Trim the leads on a 27 μ μ f mica capacitor (red-violet-black) to 3/8" long. Connect one end to ground lug #2 on socket G (S-3). Leave the other end free.
- () Trim the leads on a .002 μ f disc capacitor to 3/8" long. Connect one end to pin #6 (hole close to socket) on socket G (NS). Connect the other end to ground lug #3 (S-1).
- () Cut a piece of gray hookup wire to 3 3/4" long. Trim the insulation 1/4" off each end. Connect one end to pin #6 on socket G (S-2). Thread the other end through the 5/16 grommet and connect to #3 on AA (NS).
- () Trim the leads on the .67 Ω 1% precision resistor to 1/2" long. Connect one end to #3 on AA (NS). Connect the other end to #1 on AA (NS).
- () Cut a piece of gray hookup wire to 5 3/4" long. Connect one end to #3 on AA (S-3). Run the other lead down under the RF ground lead, close to the chassis, toward the operation switch and down through the 3/8" grommet, to be connected later to the meter switch on the front panel.
- () Cut a piece of yellow hookup wire to 4 1/2" long. Trim the insulation 1/4" off the ends. Connect one end to #1 on AA (NS). Run this lead along with the wiring cable to just beneath the key jack. Bend the lead up and connect to key jack terminal #1 (NS).
- () Cut a piece of yellow hookup wire to 5" long and strip both ends 1/4". Connect one end to #1 on AA (S-3). Run the other end down through the 3/8" grommet near the operation switch and leave it free.
- () Cut the leads on a 47 K Ω (yellow-violet-orange) 2-watt resistor to 3/4" long. Connect one end to key jack terminal #1 (NS). Connect the other end to terminal #3 (NS). Maintain the resistor position close to the chassis front apron.
- () Trim one lead on a .002 μ f disc capacitor to 3/8" and the other 7/8" long. Connect the long end through key jack terminal #2 and #3 (NS). Connect the short end to terminal #1. Check Pictorial 2 to be sure, then solder #1, #2, and #3.

- () Mount the coax connector on the rear chassis apron using a 4-40 x 3/8" screw and a 4-40 nut to hold it in place while connections are made.
- () Prepare the coaxial cable as shown in Figure 11, using a sharp knife. In cutting the shield braid, be careful not to cut through the inner insulation. When soldering the outer braid, solder quickly to prevent melting the inner insulation. The ground lead is #20 wire.

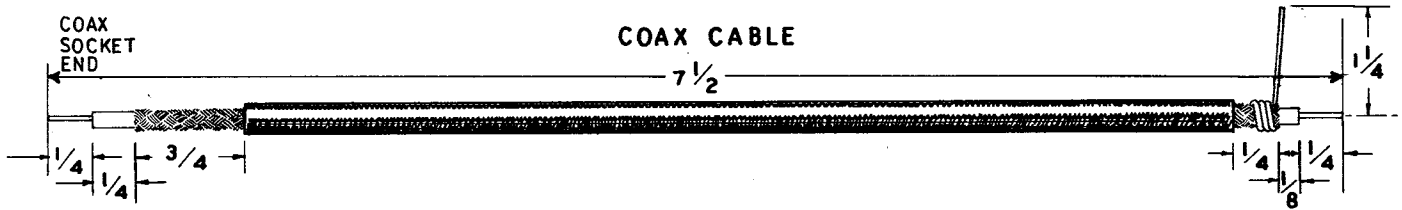

Figure 11

- () Tin the inner-conductor of the coaxial cable at the end having the most shield braid exposed. Slide the coax shield cup over the cable in such a manner that its narrow end passes under the shield braid. Hold the shield cup back to expose the coax center conductor and solder the center conductor to the center terminal of the coax fitting on the rear chassis apron. Remove the nut holding the coax connector and replace it with the shield cup against the chassis. Add three more 4-40 screws and nuts to secure the assembly.
- () Smooth the coax shield braid over the narrow end of the coax shield cup and solder.
- () Cut a piece of #16 bare wire to 4 3/8" long. Cover with a piece of insulated sleeving 3 3/4" long. Connect one end through the (inside) hole of the solder lug on the feedthrough insulator next to the operation switch (NS). The other end is connected later to A1 on the bandswitch.
- () Connect the ground lead from the piece of coax cable to #2 on AA (NS). Connect the inner conductor of the coax cable through the (outside) hole of the solder lug on the feedthrough insulator. Solder the end of the coax cable and the piece of #16 wire, positioned as shown in Pictorial 3.
- () Cut a piece of gray hookup wire to 3" long. Trim the insulation 1/4" off the ends. Connect one end to #2 on AA (S-2). Connect the other end to #5 on the operation switch after bending the two #5 tabs toward each other (S-1). See Pictorial 2.
- () Trim the leads on a 6800Ω (blue-gray-red) 2-watt resistor to 3/4" long. Connect one end to #4 on AA (NS). Connect the other end to #1 on the operation switch (S-1).
- () Cut a piece of gray wire to 8" long. Trim the insulation 1/4" off the ends. Connect one end to #2 on HH (NS). Run the other end close to the chassis, in front of socket G, and through the 5/16" grommet and connect to #4 on AA (S-2).
- () Trim the leads on a 1 KΩ (brown-black-red) 1/2 watt resistor to 3/8" long. Connect one end to #5 on KK (S-3). Connect the other end through the hole in terminal strip JJ as shown in Pictorial 2 (NS).
- () Trim the leads on a .005 μf 1.6 kv large disc capacitor to 1/2" long. Connect one end to JJ (S-2). Connect the other end to ground lug #4 on socket E (S-1).
- () Cut a piece of gray hookup wire to 3 1/4" long. Run one end under the .005 μf 1.6 kv disc capacitor and connect to pin #1 on socket E (NS). Connect the other end to #4 on KK (NS).
- () Trim the leads on a 20 KΩ 10-watt resistor to 3/4" long. Connect one end to pin #4 on accessory socket F (NS). Connect the other end to #4 on KK (S-2).

- () Trim the leads on a .002 μ f disc capacitor to 3/8" long. Connect one end to pin #4 on accessory socket F (S-2). Connect the other end to #2 on MM (NS).
- () Trim the leads on a .002 μ f disc capacitor to 3/8" long. Connect one end to ground lug #3 on accessory socket F (S-1). Connect the other end to pin #6 on socket F (S-2).

NOTE: Before doing the next step, remove the yellow cable lead from pin #8 on socket F to avoid burning it. Refer to Figure 12.

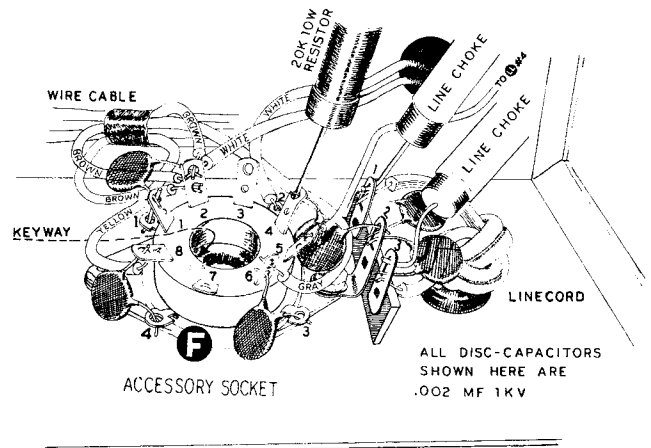

Figure 12

- () Thread a piece of #20 bare wire 3/4" long through pin #1 and ground lug #1 on power socket F. Solder just ground lug #1.
- () Trim the leads on a .002 μ f disc capacitor to 3/8" long. Connect one end to pin #1 on socket F (S-2). Connect the other end to pin #2 on socket F (S-5). Replace the yellow cable lead on pin #8 of socket F (NS).
- () Trim the leads on a .002 μ f disc capacitor to 3/8" long. Connect one end to ground lug #4 on socket F (S-1). Connect the other end to pin #8 on socket F (S-2).
- () Cut a piece of gray hookup wire to 2 1/2" long. Trim the insulation 1/4" off the ends. Connect one end to pin #5 on accessory socket F (S-1). Connect the other end to #4 on LL (NS).
- () Insert one end of the line cord through the 3/8" grommet next to MM on the chassis rear apron. Tie a knot 1 1/4" from the end. Connect one lead to #1 on MM (NS). Connect the other lead to #3 on MM (NS).
- () Trim the leads on a .002 μ f disc capacitor to 3/8" long. Connect one end to #1 on MM (NS). Connect the other end to #2 on MM (NS).
- () Trim the leads on a (white dot) line choke to 5/8" long. Connect one end to #2 on LL (NS). Connect the other end to #1 on MM (S-3).
- () Trim the leads on a .002 disc capacitor to 3/8" long. Connect one end to #3 on LL (NS). Connect the other end to #2 on LL (S-3).
- () Trim the leads on a .002 disc capacitor to 3/8" long. Connect one end to #3 on MM (NS). Connect the other end to #2 on MM (S-3).
- () Trim the leads on a (white dot) line choke to 3/4" long. Connect one end to #3 on MM (S-3). Connect the other end to #4 on LL (NS).
- () Trim the leads on a .002 μ f disc capacitor to 3/8" long. Connect one end to #4 on LL (S-4). Connect the other end to #3 on LL (S-2).
- () Trim the leads on the 20 Ω 1% precision resistor to 1/2" long. Connect one end to #1 on terminal strip II (NS). Connect the other end to #2 on II (NS).
- () Trim the leads on a .002 μ f disc capacitor to 3/8" long. Connect one end to #1 on II (S-2). Connect the other end to #2 on II (NS).
- () Cut a piece of green hookup wire to 10" long. Trim the insulation off the ends 1/4". Connect one end to #2 on II (NS). Run the other end close to the chassis and up to the front apron toward the operation switch, and down through the 3/8" grommet, to be connected later.

- () Trim the leads on a 27 K Ω (red-violet-orange) 1-watt resistor to 3/4" long. Connect one end to #2 on II (S-4). Leave the other end free.
- () Cut a piece of gray hookup wire to 4" long. Trim the insulation 1/4" off the ends. Connect one end to pin #1 on socket E (NS). Run the other end close to the chassis and down through the 5/16" grommet next to the pilot light socket. Connect this end to #2 on terminal strip NN (NS). See Pictorial 2 and Figure 13.
- () Cut a piece of gray hookup wire to 5 1/2" long. Trim the insulation 1/4" off the ends. Connect one end to #2 on HH (NS). Run the other end down the 5/16" grommet next to the pilot lamp socket and connect to #2 on terminal strip OO on the top side of the chassis (NS). See Pictorial 2 and Figure 13.

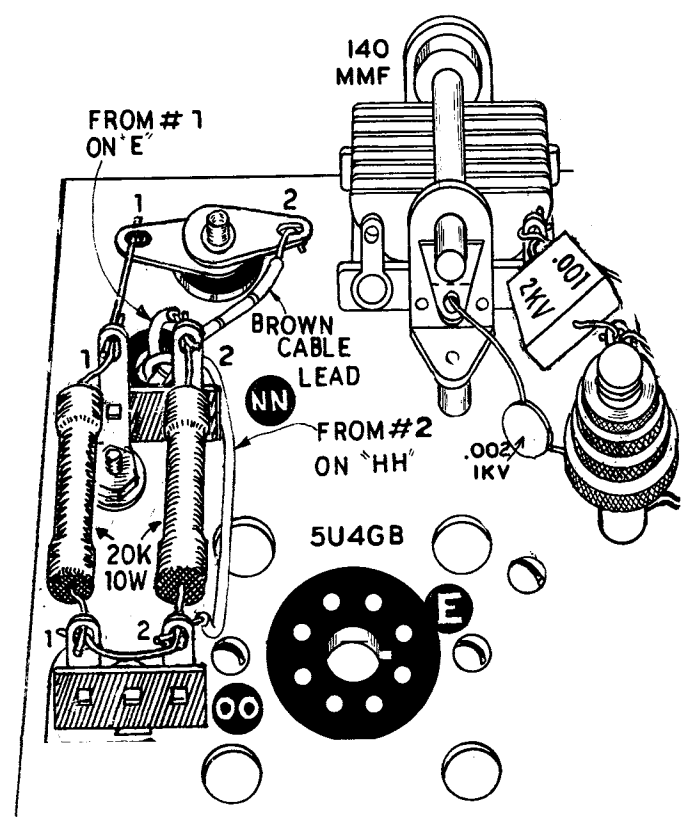

Figure 13

- () On the top side of the chassis, connect one end of a 1 1/2" piece of #20 bare wire to #1 on terminal strip NN (NS). Connect the other end to #1 on the pilot light socket (S-1). See Figure 13.
- () Trim one lead on a 20 K Ω 10-watt resistor to 1/2" long. Thread the longer end through #2 then #1 on terminal strip OO (NS). The short end connects to #2 on terminal strip NN (NS). Position the resistor body an equal distance between NN and OO, then solder #2 on NN and #2 on OO.
- () Trim one lead on a 20 K Ω 10-watt resistor to 3/4" long and the other to 1/2" long. Connect the 3/4" end through #1 on NN and the other 1/2" end through #1 on OO. Align the resistor body neatly as shown in Figure 13. Then solder both connections.

BANDSWITCH MOUNTING AND WIRING

See Figure 14 for the bandswitch number sequence and wiring.

- () On the rear (switched) wafer of the bandswitch, there are two combined circuits. One circuit switches the 5-band coils and the other switches a 27 $\mu\mu\text{f}$ mica capacitor on all bands except 80 meters. The extreme rear wafer serves only as a tie point for the ends of the coils. The four contacts numbered B5, B6, B7 and B8 are strapped together with a piece of #20 bare wire. Solder all except B5, as the 27 $\mu\mu\text{f}$ mica capacitor lead connects there. Be cautious of shorting to the bandswitch frame.

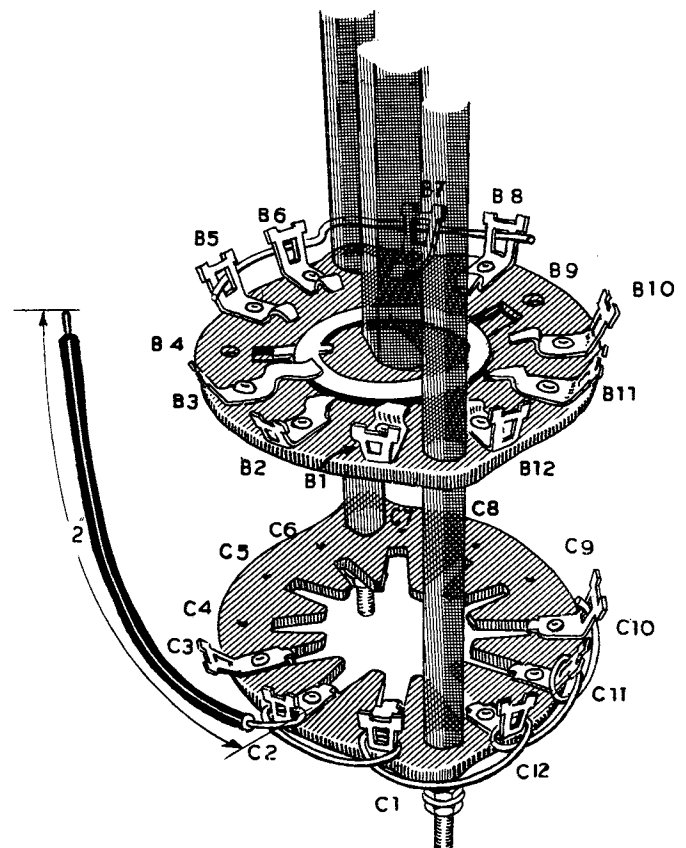

Figure 14

() Take a 5" length of #20 bare wire and insert one end through terminal C10 on the rear wafer. Now run the wire around C11 one tight turn, then C12, C1 and C2. See Figure 14 for detail. Measure out from C2 and trim this lead to 2" long. Cover this lead with a piece of insulating sleeving 1 3/4" long. Be cautious of a short between this wire and the switch frame between C1 and C12.

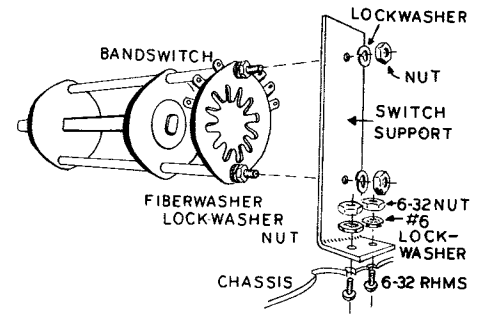

Figure 15

() Take one nut and lockwasher off each end of the bandswitch and mount the switch support L bracket as shown in Figure 15. Replace the two lockwashers and nuts.

() Put a 3/8" lockwasher over the end of the bandswitch and secure the bandswitch temporarily with a 3/8" flat washer and a 3/8" control nut, in the position shown in Pictorial 3. Use two 6-32 x 3/8" RH screws, #6 lockwashers and 6-32 nuts to secure the foot of the L bracket to the chassis.

() Connect the gray lead from pin #6 on socket C to C3 on the bandswitch (NS). See Pictorial 3.

() Trim the leads on a .001 μ f 1 kv disc capacitor to 5/8" long. Connect one end to B3 on the bandswitch (NS). Connect the other end to C3 on the bandswitch (S-2).

() Connect the free end of the 27 μ μ f (red-violet-black) mica capacitor to B5 on the bandswitch (S-2).

() The sleeving covered lead from C2 on the bandswitch is connected to pin #5 on the 6146 socket G (S-2).

() The free end of the 27 K Ω (red-violet-orange) 1-watt resistor from terminal strip II connects to C10 on the bandswitch (NS). See Figure 17 and 18 and Pictorial 3 for mounting position.

() With a piece of #16 bare wire connect terminal A7 from the bandswitch to the solder lug on the adjacent feedthrough insulator and solder both connections. See Pictorial 3.

() Trim the leads on the 68 μ μ f 4 kv disc ceramic capacitor to 7/8" long. Connect one end to the grounded #1 lug on terminal strip HH (S-1). Connect the other end to terminal A8 on the bandswitch (S-1). Refer to Pictorial 3.

() The coil leads coming through the large hole are numbered 1, 2, 3 and 4 as shown in Figure 16. Trim these leads to optimum length as you connect them. Connect coil lead #4 to bandswitch A5 (S-1). Bend the coil lead as shown in Pictorial 3 to allow easy insertion to the bandswitch terminal.

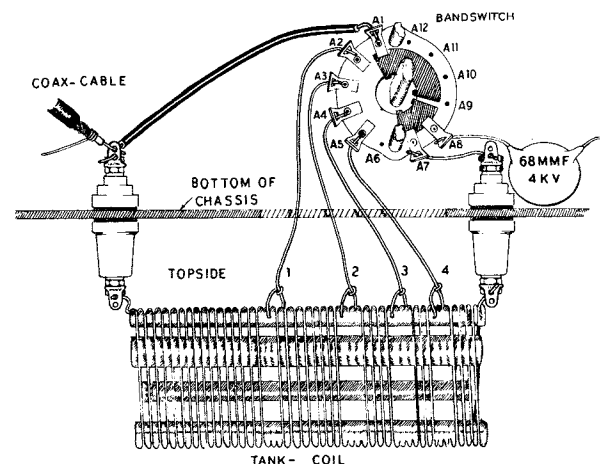

Figure 16

() Connect coil lead #3 to A4 on the bandswitch (S-1).

() Connect coil lead #2 to A3 on the bandswitch (S-1).

() Connect coil lead #1 to A2 on the bandswitch (S-1).

- () Connect the free end of the #16 wire coming from the feedthrough insulator under the operation switch to A1 of the band switch (S-1). See Pictorial 3 and Figure 16.

NOTE: Extreme care and good soldering is a must for the following.

MOUNTING THE BUFFER COIL SET

- () Select the 80-meter coil which is marked with a black dot of paint on one end. Trim the leads to 3/4" long. Connect one end to C10 and the other end to B10 on the band-switch. Bend the coil down toward the chassis to isolate it from the other coils which have to be mounted yet. See Figure 17 and 18. When positioned properly, solder both ends.
- () The 40-meter (blue dot) coil mounts with 5/8" leads from C11 to B11 on the bandswitch. Bend the coil down to provide room for the 20-meter coil. Avoid shorting to the other coils connection points. When properly placed according to Figure 17, solder both ends.
- () The 20-meter (orange dot) coil mounts with 1/2" leads from C12 to B12 on the bandswitch. Lay a rule across the chassis to establish the amount of clearance there will be when the chassis is in the steel cabinet. A space of approximately 3/8" to 1/2" between the 20 and 10 meter coil bodies and the underside of the rule is normal. The space between the coils should be approximately 3/8" or more to limit undesired RF coupling. Solder both ends.
- () The 10-meter (green dot) coil mounts with 1/2" leads from C2 to B2 on the bandswitch. Bend the coil down close to the .001 μf disc capacitor to obtain sufficient clearance for mounting the 15-meter coil. Solder both ends.
- () The 15-meter (yellow dot) coil mounts with 1/2" leads from C1 to B1 on the bandswitch. Bend the coil down slightly to maintain a reasonable distance between it, the adjacent 10-meter coil, and the underside of the rule held across the chassis. Solder both ends. This completes the bandswitch wiring.

SHIELD BRACKET MOUNTING

- () Screw the small 6-32 set screw part way into the 20 μf variable capacitor extension shaft and insert the shaft through the hole in the chassis front apron. To be mounted later. See Pictorial 3.
- () Mount the shield bracket in its place according to Pictorial 3. Allow the grommets to slide in the slots provided. Pick the leads up out of the way that lie in front of the 6146 socket G to avoid pinching and shorting.

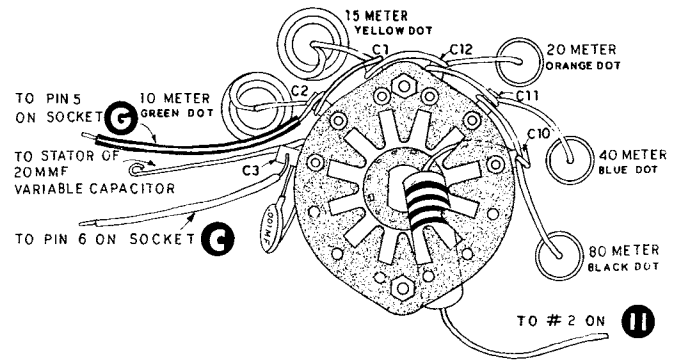

Figure 17

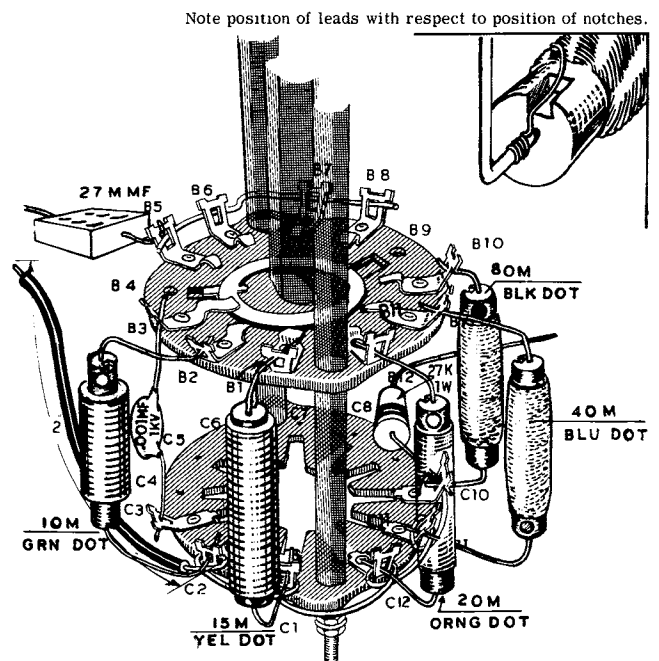

Figure 18

- () Slip the shaft extension on the end of the small 20 $\mu\mu\text{f}$ variable capacitor. Tighten the set screw. Now orient the shield bracket to prevent any misalignment and binding of this shaft. Some free play is provided for this by the slightly oversize mounting holes in the chassis. Secure the shield bracket from the top side of the chassis by using #6 lockwashers and 6-32 nuts. Do not overtighten, as you will shear the spade screws off.
- () Lay the short #16 wire ground lead tight against the 20 $\mu\mu\text{f}$ variable capacitor ground lug and solder. See Pictorial 3.
- () Cut a piece of #20 bare wire 1" long and form a very small loop at one end. Slip the loop over the end of the stator terminal on the small 20 $\mu\mu\text{f}$ variable tuning capacitor (S-1). See Figure 17 and Pictorial 3. CAUTION: Do not use too much heat or solder to prevent damage to the capacitor. Connect the other end of the wire to B3 on the bandswitch (S-2).
- () Connect the free end of the 47 Ω (yellow-violet-black) 1/2 watt resistor to terminal strip PP, which is mounted on the shield bracket (NS) See Pictorial 3.
- () Trim the leads on a ⁴⁷~~100~~ $\mu\mu\text{f}$ silver mica capacitor to 3/4" long. Connect one end to terminal strip PP (S-2). Connect the other end to the (nearest to the chassis rear apron) terminal of the 40-meter coil (S-2).
- () Trim the leads on a 40 μf 450-volt electrolytic capacitor to 1 1/4" long. Connect the negative (outside casing) lead to #2 on HH (NS). Connect the positive (red end) to pin #1 on socket E (S-5).
- () Trim the leads on a 40 μf 450-volt electrolytic capacitor to 1 3/8" long. Connect the positive (red end) to #2 on HH (S-4). Connect the negative end to ground lug #3 on socket E (S-1). See Pictorial 3.
- () On the top side of the chassis, mount the 6146 tube in its socket. Trim the leads on the parasitic choke coil to 3/4" long. Connect one end to the plate cap connector (S-1). Mount the cap with the coil, on the 6146 tube. Connect the free end of the parasitic choke to the top of the 2.5 mh RF choke (NS). Do not allow leads to go down through the terminal and touch the choke winding. Refer to Pictorial 4.
- () Trim the leads on a .001 μf 2 kv mica capacitor to 3/4" long. Connect one end to the stator terminal of the 140 $\mu\mu\text{f}$ variable capacitor as shown in Pictorial 4 (NS). Connect the other end to the top of the 2.5 mh RF choke coil (S-2).
- () Cut a piece of #16 bare wire 1 1/2" long. Thread one end through the solder lug on the feedthrough insulator next to the 140 $\mu\mu\text{f}$ variable capacitor. Bend the other end over and pinch a small loop around the near capacitor stator terminal. Solder both ends of this #16 wire. See Pictorial 4 to clarify.
- () Cut a piece of #16 bare wire to 2 5/8" long. Connect one end to the front section terminal of the 2-gang loading capacitor. Allow this lead to lay across the second section terminal, then solder both connections. Avoid shorting this lead to the capacitor frame, or allowing solder drips to short to the chassis. Bend the other end of this lead up to the coil connection solder lug on the feed through insulator (S-2). Refer to Pictorial 4.

PANEL ASSEMBLY

- () Mount the silver Logotype on the front panel by applying a hot soldering iron to the plastic pins on the rear side of the panel. See Figure 19. Hold the type tight against the panel and remove the hot iron once a small flat retaining bead has been formed next to the panel.
- () The meter switch is mounted with 6-32 x 1/4" screws using a #6 lockwasher under one 6-32 nut and a #6 solder lug under the other. See panel rear view in Figure 19.

10-watt resistors are hot to the touch when operating normally!

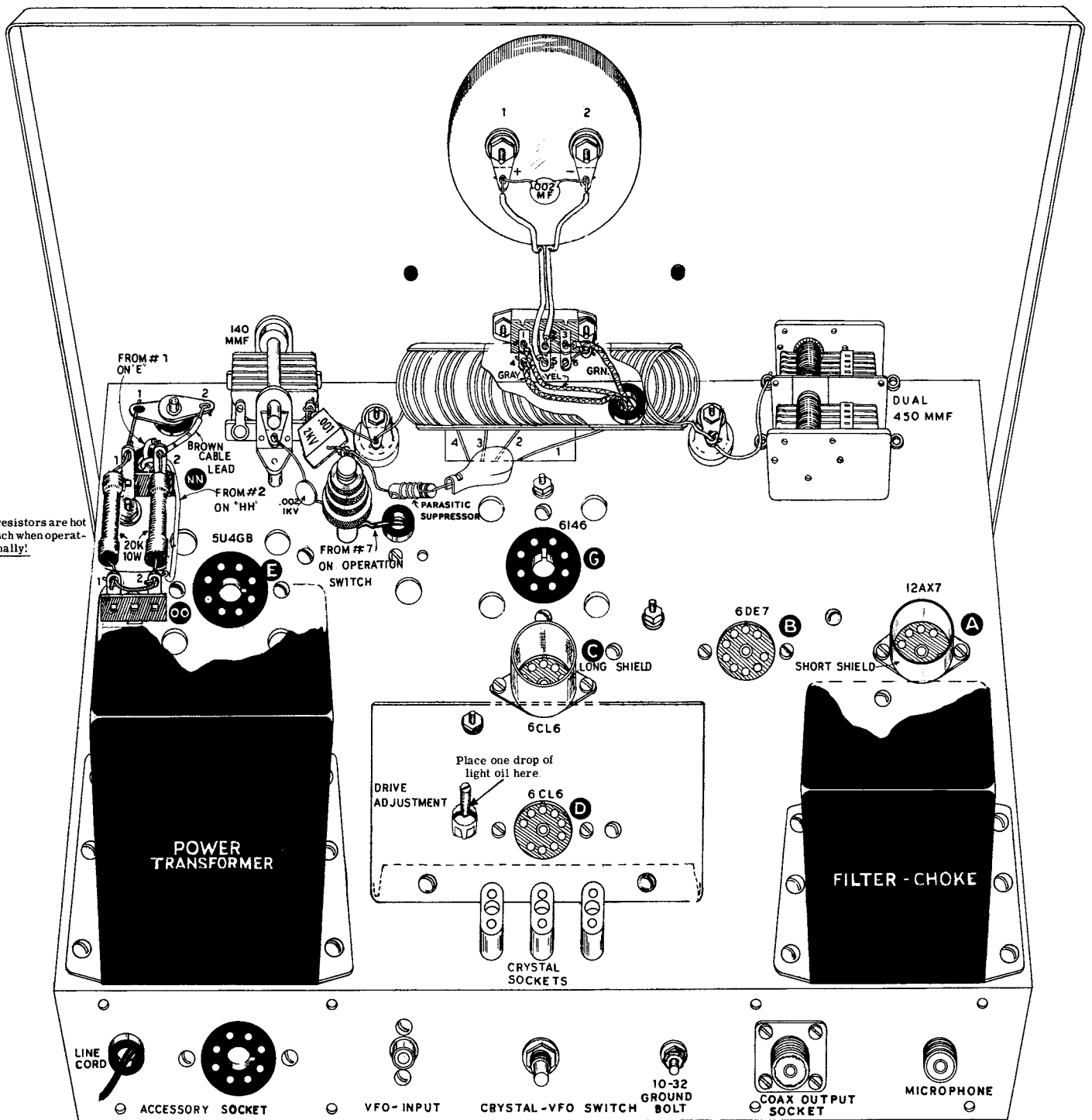

PICTORIAL 4

- () Connect a short piece of #20 bare wire from the meter switch terminal #6 to the ground lug. Solder both ends. See Pictorial 4.
- () Mount the pilot light jewel in the right hand hole marked "power". Bend out the small retaining tabs to secure it. See Figure 19.
- () Mount the meter, using the flat insulated washers under the shield and the insulated shoulder washers on the outside of the shield. Be sure they seat properly before tightening. See exploded view in Figure 20. Use a #10 solder lug under the 10-32 nuts.
- () Trim the leads on a .002 μ f disc capacitor to 1/2" long. Connect it across the meter to the two #10 solder lugs (NS).
- () Cut a piece of gray hookup wire to 4 3/4" long. Trim the insulation 1/4" off each end. Connect one end to terminal #1 on the meter (S-2). Run the lead down close to the meter case tight against the panel and up to terminal #5 on the meter switch (S-1). See Pictorial 4.

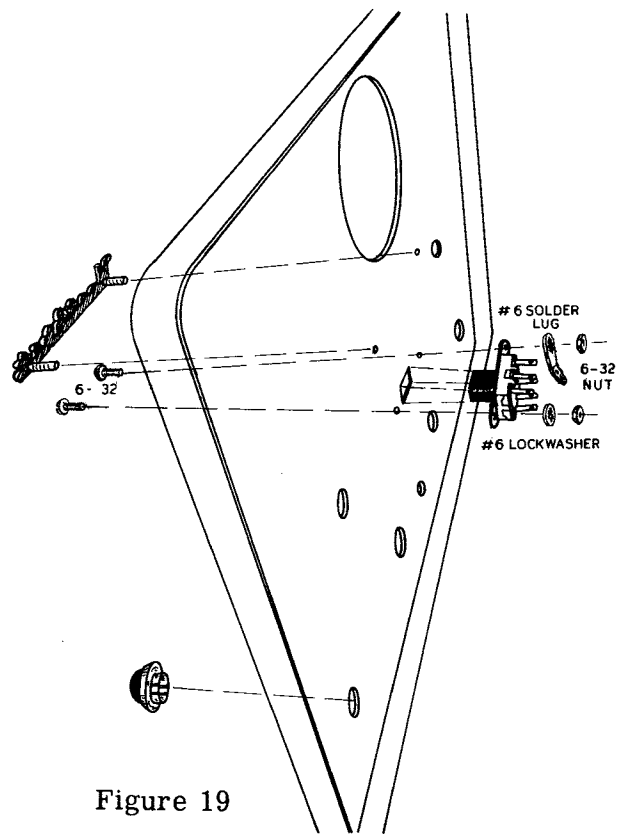

Figure 19

- () Cut a piece of gray hookup wire to 4 1/4" long. Trim the insulation 1/4" off each end. Connect one end to #2 terminal on the meter (S-2). Run the lead down close to the meter case, tight against the panel and up to terminal #2 on the meter switch (S-1).
- () Remove all the nuts and washers securing the controls on the front chassis apron, to provide for mounting the front panel to the chassis. Tighten the nut on the 140 μ μ f variable capacitor against the two spacing washers. (These are supplied with the capacitor).

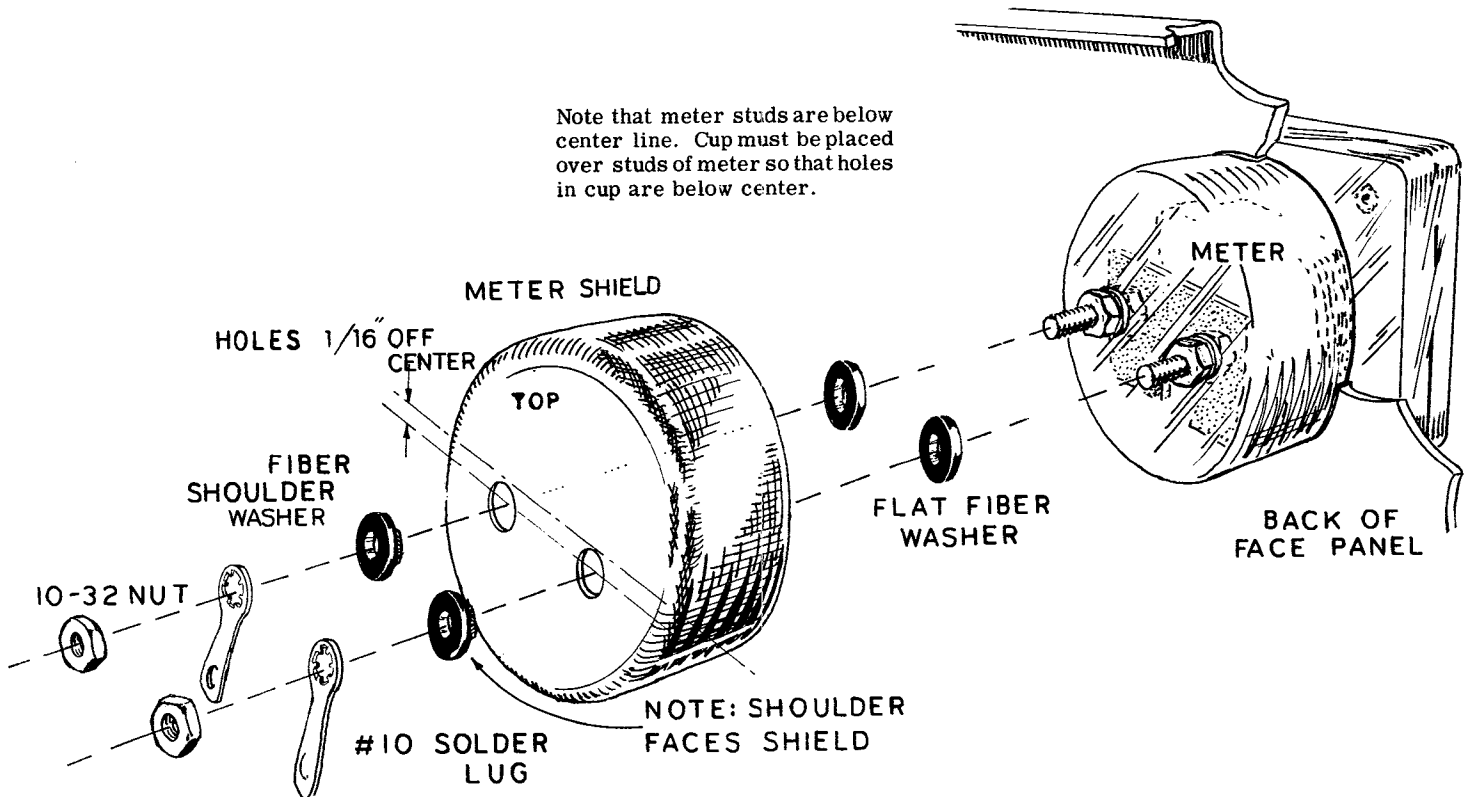

Figure 20

- () While holding the panel up to the chassis, connect the gray lead (which is one of three protruding through the 3/8" grommet) to terminal #4 on the meter switch (S-1).
- () Connect the yellow lead to terminal #1 (S-1).
- () Connect the green lead to terminal #3 (S-1).
- () Mount the panel by allowing all the control shafts to come through their hole positions. Secure all the controls with a 3/8" control nut and 3/8" flat washer.
- () After mounting the panel, with a long slender screwdriver, etc., tuck the slack meter switch leads under, or next to, the meter switch to get them out of the RF field from the tank coil.
- () The small 2" x 3" shield plate is mounted on the top side of the chassis with two #6 sheet metal screws, between the crystal sockets and the oscillator tube. Mount the shield with the lip towards the oscillator tube. See Pictorial 4.

MOUNTING THE CONTROL KNOBS

- () Close the 2-gang capacitor, set the large pointer knob to #0 and tighten the set screw.
- () Close the final tuning capacitor, set the large pointer knob to #0 and tighten the set screw.
- () Adjust the operation switch to the third position (clockwise). Set the knob to "stand-by" and tighten the set screw.
- () Mount the small red knob with the white indicating dot to the extreme left with the 20 $\mu\mu\text{f}$ drive capacitor closed. Tighten the set screw.
- () Set the bandswitch to the third position clockwise. With the knob indicating the 20-meter band, tighten the set screw.
- () Mount a small knob on the crystal switch on the rear chassis apron. With the switch in the third position (clockwise) the knob should point to the middle crystal socket.

NOTE: Use extreme caution when installing tubes to avoid bending or breaking off the small pins. Be sure the pins are centered properly in the sockets before exerting pressure.

- () Install the pilot light and the tubes in their proper positions as shown in Pictorial 4. The longer tube shield is used over the 6CL6 buffer tube and the short one is for the 12AX7. Your transmitter is now completed--congratulations.

Upon completing the operational checks, and obtaining satisfactory results, the transmitter can be mounted in the steel cabinet.

The four rubber feet are mounted using 8-32 x 3/8" screws, through the rubber feet and up through the holes in the dimples of the cabinet bottom, and secured on the inside with #8 lockwashers and 8-32 nuts.

The chassis is held tightly in the cabinet by eight #6 sheet metal screws which go through the holes in the rear of the cabinet and into the chassis rear apron.

Once the proper crystals are installed the crystal access door can be secured with a #6 sheet metal screw.

NOTE: In localities where television interference is not likely, this door may be left off for convenience of changing crystals as well as providing additional ventilation.

PRELIMINARY OPERATION CHECKS

Before applying power to the transmitter, examine your wiring very carefully for possible shorts, such as tube pins touching, resistor or capacitor leads contacting each other, or shorting to the tube socket center shield or to the chassis, coil leads shorting to each other or to the bandswitch frame. Also be sure no wire clippings or solder drops are loose in the chassis. Turn it upside down and give it a good shake.

If there are any short circuits, serious damage may result to the tubes and components when power is applied. As an additional check, **WITH THE LINE CORD DISCONNECTED FROM THE POWER SOURCE**, connect an ohmmeter from pin #1 on socket E to ground. It should read between 30 K Ω and 40 K Ω in all positions of the operations switch, except the phone position, where

it will read approximately 23 K Ω . Any abnormal reading should be completely investigated before applying power.

NOTE: Due to the action of the polarized electrolytic capacitors the ohmmeter test leads should be interchanged to favor the higher resistance readings.

Again, before applying power, check all solder connections, making sure none have been missed and that all are good electrical connections. Check the coax connector (center) with an ohmmeter for "open" and the mike connector (center) for a short to chassis.

TUNING INSTRUCTIONS

If any of the following tests cannot be performed or show abnormal indications, turn to the section of the manual entitled Service and Maintenance Hints. Set the transmitter up as follows: crystal switch in any position (no crystals or VFO plugged in) operation switch OFF, DRIVE control in any position, bandswitch 10-11 meter position, antenna tuning "O" position. GRID-PLATE switch in PLATE position, final tuning "O" position.

Plug the line cord into a 117-volt AC receptacle. Nothing should happen, if anything does, pull the line cord immediately. There is trouble in the AC power circuits which must be corrected before proceeding. If operation is normal so far, switch the operation switch to the "standby" position.

The pilot light and all tubes should light but there should be no meter reading or other indication yet. Switch to PHONE position. With the key plugged in there will now be voltage across the key terminals so use caution. Depress the key momentarily. The meter (switched to plate position) should read between 1/2 and full scale. Release the key.

For the following adjustments an 80-meter crystal in the range of 3500 to 3600 or a 40-meter crystal in the range of 7000 to 7200 should be used. A VFO tuned within these limits would also suffice. Install the crystal in any of the three sockets and set the crystal switch for this socket or the VFO position. Set the bandswitch to 10 meters and connect a dummy load such as a 40-watt light bulb from the ground bolt to the center of the coax connector. Switch the meter to read grid current. Set the operation switch to STANDBY and plug the line cord into a power source. Set the loading (antenna tuning) control to "O" (capacitor fully meshed). After about two minutes time for tube warmup, switch to TUNE position, with the meter switched to read grid current, depress the key and adjust the drive control for maximum grid current reading. Release the key.

Locate the 40-meter oscillator coil adjustment on top of the chassis and lubricate it with one drop of light oil. With a radio-TV type alignment tool or a small screwdriver, turn the slug (counter-clockwise) to the end of its travel. Do not try to force it past this point to avoid fracturing the powdered iron core slug.

Close the key and turn the slug (clockwise) until maximum grid current is indicated. Release the key.

NOTE: This indication does not mean that the oscillator plate coil is tuned exactly to the frequency, the fact being that in some cases the oscillator provides more than sufficient drive for the buffer stage, in which case a slight off-tuning of the oscillator coil results in an increased grid current reading to the 6146 final tube.

In general, this tuned coil should be adjusted for the highest reading of grid current near the range of frequencies in which operations are planned. Once adjusted, it can be left alone as long as sufficient grid drive is obtained.

On 10 meters with a 40-meter crystal, a higher reading is obtained with the slug screwed out farther than when an 80-meter crystal is used. In effect, the oscillator is overdriving the buffer with the 40-meter crystal and detuning the oscillator plate circuit reduces the excess drive to the buffer stage.

Upon obtaining a reading at, or near 3 milliamperes grid current to the final amplifier, switch the meter to read plate current. The operation switch is switched to PHONE position and the final tuning control is tuned to the lowest reading of plate current. This "dip" should occur near #90 on the dial with the bandswitch on 10 meters.

NOTE: These tests were made with a 3500 kc and 7000 kc crystal. The "off-tuned" plate current generally does not exceed 75 milliamperes due to the low screen voltage on the 6146 in the phone position without modulation. Once tuned to minimum current in the phone position, switch to CW operation. This will show a much higher average plate current, with more pronounced "dips".

To load the antenna or dummy load, always start with the antenna tuning (loading) control closed at "O" position. The final tuning is always tuned to resonance, or minimum plate current. When the loading control is moved, it detunes the output circuit and this has to be compensated for by redipping the final tuning control to resonance. Keeping this in mind, gradually open the antenna tuning to indicate #20 on the dial. Now return to the final tuning control and redip it to minimum current. Increase the loading to approximately 40 on the dial. Redip the final to minimum. Increase the loading still farther and redip the final until the "dip" is at, or near, the recommended "loaded" current which is 125 milliamperes in the CW position.

This successive loading and redipping is recommended for tuning of the pi network output circuit of this transmitter except when using an antenna tuner or coupler, in which case the loading capacitor is left closed at the "O" position to provide a low impedance.

It would be more convenient to make the operation of "loading" two handed. Bringing up the loading with the left hand and dipping the final with the right hand in succession until the required plate current is reached. With a little practice "loading" will be no problem. When loaded to the full CW rating, switch to PHONE position and modulate. With sufficient modulation the plate current should kick-up near 125 milliamperes on peaks. If a light bulb is being used as a dummy load it should increase in brilliance in accordance with the voice level. A field strength meter or the "S" meter on the station receiver will also show a definite increase in carrier level.

NOTE: This particular modulation system requires quite heavy antenna loading. Loading to the CW rating and then switching to the PHONE position is customary procedure. It has been noted that with a constant audio tone of sufficient amplitude the RF output can be adjusted to maximum with greater ease.

In most cases the RF gain control of the receiver has to be reduced and/or the antenna removed or the antenna terminal grounded to the receiver chassis to prevent pinning the "S" meter. With the gain reduced on the receiver to prevent overloading the AVC or causing audio feedback, the speech should sound clear and distinct.

NOTE: There are times when quite heavy loading is obtained with the (antenna tuning) loading capacitor completely closed at "O" position. This will occur especially at the low frequency end of the 80-meter band when working into a low impedance 50 Ω line. When this occurs, additional capacity will be required in parallel with the 2-gang loading capacitor. See Service and Maintenance Hints.

INSTALLATION AND OPERATION

NOTE: It should be noted that an Amateur Radio Operator and Station License is required to place this transmitter on the air. Information regarding licensing and amateur frequency allocations may be had from publications of the Federal Communications Commission or the American Radio Relay League. This transmitter can be used for novice operation only if the following two requirements are met: (a) CW operation only. (b) Crystal control only, on assigned novice frequencies.

GROUNDING: The importance of a good ground that presents low impedance at all frequencies cannot be emphasized too strongly. What may be a perfectly satisfactory ground at 80 meters

could place the transmitter considerably above ground at the higher RF frequencies. As an example, the length of the ground wire is sometimes critical. An 8 foot wire from the transmitter to ground would be a direct short at 80 meters but becomes one-quarter wave length at 10 meters and therefore places the chassis at a high RF potential. Some hints that will be of assistance in obtaining a good ground are:

1. Connection for the ground should be made to cold water or well pipes and/or multiple pipes or rods driven approximately eight or more feet into moist earth. A salt solution poured around the ground rods will further increase the conductivity to ground. A more elaborate installation might include a system of wires approximately one-quarter wave length long laid a few inches under the surface of the earth in a grid or radial pattern. The use of one or all of these grounding systems may be combined to form a good ground reference.
2. The electrical connection to the ground point should consist of a short heavy conductor (#12 wire or heavier, or copper braid). If a short ground wire is difficult to obtain because of transmitter location, several leads of random length may be used. The use of random leads lessens the possibility that all leads should become one-quarter wave length at the frequency of operation. If the transmitter becomes hot with RF at one particular frequency, the addition of a ground wire cut to one-half wave length at this frequency may clear up the difficulty.

Some of the symptoms of inadequate grounding are manifested in the form of:

1. Inability to load the antenna properly.
2. High RF potentials on the chassis or case of the transmitter as well as the microphone and cable.
3. Undue voltage strain on output circuit components.
4. Final plate current reading affected by touching the panel or case.
5. Television or broadcast interference.

LOCATION: The transmitter should be located where free circulation of air is possible and objects should not be placed on the case as this might restrict the circulation of air. Good ventilation is essential to insure maximum component life. The considerations mentioned with regard to grounding will also affect the selection of a good location, as will the point of entry of the antenna feed line.

OPERATION: The tuning procedure outlined previously will also apply when loading an actual antenna. Some special cases involving particular antenna types will require special consideration and will be covered under antennas.

ACCESSORY SOCKET

The octal accessory socket on the rear of the chassis was provided to furnish power for an external VFO such as the Heathkit VF-1. Filament power is obtained from pins 1 and 2 with 1 being ground for operation of an external unit having one side of the filament at ground potential. Pin 4 supplies B+ voltage through a 20 K Ω 10 watt resistor. This provides approximately 250 volts at 20 milliamperes. Pin 8 is connected to the cathode keying circuit and allows an external VFO to be keyed along with the DX-40. Pin 1 is grounded for the filament and the shield cable between the transmitter and the VFO. See Figure 21.

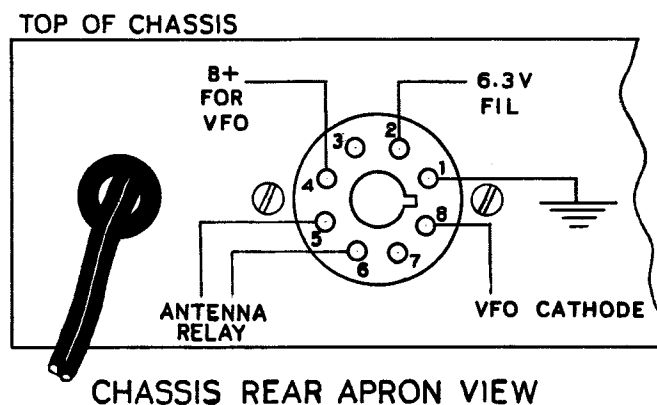

Figure 21

NOTE: Connection points are provided on the Accessory socket for the operation of an antenna relay, to take advantage of the improved receiver performance realized when using the transmitting antenna on the receiver.

Switching the operation switch to either the PHONE or CW position will provide the full line voltage at socket connections #5 and #6. CAUTION: This switch breaks only one side of the line, consequently socket connection #5 is always "alive" with the line voltage. We urge that due safety precautions be observed when connections are made to the accessory socket and relay circuit.

SERVICE AND MAINTENANCE HINTS

WARNING: Voltages dangerous to life are present at practically all points on the chassis. The Heath Company will not be responsible for injuries which could occur while making tests. Do not attempt to make voltage checks or service the transmitter without taking standard precautions and using the proper equipment. If in doubt, secure the assistance of a competent technician.

IMPORTANT: Read list of errors that could possibly damage your transmitter.

General Service

Analyzing and Isolating Difficulties

Power Supply

Oscillator Stage

Buffer Stage

Final Amplifier Stage

Speech Amplifier and Modulator Stages

Grid Drive -- See Oscillator and Buffer Sections

Plate Current -- See Final Amplifier Section and Antenna Considerations.

Meter Circuit

Antenna Considerations and TVI.

Listed below are several of the common mistakes that can permanently damage components in your transmitter. Oftentimes while hunting for a minor difficulty in a particular section of the transmitter with the power on, components in another section may be seriously damaged. For example, a high current will be flowing in the final amplifier tube if the final tuning control is not in resonance while observing grid drive readings with the operation switch in the CW position. Switch to the TUNE position.

1. Don't make voltage checks without proper safety precautions. Voltage checks should be done without any distraction. Children should not be allowed near the equipment. Electric shock can be fatal.
2. Don't turn the transmitter to the CW or PHONE position unless you have first obtained a reasonable grid drive reading on the TUNE position.
3. Don't operate the transmitter without proper crystals installed, or the VFO tuned to the proper frequency. Be sure the CRYSTAL-VFO switch is turned to the proper position.
4. Don't leave the transmitter in operation over 5 minutes, even when testing. The duty cycle of the power transformer is 5 minutes on and 10 minutes off. This, of course, refers to continuous operation and does not apply to CW or PHONE operation. PHONE or CW operation under normal operating conditions will not approach the maximum limit.
5. Don't cover the ventilation holes provided in the cabinet.
6. Don't test the oscillator, buffer or modulator stages with the final amplifier on PHONE or CW position if it is not dipped to resonance as indicated by minimum plate current.

Don't try to read grid current to the final amplifier:

- a. When the key circuit is open.
- b. When the meter switch is in the plate position.
- c. With an improper crystal (the drive control tunes a limited range).
- d. With the CRYSTAL-VFO switch in the wrong position.

GENERAL SERVICE

SOLDERING: Cold and loose solder connections are a common source of trouble in assembling any piece of electronic equipment. Sometimes apparently good solder connections will have an insulating coating of rosin between the wire, the terminal and the solder. This type of defective soldering is very difficult to locate in the process of trouble-shooting, and the builder will do well to see that each wire in a connection point is firmly embedded in the solder. Many times when more than one wire is connected to a terminal or lug the lower wire will not receive sufficient heat or solder even though the connection looks satisfactory. Trouble can also be caused by being too generous with solder and heat, with a short resulting from solder running down the lug and touching the chassis or other components. Use extreme care when soldering to switch contact points, to avoid solder running too far and spoiling the spring tension of the contacts.

With miniature tube sockets there is a possibility of shorts between adjacent socket terminals due to the close spacing. This should be checked and if any doubt exists, the terminals should be pried apart until obvious spacing can be seen between them.

In general, do not rely on the solder itself to form the electrical connection. A firm metal to metal contact should be made before flowing the solder over it.

COMPONENTS: Any part that physically looks defective should be tested with the proper instrument.

TUBES: Tubes can be checked on a tube checker but the best method is by substitution. An extra set of tubes should be on hand for testing and to replace normal tube failures.

WIRING: Mistakes in wiring are the most common cause of difficulty. Consequently, the first step is to recheck all wiring against the pictorials and schematic diagrams. Often having a friend check the wiring will locate an error consistently overlooked.

Follow the construction manual and pictorials so that each lead is placed in its proper position. Make leads as short as possible, except where leads are measured or specifically routed around the edge of the chassis. This is to prevent adverse effects such as spurious RF oscillations and audio feedback.

CAUSE AND EFFECT: Be sure to reread the circuit description on page 3 so that "cause and effect" reasoning may be employed as the search for trouble progresses. If some difficulty still persists after the steps outlined have been completed, attempt to localize the trouble to a particular stage in the transmitter circuit. Use the tuning procedure as a basis for localization and refer to the block diagram and schematic to visualize circuit relationships. The panel meter and station receiver are valuable tools to use in locating trouble.

TRACING PROCEDURE: For the following tracing procedures, use the schematic diagram for reference.

If any activity is noted when the line cord is plugged in and the operation switch is in the OFF position the AC circuit should be traced. One side of the line cord is connected through a line choke to one side of the primary of the power transformer. The other side of the line cord is connected through a line choke to the blue cable wire which connects to terminal 11 of the operation switch; the black cable wire returns from switch terminal 12, to the other primary side of the transformer. Contacts 11 and 12, of the switch thus control line power to the transformer. Also check the four .002 μ f disc ceramic capacitors connected across the line for shorts.

If the tubes and pilot light do not light up when the operation switch is set to STANDBY position, again check the AC circuit with the line cord unplugged to determine why the transformer is not receiving power. If the tubes do light up with the power on and the meter reads in PLATE position, or some other indication of high voltage being applied is apparent, check the following. Unplug the line cord, then with an ohmmeter, check from #5 on KK to ground. It should read

an open circuit. This is the power transformer center tap. The white cable wire at KK5 should connect to terminal 4 of the operating switch and through terminal 5 to ground but should not be grounded in the STANDBY position. Check this wiring to be sure it is correct. CAUTION: The following tests are made with power on, use extreme care. With the operation switch in the PHONE position, the KEY momentarily depressed, and the meter switch in PLATE position, it should read about 1/3 scale, when not tuned to resonance. If the meter shows little or no indication check the screen voltage at pin 3 of the 6146 tube with a (VOM) Volt-Ohm-Millimeter using a DC range of at least 150 volts. The screen should read about 65 volts. If much less than this, trace back through contact 3 of the operation switch, through contact 2 to pin 9 of the 6DE7 tube, all should read near 65 volts. Switch the meter to a higher range, 500 volts, and check pin 1 of the 6DE7. This should read about 400 volts. If the voltages are missing or very far from normal, using the voltmeter on a 1500 volt scale and the schematic diagram, trace the voltage back to its source at the rectifier pin 1. No voltage at E1 indicates an open power transformer primary, open power transformer center tap outlined in the steps above, defective 5U4GB rectifier tube or a short circuit. The latter would probably have made itself known by now.

Lack of grid drive may be traced back to the oscillator. Turn to the TUNE position, make sure the key circuit is closed, and listen with a receiver for the oscillator. Try different crystals. If no signal is heard, check the plate voltage of the oscillator at pin 6 and screen voltage at pin 8. There should be about 330 volts on the plate and about 185 on the screen in the TUNE position.

As the two 6CL6 tubes are in series, no voltages on the oscillator may be due to an open circuit or defective 6CL6 in the buffer stage. Consequently, both stages must be operating properly to obtain grid drive. The plate voltage of the buffer stage will be about 630 volts to ground and its cathode should be about 330 volts to ground (in the TUNE position). If the voltages differ greatly, remove the power and completely check the circuit.

FINAL AMPLIFIER STAGE: The 6146 final tube can be damaged in a few seconds if the final is not tuned to resonance. If you wish to test other stages with the plate current on, switch to the TUNE position. This will enable you to operate the transmitter up to the final amplifier, including the indication of grid current on the panel meter without any RF output. The TUNE position removes the plate and screen voltage from the 6146 and grounds the screen grid, however, use caution as the high voltage is still present in other sections of the transmitter. Failure to obtain a dip in plate current when tuning the final amplifier may be due to a lack of grid drive, incorrectly wired final tank coil, loading capacitor advanced too far (insufficient capacity), shorted coax line, the crystal switch in the wrong position, or with an improper crystal or one out of the tuning range of the buffer stage.

A low impedance antenna system on the 80-meter band will also give the same effect and may even result in the meter being "pinned" at the full scale reading until sufficient capacity has been added in parallel to the 2-gang output loading capacitor. See Final Amplifier section.

NOTE: When using the DX-40 on CW with the VF-1, the VF-1 operation switch should be placed in the STANDBY position and the key plugged into the DX-40. For best results with either crystal or VFO, the grid drive should be adjusted as near as possible to 3 milliamperes. In some cases and on certain bands slightly more than the indicated 3 milliamperes will result in added efficiency.

ANALYZING AND ISOLATION

The transmitter can be divided into stages. Each stage can then be isolated and worked on individually. In the next section, simple steps will be outlined to test each stage. A Vacuum Tube Voltmeter or Multimeter is necessary to check voltages and resistance. Voltages listed were made with a Heathkit Multi-purpose VTVM (Vacuum Tube Voltmeter). The line voltage was 115 volts AC. The transmitter was set up for crystal controlled 80-meter PHONE operation (key circuit closed) for all checks.

Voltages listed do not necessarily indicate those in your transmitter. Line voltage variation, component tolerance and the presence of RF will cause variations. They should only serve as a basis of comparison. AC filament voltage may read high due to the presence of RF which effects the readings on vacuum tube type voltmeters. A more conclusive check in this case may be obtained with a Volt-Ohm-Millimeter such as the Heathkit Multimeter.

POWER SUPPLY

TUBE E 5U4 RECTIFIER

1. Check the rectifier tube E by substitution. Be sure the socket is wired to the correct pin connections.
2. REMOVE THE LINE CORD FROM THE POWER SOURCE. Test the filter capacitors in the high voltage circuit by measuring the resistance between pin #1 of tube E and the chassis. It should read between 35 K Ω and 40 K Ω in the CW and TUNE positions and between 20 K Ω and 25 K Ω in the PHONE position. A much lower resistance may indicate a short circuit in the B+ circuit, a leaky or shorted filter capacitor, or the ohmmeter leads are not polarized properly. The meter polarity should favor the higher readings.
3. Check the operation switch for open contacts, or solder run into the contacts.
4. Test the transformer by removing the rectifier tube E and measuring the AC voltages. The voltage between the yellow leads should read approximately 5 volts. The voltage between each red lead and the center tap should be 700 to 800 volts. The center tap is the yellow and red lead. Both filament windings should read approximately 6.3 volts AC. The green leads are filament winding #1 and the white leads are filament winding #2.
5. Inspect the filter capacitors and see that they are polarized properly. If not, they should be replaced if current has been allowed to flow through them for any length of time.

OSCILLATOR STAGE

TUBE D -- 6CL6 Oscillator:

1. Test the 6CL6 tube D by substitution.
2. Check the crystal switch. Make sure the switch is turned to the proper crystal or VFO position.
3. Test the crystal you are using by substituting other crystals of proper frequency.
4. Test the 1.1 mh RF choke in the cathode circuit for an "open" winding (POWER OFF).
5. Check the 40-meter plate coil for an "open" winding (POWER OFF).
6. Filament voltage should check near 6.3 v AC from Pin #4 on socket D to chassis.
7. Plate voltage should read approximately 290 to 320 volts, depending on the adjustment of the drive control. This reading is taken from #1 on terminal strip FF to chassis.
8. Screen voltage should read approximately 155 to 185 volts depending on the adjustment of the drive control. This reading is taken from Pin #8 on the 6CL6 socket D to the chassis.

BUFFER STAGE

TUBE C 6CL6 Buffer:

1. Test the 6CL6 tube C by substitution.
2. DISCONNECT THE LINE CORD. Inspect the rotary switch contacts. Be sure there is no solder on the contacts and that each is making a good electrical connection with the rotor.

3. If little or no grid drive is available, there is the possibility that the small buffer coils have been interchanged. A rough check can be made by noting the size of the wire and apparent number of turns. Fine wire and more turns are used on the low frequency coils, with progressively larger wire and lesser turns as 10 meters is approached. Check each coil for a broken winding which would check "open" on an ohmmeter. Also, be sure the coil leads do not short to each other or to the switch frame.
4. WITH ALL POWER REMOVED, test the 1.1 mh RF choke which is connected in the plate circuit for an open winding.
5. With the line cord plugged in, high voltage will be indicated on all pins except 4 and 5 (if measurements are taken from the chassis). This is due to the buffer stage being operated in series with the oscillator stage. Voltage readings on the buffer stage should be taken from the tube cathode which is tied to lug #1 on terminal strip FF. CAUTION: Both meter leads will therefore be "alive". Plate voltage read from lug #1 on terminal strip GG should be approximately 320 volts depending on the adjustment of the drive control. Screen voltage should be about 155 volts also depending on the adjustment of the drive control. Approximately 6.3 volts AC should be indicated between filament pins 4 and 5 on socket D.

FINAL AMPLIFIER

TUBE F 6146

1. Test the 6146 tube G by substitution.
2. Grid drive should be approximately 3 ma. for proper operation.
3. WITH THE LINE CORD DISCONNECTED, check the 2.5 mh RF choke in the final plate circuit with an ohmmeter.
4. Tighten the nuts on the feedthrough insulators (top and bottom).
5. Inspect the antenna tuning condenser and the final amplifier condenser for shorts, such as solder drips from capacitor terminals shorting to the chassis.
6. Check the 68 $\mu\mu\text{f}$ capacitor between the bandswitch terminal A8 and the grounded lug on the terminal strip. A swollen capacitor will indicate that the component has been damaged by excessive RF current due to trying to load an improper antenna impedance. The swelling of the capacitor will have decreased in its capacity and it will require replacement. This capacitor is only used in the circuit on the 80-meter band.
7. Inspect the connections of the final tank coil to the bandswitch. Make sure each is connected to the proper terminal on the switch.

GRID DRIVE to the final amplifier stage is essential to supply safe operating bias to the 6146. The final amplifier should not be on for more than a few seconds if no grid drive is indicated on the panel meter.

THE DRIVE CONTROL tunes only the upper and lower extremes of the band, no (outside) harmonics.

KEYING is accomplished by grounding the cathode of the Final Amplifier and the Oscillator stage. Poor solder connections in this circuit can cause erratic keying.

DIPPING the final is accomplished by tuning the stage to resonance or to minimum plate current indication. The antenna tuning or loading capacitor should be closed at "O" position before beginning to load an antenna. Dip the final to read minimum plate current, open the loading capacitor a little at a time, successively redipping the final until the final "dip" is at the recommended current value. If the dip is too low on the plate meter and it is impossible to load it with the

Antenna Tuning Condenser, the antenna impedance is not proper and should be checked. This is also true if it will not dip at all. The easiest test for this condition is to substitute a dummy load, (a 115 volt, 60-watt bulb) for the antenna.

NOTE: Feeding a very low impedance antenna, especially at the low frequency end of the 80-meter band may require additional capacity, such as a .001 μ f (large size mica) connected across the coax output connector to allow a proper "dip" in plate current. This may be done with a coax "T" connector if required. CAUTION: Remove this capacitor before attempting operation on any other band as it will make it impossible to "load" the antenna.

CREeping PLATE CURRENT will usually indicate a "soft" 6146 final amplifier tube. Loss of grid drive usually accompanies this condition. This is usually caused by consistent operation of the 6146 tube in an overloaded condition. Plate voltage reading will be the total B+ voltage which can be read at Pin #1 on the 5U4GB rectifier socket E and should be near 630 volts. Once again, use caution in testing high voltages. The screen voltage (with no modulation) should be about 65 volts.

SPEECH AMPLIFIER AND MODULATOR STAGES

TUBE A -- 12AX7 Dual Triode

TUBE B -- 6DE7 Dual Dissimilar Triode

1. Test the 12AX7 tube A, and the 6DE7 tube B, by substitution.
2. WITH THE LINE CORD DISCONNECTED, test the resistance between the positive end of the 20 μ f electrolytic capacitor and the chassis. It should read, with the ohmmeter leads polarized correctly, between 40 K Ω and 50 K Ω on TUNE, STANDBY, and CW positions of the operation switch. On PHONE and OFF positions it should test between 20 K Ω and 28 K Ω .
3. Inspect all pin connections on the tube sockets for poor solder connections.
4. Recheck the step-by-step wiring and be sure that components and leads are connected to the correct numbered pin connections on the sockets.
5. With the power on and the transmitter switched to PHONE operation, measure the voltage across the 20 μ f capacitor from #1 on terminal strip BB to the chassis. It should be approximately 400 volts. The plate voltage on the first triode section of the 12AX7 read at pin #6 to the chassis with the Heathkit VTVM should be about 88 volts on the 150 volt scale, and the grid voltage near -.6 volt on the 1.5 volt scale, read from pin #7 to the chassis. The second triode plate on pin #1 to chassis should read about 185 volts. The first triode cathode is grounded. Voltage reading on the 12AX7 second triode cathode should be about 1.8 volts measured across the 2.7 K Ω resistor on pin #3 to the chassis.
6. Plate voltage on the 7 watt triode section of the 6DE7 should be approximately 400 volts. This is read from pin #1 of the 6DE7 socket to the chassis. The plate voltage of the 1.5 watt driver triode is about 60 volts (with no modulation) read on the 150 volt scale of the VTVM from pin #6. The cathode of the first triode of the 6DE7 is grounded. Screen voltage for the 6146 final amplifier is obtained from the heavy duty triode section cathode, which is pin #9. This voltage reading should be approximately 65 to 80 volts with no modulation. The grid voltage read from pin #7 with the VTVM should be near -.9 volts.

METER CIRCUIT: A 100 Ω one milliampere D'Arsonval movement meter is switched to read plate or grid current to the 6146 final amplifier tube. To avoid extreme excursions of the meter pointer while operation on CW, it may be advisable to leave it switched to the lower reading grid position.

The meter shield can serve to mount the meter as well as shielding any RF radiation through the meter hole which could cause TVI.

THE ANTENNA

NOTE: How important a part the antenna plays in attaining the final result required of a transmitter cannot be stressed too strongly. Any additional effort spent to obtain an "ideal" antenna will more than pay for itself in making possible many satisfactory "over the air" contacts.

The pi network output circuit of the Model DX-40 will match pure resistive loads from approximately 50 to 1000 Ω , and will eliminate the need for an antenna coupler when used with nominal impedance feed lines. The transmitter will match antennas and unbalanced lines within these limits provided such antennas or lines are nonreactive. Reactive antennas or lines present a somewhat different problem since the reactance takes the form of impedance which may raise or lower the antenna impedance beyond the matching range of the transmitter output circuit. It is possible to load a high impedance line, but it is preferable to use a low impedance feed line which will reduce the voltage and radiation from the feeders. Feeding a doublet antenna with 72 Ω coax is an example of a low impedance match, when used on the band for which it is cut.

Attempting to load the transmitter to an improper antenna will cause high percentages of reflected power to flow in the final tank circuit. This may damage the components in the final stage. Usually, a mismatched antenna will also be more conducive to television interference and the amateur may be well advised in the case of persistent TVI to experiment with various antennas and feed lines. Also a loose contact or any shorting in the antenna system will cause interference.

Balanced antenna systems should be fed through an antenna coupler so that neither leg of the line nor the antenna will be at ground potential. Normally the output of the transmitter is unbalanced since one side of the output circuit is grounded.

When loading to either a balanced or an unbalanced system, the maximum loading point of 125 milliamperes in the final stage should not be exceeded. In many instances, the transmitter will load to a higher level, but the harmonic suppression of the pi network is better if the output coupling capacitor is not reduced to absolute minimum value. Then too, the extra 5 or 10 watts which would be gained by maximum loading would not make any detectable difference at the receiving end of the transmission.

END FED HERTZ AND MARCONI ANTENNAS

This type of antenna consists merely of a single wire from one-fourth wave length long to any even multiple thereof. One end of the wire is coupled to the transmitter and the other end supported in space. If this antenna is operated against ground, it is known as a Marconi antenna, while if the length is one-half wave length or more, it is known as a Hertz antenna. The greatest disadvantage of feeding a single wire is the necessity of bringing part of the radiating element into the radio room where its proximity to nearby objects increases losses. The greatest advantage of such an antenna is the simplicity with which it may be constructed and its compact size where space is at a premium. Providing the reactance of such antennas is not excessive they may be loaded satisfactorily with the pi network output circuit of the DX-40.

The length of such antennas can be calculated from the information given in the Radio Handbook or the ARRL Antenna Manual. Random lengths may also be used effectively except for some critical antenna lengths where the antenna impedance becomes too high or too low to be matched satisfactorily at the output of the transmitter. When such a situation is encountered it can usually be recognized by the action of the loading control on the transmitter. Should it be found that increasing the loading (reducing the antenna tuning capacitor value) does not raise the final amplifier plate current reading on the meter and yet the final amplifier has not become fully loaded, it is very likely that the antenna being used has a higher than normal reactance at the frequency of operation, resulting in the transmitter looking into a higher overall impedance.

If it is found that a change in the antenna tuning capacitor value has little effect on the final amplifier loading and does not affect the final amplifier tuning in the normal fashion, the antenna in use is probably presenting lower than normal impedance to the transmitter.

BALANCED ANTENNA FEEDERS AND SYSTEMS

In the average station it will be found expedient to have the radiating portion of the antenna some distance from the transmitter. This statement assumes that the amateur will have his antenna up high and clear of nearby objects, whereas the actual transmitter may be in the basement or any other room in the home. In such a case, some form of transmission line must be used to efficiently connect the transmitter to the antenna. In many instances, the transmission line is of the "balanced" type in which neither leg of the line is grounded. Such transmission lines may be either tuned or untuned, but in either case, a balanced line must be fed through an antenna coupler or "balun" coils. The coupler also provides the means for matching the impedance of the antenna, which will vary depending upon the type of antenna employed. A typical antenna coupler circuit is shown in Figure 22.

Basically the antenna coupler is an impedance transformer, transforming the impedance of the transmitter to the impedance of the transmission line.

Referring to Figure 22, coil L1 should match the impedance of the coaxial cable as closely as possible at the frequency of operation. The circuit consisting of L2, C1 and C2 must tune to the transmitter frequency. If it is desired to series tune the antenna, the shorting bar between 3 and 4 is opened and the transmission line connected at these points. For parallel tuning, 3 is shorted to 4 and the transmission line connected to 1 and 2. Taps are provided on coil L2 to facilitate matching the transmission line.

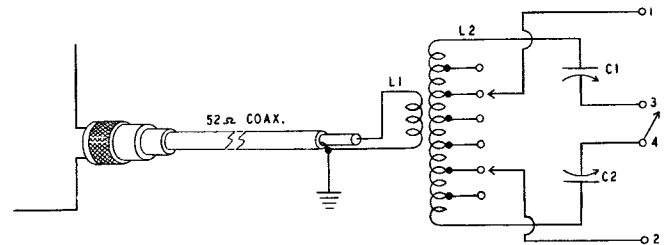

Figure 22

Such a unit can be built up from this or other suggested circuits or may be purchased commercially as a completed unit. In any case, feeding folded dipoles, end-fed "Zepps" and similar antenna types will require an antenna coupler or balun coils since the normal output of the DX-40 is designed for single-ended, unbalanced operation.

There are countless variables which affect the proper operation of an antenna. For example, one leg or section, or the entire antenna may be in close proximity to a large metal body such as a metal covered roof, the steel framework of buildings, eavestroughs, pipes, and other wires, etc. This would cause an unbalance and more difficult loading and have the result of absorbing a good deal of the radiated RF energy which would limit the transmitter's ability to "get out".

The Heath Company would rather not make recommendations as to the kind of antenna you should use. There are many that will work and each has its own characteristics. In general, a tuned antenna fed with untuned feeders can be connected directly to the transmitter. The antenna should be cut to one-half wave length for the frequency and fed in the center with 72Ω coax.

A Folded Dipole type of antenna can be used if it is cut to one-half wave length at the operating frequency and fed with balanced lines. However, Balun coils should be used such as the Heath-kit Balun Coil Set.

The long wire type of antenna is considered high impedance when end fed. For best results, it should be equal to one-half wave length at the lowest operating frequency and connected to the transmitter through a suitable antenna coupler.

Certain types of off-center fed antennas are not recommended for use with the DX-40 without the proper use of Baluns.

Harmonic radiation or TVI in some cases has been traced to an improper antenna or an incorrectly loaded antenna. Be sure your final stage tuning is dipped to the proper point of resonance. A strong second harmonic can usually be corrected by the use of an antenna that is not resonant to the second harmonic. A Folded Dipole antenna cut to one-half wave length at the operating frequency and fed through Balun Coils will usually correct this condition.

Needless to say, no attempt has been made here to cover the theory of antennas, as such, since much has been written on this subject. The possibilities in different antenna types and different feed systems are many and the factors mentioned herein only scratch the surface of the subject. Each operator will need to do his own investigation into the advantages and disadvantages of the various systems to determine just which one will best suit his needs. Basic data is available through the Radio Amateur Handbooks and other technical publications.

Some formulas that should prove helpful are listed as follows:

$$1 \text{ wave length in space} = \frac{300,000 \text{ meters}}{F_{kc}}$$

$$\text{Center fed dipole one-half wave long (length in feet)} = \frac{468}{F_{mc}}$$

$$\text{Folded dipole one-half wave long (length in feet)} = \frac{462}{F_{mc}}$$

$$\text{Zepp antenna one-half wave long (length in feet)} = \frac{492}{F_{mc}}$$

LOW PASS FILTERS: The harmonic rejection of the pi network output circuit of the DX-40 is excellent and will attenuate harmonics considerably when the transmitter is properly grounded and carefully tuned. However, additional harmonic attenuation may be had with the use of a low-pass filter between the output of the transmitter and the feed line or antenna. Such a filter should be designed to handle the maximum power output of the transmitter and must be operated into its nominal impedance.

An instrument to determine standing wave ratio on the feed line is a necessity in every ham shack. The Heathkit Reflected Power Meter serves this purpose, and may be left permanently connected in the feed line of any amateur transmitter.

While the above instrument is preferred, the Heathkit Power Meter will indicate maximum power output when tuning the transmitter. It will not indicate standing wave ratio, and is recommended only as a tuning aid.

Additional information on antennas can be found in:

Radio Amateurs Handbook - ARRL
The Antenna Handbook - ARRL
The Radio Handbook - Editors and Engineers, Ltd.
The Antenna Manual - Editors and Engineers, Ltd.
The Beam Antenna Handbook - Radio Publications

REPLACEMENTS

Material supplied with Heathkits has been carefully selected to meet design requirements and ordinarily will fulfill its function without difficulty. Occasionally improper instrument operation can be traced to a faulty tube or component. Should inspection reveal the necessity for replacement, write to the Heath Company and supply all of the following information:

- A. Thoroughly identify the part in question by using the part number and description found in the manual parts list.
- B. Identify the type and model number of kit in which it is used.
- C. Mention the order number and date of purchase.
- D. Describe the nature of defect or reason for requesting replacement.

The Heath Company will promptly supply the necessary replacement. Please do not return the original component until specifically requested to do so. Do not dismantle the component in question as this will void the guarantee. If tubes are to be returned, pack them carefully to prevent breakage in shipment as broken tubes are not eligible for replacement. This replacement policy does not cover the free replacement of parts that may have been broken or damaged through carelessness on the part of the kit builder.

SERVICE

In event continued operational difficulties of the completed instrument are experienced, the facilities of the Heath Company Service Department are at your disposal. Your instrument may be returned for inspection and repair for a service charge of \$5.00 plus the cost of any additional material that may be required. THIS SERVICE POLICY APPLIES ONLY TO COMPLETED INSTRUMENTS CONSTRUCTED IN ACCORDANCE WITH THE INSTRUCTIONS AS STATED IN THE MANUAL. Instruments that are not entirely completed or instruments that are modified in design will not be accepted for repair. Instruments showing evidence of acid core solder or paste fluxes will be returned not repaired.

The Heath Company is willing to offer its full cooperation to assist you in obtaining the specified performance level in your instrument. Factory repair service is available for a period of one year from the date of purchase or you may contact the Engineering Consultation Department by mail. For information regarding possible modification of existing kits, it is suggested that you refer to any one or more of the many publications that are available on all phases of electronics. They can be obtained at or through your local library, as well as at any electronic outlet store. Although the Heath Company sincerely welcomes all comments and suggestions, it would be impossible to design, test, evaluate and assume responsibility for proposed circuit changes for specific purposes. Therefore, such modifications must be made at the discretion of the kit builder according to information which will be much more readily available from some local source.

SHIPPING INSTRUCTIONS

Before returning a unit for service, be sure that all parts are securely mounted.

ATTACH A TAG TO THE INSTRUMENT GIVING
NAME, ADDRESS AND TROUBLE EXPERIENCED.

Pack in a rugged container, preferably wood, using at least three inches of shredded newspaper or excelsior on all sides. DO NOT SHIP IN THE ORIGINAL KIT CARTON AS THIS CARTON IS NOT CONSIDERED ADEQUATE FOR SAFE SHIPMENT OF THE COMPLETED INSTRUMENT. Ship by prepaid express if possible. Return shipment will be made by express collect. Note that a carrier cannot be held liable for damage in transit if packing, in HIS OPINION, is insufficient.

SPECIFICATIONS

All prices are subject to change without notice. The Heath Company reserves the right to discontinue instruments and to change specifications at any time without incurring any obligation to incorporate new features in instruments previously sold.

WARRANTY

Heath Company warrants that for a period of three months from the date of shipment, all Heathkit parts shall be free of defects in materials and workmanship under normal use and service and that in fulfillment of any breach of such warranty, Heath Company shall replace such defective parts upon the return of the same to its factory. The foregoing warranty shall apply only to the original buyer, and is and shall be in lieu of all other warranties, whether express or implied and of all other obligations or liabilities on the part of Heath Company and in no event shall Heath Company be liable for any anticipated profits, consequential damages, loss of time or other losses incurred by the buyer in connection with the purchase, assembly or operation of Heathkits or components thereof. No replacement shall be made of parts damaged by the buyer in the course of handling or assembling Heathkit equipment.

NOTE: The foregoing warranty is completely void and we will not replace, repair or service instruments or parts thereof in which acid core solder or paste fluxes have been used.

PART No.	PARTS Per Kit	DESCRIPTION
----------	---------------	-------------

Resistors

1-1	2	47Ω 1/2 watt
1-9	1	1000Ω 1/2 watt
1-13	1	2700Ω 1/2 watt
1-16	1	4700Ω 1/2 watt
1-26	2	100 KΩ 1/2 watt
1-33	3	470 KΩ 1/2 watt
1-35	2	1 megohm 1/2 watt
1-37	1	2.2 megohm 1/2 watt
1-40	1	10 megohm 1/2 watt
1-46A	3	27 KΩ 1 watt
1-10B	1	47 KΩ 2 watt
1-17B	1	6800Ω 2 watt
1-22B	1	12 KΩ 2 watt
2-127	1	.67Ω 1% precision
2-128	1	20Ω 1% precision
3-9J	4	20 KΩ 10 watt
3-10J	1	50 KΩ 10 watt

Capacitors

20-1	2	47 μμf silver mica
20-38	1	100 μμf silver mica
20-39	1	220 μμf silver mica
20-41	1	22 μμf silver mica
20-48	1	.001 μμf 2 kv mica
20-61	1	27 μμf mica
21-9	2	100 μμf disc ceramic
21-13	1	500 μμf disc ceramic
21-31	3	.02 μf disc ceramic
21-35	1	.005 μf 1.6 kv disc ceramic
21-43	4	.001 μf 1 kv disc ceramic
21-49	1	68 μμf 4 kv disc ceramic
21-52	26	.002 μf 1 kv disc ceramic
23-17	1	2 μf 200 v paper
25-33	1	20 μf 450 v electrolytic
25-36	2	40 μf 450 v electrolytic
26-9	1	450 μμf variable (dual)
26-24	1	20 μμf variable
26-31	1	140 μμf variable

Coils-Chokes-Transformers

40-86	1	Amplifier plate coil
40-104	1	40 meter oscillator coil
40-105	1	80 meter buffer coil
40-106	1	40 meter buffer coil
40-107	1	20 meter buffer coil
40-108	1	15 meter buffer coil
40-109	1	10 meter buffer coil
45-4	2	1.1 mh RF choke
45-19	1	Parasitic choke
45-21	1	2.5 mh RF choke
45-28	2	Line choke
46-12	1	7 henry 150 ma filter choke
54-38	1	Power transformer

PART No.	PARTS Per Kit	DESCRIPTION
----------	---------------	-------------

Switches-Meters-Tubes

60-2	1	DPDT slide switch
63-115	1	Crystal switch
63-139	1	Operations switch
63-140	1	Bandswitch
407-46	1	1 milliamper meter
411-2	1	5U4GB tube
411-26	1	12AX7 tube
411-63	2	6CL6 tube
411-75	1	6146 tube
411-109	1	6DE7 tube
412-1	1	#47 pilot light
413-2	1	Pilot light jewel

Terminal Strips-Sockets-Knobs

431-2	3	2 lug terminal strip
431-3	1	3 lug terminal strip
431-10	4	3 lug terminal strip
431-11	1	5 lug terminal strip
431-12	2	4 lug terminal strip
431-15	1	1 lug terminal strip
431-16	3	2 lug terminal strip
431-26	1	1 lug terminal strip
432-3	1	Microphone connector
434-21	1	Pilot light socket
434-38	3	Crystal socket
434-39	3	Octal socket
434-42	1	Phono socket
434-43	1	9 pin shield socket
434-56	2	9 pin socket
434-75	1	9 pin (ceramic) socket
436-4	1	Phone jack
436-5	1	Coaxial jack
100-M54	2	Pointer knob, large
462-19	3	Gray knob, small
462-36	1	Red knob, small

Miscellaneous

71-2	2	Feedthrough insulator
73-1	2	3/8" Rubber grommet
73-3	1	1/2" Rubber grommet
73-4	5	5/16 Rubber grommet
89-1	1	Line cord
100-105	1	Cable assembly
260-10	1	Ceramic plate cap
261-6	4	Rubber feet
340-1	1	Length #14 tinned wire
340-2	1	Length #20 tinned wire
340-3	1	Length #16 tinned wire
343-2	1	Length coaxial cable
343-3	1	Length shield wire
344-1	3	Lengths hookup wire (gray, green, yellow)
346-1	1	Length sleeving
391-3	1	Logotype (silver)
453-22	1	Shaft extention
595-180	1	Instruction manual

PART No. **PARTS Per Kit** **DESCRIPTION**

Metal Parts		
90-68	1	Cabinet
200M136	1	Chassis
203-133-F171	1	Front panel
204-M137	1	Shield bracket
204-M138	1	Switch support
206-3	1	Tube shield
206-43	1	Coaxial shield
206-54	1	Tube shield 2 3/8"
206-55	1	Tube shield base
206-56	1	Meter shield
206-M59	1	Shield Plate
Hardware		
250-4	4	4-40 3/8 RHMS
250-8	11	#6 sheet metal screw
250-9	9	6-32 x 3/8 RHMS
250-18	13	8-32 x 3/8 RHMS
250-31	22	6-32 x 1/4 RHMS
250-33	1	#6 1/8" set screw
250-34	3	4-40 x 1/2" RHMS
250-48	2	6-32 x 1/2" RHMS
250-49	8	3-48 x 1/4 BHMS
250-54	1	10-32 x 5/8 RHMS
251-1	3	6-32 spade bolt
252-1	8	3-48 nut
252-2	4	4-40 nut
252-3	29	6-32 nut
252-4	13	8-32 nut
252-5	2	#10-32 nut
252-7	5	3/8-32 control nut
252-15	3	4-40 x 3/16 nut
253-1	1	#6 fiber flat washer
253-3	2	#10 fiber flat washer
253-7	2	#10 fiber shoulder washer
253-10	5	3/8 flat washer
254-1	33	#6 lockwasher
254-2	18	#8 lockwasher
254-3	1	#10 lockwasher
254-4	4	3/8" lockwasher
254-7	8	#3 lockwasher
255-13	2	#6 1/4" spacer
259-1	7	#6 solder lug

RESISTORS

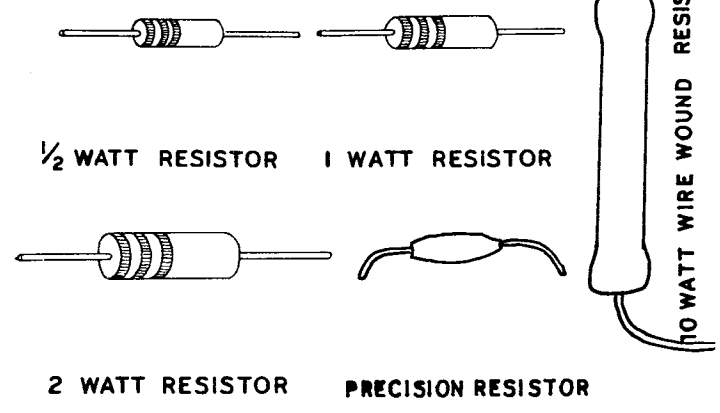

CAPACITORS

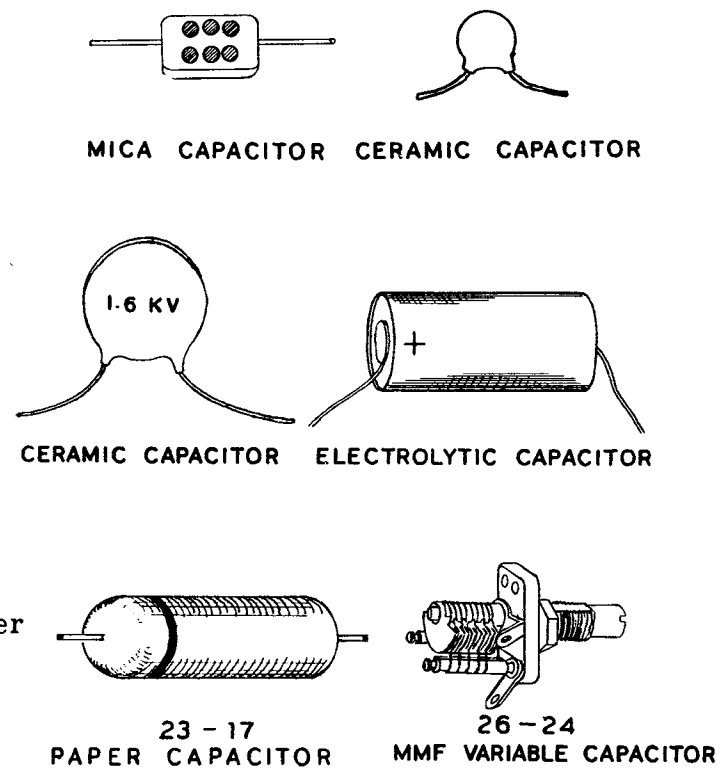

CHOKES

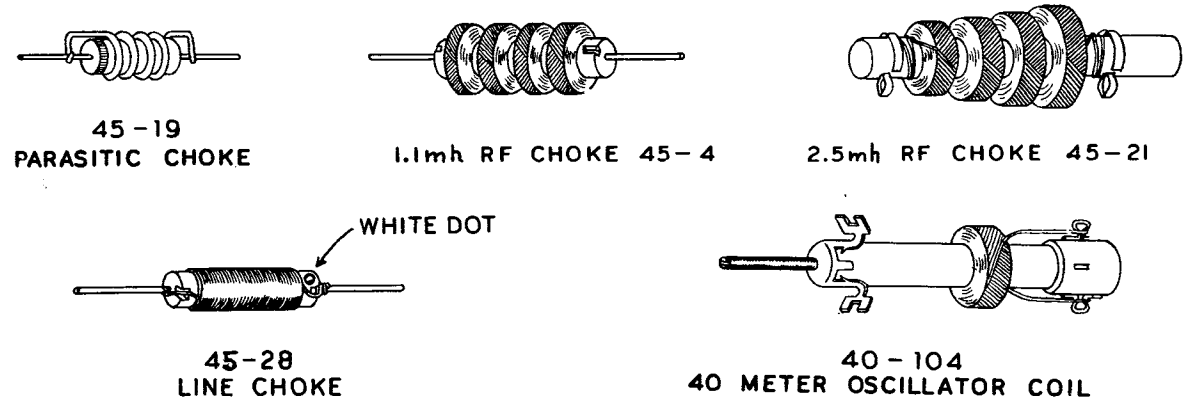

TERMINAL STRIPS

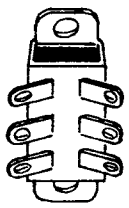

DPDT
SWITCH

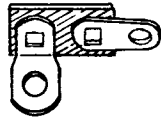

1 LUG

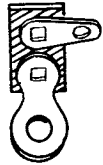

1 LUG

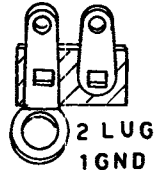

2 LUG
1 GND

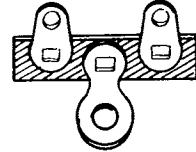

2 LUG

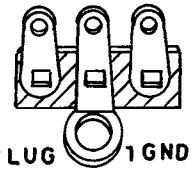

3 LUG
1 GND

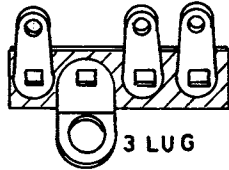

3 LUG

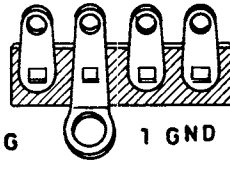

4 LUG
1 GND

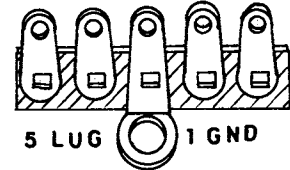

5 LUG
1 GND

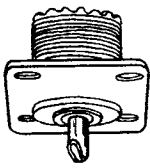

COAXIAL
CONNECTOR

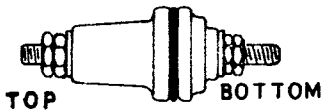

TOP
BOTTOM

FEEDTHROUGH INSULATOR

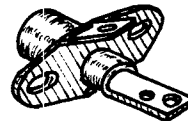

PHONO SOCKET

GROMMETS



3/16



3/8



1/2

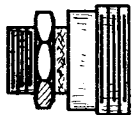

MICROPHONE
CONNECTOR

SCREWS



3-48



4-40



6-32



8-32

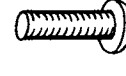

10-32



6

SHEET METAL

HEX NUTS



3-48



4-40



6-32



8-32



10-32

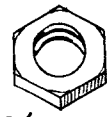

3/8 X32
CONTROL



MOUNTING FOOT

LOCKWASHERS



FIBER WASHER



#3



#6



#8



#10



CONTROL

SOLDER LUGS



#6



#10

SPADE BOLT



#6



3/8 CONTROL

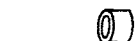

1/4 SPACER

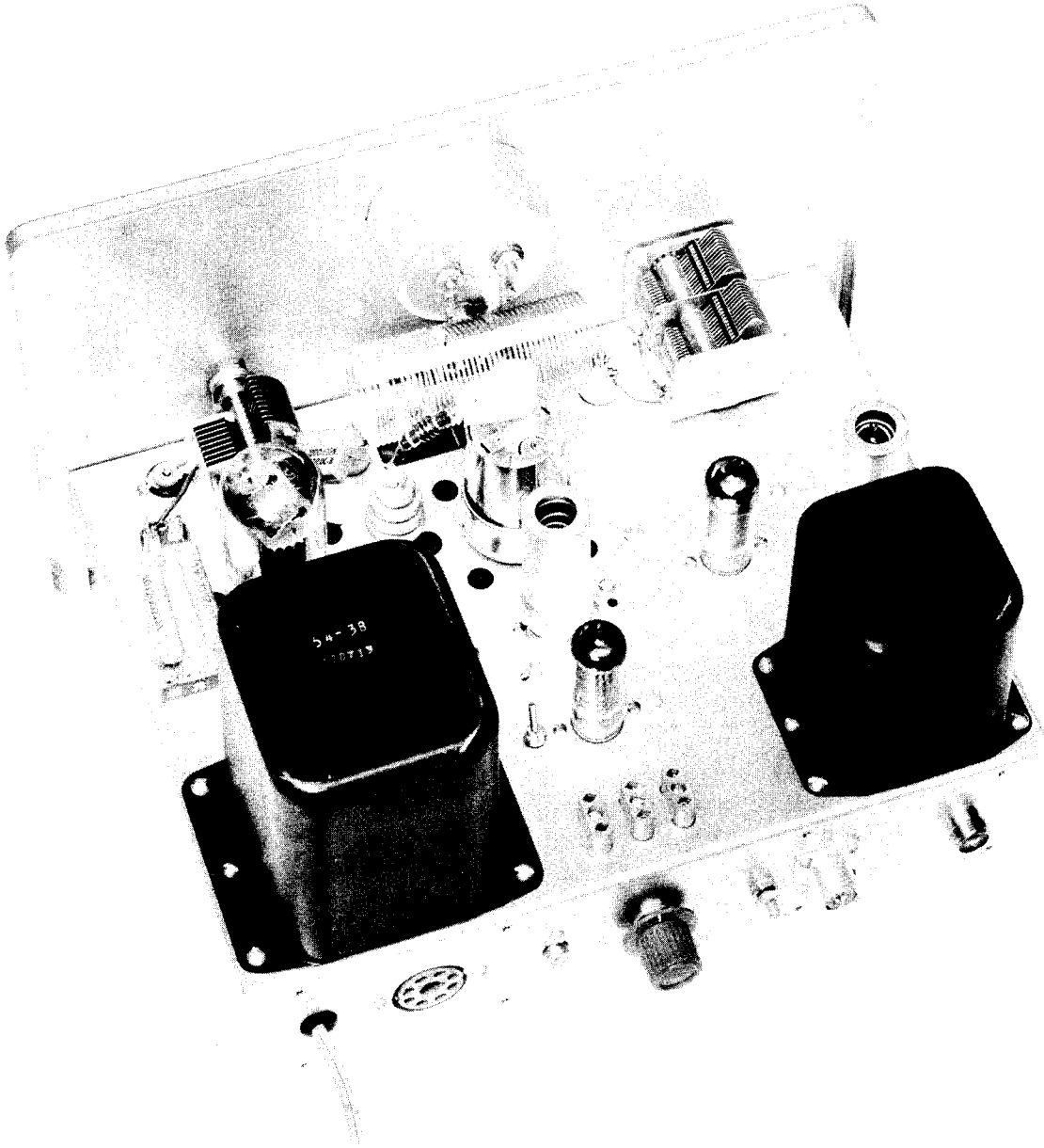

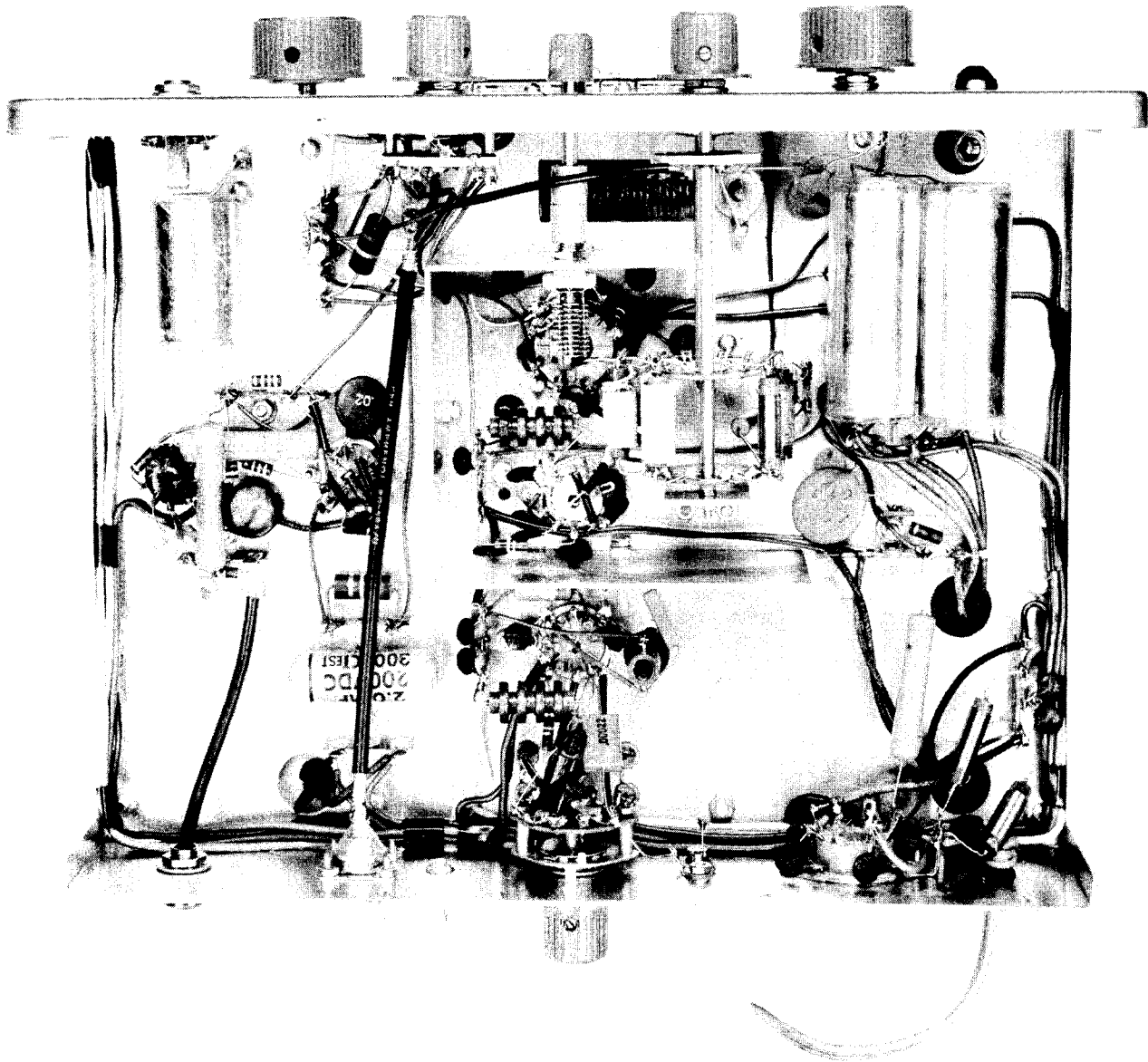

HELPFUL KIT BUILDING INFORMATION

Before attempting actual kit construction read the construction manual through thoroughly to familiarize yourself with the general procedure. Note the relative location of pictorials and pictorial inserts in respect to the progress of the assembly procedure outlined.

This information is offered primarily for the convenience of novice kit builders and will be of definite assistance to those lacking thorough knowledge of good construction practices. Even the advanced electronics enthusiast may benefit by a brief review of this material before proceeding with kit construction. In the majority of cases, failure to observe basic instruction fundamentals is responsible for inability to obtain desired level of performance.

RECOMMENDED TOOLS

The successful construction of Heathkits does not require the use of specialized equipment and only basic tools are required. A good quality electric soldering iron is essential. The preferred size would be a 100 watt iron with a small tip. The use of long nose pliers and diagonal or side cutting pliers is recommended. A small screw driver will prove adequate and several additional assorted screw drivers will be helpful. Be sure to obtain a good supply of rosin core type radio solder. Never use separate fluxes, paste or acid solder in electronic work.

ASSEMBLY

In the actual mechanical assembly of components to the chassis and panel, it is important that the procedure shown in the manual be carefully followed. Make sure that tube sockets are properly mounted in respect to keyway or pin numbering location. The same applies to transformer mountings so that the correct transformer color coded wires will be available at the proper chassis opening.

Make it a standard practice to use lock washers under all 6-32 and 8-32 nuts. The only exception being in the use of solder lugs—the necessary locking feature is already incorporated in the design of the solder lugs. A control lock washer should always be used between the control and the chassis to prevent undesirable rotation in the panel. To improve instrument appearance and to prevent possible panel marring use a control flat nickel washer under each control nut.

When installing binding posts that require the use of fiber insulating washers, it is good practice to slip the shoulder washer over the binding post mounting stud before installing the mounting stud in the panel hole provided. Next, install a flat fiber washer and a solder lug under the mounting nut. Be sure that the shoulder washer is properly centered in the panel to prevent possible shorting of the binding post.

WIRING

When following wiring procedure make the leads as short and direct as possible. In filament wiring requiring the use of a twisted pair of wires allow sufficient slack in the wiring that will permit the twisted pair to be pushed against the chassis as closely as possible thereby affording relative isolation from adjacent parts and wiring.

















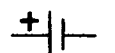





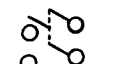



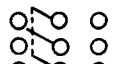

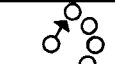

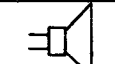
When removing insulation from the end of hookup wire, it is seldom necessary to expose more than a quarter inch of the wire. Excessive insulation removal may cause a short circuit condition in respect to nearby wiring or terminals. In some instances, transformer leads of solid copper will have a brown baked enamel coating. After the transformer leads have been trimmed to a suitable length, it is necessary to scrape the enamel coating in order to expose the bright copper wire before making a terminal or soldered connection.

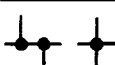
In mounting parts such as resistors or condensers, trim off all excess lead lengths so that the parts may be installed in a direct point-to-point manner. When necessary use spaghetti or insulated sleeving over exposed wires that might short to nearby wiring.

It is urgently recommended that the wiring dress and parts layout as shown in the construction manual be faithfully followed. In every instance, the desirability of this arrangement was carefully determined through the construction of a series of laboratory models.

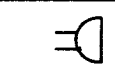
SOLDERING

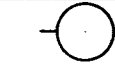
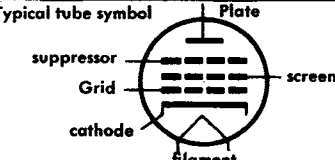
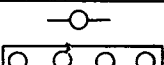
Much of the performance of the kit instrument, particularly in respect to accuracy and stability, depends upon the degree of workmanship used in making soldered connections. Proper soldered connections are not at all difficult to make but it would be advisable to observe a few precautions. First of all before a connection is to be soldered, the connection itself should be clean and mechanically strong. Do not depend on solder alone to hold a connection together. The tip of the soldering iron should be bright, clean and free of excess solder. Use enough heat to thoroughly flow the solder smoothly into the joint. Avoid excessive use of solder and do not allow a flux flooding condition to occur which could conceivably cause a leakage path between adjacent terminals on switch assemblies and tube sockets. This is particularly important in instruments such as the VTVM, oscilloscope and generator kits. Excessive heat will also burn or damage the insulating material used in the manufacture of switch assemblies. Be sure to use only good quality rosin core radio type solder.

Antenna General		Resistor General		Neon Bulb		Receptacle two-conductor	
Loop		Resistor Tapped		Illuminating Lamp		Battery	
Ground		Resistor Variable		Switch Single pole Single throw		Fuse	
Inductor General		Potentiometer		Switch double pole single throw		Piezoelectric Crystal	
Air core Transformer General		Thermistor		Switch Triple pole Double throw		1000 =	K
Adjustable Powdered Iron Core		Jack two conductor		Switch Multipoint or Rotary		1,000,000 =	M
Magnetic Core Variable Coupling		Jack three conductor		Speaker		OHM =	Ω
Iron Core Transformer		Wires connected		Rectifier		Microfarad =	MF
Capacitor General		Wires Crossing but not connected		Microphone		Micro Microfarad =	MMF
Capacitor Electrolytic		A. Ammeter V. Voltmeter		Typical tube symbol 	Binding post Terminal strip		
Capacitor Variable		G. Galvanometer MA. Milliammeter uA. Microammeter, etc.			Wiring between like letters is	$\begin{matrix} \downarrow & \downarrow & \downarrow & \downarrow \\ \rightarrow & X & Y & X & Y & X \\ \rightarrow & & & & & \end{matrix}$	understood

HEATH COMPANY

A Subsidiary of Daystrom Inc.

THE WORLD'S FINEST ELECTRONIC EQUIPMENT IN KIT FORM

BENTON HARBOR, MICHIGAN