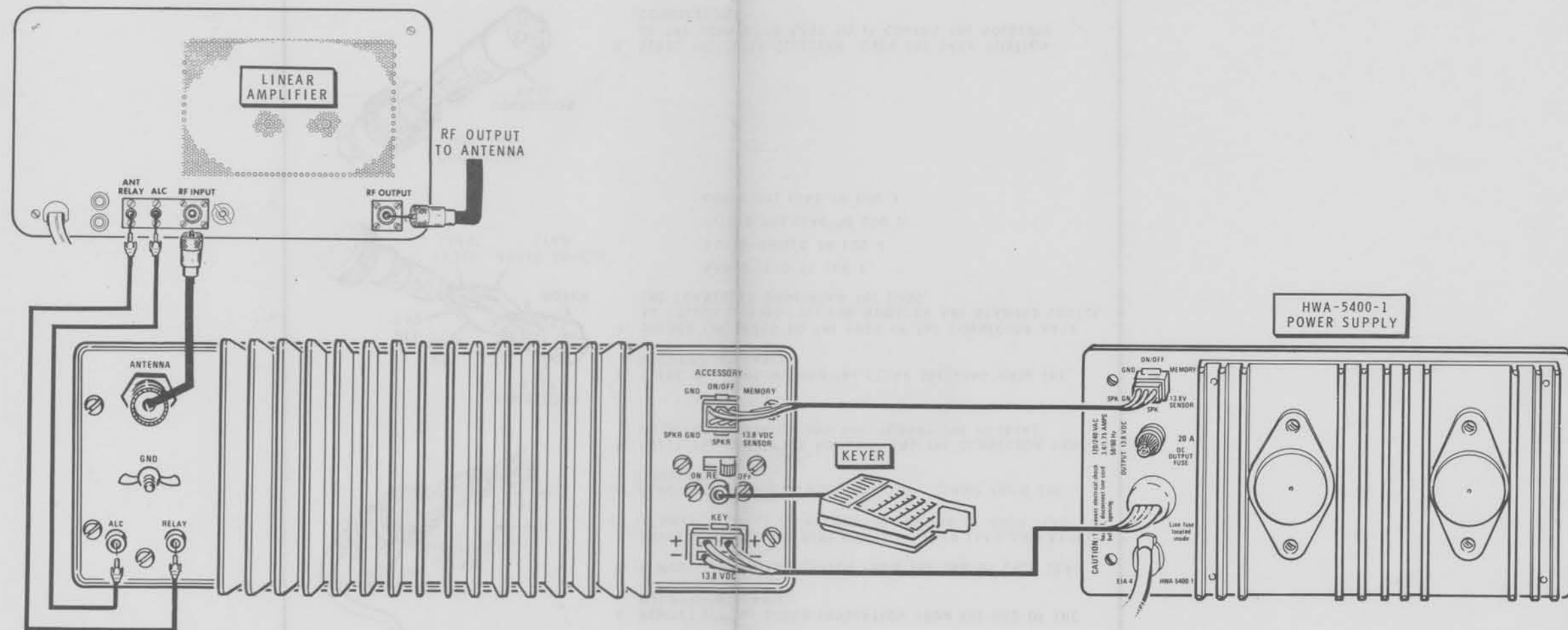
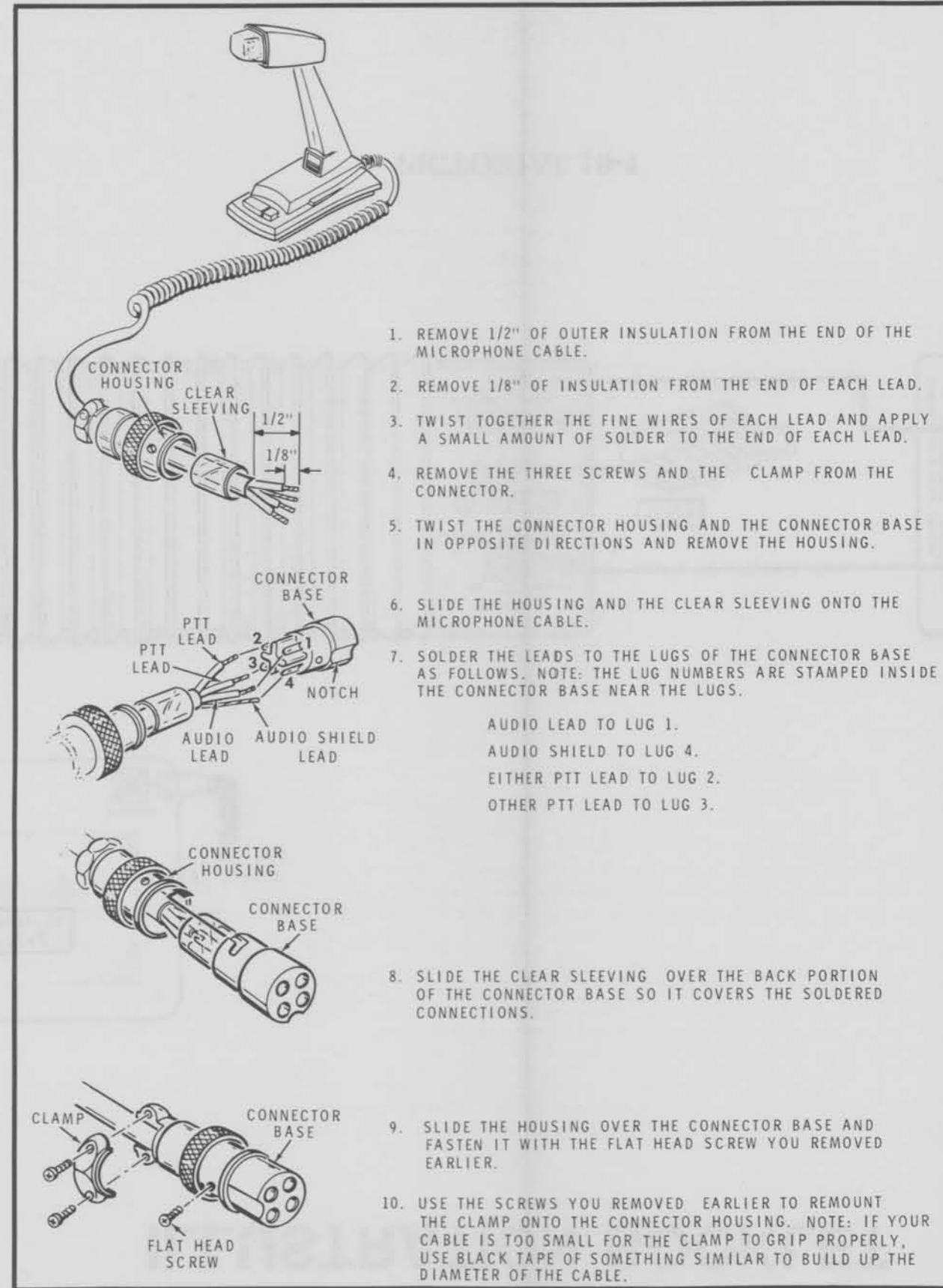

ILLUSTRATION BOOKLET

Part of 595-2952-01



PICTORIAL 18-1



1. REMOVE 1/2" OF OUTER INSULATION FROM THE END OF THE MICROPHONE CABLE.
2. REMOVE 1/8" OF INSULATION FROM THE END OF EACH LEAD.
3. TWIST TOGETHER THE FINE WIRES OF EACH LEAD AND APPLY A SMALL AMOUNT OF SOLDER TO THE END OF EACH LEAD.
4. REMOVE THE THREE SCREWS AND THE CLAMP FROM THE CONNECTOR.
5. TWIST THE CONNECTOR HOUSING AND THE CONNECTOR BASE IN OPPOSITE DIRECTIONS AND REMOVE THE HOUSING.
6. SLIDE THE HOUSING AND THE CLEAR SLEEVING ONTO THE MICROPHONE CABLE.
7. SOLDER THE LEADS TO THE LUGS OF THE CONNECTOR BASE AS FOLLOWS. NOTE: THE LUG NUMBERS ARE STAMPED INSIDE THE CONNECTOR BASE NEAR THE LUGS.
 - AUDIO LEAD TO LUG 1.
 - AUDIO SHIELD TO LUG 4.
 - EITHER PTT LEAD TO LUG 2.
 - OTHER PTT LEAD TO LUG 3.
8. SLIDE THE CLEAR SLEEVING OVER THE BACK PORTION OF THE CONNECTOR BASE SO IT COVERS THE SOLDERED CONNECTIONS.
9. SLIDE THE HOUSING OVER THE CONNECTOR BASE AND FASTEN IT WITH THE FLAT HEAD SCREW YOU REMOVED EARLIER.
10. USE THE SCREWS YOU REMOVED EARLIER TO REMOUNT THE CLAMP ONTO THE CONNECTOR HOUSING. NOTE: IF YOUR CABLE IS TOO SMALL FOR THE CLAMP TO GRIP PROPERLY, USE BLACK TAPE OF SOMETHING SIMILAR TO BUILD UP THE DIAMETER OF THE CABLE.

Detail 18-1C

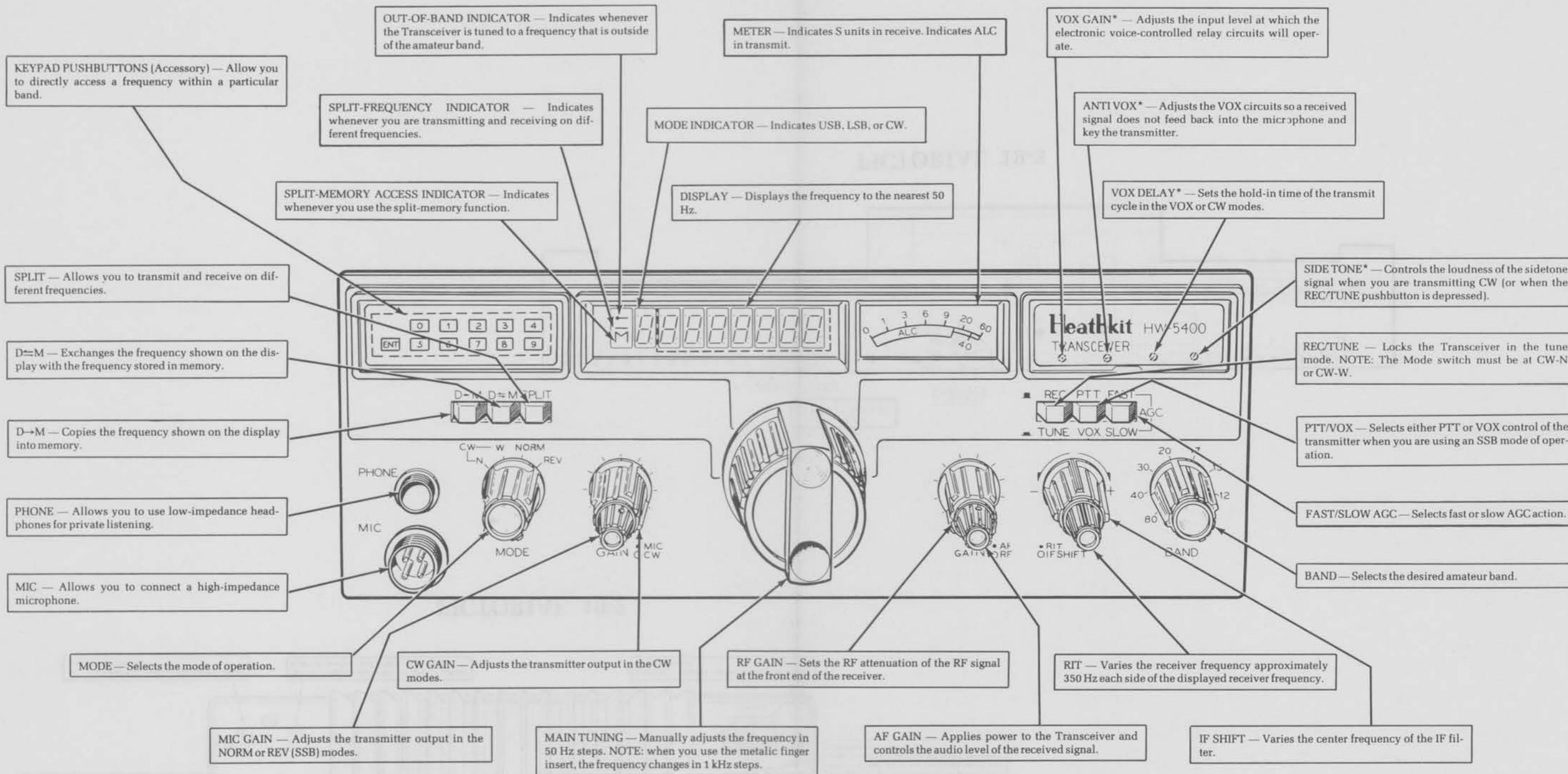

*These controls are located under a small access door in the upper right hand corner of the front panel. Push in on the top edge of the door to open it.

PICTORIAL 19-1

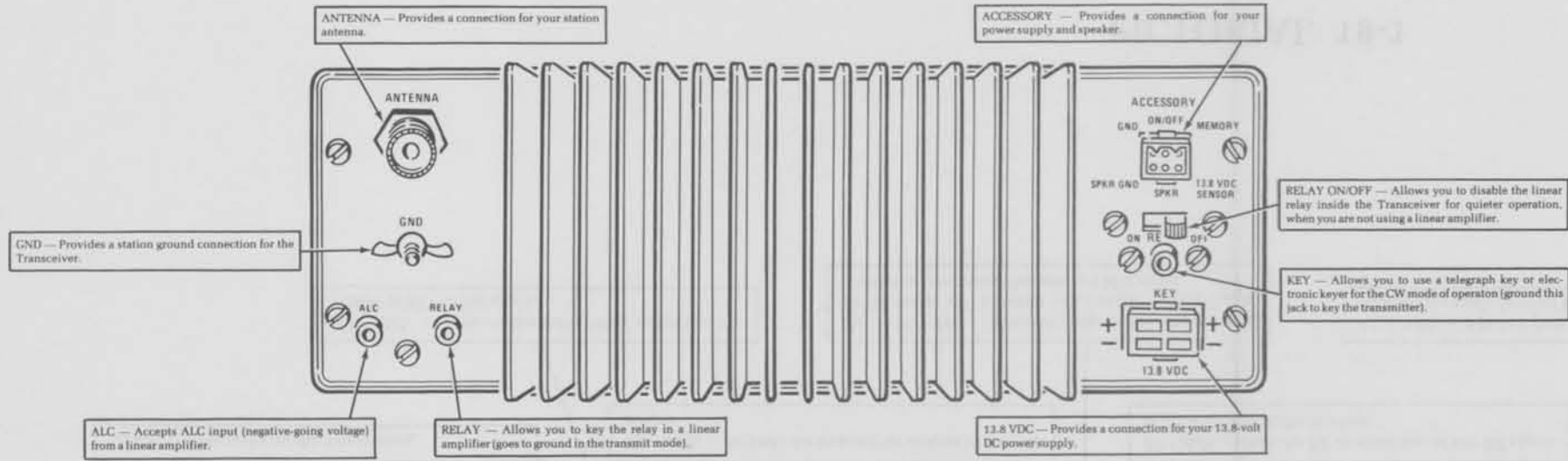

PICTORIAL 19-2

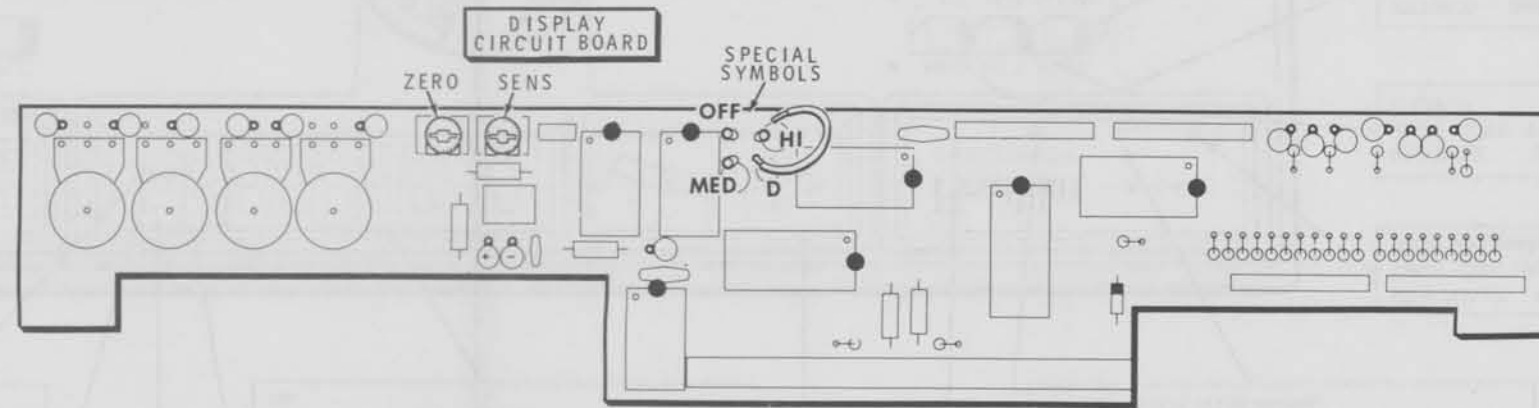

PICTORIAL 19-3

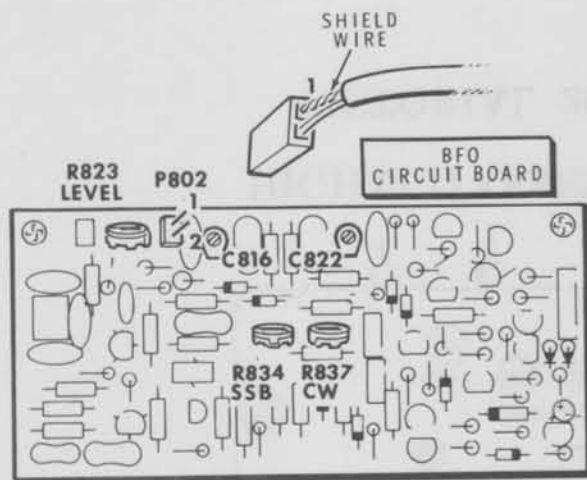

PICTORIAL 20-1

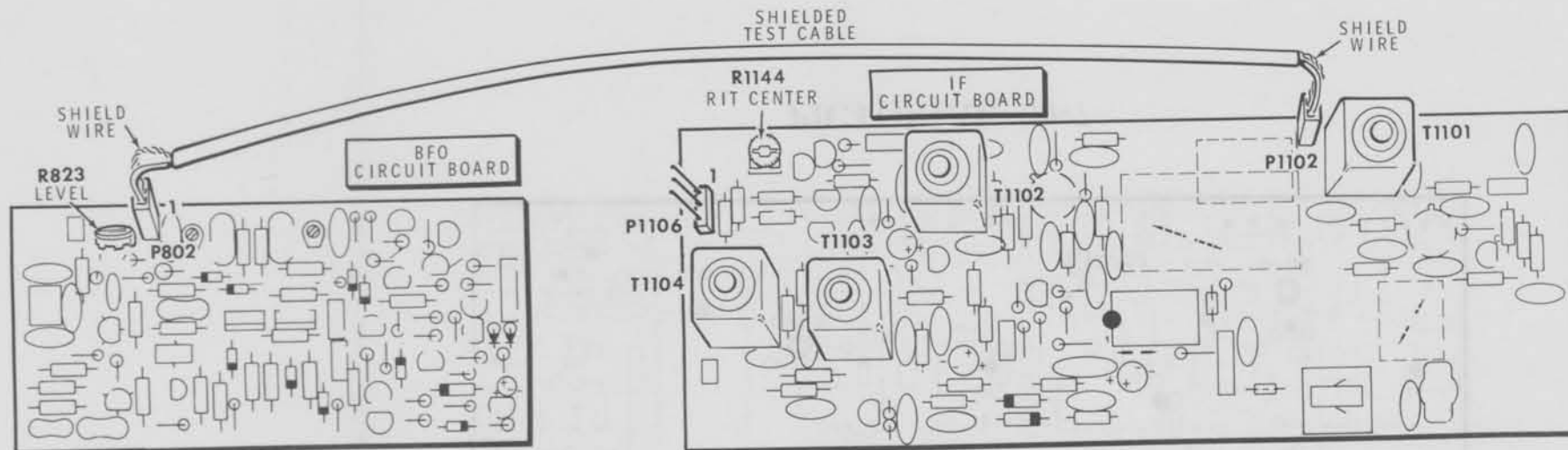

PICTORIAL 20-2

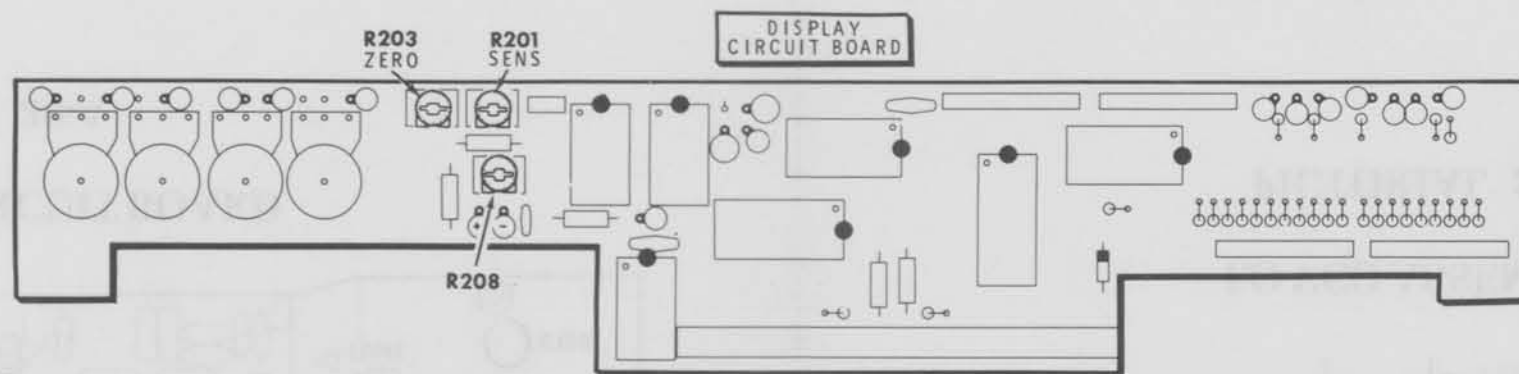

PICTORIAL 20-3

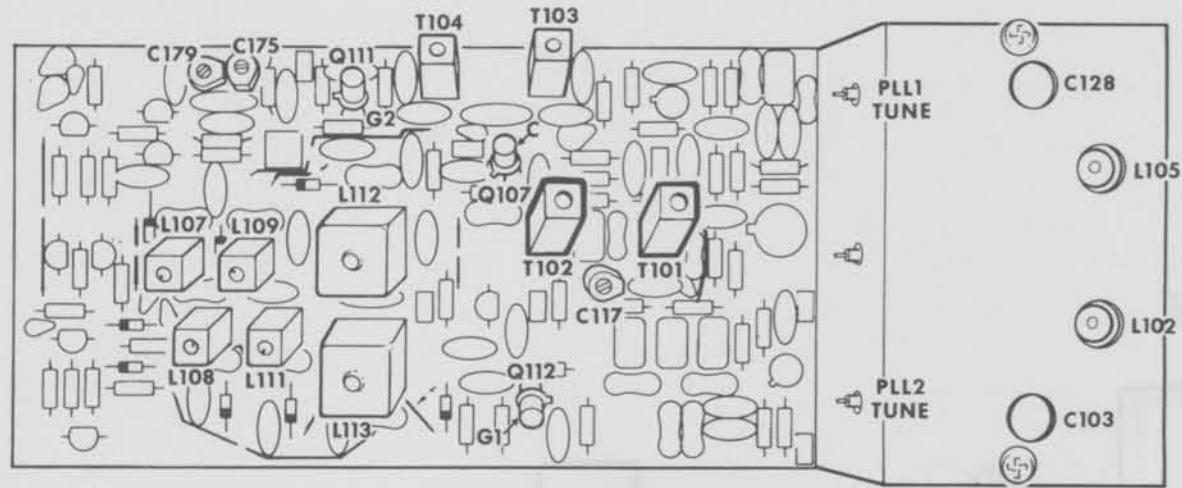

SYNTHESIZER CIRCUIT BOARD

PICTORIAL 20-4

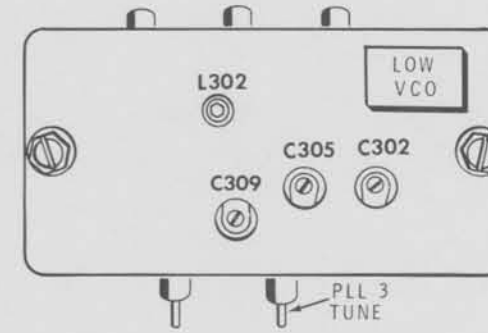

LO VCO ASSEMBLY

PICTORIAL 20-5

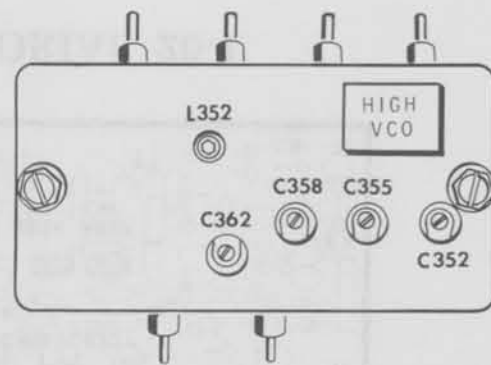

HIGH VCO ASSEMBLY

PICTORIAL 20-6

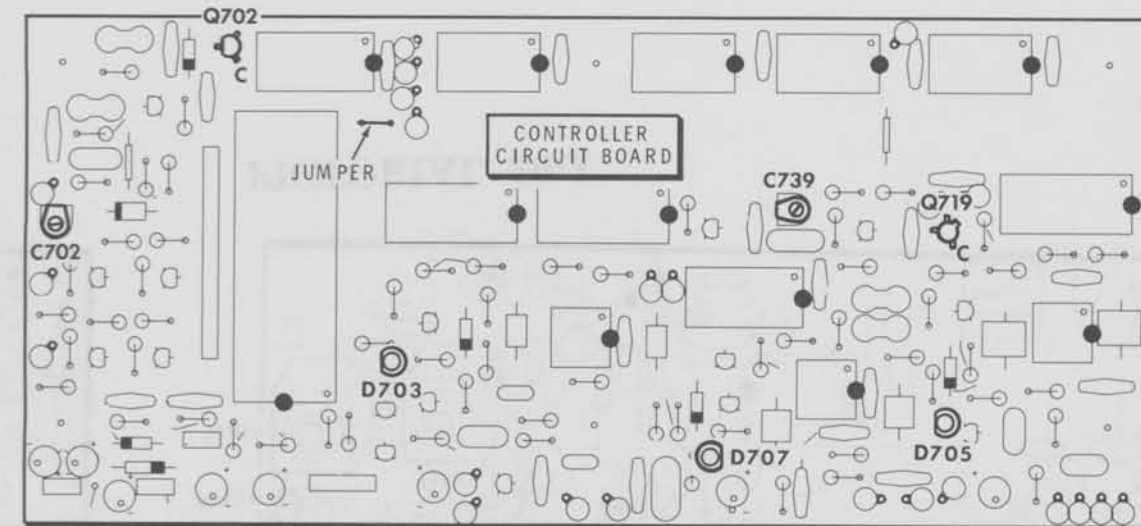

PICTORIAL 20-7

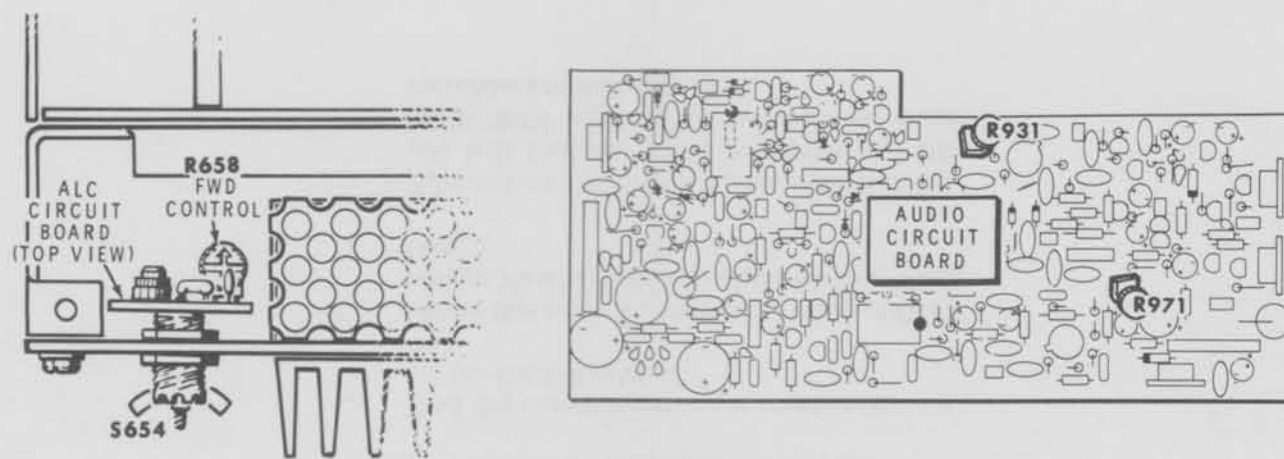
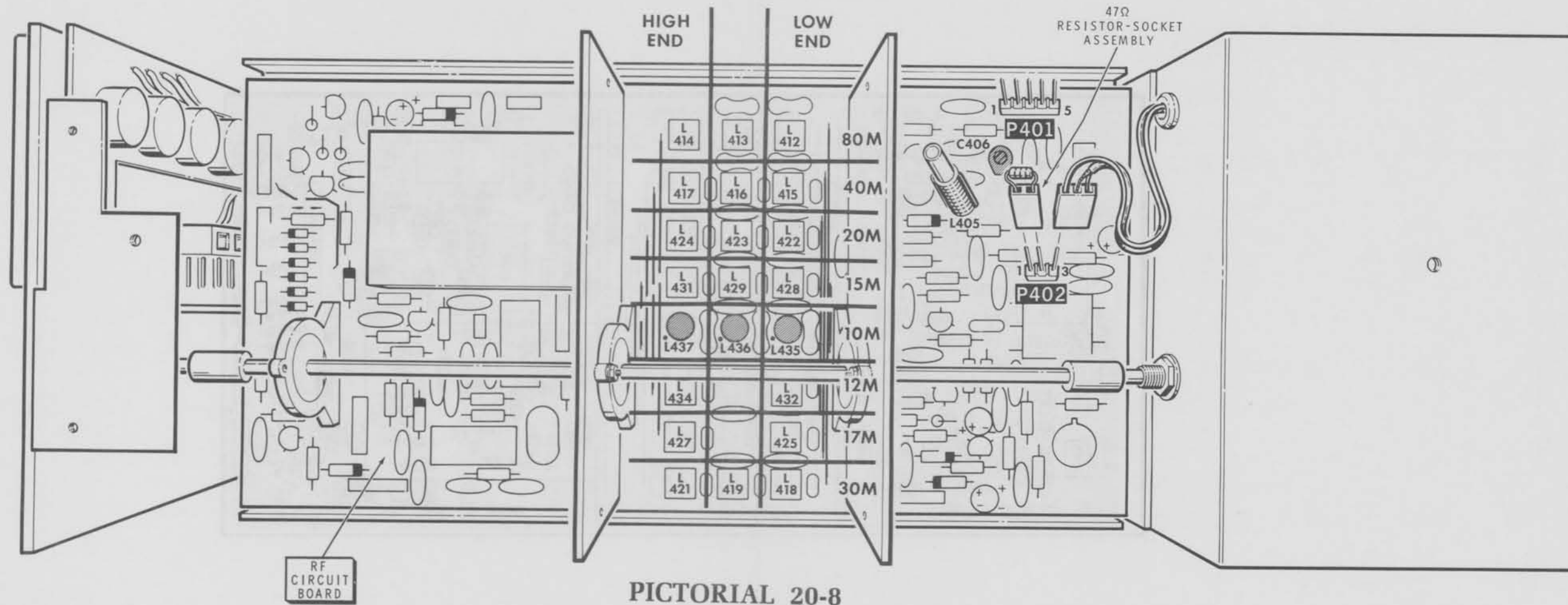

CIRCUIT BOARD X-RAY VIEWS

NOTE: To find the PART NUMBER of a component for the purpose of ordering a replacement part:

- A. Find the circuit component number (R5, C3, etc.) on the X-Ray View.
- B. Locate this same number in the "Circuit Component Number" column of the correct "Parts List."
- C. Adjacent to the circuit component number, you will find the PART NUMBER and DESCRIPTION which must be supplied when you order a replacement part.

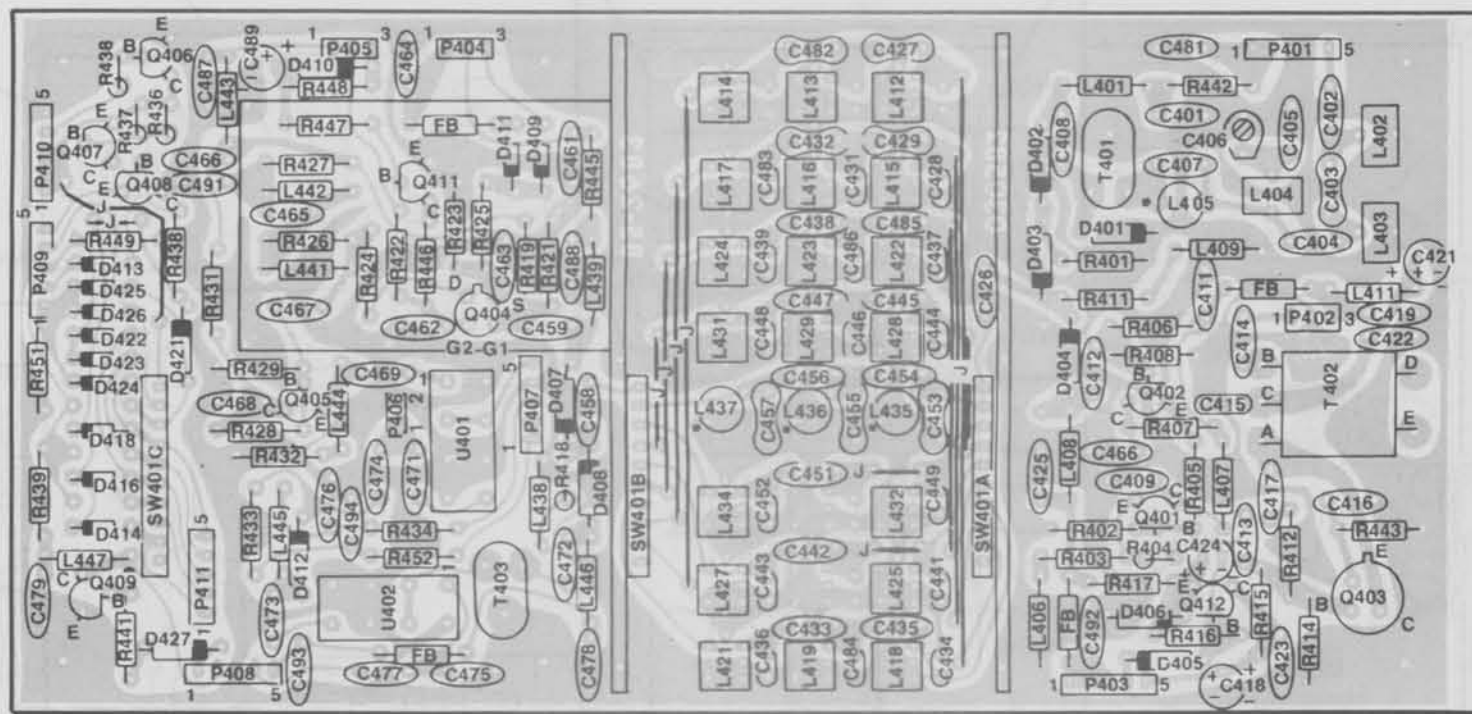

RF CIRCUIT BOARD
(Shown from the component side.)

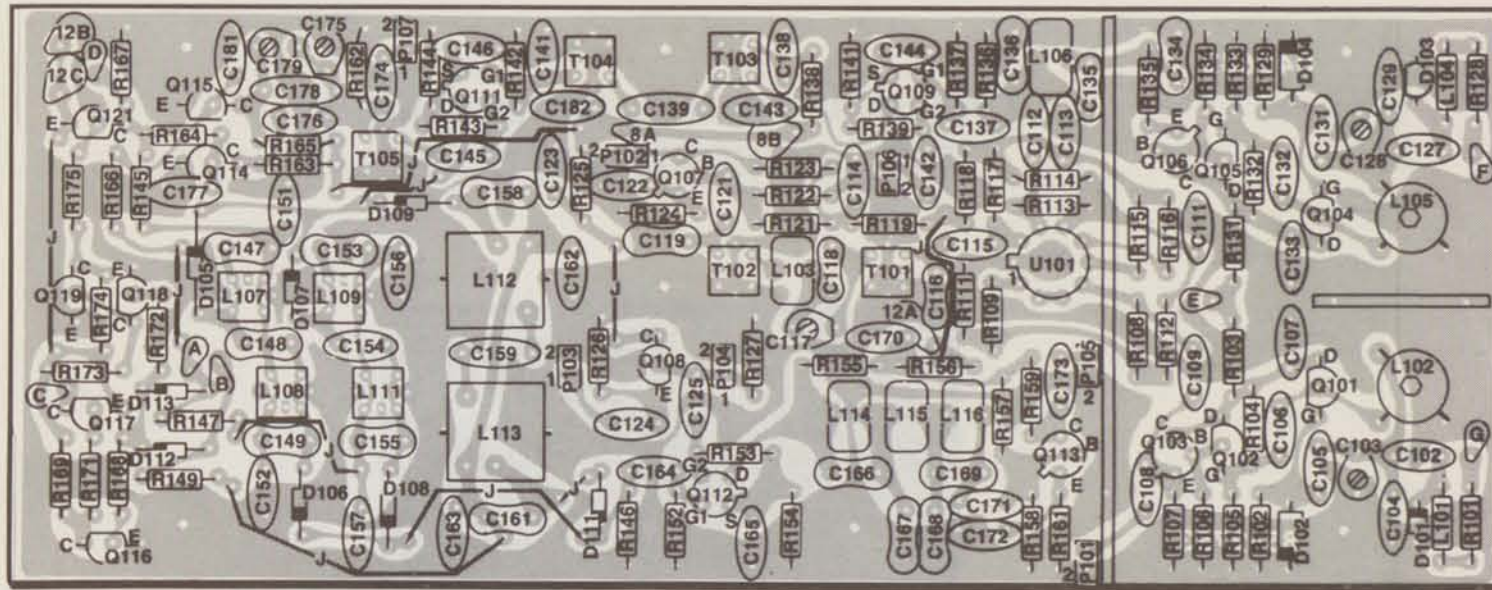

SYNTHESIZER CIRCUIT BOARD
(Shown from the component side.)

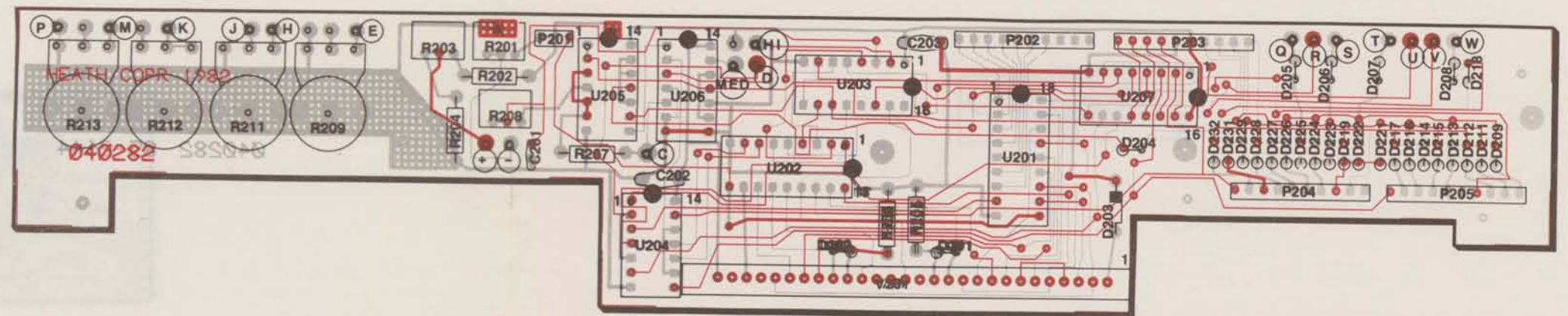

DISPLAY CIRCUIT BOARD
(Shown from the component side. The foil on the component side is shown in red.)

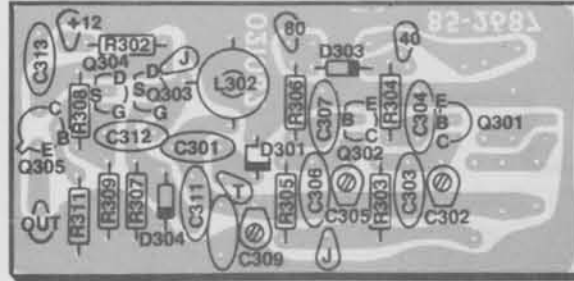

LOW VCO CIRCUIT BOARD
(Shown from the component side.)



RF PROBE CIRCUIT BOARD
(Shown from the component side.)

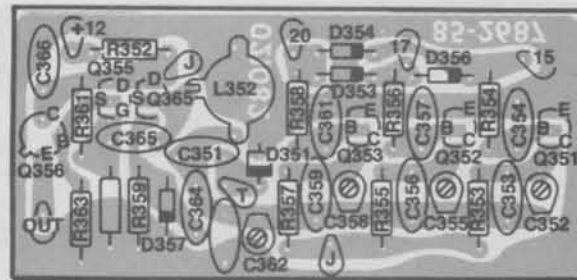

HIGH VCO CIRCUIT BOARD
(Shown from the component side.)

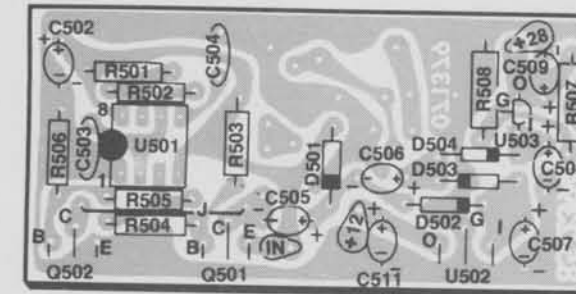

INVERTER CIRCUIT BOARD
(Shown from the component side.)

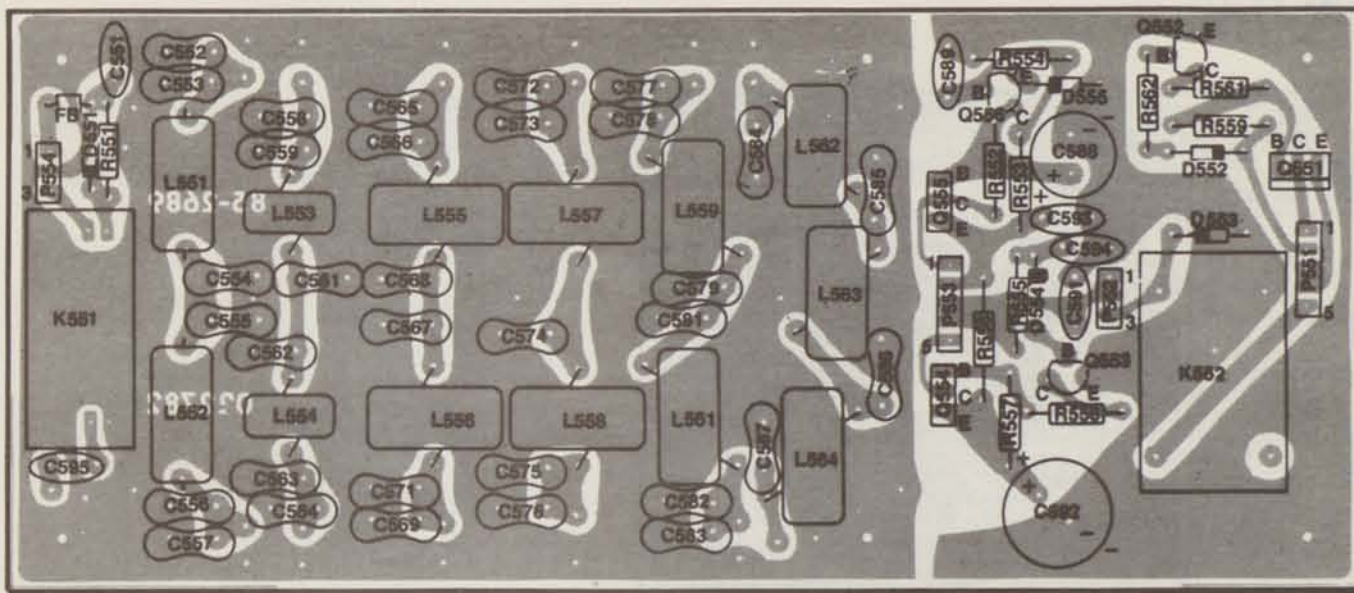

FILTER CIRCUIT BOARD
(Shown from the component side.)

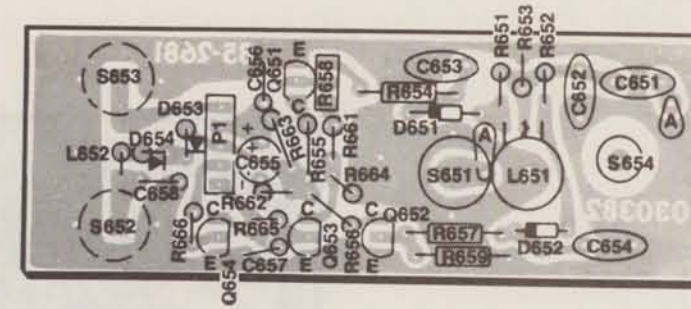

ALC CIRCUIT BOARD
(Shown from the component side.)

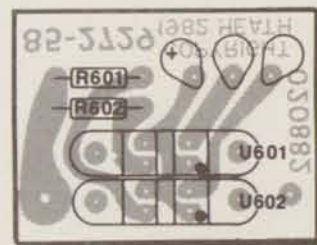

SHAFT ENCODER CIRCUIT BOARD
(Shown from the component side.)

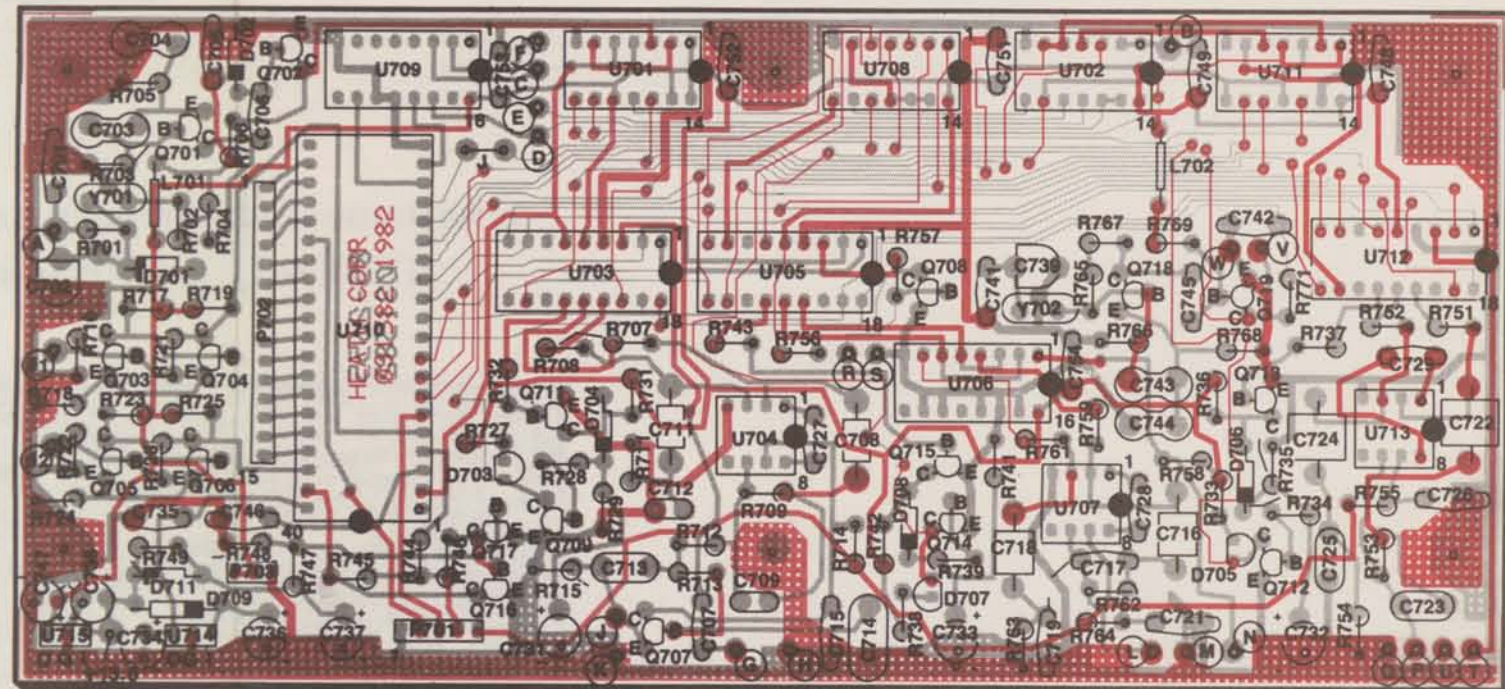

CONTROLLER CIRCUIT BOARD
(Shown from the component side. The foil on the component side is shown in red.)

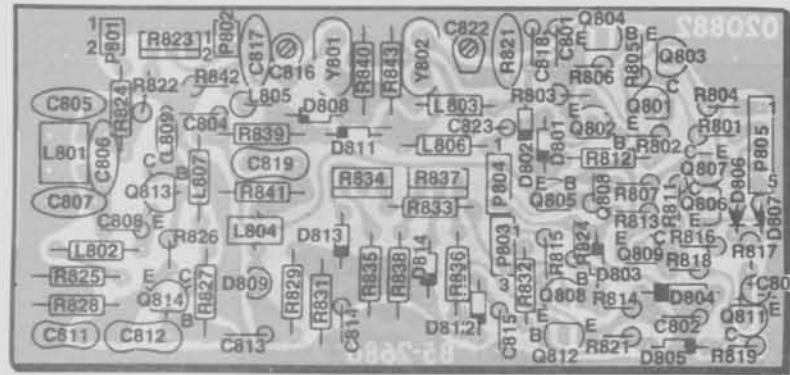

BFO CIRCUIT BOARD
Shown from the component side.

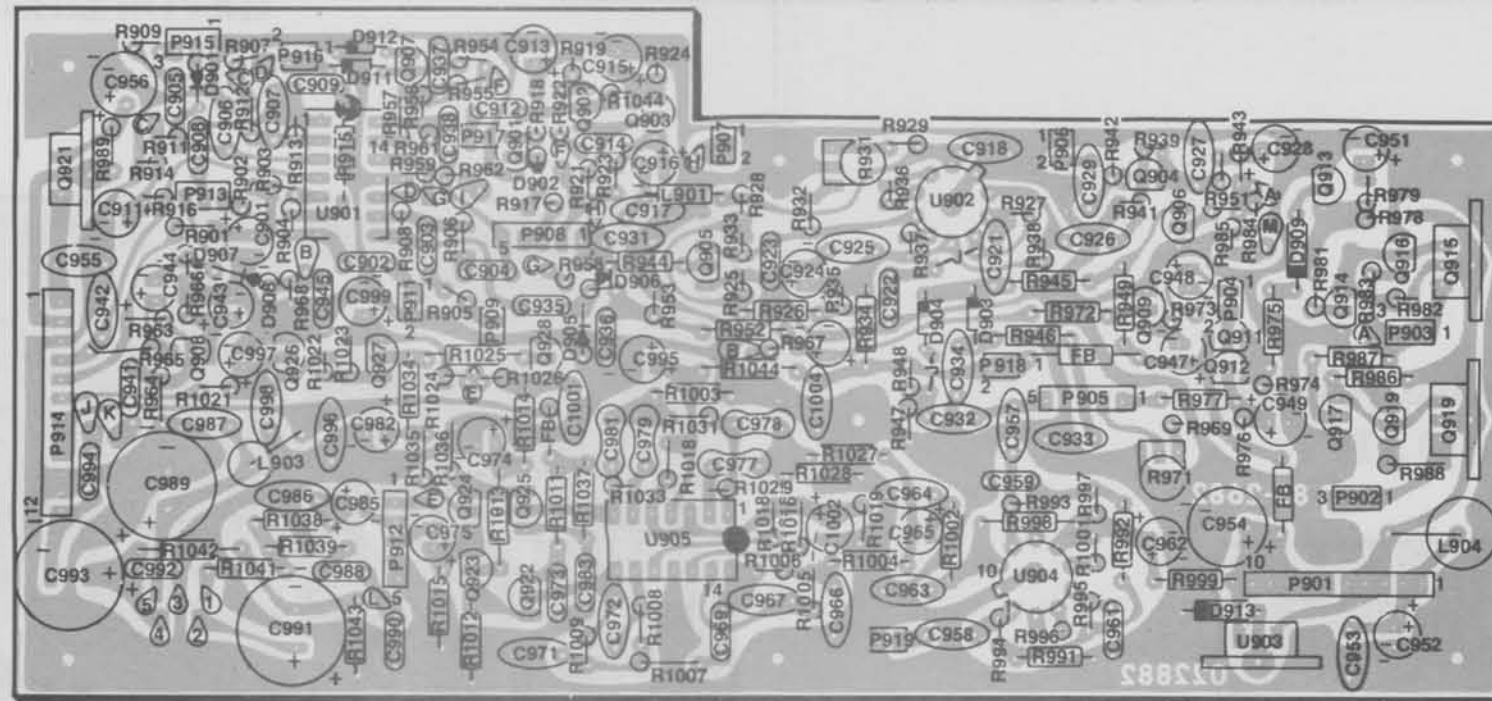

AUDIO CIRCUIT BOARD
(Shown from the component side.)

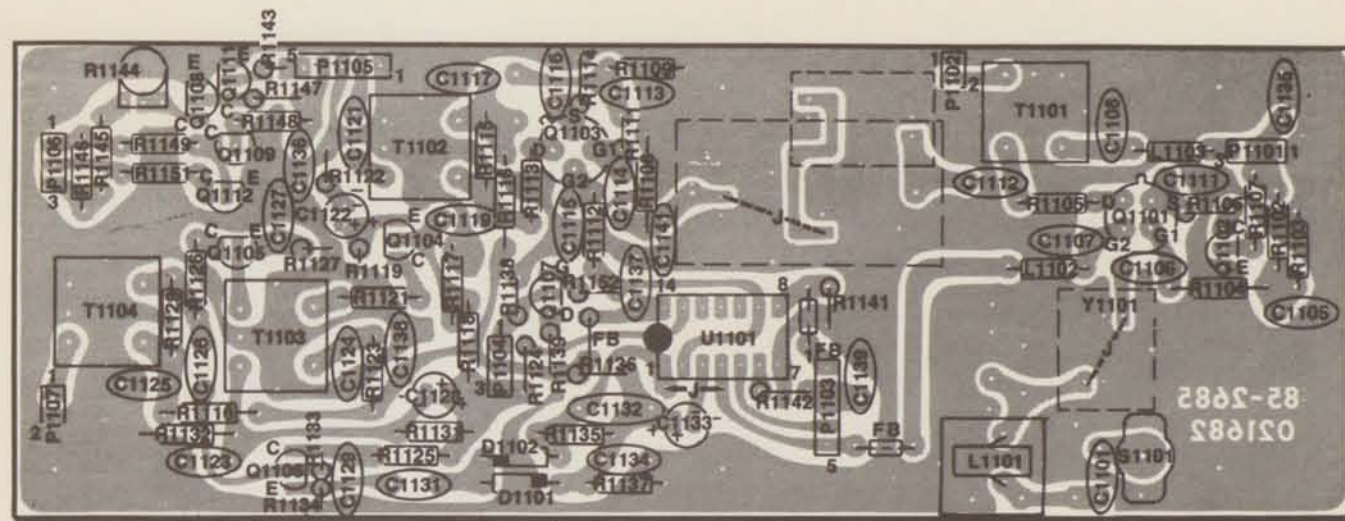

IF CIRCUIT BOARD
 (Shown from the component side.)

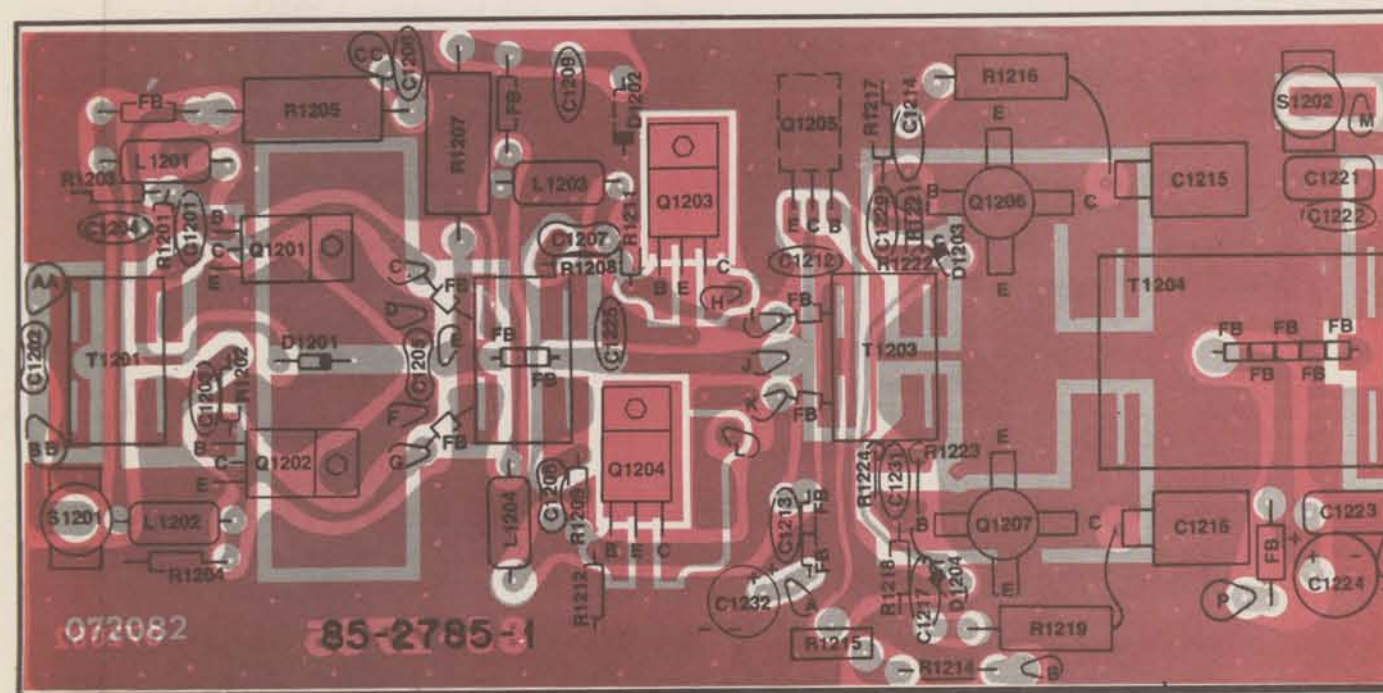

POWER AMPLIFIER (PA) CIRCUIT BOARD
 (Shown from the component side. The foil on the component side is shown in red.)