

# TM-7 使用说明书

- 使用前须知：**
- 请勿在易爆环境（如煤气、尘埃、蒸汽等）下使用车台或对电池充电；
  - 在加油或停车于加油站时，请关闭车台；
  - 不论有任何理由都不可改装或调整本机；
  - 请勿让车台受到长时间的阳光直射，也不要将它放在加热器具附近；
  - 请勿将车台放在极度多尘、潮湿及水溅之处，也不要将它放在不平稳的表面上；
  - 维修仅可由专业技术人员进行，请勿自行拆装。

**安全性：**  
请仔细阅读上面内容，使用者对使用车台的一般危险性的了解和认识是很重要的。

## 熟悉本机

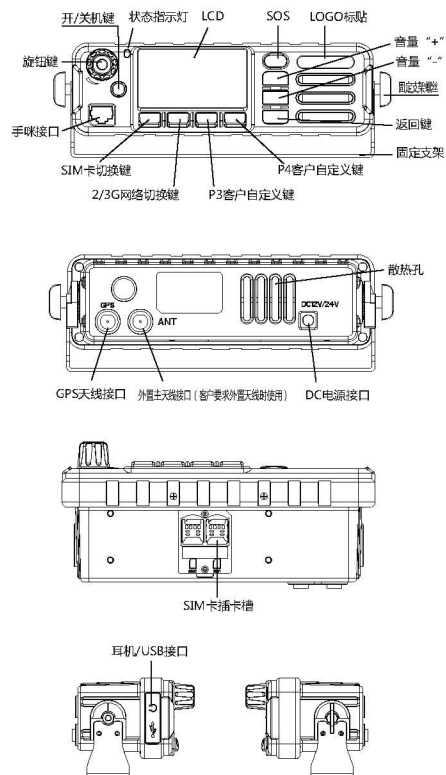

中文

## 配件安装

1 插入SIM卡，盖上SIM卡盖并锁紧螺丝

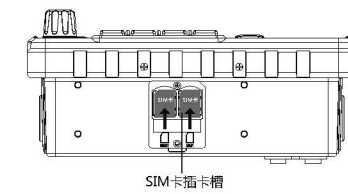

2 顺时针旋转，直到旋紧为止，注意对应天线

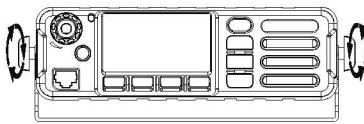
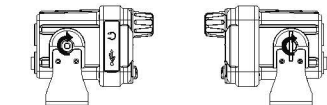

中文

3 插入DC电源

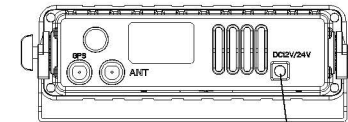

4 插入GPS天线/外置主天线

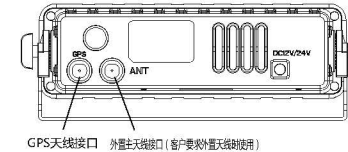

5 插入手咪

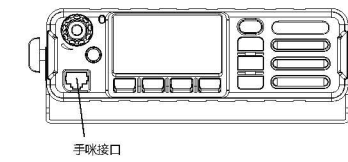

中文

## 基本功能

### 首次开机

确保电源接插好。开机：按住开机键按钮，直至显示屏出现开机的画面。某些SIM卡会有PIN码保护。如果有输入PIN码提示，输入你的PIN码。PIN码的初始密码一般为1234。

### 屏幕解锁

短按挂机键锁定屏幕，再次短按开机键唤醒屏幕。

### 系统提示栏

打开提示栏的方法：用手指按住屏幕顶端的状态栏，拽住弹出的下拉框向下拖动，即可打开提示栏。系统提示栏显示当前开启的应用程序，点击正在运行的列表栏，可快速切换到对应的应用程序。友情提示：开启飞行模式后，无法拨打电话。此外，系统提示栏还会显示系统当前的通知（如未读短信等），以及正在运行的应用程序。点击  图标，可查看图标列表，点击可快速开启相应功能。

### 个性化设置

在主屏幕的空白地方长按可进入个性化设置界面。在个性化设置界面，可以设置壁纸，添加小部件，以及进行系统设置。

### 图标的移动删除

长按屏幕中的菜单或小部件图标，可进行相应图标的移动或删除操作。

### 恢复出厂设置

在设置菜单中选择“备份和重置”可进行恢复出厂设置。警告：恢复出厂设置会将手机重置为其初始出厂状态，即清除系统、应用程序数据及设置，还包下程的应用程序。

中文

## 功能介绍

### 信息

点击进入信息界面，将显示接收到的信息列表，可以进行编辑、发送、删除信息等操作。

### 日历

可让您随时访问您的日历和事件。您可以分别查看日历，也可以同时查看若干日历。进入顶部选项是按日、周、月方式查看，开启以周（月）查看，显示的日历将以周（月）的方式呈现，更方便您查看日程表和新事项。

### 设置

进入菜单根据需要将对讲机进行个性化设置。包括无线和网络、情景模式、显示、存储、电池、应用、位置信息、安全、语言和输入法、备份和重置、添加账户、日期和时间、辅助功能、打印、开发者选项、关于手机等。

### 对讲

输入账号/密码登陆①  
(①详细登录方式见注《公网对讲使用说明书》)

## 安全信息

在使用操作设备前,请阅读并遵守下面的注意事项,以确保设备性能最佳,并避免出现危险或非法情况。

**电子设备**  
有文明规定禁止使用无线设备的场所,请勿使用设备,否则于干扰其他电子设备或导致其他危险。

### 易燃易爆区域

• 在加油站(维修站)或靠近易燃易爆物品、化学剂等任何易燃易爆区域,请勿使用设备,设备可能引起爆炸或起火。

### 操作环境

• 请勿在多灰、潮湿、肮脏或靠近磁场的地方使用设备,以免引起设备内部电路故障。

• 请勿在雷雨天气使用本设备,雷雨天气可能导致设备故障或电击危险。

• 请勿将设备放置在阳光直射的地方过久。

• 请避免设备及其配件雨淋或受潮,否则可能导致火灾或触电的危险。

• 请勿将设备靠近热源或裸露的火源,如电暖器、微波炉、烤箱、热水器、炉火、蜡烛或者其他可能产生高温的地方。

### 配件要求

• 勿使用未经认可或不兼容的电源、充电器或电池,可能引发火灾、爆炸或其他危险。

• 只能使用设备制造商认可且与此型号设备配套的配件,如果使用其他类型的配件,及引发意外损坏设备,违反本设备的保修条款。

## 维护和保养

• 清洁和维护本设备之前,先停止使用本设备,关闭电源,并断开于其他设备的所有连接。

• 当车台不使用时请将附件插孔盖盖上。

• 清洁车台外观的灰尘时,请使用中性洗涤剂(不能使用强腐蚀性化学药剂)进行擦拭。

• 请保持设备及其配件干燥。请勿使用微波炉或吹风机等外部加热设备对其进行干燥处理。

中文

感谢您选购我们的机器

本指南仅供参考,不构成任何形式的承诺,产品请以实物为准。

# TM-7 User manual

## Instructions before use:

- Do not use the mobile radio or charge the battery in the explosive environments (such as gas, dust, steam, etc.);
- In the gas or parking on the gas station please turn off the mobile radio; The machine can not be modified or adjusted for any reason;
- Please don't let the mobile radio stand in sunlight directly for a long time, or put it nearby the heating appliances;
- Do not place mobile radio in extremely dusty, moisture and water splashing places, and do not put in uneven surface.
- Maintenance can only be carried out by professional and technical personnel, Please do not disassemble by oneself.

## Security:

Please read this user manual carefully. It is very important for users to understand and be familiar with the general danger of using.

## Machine Chart :

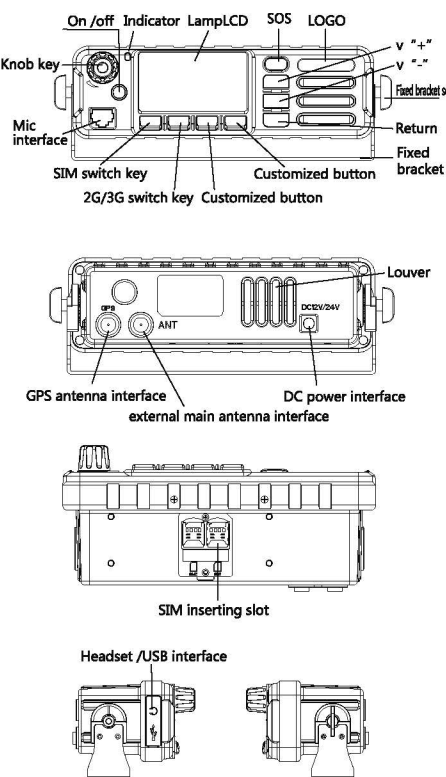

English

## Installation :

1 Insert the SIM card, cover on the SIM holder and tighten the screws.

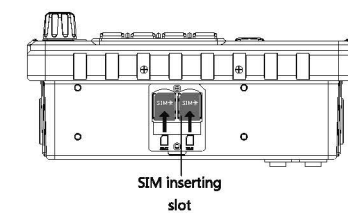

2 Rotate clockwise until the antenna is tightened, and pay attention to the antenna.

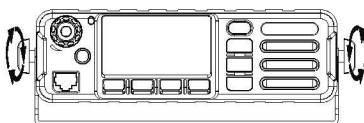
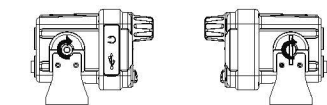

English

3 Connect with the power supply.

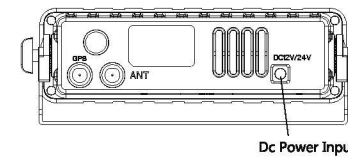

4 Insert GPS antenna / external main antenna.

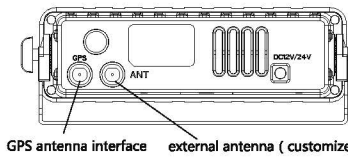

5 Plug in the microphone.

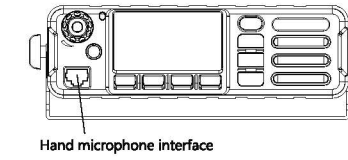

English

## Basic functions

### First boot:

Make sure the power is plugged in. Boot: press and hold the button until the screen appears on the screen. Some SIM cards will have pin code protection. If there is an input pin code prompt, please input your PIN code. The initial password of PIN code is 1234.

### Unlock the screen

Press the hang button to lock the screen, and then click the button again to wake up the screen.

### System prompt bar

The way to open the prompt bar: press on the top of the screen, grabbed the pop-up drop-down box drag down to open the prompt bar. The system prompt bar displays the currently opening applications. Click on the running list bar can quickly switch to the corresponding application.

Friendly note: You can't dial the phone when you open the flight mode. In addition, the system prompt column displays the current notifications of the system(the unread text messages, etc),and running applications. Click this icon  can view icon list. Click it can quickly open the corresponding function.

### Personalization

long press in the blank space of the main screen can access to personalized settings interface.

### Move or delete Icon

Long press the menu in the screen or widget icon, the corresponding icon can be moved or deleted.

### Factory Reset

Select " backup & reset " in the settings menu,and then the factory settings can be restored. Warning: restore the factory settings will reset the phone to its initial factory status, that means clean the system, application data and settings, including downloaded applications.

English

## Functions:

### Message

Click into the message interface, it will display the list of message received, you can edit, send, and delete message.

### Calendar

It allows you to access your calendar and events at any time. You can view the calendar respectively, You can also view several calendars at the same time. Go to the top of calendar to option that the calendar viewed by day, week, or by month. Open the week (month) to view, the calendar will be displayed by week (month) way. It's more convenient for you to look at calendar and new items.

Do not place the equipment in sunlight directly for a long time. Please avoid equipment and accessories rain or moisture, otherwise it may lead to the risk of fire or electric shock

Don't put the equipment near the heat source or the exposed fire source, such as electric heater, microwave oven, oven, water heater, fire furnace, candle or other places where high temperature may occur.

**Settings**  
Enter the menu to personalize the mobile radio according to the need. Including wireless and network, contextual model, display, storage, battery, application, location information, security, and language and typewriting, backup and reset, add account, date and time, the auxiliary function, print, developer options, about mobile phones, etc.

**Intercom**  
Login by input the account number and password (① Detail login mode please see <public network intercom instructions >)

### Accessories requirements

Do not use an unapproved or incompatible power source, charger or battery, which may cause fire, explosion, or other hazards.

Please only use the accessories approved by the equipment manufacturer and equipped with this equipment. if using other types of accessories, and it will occur accidental damage to the equipment, Also violate warranty clause of the equipment.

**Maintenance Service**  
Before cleaning and maintaining the equipment, Firstly ,stop using the equipment, turn off the power supply, and disconnect all the connections on other equipment.

When you do not use the mobile radio, please cover the socket Jack interface.

When cleaning the dust on the exterior of the truck radio, please use neutral detergent (no strong corrosive chemicals) to wipe it.

Please keep the equipment and accessories dry . Please do not use the microwave oven or hair dryer and other heating equipments for drying on it.

**The flammable and explosive area.**  
In the gas station (maintenance station) or near

English

English

Thank you for purchasing our machine

This guide is just for reference only and does not constitute any form of commitments.