

INSTRUCTION MANUAL
FOR
MODEL NRD-515 ALL WAVE RECEIVER



Japan Radio Co., Ltd.

Forword

The Model NRD-515 receiver is the highest-class all-wave receiver, which has been designed with full application of the latest solid-state elements and digital circuit design technology concepts, based on the JRC's long-year technical achievements and experiences.

You are recommended to carefully read this technical instruction manual before operation of this receiver and to properly use it. This all-wave receiver has been manufactured under a rigorous quality control in the factory, however, if you should find any questionable or defective point in the receiver, immediately contact the sales store, where you bought or JRC Sales and Service Office.



CONTENTS

SECTION	PAGE
1. SPECIFICATIONS	1
2. FEATURES	2
3. PRECAUTIONS BEFORE OPERATION	
3.1 Accessories	4
3.2 Installation Place	4
3.3 Installation Method	4
3.3.1 Connecting the Antenna	4
3.3.2 Connecting the Earth Line	4
3.3.3 Connecting the Speaker	4
3.3.4 Connecting of Power Line	4
3.4 Preparation before Operation	5
3.5 Precautions before Operation	5
4. OPERATING CONTROLS	
4.1 Front Panel Controls	6
4.2 Rear Panel	8
5. OPERATION	
5.1 Reading and Setting the Frequency	9
5.2 Operating the Controls and Switches	9
5.3 Operation for Reception	11
5.3.1 SSB Reception	11
5.3.2 CW Reception	11
5.3.3 AM Reception	11
5.3.4 RTTY Reception	11
5.4 Preset Reception with the optional NDH-515 memory unit.	11
5.5 Operation in combination with JRC Transmitter	12
5.5.1 Interconnection	12
5.5.2 Operating Procedure	14
5.6 Other Operations	15
6. CIRCUIT DESCRIPTION	
6.1 Functional Block Diagram and Schematic Diagram	17
6.2 Description of Units	17
6.2.1 Chassis and Panel Unit CFQ-608	17
6.2.2 Receiver Unit CMA-105	17
6.2.3 Synthesizer Unit CMQ-62	17
7. MAINTENANCE AND CHECKING	
7.1 Preparation before Maintenance and Checks	19
7.2 Maintenance and Checks	20
7.3 Troubleshooting	22
8. OPTION	
8.1 Memory Unit NDH-515	23
8.2 Speaker NVA-515	23
8.3 Filter CFL-260, 600Hz	23
8.4 Filter CFL-230, 300Hz	24
8.5 Mounting the Option Filters	24
8.5.1 Mounting the CFL-260 Filter	24
8.5.2 Mounting the CFL-230 Filter	24
8.5.3 Inserting the Filter into Receiver	24
9. APPENDIX DRAWING	
Functional Block Diagram	Appendix 1
Connection Diagrams	Appendix 2-6

SECTION 1

SPECIFICATIONS

1.1 Frequency Range for Reception

100kHz to 30MHz

1.2 Mode of Operation

AM, SSB (USB and LSB), CW and RTTY

1.3 Receiving System

Double superheterodyne,

First IF: 70.455MHz, Second IF: 455kHz.

1.4 Sensitivity, S/N = 10dB

MODE FREQUENCY	SSB & CW	AM
1.6 to 30MHz	Less than 0.5 μ V	Less than 2 μ V
100 to 1600kHz	Less than 2 μ V	Less than 6 μ V

1.5 Selectivity

BANDWIDTH BAND	6dB down	60dB down
6kHz	More than 4kHz	Less than 10kHz
2.4kHz	More than 2kHz	Less than 6kHz
0.6kHz*	More than 0.5kHz	Less than 3kHz
AUX*	More than 0.26kHz	Less than 2kHz

NOTE: Bands marked "*" are provided by optional filters: CFL-260 filter incorporated for the 0.6kHz-band and CFL-230 filter for the AUX.

In the AUX position, a crystal filter having a desired bandwidth may be incorporated.

1.6 Image Suppression

More than 70dB

17. IF Interference Suppression

More than 70dB

1.8 Frequency Stability

Less than 50Hz per hour, after warm-up.

1.9 Antenna Input Impedance

50 to 75 ohms, unbalanced.

1.10 AF Output Power

Speaker output: 1W or higher, 4 ohms (distortion less than 10%)

Line and record output: 1mW or higher, 600 ohms, unbalanced (distortion less than 3%)

Headphone output impedance: 4 to 8 ohms.

1.11 IF Output

Level: 50mV or higher for antenna input voltage of 3 μ V; 455kHz, 75 ohms, unbalanced.

1.12 VFO Output

Level: 0.2V or higher; 75 ohms, 2.455 to 3.4549MHz

1.13 VFO Input

Level: 0.2V or higher; 75 ohms, 2.455 to 3.4549MHz

1.14 Antenna Input Attenuator

Attenuation: 10dB, 20dB, approx.

1.15 AGC Characteristic

AF output variation less than 10dB against antenna input change of 3 μ V to 100mV.

1.16 Passband Tuning (PBT) Range

Variable in excess of \pm 2kHz

1.17 Δ F Range

Variable in excess of \pm 2kHz

1.19 Frequency Memory

Up to 24 spot frequencies using optional memory unit (separate unit).

1.20 Power Requirements

100/117/220/240V AC, 50/60Hz;

Power consumption 50VA, approx.

1.21 Dimensions (excl. projections)

340(width) x 140(height) x 300(depth)mm

1.22 Weight

7.5kg, approx.

NOTE: The specifications and used semiconductor elements may be subject to change for improvement of performance.

SECTION 2

FEATURES

2.1 PLL Digital VFO

A digital VFO system has been employed, which is a combination of a photo type rotary encoder using light-emitting diodes with a PLL synthesizer controlled by a reference crystal oscillator having an elevated stability, thus assuring a preeminently high stability of frequency and accuracy. Since the digital VFO has no mechanism for operation, neither backlash nor calibration error occurs at all in addition to no secular variation, thus providing a high reliability.

The heart of the synthesizer is housed in an aluminium die-cast case to assure a high quality.

2.2 Digital Tuning System

Rotation of the TUNE dial on the control panel produces pulses for controlling the frequency, which is changed at a rate of 10kHz per rotation in step of 100Hz. This facilitates tuning operation with the dial. An automatic quick tuning facility with the UP/DOWN switch is provided for rapid frequency setting. In addition, the frequency can be automatically made transition to the next band by turning the dial only.

Therefore, a perfectly continuous and quick tuning can be made without troublesome switching of the MHz-selector.

In addition, an electric dial lock function is provided for preventing the operating frequency from deviating due to vibration or careless operation.

2.3 Frequency Memory Unit (Option) over 24 Channels

Separate memory unit capable of storing the frequencies in 24 channels. Programming operation and change of the memory contents can be very easily performed with use of the switches on the control panel. Only by designating the channel of the memory unit, the receiving frequency can be set as a memory frequency on the spot and an automatic tuning reception can be made.

The memory unit connector located at the rear panel of the receiver is also available for frequency data input/output line, allowing extended application for control of a microcomputer or a peripheral device.

2.4 All-Wave and All-Mode Reception

The receiver can continuously cover an extensive range of 100kHz to 30MHz and receive in any of the AM, LSB, USB, CW and RTTY modes. LF/MF bands below 1.6MHz are clearly receivable through the use of a filter/tuning circuit. The receiving frequency is indicated down to the digit of 100Hz based on the frequency control information of the synthesizer, ensuring high accuracy of frequency reading.

The analog sub-dial directly connected to the tuning

dial permits reading of 500Hz, giving convenience in QSY.

2.5 Up-Conversion System in Direct Mixer

A double-superheterodyne in up-conversion system has been employed for converting the frequency of 100kHz to 30MHz into the first IF of 70.455MHz. A direct mixer consisting of a high-performance balanced mixer circuit is incorporated in the input circuit of the front end, and a crystal filter is inserted in the first IF stage. Thus, the multi-signal characteristic and proximity interference characteristic have been improved.

2.6 Passband Tuning Function

The IF filter can be switched in four steps for the bands: 6kHz, 2.4kHz, 0.6kHz (option) and AUX (option), independently of the mode switching. Into the AUX position, a 0.3kHz-filter or other filter having a desired bandwidth may be incorporated.

A passband tuning function is provided, effective for eliminating radio interference with adjacent frequencies in CW and SSB reception. In CW reception a desired tone can be heard with adjusting the BFO.

2.7 Electronic Tuning and Electronic Switching

Tuning and switching are all performed electronically; no mechanism being employed at all. As a result, this equipment has a simple construction, and provides a quick response, high reliability and long life.

2.8 Full-Solid-State Circuitry Arrangement

Using the latest semiconductor elements, including low-power Schottky TTL IC's and CMOS IC's, for all the circuits of this equipment. It requires a reduced power consumption owing to these IC's.

2.9 Full-Modular Structure with Little Wiring

A modular structure combined with plug-in type PC boards, excellent in facilitation of the service. The PC board is made of a glass-epoxy resin, and automatic soldering is applied to it. Mother boards are used for connection, reduction of wiring, equalization of quality, and improvement of the reliability.

2.10 Excellent Controllability and Compact and Robust Structure

Providing an excellent controllability, including the tuning dials with good touch and reasonable controls layout, in addition to a panel design, providing a good appearance.

The front panel is made of die-cast frame, and the chassis made of aluminium, thus forming a compact, light-weight, and robust structure.

2.11 Full Accessory Circuits

Includes a passband tuning circuit, noise blanker circuit, ΔF (RIT) circuit, two-step switching input attenuator circuit, AGC three-step switching circuit, recording output, line output, headphone output, AC voltage switchover etc.

2.12 Operable Combined with NSD-505 Transmitter

Provided with all the functions necessary for operation of an amateur radio station. Accordingly, operable combined with the NSD-505.

2.13 Various Options

A plenty of options available, including memory unit, CW 600Hz-filters, CW 300Hz-filter, and speaker unit.

SECTION 3

PRECAUTIONS FOR OPERATION

3.1 Accessories

The Model NRD-515 includes the following accessories. Check them.

- (1) Instruction manual 1
- (2) M-type coaxial plug (J1, for antenna connection) 1
- (3) RCA type pin plug (J2, for SP, RECORD, LINE OUT and IF OUT connection) 4
- (4) Square plug (J3, for TX connection) 1
- (5) Single-head plug (J7, for PHONES connection) 1
- (6) Pilot lamp (12V, 0.16A) 1
- (7) Fuse (1A) 1
- (8) AC power cord 1

3.2 Installation Place

Select a well ventilative place for installation; avoiding such places as exposing to the direct sunshine, subjecting to hot wind from an air-heater, or dusty, vibrational, or moisture places, in order to keep the proper performance and assure a long use. Reserve a free space around the equipment, as wide as possible.

3.3 Installation Method

Prior to operation, the following preparations are necessary, including the antenna and earthing works and connections of the speaker and power lines.

NOTE: In case of the operation combined with the transmitter, refer to Paragraphs 5.5 and 5.6.

3.3.1 Connecting the Antenna

Assemble the furnished M-type coaxial plug with the antenna of 50 to 75 ohms and connect the plug to the ANT jack located on the back panel.

If an antenna having other impedance than 50 to 75 ohms is to be used, insert an impedance matching unit, such as antenna coupler.

The antenna dominantly governs the performance of the receiver, and therefore should be selected an antenna having a good characteristic, as possible.

3.3.2 Connecting the Earth Line

Connect a earth line to Terminal E at the rear side of the receiver, along the shortest pass from the ground, in order to protect the user from electric shock and to prevent the receiver from interference with other equipments.

Employ a thick wire for the grounding line, if possible.

NOTE: Never use any of gas and electric wiring pipes for the ground.

3.3.3 Connecting the Speaker

Select a dynamic type speaker provided with a

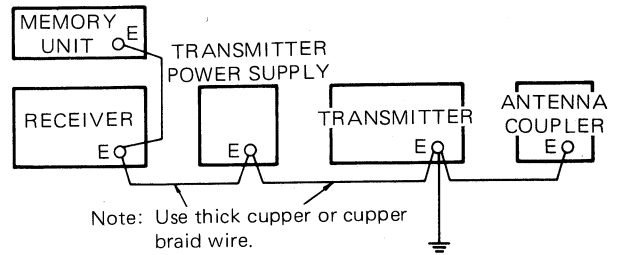

Figure 3-1 Illustrative Connection of Each Line

voice coil of 4 ohms and connect the speaker to SP jack through the furnished RCA type pin plug. The jack is located at the rear side of the receiver. An exclusive speaker NVA-515 is available at your option.

3.3.4 Connection of Power Line

100, 117, 220 or 240 volts, 50/60Hz commercially available power line can be used for the power supply.

For converting an available power line voltage, set the line voltage selector to the line voltage to be used.

If a power line having other line voltage than above is to be used, set the selector to a voltage position nearest the line voltage to be used, provided that the difference between the voltage at the selected position and line voltage to be used is less than 10V. If the difference of voltage exceeds 10V, insert a voltage step-down transformer or variable voltage transformer into the circuit.

- Example: Line voltage of 110V set to 117V
- Line voltage of 115V set to 117V
- Line voltage of 120V set to 117V
- Line voltage of 230V set to 220V

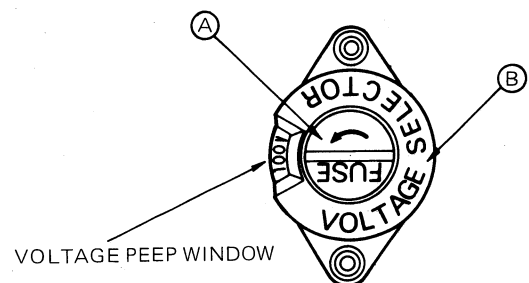

Figure 3-2 Voltage Selector

The voltage selector is combined with the fuse holder, as illustrated in Figure 3-2.

First, unscrew Cap A and then draw piece B to this side. Set the direction of piece B so that the line voltage value appears in the indication window,

and insert the piece. Then, screw Cap A into the selector in place; the fuse must be inserted together.

Make sure the POWER switch has been OFF, connect the furnished power cord to the main unit, and then insert the plug of power cord into a power outlet.

3.4 Preparation before Operation

Do the following preparation before POWER switch-on.

- (1) In case of using the headphone, prepare the furnished single-head plug and insert the PHONES jack on the panel. Insertion of the plug makes the speaker output cut off. Select headphone having low impedance.
- (2) In case of recording on a tape recorder, use the furnished RCA type pin plug for the RECORD or LINE OUT jack on the back panel.
- (3) In case of using the IF output (455kHz), use the furnished RCA type pin plug for the IF OUT jack on the back panel.

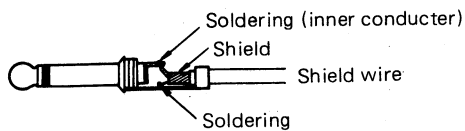

Figure 3-3 Assembling the Single-Head Plug

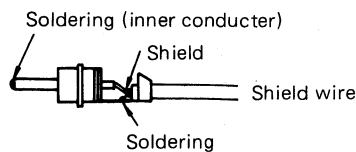

Figure 3-4 Assembling the RCA Plug

3.5 Precautions before Operation

- (1) If the MHz-dial is set halfway, the equipment may malfunction. Set the dial in place.
- (2) Do not touch unreasonably semi-fixed resistors, trimmer capacitors, cores of transformers, etc.
- (3) This equipment has employed a large number of semiconductor elements. Great care should be taken upon maintenance and checks not to short them.
- (4) When the receiver is operated with a paired transmitter, it sometimes happens that its input circuit is burnt out by transmitting waves induced to the antenna input. Therefore, the induction of transmitting waves to the antenna input must be examined by operating the transmitter before the installation of the receiver.
- (5) Arrester diodes have been inserted in the input end of the antenna in the receiving unit to protect it against an excessively high input power.

If a strong signal exists near the operating frequency, an inter- or cross modulation may occur because of the diode's property. Removal of the diode will reduce such undesired modulation but leave the possibility of damage in the receiver. The arrester diode may be removed when no combined operation is made or it is assured that no excessively high input is applied to the antenna.

Refer to Figure 3-5 for removing the diode.

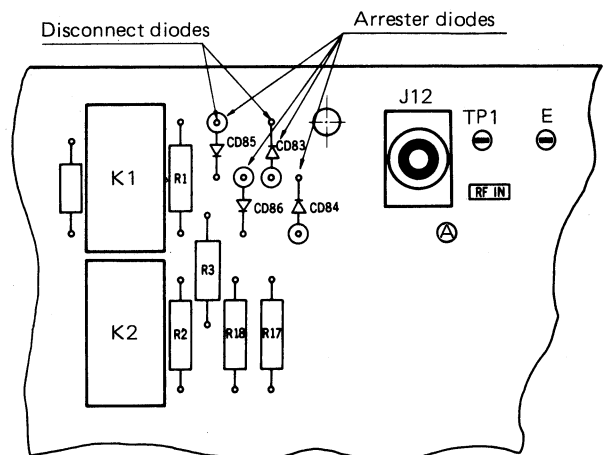

Figure 3-5

SECTION 4

OPERATING CONTROLS

4.1 Front Panel Controls

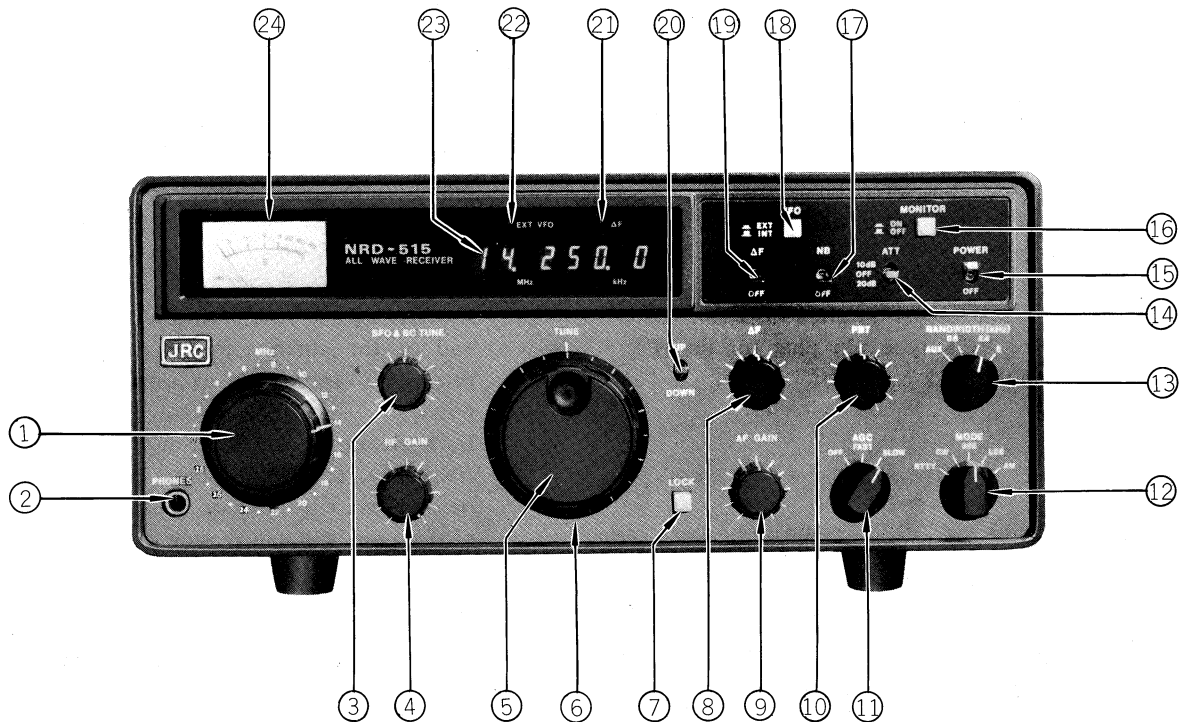

Figure 4-1 Front Panel

- (1) MHz control For selecting a desired MHz-digit. Full rotation covers the entire frequency range.
- (2) PHONES jack For connection of the headphone. Insertion of the plug disconnects the speaker output.
- (3) BFO & BC TUNE control For adjusting the beat tone, with the MODE switch set at CW. Clockwise rotation increases the BFO frequency. In the time of the MF broadcast reception in 600 to 1599.9kHz the same control is used for tuning the preselector.
- (4) RF GAIN control For adjusting the IF gain.
- (5) TUNE dial For setting the frequency. Full rotation covers 10kHz, variable in step of 100Hz.
- (6) Sub-dial scale
Having minimum division of 500Hz.
Full rotation covers 10kHz.
Available conveniently for up-down operation in QSY.
- (7) LOCK pushbutton For electrically locking the dial.
- (8) ΔF control Enabled with the ΔF switch set at ΔF . For finely adjusting the frequency.

NOTE: If this control is turned, the frequency display remains unchanged.

In the transceive operation, this control can be used as the RIT. Clockwise rotation increases the frequency.

- (9) AF GAIN control For adjusting the AF gain.
- (10) PBT control For tuning the passband. This control has a powerful ability for eliminating the adjacent radio interference in the CW, SSB or RTTY mode.
- (11) AGC switch For switching on and off the AGC and the time constant.

Position:

OFF Disabling the AGC; the gain is controlled manually by the RF GAIN control.

FAST ... For short time constant. Mainly used for reception in the AM or CW mode.

SLOW .. For long time constant. Mainly used in the SSB mode.

- (12) MODE switch
For selecting the reception mode.

Position:

- RTTY .. For receiving with a radio teletype.
 - CW For telegraph reception
 - USB For upper sideband reception
 - LSB For lower sideband reception
 - AM For AM reception
- (13) BANDWIDTH switch For switching the bandwidth of the IF filter. Both 6kHz- and 2.4kHz- filters have been incorporated, while the 0.6kHz- and AUX filters are option.
The CFL-260 filter can be incorporated in the position of 0.6kHz and the CFL-230 in the position of AUX; both being option.
- (14) ATT switch For switching on and off the attenuators of 10dB and 20dB inserted into the antenna input circuit.
10dB/20dB position when a signal is subject to a powerful radio interference.
OFF position in normal condition.
- (15) POWER switch For switching on and off the power supply.
- (16) MONITOR switch For monitoring the RF signal transmitted from the self station upon operation combined with the transmitter.
- (17) NB switch For switching on and off the noise blanker. Set at ON when a pulsive noise produced from automobiles or the like is incoming at high level.
- (18) VFO switch For selecting the alternative of the internal or external VFO operative in the receiver, in the combined operation with the transmitter.

Positions:

- INT Internal VFO
 - EXT External VFO
- If the receiver operates without combination with the transmitter, set the switch at INT.
- (19) Δ F switch For switching on and off the Δ F circuit.
Refer to Number (8).
Set at OFF in usual.
- (20) UP-DOWN switch For automatically quickly changing the tuning frequency.
Positions:
UP Increasing the frequency
DOWN Decreasing the frequency
- (21) Δ F indicator Turns to illuminate when the Δ F switch is set at Δ F.
- (22) EXT VFO indicator Turns to illuminate when the VFO switch is set at EXT.
- (23) Receiving frequency display For indication of a frequency under reception in the minimum unit of 100Hz, on the light emitting diodes indicator.
In the USB and LSB modes, the indication represents the suppressed carrier frequency.
- (24) S meter
For indicating the input intensity of a received signal. The meter is calibrated up to 9th division in S unit, with divisions of about 20dB-step above the 9th division.
Set the RF GAIN knob to maximum and the AGC switch turned to the position "FAST" or "SLOW".

4.2 Rear Panel

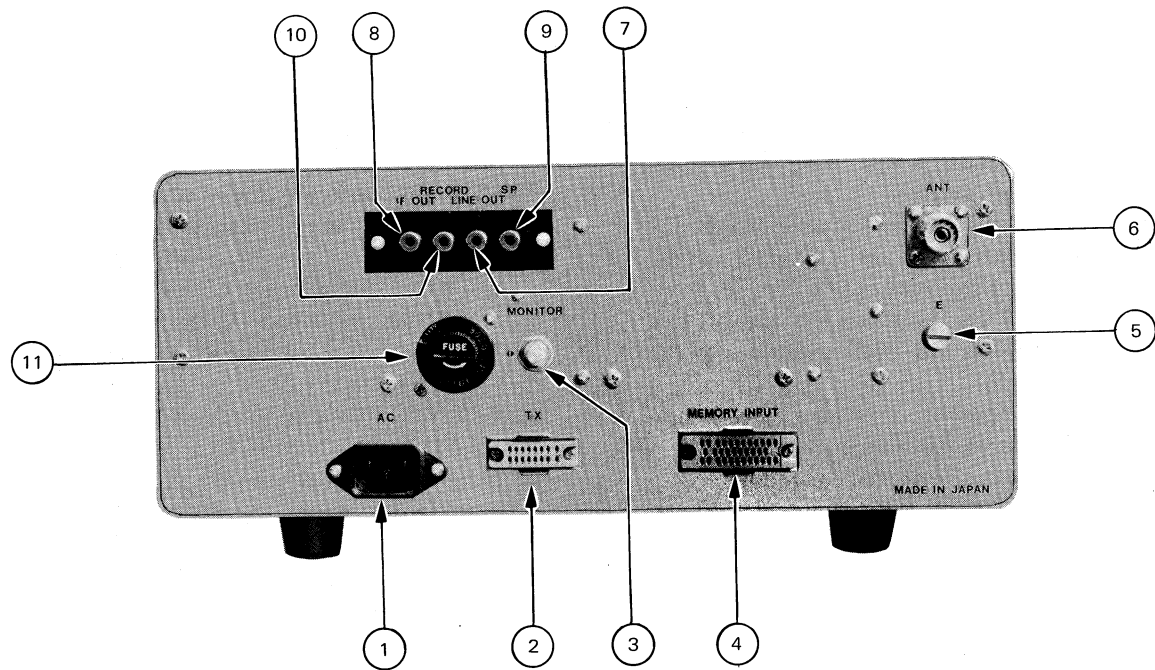

Figure 4-2 Rear Panel of Receiver

- (1) AC connector For connection of power cord.
NOTE: Read Paragraph 3.3.4 and then insert the plug into a power outlet.
- (2) TX connector For use in the combined operation with the transmitter.
To this connector have been connected the VFO output, external VFO input, MUTE line, SIDE TONE input, AF output for ANTI TRIP, VFO CONT line and MHz-digit control line of the frequency.
- (3) MONITOR control For adjusting the monitor level in the combined operation with the transmitter. Enabled for adjustment, only when the MONITOR switch is set at ON.
- (4) MEMORY INPUT connector For connection of the memory unit.
- (5) E terminal For connection of the earth line.
- (6) ANT connector For connection of an antenna of 50 to 75 ohms, unbalanced.
- (7) LINE OUT jack For connection of the AF output (600 ohms) to be recorded and others. The AF output level can be adjusted with LINE ADJ control located in the receiver unit.
- (8) IF OUT jack For connection of the IF output of 455kHz (75 ohms).
- (9) SP jack For connection of a speaker of 4 ohms.
- (10) RECORD jack For connection of the AF output (600 ohms) to be recorded.
This output is constant, irrespective of the position of the AF GAIN control, as well as the LINE OUT jack (7). The output level can be adjusted with LINE ADJ control located in the receiver unit.
- (11) VOLTAGE SELECTOR switch For switching the AC power line voltage.
Combined with the fuse holder.
The voltage is switched to one of 100V, 117V, 220V and 240V AC.
The fuse is a glass tube type of 1A.

SECTION 5

OPERATION

5.1 Reading and Setting the Frequency

The operating frequency can be directly read on the numerical LED display of 6 digits.

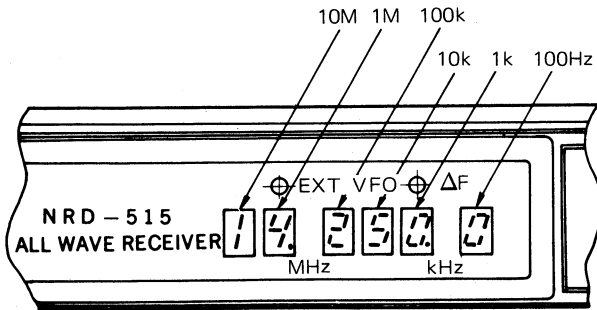

Figure 5-1

In the USB or LSB mode, a suppressed carrier frequency is indicated.

(1) MHz-control For setting the MHz-digit.

A band designated with the MHz-control is indicated on the LED display and scale on the panel with 30 equidistant divisions.

NOTE 1: If the tune dial is turned in excess of one megahertz, the LED display of the MHz digit changes to the next megahertz band automatically.

The mechanical position of the MHz control knob, relative to its scale on the panel becomes different from the actual receiving frequency which is displayed on the LED display.

NOTE 2: The manual changing of the MHz digit by the MHz control knob is preference to the automatical changing by the tune dial.

(2) TUNE dial

Several rotations of TUNE dial cover the entire frequency band continuously in step of 100Hz without switching the MHz-control. Full rotation covers 10kHz.

The automatic quick tuning function with the UP/DOWN switch is provided for rapid tuning.

If a large frequency change over 1MHz is desired, set the MHz-control at a desired band position.

NOTE 1: If the power switch is set at off and left for a while as it is, the last dialed frequency will be erased and the tuning frequency must therefore be set again.

To avoid such case, refer to Paragraph 5.6 (6).

5.2 Operating the Control and Switches

(1) PBT control

In this system the BFO is electrically ganged and tracked with the first local frequency. The desired signal can be moved around in the pass band of IF filter without changing the received frequency, and at the same time, interfering signals can be pushed off the edge of the pass band. In the SSB mode, it may also be used for changing the tone of speech signal suited for hearing.

Usually, this control is used for CW, SSB and RTTY reception.

In the AM reception, this control is disabled, but available for removing a beat interference of a desired AM signal with an adjacent signal, in such manner:

Change the MODE switch to the USB or LSB position, then adjust the ΔF control for a zero-beat with the carrier of the desired signal, and adjust the PBT control to remove the radio interference.

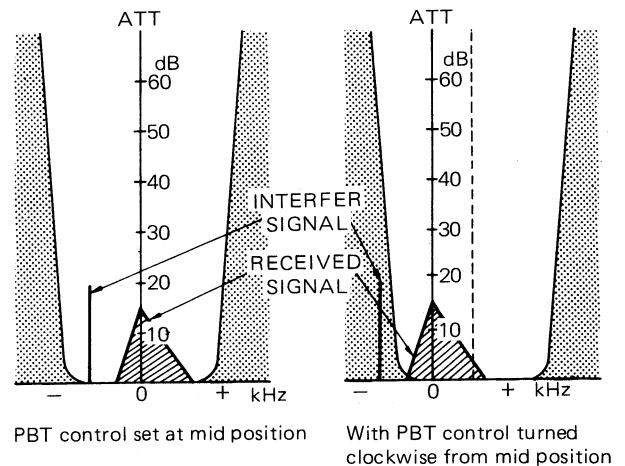

Figure 5-2 PBT Operation Illustration

Figure 5-2 illustrates an example for relatively eliminating an interfering signal until going away from the passband of the filter, as the PBT control is rotated clockwise.

The PBT control functions as follows:

PBT CONTROL	RECEIVED SIGNAL FREQUENCY
Clockwise rotation	Shifting to lower from center
Mid position	Center frequency
Counterclockwise rotation	Shifting to higher from center

NOTE: Return the PBT control to the mid position, every when the frequency for reception or operation mode is changed, or when this control is left unused.

(2) NB switch

When the equipment is used in the CW, SSB, or AM mode reception in a pulsive-noisy environment, this switch is effective for removing the noise offensive to the ear.

NOTE: NB LEVEL adjuster is located on the receiver unit. It will be found there if the upper cover removes from the case in accordance with the description in Paragraph 7.1.

This adjuster is for setting the threshold level for starting the noise blanker circuit in accordance with the noise level.

NOTE: Do not touch the NB LEVEL adjuster, unless necessary, since it has been set at the standard level.

If it is set at a wrong level, the reception signal may be distorted.

(3) ATT switch

Used when an incoming signal under reception is being subject to a powerful radio interference or an excessively high-power signal is received to cause a distortion.

In accordance with the receiving condition, set this switch at the 10dB- or 20dB-position for a best condition for reception.

In usual, set at OFF.

(4) ΔF switch and ΔF control

The ΔF control is enabled, only when the ΔF switch is set at the ΔF position.

This control is used as a

- clarifier in case of SSB reception,
- fine adjuster in case of CW, RTTY and preset reception, and
- RIT (receiver incremental tuning) in case of operation combined with the transmitter.

NOTE: So long as the equipment is in the condition of transmission, the ΔF circuit is left cut off, i.e., the RIT off, even if the ΔF switch is set at the ΔF position. As a result, the ΔF control is no more effective.

(5) LOCK pushbutton

For electrically locking the tune dial. Depressing this pushbutton causes the TUNE dial to rotate, however, once tuned frequency is held unchanged.

This pushbutton is used for

- preventing a set frequency from shifting due to vibration or mis-operation, and
- calibrating the sub-dial scale to a frequency displayed on the LED display.

(6) VFO switch

For use in operation combined with the transmitter. Refer to Paragraph 5.5.

When the receiver is used separately from the transmitter, set this switch at INT position.

(7) MONITOR switch

For monitoring the RF signal transmitted from the self station upon operation combined with the transmitter. Refer to Paragraph 5.5.

When the receiver is used independently, this switch is useless.

(8) BFO & BC TUNE control

CW reception mode:

For adjusting the beat tone under hearing. Clockwise rotation from the mid position increases the frequency of BFO and vice versa.

Medium-wave broadcast (BC) reception (600 to 1599.9kHz):

Used as a tuning control of the pre-selector and is used in conjunction with the S meter to peak the received signal. If a desired broadcast signal is being subject to a radio interference, use this control combined with the ATT switch for more suppression of the radio interference.

This BFO & BC TUNE control is available as follows:

FREQUENCY	AM MODE	CW MODE
600 to 1599.9kHz	BC TUNE	BC TUNE and variable BFO
Other frequencies than 600 to 1599.9 kHz	Inoperative	Variable BFO

NOTE: In case of reception in the CW mode in the BC range of 600 to 1599.9kHz, this control acts as a BFO doubling a BC TUNE control.

(9) Sub-dial scale

Calibrated into 20 equidistant scale divisions, each of 500Hz; full rotation covering 10kHz.

Use as follows:

- Set the TUNE dial for a value of 0 or 5 at the 100Hz-digit on the LED display.
- Depress the LOCK pushbutton.
- Then, set the TUNE dial for a desired position of the sub-dial scale.

This scale is conveniently used for changing the frequency about several kilohertz, the UP and DOWN operation, in the case of QSY etc.

(10)Others

When the frequency for reception is changed around specific frequencies of 600kHz, 1600kHz, 3MHz, 5MHz, 9MHz, and 17MHz, a click noise may be heard. This is, however, not a trouble.

5.3 Operation for Reception

In the usual case, set the controls as follows:

- LOCK button Non lock
- ATT switch OFF
- MONITOR switch OFF
- NB switch OFF
- VFO switch INT
- Δ F switch OFF
- PBT control Mid position
- and then
- POWER switch ON

Reception is made in the following steps of procedure.

5.3.1 SSB Reception

Control settings:

- (1) MODE switch USB or LSB
- (2) BANDWIDTH switch 2.4kHz
- (3) AGC switch FAST or SLOW
- (4) RF GAIN control Full clockwise
- (5) MHz-control, TUNE dial and UP/DOWN switch For a desired frequency
- (6) AF GAIN control For a desired sound level
- (7) TUNE dial
or Δ F control with Δ F
switch set at Δ F For good articulation,
if necessary.

NOTE: The amateur radio communication, in general, uses the LSB in the 3.5/7MHz-band and USB in the 14/21/28MHz-band in the SSB mode.

5.3.2. CW Reception

Control settings:

- (1) MODE switch CW
- (2) BANDWIDTH switch 2.4kHz
- (3) AGC switch OFF or FAST
- (4) BFO & BC TUNE About one division shifted from mid position in either direction
- (5) RF GAIN control For a desired noise level
- (6) MHz-control, TUNE dial and UP/DOWN switch For a desired frequency
- (7) AF GAIN control For a desired sound level
- (8) Finely adjust the BFO & BC TUNE knob for a suitable tone for listening.
- (9) If the optional filter is incorporated, turn the BANDWIDTH switch to the 0.6kHz or AUX position.

If this switching causes a received sound to be

lowered or no more heard, then finely adjust the TUNE dial or Δ F control for a maximum sensitivity.

NOTE: If the optional filters are not incorporated into the 0.6kHz and AUX positions, no reception cannot be possible, of course, when the BANDWIDTH switch is set at either of these positions.

5.3.3 AM Reception

Control settings:

- (1) MODE switch AM
- (2) BANDWIDTH switch 6kHz
- (3) AGC switch FAST or SLOW
- (4) RF GAIN control Full clockwise
- (5) MHz-control, TUNE dial and UP/DOWN switch For a desired frequency
- (6) AF GAIN control For a desired sound level
- (7) BANDWIDTH switch 2.4kHz, if high radio interference.

NOTE In this position, the quality of sound may be degraded, because of the narrow passband.

5.3.4 RTTY Reception

Control settings:

- (1) MODE switch RTTY
- (2) BANDWIDTH switch 2.4kHz
- (3) AGC switch FAST or SLOW
- (4) NB switch OFF
- (5) RF GAIN control Full clockwise
- (6) MHz-control, TUNE dial and UP/DOWN switch For a desired frequency
- (7) AF GAIN control For a desired sound level
- (8) BANDWIDTH switch Any bandwidth in accordance with the shift width of an FS signal.

NOTE: For the 0.6kHz and AUX positions, separate optional filters are necessary.

- (9) FS converter Connected to
 - a. LINE OUT jack (600 ohms, located on the rear panel) for AF operation
 - b. IF OUT jack (75 ohms) for IF operation of 455kHz.

NOTE: In the AF operation, the BFO is predetermined at 452.79kHz. This oscillator frequency can be changed by adjusting the RTTY semi-fixed resistor RV7 located on the synthesizer unit.

In the case of IF operation, take care of the IF OUT, which provides an output with marks and spaces inverse to the ANT input of the receiver.

5.4 Preset Reception with the Optional NDH-515 Memory Unit.

The optional memory unit can be connected to this equipment to easily program up to 24 frequencies for preset reception. Once they are programmed, the automatic tune preset reception can be performed only by selecting desired channels, thus providing a

more high-degree operation.

For using the memory unit, refer to the Operating Manual of the NDH-515 Memory Unit.

(1) Manual Receiving

Set the PRESET/MANUAL switch of the memory unit at MANUAL. Then, set the Receiver controls, the same as denoted in Paragraph 5.3

(2) Preset Receiving

Set the PRESET/MANUAL switch of the memory unit at PRESET.

Then, set the receiver controls, the same as denoted in Paragraph 5.3, wherein both MHz-control and TUNE dial of the receiver are no

need of adjustment.

If the frequency is wanted to be finely adjusted, use the ΔF control having a variable range in excess of $\pm 2\text{kHz}$, approx.

5.5 Operation in Combination with JRC Transmitter

Operation can be made in combination with the Model NSD-505 transmitter.

Interconnect between the receiver and transmitter in the following method.

5.5.1 Interconnection

Connect as illustrated in Figure 5-3.

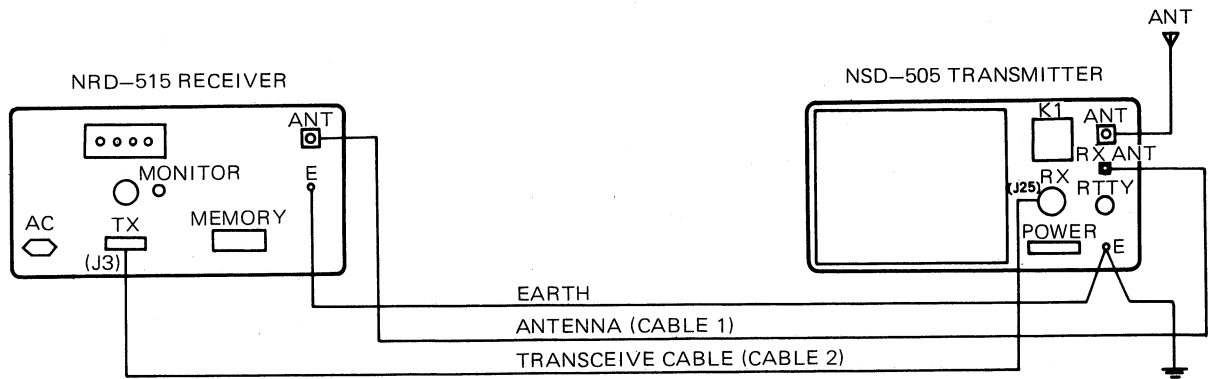

Cable 2 Connection

J3 Pin No.	Connection to	Line No.	Connection to	J25 Pin No.
14	VFO OUT	a	VFO EXT IN	2
13	EXT VFO IN	b	VFO OUT	4
11	SIDE TONE	c	SIDE TONE	6
9	ANTI TRIP	d	ANTI TRIP	7
10	MUTE	e	XMIT	8
12	EARTH	f	EARTH	1
Receiver side			Transmitter side	

NOTE 1 {

NOTE 1: No need for connection of transmitter having VFO providing other frequency than 2.455 to 3.455MHz.

Figure 5-3 Interconnection between Receiver and Transmitter

Connect the TX – RX connectors located on the rear panel, as follows:

(1) Line No a (VFO OUT)

For feeding the VFO output of the receiver to the transmitter.

Used for the transceive and cross operations.

(2) Line No. b (EXT VFO IN)

For feeding the VFO output from the transmitter to the receiver.

Used for the same operations as denoted in (1).

(3) Line No. c (SIDE TONE)

For feeding the side tone from the transmitter to the receiver in the CW operation.

Used for keying monitor.

In the keying monitor mode, set the MONITOR switch located on the receiver's panel, at OFF position.

(4) Line No. d (ANTI TRIP)

For sending the AF output from the receiver to the transmitter's VOX circuit.

Used for preventing a received tone of the speaker from entering the microphone in the time of VOX operation. If entering, the equipment could turn into the transmit mode.

(5) Line No. e (MUTE)

For muting the receiver during transmission:

Pin #10 grounded Receive mode
 opened Muting

Mute level setting:

Set the MONITOR switch at ON, located on the receiver's panel.

Then, adjust the MONITOR control for a desired mute level, located on the rear panel.

(6) In other than the transceive or cross operation, both Lines No. a and b are no need of wiring.

Assembling the cables 1 and 2 for connection are shown in Figures 5-5 and 5-6.

NOTE: In the case of operation combined with transmitter, remove the upper cover of the case and take off the short plug (P35) from J35 located in the receiver unit.

Unless taking off the short plug, the receiver cannot be muted in the time of transmission.

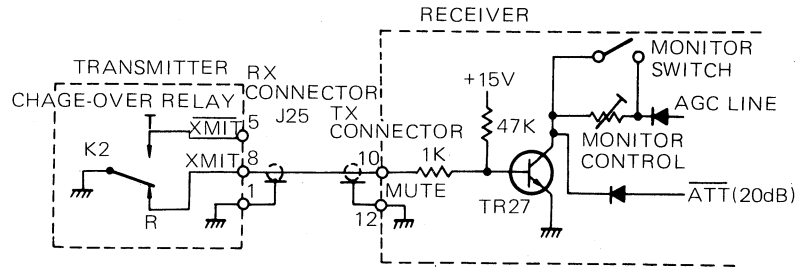

When base of TR27 is released from earth during transmission, TR27 turns on to cause AGC line to be grounded, resulting in muting the receiver.

Figure 5-4 Connection of Mute Circuit

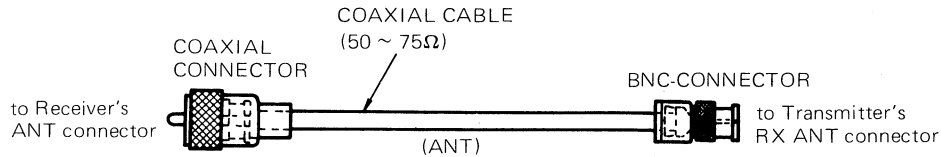
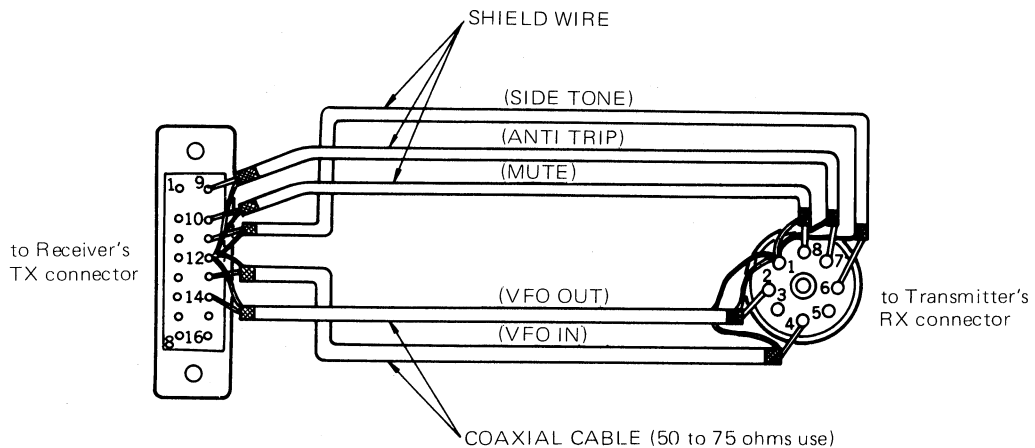

Figure 5-5 Assembling the Cable 1 with Connector



- NOTE
1. Connect cable as short as possible.
 2. Do not forget to fix the cover of each connector.
 3. Cover bundle of lines with shield in case they may be subject to induction from transmitter.

Figure 5-6 Assembling the Cable 2 with Connector

5.5.2 Operating Procedure

Table 5-1 (NOTE.1)

MEMORY UNIT MANUAL/PRESET SW.	RX VFO SW.	TX VFO SW.	RECEIV. FREQ. SETTING	RX DISPLAY	TRANSMIT. FREQ. SETTING	TX DISPLAY	OPERATING MODE
MANUAL	INT	INT	RX VFO	RECEIV. FREQ.	TX VFO	TRANSMIT. FREQ.	Separate
	INT	EXT	RX VFO	RECEIV. and TRANSMIT. FREQ.	RX VFO	RECEIV. and TRANSMIT. FREQ.	Transceive with RX VFO
	EXT	INT	TX VFO	— (NOTE.2)	TX VFO	RECEIV. and TRANSMIT. FREQ.	Transceive with TX VFO
	EXT	EXT	TX VFO	TRANSMIT. FREQ.	RX VFO	TRANSMIT. FREQ.	Cross (NOTE.3)
PRESET	INT	INT	MEMORY CHANNEL	RECEIV. FREQ.	TX VFO	TRANSMIT. FREQ.	Separate with fixed frequency for reception
	INT	EXT	MEMORY	RECEIV. and TRANSMIT. FREQ.	MEMORY CHANNEL	RECEIV. and TRANSMIT. FREQ.	Transceive with RX VFO
	EXT	INT	TX VFO	— (NOTE.2)	TX VFO	RECEIV. and TRANSMIT. FREQ.	Transceive with TX VFO
	EXT	EXT	TX VFO	TRANSMIT. FREQ.	MEMORY CHANNEL	TRANSMIT. FREQ.	Cross with fixed frequency transmission

Table 5-1 NOTE

- Table 5-1 shows the case where the NDH-515 memory unit (option) is used. For the case of no memory unit, refer to only the column of MANUAL.
- The LED display of RX is unchanged at either INT or EXT position of the VFO switch. This means that the display indicates only a frequency of the internal VFO, but a frequency of an external VFO supplied from TX cannot be read on the display.
- Read the frequency for reception on the display of TX, except its MHz-digit, by temporarily turning the VFO switch of TX to the INT position.
- For setting the frequency at the MHz-digit, use the MHz control each on RX and TX.
In particular, in the case of transceive operation with TX VFO in the 1.8MHz band, use the TUNE dial for setting the frequency up to 1.8MHz.
- If the VFO switch on RX is set at EXT, no write into the memory can be made with the VFO frequency fed from TX.
- When the VFO switch on RX is set at EXT, the ΔF control is disabled, irrespective of the position of the MANUAL/PRESET switch.

The output of the internal VFO can be finely adjusted with use of the ΔF control in the reception mode.

- Set the VFO switches of the receiver RX and transmitter TX, and MANUAL/PRESET switch of the optional memory unit, as tabulated in Table 5-1. Also set other switches and controls in the same manner as denoted in Paragraph 5.3.
- Monitoring in CW Operation**
Since the side tone signal caused in the keying operation is sent to the receiver from the transmitter and therefore can be directly monitored.
For adjusting the monitor level, the MONITOR control RV2 is provided in the VOX unit of the transmitter and SIDE TONE control RV9 in

the receiver unit of the receiver; either may be used.

Even if the frequencies for transmission and reception are different, the CW monitor can be made, provided that the MONITOR switch of the receiver is set at OFF position.

- Monitoring the SSB Operation**
For monitoring an RF wave transmitted from the own station, set the MONITOR switch of the receiver at the ON position and adjust the MONITOR control located on the rear panel. Clockwise rotation of the MONITOR control

increases the monitor level.

It is noted that if the frequencies for transmission and reception are different, no monitor can be made.

(4) Frequency Setting between Receiver and Transmitter

In the transceive operation, both the frequencies for transmission and reception must be equal. For setting them, refer to the Operating manual of the Model NSD-505 Transmitter, Paragraph 5.4.2.

NOTE: In the case where connection is made to the receiver's antenna from the other antenna change-over circuit or the like, in other way than described in Figure 5-3, prevent an excessively high power RF wave induced due to transmission from being applied to the antenna input of the receiver. In particular, in the case of a linear amplifier used, great care must be taken.

5.6 Other Operations

(1) Operation Combined with Transmitter Having Different Frequency of VFO.

The frequency of VFO in the NRD-515 Receiver ranges from 2.455 to 3.455MHz.

Neither transceive nor cross operation can be made with a transmitter having a different frequency of VFO.

When a combined operation is to be performed in other method than described above, connect in the same way as described in Paragraph 5.5.1, provided that both lines No. a and b are no need of connection.

(2) Filters for "AUX" Position of BANDWIDTH

Not only the optional CFL-230 (300Hz) filter but also other crystal filters having desired bandwidths can be incorporated into the AUX position, if meeting the following requirements.

Requirements of crystal filter:

- a. Input and output impedance . 600 ohms, 60pF
- b. Insertion loss Less than 6dB
- c. Overall dimensions . . 64(W)x24(D)x22(H)mm or less

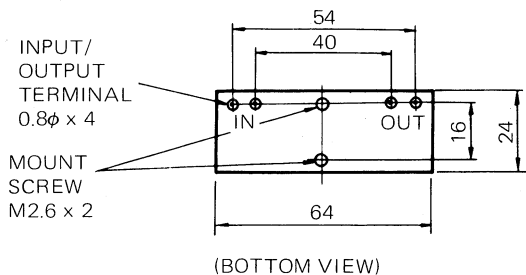

- d. Others Input and output terminals are DC-coupled.

NOTE: If the optional CFL-260 (600Hz) filter is not provided, a separate PC board (MPPC07961) is necessary for mounting the filter.

(3) Using the MEMORY INPUT Connector J4

The connector (jack) J4 located on the rear panel of the receiver provides an input/output port of frequency data.

When no memory unit (option) is used, this connector is useful for

- a. controlling the frequency of an external peripheral equipment, or
- b. controlling the frequency for reception with use of an external equipment such as micro computers.

This connector provides a frequency data which occupies six positions: 100Hz-digit through 10MHz-digit, in a form of 22-bit BCD code at the TTL level.

The PRESET line on Pin 13 of J4 must be at "H" level when the BCD code information is given from the receiver, and "L" level when the receiver is controlled by an external unit.

NOTE: To the lines of J4, various digital IC's have been connected.

Great care must be taken in use.

The output should be limited to one fan-out per TTL IC.

(4) Using the TX Connector J3

Located on the rear panel of the receiver. Pins #2 - #7 provide 6-bit BCD code signals at the TTL level, representative of the frequency information at the 1MHz- and 10MHz-digits.

This connector J3 is useful for

- a. interlock with the MHz-band in the transmitter, and
- b. controllers for antenna couplers and antenna rotors, and
- c. other utilizations described in Paragraph 5.5.1. Before use, read the NOTE in (3) for operation.

(5) Receiving the FAX Signal

The FAX signal can be received in the similar way to the CW and RTTY waves.

a. FAX Reception in CW Method

In the method described in Paragraph 5.3.2, set AGC switch at FAST BANDWIDTH switch at 2.4kHz BFO & BC TUNE control for a correct white-black signal, or for a clear picture of FAX on a recorder.

Other controls as described in Paragraph 5.3.2.

b. FAX Reception in RTTY Method

Set in the same way as described in Paragraph 5.3.4, but RV7 semi-fixed control for a desired frequency of BFO in accordance with a.

c. Connecting the FAX Unit

Connect the unit to LINE OUT jack (600 ohms) for AF operation, and IF OUT jack (75 ohms) for 455kHz-IF operation. Both jacks are located on the rear panel.

NOTE: The IF output connector provides a white-black signal inverse to the antenna input.

(In general, the center frequency of the amateur FAX unit is 1700Hz in the AF operation. Accordingly, the BFO must be set at 456.7kHz.)

(6) Back-up of up-down counter

As described in Paragraph 5-1, if the power switch is turned off and again on after a while, the last dialed frequency will be erased and the tuning frequency must therefore be set again.

To avoid such case, a cell can be connected to the CMG-62 synthesizer unit, such as

TP35 ⊕ terminal of cell

E ⊖ terminal of cell

Thus, data for the last dialed frequency is held and is displayed.

For the cell, use a silver-oxide or alkali cell of 3 to 4.5V.

The cell should be replaced after use of approximately half a year. No cell holder is provided.

SECTION 6

CIRCUIT DESCRIPTION

6.1 Functional Block Diagram and Schematic Diagram

The system diagram is illustrated in Figure 1 and connection diagrams illustrated in Figures 2 through 6.

6.2 Description of Units

6.2.1 Chassis and Panel Unit CFQ-608

The chassis and panel unit consists of a front panel, rear panel, chassis and power supply circuit.

- (1) The printed circuit board on the front panel has various controls, including switches, potentiometers, S-meter, PHONES jack, TUNE dial, frequency display, and other indicators. The MHz-switch S10 consists of a rotary switch for producing the MHz digit BCD frequency information. The TUNE dial consists of a photo type (light-emitting diodes) rotary encoder, which generates 100 pulses per rotation.

In the frequency display circuit, a BCD frequency information is code-converted in a BCD-to-7 segment decoder of IC1-IC6 to light the light emitting diodes CD1-CD6 in the digital indicator.

- (2) Rear Panel

Various jacks, connectors, monitor controls, voltage selector, and power supply unit are mounted on the rear panel.

The power supply unit comprises CD1, CD2, IC1-IC3 etc. for supply voltages of +5V and +15V to other units.

- (3) Chassis

The receiver unit, synthesizer unit, power transformer etc. are housed.

6.2.2 Receiver Unit CMA-105

The receiver unit consists of an RF input filter, RF amplifier, IF amplifier, and AF amplifier circuits.

- (1) RF Input Filter Circuit

Consisting a 10dB-20dB attenuator, 35MHz lowpass filter, 1.6MHz highpass filter, BC band preselector, and six filters.

The 1.6MHz highpass filter, preselector, and six filters are selected automatically, depending on the operating frequency.

IC1 is a decoder for converting the BCD code sent from the synthesizer unit into a 10-line signal for selecting the filters.

- (2) RF Amplifier Circuit

The RF amplifier circuit consists of lowpass filter of 35MHz, balanced mixer comprising FET TR2, first local amplifier TR7, crystal filter FL1 for the first IF frequency of 70.455MHz, first IF amplifier comprising TR3, second mixer comprising TR4, second local

amplifier TR8, second IF amplifier comprising TR5 for the second IF frequency of 455kHz, and noise blanker circuit. In the noise blanker circuit, a signal of 455kHz is amplified in transistors TR10 and TR11, detected in TR15. DC voltage proportional to the level of this signal is amplified in another amplifier of TR16 and TR17 and applied to the transistors TR10 and TR11, as an AGC signal. Pulsive noises exceeding the average level of the signal are rectified through TR12, amplified in TR13 and applied to a gate circuits of TR14 and TR32 to prevent impulsive noises from transmission.

- (3) IF Amplifier Circuit

The signal of 455kHz is passed through one of filters FL2-FL5 and amplifiers of TR20-TR23 and applied to a detector circuit. The AF output signal from the detector circuit is fed into a switching circuit of IC2. A part of signal amplified in TR25 is detected through CD61, and amplified in another amplifier of TR26 to produce IF AGC signal and RF AGC signal. A control circuit for mute consists of TR27, 28 and 29.

Filter FL2 is made of a ceramic filter, and each of filters FL3 and FL4 is made of a mechanical filter.

Filter FL5 is made of crystal filter.

Filters FL4 and FL5 are optional.

- (4) AF Amplifier Circuit

The AF output signal from detector circuit is amplified in IC3 and IC4, and applied to the line output and speaker.

6.2.3 Synthesizer Unit CMG-62

Consisting of a reference signal generator, UP/DOWN counter, digital VFO, BFO, second local oscillator, VFO mixer, and loop 1 circuits.

- (1) Reference Signal Generator Circuit

The reference signal generator circuit comprises IC41 for generation of the reference frequency signal of 10MHz, and frequency dividers of IC42-IC43 for dividing the reference frequency to provide a reference signal of 500kHz for the loop 1 and another of 1kHz for the digital VFO.

- (2) UP/DOWN Counter Circuit

Consisting of IC1 through IC19:

IC7 through IC9 for controlling the UP-DOWN pulses fed from the TUNE dial and feeding them to the UP/DOWN counter, IC18 and IC19 are multivibrator for changing the frequency quickly, IC1 through IC6 are UP/DOWN counter for

controlling the receiving frequency ranging from the 100Hz-to 10MHz-digit, and IC15 through IC17 are gate circuit for controlling the frequency information in the UP/DOWN counter.

(3) Digital VFO Circuit

Consisting of TR1 through TR9 and IC20 through IC40, as follows:

VCXO of TR8 generates a 19MHz, and the filter circuit of T1 and T2 picks out a 38MHz, twice the output of VCXO, and applies it to the mixer TR3 for mixing the 38MHz with the output of VCO (24.55 to 34.55MHz) to provide an output of 13.45 to 3.45MHz. The output is fed, after amplified, to the variable frequency divider of IC21 through IC25. Its output and reference frequency of 1kHz are applied to the phase detector of IC34 for detecting the frequency and phase difference to control the VCO.

NOTE: When the VCO is unlocked, the CD2 LED turns to illuminate.

The VCO output is applied to the amplifier, 1/10-fixed frequency divider of IC40 and lowpass filter, for providing a VFO frequency ranging from 2.455

MHz to be fed to the VFO mixer circuit. Fine adjustment of ΔF is made in the 19MHz-VCXO circuit of TR8.

(4) BFO Circuit

Consisting of TR10, TR11, TR22, TR26 and IC60.

VCXO of TR26 generates a 5.455MHz and VCXO of TR26 oscillates in 5MHz. The mixer of TR22 provides an output of 455kHz \pm 2kHz or higher in the CW mode, 456.5kHz in the USB mode, 453.5kHz in the LSB mode, and 452.79kHz in the RTTY mode. Passband tuning control is performed in the 5MHz-VCXO.

(5) Second Local Oscillator Circuit

TR21 oscillates in 70MHz and IC58 amplifies the output of TR21. The output of IC58 is fed to the second mixer in the receiver unit and

VFO mixer in the synthesizer unit.

(6) VFO Mixer Circuit

Consisting of TR23 through TR25, CD19 through CD22, as follows:

The mixer of TR23 for mixing the oscillators outputs of 70MHz and 5MHz to produce a 65MHz signal, which is, after passing through the BPF and amplifier of TR24, fed to the balanced mixer of CD19 through CD22 for mixing the 65MHz with the output of the digital VFO to produce an output signal of 67.455 to 68.455MHz. This output is fed to the loop 1 circuit, after passing through the amplifier of TR25 and BPF.

(7) Loop 1 Circuit

In the loop 1 circuit, both frequency signals of 67.455 to 68.455MHz from the VFO mixer and 70.455 to 100.455MHz fed from loop 1 VCO A-1 are applied to a balanced mixer of CD11 to CD14 to produce an output signal of 3 to 32MHz, while the output signal of the loop 1 VCO is amplified in TR17 to produce the first local frequency signal. The output signal of 3 to 32MHz fed from the mixer is passed through a lowpass filter of 35MHz, amplified in IC46 and TR12 through TR14, and then is divided by 2 through IC49. The divided output is supplied to a variable frequency divider of IC50 and IC51.

The output signal of 500kHz fed from the variable frequency divider and another reference frequency signal of 500kHz are applied to the phase detector of IC54 to detect a frequency and phase difference. The output of phase detector is passed through a lowpass filter to control the loop 1 VCO.

NOTE: When the VCO is unlocked, the CD16 LED turns to illuminate.

IC52, IC53, and TR18 through TR20 compose a VCO switching circuit, and the decoder IC61 (PROM IC of 1024-word x 4-bit) is provided for switching the RF input filter, depending on the BCD code information of frequency.

SECTION 7

MAINTENANCE AND CHECKING

This equipment has been perfectly adjusted and inspected before shipping, however, execution of the following maintenance and checks will assure a high performance for a long time.

7.1 Preparation before Maintenance and Checks

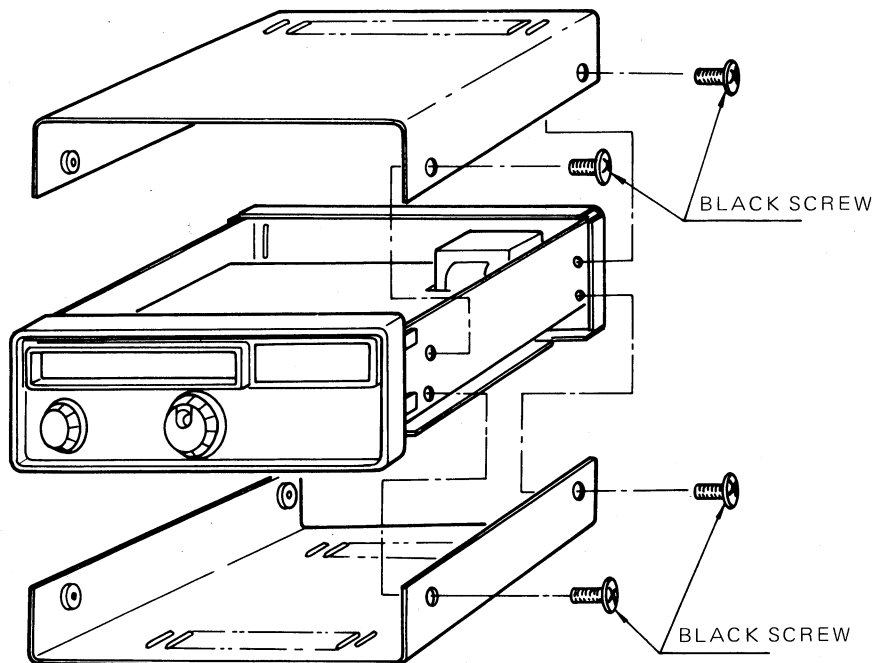

Figure 7-1

This equipment is composed of the chassis, front panel, rear panel, receiver, and synthesizer units.

In the front panel unit, a PC board doubling the mother board is mounted on a die-cast frame. Both synthesizer unit and receiver unit are each of a plug-in type and inserted into the mother board. The power supply circuit comprises a power transformer incorporated in the chassis unit and AVR unit in the rear panel unit, for supplying required power voltages to other circuits.

(1) Removing the Upper and Bottom Covers from Case

Referring to Figure 7-1, remove right and left eight black screws from the upper and bottom covers. Then, both covers will be removed.

(2) Demounting the Receiver Unit

First, remove the upper cover. Then, disconnect eight pin plugs marked "A" through "H" and square connector P11, each connected to the receiver unit, and remove seven screws, which

secure the receiver unit. Draw out this unit to the back side away from the panel.

(3) Demounting the Synthesizer Unit

First, remove the bottom cover. Then, disconnect five pin plugs marked "B", "E", "H", "I" and "J" and square connectors P29 through P31, and remove seven screws, which secure the synthesizer unit. Draw out this unit to the back side away from the panel.

(4) Precautions

- a. Avoid solder and wiring chips entering into the unit, when the cover is removed from the case.
- b. Do not touch any control, including the cores of transformers, trimmer capacitors, and semi-fixed variable resistors, unreasonably, unless necessary.
- c. Since both the receiver and synthesizer units handle high-frequency signals in the VHF band, suitable measuring instruments and skilled techniques are required.

7.2 Maintenance and Checks

(1) Cleaning

Softly wipe the panel surface, control knobs, upper cover and bottom cover with soft cloth or silicone oil, thus cleaning them.

Remove dust and chips from the interior of the equipment, using brush and cleaner. Since no gearing is used, there is no need to lubricate.

(2) Pilot Lamp

If a pilot lamp for illumination of the S-meter is broken, then remove the upper cover, loosen screws, which secure the lamp holder, and take out the holder. Replace with a furnished new lamp, 12V, 2W in rating (BA 7S/13 base type).

(3) Fuse

If the power fuse is blown, check the cause sufficiently. Replace after repair. The fuse holder doubles the voltage selector at the rear panel. For replacement, unscrew Cap A of Figure 3-2, and insert the furnished glass fuse of 1A in rating.

(4) Circuit Elements

IC's, transistors, and diodes will be damaged by only an instantaneous short-circuiting. Therefore, give great care to checking. Check the appearance of each circuit element, including resistors, capacitors, coils and transformers, if any burnt or discolored is found. When a defective element is replaced, select a new one having the same value, withstand voltage, tolerance, and size as the defective element.

(5) Power Supply Circuit

Check the DC voltages on TP terminals of the CBD-375 AVR unit, located on the rear panel.

They have standard values:

+15V between TP5 and TP9 (earth)

+15V between TP6 and TP9 (earth)

+5V between TP7 and TP9 (earth)

(6) Checks and Adjustment of Oscillators Frequencies

a. 10MHz-Reference Oscillator Circuit

a-1. Frequency Setting with Frequency Counter

1) Connect a frequency counter to TP15 of the synthesizer unit.

2) Set the trimmer CV1 for a frequency of 10000.000kHz located in the shield case at the left side of TP15.

a-2. Frequency Setting with Standard Frequency Station of the JJY.

1) Receiver settings:

MODE switch AM

BANDWIDTH switch 2.4kHz

Other controls For a desired sound level.

2) Receive the standard frequency in 2.5, 5, 10 and 15MHz, and select one of them, which can be received at a high sensitivity without radio interference.

3) Connect a thin polyvinyl wire to the terminal TP16 (500kHz output) of the synthesizer unit, through a ceramic capacitor of 0.01 μ F.

With the other free end of the wire, couple near the antenna of the receiver, slowly adjust the trimmer CV1 of the synthesizer unit to take a zero beat.

b. PBT Circuit

b-1. Frequency Setting with Frequency Counter

1) Connect a frequency counter to TP19 of the synthesizer unit.

2) Receiver settings:

MODE switch CW

PBT control Mid position.

Set the semi-fixed control RV3 for a frequency of 5000.000kHz.

3) Change the MODE switch to AM and set the other semi-fixed control RV4 for the same frequency of 5000.000kHz.

b-2. Frequency Setting with Standard Frequency Station of the JJY.

1) Receiver settings:

MODE switch CW

BANDWIDTH switch 2.4kHz

PBT control Mid position

Thus, receiving the 5MHz JJY.

Adjust the BFO & BC TUNE control for a zero-beat.

2) Connect a thin polyvinyl wire to the terminal TP19 (5MHz output) of the synthesizer unit, through a ceramic capacitor of 0.01 μ F.

With the other free end of the wire, couple near the antenna of the receiver, adjust the semi-fixed control RV3 for a zero-beat with the JJY.

3) Change the MODE switch to AM and adjust the other semi-fixed control RV4 in the same way to take a zero beat with the JJY.

c. Δ F Circuit

c-1. Frequency Setting with Frequency Counter

1) Connect a frequency counter to TP11 of the synthesizer unit.

2) Set the receiver controls:

Δ F switch Δ F

Δ F control Mid position

RV2 semi-fixed control For a frequency of 38,000.000kHz.

3) Change the Δ F switch to OFF and set the other semi-fixed control RV1 for the same frequency of 38,000.000kHz.

c-2. Frequency Setting with Reference Frequency of 10MHz

1) Set the controls just for a frequency of 10MHz as described in (6), a.

2) Set the panel controls:

MODE switch CW

BANDWIDTH switch 2.4kHz

Δ F switch Mid position

Frequency dial For a frequency of 19.0000MHz. Then, connect a thin polyvinyl wire to the terminal TP16 (500kHz output) of the synthesizer unit through a ceramic capacitor of 0.01 μ F.

With the other free end of the wire, couple near the antenna of the receiver, adjust the BFO & BC TUNE control to take a beat tone of 1000Hz, approx.

- 3) Connect a thin polyvinyl wire to the terminal TP11 of the synthesizer through a ceramic capacitor of 0.01 μ F. With the other free end of the wire, couple near the antenna of the receiver, adjust the other semi-fixed control RV2 to take a double zero beat (resonance point) with the reference signal.
- 4) Set the Δ F switch at OFF and then the semi-fixed control RV1 in the same way to take a zero beat (resonance point) with the 500kHz reference signal.
- d. Second Local Oscillator
Connect a frequency counter to TP31 of the synthesizer unit and then adjust the trimmer CV2 for a frequency of 70MHz.
- e. BFO Circuit
Connect a frequency counter to TP30 of the synthesizer unit. With BFO & BC TUNE control and PBT control set at mid positions, adjust as tabulated in Table 7-1.

Table 7-1

MODE SWITCH AT	CONTROL	FREQUENCY
CW	RV8	455kHz
USB	RV5	456.5kHz
LSB	RV6	453.5kHz
RTTY	RV7	452.79kHz

(7) Lock Indicator

The synthesizer unit is provided with two lock indicators of LED CD2 and CD16. The indicator of CD2 turns to illuminate when the digital VFO circuit is unlocked, and the other of CD16 turns on when the loop 1 circuit is unlocked.

Both indicators serve for locating a defective, judging from their indications, as tabulated in Table 7-2.

Table 7-2

LOCK INDICATOR		TROUBLE
CD2	CD16	
Lighting	Lighting	VFO switch being set at EXT.
Lighting	Lighting	Defective 10MHz reference oscillator circuit
Lighting	Lighting	Defective Δ F oscillator circuit
Not lighting	Lighting	Defective PBT oscillator circuit
Not lighting	Lighting	Defective second local oscillator circuit
Lighting	Lighting	Defective UP/DOWN counter circuit

- NOTE 1. This table illustrates possible troubles in the case of no external VFO connected.
2. The CD2 instantaneously illuminates when the frequency is changed in transition from 999.9kHz to 000.0kHz and from 000.0 kHz to 999.9kHz below the MHz-digit.
 3. The CD16 also instantaneously illuminates when the MHz control is switched and the frequency is changed in the same way as denoted in NOTE 2.

(8) Others

- a. Check the pin plugs and connectors connected to the units, if any poorly contacted.

- b. Adjusting the S-Meter
Set the panel controls:

MODE switch AM
RF GAIN control Maximum
AGC switch FAST
BANDWIDTH switch 2.4kHz.

With the ANT connector set opened, adjust the ZERO ADJ of the receiver unit for a reading of S1 on the S-meter.

Then, connect an SSG (output level of 100dB, not modulated) to the ANT connector and tune it. Adjust the FULL ADJ control for a reading of S9 + 60dB. The frequency for reception is set near 7.15MHz for this adjustment.

7.3 Troubleshooting

Do troubleshooting for uncomplicated troubles with referring to the following table.

NO.	SYMPTOM	POSSIBLE TROUBLE	REMEDY
1	Neither frequency display nor meter lamp lighting, when POWER switch is on.	1) Poor contact of AC power plug 2) Fuse blown	1) Fully insert the AC power plug into service outlet. 2) Locate a defective section, repair it and replace the fuse.
2.	No sounding with POWER switch-on	1) No speaker connected 2) Head phone connected to PHONES jack	1) Connect the speaker to SP jack on rear panel. 2) Draw off the head phone.
3.	Meter lamp dim (or too bright)	AC line voltage low (or high)	Switch the voltage selector (located on rear panel) to line voltage.
4.	Can not receive; antenna connected satisfactorily	1) VFO switch set at EXT. 2) BANDWIDTH switch set at 0.6kHz or AUX position, where no option filter is incorporated. 3) PBT control set full clockwise or counterclockwise.	1) Set at INT. 2) Set at 6kHz or 2.4kHz position. For 0.6kHz and AUX positions separate option filters are required.
5.	Reading of frequency for reception on display cannot be changed by turning TUNE dial.	LOCK pushbutton set depressed.	Release the LOCK pushbutton.
6.	Reading above zero on S-meter, while no signal incoming into receiver.	RF GAIN control set full counterclockwise.	Set full clockwise.
7.	Tone distorted in the time of broadcast reception	1) AGC switch set at OFF. 2) Excessively large input.	1) Set at FAST. 2) Insert attenuator.
8.	Tone distorted and poor articulation in the time of SSB reception	1) MODE switch set at wrong position. 2) AGC switch set at OFF. 3) Tuned frequency slightly deviated. 4) BANDWIDTH switch set at wrong position. 5) PBT control deviated.	1) Change MODE switch at USB or LSB. 2) Set at SLOW or FAST. 3) Accurately set TUNE dial and ΔF control. 4) Change BANDWIDTH switch to 2.4kHz position. 5) Set PBT control at mid position in usual. If radio interference occurs, adjust this control.
9.	No tone variable with turning ΔF control.	ΔF switch set at OFF.	Set at ON.
10.	PBT control disabled in AM reception.	PBT function disabled if MODE switch is set at AM	
11.	Poor sensitivity	ATT switch set at 10dB or 20dB position.	Set at OFF.

SECTION 8

OPTION

For operation of this equipment at more high degree, the following options are available.

8.1 Memory Unit NDH-515

This unit is capable of storing up to 24 desired frequencies, and once stored frequencies are easily changeable. This assures a greatly graded up and more high degree operation for the user.

This unit can be used only by inserting the plug of a connection cable furnished in the unit into the receiver connector.

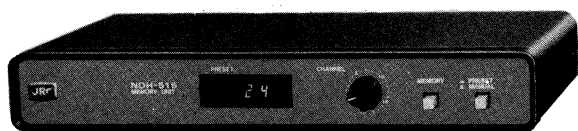

Figure 8-1

Specifications:

- | | |
|-----------------------|---------------------------|
| a. Memory capacity | 24 frequencies |
| b. Channel indication | Numeric display of LED |
| c. Input/output data | BCD code, 22 bits |
| d. Memory write | Possible at any time |
| e. Power source | Supplied from receiver |
| f. Dimensions | 340(W) x 50(H) x 200(D)mm |
| g. Weight | 3.5kg, approx. |

8.2 Speaker NVA-515

This receiver is not provided with any built-in speaker.

The NVA-515 speaker is available for the receiver's exclusive use. It has been finished to match the design of the receiver and provides a clear and soft quality of sound.



Figure 8-2

Specifications

- | | |
|--------------------|----------------------------|
| a. Input impedance | 4 ohms |
| b. Maximum input | 3W, nominal |
| c. Dimensions | 130(W) x 140(H) x 200(D)mm |
| d. Weight | 1kg, approx. |

8.3 Filter CFL-260, 600Hz

Mechanical filter provides a sharp selectivity in the CW signal reception and very effective for rejection of radio interferences.

This filter is operable only by mounting it on the filter PC board and inserting it to the receiver.

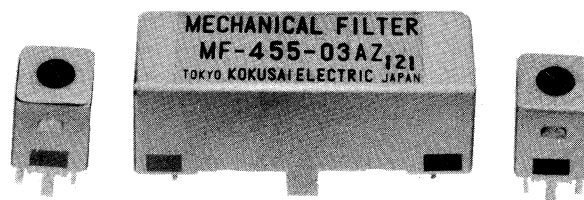

Figure 8-3

Specifications

- | | |
|---------------------------|---|
| a. Input/output impedance | 1 kilohms |
| b. Bandwidth | 6dB; more than 0.5kHz
60dB; less than 3kHz |

NOTE: For mounting, refer to Paragraph 8.5.

8.4 Filter CFL-230, 300Hz

Consisting of a crystal filter having a more sharp selectivity suited for reception of CW signal.

This filter is operable only by mounting it on the filter PC board and inserting it to the receiver unit.



Figure 8-4

Specifications

- a. Input/output impedance 600 ohms, 60pF
- b. Bandwidth 6dB; more than 0.26kHz
60dB; less than 2kHz

NOTE: For mounting, refer to Paragraph 8.5.

8.5 Mounting the Option Filters

The filters CFL-260 and -230 must be mounted in the following manner.

NOTE: Each of these filters has one PC board for mounting the filter.

In the case of using both filters, mount them on either PC board.

8.5.1 Mounting the CFL-260 Filter

Mount both transformers marked P28 and G28 on the PC board at areas marked P28 and G28, and the main body of filter at an area marked CFL-260 so that letters P and G are arranged in the same direction.

Using a soldering iron of about 20W in capacity, skillfully solder the leadwire.

8.5.2 Mounting the CFL-230 Filter

Mount the filter on the PC board at an area marked CFL-230, then clamp nuts set over two screws projecting to the back side, until tight, and solder four leads.

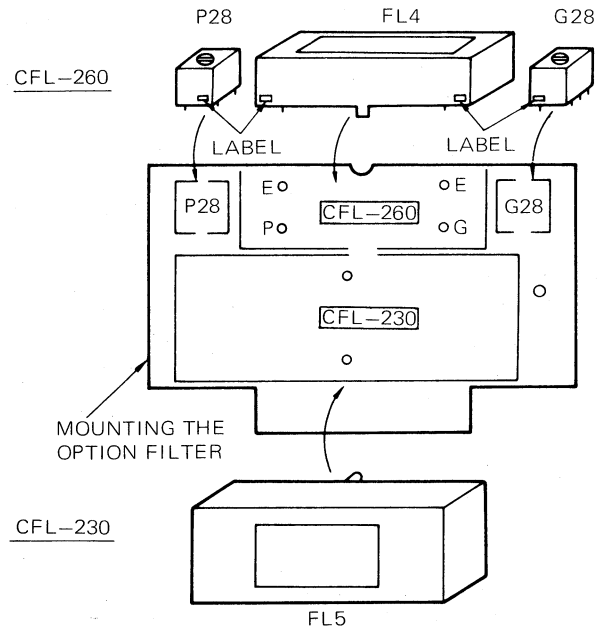

Figure 8-5

8.5.3 Inserting the Filter into Receiver

Insert the PC board with the filter into the receiver unit at a space marked J27 and then clamp one screw to the support for fixing the PC board. This board will be connected with a plug-in connector.

Take care of the position of the PC board upon mounting with the plug-in; circuits elements mounted on the PC board must be located at the front panel side.

Since the filter has been rigorously adjusted and inspected in the factory, there is no necessary for readjustment after mounting.

NOTE: When the CFL-260 filter of 600Hz is used, for set numbers BR20787 through BR20886, both resistors R146 of 100 ohms and R148 of 100 ohms located in the receiver unit must be removed by cutting them, using a nipper. Unless removing them, the filter cannot operate.

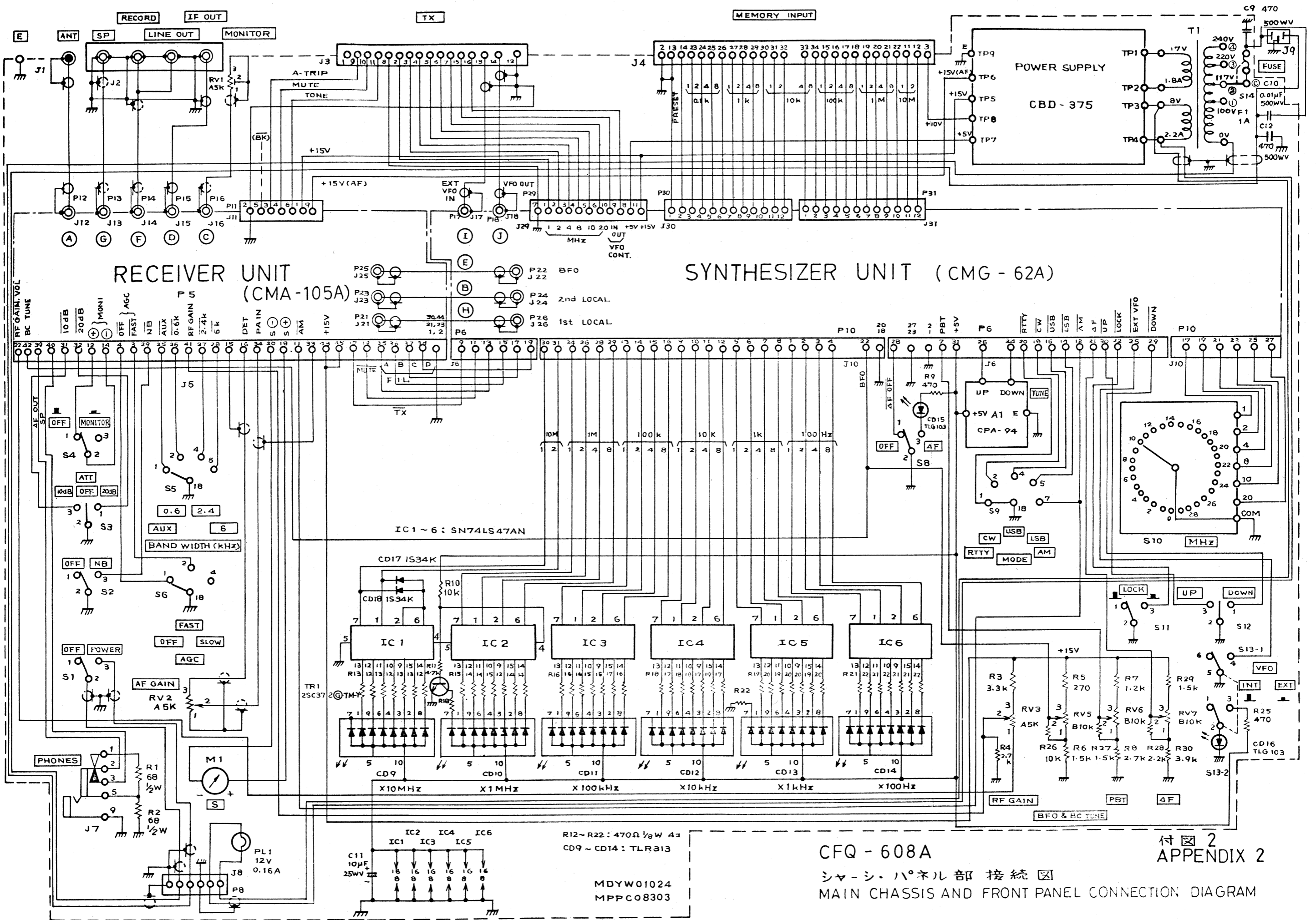

CFQ - 608A

シャーシ・パネル部 接続図
 MAIN CHASSIS AND FRONT PANEL CONNECTION DIAGRAM

付図 2
 APPENDIX 2

注1) 特記外の抵抗は全てΩおよび1/4Wを示し、容量はPFを示す。
 2) ※印は調整用部品を示す。
 NOTES 1. UNLESS OTHERWISE INDICATED RESISTANCES ARE IN OHMS CAPACITANCES ARE IN MICRO-MICRO FARADS.
 2. * VALUES SELECTED IN MANUFACTURE.

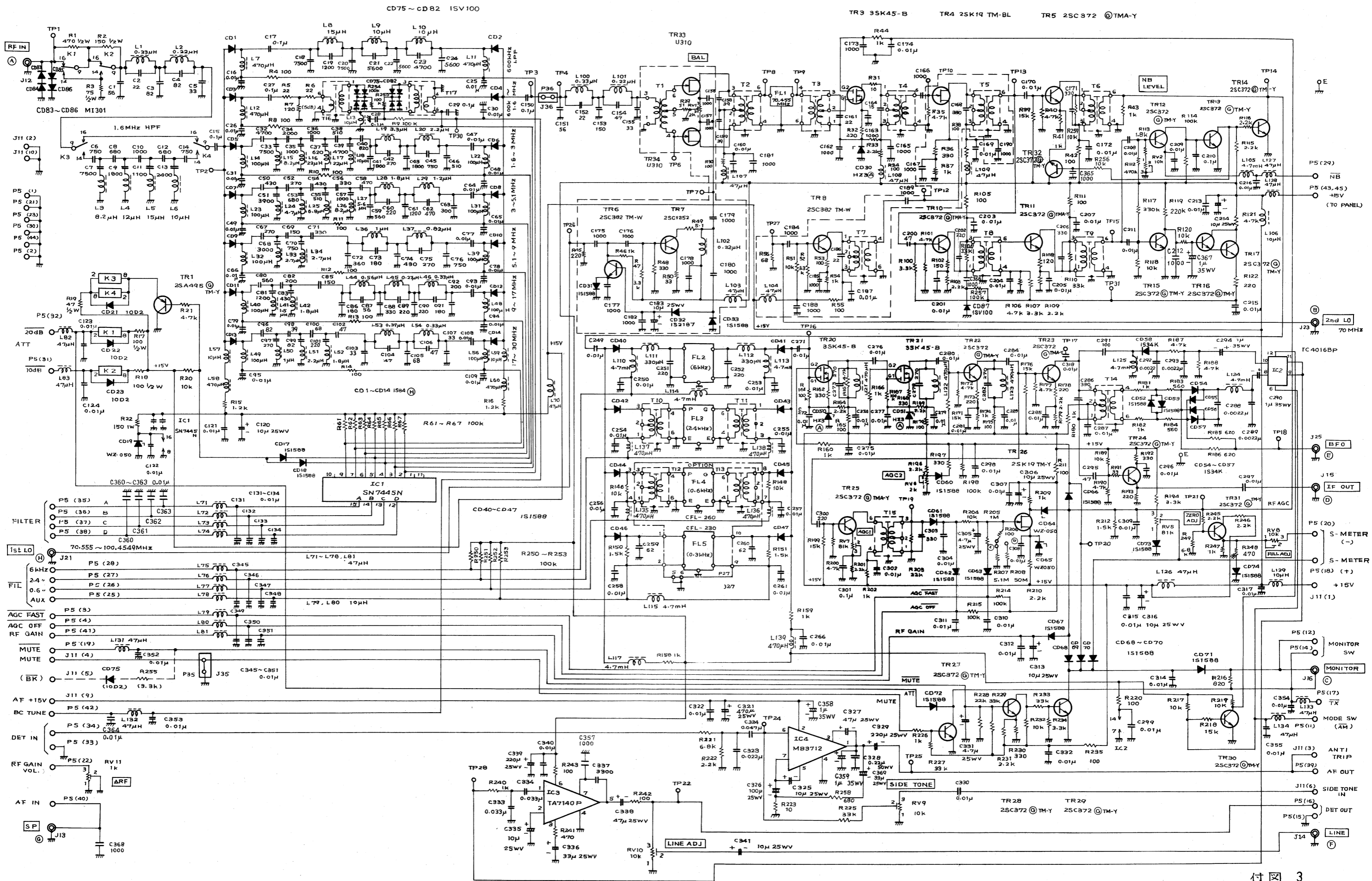

MDMW 00552.C
MPPC 07760.D

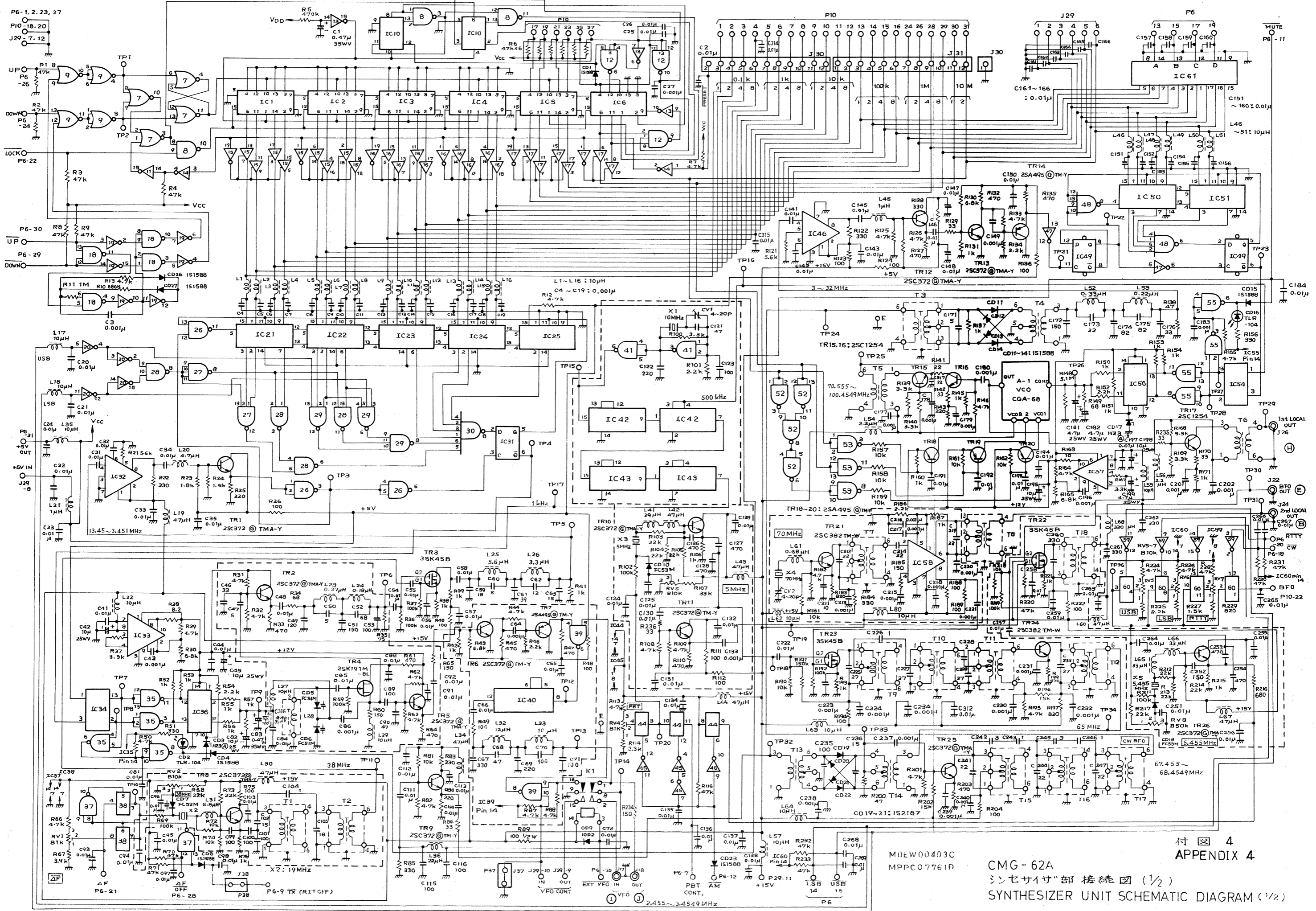

MDEW00403C
MPPC07761P

付図 4
APPENDIX 4
CMG-62A
シセサイサ部接続図 (1/2)
SYNTHESIZER UNIT SCHEMATIC DIAGRAM (1/2)

MC 4044

IC1	TC4010BP	IC36	TC4016BP
IC2	"	IC37	TC4011BP
IC3	"	IC38	TC4016BP
IC4	"	IC39	SN74LS00N
IC5	"	IC40	SN74LS196N
IC6	"	IC41	SN7400N
IC7	TC4001BP	IC42	SN74LS390N
IC8	TC4011BP	IC43	"
IC9	TC4001BP	IC44	TC4016BP
IC10	TC4013BP	IC45	TC4049BP
IC11	TC4049BP	IC46	MC1950P
IC12	TC4023BP	IC47	SN74LS04N
IC13	TC4049BP	IC48	SN74LS20N
IC14	SN74LS04N	IC49	SN74S74N
IC15	SN74LS244N	IC50	SN74LS192N
IC16	"	IC51	"
IC17	"	IC52	SN74LS00N
IC18	TC4011BP	IC53	SN74LS26N
IC19	TC4049BP	IC54	11C44DC
IC20	"	IC55	SN74LS26N
IC21	SN74LS192N	IC56	TC4016BP
IC22	"	IC57	HA723T
IC23	"	IC58	TA7045M
IC24	"	IC59	TC4049BP
IC25	"	IC60	TC4016BP
IC26	SN74LS00N	IC61	MPB426D(2)
IC27	SN74LS10N		
IC28	SN74LS00N		
IC29	SN74LS10N		
IC30	SN74LS00N		
IC31	SN74LS74N		
IC32	MC1950P		
IC33	HA723T		
IC34	11C44DC		
IC35	SN74LS26N		

MC 4044

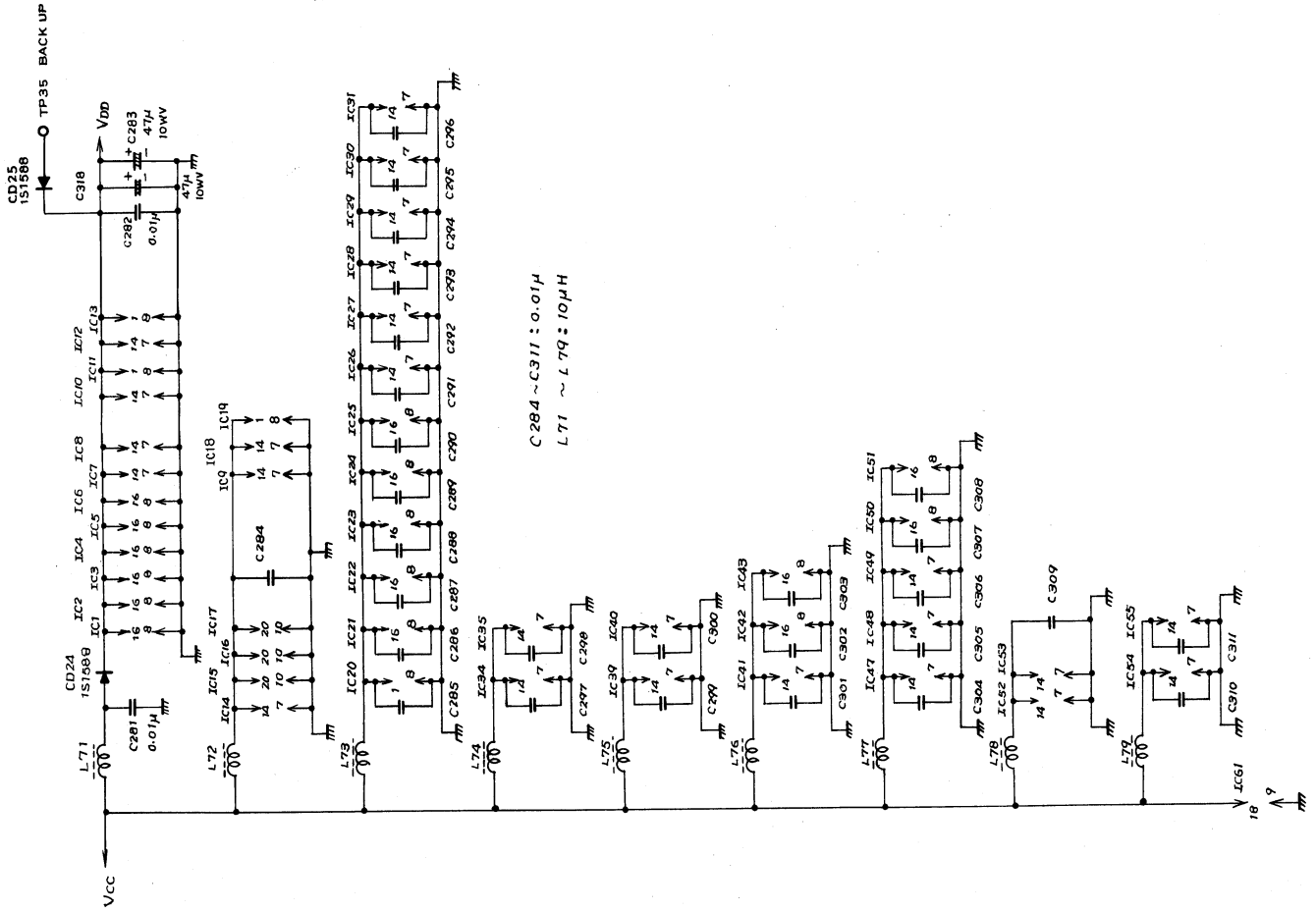

C284 ~ C311 : 0.01μH
L71 ~ L79 : 10μH

付 図 5
APPENDIX 5

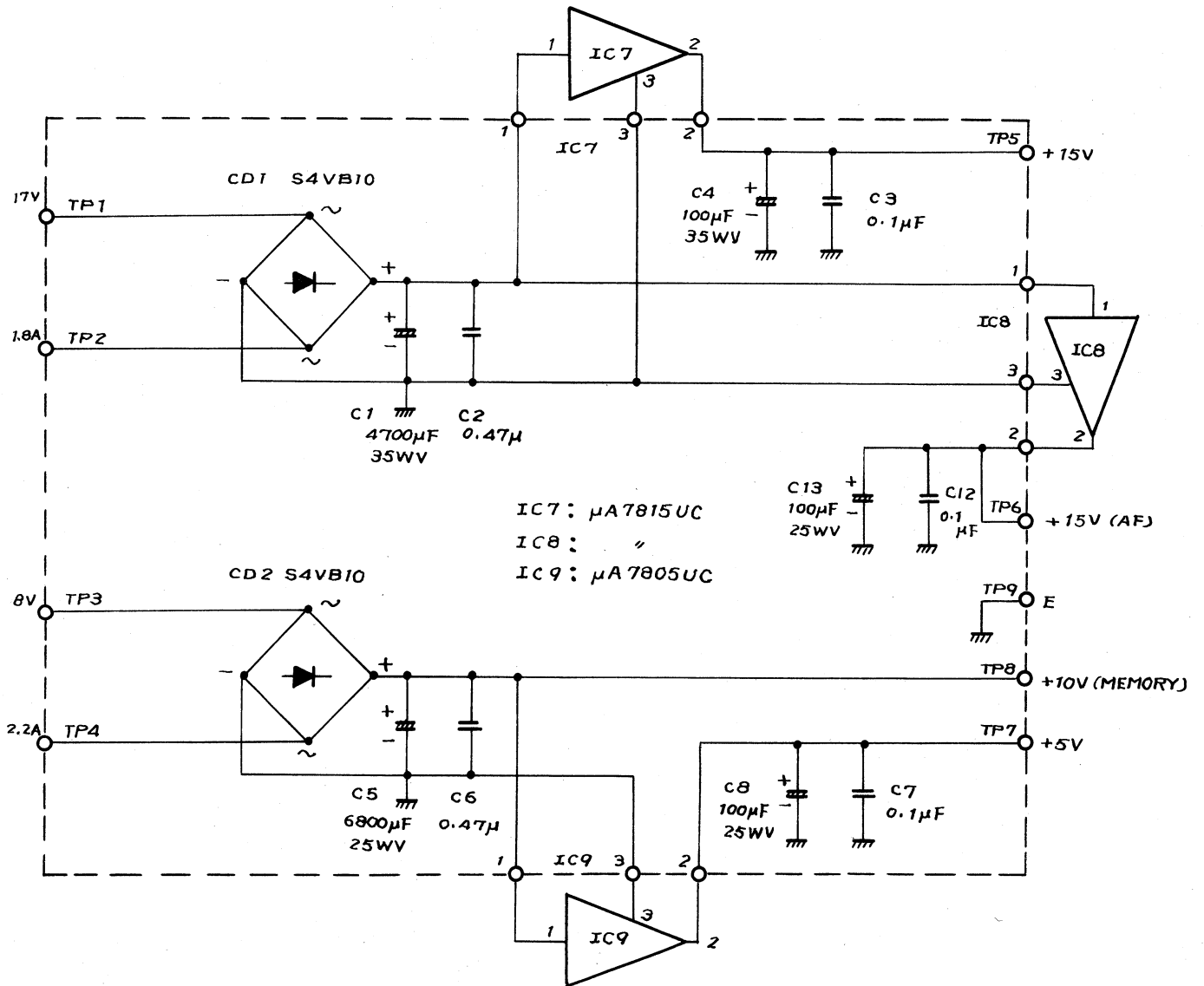

MDBW00795
MPPC07962

付図 6
APPENDIX 6

CBD - 375

電源部接続図

RECTIFIER UNIT SCHEMATIC DIAGRAM

For further information contact:



Since 1915

Japan Radio Co., Ltd.

**HEAD OFFICE &
SALES DEPT.**

1-17-1, Toranomom, Minato, Tokyo.
Telephone : Tokyo(03)591-3451
Telex : 0222-3068 JRCTOK J
Cable Address : "JAPAN RADIO TOKYO"

SALES OFFICE

1-4-28, Dojima Hama, Kita, Osaka.
Telephone : Osaka(06)344-1631
Telex : 0523-6605 JRCOSA J

MAIN FACTORY

5-1-1, Shimorenjaku, Mitaka, Tokyo.
Telephone : Musashino(0422)44-9111
Telex : 0282-2351 JRCMTK J

Printed in ABE '81. 5 (700)

№ 35141